



Programmable Controller

MELSEC iQ-F
series



MELSEC iQ-F



FX5 User's Manual (Analog Control -
CPU module built-in, Expansion adapter)

SAFETY PRECAUTIONS

(Read these precautions before use.)

Before using this product, please read this manual and the relevant manuals introduced in this manual carefully and pay full attention to safety in order to handle the product correctly.

This manual classifies the safety precautions into two categories: [ WARNING] and [ CAUTION].

 WARNING	Indicates that incorrect handling may cause hazardous conditions, resulting in death or severe injury.
 CAUTION	Indicates that incorrect handling may cause hazardous conditions, resulting in minor or moderate injury or property damage.

Depending on the circumstances, procedures indicated by [ CAUTION] may also cause severe injury.

It is important to follow all precautions for personal safety.

Store this manual in a safe place so that it can be read whenever necessary. Always forward it to the end user.

[DESIGN PRECAUTIONS]

WARNING

- Make sure to set up the following safety circuits outside the PLC to ensure safe system operation even during external power supply problems or PLC failure. Otherwise, malfunctions may cause serious accidents.
 - Most importantly, set up the following: an emergency stop circuit, a protection circuit, an interlock circuit for opposite movements (such as normal vs. reverse rotation), and an interlock circuit (to prevent damage to the equipment at the upper and lower positioning limits).
 - Note that when the CPU module detects an error, such as a watchdog timer error, during self-diagnosis, all outputs are turned off. Also, when an error that cannot be detected by the CPU module occurs in an input/output control block, output control may be disabled. External circuits and mechanisms should be designed to ensure safe machinery operation in such a case.
 - Note that the output current of the 24 V DC service power supply varies depending on the model and the absence/presence of extension modules. If an overload occurs, the voltage automatically drops, inputs in the PLC are disabled, and all outputs are turned off. External circuits and mechanisms should be designed to ensure safe machinery operation in such a case.
 - Note that when an error occurs in a relay, transistor or triac of an output circuit, the output might stay on or off. For output signals that may lead to serious accidents, external circuits and mechanisms should be designed to ensure safe machinery operation in such a case.
 - Construct an interlock circuit in the program so that the whole system always operates on the safe side before executing the control (for data change) of the PLC in operation in such a case. Read the manual thoroughly and ensure complete safety before executing other controls (for program change, parameter change, forcible output and operation status change) of the PLC in operation. Otherwise, the machine may be damaged and accidents may occur due to erroneous operations.
 - In an output circuit, when a load current exceeding the current rating or an overcurrent caused by a load short-circuit flows for a long time, it may cause smoke and fire. To prevent this, configure an external safety circuit, such as a fuse.
 - For the operating status of each station after a communication failure of the network, refer to relevant manuals for the network. Incorrect output or malfunction may result in an accident.
-

[DESIGN PRECAUTIONS]

CAUTION

- When an inductive load such as a lamp, heater, or solenoid valve is controlled, a large current (approximately ten times greater than normal) may flow when the output is turned from off to on. Take proper measures so that the flowing current does not exceed the value corresponding to the maximum load specification of the resistance load.
 - After the CPU module is powered on or is reset, the time taken to enter the RUN status varies depending on the system configuration, parameter settings, and/or program size.
Design circuits so that the entire system will always operate safely, regardless of this variation in time.
 - Simultaneously turn on and off the power supplies of the CPU module and extension modules.
 - If a long-time power failure or an abnormal voltage drop occurs, the PLC stops, and output is turned off. When the power supply is restored, it will automatically restart (when the RUN/STOP/RESET switch is on the RUN side).
-

[INSTALLATION PRECAUTIONS]

WARNING

- Make sure to cut off all phases of the power supply externally before attempting installation or wiring work. Failure to do so may cause electric shock or damage to the product.
 - Use the product within the generic environment specifications described in the User's Manual (Hardware) of the CPU module used.
Never use the product in areas with excessive dust, oily smoke, conductive dusts, corrosive gas (salt air, Cl₂, H₂S, SO₂ or NO₂), flammable gas, vibration or impacts, or expose it to high temperature, condensation, or rain and wind.
If the product is used in such conditions, electric shock, fire, malfunctions, deterioration or damage may occur.
-

[INSTALLATION PRECAUTIONS]

CAUTION

- Do not touch the conductive parts of the product directly. Doing so may cause device failures or malfunctions.
 - When drilling screw holes or wiring, make sure that cutting and wiring debris do not enter the ventilation slits of the PLC. Failure to do so may cause fire, equipment failures or malfunctions.
 - For the product supplied together with a dust proof sheet, the sheet should be affixed to the ventilation slits before the installation and wiring work to prevent foreign objects such as cutting and wiring debris.
However, when the installation work is completed, make sure to remove the sheet to provide adequate ventilation. Failure to do so may cause fire, equipment failures or malfunctions.
 - Install the product on a flat surface. If the mounting surface is rough, undue force will be applied to the PC board, thereby causing nonconformities.
 - Install the product securely using a DIN rail or mounting screws.
 - Connect the expansion board and expansion adapter securely to their designated connectors. Loose connections may cause malfunctions.
 - Make sure to affix the expansion board with tapping screws. Tightening torque should follow the specifications in the manual. If the screws are tightened outside of the specified torque range, poor connections may cause malfunctions.
-

CAUTION

- Work carefully when using a screwdriver such as installation of the product. Failure to do so may cause damage to the product or accidents.
 - Connect the extension cables, peripheral device cables, input/output cables and battery connecting cable securely to their designated connectors. Loose connections may cause malfunctions.
 - Turn off the power to the PLC before attaching or detaching the following devices. Failure to do so may cause equipment failures or malfunctions.
 - Peripheral devices, expansion board, expansion adapter, and connector conversion adapter
 - Extension modules, bus conversion module, and connector conversion module
 - Battery
-

[WIRING PRECAUTIONS]

WARNING

- Make sure to cut off all phases of the power supply externally before attempting installation or wiring work. Failure to do so may cause electric shock or damage to the product.
 - Make sure to attach the terminal cover, provided as an accessory, before turning on the power or initiating operation after installation or wiring work. Failure to do so may cause electric shock.
 - The temperature rating of the cable should be 80°C or more.
 - Make sure to wire the screw terminal block in accordance with the following precautions. Failure to do so may cause electric shock, equipment failures, a short-circuit, wire breakage, malfunctions, or damage to the product.
 - The disposal size of the cable end should follow the dimensions described in the manual.
 - Tightening torque should follow the specifications in the manual.
 - Tighten the screws using a Phillips-head screwdriver No. 2 (shaft diameter 6 mm or less). Make sure that the screwdriver does not touch the partition part of the terminal block.
 - Make sure to properly wire to the terminal block (European type) in accordance with the following precautions. Failure to do so may cause electric shock, equipment failures, a short-circuit, wire breakage, malfunctions, or damage to the product.
 - The disposal size of the cable end should follow the dimensions described in the manual.
 - Tightening torque should follow the specifications in the manual.
 - Twist the ends of stranded wires and make sure that there are no loose wires.
 - Do not solder-plate the electric wire ends.
 - Do not connect more than the specified number of wires or electric wires of unspecified size.
 - Affix the electric wires so that neither the terminal block nor the connected parts are directly stressed.
-

[WIRING PRECAUTIONS]

CAUTION

- Do not supply power to the [24+] and [24V] terminals (24 V DC service power supply) on the CPU module or extension modules. Doing so may cause damage to the product.
 - Perform class D grounding (grounding resistance: 100 Ω or less) of the grounding terminal on the CPU module and extension modules with a wire 2 mm² or thicker.
Do not use common grounding with heavy electrical systems (refer to the User's Manual (Hardware) of the CPU module used).
 - Connect the power supply wiring to the dedicated terminals described in this manual. If an AC power supply is connected to a DC input/output terminal or DC power supply terminal, the PLC will burn out.
 - Do not wire vacant terminals externally. Doing so may damage the product.
 - Install module so that excessive force will not be applied to terminal blocks, power connectors, I/O connectors, communication connectors, or communication cables. Failure to do so may result in wire damage/breakage or PLC failure.
 - Make sure to observe the following precautions in order to prevent any damage to the machinery or accidents due to malfunction of the PLC caused by abnormal data written to the PLC due to the effects of noise.
 - Do not bundle the power line, control line and communication cables together with or lay them close to the main circuit, high-voltage line, load line or power line. As a guideline, lay the power line, control line and communication cables at least 100 mm away from the main circuit, high-voltage line, load line or power line.
 - Ground the shield of the shield wire or shielded cable at one point on the PLC. However, do not use common grounding with heavy electrical systems.
 - Ground the shield of the analog input/output cable in accordance with the manuals of each model. However, do not use common grounding with heavy electrical systems.
-

[STARTUP AND MAINTENANCE PRECAUTIONS]

WARNING

- Do not touch any terminal while the PLC's power is on. Doing so may cause electric shock or malfunctions.
 - Before cleaning or retightening terminals, cut off all phases of the power supply externally. Failure to do so in the power ON status may cause electric shock.
 - Before modifying the program in operation, forcible output, running or stopping the PLC, read through this manual carefully, and ensure complete safety. An operation error may damage the machinery or cause accidents.
 - Do not change the program in the PLC from two or more peripheral equipment devices at the same time. (i.e. from an engineering tool and a GOT) Doing so may cause destruction or malfunction of the PLC program.
-

WARNING

- Use the battery for memory backup in conformance to the User's Manual (Hardware) of the CPU module used.
 - Use the battery for the specified purpose only.
 - Connect the battery correctly.
 - Do not charge, disassemble, heat, put in fire, short-circuit, connect reversely, weld, swallow or burn the battery, or apply excessive forces (vibration, impact, drop, etc.) to the battery.
 - Do not store or use the battery at high temperatures or expose to direct sunlight.
 - Do not expose to water, bring near fire or touch liquid leakage or other contents directly.
- Incorrect handling of the battery may cause heat excessive generation, bursting, ignition, liquid leakage or deformation, and lead to injury, fire or failures and malfunction of facilities and other equipment.
-

[STARTUP AND MAINTENANCE PRECAUTIONS]

CAUTION

- Do not disassemble or modify the PLC. Doing so may cause fire, equipment failures, or malfunctions. For repair, contact your local Mitsubishi Electric representative.
 - Turn off the power to the PLC before connecting or disconnecting any extension cable. Failure to do so may cause equipment failures or malfunctions.
 - Turn off the power to the PLC before attaching or detaching the following devices. Failure to do so may cause equipment failures or malfunctions.
 - Peripheral devices, expansion board, expansion adapter, and connector conversion adapter
 - Extension modules, bus conversion module, and connector conversion module
 - Battery
 - Since there are risks such as burn injuries, please do not touch the surface of the equipment with bare hands when it is operating in an environment which exceeds ambient temperature of 50°C.
-

[OPERATION PRECAUTIONS]

CAUTION

- Construct an interlock circuit in the program so that the whole system always operates on the safe side before executing the control (for data change) of the PLC in operation. Read the manual thoroughly and ensure complete safety before executing other controls (for program change, parameter change, forcible output and operation status change) of the PLC in operation. Otherwise, the machine may be damaged and accidents may occur by erroneous operations.
-

[DISPOSAL PRECAUTIONS]

CAUTION

- Please contact a certified electronic waste disposal company for the environmentally safe recycling and disposal of your device.
 - When disposing of batteries, separate them from other waste according to local regulations. (For details of the Battery Directive in EU countries, refer to the User's Manual (Hardware) of the CPU module used.)
-

[TRANSPORTATION PRECAUTIONS]

CAUTION

- When transporting the PLC with the optional battery, turn on the PLC before shipment, confirm that the battery mode is set using a parameter and the BAT LED is OFF, and check the battery life. If the PLC is transported with the BAT LED ON or the battery exhausted, the battery-backed data may be unstable during transportation.
 - The PLC is a precision instrument. During transportation, avoid impacts larger than those specified in the general specifications of the User's Manual (Hardware) of the CPU module by using dedicated packaging boxes and shock-absorbing palettes. Failure to do so may cause failures in the PLC. After transportation, verify operation of the PLC and check for damage of the mounting part, etc.
 - When transporting lithium batteries, follow required transportation regulations. (For details on the regulated products, refer to the User's Manual (Hardware) of the CPU module used.)
 - When fumigants that contain halogen materials such as fluorine, chlorine, bromine, and iodine are used for disinfecting and protecting wooden packaging from insects, they cause malfunction when entering our products. Please take necessary precautions to ensure that remaining materials from fumigant do not enter our products, or treat packaging with methods other than fumigation (heat method). Additionally, disinfect and protect wood from insects before packing products.
-

INTRODUCTION

This manual contains text, diagrams and explanations which will guide the reader in the correct installation, safe use and operation of the FX5 Programmable Controllers and should be read and understood before attempting to install or use the module.

Always forward it to the end user.

Regarding use of this product

- This product has been manufactured as a general-purpose part for general industries, and has not been designed or manufactured to be incorporated in a device or system used in purposes related to human life.
- Before using the product for special purposes such as nuclear power, electric power, aerospace, medicine or passenger movement vehicles, consult Mitsubishi Electric.
- This product has been manufactured under strict quality control. However when installing the product where major accidents or losses could occur if the product fails, install appropriate backup or failsafe functions in the system.

Note

- If in doubt at any stage during the installation of the product, always consult a professional electrical engineer who is qualified and trained in the local and national standards. If in doubt about the operation or use, please consult the nearest Mitsubishi Electric representative.
- Since the examples indicated by this manual, technical bulletin, catalog, etc. are used as a reference, please use it after confirming the function and safety of the equipment and system. Mitsubishi Electric will accept no responsibility for actual use of the product based on these illustrative examples.
- This manual content, specification etc. may be changed without a notice for improvement.
- The information in this manual has been carefully checked and is believed to be accurate; however, if you notice a doubtful point, an error, etc., please contact the nearest Mitsubishi Electric representative. When doing so, please provide the manual number given at the end of this manual.

CONTENTS

SAFETY PRECAUTIONS	1
INTRODUCTION	7
RELEVANT MANUALS	20
TERMS	21
CHAPTER 1 OUTLINE	23
CHAPTER 2 FX5-4AD-ADP	24
2.1 Specifications	24
Generic specifications	24
Power supply specifications	24
Performance specifications	25
Input conversion characteristics	26
Accuracy	29
2.2 List of functions.	30
2.3 Functions	31
Processing of Each Function	31
Range Switching Function	32
A/D Conversion Enable/Disable Setting Function	33
A/D Conversion Method	33
Over Scale Detection Function	35
Scaling Function	37
Shift Function	40
Digital Clipping Function	41
Maximum Value/Minimum Value Hold Function	42
Warning Output Function	43
Disconnection Detection Function	48
Convergence Detection Function	50
Deviation Detection Between Channel Function	51
Event History Function	52
Offset/gain Setting Function	53
Offset/gain Initialization Function	56
Common Function	57
2.4 Procedure to Execute the FX5-4AD-ADP	58
2.5 System Configuration	59
2.6 Wiring	60
European-type terminal block	60
Terminal layout	61
Analog input wiring	61
Grounding	61
2.7 Parameter Setting	62
Basic settings	62
Application settings	63
2.8 Troubleshooting	65
Troubleshooting with the LEDs	65
Checking the state of the module	65
Troubleshooting by Symptom	66
2.9 List of Error Code	67

2.10	List of Alarm Code	69
2.11	List of Special Relays	70
2.12	Detail of Special Relays	74
	A/D conversion completed flag	74
	A/D conversion enable/disable setting	74
	Over scale upper limit detection flag	74
	Over scale lower limit detection flag	75
	Over scale detection enable/disable setting	75
	Maximum value/minimum value reset completed flag	75
	Maximum value reset request	76
	Minimum value reset request	76
	Scaling enable/disable setting	76
	Digital clipping enable/disable setting	77
	Warning output flag (process alarm upper limit)	77
	Warning output flag (process alarm lower limit)	77
	Warning output setting (process alarm)	78
	Warning output flag (rate alarm upper)	78
	Warning output flag (rate alarm lower)	78
	Warning output setting (rate alarm)	79
	Disconnection detection flag	79
	Disconnection detection enable/disable setting	79
	Disconnection recovery detection enable/disable setting	80
	Convergence detection flag	80
	Convergence detection enable/disable setting	80
	Deviation detection flag between channel	81
	Deviation detection trigger between channel	81
	Offset/gain reading	81
	Offset/gain writing	82
	Offset/gain initialization	82
	A/D conversion alarm clear request	82
	A/D conversion alarm flag	83
	A/D conversion error flag	83
2.13	List of Special Registers	84
2.14	Detail of Special Registers	88
	Module Information	88
	Digital output value	88
	Digital operation value	88
	Analog input value monitor	89
	Average processing specify	89
	Time Average/Count Average/Moving Average setting	90
	Input range setting	90
	Maximum value	91
	Minimum value	91
	Scaling upper limit value	91
	Scaling lower limit value	92
	Conversion value shift amount	92
	Process alarm upper upper limit value	92
	Process alarm upper lower limit value	93
	Process alarm lower upper limit value	93
	Process alarm lower lower limit value	94
	Rate alarm upper limit value	94

Rate alarm lower limit value	95
Rate alarm warning detection period setting	95
Convergence detection upper limit value	96
Convergence detection lower limit value	96
Detection time setting for convergence detection	97
Deviation detection CH1	97
Deviation detection CH2	98
Deviation value for deviation detection between channel	98
CH setting 1 for deviation detection between channel	99
CH setting 2 for deviation detection between channel	99
Offset setting value	100
Gain setting value	100
Offset/gain writing enable code	100
A/D conversion latest alarm code	101
A/D conversion latest error code	101

CHAPTER 3 FX5-4AD-PT-ADP 102

3.1 Specifications	102
Generic specifications	102
Power supply specifications	102
Performance specifications	103
Accuracy	103
3.2 List of functions.	104
3.3 Functions	105
Processing of Each Function	105
Temperature Unit Choice Function	106
Conversion Enable/Disable Setting Function	106
Temperature Conversion Method	107
Temperature Resistance Choice Function	109
Disconnection Detection Function	110
Alarm Output Function	112
Event History Function	117
Offset/gain Setting Function	118
Offset/gain Initialization Function	122
Maximum Value/Minimum Value Hold Function	123
Common Function	123
3.4 Procedure to Execute the FX5-4AD-PT-ADP.	125
3.5 System Configuration	126
3.6 Wiring	127
European-type terminal block	127
Terminal layout	128
Wiring of resistance temperature detector	128
Grounding	128
3.7 Parameter Setting	129
Basic settings	129
Application settings	130
3.8 Troubleshooting	131
Troubleshooting with the LEDs	131
Checking the state of the module	131
Troubleshooting by Symptom	133

3.9	List of Error Code	134
3.10	List of Alarm Code	135
3.11	List of Special Relays	136
3.12	Detail of Special Relays	140
	Temperature unit selection	140
	Conversion completed flag	140
	Conversion enable/disable setting	140
	Maximum value/minimum value reset completed flag	141
	Maximum value reset request	141
	Minimum value reset request	142
	Warning output flag (process alarm upper limit)	142
	Warning output flag (process alarm lower limit)	142
	Warning output setting (Process alarm)	143
	Warning output flag (rate alarm upper limit)	143
	Warning output flag (rate alarm lower limit)	143
	Warning output setting (rate alarm)	144
	Disconnection detection flag	144
	Disconnection detection enable/disable setting	144
	Disconnection detection automatic clear enable/disable setting	145
	Offset/gain setting flag	145
	Read offset/gain	145
	Write offset/gain	146
	Initialize offset/gain	146
	Conversion alarm clear request	146
	Conversion alarm flag	147
	Conversion error flag	147
3.13	List of Special Registers	148
3.14	Detail of Special Registers	152
	Module Information	152
	Measured temperature value	152
	Average processing setting	153
	Time average/count average/moving average	153
	Setting RTD type	154
	Maximum value	154
	Minimum value	154
	Process alarm upper upper limit value	155
	Process alarm upper lower limit value	155
	Process alarm lower upper limit value	156
	Process alarm lower lower limit value	156
	Rate alarm upper limit value	157
	Rate alarm lower limit value	157
	Rate alarm detection cycle setting	158
	Conversion setting for disconnection detection	158
	Conversion setting value for disconnection detection	159
	Offset temperature setting value	159
	Gain temperature setting value	160
	Offset/gain code	160
	Resistance offset value	161
	Resistance gain value	161
	Input offset value	161
	Input gain value	162

Conversion latest alarm code	162
Conversion latest error code	163

CHAPTER 4 FX5-4AD-TC-ADP 164

4.1 Specifications	164
Generic specifications	164
Power supply specifications	164
Performance specifications	165
Accuracy	165
4.2 List of functions.	166
4.3 Functions	167
Processing of Each Function	167
Temperature Unit Choice Function	168
Conversion Enable/Disable Setting Function	168
Temperature Conversion Method	169
Thermocouple Type Choice Function	171
Disconnection Detection Function	172
Alarm Output Function	174
Event History Function	179
Offset/gain Setting Function	180
Offset/gain Initialization Function	184
Maximum Value/Minimum Value Hold Function	185
Common Function	185
4.4 Procedure to Execute the FX5-4AD-TC-ADP	187
4.5 System Configuration	188
4.6 Wiring	189
European-type terminal block	189
Terminal layout	190
Selection of the thermocouple	190
Wiring of thermocouple	190
Grounding	191
4.7 Parameter Setting	192
Basic settings	192
Application settings	193
4.8 Troubleshooting	194
Troubleshooting with the LEDs	194
Checking the state of the module	194
Troubleshooting by Symptom	196
4.9 List of Error Code	197
4.10 List of Alarm Code	198
4.11 List of Special Relays	199
4.12 Detail of Special Relays	203
Temperature unit selection	203
Conversion completed flag	203
Conversion enable/disable setting	203
Maximum value/minimum value reset completed flag	204
Maximum value reset request	204
Minimum value reset request	205
Warning output flag (process alarm upper limit)	205
Warning output flag (process alarm lower limit)	205

Warning output setting (process alarm)	206
Warning output flag (rate alarm upper limit)	206
Warning output flag (rate alarm lower limit)	206
Warning output setting (rate alarm)	207
Disconnection detection flag	207
Disconnection detection enable/disable setting	207
Disconnection detection automatic clear enable/disable setting	208
Offset/gain setting flag	208
Read offset/gain	208
Write offset/gain	209
Initialize offset/gain	209
Conversion alarm clear request	209
Conversion alarm flag	210
Conversion error flag	210
4.13 List of Special Registers	211
4.14 Detail of Special Registers	215
Module Information	215
Measured temperature value	215
Average processing setting	216
Time average/count average/moving average	216
Setting thermocouple type	217
Maximum value	217
Minimum value	218
Process alarm upper upper limit value	218
Process alarm upper lower limit value	219
Process alarm lower upper limit value	219
Process alarm lower lower limit value	220
Rate alarm upper limit value	220
Rate alarm lower limit value	221
Rate alarm detection cycle setting	221
Conversion setting for disconnection detection	222
Conversion setting value for disconnection detection	223
Offset temperature setting value	223
Gain temperature setting value	224
Offset/gain code	224
Thermal EMF offset value	225
Thermal EMF gain value	225
Input offset value	226
Input gain value	226
Conversion latest alarm code	227
Conversion latest error code	227

CHAPTER 5 FX5-4DA-ADP 228

5.1 Specifications	228
Generic specifications	228
Power supply specifications	228
Performance specifications	229
Output conversion characteristics	230
Accuracy	233
5.2 List of functions	233

5.3	Functions	234
	Processing of Each Function	234
	Range Switching Function	235
	D/A Conversion Enable/Disable Function	236
	D/A Output Enable/Disable Setting Function	236
	Analog Output HOLD/CLEAR Function	237
	Analog Output Test when CPU Module is in STOP Status Function	238
	Scaling Function	239
	Shift Function	241
	Warning Output Function	242
	External Power Supply Disconnection Detection Function	243
	Disconnection Detection Function	243
	Event History Function	245
	Offset/gain Setting Function	245
	Offset/gain Initialization Function	250
	Common Function	251
5.4	Procedure to Execute the FX5-4DA-ADP	252
5.5	System Configuration	253
5.6	Wiring	254
	European-type terminal block	254
	Terminal layout	255
	Power supply wiring	256
	Analog output wiring	257
	Grounding	257
5.7	Parameter Setting	258
	Basic settings	258
	Application settings	259
5.8	Troubleshooting	260
	Troubleshooting with the LEDs	260
	Checking the state of the module	260
	Troubleshooting by Symptom	261
5.9	List of Error Code	263
5.10	List of Alarm Code	264
5.11	List of Special Relays	265
5.12	Detail of Special Relays	267
	D/A conversion enable/disable setting	267
	D/A output enable/disable setting	267
	Scaling enable/disable setting	268
	Warning output upper limit value flag	268
	Warning output lower limit value flag	268
	Warning output setting	269
	Disconnection detection flag	269
	Disconnection detection enable/disable setting	269
	Disconnection recovery detection enable/disable setting	270
	Offset/gain reading	270
	Offset/gain writing	270
	Offset/gain initialization	271
	D/A conversion alarm clear request	271
	D/A conversion alarm flag	271
	D/A conversion error flag	272
5.13	List of Special Registers	273

5.14	Detail of Special Registers	275
	Module Information	275
	Digital value	275
	Digital operation value	276
	Analog output value monitor	276
	HOLD/CLEAR function setting	276
	HOLD setting value	277
	Output range setting	277
	Scaling upper limit value	277
	Scaling lower limit value	278
	Input value shift amount	278
	Warning output upper limit value	278
	Warning output lower limit value	279
	Offset setting value	279
	Gain setting value	279
	Offset/gain writing enable code	280
	D/A conversion latest alarm code	280
	D/A conversion latest error code	280

CHAPTER 6 FX5-4A-ADP **281**

6.1	Specifications	281
	Generic specifications	281
	Power supply specifications	281
	Performance specifications	281
	Input conversion characteristics	283
	Output conversion characteristics	286
	Accuracy	289
6.2	List of functions.	290
	A/D conversion function	290
	D/A conversion function	291
	Common function	291
6.3	A/D Conversion Function	292
	Processing of Each Function	292
	Range Switching Function	293
	A/D Conversion Enable/Disable Setting Function	294
	A/D Conversion Method	295
	Over Scale Detection Function	297
	Scaling Function	299
	Shift Function	302
	Digital Clipping Function	303
	Maximum Value/Minimum Value Hold Function	304
	Warning Output Function	305
	Disconnection Detection Function	310
	Convergence Detection Function	312
	Deviation Detection Between Channel Function	313
	Offset/gain Setting Function	314
	Offset/gain Initialization Function	319
6.4	D/A Conversion Function	320
	Processing of Each Function	320
	Range Switching Function	321

	D/A Conversion Enable/Disable Function	322
	D/A Output Enable/Disable Setting Function	322
	Analog Output HOLD/CLEAR Function	323
	Analog Output Test when CPU Module is in STOP Status Function	324
	Scaling Function	325
	Shift Function	327
	Warning Output Function	328
	External Power Supply Disconnection Detection Function	329
	Disconnection Detection Function	330
	Offset/gain Setting Function	332
	Offset/gain Initialization Function	337
6.5	Common Function	338
	Event History Function	338
	Changing the setting value while the CPU module is operating	338
	Starting/stopping the analog function in accordance with the CPU module status	339
	Alarm clear request	340
6.6	Procedure to Execute the FX5-4A-ADP	341
6.7	System Configuration	342
6.8	Wiring	343
	European-type terminal block	343
	Terminal layout	344
	Power supply wiring	344
	Analog input/output wiring	345
	Grounding	346
6.9	Parameter Setting	347
	Basic settings (Input)	348
	Application settings (Input)	349
	Basic settings (Output)	351
	Application settings (Output)	352
6.10	Troubleshooting	353
	Troubleshooting with the LEDs	353
	Checking the state of the module	353
	Troubleshooting by Symptom	355
6.11	List of Error Code	358
	A/D conversion error code	358
	D/A conversion error code	359
6.12	List of Alarm Code	360
	A/D conversion alarm code	360
	D/A conversion alarm code	361
6.13	List of A/D Conversion Special Relays	362
6.14	Detail of A/D Conversion Special Relays	366
	A/D conversion completed flag	366
	A/D conversion enable/disable setting	366
	Over scale upper limit detection flag	366
	Over scale lower limit detection flag	367
	Over scale detection enable/disable setting	367
	Maximum value/minimum value reset completed flag	367
	Maximum value reset request	368
	Minimum value reset request	368
	Scaling enable/disable setting	368
	Digital clipping enable/disable setting	369

Warning output flag (process alarm upper limit)	369
Warning output flag (process alarm lower limit)	369
Warning output setting (process alarm)	370
Warning output flag (rate alarm upper)	370
Warning output flag (rate alarm lower)	370
Warning output setting (rate alarm)	371
Disconnection detection flag	371
Disconnection detection enable/disable setting	371
Disconnection recovery detection enable/disable setting	372
Convergence detection flag	372
Convergence detection enable/disable setting	372
Deviation detection flag between channel	373
Deviation detection trigger between channel	373
Offset/gain reading	373
Offset/gain writing	374
Offset/gain initialization	374
A/D conversion alarm clear request	374
A/D conversion alarm flag	375
A/D conversion error flag	375
6.15 List of A/D Conversion Special Registers	376
6.16 Detail of A/D Conversion Special Registers	380
Module Information	380
Digital output value	380
Digital operation value	380
Analog input value monitor	381
Average processing specify	381
Time Average/Count Average/Moving Average setting	382
Input range setting	382
Maximum value	383
Minimum value	383
Scaling upper limit value	383
Scaling lower limit value	384
Conversion value shift amount	384
Process alarm upper upper limit value	384
Process alarm upper lower limit value	385
Process alarm lower upper limit value	385
Process alarm lower lower limit value	386
Rate alarm upper limit value	386
Rate alarm lower limit value	387
Rate alarm warning detection period setting	387
Convergence detection upper limit value	388
Convergence detection lower limit value	388
Detection time setting for convergence detection	389
Deviation detection CH1	389
Deviation detection CH2	390
Deviation value for deviation detection between channel	390
CH setting 1 for deviation detection between channel	391
CH setting 2 for deviation detection between channel	391
Offset setting value	392
Gain setting value	392
Offset/gain writing enable code	392

	A/D conversion latest alarm code	393
	A/D conversion latest error code	393
6.17	List of D/A Conversion Special Relays	394
6.18	Detail of D/A Conversion Special Relays	396
	D/A conversion enable/disable setting	396
	D/A output enable/disable setting	396
	Scaling enable/disable setting	397
	Warning output upper limit value flag	397
	Warning output lower limit value flag	397
	Warning output setting	398
	Disconnection detection flag	398
	Disconnection detection enable/disable setting	398
	Disconnection recovery detection enable/disable setting	399
	Offset/gain reading	399
	Offset/gain writing	399
	Offset/gain initialization	400
	D/A conversion alarm clear request	400
	D/A conversion alarm flag	400
	D/A conversion error flag	401
6.19	List of D/A Conversion Special Registers	402
6.20	Detail of D/A Conversion Special Registers	404
	Digital value	404
	Digital operation value	404
	Analog output value monitor	405
	HOLD/CLEAR function setting	405
	HOLD setting value	405
	Output range setting	406
	Scaling upper limit value	406
	Scaling lower limit value	406
	Input value shift amount	407
	Warning output upper limit value	407
	Warning output lower limit value	407
	Offset setting value	408
	Gain setting value	408
	Offset/gain writing enable code	408
	D/A conversion latest alarm code	409
	D/A conversion latest error code	409

CHAPTER 7 FX5U CPU MODULE BUILT-IN ANALOG 410

7.1	Specifications	410
	Generic specifications	410
	Performance specifications	410
	Accuracy	411
7.2	List of functions.	412
7.3	Functions (Analog input)	412
	Processing of each function	413
	A/D Conversion Enable/Disable Setting Function	414
	A/D Conversion Method	414
	Over Scale Detection Function	416
	Scaling Function	417

Shift Function	418
Digital Clipping Function	419
Maximum Value/Minimum Value Hold Function	419
Warning Output Function	420
Event History Function	421
7.4 Functions (Analog output)	422
Processing of each function	422
D/A Conversion Enable/Disable Function	423
D/A Output Enable/Disable Setting Function	423
Analog Output HOLD/CLEAR Function	424
Analog Output Test when CPU Module is in STOP Status Function	425
Scaling Function	426
Shift Function	427
Warning Output Function	427
Event History Function	429
7.5 Procedure to Execute the Built-in Analog Function	429
7.6 Wiring	430
European-type terminal block	430
Terminal layout	431
Analog input wiring	431
Analog output wiring	431
Grounding	431
7.7 Parameter Setting	432
Basic settings (Analog input)	432
Application setting (Analog input)	433
Basic settings (Analog output)	434
Application setting (Analog output)	435
7.8 List of Error Code	436
7.9 List of Alarm Code	437
7.10 List of Special Relays	438
Special relays for analog input	438
Special relays for analog output	438
7.11 List of Special Registers	439
Special registers for analog input	439
Special registers for analog output	439
7.12 How to use analog inputs built in CPU module for current inputs	440
APPENDIX	441
<hr/>	
Appendix 1 Added and Enhanced Functions	441
INDEX	442
<hr/>	
REVISIONS	444
WARRANTY	445
TRADEMARKS	446

RELEVANT MANUALS

Manual name <manual number>	Description
MELSEC iQ-F FX5 User's Manual (Startup) <JY997D58201>	Describes the performance specifications, procedures before operation, and troubleshooting of the FX5 CPU module.
MELSEC iQ-F FX5UJ User's Manual (Hardware) <SH-082206ENG>	Describes the details of hardware of the FX5UJ CPU module, including input/output specifications, wiring, installation, and maintenance.
MELSEC iQ-F FX5U User's Manual (Hardware) <JY997D55301>	Describes the details of hardware of the FX5U CPU module, including input/output specifications, wiring, installation, and maintenance.
MELSEC iQ-F FX5UC User's Manual (Hardware) <JY997D61401>	Describes the details of hardware of the FX5UC CPU module, including input/output specifications, wiring, installation, and maintenance.
MELSEC iQ-F FX5 User's Manual (Application) <JY997D55401>	Describes the basic knowledge required for program design, functions of the CPU module, devices/labels, and parameters.
MELSEC iQ-F FX5 Programming Manual (Program Design) <JY997D55701>	Describes the specifications of ladder, ST, FBD/LD, and SFC programs, and labels.
MELSEC iQ-F FX5 Programming Manual (Instructions, Standard Functions/Function Blocks) <JY997D55801>	Describes the specifications of instructions and functions that can be used in programs.
MELSEC iQ-F FX5 User's Manual (Serial Communication) <JY997D55901>	Describes the N:N network, Parallel link, MELSEC Communication protocol, inverter communication, non-protocol communication, and predefined protocol support.
MELSEC iQ-F FX5 User's Manual (MELSEC Communication Protocol) <JY997D60801>	Explains methods for the device that is communicating with the CPU module by MC protocol to read and write the data of the CPU module.
MELSEC iQ-F FX5 User's Manual (MODBUS Communication) <JY997D56101>	Describes the MODBUS serial communication and MODBUS/TCP communication.
MELSEC iQ-F FX5 User's Manual (PROFIBUS) <SH-081910ENG>	Describes the PROFIBUS-DP master module.
MELSEC iQ-F FX5 User's Manual (Ethernet Communication) <JY997D56201>	Describes the Ethernet communication function of the CPU module built-in and the Ethernet module.
MELSEC iQ-F FX5-ENET User's Manual <SH-082026ENG>	Describes the FX5-ENET.
MELSEC iQ-F FX5-ENET/IP User's Manual <SH-082027ENG>	Describes the FX5-ENET/IP.
MELSEC iQ-F FX5 User's Manual (BACnet) <SH-082218ENG>	BACnet functions of the Ethernet module.
MELSEC iQ-F FX5 User's Manual (SLMP) <JY997D56001>	Explains methods for the device that is communicating with the CPU module by SLMP to read and write the data of the CPU module.
MELSEC iQ-F FX5 User's Manual (CC-Link IE TSN) <SH-082215ENG>	Describes the CC-Link IE TSN module.
MELSEC iQ-F FX5 User's Manual (CC-Link IE) <JY997D64201>	Describes the CC-Link IE field network module.
MELSEC iQ-F FX5 User's Manual (CC-Link) <SH-081793ENG>	Describes the CC-Link system master/intelligent device module.
MELSEC iQ-F FX5 User's Manual (AnyWireASLINK) <SH-081796ENG>	Describes the AnyWireASLINK system master module.
MELSEC iQ-F FX5 User's Manual (Positioning Control - CPU module built-in, High-speed pulse input/output module) <JY997D56301>	Describes the positioning function of the CPU module built-in and the high-speed pulse input/output module.
MELSEC iQ-F FX5 User's Manual (Positioning Control - Intelligent function module) <SH-081805ENG>	Describes the positioning module.
MELSEC iQ-F FX5 Motion Module/Simple Motion Module User's Manual (Startup) <IB0300251>	Describes the specifications, procedures before operation, system configuration, wiring, and operation examples of the Motion module/Simple Motion module.
MELSEC iQ-F FX5 Motion Module/Simple Motion Module User's Manual (Application) <IB0300253>	Describes the functions, input/output signals, buffer memories, parameter settings, programming, and troubleshooting of the Motion module/Simple Motion module.
MELSEC iQ-F FX5 Motion Module/Simple Motion Module User's Manual (Advanced Synchronous Control) <IB0300255>	Describes the functions and programming for the synchronous control of the Motion module/Simple Motion module.
MELSEC iQ-F FX5 Motion Module User's Manual (CC-Link IE TSN) <IB0300568>	Describes the functions, parameter settings, troubleshooting, and buffer memories of the CC-Link IE TSN network.

Manual name <manual number>	Description
MELSEC iQ-F FX5 User's Manual (Analog Control - CPU module built-in, Expansion adapter) <JY997D60501> (This manual)	Describes the analog function of the CPU module built-in and the analog adapter.
MELSEC iQ-F FX5 User's Manual (Analog Control - Intelligent function module) <SH-081802ENG>	Describes the analog input module, analog output module, and multiple input module.
MELSEC iQ-F FX5 User's Manual (Temperature Control) <SH-081799ENG>	Describes the temperature control module.
MELSEC iQ-F FX5 User's Manual (Safety Control) <SH-082078ENG>	Describes the safety extension modules.
GX Works3 Operating Manual <SH-081215ENG>	Describes the system configuration, parameter settings, and online operations of GX Works3.
Transition from MELSEC FX3G, FX3U, FX3UC Series to MELSEC iQ-F Series Handbook <JY997D66201>	Describes the transition from MELSEC FX3G/FX3U/FX3UC series to MELSEC iQ-F series.

TERMS

Unless otherwise specified, this manual uses the following terms.

For details on the FX3 devices that can be connected with the FX5, refer to the User's Manual (Hardware) of the CPU module to be used.

Terms	Description
■Devices	
FX5	Generic term for FX5UJ, FX5U and FX5UC PLCs
FX3	Generic term for FX3S, FX3G, FX3GC, FX3U, and FX3UC PLCs
FX5 CPU module	Generic term for FX5UJ CPU module, FX5U CPU module and FX5UC CPU module
FX5UJ CPU module	Generic term for FX5UJ-24MR/ES, FX5UJ-24MT/ES, FX5UJ-24MT/ESS, FX5UJ-40MR/ES, FX5UJ-40MT/ES, FX5UJ-40MT/ESS, FX5UJ-60MR/ES, FX5UJ-60MT/ES, and FX5UJ-60MT/ESS
FX5U CPU module	Generic term for FX5U-32MR/ES, FX5U-32MT/ES, FX5U-32MT/ESS, FX5U-64MR/ES, FX5U-64MT/ES, FX5U-64MT/ESS, FX5U-80MR/ES, FX5U-80MT/ES, FX5U-80MT/ESS, FX5U-32MR/DS, FX5U-32MT/DS, FX5U-32MT/DSS, FX5U-64MR/DS, FX5U-64MT/DS, FX5U-64MT/DSS, FX5U-80MR/DS, FX5U-80MT/DS, and FX5U-80MT/DSS
FX5UC CPU module	Generic term for FX5UC-32MT/D, FX5UC-32MT/DSS, FX5UC-64MT/D, FX5UC-64MT/DSS, FX5UC-96MT/D, FX5UC-96MT/DSS, FX5UC-32MT/DS-TS, FX5UC-32MT/DSS-TS, and FX5UC-32MR/DS-TS
Extension module	Generic term for FX5 extension modules, FX3 function modules, Extension modules (extension cable type) and Extension module (extension connector type)
FX5 extension module	Generic term for I/O modules, FX5 extension power supply modules, FX5 intelligent function modules, and FX5 safety extension modules
FX3 extension module	Generic term for FX3 extension power supply module and FX3 intelligent function module
Extension module (extension cable type)	Generic term for Input modules (extension cable type), Output modules (extension cable type), Input/output modules (extension cable type), Powered input/output module, High-speed pulse input/output module, Extension power supply module (extension cable type), Connector conversion module (extension cable type), Intelligent function modules, Safety extension modules, and Bus conversion module (extension cable type)
Extension module (extension connector type)	Generic term for Input modules (extension connector type), Output modules (extension connector type), Input/output modules (extension connector type), Extension power supply module (extension connector type), Connector conversion module (extension connector type), and Bus conversion module (extension connector type)
I/O module	Generic term for Input modules, Output modules, Input/output modules, Powered input/output modules, and High-speed pulse input/output modules
Input module	Generic term for Input modules (extension cable type) and Input modules (extension connector type)
Input module (extension cable type)	Generic term for FX5-8EX/ES and FX5-16EX/ES
Input module (extension connector type)	Generic term for FX5-C16EX/D, FX5-C16EX/DS, FX5-C32EX/D, FX5-C32EX/DS, and FX5-C32EX/DS-TS
Output module	Generic term for Output modules (extension cable type) and Output modules (extension connector type)
Output module (extension cable type)	Generic term for FX5-8EYR/ES, FX5-8EYT/ES, FX5-8EYT/ESS, FX5-16EYR/ES, FX5-16EYT/ES, and FX5-16EYT/ESS
Output module (extension connector type)	Generic term for FX5-C16EYT/D, FX5-C16EYT/DSS, FX5-C16EYR/D-TS, FX5-C32EYT/D, FX5-C32EYT/DSS, FX5-C32EYT/D-TS, and FX5-C32EYT/DSS-TS
Input/output module	Generic term for Input/output modules (extension cable type) and Input/output modules (extension connector type)
Input/output module (extension cable type)	Generic term for FX5-16ER/ES, FX5-16ET/ES, and FX5-16ET/ESS

Terms	Description
Input/output module (extension connector type)	Generic term for FX5-C32ET/D, FX5-C32ET/DSS, FX5-C32ET/DS-TS, and FX5-C32ET/DSS-TS
Powered input/output module	Generic term for FX5-32ER/ES, FX5-32ET/ES, FX5-32ET/ESS, FX5-32ER/DS, FX5-32ET/DS, and FX5-32ET/DSS
High-speed pulse input/output module	Generic term for FX5-16ET/ES-H and FX5-16ET/ESS-H
Extension power supply module	Generic term for FX5 extension power supply module and FX3 extension power supply module
FX5 extension power supply module	Generic term for FX5 extension power supply module (extension cable type) and FX5 extension power supply module (extension connector type)
FX5 extension power supply module (extension cable type)	Different name for FX5-1PSU-5V
FX5 extension power supply module (extension connector type)	Different name for FX5-C1PS-5V
FX3 extension power supply module	Different name for FX3U-1PSU-5V
Intelligent module	The abbreviation for intelligent function modules
Intelligent function module	Generic term for FX5 intelligent function modules and FX3 intelligent function modules
FX5 intelligent function module	Generic term for FX5-4AD, FX5-4DA, FX5-8AD, FX5-4LC, FX5-20PG-P, FX5-20PG-D, FX5-40SSC-G, FX5-80SSC-G, FX5-40SSC-S, FX5-80SSC-S, FX5-ENET, FX5-ENET/IP, FX5-CCLGN-MS, FX5-CCLIEF, FX5-CCL-MS, FX5-ASL-M, and FX5-DP-M
FX3 intelligent function module	Generic term for FX3U-4AD, FX3U-4DA, FX3U-4LC, FX3U-1PG, FX3U-2HC, FX3U-16CCL-M, FX3U-64CCL, FX3U-128ASL-M, and FX3U-32DP
FX5 safety extension module	Generic term for safety main modules and safety expansion modules
Safety main module	Different name for FX5-SF-MU4T5
Safety expansion module	Generic term for expansion modules installed to a safety main module
Safety input expansion module	Different name for FX5-SF-8DI4
Expansion board	Generic term for board for FX5UJ CPU module and FX5U CPU module
Communication board	Generic term for FX5-232-BD, FX5-485-BD, and FX5-422-BD-GOT
Expansion adapter	Generic term for adapter for FX5 CPU module
Communication adapter	Generic term for FX5-232ADP and FX5-485ADP
Analog adapter	Generic term for FX5-4AD-ADP, FX5-4DA-ADP, FX5-4AD-PT-ADP, FX5-4AD-TC-ADP, and FX5-4A-ADP
Bus conversion module	Generic term for Bus conversion module (extension cable type) and Bus conversion module (extension connector type)
Bus conversion module (extension cable type)	Different name for FX5-CNV-BUS
Bus conversion module (extension connector type)	Different name for FX5-CNV-BUSC
Connector conversion module	Generic term for Connector conversion module (extension cable type) and Connector conversion module (extension connector type)
Connector conversion module (extension cable type)	Different name for FX5-CNV-IF
Connector conversion module (extension connector type)	Different name for FX5-CNV-IFC
Extended extension cable	Generic term for FX5-30EC and FX5-65EC
Connector conversion adapter	Different name for FX5-CNV-BC
Battery	Different name for FX3U-32BL
SD memory card	Generic term for NZ1MEM-2GBSD, NZ1MEM-4GBSD, NZ1MEM-8GBSD, NZ1MEM-16GBSD, L1MEM-2GBSD and L1MEM-4GBSD SD memory cards Abbreviation of Secure Digital Memory Card. Device that stores data using flash memory.
Peripheral device	Generic term for engineering tools and GOTs
GOT	Generic term for Mitsubishi Electric Graphic Operation Terminal GOT1000 and GOT2000 series
■Software packages	
Engineering tool	The product name of the software package for the MELSEC programmable controllers
GX Works3	The product name of the software package, SWnDND-GXW3, for the MELSEC programmable controllers (The 'n' represents a version.)

1 OUTLINE

The FX5 supports the following analog functions:

Model	Item	Outline	Reference
FX5-4AD-ADP	Analog input	The FX5-4AD-ADP is an analog adapter which inputs 4 points of analog input (voltage/current) when connected to the FX5 CPU module. A/D-converted values are written to special registers assigned to each channel. The maximum number of analog adapters that can be connected in total is as follows. <ul style="list-style-type: none"> FX5UJ CPU module: Up to 2 modules FX5U/FX5UC CPU module: Up to 4 modules 	Page 24
FX5-4AD-PT-ADP	Temperature sensor input (for resistance temperature detector)	The FX5-4AD-PT-ADP is an analog adapter which inputs 4 points of temperature of resistance temperature detector (analog input) when connected to the FX5 CPU module. Temperature converted values are written to special registers assigned to each channel. The maximum number of analog adapters that can be connected in total is as follows. <ul style="list-style-type: none"> FX5UJ CPU module: Up to 2 modules FX5U/FX5UC CPU module: Up to 4 modules 	Page 102
FX5-4AD-TC-ADP	Temperature sensor input (for thermocouple)	The FX5-4AD-TC-ADP is an analog adapter which inputs 4 points of temperature of thermocouple (analog input) when connected to the FX5 CPU module. Temperature converted values are written to special registers assigned to each channel. The maximum number of analog adapters that can be connected in total is as follows. <ul style="list-style-type: none"> FX5UJ CPU module: Up to 2 modules FX5U/FX5UC CPU module: Up to 4 modules 	Page 164
FX5-4DA-ADP	Analog output	The FX5-4DA-ADP is an analog adapter which outputs 4 points of voltage/current when connected to the FX5 CPU module. D/A-converted analog data are output when values are set to special registers assigned to each channel. The maximum number of analog adapters that can be connected in total is as follows. <ul style="list-style-type: none"> FX5UJ CPU module: Up to 2 modules FX5U/FX5UC CPU module: Up to 4 modules 	Page 228
FX5-4A-ADP	Analog input/output	The FX5-4A-ADP is an analog adapter which inputs 2 points of voltage/current and outputs 2 points of voltage/current when connected to the FX5 CPU module. A/D-converted values are written to special registers assigned to each channel. D/A-converted analog data are output when values are set to special registers assigned to each channel. The maximum number of analog adapters that can be connected in total is as follows. <ul style="list-style-type: none"> FX5UJ CPU module: Up to 2 modules FX5U/FX5UC CPU module: Up to 2 modules 	Page 281
FX5U CPU module built-in analog	Analog input/output	The FX5 CPU module has 2 points of built-in analog voltage input and 1 point of built-in analog voltage output. Values A/D-converted by the FX5U CPU module are written to special registers assigned to each channel. D/A-converted analog data are output when values are set to special registers in the FX5U CPU module.	Page 410

2 FX5-4AD-ADP

This chapter describes the FX5-4AD-ADP.

2.1 Specifications

This section describes the specifications.

Generic specifications

The items other than the following are equivalent to those of the CPU module.

For general specifications, refer to the following manual.

📖 MELSEC iQ-F FX5UJ User's Manual (Hardware)

📖 MELSEC iQ-F FX5U User's Manual (Hardware)

📖 MELSEC iQ-F FX5UC User's Manual (Hardware)

Item	Specification
Dielectric withstand voltage	500 V AC for one minute
Insulation resistance	10 MΩ or higher by 500 V DC insulation resistance tester

Between all external terminals and ground terminal of CPU module

Power supply specifications

Power supply specifications is shown below.

Item	Specification
Internal electric supply (A/D conversion circuit)	24 V DC 20 mA Internal electric supply is carried out from 24 V DC power supply of a CPU module.
Internal electric supply (Interface)	5 V DC 10 mA Internal electric supply is carried out from 5 V DC power supply of a CPU module.

Performance specifications

Performance specifications is shown below.

Item	Specification		
Number of analog input points	4 points (4 channels)		
Analog input voltage	-10 to +10 V DC (input resistance 1 MΩ)		
Analog input current	-20 to +20 mA DC (input resistance 250 Ω)		
Digital output value	14-bit binary value		
Input characteristics, resolution*1	Analog input range		Digital output value
	Voltage	0 to 10 V	0 to 16000
		0 to 5 V	0 to 16000
		1 to 5 V	0 to 12800
		-10 to +10 V	-8000 to +8000
	Current	0 to 20 mA	0 to 16000
		4 to 20 mA	0 to 12800
-20 to +20 mA		-8000 to +8000	
Accuracy (accuracy for the full scale of digital output value)	Ambient temperature 25±5°C: within ±0.1 % (±16 digit)		
	Ambient temperature 0 to 55°C: within .0.2 % (±32 digit)		
	Ambient temperature -20 to 0°C*2: within .0.3 % (±48 digit)		
Conversion speed	Maximum 450 μs (The data will be updated at every scan time of the PLC.)		
Absolute maximum input	Voltage: ±15 V, Current: ±30 mA		
Isolation method	Between input terminal and PLC: Photocoupler Between input channels: Non-isolation		
Number of occupied I/O points	0 point (This number is not related to the maximum number of I/O points of the PLC.)		
Applicable CPU module	<ul style="list-style-type: none"> • FX5UJ CPU module (From the first) • FX5U CPU module (From the first) • FX5UC CPU module (From the first) 		
Applicable engineering tool	<ul style="list-style-type: none"> • FX5UJ CPU module: GX Works3 (Ver.1.060N or later) • FX5U/FX5UC CPU module: GX Works3 (Ver.1.007H or later) 		

*1 For the input conversion characteristic, refer to the  Page 26 Input conversion characteristics.

*2 This specification does not apply to products manufactured before June 2016.

Input conversion characteristics

An input conversion characteristic of A/D conversion is expressed by the slope of the straight line connecting the offset value and the gain value at the time when an analog input (voltage or current) from outside the programmable controller is converted to a digital value.

Voltage input characteristic

The following shows the list of the analog input ranges and the graphs of each voltage input characteristic, at the voltage input.

No.	Input range setting	Offset value	Gain value	Digital output value ^{*1}	Resolution
(1)	0 to 10 V	0 V	10 V	0 to 16000	625 μ V
(2)	0 to 5 V	0 V	5 V	0 to 16000	312.5 μ V
(3)	1 to 5 V	1 V	5 V	0 to 12800	312.5 μ V
(4)	-10 to +10 V	0 V	10 V	-8000 to +8000	1250 μ V

*1 When analog input exceeds the range of the digital output value, the digital output value is fixed to the maximum or minimum.

Input range setting	Digital output value	
	Minimum	Maximum
0 to 10 V	-384	16383
0 to 5 V	-384	16383
1 to 5 V	-3584	13183
-10 to +10 V	-8192	8191

Point

- Set values within the practical range of the analog input and digital output at each input range. If the values are out of the range, the resolution and accuracy may not fall within the range of the performance specifications. (Do not use values in the dotted line region in the graph of voltage input characteristics.)
- Do not set the voltage over ± 15 V. Doing so can cause breakdown of the products.

■ Voltage input characteristics graph (0 to 10 V)

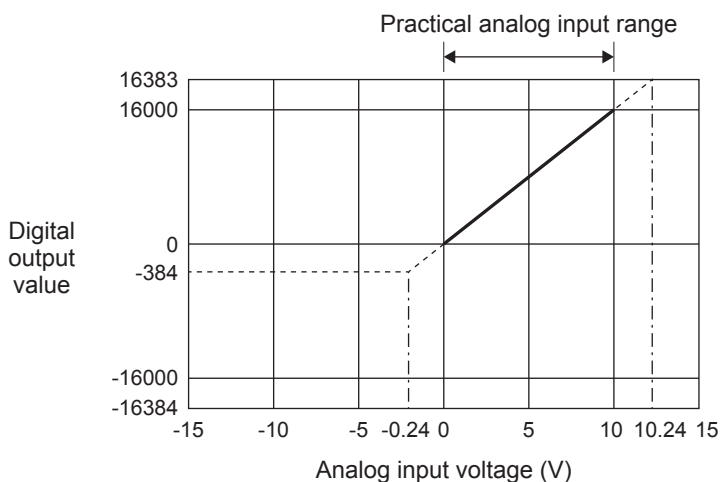

■ Voltage input characteristics graph (0 to 5 V)

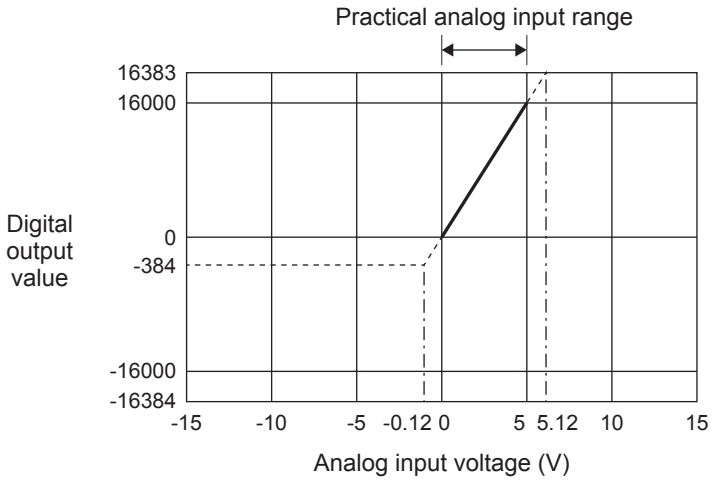

■ Voltage input characteristics graph (1 to 5 V)

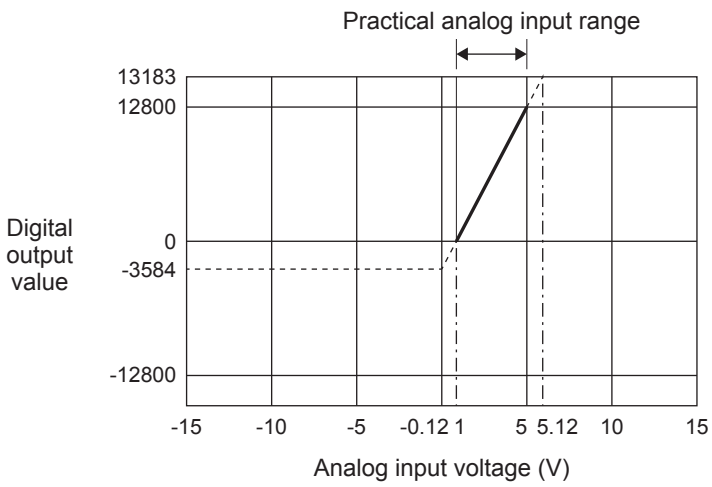

■ Voltage input characteristics graph (-10 to +10 V)

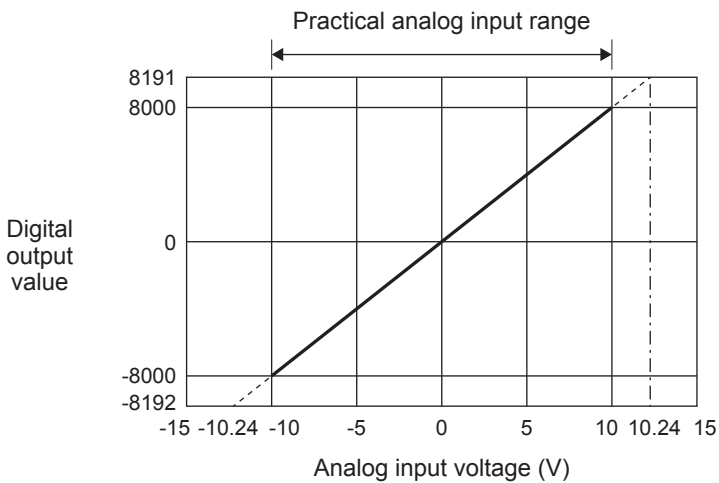

Current input characteristic

The following shows the list of the analog input ranges and the graph of each current input characteristic, at the current input.

No.	Input range setting	Offset value	Gain value	Digital output value ^{*1}	Resolution
(1)	0 to 20 mA	0 mA	20 mA	0 to 16000	1.25 μ A
(2)	4 to 20 mA	4 mA	20 mA	0 to 12800	1.25 μ A
(3)	-20 to +20 mA	0 mA	20 mA	-8000 to +8000	2.5 μ A

*1 When analog input exceeds the range of the digital output value, the digital output value is fixed to the maximum or minimum.

Input range setting	Digital output value	
	Minimum	Maximum
0 to 20 mA	-384	16383
4 to 20 mA	-3584	13183
-20 to +20 mA	-8129	8191

Point

- Set values within the practical range of the analog input and digital output at each input range. If the values are out of the range, the resolution and accuracy may not fall within the range of the performance specifications. (Do not use values in the dotted line region in the graph of current input characteristics.)
- Do not set the voltage over ± 30 mA. Doing so can cause breakdown of the products.

■ Current input characteristics graph (0 to 20 mA)

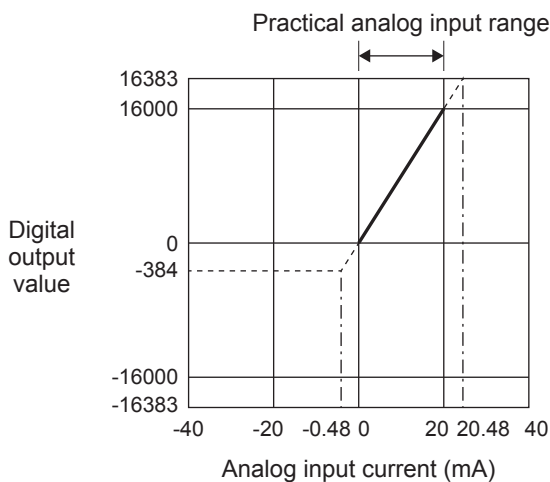

■ Current input characteristics graph (4 to 20 mA)

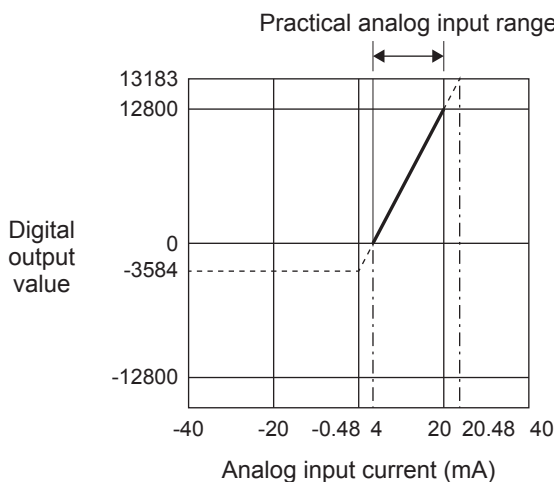

■ Current input characteristics graph (-20 to +20 mA)

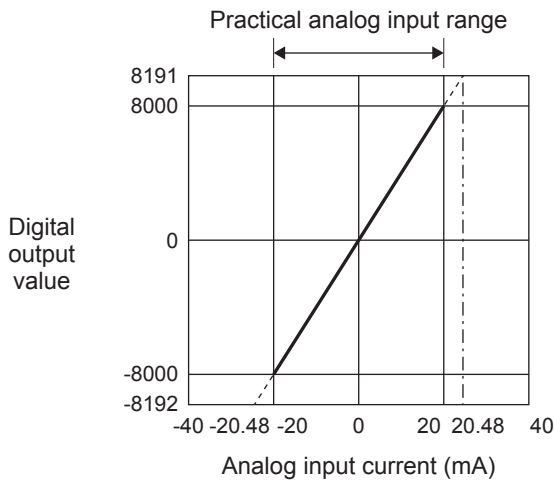

Accuracy

Accuracy of A/D conversion is determined by the accuracy for the full scale of digital output value. An input characteristic change through changes of the offset/gain setting or the input range does not sacrifice the accuracy, which is maintained within the described range of the performance specifications. The following graph shows the fluctuation range of accuracy when the range of -10 to +10 V is selected. The accuracy is $\pm 0.1\%$ (± 16 digits) at ambient temperature of $25 \pm 5^\circ\text{C}$; the accuracy is $\pm 0.2\%$ (± 32 digits) at ambient temperature of 0 to 55°C ; the accuracy is $\pm 0.3\%$ (± 48 digits) at ambient temperature of -20 to 0°C (except for the conditions under noise influence).

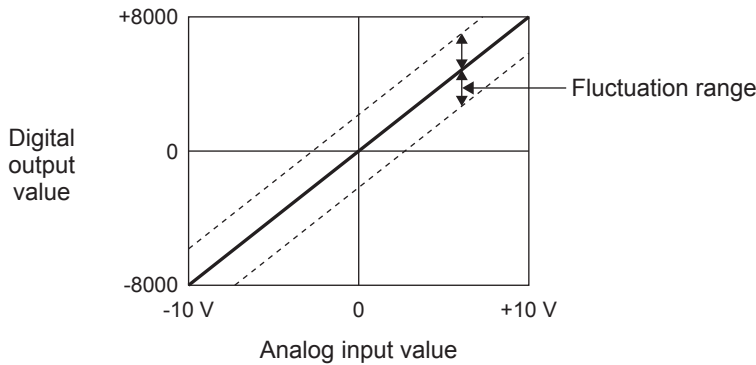

2.2 List of functions

The following table lists the functions list.

List of Functions		Description	Reference	
Range switching function		Allows switching the input range of an analog input for each channel. Switching the range makes it possible to change the input conversion characteristics.	Page 32	
A/D conversion enable/disable setting function		Controls whether to enable or disable the A/D conversion for each channel.	Page 33	
A/D conversion method	Sampling processing	Executes A/D conversion of analog input values sequentially and stores the digital output values to the special registers.	Page 33	
	Averaging processing	Time average		Executes A/D conversion for a set time, calculates the average of the total value, and stores the result in special registers. The number of processing times within the set time changes depending on the number of channels where A/D conversion is enabled.
		Count average		Executes A/D conversion for a set number of times, and calculates the average of the total value excluding the maximum value and the minimum value to store it in the special registers. The time taken to store the average value obtained by the average processing in the special registers changes depending on the number of channels where the A/D conversion is enabled.
		Moving average		Averages digital output values taken at every scan for a specified number of times, and stores the averaged value in the special registers. Because the target range for averaging processing is moved in response to every sampling processing, the latest digital output value can be obtained.
Over scale detection function		Function to detect analog input values that are over a input range.	Page 35	
Scaling function		Performs scale conversion on digital output values within a specified range between a scaling upper limit value and a scaling lower limit value. This function reduces the time and effort to create a program of the scale conversion.	Page 37	
Shift function		Adds (shifts) a set conversion value shift amount to a digital output value and stores the result in the digital operation value. The digital operation value reflects the change in the conversion value shift amount on a realtime basis. Therefore, fine adjustment can be easily performed when the system starts.	Page 40	
Digital clipping function		Fixes a possible digital operation value to the maximum digital output value or the minimum digital output value when an input current or voltage exceeds the input range.	Page 41	
Maximum value/minimum value hold function		Stores the maximum and minimum values of digital operation values to the special registers for each channel.	Page 42	
Warning output function	Process alarm	Outputs a warning when a digital operation value enters the preset warning output range.	Page 43	
	Rate alarm	Outputs a warning when the change rate of a digital output value is equal to or more than the rate alarm upper limit value, or the rate is equal to or less than the rate alarm lower limit value.	Page 45	
Disconnection detection function		Disconnection can be detected for each channel.	Page 48	
Convergence detection function		Detects whether the digital operation value is within a certain range in the specified time.	Page 50	
Deviation detection between channel function		Detects whether the difference in the digital operation value is larger than a specified value between channels.	Page 51	
Event history function		Collects errors from FX5-4AD-ADP, and stores them as event information into the CPU module.	Page 52	
Offset/gain setting function		Corrects errors in digital output values.	Page 53	
Offset/gain initialization function		Initializes the offset value and gain value stored in the built-in memory of the FX5-4AD-ADP.	Page 56	
Common function		Explains the common functions such as changing the setting values while the CPU module is operating.	Page 57	

2.3 Functions

This section describes the functions of the FX5-4AD-ADP and the setting procedures for those functions using GX Works3.

Point

This section describes the special relays and special registers for the 1st FX5-4AD-ADP module. For checking the special relays and special registers for the 2nd and later FX5-4AD-ADP modules, refer to the following:

☞ Page 70 List of Special Relays, ☞ Page 84 List of Special Registers

2

Processing of Each Function

The functions are processed in the order shown below.

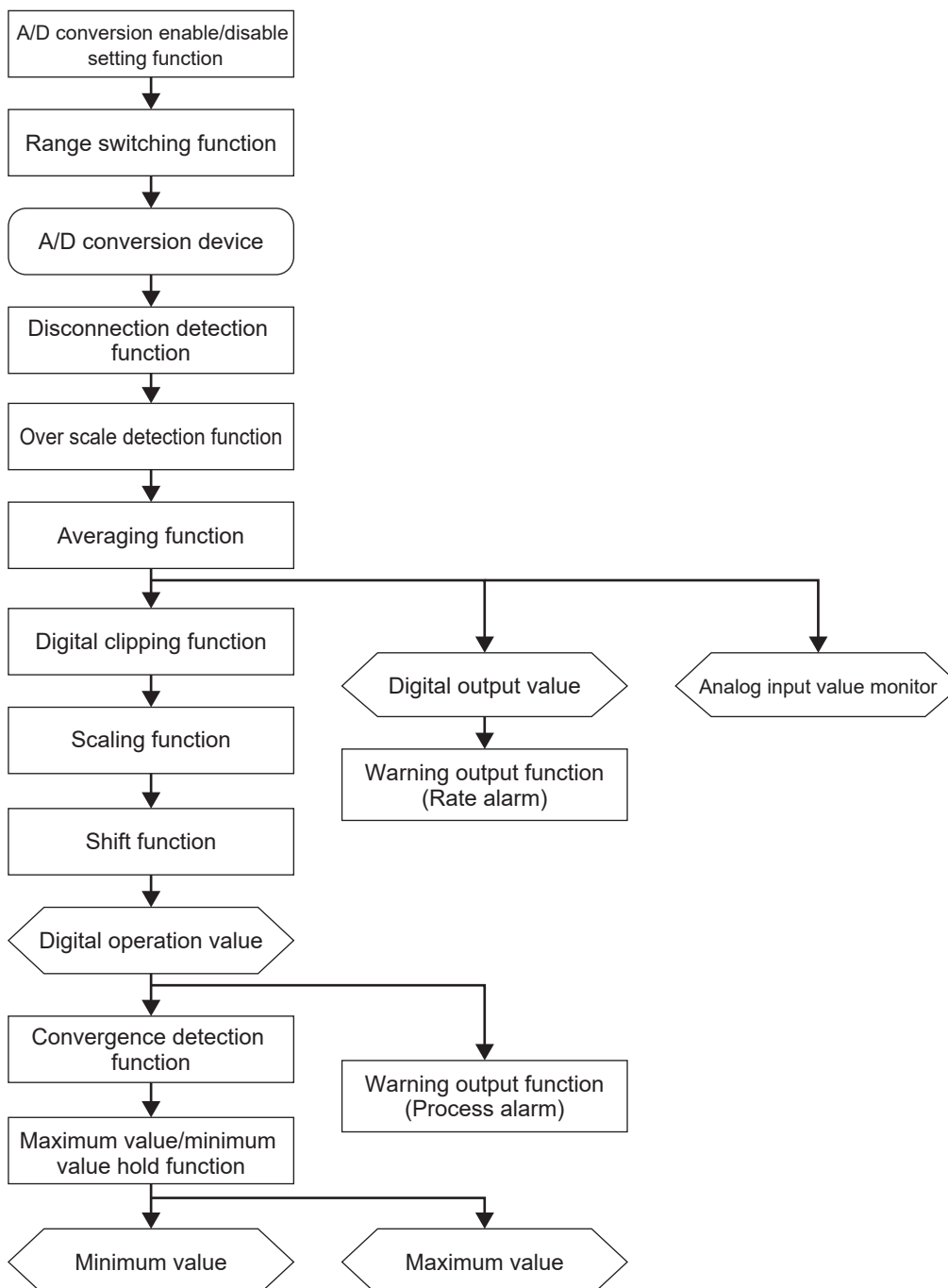

Digital output value

These values are the digital values after the sampling processing or each averaging processing has been performed.

Digital operation value

These values are obtained by operating a digital output value using the digital clipping function, scaling function, or shift function. When each function is not used, the same value as the digital output value is stored.

Analog input value monitor

The input analog value is displayed. Voltage and current are displayed in the following units.

Voltage: mV, Current: μ A

Maximum and minimum value

The maximum and minimum values of the digital operation values are stored.

Range Switching Function

This function allows switching the input range of an analog input for each channel.

Switching the range makes it possible to change the input conversion characteristics.

Setting procedure

Set the input range to be used in the "Input range setting".

 Navigation window \Rightarrow [Parameter] \Rightarrow [Module Information] \Rightarrow Module model name \Rightarrow [Module Parameter] \Rightarrow "Basic Settings" \Rightarrow "Range switching function"

Input range setting	Digital output value
0 to 10 V	0 to 16000
0 to 5 V	0 to 16000
1 to 5 V	0 to 12800
-10 to +10 V	-8000 to +8000
0 to 20 mA	0 to 16000
4 to 20 mA	0 to 12800
-20 to +20 mA	-8000 to +8000

Corresponding devices

The devices which are used by the range switching function are listed below.

Name	CH1	CH2	CH3	CH4	Reference
Input range setting	SD6305	SD6345	SD6385	SD6425	Page 90

Operation

The input range is switched when the "input range setting" is changed while the "A/D conversion enable/disable setting" is set to "disable".

When the input range is switched, the following special devices are initialized:

Name	CH1	CH2	CH3	CH4	Reference
A/D conversion completed flag	SM6300	SM6340	SM6380	SM6420	Page 74
Over scale upper limit detection flag	SM6302	SM6342	SM6382	SM6422	Page 74
Over scale lower limit detection flag	SM6303	SM6343	SM6383	SM6423	Page 75
Warning output flag (process alarm upper limit)	SM6311	SM6351	SM6391	SM6431	Page 77
Warning output flag (process alarm lower limit)	SM6312	SM6352	SM6392	SM6432	Page 77
Warning output flag (rate alarm upper)	SM6315	SM6355	SM6395	SM6435	Page 78
Warning output flag (rate alarm lower)	SM6316	SM6356	SM6396	SM6436	Page 78
Disconnection detection flag	SM6318	SM6358	SM6398	SM6438	Page 79
Convergence detection flag	SM6321	SM6361	SM6401	SM6441	Page 80
Deviation detection flag between channel	SM6325	SM6365	SM6405	SM6445	Page 81
Digital output value	SD6300	SD6340	SD6380	SD6420	Page 88
Digital operation value	SD6301	SD6341	SD6381	SD6421	Page 88
Analog input value monitor	SD6302	SD6342	SD6382	SD6422	Page 89
Maximum value	SD6306	SD6346	SD6386	SD6426	Page 91
Minimum value	SD6307	SD6347	SD6387	SD6427	Page 91
Offset setting value ^{*1}	SD6332	SD6372	SD6412	SD6452	Page 100
Gain setting value ^{*1}	SD6333	SD6373	SD6413	SD6453	Page 100

*1 When the input range setting after change is equivalent to the input range setting set by the offset/gain setting function, the values set by the offset/gain setting function are reflected. In any other case, they are initialized to the initial value.

A/D Conversion Enable/Disable Setting Function

This function controls whether to enable or disable the A/D conversion for each channel.

Setting procedure

Set "A/D conversion enable/disable setting" to "A/D conversion enable" or "A/D conversion disable".

Navigation window ⇒ [Parameter] ⇒ [Module Information] ⇒ Module model name ⇒ [Module Parameter] ⇒ "Basic Settings" ⇒ "A/D Conversion Enable/Disable Setting Function"

Corresponding devices

The devices which are used by the A/D conversion enable/disable setting function are listed below.

Name	CH1	CH2	CH3	CH4	Reference
A/D conversion enable/disable setting	SM6301	SM6341	SM6381	SM6421	Page 74

Operation

The analog input is A/D-converted only in the channels for which the "A/D conversion enable/disable setting" is set to "enable", and values are stored in the "digital output value", "digital operation value" and "analog input value monitor".

When the "A/D conversion enable/disable setting" is changed from "enable" to "disable", the digital value, digital operation value and analog input value monitor are cleared.

A/D Conversion Method

An A/D conversion method can be set for each channel.

Sampling processing

The analog input is A/D-converted in each scan of the CPU module, the converted value is output in digital at each time, and values are stored in the "digital output value", "digital operation value" and "analog input value monitor".

Averaging processing

The FX5-4AD-ADP performs the averaging processing on digital output values for each channel and stores the mean values to the special registers.

The following three types of averaging processing are provided.

- Time average
- Count average
- Moving average

■Time average

A/D conversion is executed for a set time, the total value is averaged, and values are stored in the "digital output value", "digital operation value" and "analog input value monitor".

The number of times of processing within the set time varies depending on the number of channels for which A/D conversion is enabled.

Number of processing times=Setting time÷Scan time

Point

If the set time is shorter than the scan time, the averaging processing is not executed, but the sampling value is output. However, only in the first output, the averaged value of the 1st sample and 2nd sample is output.

■Count average

A/D conversion is executed for a set number of times of count average, the averaged value excluding the maximum value and minimum value is output in digital, and values are stored in the "digital output value", "digital operation value" and "analog input value monitor".

The time required to store the averaged value obtained by count average in the "digital output value", "digital operation value" and "analog input value monitor" varies depending on the scan time.

Processing time=Set number of times×Scan time

Point

The count average requires a total of at least two values excluding the maximum value and minimum value. Set the number of times to "4" or larger value.

■Moving average

A/D conversion is executed for a set number of times of moving average, and the averaged value is output in digital, and values are stored in the "digital output value", "digital operation value" and "analog input value monitor".

Because the target range for averaging processing is moved in each conversion cycle and the averaging processing is executed using A/D conversion values for the set number of times, the latest "digital output value", "digital operation value" and "analog input value monitor" can be obtained.

The figure below shows the moving average when the number of times of averaging processing is set to "4".

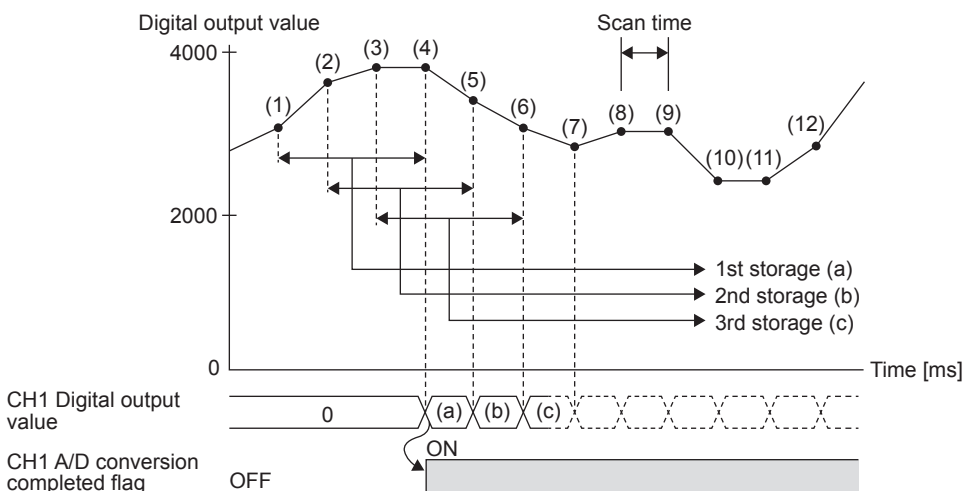

Setting procedure

■ Sampling processing

Set "Average Processing Specification" to "Sampling Processing".

Navigation window ⇒ [Parameter] ⇒ [Module Information] ⇒ Module model name ⇒ [Module Parameter] ⇒ "Basic Settings" ⇒ "A/D conversion method"

■ Averaging processing

1. Set "Average Processing Specification" to "Time Average", "Count Average", or "Moving Average".

Navigation window ⇒ [Parameter] ⇒ [Module Information] ⇒ Module model name ⇒ [Module Parameter] ⇒ "Basic Settings" ⇒ "A/D Conversion Method"

2. Set a value for "Time Average Counts Average Moving Average".

Item	Setting range
Time Average	1 to 10000 (ms)
Count Average	4 to 32767 (times)
Moving Average	2 to 64 (times)

Corresponding devices

The devices which are used by the A/D conversion method are listed below.

Name	CH1	CH2	CH3	CH4	Reference
Digital output value	SD6300	SD6340	SD6380	SD6420	Page 88
Digital operation value	SD6301	SD6341	SD6381	SD6421	Page 88
Analog input value monitor	SD6302	SD6342	SD6382	SD6422	Page 89
Average processing specify	SD6303	SD6343	SD6383	SD6423	Page 89
Time Average/Count Average/Moving Average setting	SD6304	SD6344	SD6384	SD6424	Page 90

Over Scale Detection Function

This function detects analog input values that are over a input range.

Setting procedure

Set "Over scale detection enable/disable" to "Enable".

Navigation window ⇒ [Parameter] ⇒ [Module Information] ⇒ Module model name ⇒ [Module Parameter] ⇒ "Application Settings" ⇒ "Over Scale Detection"

Corresponding devices

The devices which are used by the over scale detection function are listed below.

Name	CH1	CH2	CH3	CH4	Reference
Over scale upper limit detection flag	SM6302	SM6342	SM6382	SM6422	Page 74
Over scale lower limit detection flag	SM6303	SM6343	SM6383	SM6423	Page 75
Over scale detection enable/disable setting	SM6304	SM6344	SM6384	SM6424	Page 75

Over-scale detection condition

The table below shows the condition for detecting over-scale when the over-scale detection function is enabled.

Input range	Normal range	Over-scale detection condition	
		Analog input value lower limit	Analog input value upper limit
0 to 10 V	-0.2 to +10.2 V	-0.2 V > Analog input value	+10.2 V < Analog input value
0 to 5 V	-0.1 to +5.1 V	-0.1 V > Analog input value	+5.1 V < Analog input value
1 to 5 V	-0.1 to +5.1 V	-0.1 V > Analog input value	+5.1 V < Analog input value
-10 to +10 V	-10.2 to +10.2 V	-10.2 V > Analog input value	+10.2 V < Analog input value
0 to 20 mA	-0.4 to +20.4 mA	-0.4 mA > Analog input value	+20.4 mA < Analog input value
4 to 20 mA	-0.4 to +20.4 mA	-0.4 mA > Analog input value	+20.4 mA < Analog input value
-20 to +20 mA	-20.4 to +20.4 mA	-20.4 mA > Analog input value	+20.4 mA < Analog input value

Operation

When the analog input value is outside the normal range, it is regarded as over-scale and the corresponding over-scale detection flag turns ON.

- Over-scale upper limit detection flag: Turns ON when the analog input value is above the normal range. (Alarm code: 090□H)
- Over-scale lower limit detection flag: Turns ON when the analog input value is below the normal range. (Alarm code: 091□H)

The digital output value from the channel where over-scale is detected is held with the value just before over-scale is detected, and the "A/D conversion completion flag" of the corresponding channel turns OFF.

When the analog input value becomes normal, A/D conversion is restarted. After the first update, the "A/D conversion completion flag" of the corresponding channel turns ON, but the "over-scale upper limit detection flag", "over-scale lower limit detection flag" does not turn OFF.

It is necessary to set to ON the "alarm clear request" for turning OFF the "over-scale upper limit detection flag", "over-scale lower limit detection flag". The "over-scale upper limit detection flag", "over-scale lower limit detection flag" turns OFF also when the "over-scale detection enable/disable" is changed to "disable".

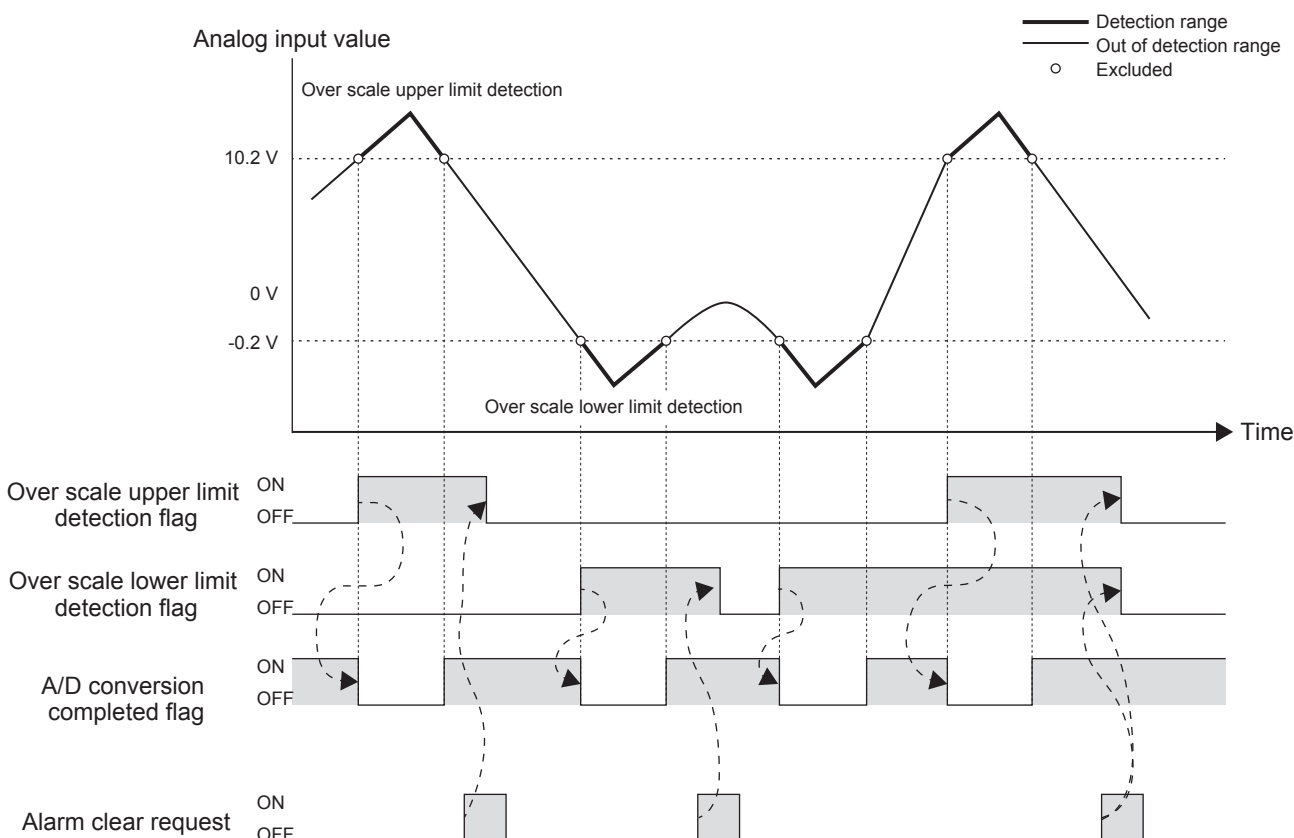

Point 

- The "alarm clear request" is not turned off automatically. To perform an alarm clear again, it is necessary to turn it OFF once.
- To clear the alarm code, set the "alarm clear request" to ON.

Scaling Function

This function performs the scale conversion on digital output values. The values are converted within a specified range between a scaling upper limit value and scaling lower limit value.
The converted values are stored in "digital operation value".

Concept of scaling setting

Ex.

When the input range is set to -10 to +10 V:
For the scaling lower limit value, set a value corresponding to the lower limit value of the input range (-8000).
For the scaling upper limit value, set a value corresponding to the upper limit value of the input range (+8000).

Calculating the scaling value

The scale conversion is based on the following formula. (In scale conversion, values are rounded to the nearest whole number.)

■Current (0 to 20 mA, 4 to 20 mA), voltage (0 to 10 V, 0 to 5 V, 1 to 5 V)

Calculation formula	Symbol
$D_Y = \frac{D_X \times (S_H - S_L)}{D_{Max}} + S_L$	D _X : Digital output value D _Y : Scaling value (Digital operation value) D _{Max} : Maximum digital output value of the input range in use S _H : Scaling upper limit value S _L : Scaling lower limit value

■Current (-20 to +20 mA), voltage (-10 to +10 V)

Calculation formula	Symbol
$D_Y = \frac{D_X \times (S_H - S_L)}{D_{Max} - D_{Min}} + \frac{(S_H + S_L)}{2}$	D _X : Digital output value D _Y : Scaling value (Digital operation value) D _{Max} : Maximum digital output value of the input range in use D _{Min} : Minimum digital output value of the input range in use S _H : Scaling upper limit value S _L : Scaling lower limit value

Setting procedure

1. Set "Scaling enable/disable setting" to "Enable".
 Navigation window ⇒ [Parameter] ⇒ [Module Information] ⇒ Module model name ⇒ [Module Parameter] ⇒ "Application Settings" ⇒ "Scaling Setting"
2. Set values for "Scaling upper limit value" and "Scaling lower limit value".

Item	Setting range
Scaling upper limit value	-32768 to +32767
Scaling lower limit value	-32768 to +32767

Point 

- Even when the scaling upper limit value and the scaling lower limit value are set so that the change is greater than the resolution, the max. resolution will not increase.
- If the relation between the values is scaling lower limit value > scaling upper limit value, the scale conversion can be performed according to a negative slope.
- Set the scaling with the condition "Scaling upper limit value ≠ Scaling lower limit value".

Corresponding devices

The devices which are used by the scaling function are listed below.

Name	CH1	CH2	CH3	CH4	Reference
Scaling enable/disable setting	SM6308	SM6348	SM6388	SM6428	Page 76
Scaling upper limit value	SD6308	SD6348	SD6388	SD6428	Page 91
Scaling lower limit value	SD6309	SD6349	SD6389	SD6429	Page 92

Setting example

Ex.

When 5000 is set to the scaling upper limit value and 1000 is set to the scaling lower limit value for the channel with the input range of 0 to 5 V

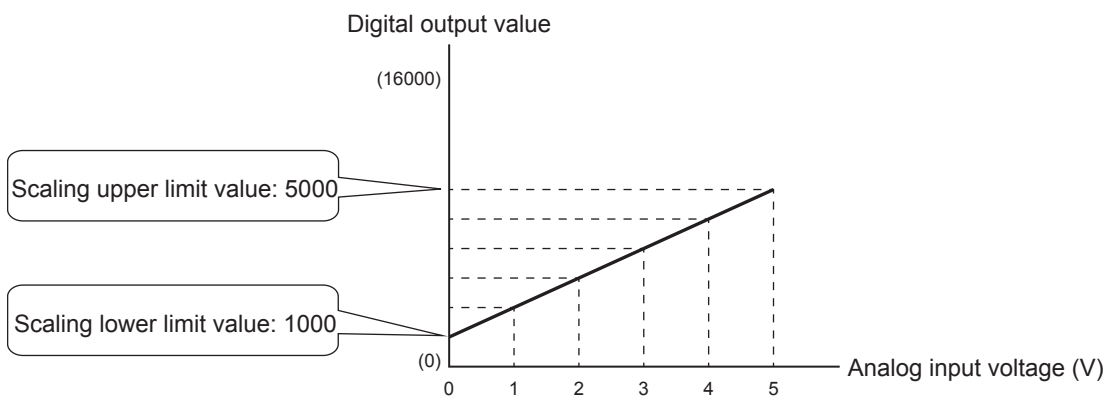

Voltage input (V)	Digital output value	Digital operation value (scaling value)
0	0	1000
1	3200	1800
2	6400	2600
3	9600	3400
4	12800	4200
5	16000	5000

Ex.

When 1000 is set to the scaling upper limit value and 5000 is set to the scaling lower limit value for the channel with the input range of 0 to 5 V

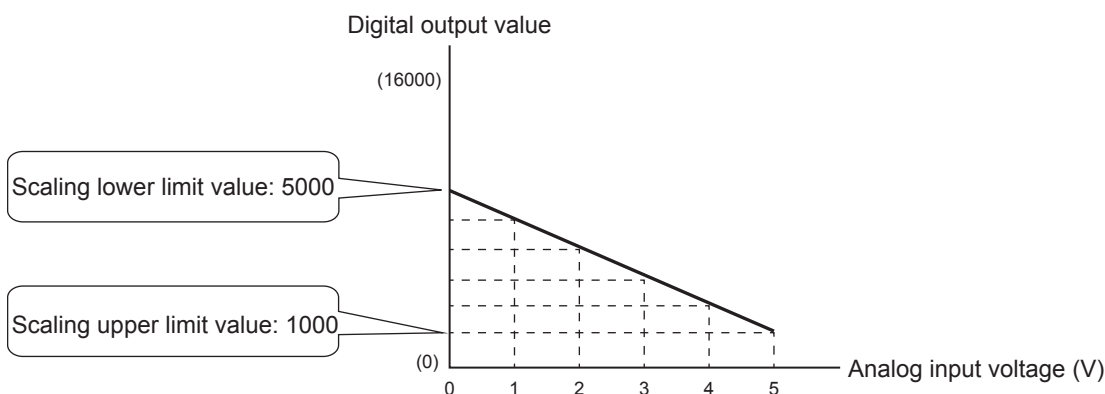

Voltage input (V)	Digital output value	Digital operation value (scaling value)
0	0	5000
1	3200	4200
2	6400	3400
3	9600	2600
4	12800	1800
5	16000	1000

Ex.

When 2500 is set to the scaling upper limit value and 500 is set to the scaling lower limit value for the channel with the input range of -10 to +10 V

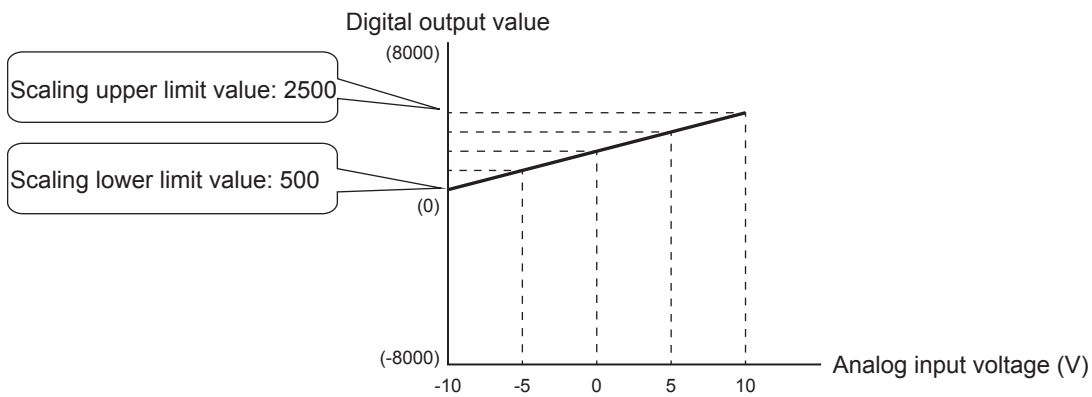

Voltage input (V)	Digital output value	Digital operation value (scaling value)
-10	-8000	500
-5	-4000	1000
0	0	1500
5	4000	2000
10	8000	2500

Ex.

When 500 is set to the scaling upper limit value and 2500 is set to the scaling lower limit value for the channel with the input range of -10 to +10 V

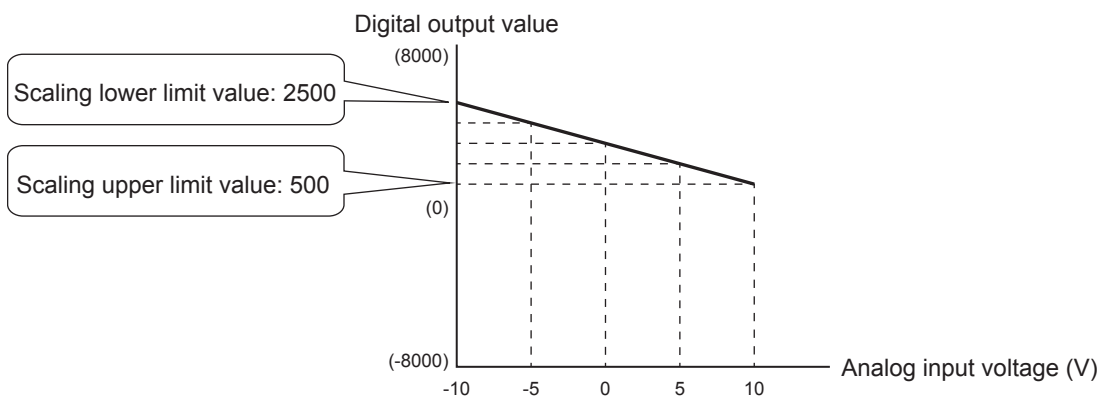

Voltage input (V)	Digital output value	Digital operation value (scaling value)
-10	-8000	2500
-5	-4000	2000
0	0	1500
5	4000	1000
10	8000	500

Point

When the scaling function is used with the digital clipping function, the scale conversion is performed on the digital operation values after digital clipping.

Shift Function

This function adds (shifts) a set conversion value shift amount to a digital operation value and stores the result in the "digital operation value". The digital operation value reflects the change in the conversion value shift amount on a realtime basis. Therefore, fine adjustment can be easily performed when the system starts.

Operation

A set "conversion value shift amount" is added to the "digital operation value". The digital operation value with shift addition is stored in "digital operation value".

The conversion value shift amount is added in every scan for sampling processing and is added in every averaging process cycle for averaging processing. After that, the added values are stored in "digital operation value".

When the digital operation value becomes outside the range from -32768 to +32767 as the result of shift processing, the shifted value is fixed to the lower limit value (-32768) or upper limit value (+32767).

Point

- When the scaling function is used together, the shift processing is executed to the value after scale conversion.
- When the digital clipping function and scaling function are used together, the shift processing is executed to the value after digital clipping and scale conversion.

Setting procedure

Set a value for "Shifting amount to conversion value".

Navigation window ⇒ [Parameter] ⇒ [Module Information] ⇒ Module [model name] ⇒ [Module Parameter] ⇒ "Application Settings" ⇒ "Shift Function"

Item	Setting range
Conversion value shift amount	-32768 to +32767

Corresponding devices

The devices which are used by the shift function are listed below.

Name	CH1	CH2	CH3	CH4	Reference
Conversion value shift amount	SD6310	SD6350	SD6390	SD6430	Page 92

Setting example

Ex.

When the input characteristics is adjusted in a channel where the input range of 0 to 10 V is set by the shift function

Digital output value

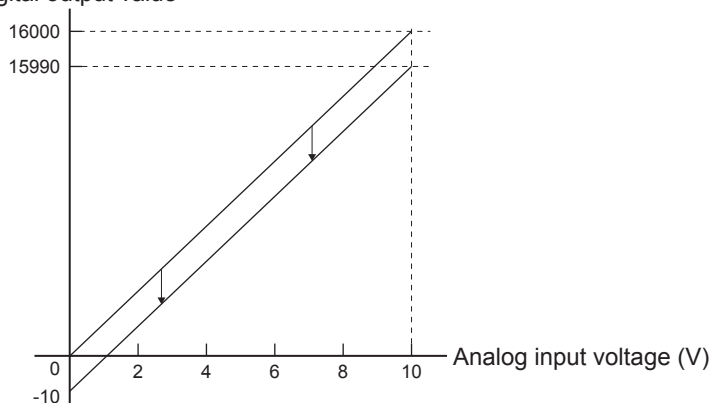

Voltage input (V)	Digital output value	Digital operation value
0	0	-10
10	16000	15990

Digital Clipping Function

This function fixes the range of the digital operation value with the maximum digital output value and the minimum digital output value when the corresponding current or voltage exceeds the input range.

List of output ranges

The following table lists the output ranges of the digital operation values when the digital clipping function is enabled with each range.

Input range	Output range of digital operation values		
	Digital clipping function is enabled	Digital clipping function is disabled (over-scale is enabled)	Digital clipping function is disabled
0 to 10 V	0 to 16000	-320 to +16320	-384 to +16383
0 to 5 V			
1 to 5 V	0 to 12800	-3520 to +13120	-3584 to +13183
-10 to +10 V	-8000 to +8000	-8160 to +8160	-8192 to +8191
0 to 20 mA	0 to 16000	-320 to +16320	-384 to +16383
4 to 20 mA	0 to 12800	-3520 to +13120	-3584 to +13183
-20 to +20 mA	-8000 to +8000	-8160 to +8160	-8192 to +8191

Setting procedure

Set "Digital clipping enable/disable" to "Enable".

Navigation window ⇒ [Parameter] ⇒ [Module Information] ⇒ Module model name ⇒ [Module Parameter] ⇒ "Application Settings" ⇒ "Digital Clipping Setting"

Corresponding devices

The devices which are used by the digital clipping function are listed below.

Name	CH1	CH2	CH3	CH4	Reference
Digital clipping enable/disable setting	SM6309	SM6349	SM6389	SM6429	Page 77

Setting example

Ex.

When the following values are used for the channel with the input range of 0 to 10 V

■Setting value

- Scaling upper limit value: 12000
- Scaling lower limit value: 2000
- Conversion value shift amount: 2000
- Digital clipping enable/disable setting: Enable

■Setting procedure

1. Set the "A/D conversion enable/disable setting" to "enable".
2. Set "2000" to the scaling lower limit value.
3. Set "12000" to the scaling upper limit value.
4. Set the "scaling enable/disable setting" to "enable".
5. Set "2000" to the conversion value shift amount.
6. Set the "digital clipping enable/disable setting" to "enable".

■ Operation

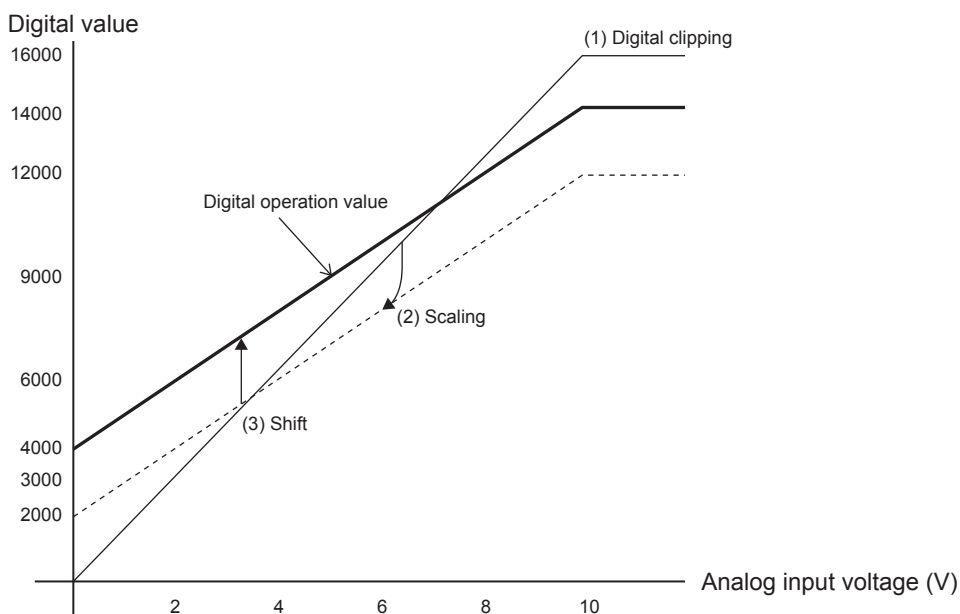

Maximum Value/Minimum Value Hold Function

This function stores the maximum value and minimum value of the digital operation value to the special registers for each channel.

This function can be set only with special devices.

Setting procedure

When the "maximum value reset request" or "minimum value reset request" is set from OFF to ON, the maximum value or minimum value is updated to the digital operation value.

Setting value	Description	Default value
0: OFF	With no maximum value or minimum value reset request	0: OFF
1: ON	With maximum value or minimum value reset request	

Corresponding devices

The devices which are used by the maximum value/minimum value hold function are listed below.

Name	CH1	CH2	CH3	CH4	Reference
Maximum value/minimum value reset completed flag	SM6305	SM6345	SM6385	SM6425	Page 75
Maximum value reset request	SM6306	SM6346	SM6386	SM6426	Page 76
Minimum value reset request	SM6307	SM6347	SM6387	SM6427	Page 76
Maximum value	SD6306	SD6346	SD6386	SD6426	Page 91
Minimum value	SD6307	SD6347	SD6387	SD6427	Page 91

Operation

When the "maximum value reset request" or "minimum value reset request" is set from OFF to ON, the maximum value or minimum value of the specified channel is updated to the "digital operation value". The "maximum value/minimum value reset completion flag" turns ON.

When the range is switched, the "maximum value" and "minimum value" are cleared (to "0").

Warning Output Function

This section describes process alarms and rate alarms used for the warning output function.

Process alarm

This function outputs a warning when a digital operation value enters the preset warning output range.

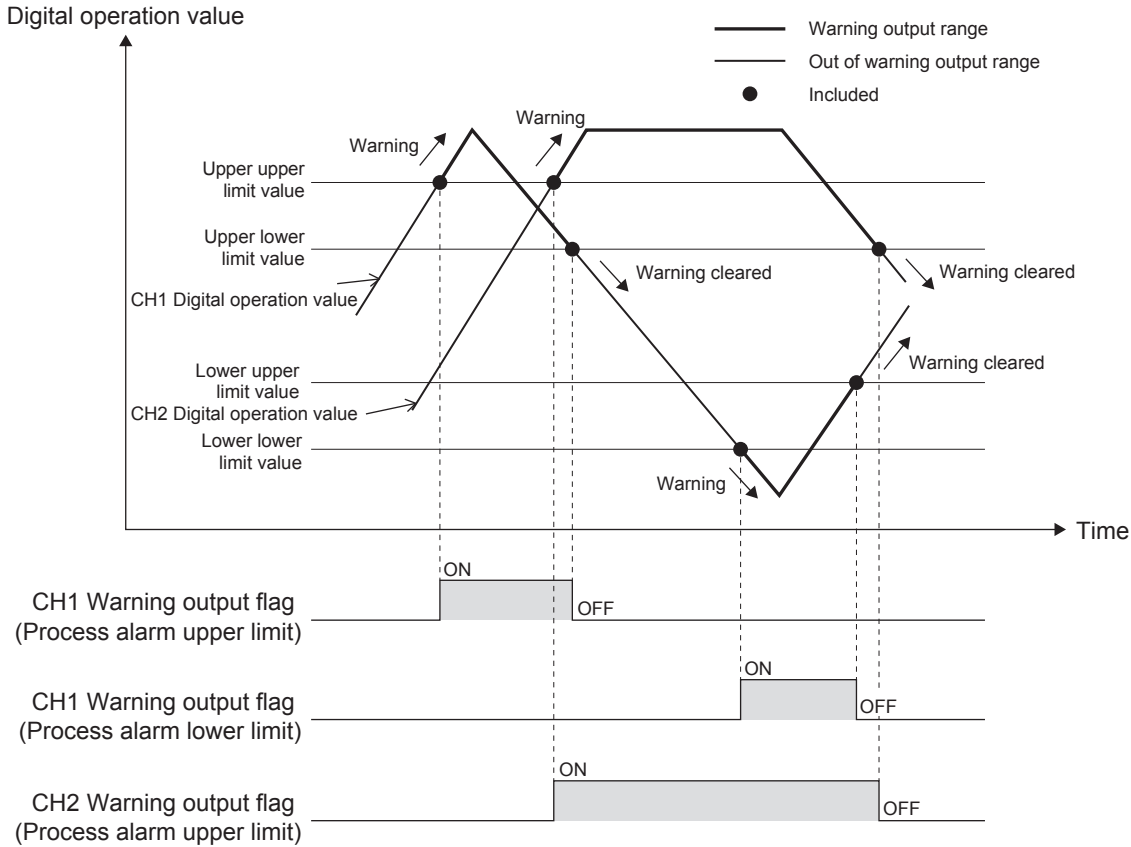

■Operation

When the digital operation value is above the process alarm upper upper limit value or below the process alarm lower lower limit value and the warning output condition is satisfied, the "warning output flag (process alarm upper limit)" or "warning output flag (process alarm lower limit)" turns ON.

When the digital operation value changes to a value below the process alarm upper lower limit value or above the process alarm lower upper limit value and the warning output condition is not satisfied after the warning output, the "warning output flag (process alarm upper limit)" or "warning output flag (process alarm lower limit)" turns OFF. The "warning output flag (process alarm upper limit)" and "warning output flag (process alarm lower limit)" turn OFF also when the "warning output enable/disable setting" is changed to "disable". However, the alarm code stored in the "A/D conversion latest alarm code" is not cleared.

For clearing the alarm code stored in the "A/D conversion latest alarm code", wait until the "warning output flag (process alarm upper limit)" and "warning output flag (process alarm lower limit)" turn OFF, and then set the "alarm clear request" to OFF, ON and OFF.

■Detection cycle

When time average is specified, the function works at every interval of the time (for averaging). When count average is specified, the function works at every count (for averaging). When the sampling processing and moving average is specified, this function works at every sampling cycle.

■Detection target for outputting a warning

When the digital clipping function, scaling function and shift function are used, digital operation values on which digital clipping, scale conversion and shift amount addition are executed are regarded as targets of alarm detection.

With regard to the process alarm upper upper limit value, process alarm lower upper limit value, process alarm lower upper limit value and process alarm lower lower limit value, make sure to set such values as to consider digital clipping, scale conversion and shift amount addition.

■Setting procedure

1. Set "Warning output setting (Process alarm)" to "Enable".

 Navigation window ⇒ [Parameter] ⇒ [Module Information] ⇒ Module model name ⇒ [Module Parameter] ⇒ "Application Settings" ⇒ "Warning output function (Process alarm)"

2. Set values for "Process alarm upper upper limit value", "Process alarm upper lower limit value", "Process alarm lower upper limit value", and "Process alarm lower lower limit value".

Item	Setting range
Process alarm upper upper limit value	-32768 to +32767
Process alarm upper lower limit value	
Process alarm lower upper limit value	
Process alarm lower lower limit value	

Point

Set values within the range satisfying the condition "Process alarm upper upper limit value \geq Process alarm upper lower limit value \geq Process alarm lower upper limit value \geq Process alarm lower lower limit value".

When not satisfying the above conditions, a process alarm upper lower limit value setting range error occurs. (Error code: 1A4□H)

■Corresponding devices

The devices which are used by the process alarm are listed below.

Name	CH1	CH2	CH3	CH4	Reference
Warning output flag (process alarm upper limit)	SM6311	SM6351	SM6391	SM6431	Page 77
Warning output flag (process alarm lower limit)	SM6312	SM6352	SM6392	SM6432	Page 77
Warning output setting (process alarm)	SM6313	SM6353	SM6393	SM6433	Page 78
Process alarm upper upper limit value	SD6311	SD6351	SD6391	SD6431	Page 92
Process alarm upper lower limit value	SD6312	SD6352	SD6392	SD6432	Page 93
Process alarm lower upper limit value	SD6313	SD6353	SD6393	SD6433	Page 93
Process alarm lower lower limit value	SD6314	SD6354	SD6394	SD6434	Page 94

Rate alarm

This function outputs a warning when the change rate of a digital output value is equal to or more than the rate alarm upper limit value, or the rate is equal to or less than the rate alarm lower limit value.

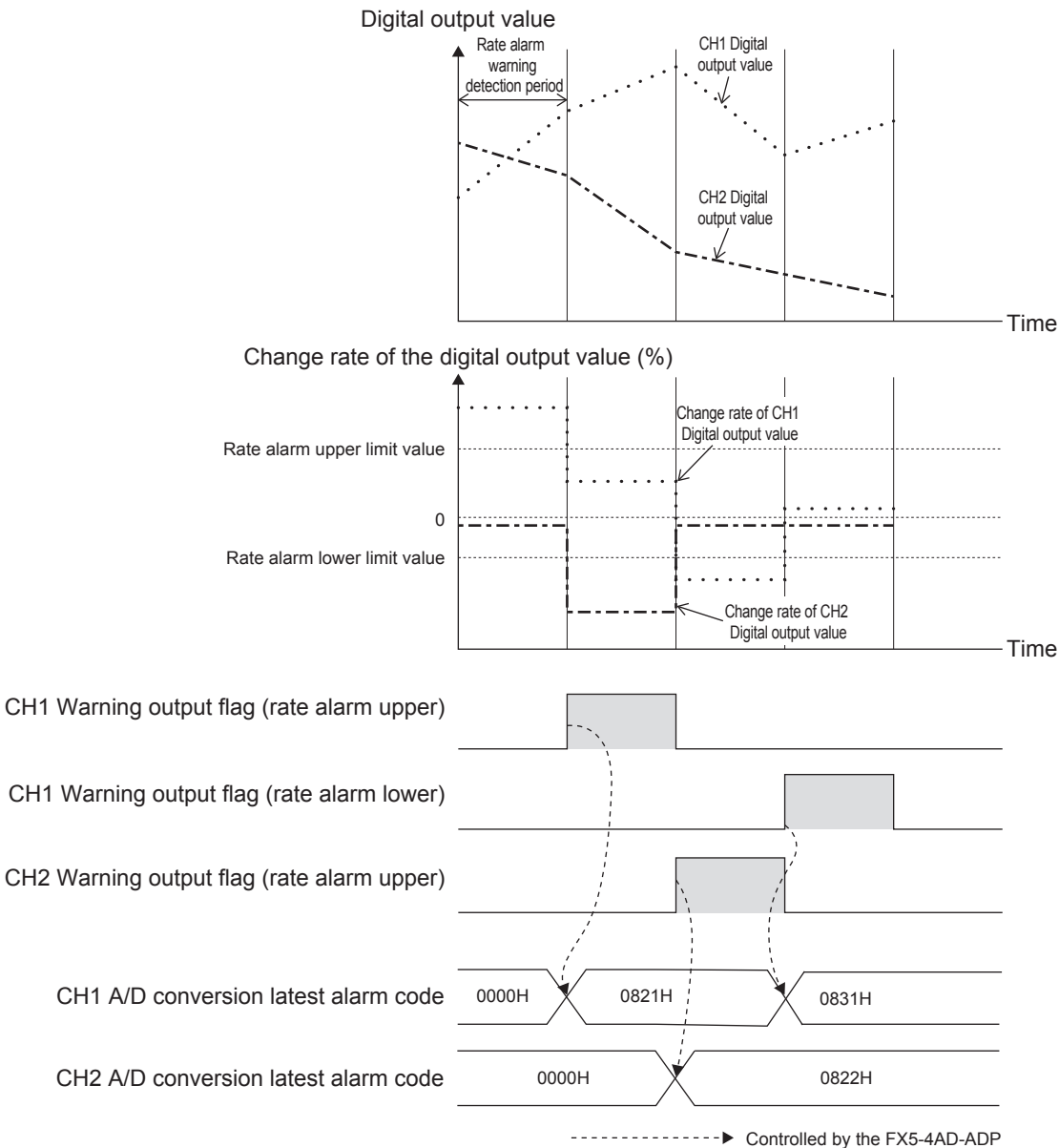

■ Operation

The digital output value is monitored in each rate alarm warning detection period. When the change from the previous value shows the change rate above the rate alarm upper limit value or below the rate alarm lower limit value, the "warning output flag (rate alarm upper limit)" or "warning output flag (rate alarm lower limit)" turns ON.

When the digital output value changes to a value below the rate alarm upper limit value or above the rate alarm lower limit value and the warning output condition is not satisfied after the warning output, the "warning output flag (rate alarm upper limit)" or "warning output flag (rate alarm lower limit)" turns OFF. The "warning output flag (rate alarm upper limit)" and "warning output flag (rate alarm lower limit)" turn OFF also when the "warning output setting (rate alarm)" is set to "disable". However, the alarm code stored in the "A/D conversion latest alarm code" is not cleared.

For clearing the alarm code stored in the latest alarm code, wait until the "warning output flag (rate alarm upper limit)" and "warning output flag (rate alarm lower limit)" turn OFF, and then set the "alarm clear request" to OFF, ON and OFF.

■ Detection cycle

Set the rate alarm warning detection period in "rate alarm warning detection period setting".

■ Judgment of rate alarm

A change rate is judged with "Rate alarm upper limit value" and "Rate alarm lower limit value" converted to digital values per rate alarm warning detection period.

The following shows the conversion formula of judgment values used for the rate alarm detection.

Value used for judgment in every rate alarm alert detection cycle [digit]^{*1} = "Rate alarm upper limit value (lower limit value)" × 0.1 × 0.01 × Maximum digital output value

Ex.

The judgment value under the following conditions

Setting item	Description
Averaging process specify	Sampling processing
Rate alarm warning detection period setting	10 (ms)
Rate alarm upper limit value	250 (25.0 %)
Rate alarm lower limit value	50 (5.0 %)

Upper limit value: $250 \times 0.1 \times 0.01 \times 16000 = 4000$ (digit)

Lower limit value: $50 \times 0.1 \times 0.01 \times 16000 = 800$ (digit)

The current value is compared with the previous value in every rate alarm warning detection period ("10 ms" in this example). It is checked whether the current digital value is larger by more than 4000 digit (25 %) or smaller by more than 800 digit (5 %) compared to the previous value.

The following formula is used to obtain the change rate to be set based on the change amount of the voltage/current to detect warning:

$$\text{Change rate to be set (0.1 \%)} = \left(\frac{\text{Change amount of the voltage (current) to detect warning (V (mA))}}{\text{Gain voltage (current) (V(mA)) - Offset voltage (current) (V (mA))}} \times 1000 \right)^{*1}$$

*1 The value below the decimal point obtained by calculation is rounded.

■ Application examples of rate alarms

A rate alarm serves to monitor that the variation rate of a digital output value lies in a limited range as shown below.

Ex.

To monitor that a rising rate of a digital output value is within the specified range

Change rate of the digital output value (%)

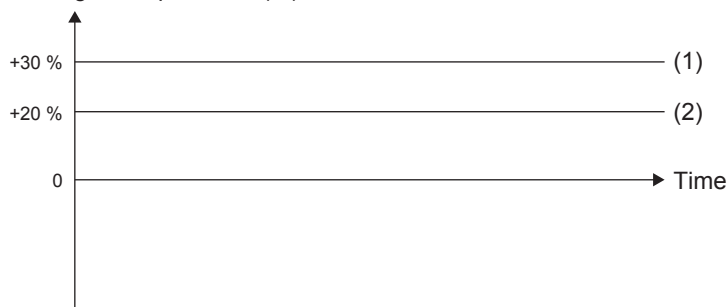

(1) Rate alarm upper value
(2) Rate alarm lower value

Ex.

To monitor that a drop rate of a digital output value is within the specified range

Change rate of the digital output value (%)

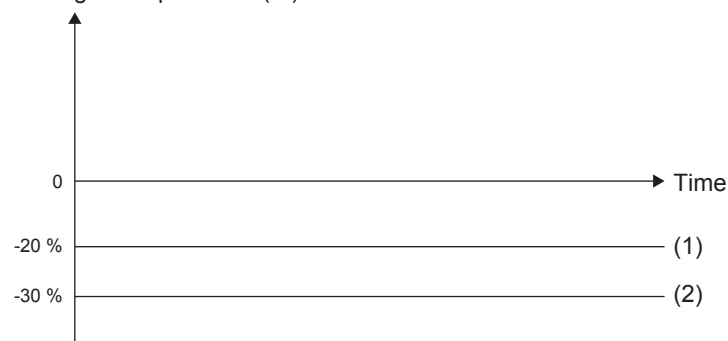

(1) Rate alarm upper value
(2) Rate alarm lower value

Ex.

To monitor that a change rate of a digital output value is within the specified range

Change rate of the digital output value (%)

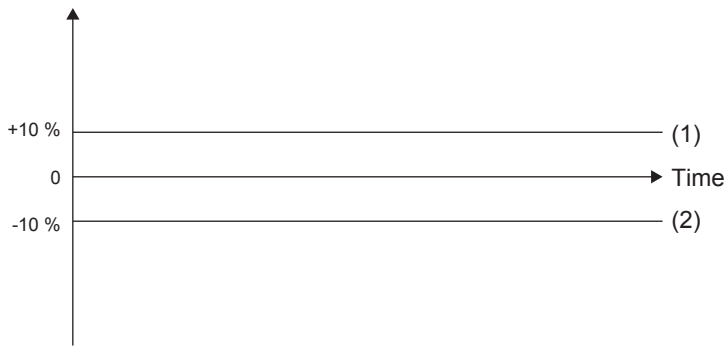

(1) Rate alarm upper value

(2) Rate alarm lower value

Setting procedure

1. Set "Warning output function (Rate alarm)" to "Enable".

Navigation window ⇒ [Parameter] ⇒ [Module Information] ⇒ Module model name ⇒ [Module Parameter] ⇒ "Application Settings" ⇒ "Warning output function (Rate alarm)"

2. Set a warning detection period of rate alarms.

Set the cycle in "Rate alarm warning detection period setting".

Item	Setting range
Rate alarm warning detection period setting	1 to 10000 (ms)

Point

When a value outside the setting range is set, the rate alarm warning detection period setting range error occurs. (Error code: 1A6□H)

3. Set values for "Rate alarm upper limit value" and "Rate alarm lower limit value".

Set a value for the maximum value (16000) of the digital output value in increments of 0.1 %.

Item	Setting range
Rate alarm upper limit value	-1000 to +1000 (0.1 %)
Rate alarm lower limit value	

Point

Set values within the range satisfying the condition "Rate alarm upper limit value > Rate alarm lower limit value".

When not satisfying the above conditions, a rate alarm upper/lower limit setting value inversion error occurs. (Error code: 1A5□H).

Corresponding devices

The devices which are used by the rate alarm are listed below.

Name	CH1	CH2	CH3	CH4	Reference
Warning output flag (rate alarm upper)	SM6315	SM6355	SM6395	SM6435	Page 78
Warning output flag (rate alarm lower)	SM6316	SM6356	SM6396	SM6436	Page 78
Warning output setting (rate alarm)	SM6317	SM6357	SM6397	SM6437	Page 79
Rate alarm upper limit value	SD6315	SD6355	SD6395	SD6435	Page 94
Rate alarm lower limit value	SD6316	SD6356	SD6396	SD6436	Page 95
Rate alarm warning detection period setting	SD6317	SD6357	SD6397	SD6437	Page 95

Disconnection Detection Function

Simple disconnection detection is performed.

This function is enabled when the analog input range is 1 to 5 V or 4 to 20 mA.

Setting procedure

1. Set "Disconnection detection enable/disable setting" to "Enable".

Navigation window ⇒ [Parameter] ⇒ [Module Information] ⇒ Module model name ⇒ [Module Parameter] ⇒ "Application Settings" ⇒ "Disconnection detection enable/disable setting"

2. Set "Disconnection recovery detection enable/disable setting".

Navigation window ⇒ [Parameter] ⇒ [Module Information] ⇒ Module model name ⇒ [Module Parameter] ⇒ "Application Settings" ⇒ "Disconnection recovery detection enable/disable setting"

Corresponding devices

The devices which are used by the disconnection detection function are listed below.

Name	CH1	CH2	CH3	CH4	Reference
Disconnection detection flag	SM6318	SM6358	SM6398	SM6438	Page 79
Disconnection detection enable/disable setting	SM6319	SM6359	SM6399	SM6439	Page 79
Disconnection recovery detection enable/disable setting	SM6320	SM6360	SM6400	SM6440	Page 80

Disconnection detection condition

The table below shows the disconnection detection condition and disconnection recovery condition.

Input range	Disconnection detection condition	Disconnection recovery condition
1 to 5 V	Analog input value ≤ 0.5 V	Analog input value > 0.5 V
4 to 20 mA	Analog input value ≤ 2 mA	Analog input value > 2 mA

Operation

When the input voltage or input current reaches the disconnection detection condition in a channel for which the "A/D conversion enable/disable setting" is set to "enable" and the "disconnection detection enable/disable setting" is set to "enable", it is regarded as disconnection. As a result, alarm occurs and the "disconnection detection flag" turns ON (Alarm code: 0A0□H).

The "A/D conversion completion flag" turns OFF, A/D conversion is interrupted, and the later processing is not executed in the disconnected channel.

When the "disconnection recovery detection enable/disable setting" is set to "enable", the "disconnection detection flag" turns OFF when the channel is recovered from disconnection. When the channel is recovered from disconnection, A/D conversion is restarted.

When the "disconnection recovery detection enable/disable setting" is set to "disable", the "disconnection detection flag" remains ON. It is necessary to set the "alarm clear request" to ON to turn OFF the "disconnection detection flag". The "disconnection detection flag" turns OFF also when the "disconnection detection enable/disable setting" is changed to "disable".

The range setting range error with disconnection detection enabled (Error code: 1AA□H) occurs when the input range of a channel for which the "disconnection detection enable/disable setting" is set to "enable" is set outside "1 to 5 V" or "4 to 20 mA".

■When the "disconnection detection recovery enable/disable setting" is set to "enable"

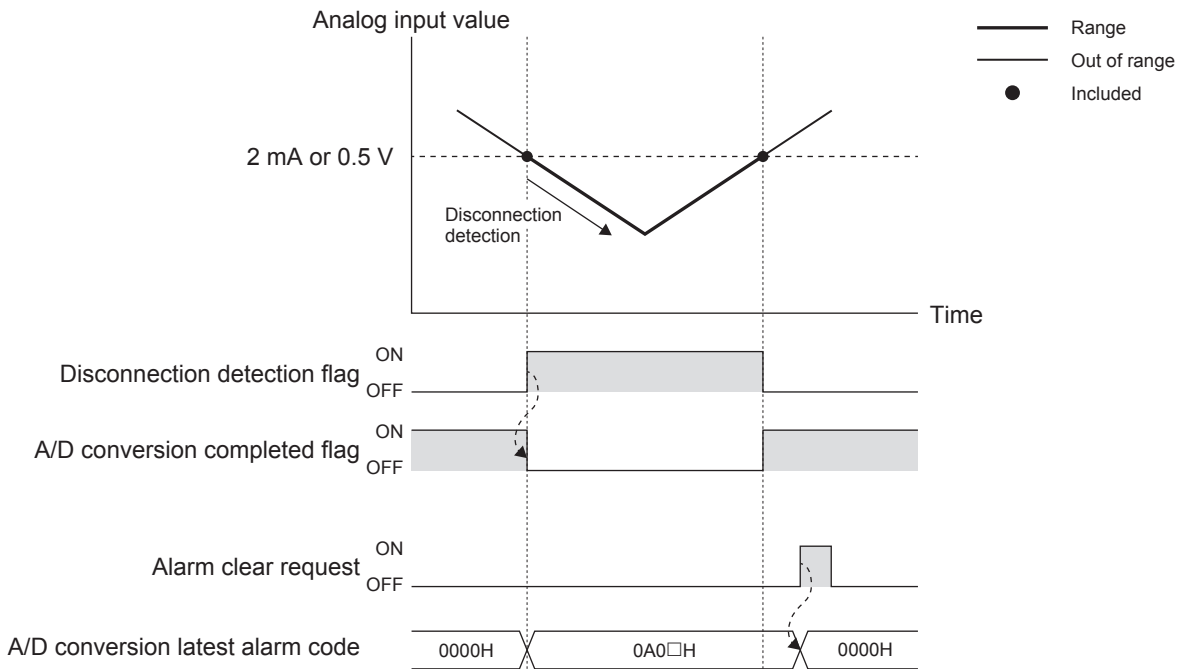

Point

- The "disconnection detection flag" automatically turns OFF.
- For clearing the "A/D conversion latest alarm code", set to ON the "alarm clear request".

■When the "disconnection detection recovery enable/disable setting" is set to "disable"

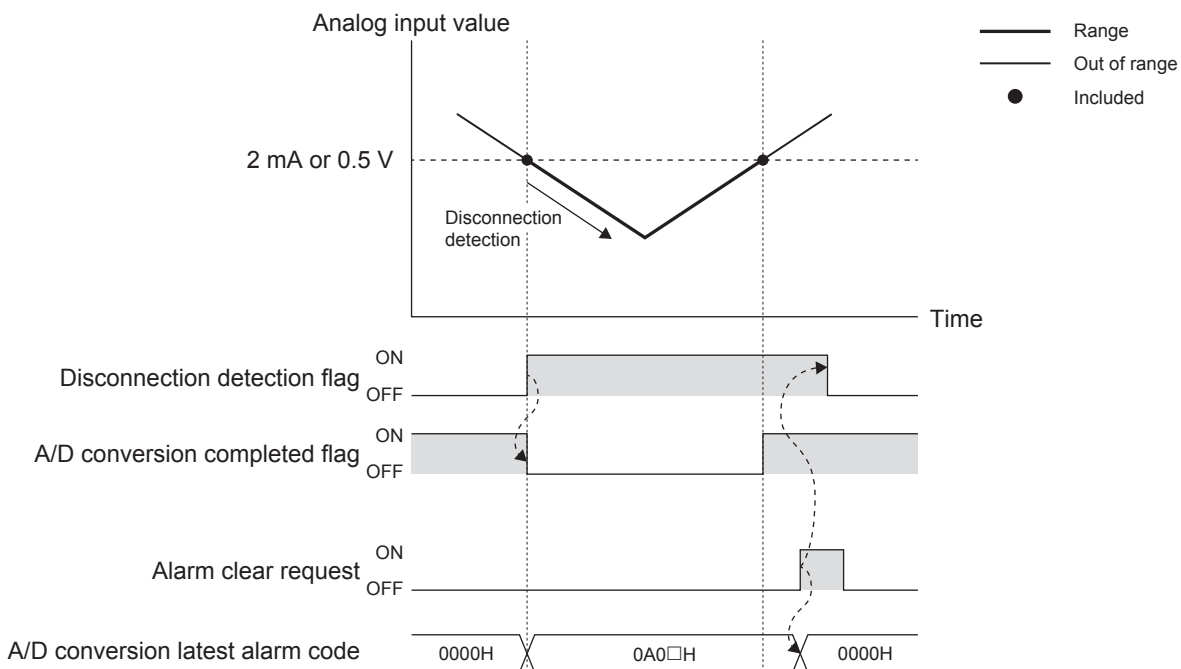

Point

- The "disconnection detection flag" does not automatically turn OFF. To turn OFF this flag, set the "alarm clear request" to ON.
- To clear the "A/D conversion latest alarm code", set the "alarm clear request" to ON.

Convergence Detection Function

This function detects whether the digital operation value is within a certain range in the specified time.

Setting procedure

1. Set "Convergence detection enable/disable setting" to "Enable".

 Navigation window ⇒ [Parameter] ⇒ [Module Information] ⇒ Module model name ⇒ [Module Parameter] ⇒ "Application Settings" ⇒ "Convergence detection enable/disable setting"

2. Set values for "Detection time setting for convergence detection".

Item	Setting range
Detection time setting for convergence detection	1 to 10000 (ms)

Point

When a value outside the setting range is set, the convergence detection time setting range error occurs. (Error code: 1AC□H)

3. Set values for "Convergence detection upper limit value" and "Convergence detection lower limit value".

Item	Setting range
Convergence detection upper limit value	-32768 to +32767
Convergence detection lower limit value	

Point

Set values so that the condition "Convergence detection upper limit value > Convergence detection lower limit value" is satisfied.

When not satisfying the above conditions, a convergence detection upper limit value/lower limit value setting inversion error occurs. (Error code: 1AD□H)

Corresponding devices

The devices which are used by the convergence detection function are listed below.

Name	CH1	CH2	CH3	CH4	Reference
Convergence detection flag	SM6321	SM6361	SM6401	SM6441	Page 80
Convergence detection enable/disable setting	SM6322	SM6362	SM6402	SM6442	Page 80
Convergence detection upper limit value	SD6322	SD6362	SD6402	SD6442	Page 96
Convergence detection lower limit value	SD6323	SD6363	SD6403	SD6443	Page 96
Detection time setting for convergence detection	SD6324	SD6364	SD6404	SD6444	Page 97

Convergence detection condition

The table below shows the convergence detection condition when the "convergence detection enable/disable setting" is set to "enable".

Within convergence range	Outside convergence range
Not less than convergence detection lower limit value and not more than convergence detection upper limit value	Less than convergence detection lower limit value or more than convergence detection upper limit value

Operation

The time starts to be measured when the digital operation value enters the steady state range.

When the digital operation value goes in the convergence range within the time set in the "convergence detection time setting", the "convergence detection flag" turns ON. When the digital operation value goes outside of the convergence range, the "convergence detection flag" turns OFF. The "convergence detection flag" turns OFF also when the "convergence detection enable/disable setting" is changed to "disable".

The digital operation value is always monitored until the "convergence detection enable/disable setting" is set to "disable".

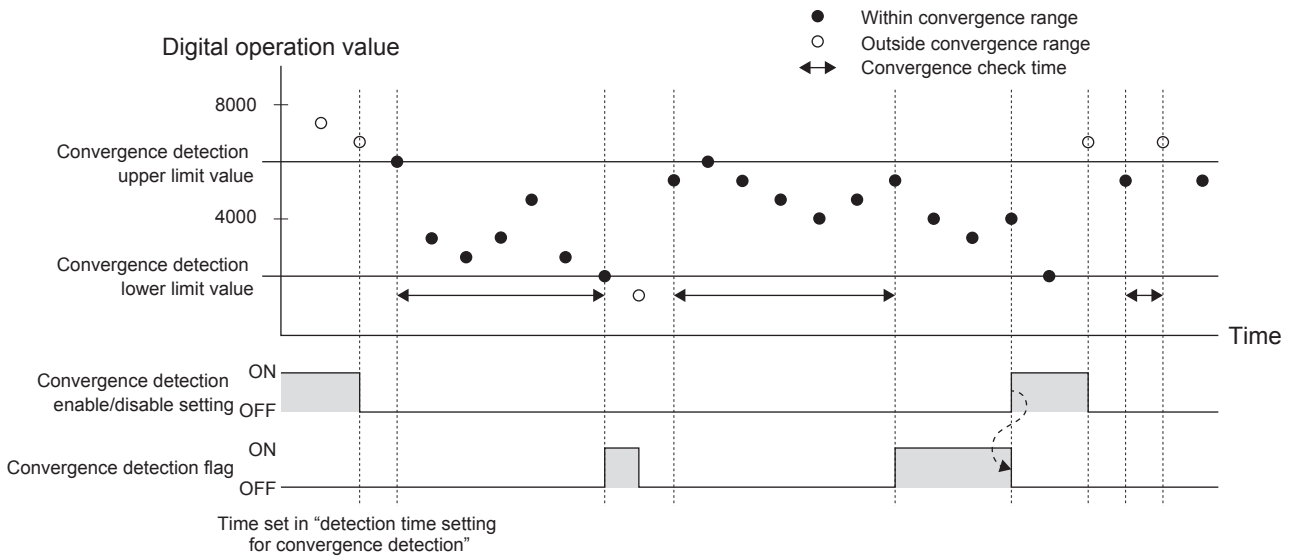

Deviation Detection Between Channel Function

This function detects the difference in the digital operation value between channels larger than a specified value.

Setting procedure

1. Set "Deviation detection trigger between channel" to "Enable".

Navigation window ⇒ [Parameter] ⇒ [Module Information] ⇒ Module model name ⇒ [Module Parameter] ⇒ "Application Settings" ⇒ "Deviation detection trigger between channel"

2. Set values for "Deviation value for deviation detection between channel".

Item	Setting range
Deviation value for deviation detection between channel	0 to 65535

3. Set whether to target each channel for "Deviation detection between channels".

Item	Setting range
CH setting for deviation detection between channel	Non-target
	Target

Corresponding devices

The devices which are used by the deviation detection between channel function are listed below.

Name	CH1	CH2	CH3	CH4	Reference
Deviation detection flag between channel	SM6325	SM6365	SM6405	SM6445	Page 81
Deviation detection trigger between channel	SM6326	SM6366	SM6406	SM6446	Page 81
Deviation detection CH1	SD6325	SD6365	SD6405	SD6445	Page 97
Deviation detection CH2 ^{*1}	SD6326	SD6366	SD6406	SD6446	Page 98
Deviation value for deviation detection between channel	SD6327	SD6367	SD6407	SD6447	Page 98
CH setting 1 for deviation detection between channel	SD6328	SD6368	SD6408	SD6448	Page 99
CH setting 2 for deviation detection between channel ^{*1}	SD6329	SD6369	SD6409	SD6449	Page 99

*1 Only FX5U/FX5UC CPU module is supported.

Operation

The "digital operation value" of the specified channels is compared with the "digital operation value" of the channel set in the "deviation between CH detection CH setting".

When the difference in the digital operation value between the specified channel and the compared channel is equal or more than the "deviation value in deviation between CH detection" even in 1 channel, it is regarded as deviation and the "deviation between CH detection flag" turns ON (Alarm code: 0B0□H).

When the difference in the digital operation value between the specified channel and the compared channel is less than the "deviation value in deviation between CH detection" in all channels, the "deviation between CH detection flag" turns OFF.

When the "deviation between CH detection trigger" is changed to "disable", the "deviation between CH detection flag" turns OFF, and the "deviation detection CH1" and "deviation detection CH2" become "0" (initial value).

Event History Function

This function collects errors from FX5-4AD-ADP, and keeps them in the SD memory card, and data memory or battery backed built-in RAM of the CPU module.

The event information collected by the CPU module can be displayed on GX Works3 to check the occurrence history in chronological order.

Event type	Classification	Description
System	Error	An error detected by the self diagnostics in each module.

Setting procedure

The event history function can be set from the event history setting window of GX Works3. For the setting procedure, refer to the following.

 MELSEC iQ-F FX5 User's Manual (Application)

Displaying event history

Access the menu of GX Works3. For details on the operating procedure and how to view the contents, refer to the following.

 GX Works3 Operating Manual

Offset/gain Setting Function

This function sets any analog value to the offset/gain value without regard to the setting prepared in advance as the analog input range. The offset setting value and gain setting value are saved in the built-in memory of the FX5-4AD-ADP.

For changing the offset/gain data, set an analog value to the "offset setting value" or "gain setting value".

The table below shows the available setting range.

Item	Description	Setting range	
		Voltage input (mV)	Current input (μA)
Offset setting value	Analog input value when the digital value is "0" (offset reference value)	-10000 to +9000	-20000 to +17000
Gain setting value	Analog input value when the digital value is the gain reference value	-9000 to +10000	-17000 to +30000

Point

An offset/Gain setting value range error occurs when the following condition is not satisfied: (Error code: 1A9□H)

- Voltage input: $1000 \leq \text{Gain setting value} - \text{Offset setting value}$
- Current input: $3000 \leq \text{Gain setting value} - \text{Offset setting value} \leq 30000$

The table below shows the reference value and initial value of the offset/gain setting value.

Description		Digital output value	Offset setting value		Gain setting value	
Voltage/ current	Input range		Reference value	Default value	Reference value	Default value
Voltage	0 to 10 V	0 to 16000	0	0 mV	8000	5000 mV
	0 to 5 V	0 to 16000	0	0 mV	16000	5000 mV
	1 to 5 V	0 to 12800	0	1000 mV	12800	5000 mV
	-10 to +10 V	-8000 to +8000	0	0 mV	4000	5000 mV
Current	0 to 20 mA	0 to 16000	0	0 μA	16000	20000 μA
	4 to 20 mA	0 to 12800	0	4000 μA	12800	20000 μA
	-20 to +20 mA	-8000 to +8000	0	0 μA	8000	20000 μA

Setting procedure

Access to the offset/gain setting window in the GX Works3 to set the offset and gain values.

The setting procedure for the offset/gain setting of the FX5-4AD-ADP is as follows:

 [Tool] ⇒ [Module Tool List]

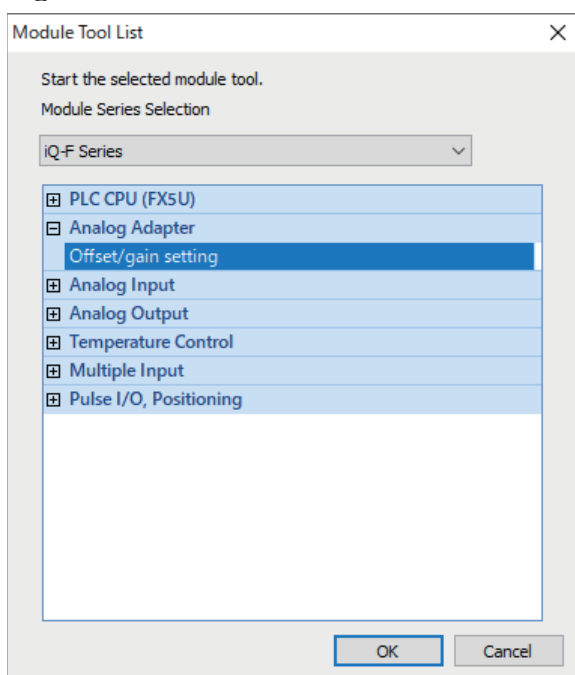

1. In "Analog Adapter", select "Offset/gain setting" and click [OK] button.

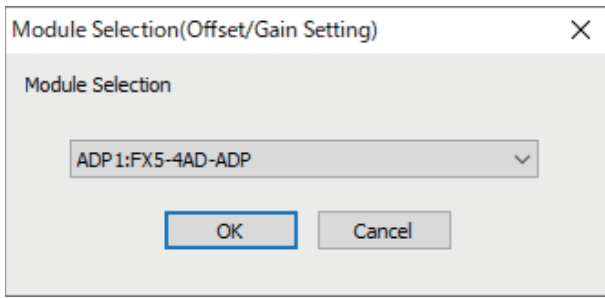

2. Select the target module for the offset/gain setting, and click [OK] button.

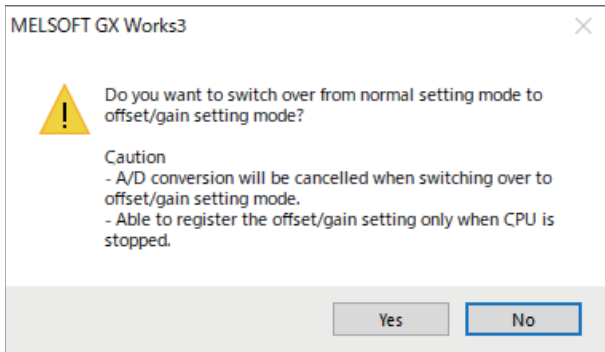

3. Click [Yes] button.

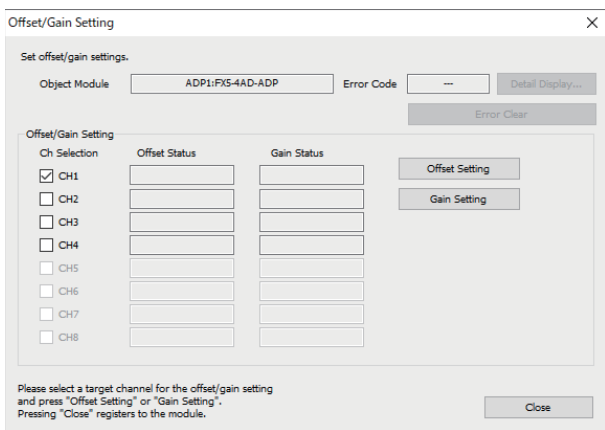

4. Mark the checkbox of the channel where offset and gain values are to be set, and click [Offset Setting] button.

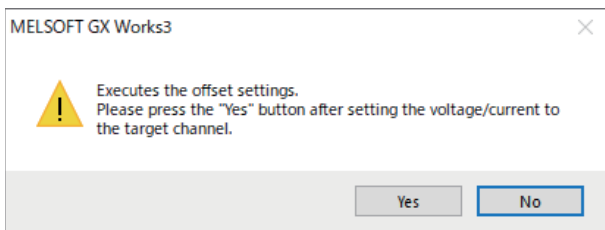

5. Apply the offset voltage or current to the terminal of the corresponding channel, and click [Yes] button.

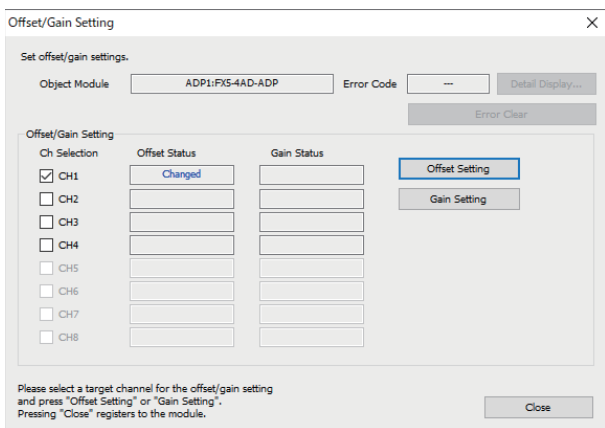

6. Check that "Offset Status" has changed to "Changed", and click [Gain Setting] button.

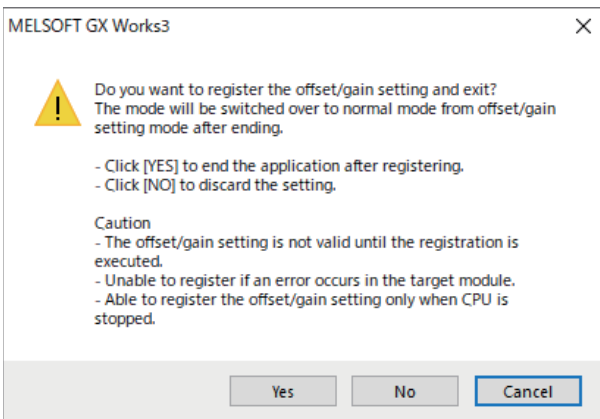
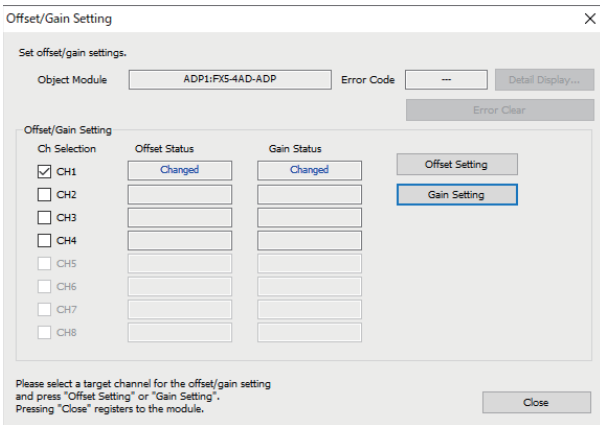
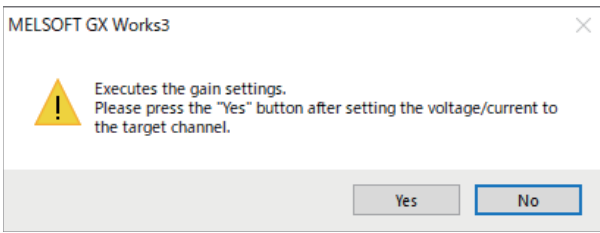

7. Apply the gain voltage or current to the terminal of the corresponding channel, and click [Yes] button.
8. Check that "Gain Status" has changed to "Changed", and click [Close] button.
9. Click [Yes] button.

Corresponding devices

The devices which are used by the offset/gain setting function are listed below.

Name	CH1	CH2	CH3	CH4	Reference
Offset/gain reading	SM6332	SM6372	SM6412	SM6452	Page 81
Offset/gain writing	SM6333	SM6373	SM6413	SM6453	Page 82
Offset setting value	SD6332	SD6372	SD6412	SD6452	Page 100
Gain setting value	SD6333	SD6373	SD6413	SD6453	Page 100
Offset/gain writing enable code	SD6334	SD6374	SD6414	SD6454	Page 100

Operation

■Offset/gain writing

For changing the offset/gain data, set "E20FH" to the "offset/gain writing enable code" and set the "offset/gain writing" from OFF to ON to write the "input range setting", "offset setting value" and "gain setting value" to the built-in memory of the FX5-4AD-ADP. Only 1 range can be changed for 1 channel, and the latest contents are valid.

When writing is completed, the "offset/gain writing" automatically turns OFF. Also, the "offset/gain writing enable code" is cleared to 0.

When the "input range setting" is changed, the initial value becomes valid.

For returning the offset/gain data to the initial value, use the offset/gain initialization function (☞ Page 56 Offset/gain Initialization Function).

Point

- The offset/gain value is written when the "offset/gain writing enable code" is set to "E20FH".
- The offset/gain value can be written only while A/D conversion is disabled.
- The "A/D conversion enable/disable setting" cannot be changed to "enable" while the offset/gain value is being written.

■ Offset/gain reading

For reading the offset/gain data saved in the built-in memory of the FX5-4AD-ADP, set the "offset/gain reading" from OFF to ON to read the "input range setting", "offset setting value" and "gain setting value".

When the input range setting selected during reading is equivalent to the input range setting saved in the built-in memory of the FX5-4AD-ADP, the read values are set to the "offset setting value" and "gain setting value".

If the input range setting is different, the initial value of the input range setting selected during reading is valid and set to the "offset setting value" and "gain setting value". In this case, the offset/gain setting input range mismatch alarm occurs (Alarm code: 0C0□H).

Offset/gain Initialization Function

This function initializes the offset value and gain value saved in the built-in memory of the FX5-4AD-ADP.

This function can be set only with special devices.

Setting procedure

1. Set "E20FH" to the "offset/gain writing enable code".

Setting value	Description	Default value
Other than E20FH	Offset/gain writing disable	0
E20FH	Offset/gain writing enable	

2. Set the "offset/gain initialization" from OFF to ON.

Setting value	Description	Default value
0: OFF	Offset/gain initialization is not performed.	0: OFF
1: ON	Offset/gain initialization is performed.	

Corresponding devices

The devices which are used by the offset/gain initialization function are listed below.

Name	CH1	CH2	CH3	CH4	Reference
Offset/gain initialization	SM6334	SM6374	SM6414	SM6454	Page 82
Offset/gain writing enable code	SD6334	SD6374	SD6414	SD6454	Page 100

Operation

Set "E20FH" to the "offset/gain writing enable code" and set the "offset/gain initialization" from OFF to ON to initialize the offset value and gain value saved in the built-in memory of the FX5-4AD-ADP. When initialization is completed, the "offset/gain initialization" automatically turns OFF. Also, the "offset/gain writing enable code" is cleared to 0.

Point

- Offset/gain initialization is executed when the "offset/gain writing enable code" is set to "E20FH".
- Offset/gain initialization is enabled only while A/D conversion is disabled.
- The "A/D conversion enable/disable setting" cannot be changed to "enable" while offset/gain initialization is being executed.

Common Function

Changing the setting value while the CPU module is operating

This paragraph shows the procedure to adopt values (of special relays and special registers) other than the values set by the parameters of GX Works3.

1. Disable A/D conversion.

Set "A/D conversion enable/disable setting" to ON. (☞ Page 74 A/D conversion enable/disable setting)

2. Change the value of a target special relay/device.

Change the value of a target device.

3. Enable A/D conversion.

Set "A/D conversion enable/disable setting" to OFF. (☞ Page 74 A/D conversion enable/disable setting)

Precautions

- An alarm occurs when the value of a special relay/device is changed while A/D conversion is enabled (Alarm code: 0F0□H).
- When the value of a special relay/device related to the scaling, shift, average counts or averaging processing specification was changed in A/D conversion and "count average" or "moving average" was specified as the averaging processing, clear the number of times of sampling and execute sampling again from "0 time".

Starting/stopping the analog function in accordance with the CPU module status

This paragraph shows the analog operation in accordance with the CPU module status.

■RUN

The FX5-4AD-ADP operates in accordance with its parameters.

■PAUSE

The FX5-4AD-ADP operates in accordance with its parameters.

■STOP

The FX5-4AD-ADP continues A/D conversion.

Alarm clear request

It is necessary to set the "alarm clear request" from OFF to ON to clear the alarm code.

The table below shows the necessity of the alarm clear request for turning OFF each flag and clearing the alarm code.

Flag name	Alarm clear request required to turn OFF the flag	Alarm clear request required to clear the alarm code
A/D conversion completed flag	—	—
Over scale upper limit detection flag	○	○
Over scale lower limit detection flag	○	○
Maximum value/minimum value reset completed flag	—	—
Warning output flag (process alarm upper limit)	—	○
Warning output flag (process alarm lower limit)	—	○
Warning output flag (rate alarm upper)	—	○
Warning output flag (rate alarm lower)	—	○
Disconnection detection flag	○*1	○
Convergence detection flag	—	—
Deviation detection flag between channel	—	○

*1 The alarm clear request is required when disconnection recovery is set to "disable".

○: Requires the alarm clear request.

—: Does not require the alarm clear request.

- The "alarm clear request" is required for flags which do not turn OFF automatically and flags which cause alarms.
- The "alarm clear request" is not turned off automatically. To perform an alarm clear again, it is necessary to turn it OFF once.
- Use the "error clear request" (SM50) of the CPU module to turn OFF the A/D conversion error flag and clear the A/D conversion latest error code.

2.4 Procedure to Execute the FX5-4AD-ADP

The procedure to execute the FX5-4AD-ADP is described below.

1. Confirm the specifications of the FX5-4AD-ADP.

Confirm the specifications of the FX5-4AD-ADP. ( Page 24 Specifications)

2. Check the system configuration.

Check the system configuration. ( Page 59 System Configuration)

3. Attach the FX5-4AD-ADP.

Refer to the following manuals for attachment to the CPU module:

 MELSEC iQ-F FX5UJ User's Manual (Hardware)

 MELSEC iQ-F FX5U User's Manual (Hardware)

 MELSEC iQ-F FX5UC User's Manual (Hardware)

4. Connect the FX5-4AD-ADP to the external device.

Wiring to external devices. ( Page 60 Wiring)

5. Set the parameters.

Set the parameters to configure the FX5-4AD-ADP. ( Page 62 Parameter Setting)

6. Create the program.

Create the program to use the FX5-4AD-ADP.

7. Run the program.

Precautions

Do not write to the special relay/special register in the user interrupt program.

2.5 System Configuration

This section describes the system configuration including analog adapters.

Up to two analog adapters can be connected to an FX5UJ CPU module.

Up to four analog adapters can be connected to an FX5U/FX5UC CPU module.*¹

The connection position of the analog adapter connected to each CPU module are counted as the first module, the second module, and so on in order of proximity to the CPU module.

However, communication adapters are not counted towards the number of analog adapters.

■FX5UJ CPU module

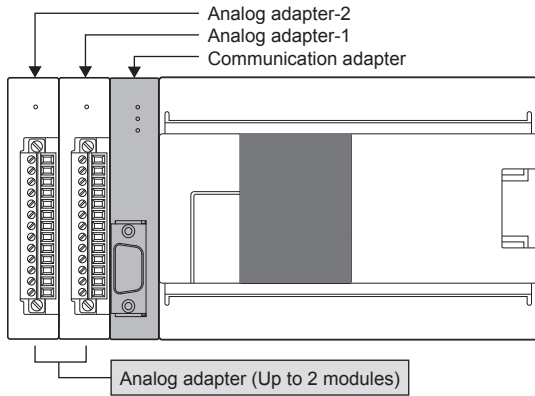

■FX5U CPU module

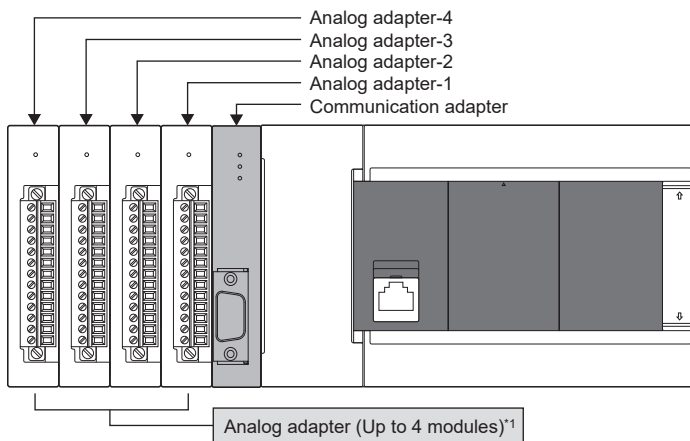

■FX5UC CPU module

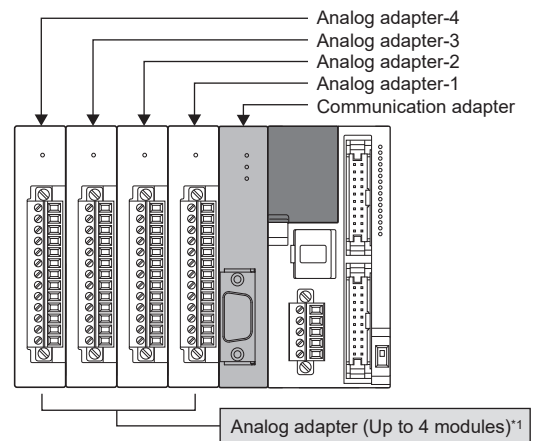

*¹ For FX5-4A-ADP, up to two modules can be connected.

2.6 Wiring

This section describes the wiring.

European-type terminal block

Wire the European-type terminal block in accordance with the following specifications.

Suitable wiring

Number of wires connected per terminal	Wire size		Tightening torque
	Solid wire, Stranded wire	Wire ferrule with insulation sleeve	
One wire	0.3 to 0.5 mm ² (AWG22 to 20)	0.3 to 0.5 mm ² (AWG22 to 20)	0.20 N·m
Two wires	0.3 mm ² (AWG22)	—	

Precautions

Do not tighten terminal screws with torque exceeding the specified range. Failure to do so may cause equipment failures or malfunctions.

Wire end treatment

Treat stranded and solid wires as they are or use wire ferrules with insulation sleeves for wiring terminals.

■When stranded and solid wires are treated as they are

- Twist the end of stranded wires and make sure that there are no loose wires.
- Do not solder-plate the electric wire ends.

Stripping dimensions of electric wire ends

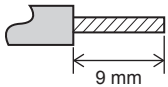

■When wire ferrules with insulation sleeves are used

Depending on the thickness of a wiring sheath used, it may be difficult to insert the sheath into an insulation sleeve. Refer to the external dimensions as a reference to select wires.

External dimension of wire ferrules with insulation sleeves

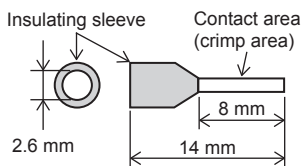

<Reference>

Manufacturer	Model	Crimp tool
Phoenix Contact GmbH & Co. KG	AI 0.5-8 WH	CRIMPFOX 6 CRIMPFOX 6T-F

■Tool

For tightening terminals, use a small, commercially-available screwdriver with a straight tip. The recommended shape is shown in the figure on the right.

■Precautions

When a precision screwdriver with a small grip is used, the specified tightening torque cannot be obtained. Use the following screwdriver or equivalent product (grip diameter: 25 mm) to obtain the tightening torque specified above.

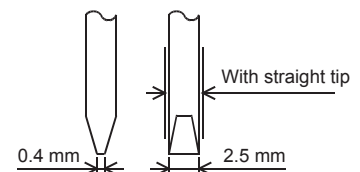

<Reference>

Manufacturer	Model
Phoenix Contact GmbH & Co. KG	SZS 0.4×2.5

Terminal layout

The following table shows the terminal layout

Terminal block	Signal name	Function
	V1+	CH1 Voltage/current input For current input short circuit Common
	I1+	
	COM1	
	V2+	CH2 Voltage/current input For current input short circuit Common
	I2+	
	COM2	
	V3+	CH3 Voltage/current input For current input short circuit Common
	I3+	
	COM3	
	V4+	CH4 Voltage/current input For current input short circuit Common
	I4+	
	COM4	
		⏏

Analog input wiring

The following figures show wiring of the analog input.

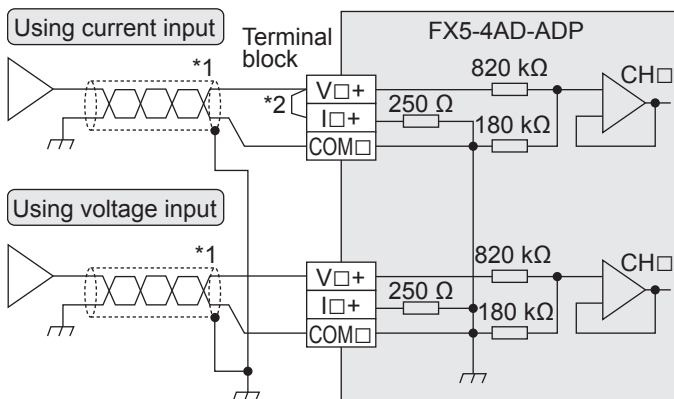

V□+, I□+, COM□, CH□: □ represents the channel number.

- *1 For analog input wiring, use shielded twisted-pair cables (double-core type). Separate them from other power lines or lines which can be induced by others.
- *2 For unused channels, short-circuit the "V□+" and "I□+" terminals.

Grounding

Perform the following.

- Perform class D grounding (Grounding resistance: 100 Ω or less).
- Ground the PLC independently when possible.

If the PLC cannot be grounded independently, perform the "Shared grounding" shown below.

For the details, refer to the following manual.

- 📖 MELSEC iQ-F FX5UJ User's Manual (Hardware)
- 📖 MELSEC iQ-F FX5U User's Manual (Hardware)
- 📖 MELSEC iQ-F FX5UC User's Manual (Hardware)

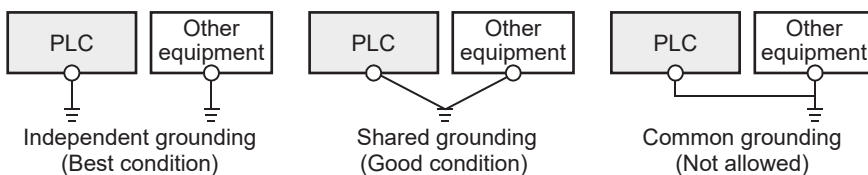

- Use a grounding wire with thickness of AWG 22 to 20 (0.3 to 0.5 mm²).
- Bring the grounding point close to the PLC as much as possible so that the ground cable can be shortened.

2.7 Parameter Setting

Set the parameters of each channel.

Setting parameters here eliminates the need to program them.

Point

Parameters are enabled when the CPU module is powered ON or after a reset. In addition, operations different from the parameter settings are possible by transferring values to special relays and special registers while changing these values in the program.

Refer to Page 70 List of Special Relays or Page 84 List of Special Registers for details on the special relays and special registers.

Basic settings

Setting procedure

Open "Basic Settings" of the GX Works3.

1. Start Module parameter.

Navigation window ⇒ [Parameter] ⇒ [Module Information] ⇒ Module model name ⇒ [Module Parameter] ⇒ "Basic Settings"

Window

Item	CH1	CH2	CH3	CH4
A/D Conversion Enable/Disable Setting Function	Set A/D conversion method.			
A/D Conversion Enable/Disable Setting	Disable	Disable	Disable	Disable
A/D Conversion Method	Set A/D conversion method.			
Average Processing Specify	Sampling Processing	Sampling Processing	Sampling Processing	Sampling Processing
Time Average Counts Average Moving Average	0 Times	0 Times	0 Times	0 Times
Range switching function	Able to set the analog input range and to change the input conversion characteristics.			
Input range setting	Input Voltage (0 to 10V)	Input Voltage (0 to 10V)	Input Voltage (0 to 10V)	Input Voltage (0 to 10V)

Displayed items

Item	Description	Setting range	Default
A/D Conversion Enable/Disable Setting	Set whether to "enable" or "disable" AD conversion value output.	<ul style="list-style-type: none"> Disable Enable 	Disable
Average Processing Specify	Execute whether to set "average process" or "sampling processing".	<ul style="list-style-type: none"> Sampling Processing Time Average Count Average Moving Average 	Sampling Processing
Time Average Counts Average Moving Average	Set average time, average counts, moving average counts when specifying average process for each channel.	Set range setting for each channel.	—
Input range setting	Setting area for input range setting.	<ul style="list-style-type: none"> Input Voltage (0 to 10 V) Input Voltage (0 to 5 V) Input Voltage (1 to 5 V) Input Voltage (-10 to 10 V) Input Current (0 to 20 mA) Input Current (4 to 20 mA) Input Current (-20 to 20 mA) 	Input Voltage (0 to 10 V)

2. Click the item to be changed to enter the setting value.

- Item where a value is selected from the pull-down list

Click [▼] button of the item to be set, and from the pull-down list that appears, select the value.

- Item where a value is entered into the text box

Double-click the item to be set to enter the numeric value.

Application settings

Setting procedure

Open "Application Settings" of the GX Works3.

1. Start Module parameter.

Navigation window ⇒ [Parameter] ⇒ [Module Information] ⇒ Module model name ⇒ [Module Parameter] ⇒ "Application Settings"

Window

Item	CH1	CH2	CH3	CH4
Warning output function (Process alarm)				
Execute the setting related to warning at A/D conversion.				
Warning output setting (Process alarm)	Disable	Disable	Disable	Disable
Process Alarm Upper Upper Limit Value	0	0	0	0
Process Alarm Upper Lower Limit Value	0	0	0	0
Process Alarm Lower Upper Limit Value	0	0	0	0
Process Alarm Lower Lower Limit Value	0	0	0	0
Warning output function (Rate alarm)				
Set the value for the warning when A/D conversion is executed.				
Warning output setting (Rate alarm)	Disable	Disable	Disable	Disable
Rate alarm warning detection period setting	1 ms	1 ms	1 ms	1 ms
Rate alarm upper limit value	0	0	0	0
Rate alarm lower limit value	0	0	0	0
Over Scale Detection				
Execute the setting related to analog input value detection which exceeds the setting range.				
Over Scale Detection Enable/Disable	Disable	Disable	Disable	Disable
Scaling Setting				
Execute the setting related to scaling at A/D conversion.				
Scaling Enable/Disable	Disable	Disable	Disable	Disable
Scaling Upper Limit Value	0	0	0	0
Scaling Lower Limit Value	0	0	0	0
Shift Function				
Execute the setting related to shift function at A/D conversion.				
Shifting amount to conversion value	0	0	0	0
Digital Clip Setting				
Execute the setting related to digital clip function at A/D conversion.				
Digital Clip Enable/Disable	Disable	Disable	Disable	Disable
Disconnection detection function				
Set value for Disconnection detection.				
Disconnection detection enable/disable setting	Disable	Disable	Disable	Disable
Disconnection recovery detection enable/disable setting	Disable	Disable	Disable	Disable
Convergence detection function				
Set value for Convergence detection.				
Convergence detection enable/disable setting	Disable	Disable	Disable	Disable
Convergence detection upper limit value	0	0	0	0
Convergence detection lower limit value	0	0	0	0
Detection time setting for Convergence detection	1 ms	1 ms	1 ms	1 ms
Deviation detection function between channels				
Set value for Deviation detection between channels.				
Deviation detection trigger between channels	Disable	Disable	Disable	Disable
Deviation value for deviation detection between channels	0	0	0	0
Target CH setting for deviation detection between channels: No.1 CH1	Non-target	Non-target	Non-target	Non-target

Displayed items

Item	Description	Setting range	Default
Warning output setting (Process alarm)	Set whether to "enable" or "disable" process alarm warning.	• Disable • Enable	Disable
Process Alarm Upper Upper Limit Value	Set upper upper limit value of digital output value.	-32768 to +32767	—
Process Alarm Upper Lower Limit Value	Set upper lower limit value of digital output value.	-32768 to +32767	—
Process Alarm Lower Upper Limit Value	Set lower upper limit value of digital output value.	-32768 to +32767	—
Process Alarm Lower Lower Limit Value	Set lower lower limit value of digital output value.	-32768 to +32767	—
Warning output setting (Rate alarm)	Set whether to "enable" or "disable" the rate alarm warning.	• Disable • Enable	Disable
Rate alarm warning detection period setting	Set the value for the sampling cycle to detect the rate alarm warning.	1 to 10000	—
Rate alarm upper limit value	Set the upper limit value of the digital output value.	-999 to +1000	—
Rate alarm lower limit value	Set the lower limit value of the digital output value.	-1000 to +999	—

Item	Description	Setting range	Default
Over Scale Detection Enable/Disable	Set whether to "enable" or "disable" over scale detection.	<ul style="list-style-type: none"> • Disable • Enable 	Disable
Scaling Enable/Disable	Set whether to "enable" or "disable" scaling.	<ul style="list-style-type: none"> • Disable • Enable 	Disable
Scaling Upper Limit Value	Set the upper limit value for scaling calculation.	-32768 to +32767	—
Scaling Lower Limit Value	Set the lower limit value for scaling calculation.	-32768 to +32767	—
Shifting amount to conversion value	Set shifting amount for shifting function.	-32768 to +32767	0
Digital Clip Enable/Disable	Whether to "enable" or "disable" digital clip.	<ul style="list-style-type: none"> • Disable • Enable 	Disable
Disconnection detection enable/disable setting	Set whether to "enable" or "disable" disconnection detection.	<ul style="list-style-type: none"> • Disable • Enable 	Disable
Disconnection recovery detection enable/disable setting	Set whether to "enable" or "disable" disconnection recovery detection.	<ul style="list-style-type: none"> • Disable • Enable 	Disable
Convergence detection enable/disable setting	Set whether to "enable" or "disable" convergence detection.	<ul style="list-style-type: none"> • Disable • Enable 	Disable
Convergence detection upper limit value	Set the upper limit value for convergence range.	-32767 to +32767	—
Convergence detection lower limit value	Set the lower limit value for convergence range.	-32768 to +32766	—
Detection time setting for Convergence detection	Set the convergence time.	1 to 10000	—
Deviation detection trigger between channels	Set whether to "enable" or "disable" deviation detection between channels.	<ul style="list-style-type: none"> • Disable • Enable 	Disable
Deviation value for deviation detection between channels	Set the deviation value for deviation detection between channels.	0 to 65535	—
Target CH setting for deviation detection between channels: No. 1 to 4, CH1 to 4	Set whether to target each channel for deviation detection between channels.	<ul style="list-style-type: none"> • Non-target • Target 	Non-target

2. Click the item to be changed to enter the setting value.

- Item where a value is selected from the pull-down list

Click [▼] button of the item to be set, and from the pull-down list that appears, select the value.

- Item where a value is entered into the text box

Double-click the item to be set to enter the numeric value.

2.8 Troubleshooting

This section describes errors that may occur in the use of the FX5-4AD-ADP and those troubleshooting.

Troubleshooting with the LEDs

Check the state of the LED to narrow down the possible causes of the trouble. This step is the first diagnostics.

A state of the FX5-4AD-ADP can be checked with the PWR LED. The following table shows the correspondence of LED and a state of the FX5-4AD-ADP.

Name	Description
PWR LED	Indicates the power supply status of the FX5-4AD-ADP. On: The power supply is supplied. Off: The power supply is not supplied.

Checking the state of the module

Open the module diagnostics window of the GX Works3 to check the error codes (alarm codes) and error history of the FX5-4AD-ADP.

[Diagnostics] ⇒ [Module Diagnostics (CPU Diagnostics)]

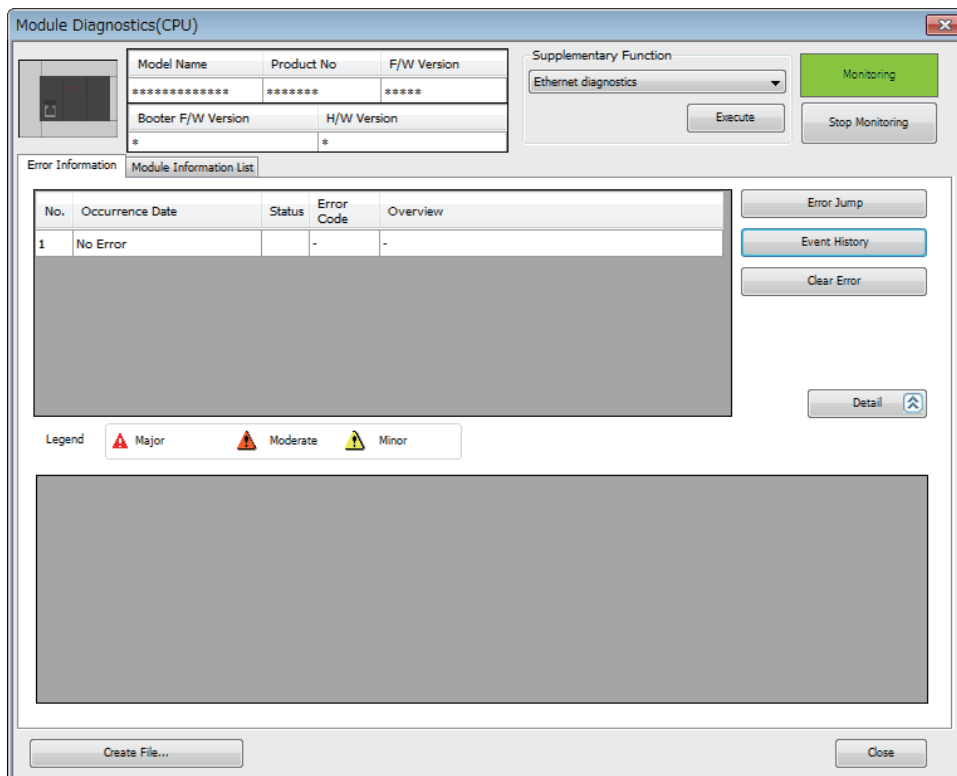

Error history, alarm history can be checked with the event history window of the GX Works3.

[Diagnostics] ⇒ [[Module Diagnostics (CPU Diagnostics)] ⇒ [Event History] button

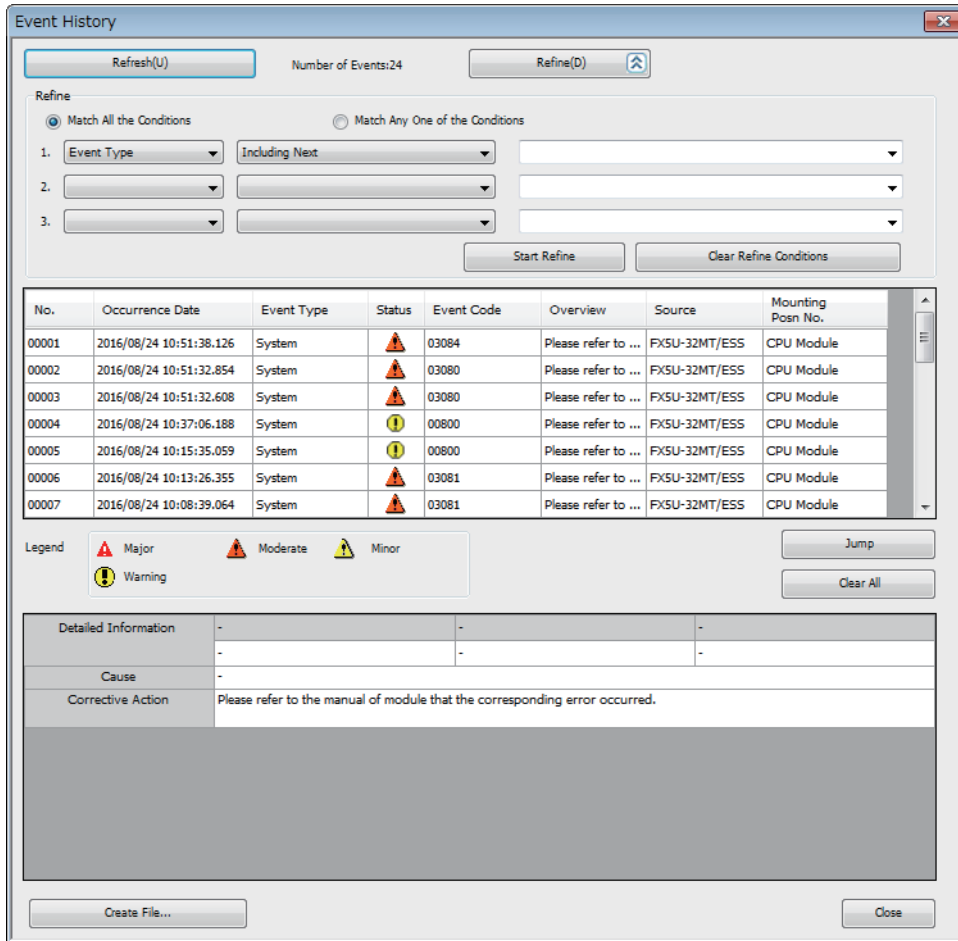

Troubleshooting by Symptom

When the PWR LED does not turn ON

Check item	Action
Check whether the power is supplied.	Check whether the voltage supplied to the CPU module is within the rated range.
Whether the FX5-4AD-ADP is attached normally to the CPU module.	Check the FX5-4AD-ADP attachment status.

When a digital output value cannot be read

Check item	Action
Whether the analog signal cable is connected normally to the FX5-4AD-ADP.	Check the signal cables visually, and wire the analog signal cable correctly.
Whether the external equipment is wired correctly.	Wire the external equipment correctly to the FX5-4AD-ADP. <ul style="list-style-type: none"> • Check whether the shield wire of the channel to be used is grounded. • Check whether the V\square+ terminal and I\square+ terminal are connected to each other when the current is input.
Whether the offset/gain is set correctly.	Check whether the offset/gain is set correctly. Check whether A/D conversion is executed correctly. When A/D conversion is executed correctly, set the offset/gain again.
Check whether the input range setting is correct.	Check the input range setting in the parameter setting of GX Works3. If the contents of setting are wrong, set the input range again.
Whether the "A/D conversion enable/disable setting" is set to "enable" for the channel to be used.	Check the "A/D conversion enable/disable setting" for the channel to be used in the parameter setting of GX Works3, and set "enable" in the parameter of GX Works3 or in the program.

When the digital output value does not change

Check item	Action
Whether disconnection is detected.	Remove the cause of disconnection by replacing the analog signal cable, etc., and then check the digital output value.
Whether over-scale is detected.	Remove the cause of over-scale, and then check the digital output value.
Whether the shift function is working with a proper setting value	Set the conversion value shift amount suitable for the system.

When a value is not converted into the expected digital output value

Check item	Action
Check whether the input range setting is correct.	Check the input range setting in the parameter setting of GX Works3. If the contents of setting are wrong, set the input range again.
Check whether the offset/gain setting is correct.	Check whether the offset/gain is set correctly. Check whether A/D conversion is executed correctly. When A/D conversion is executed correctly, set the offset/gain again.
Whether the A/D conversion method is set correctly.	Check the A/D conversion method in the parameter setting of GX Works3. If the contents of setting are wrong, set the A/D conversion method again.
Whether the scaling function is set correctly.	When the scaling function is used, check the scaling function setting in the parameter setting of GX Works3. If the contents of setting are wrong, set the scaling function again.
Whether the shift function is working with a proper setting value.	Set the conversion value shift amount suitable for the system.

When the digital output value is dispersed

Check item	Action
Whether an A/D conversion method other than sampling processing is set.	Check the A/D conversion method in the parameter setting of GX Works3. Set the averaging processing to the A/D conversion method, and then check again for dispersion of the digital output value.

When the A/D conversion completed flag does not turn ON

Check item	Action
Whether A/D conversion is disabled in every channel.	Check the channels for which A/D conversion is enabled in the parameter setting of GX Works3. If A/D conversion is not enabled in any channel, enable A/D conversion for 1 or more channels in the parameter of GX Works3 or in the program.
Whether disconnection is detected.	Remove the cause of disconnection by replacing the analog signal cable, etc., and then check the digital output value.

Point

If digital output values cannot be read even after the above actions are taken, the possible cause is a failure of the FX5-4AD-ADP. Please consult your local Mitsubishi representative.

2.9 List of Error Code

The following table lists the error codes that may be stored.

□: This symbol indicates the number of the channel where a error has occurred. (1: CH1 to 4: CH4)

Error code	Error name	Description and cause	Action
0000H	—	There is no error.	—
1A0□H	Averaging process specification setting range error	A value other than 0 to 3 was set in CH□ Averaging process specification.	Reset CH□ the Averaging process specification to 0 to 3.
1A1□H	Average time setting range error	When the time average is set to CH□ Averaging process specification, a value other than 1 to 10000 was set to CH□ time average/count average/moving average settings.	Reset CH□ time average/count average/moving average setting to the following value. 1 to 10000
1A2□H	Average count setting range error	When the count average is set to CH□ Averaging process specification, a value other than 4 to 32767 was set to CH□ time average/count average/moving average settings.	Reset CH□ time average/count average/moving average setting to the following value. 4 to 32767

Error code	Error name	Description and cause	Action
1A3□H	Moving average count setting range error	When the moving average is set to CH□ Averaging process specification, the following value was set to CH□ moving average count setting. Value other than 2 to 64	Reset CH□ moving average process setting to the following value. 2 to 64
1A4□H	Process alarm upper-lower limit value setting range error	The value not meeting the following conditions was set to CH□ process alarm upper-upper limit value to CH□ process alarm lower-lower limit value. Upper-upper limit value ≥ Upper-lower limit value ≥ Lower-upper limit value ≥ Lower-lower limit value	Reset CH□ process alarm upper-upper limit value to CH□ process alarm lower-lower limit value to the value meeting the following conditions. Upper-upper limit value ≥ Upper-lower limit value ≥ Lower-upper limit value ≥ Lower-lower limit value
1A5□H	Rate alarm upper limit value/lower limit value setting inversion error	Lower limit value ≥ upper limit value was set to CH□ rate alarm upper limit value and CH□ rate alarm lower limit value.	Reset CH□ rate alarm upper limit value and CH□ rate alarm lower limit value to lower limit value < upper limit value.
1A6□H	Rate alarm warning detection period setting range error	A value other than 1 to 10000 was set to CH□ rate alarm warning detection period setting.	Reset the CH□ rate alarm warning detection period setting to the value within 1 to 10000.
1A7□H	Scaling upper and lower limit value setting error	CH□ Scaling upper limit value and CH□ Scaling lower limit value are equal.	Reset CH□ Scaling upper limit value or CH□ scaling lower limit value such that Scaling upper limit value ≠ Scaling lower limit value.
1A8□H	Range setting range error	A value outside the range was set to the CH□ range setting.	Reset the CH□ range setting to the following value. 0 to 6
1A9□H	Offset/Gain setting value range error	A value outside the range was set to CH□ Offset setting value or CH□ Gain setting value.	Reset CH□ Offset setting value or CH□ Gain setting value to the following value. ■Voltage Offset value: -10000 to +9000 Gain value: -9000 to +10000 ■Current Offset value: -20000 to +17000 Gain value: -17000 to +30000
1AA□H	Range setting range error with disconnection detection enabled	CH□ Disconnection detection functions were set to Enable and CH□ Input range is set to those other than the following. • 1 to 5 V • 4 to 20 mA	For the channel detecting simple disconnection using the disconnection detection function, reset CH□ Input range to any of the following. • 1 to 5 V • 4 to 20 mA
1AC□H	Convergence detection time setting range error	A value other than 1 to 10000 was set to CH□ Convergence detection time setting.	Reset CH□ Convergence detection time setting to the value within 1 to 10000.
1AD□H	Convergence detection upper limit value/lower limit value setting inversion error	Lower limit value ≤ the upper limit value was set to CH□ Convergence detection upper limit value and CH□ Convergence detection lower limit value.	Reset CH□ Convergence detection upper limit value and CH□ Convergence detection lower limit value such that lower limit value > upper limit value.
1AF□H	Offset/Gain setting write error	During CH□ Offset/Gain setting write or CH□ Offset/Gain setting initialization, 'CH□ A/D conversion enable/disable setting' was set to conversion enable.	Set 'CH□ A/D conversion enable/disable setting' to conversion disable and write CH□ Offset /Gain setting or initialize CH□ Offset /Gain setting.
1D7□H	Offset/Gain computed value range error	CH□ Offset/Gain computed value became out of range.	Reset CH□ Offset value and CH□ Gain setting value.
3080H	Analog ADP Hardware error	Hardware error of analog ADP was detected.	After resetting the CPU module, carry out RUN. If the same error is displayed again, there is a possibility of hardware error of the analog ADP. Consult the nearest Mitsubishi Electric representative.
3081H	Analog ADP Power failure	The power is not supplied normally.	Confirm if the power is supplied properly.
3082H	Analog ADP Memory Error	Read error or damaged EEPROM.	After resetting the CPU module, carry out RUN. If the same error is displayed again, there is a possibility of damaged EEPROM. Consult the nearest Mitsubishi Electric representative.
3083H	Analog ADP Memory Error	There is some offset/gain data defect or setting defect in EEPROM.	After offset/gain initialization of the analog ADP is finished, set the data by offset/gain settings again.
3084H	Analog ADP Communication error	Communication error occurred between the analog ADP and the CPU module.	Confirm if ADP is connected properly to the CPU module. If not improved, consult the nearest Mitsubishi Electric representative.

2.10 List of Alarm Code

The following table shows the list of the alarm codes stored.

□: This symbol indicates the number of the channel where an alarm has occurred. (1: CH1 to 4: CH4)

Alarm code	Alarm name	Description and cause	Action
0000H	—	There is no error.	—
080□H	Process alarm (upper limit)	The process alarm (upper limit) has occurred in CH□.	When the CH□ digital operation value returns from the warning output range, the alarm code automatically changes to "0: Normal".
081□H	Process alarm (lower limit)	The process alarm (lower limit) has occurred in CH□.	
082□H	Rate alarm (upper limit)	The rate alarm (upper limit) has occurred in CH□.	When the CH□ digital operation value change rate returns to the setting range, the alarm code automatically changes to "0: Normal".
083□H	Rate alarm (lower limit)	The rate alarm (lower limit) has occurred in CH□.	
090□H	Over scale (upper limit)	The over scale (upper limit) has occurred in CH□.	When the alarm clear request is set to ON after the analog input value returns to the setting range, all over-scale detection flags become "0: Normal", and the alarm code stored in the "A/D conversion latest alarm code" is cleared.
091□H	Over scale (lower limit)	The over scale (lower limit) has occurred in CH□.	
0A0□H	Disconnection detection	Disconnection is detected in the CH□.	When the alarm clear request is set to ON after the CH□ is recovered from disconnection, all CH□ disconnection detection flags become "0: Normal", and the alarm code stored in the "A/D conversion latest alarm code" is cleared.
0B0□H	Deviation detection	Deviation is detected in the CH□.	When the deviation between the CH□ becomes less than the deviation value for deviation between CH detection, the deviation between CH detection flag automatically becomes "0: Normal".
0C0□H	Offset/gain reading input range mismatch	The saved offset/gain input range is different from the currently set input range.	Change the currently set input range to the input range selected when the offset/gain was written, and then read the offset/gain.
0E0□H	Range change alarm during offset/gain writing or offset/gain initialization	The range was changed during offset/gain writing or offset/gain initialization.	Wait until offset/gain writing or offset/gain initialization is finished, and then change the range.
0E1□H	Offset/gain initialization execution alarm	Offset/gain initialization was executed during offset/gain writing.	Wait until offset/gain writing is finished, and then initialize the offset/gain.
0E2□H	Offset/gain writing execution alarm	Offset/gain writing was executed during offset/gain initialization.	Wait until offset/gain initialization is finished, and then write the offset/gain.
0E3□H	Analog ADP memory access alarm	Offset/gain writing, offset/gain reading or offset/gain initialization was executed while the analog ADP memory error (Error code: 3082H) was detected. Or offset reading was executed while the analog ADP memory error (Error code: 3083H) was detected.	Reset the CPU module.
0F0□H	Setting change alarm	Special relays/registers for analog are changed while conversion is enabled.	Change the setting of special relays/registers while conversion is disabled.

2.11 List of Special Relays

The special relays are shown below.

1st analog expansion adapter

The special relays list for the 1st FX5-4AD-ADP module is shown below.

Special relays				Name	Reference
CH1	CH2	CH3	CH4		
SM6300	SM6340	SM6380	SM6420	A/D conversion completed flag	Page 74
SM6301	SM6341	SM6381	SM6421	A/D conversion enable/disable setting	Page 74
SM6302	SM6342	SM6382	SM6422	Over scale upper limit detection flag	Page 74
SM6303	SM6343	SM6383	SM6423	Over scale lower limit detection flag	Page 75
SM6304	SM6344	SM6384	SM6424	Over scale detection enable/disable setting	Page 75
SM6305	SM6345	SM6385	SM6425	Maximum value/minimum value reset completed flag	Page 75
SM6306	SM6346	SM6386	SM6426	Maximum value reset request	Page 76
SM6307	SM6347	SM6387	SM6427	Minimum value reset request	Page 76
SM6308	SM6348	SM6388	SM6428	Scaling enable/disable setting	Page 76
SM6309	SM6349	SM6389	SM6429	Digital clipping enable/disable setting	Page 77
SM6311	SM6351	SM6391	SM6431	Warning output flag (process alarm upper limit)	Page 77
SM6312	SM6352	SM6392	SM6432	Warning output flag (process alarm lower limit)	Page 77
SM6313	SM6353	SM6393	SM6433	Warning output setting (process alarm)	Page 78
SM6315	SM6355	SM6395	SM6435	Warning output flag (rate alarm upper)	Page 78
SM6316	SM6356	SM6396	SM6436	Warning output flag (rate alarm lower)	Page 78
SM6317	SM6357	SM6397	SM6437	Warning output setting (rate alarm)	Page 79
SM6318	SM6358	SM6398	SM6438	Disconnection detection flag	Page 79
SM6319	SM6359	SM6399	SM6439	Disconnection detection enable/disable setting	Page 79
SM6320	SM6360	SM6400	SM6440	Disconnection recovery detection enable/disable setting	Page 80
SM6321	SM6361	SM6401	SM6441	Convergence detection flag	Page 80
SM6322	SM6362	SM6402	SM6442	Convergence detection enable/disable setting	Page 80
SM6325	SM6365	SM6405	SM6445	Deviation detection flag between channel	Page 81
SM6326	SM6366	SM6406	SM6446	Deviation detection trigger between channel	Page 81
SM6332	SM6372	SM6412	SM6452	Offset/gain reading	Page 81
SM6333	SM6373	SM6413	SM6453	Offset/gain writing	Page 82
SM6334	SM6374	SM6414	SM6454	Offset/gain initialization	Page 82
SM6337	SM6377	SM6417	SM6457	A/D conversion alarm clear request	Page 82
SM6338	SM6378	SM6418	SM6458	A/D conversion alarm flag	Page 83
SM6339	SM6379	SM6419	SM6459	A/D conversion error flag	Page 83

2nd analog expansion adapter

The special relays list for the 2nd FX5-4AD-ADP module is shown below.

Special relays				Name	Reference
CH1	CH2	CH3	CH4		
SM6660	SM6700	SM6740	SM6780	A/D conversion completed flag	Page 74
SM6661	SM6701	SM6741	SM6781	A/D conversion enable/disable setting	Page 74
SM6662	SM6702	SM6742	SM6782	Over scale upper limit detection flag	Page 74
SM6663	SM6703	SM6743	SM6783	Over scale lower limit detection flag	Page 75
SM6664	SM6704	SM6744	SM6784	Over scale detection enable/disable setting	Page 75
SM6665	SM6705	SM6745	SM6785	Maximum value/minimum value reset completed flag	Page 75
SM6666	SM6706	SM6746	SM6786	Maximum value reset request	Page 76
SM6667	SM6707	SM6747	SM6787	Minimum value reset request	Page 76
SM6668	SM6708	SM6748	SM6788	Scaling enable/disable setting	Page 76
SM6669	SM6709	SM6749	SM6789	Digital clipping enable/disable setting	Page 77
SM6671	SM6711	SM6751	SM6791	Warning output flag (process alarm upper limit)	Page 77
SM6672	SM6712	SM6752	SM6792	Warning output flag (process alarm lower limit)	Page 77
SM6673	SM6713	SM6753	SM6793	Warning output setting (process alarm)	Page 78
SM6675	SM6715	SM6755	SM6795	Warning output flag (rate alarm upper)	Page 78
SM6676	SM6716	SM6756	SM6796	Warning output flag (rate alarm lower)	Page 78
SM6677	SM6717	SM6757	SM6797	Warning output setting (rate alarm)	Page 79
SM6678	SM6718	SM6758	SM6798	Disconnection detection flag	Page 79
SM6679	SM6719	SM6759	SM6799	Disconnection detection enable/disable setting	Page 79
SM6680	SM6720	SM6760	SM6800	Disconnection recovery detection enable/disable setting	Page 80
SM6681	SM6721	SM6761	SM6801	Convergence detection flag	Page 80
SM6682	SM6722	SM6762	SM6802	Convergence detection enable/disable setting	Page 80
SM6685	SM6725	SM6765	SM6805	Deviation detection flag between channel	Page 81
SM6686	SM6726	SM6766	SM6806	Deviation detection trigger between channel	Page 81
SM6692	SM6732	SM6772	SM6812	Offset/gain reading	Page 81
SM6693	SM6733	SM6773	SM6813	Offset/gain writing	Page 82
SM6694	SM6734	SM6774	SM6814	Offset/gain initialization	Page 82
SM6697	SM6737	SM6777	SM6817	A/D conversion alarm clear request	Page 82
SM6698	SM6738	SM6778	SM6818	A/D conversion alarm flag	Page 83
SM6699	SM6739	SM6779	SM6819	A/D conversion error flag	Page 83

3rd analog expansion adapter

The special relays list for the 3rd FX5-4AD-ADP module is shown below.

Special relays				Name	Reference
CH1	CH2	CH3	CH4		
SM7020	SM7060	SM7100	SM7140	A/D conversion completed flag	Page 74
SM7021	SM7061	SM7101	SM7141	A/D conversion enable/disable setting	Page 74
SM7022	SM7062	SM7102	SM7142	Over scale upper limit detection flag	Page 74
SM7023	SM7063	SM7103	SM7143	Over scale lower limit detection flag	Page 75
SM7024	SM7064	SM7104	SM7144	Over scale detection enable/disable setting	Page 75
SM7025	SM7065	SM7105	SM7145	Maximum value/minimum value reset completed flag	Page 75
SM7026	SM7066	SM7106	SM7146	Maximum value reset request	Page 76
SM7027	SM7067	SM7107	SM7147	Minimum value reset request	Page 76
SM7028	SM7068	SM7108	SM7148	Scaling enable/disable setting	Page 76
SM7029	SM7069	SM7109	SM7149	Digital clipping enable/disable setting	Page 77
SM7031	SM7071	SM7111	SM7151	Warning output flag (process alarm upper limit)	Page 77
SM7032	SM7072	SM7112	SM7152	Warning output flag (process alarm lower limit)	Page 77
SM7033	SM7073	SM7113	SM7153	Warning output setting (process alarm)	Page 78
SM7035	SM7075	SM7115	SM7155	Warning output flag (rate alarm upper)	Page 78
SM7036	SM7076	SM7116	SM7156	Warning output flag (rate alarm lower)	Page 78
SM7037	SM7077	SM7117	SM7157	Warning output setting (rate alarm)	Page 79
SM7038	SM7078	SM7118	SM7158	Disconnection detection flag	Page 79
SM7039	SM7079	SM7119	SM7159	Disconnection detection enable/disable setting	Page 79
SM7040	SM7080	SM7120	SM7160	Disconnection recovery detection enable/disable setting	Page 80
SM7041	SM7081	SM7121	SM7161	Convergence detection flag	Page 80
SM7042	SM7082	SM7122	SM7162	Convergence detection enable/disable setting	Page 80
SM7045	SM7085	SM7125	SM7165	Deviation detection flag between channel	Page 81
SM7046	SM7086	SM7126	SM7166	Deviation detection trigger between channel	Page 81
SM7052	SM7092	SM7132	SM7172	Offset/gain reading	Page 81
SM7053	SM7093	SM7133	SM7173	Offset/gain writing	Page 82
SM7054	SM7094	SM7134	SM7174	Offset/gain initialization	Page 82
SM7057	SM7097	SM7137	SM7177	A/D conversion alarm clear request	Page 82
SM7058	SM7098	SM7138	SM7178	A/D conversion alarm flag	Page 83
SM7059	SM7099	SM7139	SM7179	A/D conversion error flag	Page 83

4th analog expansion adapter

The special relays list for the 4th FX5-4AD-ADP module is shown below.

Special relays				Name	Reference
CH1	CH2	CH3	CH4		
SM7380	SM7420	SM7460	SM7500	A/D conversion completed flag	Page 74
SM7381	SM7421	SM7461	SM7501	A/D conversion enable/disable setting	Page 74
SM7382	SM7422	SM7462	SM7502	Over scale upper limit detection flag	Page 74
SM7383	SM7423	SM7463	SM7503	Over scale lower limit detection flag	Page 75
SM7384	SM7424	SM7464	SM7504	Over scale detection enable/disable setting	Page 75
SM7385	SM7425	SM7465	SM7505	Maximum value/minimum value reset completed flag	Page 75
SM7386	SM7426	SM7466	SM7506	Maximum value reset request	Page 76
SM7387	SM7427	SM7467	SM7507	Minimum value reset request	Page 76
SM7388	SM7428	SM7468	SM7508	Scaling enable/disable setting	Page 76
SM7389	SM7429	SM7469	SM7509	Digital clipping enable/disable setting	Page 77
SM7391	SM7431	SM7471	SM7511	Warning output flag (process alarm upper limit)	Page 77
SM7392	SM7432	SM7472	SM7512	Warning output flag (process alarm lower limit)	Page 77
SM7393	SM7433	SM7473	SM7513	Warning output setting (process alarm)	Page 78
SM7395	SM7435	SM7475	SM7515	Warning output flag (rate alarm upper)	Page 78
SM7396	SM7436	SM7476	SM7516	Warning output flag (rate alarm lower)	Page 78
SM7397	SM7437	SM7477	SM7517	Warning output setting (rate alarm)	Page 79
SM7398	SM7438	SM7478	SM7518	Disconnection detection flag	Page 79
SM7399	SM7439	SM7479	SM7519	Disconnection detection enable/disable setting	Page 79
SM7400	SM7440	SM7480	SM7520	Disconnection recovery detection enable/disable setting	Page 80
SM7401	SM7441	SM7481	SM7521	Convergence detection flag	Page 80
SM7402	SM7442	SM7482	SM7522	Convergence detection enable/disable setting	Page 80
SM7405	SM7445	SM7485	SM7525	Deviation detection flag between channel	Page 81
SM7406	SM7446	SM7486	SM7526	Deviation detection trigger between channel	Page 81
SM7412	SM7452	SM7492	SM7532	Offset/gain reading	Page 81
SM7413	SM7453	SM7493	SM7533	Offset/gain writing	Page 82
SM7414	SM7454	SM7494	SM7534	Offset/gain initialization	Page 82
SM7417	SM7457	SM7497	SM7537	A/D conversion alarm clear request	Page 82
SM7418	SM7458	SM7498	SM7538	A/D conversion alarm flag	Page 83
SM7419	SM7459	SM7499	SM7539	A/D conversion error flag	Page 83

2.12 Detail of Special Relays

This section explains the details of special relays. Only the FX5U/FX5UC CPU module supports the special relays of the third and fourth modules.

R: Read only, R/W: Read/Write

A/D conversion completed flag

This flag monitors the A/D conversion status.

Monitor value	Display description	Default value	R/W
0: OFF	It turns OFF during the disable of an A/D conversion, and an A/D conversion.	0: OFF	R
1: ON	In the state of A/D conversion enable, if an A/D conversion is completed, it turns ON.		



The "A/D conversion completion flag" turns OFF when an error occurs.

Name	Connection part	Special relay			
		CH1	CH2	CH3	CH4
A/D conversion completed flag	1st adapter	SM6300	SM6340	SM6380	SM6420
	2nd adapter	SM6660	SM6700	SM6740	SM6780
	3rd adapter	SM7020	SM7060	SM7100	SM7140
	4th adapter	SM7380	SM7420	SM7460	SM7500

A/D conversion enable/disable setting

Set whether to enable or disable A/D conversion.

Setting value	Setting description	Default value	R/W
0: OFF	A/D conversion enable	1: ON	R/W
1: ON	A/D conversion disable		

For details A/D conversion enable/disable setting function, refer to the following.

Page 33 A/D Conversion Enable/Disable Setting Function

Name	Connection part	Special relay			
		CH1	CH2	CH3	CH4
A/D conversion enable/disable setting	1st adapter	SM6301	SM6341	SM6381	SM6421
	2nd adapter	SM6661	SM6701	SM6741	SM6781
	3rd adapter	SM7021	SM7061	SM7101	SM7141
	4th adapter	SM7381	SM7421	SM7461	SM7501

Over scale upper limit detection flag

This flag monitors the over-scale upper limit detection status in the over-scale detection function.

Monitor value	Display description	Default value	R/W
0: OFF	Normal	0: OFF	R
1: ON	Over scale upper limit detection		

For details over scale detection function, refer to the following.

Page 35 Over Scale Detection Function

Name	Connection part	Special relay			
		CH1	CH2	CH3	CH4
Over scale upper limit detection flag	1st adapter	SM6302	SM6342	SM6382	SM6422
	2nd adapter	SM6662	SM6702	SM6742	SM6782
	3rd adapter	SM7022	SM7062	SM7102	SM7142
	4th adapter	SM7382	SM7422	SM7462	SM7502

Over scale lower limit detection flag

This flag monitors the over-scale lower limit detection status in the over-scale detection function.

Monitor value	Display description	Default value	R/W
0: OFF	Normal	0: OFF	R
1: ON	Over scale lower limit detection		

For details over scale detection function, refer to the following.

☞ Page 35 Over Scale Detection Function

Name	Connection part	Special relay			
		CH1	CH2	CH3	CH4
Over scale lower limit detection flag	1st adapter	SM6303	SM6343	SM6383	SM6423
	2nd adapter	SM6663	SM6703	SM6743	SM6783
	3rd adapter	SM7023	SM7063	SM7103	SM7143
	4th adapter	SM7383	SM7423	SM7463	SM7503

Over scale detection enable/disable setting

Set whether to enable or disable over scale detection.

Setting value	Setting description	Default value	R/W
0: OFF	Over scale detection enable	1: ON	R/W
1: ON	Over scale detection disable		

For details over scale detection function, refer to the following.

☞ Page 35 Over Scale Detection Function

Name	Connection part	Special relay			
		CH1	CH2	CH3	CH4
Over scale detection enable/disable setting	1st adapter	SM6304	SM6344	SM6384	SM6424
	2nd adapter	SM6664	SM6704	SM6744	SM6784
	3rd adapter	SM7024	SM7064	SM7104	SM7144
	4th adapter	SM7384	SM7424	SM7464	SM7504

Maximum value/minimum value reset completed flag

This flag monitors the "maximum value/minimum value" reset status.

When the "maximum value reset request" or "minimum value reset request" is set from OFF to ON and then the value stored in the "maximum value" or "minimum value" is reset, the "maximum value/minimum value reset completion flag" turns ON.

Monitor value	Display description	Default value	R/W
0: OFF	Reset is not completed	0: OFF	R
1: ON	Reset is completed		

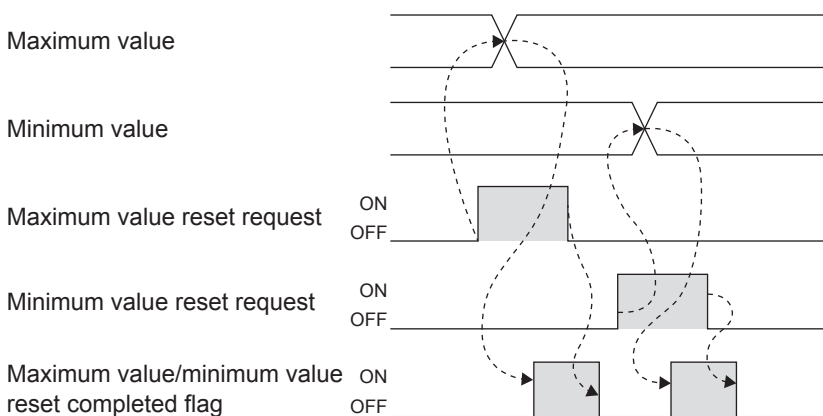

Name	Connection part	Special relay			
		CH1	CH2	CH3	CH4
Maximum value/minimum value reset completed flag	1st adapter	SM6305	SM6345	SM6385	SM6425
	2nd adapter	SM6665	SM6705	SM6745	SM6785
	3rd adapter	SM7025	SM7065	SM7105	SM7145
	4th adapter	SM7385	SM7425	SM7465	SM7505

Maximum value reset request

When the "maximum value reset request" is set from OFF to ON, the maximum value is updated to the "digital operation value".

Setting value	Setting description	Default value	R/W
0: OFF	No maximum value reset request	0: OFF	R/W
1: ON	Maximum value reset request		

For the timing of turning the signal on and off, refer to the following.

 Page 75 Maximum value/minimum value reset completed flag

Name	Connection part	Special relay			
		CH1	CH2	CH3	CH4
Maximum value reset request	1st adapter	SM6306	SM6346	SM6386	SM6426
	2nd adapter	SM6666	SM6706	SM6746	SM6786
	3rd adapter	SM7026	SM7066	SM7106	SM7146
	4th adapter	SM7386	SM7426	SM7466	SM7506

Minimum value reset request

When the "minimum value reset request" is set from OFF to ON, the minimum value is updated to the "digital operation value".

Setting value	Setting description	Default value	R/W
0: OFF	No minimum value reset request	0: OFF	R/W
1: ON	Maximum value reset request		

For the timing of turning the signal on and off, refer to the following.

 Page 75 Maximum value/minimum value reset completed flag

Name	Connection part	Special relay			
		CH1	CH2	CH3	CH4
Minimum value reset request	1st adapter	SM6307	SM6347	SM6387	SM6427
	2nd adapter	SM6667	SM6707	SM6747	SM6787
	3rd adapter	SM7027	SM7067	SM7107	SM7147
	4th adapter	SM7387	SM7427	SM7467	SM7507

Scaling enable/disable setting

Set whether to enable or disable the scaling function.

Setting value	Setting description	Default value	R/W
0: OFF	Scaling function enable	1: ON	R/W
1: ON	Scaling function disable		

For details scaling function, refer to the following.

 Page 37 Scaling Function

Name	Connection part	Special relay			
		CH1	CH2	CH3	CH4
Scaling enable/disable setting	1st adapter	SM6308	SM6348	SM6388	SM6428
	2nd adapter	SM6668	SM6708	SM6748	SM6788
	3rd adapter	SM7028	SM7068	SM7108	SM7148
	4th adapter	SM7388	SM7428	SM7468	SM7508

Digital clipping enable/disable setting

Set whether to enable or disable the digital clipping function.

Setting value	Setting description	Default value	R/W
0: OFF	Digital clipping function enable	1: ON	R/W
1: ON	Digital clipping function disable		

For details digital clipping, refer to the following.

 Page 41 Digital Clipping Function

Name	Connection part	Special relay			
		CH1	CH2	CH3	CH4
Digital clipping enable/disable setting	1st adapter	SM6309	SM6349	SM6389	SM6429
	2nd adapter	SM6669	SM6709	SM6749	SM6789
	3rd adapter	SM7029	SM7069	SM7109	SM7149
	4th adapter	SM7389	SM7429	SM7469	SM7509

Warning output flag (process alarm upper limit)

This flag monitors the upper limit value warning in the process alarm.

Monitor value	Display description	Default value	R/W
0: OFF	Normal	0: OFF	R
1: ON	Process alarm upper limit detection		

For details warning output function, refer to the following.

 Page 43 Process alarm

Name	Connection part	Special relay			
		CH1	CH2	CH3	CH4
Warning output flag (process alarm upper limit)	1st adapter	SM6311	SM6351	SM6391	SM6431
	2nd adapter	SM6671	SM6711	SM6751	SM6791
	3rd adapter	SM7031	SM7071	SM7111	SM7151
	4th adapter	SM7391	SM7431	SM7471	SM7511

Warning output flag (process alarm lower limit)

This flag monitors the lower limit value warning in the process alarm.

Monitor value	Display description	Default value	R/W
0: OFF	Normal	0: OFF	R
1: ON	Process alarm lower limit detection		

For details warning output function, refer to the following.

 Page 43 Process alarm

Name	Connection part	Special relay			
		CH1	CH2	CH3	CH4
Warning output flag (process alarm lower limit)	1st adapter	SM6312	SM6352	SM6392	SM6432
	2nd adapter	SM6672	SM6712	SM6752	SM6792
	3rd adapter	SM7032	SM7072	SM7112	SM7152
	4th adapter	SM7392	SM7432	SM7472	SM7512

Warning output setting (process alarm)

Set whether to enable or disable the warning output of process alarm.

Setting value	Setting description	Default value	R/W
0: OFF	Warning output of process alarm enable	1: ON	R/W
1: ON	Warning output of process alarm disable		

For details warning output function, refer to the following.

☞ Page 43 Process alarm

Name	Connection part	Special relay			
		CH1	CH2	CH3	CH4
Warning output setting (process alarm)	1st adapter	SM6313	SM6353	SM6393	SM6433
	2nd adapter	SM6673	SM6713	SM6753	SM6793
	3rd adapter	SM7033	SM7073	SM7113	SM7153
	4th adapter	SM7393	SM7433	SM7473	SM7513

Warning output flag (rate alarm upper)

This flag monitors the upper limit value warning in the rate alarm.

Monitor value	Display description	Default value	R/W
0: OFF	Normal	0: OFF	R
1: ON	Rate alarm upper limit detection		

For details warning output function, refer to the following.

☞ Page 45 Rate alarm

Name	Connection part	Special relay			
		CH1	CH2	CH3	CH4
Warning output flag (rate alarm upper)	1st adapter	SM6315	SM6355	SM6395	SM6435
	2nd adapter	SM6675	SM6715	SM6755	SM6795
	3rd adapter	SM7035	SM7075	SM7115	SM7155
	4th adapter	SM7395	SM7435	SM7475	SM7515

Warning output flag (rate alarm lower)

This flag monitors the lower limit value warning in the rate alarm.

Monitor value	Display description	Default value	R/W
0: OFF	Normal	0: OFF	R
1: ON	Rate alarm lower limit detection		

For details warning output function, refer to the following.

☞ Page 45 Rate alarm

Name	Connection part	Special relay			
		CH1	CH2	CH3	CH4
Warning output flag (rate alarm lower)	1st adapter	SM6316	SM6356	SM6396	SM6436
	2nd adapter	SM6676	SM6716	SM6756	SM6796
	3rd adapter	SM7036	SM7076	SM7116	SM7156
	4th adapter	SM7396	SM7436	SM7476	SM7516

Warning output setting (rate alarm)

Set whether to enable or disable the warning output of rate alarm.

Setting value	Setting description	Default value	R/W
0: OFF	Warning output of rate alarm enable	1: ON	R/W
1: ON	Warning output of rate alarm disable		

For details warning output function, refer to the following.

 Page 45 Rate alarm

Name	Connection part	Special relay			
		CH1	CH2	CH3	CH4
Warning output setting (rate alarm)	1st adapter	SM6317	SM6357	SM6397	SM6437
	2nd adapter	SM6677	SM6717	SM6757	SM6797
	3rd adapter	SM7037	SM7077	SM7117	SM7157
	4th adapter	SM7397	SM7437	SM7477	SM7517

Disconnection detection flag

This flag monitors the disconnection detection.

Monitor value	Display description	Default value	R/W
0: OFF	Normal	0: OFF	R
1: ON	Disconnection detection		

For details disconnection detection function, refer to the following.

 Page 48 Disconnection Detection Function

Name	Connection part	Special relay			
		CH1	CH2	CH3	CH4
Disconnection detection flag	1st adapter	SM6318	SM6358	SM6398	SM6438
	2nd adapter	SM6678	SM6718	SM6758	SM6798
	3rd adapter	SM7038	SM7078	SM7118	SM7158
	4th adapter	SM7398	SM7438	SM7478	SM7518

Disconnection detection enable/disable setting

Set whether to enable or disable the disconnection detection function.

Setting value	Setting description	Default value	R/W
0: OFF	Disconnection detection enable	1: ON	R/W
1: ON	Disconnection detection disable		

For details disconnection detection function, refer to the following.

 Page 48 Disconnection Detection Function

Name	Connection part	Special relay			
		CH1	CH2	CH3	CH4
Disconnection detection enable/disable setting	1st adapter	SM6319	SM6359	SM6399	SM6439
	2nd adapter	SM6679	SM6719	SM6759	SM6799
	3rd adapter	SM7039	SM7079	SM7119	SM7159
	4th adapter	SM7399	SM7439	SM7479	SM7519

Disconnection recovery detection enable/disable setting

Set whether to enable or disable the disconnection detection recovery.

Setting value	Setting description	Default value	R/W
0: OFF	Disconnection recovery detection enable	1: ON	R/W
1: ON	Disconnection recovery detection disable		

For details disconnection detection function, refer to the following.

☞ Page 48 Disconnection Detection Function

Name	Connection part	Special relay			
		CH1	CH2	CH3	CH4
Disconnection recovery detection enable/disable setting	1st adapter	SM6320	SM6360	SM6400	SM6440
	2nd adapter	SM6680	SM6720	SM6760	SM6800
	3rd adapter	SM7040	SM7080	SM7120	SM7160
	4th adapter	SM7400	SM7440	SM7480	SM7520

Convergence detection flag

This flag monitors the convergence detection.

Monitor value	Display description	Default value	R/W
0: OFF	Normal	0: OFF	R
1: ON	Convergence detection		

For details convergence detection function, refer to the following.

☞ Page 50 Convergence Detection Function

Name	Connection part	Special relay			
		CH1	CH2	CH3	CH4
Convergence detection flag	1st adapter	SM6321	SM6361	SM6401	SM6441
	2nd adapter	SM6681	SM6721	SM6761	SM6801
	3rd adapter	SM7041	SM7081	SM7121	SM7161
	4th adapter	SM7401	SM7441	SM7481	SM7521

Convergence detection enable/disable setting

Set whether to enable or disable the convergence detection.

Setting value	Setting description	Default value	R/W
0: OFF	Convergence detection enable	1: ON	R/W
1: ON	Convergence detection disable		

For details convergence detection function, refer to the following.

☞ Page 50 Convergence Detection Function

Name	Connection part	Special relay			
		CH1	CH2	CH3	CH4
Convergence detection enable/disable setting	1st adapter	SM6322	SM6362	SM6402	SM6442
	2nd adapter	SM6682	SM6722	SM6762	SM6802
	3rd adapter	SM7042	SM7082	SM7122	SM7162
	4th adapter	SM7402	SM7442	SM7482	SM7522

Deviation detection flag between channel

This flag monitors the deviation detection flag between channel.

Monitor value	Display description	Default value	R/W
0: OFF	Normal	0: OFF	R
1: ON	Deviation detection		

For details deviation detection between channel function, refer to the following.

 Page 51 Deviation Detection Between Channel Function

Name	Connection part	Special relay			
		CH1	CH2	CH3	CH4
Deviation detection flag between channel	1st adapter	SM6325	SM6365	SM6405	SM6445
	2nd adapter	SM6685	SM6725	SM6765	SM6805
	3rd adapter	SM7045	SM7085	SM7125	SM7165
	4th adapter	SM7405	SM7445	SM7485	SM7525

Deviation detection trigger between channel

Set whether to enable or disable the deviation detection flag between channel.

Setting value	Setting description	Default value	R/W
0: OFF	Deviation detection enable	1: ON	R/W
1: ON	Deviation detection disable		

For details deviation detection between channel function, refer to the following.

 Page 51 Deviation Detection Between Channel Function

Name	Connection part	Special relay			
		CH1	CH2	CH3	CH4
Deviation detection trigger between channel	1st adapter	SM6326	SM6366	SM6406	SM6446
	2nd adapter	SM6686	SM6726	SM6766	SM6806
	3rd adapter	SM7046	SM7086	SM7126	SM7166
	4th adapter	SM7406	SM7446	SM7486	SM7526

Offset/gain reading

An offset/gain setting value is read.

Setting value	Setting description	Default value	R/W
0: OFF	Offset/gain reading is not performed.	0: OFF	R/W
1: ON	Offset/gain reading is performed.		

For details offset/gain setting, refer to the following.

 Page 53 Offset/gain Setting Function

Name	Connection part	Special relay			
		CH1	CH2	CH3	CH4
Offset/gain reading	1st adapter	SM6332	SM6372	SM6412	SM6452
	2nd adapter	SM6692	SM6732	SM6772	SM6812
	3rd adapter	SM7052	SM7092	SM7132	SM7172
	4th adapter	SM7412	SM7452	SM7492	SM7532

Offset/gain writing

An offset/gain setting value is written in.

Setting value	Setting description	Default value	R/W
0: OFF	Offset/gain writing is not performed.	0: OFF	R/W
1: ON	Offset/gain writing is performed.		

For details offset/gain setting, refer to the following.

 Page 53 Offset/gain Setting Function

Name	Connection part	Special relay			
		CH1	CH2	CH3	CH4
Offset/gain writing	1st adapter	SM6333	SM6373	SM6413	SM6453
	2nd adapter	SM6693	SM6733	SM6773	SM6813
	3rd adapter	SM7053	SM7093	SM7133	SM7173
	4th adapter	SM7413	SM7453	SM7493	SM7533

Offset/gain initialization

An offset/gain setting value is initialized.

Setting value	Setting description	Default value	R/W
0: OFF	Offset/gain initialization is not performed.	0: OFF	R/W
1: ON	Offset/gain initialization is performed.		

For details offset/gain initialization, refer to the following.

 Page 56 Offset/gain Initialization Function

Name	Connection part	Special relay			
		CH1	CH2	CH3	CH4
Offset/gain initialization	1st adapter	SM6334	SM6374	SM6414	SM6454
	2nd adapter	SM6694	SM6734	SM6774	SM6814
	3rd adapter	SM7054	SM7094	SM7134	SM7174
	4th adapter	SM7414	SM7454	SM7494	SM7534

A/D conversion alarm clear request

An A/D conversion alarm clear request is performed.

Setting value	Setting description	Default value	R/W
0: OFF	With no A/D conversion alarm clear request.	0: OFF	R/W
1: ON	Those with an A/D conversion alarm clear request.		

For details A/D conversion alarm clear request, refer to the following.

 Page 57 Alarm clear request

Name	Connection part	Special relay			
		CH1	CH2	CH3	CH4
A/D conversion alarm clear request	1st adapter	SM6337	SM6377	SM6417	SM6457
	2nd adapter	SM6697	SM6737	SM6777	SM6817
	3rd adapter	SM7057	SM7097	SM7137	SM7177
	4th adapter	SM7417	SM7457	SM7497	SM7537

A/D conversion alarm flag

"A/D conversion alarm flag" turns on when an alarm occurs.

Monitor value	Display description	Default value	R/W
0: OFF	Normal	0: OFF	R
1: ON	A/D conversion alarm occur		

To turn OFF the "A/D conversion alarm flag" and clear the "A/D conversion latest alarm code", set the "A/D conversion alarm clear request" from OFF to ON.

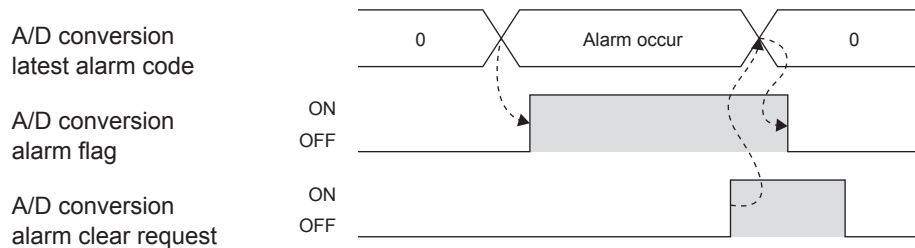

Name	Connection part	Special relay			
		CH1	CH2	CH3	CH4
A/D conversion alarm flag	1st adapter	SM6338	SM6378	SM6418	SM6458
	2nd adapter	SM6698	SM6738	SM6778	SM6818
	3rd adapter	SM7058	SM7098	SM7138	SM7178
	4th adapter	SM7418	SM7458	SM7498	SM7538

A/D conversion error flag

"A/D conversion error flag" turns on when an error occurs.

Monitor value	Display description	Default value	R/W
0: OFF	Normal	0: OFF	R
1: ON	A/D conversion error occur		

To turn OFF the "A/D conversion error flag" and clear the "A/D conversion latest error code", set the "error clear request" (SM50) of the CPU module from OFF to ON.

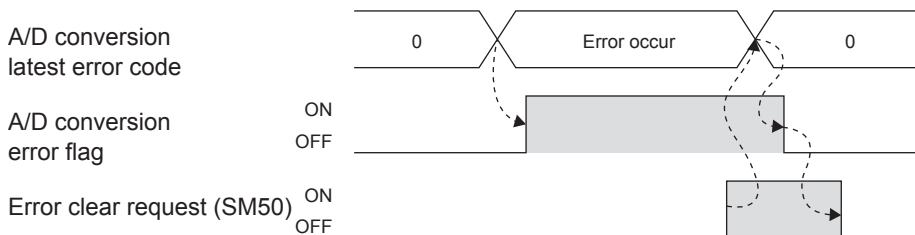

Name	Connection part	Special relay			
		CH1	CH2	CH3	CH4
A/D conversion error flag	1st adapter	SM6339	SM6379	SM6419	SM6459
	2nd adapter	SM6699	SM6739	SM6779	SM6819
	3rd adapter	SM7059	SM7099	SM7139	SM7179
	4th adapter	SM7419	SM7459	SM7499	SM7539

2.13 List of Special Registers

The special registers are shown below.

1st analog expansion adapter

The special registers list for the 1st FX5-4AD-ADP module is shown below.

Special registers				Name	Reference
CH1	CH2	CH3	CH4		
SD6280				Module Information	Page 88
SD6300	SD6340	SD6380	SD6420	Digital output value	Page 88
SD6301	SD6341	SD6381	SD6421	Digital operation value	Page 88
SD6302	SD6342	SD6382	SD6422	Analog input value monitor	Page 89
SD6303	SD6343	SD6383	SD6423	Average processing specify	Page 89
SD6304	SD6344	SD6384	SD6424	Time Average/Count Average/Moving Average setting	Page 90
SD6305	SD6345	SD6385	SD6425	Input range setting	Page 90
SD6306	SD6346	SD6386	SD6426	Maximum value	Page 91
SD6307	SD6347	SD6387	SD6427	Minimum value	Page 91
SD6308	SD6348	SD6388	SD6428	Scaling upper limit value	Page 91
SD6309	SD6349	SD6389	SD6429	Scaling lower limit value	Page 92
SD6310	SD6350	SD6390	SD6430	Conversion value shift amount	Page 92
SD6311	SD6351	SD6391	SD6431	Process alarm upper upper limit value	Page 92
SD6312	SD6352	SD6392	SD6432	Process alarm upper lower limit value	Page 93
SD6313	SD6353	SD6393	SD6433	Process alarm lower upper limit value	Page 93
SD6314	SD6354	SD6394	SD6434	Process alarm lower lower limit value	Page 94
SD6315	SD6355	SD6395	SD6435	Rate alarm upper limit value	Page 94
SD6316	SD6356	SD6396	SD6436	Rate alarm lower limit value	Page 95
SD6317	SD6357	SD6397	SD6437	Rate alarm warning detection period setting	Page 95
SD6322	SD6362	SD6402	SD6442	Convergence detection upper limit value	Page 96
SD6323	SD6363	SD6403	SD6443	Convergence detection lower limit value	Page 96
SD6324	SD6364	SD6404	SD6444	Detection time setting for convergence detection	Page 97
SD6325	SD6365	SD6405	SD6445	Deviation detection CH1	Page 97
SD6326	SD6366	SD6406	SD6446	Deviation detection CH2	Page 98
SD6327	SD6367	SD6407	SD6447	Deviation value for deviation detection between channel	Page 98
SD6328	SD6368	SD6408	SD6448	CH setting 1 for deviation detection between channel	Page 99
SD6329	SD6369	SD6409	SD6449	CH setting 2 for deviation detection between channel	Page 99
SD6332	SD6372	SD6412	SD6452	Offset setting value	Page 100
SD6333	SD6373	SD6413	SD6453	Gain setting value	Page 100
SD6334	SD6374	SD6414	SD6454	Offset/gain writing enable code	Page 100
SD6338	SD6378	SD6418	SD6458	A/D conversion latest alarm code	Page 101
SD6339	SD6379	SD6419	SD6459	A/D conversion latest error code	Page 101

2nd analog expansion adapter

The special registers list for the 2nd FX5-4AD-ADP module is shown below.

Special registers				Name	Reference
CH1	CH2	CH3	CH4		
SD6640				Module Information	Page 88
SD6660	SD6700	SD6740	SD6780	Digital output value	Page 88
SD6661	SD6701	SD6741	SD6781	Digital operation value	Page 88
SD6662	SD6702	SD6742	SD6782	Analog input value monitor	Page 89
SD6663	SD6703	SD6743	SD6783	Average processing specify	Page 89
SD6664	SD6704	SD6744	SD6784	Time Average/Count Average/Moving Average setting	Page 90
SD6665	SD6705	SD6745	SD6785	Input range setting	Page 90
SD6666	SD6706	SD6746	SD6786	Maximum value	Page 91
SD6667	SD6707	SD6747	SD6787	Minimum value	Page 91
SD6668	SD6708	SD6748	SD6788	Scaling upper limit value	Page 91
SD6669	SD6709	SD6749	SD6789	Scaling lower limit value	Page 92
SD6670	SD6710	SD6750	SD6790	Conversion value shift amount	Page 92
SD6671	SD6711	SD6751	SD6791	Process alarm upper upper limit value	Page 92
SD6672	SD6712	SD6752	SD6792	Process alarm upper lower limit value	Page 93
SD6673	SD6713	SD6753	SD6793	Process alarm lower upper limit value	Page 93
SD6674	SD6714	SD6754	SD6794	Process alarm lower lower limit value	Page 94
SD6675	SD6715	SD6755	SD6795	Rate alarm upper limit value	Page 94
SD6676	SD6716	SD6756	SD6796	Rate alarm lower limit value	Page 95
SD6677	SD6717	SD6757	SD6797	Rate alarm warning detection period setting	Page 95
SD6682	SD6722	SD6762	SD6802	Convergence detection upper limit value	Page 96
SD6683	SD6723	SD6763	SD6803	Convergence detection lower limit value	Page 96
SD6684	SD6724	SD6764	SD6804	Detection time setting for convergence detection	Page 97
SD6685	SD6725	SD6765	SD6805	Deviation detection CH1	Page 97
SD6686	SD6726	SD6766	SD6806	Deviation detection CH2	Page 98
SD6687	SD6727	SD6767	SD6807	Deviation value for deviation detection between channel	Page 98
SD6688	SD6728	SD6768	SD6808	CH setting 1 for deviation detection between channel	Page 99
SD6689	SD6729	SD6769	SD6809	CH setting 2 for deviation detection between channel	Page 99
SD6692	SD6732	SD6772	SD6812	Offset setting value	Page 100
SD6693	SD6733	SD6773	SD6813	Gain setting value	Page 100
SD6694	SD6734	SD6774	SD6814	Offset/gain writing enable code	Page 100
SD6698	SD6738	SD6778	SD6818	A/D conversion latest alarm code	Page 101
SD6699	SD6739	SD6779	SD6819	A/D conversion latest error code	Page 101

3rd analog expansion adapter

The special registers list for the 3rd FX5-4AD-ADP module is shown below.

Special registers				Name	Reference
CH1	CH2	CH3	CH4		
SD7000				Module Information	Page 88
SD7020	SD7060	SD7100	SD7140	Digital output value	Page 88
SD7021	SD7061	SD7101	SD7141	Digital operation value	Page 88
SD7022	SD7062	SD7102	SD7142	Analog input value monitor	Page 89
SD7023	SD7063	SD7103	SD7143	Average processing specify	Page 89
SD7024	SD7064	SD7104	SD7144	Time Average/Count Average/Moving Average setting	Page 90
SD7025	SD7065	SD7105	SD7145	Input range setting	Page 90
SD7026	SD7066	SD7106	SD7146	Maximum value	Page 91
SD7027	SD7067	SD7107	SD7147	Minimum value	Page 91
SD7028	SD7068	SD7108	SD7148	Scaling upper limit value	Page 91
SD7029	SD7069	SD7109	SD7149	Scaling lower limit value	Page 92
SD7030	SD7070	SD7110	SD7150	Conversion value shift amount	Page 92
SD7031	SD7071	SD7111	SD7151	Process alarm upper upper limit value	Page 92
SD7032	SD7072	SD7112	SD7152	Process alarm upper lower limit value	Page 93
SD7033	SD7073	SD7113	SD7153	Process alarm lower upper limit value	Page 93
SD7034	SD7074	SD7114	SD7154	Process alarm lower lower limit value	Page 94
SD7035	SD7075	SD7115	SD7155	Rate alarm upper limit value	Page 94
SD7036	SD7076	SD7116	SD7156	Rate alarm lower limit value	Page 95
SD7037	SD7077	SD7117	SD7157	Rate alarm warning detection period setting	Page 95
SD7042	SD7082	SD7122	SD7162	Convergence detection upper limit value	Page 96
SD7043	SD7083	SD7123	SD7163	Convergence detection lower limit value	Page 96
SD7044	SD7084	SD7124	SD7164	Detection time setting for convergence detection	Page 97
SD7045	SD7085	SD7125	SD7165	Deviation detection CH1	Page 97
SD7046	SD7086	SD7126	SD7166	Deviation detection CH2	Page 98
SD7047	SD7087	SD7127	SD7167	Deviation value for deviation detection between channel	Page 98
SD7048	SD7088	SD7128	SD7168	CH setting 1 for deviation detection between channel	Page 99
SD7049	SD7089	SD7129	SD7169	CH setting 2 for deviation detection between channel	Page 99
SD7052	SD7092	SD7132	SD7172	Offset setting value	Page 100
SD7053	SD7093	SD7133	SD7173	Gain setting value	Page 100
SD7054	SD7094	SD7134	SD7174	Offset/gain writing enable code	Page 100
SD7058	SD7098	SD7138	SD7178	A/D conversion latest alarm code	Page 101
SD7059	SD7099	SD7139	SD7179	A/D conversion latest error code	Page 101

4th analog expansion adapter

The special registers list for the 4th FX5-4AD-ADP module is shown below.

Special registers				Name	Reference
CH1	CH2	CH3	CH4		
SD7360				Module Information	Page 88
SD7380	SD7420	SD7460	SD7500	Digital output value	Page 88
SD7381	SD7421	SD7461	SD7501	Digital operation value	Page 88
SD7382	SD7422	SD7462	SD7502	Analog input value monitor	Page 89
SD7383	SD7423	SD7463	SD7503	Average processing specify	Page 89
SD7384	SD7424	SD7464	SD7504	Time Average/Count Average/Moving Average setting	Page 90
SD7385	SD7425	SD7465	SD7505	Input range setting	Page 90
SD7386	SD7426	SD7466	SD7506	Maximum value	Page 91
SD7387	SD7427	SD7467	SD7507	Minimum value	Page 91
SD7388	SD7428	SD7468	SD7508	Scaling upper limit value	Page 91
SD7389	SD7429	SD7469	SD7509	Scaling lower limit value	Page 92
SD7390	SD7430	SD7470	SD7510	Conversion value shift amount	Page 92
SD7391	SD7431	SD7471	SD7511	Process alarm upper upper limit value	Page 92
SD7392	SD7432	SD7472	SD7512	Process alarm upper lower limit value	Page 93
SD7393	SD7433	SD7473	SD7513	Process alarm lower upper limit value	Page 93
SD7394	SD7434	SD7474	SD7514	Process alarm lower lower limit value	Page 94
SD7395	SD7435	SD7475	SD7515	Rate alarm upper limit value	Page 94
SD7396	SD7436	SD7476	SD7516	Rate alarm lower limit value	Page 95
SD7397	SD7437	SD7477	SD7517	Rate alarm warning detection period setting	Page 95
SD7402	SD7442	SD7482	SD7522	Convergence detection upper limit value	Page 96
SD7403	SD7443	SD7483	SD7523	Convergence detection lower limit value	Page 96
SD7404	SD7444	SD7484	SD7524	Detection time setting for convergence detection	Page 97
SD7405	SD7445	SD7485	SD7525	Deviation detection CH1	Page 97
SD7406	SD7446	SD7486	SD7526	Deviation detection CH2	Page 98
SD7407	SD7447	SD7487	SD7527	Deviation value for deviation detection between channel	Page 98
SD7408	SD7448	SD7488	SD7528	CH setting 1 for deviation detection between channel	Page 99
SD7409	SD7449	SD7489	SD7529	CH setting 2 for deviation detection between channel	Page 99
SD7412	SD7452	SD7492	SD7532	Offset setting value	Page 100
SD7413	SD7453	SD7493	SD7533	Gain setting value	Page 100
SD7414	SD7454	SD7494	SD7534	Offset/gain writing enable code	Page 100
SD7418	SD7458	SD7498	SD7538	A/D conversion latest alarm code	Page 101
SD7419	SD7459	SD7499	SD7539	A/D conversion latest error code	Page 101

2.14 Detail of Special Registers

This section explains the details of special registers. Only the FX5U/FX5UC CPU module supports the third and fourth special register.

R: Read only, R/W: Read/Write

Module Information

Module information of FX5-4AD-ADP is stored.

Stored value	R/W
6141H	R

Name	Connection part	Special register			
		CH1	CH2	CH3	CH4
Module Information	1st adapter	SD6280			
	2nd adapter	SD6640			
	3rd adapter	SD7000			
	4th adapter	SD7360			

Digital output value

The A/D-converted digital output value is stored.

Range	Default value	R/W
-8192 to +16383	0	R

Point

The value is updated in every averaging processing cycle when the averaging processing is executed, or in every sampling cycle when the averaging processing is not executed.

Name	Connection part	Special register			
		CH1	CH2	CH3	CH4
Digital output value	1st adapter	SD6300	SD6340	SD6380	SD6420
	2nd adapter	SD6660	SD6700	SD6740	SD6780
	3rd adapter	SD7020	SD7060	SD7100	SD7140
	4th adapter	SD7380	SD7420	SD7460	SD7500

Digital operation value

The digital operation value obtained by the scaling function, shift function and digital clipping function is stored.

Range	Default value	R/W
-32768 to +32767	0	R

Point

The value equivalent to the digital output value is stored when the scaling function, shift function and digital clipping function are not executed.

Name	Connection part	Special register			
		CH1	CH2	CH3	CH4
Digital operation value	1st adapter	SD6301	SD6341	SD6381	SD6421
	2nd adapter	SD6661	SD6701	SD6741	SD6781
	3rd adapter	SD7021	SD7061	SD7101	SD7141
	4th adapter	SD7381	SD7421	SD7461	SD7501

Analog input value monitor

The input analog value is stored.

Range	Default value	R/W
-20480 to +20479	0	R

2



The unit of the analog value is "mV" when the voltage is input, or "μA" when the current is input.

Name	Connection part	Special register			
		CH1	CH2	CH3	CH4
Analog input value monitor	1st adapter	SD6302	SD6342	SD6382	SD6422
	2nd adapter	SD6662	SD6702	SD6742	SD6782
	3rd adapter	SD7022	SD7062	SD7102	SD7142
	4th adapter	SD7382	SD7422	SD7462	SD7502

Average processing specify

Set which one between the sampling processing and the averaging processing is to be selected.

The averaging processing is classified into "time average", "count average" and "moving average".

Setting value	Description	Default value	R/W
0	Sampling processing	0	R/W
1	Time average		
2	Count average		
3	Moving average		



The averaging process specification setting range error (Error code: 1A0□H) occurs when any value other than the above values is set.

Name	Connection part	Special register			
		CH1	CH2	CH3	CH4
Average processing specify	1st adapter	SD6303	SD6343	SD6383	SD6423
	2nd adapter	SD6663	SD6703	SD6743	SD6783
	3rd adapter	SD7023	SD7063	SD7103	SD7143
	4th adapter	SD7383	SD7423	SD7463	SD7503

Time Average/Count Average/Moving Average setting

Set the average time, average counts and moving average counts in the averaging processing for each channel.
The table below shows the available setting range.

Setting value	Description	Default value	R/W
1 to 10000 (ms)	Time average	0	R/W
4 to 32767 (times)	Count average		
2 to 64 (times)	Moving average		

Point

The average time setting range error (Error code: 1A1□H), average counts setting range error (Error code: 1A2□H) or moving average count setting range error (Error code: 1A3□H) occurs when any value other than the above values is set. In this case, the A/D conversion processing is executed using the setting set before the error occurs.

Name	Connection part	Special register			
		CH1	CH2	CH3	CH4
Time Average/Count Average/ Moving Average setting	1st adapter	SD6304	SD6344	SD6384	SD6424
	2nd adapter	SD6664	SD6704	SD6744	SD6784
	3rd adapter	SD7024	SD7064	SD7104	SD7144
	4th adapter	SD7384	SD7424	SD7464	SD7504

Input range setting

Set the input range.

Setting value	Description	Default value	R/W
0	0 to 10 V	0	R/W
1	0 to 5 V		
2	1 to 5 V		
3	-10 to +10 V		
4	0 to 20 mA		
5	4 to 20 mA		
6	-20 to +20 mA		

Point

The range setting range error (Error code: 1A8□H) occurs when any value other than the above values is set.

Name	Connection part	Special register			
		CH1	CH2	CH3	CH4
Input range setting	1st adapter	SD6305	SD6345	SD6385	SD6425
	2nd adapter	SD6665	SD6705	SD6745	SD6785
	3rd adapter	SD7025	SD7065	SD7105	SD7145
	4th adapter	SD7385	SD7425	SD7465	SD7505

Maximum value

The maximum value of the digital operation value is stored. When the "maximum value reset request" is set from OFF to ON, the maximum value of the specified channel is updated to the "digital operation value".

Range	Default value	R/W
-32768 to +32767	0	R

For details maximum value/minimum value hold function, refer to the following.

 Page 42 Maximum Value/Minimum Value Hold Function

Name	Connection part	Special register			
		CH1	CH2	CH3	CH4
Maximum value	1st adapter	SD6306	SD6346	SD6386	SD6426
	2nd adapter	SD6666	SD6706	SD6746	SD6786
	3rd adapter	SD7026	SD7066	SD7106	SD7146
	4th adapter	SD7386	SD7426	SD7466	SD7506

Minimum value

The minimum value of the digital operation value is stored. When the "minimum value reset request" is set from OFF to ON, the minimum value of the specified channel is updated to the "digital operation value".

Range	Default value	R/W
-32768 to +32767	0	R

For details maximum value/minimum value hold function, refer to the following.

 Page 42 Maximum Value/Minimum Value Hold Function

Name	Connection part	Special register			
		CH1	CH2	CH3	CH4
Minimum value	1st adapter	SD6307	SD6347	SD6387	SD6427
	2nd adapter	SD6667	SD6707	SD6747	SD6787
	3rd adapter	SD7027	SD7067	SD7107	SD7147
	4th adapter	SD7387	SD7427	SD7467	SD7507

Scaling upper limit value

Set the upper limit value of the scaling conversion range.

Range	Default value	R/W
-32768 to +32767	0	R/W

For details scaling function, refer to the following.

 Page 37 Scaling Function

Name	Connection part	Special register			
		CH1	CH2	CH3	CH4
Scaling upper limit value	1st adapter	SD6308	SD6348	SD6388	SD6428
	2nd adapter	SD6668	SD6708	SD6748	SD6788
	3rd adapter	SD7028	SD7068	SD7108	SD7148
	4th adapter	SD7388	SD7428	SD7468	SD7508

Scaling lower limit value

Set the lower limit value of the scaling conversion range.

Range	Default value	R/W
-32768 to +32767	0	R/W

For details scaling function, refer to the following.

 Page 37 Scaling Function

Name	Connection part	Special register			
		CH1	CH2	CH3	CH4
Scaling lower limit value	1st adapter	SD6309	SD6349	SD6389	SD6429
	2nd adapter	SD6669	SD6709	SD6749	SD6789
	3rd adapter	SD7029	SD7069	SD7109	SD7149
	4th adapter	SD7389	SD7429	SD7469	SD7509

Conversion value shift amount

Set the "conversion value shift amount" used in the shift function.

The setting value is added to the "digital operation value".

Range	Default value	R/W
-32768 to +32767	0	R/W

For details shift function, refer to the following.

 Page 40 Shift Function

Name	Connection part	Special register			
		CH1	CH2	CH3	CH4
Conversion value shift amount	1st adapter	SD6310	SD6350	SD6390	SD6430
	2nd adapter	SD6670	SD6710	SD6750	SD6790
	3rd adapter	SD7030	SD7070	SD7110	SD7150
	4th adapter	SD7390	SD7430	SD7470	SD7510

Process alarm upper upper limit value

Set the upper upper limit value of the warning output function (process alarm).

Range	Default value	R/W
-32768 to +32767	0	R/W

Point

The process alarm upper-lower limit value setting range error (Error code: 1A4□H) occurs when the condition "Process alarm upper upper limit value \geq Process alarm upper lower limit value \geq Process alarm lower upper limit value \geq Process alarm lower lower limit value" is not satisfied.

For details warning output function, refer to the following.

 Page 43 Process alarm

Name	Connection part	Special register			
		CH1	CH2	CH3	CH4
Process alarm upper upper limit value	1st adapter	SD6311	SD6351	SD6391	SD6431
	2nd adapter	SD6671	SD6711	SD6751	SD6791
	3rd adapter	SD7031	SD7071	SD7111	SD7151
	4th adapter	SD7391	SD7431	SD7471	SD7511

Process alarm upper lower limit value

Set the upper lower limit value of the warning output function (process alarm).

Range	Default value	R/W
-32768 to +32767	0	R/W

2

Point

The process alarm upper-lower limit value setting range error (Error code: 1A4□H) occurs when the condition "Process alarm upper upper limit value \geq Process alarm upper lower limit value \geq Process alarm lower upper limit value \geq Process alarm lower lower limit value" is not satisfied.

For details warning output function, refer to the following.

 Page 43 Process alarm

Name	Connection part	Special register			
		CH1	CH2	CH3	CH4
Process alarm upper lower limit value	1st adapter	SD6312	SD6352	SD6392	SD6432
	2nd adapter	SD6672	SD6712	SD6752	SD6792
	3rd adapter	SD7032	SD7072	SD7112	SD7152
	4th adapter	SD7392	SD7432	SD7472	SD7512

Process alarm lower upper limit value

Set the lower upper limit value of the warning output function (process alarm).

Range	Default value	R/W
-32768 to +32767	0	R/W

Point

The process alarm upper-lower limit value setting range error (Error code: 1A4□H) occurs when the condition "Process alarm upper upper limit value \geq Process alarm upper lower limit value \geq Process alarm lower upper limit value \geq Process alarm lower lower limit value" is not satisfied.

For details warning output function, refer to the following.

 Page 43 Process alarm

Name	Connection part	Special register			
		CH1	CH2	CH3	CH4
Process alarm lower upper limit value	1st adapter	SD6313	SD6353	SD6393	SD6433
	2nd adapter	SD6673	SD6713	SD6753	SD6793
	3rd adapter	SD7033	SD7073	SD7113	SD7153
	4th adapter	SD7393	SD7433	SD7473	SD7513

Process alarm lower lower limit value

Set the lower lower limit value of the warning output function (process alarm).

Range	Default value	R/W
-32768 to +32767	0	R/W

Point

The process alarm upper-lower limit value setting range error (Error code: 1A4□H) occurs when the condition "Process alarm upper upper limit value \geq Process alarm upper lower limit value \geq Process alarm lower upper limit value \geq Process alarm lower lower limit value" is not satisfied.

For details warning output function, refer to the following.

 Page 43 Process alarm

Name	Connection part	Special register			
		CH1	CH2	CH3	CH4
Process alarm lower lower limit value	1st adapter	SD6314	SD6354	SD6394	SD6434
	2nd adapter	SD6674	SD6714	SD6754	SD6794
	3rd adapter	SD7034	SD7074	SD7114	SD7154
	4th adapter	SD7394	SD7434	SD7474	SD7514

Rate alarm upper limit value

Set the upper limit of the change rate of the digital output value for detecting rate alarms.

Range	Default value	R/W
-1000 to +1000	0	R/W

Point

- Set the rate alarm upper limit value in the unit "0.1 %".
- The rate alarm upper limit value/lower limit value setting inversion error (Error code: 1A5□H) occurs when the condition "Rate alarm upper limit value $>$ Rate alarm lower limit value" is not satisfied.

For details warning output function, refer to the following.

 Page 45 Rate alarm

Name	Connection part	Special register			
		CH1	CH2	CH3	CH4
Rate alarm upper limit value	1st adapter	SD6315	SD6355	SD6395	SD6435
	2nd adapter	SD6675	SD6715	SD6755	SD6795
	3rd adapter	SD7035	SD7075	SD7115	SD7155
	4th adapter	SD7395	SD7435	SD7475	SD7515

Rate alarm lower limit value

Set the lower limit of the change rate of the digital output value for detecting rate alarms.

Range	Default value	R/W
-1000 to +1000	0	R/W

Point

- Set the rate alarm lower limit value in the unit "0.1 %".
- The rate alarm upper limit value/lower limit value setting inversion error (Error code: 1A5□H) occurs when the condition "Rate alarm upper limit value > Rate alarm lower limit value" is not satisfied.

For details warning output function, refer to the following.

 Page 45 Rate alarm

Name	Connection part	Special register			
		CH1	CH2	CH3	CH4
Rate alarm lower limit value	1st adapter	SD6316	SD6356	SD6396	SD6436
	2nd adapter	SD6676	SD6716	SD6756	SD6796
	3rd adapter	SD7036	SD7076	SD7116	SD7156
	4th adapter	SD7396	SD7436	SD7476	SD7516

Rate alarm warning detection period setting

Set the cycle for checking the change rate of the digital output value.

The "rate alarm warning detection period setting" multiplied by the sampling cycle indicates the cycle for detecting rate alarms.

Range	Default value	R/W
1 to 10000 (ms)	1	R/W

Point

The rate alarm warning detection period setting range error (Error code: 1A6□H) occurs when any value other than the above values is set.

For details warning output function, refer to the following.

 Page 45 Rate alarm

Name	Connection part	Special register			
		CH1	CH2	CH3	CH4
Rate alarm warning detection period setting	1st adapter	SD6317	SD6357	SD6397	SD6437
	2nd adapter	SD6677	SD6717	SD6757	SD6797
	3rd adapter	SD7037	SD7077	SD7117	SD7157
	4th adapter	SD7397	SD7437	SD7477	SD7517

Convergence detection upper limit value

Set the upper limit of the digital output value used in the convergence detection function.

Range	Default value	R/W
-32768 to +32767	0	R/W

Point

The convergence detection upper limit value/lower limit value setting inversion error (Error code: 1AD□H) occurs when the condition "Convergence detection upper limit value > Convergence detection lower limit value" is not satisfied.

For details convergence detection function, refer to the following.

 Page 50 Convergence Detection Function

Name	Connection part	Special register			
		CH1	CH2	CH3	CH4
Convergence detection upper limit value	1st adapter	SD6322	SD6362	SD6402	SD6442
	2nd adapter	SD6682	SD6722	SD6762	SD6802
	3rd adapter	SD7042	SD7082	SD7122	SD7162
	4th adapter	SD7402	SD7442	SD7482	SD7522

Convergence detection lower limit value

Set the lower limit of the digital output value used in the convergence detection function.

Range	Default value	R/W
-32768 to +32767	0	R/W

Point

The convergence detection upper limit value/lower limit value setting inversion error (Error code: 1AD□H) occurs when the condition "Convergence detection upper limit value > Convergence detection lower limit value" is not satisfied.

For details convergence detection function, refer to the following.

 Page 50 Convergence Detection Function

Name	Connection part	Special register			
		CH1	CH2	CH3	CH4
Convergence detection lower limit value	1st adapter	SD6323	SD6363	SD6403	SD6443
	2nd adapter	SD6683	SD6723	SD6763	SD6803
	3rd adapter	SD7043	SD7083	SD7123	SD7163
	4th adapter	SD7403	SD7443	SD7483	SD7523

Detection time setting for convergence detection

Set the convergence detection time used in the convergence detection function.

Range	Default value	R/W
1 to 10000 (ms)	1	R/W

Point

- When a value outside the setting range is set, the convergence detection time setting range error occurs (Error code: 1AC□H).
- The setting value will be ignored when the convergence detection enable/disable setting is set to "disable".

For details convergence detection function, refer to the following.

 Page 50 Convergence Detection Function

Name	Connection part	Special register			
		CH1	CH2	CH3	CH4
Detection time setting for convergence detection	1st adapter	SD6324	SD6364	SD6404	SD6444
	2nd adapter	SD6684	SD6724	SD6764	SD6804
	3rd adapter	SD7044	SD7084	SD7124	SD7164
	4th adapter	SD7404	SD7444	SD7484	SD7524

Deviation detection CH1

Check the status of the deviation between CH detection flag in the 1st and 2nd FX5-4AD-ADP, or FX5-4A-ADP used in the deviation between CH detection function.

Monitor value	Display description	Default value	R/W
0: OFF	Normal	0: OFF	R
1: ON	Deviation detection		

■ When the deviation detection target is FX5-4AD-ADP

■ When the deviation detection target is FX5-4A-ADP

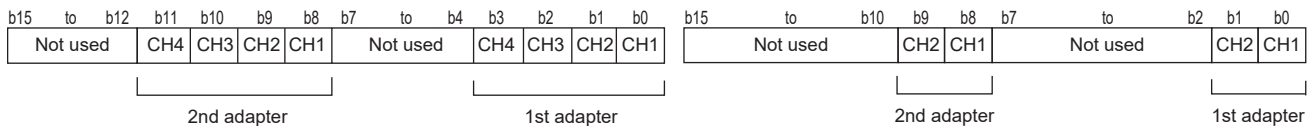

For details deviation detection between channel function, refer to the following.

 Page 51 Deviation Detection Between Channel Function

Name	Connection part	Special register			
		CH1	CH2	CH3	CH4
Deviation detection CH1	1st adapter	SD6325	SD6365	SD6405	SD6445
	2nd adapter	SD6685	SD6725	SD6765	SD6805
	3rd adapter	SD7045	SD7085	SD7125	SD7165
	4th adapter	SD7405	SD7445	SD7485	SD7525

Deviation detection CH2

Check the status of the deviation between CH detection flag in the 3rd and 4th FX5-4AD-ADP, or FX5-4A-ADP used in the deviation between CH detection function.

Only FX5U/FX5UC CPU module is supported.

Monitor value	Display description	Default value	R/W
0: OFF	Normal	0: OFF	R
1: ON	Deviation detection		

■ When the deviation detection target is FX5-4AD-ADP

■ When the deviation detection target is FX5-4A-ADP

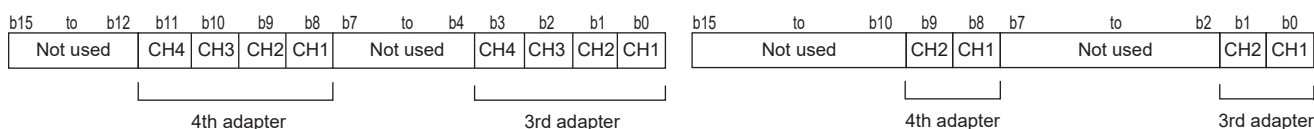

For details deviation detection between channel function, refer to the following.

☞ Page 51 Deviation Detection Between Channel Function

Name	Connection part	Special register			
		CH1	CH2	CH3	CH4
Deviation detection CH2	1st adapter	SD6326	SD6366	SD6406	SD6446
	2nd adapter	SD6686	SD6726	SD6766	SD6806
	3rd adapter	SD7046	SD7086	SD7126	SD7166
	4th adapter	SD7406	SD7446	SD7486	SD7526

Deviation value for deviation detection between channel

Set the deviation value between channels used in the deviation detection between channel function.

Range	Default value	R/W
0 to 65535	0	R/W

Name	Connection part	Special register			
		CH1	CH2	CH3	CH4
Deviation value for deviation detection between channel	1st adapter	SD6327	SD6367	SD6407	SD6447
	2nd adapter	SD6687	SD6727	SD6767	SD6807
	3rd adapter	SD7047	SD7087	SD7127	SD7167
	4th adapter	SD7407	SD7447	SD7487	SD7527

CH setting 1 for deviation detection between channel

Set the channels whose deviation will be checked in the 1st and 2nd FX5-4AD-ADP, or FX5-4A-ADP used in the deviation detection between channel function.

Monitor value	Display description	Default value	R/W
0: OFF	Non target	0	R/W
1: ON	Target		

■ When the deviation detection target is FX5-4AD-ADP

■ When the deviation detection target is FX5-4A-ADP

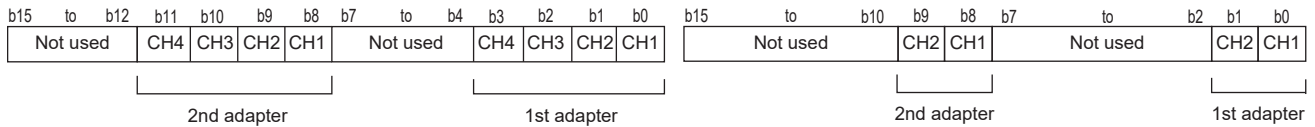

For details deviation detection between channel function, refer to the following.

☞ Page 51 Deviation Detection Between Channel Function

Name	Connection part	Special register			
		CH1	CH2	CH3	CH4
CH setting 1 for deviation detection between channel	1st adapter	SD6328	SD6368	SD6408	SD6448
	2nd adapter	SD6688	SD6728	SD6768	SD6808
	3rd adapter	SD7048	SD7088	SD7128	SD7168
	4th adapter	SD7408	SD7448	SD7488	SD7528

CH setting 2 for deviation detection between channel

Set the channels whose deviation will be checked in the 3rd and 4th FX5-4AD-ADP, or FX5-4A-ADP used in the deviation detection between channel function.

Only FX5U/FX5UC CPU module is supported.

Monitor value	Display description	Default value	R/W
0: OFF	Non target	0	R/W
1: ON	Target		

■ When the deviation detection target is FX5-4AD-ADP

■ When the deviation detection target is FX5-4A-ADP

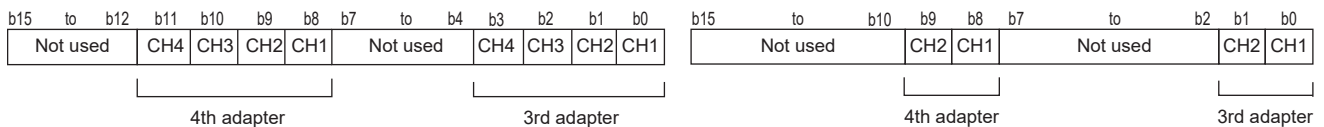

For details deviation detection between channel function, refer to the following.

☞ Page 51 Deviation Detection Between Channel Function

Name	Connection part	Special register			
		CH1	CH2	CH3	CH4
CH setting 2 for deviation detection between channel	1st adapter	SD6329	SD6369	SD6409	SD6449
	2nd adapter	SD6689	SD6729	SD6769	SD6809
	3rd adapter	SD7049	SD7089	SD7129	SD7169
	4th adapter	SD7409	SD7449	SD7489	SD7529

Offset setting value

Set the offset data used in the offset/gain setting function.

Range	Default value	R/W
Voltage: -10000 to +9000 Current: -20000 to +17000	0	R/W

For details offset/gain setting, refer to the following.

 Page 53 Offset/gain Setting Function

Name	Connection part	Special register			
		CH1	CH2	CH3	CH4
Offset setting value	1st adapter	SD6332	SD6372	SD6412	SD6452
	2nd adapter	SD6692	SD6732	SD6772	SD6812
	3rd adapter	SD7052	SD7092	SD7132	SD7172
	4th adapter	SD7412	SD7452	SD7492	SD7532

Gain setting value

Set the gain data used in the offset/gain setting function.

Range	Default value	R/W
Voltage: -9000 to +10000 Current: -17000 to +30000	Voltage input: 5000 Current input: 20000	R/W

For details offset/gain setting, refer to the following.

 Page 53 Offset/gain Setting Function

Name	Connection part	Special register			
		CH1	CH2	CH3	CH4
Gain setting value	1st adapter	SD6333	SD6373	SD6413	SD6453
	2nd adapter	SD6693	SD6733	SD6773	SD6813
	3rd adapter	SD7053	SD7093	SD7133	SD7173
	4th adapter	SD7413	SD7453	SD7493	SD7533

Offset/gain writing enable code

Set the offset/gain writing enable code used for changing the offset/gain.

Range	Default value	R/W
Offset/gain writing enable: E20FH Offset/gain writing disable: Other than E20FH	0	R/W

For details offset/gain setting, refer to the following.

 Page 53 Offset/gain Setting Function

Name	Connection part	Special register			
		CH1	CH2	CH3	CH4
Offset/gain writing enable code	1st adapter	SD6334	SD6374	SD6414	SD6454
	2nd adapter	SD6694	SD6734	SD6774	SD6814
	3rd adapter	SD7054	SD7094	SD7134	SD7174
	4th adapter	SD7414	SD7454	SD7494	SD7534

A/D conversion latest alarm code

The latest alarm code detected in the FX5-4AD-ADP is stored.

Monitor value	Default value	R/W
—	0	R

For details alarm code, refer to the following.

 Page 69 List of Alarm Code

Name	Connection part	Special register			
		CH1	CH2	CH3	CH4
A/D conversion latest alarm code	1st adapter	SD6338	SD6378	SD6418	SD6458
	2nd adapter	SD6698	SD6738	SD6778	SD6818
	3rd adapter	SD7058	SD7098	SD7138	SD7178
	4th adapter	SD7418	SD7458	SD7498	SD7538



Set the "A/D conversion alarm clear request" from OFF to ON to clear the alarm code.

A/D conversion latest error code

The latest error code detected in the FX5-4AD-ADP is stored.

Monitor value	Default value	R/W
—	0	R

For details error code, refer to the following.

 Page 67 List of Error Code

Name	Connection part	Special register			
		CH1	CH2	CH3	CH4
A/D conversion latest error code	1st adapter	SD6339	SD6379	SD6419	SD6459
	2nd adapter	SD6699	SD6739	SD6779	SD6819
	3rd adapter	SD7059	SD7099	SD7139	SD7179
	4th adapter	SD7419	SD7459	SD7499	SD7539



Set the "error clear request" (SM50) of CPU module from OFF to ON to clear the error code.

3 FX5-4AD-PT-ADP

This chapter describes the FX5-4AD-PT-ADP.

3.1 Specifications

This section describes the specifications.

Generic specifications

The items other than the following are equivalent to those of the CPU module.

For general specifications, refer to the following manual.

📖 MELSEC iQ-F FX5UJ User's Manual (Hardware)

📖 MELSEC iQ-F FX5U User's Manual (Hardware)

📖 MELSEC iQ-F FX5UC User's Manual (Hardware)

Item	Specification
Dielectric withstand voltage	500 V AC for one minute
Insulation resistance	10 MΩ or higher by 500 V DC insulation resistance tester

Between all external terminals and ground terminal of CPU module

Power supply specifications

Power supply specifications is shown below.

Item	Specification
Internal electric supply (A/D conversion circuit)	24 V DC 20 mA Internal electric supply is carried out from 24 V DC power supply of a CPU module.
Internal electric supply (Interface)	5 V DC 10 mA Internal electric supply is carried out from 5 V DC power supply of a CPU module.

Performance specifications

Performance specifications is shown below.

Item		Specification		
		Centigrade (°C)	Fahrenheit (°F)	
Number of analog input points		4 points (4 channels)		
Usable resistance temperature detector ^{*1}		Pt100 (JIS C 1604-1997, JIS C 1604-2013) Ni100 (DIN 43760 1987)		
Temperature measuring range		Pt100	-200 to +850°C	-328 to +1562°F
		Ni100	-60 to +250°C	-76 to +482°F
Digital output value		—	16-bit signed binary	
		Pt100	-2000 to +8500	-3280 to +15620
		Ni100	-600 to +2500	-760 to +4820
Accuracy	Ambient temperature 25±5°C	Pt100	±0.8°C	
		Ni100	±0.4°C	
	Ambient temperature -20 to 55°C	Pt100	±2.4°C	
		Ni100	±1.2°C	
Resolution		0.1°C	0.1 to 0.2°F	
Conversion speed		Approx. 85 ms/channel ^{*2}		
Isolation method		Between input terminal and CPU module: Photocoupler Between input channels: Non-isolation		
Number of occupied I/O points		0 point (This number is not related to the maximum number of I/O points of the PLC.)		
Applicable CPU module		<ul style="list-style-type: none"> • FX5UJ CPU module (From the first) • FX5U CPU module (Ver. 1.040 or later) • FX5UC CPU module (Ver. 1.040 or later) 		
Applicable engineering tool		<ul style="list-style-type: none"> • FX5UJ CPU module: GX Works3 (Ver.1.060N or later) • FX5U/FX5UC CPU module: GX Works3 (Ver.1.030G or later) 		

*1 An usable resistance temperature detector is 3-wire type only.

*2 For details of the conversion speed, refer to  Page 106 Temperature Unit Choice Function.

Accuracy

Does not include the accuracy of the resistance temperature detector (including cable).

The accuracy specifications may not be satisfied temporarily when affected by noise.

3.2 List of functions

The following table lists the functions list.

List of Functions		Description	Reference	
Temperature unit choice function		Sets a temperature unit (Centigrade/Fahrenheit) for each FX5-4AD-PT-ADP.	Page 106	
Conversion enable/disable function		Sets whether to enable or disable the temperature conversion for each channel. Disabling the conversion on unused channels reduces the conversion cycles.	Page 106	
Temperature conversion method	Sampling processing	Executes the temperature conversion on analog input every END processing and stores the result as a measured temperature value in the special registers.	Page 107	
	Averaging processing	Time average		Executes temperature conversion for a set time, calculates the average of the total value, and stores the result in special registers. The number of processing times within the set time varies depending on the scan time.
		Count average		Executes temperature conversion for a set number of times, and calculates the average of the total value excluding the maximum value and the minimum value to store it in the special registers. The time taken to store the average value obtained by the averaging processing in the special registers changes depending on the scan time.
		Moving average		Averages measured temperature values taken at every sampling cycle for a specified number of times, and stores the averaged value in the special registers. Because the target range for averaging processing is moved in response to every sampling processing, the latest measured temperature value can be obtained.
Temperature resistance choice function		Sets a resistance temperature detector type for each channel. Selecting the resistance temperature detector type sets the input conversion characteristics.	Page 109	
Disconnection detection function		Disconnection can be detected for each channel.	Page 110	
Alarm output function	Process alarm	Outputs a alarm when a measured temperature value enters the preset alarm output range.	Page 112	
	Rate alarm	Outputs an alert when the change of a measured temperature value is equal to or greater than the rate alarm upper limit value, or equal to or smaller than the rate alarm lower limit value.		
Event history function		Collects errors from FX5-4AD-PT-ADP, and stores them as event information into the CPU module.	Page 117	
Offset/gain setting function		Corrects errors in measured temperature value.	Page 118	
Offset/gain initialization function		Initializes the offset value and gain value stored in the built-in memory of the FX5-4AD-PT-ADP.	Page 122	
Maximum value/minimum value hold function		Stores the maximum and minimum values of measured temperature values to the special registers for each channel.	Page 123	
Common function		Explains the common functions such as changing the setting values while the CPU module is operating.	Page 123	

3.3 Functions

This section describes the functions of the FX5-4AD-PT-ADP and the setting procedures for those functions using GX Works3.

Point

This section describes the special relays and special registers for the 1st FX5-4AD-PT-ADP module. For checking the special relays and special registers for the 2nd and later FX5-4AD-PT-ADP modules, refer to the following:

☞ Page 136 List of Special Relays, ☞ Page 148 List of Special Registers

Processing of Each Function

The functions are processed in the order shown below.

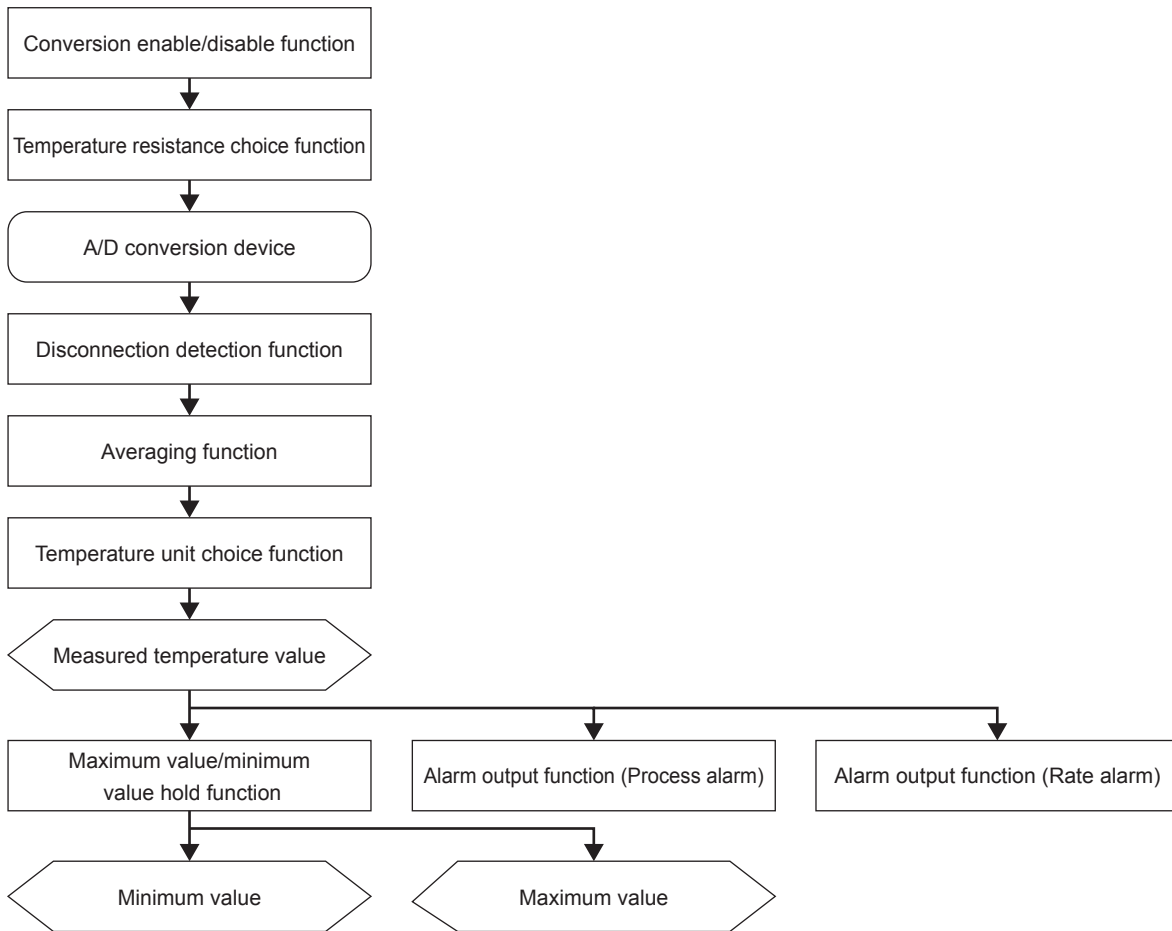

Measured temperature value

These values are the digital values after the sampling processing or each averaging processing has been performed.

Maximum and minimum value

The maximum and minimum values of the measured temperature value are stored.

Temperature Unit Choice Function

Set whether to use centigrade or fahrenheit as the temperature unit. This setting is for all channels.

Setting procedure

Set temperature unit of the "Temperature unit setting".

 Navigation window ⇒ [Parameter] ⇒ [Module Information] ⇒ Module model name ⇒ [Module Parameter] ⇒ "Basic Settings" ⇒ "Temperature unit selection function"

Corresponding devices

The devices which are used by the temperature unit choice function are listed below.

Name	CH1	CH2	CH3	CH4	Reference
Temperature unit setting	SM6280				Page 140

Operation

The "measured temperature value", "maximum value", and "minimum value" are displayed in the temperature unit set by the "temperature unit setting".

The temperature unit can be set only when the "conversion enable/disable setting" is "disable", and the set temperature unit becomes valid after completion of the first temperature conversion.

Point

- Set this function for each FX5-4AD-PT-ADP.
- After selecting the temperature unit, correct the setting values for the alarm output function and the disconnection detection function according to the set temperature unit.

Precautions

If the "temperature unit setting" has been changed while the alarm output function and the disconnection detection function are operating, the setting values for each function are not re-calculated. If the setting values on which the temperature unit has been changed become out of the setting ranges, a range error for each setting is detected. The error detection is performed at the change timing of "conversion enable/disable setting" from "disable" to "enable".

Conversion Enable/Disable Setting Function

This function sets whether to enable or disable the temperature conversion for each channel. Disabling the conversion on unused channels reduces the conversion cycles.

Setting procedure

Set "Conversion enable/disable setting" to "conversion enable".

 Navigation window ⇒ [Parameter] ⇒ [Module Information] ⇒ Module model name ⇒ [Module Parameter] ⇒ "Basic Settings" ⇒ "Conversion Enable/Disable Setting Function"

Corresponding devices

The devices which are used by the conversion enable/disable setting function are listed below.

Name	CH1	CH2	CH3	CH4	Reference
Conversion enable/disable setting	SM6301	SM6341	SM6381	SM6421	Page 140

Operation

The analog input is temperature converted only in the channels for which the "conversion enable/disable setting" is set to "enable", and values are stored in the "measured temperature value". Changing "conversion enable/disable setting" from "enable" to "disable" clears the following.

- "Conversion completed flag"
- "Warning output flag (process alarm upper limit)"
- "Warning output flag (process alarm lower limit)"
- "Warning output flag (rate alarm upper limit)"
- "Warning output flag (rate alarm lower limit)"
- "Disconnection detection flag"
- "Measured temperature value"
- "Maximum value"
- "Minimum value"

Temperature Conversion Method

This function sets a temperature conversion method for each channel.

Sampling processing

Executes the temperature conversion on the analog input approx. 85 ms/channel, and stores the result in the "measured temperature value" each time.

Point

Temperature conversion is executed one channel at a time. The time required to convert one channel is approx. 85 ms. Thus, if the conversion is incomplete during the END process, the "measured temperature value" will not be updated until the conversion is completed. The "measured temperature value" is updated during the END Process after the conversion is completed, and then conversion of the next channel will be started within the same END process.

Averaging processing

The FX5-4AD-PT-ADP performs the averaging processing on measured temperature values for each channel and stores the mean values to the "measured temperature value".

The following three types of averaging processing are provided.

- Time average
- Count average
- Moving average

■Time average

Temperature conversion is executed for a set time, the total value is averaged, and values are stored in the "measured temperature value".

The number of times of processing within the set time varies depending on the number of channels for which temperature conversion is enabled.

Point

If the set time is shorter than the scan time, the averaging processing is not executed, but the sampling value is output. However, only in the first output, the averaged value of the 1st sample and 2nd sample is output.

■Count average

Temperature conversion is executed for a set number of times, and the averaged value excluding the maximum value and minimum value is stored in the "measured temperature value".

The time required to store the averaged value obtained by count average in the "measured temperature value" varies depending on the scan time.

The count average requires a total of at least two values excluding the maximum value and minimum value. Set the number of times to "4" or larger value. Note that only in the first output, sampling values are output until the conversion is executed for a set number of times.

■Moving average

FX5-4AD-PT-ADP averages measured temperature values taken at every sampling cycle for a specified number of times, and stores the averaged value in the "measured temperature value".

Because the target range for averaging processing is moved in response to every sampling processing, the latest measured temperature value is constantly obtained.

The following figure shows the moving average processing of when the set number of times to "4".

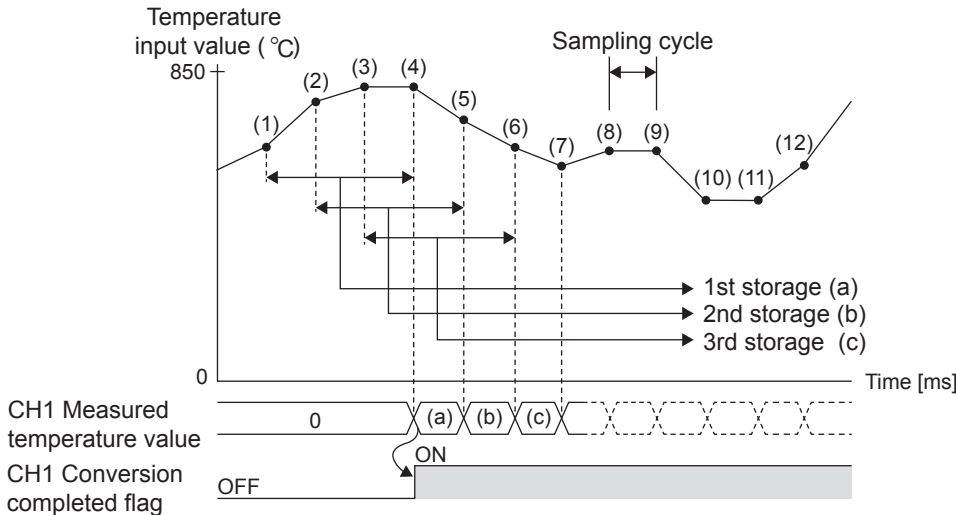

Setting procedure

■Sampling processing

Set "Average Processing Specification" to "Sampling Processing".

Navigation window ⇒ [Parameter] ⇒ [Module Information] ⇒ Module model name ⇒ [Module Parameter] ⇒ "Basic Settings" ⇒ "Temperature Conversion Method"

■Averaging processing

1. Set "Average Processing Specification" to "Time Average", "Count Average", or "Moving Average".

Navigation window ⇒ [Parameter] ⇒ [Module Information] ⇒ Module model name ⇒ [Module Parameter] ⇒ "Basic Settings" ⇒ "Temperature Conversion Method"

2. Set a value for "Time Average Counts Average Moving Average".

Item	Setting range
Time Average	340 to 10000 (ms)
Count Average	4 to 4095 (times)
Moving Average	2 to 64 (times)

Corresponding devices

The devices which are used by the temperature conversion method are listed below.

Name	CH1	CH2	CH3	CH4	Reference
Measured temperature value	SD6300	SD6340	SD6380	SD6420	Page 152
Average processing setting	SD6303	SD6343	SD6383	SD6423	Page 153
Time average/count average/moving average	SD6304	SD6344	SD6384	SD6424	Page 153

Temperature Resistance Choice Function

This function sets a resistance temperature detector type for each channel.

Selecting the resistance temperature detector type sets the input conversion characteristics.

Setting procedure

Set "Resistance temperature detector type setting" to a desired resistance temperature detector.

Navigation window ⇒ [Parameter] ⇒ [Module Information] ⇒ Module model name ⇒ [Module Parameter] ⇒ "Basic Settings" ⇒ "Resistance temperature detector type selection function"

Item	Temperature unit	Temperature input range	Input characteristic (measured temperature value)
Pt100	Centigrade (°C)	-200 to +850°C	-2000 to +8500
	Fahrenheit (°F)	-328 to +1562°F	-3280 to +15620
Ni100	Centigrade (°C)	-60 to +250°C	-600 to +2500
	Fahrenheit (°F)	-76 to +482°F	-760 to +4820

Corresponding devices

The devices which are used by the temperature resistance choice function are listed below.

Name	CH1	CH2	CH3	CH4	Reference
Setting RTD type	SD6305	SD6345	SD6385	SD6425	Page 154

Operation

A resistance temperature detector is switched when the "conversion enable/disable setting" is "disable" and "setting RTD type" has been changed.

When the resistance temperature detector is switched, the following special devices are initialized:

Name	CH1	CH2	CH3	CH4	Reference
Conversion completed flag	SM6300	SM6340	SM6380	SM6420	Page 140
Warning output flag (process alarm upper limit)	SM6311	SM6351	SM6391	SM6431	Page 142
Warning output flag (process alarm lower limit)	SM6312	SM6352	SM6392	SM6432	Page 142
Warning output flag (rate alarm upper limit)	SM6315	SM6355	SM6395	SM6435	Page 143
Warning output flag (rate alarm lower limit)	SM6316	SM6356	SM6396	SM6436	Page 143
Disconnection detection flag	SM6318	SM6358	SM6398	SM6438	Page 144
Offset gain setting flag	SM6331	SM6371	SM6411	SM6451	Page 145
Measured temperature value	SD6300	SD6340	SD6380	SD6420	Page 152
Maximum value	SD6306	SD6346	SD6386	SD6426	Page 154
Minimum value	SD6307	SD6347	SD6387	SD6427	Page 154
Offset temperature setting value ^{*1}	SD6327	SD6367	SD6407	SD6447	Page 159
Gain temperature setting value ^{*1}	SD6328	SD6368	SD6408	SD6448	Page 160
Resistance offset value (L) ^{*1}	SD6330	SD6370	SD6410	SD6450	Page 161
Resistance offset value (H) ^{*1}	SD6331	SD6371	SD6411	SD6451	
Resistance gain value (L) ^{*1}	SD6332	SD6372	SD6412	SD6452	Page 161
Resistance gain value (H) ^{*1}	SD6333	SD6373	SD6413	SD6453	
Input offset value (L) ^{*1}	SD6334	SD6374	SD6414	SD6454	Page 161
Input offset value (H) ^{*1}	SD6335	SD6375	SD6415	SD6455	
Input gain value (L) ^{*1}	SD6336	SD6376	SD6416	SD6456	Page 162
Input gain value (H) ^{*1}	SD6337	SD6377	SD6417	SD6457	

*1 When the thermocouple after change is equivalent to the thermocouple set by the offset/gain setting function, the values (user range setting) set by the offset/gain setting function are reflected. In any other case, they are initialized to the initial value.

Disconnection Detection Function

Simple disconnection detection is performed.

Precautions

The disconnection detection function operates according to the user environment, and thus the detection value varies depending on the difference of wiring resistance.

Setting procedure

1. Set "Disconnection detection enable/disable setting" to "Enable".
 Navigation window ⇒ [Parameter] ⇒ [Module Information] ⇒ Module model name ⇒ [Module Parameter] ⇒ "Application Settings" ⇒ "Disconnection detection function"
2. Set "Enable/Disable setting for disconnection detection automatic clear" to "Enable" or "Disable".
3. Using "Conversion setting for disconnection detection", set what value is to be stored in "Measured temperature value" at the time of the disconnection detection.

Item	Setting range
Conversion setting for disconnection detection	<ul style="list-style-type: none"> • Upscale • Downscale • Any value • Value before disconnection

When "Conversion setting for disconnection detection" is set to "Upscale" (upper limit value + 5% of measurement range) or "Downscale" (lower limit value - 5% of measurement range), the following values are stored in the "measured temperature value".

Resistance temperature detector	Temperature unit	Downscale	Upscale
Pt100	Centigrade (°C)	-2525	9025
	Fahrenheit (°F)	-4225	16565
Ni100	Centigrade (°C)	-755	2655
	Fahrenheit (°F)	-1039	5099

4. "When "Conversion setting for disconnection detection" is set to "Any value", set "Conversion setting for disconnection detection".

Item	Setting range
Conversion setting function for disconnection detection	-3276.8 to 3276.7 ^{*1}

*1 If the temperature unit is Fahrenheit (°F), set the value in increments of 2 (0.2°F).

Corresponding devices

The devices which are used by the disconnection detection function are listed below.

Name	CH1	CH2	CH3	CH4	Reference
Disconnection detection flag	SM6318	SM6358	SM6398	SM6438	Page 144
Disconnection detection enable/disable setting	SM6319	SM6359	SM6399	SM6439	Page 144
Disconnection detection automatic clear enable/disable setting	SM6320	SM6360	SM6400	SM6440	Page 145
Conversion setting for disconnection detection	SD6318	SD6358	SD6398	SD6438	Page 158
Conversion setting value for disconnection detection	SD6319	SD6359	SD6399	SD6439	Page 159

Operation

■ Operations at disconnection

When an analog input value (temperature) reaches the disconnection detection condition in a channel where "conversion enable/disable setting" is set to "enable" and "disconnection detection enable/disable setting" is set to "enable", it is regarded as disconnected. An alarm occurs, and "conversion alarm flag" and "disconnection detection flag" turn on accordingly. (Alarm code: 0A0□H)

If disconnection is detected, the temperature conversion is interrupted, and a value (upscale, downscale, any value, or value immediately before disconnection) is stored in the "measured temperature value" according to the setting of "conversion setting for disconnection detection".

Precautions

While the disconnection detection function is operating, the alarm output function (process alarm), alarm output function (rate alarm), maximum value/minimum value hold function do not operate. In addition, when "conversion enable/disable setting" is "enable", the data related to the disconnection detection function cannot be changed.

■ Operations when the connection is re-established

The operations when the disconnection cause is eliminated and the connection to an external device is re-established vary depending on the setting of "disconnection detection automatic clear enable/disable setting".

- "When "enable" is set

When the connection is re-established, "disconnection detection flag" turns off and the temperature conversion is restarted. "conversion alarm flag" and the alarm code stored in "conversion latest alarm code", however, are not cleared. To clear "conversion alarm flag" and the alarm code stored in "conversion latest alarm code", turn on and off "conversion alarm clear request".

- When "disable" is set

"disconnection detection flag" remains in the state when the disconnection was detected. To return the flag to the normal state, turn on and off "Conversion alarm clear request" after re-establishing connections for all channels.

Note that when "disconnection detection enable/disable setting" is changed to "disable", "disconnection detection flag" turns off.

Detection cycle

Disconnection detection is executed every sampling cycle.

Alarm Output Function

This section describes process alarms and rate alarms used for the alarm output function.

Process alarm

This function outputs a alarm when a measured temperature value enters the preset alarm output range.

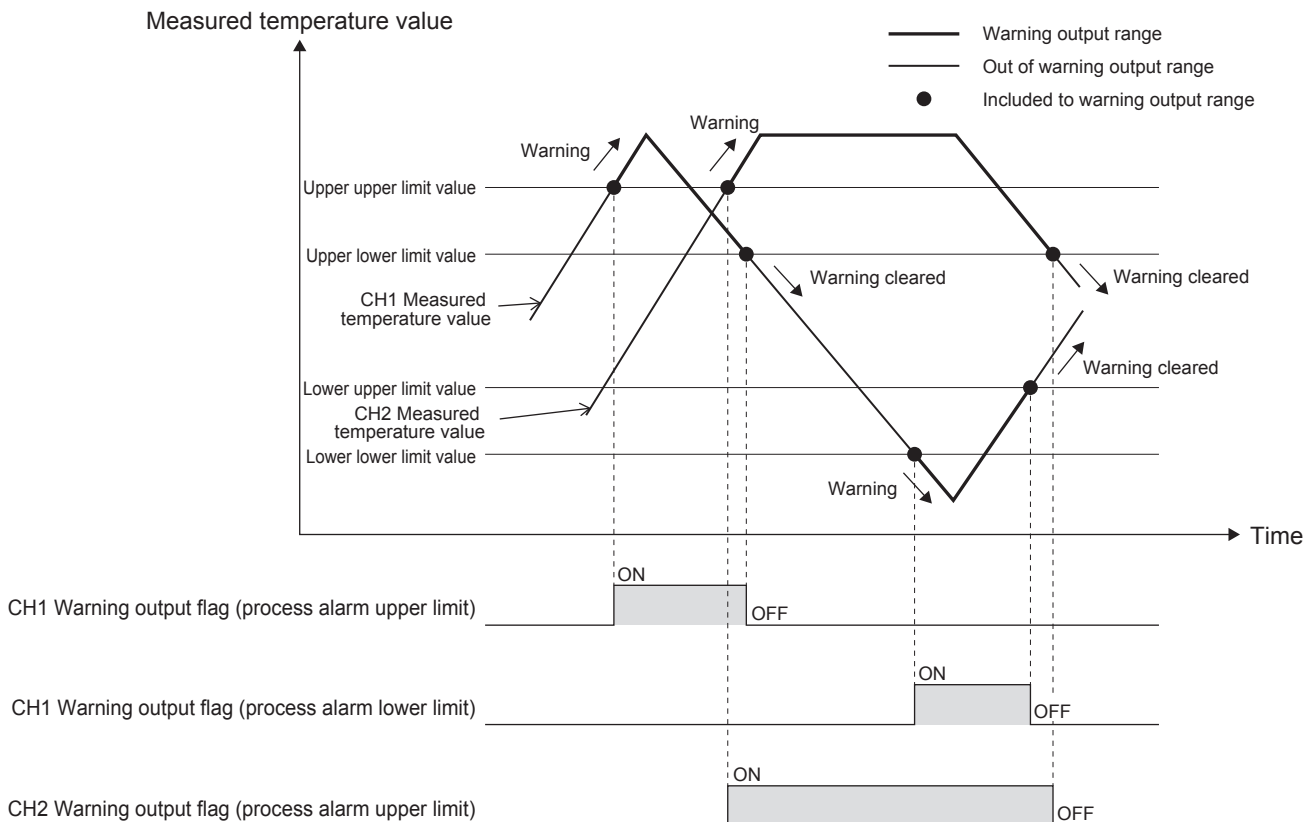

■ Operation

If a measured temperature value satisfies the following conditions where a warning is output, a warning output flag corresponding to "conversion alarm flag" turns on.

- The value is equal to or greater than the process alarm upper upper limit value: "Warning output flag (process alarm upper limit)" turns on. (Alarm code: 080□H)
- The value is equal to or smaller than the process alarm lower lower limit value: "Warning output flag (process alarm lower limit)" turns on. (Alarm code: 081□H)

After a warning was output, if a measured temperature value becomes out of the conditions where a warning is output, the corresponding warning output flag turns off.

- The value is smaller than the process alarm upper lower limit value: "Warning output flag (process alarm upper limit)" turns off.
- The value is greater than the process alarm lower upper limit value: "Warning output flag (process alarm lower limit)" turns off.

In addition, when the "warning output setting (process alarm)" is changed to be disabled, "warning output flag (process alarm upper limit)" and "warning output flag (process alarm lower limit)" turn off. "Conversion alarm flag" and the alarm code stored in "conversion latest alarm code", however, are not cleared.

To clear "conversion alarm flag" and the alarm code stored in "conversion latest alarm code", turn on and off "conversion alarm clear request" after all of "warning output flag (process alarm upper limit)" and "warning output flag (process alarm lower limit)" turn off.

Precautions

When "conversion enable/disable setting" is "enable", the data related to the alarm output function (process alarm) cannot be changed.

■Detection cycle

The process alarm detection is performed every sampling cycle.

■Setting procedure

1. Set "Warning output setting (Process alarm)" to "Enable".

 Navigation window ⇒ [Parameter] ⇒ [Module Information]⇒ Module model name ⇒ [Module Parameter] ⇒ "Application Settings" ⇒ "Warning output function (Process alarm)"

2. Set values for "Process Alarm Upper Upper Limit Value", "Process Alarm Upper Lower Limit Value", "Process Alarm Lower Upper Limit Value", and "Process Alarm Lower Lower Limit Value".

Item	Setting RTD type			Setting range
	Resistance temperature detector	Temperature unit	Temperature input range	
Process Alarm Upper Upper Limit Value	Pt100	Centigrade (°C)	-200 to +850°C	-2000 to +8500
Process Alarm Upper Lower Limit Value		Fahrenheit (°F)	-328 to +1562°F	-3280 to +15620 ^{*1}
Process Alarm Lower Upper Limit Value	Ni100	Centigrade (°C)	-60 to +250°C	-600 to +2500
Process Alarm Lower Lower Limit Value		Fahrenheit (°F)	-76 to +482°F	-760 to +4820 ^{*1}

*1 Set the value in increments of 2 (0.2°F).

Point

Set values within the range satisfying the condition "Process Alarm Upper Upper Limit Value ≥ Process Alarm Upper Lower Limit Value ≥ Process Alarm Lower Upper Limit Value ≥ Process Alarm Lower Lower Limit Value".

When not satisfying the above conditions, a process alarm upper lower limit value setting range error occurs. (Error code: 1A4□H)

■Corresponding devices

The devices which are used by the process alarm are listed below.

Name	CH1	CH2	CH3	CH4	Reference
Warning output flag (process alarm upper limit)	SM6311	SM6351	SM6391	SM6431	Page 142
Warning output flag (process alarm lower limit)	SM6312	SM6352	SM6392	SM6432	Page 142
Warning output setting (process alarm)	SM6313	SM6353	SM6393	SM6433	Page 143
Process alarm upper upper limit value	SD6311	SD6351	SD6391	SD6431	Page 155
Process alarm upper lower limit value	SD6312	SD6352	SD6392	SD6432	Page 155
Process alarm lower upper limit value	SD6313	SD6353	SD6393	SD6433	Page 156
Process alarm lower lower limit value	SD6314	SD6354	SD6394	SD6434	Page 156

Rate alarm

This function outputs an alert when the change of a measured temperature value is equal to or greater than the rate alarm upper limit value, or equal to or smaller than the rate alarm lower limit value.

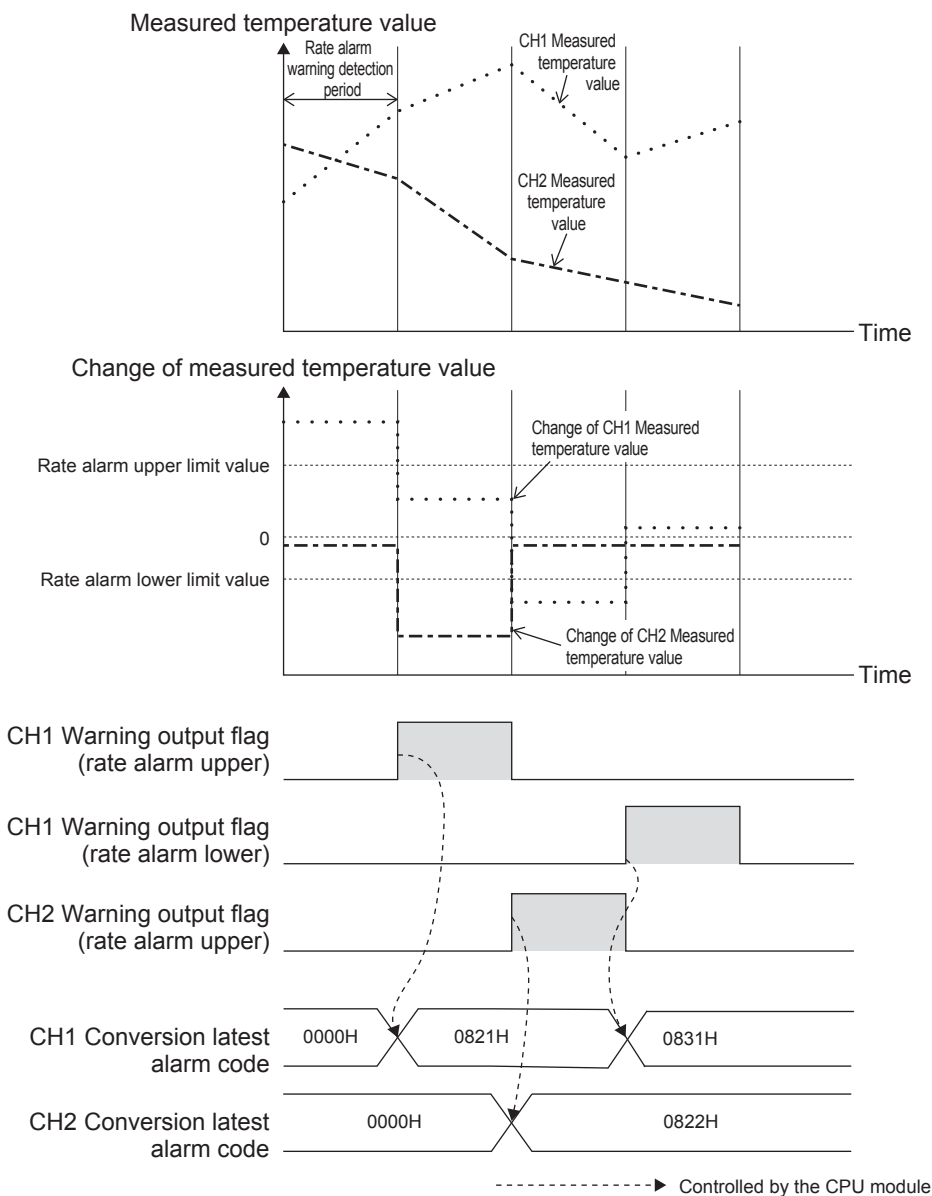

■ Operation

The measured temperature value is monitored every rate alarm warning detection period. When the change from the previous value is equal to or greater than the rate alarm upper limit value, or equal to or smaller than the rate alarm lower limit value, a warning output flag corresponding to "conversion alarm flag" turns on.

- The value is equal to or greater than the rate alarm upper limit value: "Warning output flag (rate alarm upper)" turns on. (Alarm code: 082□H)
- The value is equal to or smaller than the rate alarm lower limit value: "Warning output flag (rate alarm lower)" turns on. (Alarm code: 083□H)

After a warning is output, if the measured temperature value becomes out of the conditions where a warning is output, the corresponding warning output flag turns off.

- The value is smaller than the rate alarm upper limit value: "Warning output flag (rate alarm upper)" turns off.
- The value is greater than the rate alarm lower limit value: "Warning output flag (rate alarm lower)" turns off.

In addition, when the "warning output setting (rate alarm)" is changed to be disabled, "warning output flag (rate alarm upper)" and "warning output flag (rate alarm lower)" turn off. "Conversion alarm flag" and the alarm code stored in "conversion latest alarm code", however, are not cleared.

To clear "conversion alarm flag" and the alarm code stored in "conversion latest alarm code", turn on and off "conversion alarm clear request" after all of "warning output flag (rate alarm upper)" and "warning output flag (rate alarm lower)" turn off.

Precautions

When "conversion enable/disable setting" is "enable", the data related to the alarm output function (rate alarm) cannot be changed.

■Detection cycle

Set the rate alarm warning detection period in "rate alarm detection cycle setting".

■Judgment of rate alarm

A change rate is judged with the following formulae every rate alarm alert detection cycle.

- For alert outputting of rate alarm upper limit

Measured temperature value of this time - Measured temperature value of previous detection cycle \geq Rate alarm upper limit value

- For alert outputting of rate alarm lower limit

Measured temperature value of this time - Measured temperature value of previous detection cycle \leq Rate alarm lower limit value

Ex.

Judgment with the following conditions (for Pt100 (-200 to +850°C))

- Rate alarm detection cycle setting: 150 (ms)
- Rate alarm upper limit value: 5000 (500.0°C)
- Rate alarm lower limit value: 1000 (100.0°C)

A measured temperature value of this time is compared to the previous value (measured temperature value 150ms before), every rate alarm alert detection cycle of 150ms. From the comparison, whether the increase in the measured temperature value is 5000 (500.0°C) or more, or 1000 (100.0°C) or less is judged.

■Application examples of rate alarms

A rate alarm serves to monitor the change of a measured temperature value in a limited range as shown below.

Ex.

To monitor that an increase rate of a measured temperature value (Temperature unit: Centigrade) is within the specified range

Change of the measured temperature value (°C)

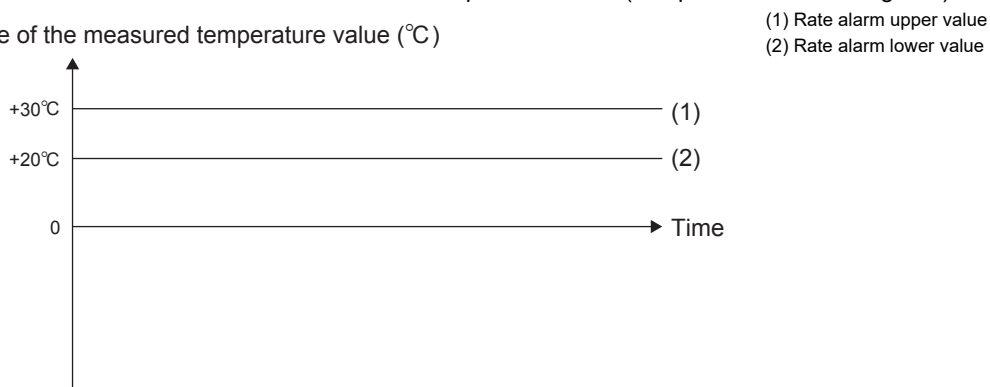

Ex.

To monitor that a decrease rate of a measured temperature value (Temperature unit: Fahrenheit) is within the specified range

Change of the measured temperature value (°F)

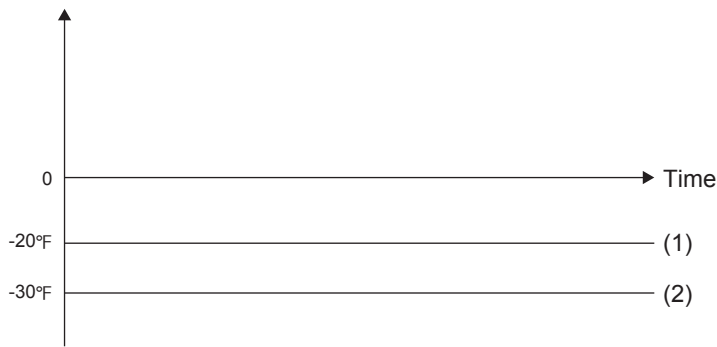

(1) Rate alarm upper value
(2) Rate alarm lower value

Ex.

To monitor that a change rate of a measured temperature value (Temperature unit: Centigrade) is within the specified range

Change of the measured temperature value (°C)

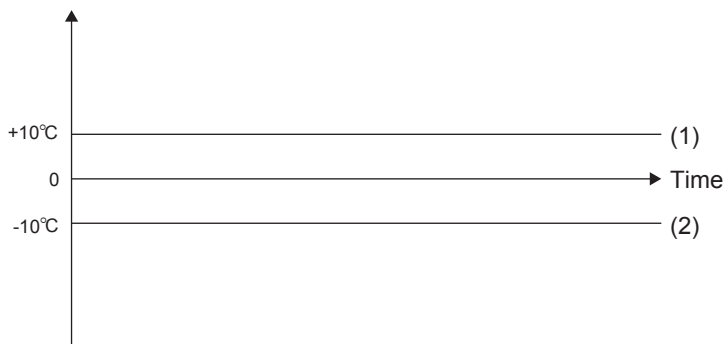

(1) Rate alarm upper value
(2) Rate alarm lower value

Setting procedure

1. Set "Warning output function (Rate alarm)" to "Enable".

Navigation window ⇒ [Parameter] ⇒ [Module Information] ⇒ Module model name ⇒ [Module Parameter] ⇒ "Application Settings" ⇒ "Warning output function (Rate alarm)"

2. Set a value in "Rate alarm warning detection period setting".

Item	Setting range
Rate alarm warning detection period setting	85 to 10000 (ms)

Point

- When a value outside the setting range is set, the rate alarm warning detection period setting range error occurs. (Error code: 1A6□H)
- The rate alarm warning detection period is obtained by Set value + 1 scan time.

3. Set values for "Rate alarm upper limit value" and "Rate alarm lower limit value".

Item	Setting range
Rate alarm upper limit value	-3276.8 to 3276.7* ¹
Rate alarm lower limit value	

*1 If the temperature unit is Fahrenheit (°F), set the value in increments of 2 (0.2°F).

Point

Set values within the range satisfying the condition "Rate alarm upper limit value > Rate alarm lower limit value".

When not satisfying the above conditions, a rate alarm upper/lower limit setting value inversion error occurs. (Error code: 1A5□H)

■Corresponding devices

The devices which are used by the rate alarm are listed below.

Name	CH1	CH2	CH3	CH4	Reference
Warning output flag (rate alarm upper limit)	SM6315	SM6355	SM6395	SM6435	Page 143
Warning output flag (rate alarm lower limit)	SM6316	SM6356	SM6396	SM6436	Page 143
Warning output setting (rate alarm)	SM6317	SM6357	SM6397	SM6437	Page 144
Rate alarm upper limit value	SD6315	SD6355	SD6395	SD6435	Page 157
Rate alarm lower limit value	SD6316	SD6356	SD6396	SD6435	Page 157
Rate alarm detection cycle setting	SD6317	SD6357	SD6397	SD6437	Page 158

Event History Function

This function collects errors from FX5-4AD-PT-ADP, and keeps them in the SD memory card, and data memory or battery backed built-in RAM of the CPU module.

The event information collected by the CPU module can be displayed on GX Works3 to check the occurrence history in chronological order.

Event type	Classification	Description
System	Error	An error detected by the self diagnostics in each module.

Setting procedure

The event history function can be set from the event history setting window of GX Works3. For the setting procedure, refer to the following.

 MELSEC iQ-F FX5 User's Manual (Application)

Displaying event history

Access the menu of GX Works3. For details on the operating procedure and how to view the contents, refer to the following.

 GX Works3 Operating Manual

Offset/gain Setting Function

This function sets any analog (temperature) value to the offset/gain value without regard to the setting prepared in advance. (user range setting) The function corrects error of the temperature conversion caused by noise or other factors. Note that the resolution is not changed. The offset setting value and gain setting value are saved in the built-in memory of the FX5-4AD-PT-ADP.

For changing the offset/gain data, set an analog value to the "offset temperature setting value" or "gain temperature setting value".

The table below shows the available setting range.

Item	Description	Setting range		
		Unit/RTD	Pt100	Ni100
Offset temperature setting value	Temperature setting value corresponding to the input offset value	Centigrade (°C)	-200.0 to +850.0°C	-60.0 to +250.0°C
		Fahrenheit (°F)	-328.0 to +1562.0°F	-76.0 to +482.0°F
Gain temperature setting value	Temperature setting value corresponding to the input gain value	Centigrade (°C)	-200.0 to +850.0°C	-60.0 to +250.0°C
		Fahrenheit (°F)	-328.0 to +1562.0°F	-76.0 to +482.0°F

Point

When the offset temperature setting value and the gain temperature setting value do not satisfy the following condition, the offset/gain temperature setting value error occurs. (Error code: 1D1□H)

- When the temperature unit is centigrade: Gain temperature setting value - offset temperature setting value > 0.1°C
- When the temperature unit is fahrenheit: Gain temperature setting value - offset temperature setting value > 0.3°F

If the "offset temperature setting value" and the "gain temperature setting value" are set using this function, the following values are also stored.

Item	Description	Setting range
Input offset value	The resistance value obtained through the temperature conversion (averaging processing) where the measured temperature value becomes the lower limit value (offset reference value)	0 to 450000 (mΩ)
Input gain value	The resistance value obtained through the temperature conversion (averaging processing) where the measured temperature value becomes the upper limit value (gain reference value)	

Setting procedure

Access to the offset/gain setting window in the GX Works3 to set the offset and gain values.

The setting procedure for the offset/gain setting of the FX5-4AD-PT-ADP is as follows:

 [Tool] ⇒ [Module Tool List]

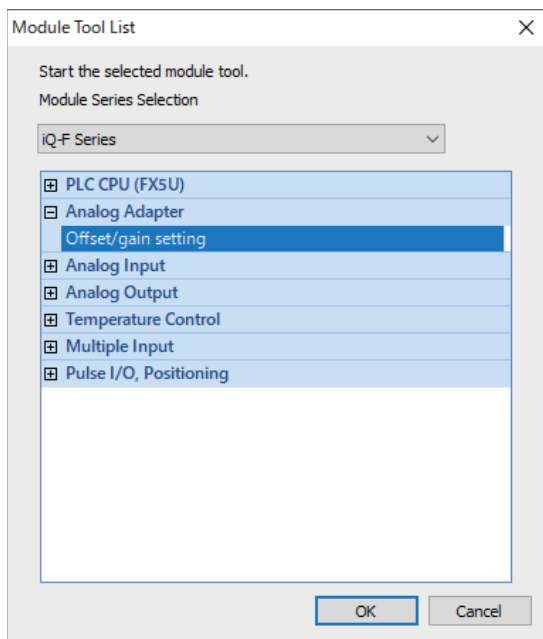

1. In "Analog Adapter", select " Offset/gain setting" and click [OK] button.

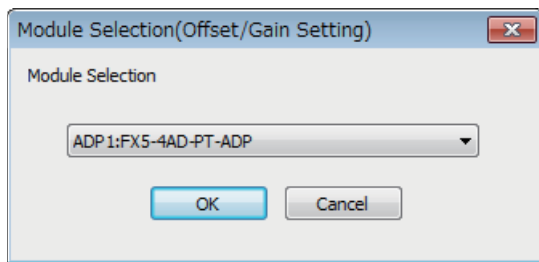

2. Select the target module for the offset/gain setting, and click [OK] button.

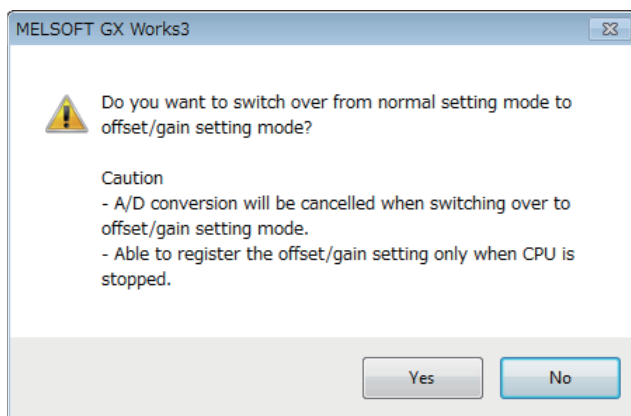

3. Click [Yes] button.

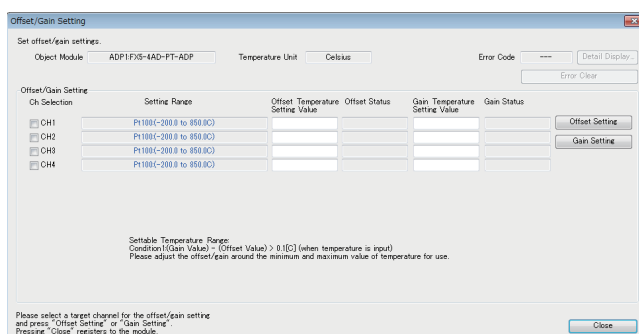

4. Mark the checkbox of the channel where offset and gain values are to be set, and click [Offset Setting] button.

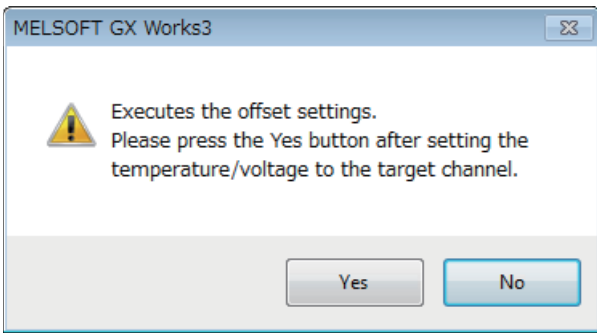

5. Apply the offset temperature to the terminal of the corresponding channel, and click [Yes] button.

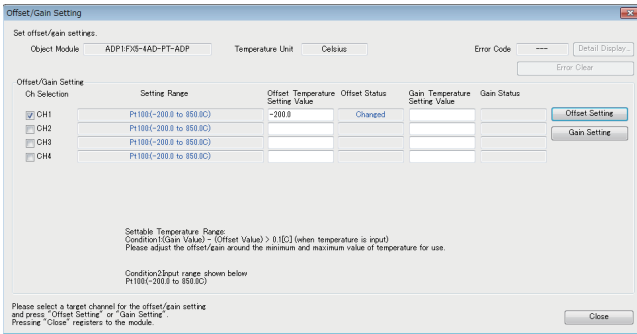

6. Check that "Offset Status" has changed to "Changed", and click [Gain Setting] button.

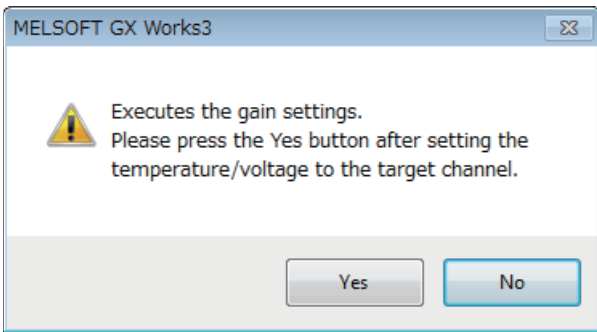

7. Apply the gain temperature to the terminal of the corresponding channel, and click [Yes] button.

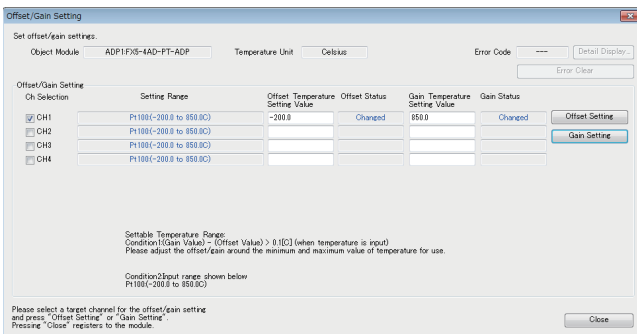

8. Check that "Gain Status" has changed to "Changed", and click [Close] button.

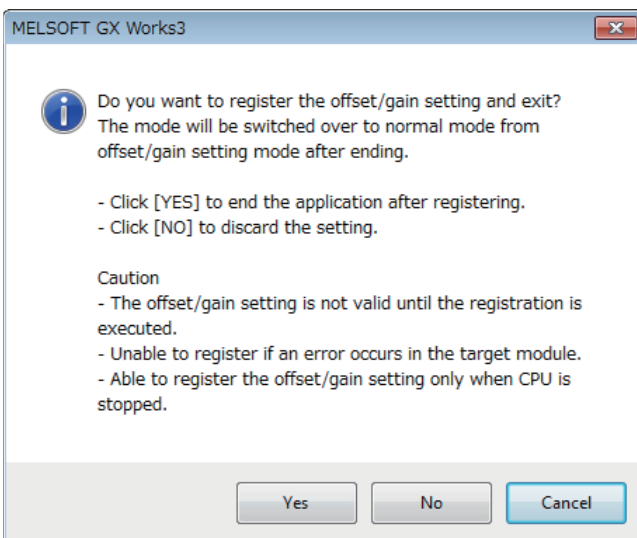

9. Click [Yes] button.

Corresponding devices

The devices which are used by the offset/gain setting function are listed below.

Name	CH1	CH2	CH3	CH4	Reference
Offset gain setting flag	SM6331	SM6371	SM6411	SM6451	Page 145
Read offset/gain	SM6332	SM6372	SM6412	SM6452	Page 145
Write offset/gain	SM6333	SM6373	SM6413	SM6453	Page 146
Offset temperature setting value	SD6327	SD6367	SD6407	SD6447	Page 159
Gain temperature setting value	SD6328	SD6368	SD6408	SD6448	Page 160
Offset/gain code	SD6329	SD6369	SD6409	SD6449	Page 160
Input offset value (L)	SD6334	SD6374	SD6414	SD6454	Page 161
Input offset value (H)	SD6335	SD6375	SD6415	SD6455	
Input gain value (L)	SD6336	SD6376	SD6416	SD6456	Page 162
Input gain value (H)	SD6337	SD6377	SD6417	SD6457	

Operation

■Offset/gain writing

For changing the offset/gain data, set "E215H" to the "offset/gain writing enable code" and set the "offset/gain writing" from OFF to ON to write the "setting RTD type", "offset temperature setting value", "gain temperature setting value", "input offset value" and "input gain value" to the built-in memory of the FX5- 4AD-PT-ADP. This enables the user range setting change for each channel, and the latest contents become valid.

When writing is completed, the "write offset/gain" automatically turns OFF. Also, the "offset/gain code" is cleared to 0.

When the "setting RTD type" is changed, the initial value becomes valid.

For returning the offset/gain data to the initial value, use the offset/gain initialization function. (☞ Page 122 Offset/gain Initialization Function)

Point

- The offset/gain value is written when the "offset/gain code" is set to "E215H".
- The offset/gain value can be written only while temperature conversion is disabled.
- The "conversion enable/disable setting" cannot be changed to "enable" while the offset/gain value is being written.

■Offset/gain reading

For reading the offset/gain data saved in the built-in memory of the FX5-4AD-PT-ADP, set the "read offset/gain" from OFF to ON to read the "setting RTD type", "offset temperature setting value", "gain temperature setting value", "input offset value" and "input gain value".

When the resistance temperature detector type setting that is read is same as the "setting RTD type" stored in the built-in memory of the FX5-4AD-PT-ADP, the obtained values are stored in the "offset temperature setting value", "gain temperature setting value", "input offset value", and "input gain value". If the setting RTD type is different, the initial value of the "setting RTD type" selected during reading is valid and set to the "offset temperature setting value", "gain temperature setting value", "input offset value" and "input gain value". In this case, the offset/gain RTD type mismatch alarm occurs (Alarmcode: 0C0□H)

Offset/gain Initialization Function

This function initializes the offset value and gain value saved in the built-in memory of the FX5-4AD-PT-ADP. This function can be set only with special devices.

Setting procedure

1. Set "E215H" to the "offset/gain code".

Setting value	Description	Default value
Other than E215H	Offset/gain writing disable	0
E215H	Offset/gain writing enable	

2. Set the "initialize offset/gain" from OFF to ON.

Setting value	Description	Default value
0: OFF	Offset/gain initialization is not performed.	0: OFF
1: ON	Offset/gain initialization is performed.	

Corresponding devices

The devices which are used by the offset/gain initialization function are listed below.

Name	CH1	CH2	CH3	CH4	Reference
Initialize offset/gain	SM6334	SM6374	SM6414	SM6454	Page 146
Offset/gain code	SD6329	SD6369	SD6409	SD6449	Page 160

Operation

Set "E215H" to the "offset/gain code" and set the "initialize offset/gain" from OFF to ON to initialize the offset temperature setting value, gain temperature setting value, input offset value and input gain value saved in the built-in memory of the FX5-4AD-PT-ADP. When initialization is completed, the "initialize offset/gain" automatically turns OFF. Also, the "offset/gain code" is cleared to 0.

Point

- Offset/gain initialization is executed when the "offset/gain code" is set to "E215H".
- Offset/gain initialization is enabled only while temperature conversion is disabled.
- The "conversion enable/disable setting" cannot be changed to "enable" while offset/gain initialization is being executed.

Maximum Value/Minimum Value Hold Function

This function stores the maximum value and minimum value of the measured temperature value to the special registers for each channel.

This function can be set only with special devices.

Setting procedure

When the "maximum value reset request" or "minimum value reset request" is set from OFF to ON, the maximum value or minimum value is updated to the measured temperature value.

Setting value	Description	Default value
0: OFF	With no maximum value or minimum value reset request	0: OFF
1: ON	With maximum value or minimum value reset request	

Corresponding devices

The devices which are used by the maximum value/minimum value hold function are listed below.

Name	CH1	CH2	CH3	CH4	Reference
Maximum value/minimum value reset completed flag	SM6305	SM6345	SM6385	SM6425	Page 141
Maximum value reset request	SM6306	SM6346	SM6386	SM6426	Page 141
Minimum value reset request	SM6307	SM6347	SM6387	SM6427	Page 142
Maximum value	SD6306	SD6346	SD6386	SD6426	Page 154
Minimum value	SD6307	SD6347	SD6387	SD6427	Page 154

Operation

When the "maximum value reset request" or "minimum value reset request" is set from OFF to ON, the maximum value or minimum value of the specified channel is updated to the "measured temperature value" every sampling cycle. In addition, the "maximum value/minimum value reset completed flag" turns ON.

When the temperature resistance choice is changed, the "maximum value" and "minimum value" are cleared (to "0").

Common Function

Changing the setting value while the CPU module is operating

This paragraph shows the procedure to adopt values (of special relays and special registers) other than the values set by the parameters of GX Works3.

1. Disable temperature conversion.

Set "conversion enable/disable setting" to ON. (☞ Page 140 Conversion enable/disable setting)

2. Change the value of a target special relay/device.

Change the value of a target device.

3. Enable temperature conversion.

Set "conversion enable/disable setting" to OFF. (☞ Page 140 Conversion enable/disable setting)

Precautions

- If the value of the special relay or special device has been changed while the temperature conversion is enabled, an alarm occurs and, at the END processing, the value is overwritten with the value used for the current operation. (Alarm code: 0F0□H)
- When the temperature conversion method is count average or moving average, if the temperature conversion is set to be disabled, the values of special relay or special device related to average counts and averaging process setting are changed, and the temperature conversion is set to be enabled again, the number of sampling times is cleared and the sampling is performed from 0 time.

Starting/stopping the analog function in accordance with the CPU module status

This paragraph shows the analog operation in accordance with the CPU module status.

■RUN

The FX5-4AD-PT-ADP operates in accordance with its parameters.

■PAUSE

The FX5-4AD-PT-ADP operates in accordance with its parameters.

■STOP

The FX5-4AD-PT-ADP continues temperature conversion.

Alarm clear request

It is necessary to set the "conversion alarm clear request" from OFF to ON to clear the alarm code.

The table below shows the necessity of the alarm clear request for turning OFF each flag and clearing the alarm code.

Flag name	Alarm clear request required to turn OFF the flag	Alarm clear request required to clear the alarm code
Conversion completed flag	—	—
Maximum value/minimum value reset completed flag	—	—
Warning output flag (process alarm upper limit)	—	○
Warning output flag (process alarm lower limit)	—	○
Warning output flag (rate alarm upper limit)	—	○
Warning output flag (rate alarm lower limit)	—	○
Disconnection detection flag	○*1	○

*1 The alarm clear request is required when "disconnection detection automatic clear enable/disable setting" is set to "disable".

○: Requires the alarm clear request.

—: Does not require the alarm clear request.

Point

- The "conversion alarm clear request" is required for flags which do not turn OFF automatically and flags which cause alarms.
- The "conversion alarm clear request" is not turned off automatically. To perform an alarm clear again, it is necessary to turn it OFF once.

3.4 Procedure to Execute the FX5-4AD-PT-ADP

The procedure to execute FX5-4AD-PT-ADP is described below.

1. Confirm the specifications of the FX5-4AD-PT-ADP.

Confirm the specifications of the FX5-4AD-PT-ADP. (☞ Page 102 Specifications)

2. Check the system configuration.

Check the system configuration. (☞ Page 126 System Configuration)

3. Attach the FX5-4AD-PT-ADP.

Refer to the following manuals for attachment to the CPU module:

📖 MELSEC iQ-F FX5UJ User's Manual (Hardware)

📖 MELSEC iQ-F FX5U User's Manual (Hardware)

📖 MELSEC iQ-F FX5UC User's Manual (Hardware)

4. Connect the FX5-4AD-PT-ADP to the external device.

Wiring to external devices. (☞ Page 127 Wiring)

5. Set the parameters.

Set the parameters to configure the FX5-4AD-PT-ADP. (☞ Page 129 Parameter Setting)

6. Create the program.

Create the program to use the FX5-4AD-PT-ADP.

7. Run the program.

Precautions

Do not write to the special relay/special register in the user interrupt program.

3.5 System Configuration

This section describes the system configuration including analog adapters.

Up to two analog adapters can be connected to an FX5UJ CPU module.

Up to four analog adapters can be connected to an FX5U/FX5UC CPU module.*¹

The connection position of the analog adapter connected to each CPU module are counted as the first module, the second module, and so on in order of proximity to the CPU module.

However, communication adapters are not counted towards the number of analog adapters.

■FX5UJ CPU module

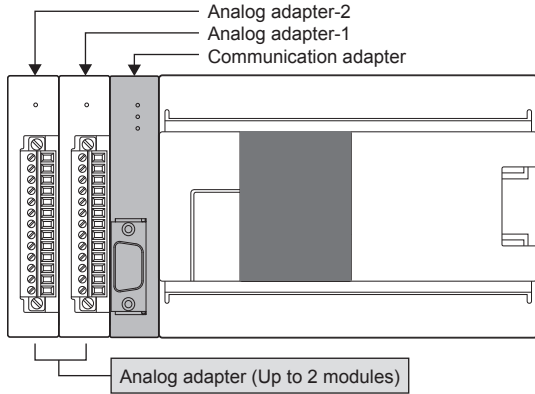

■FX5U CPU module

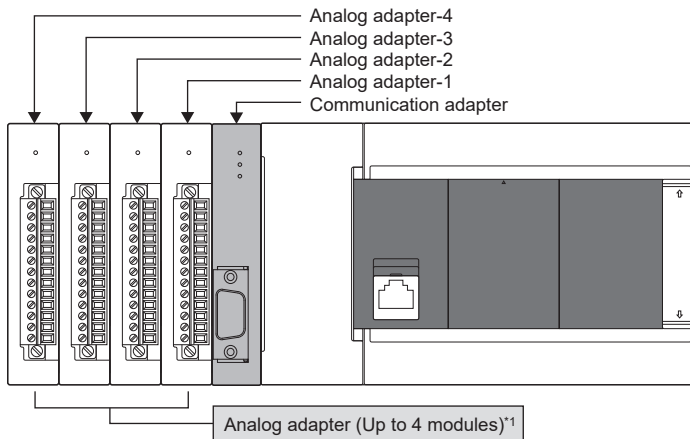

■FX5UC CPU module

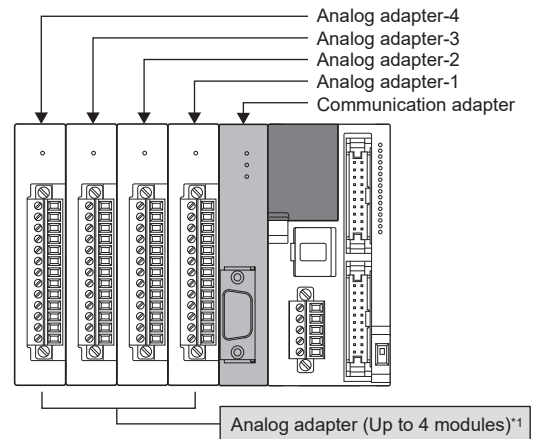

*¹ For FX5-4A-ADP, up to two modules can be connected.

3.6 Wiring

This section describes the wiring.

European-type terminal block

Wire the European-type terminal block in accordance with the following specifications.

Suitable wiring

Number of wires connected per terminal	Wire size		Tightening torque
	Solid wire, Stranded wire	Wire ferrule with insulation sleeve	
One wire	0.3 to 0.5 mm ² (AWG22 to 20)	0.3 to 0.5 mm ² (AWG22 to 20)	0.20 N·m
Two wires	0.3mm ² (AWG22)	—	

Precautions

Do not tighten terminal screws with torque exceeding the specified range. Failure to do so may cause equipment failures or malfunctions.

Wire end treatment

Treat stranded and solid wires as they are or use wire ferrules with insulation sleeves for wiring terminals.

■When stranded and solid wires are treated as they are

- Twist the end of stranded wires and make sure that there are no loose wires.
- Do not solder-plate the electric wire ends.

Stripping dimensions of electric wire ends

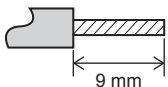

■When wire ferrules with insulation sleeves are used

Depending on the thickness of a wiring sheath used, it may be difficult to insert the sheath into an insulation sleeve. Refer to the external dimensions as a reference to select wires.

External dimension of wire ferrules with insulation sleeves

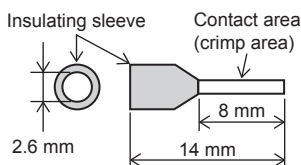

<Reference>

Manufacturer	Model	Crimp tool
Phoenix Contact GmbH & Co. KG	Al 0.5-8 WH	CRIMPFOX 6 CRIMPFOX 6T-F

■Tool

For tightening terminals, use a small, commercially-available screwdriver with a straight tip. The recommended shape is shown in the figure on the right.

■Precautions

When a precision screwdriver with a small grip is used, the specified tightening torque cannot be obtained. Use the following screwdriver or equivalent product (grip diameter: 25 mm) to obtain the tightening torque specified above.

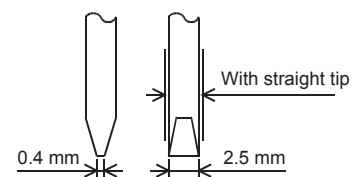

<Reference>

Manufacturer	Model
Phoenix Contact GmbH & Co. KG	SZS 0.4×2.5

Terminal layout

The following table shows the terminal layout.

Terminal block	Signal name	Function	
	L1+	CH1	Resistance temperature detector + input
	L1-		Resistance temperature detector - input
	I1-		Resistance temperature detector common input
	L2+	CH2	Resistance temperature detector + input
	L2-		Resistance temperature detector - input
	I2-		Resistance temperature detector common input
	L3+	CH3	Resistance temperature detector + input
	L3-		Resistance temperature detector - input
	I3-		Resistance temperature detector common input
	L4+	CH4	Resistance temperature detector + input
	L4-		Resistance temperature detector - input
	I4-		Resistance temperature detector common input
	•	Do not wire this terminal.	

Wiring of resistance temperature detector

The following figures show wiring of the resistance temperature detector.

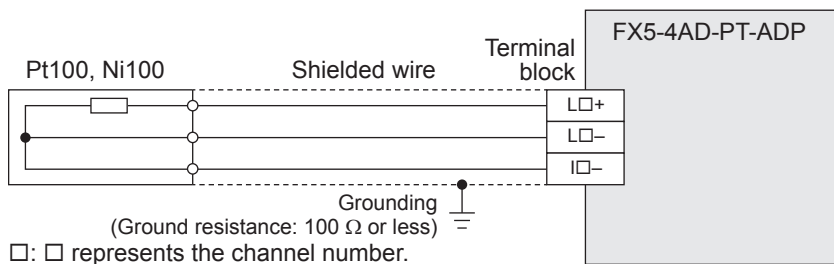

Point

- Only 3 wire Pt100 and Ni100 resistance temperature detectors can be used.
- Separate the cable of the resistance thermometer detector from other power cables or areas easily affected by inductive noise (from commercial power, etc.).

Grounding

Perform the following.

- Perform class D grounding (Grounding resistance: 100 Ω or less).
- Ground the PLC independently when possible.

If the PLC cannot be grounded independently, perform the "Shared grounding" shown below.

For the details, refer to the following manual.

📖 MELSEC iQ-F FX5UJ User's Manual (Hardware)

📖 MELSEC iQ-F FX5U User's Manual (Hardware)

📖 MELSEC iQ-F FX5UC User's Manual (Hardware)

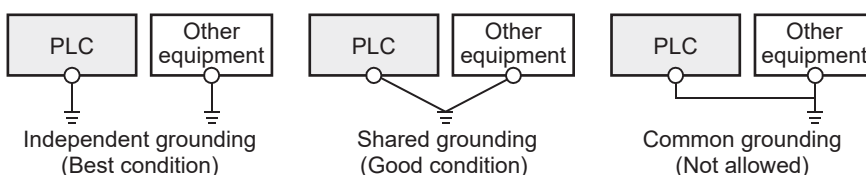

- Use a grounding wire with thickness of AWG 22 to 20 (0.3 to 0.5 mm²).
- Bring the grounding point close to the PLC as much as possible so that the ground cable can be shortened.

3.7 Parameter Setting

Set the parameters of each channel.

Setting parameters here eliminates the need to program them.

Point

Parameters are enabled when the CPU module is powered ON or after a reset. In addition, operations different from the parameter settings are possible by transferring values to special relays and special registers while changing these values in the program.

Refer to Page 136 List of Special Relays or Page 148 List of Special Registers for details on the special relays and special registers.

Basic settings

Setting procedure

Open "Basic Settings" of the GX Works3.

1. Start Module parameter.

Navigation window ⇒ [Parameter] ⇒ [Module Information] ⇒ Module model name ⇒ [Module Parameter] ⇒ "Basic Settings"

Window

Item	CH1	CH2	CH3	CH4
<input type="checkbox"/> Temperature unit selection function	Set the temperature unit selection function.			
Temperature unit setting	Celsius			
<input type="checkbox"/> Conversion enable/disable setting function	Set the Conversion enable/disable function.			
Conversion enable/disable setting	Disable	Disable	Disable	Disable
<input type="checkbox"/> Temperature conversion method	Set the temperature conversion method.			
Average Processing Specification	Sampling Processing	Sampling Processing	Sampling Processing	Sampling Processing
Time Average Counts Average Moving Average	0 Times	0 Times	0 Times	0 Times
<input type="checkbox"/> Resistance temperature detector type selection function	Set the resistance temperature detector type.			
Resistance temperature detector type setting	Pt100 (-200 to 850 C)	Pt100 (-200 to 850 C)	Pt100 (-200 to 850 C)	Pt100 (-200 to 850 C)

Displayed items

Item	Description	Setting range	Default
Temperature unit setting	Set whether to use 'Celsius' or 'Fahrenheit' as the temperature unit.	<ul style="list-style-type: none"> • Celsius • Fahrenheit 	Celsius
Conversion enable/disable setting	Set whether to use 'Enable' or 'Disable' to output the converted for each channel.	<ul style="list-style-type: none"> • Disable • Enable 	Disable
Average Processing Specification	Execute whether to set "average process" or "sampling processing".	<ul style="list-style-type: none"> • Sampling Processing • Time Average • Count Average • Moving Average 	Sampling Processing
Time Average Counts Average Moving Average	Set average time, average counts, moving average counts for each channel.	Set range setting for each channel.	—
Resistance temperature detector type setting	Set the resistance temperature detector type to connect for each channel.	<ul style="list-style-type: none"> ■ Celsius <ul style="list-style-type: none"> • Pt100 (-200 to 850 °C) • Ni100 (-60 to 250 °C) ■ Fahrenheit <ul style="list-style-type: none"> • Pt100 (-328 to 1562 °F) • Ni100 (-76 to 482 °F) 	—

2. Click the item to be changed to enter the setting value.

- Item where a value is selected from the pull-down list

Click [▼] button of the item to be set, and from the pull-down list that appears, select the value.

- Item where a value is entered into the text box

Double-click the item to be set to enter the numeric value.

Application settings

Setting procedure

Open "Application Settings" of the GX Works3.

1. Start Module parameter.

Navigation window ⇒ [Parameter] ⇒ [Module Information] ⇒ Module model name ⇒ [Module Parameter] ⇒ "Application Settings"

Window

Item	CH1	CH2	CH3	CH4
Warning output function (Process alarm)	Execute the setting related to A/D conversion warning.			
Warning output setting (Process alarm)	Disable	Disable	Disable	Disable
Process Alarm Upper Upper Limit Value	850.0 C	850.0 C	850.0 C	850.0 C
Process Alarm Upper Lower Limit Value	850.0 C	850.0 C	850.0 C	850.0 C
Process Alarm Lower Upper Limit Value	-200.0 C	-200.0 C	-200.0 C	-200.0 C
Process Alarm Lower Lower Limit Value	-200.0 C	-200.0 C	-200.0 C	-200.0 C
Warning output function (Rate alarm)	Execute the setting related to A/D conversion warning.			
Warning output setting (Rate alarm)	Disable	Disable	Disable	Disable
Rate alarm warning detection period setting	85 ms	85 ms	85 ms	85 ms
Rate alarm upper limit value	0.0 C	0.0 C	0.0 C	0.0 C
Rate alarm lower limit value	0.0 C	0.0 C	0.0 C	0.0 C
Disconnection detection function	Execute the setting related to disconnection detection.			
Disconnection detection enable/disable setting	Enable	Enable	Enable	Enable
Conversion setting for disconnection detection	Downscale	Downscale	Downscale	Downscale
Conversion setting function for disconnection detection	0.0 C	0.0 C	0.0 C	0.0 C
Enable/Disable setting for disconnection detection automatic clear	Disable	Disable	Disable	Disable

Displayed items

Item	Description	Setting range	Default
Warning output setting (Process alarm)	Set whether to "enable" or "disable" process alarm warning.	<ul style="list-style-type: none"> Disable Enable 	Disable
Process Alarm Upper Upper Limit Value	Set upper upper limit value of measured temperature value	-3276.8 to +3276.7	—
Process Alarm Upper Lower Limit Value	Set upper lower limit value of measured temperature value.	-3276.8 to +3276.7	—
Process Alarm Lower Upper Limit Value	Set lower upper limit value of measured temperature value.	-3276.8 to +3276.7	—
Process Alarm Lower Lower Limit Value	Set lower lower limit value of measured temperature value.	-3276.8 to +3276.7	—
Warning output setting (rate alarm)	Set whether to "enable" or "disable" the rate alarm warning.	<ul style="list-style-type: none"> Disable Enable 	Disable
Rate alarm warning detection period setting	Set the value for the sampling cycle to detect the rate alarm warning.	85 to 10000	—
Rate alarm upper limit value	Set the upper limit value of the measured temperature value.	-3276.8 to +3276.7	—
Rate alarm lower limit value	Set the lower limit value of the measured temperature value.	-3276.8 to +3276.7	—
Disconnection detection enable/disable setting	Set whether to "Enable" or "Disable" disconnection detection.	<ul style="list-style-type: none"> Enable Disable 	Enable
Conversion setting for disconnection detection	In disconnection detection function, set the value to be converted detecting for each channel.	<ul style="list-style-type: none"> Upscale Downscale Any value Value before disconnection 	Downscale
Conversion setting function for disconnection detection	Set the value to convert when 'Any value' is selected for conversion setting function for disconnection detection.	-3276.8 to +3276.7	—
Enable/Disable setting for disconnection detection automatic clear	Set whether to 'Enable' or 'Disable' the auto-clear of the disconnection detection for disconnection detection function.	<ul style="list-style-type: none"> Enable Disable 	Enable

2. Click the item to be changed to enter the setting value.

- Item where a value is selected from the pull-down list

Click [▼] button of the item to be set, and from the pull-down list that appears, select the value.

- Item where a value is entered into the text box

Double-click the item to be set to enter the numeric value.

3.8 Troubleshooting

This section describes errors that may occur in the use of the FX5-4AD-PT-ADP and those troubleshooting.

Troubleshooting with the LEDs

Check the state of the LED to narrow down the possible causes of the trouble. This step is the first diagnostics.

A state of the FX5-4AD-PT-ADP can be checked with the PWR LED. The following table shows the correspondence of LED and a state of the FX5-4AD-PT-ADP

Name	Description
PWR LED	Indicates the power supply status of the FX5-4AD-PT-ADP. On: The power supply is supplied. Off: The power supply is not supplied.

Checking the state of the module

Open the module diagnostics window of the GX Works3 to check the error codes (alarm codes) and error history of the FX5-4AD-PT-ADP.

 [Diagnostics] ⇒ [Module Diagnostics (CPU Diagnostics)]

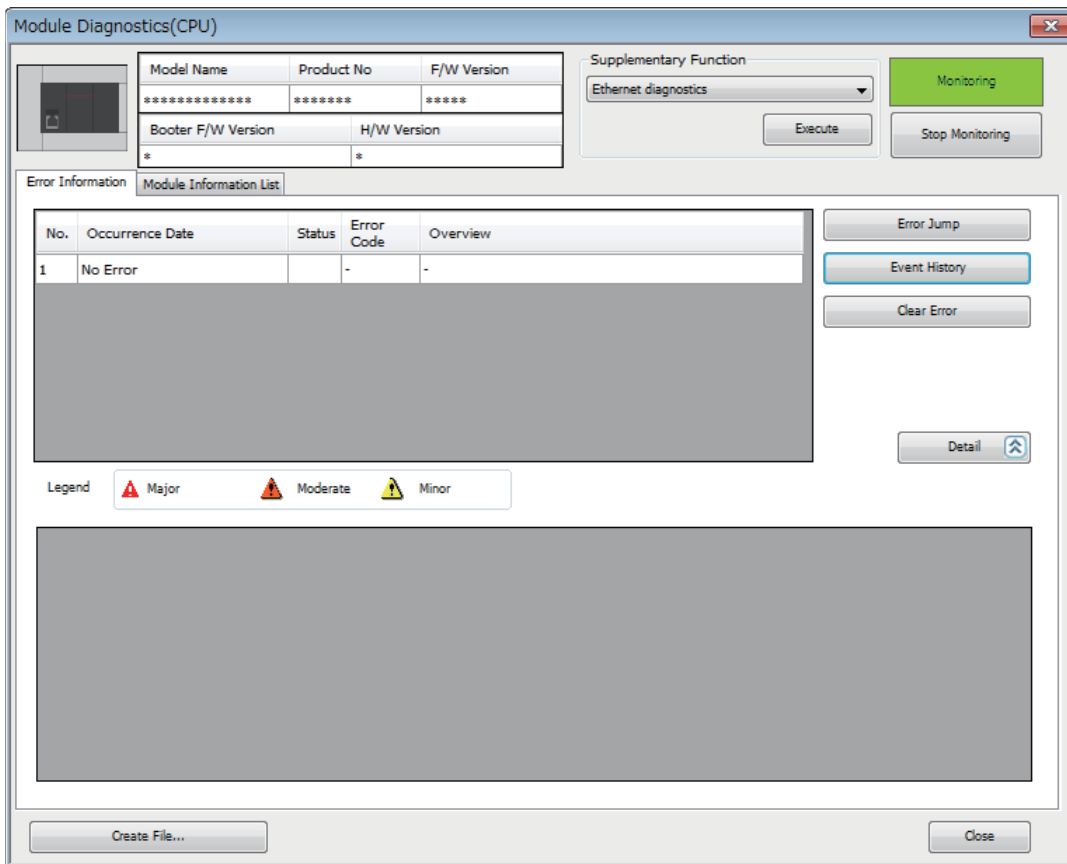

Error history, alarm history can be checked with the event history window of the GX Works3.

 [Diagnostics] ⇒ [Module Diagnostics (CPU Diagnostics)] ⇒ [Event History] button

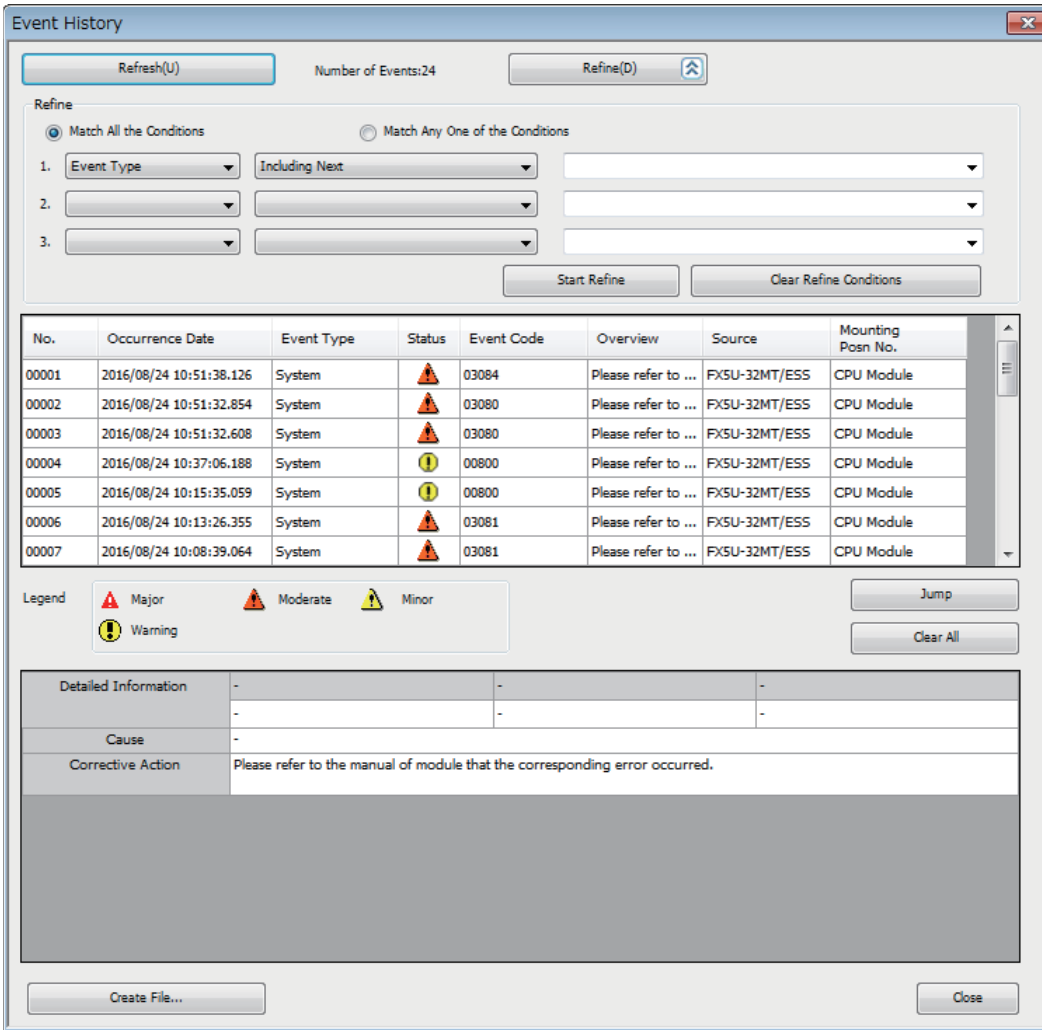

Event History

Refresh(U) Number of Events:24 Refine(D)

Refine







Match All the Conditions Match Any One of the Conditions

1. Event Type Including Next [Dropdown]



2. [Dropdown] [Dropdown] [Dropdown]

3. [Dropdown] [Dropdown] [Dropdown]

Start Refine Clear Refine Conditions

No.	Occurrence Date	Event Type	Status	Event Code	Overview	Source	Mounting Posn No.
00001	2016/08/24 10:51:38.126	System		03084	Please refer to ...	FXSU-32MT/ESS	CPU Module
00002	2016/08/24 10:51:32.854	System		03080	Please refer to ...	FXSU-32MT/ESS	CPU Module
00003	2016/08/24 10:51:32.608	System		03080	Please refer to ...	FXSU-32MT/ESS	CPU Module
00004	2016/08/24 10:37:06.188	System		00800	Please refer to ...	FXSU-32MT/ESS	CPU Module
00005	2016/08/24 10:15:35.059	System		00800	Please refer to ...	FXSU-32MT/ESS	CPU Module
00006	2016/08/24 10:13:26.355	System		03081	Please refer to ...	FXSU-32MT/ESS	CPU Module
00007	2016/08/24 10:08:39.064	System		03081	Please refer to ...	FXSU-32MT/ESS	CPU Module

Legend

 Major  Moderate  Minor

 Warning

Jump Clear All

Detailed Information	-	-	-
Cause	-	-	-
Corrective Action	Please refer to the manual of module that the corresponding error occurred.		

Create File... Close

Troubleshooting by Symptom

When the PWR LED does not turn ON

Check item	Action
Check whether the power is supplied.	Check whether the voltage supplied to the CPU module is within the rated range.
Whether the FX5-4AD-PT-ADP is attached normally to the CPU module.	Check the FX5-4AD-PT-ADP attachment status.

When a measured temperature value cannot be read

Check item	Action
Whether the analog signal cable is connected normally to the FX5-4AD-PT-ADP.	Check the signal cables visually, and wire the analog signal cable correctly.
Whether the external equipment is wired correctly.	Wire the external equipment correctly to the FX5-4AD-PT-ADP.
Whether the offset/gain is set correctly.	Check whether the offset/gain is set correctly. Check whether temperature conversion is executed correctly. When temperature conversion is executed correctly, set the offset/gain again.
Check whether the setting resistance temperature detector type is correct.	Check the setting resistance temperature detector type of GX Works3. If the contents of setting are wrong, set the resistance temperature detector type again.
Whether the "conversion enable/disable setting" is set to "enable" for the channel to be used.	Check the "Conversion enable/disable setting" for the channel to be used in the parameter setting of GX Works3, and set "enable" in the parameter of GX Works3 or in the program.

When the Measured temperature value does not change

Check item	Action
Whether disconnection is detected.	Remove the cause of disconnection by replacing the analog signal cable, etc., and then check the Measured temperature value.

When a value is not converted into the expected digital output value

Check item	Action
Check whether the setting RTD type is correct.	Check the setting RTD type in the parameter setting of GX Works3. If the contents of setting are wrong, set the RTD type again.
Check whether the offset/gain setting is correct.	Check whether the offset/gain is set correctly. Check whether temperature conversion is executed correctly. When temperature conversion is executed correctly, set the offset/gain again.
Whether the temperature conversion method is set correctly.	Check the temperature conversion method in the parameter setting of GX Works3. If the contents of setting are wrong, set the temperature conversion method again.

When the measured temperature value is dispersed

Check item	Action
Whether an temperature conversion method other than sampling processing is set.	Check the temperature conversion method in the parameter setting of GX Works3. Set the averaging processing to the temperature conversion method, and then check again for dispersion of the measured temperature value.

When the conversion completed flag does not turn ON

Check item	Action
Whether conversion is disabled in every channel.	Check the channels for which conversion is enabled in the parameter setting of GX Works3. If conversion is not enabled in any channel, enable conversion for 1 or more channels in the parameter of GX Works3 or in the program.
Whether disconnection is detected.	Remove the cause of disconnection by replacing the analog signal cable, etc., and then check the measured temperature value.



If digital output values cannot be read even after the above actions are taken, the possible cause is a failure of the FX5-4AD-PT-ADP. Please consult your local Mitsubishi representative.

3.9 List of Error Code

The following table lists the error codes that may be stored.

□: This symbol indicates the number of the channel where a error has occurred. (1: CH1 to 4: CH4)

Error code	Error name	Description and cause	Action
0000H	—	There is no error.	—
1A0□H	Averaging process specification setting range error	A value other than 0 to 3 was set in CH□ average processing setting.	Reset CH□ the average processing setting to 0 to 3.
1A1□H	Average time setting range error	When the time average is set to CH□ average processing setting, a value other than 340 to 10000 was set to CH□ time average/count average/moving average settings.	Reset CH□ time average/count average/moving average setting to the following value. 340 to 10000
1A2□H	Average count setting range error When the count average is set to CH□	Averaging process specification, a value other than 4 to 4095 was set to CH□ time average/count average/moving average settings.	Reset CH□ time average/count average/moving average setting to the following value. 4 to 4095
1A3□H	Moving average count setting range error	When the moving average is set to CH□ average processing setting, the following value was set to CH□ moving average count setting. Value other than 2 to 64	Reset CH□ moving average process setting to the following value. 2 to 64
1A4□H	Process alarm upper-lower limit value setting range error	The value not meeting the following conditions was set to CH□ process alarm upper-upper limit value to CH□ process alarm lower-lower limit value. Upper-upper limit value ≥ Upper-lower limit value ≥ Lower-upper limit value ≥ Lower-lower limit value	Reset CH□ process alarm upper-upper limit value to CH□ process alarm lower-lower limit value to the value meeting the following conditions. Upper-upper limit value ≥ Upper-lower limit value ≥ Lower-upper limit value ≥ Lower-lower limit value
1A5□H	Rate alarm upper limit value/lower limit value setting inversion error	Lower limit value ≥ upper limit value was set to CH□ rate alarm upper limit value and CH□ rate alarm lower limit value.	Reset CH□ rate alarm upper limit value and CH□ rate alarm lower limit value to lower limit value < upper limit value.
1A6□H	Rate alarm warning detection period setting range error	A value other than 85 to 10000 was set to CH□ rate alarm warning detection period setting.	Reset the CH□ rate alarm warning detection period setting to the value within 85 to 10000.
1A8□H	Resistance temperature detector type error	A value outside the range was set to the CH□ setting RTD type.	Reset the CH□ setting RTD type to the following value. 0 to 1
1AB□H	Conversion setting range error with disconnection detection enabled	A value outside the range was set to CH□ conversion setting for disconnection detection.	Set CH□ conversion setting for disconnection detection to the following value. 0 to 3
1AF□H	Offset/Gain setting write error	During CH□ write offset/gain or CH□ initialize offset/gain, CH□ conversion enable/disable setting was set to conversion enable.	Set CH□ conversion enable/disable setting to conversion disable and write CH□ offset/gain setting or initialize CH□ offset/gain setting.
1D0□H	Offset/Gain input value error	At the temperature conversion, the input offset value and input gain value do not satisfy the following condition. • Centigrade: Input gain value - input offset value > 0.1°C • Fahrenheit: Input gain value - input offset value > 0.3°F	At the temperature conversion, correct values so that the input offset value and input gain value satisfy the following condition. • Centigrade: Input gain value - input offset value > 0.1°C • Fahrenheit: Input gain value - input offset value > 0.3°F
1D1□H	Offset/Gain temperature setting value error	The set offset/gain temperature setting values are outside the ranges. Or the set offset/gain temperature setting values do not satisfy the following condition. • Centigrade: Gain temperature setting value - offset temperature setting value > 0.1°C • Fahrenheit: Gain temperature setting value - offset temperature setting value > 0.3°F	Correct values so that the offset/gain temperature setting values satisfy the following condition. • Centigrade: Gain temperature setting value - offset temperature setting value > 0.1°C • Fahrenheit: Gain temperature setting value - offset temperature setting value > 0.3°F
3080H	Analog ADP Hardware error	Hardware error of analog ADP was detected.	After resetting the CPU module, carry out RUN. If the same error is displayed again, there is a possibility of hardware error of the analog ADP. Consult the nearest Mitsubishi Electric representative.
3081H	Analog ADP Power failure	The power is not supplied normally.	Confirm if the power is supplied properly.

Error code	Error name	Description and cause	Action
3082H	Analog ADP Memory Error	Read error or damaged EEPROM.	After resetting the CPU module, carry out RUN. If the same error is displayed again, there is a possibility of damaged EEPROM. Consult the nearest Mitsubishi Electric representative.
3083H	Analog ADP Memory Error	There is some offset/gain data defect or setting defect in EEPROM.	After offset/gain initialization of the analog ADP is finished, set the data by offset/gain settings again.
3084H	Analog ADP Communication error	Communication error occurred between the analog ADP and the CPU module.	Confirm if ADP is connected properly to the CPU module. If not improved, consult the nearest Mitsubishi Electric representative.

3.10 List of Alarm Code

The following table shows the list of the alarm codes stored.

□: This symbol indicates the number of the channel where an alarm has occurred. (1: CH1 to 4: CH4)

Alarm code	Alarm name	Description and cause	Action
0000H	—	There is no error.	—
080□H	Process alarm (upper limit)	The process alarm (upper limit) has occurred in CH□.	When the CH□ measured temperature value returns from the alarm output range, the alarm code automatically changes to "0: Normal".
081□H	Process alarm (lower limit)	The process alarm (lower limit) has occurred in CH□.	
082□H	Rate alarm (upper limit)	The rate alarm (upper limit) has occurred in CH□.	When the change of CH□ measured temperature value from the previous value returns to the setting range, the alarm code automatically changes to "0: Normal".
083□H	Rate alarm (lower limit)	The rate alarm (lower limit) has occurred in CH□.	
0A0□H	Disconnection detection	Disconnection is detected in the CH□.	When the conversion alarm clear request is set to ON after the CH□ is recovered from disconnection, all CH□ disconnection detection flag become "0: Normal", and the alarm code stored in the "conversion latest alarm code" is cleared.
0C0□H	Offset/gain reading RTD type mismatch	The saved offset/gain RTD type is different from the currently set RTD type.	Change the currently set RTD type to the RTD type selected when the offset/gain was written, and then read the offset/gain.
0E0□H	RTD type change alarm during offset/gain writing or offset/gain initialization	The RTD type was changed during offset/gain writing or offset/gain initialization.	Wait until offset/gain writing or offset/gain initialization is finished, and then change the RTD type.
0E1□H	Offset/gain initialization execution alarm	Offset/gain initialization was executed during offset/gain writing.	Wait until offset/gain writing is finished, and then initialize the offset/gain.
0E2□H	Offset/gain writing execution alarm	Offset/gain writing was executed during offset/gain initialization.	Wait until offset/gain initialization is finished, and then write the offset/gain.
0E3□H	Analog ADP memory access alarm	Offset/gain writing, offset/gain reading or offset/gain initialization was executed while the analog ADP memory error (Error code: 3082H) was detected. Or offset reading was executed while the analog ADP memory error (Error code: 3083H) was detected.	Reset the CPU module.
0F0□H	Setting change alarm	Special relays/registers for analog are changed while conversion is enabled.	Change the setting of special relays/registers while conversion is disabled.

3.11 List of Special Relays

The special relays are shown below.

1st analog expansion adapter

The special relays list for the 1st FX5-4AD-PT-ADP module is shown below.

Special relays				Name	Reference
CH1	CH2	CH3	CH4		
SM6280				Temperature unit selection	Page 140
SM6300	SM6340	SM6380	SM6420	Conversion completed flag	Page 140
SM6301	SM6341	SM6381	SM6421	Conversion enable/disable setting	Page 140
SM6305	SM6345	SM6385	SM6425	Maximum value/minimum value reset completed flag	Page 141
SM6306	SM6346	SM6386	SM6426	Maximum value reset request	Page 141
SM6307	SM6347	SM6387	SM6427	Minimum value reset request	Page 142
SM6311	SM6351	SM6391	SM6431	Warning output flag (process alarm upper limit)	Page 142
SM6312	SM6352	SM6392	SM6432	Warning output flag (process alarm lower limit)	Page 142
SM6313	SM6353	SM6393	SM6433	Warning output setting (process alarm)	Page 143
SM6315	SM6355	SM6395	SM6435	Warning output flag (rate alarm upper limit)	Page 143
SM6316	SM6356	SM6396	SM6436	Warning output flag (rate alarm lower limit)	Page 143
SM6317	SM6357	SM6397	SM6437	Warning output setting (rate alarm)	Page 144
SM6318	SM6358	SM6398	SM6438	Disconnection detection flag	Page 144
SM6319	SM6359	SM6399	SM6439	Disconnection detection enable/disable setting	Page 144
SM6320	SM6360	SM6400	SM6440	Disconnection detection automatic clear enable/disable setting	Page 145
SM6331	SM6371	SM6411	SM6451	Offset/gain setting flag	Page 145
SM6332	SM6372	SM6412	SM6452	Read offset/gain	Page 145
SM6333	SM6373	SM6413	SM6453	Write offset/gain	Page 146
SM6334	SM6374	SM6414	SM6454	Initialize offset/gain	Page 146
SM6337	SM6377	SM6417	SM6457	Conversion alarm clear request	Page 146
SM6338	SM6378	SM6418	SM6458	Conversion alarm flag	Page 147
SM6339	SM6379	SM6419	SM6459	Conversion error flag	Page 147

2nd analog expansion adapter

The special relays list for the 2nd FX5-4AD-PT-ADP module is shown below.

Special relays				Name	Reference
CH1	CH2	CH3	CH4		
SM6640				Temperature unit selection	Page 140
SM6660	SM6700	SM6740	SM6780	Conversion completed flag	Page 140
SM6661	SM6701	SM6741	SM6781	Conversion enable/disable setting	Page 140
SM6665	SM6705	SM6745	SM6785	Maximum value/minimum value reset completed flag	Page 141
SM6666	SM6706	SM6746	SM6786	Maximum value reset request	Page 141
SM6667	SM6707	SM6747	SM6787	Minimum value reset request	Page 142
SM6671	SM6711	SM6751	SM6791	Warning output flag (process alarm upper limit)	Page 142
SM6672	SM6712	SM6752	SM6792	Warning output flag (process alarm lower limit)	Page 142
SM6673	SM6713	SM6753	SM6793	Warning output setting (process alarm)	Page 143
SM6675	SM6715	SM6755	SM6795	Warning output flag (rate alarm upper limit)	Page 143
SM6676	SM6716	SM6756	SM6796	Warning output flag (rate alarm lower limit)	Page 143
SM6677	SM6717	SM6757	SM6797	Warning output setting (rate alarm)	Page 144
SM6678	SM6718	SM6758	SM6798	Disconnection detection flag	Page 144
SM6679	SM6719	SM6759	SM6799	Disconnection detection enable/disable setting	Page 144
SM6680	SM6720	SM6760	SM6800	Disconnection detection automatic clear enable/disable setting	Page 145
SM6691	SM6731	SM6771	SM6811	Offset/gain setting flag	Page 145
SM6692	SM6732	SM6772	SM6812	Read offset/gain	Page 145
SM6693	SM6733	SM6773	SM6813	Write offset/gain	Page 146
SM6694	SM6734	SM6774	SM6814	Initialize offset/gain	Page 146
SM6697	SM6737	SM6777	SM6817	Conversion alarm clear request	Page 146
SM6698	SM6738	SM6778	SM6818	Conversion alarm flag	Page 147
SM6699	SM6739	SM6779	SM6819	Conversion error flag	Page 147

3rd analog expansion adapter

The special relays list for the 3rd FX5-4AD-PT-ADP module is shown below.

Special relays				Name	Reference
CH1	CH2	CH3	CH4		
SM7000				Temperature unit selection	Page 140
SM7020	SM7060	SM7100	SM7140	Conversion completed flag	Page 140
SM7021	SM7061	SM7101	SM7141	Conversion enable/disable setting	Page 140
SM7025	SM7065	SM7105	SM7145	Maximum value/minimum value reset completed flag	Page 141
SM7026	SM7066	SM7106	SM7146	Maximum value reset request	Page 141
SM7027	SM7067	SM7107	SM7147	Minimum value reset request	Page 142
SM7031	SM7071	SM7111	SM7151	Warning output flag (process alarm upper limit)	Page 142
SM7032	SM7072	SM7112	SM7152	Warning output flag (process alarm lower limit)	Page 142
SM7033	SM7073	SM7113	SM7153	Warning output setting (process alarm)	Page 143
SM7035	SM7075	SM7115	SM7155	Warning output flag (rate alarm upper limit)	Page 143
SM7036	SM7076	SM7116	SM7156	Warning output flag (rate alarm lower limit)	Page 143
SM7037	SM7077	SM7117	SM7157	Warning output setting (rate alarm)	Page 144
SM7038	SM7078	SM7118	SM7158	Disconnection detection flag	Page 144
SM7039	SM7079	SM7119	SM7159	Disconnection detection enable/disable setting	Page 144
SM7040	SM7080	SM7120	SM7160	Disconnection detection automatic clear enable/disable setting	Page 145
SM7051	SM7091	SM7131	SM7171	Offset/gain setting flag	Page 145
SM7052	SM7092	SM7132	SM7172	Read offset/gain	Page 145
SM7053	SM7093	SM7133	SM7173	Write offset/gain	Page 146
SM7054	SM7094	SM7134	SM7174	Initialize offset/gain	Page 146
SM7057	SM7097	SM7137	SM7177	Conversion alarm clear request	Page 146
SM7058	SM7098	SM7138	SM7178	Conversion alarm flag	Page 147
SM7059	SM7099	SM7139	SM7179	Conversion error flag	Page 147

4th analog expansion adapter

The special relays list for the 4th FX5-4AD-ADP module is shown below.

Special relays				Name	Reference
CH1	CH2	CH3	CH4		
SM7360				Temperature unit selection	Page 140
SM7380	SM7420	SM7460	SM7500	Conversion completed flag	Page 140
SM7381	SM7421	SM7461	SM7501	Conversion enable/disable setting	Page 140
SM7385	SM7425	SM7465	SM7505	Maximum value/minimum value reset completed flag	Page 141
SM7386	SM7426	SM7466	SM7506	Maximum value reset request	Page 141
SM7387	SM7427	SM7467	SM7507	Minimum value reset request	Page 142
SM7391	SM7431	SM7471	SM7511	Warning output flag (process alarm upper limit)	Page 142
SM7392	SM7432	SM7472	SM7512	Warning output flag (process alarm lower limit)	Page 142
SM7393	SM7433	SM7473	SM7513	Warning output setting (process alarm)	Page 143
SM7395	SM7435	SM7475	SM7515	Warning output flag (rate alarm upper limit)	Page 143
SM7396	SM7436	SM7476	SM7516	Warning output flag (rate alarm lower limit)	Page 143
SM7397	SM7437	SM7477	SM7517	Warning output setting (rate alarm)	Page 144
SM7398	SM7438	SM7478	SM7518	Disconnection detection flag	Page 144
SM7399	SM7439	SM7479	SM7519	Disconnection detection enable/disable setting	Page 144
SM7400	SM7440	SM7480	SM7520	Disconnection detection automatic clear enable/disable setting	Page 145
SM7411	SM7451	SM7491	SM7531	Offset/gain setting flag	Page 145
SM7412	SM7452	SM7492	SM7532	Read offset/gain	Page 145
SM7413	SM7453	SM7493	SM7533	Write offset/gain	Page 146
SM7414	SM7454	SM7494	SM7534	Initialize offset/gain	Page 146
SM7417	SM7457	SM7497	SM7537	Conversion alarm clear request	Page 146
SM7418	SM7458	SM7498	SM7538	Conversion alarm flag	Page 147
SM7419	SM7459	SM7499	SM7539	Conversion error flag	Page 147

3.12 Detail of Special Relays

This section explains the details of special relays. Only the FX5U/FX5UC CPU module supports the special relays of the third and fourth modules.

R: Read only, R/W: Read/Write

Temperature unit selection

Set the desired temperature unit.

Monitor value	Display description	Default value	R/W
0: OFF	Centigrade (°C)	0: OFF	R/W
1: ON	Fahrenheit (°F)		

For details temperature unit choice function, refer to the following.

 Page 106 Temperature Unit Choice Function

Name	Connection part	Special relay
Temperature unit selection	1st adapter	SM6280
	2nd adapter	SM6640
	3rd adapter	SM7000
	4th adapter	SM7360

Conversion completed flag

This flag monitors the temperature conversion status.

Monitor value	Display description	Default value	R/W
0: OFF	It turns OFF during the disable of an temperature conversion, and an temperature conversion.	0: OFF	R
1: ON	In the state of conversion enable, if an temperature conversion is completed, it turns ON.		

Name	Connection part	Special relay			
		CH1	CH2	CH3	CH4
Conversion completed flag	1st adapter	SM6300	SM6340	SM6380	SM6420
	2nd adapter	SM6660	SM6700	SM6740	SM6780
	3rd adapter	SM7020	SM7060	SM7100	SM7140
	4th adapter	SM7380	SM7420	SM7460	SM7500

Conversion enable/disable setting

Set whether to enable or disable temperature conversion.

Monitor value	Display description	Default value	R/W
0: OFF	Temperature conversion enable	1: ON	R/W
1: ON	Temperature conversion disable		

For details conversion enable/disable function, refer to the following.

 Page 106 Conversion Enable/Disable Setting Function

Name	Connection part	Special relay			
		CH1	CH2	CH3	CH4
Conversion enable/disable setting	1st adapter	SM6301	SM6341	SM6381	SM6421
	2nd adapter	SM6661	SM6701	SM6741	SM6781
	3rd adapter	SM7021	SM7061	SM7101	SM7141
	4th adapter	SM7381	SM7421	SM7461	SM7501

Maximum value/minimum value reset completed flag

This flag monitors the "maximum value/minimum value" reset status.

When the "maximum value reset request" or "minimum value reset request" is set from OFF to ON and then the value stored in the "maximum value" or "minimum value" is reset, the "maximum value/minimum value reset completed flag" turns ON.

Monitor value	Display description	Default value	R/W
0: OFF	Reset is not completed	0: OFF	R
1: ON	Reset is completed		

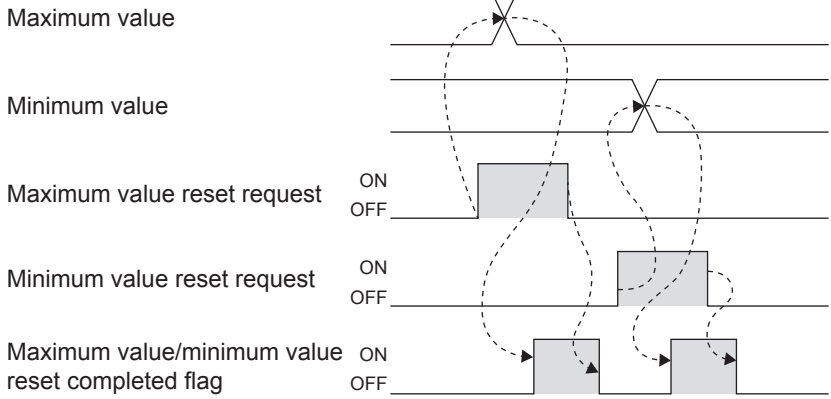

Name	Connection part	Special relay			
		CH1	CH2	CH3	CH4
Maximum value/minimum value reset completed flag	1st adapter	SM6305	SM6345	SM6385	SM6425
	2nd adapter	SM6665	SM6705	SM6745	SM6785
	3rd adapter	SM7025	SM7065	SM7105	SM7145
	4th adapter	SM7385	SM7425	SM7465	SM7505

Maximum value reset request

When the "maximum value reset request" is set from OFF to ON, the maximum value is updated to the "measured temperature value".

Monitor value	Display description	Default value	R/W
0: OFF	No maximum value reset request	0: OFF	R/W
1: ON	Maximum value reset request		

For the timing of turning the signal on and off, refer to the following.

☞ Page 141 Maximum value/minimum value reset completed flag

Name	Connection part	Special relay			
		CH1	CH2	CH3	CH4
Maximum value reset request	1st adapter	SM6306	SM6346	SM6386	SM6426
	2nd adapter	SM6666	SM6706	SM6746	SM6786
	3rd adapter	SM7026	SM7066	SM7106	SM7146
	4th adapter	SM7386	SM7426	SM7466	SM7506

Minimum value reset request

When the "minimum value reset request" is set from OFF to ON, the minimum value is updated to the "measured temperature value".

Monitor value	Display description	Default value	R/W
0: OFF	No minimum value reset request	0: OFF	R/W
1: ON	Maximum value reset request		

For the timing of turning the signal on and off, refer to the following.

 Page 141 Maximum value/minimum value reset completed flag

Name	Connection part	Special relay			
		CH1	CH2	CH3	CH4
Minimum value reset request	1st adapter	SM6307	SM6347	SM6387	SM6427
	2nd adapter	SM6667	SM6707	SM6747	SM6787
	3rd adapter	SM7027	SM7067	SM7107	SM7147
	4th adapter	SM7387	SM7427	SM7467	SM7507

Warning output flag (process alarm upper limit)

This flag monitors the upper limit value alarm in the process alarm.

Monitor value	Display description	Default value	R/W
0: OFF	Normal	0: OFF	R
1: ON	Process alarm upper limit detection		

For details alarm output function, refer to the following.

 Page 112 Process alarm

Name	Connection part	Special relay			
		CH1	CH2	CH3	CH4
Warning output flag (process alarm upper limit)	1st adapter	SM6311	SM6351	SM6391	SM6431
	2nd adapter	SM6671	SM6711	SM6751	SM6791
	3rd adapter	SM7031	SM7071	SM7111	SM7151
	4th adapter	SM7391	SM7431	SM7471	SM7511

Warning output flag (process alarm lower limit)

This flag monitors the lower limit value alarm in the process alarm.

Monitor value	Display description	Default value	R/W
0: OFF	Normal	0: OFF	R
1: ON	Process alarm lower limit detection		

For details alarm output function, refer to the following.

 Page 112 Process alarm

Name	Connection part	Special relay			
		CH1	CH2	CH3	CH4
Warning output flag (process alarm lower limit)	1st adapter	SM6312	SM6352	SM6392	SM6432
	2nd adapter	SM6672	SM6712	SM6752	SM6792
	3rd adapter	SM7032	SM7072	SM7112	SM7152
	4th adapter	SM7392	SM7432	SM7472	SM7512

Warning output setting (Process alarm)

Set whether to enable or disable the alarm output of process alarm.

Monitor value	Display description	Default value	R/W
0: OFF	Warning output of process alarm enable	1: ON	R/W
1: ON	Warning output of process alarm disable		

For details alarm output function, refer to the following.

☞ Page 112 Process alarm

Name	Connection part	Special relay			
		CH1	CH2	CH3	CH4
Warning output setting (Process alarm)	1st adapter	SM6313	SM6353	SM6393	SM6433
	2nd adapter	SM6673	SM6713	SM6753	SM6793
	3rd adapter	SM7033	SM7073	SM7113	SM7153
	4th adapter	SM7393	SM7433	SM7473	SM7513

Warning output flag (rate alarm upper limit)

This flag monitors the upper limit value alarm in the rate alarm.

Monitor value	Display description	Default value	R/W
0: OFF	Normal	0: OFF	R
1: ON	Rate alarm upper limit detection		

For details alarm output function, refer to the following.

☞ Page 114 Rate alarm

Name	Connection part	Special relay			
		CH1	CH2	CH3	CH4
Warning output flag (rate alarm upper limit)	1st adapter	SM6315	SM6355	SM6395	SM6435
	2nd adapter	SM6675	SM6715	SM6755	SM6795
	3rd adapter	SM7035	SM7075	SM7115	SM7155
	4th adapter	SM7395	SM7435	SM7475	SM7515

Warning output flag (rate alarm lower limit)

This flag monitors the lower limit value alarm in the rate alarm.

Monitor value	Display description	Default value	R/W
0: OFF	Normal	0: OFF	R
1: ON	Rate alarm lower limit detection		

For details alarm output function, refer to the following.

☞ Page 114 Rate alarm

Name	Connection part	Special relay			
		CH1	CH2	CH3	CH4
Warning output flag (rate alarm lower limit)	1st adapter	SM6316	SM6356	SM6396	SM6436
	2nd adapter	SM6676	SM6716	SM6756	SM6796
	3rd adapter	SM7036	SM7076	SM7116	SM7156
	4th adapter	SM7396	SM7436	SM7476	SM7516

Warning output setting (rate alarm)

Set whether to enable or disable the alarm output of rate alarm.

Monitor value	Display description	Default value	R/W
0: OFF	Warning output of rate alarm enable	1: ON	R/W
1: ON	Warning output of rate alarm disable		

For details alarm output function, refer to the following.

 Page 114 Rate alarm

Name	Connection part	Special relay			
		CH1	CH2	CH3	CH4
Warning output setting (rate alarm)	1st adapter	SM6317	SM6357	SM6397	SM6437
	2nd adapter	SM6677	SM6717	SM6757	SM6797
	3rd adapter	SM7037	SM7077	SM7117	SM7157
	4th adapter	SM7397	SM7437	SM7477	SM7517

Disconnection detection flag

This flag monitors the disconnection detection.

Monitor value	Display description	Default value	R/W
0: OFF	Normal	0: OFF	R
1: ON	Disconnection detection		

For details disconnection detection function, refer to the following.

 Page 110 Disconnection Detection Function

Name	Connection part	Special relay			
		CH1	CH2	CH3	CH4
Disconnection detection flag	1st adapter	SM6318	SM6358	SM6398	SM6438
	2nd adapter	SM6678	SM6718	SM6758	SM6798
	3rd adapter	SM7038	SM7078	SM7118	SM7158
	4th adapter	SM7398	SM7438	SM7478	SM7518

Disconnection detection enable/disable setting

Set whether to enable or disable the disconnection detection function.

Monitor value	Display description	Default value	R/W
0: OFF	Disconnection detection enable	0: OFF	R/W
1: ON	Disconnection detection disable		

For details disconnection detection function, refer to the following.

 Page 110 Disconnection Detection Function

Name	Connection part	Special relay			
		CH1	CH2	CH3	CH4
Disconnection detection enable/disable setting	1st adapter	SM6319	SM6359	SM6399	SM6439
	2nd adapter	SM6679	SM6719	SM6759	SM6799
	3rd adapter	SM7039	SM7079	SM7119	SM7159
	4th adapter	SM7399	SM7439	SM7479	SM7519

Disconnection detection automatic clear enable/disable setting

Set whether to enable or disable the disconnection detection automatic clear.

Monitor value	Display description	Default value	R/W
0: OFF	Disconnection recovery detection enable	1: ON	R/W
1: ON	Disconnection recovery detection disable		

For details disconnection detection function, refer to the following.

☞ Page 110 Disconnection Detection Function

Name	Connection part	Special relay			
		CH1	CH2	CH3	CH4
Disconnection detection automatic clear enable/disable setting	1st adapter	SM6320	SM6360	SM6400	SM6440
	2nd adapter	SM6680	SM6720	SM6760	SM6800
	3rd adapter	SM7040	SM7080	SM7120	SM7160
	4th adapter	SM7400	SM7440	SM7480	SM7520

Offset/gain setting flag

The offset/gain setting used for each channel is monitored.

Monitor value	Display description	Default value	R/W
0: OFF	Initial value	0: OFF	R
1: ON	User range setting		

For details offset/gain setting, refer to the following.

☞ Page 118 Offset/gain Setting Function

Name	Connection part	Special relay			
		CH1	CH2	CH3	CH4
Offset/gain setting flag	1st adapter	SM6331	SM6371	SM6411	SM6451
	2nd adapter	SM6691	SM6731	SM6771	SM6811
	3rd adapter	SM7051	SM7091	SM7131	SM7171
	4th adapter	SM7411	SM7451	SM7491	SM7531

Read offset/gain

An offset/gain setting value is read.

Monitor value	Display description	Default value	R/W
0: OFF	Offset/gain reading is not performed.	0: OFF	R/W
1: ON	Offset/gain reading is performed.		

For details offset/gain setting, refer to the following.

☞ Page 118 Offset/gain Setting Function

Name	Connection part	Special relay			
		CH1	CH2	CH3	CH4
Read offset/gain	1st adapter	SM6332	SM6372	SM6412	SM6452
	2nd adapter	SM6692	SM6732	SM6772	SM6812
	3rd adapter	SM7052	SM7092	SM7132	SM7172
	4th adapter	SM7412	SM7452	SM7492	SM7532

Write offset/gain

An offset/gain setting value is written in.

Monitor value	Display description	Default value	R/W
0: OFF	Offset/gain writing is not performed.	0: OFF	R/W
1: ON	Offset/gain writing is performed.		

For details offset/gain setting, refer to the following.

 Page 118 Offset/gain Setting Function

Name	Connection part	Special relay			
		CH1	CH2	CH3	CH4
Write offset/gain	1st adapter	SM6333	SM6373	SM6413	SM6453
	2nd adapter	SM6693	SM6733	SM6773	SM6813
	3rd adapter	SM7053	SM7093	SM7133	SM7173
	4th adapter	SM7413	SM7453	SM7493	SM7533

Initialize offset/gain

An offset/gain setting value is initialized.

Monitor value	Display description	Default value	R/W
0: OFF	Offset/gain initialization is not performed.	0: OFF	R/W
1: ON	Offset/gain initialization is performed.		

For details offset/gain initialization, refer to the following.

 Page 122 Offset/gain Initialization Function

Name	Connection part	Special relay			
		CH1	CH2	CH3	CH4
Initialize offset/gain	1st adapter	SM6334	SM6374	SM6414	SM6454
	2nd adapter	SM6694	SM6734	SM6774	SM6814
	3rd adapter	SM7054	SM7094	SM7134	SM7174
	4th adapter	SM7414	SM7454	SM7494	SM7534

Conversion alarm clear request

An conversion alarm clear request is performed.

Monitor value	Display description	Default value	R/W
0: OFF	With no conversion alarm clear request.	0: OFF	R/W
1: ON	Those with an conversion alarm clear request.		

For details conversion alarm clear request, refer to the following.

 Page 124 Alarm clear request

Name	Connection part	Special relay			
		CH1	CH2	CH3	CH4
Conversion alarm clear request	1st adapter	SM6337	SM6377	SM6417	SM6457
	2nd adapter	SM6697	SM6737	SM6777	SM6817
	3rd adapter	SM7057	SM7097	SM7137	SM7177
	4th adapter	SM7417	SM7457	SM7497	SM7537

Conversion alarm flag

"Conversion alarm flag" turns on when an alarm occurs.

Monitor value	Display description	Default value	R/W
0: OFF	Normal	0: OFF	R/W
1: ON	Conversion alarm occur		

To turn OFF the "conversion alarm flag" and clear the "conversion latest alarm code", set the "conversion alarm clear request" from OFF to ON.

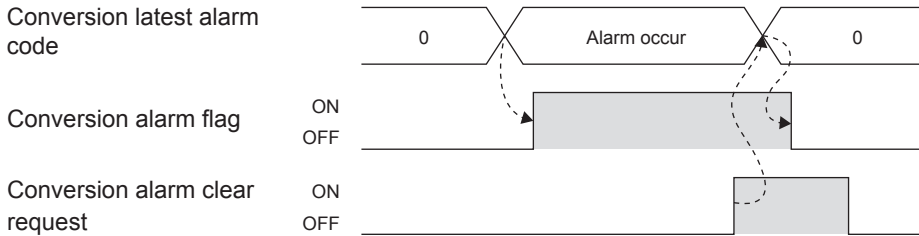

Name	Connection part	Special relay			
		CH1	CH2	CH3	CH4
Conversion alarm flag	1st adapter	SM6338	SM6378	SM6418	SM6458
	2nd adapter	SM6698	SM6738	SM6778	SM6818
	3rd adapter	SM7058	SM7098	SM7138	SM7178
	4th adapter	SM7418	SM7458	SM7498	SM7538

Conversion error flag

"Conversion error flag" turns on when an error occurs.

Monitor value	Display description	Default value	R/W
0: OFF	Normal	0: OFF	R
1: ON	Conversion error occur		

To turn OFF the "conversion error flag", set the "error clear request" (SM50) of the CPU module from OFF to ON.

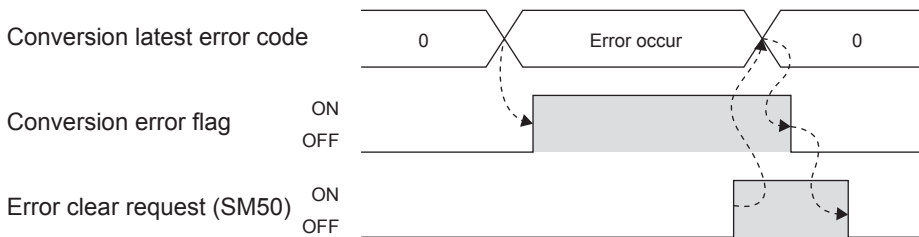

Name	Connection part	Special relay			
		CH1	CH2	CH3	CH4
Conversion error flag	1st adapter	SM6339	SM6379	SM6419	SM6459
	2nd adapter	SM6699	SM6739	SM6779	SM6819
	3rd adapter	SM7059	SM7099	SM7139	SM7179
	4th adapter	SM7419	SM7459	SM7499	SM7539

3.13 List of Special Registers

The special registers are shown below.

1st analog expansion adapter

The special registers list for the 1st FX5-4AD-PT-ADP module is shown below.

Special registers				Name	Reference
CH1	CH2	CH3	CH4		
SD6280				Module Information	Page 152
SD6300	SD6340	SD6380	SD6420	Measured temperature value	Page 152
SD6303	SD6343	SD6383	SD6423	Average processing setting	Page 153
SD6304	SD6344	SD6384	SD6424	Time average/count average/moving average	Page 153
SD6305	SD6345	SD6385	SD6425	Setting RTD type	Page 154
SD6306	SD6346	SD6386	SD6426	Maximum value	Page 154
SD6307	SD6347	SD6387	SD6427	Minimum value	Page 154
SD6311	SD6351	SD6391	SD6431	Process alarm upper upper limit value	Page 155
SD6312	SD6352	SD6392	SD6432	Process alarm upper lower limit value	Page 155
SD6313	SD6353	SD6393	SD6433	Process alarm lower upper limit value	Page 156
SD6314	SD6354	SD6394	SD6434	Process alarm lower lower limit value	Page 156
SD6315	SD6355	SD6395	SD6435	Rate alarm upper limit value	Page 157
SD6316	SD6356	SD6396	SD6436	Rate alarm lower limit value	Page 157
SD6317	SD6357	SD6397	SD6437	Rate alarm detection cycle setting	Page 158
SD6318	SD6358	SD6398	SD6438	Conversion setting for disconnection detection	Page 158
SD6319	SD6359	SD6399	SD6439	Conversion setting value for disconnection detection	Page 159
SD6327	SD6367	SD6407	SD6447	Offset temperature setting value	Page 159
SD6328	SD6368	SD6408	SD6448	Gain temperature setting value	Page 160
SD6329	SD6369	SD6409	SD6449	Offset/gain code	Page 160
SD6330	SD6370	SD6410	SD6450	Resistance offset value (L)	Page 161
SD6331	SD6371	SD6411	SD6451	Resistance offset value (H)	
SD6332	SD6372	SD6412	SD6452	Resistance gain value (L)	Page 161
SD6333	SD6373	SD6413	SD6453	Resistance gain value (H)	
SD6334	SD6374	SD6414	SD6454	Input offset value (L)	Page 161
SD6335	SD6375	SD6415	SD6455	Input offset value (H)	
SD6336	SD6376	SD6416	SD6456	Input gain value (L)	Page 162
SD6337	SD6377	SD6417	SD6457	Input gain value (H)	
SD6338	SD6378	SD6418	SD6458	Conversion latest alarm code	Page 162
SD6339	SD6379	SD6419	SD6459	Conversion latest error code	Page 163

2nd analog expansion adapter

The special registers list for the 2nd FX5-4AD-PT-ADP module is shown below.

Special registers				Name	Reference
CH1	CH2	CH3	CH4		
SD6640				Module Information	Page 152
SD6660	SD6700	SD6740	SD6780	Measured temperature value	Page 152
SD6663	SD6703	SD6743	SD6783	Average processing setting	Page 153
SD6664	SD6704	SD6744	SD6784	Time average/count average/moving average	Page 153
SD6665	SD6705	SD6745	SD6785	Setting RTD type	Page 154
SD6666	SD6706	SD6746	SD6786	Maximum value	Page 154
SD6667	SD6707	SD6747	SD6787	Minimum value	Page 154
SD6671	SD6711	SD6751	SD6791	Process alarm upper upper limit value	Page 155
SD6672	SD6712	SD6752	SD6792	Process alarm upper lower limit value	Page 155
SD6673	SD6713	SD6753	SD6793	Process alarm lower upper limit value	Page 156
SD6674	SD6714	SD6754	SD6794	Process alarm lower lower limit value	Page 156
SD6675	SD6715	SD6755	SD6795	Rate alarm upper limit value	Page 157
SD6676	SD6716	SD6756	SD6796	Rate alarm lower limit value	Page 157
SD6677	SD6717	SD6757	SD6797	Rate alarm detection cycle setting	Page 158
SD6678	SD6718	SD6758	SD6798	Conversion setting for disconnection detection	Page 158
SD6679	SD6719	SD6759	SD6799	Conversion setting value for disconnection detection	Page 159
SD6687	SD6727	SD6767	SD6807	Offset temperature setting value	Page 159
SD6688	SD6728	SD6768	SD6808	Gain temperature setting value	Page 160
SD6689	SD6729	SD6769	SD6809	Offset/gain code	Page 160
SD6690	SD6730	SD6770	SD6810	Resistance offset value (L)	Page 161
SD6691	SD6731	SD6771	SD6811	Resistance offset value (H)	
SD6692	SD6732	SD6772	SD6812	Resistance gain value (L)	Page 161
SD6693	SD6733	SD6773	SD6813	Resistance gain value (H)	
SD6694	SD6734	SD6774	SD6814	Input offset value (L)	Page 161
SD6695	SD6735	SD6775	SD6815	Input offset value (H)	
SD6696	SD6736	SD6776	SD6816	Input gain value (L)	Page 162
SD6697	SD6737	SD6777	SD6817	Input gain value (H)	
SD6698	SD6738	SD6778	SD6818	Conversion latest alarm code	Page 162
SD6699	SD6739	SD6779	SD6819	Conversion latest error code	Page 163

3rd analog expansion adapter

The special registers list for the 3rd FX5-4AD-PT-ADP module is shown below.

Special registers				Name	Reference
CH1	CH2	CH3	CH4		
SD7000				Module Information	Page 152
SD7020	SD7060	SD7100	SD7140	Measured temperature value	Page 152
SD7023	SD7063	SD7103	SD7143	Average processing setting	Page 153
SD7024	SD7064	SD7104	SD7144	Time average/count average/moving average	Page 153
SD7025	SD7065	SD7105	SD7145	Setting RTD type	Page 154
SD7026	SD7066	SD7106	SD7146	Maximum value	Page 154
SD7027	SD7067	SD7107	SD7147	Minimum value	Page 154
SD7031	SD7071	SD7111	SD7151	Process alarm upper upper limit value	Page 155
SD7032	SD7072	SD7112	SD7152	Process alarm upper lower limit value	Page 155
SD7033	SD7073	SD7113	SD7153	Process alarm lower upper limit value	Page 156
SD7034	SD7074	SD7114	SD7154	Process alarm lower lower limit value	Page 156
SD7035	SD7075	SD7115	SD7155	Rate alarm upper limit value	Page 157
SD7036	SD7076	SD7116	SD7156	Rate alarm lower limit value	Page 157
SD7037	SD7077	SD7117	SD7157	Rate alarm detection cycle setting	Page 158
SD7038	SD7078	SD7118	SD7158	Conversion setting for disconnection detection	Page 158
SD7039	SD7079	SD7119	SD7159	Conversion setting value for disconnection detection	Page 159
SD7047	SD7087	SD7127	SD7167	Offset temperature setting value	Page 159
SD7048	SD7088	SD7128	SD7168	Gain temperature setting value	Page 160
SD7049	SD7089	SD7129	SD7169	Offset/gain code	Page 160
SD7050	SD7090	SD7130	SD7170	Resistance offset value (L)	Page 161
SD7051	SD7091	SD7131	SD7171	Resistance offset value (H)	
SD7052	SD7092	SD7132	SD7172	Resistance gain value (L)	Page 161
SD7053	SD7093	SD7133	SD7173	Resistance gain value (H)	
SD7054	SD7094	SD7134	SD7174	Input offset value (L)	Page 161
SD7055	SD7095	SD7135	SD7175	Input offset value (H)	
SD7056	SD7096	SD7136	SD7176	Input gain value (L)	Page 162
SD7057	SD7097	SD7137	SD7177	Input gain value (H)	
SD7058	SD7098	SD7138	SD7178	Conversion latest alarm code	Page 162
SD7059	SD7099	SD7139	SD7179	Conversion latest error code	Page 163

4th analog expansion adapter

The special registers list for the 4th FX5-4AD-PT-ADP module is shown below.

Special registers				Name	Reference
CH1	CH2	CH3	CH4		
SD7360				Module Information	Page 152
SD7380	SD7420	SD7460	SD7500	Measured temperature value	Page 152
SD7383	SD7423	SD7463	SD7503	Average processing setting	Page 153
SD7384	SD7424	SD7464	SD7504	Time average/count average/moving average	Page 153
SD7385	SD7425	SD7465	SD7505	Setting RTD type	Page 154
SD7386	SD7426	SD7466	SD7506	Maximum value	Page 154
SD7387	SD7427	SD7467	SD7507	Minimum value	Page 154
SD7391	SD7431	SD7471	SD7511	Process alarm upper upper limit value	Page 155
SD7392	SD7432	SD7472	SD7512	Process alarm upper lower limit value	Page 155
SD7393	SD7433	SD7473	SD7513	Process alarm lower upper limit value	Page 156
SD7394	SD7434	SD7474	SD7514	Process alarm lower lower limit value	Page 156
SD7395	SD7435	SD7475	SD7515	Rate alarm upper limit value	Page 157
SD7396	SD7436	SD7476	SD7516	Rate alarm lower limit value	Page 157
SD7397	SD7437	SD7477	SD7517	Rate alarm detection cycle setting	Page 158
SD7398	SD7438	SD7478	SD7518	Conversion setting for disconnection detection	Page 158
SD7399	SD7439	SD7479	SD7519	Conversion setting value for disconnection detection	Page 159
SD7407	SD7447	SD7487	SD7527	Offset temperature setting value	Page 159
SD7408	SD7448	SD7488	SD7528	Gain temperature setting value	Page 160
SD7409	SD7449	SD7489	SD7529	Offset/gain code	Page 160
SD7410	SD7450	SD7490	SD7530	Resistance offset value (L)	Page 161
SD7411	SD7451	SD7491	SD7531	Resistance offset value (H)	
SD7412	SD7452	SD7492	SD7532	Resistance gain value (L)	Page 161
SD7413	SD7453	SD7493	SD7533	Resistance gain value (H)	
SD7414	SD7454	SD7494	SD7534	Input offset value (L)	Page 161
SD7415	SD7455	SD7495	SD7535	Input offset value (H)	
SD7416	SD7456	SD7496	SD7536	Input gain value (L)	Page 162
SD7417	SD7457	SD7497	SD7537	Input gain value (H)	
SD7418	SD7458	SD7498	SD7538	Conversion latest alarm code	Page 162
SD7419	SD7459	SD7499	SD7539	Conversion latest error code	Page 163

3.14 Detail of Special Registers

This section explains the details of special registers. Only the FX5U/FX5UC CPU module supports the third and fourth special register.

R: Read only, R/W: Read/Write

Module Information

Module information of FX5-4AD-PT-ADP is stored.

Stored value		R/W
61A1H		R

Name	Connection part	Special register			
		CH1	CH2	CH3	CH4
Module Information	1st adapter	SD6280			
	2nd adapter	SD6640			
	3rd adapter	SD7000			
	4th adapter	SD7360			

Measured temperature value

The temperature converted digital output value is stored.

Range	Default value	R/W
-32768 to +32767	0	R



The value is updated in every averaging processing cycle when the averaging processing is executed, or in every sampling cycle when the averaging processing is not executed.

Name	Connection part	Special register			
		CH1	CH2	CH3	CH4
Measured temperature value	1st adapter	SD6300	SD6340	SD6380	SD6420
	2nd adapter	SD6660	SD6700	SD6740	SD6780
	3rd adapter	SD7020	SD7060	SD7100	SD7140
	4th adapter	SD7380	SD7420	SD7460	SD7500

Average processing setting

Set which one between the sampling processing and the averaging processing is to be selected.
The averaging processing is classified into "time average", "count average" and "moving average".

Setting value	Description	Default value	R/W
0	Sampling processing	0	R/W
1	Time average		
2	Count average		
3	Moving average		

3

Point

If a value other than the above is set, the averaging process specification setting range error (Error code: 1A0□H) occurs and the temperature conversion cannot be performed.

Name	Connection part	Special register			
		CH1	CH2	CH3	CH4
Average processing setting	1st adapter	SD6303	SD6343	SD6383	SD6423
	2nd adapter	SD6663	SD6703	SD6743	SD6783
	3rd adapter	SD7023	SD7063	SD7103	SD7143
	4th adapter	SD7383	SD7423	SD7463	SD7503

Time average/count average/moving average

Set the average time, average counts and moving average counts in the averaging processing for each channel.
The table below shows the available setting range.

Setting value	Description	Default value	R/W
340 to 10000 (ms)	Time average	0	R/W
4 to 4095 (times)	Count average		
2 to 64 (times)	Moving average		

Point

If a value other than the above is set, the average time setting range error (Error code: 1A1□H), average count setting range error (Error code: 1A2□H) or moving average count setting range error (Error code: 1A3□H) occurs and the temperature conversion cannot be performed.

Name	Connection part	Special register			
		CH1	CH2	CH3	CH4
Time average/count average/moving average	1st adapter	SD6304	SD6344	SD6384	SD6424
	2nd adapter	SD6664	SD6704	SD6744	SD6784
	3rd adapter	SD7024	SD7064	SD7104	SD7144
	4th adapter	SD7384	SD7424	SD7464	SD7504

Setting RTD type

Set the RTD type.

Setting value	Description	Default value	R/W
0	Pt100	0	R/W
1	Ni100		



If a value other than the above is set, the resistance temperature detector type error (Error code: 1A8□H) occurs and the temperature conversion cannot be performed.

Name	Connection part	Special register			
		CH1	CH2	CH3	CH4
Setting RTD type	1st adapter	SD6305	SD6345	SD6385	SD6425
	2nd adapter	SD6665	SD6705	SD6745	SD6785
	3rd adapter	SD7025	SD7065	SD7105	SD7145
	4th adapter	SD7385	SD7425	SD7465	SD7505

Maximum value

The maximum value of the measured temperature value is stored. When the "maximum value reset request" is set from OFF to ON, the maximum value of the specified channel is updated to the "measured temperature value".

Range	Default value	R/W
-32768 to +32767	0	R

For details maximum value/minimum value hold function, refer to the following.

Page 123 Maximum Value/Minimum Value Hold Function

Name	Connection part	Special register			
		CH1	CH2	CH3	CH4
Maximum value	1st adapter	SD6306	SD6346	SD6386	SD6426
	2nd adapter	SD6666	SD6706	SD6746	SD6786
	3rd adapter	SD7026	SD7066	SD7106	SD7146
	4th adapter	SD7386	SD7426	SD7466	SD7506

Minimum value

The minimum value of the digital operation value is stored. When the "minimum value reset request" is set from OFF to ON, the minimum value of the specified channel is updated to the "measured temperature value".

Range	Default value	R/W
-32768 to +32767	0	R

For details maximum value/minimum value hold function, refer to the following.

Page 123 Maximum Value/Minimum Value Hold Function

Name	Connection part	Special register			
		CH1	CH2	CH3	CH4
Minimum value	1st adapter	SD6307	SD6347	SD6387	SD6427
	2nd adapter	SD6667	SD6707	SD6747	SD6787
	3rd adapter	SD7027	SD7067	SD7107	SD7147
	4th adapter	SD7387	SD7427	SD7467	SD7507

Process alarm upper upper limit value

Set the upper upper limit value of the alarm output function (process alarm).

Range	Default value	R/W
-32768 to +32767 (If the temperature unit is Fahrenheit (°F), set the value in increments of 2 (0.2°F).)	8500	R/W

Point

- When changing this device, set process alarm upper upper limit value, process alarm upper lower limit value, process alarm lower upper limit value, and process alarm lower lower limit value within the same scan.
- If the condition "process alarm upper upper limit value \geq process alarm upper lower limit value \geq process alarm lower upper limit value \geq process alarm lower lower limit value" is not satisfied, the process alarm upper lower limit value setting range error occurs and the temperature conversion cannot be performed. (Error code: 1A4□H)

For details alarm output function, refer to the following.

☞ Page 112 Process alarm

Name	Connection part	Special register			
		CH1	CH2	CH3	CH4
Process alarm upper upper limit value	1st adapter	SD6311	SD6351	SD6391	SD6431
	2nd adapter	SD6671	SD6711	SD6751	SD6791
	3rd adapter	SD7031	SD7071	SD7111	SD7151
	4th adapter	SD7391	SD7431	SD7471	SD7511

Process alarm upper lower limit value

Set the upper lower limit value of the alarm output function (process alarm).

Range	Default value	R/W
-32768 to +32767 (If the temperature unit is Fahrenheit (°F), set the value in increments of 2 (0.2°F).)	8500	R/W

Point

- When changing this device, set process alarm upper upper limit value, process alarm upper lower limit value, process alarm lower upper limit value, and process alarm lower lower limit value within the same scan.
- If the condition "process alarm upper upper limit value \geq process alarm upper lower limit value \geq process alarm lower upper limit value \geq process alarm lower lower limit value" is not satisfied, the process alarm upper lower limit value setting range error occurs and the temperature conversion cannot be performed. (Error code: 1A4□H)

For details alarm output function, refer to the following.

☞ Page 112 Process alarm

Name	Connection part	Special register			
		CH1	CH2	CH3	CH4
Process alarm upper lower limit value	1st adapter	SD6312	SD6352	SD6392	SD6432
	2nd adapter	SD6672	SD6712	SD6752	SD6792
	3rd adapter	SD7032	SD7072	SD7112	SD7152
	4th adapter	SD7392	SD7432	SD7472	SD7512

Process alarm lower upper limit value

Set the lower upper limit value of the alarm output function (process alarm).

Range	Default value	R/W
-32768 to +32767 (If the temperature unit is Fahrenheit (°F), set the value in increments of 2 (0.2°F).)	-2000	R/W

Point

- When changing this device, set process alarm upper upper limit value, process alarm upper lower limit value, process alarm lower upper limit value, and process alarm lower lower limit value within the same scan.
- If the condition "process alarm upper upper limit value \geq process alarm upper lower limit value \geq process alarm lower upper limit value \geq process alarm lower lower limit value" is not satisfied, the process alarm upper lower limit value setting range error occurs and the temperature conversion cannot be performed. (Error code: 1A4□H)

For details alarm output function, refer to the following.

☞ Page 112 Process alarm

Name	Connection part	Special register			
		CH1	CH2	CH3	CH4
Process alarm lower upper limit value	1st adapter	SD6313	SD6353	SD6393	SD6433
	2nd adapter	SD6673	SD6713	SD6753	SD6793
	3rd adapter	SD7033	SD7073	SD7113	SD7153
	4th adapter	SD7393	SD7433	SD7473	SD7513

Process alarm lower lower limit value

Set the lower lower limit value of the alarm output function (process alarm).

Range	Default value	R/W
-32768 to +32767 (If the temperature unit is Fahrenheit (°F), set the value in increments of 2 (0.2°F).)	-2000	R/W

Point

- When changing this device, set process alarm upper upper limit value, process alarm upper lower limit value, process alarm lower upper limit value, and process alarm lower lower limit value within the same scan.
- If the condition "process alarm upper upper limit value \geq process alarm upper lower limit value \geq process alarm lower upper limit value \geq process alarm lower lower limit value" is not satisfied, the process alarm upper lower limit value setting range error occurs and the temperature conversion cannot be performed. (Error code: 1A4□H)

For details alarm output function, refer to the following.

☞ Page 112 Process alarm

Name	Connection part	Special register			
		CH1	CH2	CH3	CH4
Process alarm lower lower limit value	1st adapter	SD6314	SD6354	SD6394	SD6434
	2nd adapter	SD6674	SD6714	SD6754	SD6794
	3rd adapter	SD7034	SD7074	SD7114	SD7154
	4th adapter	SD7394	SD7434	SD7474	SD7514

Rate alarm upper limit value

Set the upper limit of the change amount of the measured temperature value for detecting rate alarms.

Range	Default value	R/W
-32768 to +32767 (If the temperature unit is Fahrenheit (°F), set the value in increments of 2 (0.2°F).)	0	R/W

Point

- When changing this device, set rate alarm upper limit value and rate alarm lower limit value within the same scan.
- If the condition "rate alarm upper limit value \geq rate alarm lower limit value is not satisfied, the rate alarm upper limit value/lower limit value setting inversion error (Error code: 1A5□H) occurs and the temperature conversion cannot be performed.

For details alarm output function, refer to the following.

 Page 114 Rate alarm

Name	Connection part	Special register			
		CH1	CH2	CH3	CH4
Rate alarm upper limit value	1st adapter	SD6315	SD6355	SD6395	SD6435
	2nd adapter	SD6675	SD6715	SD6755	SD6795
	3rd adapter	SD7035	SD7075	SD7115	SD7155
	4th adapter	SD7395	SD7435	SD7475	SD7515

Rate alarm lower limit value

Set the lower limit of the change amount of the measured temperature value for detecting rate alarms.

Range	Default value	R/W
-32768 to +32767 (If the temperature unit is Fahrenheit (°F), set the value in increments of 2 (0.2°F).)	0	R/W

Point

- When changing this device, set rate alarm upper limit value and rate alarm lower limit value within the same scan.
- If the condition "rate alarm upper limit value \geq rate alarm lower limit value is not satisfied, the rate alarm upper limit value/lower limit value setting inversion error (Error code: 1A5□H) occurs and the temperature conversion cannot be performed.

For details alarm output function, refer to the following.

 Page 114 Rate alarm

Name	Connection part	Special register			
		CH1	CH2	CH3	CH4
Rate alarm lower limit value	1st adapter	SD6316	SD6356	SD6396	SD6436
	2nd adapter	SD6676	SD6716	SD6756	SD6796
	3rd adapter	SD7036	SD7076	SD7116	SD7156
	4th adapter	SD7396	SD7436	SD7476	SD7516

Rate alarm detection cycle setting

Set the cycle for checking the change amount of the measured temperature value.

Range	Default value	R/W
85 to 10000 (ms)	85	R/W

Point

If a value other than the above is set, the rate alarm warning detection period setting range error (Error code: 1A6□H) occurs and the temperature conversion cannot be performed.

For details alarm output function, refer to the following.

☞ Page 114 Rate alarm

Name	Connection part	Special register			
		CH1	CH2	CH3	CH4
Rate alarm detection cycle setting	1st adapter	SD6317	SD6357	SD6397	SD6437
	2nd adapter	SD6677	SD6717	SD6757	SD6797
	3rd adapter	SD7037	SD7077	SD7117	SD7157
	4th adapter	SD7397	SD7437	SD7477	SD7517

Conversion setting for disconnection detection

Set the value that is to be stored in the "measured temperature value" when a disconnection is detected.

Setting value	Description	Default value	R/W
0	Upscale	1	R/W
1	Downscale		
2	Any value		
3	Value immediately before disconnection		

Point

If a value other than the above is set, the conversion setting range error with disconnection detection enabled (Error code: 1AB□H) occurs and the temperature conversion cannot be performed.

When "upscale" (upper limit value + 5% of measurement range) or "downscale" (lower limit value - 5% of measurement range) is selected, the following values are stored in the "measured temperature value".

RTD	Temperature unit	Downscale	Upscale
Pt100	Centigrade (°C)	-2525	9025
	Fahrenheit (°F)	-4225	16565
Ni100	Centigrade (°C)	-755	2655
	Fahrenheit (°F)	-1039	5099

For details disconnection detection function, refer to the following.

☞ Page 110 Disconnection Detection Function

Name	Connection part	Special register			
		CH1	CH2	CH3	CH4
Conversion setting for disconnection detection	1st adapter	SD6318	SD6358	SD6398	SD6438
	2nd adapter	SD6678	SD6718	SD6758	SD6798
	3rd adapter	SD7038	SD7078	SD7118	SD7158
	4th adapter	SD7398	SD7438	SD7478	SD7518

Conversion setting value for disconnection detection

Set the value that is to be stored in the "measured temperature value" when "conversion setting for disconnection detection" is set to "any value".

Range	Default value	R/W
-32768 to +32767 (If the temperature unit is Fahrenheit (°F), set the value in increments of 2 (0.2°F).)	0	R/W

For details disconnection detection function, refer to the following.

 Page 110 Disconnection Detection Function

Name	Connection part	Special register			
		CH1	CH2	CH3	CH4
Conversion setting value for disconnection detection	1st adapter	SD6319	SD6359	SD6399	SD6439
	2nd adapter	SD6679	SD6719	SD6759	SD6799
	3rd adapter	SD7039	SD7079	SD7119	SD7159
	4th adapter	SD7399	SD7439	SD7479	SD7519

Offset temperature setting value

Set the offset temperature setting value used in the offset/gain setting function.

Range	Default value	R/W
Pt100 (Centigrade): -2000 to +8500 Pt100 (Fahrenheit): -3280 to +15620* ¹ NI100 (Centigrade): -600 to +2500 NI100 (Fahrenheit): -760 to +4820* ¹	0	R/W

*¹ Set the value in increments of 2 (0.2°F).

Point

The setting value is obtained from the built-in memory of the FX5-4AD-PT-ADP when "offset/gain reading" is set from OFF to ON or the power supply of the FX5-4AD-PT-ADP is turned on.

For details offset/gain setting function, refer to the following.

 Page 118 Offset/gain Setting Function

Name	Connection part	Special register			
		CH1	CH2	CH3	CH4
Offset temperature setting value	1st adapter	SD6327	SD6367	SD6407	SD6447
	2nd adapter	SD6687	SD6727	SD6767	SD6807
	3rd adapter	SD7047	SD7087	SD7127	SD7167
	4th adapter	SD7407	SD7447	SD7487	SD7527

Gain temperature setting value

Set the gain temperature setting value used in the offset/gain setting function.

Range	Default value	R/W
Pt100 (Centigrade): -2000 to +8500 Pt100 (Fahrenheit): -3280 to +15620 ^{*1} NI100 (Centigrade): -600 to +2500 NI100 (Fahrenheit): -760 to +4820 ^{*1}	8460	R/W

*1 Set the value in increments of 2 (0.2°F).



The setting value is obtained from the built-in memory of the FX5-4AD-PT-ADP when "offset/gain reading" is set from OFF to ON or the power supply of the FX5-4AD-PT-ADP is turned on.

For details offset/gain setting function, refer to the following.

Page 118 Offset/gain Setting Function

Name	Connection part	Special register			
		CH1	CH2	CH3	CH4
Gain temperature setting value	1st adapter	SD6328	SD6368	SD6408	SD6448
	2nd adapter	SD6688	SD6728	SD6768	SD6808
	3rd adapter	SD7048	SD7088	SD7128	SD7168
	4th adapter	SD7408	SD7448	SD7488	SD7528

Offset/gain code

Set the offset/gain writing enable code used for changing the offset/gain.

Range	Default value	R/W
Offset/gain writing enable: E215H Offset/gain writing disable: Other than E215H	0	R/W



When "offset/gain writing" is set from OFF to ON while the offset/gain writing is enabled, the "setting RTD type", "offset temperature setting value", "gain temperature setting value", "input offset value" and "input gain value" are written to the built-in memory of the FX5-4AD-PT-ADP.

For details offset/gain setting function, refer to the following.

Page 118 Offset/gain Setting Function

Name	Connection part	Special register			
		CH1	CH2	CH3	CH4
Offset/gain code	1st adapter	SD6329	SD6369	SD6409	SD6449
	2nd adapter	SD6689	SD6729	SD6769	SD6809
	3rd adapter	SD7049	SD7089	SD7129	SD7169
	4th adapter	SD7409	SD7449	SD7489	SD7529

Resistance offset value

The resistance offset value calculated based on the "offset temperature setting value" and "setting RTD type" is stored.

Point

When "offset/gain reading" is set from OFF to ON or the power supply of the FX5-4AD-PT-ADP is turned on, the resistance offset value, which is calculated based on the "offset temperature setting value" and "setting RTD type" obtained from the built-in memory of the FX5-4AD-PT-ADP, is stored.

For details offset/gain setting function, refer to the following.

 Page 118 Offset/gain Setting Function

Name	Connection part	Special register			
		CH1	CH2	CH3	CH4
Resistance offset value	1st adapter	SD6331, SD6330	SD6371, SD6370	SD6411, SD6410	SD6451, SD6450
	2nd adapter	SD6691, SD6690	SD6731, SD6730	SD6771, SD6770	SD6811, SD6810
	3rd adapter	SD7051, SD7050	SD7091, SD7090	SD7131, SD7130	SD7171, SD7170
	4th adapter	SD7411, SD7410	SD7451, SD7450	SD7491, SD7490	SD7531, SD7530

Resistance gain value

The resistance gain value calculated based on the "gain temperature setting value" and "setting RTD type" is stored.

Point

When "offset/gain reading" is set from OFF to ON or the power supply of the FX5-4AD-PT-ADP is turned on, the resistance gain value, which is calculated based on the "gain temperature setting value" and "setting RTD type" obtained from the built-in memory of the FX5-4AD-PT-ADP, is stored.

For details offset/gain setting function, refer to the following.

 Page 118 Offset/gain Setting Function

Name	Connection part	Special register			
		CH1	CH2	CH3	CH4
Resistance gain value	1st adapter	SD6333, SD6332	SD6373, SD6372	SD6413, SD6412	SD6453, SD6452
	2nd adapter	SD6693, SD6692	SD6733, SD6732	SD6773, SD6772	SD6813, SD6812
	3rd adapter	SD7053, SD7052	SD7093, SD7092	SD7133, SD7132	SD7173, SD7172
	4th adapter	SD7413, SD7412	SD7453, SD7452	SD7493, SD7492	SD7533, SD7532

Input offset value

Set the offset value used in the offset/gain setting function.

Range	Default value	R/W
0 to 450000 (mΩ)	99820	R/W

Point

The setting value is obtained from the built-in memory of the FX5-4AD-PT-ADP when "offset/gain reading" is set from OFF to ON or the power supply of the FX5-4AD-PT-ADP is turned on.

For details offset/gain setting function, refer to the following.

 Page 118 Offset/gain Setting Function

Name	Connection part	Special register			
		CH1	CH2	CH3	CH4
Input offset value	1st adapter	SD6335, SD6334	SD6375, SD6374	SD6415, SD6414	SD6455, SD6454
	2nd adapter	SD6695, SD6694	SD6735, SD6734	SD6775, SD6774	SD6815, SD6814
	3rd adapter	SD7055, SD7054	SD7095, SD7094	SD7135, SD7134	SD7175, SD7174
	4th adapter	SD7415, SD7414	SD7455, SD7454	SD7495, SD7494	SD7535, SD7534

Input gain value

Set the gain value used in the offset/gain setting function.

Range	Default value	R/W
0 to 450000 (mΩ)	388610	R/W

Point

The setting value is obtained from the built-in memory of the FX5-4AD-PT-ADP when "offset/gain reading" is set from OFF to ON or the power supply of the FX5-4AD-PT-ADP is turned on.

For details offset/gain setting function, refer to the following.

 Page 118 Offset/gain Setting Function

Name	Connection part	Special register			
		CH1	CH2	CH3	CH4
Input gain value	1st adapter	SD6337, SD6336	SD6377, SD6376	SD6417, SD6416	SD6457, SD6456
	2nd adapter	SD6697, SD6696	SD6737, SD6736	SD6777, SD6776	SD6817, SD6816
	3rd adapter	SD7057, SD7056	SD7097, SD7096	SD7137, SD7136	SD7177, SD7176
	4th adapter	SD7417, SD7416	SD7457, SD7456	SD7497, SD7496	SD7537, SD7536

Conversion latest alarm code

The latest alarm code detected in the FX5-4AD-PT-ADP is stored.

Monitor value	Default value	R/W
—	0	R

For details alarm code, refer to the following.

 Page 135 List of Alarm Code

Name	Connection part	Special register			
		CH1	CH2	CH3	CH4
Conversion latest alarm code	1st adapter	SD6338	SD6378	SD6418	SD6458
	2nd adapter	SD6698	SD6738	SD6778	SD6818
	3rd adapter	SD7058	SD7098	SD7138	SD7178
	4th adapter	SD7418	SD7458	SD7498	SD7538

Point

Set the "conversion alarm clear request" from OFF to ON to clear the alarm code.

Conversion latest error code

The latest error code detected in the FX5-4AD-PT-ADP is stored.

Monitor value	Default value	R/W
—	0	R

For details error code, refer to the following.

 Page 134 List of Error Code

Name	Connection part	Special register			
		CH1	CH2	CH3	CH4
Conversion latest error code	1st adapter	SD6339	SD6379	SD6419	SD6459
	2nd adapter	SD6699	SD6739	SD6779	SD6819
	3rd adapter	SD7059	SD7099	SD7139	SD7179
	4th adapter	SD7419	SD7459	SD7499	SD7539

3



Set the "error clear request" (SM50) of CPU module from OFF to ON to clear the error code.

4 FX5-4AD-TC-ADP

This chapter describes the FX5-4AD-TC-ADP.

4.1 Specifications

This section describes the specifications.

Generic specifications

The items other than the following are equivalent to those of the CPU module.

For general specifications, refer to the following manual.

📖 MELSEC iQ-F FX5UJ User's Manual (Hardware)

📖 MELSEC iQ-F FX5U User's Manual (Hardware)

📖 MELSEC iQ-F FX5UC User's Manual (Hardware)

Item	Specification
Dielectric withstand voltage	500 V AC for one minute
Insulation resistance	10 MΩ or higher by 500 V DC insulation resistance tester

Between all external terminals and ground terminal of CPU module

Power supply specifications

Power supply specifications is shown below.

Item	Specification
Internal electric supply (A/D conversion circuit)	24 V DC 20 mA Internal electric supply is carried out from 24 V DC power supply of a CPU module.
Internal electric supply (Interface)	5 V DC 10 mA Internal electric supply is carried out from 5 V DC power supply of a CPU module.

Performance specifications

Performance specifications is shown below.

Item		Specification		
		Centigrade (°C)	Fahrenheit (°F)	
Number of analog input points		4 points (4 channels)		
Usable thermocouple		K, J, T, B, R, S (JIS C 1602-1995)		
Temperature measuring range	K	-200 to +1200°C	-328 to +2192°F	
	J	-40 to +750°C	-40 to +1382°F	
	T	-200 to +350°C	-328 to +662°F	
	B	600 to 1700°C	1112 to 3092°F	
	R	0 to 1600°C	32 to 2912°F	
	S	0 to 1600°C	32 to 2912°F	
Digital output value	—	16-bit signed binary		
	K	-2000 to +12000	-3280 to +21920	
	J	-400 to +7500	-400 to +13820	
	T	-2000 to +3500	-3280 to +6620	
	B	6000 to 17000	11120 to 30920	
	R	0 to 16000	320 to 29120	
	S	0 to 16000	320 to 29120	
Accuracy*1	Ambient temperature 25±5°C	K	$\pm 3.7^{\circ}\text{C}$ (-100 to +1200°C) ^{*2} , $\pm 4.9^{\circ}\text{C}$ (-150 to -100°C) ^{*2} , $\pm 7.2^{\circ}\text{C}$ (-200 to -150°C) ^{*2}	
		J	$\pm 2.8^{\circ}\text{C}$	
		T	$\pm 3.1^{\circ}\text{C}$ (0 to 350°C) ^{*2} , $\pm 4.1^{\circ}\text{C}$ (-100 to 0°C) ^{*2} , $\pm 5.0^{\circ}\text{C}$ (-150 to -100°C) ^{*2} , $\pm 6.7^{\circ}\text{C}$ (-200 to -150°C) ^{*2}	
		B	$\pm 3.5^{\circ}\text{C}$	
		R	$\pm 3.7^{\circ}\text{C}$	
		S	$\pm 3.7^{\circ}\text{C}$	
	Ambient temperature -20 to 55°C	K	$\pm 6.5^{\circ}\text{C}$ (-100 to +1200°C) ^{*2} , $\pm 7.5^{\circ}\text{C}$ (-150 to -100°C) ^{*2} , $\pm 8.5^{\circ}\text{C}$ (-200 to -150°C) ^{*2}	
		J	$\pm 4.5^{\circ}\text{C}$	
		T	$\pm 4.1^{\circ}\text{C}$ (0 to 350°C) ^{*2} , $\pm 5.1^{\circ}\text{C}$ (-100 to 0°C) ^{*2} , $\pm 6.0^{\circ}\text{C}$ (-150 to -100°C) ^{*2} , $\pm 7.7^{\circ}\text{C}$ (-200 to -150°C) ^{*2}	
		B	$\pm 6.5^{\circ}\text{C}$	
		R	$\pm 6.5^{\circ}\text{C}$	
		S	$\pm 6.5^{\circ}\text{C}$	
Resolution	K, J, T	0.1°C	0.1 to 0.2°F	
	B, R, S	0.1 to 0.3°C	0.1 to 0.6°F	
Conversion speed		Approx. 85 ms/channel ^{*3}		
Isolation method		Between input terminal and CPU module: Photocoupler Between input channels: Non-isolation		
Number of occupied I/O points		0 point (This number is not related to the maximum number of I/O points of the PLC.)		
Applicable CPU module		<ul style="list-style-type: none"> FX5UJ CPU module (From the first) FX5U CPU module (Ver. 1.040 or later) FX5UC CPU module (Ver. 1.040 or later) 		
Applicable engineering tool		<ul style="list-style-type: none"> FX5UJ CPU module: GX Works3 (Ver.1.060N or later) FX5U/FX5UC CPU module: GX Works3 (Ver.1.030G or later) 		

*1 To satisfy the accuracy, it is required to warm up (supply the power) for 45 min.

*2 The accuracy differs depending on the ranges of the measured temperature in ().

*3 For details of the conversion speed, refer to  Page 168 Temperature Unit Choice Function.

Accuracy

Does not include the accuracy of the thermocouple and the compensating conductor.

The accuracy specifications may not be satisfied temporarily when affected by noise.

4.2 List of functions

The following table lists the functions list.

List of Functions		Description	Reference	
Temperature unit choice function		Sets a temperature unit (Centigrade/Fahrenheit) for each FX5-4AD-TC-ADP.	Page 168	
Conversion enable/disable function		Sets whether to enable or disable the temperature conversion for each channel. Disabling the conversion on unused channels reduces the conversion cycles.	Page 168	
Temperature conversion method	Sampling processing	Executes the temperature conversion on analog input every END processing and stores the result as a measured temperature value in the special registers.	Page 169	
	Averaging processing	Time average		Executes temperature conversion for a set time, calculates the average of the total value, and stores the result in special registers. The number of processing times within the set time varies depending on the scan time.
		Count average		Executes temperature conversion for a set number of times, and calculates the average of the total value excluding the maximum value and the minimum value to store it in the special registers. The time taken to store the average value obtained by the averaging processing in the special registers changes depending on the scan time.
		Moving average		Averages measured temperature values taken at every sampling cycle for a specified number of times, and stores the averaged value in the special registers. Because the target range for averaging processing is moved in response to every sampling processing, the latest measured temperature value can be obtained.
Thermocouple type choice function		Sets a thermocouple type for each channel. Selecting the thermocouple type sets the input conversion characteristics.	Page 171	
Disconnection detection function		Detects disconnection of a thermocouple or a compensating lead wire for each channel.	Page 172	
Alarm output function	Process alarm	Outputs a alarm when a measured temperature value enters the preset alarm output range.	Page 174	
	Rate alarm	Outputs an alert when the change of a measured temperature value is equal to or greater than the rate alarm upper limit value, or equal to or smaller than the rate alarm lower limit value.		
Event history function		Collects errors from FX5-4AD-TC-ADP, and stores them as event information into the CPU module.	Page 179	
Offset/gain setting function		Corrects errors in measured temperature value.	Page 180	
Offset/gain initialization function		Initializes the offset value and gain value stored in the built-in memory of the FX5-4AD-TC-ADP.	Page 184	
Maximum value/minimum value hold function		Stores the maximum and minimum values of measured temperature values to the special registers for each channel.	Page 185	
Common function		Explains the common functions such as changing the setting values while the CPU module is operating.	Page 185	

4.3 Functions

This section describes the functions of the FX5-4AD-TC-ADP and the setting procedures for those functions using GX Works3.

Point

This section describes the special relays and special registers for the 1st FX5-4AD-TC-ADP module. For checking the special relays and special registers for the 2nd and later FX5-4AD-TC-ADP modules, refer to the following:

☞ Page 199 List of Special Relays, ☞ Page 211 List of Special Registers

Processing of Each Function

The functions are processed in the order shown below.

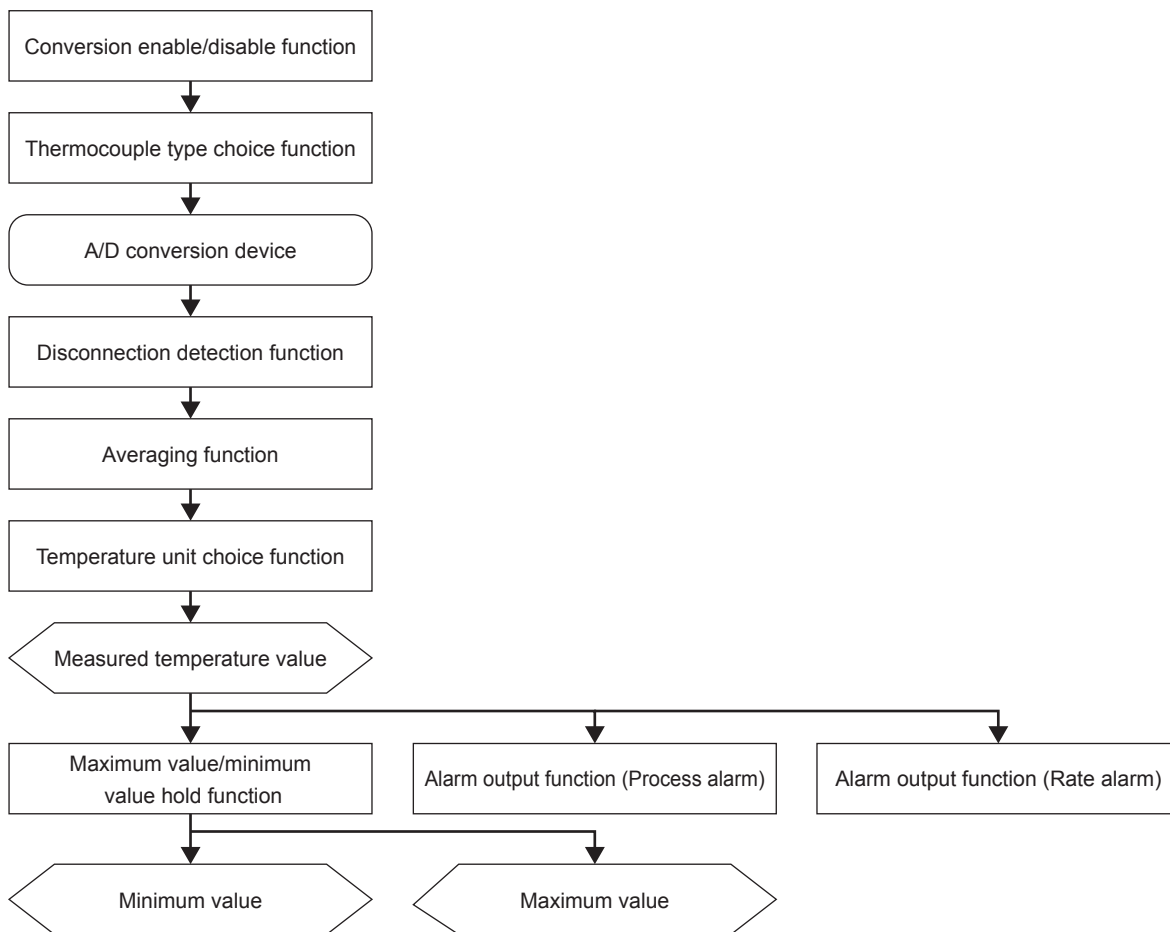

Measured temperature value

These values are the digital values after the sampling processing or each averaging processing has been performed.

Maximum and minimum value

The maximum and minimum values of the measured temperature value are stored.

Temperature Unit Choice Function

Set whether to use centigrade or fahrenheit as the temperature unit. This setting is for all channels.

Setting procedure

Set temperature unit of the "Temperature unit setting".

 Navigation window ⇒ [Parameter] ⇒ [Module Information] ⇒ Module model name ⇒ [Module Parameter] ⇒ "Basic Settings" ⇒ "Temperature unit selection function"

Corresponding devices

The devices which are used by the temperature unit choice function are listed below.

Name	CH1	CH2	CH3	CH4	Reference
Temperature unit setting	SM6280				Page 203

Operation

The "measured temperature value", "maximum value", and "minimum value" are displayed in the temperature unit set by the "temperature unit setting".

The temperature unit can be set only when the "conversion enable/disable setting" is "disable", and the set temperature unit becomes valid after completion of the first temperature conversion.

Point

- Set this function for each FX5-4AD-TC-ADP.
- After selecting the temperature unit, correct the setting values for the alarm output function and the disconnection detection function according to the set temperature unit.

Precautions

If the "temperature unit setting" has been changed while the alarm output function and the disconnection detection function are operating, the setting values for each function are not re-calculated. If the setting values on which the temperature unit has been changed become out of the setting ranges, a range error for each setting is detected. The error detection is performed at the change timing of "conversion enable/disable setting" from "disable" to "enable".

Conversion Enable/Disable Setting Function

This function sets whether to enable or disable the temperature conversion for each channel. Disabling the conversion on unused channels reduces the conversion cycles.

Setting procedure

Set "Conversion enable/disable setting" to "conversion enable".

 Navigation window ⇒ [Parameter] ⇒ [Module Information] ⇒ Module model name ⇒ [Module Parameter] ⇒ "Basic Settings" ⇒ "Conversion Enable/Disable Setting Function"

Corresponding devices

The devices which are used by the conversion enable/disable setting function are listed below.

Name	CH1	CH2	CH3	CH4	Reference
Conversion enable/disable setting	SM6301	SM6341	SM6381	SM6421	Page 203

Operation

The analog input is temperature converted only in the channels for which the "conversion enable/disable setting" is set to "enable", and values are stored in the "measured temperature value". Changing "conversion enable/disable setting" from "enable" to "disable" clears the following.

- "Conversion completed flag"
- "Warning output flag (process alarm upper limit)"
- "Warning output flag (process alarm lower limit)"
- "Warning output flag (rate alarm upper limit)"
- "Warning output flag (rate alarm lower limit)"
- "Disconnection detection flag"
- "Measured temperature value"
- "Maximum value"
- "Minimum value"

Temperature Conversion Method

This function sets a temperature conversion method for each channel.

Sampling processing

Executes the temperature conversion on the analog input approx. 85 ms/channel, and stores the result in the "measured temperature value" each time.

Point

Temperature conversion is executed one channel at a time. The time required to convert one channel is approx. 85 ms. Thus, if the conversion is incomplete during the END process, the "measured temperature value" will not be updated until the conversion is completed. The "measured temperature value" is updated during the END Process after the conversion is completed, and then conversion of the next channel will be started within the same END process.

Averaging processing

The FX5-4AD-TC-ADP performs the averaging processing on measured temperature values for each channel and stores the mean values to the "measured temperature value".

The following three types of averaging processing are provided.

- Time average
- Count average
- Moving average

■Time average

Temperature conversion is executed for a set time, the total value is averaged, and values are stored in the "measured temperature value".

The number of times of processing within the set time varies depending on the number of channels for which temperature conversion is enabled.

Point

If the set time is shorter than the scan time, the averaging processing is not executed, but the sampling value is output. However, only in the first output, the averaged value of the 1st sample and 2nd sample is output.

■Count average

Temperature conversion is executed for a set number of times, and the averaged value excluding the maximum value and minimum value is stored in the "measured temperature value".

The time required to store the averaged value obtained by count average in the "measured temperature value" varies depending on the scan time.

The count average requires a total of at least two values excluding the maximum value and minimum value. Set the number of times to "4" or larger value. Note that only in the first output, sampling values are output until the conversion is executed for a set number of times.

■Moving average

FX5-4AD-TC-ADP averages measured temperature values taken at every sampling cycle for a specified number of times, and stores the averaged value in the "measured temperature value".

Because the target range for averaging processing is moved in response to every sampling processing, the latest measured temperature value is constantly obtained.

The following figure shows the moving average processing of when the set number of times to "4".

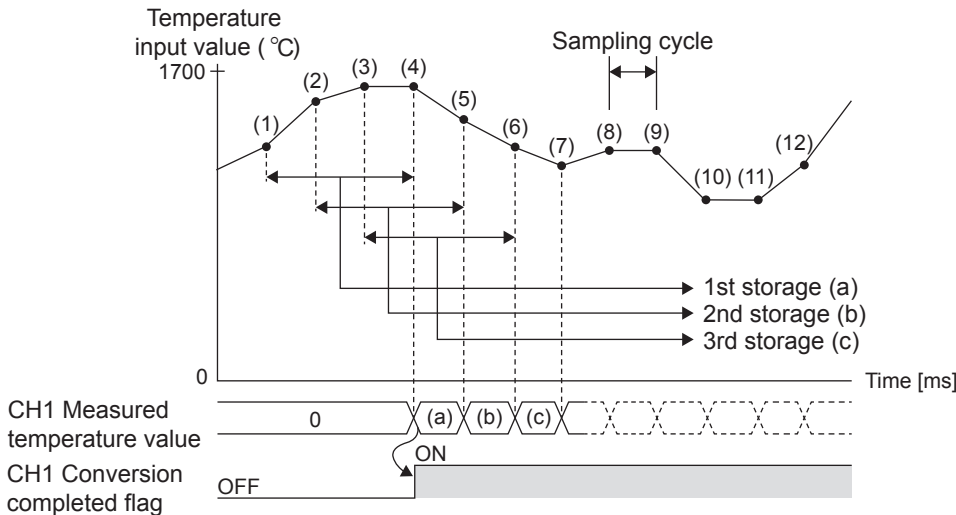

Setting procedure

■Sampling processing

Set "Average Processing Specification" to "Sampling Processing".

Navigation window ⇒ [Parameter] ⇒ [Module Information] ⇒ Module model name ⇒ [Module Parameter] ⇒ "Basic Settings" ⇒ "Temperature Conversion Method"

■Averaging processing

1. Set "Average Processing Specification" to "Time Average", "Count Average", or "Moving Average".

Navigation window ⇒ [Parameter] ⇒ [Module Information] ⇒ Module model name ⇒ [Module Parameter] ⇒ "Basic Settings" ⇒ "Temperature Conversion Method"

2. Set a value for "Time Average Counts Average Moving Average".

Item	Setting range
Time Average	340 to 10000 (ms)
Count Average	4 to 4095 (times)
Moving Average	2 to 64 (times)

Corresponding devices

The devices which are used by the temperature conversion method are listed below.

Name	CH1	CH2	CH3	CH4	Reference
Measured temperature value	SD6300	SD6340	SD6380	SD6420	Page 215
Average processing setting	SD6303	SD6343	SD6383	SD6423	Page 216
Time average/count average/moving average	SD6304	SD6344	SD6384	SD6424	Page 216

Thermocouple Type Choice Function

This function sets a thermocouple type for each channel.

Selecting the thermocouple type sets the input conversion characteristics.

Setting procedure

Set "Thermocouple type setting" to the desired thermocouple.

Navigation window ⇒ [Parameter] ⇒ [Module Information] ⇒ Module model name ⇒ [Module Parameter] ⇒ "Basic Settings" ⇒ "Thermocouple type selection function"

Item	Temperature unit	Temperature input range	Input characteristic (measured temperature value)
K	Centigrade (°C)	-270 to +1370°C	-2700 to +13700
	Fahrenheit (°F)	-454 to +2498°F	-4540 to +24980
J	Centigrade (°C)	-210 to +1130°C	-2100 to +11300
	Fahrenheit (°F)	-346 to +2066°F	-3460 to +20660
T	Centigrade (°C)	-270 to +400°C	-2700 to +4000
	Fahrenheit (°F)	-454 to +752°F	-4540 to +7520
B	Centigrade (°C)	0 to 1710°C	0 to 17100
	Fahrenheit (°F)	32 to 3110°F	320 to 31100
R	Centigrade (°C)	-50 to +1710°C	-500 to +17100
	Fahrenheit (°F)	-58 to +3110°F	-580 to +31100
S	Centigrade (°C)	-50 to +1710°C	-500 to +17100
	Fahrenheit (°F)	-58 to +3110°F	-580 to +31100

Corresponding devices

The devices which are used by the temperature resistance choice function are listed below.

Name	CH1	CH2	CH3	CH4	Reference
Setting thermocouple type	SD6305	SD6345	SD6385	SD6425	Page 217

Operation

Thermocouple type is switched when the "conversion enable/disable setting" is "disable" and "thermocouple type setting" has been changed.

When the thermocouple type is switched, the following special devices are initialized:

Name	CH1	CH2	CH3	CH4	Reference
Conversion completed flag	SM6300	SM6340	SM6380	SM6420	Page 203
Warning output flag (process alarm upper limit)	SM6311	SM6351	SM6391	SM6431	Page 205
Warning output flag (process alarm lower limit)	SM6312	SM6352	SM6392	SM6432	Page 205
Warning output flag (rate alarm upper limit)	SM6315	SM6355	SM6395	SM6435	Page 206
Warning output flag (rate alarm lower limit)	SM6316	SM6356	SM6396	SM6436	Page 206
Disconnection detection flag	SM6318	SM6358	SM6398	SM6438	Page 207
Offset gain setting flag	SM6331	SM6371	SM6411	SM6451	Page 208
Measured temperature value	SD6300	SD6340	SD6380	SD6420	Page 215
Maximum value	SD6306	SD6346	SD6386	SD6426	Page 217
Minimum value	SD6307	SD6347	SD6387	SD6427	Page 218
Offset temperature setting value ^{*1}	SD6327	SD6367	SD6407	SD6447	Page 223
Gain temperature setting value ^{*1}	SD6328	SD6368	SD6408	SD6448	Page 224
Thermal EMF offset value (L) ^{*1}	SD6330	SD6370	SD6410	SD6450	Page 225
Thermal EMF offset value (H) ^{*1}	SD6331	SD6371	SD6411	SD6451	
Thermal EMF gain value (L) ^{*1}	SD6332	SD6372	SD6412	SD6452	Page 225
Thermal EMF gain value (H) ^{*1}	SD6333	SD6373	SD6413	SD6453	

Name	CH1	CH2	CH3	CH4	Reference
Input offset value (L) ^{*1}	SD6334	SD6374	SD6414	SD6454	Page 226
Input offset value (H) ^{*1}	SD6335	SD6375	SD6415	SD6455	
Input gain value (L) ^{*1}	SD6336	SD6376	SD6416	SD6456	Page 226
Input gain value (H) ^{*1}	SD6337	SD6377	SD6417	SD6457	

*1 When the thermocouple after change is equivalent to the thermocouple set by the offset/gain setting function, the values (user range setting) set by the offset/gain setting function are reflected. In any other case, they are initialized to the initial value.

Disconnection Detection Function

Simple disconnection detection is performed.

Precautions

The disconnection detection function operates according to the user environment, and thus the detection value varies depending on the difference of wiring resistance.

Setting procedure

- Set "Disconnection detection enable/disable setting" to "Enable".
- Navigation window ⇒ [Parameter] ⇒ [Module Information] ⇒ Module model name ⇒ [Module Parameter] ⇒ "Application Settings" ⇒ "Disconnection detection function"
- Set "Enable/Disable setting for disconnection detection automatic clear" to "Enable" or "Disable".
- Using "Conversion setting for disconnection detection", set what value is to be stored in "Measured temperature value" at the time of the disconnection detection.

Item	Setting range
Conversion setting for disconnection detection	<ul style="list-style-type: none"> Upscale Downscale Any value Value before disconnection

When "Conversion setting for disconnection detection" is set to "Upscale" (upper limit value + 5% of measurement range) or "Downscale" (lower limit value - 5% of measurement range), the following values are stored in the "measured temperature value".

Thermocouple	Temperature unit	Downscale	Upscale
K	Centigrade (°C)	-3520	14520
	Fahrenheit (°F)	-6016	26456
J	Centigrade (°C)	-2770	11970
	Fahrenheit (°F)	-4666	21866
T	Centigrade (°C)	-3035	4335
	Fahrenheit (°F)	-5143	8123
B	Centigrade (°C)	-855	17955
	Fahrenheit (°F)	-1219	32639
R	Centigrade (°C)	-1380	17980
	Fahrenheit (°F)	-2164	32684
S	Centigrade (°C)	-1380	17980
	Fahrenheit (°F)	-2164	32684

- "When "Conversion setting for disconnection detection" is set to "Any value", set "Conversion setting for disconnection detection".

Item	Setting range
Conversion setting function for disconnection detection	-3276.8 to 3276.7 ^{*1}

*1 If the temperature unit is Fahrenheit (°F), set the value in increments of 2 (0.2°F).

Corresponding devices

The devices which are used by the disconnection detection function are listed below.

Name	CH1	CH2	CH3	CH4	Reference
Disconnection detection flag	SM6318	SM6358	SM6398	SM6438	Page 207
Disconnection detection enable/disable setting	SM6319	SM6359	SM6399	SM6439	Page 207
Disconnection detection automatic clear enable/disable setting	SM6320	SM6360	SM6400	SM6440	Page 208
Conversion setting for disconnection detection	SD6318	SD6358	SD6398	SD6438	Page 222
Conversion setting value for disconnection detection	SD6319	SD6359	SD6399	SD6439	Page 223

Operation

■Operations at disconnection

When an analog input value (temperature) reaches the disconnection detection condition in a channel where "conversion enable/disable setting" is set to "enable" and "disconnection detection enable/disable setting" is set to "enable", it is regarded as disconnected. An alarm occurs, and "conversion alarm flag" and "disconnection detection flag" turn on accordingly. (Alarm code: 0A0□H)

If disconnection is detected, the temperature conversion is interrupted, and a value (upscale, downscale, any value, or value immediately before disconnection) is stored in the "measured temperature value" according to the setting of "conversion setting for disconnection detection".

Precautions

While the disconnection detection function is operating, the alarm output function (process alarm), alarm output function (rate alarm), maximum value/minimum value hold function do not operate. In addition, when "conversion enable/disable setting" is "enable", the data related to the disconnection detection function cannot be changed.

■Operations when the connection is re-established

The operations when the disconnection cause is eliminated and the connection to an external device is re-established vary depending on the setting of "disconnection detection automatic clear enable/disable setting".

- When "enable" is set

When the connection is re-established, "disconnection detection flag" turns off and the temperature conversion is restarted. "conversion alarm flag" and the alarm code stored in "conversion latest alarm code", however, are not cleared. To clear "conversion alarm flag" and the alarm code stored in "conversion latest alarm code", turn on and off "conversion alarm clear request".

- When "disable" is set

"disconnection detection flag" remains in the state when the disconnection was detected. To return the flag to the normal state, turn on and off "Conversion alarm clear request" after re-establishing connections for all channels.

Note that when "disconnection detection enable/disable setting" is changed to "disable", "disconnection detection flag" turns off.

Detection cycle

Disconnection detection is executed every sampling cycle.

Alarm Output Function

This section describes process alarms and rate alarms used for the alarm output function.

Process alarm

This function outputs a alarm when a measured temperature value enters the preset alarm output range.

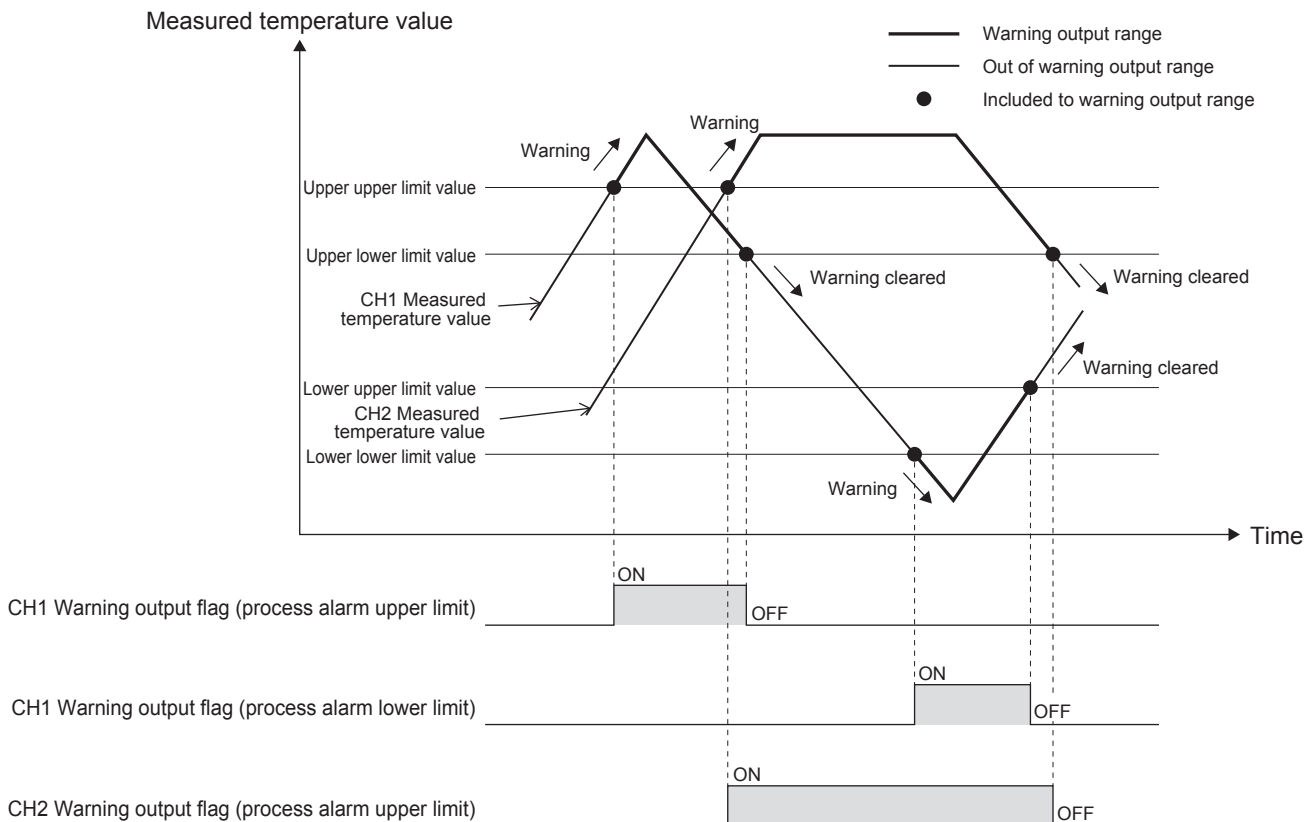

■ Operation

If a measured temperature value satisfies the following conditions where a warning is output, a warning output flag corresponding to "conversion alarm flag" turns on.

- The value is equal to or greater than the process alarm upper upper limit value: "Warning output flag (process alarm upper limit)" turns on. (Alarm code: 080□H)
- The value is equal to or smaller than the process alarm lower lower limit value: "Warning output flag (process alarm lower limit)" turns on. (Alarm code: 081□H)

After a warning was output, if a measured temperature value becomes out of the conditions where a warning is output, the corresponding warning output flag turns off.

- The value is smaller than the process alarm upper lower limit value: "Warning output flag (process alarm upper limit)" turns off.
- The value is greater than the process alarm lower upper limit value: "Warning output flag (process alarm lower limit)" turns off.

In addition, when the "warning output setting (process alarm)" is changed to be disabled, "warning output flag (process alarm upper limit)" and "warning output flag (process alarm lower limit)" turn off. "Conversion alarm flag" and the alarm code stored in "conversion latest alarm code", however, are not cleared.

To clear "conversion alarm flag" and the alarm code stored in "conversion latest alarm code", turn on and off "conversion alarm clear request" after all of "warning output flag (process alarm upper limit)" and "warning output flag (process alarm lower limit)" turn off.

Precautions

When "conversion enable/disable setting" is "enable", the data related to the alarm output function (process alarm) cannot be changed.

■Detection cycle

The process alarm detection is performed every sampling cycle.

■Setting procedure

1. Set "Warning output setting (Process alarm)" to "Enable".

 Navigation window ⇒ [Parameter] ⇒ [Module Information] ⇒ Module model name ⇒ [Module Parameter] ⇒ "Application Settings" ⇒ "Warning output function (Process alarm)"

2. Set values for "Process Alarm Upper Upper Limit Value", "Process Alarm Upper Lower Limit Value", "Process Alarm Lower Upper Limit Value", and "Process Alarm Lower Lower Limit Value".

Item	Setting thermocouple type			Setting range
	Thermocouple	Temperature unit	Temperature input range	
Process Alarm Upper Upper Limit Value Process Alarm Upper Lower Limit Value Process Alarm Lower Upper Limit Value Process Alarm Lower Lower Limit Value	K	Centigrade (°C)	-270 to +1370°C	-2700 to +13700
		Fahrenheit (°F)	-454 to +2498°F	-4540 to +24980 ^{*1}
	J	Centigrade (°C)	-210 to +1130°C	-2100 to +11300
		Fahrenheit (°F)	-346 to +2066°F	-3460 to +20660 ^{*1}
	T	Centigrade (°C)	-270 to +400°C	-2700 to +4000
		Fahrenheit (°F)	-454 to +752°F	-4540 to +7520 ^{*1}
	B	Centigrade (°C)	0 to 1710°C	0 to 17100
		Fahrenheit (°F)	32 to 3110°F	320 to 31100 ^{*1}
	R	Centigrade (°C)	-50 to +1710°C	-500 to +17100
		Fahrenheit (°F)	-58 to +3110°F	-580 to +31100 ^{*1}
	S	Centigrade (°C)	-50 to +1710°C	-500 to +17100
		Fahrenheit (°F)	-58 to +3110°F	-580 to +31100 ^{*1}

*1 Set the value in increments of 2 (0.2°F).

Point

Set values within the range satisfying the condition "Process Alarm Upper Upper Limit Value ≥ Process Alarm Upper Lower Limit Value ≥ Process Alarm Lower Upper Limit Value ≥ Process Alarm Lower Lower Limit Value".

When not satisfying the above conditions, a process alarm upper lower limit value setting range error occurs. (Error code: 1A4□H)

■Corresponding devices

The devices which are used by the process alarm are listed below.

Name	CH1	CH2	CH3	CH4	Reference
Warning output flag (process alarm upper limit)	SM6311	SM6351	SM6391	SM6431	Page 205
Warning output flag (process alarm lower limit)	SM6312	SM6352	SM6392	SM6432	Page 205
Warning output setting (process alarm)	SM6313	SM6353	SM6393	SM6433	Page 206
Process alarm upper upper limit value	SD6311	SD6351	SD6391	SD6431	Page 218
Process alarm upper lower limit value	SD6312	SD6352	SD6392	SD6432	Page 219
Process alarm lower upper limit value	SD6313	SD6353	SD6393	SD6433	Page 219
Process alarm lower lower limit value	SD6314	SD6354	SD6394	SD6434	Page 220

Rate alarm

This function outputs an alert when the change of a measured temperature value is equal to or greater than the rate alarm upper limit value, or equal to or smaller than the rate alarm lower limit value.

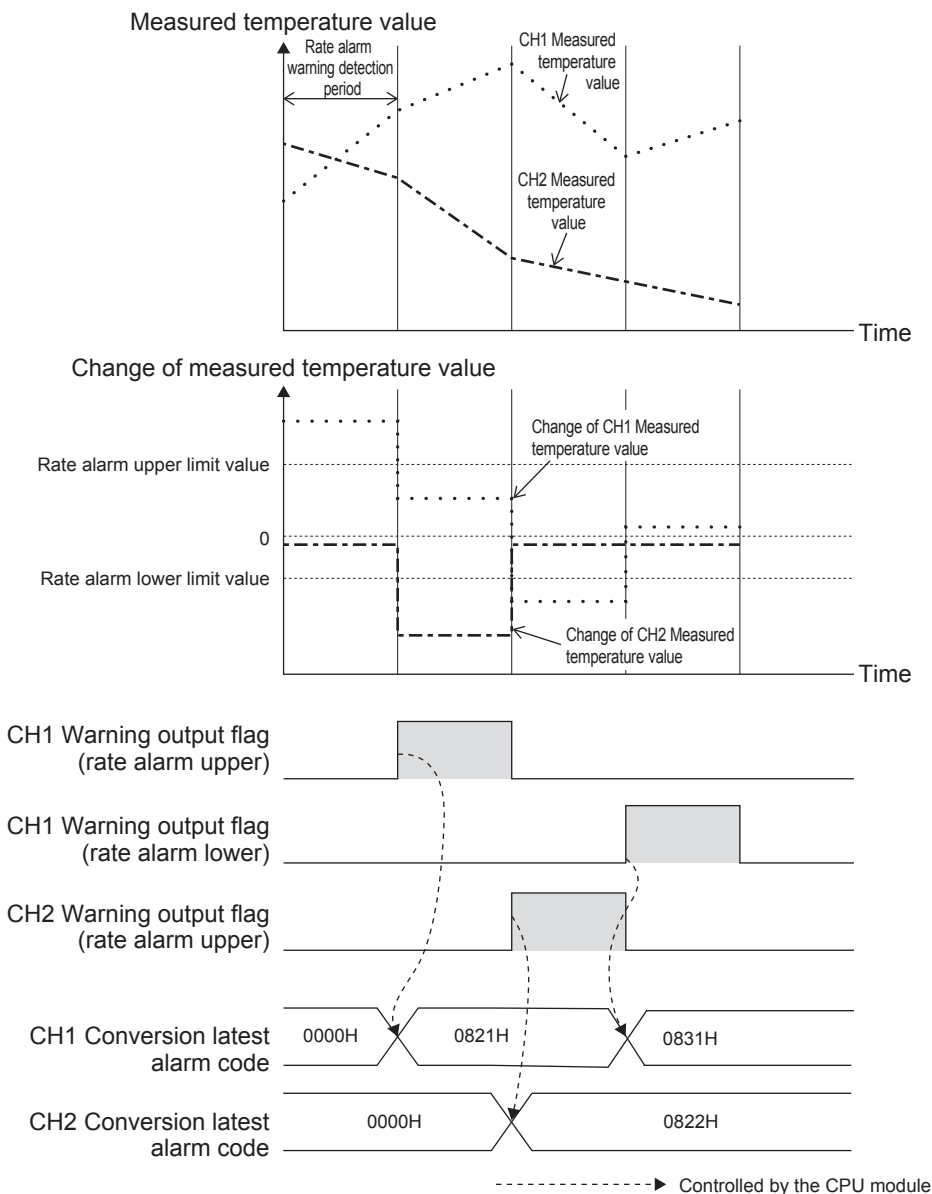

■ Operation

The measured temperature value is monitored every rate alarm warning detection period. When the change from the previous value is equal to or greater than the rate alarm upper limit value, or equal to or smaller than the rate alarm lower limit value, a warning output flag corresponding to "conversion alarm flag" turns on.

- The value is equal to or greater than the rate alarm upper limit value: "Warning output flag (rate alarm upper)" turns on. (Alarm code: 082□H)
- The value is equal to or smaller than the rate alarm lower limit value: "Warning output flag (rate alarm lower)" turns on. (Alarm code: 083□H)

After a warning is output, if the measured temperature value becomes out of the conditions where a warning is output, the corresponding warning output flag turns off.

- The value is smaller than the rate alarm upper limit value: "Warning output flag (rate alarm upper)" turns off.
- The value is greater than the rate alarm lower limit value: "Warning output flag (rate alarm lower)" turns off.

In addition, when the "warning output setting (rate alarm)" is changed to be disabled, "warning output flag (rate alarm upper)" and "warning output flag (rate alarm lower)" turn off. "Conversion alarm flag" and the alarm code stored in "conversion latest alarm code", however, are not cleared.

To clear "conversion alarm flag" and the alarm code stored in "conversion latest alarm code", turn on and off "conversion alarm clear request" after all of "warning output flag (rate alarm upper)" and "warning output flag (rate alarm lower)" turn off.

Precautions

When "conversion enable/disable setting" is "enable", the data related to the alarm output function (rate alarm) cannot be changed.

■Detection cycle

Set the rate alarm warning detection period in "rate alarm detection cycle setting".

■Judgment of rate alarm

A change rate is judged with the following formulae every rate alarm alert detection cycle.

- For alert outputting of rate alarm upper limit

Measured temperature value of this time - Measured temperature value of previous detection cycle \geq Rate alarm upper limit value

- For alert outputting of rate alarm lower limit

Measured temperature value of this time - Measured temperature value of previous detection cycle \leq Rate alarm lower limit value

Ex.

Judgment with the following conditions (for thermocouple B (600 to 1700°C))

- Rate alarm detection cycle setting: 150 (ms)
- Rate alarm upper limit value: 10000 (1000.0°C)
- Rate alarm lower limit value: 7000 (700.0°C)

A measured temperature value of this time is compared to the previous value (measured temperature value 150 ms before), every rate alarm alert detection cycle of 150ms. From the comparison, whether the increase in the measured temperature value is 10000 (1000.0°C) or more, or 7000 (700.0°C) or less is judged.

■Application examples of rate alarms

A rate alarm serves to monitor the change of a measured temperature value in a limited range as shown below.

Ex.

To monitor that an increase rate of a measured temperature value (Temperature unit: Centigrade) is within the specified range

Change of the measured temperature value (°C)

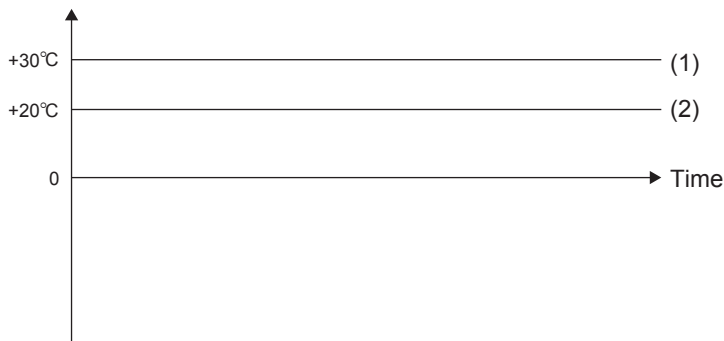

Ex.

To monitor that a decrease rate of a measured temperature value (Temperature unit: Fahrenheit) is within the specified range

Change of the measured temperature value (°F)

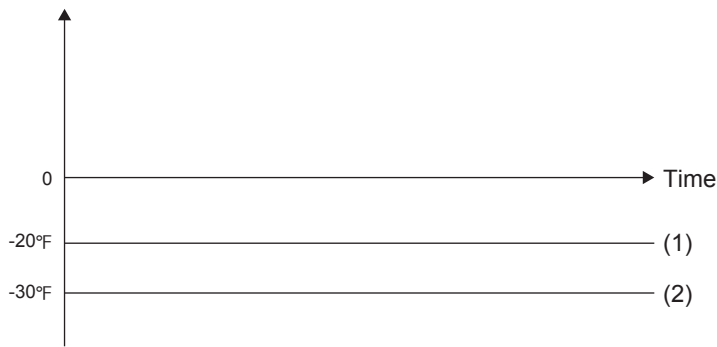

(1) Rate alarm upper value
(2) Rate alarm lower value

Ex.

To monitor that a change rate of a measured temperature value (Temperature unit: Centigrade) is within the specified range

Change of the measured temperature value (°C)

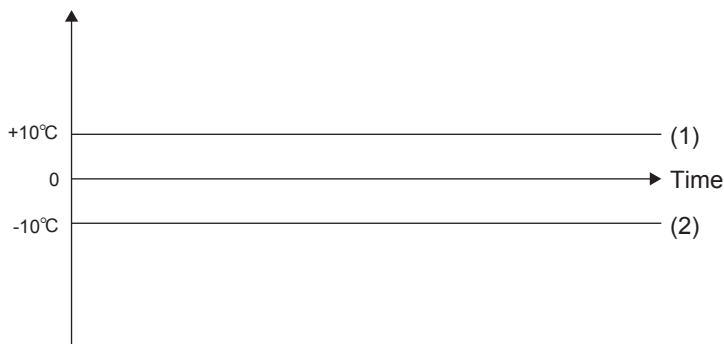

(1) Rate alarm upper value
(2) Rate alarm lower value

Setting procedure

1. Set "Warning output function (Rate alarm)" to "Enable".

Navigation window ⇒ [Parameter] ⇒ [Module Information] ⇒ Module model name ⇒ [Module Parameter] ⇒ "Application Settings" ⇒ "Warning output function (Rate alarm)"

2. Set a value in "Rate alarm warning detection period setting".

Item	Setting range
Rate alarm warning detection period setting	85 to 10000 (ms)

Point

- When a value outside the setting range is set, the rate alarm warning detection period setting range error occurs. (Error code: 1A6□H)
- The rate alarm warning detection period is obtained by Set value + 1 scan time.

3. Set values for "Rate alarm upper limit value" and "Rate alarm lower limit value".

Item	Setting range
Rate alarm upper limit value	-3276.8 to 3276.7* ¹
Rate alarm lower limit value	

*1 If the temperature unit is Fahrenheit (°F), set the value in increments of 2 (0.2°F).

Point

Set values within the range satisfying the condition "Rate alarm upper limit value > Rate alarm lower limit value".

When not satisfying the above conditions, a rate alarm upper/lower limit setting value inversion error occurs. (Error code: 1A5□H)

■Corresponding devices

The devices which are used by the rate alarm are listed below.

Name	CH1	CH2	CH3	CH4	Reference
Warning output flag (rate alarm upper limit)	SM6315	SM6355	SM6395	SM6435	Page 206
Warning output flag (rate alarm lower limit)	SM6316	SM6356	SM6396	SM6436	Page 206
Warning output setting (rate alarm)	SM6317	SM6357	SM6397	SM6437	Page 207
Rate alarm upper limit value	SD6315	SD6355	SD6395	SD6435	Page 220
Rate alarm lower limit value	SD6316	SD6356	SD6396	SD6435	Page 221
Rate alarm detection cycle setting	SD6317	SD6357	SD6397	SD6437	Page 221

Event History Function

This function collects errors from FX5-4AD-TC-ADP, and keeps them in the SD memory card, and data memory or battery backed built-in RAM of the CPU module.

The event information collected by the CPU module can be displayed on GX Works3 to check the occurrence history in chronological order.

Event type	Classification	Description
System	Error	An error detected by the self diagnostics in each module.

Setting procedure

The event history function can be set from the event history setting window of GX Works3. For the setting procedure, refer to the following.

 MELSEC iQ-F FX5 User's Manual (Application)

Displaying event history

Access the menu of GX Works3. For details on the operating procedure and how to view the contents, refer to the following.

 GX Works3 Operating Manual

Offset/gain Setting Function

This function sets any analog (temperature) value to the offset/gain value without regard to the setting prepared in advance. (user range setting) The function corrects error of the temperature conversion caused by noise or other factors. Note that the resolution is not changed. The offset setting value and gain setting value are saved in the built-in memory of the FX5-4AD-TC-ADP.

For changing the offset/gain data, set an analog value to the "offset temperature setting value" or "gain temperature setting value".

The table below shows the available setting range.

Item	Description	Setting range						
		Unit/ Thermocouple	K	J	T	B	R	S
Offset temperature setting value	Temperature setting value corresponding to the input offset value	Centigrade (°C)	-270.0 to +1370.0°C	-210.0 to +1130.0°C	-270.0 to +400.0°C	0 to 710.0°C	-50.0 to +1710.0°C	-50.0 to +1710.0°C
		Fahrenheit (°F)	-454.0 to +2498.0°F	-346.0 to +2066.0°F	-454.0 to +752.0°F	32.0 to 3110.0°F	-58.0 to +3110.0°F	-58.0 to +3110.0°F
Gain temperature setting value	Temperature setting value corresponding to the input gain value	Centigrade (°C)	-270.0 to +1370.0°C	-210.0 to +1130.0°C	-270.0 to +400.0°C	0 to 710.0°C	-50.0 to +1710.0°C	-50.0 to +1710.0°C
		Fahrenheit (°F)	-454.0 to +2498.0°F	-346.0 to +2066.0°F	-454.0 to +752.0°F	32.0 to 3110.0°F	-58.0 to +3110.0°F	-58.0 to +3110.0°F

Point

When the offset temperature setting value and the gain temperature setting value do not satisfy the following condition, the offset/gain temperature setting value error occurs. (Error code: 1D1□H)

- When the temperature unit is centigrade: Gain temperature setting value - offset temperature setting value > 0.1°C
- When the temperature unit is fahrenheit: Gain temperature setting value - offset temperature setting value > 0.3°F

If the "offset temperature setting value" and the "gain temperature setting value" are set using this function, the following values are also stored.

Item	Description	Setting range
Input offset value	The thermoelectromotive force value obtained through the temperature conversion (averaging processing) where the measured temperature value becomes the lower limit value (offset reference value)	0 to 78125 (μV)
Input gain value	The thermoelectromotive force value obtained through the temperature conversion (averaging processing) where the measured temperature value becomes the upper limit value (gain reference value)	

Setting procedure

Access to the offset/gain setting window in the GX Works3 to set the offset and gain values.

The setting procedure for the offset/gain setting of the FX5-4AD-TC-ADP is as follows:

[Tool] ⇒ [Module Tool List]

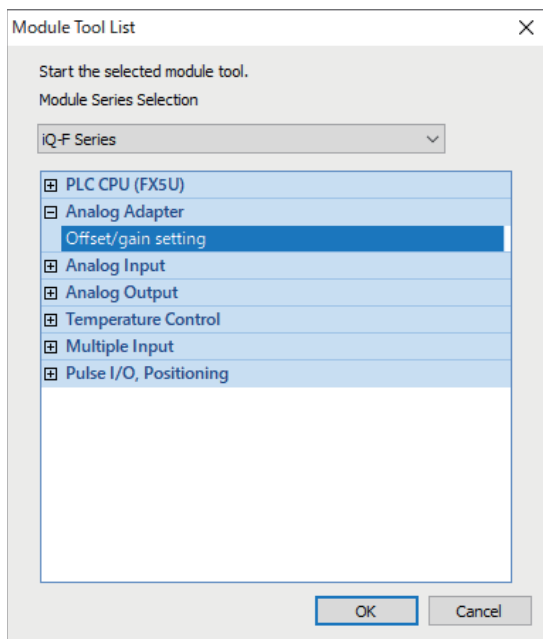

1. In "Analog Adapter", select " Offset/gain setting" and click [OK] button.

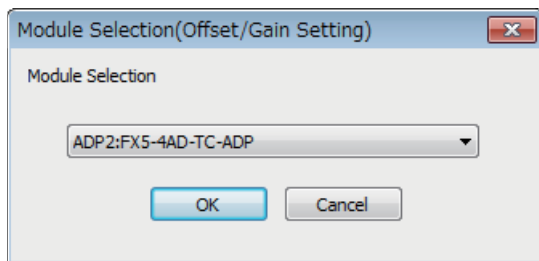

2. Select the target module for the offset/gain setting, and click [OK] button.

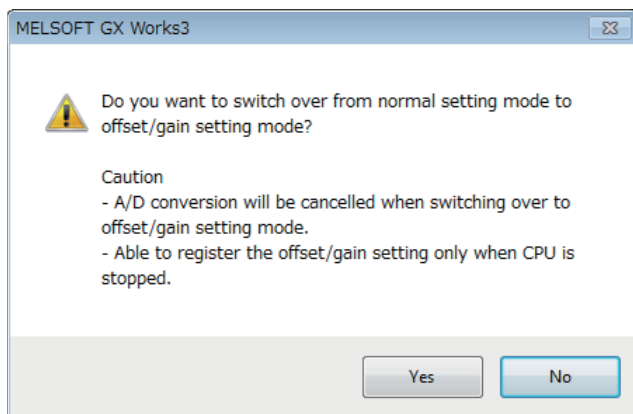

3. Click [Yes] button.

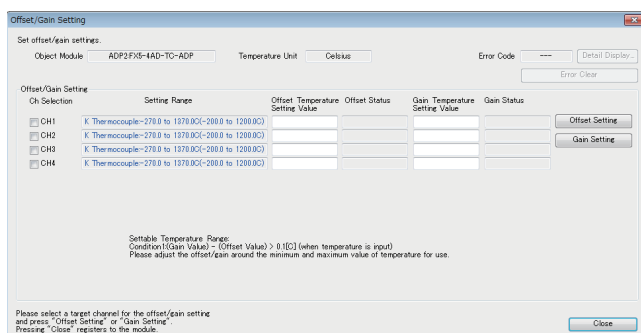

4. Mark the checkbox of the channel where offset and gain values are to be set, and click [Offset Setting] button.

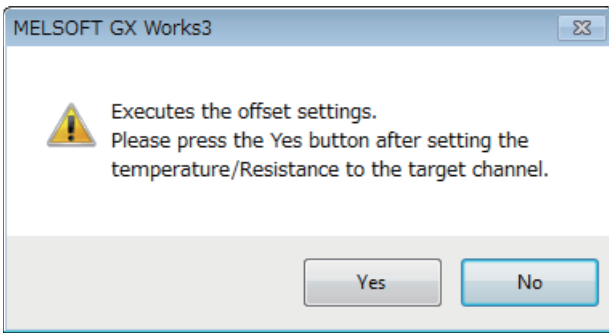

5. Apply the offset temperature to the terminal of the corresponding channel, and click [Yes] button.

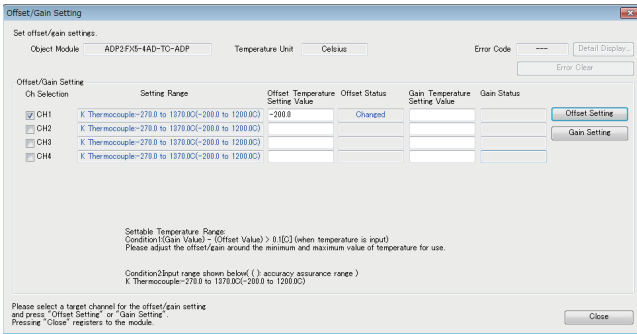

6. Check that "Offset Status" has changed to "Changed", and click [Gain Setting] button.

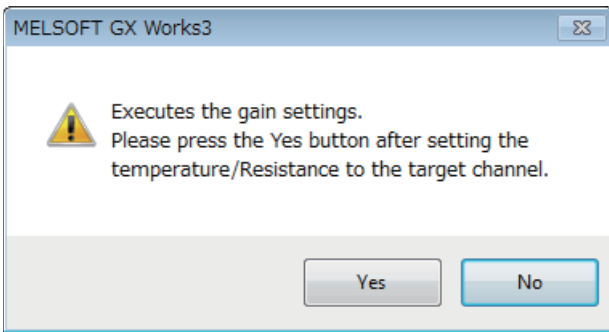

7. Apply the gain temperature to the terminal of the corresponding channel, and click [Yes] button.

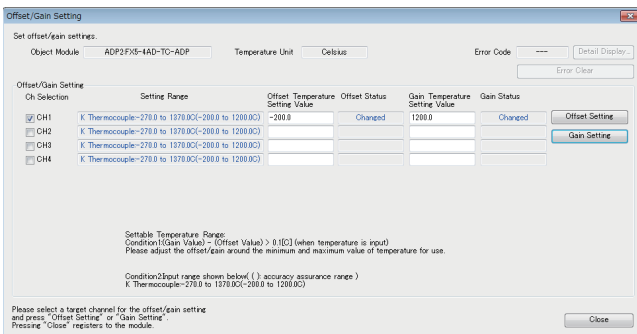

8. Check that "Gain Status" has changed to "Changed", and click [Close] button.

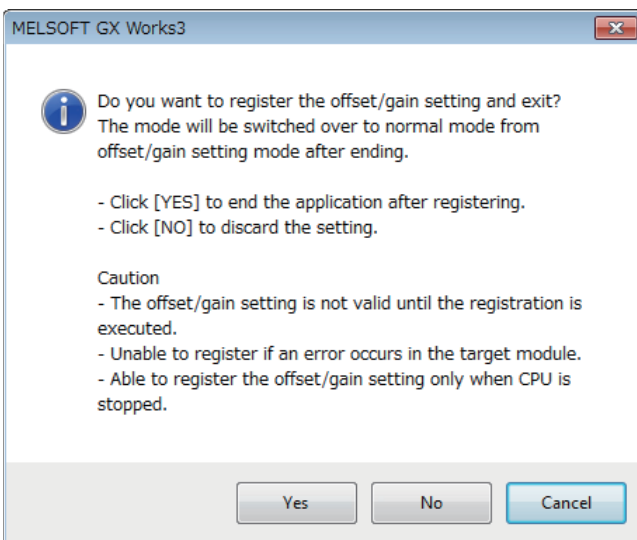

9. Click [Yes] button.

Corresponding devices

The devices which are used by the offset/gain setting function are listed below.

Name	CH1	CH2	CH3	CH4	Reference
Offset gain setting flag	SM6331	SM6371	SM6411	SM6451	Page 208
Read offset/gain	SM6332	SM6372	SM6412	SM6452	Page 208
Write offset/gain	SM6333	SM6373	SM6413	SM6453	Page 209
Offset temperature setting value	SD6327	SD6367	SD6407	SD6447	Page 223
Gain temperature setting value	SD6328	SD6368	SD6408	SD6448	Page 224
Offset/gain code	SD6329	SD6369	SD6409	SD6449	Page 224
Input offset value (L)	SD6334	SD6374	SD6414	SD6454	Page 226
Input offset value (H)	SD6335	SD6375	SD6415	SD6455	
Input gain value (L)	SD6336	SD6376	SD6416	SD6456	Page 226
Input gain value (H)	SD6337	SD6377	SD6417	SD6457	

Operation

■Offset/gain writing

For changing the offset/gain data, set "E21AH" to the "offset/gain writing enable code" and set the "offset/gain writing" from OFF to ON to write the "setting thermocouple type", "offset temperature setting value", "gain temperature setting value", "input offset value" and "input gain value" to the built-in memory of the FX5- 4AD-TC-ADP. This enables the user range setting change for each channel, and the latest contents become valid.

When writing is completed, the "write offset/gain" automatically turns OFF. Also, the "offset/gain code" is cleared to 0.

When the "setting thermocouple type" is changed, the initial value becomes valid.

For returning the offset/gain data to the initial value, use the offset/gain initialization function. (☞ Page 184 Offset/gain Initialization Function)

Point

- The offset/gain value is written when the "offset/gain code" is set to "E21AH".
- The offset/gain value can be written only while temperature conversion is disabled.
- The "conversion enable/disable setting" cannot be changed to "enable" while the offset/gain value is being written.

■Offset/gain reading

For reading the offset/gain data saved in the built-in memory of the FX5-4AD-TC-ADP, set the "read offset/gain" from OFF to ON to read the "setting thermocouple type", "offset temperature setting value", "gain temperature setting value", "input offset value" and "input gain value".

When the thermocouple type setting that is read is same as the "setting thermocouple type" stored in the built-in memory of the FX5-4AD-TC-ADP, the obtained values are stored in the "offset temperature setting value", "gain temperature setting value", "input offset value", and "input gain value". If the setting thermocouple type is different, the initial value of the "setting thermocouple type" selected during reading is valid and set to the "offset temperature setting value", "gain temperature setting value", "input offset value" and "input gain value". In this case, the offset/gain thermocouple type mismatch alarm occurs (Alarmcode: 0C0□H)

Offset/gain Initialization Function

This function initializes the offset value and gain value saved in the built-in memory of the FX5-4AD-TC-ADP.

This function can be set only with special devices.

Setting procedure

1. Set "E21AH" to the "offset/gain code".

Setting value	Description	Default value
Other than E21AH	Offset/gain writing disable	0
E21AH	Offset/gain writing enable	

2. Set the "initialize offset/gain" from OFF to ON.

Setting value	Description	Default value
0: OFF	Offset/gain initialization is not performed.	0: OFF
1: ON	Offset/gain initialization is performed.	

Corresponding devices

The devices which are used by the offset/gain initialization function are listed below.

Name	CH1	CH2	CH3	CH4	Reference
Initialize offset/gain	SM6334	SM6374	SM6414	SM6454	Page 209
Offset/gain code	SD6329	SD6369	SD6409	SD6449	Page 224

Operation

Set "E21AH" to the "offset/gain code" and set the "initialize offset/gain" from OFF to ON to initialize the offset temperature setting value, gain temperature setting value, input offset value and input gain value saved in the built-in memory of the FX5-4AD-TC-ADP. When initialization is completed, the "initialize offset/gain" automatically turns OFF. Also, the "offset/gain code" is cleared to 0.

Point

- Offset/gain initialization is executed when the "offset/gain code" is set to "E21AH".
- Offset/gain initialization is enabled only while temperature conversion is disabled.
- The "conversion enable/disable setting" cannot be changed to "enable" while offset/gain initialization is being executed.

Maximum Value/Minimum Value Hold Function

This function stores the maximum value and minimum value of the measured temperature value to the special registers for each channel.

This function can be set only with special devices.

Setting procedure

When the "maximum value reset request" or "minimum value reset request" is set from OFF to ON, the maximum value or minimum value is updated to the measured temperature value.

Setting value	Description	Default value
0: OFF	With no maximum value or minimum value reset request	0: OFF
1: ON	With maximum value or minimum value reset request	

Corresponding devices

The devices which are used by the maximum value/minimum value hold function are listed below.

Name	CH1	CH2	CH3	CH4	Reference
Maximum value/minimum value reset completed flag	SM6305	SM6345	SM6385	SM6425	Page 204
Maximum value reset request	SM6306	SM6346	SM6386	SM6426	Page 204
Minimum value reset request	SM6307	SM6347	SM6387	SM6427	Page 205
Maximum value	SD6306	SD6346	SD6386	SD6426	Page 217
Minimum value	SD6307	SD6347	SD6387	SD6427	Page 218

Operation

When the "maximum value reset request" or "minimum value reset request" is set from OFF to ON, the maximum value or minimum value of the specified channel is updated to the "measured temperature value" every sampling cycle. In addition, the "maximum value/minimum value reset completed flag" turns ON.

When the thermocouple choice is changed, the "maximum value" and "minimum value" are cleared (to "0").

Common Function

Changing the setting value while the CPU module is operating

This paragraph shows the procedure to adopt values (of special relays and special registers) other than the values set by the parameters of GX Works3.

1. Disable temperature conversion.

Set "conversion enable/disable setting" to ON. (☞ Page 203 Conversion enable/disable setting)

2. Change the value of a target special relay/device.

Change the value of a target device.

3. Enable temperature conversion.

Set "conversion enable/disable setting" to OFF. (☞ Page 203 Conversion enable/disable setting)

Precautions

- If the value of the special relay or special device has been changed while the temperature conversion is enabled, an alarm occurs and, at the END processing, the value is overwritten with the value used for the current operation. (Alarm code: 0F0□H)
- When the temperature conversion method is count average or moving average, if the temperature conversion is set to be disabled, the values of special relay or special device related to average counts and averaging process setting are changed, and the temperature conversion is set to be enabled again, the number of sampling times is cleared and the sampling is performed from 0 time.

Starting/stopping the analog function in accordance with the CPU module status

This paragraph shows the analog operation in accordance with the CPU module status.

■RUN

The FX5-4AD-TC-ADP operates in accordance with its parameters.

■PAUSE

The FX5-4AD-TC-ADP operates in accordance with its parameters.

■STOP

The FX5-4AD-TC-ADP continues temperature conversion.

Alarm clear request

It is necessary to set the "conversion alarm clear request" from OFF to ON to clear the alarm code.

The table below shows the necessity of the alarm clear request for turning OFF each flag and clearing the alarm code.

Flag name	Alarm clear request required to turn OFF the flag	Alarm clear request required to clear the alarm code
Conversion completed flag	—	—
Maximum value/minimum value reset completed flag	—	—
Warning output flag (process alarm upper limit)	—	○
Warning output flag (process alarm lower limit)	—	○
Warning output flag (rate alarm upper limit)	—	○
Warning output flag (rate alarm lower limit)	—	○
Disconnection detection flag	○*1	○

*1 The alarm clear request is required when "disconnection detection automatic clear enable/disable setting" is set to "disable".

○: Requires the alarm clear request.

—: Does not require the alarm clear request.

Point

- The "conversion alarm clear request" is required for flags which do not turn OFF automatically and flags which cause alarms.
- "The "conversion alarm clear request" is not turned off automatically. To perform an alarm clear again, it is necessary to turn it OFF once.

4.4 Procedure to Execute the FX5-4AD-TC-ADP

The procedure to execute FX5-4AD-TC-ADP is described below.

1. Confirm the specifications of the FX5-4AD-TC-ADP.

Confirm the specifications of the FX5-4AD-TC-ADP. ( Page 164 Specifications)

2. Check the system configuration.

Check the system configuration. ( Page 188 System Configuration)

3. Attach the FX5-4AD-TC-ADP.

Refer to the following manuals for attachment to the CPU module:

 MELSEC iQ-F FX5UJ User's Manual (Hardware)

 MELSEC iQ-F FX5U User's Manual (Hardware)

 MELSEC iQ-F FX5UC User's Manual (Hardware)

When using two or more FX5-4DA-ADP or FX5-4A-ADP and connecting them next to FX5-4AD-TC-ADP, connect them to only one side of FX5-4AD-TC-ADP to satisfy the specification accuracy. Do not connect them to both sides.

Also, when using FX5-4DA-ADP and FX5-4A-ADP and connecting them next to FX5-4AD-TC-ADP, connect them to only one side of FX5-4AD-TC-ADP. Do not connect them to both sides.

4. Connect the FX5-4AD-TC-ADP to the external device.

Wiring to external devices. ( Page 189 Wiring)

5. Set the parameters.

Set the parameters to configure the FX5-4AD-TC-ADP. ( Page 192 Parameter Setting)

6. Create the program.

Create the program to use the FX5-4AD-TC-ADP.

7. Run the program.

Precautions

Do not write to the special relay/special register in the user interrupt program.

4.5 System Configuration

This section describes the system configuration including analog adapters.

Up to two analog adapters can be connected to an FX5UJ CPU module.

Up to four analog adapters can be connected to an FX5U/FX5UC CPU module.*¹

The connection position of the analog adapter connected to each CPU module are counted as the first module, the second module, and so on in order of proximity to the CPU module.

However, communication adapters are not counted towards the number of analog adapters.

■FX5UJ CPU module

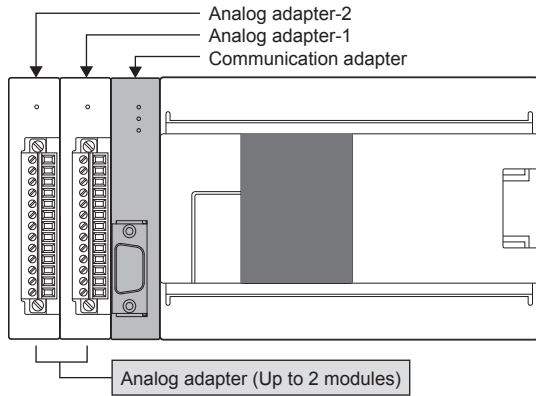

■FX5U CPU module

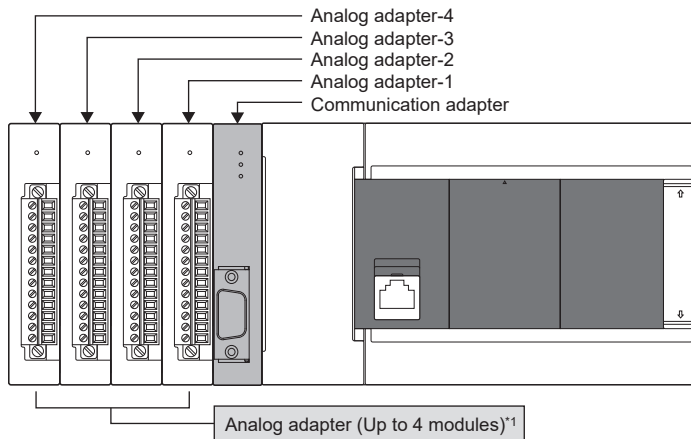

■FX5UC CPU module

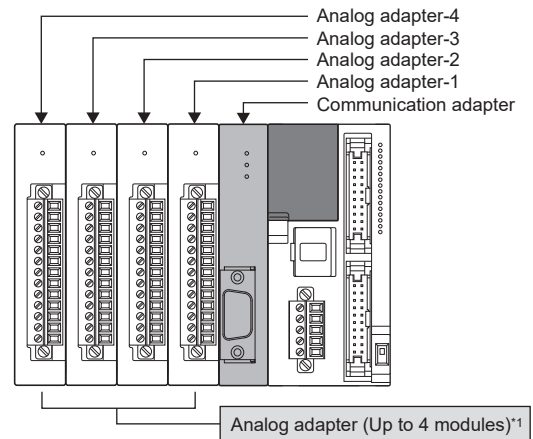

*¹ For FX5-4A-ADP, up to two modules can be connected.

4.6 Wiring

This section describes the wiring.

European-type terminal block

Wire the European-type terminal block in accordance with the following specifications.

Suitable wiring

Number of wires connected per terminal	Wire size		Tightening torque
	Solid wire, Stranded wire	Wire ferrule with insulation sleeve	
One wire	0.3 to 0.5 mm ² (AWG22 to 20)	0.3 to 0.5 mm ² (AWG22 to 20)	0.20 N·m
Two wires	0.3mm ² (AWG22)	—	

Precautions

Do not tighten terminal screws with torque exceeding the specified range. Failure to do so may cause equipment failures or malfunctions.

Wire end treatment

Treat stranded and solid wires as they are or use wire ferrules with insulation sleeves for wiring terminals.

■When stranded and solid wires are treated as they are

- Twist the end of stranded wires and make sure that there are no loose wires.
- Do not solder-plate the electric wire ends.

Stripping dimensions of electric wire ends

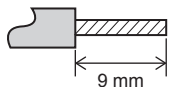

■When wire ferrules with insulation sleeves are used

Depending on the thickness of a wiring sheath used, it may be difficult to insert the sheath into an insulation sleeve. Refer to the external dimensions as a reference to select wires.

External dimension of wire ferrules with insulation sleeves

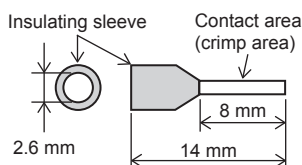

<Reference>

Manufacturer	Model	Crimp tool
Phoenix Contact GmbH & Co. KG	Al 0.5-8 WH	CRIMPFOX 6 CRIMPFOX 6T-F

■Tool

For tightening terminals, use a small, commercially-available screwdriver with a straight tip. The recommended shape is shown in the figure on the right.

■Precautions

When a precision screwdriver with a small grip is used, the specified tightening torque cannot be obtained. Use the following screwdriver or equivalent product (grip diameter: 25 mm) to obtain the tightening torque specified above.

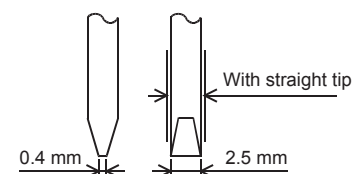

<Reference>

Manufacturer	Model
Phoenix Contact GmbH & Co. KG	SZS 0.4×2.5

Terminal layout

The following table shows the terminal layout.

Terminal block	Signal name	Function
	•	CH1
	L1+	Do not wire this terminal.
	L1-	Thermocouple + input
	•	Thermocouple - input
	L2+	CH2
	L2-	Do not wire this terminal.
	•	Thermocouple + input
	L3+	Thermocouple - input
	L3-	CH3
	•	Do not wire this terminal.
	L4+	Thermocouple + input
	L4-	Thermocouple - input
	•	CH4
	•	Do not wire this terminal.
	•	Do not wire this terminal.

Selection of the thermocouple

Thermocouple type

There are 6 types of thermocouples: K, J, T, B, R, and S type.
Use insulated thermocouple types.

Compensating lead wire

When the thermocouple is extended, use compensating lead wire that is suitable for the type.
The influence of wiring resistance of thermocouple and compensating lead wire is approximately $-0.083 \mu\text{V}/\Omega$.

Wiring of thermocouple

The following figures show wiring of the thermocouple.

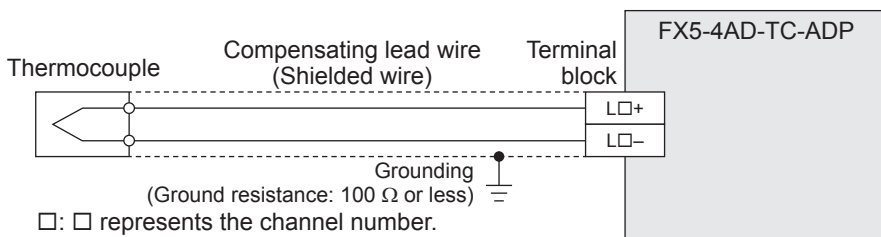

Point

Separate the cable of the resistance thermometer detector from other power cables or areas easily affected by inductive noise (from commercial power, etc.).

Grounding

Perform the following.

- Perform class D grounding (Grounding resistance: 100 Ω or less).
- Ground the PLC independently when possible.

If the PLC cannot be grounded independently, perform the "Shared grounding" shown below.

For the details, refer to the following manual.

📖 MELSEC iQ-F FX5UJ User's Manual (Hardware)

📖 MELSEC iQ-F FX5U User's Manual (Hardware)

📖 MELSEC iQ-F FX5UC User's Manual (Hardware)

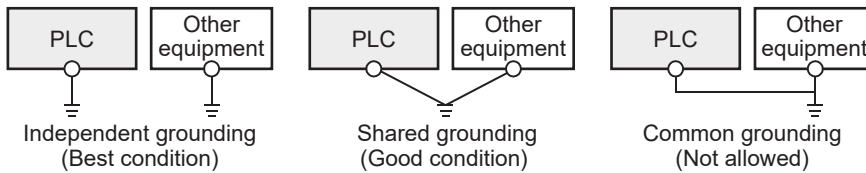

- Use a grounding wire with thickness of AWG 22 to 20 (0.3 to 0.5 mm²).
- Bring the grounding point close to the PLC as much as possible so that the ground cable can be shortened.

4.7 Parameter Setting

Set the parameters of each channel.

Setting parameters here eliminates the need to program them.

Point

Parameters are enabled when the CPU module is powered ON or after a reset. In addition, operations different from the parameter settings are possible by transferring values to special relays and special registers while changing these values in the program.

Refer to Page 199 List of Special Relays or Page 211 List of Special Registers for details on the special relays and special registers.

Basic settings

Setting procedure

Open "Basic Settings" of the GX Works3.

1. Start Module parameter.

Navigation window ⇒ [Parameter] ⇒ [Module Information] ⇒ Module model name ⇒ [Module Parameter] ⇒ "Basic Settings"

Window

Item	CH1	CH2	CH3	CH4
<input type="checkbox"/> Temperature unit selection function	Set the temperature unit selection function.			
Temperature unit setting	Celsius			
<input type="checkbox"/> Conversion enable/disable setting function	Set the Conversion enable/disable function.			
Conversion enable/disable setting	Disable	Disable	Disable	Disable
<input type="checkbox"/> Temperature conversion method	Set the temperature conversion method.			
Average Processing Specification	Sampling Processing	Sampling Processing	Sampling Processing	Sampling Processing
Time Average Counts Average Moving Average	0 Times	0 Times	0 Times	0 Times
<input type="checkbox"/> Thermocouple type selection function	Set the thermocouple type.			
Thermocouple type setting	K (-270 to 1370 C)	K (-270 to 1370 C)	K (-270 to 1370 C)	K (-270 to 1370 C)

Displayed items

Item	Description	Setting range	Default
Temperature unit setting	Set whether to use 'Celsius' or 'Fahrenheit' as the temperature unit.	<ul style="list-style-type: none"> Celsius Fahrenheit 	Celsius
Conversion enable/disable setting	Set whether to use 'Enable' or 'Disable' to output the converted for each channel.	<ul style="list-style-type: none"> Disable Enable 	Disable
Average Processing Specification	Execute whether to set "average process" or "sampling processing".	<ul style="list-style-type: none"> Sampling Processing Time Average Count Average Moving Average 	Sampling Processing
Time Average Counts Average Moving Average	Set average time, average counts, moving average counts for each channel.	Set range setting for each channel.	—
Thermocouple type setting	Set the thermocouple type to connect for each channel.	<ul style="list-style-type: none"> ■ Celsius <ul style="list-style-type: none"> K (-270 to 1370 °C) J (-210 to 1130 °C) T (-270 to 400 °C) B (0 to 1710 °C) R (-50 to 1710 °C) S (-50 to 1710 °C) ■ Fahrenheit <ul style="list-style-type: none"> K (-454 to 2498 °F) J (-346 to 2066 °F) T (-454 to 752 °F) B (32 to 3110 °F) R (-58 to 3110 °F) S (-58 to 3110 °F) 	—

2. Click the item to be changed to enter the setting value.

- Item where a value is selected from the pull-down list

Click [▼] button of the item to be set, and from the pull-down list that appears, select the value.

- Item where a value is entered into the text box

Double-click the item to be set to enter the numeric value.

Application settings

Setting procedure

Open "Application Settings" of the GX Works3.

1. Start Module parameter.

Navigation window ⇒ [Parameter] ⇒ [Module Information] ⇒ Module model name ⇒ [Module Parameter] ⇒ "Application Settings"

Window

Item	CH1	CH2	CH3	CH4
Warning output function (Process alarm)	Execute the setting related to A/D conversion warning.			
Warning output setting (Process alarm)	Disable	Disable	Disable	Disable
Process Alarm Upper Upper Limit Value	1200.0 C	1200.0 C	1200.0 C	1200.0 C
Process Alarm Upper Lower Limit Value	1200.0 C	1200.0 C	1200.0 C	1200.0 C
Process Alarm Lower Upper Limit Value	-200.0 C	-200.0 C	-200.0 C	-200.0 C
Process Alarm Lower Lower Limit Value	-200.0 C	-200.0 C	-200.0 C	-200.0 C
Warning output function (Rate alarm)	Execute the setting related to A/D conversion warning.			
Warning output setting (Rate alarm)	Disable	Disable	Disable	Disable
Rate alarm warning detection period setting	85 ms	85 ms	85 ms	85 ms
Rate alarm upper limit value	0.0 C	0.0 C	0.0 C	0.0 C
Rate alarm lower limit value	0.0 C	0.0 C	0.0 C	0.0 C
Disconnection detection function	Execute the setting related to disconnection detection.			
Disconnection detection enable/disable setting	Enable	Enable	Enable	Enable
Conversion setting for disconnection detection	Downscale	Downscale	Downscale	Downscale
Conversion setting function for disconnection detection	0.0 C	0.0 C	0.0 C	0.0 C
Enable/Disable setting for disconnection detection automatic clear	Disable	Disable	Disable	Disable

Displayed items

Item	Description	Setting range	Default
Warning output setting (Process alarm)	Set whether to "enable" or "disable" process alarm warning.	• Disable • Enable	Disable
Process Alarm Upper Upper Limit Value	Set upper upper limit value of measured temperature value	-3276.8 to +3276.7	—
Process Alarm Upper Lower Limit Value	Set upper lower limit value of measured temperature value.	-3276.8 to +3276.7	—
Process Alarm Lower Upper Limit Value	Set lower upper limit value of measured temperature value.	-3276.8 to +3276.7	—
Process Alarm Lower Lower Limit Value	Set lower lower limit value of measured temperature value.	-3276.8 to +3276.7	—
Warning output setting (rate alarm)	Set whether to "enable" or "disable" the rate alarm warning.	• Disable • Enable	Disable
Rate alarm warning detection period setting	Set the value for the sampling cycle to detect the rate alarm warning.	85 to 10000	—
Rate alarm upper limit value	Set the upper limit value of the measured temperature value.	-3276.8 to +3276.7	—
Rate alarm lower limit value	Set the lower limit value of the measured temperature value.	-3276.8 to +3276.7	—
Disconnection detection enable/disable setting	Set whether to "Enable" or "Disable" disconnection detection.	• Enable • Disable	Enable
Conversion setting for disconnection detection	In disconnection detection function, set the value to be converted detecting for each channel.	• Upscale • Downscale • Any value • Value before disconnection	Downscale
Conversion setting function for disconnection detection	Set the value to convert when 'Any value' is selected for conversion setting function for disconnection detection.	-3276.8 to +3276.7	—

Item	Description	Setting range	Default
Enable/Disable setting for disconnection detection automatic clear	Set whether to 'Enable' or 'Disable' the auto-clear of the disconnection detection for disconnection detection function.	<ul style="list-style-type: none"> • Enable • Disable 	Enable

2. Click the item to be changed to enter the setting value.

- Item where a value is selected from the pull-down list

Click [▼] button of the item to be set, and from the pull-down list that appears, select the value.

- Item where a value is entered into the text box

Double-click the item to be set to enter the numeric value.

4.8 Troubleshooting

This section describes errors that may occur in the use of the FX5-4AD-TC-ADP and those troubleshooting.

Troubleshooting with the LEDs

Check the state of the LED to narrow down the possible causes of the trouble. This step is the first diagnostics.

A state of the FX5-4AD-TC-ADP can be checked with the PWR LED. The following table shows the correspondence of LED and a state of the FX5-4AD-TC-ADP.

Name	Description
PWR LED	Indicates the power supply status of the FX5-4AD-TC-ADP. On: The power supply is supplied. Off: The power supply is not supplied.

Checking the state of the module

Open the module diagnostics window of the GX Works3 to check the error codes (alarm codes) and error history of the FX5-4AD-TC-ADP.

[Diagnostics] ⇒ [Module Diagnostics (CPU Diagnostics)]

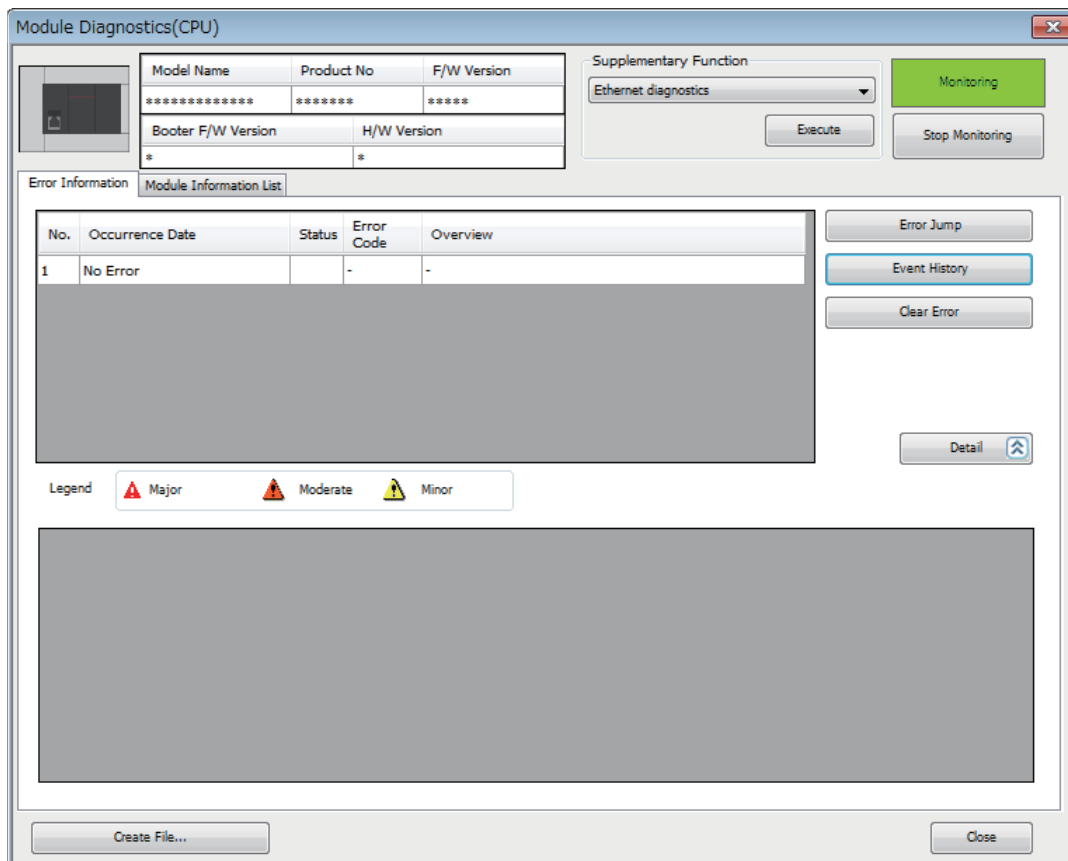

Error history, alarm history can be checked with the event history window of the GX Works3.

 [Diagnostics] ⇒ [Module Diagnostics (CPU Diagnostics)] ⇒ [Event History] button

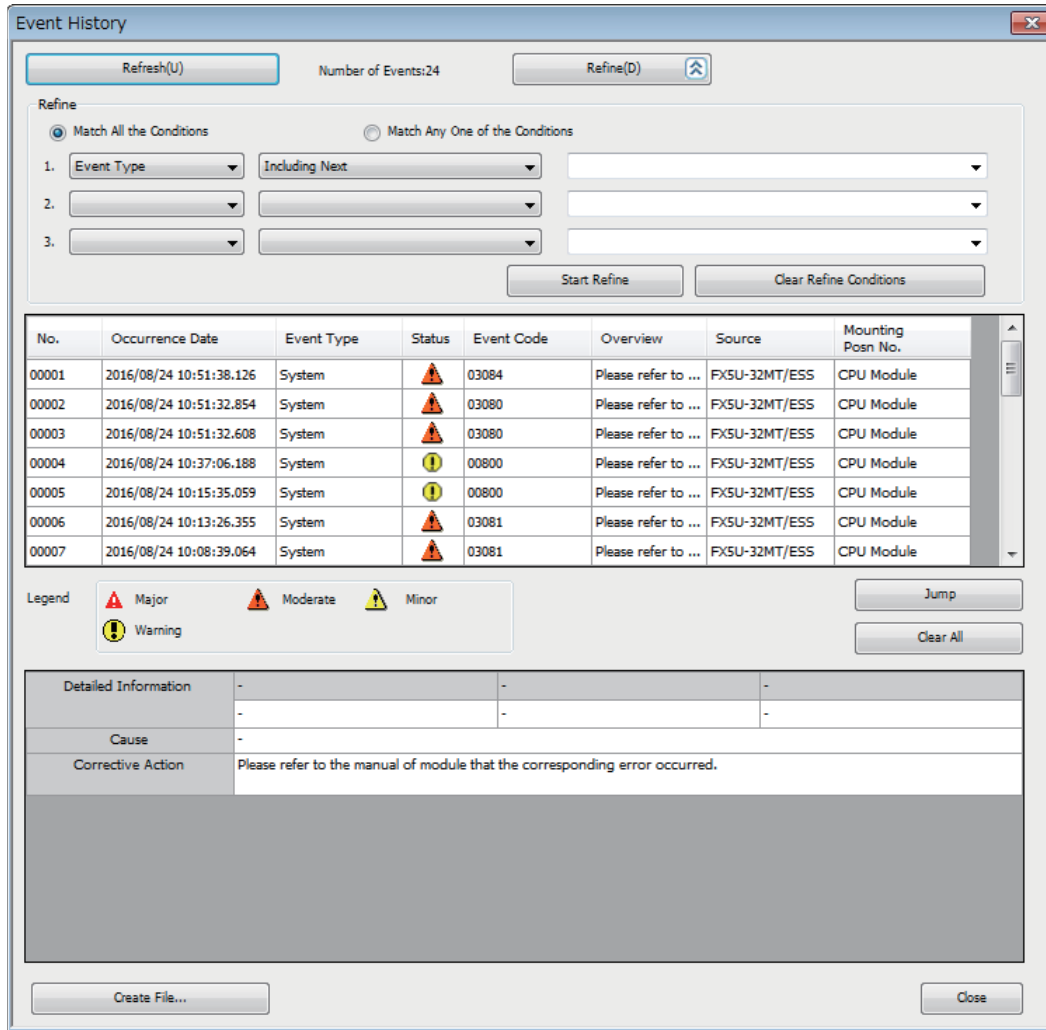

Event History

Refresh(U) Number of Events:24 Refine(D)

Refine







Match All the Conditions Match Any One of the Conditions

1. Event Type Including Next



2.

3.

Start Refine Clear Refine Conditions

No.	Occurrence Date	Event Type	Status	Event Code	Overview	Source	Mounting Posn No.
00001	2016/08/24 10:51:38.126	System		03084	Please refer to ...	FXSU-32MT/ESS	CPU Module
00002	2016/08/24 10:51:32.854	System		03080	Please refer to ...	FXSU-32MT/ESS	CPU Module
00003	2016/08/24 10:51:32.608	System		03080	Please refer to ...	FXSU-32MT/ESS	CPU Module
00004	2016/08/24 10:37:06.188	System		00800	Please refer to ...	FXSU-32MT/ESS	CPU Module
00005	2016/08/24 10:15:35.059	System		00800	Please refer to ...	FXSU-32MT/ESS	CPU Module
00006	2016/08/24 10:13:26.355	System		03081	Please refer to ...	FXSU-32MT/ESS	CPU Module
00007	2016/08/24 10:08:39.064	System		03081	Please refer to ...	FXSU-32MT/ESS	CPU Module

Legend

 Major  Moderate  Minor

 Warning

Jump

Clear All

Detailed Information - - -

Cause - - -

Corrective Action Please refer to the manual of module that the corresponding error occurred.

Create File... Close

Troubleshooting by Symptom

When the PWR LED does not turn ON

Check item	Action
Check whether the power is supplied.	Check whether the voltage supplied to the CPU module is within the rated range.
Whether the FX5-4AD-TC-ADP is attached normally to the CPU module.	Check the FX5-4AD-TC-ADP attachment status.

When a measured temperature value cannot be read

Check item	Action
Whether the analog signal cable is connected normally to the FX5-4AD-TC-ADP.	Check the signal cables visually, and wire the analog signal cable correctly.
Whether the external equipment is wired correctly.	Wire the external equipment correctly to the FX5-4AD-TC-ADP.
Whether the offset/gain is set correctly.	Check whether the offset/gain is set correctly. Check whether temperature conversion is executed correctly. When temperature conversion is executed correctly, set the offset/gain again.
Check whether the setting thermocouple type is correct.	Check the setting thermocouple type in the parameter setting of GX Works3. If the contents of setting are wrong, set the thermocouple type again.
Whether the "conversion enable/disable setting" is set to "enable" for the channel to be used.	Check the "Conversion enable/disable setting" for the channel to be used in the parameter setting of GX Works3, and set "enable" in the parameter of GX Works3 or in the program.

When the Measured temperature value does not change

Check item	Action
Whether disconnection is detected.	Remove the cause of disconnection by replacing the analog signal cable, etc., and then check the Measured temperature value.

When a value is not converted into the expected digital output value

Check item	Action
Check whether the setting thermocouple type is correct.	Check the setting thermocouple type in the parameter setting of GX Works3. If the contents of setting are wrong, set the thermocouple type again.
Check whether the offset/gain setting is correct.	Check whether the offset/gain is set correctly. Check whether temperature conversion is executed correctly. When temperature conversion is executed correctly, set the offset/gain again.
Whether the temperature conversion method is set correctly.	Check the temperature conversion method in the parameter setting of GX Works3. If the contents of setting are wrong, set the temperature conversion method again.

When the measured temperature value is dispersed

Check item	Action
Whether an temperature conversion method other than sampling processing is set.	Check the temperature conversion method in the parameter setting of GX Works3. Set the averaging processing to the temperature conversion method, and then check again for dispersion of the measured temperature value.

When the conversion completed flag does not turn ON

Check item	Action
Whether conversion is disabled in every channel.	Check the channels for which conversion is enabled in the parameter setting of GX Works3. If conversion is not enabled in any channel, enable conversion for 1 or more channels in the parameter of GX Works3 or in the program.
Whether disconnection is detected.	Remove the cause of disconnection by replacing the analog signal cable, etc., and then check the measured temperature value.

Point

If digital output values cannot be read even after the above actions are taken, the possible cause is a failure of the FX5-4AD-TC-ADP. Please consult your local Mitsubishi representative.

4.9 List of Error Code

The following table lists the error codes that may be stored.

□: This symbol indicates the number of the channel where a error has occurred. (1: CH1 to 4: CH4)

Error code	Error name	Description and cause	Action
0000H	—	There is no error.	—
1A0□H	Averaging process specification setting range error	A value other than 0 to 3 was set in CH□ average processing setting.	Reset CH□ the average processing setting to 0 to 3.
1A1□H	Average time setting range error	When the time average is set to CH□ average processing setting, a value other than 340 to 10000 was set to CH□ time average/count average/moving average settings.	Reset CH□ time average/count average/moving average setting to the following value. 340 to 10000
1A2□H	Average count setting range error When the count average is set to CH□	Averaging process specification, a value other than 4 to 4095 was set to CH□ time average/count average/moving average settings.	Reset CH□ time average/count average/moving average setting to the following value. 4 to 4095
1A3□H	Moving average count setting range error	When the moving average is set to CH□ average processing setting, the following value was set to CH□ moving average count setting. Value other than 2 to 64	Reset CH□ moving average process setting to the following value. 2 to 64
1A4□H	Process alarm upper-lower limit value setting range error	The value not meeting the following conditions was set to CH□ process alarm upper-upper limit value to CH□ process alarm lower-lower limit value. Upper-upper limit value ≥ Upper-lower limit value ≥ Lower-upper limit value ≥ Lower-lower limit value	Reset CH□ process alarm upper-upper limit value to CH□ process alarm lower-lower limit value to the value meeting the following conditions. Upper-upper limit value ≥ Upper-lower limit value ≥ Lower-upper limit value ≥ Lower-lower limit value
1A5□H	Rate alarm upper limit value/lower limit value setting inversion error	Lower limit value ≥ upper limit value was set to CH□ rate alarm upper limit value and CH□ rate alarm lower limit value.	Reset CH□ rate alarm upper limit value and CH□ rate alarm lower limit value to lower limit value < upper limit value.
1A6□H	Rate alarm warning detection period setting range error	A value other than 85 to 10000 was set to CH□ rate alarm warning detection period setting.	Reset the CH□ rate alarm warning detection period setting to the value within 85 to 10000.
1A8□H	Thermocouple type error	A value outside the range was set to the CH□ setting thermocouple type.	Reset the CH□ setting thermocouple type to the following value. 0 to 1
1AB□H	Conversion setting range error with disconnection detection enabled	A value outside the range was set to CH□ conversion setting for disconnection detection.	Set CH□ conversion setting for disconnection detection to the following value. 0 to 3
1AF□H	Offset/Gain setting write error	During CH□ write offset/gain or CH□ initialize offset/gain, CH□ conversion enable/disable setting was set to conversion enable.	Set CH□ conversion enable/disable setting to conversion disable and write CH□ offset/gain setting or initialize CH□ offset/gain setting.
1D0□H	Offset/Gain input value error	At the temperature conversion, the input offset value and input gain value do not satisfy the following condition. • Centigrade: Input gain value - input offset value > 0.1°C • Fahrenheit: Input gain value - input offset value > 0.3°F	At the temperature conversion, correct values so that the input offset value and input gain value satisfy the following condition. • Centigrade: Input gain value - input offset value > 0.1°C • Fahrenheit: Input gain value - input offset value > 0.3°F
1D1□H	Offset/Gain temperature setting value error	The set offset/gain temperature setting values are outside the ranges. Or the set offset/gain temperature setting values do not satisfy the following condition. • Centigrade: Gain temperature setting value - offset temperature setting value > 0.1°C • Fahrenheit: Gain temperature setting value - offset temperature setting value > 0.3°F	Correct values so that the offset/gain temperature setting values satisfy the following condition. • Centigrade: Gain temperature setting value - offset temperature setting value > 0.1°C • Fahrenheit: Gain temperature setting value - offset temperature setting value > 0.3°F
3080H	Analog ADP Hardware error	Hardware error of analog ADP was detected.	After resetting the CPU module, carry out RUN. If the same error is displayed again, there is a possibility of hardware error of the analog ADP. Consult the nearest Mitsubishi Electric representative.
3081H	Analog ADP Power failure	The power is not supplied normally.	Confirm if the power is supplied properly.

Error code	Error name	Description and cause	Action
3082H	Analog ADP Memory Error	Read error or damaged EEPROM.	After resetting the CPU module, carry out RUN. If the same error is displayed again, there is a possibility of damaged EEPROM. Consult the nearest Mitsubishi Electric representative.
3083H	Analog ADP Memory Error	There is some offset/gain data defect or setting defect in EEPROM.	After offset/gain initialization of the analog ADP is finished, set the data by offset/gain settings again.
3084H	Analog ADP Communication error	Communication error occurred between the analog ADP and the CPU module.	Confirm if ADP is connected properly to the CPU module. If not improved, consult the nearest Mitsubishi Electric representative.

4.10 List of Alarm Code

The following table shows the list of the alarm codes stored.

□: This symbol indicates the number of the channel where an alarm has occurred. (1: CH1 to 4: CH4)

Alarm code	Alarm name	Description and cause	Action
0000H	—	There is no error.	—
080□H	Process alarm (upper limit)	The process alarm (upper limit) has occurred in CH□.	When the CH□ measured temperature value returns from the alarm output range, the alarm code automatically changes to "0: Normal".
081□H	Process alarm (lower limit)	The process alarm (lower limit) has occurred in CH□.	
082□H	Rate alarm (upper limit)	The rate alarm (upper limit) has occurred in CH□.	When the change of CH□ measured temperature value from the previous value returns to the setting range, the alarm code automatically changes to "0: Normal".
083□H	Rate alarm (lower limit)	The rate alarm (lower limit) has occurred in CH□.	
0A0□H	Disconnection detection	Disconnection is detected in the CH□.	When the conversion alarm clear request is set to ON after the CH□ is recovered from disconnection, all CH□ disconnection detection flag become "0: Normal", and the alarm code stored in the "conversion latest alarm code" is cleared.
0C0□H	Offset/gain reading thermocouple type mismatch	The saved offset/gain thermocouple type is different from the currently set thermocouple type.	Change the currently set thermocouple type to the thermocouple type selected when the offset/gain was written, and then read the offset/gain.
0E0□H	Thermocouple type change alarm during offset/gain writing or offset/gain initialization	The thermocouple type was changed during offset/gain writing or offset/gain initialization.	Wait until offset/gain writing or offset/gain initialization is finished, and then change the thermocouple type.
0E1□H	Offset/gain initialization execution alarm	Offset/gain initialization was executed during offset/gain writing.	Wait until offset/gain writing is finished, and then initialize the offset/gain.
0E2□H	Offset/gain writing execution alarm	Offset/gain writing was executed during offset/gain initialization.	Wait until offset/gain initialization is finished, and then write the offset/gain.
0E3□H	Analog ADP memory access alarm	Offset/gain writing, offset/gain reading or offset/gain initialization was executed while the analog ADP memory error (Error code: 3082H) was detected. Or offset reading was executed while the analog ADP memory error (Error code: 3083H) was detected.	Reset the CPU module.
0F0□H	Setting change alarm	Special relays/registers for analog are changed while conversion is enabled.	Change the setting of special relays/registers while conversion is disabled.

4.11 List of Special Relays

The special relays are shown below.

1st analog expansion adapter

The special relays list for the 1st FX5-4AD-TC-ADP module is shown below.

Special relays				Name	Reference
CH1	CH2	CH3	CH4		
SM6280				Temperature unit selection	Page 203
SM6300	SM6340	SM6380	SM6420	Conversion completed flag	Page 203
SM6301	SM6341	SM6381	SM6421	Conversion enable/disable setting	Page 203
SM6305	SM6345	SM6385	SM6425	Maximum value/minimum value reset completed flag	Page 204
SM6306	SM6346	SM6386	SM6426	Maximum value reset request	Page 204
SM6307	SM6347	SM6387	SM6427	Minimum value reset request	Page 205
SM6311	SM6351	SM6391	SM6431	Warning output flag (process alarm upper limit)	Page 205
SM6312	SM6352	SM6392	SM6432	Warning output flag (process alarm lower limit)	Page 205
SM6313	SM6353	SM6393	SM6433	Warning output setting (process alarm)	Page 206
SM6315	SM6355	SM6395	SM6435	Warning output flag (rate alarm upper limit)	Page 206
SM6316	SM6356	SM6396	SM6436	Warning output flag (rate alarm lower limit)	Page 206
SM6317	SM6357	SM6397	SM6437	Warning output setting (rate alarm)	Page 207
SM6318	SM6358	SM6398	SM6438	Disconnection detection flag	Page 207
SM6319	SM6359	SM6399	SM6439	Disconnection detection enable/disable setting	Page 207
SM6320	SM6360	SM6400	SM6440	Disconnection detection automatic clear enable/disable setting	Page 208
SM6331	SM6371	SM6411	SM6451	Offset/gain setting flag	Page 208
SM6332	SM6372	SM6412	SM6452	Read offset/gain	Page 208
SM6333	SM6373	SM6413	SM6453	Write offset/gain	Page 209
SM6334	SM6374	SM6414	SM6454	Initialize offset/gain	Page 209
SM6337	SM6377	SM6417	SM6457	Conversion alarm clear request	Page 209
SM6338	SM6378	SM6418	SM6458	Conversion alarm flag	Page 210
SM6339	SM6379	SM6419	SM6459	Conversion error flag	Page 210

2nd analog expansion adapter

The special relays list for the 2nd FX5-4AD-TC-ADP module is shown below.

Special relays				Name	Reference
CH1	CH2	CH3	CH4		
SM6640				Temperature unit selection	Page 203
SM6660	SM6700	SM6740	SM6780	Conversion completed flag	Page 203
SM6661	SM6701	SM6741	SM6781	Conversion enable/disable setting	Page 203
SM6665	SM6705	SM6745	SM6785	Maximum value/minimum value reset completed flag	Page 204
SM6666	SM6706	SM6746	SM6786	Maximum value reset request	Page 204
SM6667	SM6707	SM6747	SM6787	Minimum value reset request	Page 205
SM6671	SM6711	SM6751	SM6791	Warning output flag (process alarm upper limit)	Page 205
SM6672	SM6712	SM6752	SM6792	Warning output flag (process alarm lower limit)	Page 205
SM6673	SM6713	SM6753	SM6793	Warning output setting (process alarm)	Page 206
SM6675	SM6715	SM6755	SM6795	Warning output flag (rate alarm upper limit)	Page 206
SM6676	SM6716	SM6756	SM6796	Warning output flag (rate alarm lower limit)	Page 206
SM6677	SM6717	SM6757	SM6797	Warning output setting (rate alarm)	Page 207
SM6678	SM6718	SM6758	SM6798	Disconnection detection flag	Page 207
SM6679	SM6719	SM6759	SM6799	Disconnection detection enable/disable setting	Page 207
SM6680	SM6720	SM6760	SM6800	Disconnection detection automatic clear enable/disable setting	Page 208
SM6691	SM6731	SM6771	SM6811	Offset/gain setting flag	Page 208
SM6692	SM6732	SM6772	SM6812	Read offset/gain	Page 208
SM6693	SM6733	SM6773	SM6813	Write offset/gain	Page 209
SM6694	SM6734	SM6774	SM6814	Initialize offset/gain	Page 209
SM6697	SM6737	SM6777	SM6817	Conversion alarm clear request	Page 209
SM6698	SM6738	SM6778	SM6818	Conversion alarm flag	Page 210
SM6699	SM6739	SM6779	SM6819	Conversion error flag	Page 210

3rd analog expansion adapter

The special relays list for the 3rd FX5-4AD-TC-ADP module is shown below.

Special relays				Name	Reference
CH1	CH2	CH3	CH4		
SM7000				Temperature unit selection	Page 203
SM7020	SM7060	SM7100	SM7140	Conversion completed flag	Page 203
SM7021	SM7061	SM7101	SM7141	Conversion enable/disable setting	Page 203
SM7025	SM7065	SM7105	SM7145	Maximum value/minimum value reset completed flag	Page 204
SM7026	SM7066	SM7106	SM7146	Maximum value reset request	Page 204
SM7027	SM7067	SM7107	SM7147	Minimum value reset request	Page 205
SM7031	SM7071	SM7111	SM7151	Warning output flag (process alarm upper limit)	Page 205
SM7032	SM7072	SM7112	SM7152	Warning output flag (process alarm lower limit)	Page 205
SM7033	SM7073	SM7113	SM7153	Warning output setting (process alarm)	Page 206
SM7035	SM7075	SM7115	SM7155	Warning output flag (rate alarm upper limit)	Page 206
SM7036	SM7076	SM7116	SM7156	Warning output flag (rate alarm lower limit)	Page 206
SM7037	SM7077	SM7117	SM7157	Warning output setting (rate alarm)	Page 207
SM7038	SM7078	SM7118	SM7158	Disconnection detection flag	Page 207
SM7039	SM7079	SM7119	SM7159	Disconnection detection enable/disable setting	Page 207
SM7040	SM7080	SM7120	SM7160	Disconnection detection automatic clear enable/disable setting	Page 208
SM7051	SM7091	SM7131	SM7171	Offset/gain setting flag	Page 208
SM7052	SM7092	SM7132	SM7172	Read offset/gain	Page 208
SM7053	SM7093	SM7133	SM7173	Write offset/gain	Page 209
SM7054	SM7094	SM7134	SM7174	Initialize offset/gain	Page 209
SM7057	SM7097	SM7137	SM7177	Conversion alarm clear request	Page 209
SM7058	SM7098	SM7138	SM7178	Conversion alarm flag	Page 210
SM7059	SM7099	SM7139	SM7179	Conversion error flag	Page 210

4th analog expansion adapter

The special relays list for the 4th FX5-4AD-TC-ADP module is shown below.

Special relays				Name	Reference
CH1	CH2	CH3	CH4		
SM7360				Temperature unit selection	Page 203
SM7380	SM7420	SM7460	SM7500	Conversion completed flag	Page 203
SM7381	SM7421	SM7461	SM7501	Conversion enable/disable setting	Page 203
SM7385	SM7425	SM7465	SM7505	Maximum value/minimum value reset completed flag	Page 204
SM7386	SM7426	SM7466	SM7506	Maximum value reset request	Page 204
SM7387	SM7427	SM7467	SM7507	Minimum value reset request	Page 205
SM7391	SM7431	SM7471	SM7511	Warning output flag (process alarm upper limit)	Page 205
SM7392	SM7432	SM7472	SM7512	Warning output flag (process alarm lower limit)	Page 205
SM7393	SM7433	SM7473	SM7513	Warning output setting (process alarm)	Page 206
SM7395	SM7435	SM7475	SM7515	Warning output flag (rate alarm upper limit)	Page 206
SM7396	SM7436	SM7476	SM7516	Warning output flag (rate alarm lower limit)	Page 206
SM7397	SM7437	SM7477	SM7517	Warning output setting (rate alarm)	Page 207
SM7398	SM7438	SM7478	SM7518	Disconnection detection flag	Page 207
SM7399	SM7439	SM7479	SM7519	Disconnection detection enable/disable setting	Page 207
SM7400	SM7440	SM7480	SM7520	Disconnection detection automatic clear enable/disable setting	Page 208
SM7411	SM7451	SM7491	SM7531	Offset/gain setting flag	Page 208
SM7412	SM7452	SM7492	SM7532	Read offset/gain	Page 208
SM7413	SM7453	SM7493	SM7533	Write offset/gain	Page 209
SM7414	SM7454	SM7494	SM7534	Initialize offset/gain	Page 209
SM7417	SM7457	SM7497	SM7537	Conversion alarm clear request	Page 209
SM7418	SM7458	SM7498	SM7538	Conversion alarm flag	Page 210
SM7419	SM7459	SM7499	SM7539	Conversion error flag	Page 210

4.12 Detail of Special Relays

This section explains the details of special relays. Only the FX5U/FX5UC CPU module supports the special relays of the third and fourth modules.

R: Read only, R/W: Read/Write

Temperature unit selection

Set the desired temperature unit.

Monitor value	Display description	Default value	R/W
0: OFF	Centigrade (°C)	0: OFF	R/W
1: ON	Fahrenheit (°F)		

For details temperature unit choice function, refer to the following.

 Page 168 Temperature Unit Choice Function

Name	Connection part	Special relay
Temperature unit selection	1st adapter	SM6280
	2nd adapter	SM6640
	3rd adapter	SM7000
	4th adapter	SM7360

Conversion completed flag

This flag monitors the temperature conversion status.

Monitor value	Display description	Default value	R/W
0: OFF	It turns OFF during the disable of an temperature conversion, and an temperature conversion.	0: OFF	R
1: ON	In the state of conversion enable, if an temperature conversion is completed, it turns ON.		

Name	Connection part	Special relay			
		CH1	CH2	CH3	CH4
Conversion completed flag	1st adapter	SM6300	SM6340	SM6380	SM6420
	2nd adapter	SM6660	SM6700	SM6740	SM6780
	3rd adapter	SM7020	SM7060	SM7100	SM7140
	4th adapter	SM7380	SM7420	SM7460	SM7500

Conversion enable/disable setting

Set whether to enable or disable temperature conversion.

Monitor value	Display description	Default value	R/W
0: OFF	Temperature conversion enable	1: ON	R/W
1: ON	Temperature conversion disable		

For details conversion enable/disable function, refer to the following.

 Page 168 Conversion Enable/Disable Setting Function

Name	Connection part	Special relay			
		CH1	CH2	CH3	CH4
Conversion enable/disable setting	1st adapter	SM6301	SM6341	SM6381	SM6421
	2nd adapter	SM6661	SM6701	SM6741	SM6781
	3rd adapter	SM7021	SM7061	SM7101	SM7141
	4th adapter	SM7381	SM7421	SM7461	SM7501

Maximum value/minimum value reset completed flag

This flag monitors the "maximum value/minimum value" reset status.

When the "maximum value reset request" or "minimum value reset request" is set from OFF to ON and then the value stored in the "maximum value" or "minimum value" is reset, the "maximum value/minimum value reset completed flag" turns ON.

Monitor value	Display description	Default value	R/W
0: OFF	Reset is not completed	0: OFF	R
1: ON	Reset is completed		

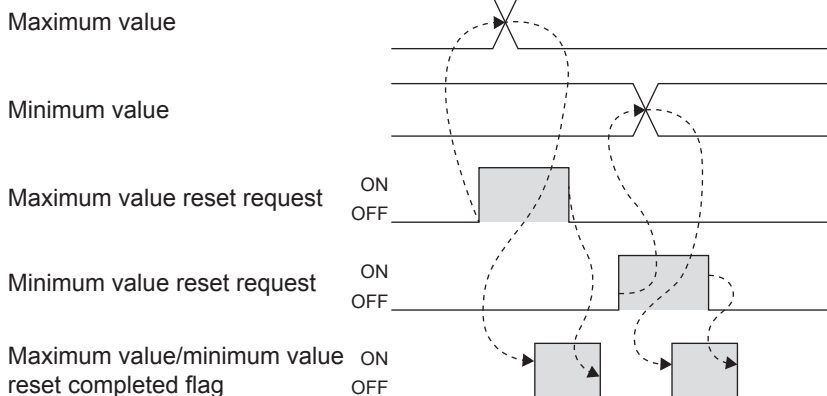

Name	Connection part	Special relay			
		CH1	CH2	CH3	CH4
Maximum value/minimum value reset completed flag	1st adapter	SM6305	SM6345	SM6385	SM6425
	2nd adapter	SM6665	SM6705	SM6745	SM6785
	3rd adapter	SM7025	SM7065	SM7105	SM7145
	4th adapter	SM7385	SM7425	SM7465	SM7505

Maximum value reset request

When the "maximum value reset request" is set from OFF to ON, the maximum value is updated to the "measured temperature value".

Monitor value	Display description	Default value	R/W
0: OFF	No maximum value reset request	0: OFF	R/W
1: ON	Maximum value reset request		

For the timing of turning the signal on and off, refer to the following.

☞ Page 204 Maximum value/minimum value reset completed flag

Name	Connection part	Special relay			
		CH1	CH2	CH3	CH4
Maximum value reset request	1st adapter	SM6306	SM6346	SM6386	SM6426
	2nd adapter	SM6666	SM6706	SM6746	SM6786
	3rd adapter	SM7026	SM7066	SM7106	SM7146
	4th adapter	SM7386	SM7426	SM7466	SM7506

Minimum value reset request

When the "minimum value reset request" is set from OFF to ON, the minimum value is updated to the "measured temperature value".

Monitor value	Display description	Default value	R/W
0: OFF	No minimum value reset request	0: OFF	R/W
1: ON	Maximum value reset request		

For the timing of turning the signal on and off, refer to the following.

☞ Page 204 Maximum value/minimum value reset completed flag

Name	Connection part	Special relay			
		CH1	CH2	CH3	CH4
Minimum value reset request	1st adapter	SM6307	SM6347	SM6387	SM6427
	2nd adapter	SM6667	SM6707	SM6747	SM6787
	3rd adapter	SM7027	SM7067	SM7107	SM7147
	4th adapter	SM7387	SM7427	SM7467	SM7507

4

Warning output flag (process alarm upper limit)

This flag monitors the upper limit value alarm in the process alarm.

Monitor value	Display description	Default value	R/W
0: OFF	Normal	0: OFF	R
1: ON	Process alarm upper limit detection		

For details alarm output function, refer to the following.

☞ Page 174 Process alarm

Name	Connection part	Special relay			
		CH1	CH2	CH3	CH4
Warning output flag (process alarm upper limit)	1st adapter	SM6311	SM6351	SM6391	SM6431
	2nd adapter	SM6671	SM6711	SM6751	SM6791
	3rd adapter	SM7031	SM7071	SM7111	SM7151
	4th adapter	SM7391	SM7431	SM7471	SM7511

Warning output flag (process alarm lower limit)

This flag monitors the lower limit value alarm in the process alarm.

Monitor value	Display description	Default value	R/W
0: OFF	Normal	0: OFF	R
1: ON	Process alarm lower limit detection		

For details alarm output function, refer to the following.

☞ Page 174 Process alarm

Name	Connection part	Special relay			
		CH1	CH2	CH3	CH4
Warning output flag (process alarm lower limit)	1st adapter	SM6312	SM6352	SM6392	SM6432
	2nd adapter	SM6672	SM6712	SM6752	SM6792
	3rd adapter	SM7032	SM7072	SM7112	SM7152
	4th adapter	SM7392	SM7432	SM7472	SM7512

Warning output setting (process alarm)

Set whether to enable or disable the alarm output of process alarm.

Monitor value	Display description	Default value	R/W
0: OFF	Warning output of process alarm enable	1: ON	R/W
1: ON	Warning output of process alarm disable		

For details alarm output function, refer to the following.

 Page 174 Process alarm

Name	Connection part	Special relay			
		CH1	CH2	CH3	CH4
Warning output setting (process alarm)	1st adapter	SM6313	SM6353	SM6393	SM6433
	2nd adapter	SM6673	SM6713	SM6753	SM6793
	3rd adapter	SM7033	SM7073	SM7113	SM7153
	4th adapter	SM7393	SM7433	SM7473	SM7513

Warning output flag (rate alarm upper limit)

This flag monitors the upper limit value alarm in the rate alarm.

Monitor value	Display description	Default value	R/W
0: OFF	Normal	0: OFF	R
1: ON	Rate alarm upper limit detection		

For details alarm output function, refer to the following.

 Page 176 Rate alarm

Name	Connection part	Special relay			
		CH1	CH2	CH3	CH4
Warning output flag (rate alarm upper limit)	1st adapter	SM6315	SM6355	SM6395	SM6435
	2nd adapter	SM6675	SM6715	SM6755	SM6795
	3rd adapter	SM7035	SM7075	SM7115	SM7155
	4th adapter	SM7395	SM7435	SM7475	SM7515

Warning output flag (rate alarm lower limit)

This flag monitors the lower limit value alarm in the rate alarm.

Monitor value	Display description	Default value	R/W
0: OFF	Normal	0: OFF	R
1: ON	Rate alarm lower limit detection		

For details alarm output function, refer to the following.

 Page 176 Rate alarm

Name	Connection part	Special relay			
		CH1	CH2	CH3	CH4
Warning output flag (rate alarm lower limit)	1st adapter	SM6316	SM6356	SM6396	SM6436
	2nd adapter	SM6676	SM6716	SM6756	SM6796
	3rd adapter	SM7036	SM7076	SM7116	SM7156
	4th adapter	SM7396	SM7436	SM7476	SM7516

Warning output setting (rate alarm)

Set whether to enable or disable the alarm output of rate alarm.

Monitor value	Display description	Default value	R/W
0: OFF	Warning output of rate alarm enable	1: ON	R/W
1: ON	Warning output of rate alarm disable		

For details alarm output function, refer to the following.

 Page 176 Rate alarm

Name	Connection part	Special relay			
		CH1	CH2	CH3	CH4
Warning output setting (rate alarm)	1st adapter	SM6317	SM6357	SM6397	SM6437
	2nd adapter	SM6677	SM6717	SM6757	SM6797
	3rd adapter	SM7037	SM7077	SM7117	SM7157
	4th adapter	SM7397	SM7437	SM7477	SM7517

4

Disconnection detection flag

This flag monitors the disconnection detection.

Monitor value	Display description	Default value	R/W
0: OFF	Normal	0: OFF	R
1: ON	Disconnection detection		

For details disconnection detection function, refer to the following.

 Page 172 Disconnection Detection Function

Name	Connection part	Special relay			
		CH1	CH2	CH3	CH4
Disconnection detection flag	1st adapter	SM6318	SM6358	SM6398	SM6438
	2nd adapter	SM6678	SM6718	SM6758	SM6798
	3rd adapter	SM7038	SM7078	SM7118	SM7158
	4th adapter	SM7398	SM7438	SM7478	SM7518

Disconnection detection enable/disable setting

Set whether to enable or disable the disconnection detection function.

Monitor value	Display description	Default value	R/W
0: OFF	Disconnection detection enable	0: OFF	R/W
1: ON	Disconnection detection disable		

For details disconnection detection function, refer to the following.

 Page 172 Disconnection Detection Function

Name	Connection part	Special relay			
		CH1	CH2	CH3	CH4
Disconnection detection enable/disable setting	1st adapter	SM6319	SM6359	SM6399	SM6439
	2nd adapter	SM6679	SM6719	SM6759	SM6799
	3rd adapter	SM7039	SM7079	SM7119	SM7159
	4th adapter	SM7399	SM7439	SM7479	SM7519

Disconnection detection automatic clear enable/disable setting

Set whether to enable or disable the disconnection detection automatic clear.

Monitor value	Display description	Default value	R/W
0: OFF	Disconnection recovery detection enable	1: ON	R/W
1: ON	Disconnection recovery detection disable		

For details disconnection detection function, refer to the following.

 Page 172 Disconnection Detection Function

Name	Connection part	Special relay			
		CH1	CH2	CH3	CH4
Disconnection detection automatic clear enable/disable setting	1st adapter	SM6320	SM6360	SM6400	SM6440
	2nd adapter	SM6680	SM6720	SM6760	SM6800
	3rd adapter	SM7040	SM7080	SM7120	SM7160
	4th adapter	SM7400	SM7440	SM7480	SM7520

Offset/gain setting flag

The offset/gain setting used for each channel is monitored.

Monitor value	Display description	Default value	R/W
0: OFF	Initial value	0: OFF	R
1: ON	User range setting		

For details offset/gain setting, refer to the following

 Page 180 Offset/gain Setting Function

Name	Connection part	Special relay			
		CH1	CH2	CH3	CH4
Offset/gain setting flag	1st adapter	SM6331	SM6371	SM6411	SM6451
	2nd adapter	SM6691	SM6731	SM6771	SM6811
	3rd adapter	SM7051	SM7091	SM7131	SM7171
	4th adapter	SM7411	SM7451	SM7491	SM7531

Read offset/gain

An offset/gain setting value is read.

Monitor value	Display description	Default value	R/W
0: OFF	Offset/gain reading is not performed.	0: OFF	R/W
1: ON	Offset/gain reading is performed.		

For details offset/gain setting, refer to the following.

 Page 180 Offset/gain Setting Function

Name	Connection part	Special relay			
		CH1	CH2	CH3	CH4
Read offset/gain	1st adapter	SM6332	SM6372	SM6412	SM6452
	2nd adapter	SM6692	SM6732	SM6772	SM6812
	3rd adapter	SM7052	SM7092	SM7132	SM7172
	4th adapter	SM7412	SM7452	SM7492	SM7532

Write offset/gain

An offset/gain setting value is written in.

Monitor value	Display description	Default value	R/W
0: OFF	Offset/gain writing is not performed.	0: OFF	R/W
1: ON	Offset/gain writing is performed.		

For details offset/gain setting, refer to the following.

 Page 180 Offset/gain Setting Function

Name	Connection part	Special relay			
		CH1	CH2	CH3	CH4
Write offset/gain	1st adapter	SM6333	SM6373	SM6413	SM6453
	2nd adapter	SM6693	SM6733	SM6773	SM6813
	3rd adapter	SM7053	SM7093	SM7133	SM7173
	4th adapter	SM7413	SM7453	SM7493	SM7533

4

Initialize offset/gain

An offset/gain setting value is initialized.

Monitor value	Display description	Default value	R/W
0: OFF	Offset/gain initialization is not performed.	0: OFF	R/W
1: ON	Offset/gain initialization is performed.		

For details offset/gain initialization, refer to the following.

 Page 184 Offset/gain Initialization Function

Name	Connection part	Special relay			
		CH1	CH2	CH3	CH4
Initialize offset/gain	1st adapter	SM6334	SM6374	SM6414	SM6454
	2nd adapter	SM6694	SM6734	SM6774	SM6814
	3rd adapter	SM7054	SM7094	SM7134	SM7174
	4th adapter	SM7414	SM7454	SM7494	SM7534

Conversion alarm clear request

An conversion alarm clear request is performed.

Monitor value	Display description	Default value	R/W
0: OFF	With no conversion alarm clear request.	0: OFF	R/W
1: ON	Those with an conversion alarm clear request.		

For details conversion alarm clear request, refer to the following.

 Page 186 Alarm clear request

Name	Connection part	Special relay			
		CH1	CH2	CH3	CH4
Conversion alarm clear request	1st adapter	SM6337	SM6377	SM6417	SM6457
	2nd adapter	SM6697	SM6737	SM6777	SM6817
	3rd adapter	SM7057	SM7097	SM7137	SM7177
	4th adapter	SM7417	SM7457	SM7497	SM7537

Conversion alarm flag

"Conversion alarm flag" turns on when an alarm occurs.

Monitor value	Display description	Default value	R/W
0: OFF	Normal	0: OFF	R
1: ON	Conversion alarm occur		

To turn OFF the "conversion alarm flag" and clear the "conversion latest alarm code", set the "conversion alarm clear request" from OFF to ON.

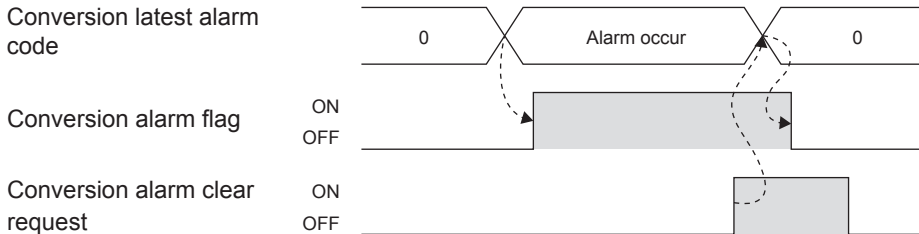

Name	Connection part	Special relay			
		CH1	CH2	CH3	CH4
Conversion alarm flag	1st adapter	SM6338	SM6378	SM6418	SM6458
	2nd adapter	SM6698	SM6738	SM6778	SM6818
	3rd adapter	SM7058	SM7098	SM7138	SM7178
	4th adapter	SM7418	SM7458	SM7498	SM7538

Conversion error flag

"Conversion error flag" turns on when an error occurs.

Monitor value	Display description	Default value	R/W
0: OFF	Normal	0: OFF	R
1: ON	Conversion error occur		

To turn OFF the "conversion error flag", set the "error clear request" (SM50) of the CPU module from OFF to ON.

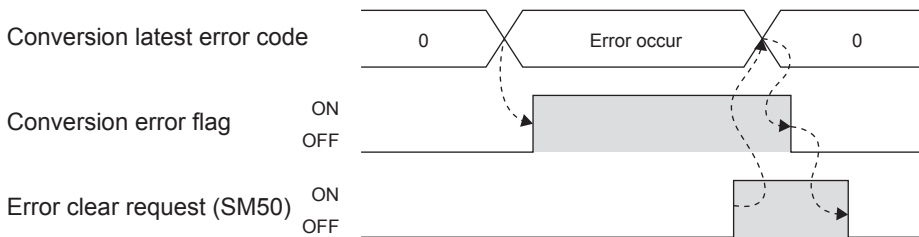

Name	Connection part	Special relay			
		CH1	CH2	CH3	CH4
Conversion error flag	1st adapter	SM6339	SM6379	SM6419	SM6459
	2nd adapter	SM6699	SM6739	SM6779	SM6819
	3rd adapter	SM7059	SM7099	SM7139	SM7179
	4th adapter	SM7419	SM7459	SM7499	SM7539

4.13 List of Special Registers

The special registers are shown below.

1st analog expansion adapter

The special registers list for the 1st FX5-4AD-TC-ADP module is shown below.

Special registers				Name	Reference
CH1	CH2	CH3	CH4		
SD6280				Module Information	Page 215
SD6300	SD6340	SD6380	SD6420	Measured temperature value	Page 215
SD6303	SD6343	SD6383	SD6423	Average processing setting	Page 216
SD6304	SD6344	SD6384	SD6424	Time average/count average/moving average	Page 216
SD6305	SD6345	SD6385	SD6425	Setting thermocouple type	Page 217
SD6306	SD6346	SD6386	SD6426	Maximum value	Page 217
SD6307	SD6347	SD6387	SD6427	Minimum value	Page 218
SD6311	SD6351	SD6391	SD6431	Process alarm upper upper limit value	Page 218
SD6312	SD6352	SD6392	SD6432	Process alarm upper lower limit value	Page 219
SD6313	SD6353	SD6393	SD6433	Process alarm lower upper limit value	Page 219
SD6314	SD6354	SD6394	SD6434	Process alarm lower lower limit value	Page 220
SD6315	SD6355	SD6395	SD6435	Rate alarm upper limit value	Page 220
SD6316	SD6356	SD6396	SD6436	Rate alarm lower limit value	Page 221
SD6317	SD6357	SD6397	SD6437	Rate alarm detection cycle setting	Page 221
SD6318	SD6358	SD6398	SD6438	Conversion setting for disconnection detection	Page 222
SD6319	SD6359	SD6399	SD6439	Conversion setting value for disconnection detection	Page 223
SD6327	SD6367	SD6407	SD6447	Offset temperature setting value	Page 223
SD6328	SD6368	SD6408	SD6448	Gain temperature setting value	Page 224
SD6329	SD6369	SD6409	SD6449	Offset/gain code	Page 224
SD6330	SD6370	SD6410	SD6450	Thermal EMF offset value (L)	Page 225
SD6331	SD6371	SD6411	SD6451	Thermal EMF offset value (H)	
SD6332	SD6372	SD6412	SD6452	Thermal EMF gain value (L)	Page 225
SD6333	SD6373	SD6413	SD6453	Thermal EMF gain value (H)	
SD6334	SD6374	SD6414	SD6454	Input offset value (L)	Page 226
SD6335	SD6375	SD6415	SD6455	Input offset value (H)	
SD6336	SD6376	SD6416	SD6456	Input gain value (L)	Page 226
SD6337	SD6377	SD6417	SD6457	Input gain value (H)	
SD6338	SD6378	SD6418	SD6458	Conversion latest alarm code	Page 227
SD6339	SD6379	SD6419	SD6459	Conversion latest error code	Page 227

2nd analog expansion adapter

The special registers list for the 2nd FX5-4AD-TC-ADP module is shown below.

Special registers				Name	Reference
CH1	CH2	CH3	CH4		
SD6640				Module Information	Page 215
SD6660	SD6700	SD6740	SD6780	Measured temperature value	Page 215
SD6663	SD6703	SD6743	SD6783	Average processing setting	Page 216
SD6664	SD6704	SD6744	SD6784	Time average/count average/moving average	Page 216
SD6665	SD6705	SD6745	SD6785	Setting thermocouple type	Page 217
SD6666	SD6706	SD6746	SD6786	Maximum value	Page 217
SD6667	SD6707	SD6747	SD6787	Minimum value	Page 218
SD6671	SD6711	SD6751	SD6791	Process alarm upper upper limit value	Page 218
SD6672	SD6712	SD6752	SD6792	Process alarm upper lower limit value	Page 219
SD6673	SD6713	SD6753	SD6793	Process alarm lower upper limit value	Page 219
SD6674	SD6714	SD6754	SD6794	Process alarm lower lower limit value	Page 220
SD6675	SD6715	SD6755	SD6795	Rate alarm upper limit value	Page 220
SD6676	SD6716	SD6756	SD6796	Rate alarm lower limit value	Page 221
SD6677	SD6717	SD6757	SD6797	Rate alarm detection cycle setting	Page 221
SD6678	SD6718	SD6758	SD6798	Conversion setting for disconnection detection	Page 222
SD6679	SD6719	SD6759	SD6799	Conversion setting value for disconnection detection	Page 223
SD6687	SD6727	SD6767	SD6807	Offset temperature setting value	Page 223
SD6688	SD6728	SD6768	SD6808	Gain temperature setting value	Page 224
SD6689	SD6729	SD6769	SD6809	Offset/gain code	Page 224
SD6690	SD6730	SD6770	SD6810	Thermal EMF offset value (L)	Page 225
SD6691	SD6731	SD6771	SD6811	Thermal EMF offset value (H)	
SD6692	SD6732	SD6772	SD6812	Thermal EMF gain value (L)	Page 225
SD6693	SD6733	SD6773	SD6813	Thermal EMF gain value (H)	
SD6694	SD6734	SD6774	SD6814	Input offset value (L)	Page 226
SD6695	SD6735	SD6775	SD6815	Input offset value (H)	
SD6696	SD6736	SD6776	SD6816	Input gain value (L)	Page 226
SD6697	SD6737	SD6777	SD6817	Input gain value (H)	
SD6698	SD6738	SD6778	SD6818	Conversion latest alarm code	Page 227
SD6699	SD6739	SD6779	SD6819	Conversion latest error code	Page 227

3rd analog expansion adapter

The special registers list for the 3rd FX5-4AD-TC-ADP module is shown below.

Special registers				Name	Reference
CH1	CH2	CH3	CH4		
SD7000				Module Information	Page 215
SD7020	SD7060	SD7100	SD7140	Measured temperature value	Page 215
SD7023	SD7063	SD7103	SD7143	Average processing setting	Page 216
SD7024	SD7064	SD7104	SD7144	Time average/count average/moving average	Page 216
SD7025	SD7065	SD7105	SD7145	Setting thermocouple type	Page 217
SD7026	SD7066	SD7106	SD7146	Maximum value	Page 217
SD7027	SD7067	SD7107	SD7147	Minimum value	Page 218
SD7031	SD7071	SD7111	SD7151	Process alarm upper upper limit value	Page 218
SD7032	SD7072	SD7112	SD7152	Process alarm upper lower limit value	Page 219
SD7033	SD7073	SD7113	SD7153	Process alarm lower upper limit value	Page 219
SD7034	SD7074	SD7114	SD7154	Process alarm lower lower limit value	Page 220
SD7035	SD7075	SD7115	SD7155	Rate alarm upper limit value	Page 220
SD7036	SD7076	SD7116	SD7156	Rate alarm lower limit value	Page 221
SD7037	SD7077	SD7117	SD7157	Rate alarm detection cycle setting	Page 221
SD7038	SD7078	SD7118	SD7158	Conversion setting for disconnection detection	Page 222
SD7039	SD7079	SD7119	SD7159	Conversion setting value for disconnection detection	Page 223
SD7047	SD7087	SD7127	SD7167	Offset temperature setting value	Page 223
SD7048	SD7088	SD7128	SD7168	Gain temperature setting value	Page 224
SD7049	SD7089	SD7129	SD7169	Offset/gain code	Page 224
SD7050	SD7090	SD7130	SD7170	Thermal EMF offset value (L)	Page 225
SD7051	SD7091	SD7131	SD7171	Thermal EMF offset value (H)	
SD7052	SD7092	SD7132	SD7172	Thermal EMF gain value (L)	Page 225
SD7053	SD7093	SD7133	SD7173	Thermal EMF gain value (H)	
SD7054	SD7094	SD7134	SD7174	Input offset value (L)	Page 226
SD7055	SD7095	SD7135	SD7175	Input offset value (H)	
SD7056	SD7096	SD7136	SD7176	Input gain value (L)	Page 226
SD7057	SD7097	SD7137	SD7177	Input gain value (H)	
SD7058	SD7098	SD7138	SD7178	Conversion latest alarm code	Page 227
SD7059	SD7099	SD7139	SD7179	Conversion latest error code	Page 227

4th analog expansion adapter

The special registers list for the 4th FX5-4AD-TC-ADP module is shown below.

Special registers				Name	Reference
CH1	CH2	CH3	CH4		
SD7360				Module Information	Page 215
SD7380	SD7420	SD7460	SD7500	Measured temperature value	Page 215
SD7383	SD7423	SD7463	SD7503	Average processing setting	Page 216
SD7384	SD7424	SD7464	SD7504	Time average/count average/moving average	Page 216
SD7385	SD7425	SD7465	SD7505	Setting thermocouple type	Page 217
SD7386	SD7426	SD7466	SD7506	Maximum value	Page 217
SD7387	SD7427	SD7467	SD7507	Minimum value	Page 218
SD7391	SD7431	SD7471	SD7511	Process alarm upper upper limit value	Page 218
SD7392	SD7432	SD7472	SD7512	Process alarm upper lower limit value	Page 219
SD7393	SD7433	SD7473	SD7513	Process alarm lower upper limit value	Page 219
SD7394	SD7434	SD7474	SD7514	Process alarm lower lower limit value	Page 220
SD7395	SD7435	SD7475	SD7515	Rate alarm upper limit value	Page 220
SD7396	SD7436	SD7476	SD7516	Rate alarm lower limit value	Page 221
SD7397	SD7437	SD7477	SD7517	Rate alarm detection cycle setting	Page 221
SD7398	SD7438	SD7478	SD7518	Conversion setting for disconnection detection	Page 222
SD7399	SD7439	SD7479	SD7519	Conversion setting value for disconnection detection	Page 223
SD7407	SD7447	SD7487	SD7527	Offset temperature setting value	Page 223
SD7408	SD7448	SD7488	SD7528	Gain temperature setting value	Page 224
SD7409	SD7449	SD7489	SD7529	Offset/gain code	Page 224
SD7410	SD7450	SD7490	SD7530	Thermal EMF offset value (L)	Page 225
SD7411	SD7451	SD7491	SD7531	Thermal EMF offset value (H)	
SD7412	SD7452	SD7492	SD7532	Thermal EMF gain value (L)	
SD7413	SD7453	SD7493	SD7533	Thermal EMF gain value (H)	Page 226
SD7414	SD7454	SD7494	SD7534	Input offset value (L)	
SD7415	SD7455	SD7495	SD7535	Input offset value (H)	
SD7416	SD7456	SD7496	SD7536	Input gain value (L)	Page 226
SD7417	SD7457	SD7497	SD7537	Input gain value (H)	
SD7418	SD7458	SD7498	SD7538	Conversion latest alarm code	Page 227
SD7419	SD7459	SD7499	SD7539	Conversion latest error code	Page 227

4.14 Detail of Special Registers

This section explains the details of special registers. Only the FX5U/FX5UC CPU module supports the third and fourth special register.

R: Read only, R/W: Read/Write

Module Information

Module information of FX5-4AD-TC-ADP is stored.

Stored value		R/W
61A0H		R

Name	Connection part	Special register			
		CH1	CH2	CH3	CH4
Module Information	1st adapter	SD6280			
	2nd adapter	SD6640			
	3rd adapter	SD7000			
	4th adapter	SD7360			

Measured temperature value

The temperature converted digital output value is stored.

Range	Default value	R/W
-32768 to +32767	0	R



The value is updated in every averaging processing cycle when the averaging processing is executed, or in every sampling cycle when the averaging processing is not executed.

Name	Connection part	Special register			
		CH1	CH2	CH3	CH4
Measured temperature value	1st adapter	SD6300	SD6340	SD6380	SD6420
	2nd adapter	SD6660	SD6700	SD6740	SD6780
	3rd adapter	SD7020	SD7060	SD7100	SD7140
	4th adapter	SD7380	SD7420	SD7460	SD7500

Average processing setting

Set which one between the sampling processing and the averaging processing is to be selected.
The averaging processing is classified into "time average", "count average" and "moving average".

Setting value	Description	Default value	R/W
0	Sampling processing	0	R/W
1	Time average		
2	Count average		
3	Moving average		

Point

If a value other than the above is set, the averaging process specification setting range error (Error code: 1A0□H) occurs and the temperature conversion cannot be performed.

Name	Connection part	Special register			
		CH1	CH2	CH3	CH4
Average processing setting	1st adapter	SD6303	SD6343	SD6383	SD6423
	2nd adapter	SD6663	SD6703	SD6743	SD6783
	3rd adapter	SD7023	SD7063	SD7103	SD7143
	4th adapter	SD7383	SD7423	SD7463	SD7503

Time average/count average/moving average

Set the average time, average counts and moving average counts in the averaging processing for each channel.
The table below shows the available setting range.

Setting value	Description	Default value	R/W
340 to 10000 (ms)	Time average	0	R/W
4 to 4095 (times)	Count average		
2 to 64 (times)	Moving average		

Point

If a value other than the above is set, the average time setting range error (Error code: 1A1□H), average count setting range error (Error code: 1A2□H) or moving average count setting range error (Error code: 1A3□H) occurs and the temperature conversion cannot be performed.

Name	Connection part	Special register			
		CH1	CH2	CH3	CH4
Time average/count average/moving average	1st adapter	SD6304	SD6344	SD6384	SD6424
	2nd adapter	SD6664	SD6704	SD6744	SD6784
	3rd adapter	SD7024	SD7064	SD7104	SD7144
	4th adapter	SD7384	SD7424	SD7464	SD7504

Setting thermocouple type

Set the thermocouple type.

Setting value	Description	Default value	R/W
0	K thermocouple	0	R/W
1	J thermocouple		
2	T thermocouple		
3	B thermocouple		
4	R thermocouple		
5	S thermocouple		

Point

If a value other than the above is set, the thermocouple type error (Error code: 1A8□H) occurs and the temperature conversion cannot be performed.

Name	Connection part	Special register			
		CH1	CH2	CH3	CH4
Setting thermocouple type	1st adapter	SD6305	SD6345	SD6385	SD6425
	2nd adapter	SD6665	SD6705	SD6745	SD6785
	3rd adapter	SD7025	SD7065	SD7105	SD7145
	4th adapter	SD7385	SD7425	SD7465	SD7505

Maximum value

The maximum value of the measured temperature value is stored. When the "maximum value reset request" is set from OFF to ON, the maximum value of the specified channel is updated to the "measured temperature value".

Range	Default value	R/W
-32768 to +32767	0	R

For details maximum value/minimum value hold function, refer to the following.

☞ Page 185 Maximum Value/Minimum Value Hold Function

Name	Connection part	Special register			
		CH1	CH2	CH3	CH4
Maximum value	1st adapter	SD6306	SD6346	SD6386	SD6426
	2nd adapter	SD6666	SD6706	SD6746	SD6786
	3rd adapter	SD7026	SD7066	SD7106	SD7146
	4th adapter	SD7386	SD7426	SD7466	SD7506

Minimum value

The minimum value of the digital operation value is stored. When the "minimum value reset request" is set from OFF to ON, the minimum value of the specified channel is updated to the "measured temperature value".

Range	Default value	R/W
-32768 to +32767	0	R

For details maximum value/minimum value hold function, refer to the following.

 Page 185 Maximum Value/Minimum Value Hold Function

Name	Connection part	Special register			
		CH1	CH2	CH3	CH4
Minimum value	1st adapter	SD6307	SD6347	SD6387	SD6427
	2nd adapter	SD6667	SD6707	SD6747	SD6787
	3rd adapter	SD7027	SD7067	SD7107	SD7147
	4th adapter	SD7387	SD7427	SD7467	SD7507

Process alarm upper upper limit value

Set the upper upper limit value of the alarm output function (process alarm).

Range	Default value	R/W
-32768 to +32767 (If the temperature unit is Fahrenheit (°F), set the value in increments of 2 (0.2°F).)	12000	R/W

Point

- When changing this device, set process alarm upper upper limit value, process alarm upper lower limit value, process alarm lower upper limit value, and process alarm lower lower limit value within the same scan.
- If the condition "process alarm upper upper limit value \geq process alarm upper lower limit value \geq process alarm lower upper limit value \geq process alarm lower lower limit value" is not satisfied, the process alarm upper lower limit value setting range error occurs and the temperature conversion cannot be performed. (Error code: 1A4□H)

For details alarm output function, refer to the following.

 Page 174 Process alarm

Name	Connection part	Special register			
		CH1	CH2	CH3	CH4
Process alarm upper upper limit value	1st adapter	SD6311	SD6351	SD6391	SD6431
	2nd adapter	SD6671	SD6711	SD6751	SD6791
	3rd adapter	SD7031	SD7071	SD7111	SD7151
	4th adapter	SD7391	SD7431	SD7471	SD7511

Process alarm upper lower limit value

Set the upper lower limit value of the alarm output function (process alarm).

Range	Default value	R/W
-32768 to +32767 (If the temperature unit is Fahrenheit (°F, set the value in increments of 2 (0.2°F).)	12000	R/W

Point

- When changing this device, set process alarm upper upper limit value, process alarm upper lower limit value, process alarm lower upper limit value, and process alarm lower lower limit value within the same scan.
- If the condition "process alarm upper upper limit value \geq process alarm upper lower limit value \geq process alarm lower upper limit value \geq process alarm lower lower limit value" is not satisfied, the process alarm upper lower limit value setting range error occurs and the temperature conversion cannot be performed. (Error code: 1A4□H)

For details alarm output function, refer to the following.

 Page 174 Process alarm

Name	Connection part	Special register			
		CH1	CH2	CH3	CH4
Process alarm upper lower limit value	1st adapter	SD6312	SD6352	SD6392	SD6432
	2nd adapter	SD6672	SD6712	SD6752	SD6792
	3rd adapter	SD7032	SD7072	SD7112	SD7152
	4th adapter	SD7392	SD7432	SD7472	SD7512

Process alarm lower upper limit value

Set the lower upper limit value of the alarm output function (process alarm).

Range	Default value	R/W
-32768 to +32767 (If the temperature unit is Fahrenheit (°F, set the value in increments of 2 (0.2°F).)	-2000	R/W

Point

- When changing this device, set process alarm upper upper limit value, process alarm upper lower limit value, process alarm lower upper limit value, and process alarm lower lower limit value within the same scan.
- If the condition "process alarm upper upper limit value \geq process alarm upper lower limit value \geq process alarm lower upper limit value \geq process alarm lower lower limit value" is not satisfied, the process alarm upper lower limit value setting range error occurs and the temperature conversion cannot be performed. (Error code: 1A4□H)

For details alarm output function, refer to the following.

 Page 174 Process alarm

Name	Connection part	Special register			
		CH1	CH2	CH3	CH4
Process alarm lower upper limit value	1st adapter	SD6313	SD6353	SD6393	SD6433
	2nd adapter	SD6673	SD6713	SD6753	SD6793
	3rd adapter	SD7033	SD7073	SD7113	SD7153
	4th adapter	SD7393	SD7433	SD7473	SD7513

Process alarm lower lower limit value

Set the lower lower limit value of the alarm output function (process alarm).

Range	Default value	R/W
-32768 to +32767 (If the temperature unit is Fahrenheit (°F), set the value in increments of 2 (0.2°F).)	-2000	R/W

Point

- When changing this device, set process alarm upper upper limit value, process alarm upper lower limit value, process alarm lower upper limit value, and process alarm lower lower limit value within the same scan.
- If the condition "process alarm upper upper limit value \geq process alarm upper lower limit value \geq process alarm lower upper limit value \geq process alarm lower lower limit value" is not satisfied, the process alarm upper lower limit value setting range error occurs and the temperature conversion cannot be performed. (Error code: 1A4□H)

For details alarm output function, refer to the following.

☞ Page 174 Process alarm

Name	Connection part	Special register			
		CH1	CH2	CH3	CH4
Process alarm lower lower limit value	1st adapter	SD6314	SD6354	SD6394	SD6434
	2nd adapter	SD6674	SD6714	SD6754	SD6794
	3rd adapter	SD7034	SD7074	SD7114	SD7154
	4th adapter	SD7394	SD7434	SD7474	SD7514

Rate alarm upper limit value

Set the upper limit of the change amount of the measured temperature value for detecting rate alarms.

Range	Default value	R/W
-32768 to +32767 (If the temperature unit is Fahrenheit (°F), set the value in increments of 2 (0.2°F).)	0	R/W

Point

- When changing this device, set rate alarm upper limit value and rate alarm lower limit value within the same scan.
- If the condition "rate alarm upper limit value \geq rate alarm lower limit value" is not satisfied, the rate alarm upper limit value/lower limit value setting inversion error (Error code: 1A5□H) occurs and the temperature conversion cannot be performed.

For details alarm output function, refer to the following.

☞ Page 176 Rate alarm

Name	Connection part	Special register			
		CH1	CH2	CH3	CH4
Rate alarm upper limit value	1st adapter	SD6315	SD6355	SD6395	SD6435
	2nd adapter	SD6675	SD6715	SD6755	SD6795
	3rd adapter	SD7035	SD7075	SD7115	SD7155
	4th adapter	SD7395	SD7435	SD7475	SD7515

Rate alarm lower limit value

Set the lower limit of the change amount of the measured temperature value for detecting rate alarms.

Range	Default value	R/W
-32768 to +32767 (If the temperature unit is Fahrenheit (°F), set the value in increments of 2 (0.2°F).)	0	R/W

Point

- When changing this device, set rate alarm upper limit value and rate alarm lower limit value within the same scan.
- If the condition "rate alarm upper limit value \geq rate alarm lower limit value is not satisfied, the rate alarm upper limit value/lower limit value setting inversion error (Error code: 1A5□H) occurs and the temperature conversion cannot be performed.

For details alarm output function, refer to the following.

 Page 176 Rate alarm

Name	Connection part	Special register			
		CH1	CH2	CH3	CH4
Rate alarm lower limit value	1st adapter	SD6316	SD6356	SD6396	SD6436
	2nd adapter	SD6676	SD6716	SD6756	SD6796
	3rd adapter	SD7036	SD7076	SD7116	SD7156
	4th adapter	SD7396	SD7436	SD7476	SD7516

Rate alarm detection cycle setting

Set the cycle for checking the change amount of the measured temperature value.

Range	Default value	R/W
85 to 10000 (ms)	85	R/W

Point

If a value other than the above is set, the rate alarm warning detection period setting range error (Error code: 1A6□H) occurs and the temperature conversion cannot be performed.

For details alarm output function, refer to the following.

 Page 176 Rate alarm

Name	Connection part	Special register			
		CH1	CH2	CH3	CH4
Rate alarm detection cycle setting	1st adapter	SD6317	SD6357	SD6397	SD6437
	2nd adapter	SD6677	SD6717	SD6757	SD6797
	3rd adapter	SD7037	SD7077	SD7117	SD7157
	4th adapter	SD7397	SD7437	SD7477	SD7517

Conversion setting for disconnection detection

Set the value that is to be stored in the "measured temperature value" when a disconnection is detected.

Setting value	Description	Default value	R/W
0	Upscale	1	R/W
1	Downscale		
2	Any value		
3	Value immediately before disconnection		

Point

If a value other than the above is set, the conversion setting range error with disconnection detection enabled (Error code: 1AB□H) occurs and the temperature conversion cannot be performed.

When "upscale" (upper limit value + 5% of measurement range) or "downscale" (lower limit value - 5% of measurement range) is selected, the following values are stored in the "measured temperature value".

Thermocouple	Temperature unit	Downscale	Upscale
K	Centigrade (°C)	-3520	14520
	Fahrenheit (°F)	-6016	26456
J	Centigrade (°C)	-2770	11970
	Fahrenheit (°F)	-4666	21866
T	Centigrade (°C)	-3035	4335
	Fahrenheit (°F)	-5143	8123
B	Centigrade (°C)	-855	17955
	Fahrenheit (°F)	-1219	32639
R	Centigrade (°C)	-1380	17980
	Fahrenheit (°F)	-2164	32684
S	Centigrade (°C)	-1380	17980
	Fahrenheit (°F)	-2164	32684

For details disconnection detection function, refer to the following.

 Page 172 Disconnection Detection Function

Name	Connection part	Special register			
		CH1	CH2	CH3	CH4
Conversion setting for disconnection detection	1st adapter	SD6318	SD6358	SD6398	SD6438
	2nd adapter	SD6678	SD6718	SD6758	SD6798
	3rd adapter	SD7038	SD7078	SD7118	SD7158
	4th adapter	SD7398	SD7438	SD7478	SD7518

Conversion setting value for disconnection detection

Set the value that is to be stored in the "measured temperature value" when "conversion setting for disconnection detection" is set to "any value".

Range	Default value	R/W
-32768 to +32767 (If the temperature unit is Fahrenheit (°F), set the value in increments of 2 (0.2°F).)	0	R/W

For details disconnection detection function, refer to the following.

 Page 172 Disconnection Detection Function

Name	Connection part	Special register			
		CH1	CH2	CH3	CH4
Conversion setting value for disconnection detection	1st adapter	SD6319	SD6359	SD6399	SD6439
	2nd adapter	SD6679	SD6719	SD6759	SD6799
	3rd adapter	SD7039	SD7079	SD7119	SD7159
	4th adapter	SD7399	SD7439	SD7479	SD7519

Offset temperature setting value

Set the offset temperature setting value used in the offset/gain setting function.

Range	Default value	R/W
K thermocouple (Centigrade): -2700 to +13700 K thermocouple (Fahrenheit): -4540 to +24980* ¹ J thermocouple (Centigrade): -2100 to +11300 J thermocouple (Fahrenheit): -3460 to +20660* ¹ T thermocouple (Centigrade): -2700 to +4000 T thermocouple (Fahrenheit): -4540 to +7520* ¹ B thermocouple (Centigrade): 0 to 17100 B thermocouple (Fahrenheit): 320 to 31100* ¹ R thermocouple (Centigrade): -500 to +17100 R thermocouple (Fahrenheit): -580 to +31100* ¹ S thermocouple (Centigrade): -500 to +17100 S thermocouple (Fahrenheit): -580 to +31100* ¹	0	R/W

*¹ Set the value in increments of 2 (0.2°F).

Point

The setting value is obtained from the built-in memory of the FX5-4AD-TC-ADP when "offset/gain reading" is set from OFF to ON or the power supply of the FX5-4AD-TC-ADP is turned on.

For details offset/gain setting function, refer to the following.

 Page 180 Offset/gain Setting Function

Name	Connection part	Special register			
		CH1	CH2	CH3	CH4
Offset temperature setting value	1st adapter	SD6327	SD6367	SD6407	SD6447
	2nd adapter	SD6687	SD6727	SD6767	SD6807
	3rd adapter	SD7047	SD7087	SD7127	SD7167
	4th adapter	SD7407	SD7447	SD7487	SD7527

Gain temperature setting value

Set the gain temperature setting value used in the offset/gain setting function.

Range	Default value	R/W
K thermocouple (Centigrade): -2700 to +13700 K thermocouple (Fahrenheit): -4540 to +24980 ^{*1} J thermocouple (Centigrade): -2100 to +11300 J thermocouple (Fahrenheit): -3460 to +20660 ^{*1} T thermocouple (Centigrade): -2700 to +4000 T thermocouple (Fahrenheit): -4540 to +7520 ^{*1} B thermocouple (Centigrade): 0 to 17100 B thermocouple (Fahrenheit): 320 to 31100 ^{*1} R thermocouple (Centigrade): -500 to +17100 R thermocouple (Fahrenheit): -580 to +31100 ^{*1} S thermocouple (Centigrade): -500 to +17100 S thermocouple (Fahrenheit): -580 to +31100 ^{*1}	11300	R/W

*1 Set the value in increments of 2 (0.2°F).



The setting value is obtained from the built-in memory of the FX5-4AD-TC-ADP when "offset/gain reading" is set from OFF to ON or the power supply of the FX5-4AD-TC-ADP is turned on.

For details offset/gain setting function, refer to the following.

Page 180 Offset/gain Setting Function

Name	Connection part	Special register			
		CH1	CH2	CH3	CH4
Gain temperature setting value	1st adapter	SD6328	SD6368	SD6408	SD6448
	2nd adapter	SD6688	SD6728	SD6768	SD6808
	3rd adapter	SD7048	SD7088	SD7128	SD7168
	4th adapter	SD7408	SD7448	SD7488	SD7528

Offset/gain code

Set the offset/gain writing enable code used for changing the offset/gain.

Range	Default value	R/W
Offset/gain writing enable: E21AH Offset/gain writing disable: Other than E21AH	0	R/W



When "offset/gain writing" is set from OFF to ON while the offset/gain writing is enabled, the "setting thermocouple type", "offset temperature setting value", "gain temperature setting value", "input offset value" and "input gain value" are written to the built-in memory of the FX5-4AD-TC-ADP.

For details offset/gain setting function, refer to the following.

Page 180 Offset/gain Setting Function

Name	Connection part	Special register			
		CH1	CH2	CH3	CH4
Offset/gain code	1st adapter	SD6329	SD6369	SD6409	SD6449
	2nd adapter	SD6689	SD6729	SD6769	SD6809
	3rd adapter	SD7049	SD7089	SD7129	SD7169
	4th adapter	SD7409	SD7449	SD7489	SD7529

Thermal EMF offset value

The thermal EMF offset value calculated based on the "offset temperature setting value" and "setting thermocouple type" is stored.

Point

When "offset/gain reading" is set from OFF to ON or the power supply of the FX5-4AD-TC-ADP is turned on, the thermal EMF offset value, which is calculated based on the offset temperature setting value and setting thermocouple type obtained from the built-in memory of the FX5-4AD-TC-ADP, is stored.

For details offset/gain setting function, refer to the following.

 Page 180 Offset/gain Setting Function

Name	Connection part	Special register			
		CH1	CH2	CH3	CH4
Thermal EMF offset value	1st adapter	SD6331, SD6330	SD6371, SD6370	SD6411, SD6410	SD6451, SD6450
	2nd adapter	SD6691, SD6690	SD6731, SD6730	SD6771, SD6770	SD6811, SD6810
	3rd adapter	SD7051, SD7050	SD7091, SD7090	SD7131, SD7130	SD7171, SD7170
	4th adapter	SD7411, SD7410	SD7451, SD7450	SD7491, SD7490	SD7531, SD7530

4

Thermal EMF gain value

The thermal EMF gain value calculated based on the "gain temperature setting value" and "setting thermocouple type" is stored.

Point

When "offset/gain reading" is set from OFF to ON or the power supply of the FX5-4AD-TC-ADP is turned on, the thermal EMF gain value, which is calculated based on the gain temperature setting value and setting thermocouple type obtained from the built-in memory of the FX5-4AD-TC-ADP, is stored.

For details offset/gain setting function, refer to the following.

 Page 180 Offset/gain Setting Function

Name	Connection part	Special register			
		CH1	CH2	CH3	CH4
Thermal EMF gain value	1st adapter	SD6333, SD6332	SD6373, SD6372	SD6413, SD6412	SD6453, SD6452
	2nd adapter	SD6693, SD6692	SD6733, SD6732	SD6773, SD6772	SD6813, SD6812
	3rd adapter	SD7053, SD7052	SD7093, SD7092	SD7133, SD7132	SD7173, SD7172
	4th adapter	SD7413, SD7412	SD7453, SD7452	SD7493, SD7492	SD7533, SD7532

Input offset value

Set the offset value used in the offset/gain setting function.

Range	Default value	R/W
0 to 78125 (μ V)	2	R/W

Point

The setting value is obtained from the built-in memory of the FX5-4AD-TC-ADP when "offset/gain reading" is set from OFF to ON or the power supply of the FX5-4AD-TC-ADP is turned on.

For details offset/gain setting function, refer to the following.

 Page 180 Offset/gain Setting Function

Name	Connection part	Special register			
		CH1	CH2	CH3	CH4
Input offset value	1st adapter	SD6335, SD6334	SD6375, SD6374	SD6415, SD6414	SD6455, SD6454
	2nd adapter	SD6695, SD6694	SD6735, SD6734	SD6775, SD6774	SD6815, SD6814
	3rd adapter	SD7055, SD7054	SD7095, SD7094	SD7135, SD7134	SD7175, SD7174
	4th adapter	SD7415, SD7414	SD7455, SD7454	SD7495, SD7494	SD7535, SD7534

Input gain value

Set the gain value used in the offset/gain setting function.

Range	Default value	R/W
0 to 78125 (μ V)	65573	R/W

Point

The setting value is obtained from the built-in memory of the FX5-4AD-TC-ADP when "offset/gain reading" is set from OFF to ON or the power supply of the FX5-4AD-TC-ADP is turned on.

For details offset/gain setting function, refer to the following.

 Page 180 Offset/gain Setting Function

Name	Connection part	Special register			
		CH1	CH2	CH3	CH4
Input gain value	1st adapter	SD6337, SD6336	SD6377, SD6376	SD6417, SD6416	SD6457, SD6456
	2nd adapter	SD6697, SD6696	SD6737, SD6736	SD6777, SD6776	SD6817, SD6816
	3rd adapter	SD7057, SD7056	SD7097, SD7096	SD7137, SD7136	SD7177, SD7176
	4th adapter	SD7417, SD7416	SD7457, SD7456	SD7497, SD7496	SD7537, SD7536

Conversion latest alarm code

The latest alarm code detected in the FX5-4AD-TC-ADP is stored.

Monitor value	Default value	R/W
—	0	R

For details alarm code, refer to the following.

 Page 198 List of Alarm Code

Name	Connection part	Special register			
		CH1	CH2	CH3	CH4
Conversion latest alarm code	1st adapter	SD6338	SD6378	SD6418	SD6458
	2nd adapter	SD6698	SD6738	SD6778	SD6818
	3rd adapter	SD7058	SD7098	SD7138	SD7178
	4th adapter	SD7418	SD7458	SD7498	SD7538



Set the "conversion alarm clear request" from OFF to ON to clear the alarm code.

Conversion latest error code

The latest error code detected in the FX5-4AD-TC-ADP is stored.

Monitor value	Default value	R/W
—	0	R

For details error code, refer to the following.

 Page 197 List of Error Code

Name	Connection part	Special register			
		CH1	CH2	CH3	CH4
Conversion latest error code	1st adapter	SD6339	SD6379	SD6419	SD6459
	2nd adapter	SD6699	SD6739	SD6779	SD6819
	3rd adapter	SD7059	SD7099	SD7139	SD7179
	4th adapter	SD7419	SD7459	SD7499	SD7539



Set the "error clear request" (SM50) of CPU module from OFF to ON to clear the error code.

5 FX5-4DA-ADP

This chapter describes the FX5-4DA-ADP.

5.1 Specifications

This section describes the specifications.

Generic specifications

The items other than the following are equivalent to those of the CPU module.

For general specifications, refer to the following manual.

📖 MELSEC iQ-F FX5UJ User's Manual (Hardware)

📖 MELSEC iQ-F FX5U User's Manual (Hardware)

📖 MELSEC iQ-F FX5UC User's Manual (Hardware)

Item	Specification
Dielectric withstand voltage	500 V AC for one minute Between all external terminals and ground terminal
Insulation resistance	10 MΩ or higher by 500 V DC insulation resistance tester

Power supply specifications

Power supply specifications is shown below.

Item	Specification
External electric supply (D/A conversion circuit)	24 V DC +20 %, -15 % 160 mA External electric supply is carried out from the power supply connector of an adapter.
Internal electric supply (Interface)	5 V DC 10 mA Internal electric supply is carried out from 5 V DC power supply of a CPU module.

Performance specifications

Performance specifications is shown below.

Item	Specification		
Number of analog output points	4 points (4 channels)		
Digital input	14-bit binary value		
Analog output voltage	-10 to +10 V DC (external load resistance value 1k to 1 MΩ)		
Analog output current	0 to 20 mA DC (external load resistance value 0 to 500 Ω)		
Output characteristics, resolution*1	Analog output range		Digital value
	Voltage	0 to 10 V	0 to 16000
		0 to 5 V	0 to 16000
		1 to 5 V	0 to 16000
		-10 to +10 V	-8000 to +8000
	Current	0 to 20 mA	0 to 16000
4 to 20 mA		0 to 16000	
Resolution			
625 μV			
312.5 μV			
250 μV			
1250 μV			
1.25 μA			
1 μA			
Accuracy (accuracy for the full scale of the analog output value)	Ambient temperature 25±5°C: ±0.1 % (Voltage ±20 mV, Current ±20 μA) Ambient temperature -20 to 55°C*2: ±0.2 % (Voltage ±40 mV, Current ±40 μA)		
Conversion speed	Maximum 950 μs (The data will be updated at every scan time of the PLC.)		
Isolation method	Between output terminal and PLC: Photocoupler Between output channels: Non-isolation		
Number of occupied I/O points	0 point (This number is not related to the maximum number of I/O points of the PLC.)		
Applicable CPU module	<ul style="list-style-type: none"> • FX5UJ CPU module (From the first) • FX5U CPU module (From the first) • FX5UC CPU module (From the first) 		
Applicable engineering tool	<ul style="list-style-type: none"> • FX5UJ CPU module: GX Works3 (Ver.1.060N or later) • FX5U/FX5UC CPU module: GX Works3 (Ver.1.007H or later) 		

*1 For the output conversion characteristic, refer to the  Page 230 Output conversion characteristics.

*2 The operating ambient temperature is 0 to 55°C for products manufactured before June 2016.

Output conversion characteristics

A output conversion characteristic of D/A conversion is expressed by the slope of the straight line connecting the offset value and the gain value at the time when a digital value written from the CPU module is converted to an analog output (voltage or current).

Voltage output characteristic

The following shows the list of the analog output ranges and the graphs of each voltage output characteristic, at the voltage output.

No.	Output range setting	Offset value	Gain value	Digital value ^{*1}	Resolution
(1)	0 to 10 V	0 V	10 V	0 to 16000	625 μ V
(2)	0 to 5 V	0 V	5 V	0 to 16000	312.5 μ V
(3)	1 to 5 V	1 V	5 V	0 to 16000	250 μ V
(4)	-10 to +10 V	0 V	10 V	-8000 to +8000	1250 μ V

*1 When value exceeds the range of the digital value, the digital value is fixed to the maximum or minimum.

Output range setting	Digital value	
	Minimum	Maximum
0 to 10 V	-384	16383
0 to 5 V	-384	16383
1 to 5 V	-384	16383
-10 to +10 V	-8192	8191

Point

Set values within the practical range of the digital input and analog output at each output range. If the values are out of the range, the resolution and accuracy may not fall within the range of the performance specifications. (Do not use values in the dotted line region in the graph of voltage output characteristics.)

■ Voltage output characteristics graph (0 to 10 V)

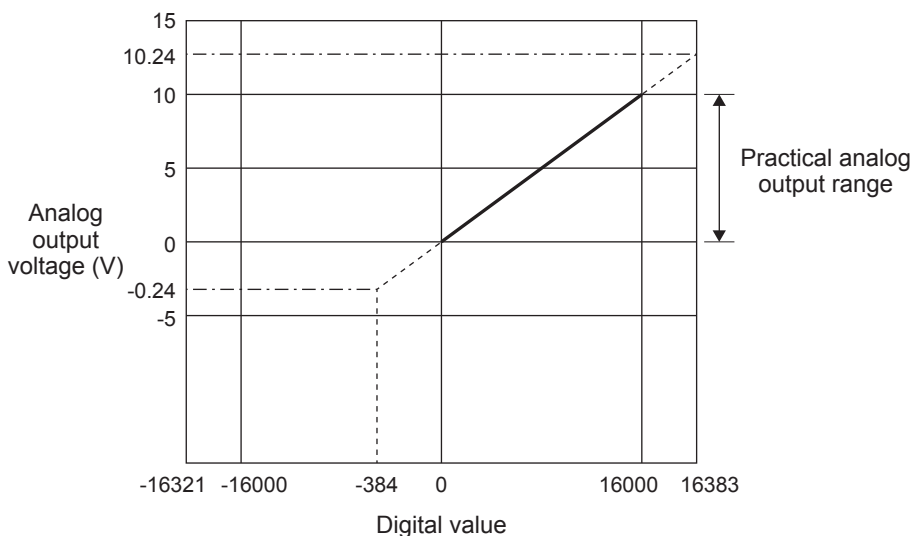

■ Voltage output characteristics graph (0 to 5 V)

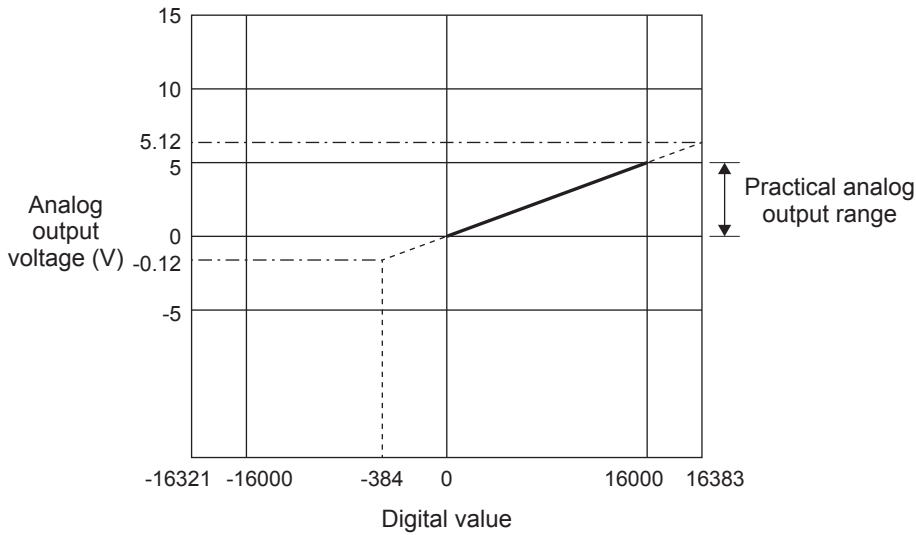

■ Voltage output characteristics graph (1 to 5 V)

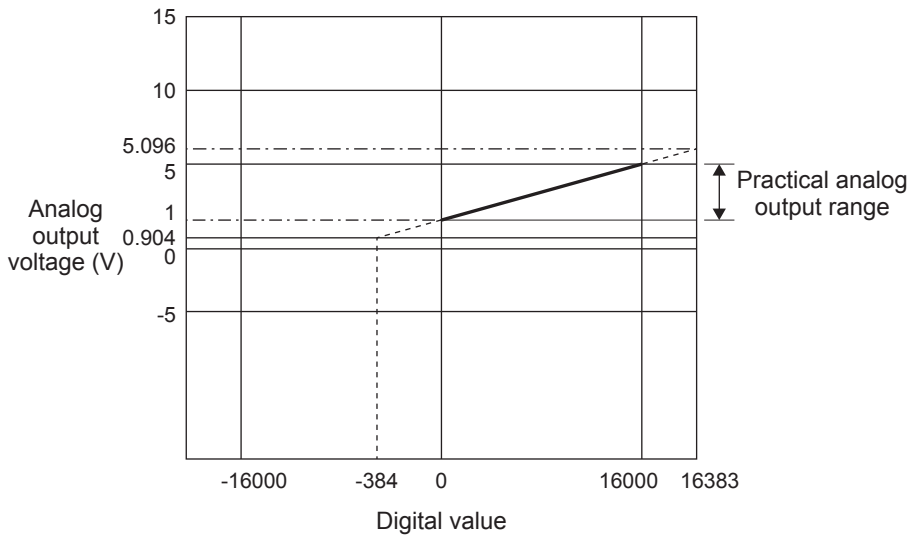

■ Voltage output characteristics graph (-10 to +10 V)

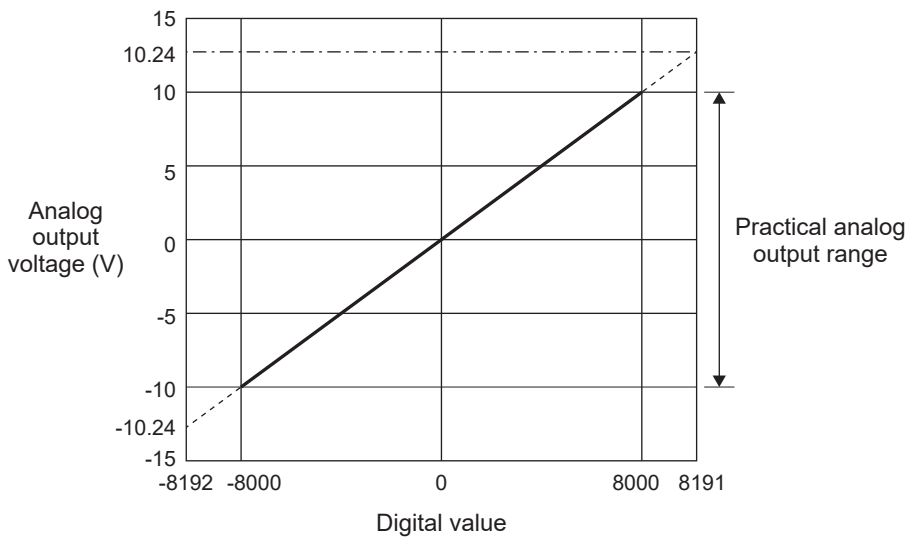

Current output characteristic

The following shows the list of the analog output ranges and the graphs of each current output characteristic, at the current output.

No.	Output range setting	Offset value	Gain value	Digital value*1	Resolution
(1)	0 to 20 mA	0 mA	20 mA	0 to 16000	1.25 μ A
(2)	4 to 20 mA	4 mA	20 mA	0 to 16000	1 μ A

*1 When value exceeds the range of the digital value, the digital value is fixed to the maximum or minimum.

Output range setting	Digital value	
	Minimum	Maximum
0 to 20 mA	-384	16383
4 to 20 mA	-384	16383

Point

Set values within the practical range of the digital input and analog output at each output range. If the values are out of the range, the resolution and accuracy may not fall within the range of the performance specifications. (Do not use values in the dotted line region in the graph of current output characteristics.)

■ Current output characteristics graph (0 to 20 mA)

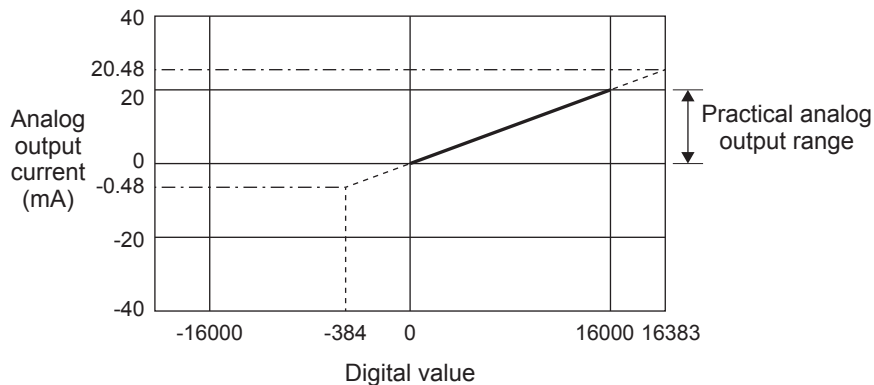

■ Current output characteristics graph (4 to 20 mA)

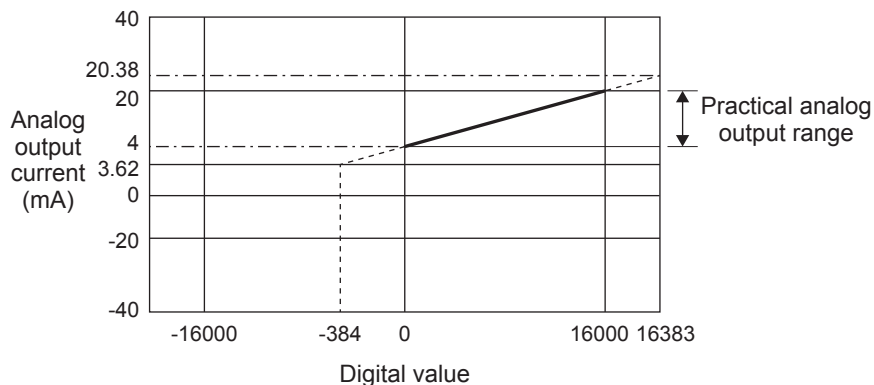

Accuracy

Accuracy of D/A conversion is determined by the accuracy for the full scale of analog output value.

An output characteristic change through changes of the offset/gain setting or the output range does not sacrifice the accuracy, which is maintained within the described range of the performance specifications.

The following graph shows the fluctuation range of accuracy when the range of -10 to 10 V is selected.

The accuracy is $\pm 0.1\%$ (± 20 mV) at ambient temperature of $25 \pm 5^\circ\text{C}$; the accuracy is $\pm 0.2\%$ (± 40 mV) at ambient temperature of -20 to 55°C (except for the conditions under noise influence).

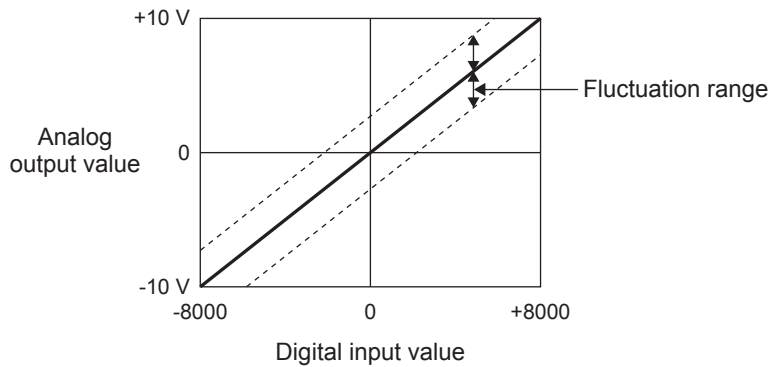

5.2 List of functions

The following table lists the functions.

Item	Description	Reference
Range switching function	Allows switching the output range of an analog output for each channel. Switching the range makes it possible to change the output conversion characteristics.	Page 235
D/A conversion enable/disable setting function	Controls whether to enable or disable the D/A conversion for each channel.	Page 236
D/A output enable/disable setting function	Specifies whether to output the D/A conversion value or offset value for each channel. The conversion speed is a constant, regardless of the output enable/disable status.	Page 236
Analog output HOLD/CLEAR function	Sets whether to hold or clear the analog output value output when the operating status of the CPU module is RUN, STOP, or stop error.	Page 237
Analog Output Test when CPU Module is in STOP Status Function	Analog output tests can be carried out when the CPU module is in the STOP status.	Page 238
Scaling function	Performs scale conversion on digital values within a specified range between a scaling upper limit value and a scaling lower limit value. The program for scale conversion can be omitted.	Page 239
Shift function	Adds a set input value shift amount to a digital value.	Page 241
Warning output function	Outputs an warning when the digital value exceeds the warning output upper limit value or becomes less than the warning output lower limit value.	Page 242
External power supply disconnection detection function	Detects that the external power supply 24 V DC is not supplied or is shut off.	Page 243
Disconnection detection function	Monitors the analog output value and detects a disconnection.	Page 243
Event history function	Collects errors from FX5-4DA-ADP, and stores them as event information into the CPU module.	Page 245
Offset/gain setting function	Corrects errors in D/A conversion values for each channel.	Page 245
Offset/gain initialization function	Initializes the offset value and gain value stored in the built-in memory of the FX5-4DA-ADP.	Page 250
Common function	Explains the common functions such as changing the setting values while the CPU module is operating.	Page 251

5.3 Functions

This section describes the functions of the FX5-4DA-ADP and the setting procedures for those functions using GX Works3.

Point

This section describes the special relays and special registers for the 1st FX5-4DA-ADP module. For checking the special relays and special registers for the 2nd and later FX5-4DA-ADP modules, refer to the following:

☞ Page 265 List of Special Relays, ☞ Page 273 List of Special Registers

Processing of Each Function

The functions are processed in the order shown below.

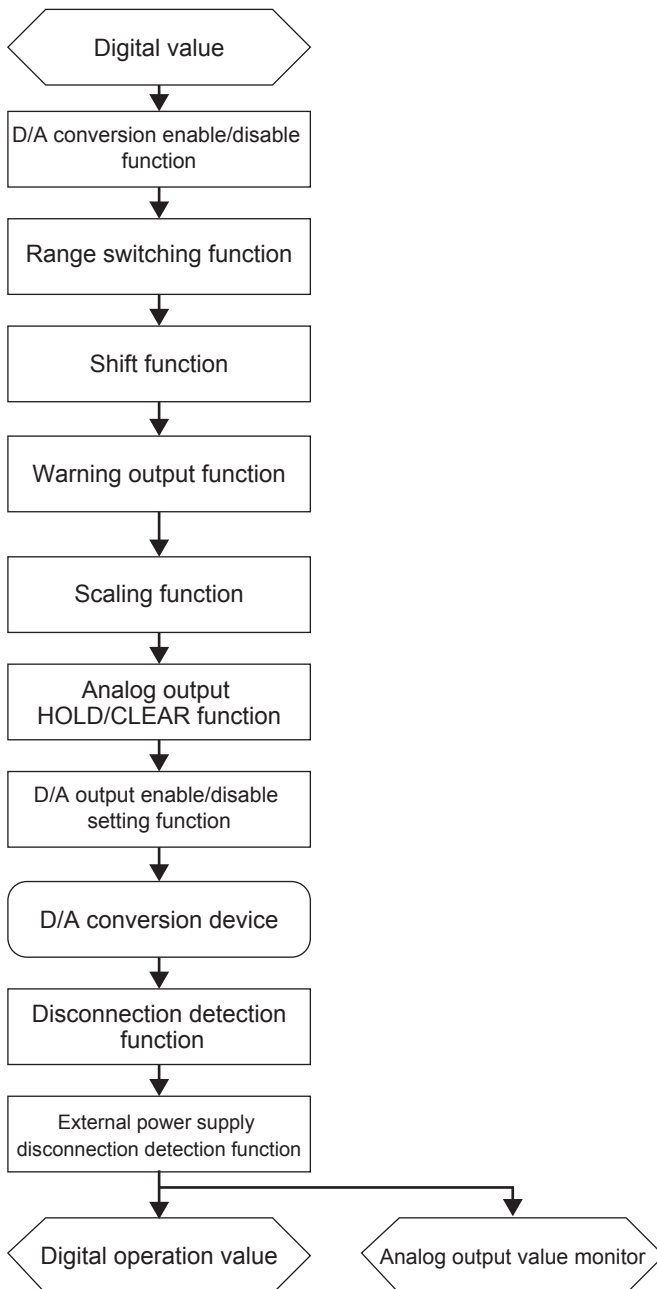

Digital value

Digital input values are stored.

Digital operation value

These values are obtained by operating a digital value using the scaling function or shift function. When each function is not used, the same value as the digital value is stored.

Analog output value monitor

The output analog value is displayed. Voltage and current are displayed in the following units.

Voltage: mV, Current: μ A

Range Switching Function

The output range of the analog output can be switched for each channel.

Switching the range makes it possible to change the output conversion characteristics.

Setting procedure

Set the input range to be used in the "output range setting".

 Navigation window \Rightarrow [Parameter] \Rightarrow [Module Information] \Rightarrow Module model name \Rightarrow [Module Parameter] \Rightarrow "Basic Settings" \Rightarrow "Range switching function"

Output range setting	Digital input range
0 to 10 V	0 to 16000
0 to 5 V	0 to 16000
1 to 5 V	0 to 16000
-10 to +10 V	-8000 to +8000
0 to 20 mA	0 to 16000
4 to 20 mA	0 to 16000

Corresponding devices

The devices which are used by the range switching function are listed below.

Name	CH1	CH2	CH3	CH4	Reference
Output range setting	SD6305	SD6345	SD6385	SD6425	Page 277

Operation

The output range is switched when the "output range setting" is changed while the "D/A conversion enable/disable setting" is set to "disable".

When the output range is switched, the following special devices are initialized:

Name	CH1	CH2	CH3	CH4	Reference
Warning output upper limit value flag	SM6311	SM6351	SM6391	SM6431	Page 268
Warning output lower limit value flag	SM6312	SM6352	SM6392	SM6432	Page 268
Disconnection detection flag	SM6318	SM6358	SM6398	SM6438	Page 269
Digital operation value	SD6301	SD6341	SD6381	SD6421	Page 276
Analog output value monitor	SD6302	SD6342	SD6382	SD6422	Page 276
Offset setting value ^{*1}	SD6332	SD6372	SD6412	SD6452	Page 279
Gain setting value ^{*1}	SD6333	SD6373	SD6413	SD6453	Page 279

*1 When the output range setting after change is equivalent to the output range setting set by the offset/gain setting function, the values set by the offset/gain setting function are reflected. In any other case, they are initialized to the initial value.

D/A Conversion Enable/Disable Function

The output range of the analog output can be switched for each channel.

Setting methods

Set "D/A conversion enable/disable setting" to "D/A conversion enable" or "D/A conversion disable".

 Navigation window ⇒ [Parameter] ⇒ [Module Information] ⇒ Module model name ⇒ [Module Parameter] ⇒ "Basic Settings" ⇒ "D/A Conversion Enable/Disable Setting"

Corresponding devices

The devices which are used by the D/A conversion enable/disable function are listed below.

Name	CH1	CH2	CH3	CH4	Reference
D/A conversion enable/disable setting	SM6300	SM6340	SM6380	SM6420	Page 267

Operation

The digital value is D/A-converted only in the channels for which the "D/A conversion enable/disable setting" is set to "enable".

The channels for which the "D/A output enable/disable setting" is set to "enable" output the converted analog value.

When the "D/A conversion enable/disable setting" is changed from "enable" to "disable", the digital value is held as is, and the digital operation value and analog output value monitor are cleared.

D/A Output Enable/Disable Setting Function

Specify whether to output the D/A conversion value or offset value for each channel.

The conversion speed is a constant, regardless of the output enable/disable state.

Setting methods

Set "D/A output enable/disable setting" to "D/A output enable" or "D/A output disable".

 Navigation window ⇒ [Parameter] ⇒ [Module Information] ⇒ Module model name ⇒ [Module Parameter] ⇒ "Basic Settings" ⇒ "D/A Output Enable/Disable Setting"

Corresponding devices

The devices which are used by the D/A output enable/disable setting function are listed below.

Name	CH1	CH2	CH3	CH4	Reference
D/A output enable/disable setting	SM6301	SM6341	SM6381	SM6421	Page 267

Operation

The channels for which the "D/A output enable/disable setting" is set to "enable" output the analog value D/A-converted from the digital value.

The channels for which the "D/A output enable/disable setting" is set to "disable" output the offset value.

Analog Output HOLD/CLEAR Function

Set whether to clear the output analog output value or to hold the previous value or setting value in accordance with the CPU module operation status (RUN, STOP or STOP (by stop error)).

Operation

When the CPU module operation status becomes "RUN", "STOP" or "STOP (by stop error)", the FX5-4DA-ADP becomes the analog output status shown in the table below in accordance with the combination of "HOLD/CLEAR setting" and "D/A output enable/disable setting".

CPU module status	D/A conversion enable/disable setting	D/A output enable/disable setting	Analog output HOLD/CLEAR setting	Output status	
RUN	Enabled	Enabled	All settings	The value after a shift and scaling	
		Disabled	All settings	Offset value	
	Disabled	Enabled	All settings	0	
		Disabled	All settings	0	
STOP (RUN→STOP, PAUSE→STOP, and Error occurs when RUN state cannot operate)	Enabled	Enabled	CLEAR	The value for which K0 was set to the digital value is output.	
			Current Value (Hold)	The value after a shift and scaling	
			Setting Value	The value set as the HOLD setting value is output.	
	Disabled	Disabled	All settings	Offset value	
			Enabled	All settings	0
			Disabled	All settings	0
PAUSE	Enabled	Enabled	All settings	The value after a shift and scaling	
		Disabled	All settings	Offset value	
	Disabled	Enabled	All settings	0	
		Disabled	All settings	0	

Setting methods

1. Set the "HOLD/CLEAR Setting" to "CLEAR", "Current Value (HOLD)" or "Setting Value".

Navigation window ⇒ [Parameter] ⇒ [Module Information] ⇒ Module model name ⇒ [Module Parameter] ⇒ "Application Settings" ⇒ "Analog Output HOLD/CLEAR Setting" ⇒ "HOLD/CLEAR Setting"

2. It is the above 1, and when "Setting Value" is chosen, a value is set to HOLD setting value.

Navigation window ⇒ [Parameter] ⇒ [Module Information] ⇒ Module model name ⇒ [Module Parameter] ⇒ "Application Settings" ⇒ "Analog Output HOLD/CLEAR Setting" ⇒ "HOLD Setting Value"

Name	Setting range
HOLD setting value	-32768 to +32767

Corresponding devices

The devices which are used by the analog output HOLD/CLEAR function are listed below.

Name	CH1	CH2	CH3	CH4	Reference
HOLD/CLEAR function setting	SD6303	SD6343	SD6383	SD6423	Page 276
HOLD setting value	SD6304	SD6344	SD6384	SD6424	Page 277

Analog Output Test when CPU Module is in STOP Status Function

Analog output tests can be carried out when the CPU module is in the STOP status.

The following functions are enabled during the analog output test.

- Scaling function ([Page 239 Scaling Function](#))
- Shift function ([Page 241 Shift Function](#))
- Warning output function ([Page 242 Warning Output Function](#))

Operation

When the "D/A conversion enable/disable setting" is set from OFF to ON and the "D/A output enable/disable setting" is set from OFF to ON, the analog output test is started and analog output is given.

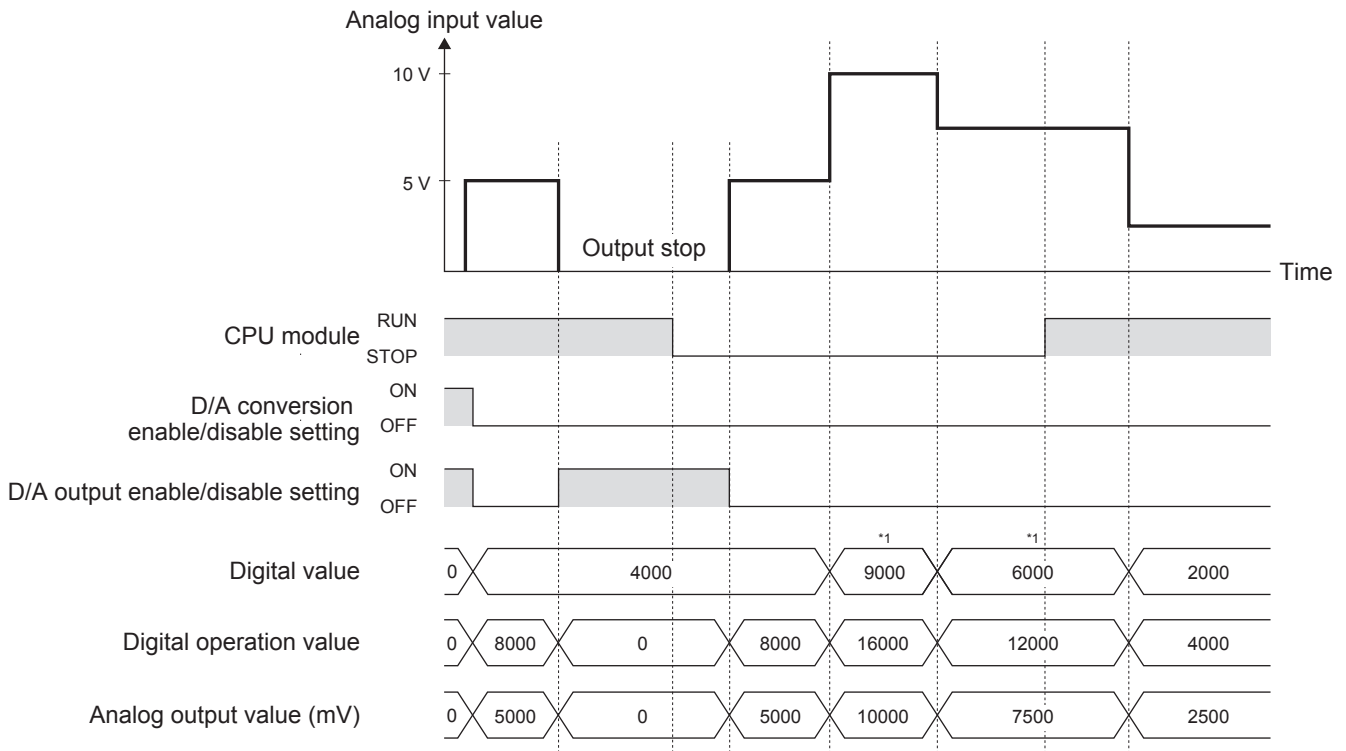

*1 Change the value using the engineering tool.

Setting methods

To perform an analog output test, configure the settings in the device test of the GX Works3 following the procedure shown below.

1. Set the digital value corresponding to the analog value to be output to the "digital value".
2. Set the "D/A conversion enable/disable setting" to OFF (Enable D/A conversion).
3. Set the "D/A output enable/disable setting" to OFF (Enable D/A output).

Corresponding devices

The devices which are used by the analog output test when CPU module is in STOP status function are listed below.

Name	CH1	CH2	CH3	CH4	Reference
D/A conversion enable/disable setting	SM6300	SM6340	SM6380	SM6420	Page 267
D/A output enable/disable setting	SM6301	SM6341	SM6381	SM6421	Page 267
Digital value	SD6300	SD6340	SD6380	SD6420	Page 275

Scaling Function

This function performs the scale conversion on digital values within a specified range between a scaling upper limit value and a scaling lower limit value. The program for scale conversion can be omitted.

Operation

This function performs the scale conversion on digital values. The values are converted within a specified range between a scaling upper limit value and scaling lower limit value. The value after the scale conversion is used for the D/A conversion. (In the scale conversion, values after the decimal point are rounded off.)

Concept of scaling setting

Ex.

When the output range is set to -10 to +10 V:

For the scaling lower limit value, set a value corresponding to the lower limit value of the output range (-8000).

For the scaling upper limit value, set a value corresponding to the upper limit value of the output range (+8000).

Calculating the scaling value

The scaling value is converted based on the calculation formula shown below. (The value below the decimal point obtained by scale conversion is rounded.)

Calculation formula	Symbol
Digital value used for D/A conversion = $\frac{D_{Max} - D_{Min}}{S_H - S_L} \times (D_X - S_L) + D_{Min}$	<p>D_X: Digital value</p> <p>D_{Max}: Maximum digital input value of the output range in use</p> <p>D_{Min}: Minimum digital input value of the output range in use</p> <p>S_H: Scaling upper limit value</p> <p>S_L: Scaling lower limit value</p>

Setting procedure

1. Set "D/A conversion enable/disable setting" to "D/A conversion enable".

Navigation window ⇒ [Parameter] ⇒ [Module Information] ⇒ Module model name ⇒ [Module Parameter] ⇒ "Basic setting" ⇒ "D/A Conversion Enable/Disable Setting"

2. Set "Scaling enable/disable setting" to "Enable".

Navigation window ⇒ [Parameter] ⇒ [Module Information] ⇒ Module model name ⇒ [Module Parameter] ⇒ "Application Settings" ⇒ "Scaling Setting"

3. Set values for "Scaling upper limit value" and "Scaling lower limit value".

Item	Setting range
Scaling upper limit value	-32768 to +32767
Scaling lower limit value	-32768 to +32767

Point

- If the relation between the values is scaling lower limit value > scaling upper limit value, the scale conversion can be performed according to a negative slope.
- Set the scaling with the condition "Scaling lower limit value ≠ Scaling upper limit value".

Corresponding devices

The devices which are used by the scaling function are listed below.

Name	CH1	CH2	CH3	CH4	Reference
Scaling enable/disable setting	SM6308	SM6348	SM6388	SM6428	Page 268
Scaling upper limit value	SD6308	SD6348	SD6388	SD6428	Page 277
Scaling lower limit value	SD6309	SD6349	SD6389	SD6429	Page 278

Setting example

Ex.

When 5000 is set to the scaling upper limit value and 1000 is set to the scaling lower limit value for the channel with the output range of 0 to 5 V

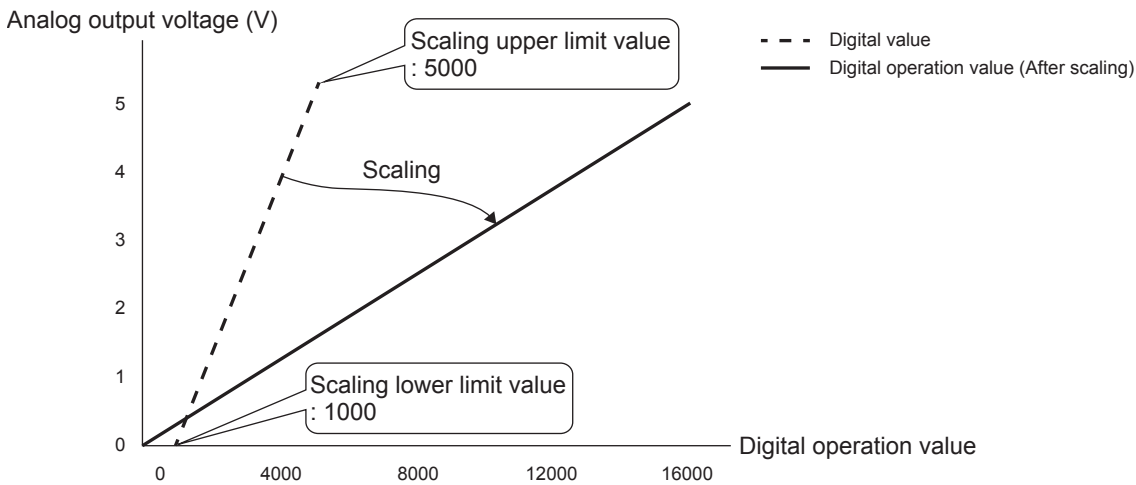

Digital value	Digital operation value (after scaling)	Output voltage (V)
1000	0	0
1800	3200	1
2600	6400	2
3400	9600	3
4200	12800	4
5000	16000	5

Ex.

When 1000 is set to the scaling upper limit value and 5000 is set to the scaling lower limit value for the channel with the output range of 0 to 5 V

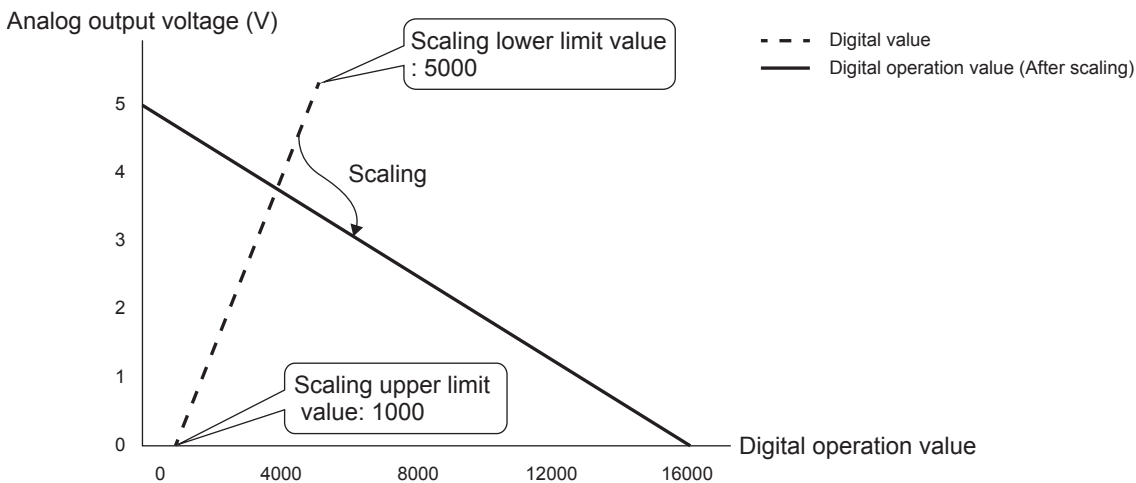

Digital value	Digital operation value (after scaling)	Output voltage (V)
1000	16000	0
1800	12800	1
2600	9600	2
3400	6400	3
4200	3200	4
5000	0	5

Shift Function

This function adds (shifts) the set input value shift amount to the digital value, and stores the result to the "digital operation value". The change in the input value shift amount is reflected in the digital operation value on real-time basis. Therefore, fine adjustment can be easily performed when the system starts.

Operation

The set "input value shift amount" is added to the digital value. The digital value obtained by the addition is stored in the "digital operation value".

When the digital value after the addition exceeds the range of -32768 to +32767 as a result of the shift processing, the value is fixed with the lower limit value (-32768) or the upper limit value (+32767).



When the scaling function is used together, the scaling processing is executed to the value after shifting.

Setting procedure

Set the shift amount to "Input value shift amount".

Navigation window ⇒ [Parameter] ⇒ [Module Information] ⇒ Module model name ⇒ [Module Parameter] ⇒ "Application Settings" ⇒ "Shift Function"

Item	Setting range
Input value shift amount	-32768 to +32767

Corresponding devices

The devices which are used by the shift function are listed below.

Name	CH1	CH2	CH3	CH4	Reference
Input value shift amount	SD6310	SD6350	SD6390	SD6430	Page 278

Setting example

Ex.

When the output range is 0 to 5V and the input value shift amount is +50

Analog output voltage (V)

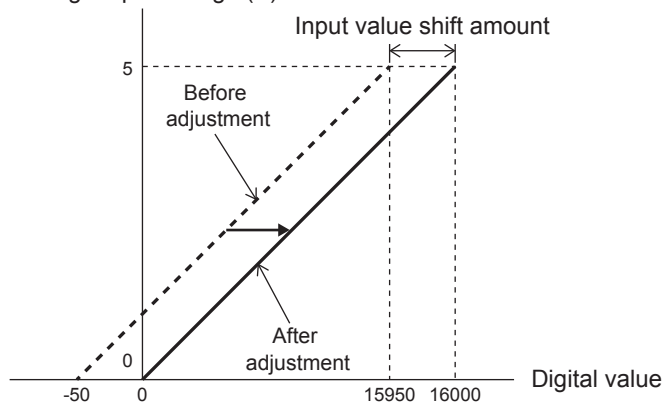

Digital value	Digital operation value	Analog output voltage (V)
Before adjustment	After adjustment	
-50	0	0
15950	16000	5

Warning Output Function

When the digital operation value to which the shift amount is added is above the warning output upper limit value or below the warning output lower limit value, warning is output.

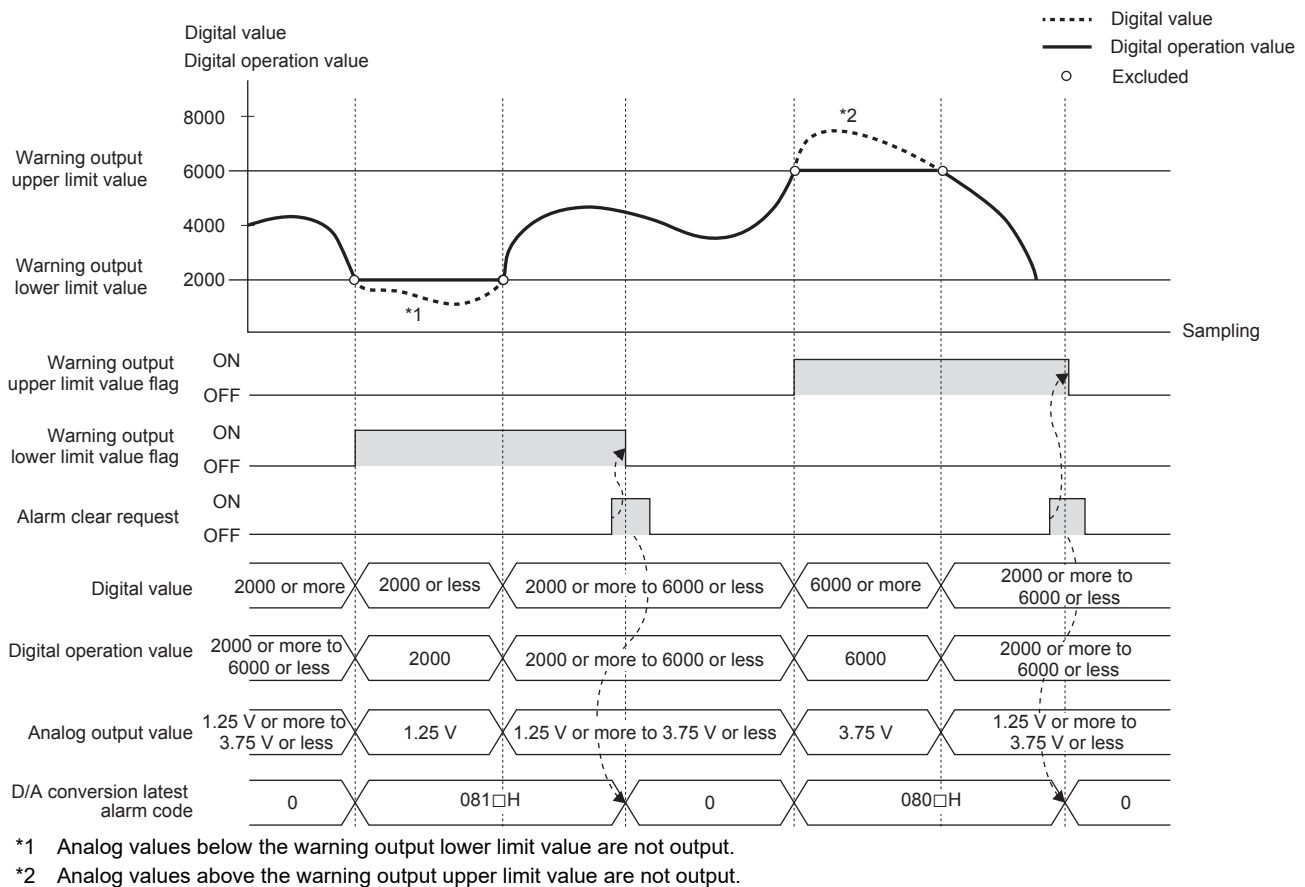

Operation

When the digital operation value to which the shift amount is added is above the warning output upper limit value or below the warning output lower limit value and the warning output condition is satisfied, the "warning output upper flag" or "warning output lower flag" turns ON.

When warning is output, the setting value of the "warning output upper limit value/warning output lower limit value" is regarded as the digital operation value and D/A-converted.

Even if the digital value changes to a value below the warning output upper limit value and above the warning output lower limit value after the warning output, the "warning output upper flag" and "warning output lower flag" do not turn OFF. When the alarm clear request is set to OFF, ON and OFF again, the "warning output upper flag" and "warning output lower flag" turn OFF. The "warning output upper flag" and "warning output lower flag" turn OFF also when the "warning output enable/disable" setting is changed to "disable", but the alarm code stored in the "D/A conversion latest alarm code" is not cleared.

For clearing the alarm code stored in the "D/A conversion latest alarm code", set the alarm clear request to OFF, ON and OFF again.

Setting procedure

1. Set "Warning Output Function" to "Enable".

Navigation window ⇒ [Parameter] ⇒ [Module Information] ⇒ Module model name ⇒ [Module Parameter] ⇒ "Application Settings" ⇒ "Warning Output Function"

2. Set values for "Warning output upper limit value" and "Warning output lower limit value".

Item	Setting range
Warning output upper limit value	-32768 to +32767
Warning output lower limit value	

Set the warning output upper limit value and warning output lower limit value while satisfying the condition "Warning output upper limit value > Warning output lower limit value".

Corresponding devices

The devices which are used by the alarm output function are listed below.

Name	CH1	CH2	CH3	CH4	Reference
Warning output upper limit value flag	SM6311	SM6351	SM6391	SM6431	Page 268
Warning output lower limit value flag	SM6312	SM6352	SM6392	SM6432	Page 268
Warning output setting	SM6313	SM6353	SM6393	SM6433	Page 269
Warning output upper limit value	SD6311	SD6351	SD6391	SD6431	Page 278
Warning output lower limit value	SD6312	SD6352	SD6392	SD6432	Page 279

External Power Supply Disconnection Detection Function

This function detects that the external power (24 V DC) is not supplied to the FX5-4DA-ADP or the supply is stopped.

Setting procedure

The user does not need to configure any settings.

Operation

The error occurs when the external power is not input. (Error code: 3081H)

Disconnection Detection Function

Disconnection can be detected in each channel.

This function is enabled when the analog output range is 4 to 20 mA.

Setting procedure

1. Set "Disconnection detection enable/disable setting" to "Enable".

 Navigation window ⇒ [Parameter] ⇒ [Module Information] ⇒ Module model name ⇒ [Module Parameter] ⇒ "Application Settings" ⇒ "Disconnection detection enable/disable setting"

2. Set "Disconnection recovery detection enable/disable setting".

 Navigation window ⇒ [Parameter] ⇒ [Module Information] ⇒ Module model name ⇒ [Module Parameter] ⇒ "Application Settings" ⇒ "Disconnection recovery detection enable/disable setting"

Corresponding devices

The devices which are used by the disconnection detection function are listed below.

Name	CH1	CH2	CH3	CH4	Reference
Disconnection detection flag	SM6318	SM6358	SM6398	SM6438	Page 269
Disconnection detection enable/disable setting	SM6319	SM6359	SM6399	SM6439	Page 269
Disconnection recovery detection enable/disable setting	SM6320	SM6360	SM6400	SM6440	Page 270

Operation

When disconnection is detected in a channel for which the "D/A conversion enable/disable setting" is set to "D/A conversion enable" and the "disconnection detection enable/disable setting" is set to "enable", it is regarded as a disconnection detection error, and the "disconnection detection flag" turns ON (Error code: 1BB□).

At this time, the digital value, digital operation value and analog output value monitor are cleared.

When the "disconnection recovery detection enable/disable setting" is set to "enable", the "disconnection detection flag" turns OFF when the channel is recovered from disconnection.

When the "disconnection recovery detection enable/disable setting" is set to "disable", the "disconnection detection flag" remains ON even if the channel is recovered from disconnection.

It is necessary to set the "error clear request" (SM50) of the CPU module to ON to turn OFF the "disconnection detection flag". The "disconnection detection flag" turns OFF also when the "disconnection detection enable/disable setting" is changed to "disable".

■When the "disconnection detection recovery enable/disable setting" is set to "enable"

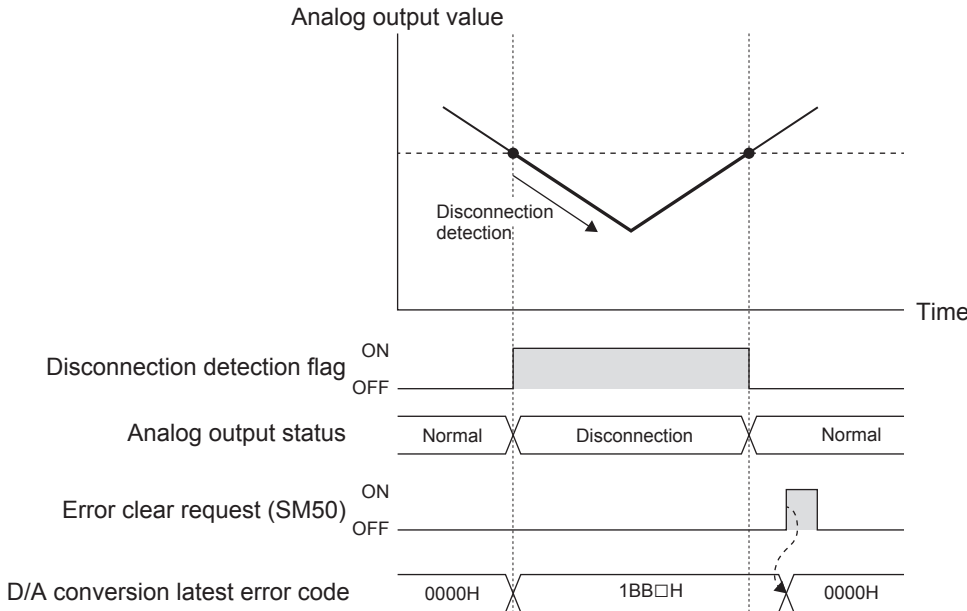

Point

- The "disconnection detection flag" automatically turns OFF.
- To clear the "D/A conversion latest error code", set the "error clear request" (SM50) of the CPU module to ON.

■When the "disconnection detection recovery enable/disable setting" is set to "disable"

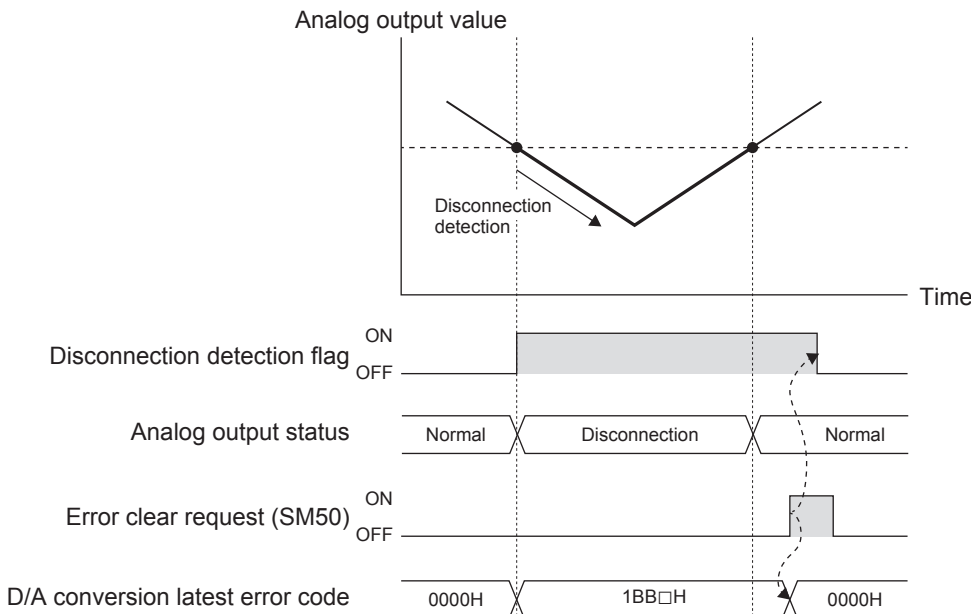

Point

- The "disconnection detection flag" does not turn OFF. To turn OFF this flag, set the alarm clear request to ON.
- To clear the "D/A conversion latest error code", set the "error clear request" (SM50) of the CPU module to ON.

Event History Function

This function collects errors from FX5-4DA-ADP, and keeps them in the SD memory card, and data memory or battery backed built-in RAM of the CPU module.

The event information collected by the CPU module can be displayed on GX Works3 to check the occurrence history in chronological order.

Event type	Classification	Description
System	Error	An error detected by the self diagnostics in each module.

Setting procedure

The event history function can be set from the event history setting window of GX Works3. For the setting procedure, refer to the following.

MELSEC iQ-F FX5 User's Manual (Application)

Displaying event history

Access the menu of GX Works3. For details on the operating procedure and how to view the contents, refer to the following.

GX Works3 Operating Manual

Offset/gain Setting Function

This function sets any analog value to the offset/gain value without regard to the setting prepared in advance as the analog output range. The offset setting value and gain setting value are saved in the built-in memory of the FX5-4DA-ADP.

For changing the offset/gain data, set an analog value to the "offset setting value" or "gain setting value".

The table below shows the available setting range.

Item	Description	Setting range	
		Voltage output (mV)	Current output (μA)
Offset setting value	Analog output value when the digital value is "0" (offset reference value)	-10000 to +9000	0 to 17000
Gain setting value	Analog output value when the digital value is the gain reference value	-9000 to +10000	3000 to 30000

Point

An offset/Gain setting value range error occurs when the following condition is not satisfied: (Error code: 1B9□H)

- Voltage output: $1000 \leq \text{Gain setting value} - \text{Offset setting value} \leq 10000$
- Current output: $3000 \leq \text{Gain setting value} - \text{Offset setting value} \leq 30000$

The table below shows the reference value and initial value of the offset/gain setting value.

Description		Digital value	Offset setting value		Gain setting value	
Voltage/current	Output range		Reference value	Default value	Reference value	Default value
Voltage	0 to 10 V	0 to 16000	0	0 mV	8000	5000 mV
	0 to 5 V	0 to 16000	0	0 mV	16000	5000 mV
	1 to 5 V	0 to 16000	0	1000 mV	16000	5000 mV
	-10 to +10 V	-8000 to +8000	0	0 mV	4000	5000 mV
Current	0 to 20 mA	0 to 16000	0	0 μA	16000	20000 μA
	4 to 20 mA	0 to 16000	0	4000 μA	16000	20000 μA

Setting procedure

Access to the offset/gain setting window in the GX Works3 to set the offset and gain values.

The setting procedure for the offset/gain setting of the FX5-4DA-ADP is as follows:

[Tool] ⇒ [Module Tool List]

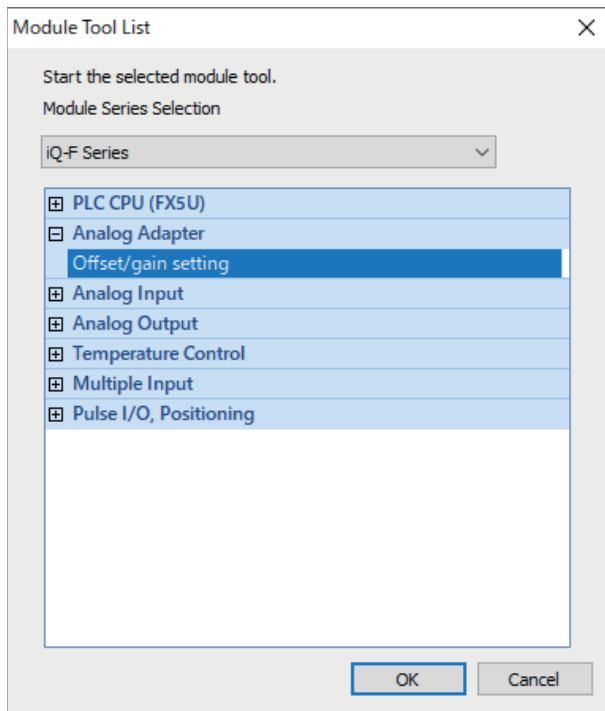

1. Select "Analog Adapter" ⇒ " Offset/gain setting" and click the [OK] button.

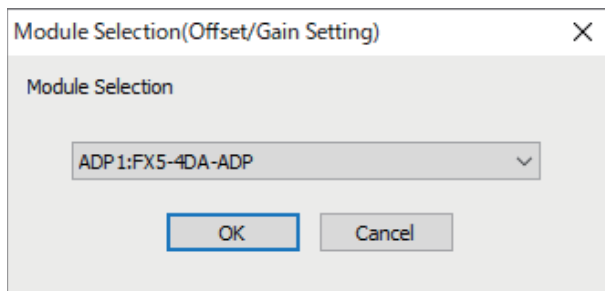

2. Select the target module for the offset/gain setting, and click [OK] button.

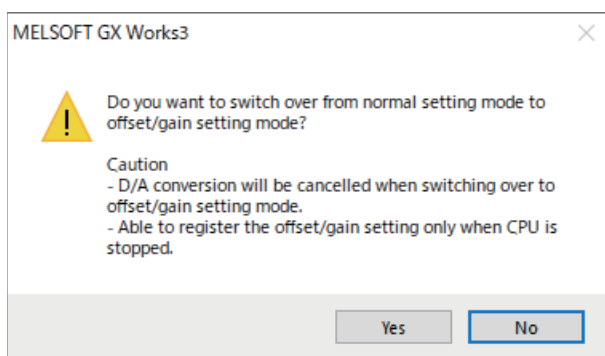

3. Click the [Yes] button.

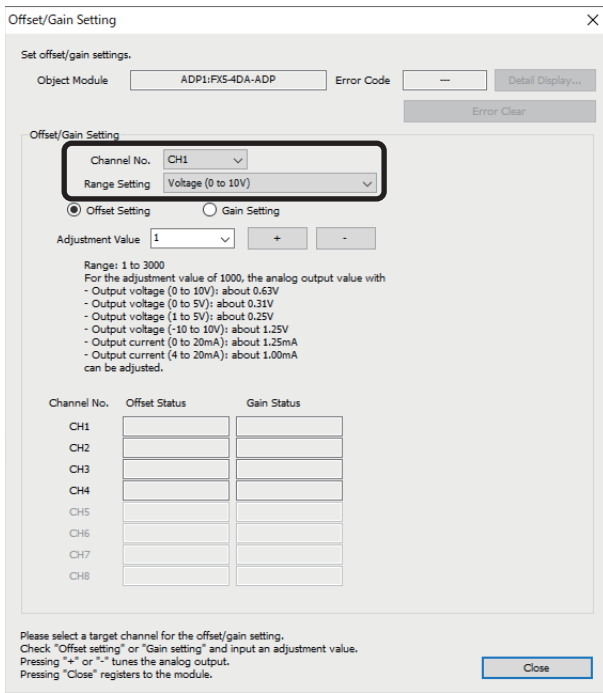

4. Specify the channel to configure the offset/gain setting and the user range setting.

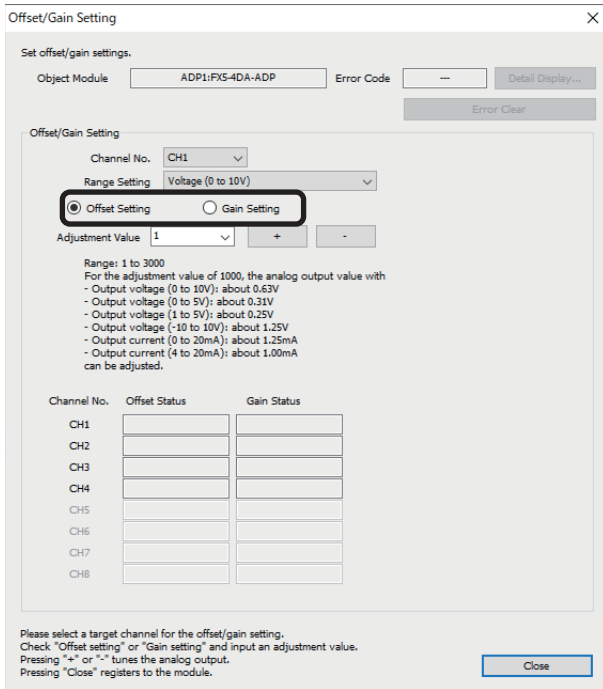

5. Use the radio button to specify whether to perform the offset setting or gain setting. (Step 6 and later describe the case when the offset setting is specified.)

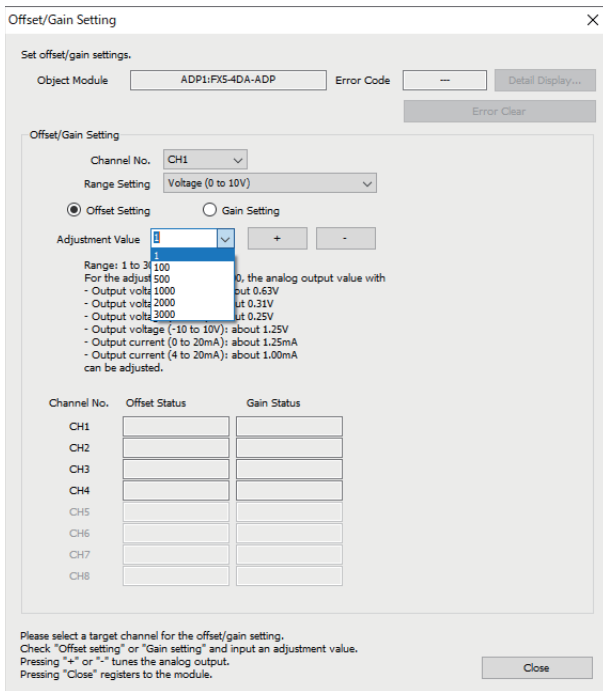

6. The adjustment value of the offset value or gain value can be selected from "1", "100", "500", "1000", "2000", and "3000" or it can be set by inputting any value (1 to 3000).

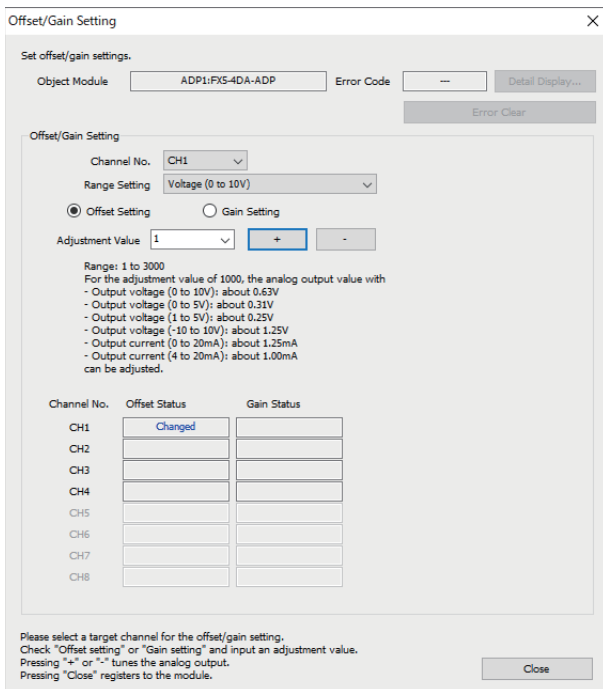

7. Clicking the [+ (+)] or [- (-)] button fine-tunes the analog output voltage or analog output current value corresponding the set adjustment value.

8. Check that the offset setting status in the selected channel has changed to "Changed".

9. To perform the gain setting, repeat the procedure from step 5.

10. After setting is completed, click the [Close] button.

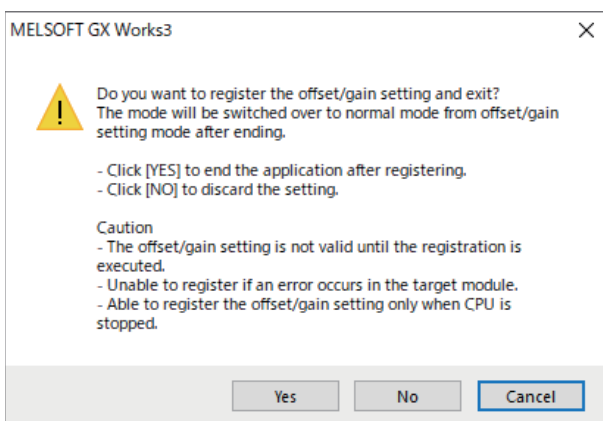

11. Click the [Yes] button.

Corresponding devices

The devices which are used by the offset/gain setting function are listed below.

Name	CH1	CH2	CH3	CH4	Reference
Offset/gain reading	SM6332	SM6372	SM6412	SM6452	Page 270
Offset/gain writing	SM6333	SM6373	SM6413	SM6453	Page 270
Offset setting value	SD6332	SD6372	SD6412	SD6452	Page 279
Gain setting value	SD6333	SD6373	SD6413	SD6453	Page 279
Offset/gain writing enable code	SD6334	SD6374	SD6414	SD6454	Page 280

Operation

■Offset/gain writing

For changing the offset/gain data, set "E210H" to the "offset/gain writing enable code" and set the "offset/gain writing" from OFF to ON to write the "output range setting", "offset setting value" and "gain setting value" to the built-in memory of the FX5-4DA-ADP. Only 1 range can be changed for 1 channel, and the latest contents are valid.

When writing is completed, the "offset/gain writing" automatically turns OFF. Also, the "offset/gain writing enable code" is cleared to 0.

When the "output range setting" is changed, the initial value becomes valid.

For returning the offset/gain data to the initial value, use the offset/gain initialization function (☞ Page 250 Offset/gain Initialization Function).

Point

- The offset/gain value is written when the "offset/gain writing enable code" is set to "E210H".
- The offset/gain value can be written only while D/A conversion is disabled.
- The "D/A conversion enable/disable setting" cannot be changed to "enable" while the offset/gain value is being written.

■Offset/gain reading

For reading the offset/gain data saved in the built-in memory of the FX5-4DA-ADP, set the "offset/gain reading" from OFF to ON to read the "output range setting", "offset setting value" and "gain setting value".

When the output range setting selected during reading is equivalent to the output range setting saved in the built-in memory of the FX5-4DA-ADP, the read values are set to the "offset setting value" and "gain setting value".

If the output range setting is different, the initial value of the output range setting selected during reading is valid and set to the "offset setting value" and "gain setting value". In this case, the offset/gain setting output range mismatch alarm occurs (Alarm code: 0C0□H).

Offset/gain Initialization Function

This function initializes the offset value and gain value saved in the built-in memory of the FX5-4DA-ADP.

This function can be set only with special devices.

Setting procedure

1. Set "E210H" to the "offset/gain writing enable code".

Setting value	Description	Default value
Other than E210H	Offset/gain writing disable	0
E210H	Offset/gain writing enable	

2. Set the "offset/gain initialization" from OFF to ON.

Setting value	Description	Default value
0: OFF	Offset/gain initialization is not performed.	0: OFF
1: ON	Offset/gain initialization is performed.	

Corresponding devices

The devices which are used by the offset/gain initialization function are listed below.

Name	CH1	CH2	CH3	CH4	Reference
Offset/gain initialization	SM6334	SM6374	SM6414	SM6454	Page 271
Offset/gain writing enable code	SD6334	SD6374	SD6414	SD6454	Page 280

Operation

Set "E210H" to the "offset/gain writing enable code" and set the "offset/gain initialization" from OFF to ON to initialize the offset value and gain value saved in the built-in memory of the FX5-4DA-ADP. When initialization is completed, the "offset/gain initialization" automatically turns OFF. Also, the "offset/gain writing enable code" is cleared to 0.

Point

- Offset/gain initialization is executed when the "offset/gain writing enable code" is set to "E210H".
- Offset/gain initialization is enabled only while D/A conversion is disabled.
- The "D/A conversion enable/disable setting" cannot be changed to "enable" while offset/gain initialization is being executed.

Common Function

Changing the setting value while the CPU module is operating

This paragraph shows the procedure to adopt values (of special relays and special registers) other than the values set by the parameters of GX Works3.

1. Disable D/A conversion.

Set "D/A conversion enable/disable setting" to ON. (☞ Page 267 D/A conversion enable/disable setting)

2. Change the value of a target special relay/device.

Change the value of a target device.

3. Enable D/A conversion.

Set "D/A conversion enable/disable setting" to OFF. (☞ Page 267 D/A conversion enable/disable setting)

Precautions

An alarm occurs when the value of a special relay/device is changed while D/A conversion is enabled (Alarm code: 0F00H).

Starting/stopping the analog function in accordance with the CPU module status

This paragraph shows the analog operation in accordance with the CPU module status.

■RUN

The FX5-4DA-ADP operates in accordance with its parameters.

■PAUSE

The FX5-4DA-ADP operates in accordance with its parameters.

■STOP

Outputs are enabled even in the STOP status by using the analog test mode available when the CPU module is in the STOP status. (☞ Page 238 Analog Output Test when CPU Module is in STOP Status Function)

Alarm clear request

It is necessary to set the "alarm clear request" for from OFF to ON clearing the alarm code.

The table below shows the necessity of the alarm clear request for turning OFF each flag and clearing the alarm code.

Flag name	Alarm clear request required to turn OFF the flag	Alarm clear request required to clear the alarm code
Warning output upper limit value flag	○	○
Warning output lower limit value flag	○	○
Disconnection detection flag	—*1	—*2

*1 The "error clear request" (SM50) of the CPU module is required when disconnection recovery is set to "disable".

*2 The "error clear request" (SM50) of the CPU module is required for clearing the error code.

○: Requires the alarm clear request.

—: Does not require the alarm clear request.

Point

- The alarm clear of the CPU module request is required for flags which do not turn OFF automatically and flags which cause alarms.
- Use the "error clear request" (SM50) of the CPU module to turn OFF the D/A conversion error flag and clear the D/A conversion latest error code.

5.4 Procedure to Execute the FX5-4DA-ADP

The procedure to execute the FX5-4DA-ADP is described below.

1. Confirm the specifications of the FX5-4DA-ADP.

Confirm the specifications of the FX5-4DA-ADP. (☞ Page 228 Specifications)

2. Check the system configuration.

Check the system configuration. (☞ Page 253 System Configuration)

3. Attach the FX5-4DA-ADP.

Refer to the following manuals for attachment to the CPU module:

📖 MELSEC iQ-F FX5UJ User's Manual (Hardware)

📖 MELSEC iQ-F FX5U User's Manual (Hardware)

📖 MELSEC iQ-F FX5UC User's Manual (Hardware)

4. Connect the FX5-4DA-ADP to the external device.

Wiring to external devices. (☞ Page 254 Wiring)

5. Set the parameters.

Set the parameters to configure the FX5-4DA-ADP. (☞ Page 258 Parameter Setting)

6. Create the program.

Create the program to use the FX5-4DA-ADP.

7. Run the program.

Precautions

Do not write to the special relay/special register in the user interrupt program.

5.5 System Configuration

This section describes the system configuration including analog adapters.

Up to two analog adapters can be connected to an FX5UJ CPU module.

Up to four analog adapters can be connected to an FX5U/FX5UC CPU module.*1

The connection position of the analog adapter connected to each CPU module are counted as the first module, the second module, and so on in order of proximity to the CPU module.

However, communication adapters are not counted towards the number of analog adapters.

■FX5UJ CPU module

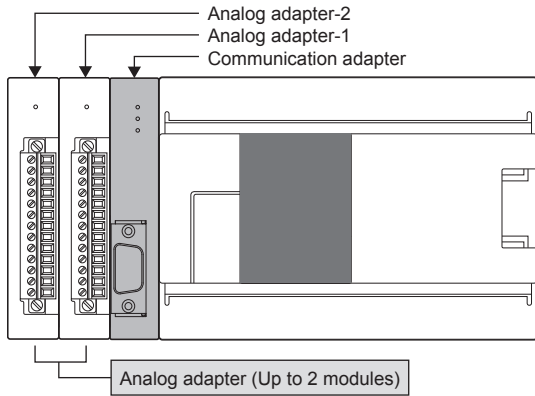

■FX5U CPU module

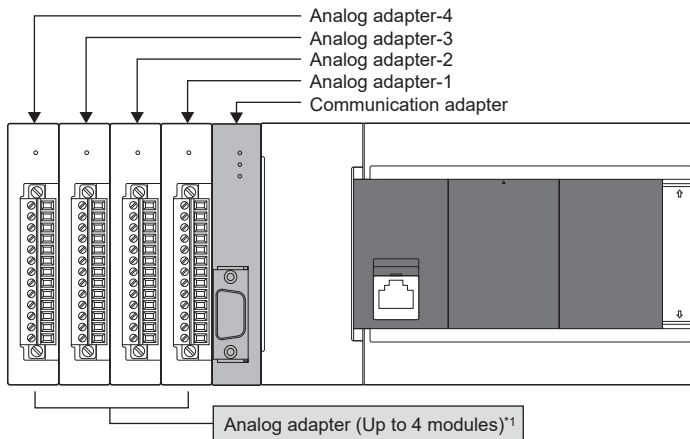

■FX5UC CPU module

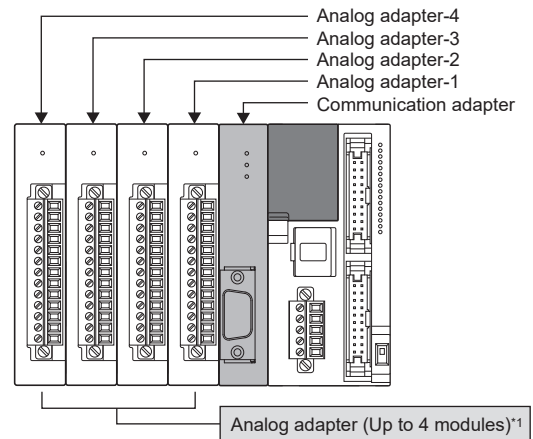

*1 For FX5-4A-ADP, up to two modules can be connected.

5.6 Wiring

This section describes the wiring.

European-type terminal block

Wire the European-type terminal block in accordance with the following specifications.

Suitable wiring

Number of wires connected per terminal	Wire size		Tightening torque
	Solid wire, Stranded wire	Wire ferrule with insulation sleeve	
One wire	0.3 to 0.5 mm ² (AWG22 to 20)	0.3 to 0.5 mm ² (AWG22 to 20)	0.20 N·m
Two wires	0.3 mm ² (AWG22)	—	

Precautions

Do not tighten terminal screws with torque exceeding the specified range. Failure to do so may cause equipment failures or malfunctions.

Wire end treatment

Treat stranded and solid wires as they are or use wire ferrules with insulation sleeves for wiring terminals.

■When stranded and solid wires are treated as they are

- Twist the end of stranded wires and make sure that there are no loose wires.
- Do not solder-plate the electric wire ends.

Stripping dimensions of electric wire ends

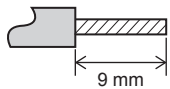

■When wire ferrules with insulation sleeves are used

Depending on the thickness of a wiring sheath used, it may be difficult to insert the sheath into an insulation sleeve. Refer to the external dimensions as a reference to select wires.

External dimension of wire ferrules with insulation sleeves

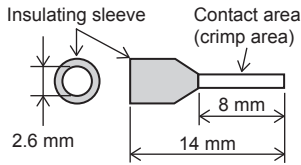

<Reference>

Manufacturer	Model	Crimp tool
Phoenix Contact GmbH & Co. KG	Al 0.5-6 WH	CRIMPFOX 6 CRIMPFOX 6T-F

■Tool

For tightening terminals, use a small, commercially-available screwdriver with a straight tip. The recommended shape is shown in the figure on the right.

■Precautions

When a precision screwdriver with a small grip is used, the specified tightening torque cannot be obtained. Use the following screwdriver or equivalent product (grip diameter: 25 mm) to obtain the tightening torque specified above.

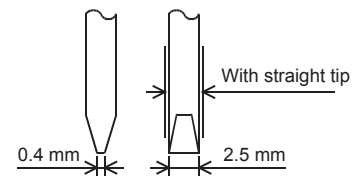

<Reference>

Manufacturer	Model
Phoenix Contact GmbH & Co. KG	SZS 0.4×2.5

Terminal layout

The following table shows the terminal layout.

Terminal block	Signal name	Function	
	V1+	CH1 Voltage output	
	I1+		Current output
	COM1		Common
	V2+	CH2 Voltage output	
	I2+		Current output
	COM2		Common
	V3+	CH3 Voltage output	
	I3+		Current output
	COM3		Common
	V4+	CH4 Voltage output	
	I4+		Current output
	COM4		Common
	•	Do not wire this terminal.	

Terminal block	Signal name	Function
	+	24 V DC power supply (+)
	-	24 V DC power supply (-)
	⊥	Ground

Power supply wiring

The following figures show wiring of the power supply.

To connect to the FX5UJ/FX5U CPU module

[When an external power supply is used]

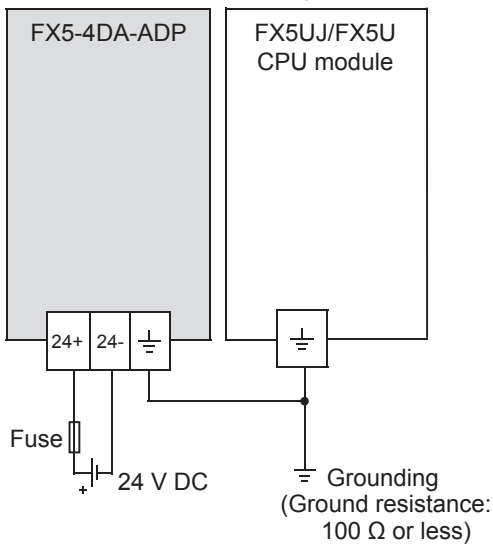

[When a service power supply is used]

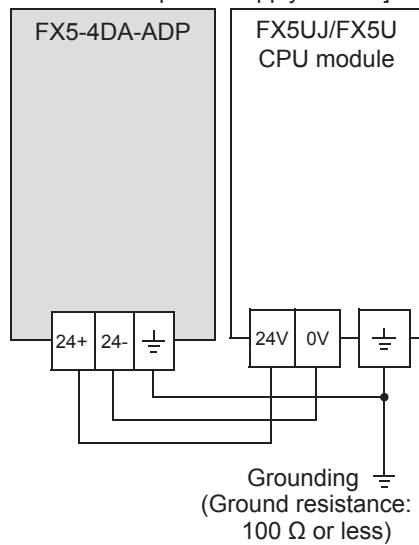

Precautions

- Ground the "ground" terminal to a class-D grounded power supply line (100 Ω or less) together with the grounding terminal of the CPU module.
- When using an external power supply, turn on the power supply at the same time as the CPU module or earlier than the CPU module. When turning off the power, confirm the safety of the system and turn off the power of the PLC (including expansion adapters) at the same time.

To connect to the FX5UC CPU module

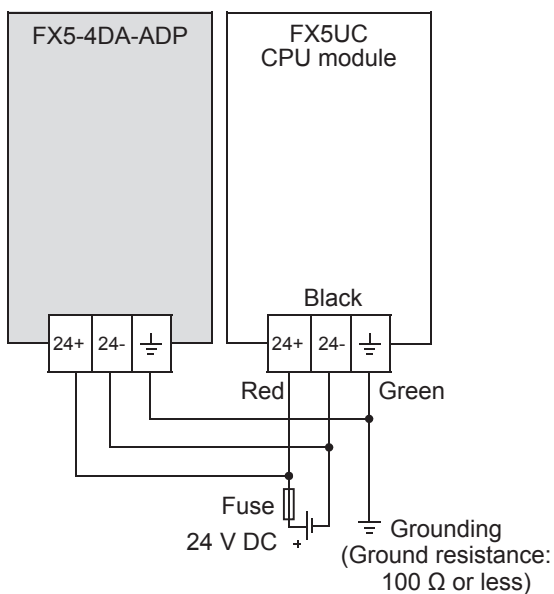

Precautions

- Ground the "ground" terminal to a class-D grounded power supply line (100 Ω or less) together with the grounding terminal of the CPU module.
- For the 24 V DC power supply, be sure to use the same power as the CPU module.

Analog output wiring

The following figures show wiring of the analog output.

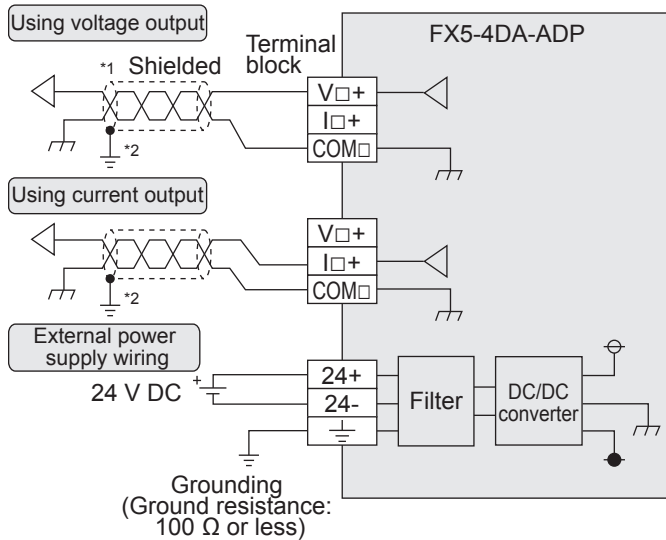

V□+, I□+, COM□, CH□: □ represents the channel number.

- *1 For analog output wiring, use shielded twisted-pair cables (double-core type). Separate them from other power lines or lines which can be induced by others.
- *2 Ground a shielded cable at one point on the signal receiving side.

Grounding

Perform the following.

- Perform class D grounding (Grounding resistance: 100 Ω or less).
- Ground the PLC independently when possible.

If the PLC cannot be grounded independently, perform the "Shared grounding" shown below.

For the details, refer to the following manual.

📖 MELSEC iQ-F FX5UJ User's Manual (Hardware)

📖 MELSEC iQ-F FX5U User's Manual (Hardware)

📖 MELSEC iQ-F FX5UC User's Manual (Hardware)

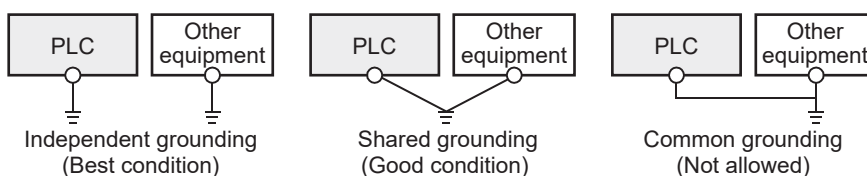

- Use a grounding wire with thickness of AWG 22 to 20 (0.3 to 0.5 mm²).
- Bring the grounding point close to the PLC as much as possible so that the ground cable can be shortened.

5.7 Parameter Setting

Set the parameters of each channel.

Setting parameters here eliminates the need to program them.

Point

Parameters are enabled when the CPU module is powered ON or after a reset. In addition, operations different from the parameter settings are possible by transferring values to special relays and special registers while changing these values in the program.

Refer to Page 265 List of Special Relays or Page 273 List of Special Registers for details on the special relays and special registers.

Basic settings

Setting procedure

Open "Basic Settings" of the GX Works3.

1. Start Module parameter.

Navigation window ⇒ [Parameter] ⇒ [Module Information] ⇒ Module model name ⇒ [Module Parameter] ⇒ "Basic Settings"

Window

Item	CH1	CH2	CH3	CH4
D/A Conversion Enable/Disable Setting Function	Set Enable/Disable D/A conversion.			
D/A Conversion Enable/Disable Setting	Disable	Disable	Disable	Disable
D/A Output Enable/Disable Setting	Set Enable/Disable D/A output.			
D/A Output Enable/Disable Setting	Disable	Disable	Disable	Disable
Range switching function	Able to set the analog input range and to change the input conversion characteristics.			
Output range setting	Output Voltage (0 to 10V)	Output Voltage (0 to 10V)	Output Voltage (0 to 10V)	Output Voltage (0 to 10V)

Displayed items

Item	Description	Setting range	Default
D/A Conversion Enable/Disable Setting	Set whether to "enable" or "disable" D/A conversion.	<ul style="list-style-type: none"> • Disable • Enable 	Disable
D/A Output Enable/Disable Setting	Set whether to "enable" or "disable" D/A output.	<ul style="list-style-type: none"> • Disable • Enable 	Disable
Output range setting	Setting area for output range setting.	<ul style="list-style-type: none"> • Output Voltage (0 to 10 V) • Output Voltage (0 to 5 V) • Output Voltage (1 to 5 V) • Output Voltage (-10 to 10 V) • Output Current (0 to 20 mA) • Output Current (4 to 20 mA) 	Output Voltage (0 to 10 V)

2. Click the item to be changed to enter the setting value.

- Item where a value is selected from the pull-down list

Click [▼] button of the item to be set, and from the pull-down list that appears, select the value.

- Item where a value is entered into the text box

Double-click the item to be set to enter the numeric value.

Application settings

Setting procedure

Open "Application Settings" of the GX Works3.

1. Start Module parameter.

Navigation window ⇒ [Parameter] ⇒ [Module Information] ⇒ Module model name ⇒ [Module Parameter] ⇒ "Application Settings"

Window

Item	CH1	CH2	CH3	CH4
Warning Output Function	Execute the setting related to warning at D/A conversion.			
Warning Output Setting	Disable	Disable	Disable	Disable
Warning output upper limit value	0	0	0	0
Warning output lower limit value	0	0	0	0
Scaling Setting	Execute the setting related to scaling at D/A conversion.			
Scaling Enable/Disable	Disable	Disable	Disable	Disable
Scaling Upper Limit Value	0	0	0	0
Scaling Lower Limit Value	0	0	0	0
Shift Function	Execute the setting related to shift function at D/A conversion.			
Shifting amount to conversion value	0	0	0	0
Analog Output HOLD/CLEAR Setting	It can be set whether to HOLD the last value, setting value or CLEAR/D/A conversion digital value according to CPU			
HOLD/CLEAR Setting	Current Value (Hold)	Current Value (Hold)	Current Value (Hold)	Current Value (Hold)
HOLD Setting Value	0	0	0	0
Disconnection detection function	Set value for Disconnection detection.			
Disconnection detection enable/disable setting	Disable	Disable	Disable	Disable
Disconnection recovery detection enable/disable setting	Disable	Disable	Disable	Disable

Displayed items

Item	Description	Setting range	Default
Warning Output Setting	Set whether to "enable" or "disable" warning output.	• Disable • Enable	Disable
Warning output upper limit value	Set upper limit value of digital input value for warning output.	-32767 to +32767	—
Warning output lower limit value	Set lower limit value of digital input value for warning output.	-32768 to +32766	—
Scaling Enable/Disable	Set whether to "enable" or "disable" scaling.	• Disable • Enable	Disable
Scaling Upper Limit Value	Set scaling conversion upper limit value.	-32768 to +32767	—
Scaling Lower Limit Value	Set scaling conversion lower limit value.	-32768 to +32767	—
Shifting amount to conversion value	Set shifting amount for shift function.	-32768 to +32767	0
HOLD/CLEAR Setting	Set output status at CLEAR or HOLD.	• CLEAR • Current Value (Hold) • Setting Value	Current Value (Hold)
HOLD Setting Value	Set digital value that output at HOLD for each channel when "setting value" is selected in "HOLD/CLEAR setting".	-32768 to +32767	—
Disconnection detection enable/disable setting	Set whether to "enable" or "disable" disconnection detection.	• Disable • Enable	Disable
Disconnection recovery detection enable/disable setting	Set whether to "enable" or "disable" disconnection recovery detection.	• Disable • Enable	Disable

2. Click the item to be changed to enter the setting value.

- Item where a value is selected from the pull-down list

Click [▼] button of the item to be set, and from the pull-down list that appears, select the value.

- Item where a value is entered into the text box

Double-click the item to be set to enter the numeric value.

5.8 Troubleshooting

This section describes errors that may occur in the use of the FX5-4DA-ADP and those troubleshooting.

Troubleshooting with the LEDs

Check the state of the LED to narrow down the possible causes of the trouble. This step is the first diagnostics.

A state of the FX5-4DA-ADP can be checked with the PWR LED. The following table shows the correspondence of LED and a state of the FX5-4DA-ADP.

Name	Description
PWR LED	Indicates the power supply status of the FX5-4DA-ADP. On: The power supply is supplied. Off: The power supply is not supplied.

Checking the state of the module

Open the module diagnostics window of the GX Works3 to check the error codes (alarm codes) and error history of the FX5-4DA-ADP.

[Diagnostics] ⇒ [Module Diagnostics (CPU Diagnostics)]

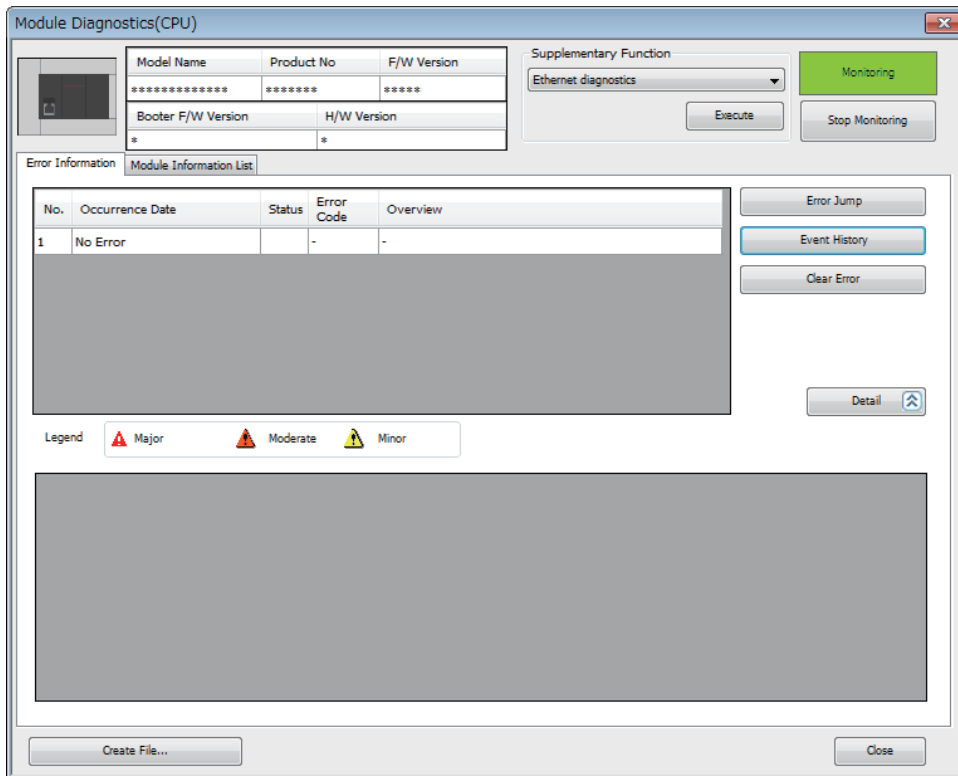

Error history, alarm history can be checked with the event history window of the GX Works3.

[Diagnostics] ⇒ [[Module Diagnostics (CPU Diagnostics)] ⇒ [Event History] button

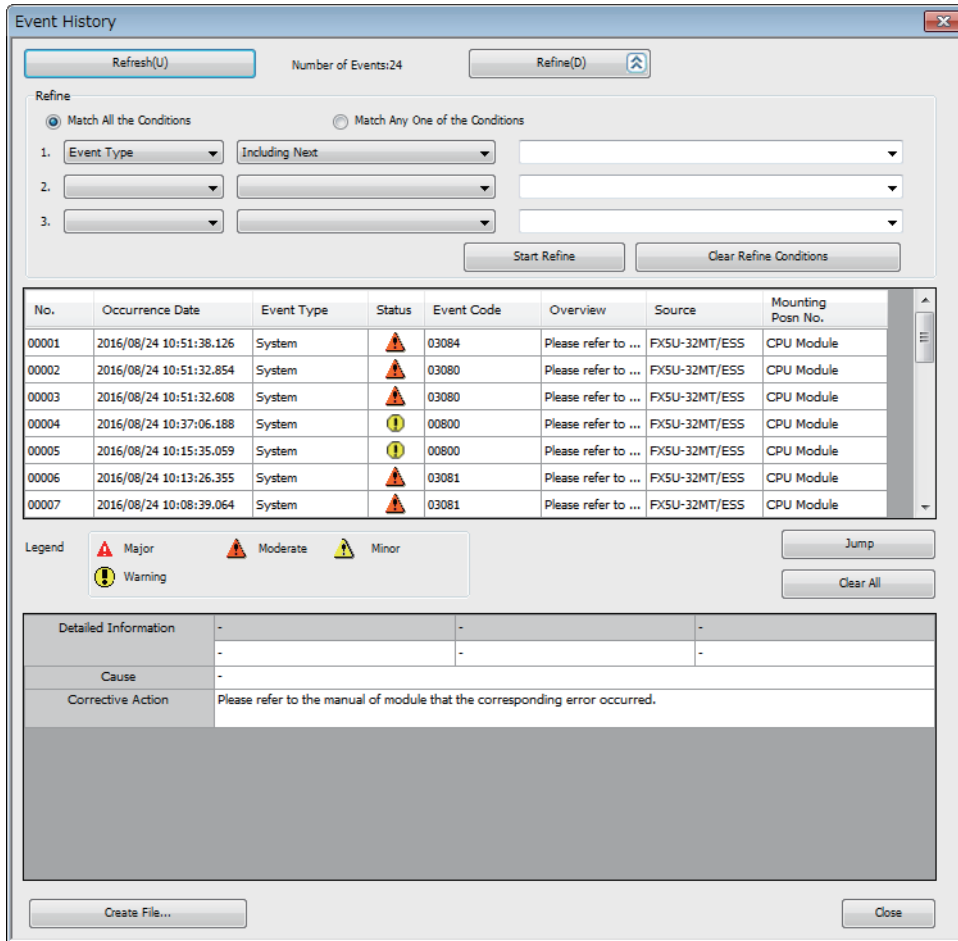

Troubleshooting by Symptom

When the PWR LED does not turn ON

Check item	Action
Whether the power is supplied	Check whether the voltage supplied to the FX5-4DA-ADP is within the rated range.
Whether the FX5-4DA-ADP is attached normally to the CPU module	Check the FX5-4DA-ADP attached status.

When the analog output value is not given

Check item	Action
Whether the analog signal cable is connected normally to the FX5-4DA-ADP	Check the signal cables visually, and wire the analog signal cable correctly.
Whether the external equipment is wired correctly	Wire the external equipment correctly to the FX5-4DA-ADP.
Whether 24 V DC is supplied as the external power to the FX5-4DA-ADP	Supply 24 V DC to the FX5-4DA-ADP.
Whether the "D/A conversion enable/disable setting" is set to "enable" for the channel to be used	Check the "D/A conversion enable/disable setting" for the channel to be used in the parameter setting of GX Works3, and set "enable" in the parameter of GX Works3 or in the program.
Whether the "D/A output enable/disable setting" is set to "enable" for the channel to be used for output	Check the "D/A output enable/disable setting" for the channel to be used in the parameter setting of GX Works3, and set "enable" in the parameter of GX Works3 or in the program.
Whether the digital value is written to the channel to be used for output	Check the digital value in GX Works3.

When the analog output value does not change

Check item	Action
Whether the CPU module operation status is "STOP" or "STOP (by stop error)"	The analog output HOLD/CLEAR function is being executed. Set the CPU module to the "RUN" status, and check whether analog output is given normally. When an error causing stop occurs, remove the cause of the error, and then turn OFF and ON the CPU module or reset the CPU module.

When a value is not converted into the expected analog output value

Check item	Action
Whether the output range is set correctly	Check the output range setting in the parameter setting of GX Works3. If the contents of setting are wrong, set the output range again.
Whether the offset/gain is set correctly	Check whether the offset/gain is set correctly. Check whether D/A conversion is executed correctly. When D/A conversion is executed correctly, set the offset/gain again.
Whether the scaling function is set correctly	When the scaling function is used, check the scaling function setting in the parameter setting of GX Works3. If the contents of setting are wrong, set the scaling function again.
Whether the shift function is working with a proper setting value	Set the input value shift amount suitable for the system.
Whether a digital value above the warning output upper limit value or below the warning output lower limit value is set	When the warning output function is used, check the warning output function setting in the parameter setting of GX Works3. When the contents of setting are all right, check whether the digital value is not set outside the warning output range.

When the analog output value is not held

Check item	Action
Whether the CPU module operation status is "STOP" or "STOP (by stop error)"	Check the CPU module operation status. The analog output HOLD/CLEAR function is enabled when the CPU module is in the "STOP" or "STOP (by stop error)" status.
Whether the analog output HOLD/CLEAR function is set correctly	Check the analog output HOLD/CLEAR function setting in the parameter setting of GX Works3. If the contents of setting are wrong, set the analog output HOLD/CLEAR function again.
Whether the PWR LED is lit	Reset the CPU module, and check whether the PWR LED turns ON.

Point

If digital values cannot be read even after the above actions are taken, the possible cause is a failure of the FX5-4DA-ADP. Please consult your local Mitsubishi representative.

5.9 List of Error Code

The following table lists the error codes that may be stored.

□: This symbol indicates the number of the channel where a error has occurred. (1: CH1 to 4: CH4)

Error code	Error name	Description and cause	Action
0000H	—	There is no error.	—
1B0□H	Warning output upper and lower limit value inversion error	The value not meeting the following condition was set to CH□ Warning output upper limit value and CH□ Warning output lower limit value. Upper limit value>Lower limit value	Reset CH□ Warning output upper limit value and CH□ Warning output lower limit value such that upper limit value>lower limit value.
1B1□H	Output status setting range error during HOLD	A value other than 0, 1 or, 2 was set in the CH□ HOLD/CLEAR function setting.	Set a value between 0 and 2 to the CH□ HOLD/CLEAR function setting.
1B2□H	Output setting value setting range error during HOLD	CH□ Output setting value during HOLD is set outside the range of scaling upper and lower limit value.	Set CH□ Output setting value during HOLD within the range of scaling upper and lower limit value.
1B7□H	Scaling upper and lower limit value setting error	CH□ Scaling upper limit value and CH□ Scaling lower limit value are equal.	Reset CH□ Scaling upper limit value or CH□ scaling lower limit value such that Scaling upper limit value≠Scaling lower limit value.
1B8□H	Range setting range error	A value outside the range was set to the CH□ range setting.	Reset the CH□ range setting to the following value. 0 to 5
1B9□H	Offset/Gain setting value range error	A value outside the range was set to CH□ Offset setting value or CH□ Gain setting value.	Reset CH□ Offset value or CH□ Gain setting value to the following value. ■Voltage Offset value: -10000 to +9000 Gain value: -9000 to +10000 ■Current Offset value: 0 to 17000 Gain value: 3000 to 30000
1BA□H	Range setting range error with disconnection detection enabled	CH□ Disconnection detection functions were set to Enable and CH□ Output range is set to other than the following. • 4 to 20 mA	For the channel detecting disconnection using the disconnection detection function, reset CH□ Output range to any of the following. • 4 to 20 mA
1BB□H	Disconnection detection error	In CH□, disconnection was detected.	Eliminate the cause of disconnection in appropriate channel and turn 'Error Clear Request' (SM50) ON.
1BF□H	Offset/Gain setting write error	During CH□ Offset/Gain setting write or CH□ Offset/Gain setting initialization, 'CH□ D/A conversion enable/disable setting' was set to conversion enable.	Set 'CH□ D/A conversion enable/disable setting' to conversion disable and write CH□ Offset /Gain setting or initialize CH□ Offset/Gain setting.
1D7□H	Offset/Gain computed value range error	CH□ Offset/Gain computed value became out of range.	Reset CH□ Offset value and CH□ Gain setting value.
3080H	Analog ADP Hardware error	Hardware error of analog ADP was detected.	After resetting the CPU module, carry out RUN. If the same error is displayed again, there is a possibility of hardware error of the analog ADP. Consult the nearest Mitsubishi Electric representative.
3081H	Analog ADP Power failure	The power is not supplied normally.	Confirm if the power is supplied properly.
3082H	Analog ADP Memory Error	Read error or damaged EEPROM.	After resetting the CPU module, carry out RUN. If the same error is displayed again, there is a possibility damaged EEPROM. Consult the nearest Mitsubishi Electric representative.
3083H	Analog ADP Memory Error	There is some offset/gain data defect or setting defect in EEPROM.	After offset/gain initialization of the analog ADP is finished, set the data by offset/gain settings again.
3084H	Analog ADP Communication error	Communication error occurred between the analog ADP and the CPU module.	Confirm if ADP is connected properly to the CPU module. If not improved, consult the nearest Mitsubishi Electric representative.

5.10 List of Alarm Code

The following table shows the list of the alarm codes stored.

□: This symbol indicates the number of the channel where an alarm has occurred. (1: CH1 to 4: CH4)

Alarm code	Alarm name	Description and cause	Action
0000H	—	There is no error.	—
080□H	Warning output (upper limit)	Warning output alarm (upper limit) has occurred in the CH□.	When the CH□ digital operation value returns from the warning output range, the alarm code automatically changes to "0: Normal".
081□H	Warning output (lower limit)	Warning output alarm (lower limit) has occurred in the CH□.	
0C0□H	Offset gain reading output range mismatch	The saved offset/gain output range is different from the currently set output range.	Change the currently set output range to the output range selected when the offset/gain was written, and then read the offset/gain.
0E0□H	Range change alarm during offset/gain writing or offset/gain initialization	The range was changed during offset/gain writing or offset/gain initialization.	Wait until offset/gain writing or offset/gain initialization is finished, and then change the range.
0E1□H	Offset/gain initialization execution alarm	Offset/gain initialization was executed during offset/gain writing.	Wait until offset/gain writing is finished, and then initialize the offset/gain.
0E2□H	Offset/gain writing execution alarm	Offset/gain writing was executed during offset/gain initialization.	Wait until offset/gain initialization is finished, and then write the offset/gain.
0E3□H	Analog ADP memory access alarm	Offset/gain writing, offset/gain reading or offset/gain initialization was executed while the analog ADP memory error (Error code: 3082H) was detected. Or offset reading was executed while the analog ADP memory error (Error code: 3083H) was detected.	Reset the CPU module.
0F0□H	Setting change alarm	Special relays/registers for analog are changed while conversion is enabled.	Change the setting of special relays/registers while conversion is disabled.

5.11 List of Special Relays

The special relays are shown below.

1st analog expansion adapter

The special relays list for the 1st FX5-4DA-ADP module is shown below.

Special relays				Name	Reference
CH1	CH2	CH3	CH4		
SM6300	SM6340	SM6380	SM6420	D/A conversion enable/disable setting	Page 267
SM6301	SM6341	SM6381	SM6421	D/A output enable/disable setting	Page 267
SM6308	SM6348	SM6388	SM6428	Scaling enable/disable setting	Page 268
SM6311	SM6351	SM6391	SM6431	Warning output upper limit value flag	Page 268
SM6312	SM6352	SM6392	SM6432	Warning output lower limit value flag	Page 268
SM6313	SM6353	SM6393	SM6433	Warning output setting	Page 269
SM6318	SM6358	SM6398	SM6438	Disconnection detection flag	Page 269
SM6319	SM6359	SM6399	SM6439	Disconnection detection enable/disable setting	Page 269
SM6320	SM6360	SM6400	SM6440	Disconnection recovery detection enable/disable setting	Page 270
SM6332	SM6372	SM6412	SM6452	Offset/gain reading	Page 270
SM6333	SM6373	SM6413	SM6453	Offset/gain writing	Page 270
SM6334	SM6374	SM6414	SM6454	Offset/gain initialization	Page 271
SM6337	SM6377	SM6417	SM6457	D/A conversion alarm clear request	Page 271
SM6338	SM6378	SM6418	SM6458	D/A conversion alarm flag	Page 271
SM6339	SM6379	SM6419	SM6459	D/A conversion error flag	Page 272

2nd analog expansion adapter

The special relays list for the 2nd FX5-4DA-ADP module is shown below.

Special relays				Name	Reference
CH1	CH2	CH3	CH4		
SM6660	SM6700	SM6740	SM6780	D/A conversion enable/disable setting	Page 267
SM6661	SM6701	SM6741	SM6781	D/A output enable/disable setting	Page 267
SM6668	SM6708	SM6748	SM6788	Scaling enable/disable setting	Page 268
SM6671	SM6711	SM6751	SM6791	Warning output upper limit value flag	Page 268
SM6672	SM6712	SM6752	SM6792	Warning output lower limit value flag	Page 268
SM6673	SM6713	SM6753	SM6793	Warning output setting	Page 269
SM6678	SM6718	SM6758	SM6798	Disconnection detection flag	Page 269
SM6679	SM6719	SM6759	SM6799	Disconnection detection enable/disable setting	Page 269
SM6680	SM6720	SM6760	SM6800	Disconnection recovery detection enable/disable setting	Page 270
SM6692	SM6732	SM6772	SM6812	Offset/gain reading	Page 270
SM6693	SM6733	SM6773	SM6813	Offset/gain writing	Page 270
SM6694	SM6734	SM6774	SM6814	Offset/gain initialization	Page 271
SM6697	SM6737	SM6777	SM6817	D/A conversion alarm clear request	Page 271
SM6698	SM6738	SM6778	SM6818	D/A conversion alarm flag	Page 271
SM6699	SM6739	SM6779	SM6819	D/A conversion error flag	Page 272

3rd analog expansion adapter

The special relays list for the 3rd FX5-4DA-ADP module is shown below.

Special relays				Name	Reference
CH1	CH2	CH3	CH4		
SM7020	SM7060	SM7100	SM7140	D/A conversion enable/disable setting	Page 267
SM7021	SM7061	SM7101	SM7141	D/A output enable/disable setting	Page 267
SM7028	SM7068	SM7108	SM7148	Scaling enable/disable setting	Page 268
SM7031	SM7071	SM7111	SM7151	Warning output upper limit value flag	Page 268
SM7032	SM7072	SM7112	SM7152	Warning output lower limit value flag	Page 268
SM7033	SM7073	SM7113	SM7153	Warning output setting	Page 269
SM7038	SM7078	SM7118	SM7158	Disconnection detection flag	Page 269
SM7039	SM7079	SM7119	SM7159	Disconnection detection enable/disable setting	Page 269
SM7040	SM7080	SM7120	SM7160	Disconnection recovery detection enable/disable setting	Page 270
SM7052	SM7092	SM7132	SM7172	Offset/gain reading	Page 270
SM7053	SM7093	SM7133	SM7173	Offset/gain writing	Page 270
SM7054	SM7094	SM7134	SM7174	Offset/gain initialization	Page 271
SM7057	SM7097	SM7137	SM7177	D/A conversion alarm clear request	Page 271
SM7058	SM7098	SM7138	SM7178	D/A conversion alarm flag	Page 271
SM7059	SM7099	SM7139	SM7179	D/A conversion error flag	Page 272

4th analog expansion adapter

The special relays list for the 4th FX5-4DA-ADP module is shown below.

Special relays				Name	Reference
CH1	CH2	CH3	CH4		
SM7380	SM7420	SM7460	SM7500	D/A conversion enable/disable setting	Page 267
SM7381	SM7421	SM7461	SM7501	D/A output enable/disable setting	Page 267
SM7388	SM7428	SM7468	SM7508	Scaling enable/disable setting	Page 268
SM7391	SM7431	SM7471	SM7511	Warning output upper limit value flag	Page 268
SM7392	SM7432	SM7472	SM7512	Warning output lower limit value flag	Page 268
SM7393	SM7433	SM7473	SM7513	Warning output setting	Page 269
SM7398	SM7438	SM7478	SM7518	Disconnection detection flag	Page 269
SM7399	SM7439	SM7479	SM7519	Disconnection detection enable/disable setting	Page 269
SM7400	SM7440	SM7180	SM7520	Disconnection recovery detection enable/disable setting	Page 270
SM7412	SM7452	SM7492	SM7532	Offset/gain reading	Page 270
SM7413	SM7453	SM7493	SM7533	Offset/gain writing	Page 270
SM7414	SM7454	SM7494	SM7534	Offset/gain initialization	Page 271
SM7417	SM7457	SM7497	SM7537	D/A conversion alarm clear request	Page 271
SM7418	SM7458	SM7498	SM7538	D/A conversion alarm flag	Page 271
SM7419	SM7459	SM7499	SM7539	D/A conversion error flag	Page 272

5.12 Detail of Special Relays

This section explains the details of special relays. Only the FX5U/FX5UC CPU module supports the special relays of the third and fourth modules.

R: Read only, R/W: Read/Write

D/A conversion enable/disable setting

Set whether to enable or disable D/A conversion.

Setting value	Setting description	Default value	R/W
0: OFF	D/A conversion enable	1: ON	R/W
1: ON	D/A conversion disable		

For details D/A conversion enable/disable function, refer to the following.

 Page 236 D/A Conversion Enable/Disable Function

Name	Connection part	Special relay			
		CH1	CH2	CH3	CH4
D/A conversion enable/disable setting	1st adapter	SM6300	SM6340	SM6380	SM6420
	2nd adapter	SM6660	SM6700	SM6740	SM6780
	3rd adapter	SM7020	SM7060	SM7100	SM7140
	4th adapter	SM7380	SM7420	SM7460	SM7500

D/A output enable/disable setting

Set whether to output the D/A conversion value or to output the offset value.

Setting value	Setting description	Default value	R/W
0: OFF	D/A conversion value	1: ON	R/W
1: ON	Offset value		



The setting value will be ignored when the D/A conversion enable/disable setting is set to "disable".

For details D/A output enable/disable setting function, refer to the following.

 Page 236 D/A Output Enable/Disable Setting Function

Name	Connection part	Special relay			
		CH1	CH2	CH3	CH4
D/A output enable/disable setting	1st adapter	SM6301	SM6341	SM6381	SM6421
	2nd adapter	SM6661	SM6701	SM6741	SM6781
	3rd adapter	SM7021	SM7061	SM7101	SM7141
	4th adapter	SM7381	SM7421	SM7461	SM7501

Scaling enable/disable setting

Set whether to enable or disable the scaling function.

Setting value	Setting description	Default value	R/W
0: OFF	Scaling function enable	1: ON	R/W
1: ON	Scaling function disable		

For details scaling function, refer to the following.

 Page 239 Scaling Function

Name	Connection part	Special relay			
		CH1	CH2	CH3	CH4
Scaling enable/disable setting	1st adapter	SM6308	SM6348	SM6388	SM6428
	2nd adapter	SM6668	SM6708	SM6748	SM6788
	3rd adapter	SM7028	SM7068	SM7108	SM7148
	4th adapter	SM7388	SM7428	SM7468	SM7508

Warning output upper limit value flag

This flag monitors the upper limit value warning in the warning output.

Monitor value	Display description	Default value	R/W
0: OFF	Normal	0: OFF	R
1: ON	Warning output upper limit detection		

For details warning output function, refer to the following.

 Page 242 Warning Output Function

Name	Connection part	Special relay			
		CH1	CH2	CH3	CH4
Warning output upper limit value flag	1st adapter	SM6311	SM6351	SM6391	SM6431
	2nd adapter	SM6671	SM6711	SM6751	SM6791
	3rd adapter	SM7031	SM7071	SM7111	SM7151
	4th adapter	SM7391	SM7431	SM7471	SM7511

Warning output lower limit value flag

This flag monitors the lower limit value warning in the warning output.

Monitor value	Display description	Default value	R/W
0: OFF	Normal	0: OFF	R
1: ON	Warning output lower limit detection		

For details warning output function, refer to the following.

 Page 242 Warning Output Function

Name	Connection part	Special relay			
		CH1	CH2	CH3	CH4
Warning output lower limit value flag	1st adapter	SM6312	SM6352	SM6392	SM6432
	2nd adapter	SM6672	SM6712	SM6752	SM6792
	3rd adapter	SM7032	SM7072	SM7112	SM7152
	4th adapter	SM7392	SM7432	SM7472	SM7512

Warning output setting

Set whether to enable or disable the warning output.

Setting value	Setting description	Default value	R/W
0: OFF	Warning output enable	1: ON	R/W
1: ON	Warning output disable		

For details warning output function, refer to the following.

 Page 242 Warning Output Function

Name	Connection part	Special relay			
		CH1	CH2	CH3	CH4
Warning output setting	1st adapter	SM6313	SM6353	SM6393	SM6433
	2nd adapter	SM6673	SM6713	SM6753	SM6793
	3rd adapter	SM7033	SM7073	SM7113	SM7153
	4th adapter	SM7393	SM7433	SM7473	SM7513

Disconnection detection flag

This flag monitors the disconnection detection.

Monitor value	Display description	Default value	R/W
0: OFF	Normal	0: OFF	R
1: ON	Disconnection detection		

For details disconnection detection function, refer to the following.

 Page 243 Disconnection Detection Function

Name	Connection part	Special relay			
		CH1	CH2	CH3	CH4
Disconnection detection flag	1st adapter	SM6318	SM6358	SM6398	SM6438
	2nd adapter	SM6678	SM6718	SM6758	SM6798
	3rd adapter	SM7038	SM7078	SM7118	SM7158
	4th adapter	SM7398	SM7438	SM7478	SM7518

Disconnection detection enable/disable setting

Set whether to enable or disable the disconnection detection function.

Setting value	Setting description	Default value	R/W
0: OFF	Disconnection detection enable	1: ON	R/W
1: ON	Disconnection detection disable		

For details disconnection detection function, refer to the following.

 Page 243 Disconnection Detection Function

Name	Connection part	Special relay			
		CH1	CH2	CH3	CH4
Disconnection detection enable/ disable setting	1st adapter	SM6319	SM6359	SM6399	SM6439
	2nd adapter	SM6679	SM6719	SM6759	SM6799
	3rd adapter	SM7039	SM7079	SM7119	SM7159
	4th adapter	SM7399	SM7439	SM7479	SM7519

Disconnection recovery detection enable/disable setting

Set whether to enable or disable the disconnection detection recovery.

Setting value	Setting description	Default value	R/W
0: OFF	Disconnection recovery detection enable	1: ON	R/W
1: ON	Disconnection recovery detection disable		

For details disconnection detection function, refer to the following.

 Page 243 Disconnection Detection Function

Name	Connection part	Special relay			
		CH1	CH2	CH3	CH4
Disconnection recovery detection enable/disable setting	1st adapter	SM6320	SM6360	SM6400	SM6440
	2nd adapter	SM6680	SM6720	SM6760	SM6800
	3rd adapter	SM7040	SM7080	SM7120	SM7160
	4th adapter	SM7400	SM7440	SM7480	SM7520

Offset/gain reading

An offset/gain setting value is read.

Setting value	Setting description	Default value	R/W
0: OFF	Offset/gain reading is not performed.	0: OFF	R/W
1: ON	Offset/gain reading is performed.		

For details offset/gain setting, refer to the following.

 Page 245 Offset/gain Setting Function

Name	Connection part	Special relay			
		CH1	CH2	CH3	CH4
Offset/gain reading	1st adapter	SM6332	SM6372	SM6412	SM6452
	2nd adapter	SM6692	SM6732	SM6772	SM6812
	3rd adapter	SM7052	SM7092	SM7132	SM7172
	4th adapter	SM7412	SM7452	SM7492	SM7532

Offset/gain writing

An offset/gain setting value is written in.

Setting value	Setting description	Default value	R/W
0: OFF	Offset/gain writing is not performed.	0: OFF	R/W
1: ON	Offset/gain writing is performed.		

For details offset/gain setting, refer to the following.

 Page 245 Offset/gain Setting Function

Name	Connection part	Special relay			
		CH1	CH2	CH3	CH4
Offset/gain writing	1st adapter	SM6333	SM6373	SM6413	SM6453
	2nd adapter	SM6693	SM6733	SM6773	SM6813
	3rd adapter	SM7053	SM7093	SM7133	SM7173
	4th adapter	SM7413	SM7453	SM7493	SM7533

Offset/gain initialization

An offset/gain setting value is initialized.

Setting value	Setting description	Default value	R/W
0: OFF	Offset/gain initialization is not performed.	0: OFF	R/W
1: ON	Offset/gain initialization is performed.		

For details offset/gain initialization, refer to the following.

☞ Page 250 Offset/gain Initialization Function

Name	Connection part	Special relay			
		CH1	CH2	CH3	CH4
Offset/gain initialization	1st adapter	SM6334	SM6374	SM6414	SM6454
	2nd adapter	SM6694	SM6734	SM6774	SM6814
	3rd adapter	SM7054	SM7094	SM7134	SM7174
	4th adapter	SM7414	SM7454	SM7494	SM7534

D/A conversion alarm clear request

A D/A conversion alarm clear request is performed.

Setting value	Setting description	Default value	R/W
0: OFF	With no D/A conversion alarm clear request.	0: OFF	R/W
1: ON	Those with D/A conversion alarm clear request.		

For details D/A conversion alarm clear request, refer to the following.

☞ Page 251 Alarm clear request

Name	Connection part	Special relay			
		CH1	CH2	CH3	CH4
D/A conversion alarm clear request	1st adapter	SM6337	SM6377	SM6417	SM6457
	2nd adapter	SM6697	SM6737	SM6777	SM6817
	3rd adapter	SM7057	SM7097	SM7137	SM7177
	4th adapter	SM7417	SM7457	SM7497	SM7537

D/A conversion alarm flag

"D/A conversion alarm flag" turns on when an alarm occurs.

Monitor value	Display description	Default value	R/W
0: OFF	Normal	0: OFF	R
1: ON	D/A conversion alarm occur		

To turn OFF the "D/A conversion alarm flag" and clear the "D/A conversion latest alarm code", set the "D/A conversion alarm clear request" from OFF to ON.

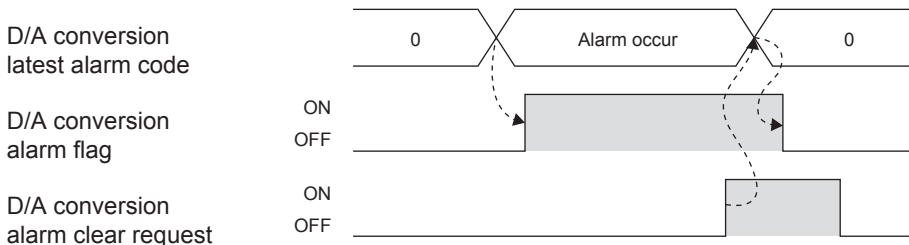

Name	Connection part	Special relay			
		CH1	CH2	CH3	CH4
D/A conversion alarm flag	1st adapter	SM6338	SM6378	SM6418	SM6458
	2nd adapter	SM6698	SM6738	SM6778	SM6818
	3rd adapter	SM7058	SM7098	SM7138	SM7178
	4th adapter	SM7418	SM7458	SM7498	SM7538

D/A conversion error flag

"D/A conversion error flag" turns on when an error occurs.

Monitor value	Display description	Default value	R/W
0: OFF	Normal	0: OFF	R
1: ON	D/A conversion error occur		

To turn OFF the "D/A conversion error flag" and clear the "D/A conversion latest error code", set the "error clear request" (SM50) of the CPU module from OFF to ON.

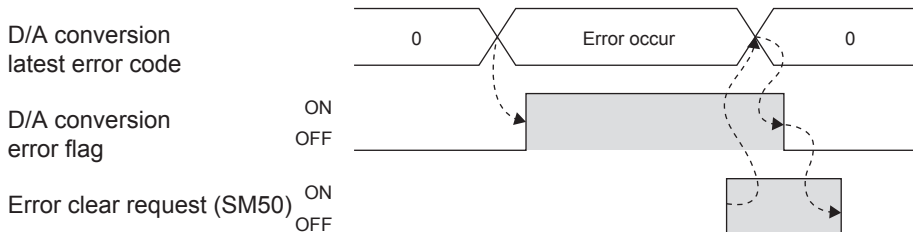

Name	Connection part	Special relay			
		CH1	CH2	CH3	CH4
D/A conversion error flag	1st adapter	SM6339	SM6379	SM6419	SM6459
	2nd adapter	SM6699	SM6739	SM6779	SM6819
	3rd adapter	SM7059	SM7099	SM7139	SM7179
	4th adapter	SM7419	SM7459	SM7499	SM7539

5.13 List of Special Registers

The special registers are shown below.

1st analog expansion adapter

The special registers list for the 1st FX5-4DA-ADP module is shown below.

Special registers				Name	Reference
CH1	CH2	CH3	CH4		
SD6290				Module Information	Page 275
SD6300	SD6340	SD6380	SD6420	Digital value	Page 275
SD6301	SD6341	SD6381	SD6421	Digital operation value	Page 276
SD6302	SD6342	SD6382	SD6422	Analog output value monitor	Page 276
SD6303	SD6343	SD6383	SD6423	HOLD/CLEAR function setting	Page 276
SD6304	SD6344	SD6384	SD6424	HOLD setting value	Page 277
SD6305	SD6345	SD6385	SD6425	Output range setting	Page 277
SD6308	SD6348	SD6388	SD6428	Scaling upper limit value	Page 277
SD6309	SD6349	SD6389	SD6429	Scaling lower limit value	Page 278
SD6310	SD6350	SD6390	SD6430	Input value shift amount	Page 278
SD6311	SD6351	SD6391	SD6431	Warning output upper limit value	Page 278
SD6312	SD6352	SD6392	SD6432	Warning output lower limit value	Page 279
SD6332	SD6372	SD6412	SD6452	Offset setting value	Page 279
SD6333	SD6373	SD6413	SD6453	Gain setting value	Page 279
SD6334	SD6374	SD6414	SD6454	Offset/gain writing enable code	Page 280
SD6338	SD6378	SD6418	SD6458	D/A conversion latest alarm code	Page 280
SD6339	SD6379	SD6419	SD6459	D/A conversion latest error code	Page 280

2nd analog expansion adapter

The special registers list for the 2nd FX5-4DA-ADP module is shown below.

Special registers				Name	Reference
CH1	CH2	CH3	CH4		
SD6650				Module Information	Page 275
SD6660	SD6700	SD6740	SD6780	Digital value	Page 275
SD6661	SD6701	SD6741	SD6781	Digital operation value	Page 276
SD6662	SD6702	SD6742	SD6782	Analog output value monitor	Page 276
SD6663	SD6703	SD6743	SD6783	HOLD/CLEAR function setting	Page 276
SD6664	SD6704	SD6744	SD6784	HOLD setting value	Page 277
SD6665	SD6705	SD6745	SD6785	Output range setting	Page 277
SD6668	SD6708	SD6748	SD6788	Scaling upper limit value	Page 277
SD6669	SD6709	SD6749	SD6789	Scaling lower limit value	Page 278
SD6670	SD6710	SD6750	SD6790	Input value shift amount	Page 278
SD6671	SD6711	SD6751	SD6791	Warning output upper limit value	Page 278
SD6672	SD6712	SD6752	SD6792	Warning output lower limit value	Page 279
SD6692	SD6732	SD6772	SD6812	Offset setting value	Page 279
SD6693	SD6733	SD6773	SD6813	Gain setting value	Page 279
SD6694	SD6734	SD6774	SD6814	Offset/gain writing enable code	Page 280
SD6698	SD6738	SD6778	SD6818	D/A conversion latest alarm code	Page 280
SD6699	SD6739	SD6779	SD6819	D/A conversion latest error code	Page 280

3rd analog expansion adapter

The special registers list for the 3rd FX5-4DA-ADP module is shown below.

Special registers				Name	Reference
CH1	CH2	CH3	CH4		
SD7010				Module Information	Page 275
SD7020	SD7060	SD7100	SD7140	Digital value	Page 275
SD7021	SD7061	SD7101	SD7141	Digital operation value	Page 276
SD7022	SD7062	SD7102	SD7142	Analog output value monitor	Page 276
SD7023	SD7063	SD7103	SD7143	HOLD/CLEAR function setting	Page 276
SD7024	SD7064	SD7104	SD7144	HOLD setting value	Page 277
SD7025	SD7065	SD7105	SD7145	Output range setting	Page 277
SD7028	SD7068	SD7108	SD7148	Scaling upper limit value	Page 277
SD7029	SD7069	SD7109	SD7149	Scaling lower limit value	Page 278
SD7030	SD7070	SD7110	SD7150	Input value shift amount	Page 278
SD7031	SD7071	SD7111	SD7151	Warning output upper limit value	Page 278
SD7032	SD7072	SD7112	SD7152	Warning output lower limit value	Page 279
SD7052	SD7092	SD7132	SD7172	Offset setting value	Page 279
SD7053	SD7093	SD7133	SD7173	Gain setting value	Page 279
SD7054	SD7094	SD7134	SD7174	Offset/gain writing enable code	Page 280
SD7058	SD7098	SD7138	SD7178	D/A conversion latest alarm code	Page 280
SD7059	SD7099	SD7139	SD7179	D/A conversion latest error code	Page 280

4th analog expansion adapter

The special registers list for the 4th FX5-4DA-ADP module is shown below.

Special registers				Name	Reference
CH1	CH2	CH3	CH4		
SD7370				Module Information	Page 275
SD7380	SD7420	SD7460	SD7500	Digital value	Page 275
SD7381	SD7421	SD7461	SD7501	Digital operation value	Page 276
SD7382	SD7422	SD7462	SD7502	Analog output value monitor	Page 276
SD7383	SD7423	SD7463	SD7503	HOLD/CLEAR function setting	Page 276
SD7384	SD7424	SD7464	SD7504	HOLD setting value	Page 277
SD7385	SD7425	SD7465	SD7505	Output range setting	Page 277
SD7388	SD7428	SD7468	SD7508	Scaling upper limit value	Page 277
SD7389	SD7429	SD7469	SD7509	Scaling lower limit value	Page 278
SD7390	SD7430	SD7470	SD7510	Input value shift amount	Page 278
SD7391	SD7431	SD7471	SD7511	Warning output upper limit value	Page 278
SD7392	SD7432	SD7472	SD7512	Warning output lower limit value	Page 279
SD7412	SD7452	SD7492	SD7532	Offset setting value	Page 279
SD7413	SD7453	SD7493	SD7533	Gain setting value	Page 279
SD7414	SD7454	SD7494	SD7534	Offset/gain writing enable code	Page 280
SD7418	SD7458	SD7498	SD7538	D/A conversion latest alarm code	Page 280
SD7419	SD7459	SD7499	SD7539	D/A conversion latest error code	Page 280

5.14 Detail of Special Registers

This section explains the details of special registers. Only the FX5U/FX5UC CPU module supports the third and fourth special register.

R: Read only, R/W: Read/Write

Module Information

Module information of FX5-4DA-ADP is stored.

Stored value		R/W
6161H		R

Name	Connection part	Special register			
		CH1	CH2	CH3	CH4
Module Information	1st adapter	SD6290			
	2nd adapter	SD6650			
	3rd adapter	SD7010			
	4th adapter	SD7370			

5

Digital value

Set the digital value for D/A conversion.

Output range setting		Digital value setting range	When the scaling function is enabled	Default value	R/W
Voltage	0 to 10 V	0 to 16000	Scaling lower limit value to Scaling upper limit value	0	R/W
	0 to 5 V				
	1 to 5 V				
	-10 to +10 V	-8000 to +8000			
Current	0 to 20 mA	0 to 16000			
	4 to 20 mA				



When the digital value is set outside the allowable setting range, D/A conversion will be executed within the allowable setting range.

Name	Connection part	Special register			
		CH1	CH2	CH3	CH4
Digital value	1st adapter	SD6300	SD6340	SD6380	SD6420
	2nd adapter	SD6660	SD6700	SD6740	SD6780
	3rd adapter	SD7020	SD7060	SD7100	SD7140
	4th adapter	SD7380	SD7420	SD7460	SD7500

Digital operation value

The digital operation value obtained by the scaling function and shift function is stored.

Monitor value	Default value	R/W
-32768 to +32767	0	R



The value equivalent to the digital value is stored when the scaling function and shift function are not used.

Name	Connection part	Special relay			
		CH1	CH2	CH3	CH4
Digital operation value	1st adapter	SD6301	SD6341	SD6381	SD6421
	2nd adapter	SD6661	SD6701	SD6741	SD6781
	3rd adapter	SD7021	SD7061	SD7101	SD7141
	4th adapter	SD7381	SD7421	SD7461	SD7501

Analog output value monitor

The D/A-converted analog value is stored.

Monitor value	Default value	R/W
-10240 to +20479	0	R



- The unit is "1 V = 1000 mV" for voltage input, and "1 mA = 1000 μ A" for current input.
- The upper limit value or lower limit value is stored when the analog value is outside the output range.

Name	Connection part	Special relay			
		CH1	CH2	CH3	CH4
Analog output value monitor	1st adapter	SD6302	SD6342	SD6382	SD6422
	2nd adapter	SD6662	SD6702	SD6742	SD6782
	3rd adapter	SD7022	SD7062	SD7102	SD7142
	4th adapter	SD7382	SD7422	SD7462	SD7502

HOLD/CLEAR function setting

Set whether to hold or clear the analog output value when the CPU module is in the "STOP" or "STOP (by stop error)" status.

Setting value	Description	Default value	R/W
0	CLEAR	1	R/W
1	Current Value (Hold)		
2	HOLD setting value		



- The output status setting range error in HOLD status (Error code: 1B1□H) occurs when any value other than the above values is set.
- Set a value to the "HOLD setting value" when setting "2" here.

For details analog output HOLD/CLEAR function, refer to the following.

Page 237 Analog Output HOLD/CLEAR Function

Name	Connection part	Special relay			
		CH1	CH2	CH3	CH4
HOLD/CLEAR function setting	1st adapter	SD6303	SD6343	SD6383	SD6423
	2nd adapter	SD6663	SD6703	SD6743	SD6783
	3rd adapter	SD7023	SD7063	SD7103	SD7143
	4th adapter	SD7383	SD7423	SD7463	SD7503

HOLD setting value

Set the output value when "2: HOLD setting value" is set to the HOLD/CLEAR function setting.

Range	Default value	R/W
-32768 to +32767	0	R/W

For details analog output HOLD/CLEAR function, refer to the following.

 Page 237 Analog Output HOLD/CLEAR Function

Name	Connection part	Special relay			
		CH1	CH2	CH3	CH4
HOLD setting value	1st adapter	SD6304	SD6344	SD6384	SD6424
	2nd adapter	SD6664	SD6704	SD6744	SD6784
	3rd adapter	SD7024	SD7064	SD7104	SD7144
	4th adapter	SD7384	SD7424	SD7464	SD7504

Output range setting

Set the output range.

Setting value	Description	Default value	R/W
0	0 to 10 V	0	R/W
1	0 to 5 V		
2	1 to 5 V		
3	-10 to +10 V		
4	0 to 20 mA		
5	4 to 20 mA		



The range setting range error (Error code: 1B8□H) occurs when any value other than the above values is set.

Name	Connection part	Special relay			
		CH1	CH2	CH3	CH4
Output range setting	1st adapter	SD6305	SD6345	SD6385	SD6425
	2nd adapter	SD6665	SD6705	SD6745	SD6785
	3rd adapter	SD7025	SD7065	SD7105	SD7145
	4th adapter	SD7385	SD7425	SD7465	SD7505

Scaling upper limit value

Set the upper limit value of the scaling conversion range.

Range	Default value	R/W
-32768 to +32767	0	R/W

For details scaling function, refer to the following.

 Page 239 Scaling Function

Name	Connection part	Special register			
		CH1	CH2	CH3	CH4
Scaling upper limit value	1st adapter	SD6308	SD6348	SD6388	SD6428
	2nd adapter	SD6668	SD6708	SD6748	SD6788
	3rd adapter	SD7028	SD7068	SD7108	SD7148
	4th adapter	SD7388	SD7428	SD7468	SD7508

Scaling lower limit value

Set the lower limit value of the scaling conversion range.

Range	Default value	R/W
-32768 to +32767	0	R/W

For details scaling function, refer to the following.

 Page 239 Scaling Function

Name	Connection part	Special register			
		CH1	CH2	CH3	CH4
Scaling lower limit value	1st adapter	SD6309	SD6349	SD6389	SD6429
	2nd adapter	SD6669	SD6709	SD6749	SD6789
	3rd adapter	SD7029	SD7069	SD7109	SD7149
	4th adapter	SD7389	SD7429	SD7469	SD7509

Input value shift amount

Set the "input value shift amount" used in the shift function.

The value set here is added to the "digital value".

Range	Default value	R/W
-32768 to +32767	0	R/W

For details shift function, refer to the following.

 Page 241 Shift Function

Name	Connection part	Special register			
		CH1	CH2	CH3	CH4
Input value shift amount	1st adapter	SD6310	SD6350	SD6390	SD6430
	2nd adapter	SD6670	SD6710	SD6750	SD6790
	3rd adapter	SD7030	SD7070	SD7110	SD7150
	4th adapter	SD7390	SD7430	SD7470	SD7510

Warning output upper limit value

Set the upper limit value of the warning output function.

Range	Default value	R/W
-32768 to +32767	0	R/W

For details warning output function, refer to the following.

 Page 242 Warning Output Function

Name	Connection part	Special register			
		CH1	CH2	CH3	CH4
Warning output upper limit value	1st adapter	SD6311	SD6351	SD6391	SD6431
	2nd adapter	SD6671	SD6711	SD6751	SD6791
	3rd adapter	SD7031	SD7071	SD7111	SD7151
	4th adapter	SD7391	SD7431	SD7471	SD7511

Warning output lower limit value

Set the lower limit value of the warning output function.

Range	Default value	R/W
-32768 to +32767	0	R/W

For details warning output function, refer to the following.

 Page 242 Warning Output Function

Name	Connection part	Special register			
		CH1	CH2	CH3	CH4
Warning output lower limit value	1st adapter	SD6312	SD6352	SD6392	SD6432
	2nd adapter	SD6672	SD6712	SD6752	SD6792
	3rd adapter	SD7032	SD7072	SD7112	SD7152
	4th adapter	SD7392	SD7432	SD7472	SD7512

Offset setting value

Set the offset data used in the offset/gain setting function.

Range	Default value	R/W
Voltage: -10000 to +9000 Current: 0 to +17000	0	R/W

For details offset/gain setting, refer to the following.

 Page 245 Offset/gain Setting Function

Name	Connection part	Special register			
		CH1	CH2	CH3	CH4
Offset setting value	1st adapter	SD6332	SD6372	SD6412	SD6452
	2nd adapter	SD6692	SD6732	SD6772	SD6812
	3rd adapter	SD7052	SD7092	SD7132	SD7172
	4th adapter	SD7412	SD7452	SD7492	SD7532

Gain setting value

Set the gain data used in the offset/gain setting function.

Range	Default value	R/W
Voltage: -9000 to +10000 Current: 3000 to 30000	Voltage output: 5000 Current output: 20000	R/W

For details offset/gain setting, refer to the following.

 Page 245 Offset/gain Setting Function

Name	Connection part	Special register			
		CH1	CH2	CH3	CH4
Gain setting value	1st adapter	SD6333	SD6373	SD6413	SD6453
	2nd adapter	SD6693	SD6733	SD6773	SD6813
	3rd adapter	SD7053	SD7093	SD7133	SD7173
	4th adapter	SD7413	SD7453	SD7493	SD7533

Offset/gain writing enable code

Set the offset/gain writing enable code used for changing the offset/gain.

Range	Default value	R/W
Offset/gain writing enable: E210H Offset/gain writing disable: Other than E210H	0	R/W

For details offset/gain setting, refer to the following.

 Page 245 Offset/gain Setting Function

Name	Connection part	Special register			
		CH1	CH2	CH3	CH4
Offset/gain writing enable code	1st adapter	SD6334	SD6374	SD6414	SD6454
	2nd adapter	SD6694	SD6734	SD6774	SD6814
	3rd adapter	SD7054	SD7094	SD7134	SD7174
	4th adapter	SD7414	SD7454	SD7494	SD7534

D/A conversion latest alarm code

The latest alarm code detected in the FX5-4DA-ADP is stored.

Monitor value	Default value	R/W
—	0	R

For details alarm code, refer to the following.

 Page 264 List of Alarm Code

Name	Connection part	Special register			
		CH1	CH2	CH3	CH4
D/A conversion latest alarm code	1st adapter	SD6338	SD6378	SD6418	SD6458
	2nd adapter	SD6698	SD6738	SD6778	SD6818
	3rd adapter	SD7058	SD7098	SD7138	SD7178
	4th adapter	SD7418	SD7458	SD7498	SD7538

Point

Set the "D/A conversion alarm clear request" from OFF to ON to clear the alarm code.

D/A conversion latest error code

The latest error code detected in the FX5-4DA-ADP is stored.

Monitor value	Default value	R/W
—	0	R

For details error code, refer to the following.

 Page 263 List of Error Code

Name	Connection part	Special register			
		CH1	CH2	CH3	CH4
D/A conversion latest error code	1st adapter	SD6339	SD6379	SD6419	SD6459
	2nd adapter	SD6699	SD6739	SD6779	SD6819
	3rd adapter	SD7059	SD7099	SD7139	SD7179
	4th adapter	SD7419	SD7459	SD7499	SD7539

Point

Set the "error clear request" (SM50) of CPU module from OFF to ON to clear the error code.

6 FX5-4A-ADP

This chapter describes the FX5-4A-ADP.

6.1 Specifications

This section describes the specifications.

Generic specifications

The items other than the following are equivalent to those of the CPU module.

For general specifications, refer to the following manual.

📖 MELSEC iQ-F FX5UJ User's Manual (Hardware)

📖 MELSEC iQ-F FX5U User's Manual (Hardware)

📖 MELSEC iQ-F FX5UC User's Manual (Hardware)

Item	Specification
Dielectric withstand voltage	500 V AC for one minute Between all external terminals and ground terminal
Insulation resistance	10 MΩ or higher by 500 V DC insulation resistance tester

Power supply specifications

Power supply specifications is shown below.

Item	Specification
External electric supply (Analog conversion circuit)	24 V DC +20 %, -15 % 100 mA External electric supply is carried out from the power supply connector of an adapter.
Internal electric supply (Interface)	5 V DC 10 mA Internal electric supply is carried out from 5 V DC power supply of a CPU module.

Performance specifications

Performance specifications is shown below.

Analog input specifications

Item	Specification			
Number of analog input points	2 points (2 channels)			
Analog input voltage	-10 to +10 V DC (input resistance 1 MΩ)			
Analog input current	-20 to +20 mA DC (input resistance 250 Ω)			
Digital output value	14-bit binary value			
Input characteristics, resolution*1	Analog input range			Resolution
	Voltage	0 to 10 V	0 to 16000	625 μV
		0 to 5 V	0 to 16000	312.5 μV
		1 to 5 V	0 to 12800	312.5 μV
		-10 to +10 V	-8000 to +8000	1250 μV
	Current	0 to 20 mA	0 to 16000	1.25 μA
		4 to 20 mA	0 to 12800	1.25 μA
-20 to +20 mA		-8000 to +8000	2.5 μA	
Accuracy (accuracy for the full scale of digital output value)	Ambient temperature 25±5°C: within ±0.1 % (±16 digit) Ambient temperature 0 to 55°C: within .0.2 % (±32 digit) Ambient temperature -20 to 0°C: within .0.3 % (±48 digit)			

*1 For the input conversion characteristic, refer to the  Page 283 Input conversion characteristics.

Analog output specifications

Item	Specification		
Number of analog output points	2 points (2 channels)		
Digital input	14-bit binary value		
Analog output voltage	-10 to +10 V DC (external load resistance value 1k to 1 M Ω)		
Analog output current	0 to 20 mA DC (external load resistance value 0 to 500 Ω)		
Output characteristics, resolution*1	Analog output range		Digital value
	Voltage	0 to 10 V	0 to 16000
		0 to 5 V	0 to 16000
		1 to 5 V	0 to 16000
		-10 to +10 V	-8000 to +8000
	Current	0 to 20 mA	0 to 16000
4 to 20 mA		0 to 16000	
Resolution			Resolution
			625 μ V
			312.5 μ V
			250 μ V
			1250 μ V
			1.25 μ A
			1 μ A
Accuracy (accuracy for the full scale of the analog output value)	Ambient temperature 25 \pm 5 $^{\circ}$ C: \pm 0.1 % (Voltage \pm 20 mV, Current \pm 20 μ A) Ambient temperature 0 to 55 $^{\circ}$ C: \pm 0.2 % (Voltage \pm 40 mV, Current \pm 40 μ A) Ambient temperature -20 to 0 $^{\circ}$ C: \pm 0.3 % (Voltage \pm 60 mV, Current \pm 60 μ A)		

*1 For the output conversion characteristic, refer to the  Page 286 Output conversion characteristics.

Common specifications

Item	Specification
Conversion speed	Maximum 2.0 ms (The data will be updated at every scan time of the PLC.)
Isolation method	Between input terminal and PLC: Photocoupler Between input channels: Non-isolation
Number of occupied I/O points	0 point (This number is not related to the maximum number of I/O points of the PLC.)
Applicable CPU module	<ul style="list-style-type: none"> • FX5UJ CPU module (Ver. 1.010 or later) • FX5U CPU module (Ver. 1.240 or later) • FX5UC CPU module (Ver. 1.240 or later)
Applicable engineering tool	GX Works3 (Ver.1.075D or later)

Input conversion characteristics

An input conversion characteristic of A/D conversion is expressed by the slope of the straight line connecting the offset value and the gain value at the time when an analog input (voltage or current) from outside the programmable controller is converted to a digital value.

Voltage input characteristic

The following shows the list of the analog input ranges and the graphs of each voltage input characteristic, at the voltage input.

No.	Input range setting	Offset value	Gain value	Digital output value ^{*1}	Resolution
(1)	0 to 10 V	0 V	10 V	0 to 16000	625 μ V
(2)	0 to 5 V	0 V	5 V	0 to 16000	312.5 μ V
(3)	1 to 5 V	1 V	5 V	0 to 12800	312.5 μ V
(4)	-10 to +10 V	0 V	10 V	-8000 to +8000	1250 μ V

*1 When analog input exceeds the range of the digital output value, the digital output value is fixed to the maximum or minimum.

Input range setting	Digital output value	
	Minimum	Maximum
0 to 10 V	-384	16383
0 to 5 V	-384	16383
1 to 5 V	-3584	13183
-10 to +10 V	-8192	8191

Point

- Set values within the practical range of the analog input and digital output at each input range. If the values are out of the range, the resolution and accuracy may not fall within the range of the performance specifications. (Do not use values in the dotted line region in the graph of voltage input characteristics.)
- Do not set the voltage over ± 15 V. Doing so can cause breakdown of the products.

■ Voltage input characteristics graph (0 to 10 V)

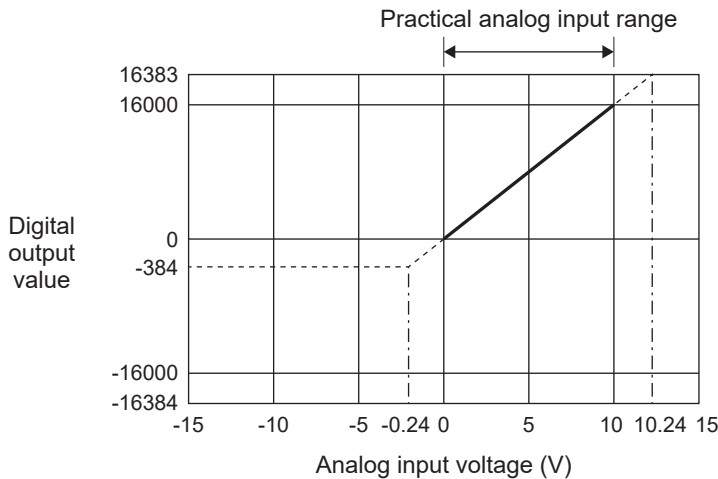

■ Voltage input characteristics graph (0 to 5 V)

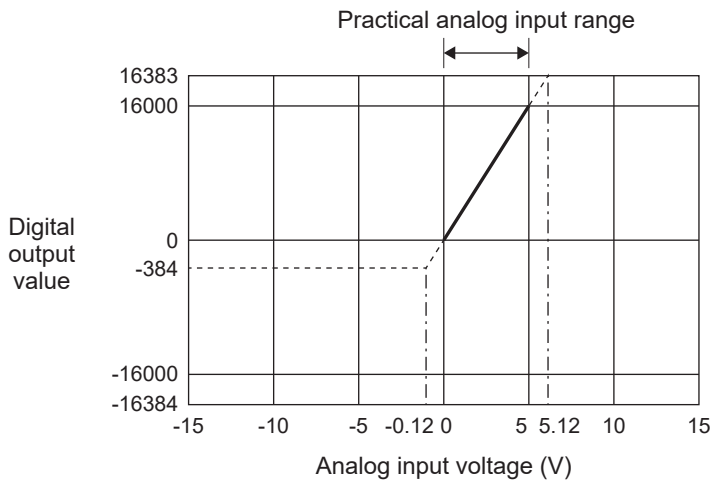

■ Voltage input characteristics graph (1 to 5 V)

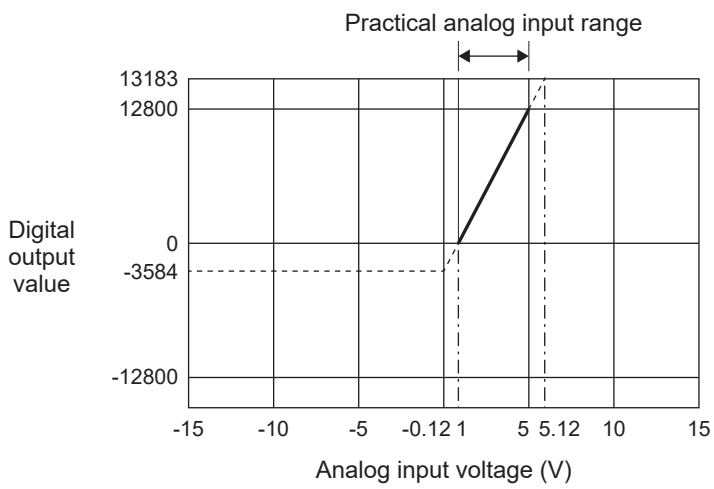

■ Voltage input characteristics graph (-10 to +10 V)

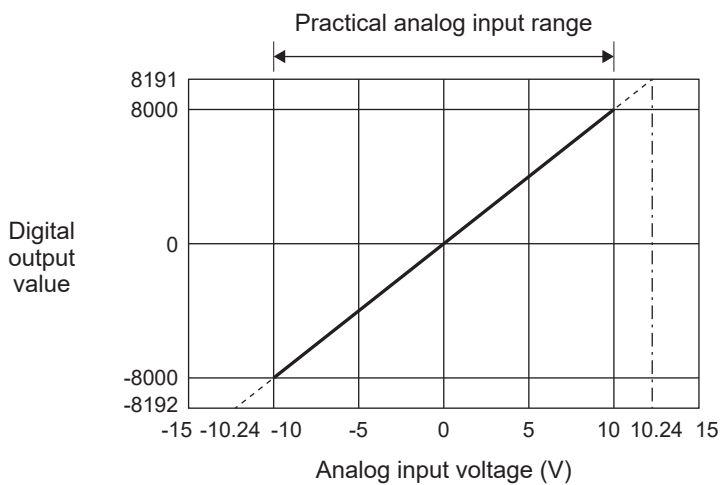

Current input characteristic

The following shows the list of the analog input ranges and the graph of each current input characteristic, at the current input.

No.	Input range setting	Offset value	Gain value	Digital output value ^{*1}	Resolution
(1)	0 to 20 mA	0 mA	20 mA	0 to 16000	1.25 μ A
(2)	4 to 20 mA	4 mA	20 mA	0 to 12800	1.25 μ A
(3)	-20 to +20 mA	0 mA	20 mA	-8000 to +8000	2.5 μ A

*1 When analog input exceeds the range of the digital output value, the digital output value is fixed to the maximum or minimum.

Input range setting	Digital output value	
	Minimum	Maximum
0 to 20 mA	-384	16383
4 to 20 mA	-3584	13183
-20 to +20 mA	-8129	8191

Point

- Set values within the practical range of the analog input and digital output at each input range. If the values are out of the range, the resolution and accuracy may not fall within the range of the performance specifications. (Do not use values in the dotted line region in the graph of current input characteristics.)
- Do not set the voltage over ± 30 mA. Doing so can cause breakdown of the products.

■ Current input characteristics graph (0 to 20 mA)

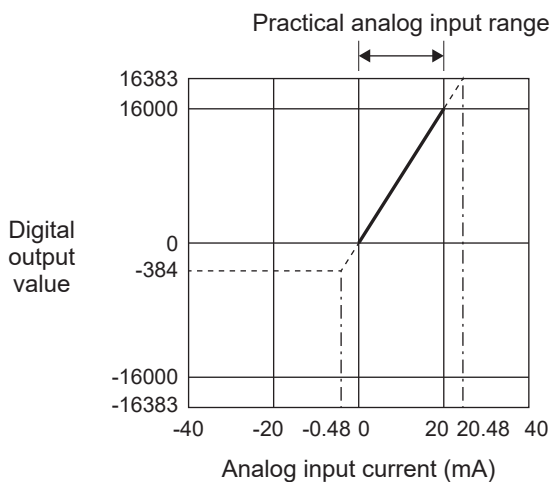

■ Current input characteristics graph (4 to 20 mA)

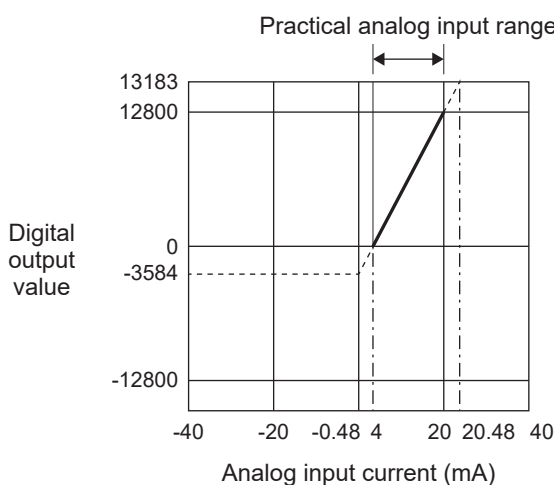

■ Current input characteristics graph (-20 to +20 mA)

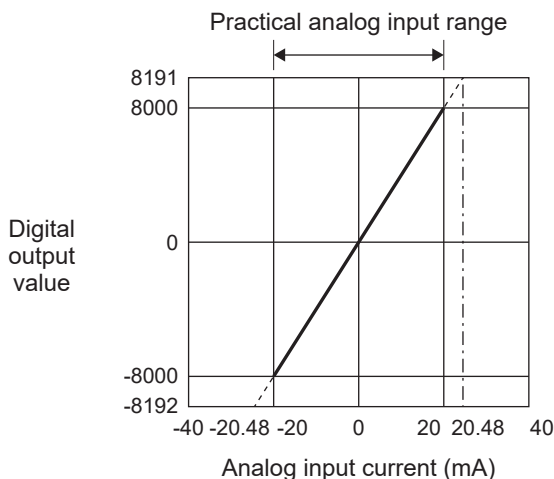

Output conversion characteristics

An output conversion characteristic of D/A conversion is expressed by the slope of the straight line connecting the offset value and the gain value at the time when a digital value written from the CPU module is converted to an analog output (voltage or current).

Voltage output characteristic

The following shows the list of the analog output ranges and the graphs of each voltage output characteristic, at the voltage output.

No.	Output range setting	Offset value	Gain value	Digital value ^{*1}	Resolution
(1)	0 to 10 V	0 V	10 V	0 to 16000	625 μ V
(2)	0 to 5 V	0 V	5 V	0 to 16000	312.5 μ V
(3)	1 to 5 V	1 V	5 V	0 to 16000	250 μ V
(4)	-10 to +10 V	0 V	10 V	-8000 to +8000	1250 μ V

*1 When value exceeds the range of the digital value, the digital value is fixed to the maximum or minimum.

Output range setting	Digital value	
	Minimum	Maximum
0 to 10 V	-384	16383
0 to 5 V	-384	16383
1 to 5 V	-384	16383
-10 to +10 V	-8192	8191

Point

Set values within the practical range of the digital input and analog output at each output range. If the values are out of the range, the resolution and accuracy may not fall within the range of the performance specifications. (Do not use values in the dotted line region in the graph of voltage output characteristics.)

■ Voltage output characteristics graph (0 to 10 V)

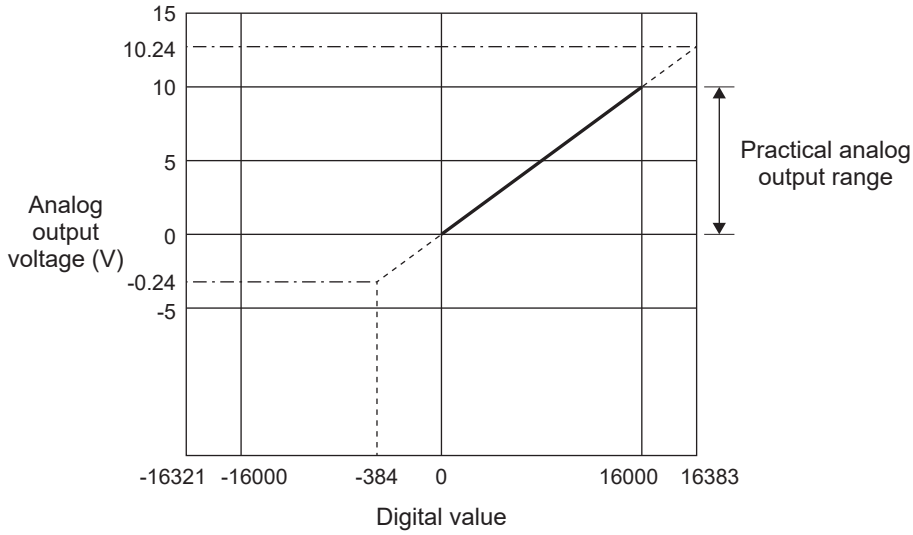

■ Voltage output characteristics graph (0 to 5 V)

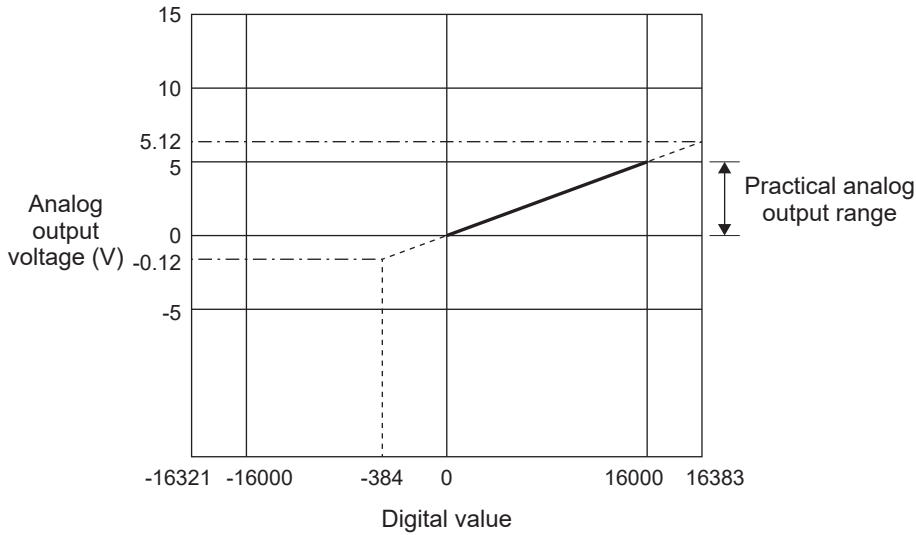

■ Voltage output characteristics graph (1 to 5 V)

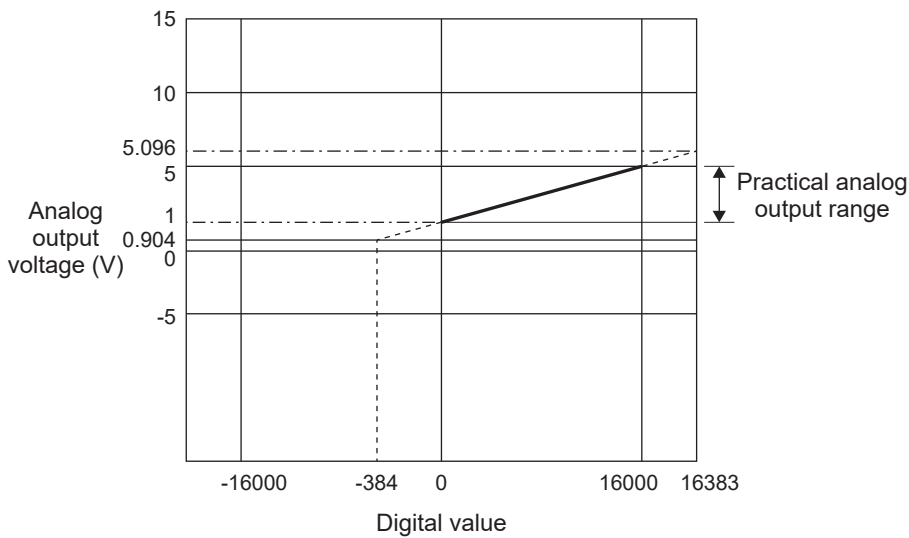

■ Voltage output characteristics graph (-10 to +10 V)

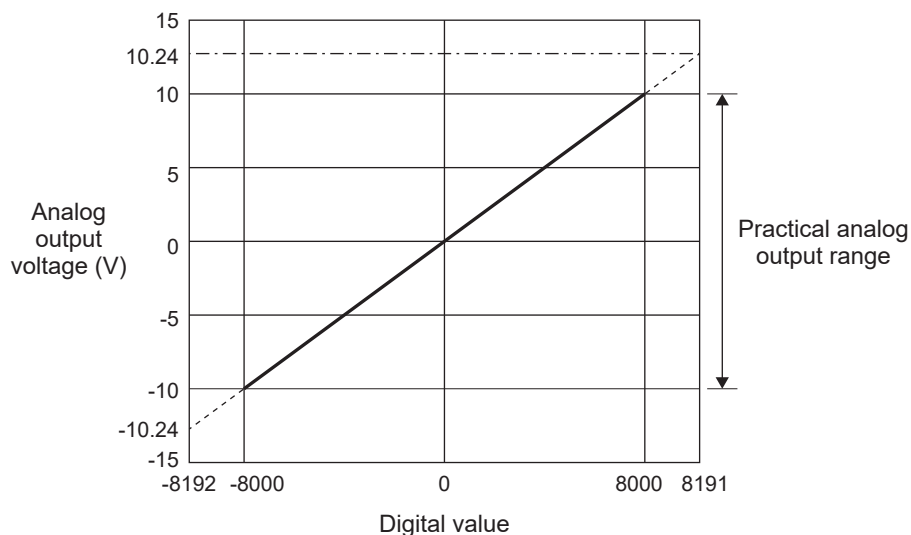

Current output characteristic

The following shows the list of the analog output ranges and the graphs of each current output characteristic, at the current output.

No.	Output range setting	Offset value	Gain value	Digital value ^{*1}	Resolution
(1)	0 to 20 mA	0 mA	20 mA	0 to 16000	1.25 μ A
(2)	4 to 20 mA	4 mA	20 mA	0 to 16000	1 μ A

*1 When value exceeds the range of the digital value, the digital value is fixed to the maximum or minimum.

Output range setting	Digital value	
	Minimum	Maximum
0 to 20 mA	-384	16383
4 to 20 mA	-384	16383

Point

Set values within the practical range of the digital input and analog output at each output range. If the values are out of the range, the resolution and accuracy may not fall within the range of the performance specifications. (Do not use values in the dotted line region in the graph of current output characteristics.)

■ Current output characteristics graph (0 to 20 mA)

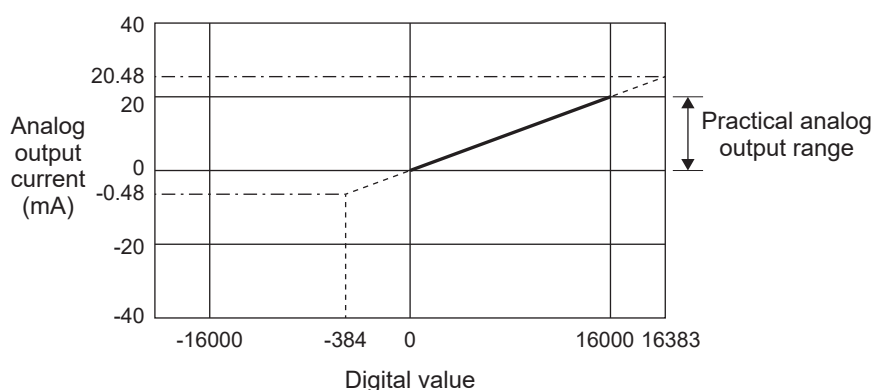

■ Current output characteristics graph (4 to 20 mA)

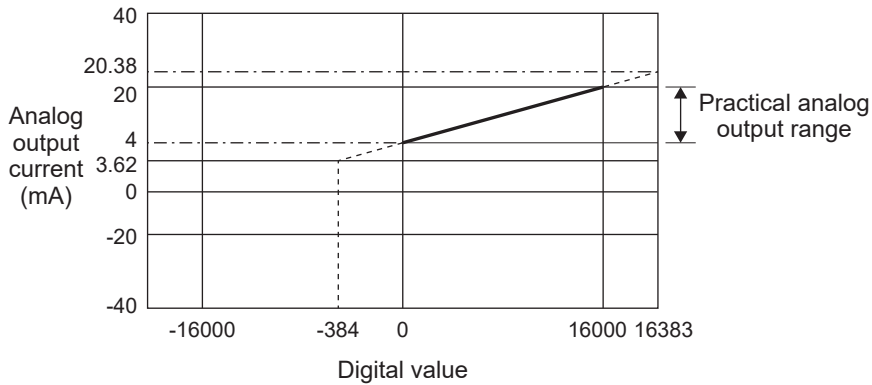

Accuracy

Accuracy of A/D conversion

Accuracy of A/D conversion is determined by the accuracy for the full scale of digital output value.

An input characteristic change through changes of the offset/gain setting or the input range does not sacrifice the accuracy, which is maintained within the described range of the performance specifications.

The following graph shows the fluctuation range of accuracy when the range of -10 to +10 V is selected.

The accuracy is $\pm 0.1\%$ (± 16 digits) at ambient temperature of $25 \pm 5^\circ\text{C}$; the accuracy is $\pm 0.2\%$ (± 32 digits) at ambient temperature of 0 to 55°C ; the accuracy is $\pm 0.3\%$ (± 48 digits) at ambient temperature of -20 to 0°C (except for the conditions under noise influence).

6

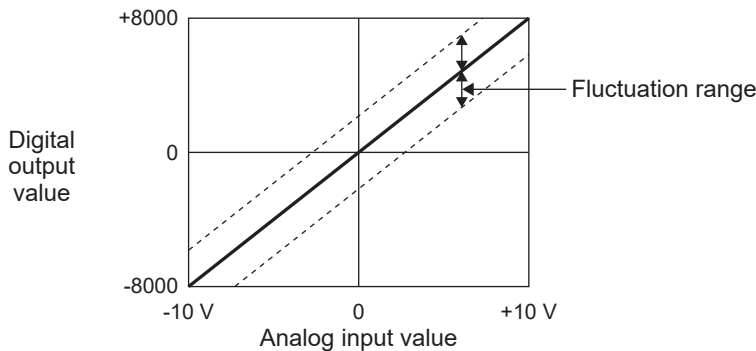

Accuracy of D/A conversion

Accuracy of D/A conversion is determined by the accuracy for the full scale of analog output value.

An output characteristic change through changes of the offset/gain setting or the output range does not sacrifice the accuracy, which is maintained within the described range of the performance specifications.

The following graph shows the fluctuation range of accuracy when the range of -10 to 10 V is selected.

The accuracy is $\pm 0.1\%$ (± 20 mV) at ambient temperature of $25 \pm 5^\circ\text{C}$; the accuracy is $\pm 0.2\%$ (± 40 mV) at ambient temperature of 0 to 55°C ; the accuracy is $\pm 0.3\%$ (± 60 mV) at ambient temperature of -20 to 0°C (except for the conditions under noise influence).

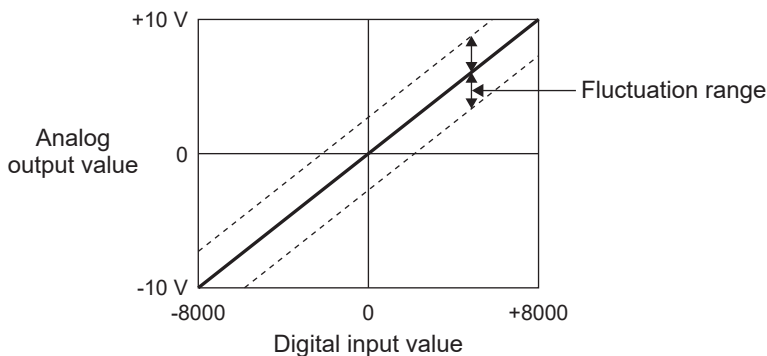

6.2 List of functions

The following table lists the functions list.

A/D conversion function

List of Functions		Description	Reference	
Range switching function		Allows switching the input range of an analog input for each channel. Switching the range makes it possible to change the input conversion characteristics.	Page 293	
A/D conversion enable/disable setting function		Controls whether to enable or disable the A/D conversion for each channel.	Page 294	
A/D conversion method	Sampling processing	Executes A/D conversion of analog input values sequentially and stores the digital output values to the special registers.	Page 295	
	Averaging processing	Time average		Executes A/D conversion for a set time, calculates the average of the total value, and stores the result in special registers. The number of processing times within the set time changes depending on the number of channels where A/D conversion is enabled.
		Count average		Executes A/D conversion for a set number of times, and calculates the average of the total value excluding the maximum value and the minimum value to store it in the special registers. The time taken to store the average value obtained by the average processing in the special registers changes depending on the number of channels where the A/D conversion is enabled.
		Moving average		Averages digital output values taken at every scan for a specified number of times, and stores the averaged value in the special registers. Because the target range for averaging processing is moved in response to every sampling processing, the latest digital output value can be obtained.
Over scale detection function		Function to detect analog input values that are over a input range.	Page 297	
Scaling function		Performs scale conversion on digital output values within a specified range between a scaling upper limit value and a scaling lower limit value. This function reduces the time and effort to create a program of the scale conversion.	Page 299	
Shift function		Adds (shifts) a set conversion value shift amount to a digital output value and stores the result in the digital operation value. The digital operation value reflects the change in the conversion value shift amount on a realtime basis. Therefore, fine adjustment can be easily performed when the system starts.	Page 302	
Digital clipping function		Fixes a possible digital operation value to the maximum digital output value or the minimum digital output value when an input current or voltage exceeds the input range.	Page 303	
Maximum value/minimum value hold function		Stores the maximum and minimum values of digital operation values to the special registers for each channel.	Page 304	
Warning output function	Process alarm	Outputs a warning when a digital operation value enters the preset warning output range.	Page 305	
	Rate alarm	Outputs a warning when the change rate of a digital output value is equal to or more than the rate alarm upper limit value, or the rate is equal to or less than the rate alarm lower limit value.	Page 307	
Disconnection detection function		Disconnection can be detected for each channel.	Page 310	
Convergence detection function		Detects whether the digital operation value is within a certain range in the specified time.	Page 312	
Deviation detection between channel function		Detects whether the difference in the digital operation value is larger than a specified value between channels.	Page 313	
Offset/gain setting function		Corrects errors in digital output values.	Page 314	
Offset/gain initialization function		Initializes the offset value and gain value stored in the built-in memory of the FX5-4A-ADP.	Page 319	

D/A conversion function

Item	Description	Reference
Range switching function	Allows switching the output range of an analog output for each channel. Switching the range makes it possible to change the output conversion characteristics.	Page 321
D/A conversion enable/disable setting function	Controls whether to enable or disable the D/A conversion for each channel.	Page 322
D/A output enable/disable setting function	Specifies whether to output the D/A conversion value or offset value for each channel. The conversion speed is a constant, regardless of the output enable/disable status.	Page 322
Analog output HOLD/CLEAR function	Sets whether to hold or clear the analog output value output when the operating status of the CPU module is RUN, STOP, or stop error.	Page 323
Analog Output Test when CPU Module is in STOP Status Function	Analog output tests can be carried out when the CPU module is in the STOP status.	Page 324
Scaling function	Performs scale conversion on digital values within a specified range between a scaling upper limit value and a scaling lower limit value. The program for scale conversion can be omitted.	Page 325
Shift function	Adds a set input value shift amount to a digital value.	Page 327
Warning output function	Outputs a warning when the digital value exceeds the warning output upper limit value or becomes less than the warning output lower limit value.	Page 328
External power supply disconnection detection function	Detects that the external power supply 24 V DC is not supplied or is shut off.	Page 329
Disconnection detection function	Monitors the analog output value and detects a disconnection.	Page 330
Offset/gain setting function	Corrects errors in D/A conversion values for each channel.	Page 332
Offset/gain initialization function	Initializes the offset value and gain value stored in the built-in memory of the FX5-4A-ADP.	Page 337

Common function

List of Functions	Description	Reference
Event history function	Collects errors from FX5-4A-ADP, and stores them as event information into the CPU module.	Page 338
Changing the setting value while the CPU module is operating	Changes the parameters set by the engineering tool by using the special device.	Page 338
Starting/stopping the analog function in accordance with the CPU module status	The operation of the FX5-4A-ADP can be checked by the CPU module.	Page 339
Alarm clear request	Clears the alarm code.	Page 340

6.3 A/D Conversion Function

This section describes the A/D conversion functions of the FX5-4A-ADP and the setting procedures for those functions using GX Works3.

Point

This section describes the special relays and special registers for the 1st FX5-4A-ADP module.

For checking the special relays and special registers for the 2nd and later FX5-4A-ADP modules, refer to the following:

☞ Page 362 List of A/D Conversion Special Relays, ☞ Page 376 List of A/D Conversion Special Registers

Processing of Each Function

The functions are processed in the order shown below.

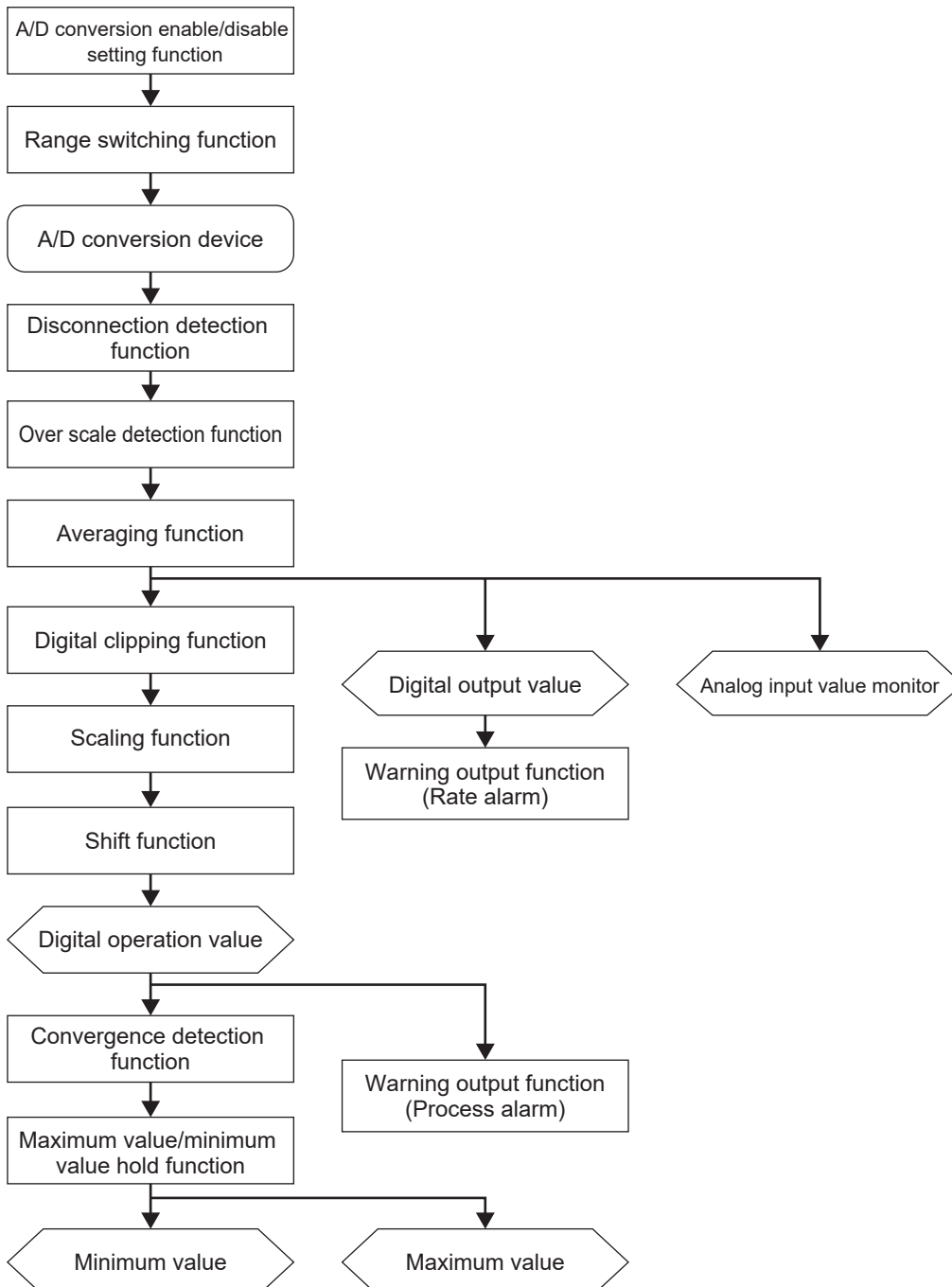

Digital output value

These values are the digital values after the sampling processing or each averaging processing has been performed.

Digital operation value

These values are obtained by operating a digital output value using the digital clipping function, scaling function, or shift function. When each function is not used, the same value as the digital output value is stored.

Analog input value monitor

The input analog value is displayed. Voltage and current are displayed in the following units.

Voltage: mV, Current: μ A

Maximum and minimum value

The maximum and minimum values of the digital operation values are stored.

Range Switching Function

This function allows switching the input range of an analog input for each channel.

Switching the range makes it possible to change the input conversion characteristics.

Setting procedure

Set the input range to be used in the "Input range setting".

 Navigation window \Rightarrow [Parameter] \Rightarrow [Module Information] \Rightarrow Module model name \Rightarrow [Module Parameter] \Rightarrow "Basic Settings" \Rightarrow "Range switching function"

Input range setting	Digital output value
0 to 10 V	0 to 16000
0 to 5 V	0 to 16000
1 to 5 V	0 to 12800
-10 to +10 V	-8000 to +8000
0 to 20 mA	0 to 16000
4 to 20 mA	0 to 12800
-20 to +20 mA	-8000 to +8000

Corresponding devices

The devices which are used by the range switching function are listed below.

Name	CH1	CH2	Reference
Input range setting	SD6305	SD6345	Page 382

Operation

The input range is switched when the "input range setting" is changed while the "A/D conversion enable/disable setting" is set to "disable".

When the input range is switched, the following special devices are initialized:

Name	CH1	CH2	Reference
A/D conversion completed flag	SM6300	SM6340	Page 366
Over scale upper limit detection flag	SM6302	SM6342	Page 366
Over scale lower limit detection flag	SM6303	SM6343	Page 367
Warning output flag (process alarm upper limit)	SM6311	SM6351	Page 369
Warning output flag (process alarm lower limit)	SM6312	SM6352	Page 369
Warning output flag (rate alarm upper)	SM6315	SM6355	Page 370
Warning output flag (rate alarm lower)	SM6316	SM6356	Page 370
Disconnection detection flag	SM6318	SM6358	Page 371
Convergence detection flag	SM6321	SM6361	Page 372
Deviation detection flag between channel	SM6325	SM6365	Page 373
Digital output value	SD6300	SD6340	Page 380
Digital operation value	SD6301	SD6341	Page 380
Analog input value monitor	SD6302	SD6342	Page 381
Maximum value	SD6306	SD6346	Page 383
Minimum value	SD6307	SD6347	Page 383
Offset setting value ^{*1}	SD6332	SD6372	Page 392
Gain setting value ^{*1}	SD6333	SD6373	Page 392

*1 When the input range setting after change is equivalent to the input range setting set by the offset/gain setting function, the values set by the offset/gain setting function are reflected. In any other case, they are initialized to the initial value.

A/D Conversion Enable/Disable Setting Function

This function controls whether to enable or disable the A/D conversion for each channel.

Setting procedure

Set "A/D conversion enable/disable setting" to "A/D conversion enable" or "A/D conversion disable".

Navigation window ⇒ [Parameter] ⇒ [Module Information] ⇒ Module model name ⇒ [Module Parameter] ⇒ "Basic Settings" ⇒ "A/D Conversion Enable/Disable Setting Function"

Corresponding devices

The devices which are used by the A/D conversion enable/disable setting function are listed below.

Name	CH1	CH2	Reference
A/D conversion enable/disable setting	SM6301	SM6341	Page 366

Operation

The analog input is A/D-converted only in the channels for which the "A/D conversion enable/disable setting" is set to "enable", and values are stored in the "digital output value", "digital operation value" and "analog input value monitor".

When the "A/D conversion enable/disable setting" is changed from "enable" to "disable", the digital value, digital operation value and analog input value monitor are cleared.

A/D Conversion Method

An A/D conversion method can be set for each channel.

Sampling processing

The analog input is A/D-converted in each scan of the CPU module, the converted value is output in digital at each time, and values are stored in the "digital output value", "digital operation value" and "analog input value monitor".

Averaging processing

The FX5-4A-ADP performs the averaging processing on digital output values for each channel and stores the mean values to the special registers.

The following three types of averaging processing are provided.

- Time average
- Count average
- Moving average

■Time average

A/D conversion is executed for a set time, the total value is averaged, and values are stored in the "digital output value", "digital operation value" and "analog input value monitor".

The number of times of processing within the set time varies depending on the number of channels for which A/D conversion is enabled.

Number of processing times=Setting time÷Scan time

Point

If the set time is shorter than the scan time, the averaging processing is not executed, but the sampling value is output. However, only in the first output, the averaged value of the 1st sample and 2nd sample is output.

■Count average

A/D conversion is executed for a set number of times of count average, the averaged value excluding the maximum value and minimum value is output in digital, and values are stored in the "digital output value", "digital operation value" and "analog input value monitor".

The time required to store the averaged value obtained by count average in the "digital output value", "digital operation value" and "analog input value monitor" varies depending on the scan time.

Processing time=Set number of times×Scan time

Point

The count average requires a total of at least two values excluding the maximum value and minimum value. Set the number of times to "4" or larger value.

■Moving average

A/D conversion is executed for a set number of times of moving average, and the averaged value is output in digital, and values are stored in the "digital output value", "digital operation value" and "analog input value monitor".

Because the target range for averaging processing is moved in each conversion cycle and the averaging processing is executed using A/D conversion values for the set number of times, the latest "digital output value", "digital operation value" and "analog input value monitor" can be obtained.

The figure below shows the moving average when the number of times of averaging processing is set to "4".

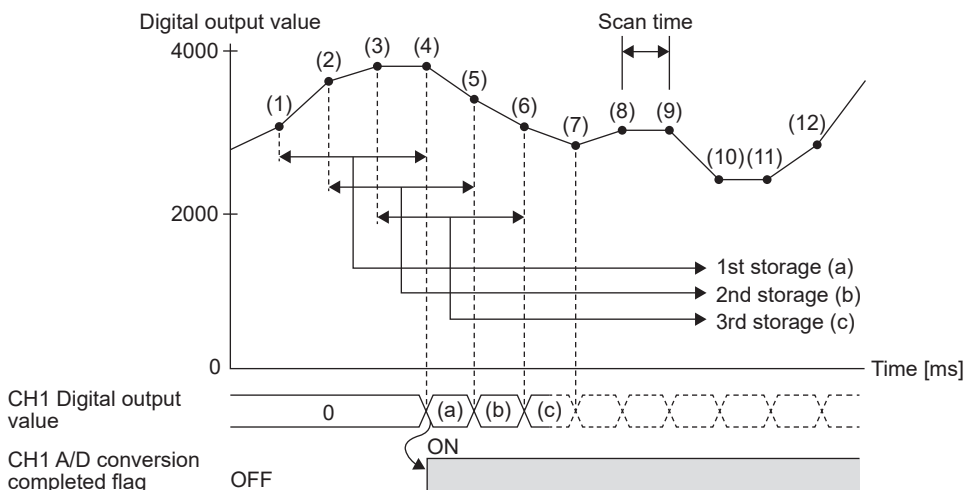

Setting procedure

■Sampling processing

Set "Average Processing Specification" to "Sampling Processing".

Navigation window ⇒ [Parameter] ⇒ [Module Information] ⇒ Module model name ⇒ [Module Parameter] ⇒ "Basic Settings" ⇒ "A/D conversion method"

■Averaging processing

1. Set "Average Processing Specification" to "Time Average", "Count Average", or "Moving Average".

Navigation window ⇒ [Parameter] ⇒ [Module Information] ⇒ Module model name ⇒ [Module Parameter] ⇒ "Basic Settings" ⇒ "A/D Conversion Method"

2. Set a value for "Time Average Counts Average Moving Average".

Item	Setting range
Time Average	1 to 10000 (ms)
Count Average	4 to 32767 (times)
Moving Average	2 to 64 (times)

Corresponding devices

The devices which are used by the A/D conversion method are listed below.

Name	CH1	CH2	Reference
Digital output value	SD6300	SD6340	Page 380
Digital operation value	SD6301	SD6341	Page 380
Analog input value monitor	SD6302	SD6342	Page 381
Average processing specify	SD6303	SD6343	Page 381
Time Average/Count Average/Moving Average setting	SD6304	SD6344	Page 382

Over Scale Detection Function

This function detects analog input values that are over a input range.

Setting procedure

Set "Over scale detection enable/disable" to "Enable".

 Navigation window ⇒ [Parameter] ⇒ [Module Information] ⇒ Module model name ⇒ [Module Parameter] ⇒ "Application Settings" ⇒ "Over Scale Detection"

Corresponding devices

The devices which are used by the over scale detection function are listed below.

Name	CH1	CH2	Reference
Over scale upper limit detection flag	SM6302	SM6342	Page 366
Over scale lower limit detection flag	SM6303	SM6343	Page 367
Over scale detection enable/disable setting	SM6304	SM6344	Page 367

Over-scale detection condition

The table below shows the condition for detecting over-scale when the over-scale detection function is enabled.

Input range	Normal range	Over-scale detection condition	
		Analog input value lower limit	Analog input value upper limit
0 to 10 V	-0.2 to +10.2 V	-0.2 V > Analog input value	+10.2 V < Analog input value
0 to 5 V	-0.1 to +5.1 V	-0.1 V > Analog input value	+5.1 V < Analog input value
1 to 5 V	-0.1 to +5.1 V	-0.1 V > Analog input value	+5.1 V < Analog input value
-10 to +10 V	-10.2 to +10.2 V	-10.2 V > Analog input value	+10.2 V < Analog input value
0 to 20 mA	-0.4 to +20.4 mA	-0.4 mA > Analog input value	+20.4 mA < Analog input value
4 to 20 mA	-0.4 to +20.4 mA	-0.4 mA > Analog input value	+20.4 mA < Analog input value
-20 to +20 mA	-20.4 to +20.4 mA	-20.4 mA > Analog input value	+20.4 mA < Analog input value

Operation

When the analog input value is outside the normal range, it is regarded as over-scale and the corresponding over-scale detection flag turns ON.

- Over-scale upper limit detection flag: Turns ON when the analog input value is above the normal range. (Alarm code: 090□H)
- Over-scale lower limit detection flag: Turns ON when the analog input value is below the normal range. (Alarm code: 091□H)

The digital output value from the channel where over-scale is detected is held with the value just before over-scale is detected, and the "A/D conversion completion flag" of the corresponding channel turns OFF.

When the analog input value becomes normal, A/D conversion is restarted. After the first update, the "A/D conversion completion flag" of the corresponding channel turns ON, but the "over-scale upper limit detection flag", "over-scale lower limit detection flag" does not turn OFF.

It is necessary to set to ON the "A/D conversion alarm clear request" for turning OFF the "over-scale upper limit detection flag", "over-scale lower limit detection flag". The "over-scale upper limit detection flag", "over-scale lower limit detection flag" turns OFF also when the "over-scale detection enable/disable" is changed to "disable".

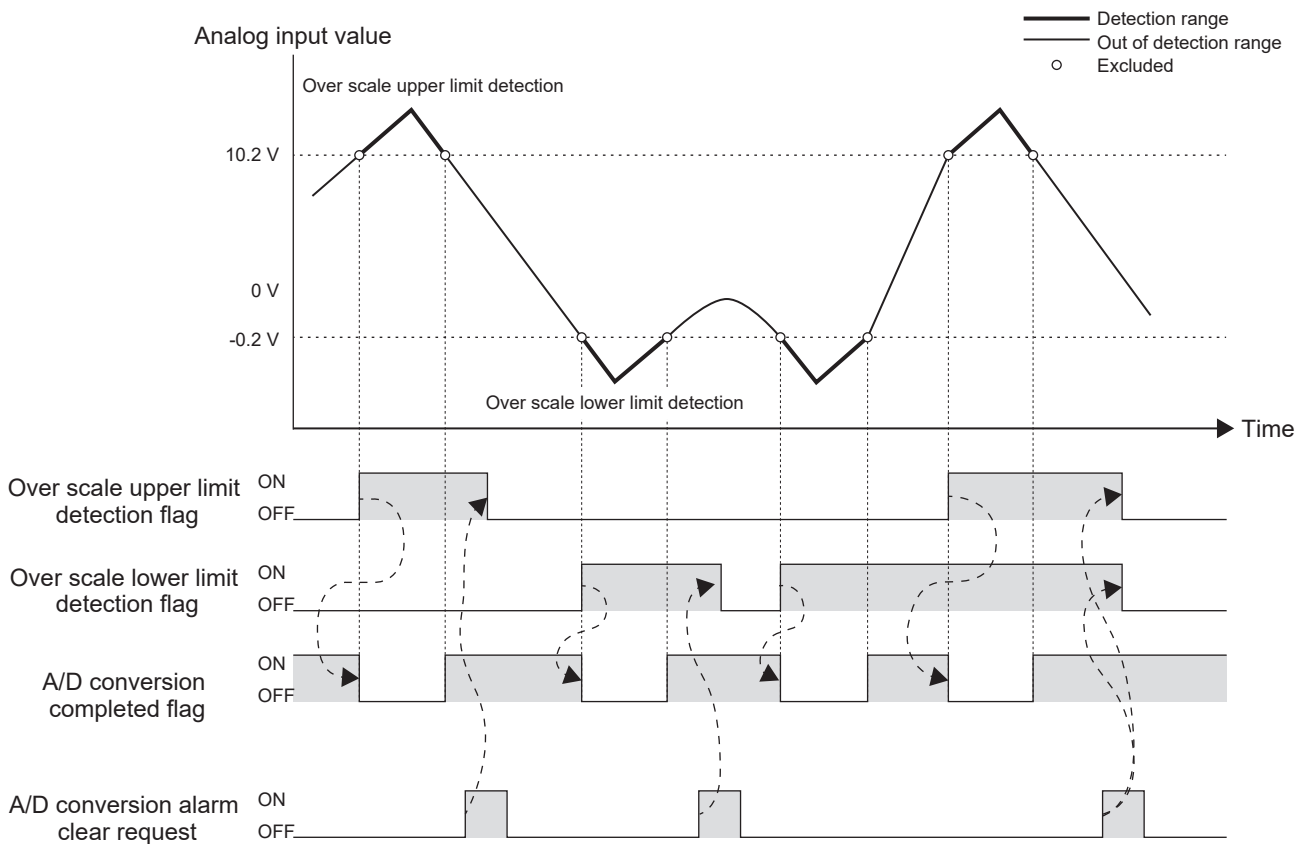

Point

- The "A/D conversion alarm clear request" is not turned off automatically. To perform an alarm clear again, it is necessary to turn it OFF once.
- To clear the alarm code, set the "A/D conversion alarm clear request" to ON.

Scaling Function

This function performs the scale conversion on digital output values. The values are converted within a specified range between a scaling upper limit value and scaling lower limit value.

The converted values are stored in "digital operation value".

Concept of scaling setting

Ex.

When the input range is set to -10 to +10 V:

For the scaling lower limit value, set a value corresponding to the lower limit value of the input range (-8000).

For the scaling upper limit value, set a value corresponding to the upper limit value of the input range (+8000).

Calculating the scaling value

The scale conversion is based on the following formula. (In scale conversion, values are rounded to the nearest whole number.)

■ Current (0 to 20 mA, 4 to 20 mA), voltage (0 to 10 V, 0 to 5 V, 1 to 5 V)

Calculation formula	Symbol
$D_Y = \frac{D_X \times (S_H - S_L)}{D_{Max}} + S_L$	D _X : Digital output value D _Y : Scaling value (Digital operation value) D _{Max} : Maximum digital output value of the input range in use S _H : Scaling upper limit value S _L : Scaling lower limit value

■ Current (-20 to +20 mA), voltage (-10 to +10 V)

Calculation formula	Symbol
$D_Y = \frac{D_X \times (S_H - S_L)}{D_{Max} - D_{Min}} + \frac{(S_H + S_L)}{2}$	D _X : Digital output value D _Y : Scaling value (Digital operation value) D _{Max} : Maximum digital output value of the input range in use D _{Min} : Minimum digital output value of the input range in use S _H : Scaling upper limit value S _L : Scaling lower limit value

Setting procedure

1. Set "Scaling enable/disable setting" to "Enable".

Navigation window ⇒ [Parameter] ⇒ [Module Information] ⇒ Module model name ⇒ [Module Parameter] ⇒ "Application Settings" ⇒ "Scaling Setting"

2. Set values for "Scaling upper limit value" and "Scaling lower limit value".

Item	Setting range
Scaling upper limit value	-32768 to +32767
Scaling lower limit value	-32768 to +32767

Point

- Even when the scaling upper limit value and the scaling lower limit value are set so that the change is greater than the resolution, the max. resolution will not increase.
- If the relation between the values is scaling lower limit value > scaling upper limit value, the scale conversion can be performed according to a negative slope.
- Set the scaling with the condition "Scaling upper limit value ≠ Scaling lower limit value".

Corresponding devices

The devices which are used by the scaling function are listed below.

Name	CH1	CH2	Reference
Scaling enable/disable setting	SM6308	SM6348	Page 368
Scaling upper limit value	SD6308	SD6348	Page 383
Scaling lower limit value	SD6309	SD6349	Page 384

Setting example

Ex.

When 5000 is set to the scaling upper limit value and 1000 is set to the scaling lower limit value for the channel with the input range of 0 to 5 V

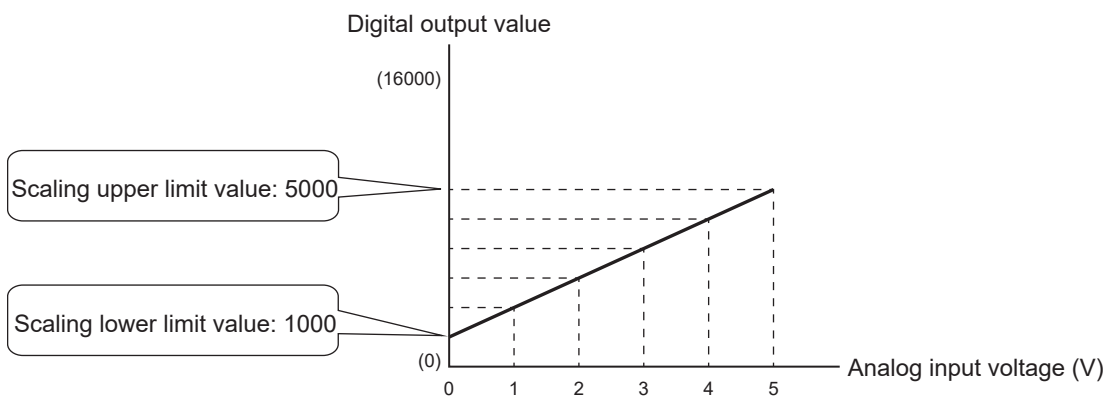

Voltage input (V)	Digital output value	Digital operation value (scaling value)
0	0	1000
1	3200	1800
2	6400	2600
3	9600	3400
4	12800	4200
5	16000	5000

Ex.

When 1000 is set to the scaling upper limit value and 5000 is set to the scaling lower limit value for the channel with the input range of 0 to 5 V

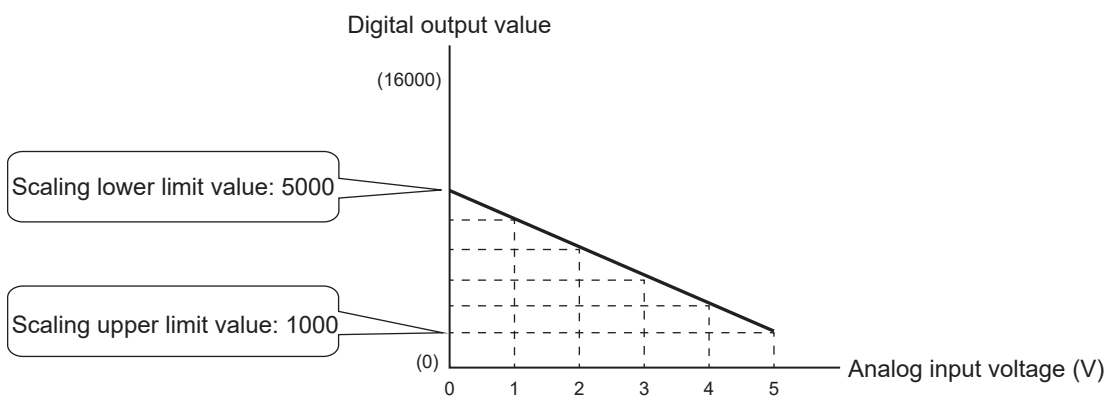

Voltage input (V)	Digital output value	Digital operation value (scaling value)
0	0	5000
1	3200	4200
2	6400	3400
3	9600	2600
4	12800	1800
5	16000	1000

Ex.

When 2500 is set to the scaling upper limit value and 500 is set to the scaling lower limit value for the channel with the input range of -10 to +10 V

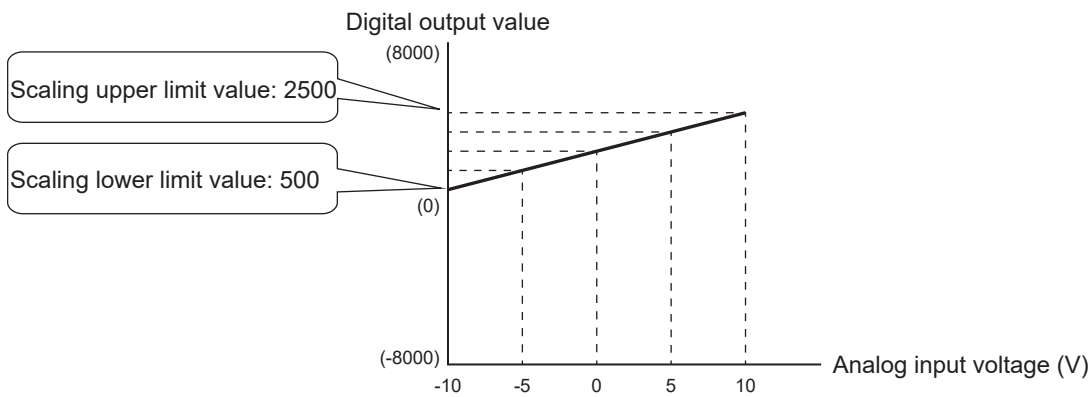

Voltage input (V)	Digital output value	Digital operation value (scaling value)
-10	-8000	500
-5	-4000	1000
0	0	1500
5	4000	2000
10	8000	2500

Ex.

When 500 is set to the scaling upper limit value and 2500 is set to the scaling lower limit value for the channel with the input range of -10 to +10 V

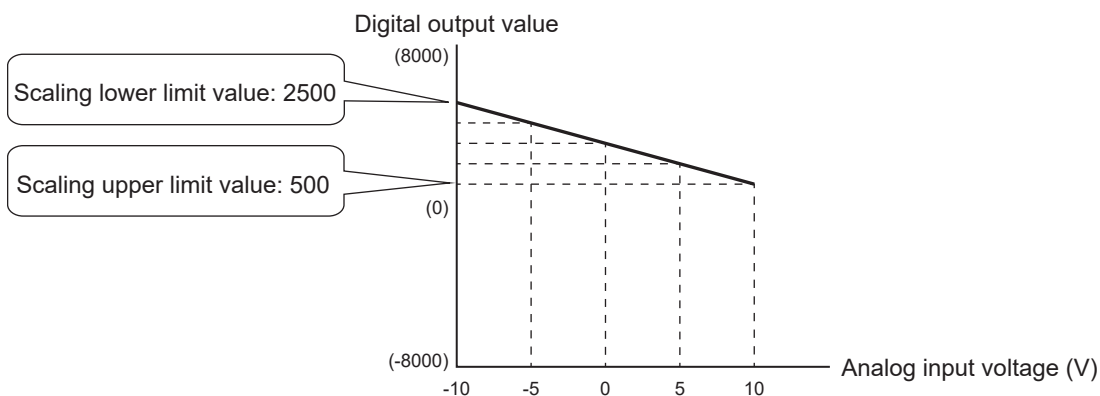

Voltage input (V)	Digital output value	Digital operation value (scaling value)
-10	-8000	2500
-5	-4000	2000
0	0	1500
5	4000	1000
10	8000	500

Point

When the scaling function is used with the digital clipping function, the scale conversion is performed on the digital operation values after digital clipping.

Shift Function

This function adds (shifts) a set conversion value shift amount to a digital operation value and stores the result in the "digital operation value". The digital operation value reflects the change in the conversion value shift amount on a realtime basis. Therefore, fine adjustment can be easily performed when the system starts.

Operation

A set "conversion value shift amount" is added to the "digital operation value". The digital operation value with shift addition is stored in "digital operation value".

The conversion value shift amount is added in every scan for sampling processing and is added in every averaging process cycle for averaging processing. After that, the added values are stored in "digital operation value".

When the digital operation value becomes outside the range from -32768 to +32767 as the result of shift processing, the shifted value is fixed to the lower limit value (-32768) or upper limit value (+32767).

Point

- When the scaling function is used together, the shift processing is executed to the value after scale conversion.
- When the digital clipping function and scaling function are used together, the shift processing is executed to the value after digital clipping and scale conversion.

Setting procedure

Set a value for "Shifting amount to conversion value".

Navigation window ⇒ [Parameter] ⇒ [Module Information] ⇒ Module [model name] ⇒ [Module Parameter] ⇒ "Application Settings" ⇒ "Shift Function"

Item	Setting range
Conversion value shift amount	-32768 to +32767

Corresponding devices

The devices which are used by the shift function are listed below.

Name	CH1	CH2	Reference
Conversion value shift amount	SD6310	SD6350	Page 384

Setting example

Ex.

When the input characteristics is adjusted in a channel where the input range of 0 to 10 V is set by the shift function

Digital output value

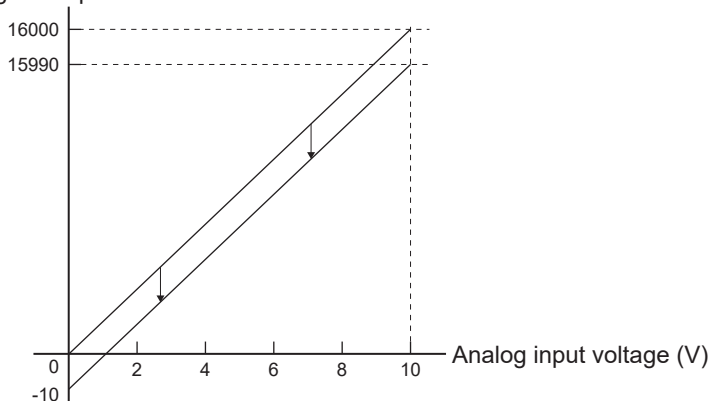

Voltage input (V)	Digital output value	Digital operation value
0	0	-10
10	16000	15990

Digital Clipping Function

This function fixes the range of the digital operation value with the maximum digital output value and the minimum digital output value when the corresponding current or voltage exceeds the input range.

List of output ranges

The following table lists the output ranges of the digital operation values when the digital clipping function is enabled with each range.

Input range	Output range of digital operation values		
	Digital clipping function is enabled	Digital clipping function is disabled (over-scale is enabled)	Digital clipping function is disabled
0 to 10 V	0 to 16000	-320 to +16320	-384 to +16383
0 to 5 V			
1 to 5 V	0 to 12800	-3520 to +13120	-3584 to +13183
-10 to +10 V	-8000 to +8000	-8160 to +8160	-8192 to +8191
0 to 20 mA	0 to 16000	-320 to +16320	-384 to +16383
4 to 20 mA	0 to 12800	-3520 to +13120	-3584 to +13183
-20 to +20 mA	-8000 to +8000	-8160 to +8160	-8192 to +8191

Setting procedure

Set "Digital clipping enable/disable" to "Enable".

Navigation window ⇒ [Parameter] ⇒ [Module Information] ⇒ Module model name ⇒ [Module Parameter] ⇒ "Application Settings" ⇒ "Digital Clipping Setting"

Corresponding devices

The devices which are used by the digital clipping function are listed below.

Name	CH1	CH2	Reference
Digital clipping enable/disable setting	SM6309	SM6349	Page 369

Setting example

Ex.

When the following values are used for the channel with the input range of 0 to 10 V

■Setting value

- Scaling upper limit value: 12000
- Scaling lower limit value: 2000
- Conversion value shift amount: 2000
- Digital clipping enable/disable setting: Enable

■Setting procedure

1. Set the "A/D conversion enable/disable setting" to "enable".
2. Set "2000" to the scaling lower limit value.
3. Set "12000" to the scaling upper limit value.
4. Set the "scaling enable/disable setting" to "enable".
5. Set "2000" to the conversion value shift amount.
6. Set the "digital clipping enable/disable setting" to "enable".

■ Operation

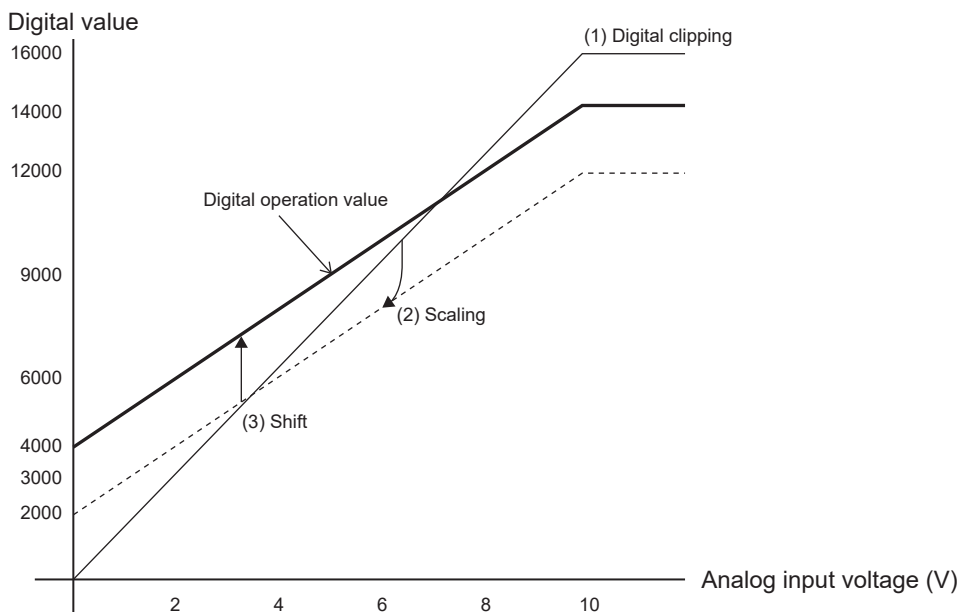

Maximum Value/Minimum Value Hold Function

This function stores the maximum value and minimum value of the digital operation value to the special registers for each channel.

This function can be set only with special devices.

Setting procedure

When the "maximum value reset request" or "minimum value reset request" is set from OFF to ON, the maximum value or minimum value is updated to the digital operation value.

Setting value	Description	Default value
0: OFF	With no maximum value or minimum value reset request	0: OFF
1: ON	With maximum value or minimum value reset request	

Corresponding devices

The devices which are used by the maximum value/minimum value hold function are listed below.

Name	CH1	CH2	Reference
Maximum value/minimum value reset completed flag	SM6305	SM6345	Page 367
Maximum value reset request	SM6306	SM6346	Page 368
Minimum value reset request	SM6307	SM6347	Page 368
Maximum value	SD6306	SD6346	Page 383
Minimum value	SD6307	SD6347	Page 383

Operation

When the "maximum value reset request" or "minimum value reset request" is set from OFF to ON, the maximum value or minimum value of the specified channel is updated to the "digital operation value". The "maximum value/minimum value reset completion flag" turns ON.

When the range is switched, the "maximum value" and "minimum value" are cleared (to "0").

Warning Output Function

This section describes process alarms and rate alarms used for the warning output function.

Process alarm

This function outputs a warning when a digital operation value enters the preset warning output range.

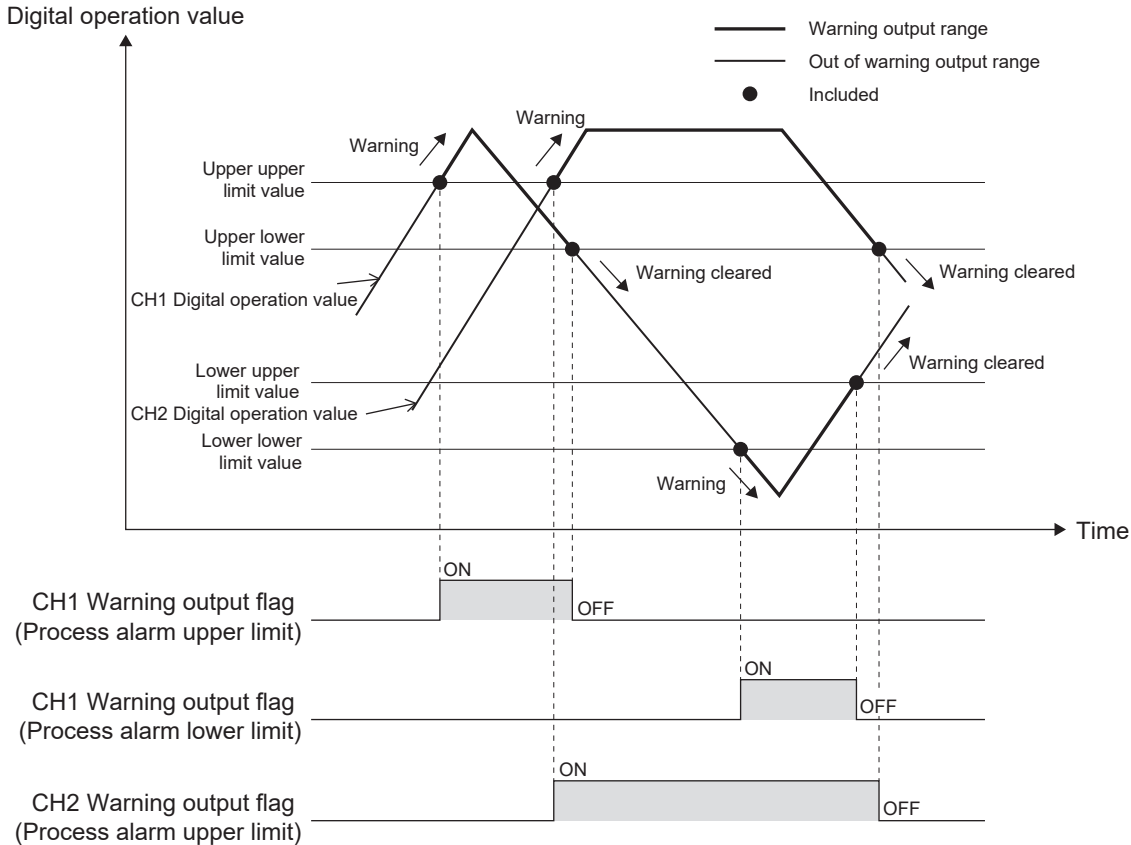

■ Operation

When the digital operation value is above the process alarm upper upper limit value or below the process alarm lower lower limit value and the warning output condition is satisfied, the "warning output flag (process alarm upper limit)" or "warning output flag (process alarm lower limit)" turns ON.

When the digital operation value changes to a value below the process alarm upper lower limit value or above the process alarm lower upper limit value and the warning output condition is not satisfied after the warning output, the "warning output flag (process alarm upper limit)" or "warning output flag (process alarm lower limit)" turns OFF. The "warning output flag (process alarm upper limit)" and "warning output flag (process alarm lower limit)" turn OFF also when the "warning output enable/disable setting" is changed to "disable". However, the alarm code stored in the "A/D conversion latest alarm code" is not cleared.

For clearing the alarm code stored in the "A/D conversion latest alarm code", wait until the "warning output flag (process alarm upper limit)" and "warning output flag (process alarm lower limit)" turn OFF, and then set the "A/D conversion alarm clear request" to OFF, ON and OFF.

■ Detection cycle

When time average is specified, the function works at every interval of the time (for averaging). When count average is specified, the function works at every count (for averaging). When the sampling processing and moving average is specified, this function works at every sampling cycle.

■Detection target for outputting a warning

When the digital clipping function, scaling function and shift function are used, digital operation values on which digital clipping, scale conversion and shift amount addition are executed are regarded as targets of alarm detection.

With regard to the process alarm upper upper limit value, process alarm lower upper limit value, process alarm lower upper limit value and process alarm lower lower limit value, make sure to set such values as to consider digital clipping, scale conversion and shift amount addition.

■Setting procedure

1. Set "Warning output setting (Process alarm)" to "Enable".

 Navigation window ⇒ [Parameter] ⇒ [Module Information] ⇒ Module model name ⇒ [Module Parameter] ⇒ "Application Settings" ⇒ "Warning output function (Process alarm)"

2. Set values for "Process alarm upper upper limit value", "Process alarm upper lower limit value", "Process alarm lower upper limit value", and "Process alarm lower lower limit value".

Item	Setting range
Process alarm upper upper limit value	-32768 to +32767
Process alarm upper lower limit value	
Process alarm lower upper limit value	
Process alarm lower lower limit value	

Point

Set values within the range satisfying the condition "Process alarm upper upper limit value \geq Process alarm upper lower limit value \geq Process alarm lower upper limit value \geq Process alarm lower lower limit value".

When not satisfying the above conditions, a process alarm upper lower limit value setting range error occurs. (Error code: 1A4□H)

■Corresponding devices

The devices which are used by the process alarm are listed below.

Name	CH1	CH2	Reference
Warning output flag (process alarm upper limit)	SM6311	SM6351	Page 369
Warning output flag (process alarm lower limit)	SM6312	SM6352	Page 369
Warning output setting (process alarm)	SM6313	SM6353	Page 370
Process alarm upper upper limit value	SD6311	SD6351	Page 384
Process alarm upper lower limit value	SD6312	SD6352	Page 385
Process alarm lower upper limit value	SD6313	SD6353	Page 385
Process alarm lower lower limit value	SD6314	SD6354	Page 386

Rate alarm

This function outputs a warning when the change rate of a digital output value is equal to or more than the rate alarm upper limit value, or the rate is equal to or less than the rate alarm lower limit value.

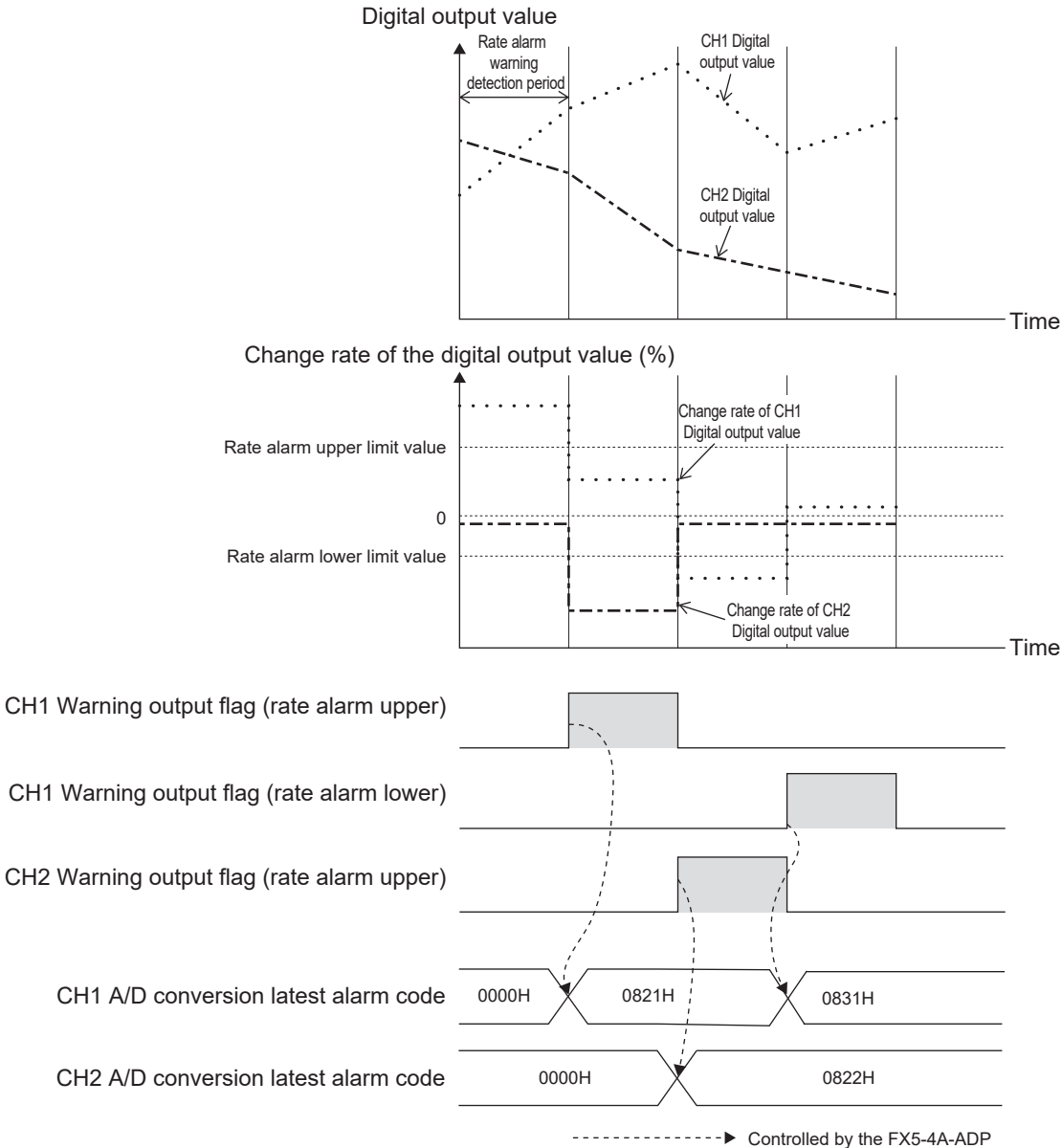

■Operation

The digital output value is monitored in each rate alarm warning detection period. When the change from the previous value shows the change rate above the rate alarm upper limit value or below the rate alarm lower limit value, the "warning output flag (rate alarm upper limit)" or "warning output flag (rate alarm lower limit)" turns ON.

When the digital output value changes to a value below the rate alarm upper limit value or above the rate alarm lower limit value and the warning output condition is not satisfied after the warning output, the "warning output flag (rate alarm upper limit)" or "warning output flag (rate alarm lower limit)" turns OFF. The "warning output flag (rate alarm upper limit)" and "warning output flag (rate alarm lower limit)" turn OFF also when the "warning output setting (rate alarm)" is set to "disable". However, the alarm code stored in the "A/D conversion latest alarm code" is not cleared.

For clearing the alarm code stored in the latest alarm code, wait until the "warning output flag (rate alarm upper limit)" and "warning output flag (rate alarm lower limit)" turn OFF, and then set the "A/D conversion alarm clear request" to OFF, ON and OFF.

■Detection cycle

Set the rate alarm warning detection period in "rate alarm warning detection period setting".

■ Judgment of rate alarm

A change rate is judged with "Rate alarm upper limit value" and "Rate alarm lower limit value" converted to digital values per rate alarm warning detection period.

The following shows the conversion formula of judgment values used for the rate alarm detection.

Value used for judgment in every rate alarm alert detection cycle [digit]^{*1} = "Rate alarm upper limit value (lower limit value)" × 0.1 × 0.01 × Maximum digital output value

Ex.

The judgment value under the following conditions

Setting item	Description
Averaging process specify	Sampling processing
Rate alarm warning detection period setting	10 (ms)
Rate alarm upper limit value	250 (25.0 %)
Rate alarm lower limit value	50 (5.0 %)

Upper limit value: $250 \times 0.1 \times 0.01 \times 16000 = 4000$ (digit)

Lower limit value: $50 \times 0.1 \times 0.01 \times 16000 = 800$ (digit)

The current value is compared with the previous value in every rate alarm warning detection period ("10 ms" in this example). It is checked whether the current digital value is larger by more than 4000 digit (25 %) or smaller by more than 800 digit (5 %) compared to the previous value.

The following formula is used to obtain the change rate to be set based on the change amount of the voltage/current to detect warning:

$$\text{Change rate to be set (0.1 \%)} = \left(\frac{\text{Change amount of the voltage (current) to detect warning (V (mA))}}{\text{Gain voltage (current) (V(mA)) - Offset voltage (current) (V (mA))}} \times 1000 \right)^{*1}$$

*1 The value below the decimal point obtained by calculation is rounded.

■ Application examples of rate alarms

A rate alarm serves to monitor that the variation rate of a digital output value lies in a limited range as shown below.

Ex.

To monitor that a rising rate of a digital output value is within the specified range

Change rate of the digital output value (%)

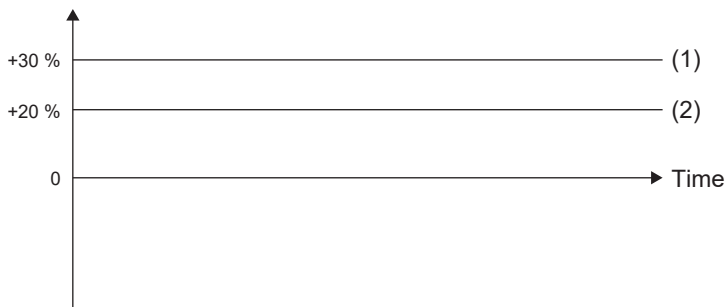

(1) Rate alarm upper value
(2) Rate alarm lower value

Ex.

To monitor that a drop rate of a digital output value is within the specified range

Change rate of the digital output value (%)

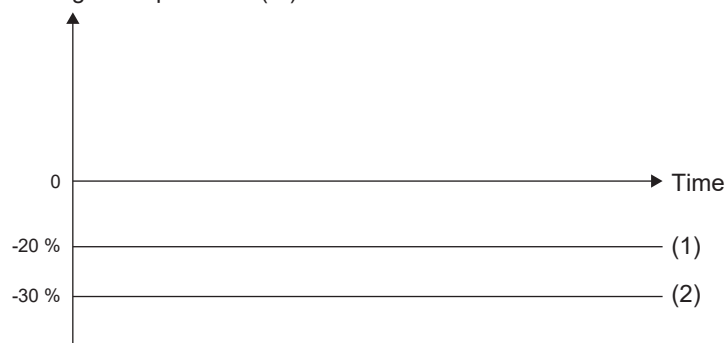

(1) Rate alarm upper value
(2) Rate alarm lower value

Ex.

To monitor that a change rate of a digital output value is within the specified range

Change rate of the digital output value (%)

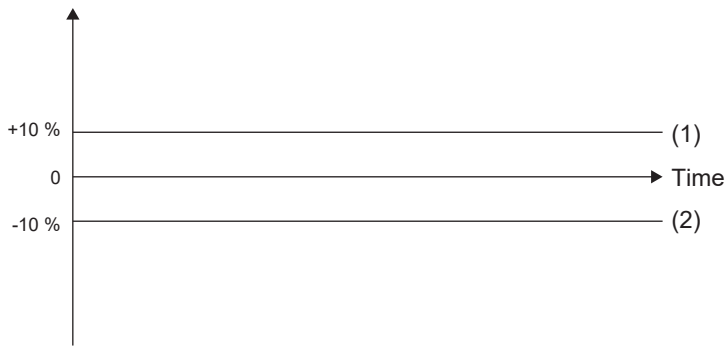

(1) Rate alarm upper value
(2) Rate alarm lower value

Setting procedure

1. Set "Warning output function (Rate alarm)" to "Enable".

Navigation window ⇒ [Parameter] ⇒ [Module Information] ⇒ Module model name ⇒ [Module Parameter] ⇒ "Application Settings" ⇒ "Warning output function (Rate alarm)"

2. Set a warning detection period of rate alarms.

Set the cycle in "Rate alarm warning detection period setting".

Item	Setting range
Rate alarm warning detection period setting	1 to 10000 (ms)

Point

When a value outside the setting range is set, the rate alarm warning detection period setting range error occurs. (Error code: 1A6□H)

3. Set values for "Rate alarm upper limit value" and "Rate alarm lower limit value".

Set a value for the maximum value (16000) of the digital output value in increments of 0.1 %.

Item	Setting range
Rate alarm upper limit value	-1000 to +1000 (0.1 %)
Rate alarm lower limit value	

Point

Set values within the range satisfying the condition "Rate alarm upper limit value > Rate alarm lower limit value".

When not satisfying the above conditions, a rate alarm upper/lower limit setting value inversion error occurs. (Error code: 1A5□H).

Corresponding devices

The devices which are used by the rate alarm are listed below.

Name	CH1	CH2	Reference
Warning output flag (rate alarm upper)	SM6315	SM6355	Page 370
Warning output flag (rate alarm lower)	SM6316	SM6356	Page 370
Warning output setting (rate alarm)	SM6317	SM6357	Page 371
Rate alarm upper limit value	SD6315	SD6355	Page 386
Rate alarm lower limit value	SD6316	SD6356	Page 387
Rate alarm warning detection period setting	SD6317	SD6357	Page 387

Disconnection Detection Function

Simple disconnection detection is performed.

This function is enabled when the analog input range is 1 to 5 V or 4 to 20 mA.

Setting procedure

1. Set "Disconnection detection enable/disable setting" to "Enable".

Navigation window ⇒ [Parameter] ⇒ [Module Information] ⇒ Module model name ⇒ [Module Parameter] ⇒ "Application Settings" ⇒ "Disconnection detection enable/disable setting"

2. Set "Disconnection recovery detection enable/disable setting".

Navigation window ⇒ [Parameter] ⇒ [Module Information] ⇒ Module model name ⇒ [Module Parameter] ⇒ "Application Settings" ⇒ "Disconnection recovery detection enable/disable setting"

Corresponding devices

The devices which are used by the disconnection detection function are listed below.

Name	CH1	CH2	Reference
Disconnection detection flag	SM6318	SM6358	Page 371
Disconnection detection enable/disable setting	SM6319	SM6359	Page 371
Disconnection recovery detection enable/disable setting	SM6320	SM6360	Page 372

Disconnection detection condition

The table below shows the disconnection detection condition and disconnection recovery condition.

Input range	Disconnection detection condition	Disconnection recovery condition
1 to 5 V	Analog input value ≤ 0.5 V	Analog input value > 0.5 V
4 to 20 mA	Analog input value ≤ 2 mA	Analog input value > 2 mA

Operation

When the input voltage or input current reaches the disconnection detection condition in a channel for which the "A/D conversion enable/disable setting" is set to "enable" and the "disconnection detection enable/disable setting" is set to "enable", it is regarded as disconnection. As a result, alarm occurs and the "disconnection detection flag" turns ON (Alarm code: 0A0□H).

The "A/D conversion completion flag" turns OFF, A/D conversion is interrupted, and the later processing is not executed in the disconnected channel.

When the "disconnection recovery detection enable/disable setting" is set to "enable", the "disconnection detection flag" turns OFF when the channel is recovered from disconnection. When the channel is recovered from disconnection, A/D conversion is restarted.

When the "disconnection recovery detection enable/disable setting" is set to "disable", the "disconnection detection flag" remains ON. It is necessary to set the "A/D conversion alarm clear request" to ON to turn OFF the "disconnection detection flag". The "disconnection detection flag" turns OFF also when the "disconnection detection enable/disable setting" is changed to "disable".

The range setting range error with disconnection detection enabled (Error code: 1AA□H) occurs when the input range of a channel for which the "disconnection detection enable/disable setting" is set to "enable" is set outside "1 to 5 V" or "4 to 20 mV".

■When the "disconnection detection recovery enable/disable setting" is set to "enable"

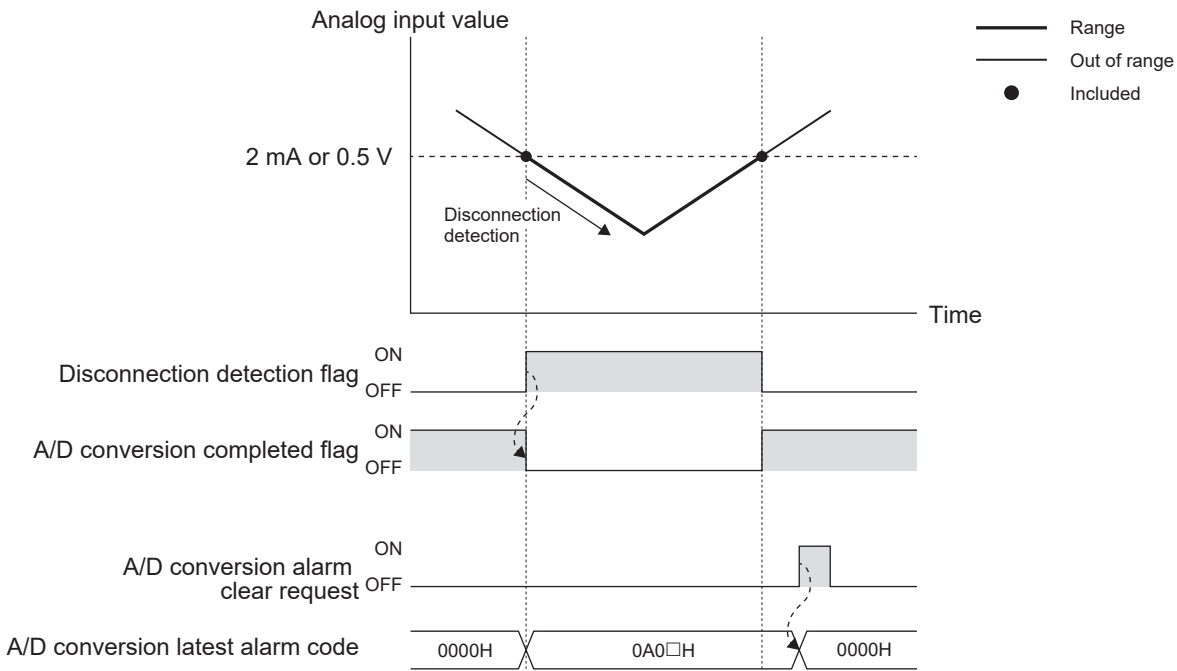

Point

- The "disconnection detection flag" automatically turns OFF.
- For clearing the "A/D conversion latest alarm code", set to ON the "A/D conversion alarm clear request".

■When the "disconnection detection recovery enable/disable setting" is set to "disable"

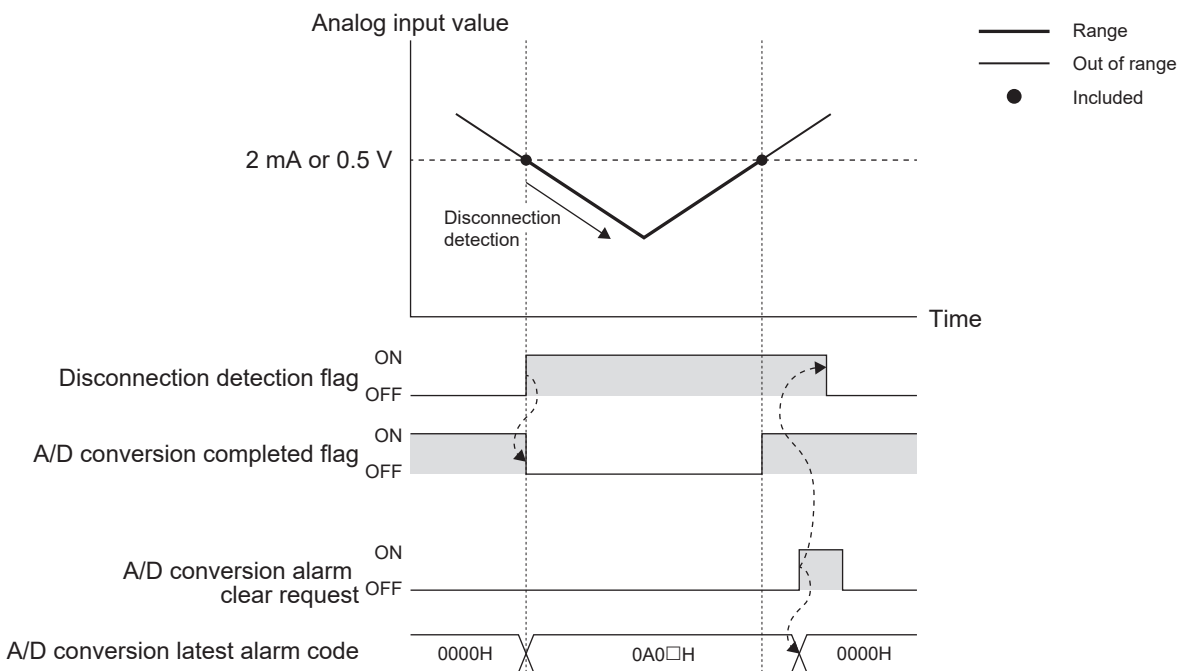

Point

- The "disconnection detection flag" does not automatically turn OFF. To turn OFF this flag, set the "A/D conversion alarm clear request" to ON.
- To clear the "A/D conversion latest alarm code", set the "A/D conversion alarm clear request" to ON.

Convergence Detection Function

This function detects whether the digital operation value is within a certain range in the specified time.

Setting procedure

1. Set "Convergence detection enable/disable setting" to "Enable".

 Navigation window ⇒ [Parameter] ⇒ [Module Information] ⇒ Module model name ⇒ [Module Parameter] ⇒ "Application Settings" ⇒ "Convergence detection enable/disable setting"

2. Set values for "Detection time setting for convergence detection".

Item	Setting range
Detection time setting for convergence detection	1 to 10000 (ms)

Point

When a value outside the setting range is set, the convergence detection time setting range error occurs. (Error code: 1AC□H)

3. Set values for "Convergence detection upper limit value" and "Convergence detection lower limit value".

Item	Setting range
Convergence detection upper limit value	-32768 to +32767
Convergence detection lower limit value	

Point

Set values so that the condition "Convergence detection upper limit value > Convergence detection lower limit value" is satisfied.

When not satisfying the above conditions, a convergence detection upper limit value/lower limit value setting inversion error occurs. (Error code: 1AD□H)

Corresponding devices

The devices which are used by the convergence detection function are listed below.

Name	CH1	CH2	Reference
Convergence detection flag	SM6321	SM6361	Page 372
Convergence detection enable/disable setting	SM6322	SM6362	Page 372
Convergence detection upper limit value	SD6322	SD6362	Page 388
Convergence detection lower limit value	SD6323	SD6363	Page 388
Detection time setting for convergence detection	SD6324	SD6364	Page 389

Convergence detection condition

The table below shows the convergence detection condition when the "convergence detection enable/disable setting" is set to "enable".

Within convergence range	Outside convergence range
Not less than convergence detection lower limit value and not more than convergence detection upper limit value	Less than convergence detection lower limit value or more than convergence detection upper limit value

Operation

The time starts to be measured when the digital operation value enters the steady state range.

When the digital operation value goes in the convergence range within the time set in the "convergence detection time setting", the "convergence detection flag" turns ON. When the digital operation value goes outside of the convergence range, the "convergence detection flag" turns OFF. The "convergence detection flag" turns OFF also when the "convergence detection enable/disable setting" is changed to "disable".

The digital operation value is always monitored until the "convergence detection enable/disable setting" is set to "disable".

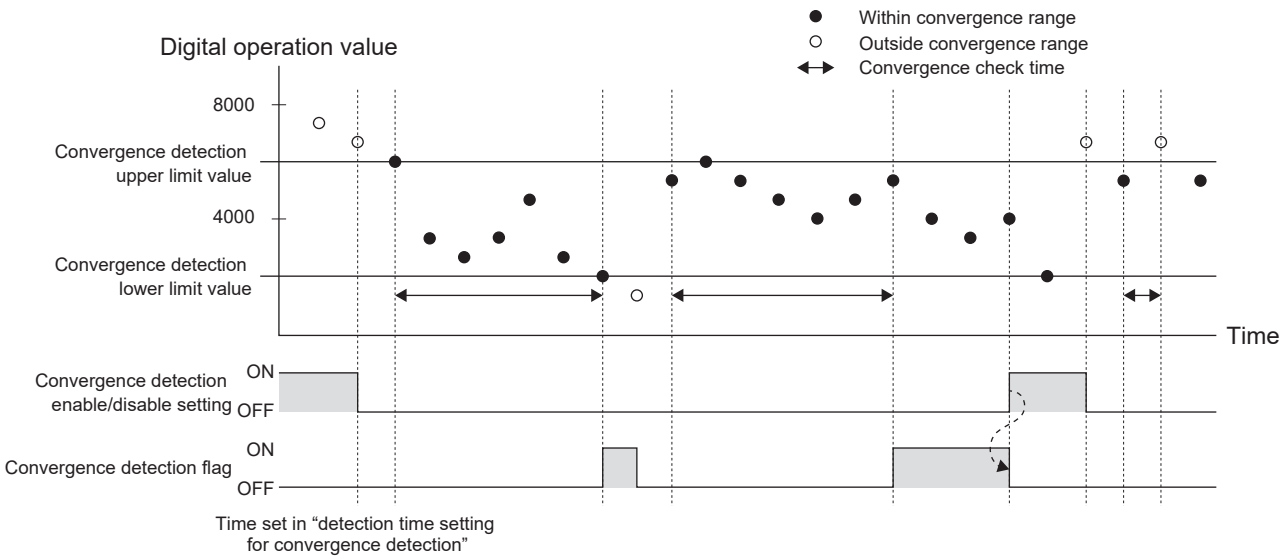

Deviation Detection Between Channel Function

This function detects the difference in the digital operation value between channels larger than a specified value.

Setting procedure

1. Set "Deviation detection trigger between channel" to "Enable".

Navigation window ⇒ [Parameter] ⇒ [Module Information] ⇒ Module model name ⇒ [Module Parameter] ⇒ "Application Settings" ⇒ "Deviation detection trigger between channel"

2. Set values for "Deviation value for deviation detection between channel".

Item	Setting range
Deviation value for deviation detection between channel	0 to 65535

3. Set whether to target each channel for "Deviation detection between channels".

Item	Setting range
CH setting for deviation detection between channel	Non-target
	Target

Corresponding devices

The devices which are used by the deviation detection between channel function are listed below.

Name	CH1	CH2	Reference
Deviation detection flag between channel	SM6325	SM6365	Page 373
Deviation detection trigger between channel	SM6326	SM6366	Page 373
Deviation detection CH1	SD6325	SD6365	Page 389
Deviation detection CH2 ^{*1}	SD6326	SD6366	Page 390
Deviation value for deviation detection between channel	SD6327	SD6367	Page 390
CH setting 1 for deviation detection between channel	SD6328	SD6368	Page 391
CH setting 2 for deviation detection between channel ^{*1}	SD6329	SD6369	Page 391

*1 Only FX5U/FX5UC CPU module is supported.

Operation

The "digital operation value" of the specified channels is compared with the "digital operation value" of the channel set in the "deviation between CH detection CH setting".

When the difference in the digital operation value between the specified channel and the compared channel is equal or more than the "deviation value in deviation between CH detection" even in 1 channel, it is regarded as deviation and the "deviation between CH detection flag" turns ON (Alarm code: 0B0□H).

When the difference in the digital operation value between the specified channel and the compared channel is less than the "deviation value in deviation between CH detection" in all channels, the "deviation between CH detection flag" turns OFF.

When the "deviation between CH detection trigger" is changed to "disable", the "deviation between CH detection flag" turns OFF, and the "deviation detection CH1" and "deviation detection CH2" become "0" (initial value).

Offset/gain Setting Function

This function sets any analog value to the offset/gain value without regard to the setting prepared in advance as the analog input range. The offset setting value and gain setting value are saved in the built-in memory of the FX5-4A-ADP.

For changing the offset/gain data, set an analog value to the "offset setting value" or "gain setting value".

The table below shows the available setting range.

Item	Description	Setting range	
		Voltage input (mV)	Current input (μA)
Offset setting value	Analog input value when the digital value is "0" (offset reference value)	-10000 to +9000	-20000 to +17000
Gain setting value	Analog input value when the digital value is the gain reference value	-9000 to +10000	-17000 to +30000

Point

An offset/Gain setting value range error occurs when the following condition is not satisfied: (Error code: 1A9□H)

- Voltage input: $1000 \leq \text{Gain setting value} - \text{Offset setting value}$
- Current input: $3000 \leq \text{Gain setting value} - \text{Offset setting value} \leq 30000$

The table below shows the reference value and initial value of the offset/gain setting value.

Description		Digital output value	Offset setting value		Gain setting value	
Voltage/ current	Input range		Reference value	Default value	Reference value	Default value
Voltage	0 to 10 V	0 to 16000	0	0 mV	8000	5000 mV
	0 to 5 V	0 to 16000	0	0 mV	16000	5000 mV
	1 to 5 V	0 to 12800	0	1000 mV	12800	5000 mV
	-10 to +10 V	-8000 to +8000	0	0 mV	4000	5000 mV
Current	0 to 20 mA	0 to 16000	0	0 μA	16000	20000 μA
	4 to 20 mA	0 to 12800	0	4000 μA	12800	20000 μA
	-20 to +20 mA	-8000 to +8000	0	0 μA	8000	20000 μA

Setting procedure

Access to the offset/gain setting window in the GX Works3 to set the offset and gain values.

The setting procedure for the offset/gain setting of the FX5-4A-ADP is as follows:

[Tool] ⇒ [Module Tool List]

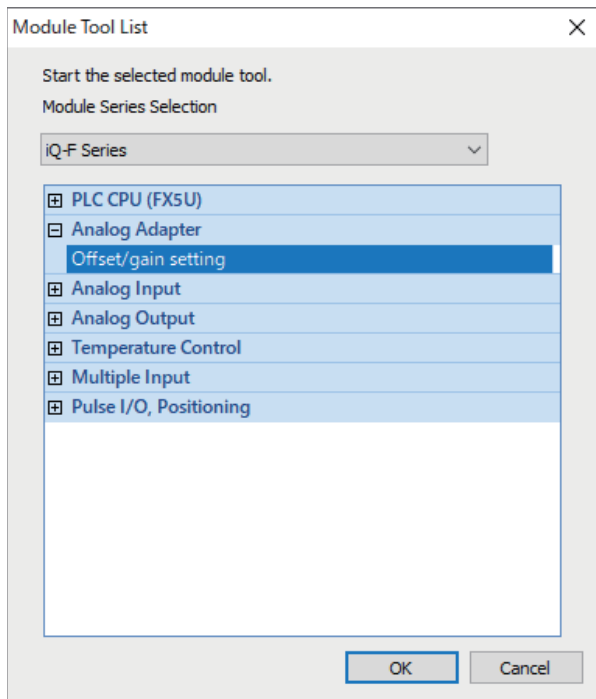

1. In "Analog Adapter", select "Offset/gain setting" and click [OK] button.

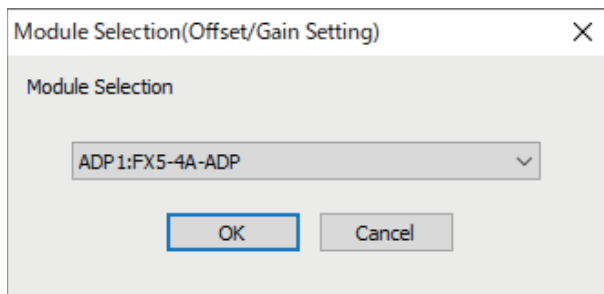

2. Select the target module for the offset/gain setting, and click [OK] button.

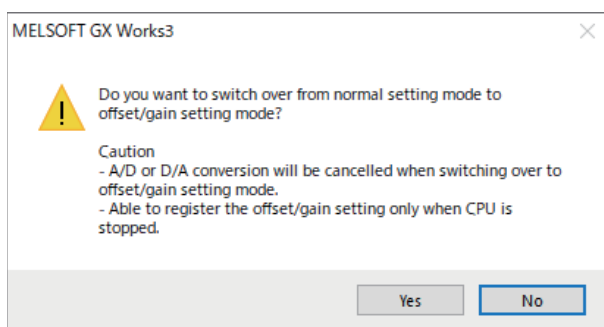

3. Click [Yes] button.

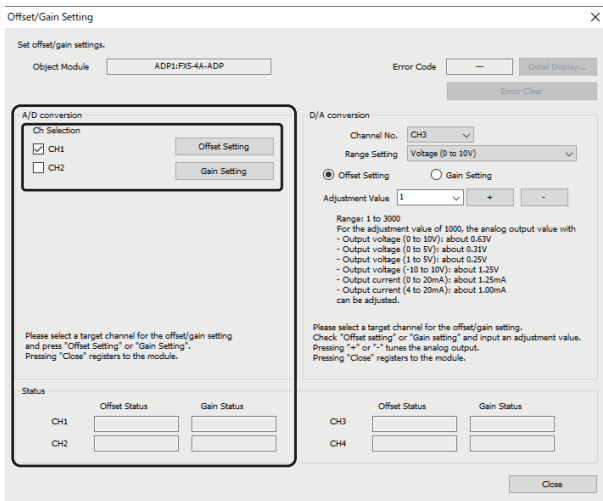

4. Execute the settings in A/D conversion. Mark the checkbox of the channel where offset and gain values are to be set, and click [Offset Setting] button.

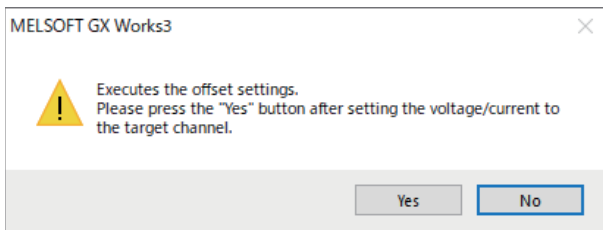

5. Apply the offset voltage or current to the terminal of the corresponding channel, and click [Yes] button.

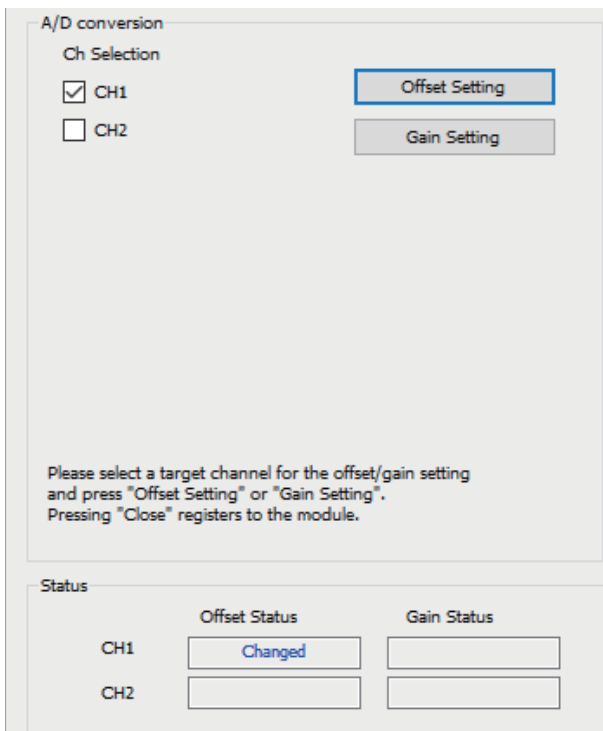

6. Check that "Offset Status" has changed to "Changed", and click [Gain Setting] button.

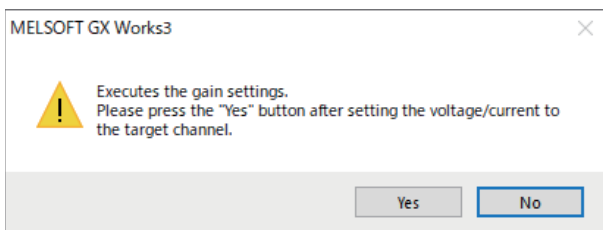

7. Apply the gain voltage or current to the terminal of the corresponding channel, and click [Yes] button.

A/D conversion

Ch Selection

CH1

CH2

Offset Setting

Gain Setting

Please select a target channel for the offset/gain setting and press "Offset Setting" or "Gain Setting". Pressing "Close" registers to the module.

Status

	Offset Status	Gain Status
CH1	Changed	Changed
CH2		

8. Check that "Gain Status" has changed to "Changed", and click [Close] button.

MELSOFT GX Works3

⌵

⚠ Do you want to register the offset/gain setting and exit?
The mode will be switched over to normal mode from offset/gain setting mode after ending.

- Click [YES] to end the application after registering.
- Click [NO] to discard the setting.

Caution

- The offset/gain setting is not valid until the registration is executed.
- Unable to register if an error occurs in the target module.
- Able to register the offset/gain setting only when CPU is stopped.

Yes No Cancel

9. Click [Yes] button.

Corresponding devices

The devices which are used by the offset/gain setting function are listed below.

Name	CH1	CH2	Reference
Offset/gain reading	SM6332	SM6372	Page 373
Offset/gain writing	SM6333	SM6373	Page 374
Offset setting value	SD6332	SD6372	Page 392
Gain setting value	SD6333	SD6373	Page 392
Offset/gain writing enable code	SD6334	SD6374	Page 392

Operation

■Offset/gain writing

For changing the offset/gain data, set "E20FH" to the "offset/gain writing enable code" and set the "offset/gain writing" from OFF to ON to write the "input range setting", "offset setting value" and "gain setting value" to the built-in memory of the FX5-4A-ADP. Only 1 range can be changed for 1 channel, and the latest contents are valid.

When writing is completed, the "offset/gain writing" automatically turns OFF. Also, the "offset/gain writing enable code" is cleared to 0.

When the "input range setting" is changed, the initial value becomes valid.

For returning the offset/gain data to the initial value, use the offset/gain initialization function (☞ Page 319 Offset/gain Initialization Function).

Point

- The offset/gain value is written when the "offset/gain writing enable code" is set to "E20FH".
- The offset/gain value can be written only while A/D conversion is disabled.
- The "A/D conversion enable/disable setting" cannot be changed to "enable" while the offset/gain value is being written.

■Offset/gain reading

For reading the offset/gain data saved in the built-in memory of the FX5-4A-ADP, set the "offset/gain reading" from OFF to ON to read the "input range setting", "offset setting value" and "gain setting value".

When the input range setting selected during reading is equivalent to the input range setting saved in the built-in memory of the FX5-4A-ADP, the read values are set to the "offset setting value" and "gain setting value".

If the input range setting is different, the initial value of the input range setting selected during reading is valid and set to the "offset setting value" and "gain setting value". In this case, the offset/gain setting input range mismatch alarm occurs (Alarm code: 0C0□H).

Offset/gain Initialization Function

This function initializes the offset value and gain value saved in the built-in memory of the FX5-4A-ADP. This function can be set only with special devices.

Setting procedure

1. Set "E20FH" to the "offset/gain writing enable code".

Setting value	Description	Default value
Other than E20FH	Offset/gain writing disable	0
E20FH	Offset/gain writing enable	

2. Set the "offset/gain initialization" from OFF to ON.

Setting value	Description	Default value
0: OFF	Offset/gain initialization is not performed.	0: OFF
1: ON	Offset/gain initialization is performed.	

Corresponding devices

The devices which are used by the offset/gain initialization function are listed below.

Name	CH1	CH2	Reference
Offset/gain initialization	SM6334	SM6374	Page 374
Offset/gain writing enable code	SD6334	SD6374	Page 392

Operation

Set "E20FH" to the "offset/gain writing enable code" and set the "offset/gain initialization" from OFF to ON to initialize the offset value and gain value saved in the built-in memory of the FX5-4A-ADP. When initialization is completed, the "offset/gain initialization" automatically turns OFF. Also, the "offset/gain writing enable code" is cleared to 0.

Point

- Offset/gain initialization is executed when the "offset/gain writing enable code" is set to "E20FH".
- Offset/gain initialization is enabled only while A/D conversion is disabled.
- The "A/D conversion enable/disable setting" cannot be changed to "enable" while offset/gain initialization is being executed.

6.4 D/A Conversion Function

This section describes the D/A conversion functions of the FX5-4A-ADP and the setting procedures for those functions using GX Works3.

Point

This section describes the special relays and special registers for the 1st FX5-4A-ADP module.

For checking the special relays and special registers for the 2nd and later FX5-4A-ADP modules, refer to the following:

☞ Page 394 List of D/A Conversion Special Relays, ☞ Page 402 List of D/A Conversion Special Registers

Processing of Each Function

The functions are processed in the order shown below.

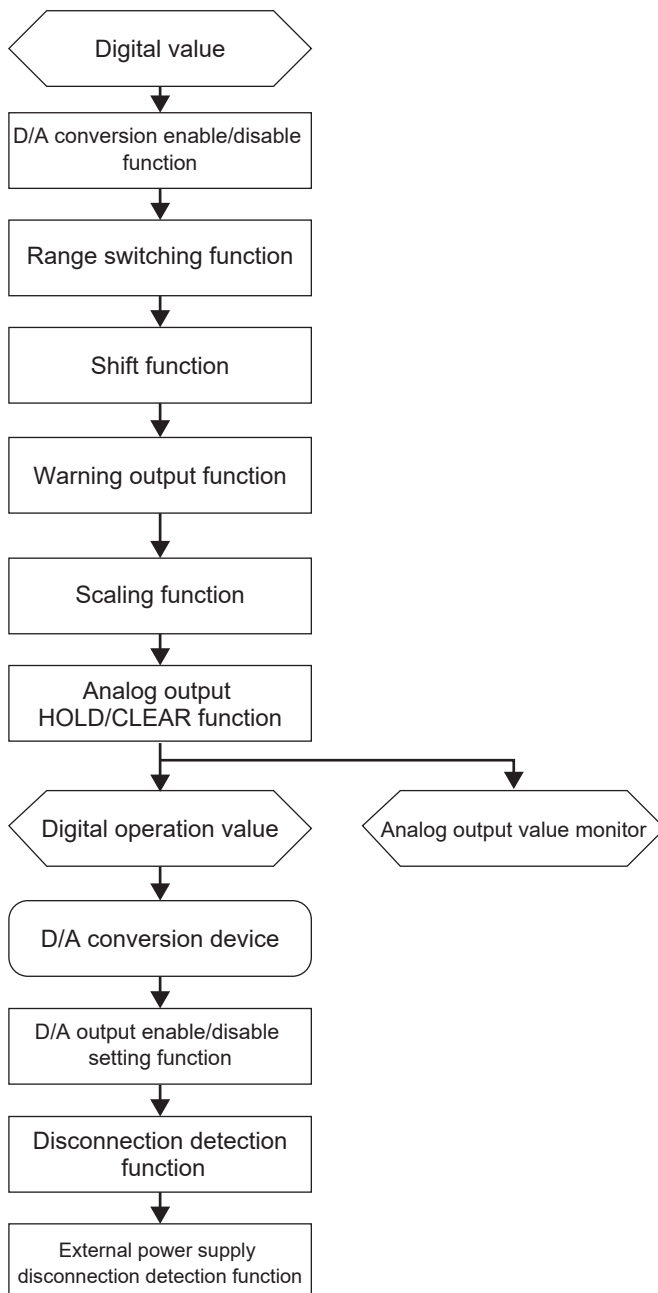

Digital value

Digital input values are stored.

Digital operation value

These values are obtained by operating a digital value using the scaling function or shift function. When each function is not used, the same value as the digital value is stored.

Analog output value monitor

The output analog value is displayed. Voltage and current are displayed in the following units.

Voltage: mV, Current: μ A

Range Switching Function

The output range of the analog output can be switched for each channel.

Switching the range makes it possible to change the output conversion characteristics.

Setting procedure

Set the input range to be used in the "output range setting".

 Navigation window \Rightarrow [Parameter] \Rightarrow [Module Information] \Rightarrow Module model name \Rightarrow [Module Parameter] \Rightarrow "Basic Settings" \Rightarrow "Range switching function"

Output range setting	Digital input range
0 to 10 V	0 to 16000
0 to 5 V	0 to 16000
1 to 5 V	0 to 16000
-10 to +10 V	-8000 to +8000
0 to 20 mA	0 to 16000
4 to 20 mA	0 to 16000

Corresponding devices

The devices which are used by the range switching function are listed below.

Name	CH3	CH4	Reference
Output range setting	SD6385	SD6425	Page 406

Operation

The output range is switched when the "output range setting" is changed while the "D/A conversion enable/disable setting" is set to "disable".

When the output range is switched, the following special devices are initialized:

Name	CH3	CH4	Reference
Warning output upper limit value flag	SM6391	SM6431	Page 397
Warning output lower limit value flag	SM6392	SM6432	Page 397
Disconnection detection flag	SM6398	SM6438	Page 398
Digital operation value	SD6381	SD6421	Page 404
Analog output value monitor	SD6382	SD6422	Page 405
Offset setting value ^{*1}	SD6412	SD6452	Page 408
Gain setting value ^{*1}	SD6413	SD6453	Page 408

*1 When the output range setting after change is equivalent to the output range setting set by the offset/gain setting function, the values set by the offset/gain setting function are reflected. In any other case, they are initialized to the initial value.

D/A Conversion Enable/Disable Function

The output range of the analog output can be switched for each channel.

Setting methods

Set "D/A conversion enable/disable setting" to "D/A conversion enable" or "D/A conversion disable".

 Navigation window ⇒ [Parameter] ⇒ [Module Information] ⇒ Module model name ⇒ [Module Parameter] ⇒ "Basic Settings" ⇒ "D/A Conversion Enable/Disable Setting"

Corresponding devices

The devices which are used by the D/A conversion enable/disable function are listed below.

Name	CH3	CH4	Reference
D/A conversion enable/disable setting	SM6380	SM6420	Page 396

Operation

The digital value is D/A-converted only in the channels for which the "D/A conversion enable/disable setting" is set to "enable".

The channels for which the "D/A output enable/disable setting" is set to "enable" output the converted analog value.

When the "D/A conversion enable/disable setting" is changed from "enable" to "disable", the digital value is held as is, and the digital operation value and analog output value monitor are cleared.

D/A Output Enable/Disable Setting Function

Specify whether to output the D/A conversion value or offset value for each channel.

The conversion speed is a constant, regardless of the output enable/disable state.

Setting methods

Set "D/A output enable/disable setting" to "D/A output enable" or "D/A output disable".

 Navigation window ⇒ [Parameter] ⇒ [Module Information] ⇒ Module model name ⇒ [Module Parameter] ⇒ "Basic Settings" ⇒ "D/A Output Enable/Disable Setting"

Corresponding devices

The devices which are used by the D/A output enable/disable setting function are listed below.

Name	CH3	CH4	Reference
D/A output enable/disable setting	SM6381	SM6421	Page 396

Operation

The channels for which the "D/A output enable/disable setting" is set to "enable" output the analog value D/A-converted from the digital value.

The channels for which the "D/A output enable/disable setting" is set to "disable" output the offset value.

Analog Output HOLD/CLEAR Function

Set whether to clear the output analog output value or to hold the previous value or setting value in accordance with the CPU module operation status (RUN, STOP or STOP (by stop error)).

Operation

When the CPU module operation status becomes "RUN", "STOP" or "STOP (by stop error)", the FX5-4A-ADP becomes the analog output status shown in the table below in accordance with the combination of "HOLD/CLEAR setting" and "D/A output enable/disable setting".

CPU module status	D/A conversion enable/disable setting	D/A output enable/disable setting	Analog output HOLD/CLEAR setting	Output status
RUN	Enabled	Enabled	All settings	The value after a shift and scaling
		Disabled	All settings	Offset value
	Disabled	Enabled	All settings	0
		Disabled	All settings	0
STOP (RUN→STOP, PAUSE→STOP, and Error occurs when RUN state cannot operate)	Enabled	Enabled	CLEAR	The value for which K0 was set to the digital value is output.
			Current Value (Hold)	The value after a shift and scaling
			Setting Value	The value set as the HOLD setting value is output.
	Disabled	Disabled	All settings	Offset value
			All settings	0
			All settings	0
PAUSE	Enabled	Enabled	All settings	The value after a shift and scaling
		Disabled	All settings	Offset value
	Disabled	Enabled	All settings	0
		Disabled	All settings	0

Setting methods

1. Set the "HOLD/CLEAR Setting" to "CLEAR", "Current Value (HOLD)" or "Setting Value".

Navigation window ⇒ [Parameter] ⇒ [Module Information] ⇒ Module model name ⇒ [Module Parameter] ⇒ "Application Settings" ⇒ "Analog Output HOLD/CLEAR Setting" ⇒ "HOLD/CLEAR Setting"

2. It is the above 1, and when "Setting Value" is chosen, a value is set to HOLD setting value.

Navigation window ⇒ [Parameter] ⇒ [Module Information] ⇒ Module model name ⇒ [Module Parameter] ⇒ "Application Settings" ⇒ "Analog Output HOLD/CLEAR Setting" ⇒ "HOLD Setting Value"

Name	Setting range
HOLD setting value	-32768 to +32767

Corresponding devices



The devices which are used by the analog output HOLD/CLEAR function are listed below.

Name	CH3	CH4	Reference
HOLD/CLEAR function setting	SD6383	SD6423	Page 405
HOLD setting value	SD6384	SD6424	Page 405

Analog Output Test when CPU Module is in STOP Status Function

Analog output tests can be carried out when the CPU module is in the STOP status.

The following functions are enabled during the analog output test.

- Scaling function ( Page 325 Scaling Function)
- Shift function ( Page 327 Shift Function)
- Warning output function ( Page 328 Warning Output Function)

Operation

When the "D/A conversion enable/disable setting" is set from OFF to ON and the "D/A output enable/disable setting" is set from OFF to ON, the analog output test is started and analog output is given.

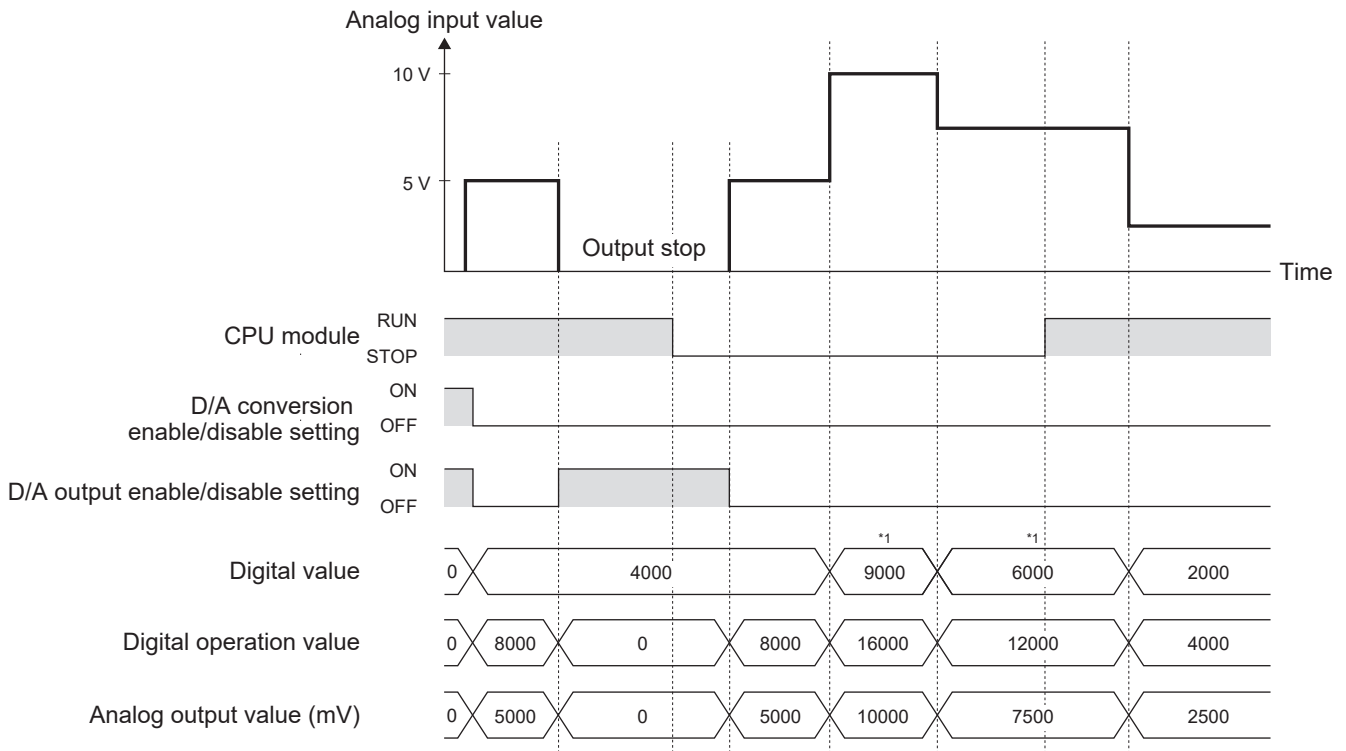

*1 Change the value using the engineering tool.

Setting methods

To perform an analog output test, configure the settings in the device test of the GX Works3 following the procedure shown below.

1. Set the digital value corresponding to the analog value to be output to the "digital value".
2. Set the "D/A conversion enable/disable setting" to OFF (Enable D/A conversion).
3. Set the "D/A output enable/disable setting" to OFF (Enable D/A output).

Corresponding devices

The devices which are used by the analog output test when CPU module is in STOP status function are listed below.

Name	CH3	CH4	Reference
D/A conversion enable/disable setting	SM6380	SM6420	Page 396
D/A output enable/disable setting	SM6381	SM6421	Page 396
Digital value	SD6380	SD6420	Page 404

Scaling Function

This function performs the scale conversion on digital values within a specified range between a scaling upper limit value and a scaling lower limit value. The program for scale conversion can be omitted.

Operation

This function performs the scale conversion on digital values. The values are converted within a specified range between a scaling upper limit value and scaling lower limit value. The value after the scale conversion is used for the D/A conversion. (In the scale conversion, values after the decimal point are rounded off.)

Concept of scaling setting

Ex.

When the output range is set to -10 to +10 V:

For the scaling lower limit value, set a value corresponding to the lower limit value of the output range (-8000).

For the scaling upper limit value, set a value corresponding to the upper limit value of the output range (+8000).

Calculating the scaling value

The scaling value is converted based on the calculation formula shown below. (The value below the decimal point obtained by scale conversion is rounded.)

Calculation formula	Symbol
Digital value used for D/A conversion = $\frac{D_{Max} - D_{Min}}{S_H - S_L} \times (D_X - S_L) + D_{Min}$	<p>D_X: Digital value</p> <p>D_{Max}: Maximum digital input value of the output range in use</p> <p>D_{Min}: Minimum digital input value of the output range in use</p> <p>S_H: Scaling upper limit value</p> <p>S_L: Scaling lower limit value</p>

Setting procedure

1. Set "D/A conversion enable/disable setting" to "D/A conversion enable".

 Navigation window ⇒ [Parameter] ⇒ [Module Information] ⇒ Module model name ⇒ [Module Parameter] ⇒ "Basic setting" ⇒ "D/A Conversion Enable/Disable Setting"

2. Set "Scaling enable/disable setting" to "Enable".

 Navigation window ⇒ [Parameter] ⇒ [Module Information] ⇒ Module model name ⇒ [Module Parameter] ⇒ "Application Settings" ⇒ "Scaling Setting"

3. Set values for "Scaling upper limit value" and "Scaling lower limit value".

Item	Setting range
Scaling upper limit value	-32768 to +32767
Scaling lower limit value	-32768 to +32767

Point

- If the relation between the values is scaling lower limit value > scaling upper limit value, the scale conversion can be performed according to a negative slope.
- Set the scaling with the condition "Scaling lower limit value ≠ Scaling upper limit value".

Corresponding devices

The devices which are used by the scaling function are listed below.

Name	CH3	CH4	Reference
Scaling enable/disable setting	SM6388	SM6428	Page 397
Scaling upper limit value	SD6388	SD6428	Page 406
Scaling lower limit value	SD6389	SD6429	Page 406

Setting example

Ex.

When 5000 is set to the scaling upper limit value and 1000 is set to the scaling lower limit value for the channel with the output range of 0 to 5 V

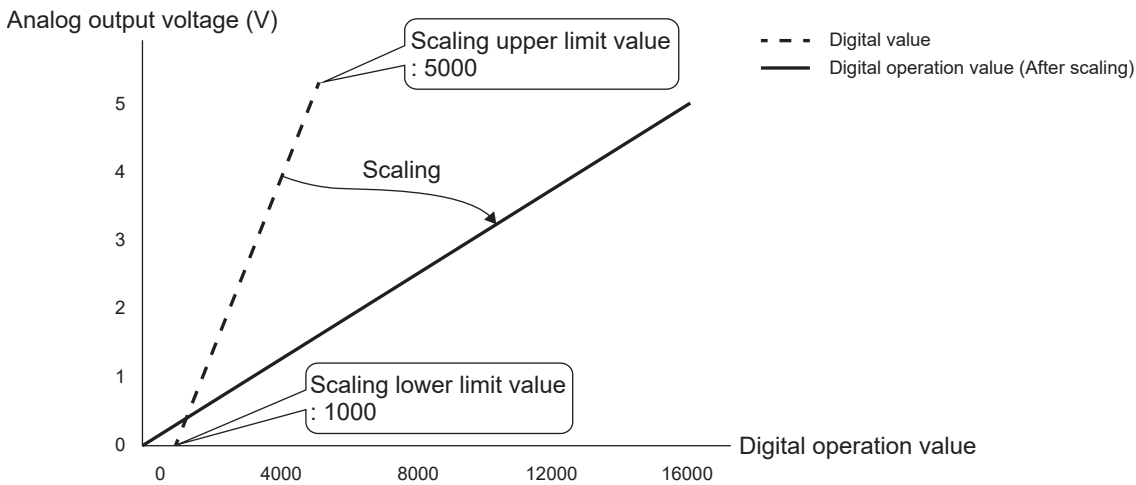

Digital value	Digital operation value (after scaling)	Output voltage (V)
1000	0	0
1800	3200	1
2600	6400	2
3400	9600	3
4200	12800	4
5000	16000	5

Ex.

When 1000 is set to the scaling upper limit value and 5000 is set to the scaling lower limit value for the channel with the output range of 0 to 5 V

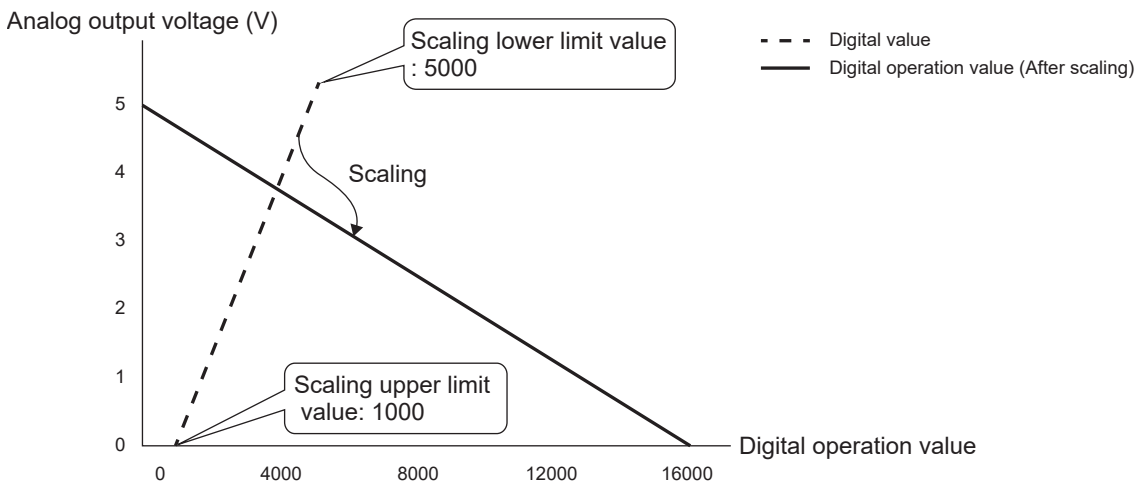

Digital value	Digital operation value (after scaling)	Output voltage (V)
1000	16000	0
1800	12800	1
2600	9600	2
3400	6400	3
4200	3200	4
5000	0	5

Shift Function

This function adds (shifts) the set input value shift amount to the digital value, and stores the result to the "digital operation value". The change in the input value shift amount is reflected in the digital operation value on real-time basis. Therefore, fine adjustment can be easily performed when the system starts.

Operation

The set "input value shift amount" is added to the digital value. The digital value obtained by the addition is stored in the "digital operation value".

When the digital value after the addition exceeds the range of -32768 to +32767 as a result of the shift processing, the value is fixed with the lower limit value (-32768) or the upper limit value (+32767).



When the scaling function is used together, the scaling processing is executed to the value after shifting.

Setting procedure

Set the shift amount to "Input value shift amount".

Navigation window ⇒ [Parameter] ⇒ [Module Information] ⇒ Module model name ⇒ [Module Parameter] ⇒ "Application Settings" ⇒ "Shift Function"

Item	Setting range
Input value shift amount	-32768 to +32767

Corresponding devices

The devices which are used by the shift function are listed below.

Name	CH3	CH4	Reference
Input value shift amount	SD6390	SD6430	Page 407

Setting example

Ex.

When the output range is 0 to 5V and the input value shift amount is +50

Analog output voltage (V)

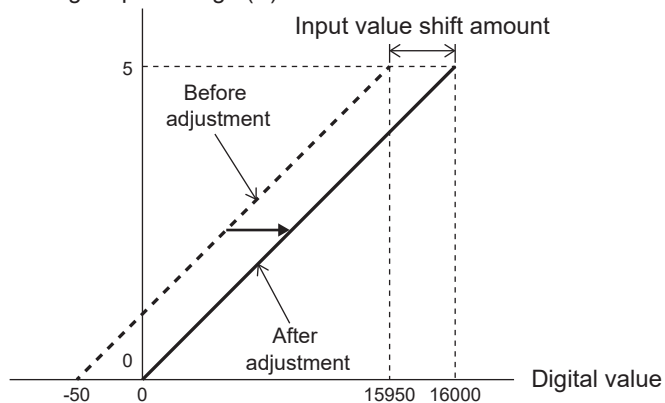

Digital value	Digital operation value	Analog output voltage (V)
Before adjustment	After adjustment	
-50	0	0
15950	16000	5

Warning Output Function

When the digital operation value to which the shift amount is added is above the warning output upper limit value or below the warning output lower limit value, warning is output.

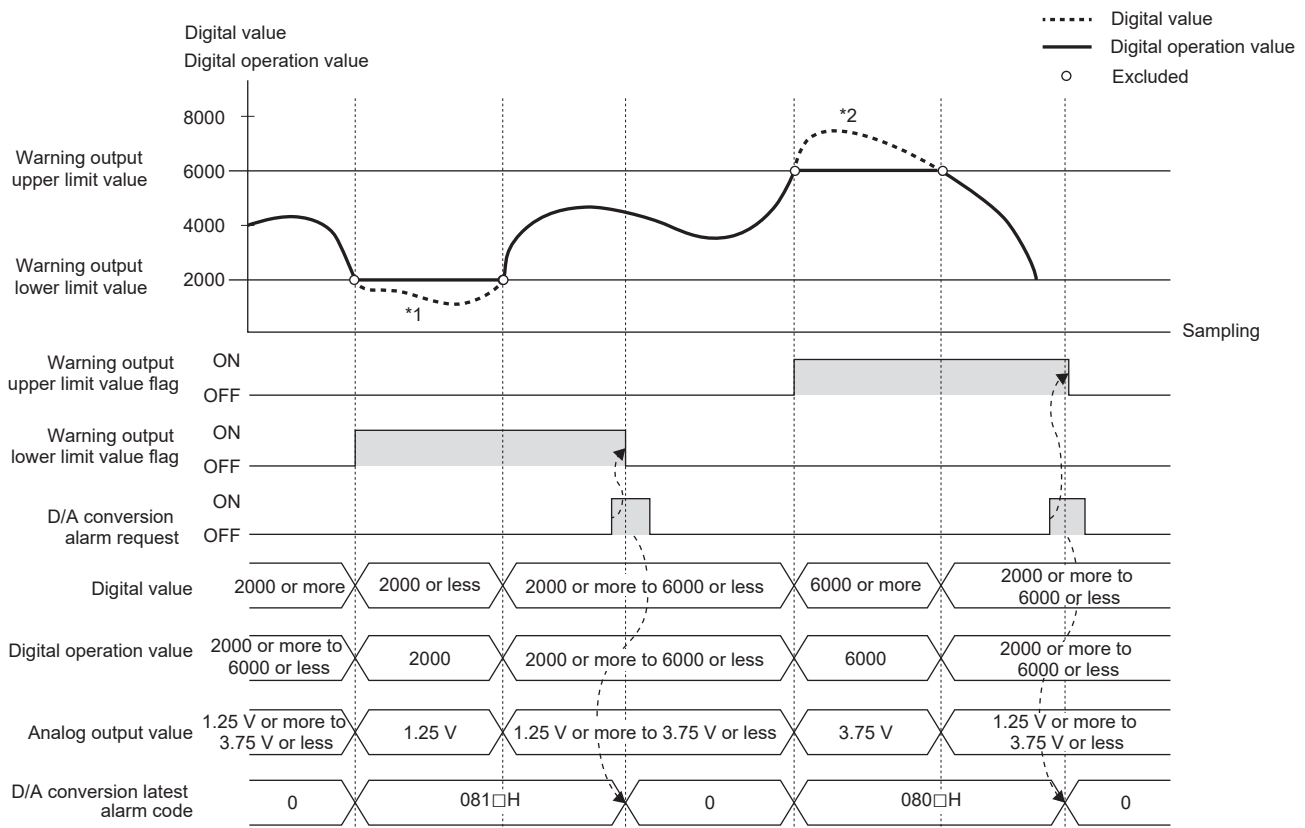

- *1 Analog values below the warning output lower limit value are not output.
- *2 Analog values above the warning output upper limit value are not output.

Operation

When the digital operation value to which the shift amount is added is above the warning output upper limit value or below the warning output lower limit value and the warning output condition is satisfied, the "warning output upper flag" or "warning output lower flag" turns ON.

When warning is output, the setting value of the "warning output upper limit value/warning output lower limit value" is regarded as the digital operation value and D/A-converted.

Even if the digital value changes to a value below the warning output upper limit value and above the warning output lower limit value after the warning output, the "warning output upper flag" and "warning output lower flag" do not turn OFF. When the D/A conversion alarm clear request is set to OFF, ON and OFF again, the "warning output upper flag" and "warning output lower flag" turn OFF. The "warning output upper flag" and "warning output lower flag" turn OFF also when the "warning output enable/disable setting" is changed to "disable", but the alarm code stored in the "D/A conversion latest alarm code" is not cleared.

For clearing the alarm code stored in the "D/A conversion latest alarm code", set the D/A conversion alarm clear request to OFF, ON and OFF again.

Setting procedure

1. Set "Warning Output Function" to "Enable".

Navigation window ⇒ [Parameter] ⇒ [Module Information] ⇒ Module model name ⇒ [Module Parameter] ⇒ "Application Settings" ⇒ "Warning Output Function"

2. Set values for "Warning output upper limit value" and "Warning output lower limit value".

Item	Setting range
Warning output upper limit value	-32768 to +32767
Warning output lower limit value	

Point

Set the warning output upper limit value and warning output lower limit value while satisfying the condition "Warning output upper limit value > Warning output lower limit value".

Corresponding devices

The devices which are used by the alarm output function are listed below.

Name	CH3	CH4	Reference
Warning output upper limit value flag	SM6391	SM6431	Page 397
Warning output lower limit value flag	SM6392	SM6432	Page 397
Warning output setting	SM6393	SM6433	Page 398
Warning output upper limit value	SD6391	SD6431	Page 407
Warning output lower limit value	SD6392	SD6432	Page 407

External Power Supply Disconnection Detection Function

This function detects that the external power (24 V DC) is not supplied to the FX5-4A-ADP or the supply is stopped.

Setting procedure

The user does not need to configure any settings.

Operation

The error occurs when the external power is not input. (Error code: 3081H)

The error code is stored in "A/D conversion latest error code" of CH1 and "D/A conversion error flag" of CH1 turns ON.

When an error occurs, the analog function performs the following operation.

- A/D conversion function: Stops the A/D conversion and holds the digital output value and digital calculation value at the previous values.
- D/A conversion function: Stops the D/A conversion and outputs 0 V/0 mA.

Disconnection Detection Function

Disconnection can be detected in each channel.

This function is enabled when the analog output range is 4 to 20 mA.

Setting procedure

1. Set "Disconnection detection enable/disable setting" to "Enable".

 Navigation window ⇒ [Parameter] ⇒ [Module Information] ⇒ Module model name ⇒ [Module Parameter] ⇒ "Application Settings" ⇒ "Disconnection detection enable/disable setting"

2. Set "Disconnection recovery detection enable/disable setting".

 Navigation window ⇒ [Parameter] ⇒ [Module Information] ⇒ Module model name ⇒ [Module Parameter] ⇒ "Application Settings" ⇒ "Disconnection recovery detection enable/disable setting"

Corresponding devices

The devices which are used by the disconnection detection function are listed below.

Name	CH3	CH4	Reference
Disconnection detection flag	SM6398	SM6438	Page 398
Disconnection detection enable/disable setting	SM6399	SM6439	Page 398
Disconnection recovery detection enable/disable setting	SM6400	SM6440	Page 399

Operation

When disconnection is detected in a channel for which the "D/A conversion enable/disable setting" is set to "D/A conversion enable" and the "disconnection detection enable/disable setting" is set to "enable", it is regarded as a disconnection detection error, and the "disconnection detection flag" turns ON (Error code: 1BB□).

At this time, the digital value, digital operation value and analog output value monitor are cleared.

When the "disconnection recovery detection enable/disable setting" is set to "enable", the "disconnection detection flag" turns OFF when the channel is recovered from disconnection.

When the "disconnection recovery detection enable/disable setting" is set to "disable", the "disconnection detection flag" remains ON even if the channel is recovered from disconnection.

It is necessary to set the "error clear request" (SM50) of the CPU module to ON to turn OFF the "disconnection detection flag". The "disconnection detection flag" turns OFF also when the "disconnection detection enable/disable setting" is changed to "disable".

■When the "disconnection detection recovery enable/disable setting" is set to "enable"

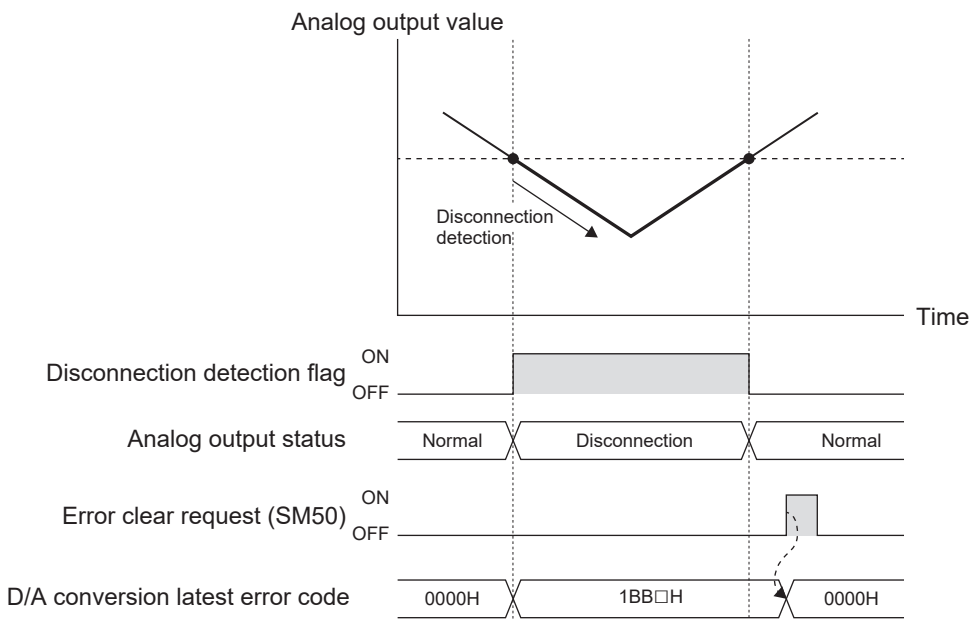

Point

- The "disconnection detection flag" automatically turns OFF.
- To clear the "D/A conversion latest error code", set the "error clear request" (SM50) of the CPU module to ON.

■When the "disconnection detection recovery enable/disable setting" is set to "disable"

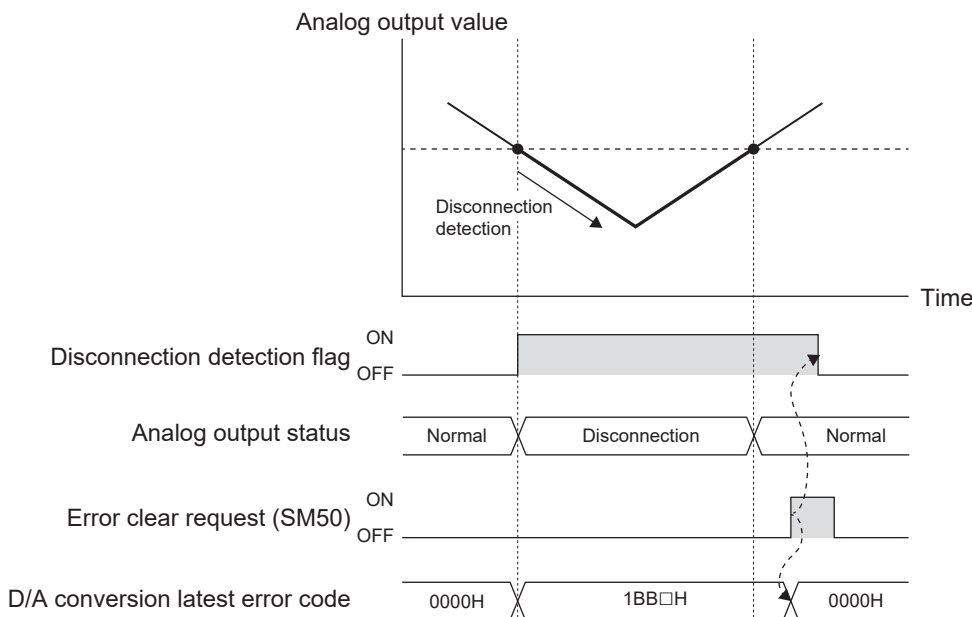

Point

- The "disconnection detection flag" does not turn OFF. To turn OFF this flag, set the alarm clear request to ON.
- To clear the "D/A conversion latest error code", set the "error clear request" (SM50) of the CPU module to ON.

Offset/gain Setting Function

This function sets any analog value to the offset/gain value without regard to the setting prepared in advance as the analog output range. The offset setting value and gain setting value are saved in the built-in memory of the FX5-4A-ADP.

For changing the offset/gain data, set an analog value to the "offset setting value" or "gain setting value".

The table below shows the available setting range.

Item	Description	Setting range	
		Voltage output (mV)	Current output (μA)
Offset setting value	Analog output value when the digital value is "0" (offset reference value)	-10000 to +9000	0 to 17000
Gain setting value	Analog output value when the digital value is the gain reference value	-9000 to +10000	3000 to 30000

Point

An offset/Gain setting value range error occurs when the following condition is not satisfied: (Error code: 1B9□H)

- Voltage output: $1000 \leq \text{Gain setting value} - \text{Offset setting value} \leq 10000$
- Current output: $3000 \leq \text{Gain setting value} - \text{Offset setting value} \leq 30000$

The table below shows the reference value and initial value of the offset/gain setting value.

Description		Digital value	Offset setting value		Gain setting value	
Voltage/current	Output range		Reference value	Default value	Reference value	Default value
Voltage	0 to 10 V	0 to 16000	0	0 mV	8000	5000 mV
	0 to 5 V	0 to 16000	0	0 mV	16000	5000 mV
	1 to 5 V	0 to 16000	0	1000 mV	16000	5000 mV
	-10 to +10 V	-8000 to +8000	0	0 mV	4000	5000 mV
Current	0 to 20 mA	0 to 16000	0	0 μA	16000	20000 μA
	4 to 20 mA	0 to 16000	0	4000 μA	16000	20000 μA

Setting procedure

Access to the offset/gain setting window in the GX Works3 to set the offset and gain values.

The setting procedure for the offset/gain setting of the FX5-4A-ADP is as follows:

[Tool] ⇒ [Module Tool List]

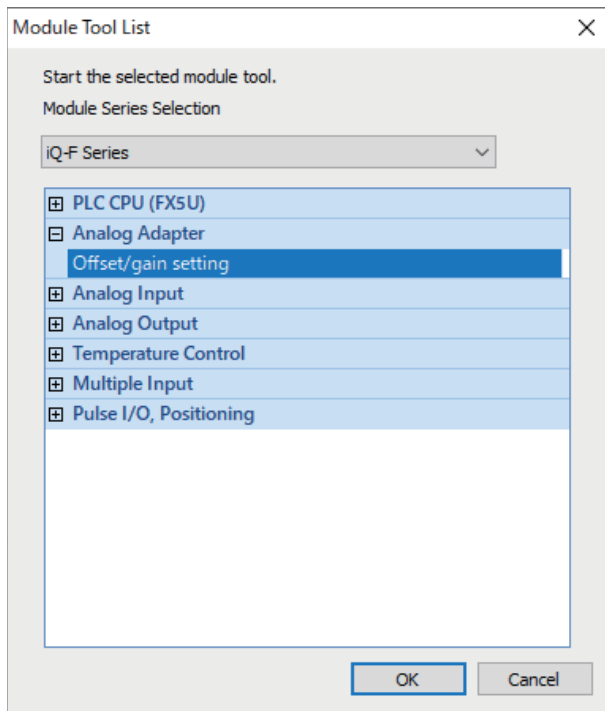

1. Select "Analog Adapter" ⇒ " Offset/gain setting" and click the [OK] button.

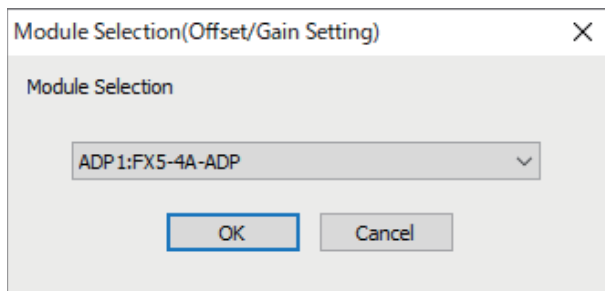

2. Select the target module for the offset/gain setting, and click [OK] button.

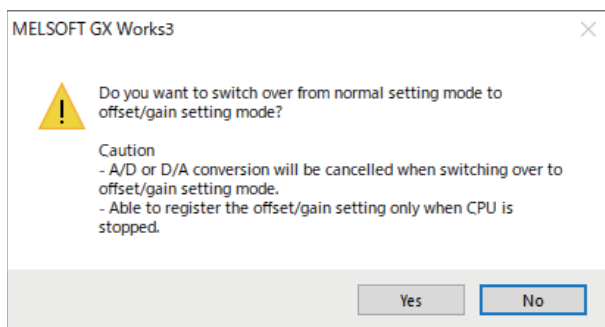

3. Click the [Yes] button.

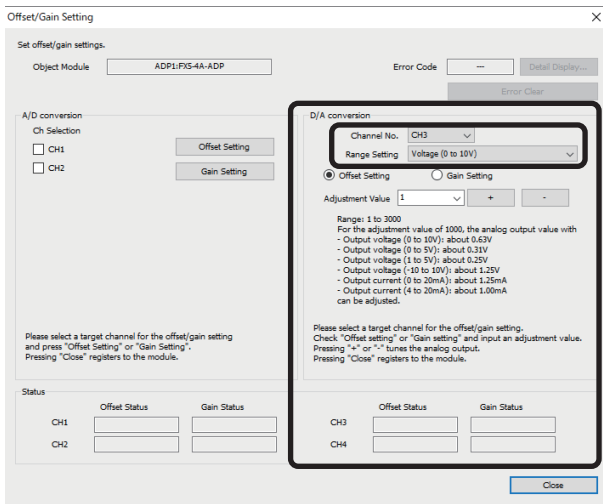

- Execute the settings in D/A conversion. Specify the channel to configure the offset/gain setting and the user range setting.

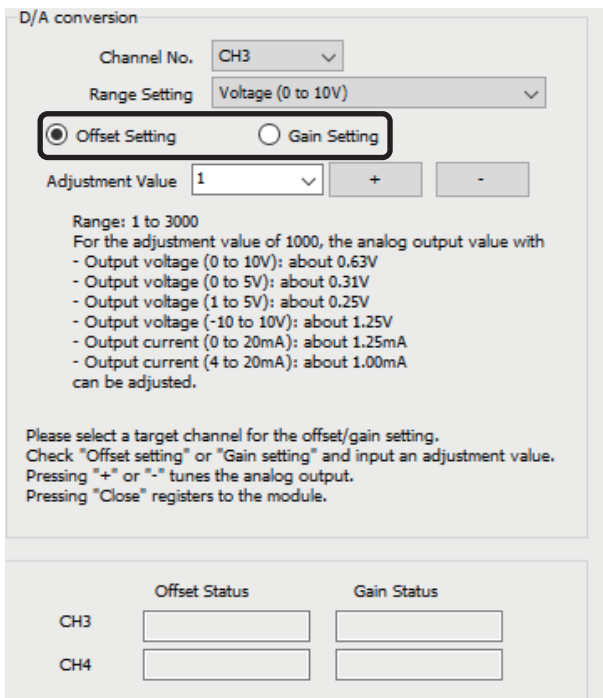

- Use the radio button to specify whether to perform the offset setting or gain setting. (Step 6 and later describe the case when the offset setting is specified.)

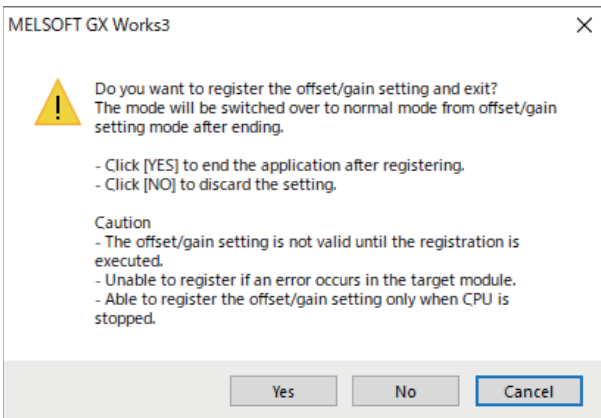
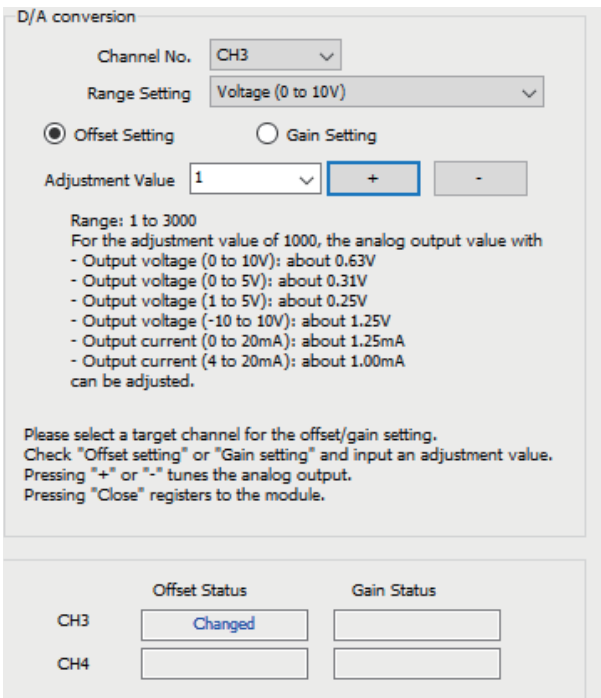
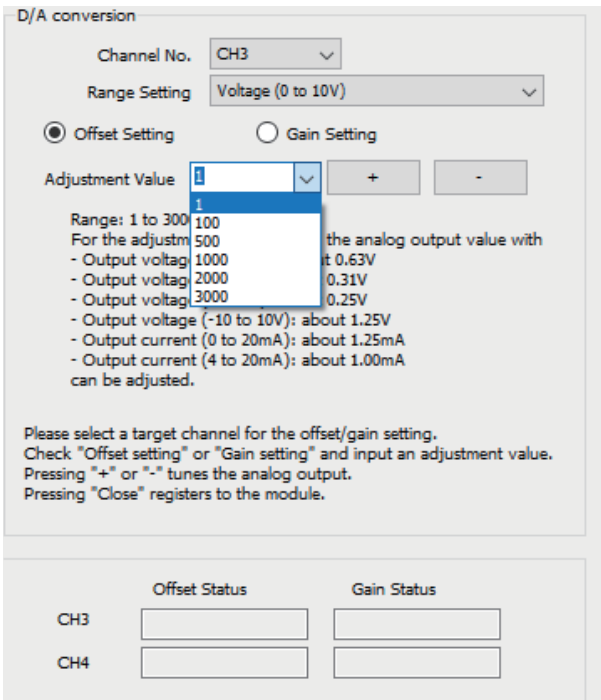

6. The adjustment value of the offset value or gain value can be selected from "1", "100", "500", "1000", "2000", and "3000" or it can be set by inputting any value (1 to 3000).

7. Clicking the [+ (+)] or [- (-)] button fine-tunes the analog output voltage or analog output current value corresponding the set adjustment value.

8. Check that the offset setting status in the selected channel has changed to "Changed".

9. To perform the gain setting, repeat the procedure from step 5.

10. After setting is completed, click the [Close] button.

11. Click the [Yes] button.

Corresponding devices

The devices which are used by the offset/gain setting function are listed below.

Name	CH3	CH4	Reference
Offset/gain reading	SM6412	SM6452	Page 399
Offset/gain writing	SM6413	SM6453	Page 399
Offset setting value	SD6412	SD6452	Page 408
Gain setting value	SD6413	SD6453	Page 408
Offset/gain writing enable code	SD6414	SD6454	Page 408

Operation

■Offset/gain writing

For changing the offset/gain data, set "E210H" to the "offset/gain writing enable code" and set the "offset/gain writing" from OFF to ON to write the "output range setting", "offset setting value" and "gain setting value" to the built-in memory of the FX5-4A-ADP. Only 1 range can be changed for 1 channel, and the latest contents are valid.

When writing is completed, the "offset/gain writing" automatically turns OFF. Also, the "offset/gain writing enable code" is cleared to 0.

When the "output range setting" is changed, the initial value becomes valid.

For returning the offset/gain data to the initial value, use the offset/gain initialization function (☞ Page 337 Offset/gain Initialization Function).

Point

- The offset/gain value is written when the "offset/gain writing enable code" is set to "E210H".
- The offset/gain value can be written only while D/A conversion is disabled.
- The "D/A conversion enable/disable setting" cannot be changed to "enable" while the offset/gain value is being written.

■Offset/gain reading

For reading the offset/gain data saved in the built-in memory of the FX5-4A-ADP, set the "offset/gain reading" from OFF to ON to read the "output range setting", "offset setting value" and "gain setting value".

When the output range setting selected during reading is equivalent to the output range setting saved in the built-in memory of the FX5-4A-ADP, the read values are set to the "offset setting value" and "gain setting value".

If the output range setting is different, the initial value of the output range setting selected during reading is valid and set to the "offset setting value" and "gain setting value". In this case, the offset/gain setting output range mismatch alarm occurs (Alarm code: 0C0□H).

Offset/gain Initialization Function

This function initializes the offset value and gain value saved in the built-in memory of the FX5-4A-ADP.

This function can be set only with special devices.

Setting procedure

1. Set "E210H" to the "offset/gain writing enable code".

Setting value	Description	Default value
Other than E210H	Offset/gain writing disable	0
E210H	Offset/gain writing enable	

2. Set the "offset/gain initialization" from OFF to ON.

Setting value	Description	Default value
0: OFF	Offset/gain initialization is not performed.	0: OFF
1: ON	Offset/gain initialization is performed.	

Corresponding devices

The devices which are used by the offset/gain initialization function are listed below.

Name	CH3	CH4	Reference
Offset/gain initialization	SM6414	SM6454	Page 400
Offset/gain writing enable code	SD6414	SD6454	Page 408

Operation

Set "E210H" to the "offset/gain writing enable code" and set the "offset/gain initialization" from OFF to ON to initialize the offset value and gain value saved in the built-in memory of the FX5-4A-ADP. When initialization is completed, the "offset/gain initialization" automatically turns OFF. Also, the "offset/gain writing enable code" is cleared to 0.

Point

- Offset/gain initialization is executed when the "offset/gain writing enable code" is set to "E210H".
- Offset/gain initialization is enabled only while D/A conversion is disabled.
- The "D/A conversion enable/disable setting" cannot be changed to "enable" while offset/gain initialization is being executed.

6.5 Common Function

Event History Function

This function collects errors from FX5-4A-ADP, and keeps them in the SD memory card, and data memory or battery backed built-in RAM of the CPU module.

The event information collected by the CPU module can be displayed on GX Works3 to check the occurrence history in chronological order.

Event type	Classification	Description
System	Error	An error detected by the self diagnostics in each module.

Setting procedure

The event history function can be set from the event history setting window of GX Works3. For the setting procedure, refer to the following.

📖 MELSEC iQ-F FX5 User's Manual (Application)

Displaying event history

Access the menu of GX Works3. For details on the operating procedure and how to view the contents, refer to the following.

📖 GX Works3 Operating Manual

Changing the setting value while the CPU module is operating

This paragraph shows the procedure to adopt values (of special relays and special registers) other than the values set by the parameters of GX Works3.

A/D conversion function

1. Disable A/D conversion.

Set "A/D conversion enable/disable setting" to ON. (📖 Page 366 A/D conversion enable/disable setting)

2. Change the value of a target special relay/device.

Change the value of a target device.

3. Enable A/D conversion.

Set "A/D conversion enable/disable setting" to OFF. (📖 Page 366 A/D conversion enable/disable setting)

Precautions

- An alarm occurs when the value of a special relay/device is changed while A/D conversion is enabled (Alarm code: 0F0□H).
- When the value of a special relay/device related to the scaling, shift, average counts or averaging processing specification was changed in A/D conversion and "count average" or "moving average" was specified as the averaging processing, clear the number of times of sampling and execute sampling again from "0 time".

D/A conversion function

1. Disable D/A conversion.

Set "D/A conversion enable/disable setting" to ON. (📖 Page 396 D/A conversion enable/disable setting)

2. Change the value of a target special relay/device.

Change the value of a target device.

3. Enable D/A conversion.

Set "D/A conversion enable/disable setting" to OFF. (📖 Page 396 D/A conversion enable/disable setting)

Precautions

An alarm occurs when the value of a special relay/device is changed while D/A conversion is enabled (Alarm code: 0F00H).

Starting/stopping the analog function in accordance with the CPU module status

This paragraph shows the analog operation in accordance with the CPU module status.

A/D conversion function

■RUN

The FX5-4A-ADP operates in accordance with its parameters.

■PAUSE

The FX5-4A-ADP operates in accordance with its parameters.

■STOP

The FX5-4A-ADP continues A/D conversion.

D/A conversion function

■RUN

The FX5-4A-ADP operates in accordance with its parameters.

■PAUSE

The FX5-4A-ADP operates in accordance with its parameters.

■STOP

Outputs are enabled even in the STOP status by using the analog test mode available when the CPU module is in the STOP status. (👉 Page 324 Analog Output Test when CPU Module is in STOP Status Function)

Alarm clear request

A/D conversion function

It is necessary to set the "A/D conversion alarm clear request" from OFF to ON to clear the alarm code.

The table below shows the necessity of the alarm clear request for turning OFF each flag and clearing the alarm code.

Flag name	Alarm clear request required to turn OFF the flag	Alarm clear request required to clear the alarm code
A/D conversion completed flag	—	—
Over scale upper limit detection flag	○	○
Over scale lower limit detection flag	○	○
Maximum value/minimum value reset completed flag	—	—
Warning output flag (process alarm upper limit)	—	○
Warning output flag (process alarm lower limit)	—	○
Warning output flag (rate alarm upper)	—	○
Warning output flag (rate alarm lower)	—	○
Disconnection detection flag	○*1	○
Convergence detection flag	—	—
Deviation detection flag between channel	—	○
A/D conversion alarm flag	○	○
A/D conversion error flag	—	—

*1 The alarm clear request is required when disconnection recovery is set to "disable".

○: Requires the alarm clear request.

—: Does not require the alarm clear request.

Point

- The "A/D conversion alarm clear request" is required for flags which do not turn OFF automatically and flags which cause alarms.
- The "A/D conversion alarm clear request" is not turned off automatically. To perform an alarm clear again, it is necessary to turn it OFF once.
- Use the "error clear request" (SM50) of the CPU module to turn OFF the A/D conversion error flag and clear the A/D conversion latest error code.

D/A conversion function

It is necessary to set the "D/A conversion alarm clear request" for from OFF to ON clearing the alarm code.

The table below shows the necessity of the alarm clear request for turning OFF each flag and clearing the alarm code.

Flag name	Alarm clear request required to turn OFF the flag	Alarm clear request required to clear the alarm code
Warning output upper limit value flag	○	○
Warning output lower limit value flag	○	○
Disconnection detection flag	—*1	—*2
D/A conversion alarm flag	○	○
D/A conversion error flag	—	—

*1 The "error clear request" (SM50) of the CPU module is required when disconnection recovery is set to "disable".

*2 The "error clear request" (SM50) of the CPU module is required for clearing the error code.

○: Requires the alarm clear request.

—: Does not require the alarm clear request.

Point

- The alarm clear of the CPU module request is required for flags which do not turn OFF automatically and flags which cause alarms.
- Use the "error clear request" (SM50) of the CPU module to turn OFF the D/A conversion error flag and clear the D/A conversion latest error code.

6.6 Procedure to Execute the FX5-4A-ADP

The procedure to execute the FX5-4A-ADP is described below.

1. Confirm the specifications of the FX5-4A-ADP.

Confirm the specifications of the FX5-4A-ADP. (☞ Page 281 Specifications)

2. Check the system configuration.

Check the system configuration. (☞ Page 342 System Configuration)

3. Attach the FX5-4A-ADP.

Refer to the following manuals for attachment to the CPU module:

☞ MELSEC iQ-F FX5UJ User's Manual (Hardware)

☞ MELSEC iQ-F FX5U User's Manual (Hardware)

☞ MELSEC iQ-F FX5UC User's Manual (Hardware)

When using two or more FX5-4DA-ADP and connecting them next to FX5-4A-ADP, do not connect them to both sides of FX5-4A-ADP.

4. Connect the FX5-4A-ADP to the external device.

Wiring to external devices. (☞ Page 343 Wiring)

5. Set the parameters.

Set the parameters to configure the FX5-4A-ADP. (☞ Page 347 Parameter Setting)

6. Create the program.

Create the program to use the FX5-4A-ADP.

7. Run the program.

Precautions

Do not write to the special relay/special register in the user interrupt program.

6.7 System Configuration

This section describes the system configuration including analog adapters.

Up to two analog adapters can be connected to an FX5UJ CPU module.

Up to four analog adapters can be connected to an FX5U/FX5UC CPU module.*¹

The connection position of the analog adapter connected to each CPU module are counted as the first module, the second module, and so on in order of proximity to the CPU module.

However, communication adapters are not counted towards the number of analog adapters.

■FX5UJ CPU module

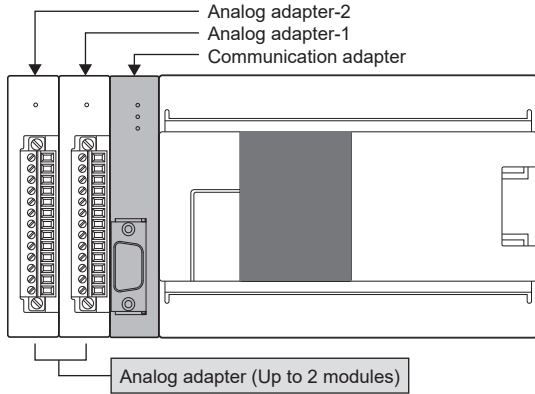

■FX5U CPU module

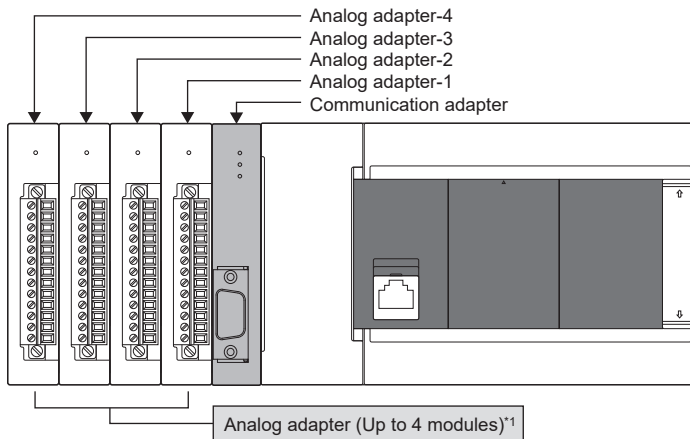

■FX5UC CPU module

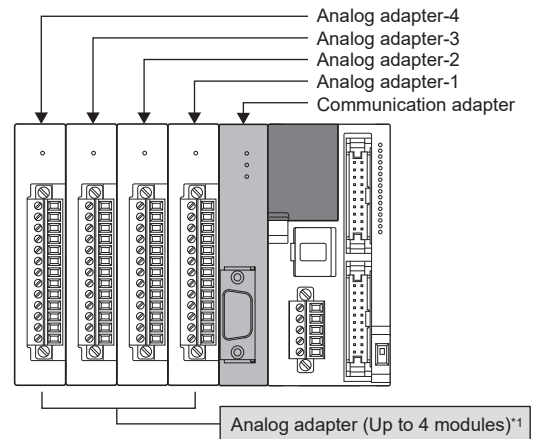

*¹ For FX5-4A-ADP, up to two modules can be connected.

6.8 Wiring

This section describes the wiring.

European-type terminal block

Wire the European-type terminal block in accordance with the following specifications.

Suitable wiring

Number of wires connected per terminal	Wire size		Tightening torque
	Solid wire, Stranded wire	Wire ferrule with insulation sleeve	
One wire	0.3 to 0.5 mm ² (AWG22 to 20)	0.3 to 0.5 mm ² (AWG22 to 20)	0.20 N·m
Two wires	0.3 mm ² (AWG22)	—	

Precautions

Do not tighten terminal screws with torque exceeding the specified range. Failure to do so may cause equipment failures or malfunctions.

Wire end treatment

Treat stranded and solid wires as they are or use wire ferrules with insulation sleeves for wiring terminals.

■When stranded and solid wires are treated as they are

- Twist the end of stranded wires and make sure that there are no loose wires.
- Do not solder-plate the electric wire ends.

Stripping dimensions of electric wire ends

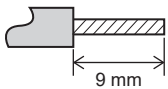

■When wire ferrules with insulation sleeves are used

Depending on the thickness of a wiring sheath used, it may be difficult to insert the sheath into an insulation sleeve. Refer to the external dimensions as a reference to select wires.

External dimension of wire ferrules with insulation sleeves

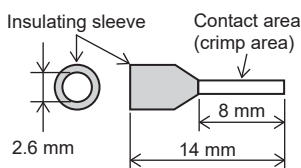

<Reference>

Manufacturer	Model	Crimp tool
Phoenix Contact GmbH & Co. KG	AI 0.5-8 WH	CRIMPFOX 6 CRIMPFOX 6T-F

■Tool

For tightening terminals, use a small, commercially-available screwdriver with a straight tip. The recommended shape is shown in the figure on the right.

■Precautions

When a precision screwdriver with a small grip is used, the specified tightening torque cannot be obtained. Use the following screwdriver or equivalent product (grip diameter: 25 mm) to obtain the tightening torque specified above.

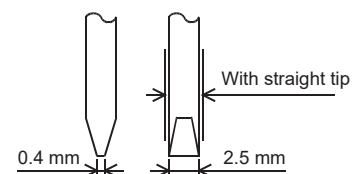

<Reference>

Manufacturer	Model
Phoenix Contact GmbH & Co. KG	SZS 0.4×2.5

Terminal layout

The following table shows the terminal layout.

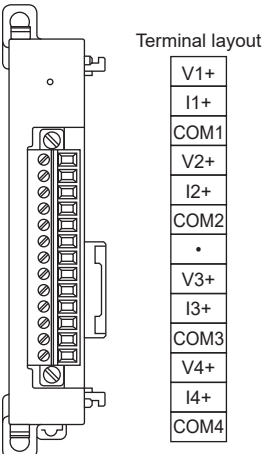
Terminal block	Signal name	Function
	V1+	CH1 Voltage/current input For current input short circuit Common
	I1+	
	COM1	
	V2+	CH2 Voltage/current input For current input short circuit Common
	I2+	
	COM2	
	•	Do not wire this terminal.
	V3+	CH3 Voltage output Current output Common
	I3+	
	COM3	
	V4+	CH4 Voltage output Current output Common
	I4+	
	COM4	

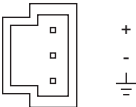
Terminal block	Signal name	Function
	+	24 V DC power supply (+)
	-	24 V DC power supply (-)
	⏏	Ground

Power supply wiring

The following figures show wiring of the power supply.

To connect to the FX5UJ/FX5U CPU module

[When an external power supply is used]

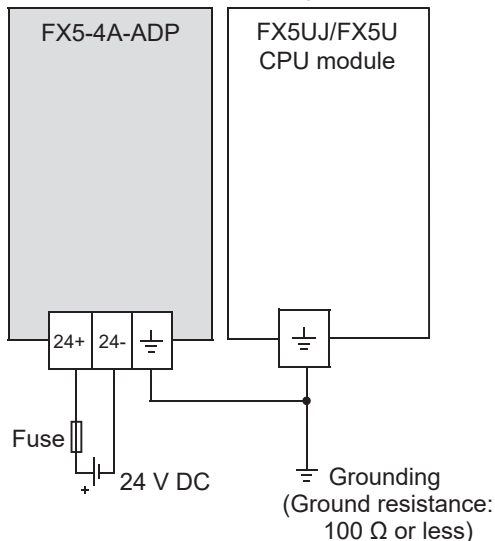

[When a service power supply is used]

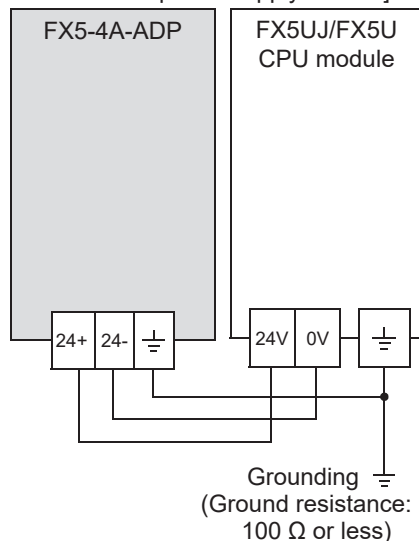

Precautions

- Ground the "ground" terminal to a class-D grounded power supply line (100 Ω or less) together with the grounding terminal of the CPU module.
- When using an external power supply, turn on the power supply at the same time as the CPU module or earlier than the CPU module. When turning off the power, confirm the safety of the system and turn off the power of the PLC (including expansion adapters) at the same time.

To connect to the FX5UC CPU module

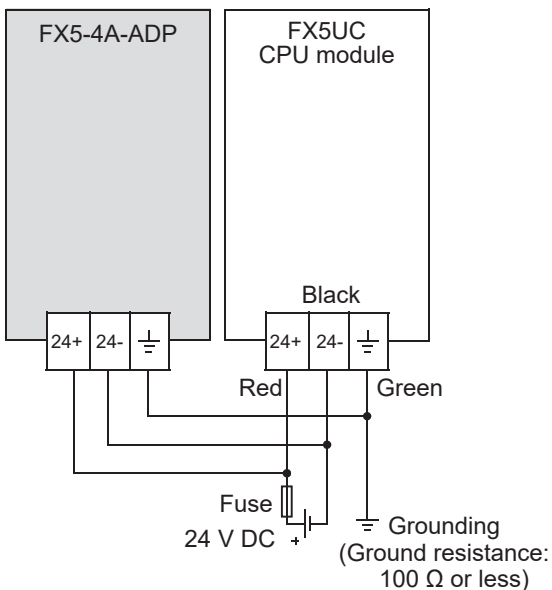

6

Precautions

- Ground the "ground" terminal to a class-D grounded power supply line (100 Ω or less) together with the grounding terminal of the CPU module.
- For the 24 V DC power supply, be sure to use the same power as the CPU module.

Analog input/output wiring

The following figures show wiring of the analog input and output. (when connecting to the FX5UJ/FX5U CPU module (when using the external power supply))

For wiring of the power supply, refer to [Page 344 Power supply wiring](#).

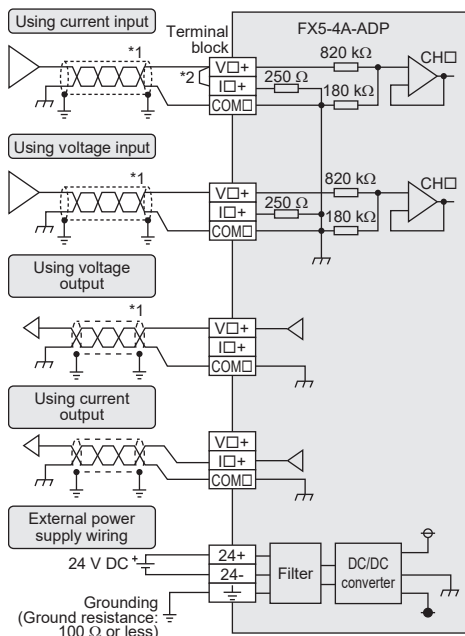

V□+, I□+, COM□, CH□: □ represents the channel number.

For analog input, use channel 1, 2.

For analog output, use channel 3, 4.

*1 Use 2-core shielded twisted pair cable for the analog input/output lines, and separate the analog output lines from other power lines or inductive lines.

*2 Make sure to short-circuit the 'V□+' and 'I□+' terminals when current is input. (□: channel 1, 2)

Grounding

Perform the following.

- Perform class D grounding (Grounding resistance: 100 Ω or less).
- Ground the PLC independently when possible.

If the PLC cannot be grounded independently, perform the "Shared grounding" shown below.

For the details, refer to the following manual.

📖 MELSEC iQ-F FX5UJ User's Manual (Hardware)

📖 MELSEC iQ-F FX5U User's Manual (Hardware)

📖 MELSEC iQ-F FX5UC User's Manual (Hardware)

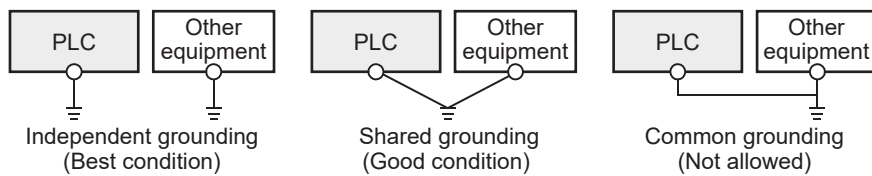

- Use a grounding wire with thickness of AWG 22 to 20 (0.3 to 0.5 mm²).
- Bring the grounding point close to the PLC as much as possible so that the ground cable can be shortened.

6.9 Parameter Setting





Set the parameters of each channel.

Setting parameters here eliminates the need to program them.

Point

Parameters are enabled when the CPU module is powered ON or after a reset. In addition, operations different from the parameter settings are possible by transferring values to special relays and special registers while changing these values in the program.

For the special relay and the special register, refer to the following.

-  Page 362 List of A/D Conversion Special Relays
 -  Page 376 List of A/D Conversion Special Registers
 -  Page 394 List of D/A Conversion Special Relays
 -  Page 402 List of D/A Conversion Special Registers
-

Basic settings (Input)

Setting procedure

Open "Basic Settings" of the GX Works3.

1. Start Module parameter.

Navigation window ⇒ [Parameter] ⇒ [Module Information] ⇒ Module model name ⇒ [Module Parameter] ⇒ "Basic Settings (Input)"

Window

Item	CH1	CH2
<input type="checkbox"/> A/D Conversion Enable/Disable Setting Function A/D Conversion Enable/Disable Setting	Set A/D conversion method. Disable	Disable
<input type="checkbox"/> A/D Conversion Method Average Processing Specification Time Average Counts Average Moving Average	Set A/D conversion method. Sampling Processing 0 Times	Sampling Processing 0 Times
<input type="checkbox"/> Range switching function Input range setting	The input range of the analog input can be set. The input conversion characteristics can be changed. Input Voltage (0 to 10V)	Input Voltage (0 to 10V)

Displayed items

Item	Description	Setting range	Default
A/D Conversion Enable/Disable Setting	Set whether to "enable" or "disable" AD conversion value output.	<ul style="list-style-type: none"> • Disable • Enable 	Disable
Average Processing Specify	Execute whether to set "average process" or "sampling processing".	<ul style="list-style-type: none"> • Sampling Processing • Time Average • Count Average • Moving Average 	Sampling Processing
Time Average Counts Average Moving Average	Set average time, average counts, moving average counts when specifying average process for each channel.	Set range setting for each channel.	—
Input range setting	Setting area for input range setting.	<ul style="list-style-type: none"> • Input Voltage (0 to 10 V) • Input Voltage (0 to 5 V) • Input Voltage (1 to 5 V) • Input Voltage (-10 to 10 V) • Input Current (0 to 20 mA) • Input Current (4 to 20 mA) • Input Current (-20 to 20 mA) 	Input Voltage (0 to 10 V)

2. Click the item to be changed to enter the setting value.

- Item where a value is selected from the pull-down list

Click [▼] button of the item to be set, and from the pull-down list that appears, select the value.

- Item where a value is entered into the text box

Double-click the item to be set to enter the numeric value.

Application settings (Input)

Setting procedure

Open "Application Settings" of the GX Works3.

1. Start Module parameter.

Navigation window ⇒ [Parameter] ⇒ [Module Information] ⇒ Module model name ⇒ [Module Parameter] ⇒ "Application Settings (Input)"

Window

Item	CH1	CH2
Warning output function (Process alarm)	Execute the setting related to A/D conversion warning.	
Warning output setting (Process alarm)	Disable	Disable
Process Alarm Upper Upper Limit Value	0	0
Process Alarm Upper Lower Limit Value	0	0
Process Alarm Lower Upper Limit Value	0	0
Process Alarm Lower Lower Limit Value	0	0
Warning output function (Rate alarm)	Execute the setting related to A/D conversion warning.	
Warning output setting (Rate alarm)	Disable	Disable
Rate alarm warning detection period setting	1 ms	1 ms
Rate alarm upper limit value	0	0
Rate alarm lower limit value	0	0
Over Scale Detection	Execute the setting related to detection of analog input exceeding the setting range.	
Over Scale Detection Enable/Disable	Disable	Disable
Scaling Setting	Execute the setting related to A/D conversion scaling.	
Scaling Enable/Disable	Disable	Disable
Scaling Upper Limit Value	0	0
Scaling Lower Limit Value	0	0
Shift Function	Execute the setting related to A/D conversion shift function.	
Shifting amount to conversion value	0	0
Digital Clip Setting	Execute the setting related to A/D conversion digital clip function.	
Digital Clip Enable/Disable	Disable	Disable
Disconnection detection function	Execute the setting related to disconnection detection.	
Disconnection detection enable/disable setting	Disable	Disable
Disconnection recovery detection enable/disable setting	Disable	Disable
Convergence detection function	Execute the setting related to steady state detection.	
Convergence detection enable/disable setting	Disable	Disable
Convergence detection upper limit value	0	0
Convergence detection lower limit value	0	0
Detection time setting for Convergence detection	1 ms	1 ms
Deviation detection function between channels	Execute the setting related to deviation between CH detection.	
Deviation detection trigger between channels	Disable	Disable
Deviation value for deviation detection between channels	0	0
Target CH setting for deviation detection between channels: No.1 CH1	Non-target	Non-target

Displayed items

Item	Description	Setting range	Default
Warning output setting (Process alarm)	Set whether to "enable" or "disable" process alarm warning.	<ul style="list-style-type: none"> • Disable • Enable 	Disable
Process Alarm Upper Upper Limit Value	Set upper upper limit value of digital output value.	-32768 to +32767	—
Process Alarm Upper Lower Limit Value	Set upper lower limit value of digital output value.	-32768 to +32767	—
Process Alarm Lower Upper Limit Value	Set lower upper limit value of digital output value.	-32768 to +32767	—
Process Alarm Lower Lower Limit Value	Set lower lower limit value of digital output value.	-32768 to +32767	—
Warning output setting (Rate alarm)	Set whether to "enable" or "disable" the rate alarm warning.	<ul style="list-style-type: none"> • Disable • Enable 	Disable
Rate alarm warning detection period setting	Set the value for the sampling cycle to detect the rate alarm warning.	1 to 10000	—
Rate alarm upper limit value	Set the upper limit value of the digital output value.	-999 to +1000	—
Rate alarm lower limit value	Set the lower limit value of the digital output value.	-1000 to +999	—
Over Scale Detection Enable/Disable	Set whether to "enable" or "disable" over scale detection.	<ul style="list-style-type: none"> • Disable • Enable 	Disable
Scaling Enable/Disable	Set whether to "enable" or "disable" scaling.	<ul style="list-style-type: none"> • Disable • Enable 	Disable
Scaling Upper Limit Value	Set the upper limit value for scaling calculation.	-32768 to +32767	—
Scaling Lower Limit Value	Set the lower limit value for scaling calculation.	-32768 to +32767	—
Shifting amount to conversion value	Set shifting amount for shifting function.	-32768 to +32767	0
Digital Clip Enable/Disable	Whether to "enable" or "disable" digital clip.	<ul style="list-style-type: none"> • Disable • Enable 	Disable
Disconnection detection enable/disable setting	Set whether to "enable" or "disable" disconnection detection.	<ul style="list-style-type: none"> • Disable • Enable 	Disable
Disconnection recovery detection enable/disable setting	Set whether to "enable" or "disable" disconnection recovery detection.	<ul style="list-style-type: none"> • Disable • Enable 	Disable
Convergence detection enable/disable setting	Set whether to "enable" or "disable" convergence detection.	<ul style="list-style-type: none"> • Disable • Enable 	Disable
Convergence detection upper limit value	Set the upper limit value for convergence range.	-32767 to +32767	—
Convergence detection lower limit value	Set the lower limit value for convergence range.	-32768 to +32766	—
Detection time setting for Convergence detection	Set the convergence time.	1 to 10000	—
Deviation detection trigger between channels	Set whether to "enable" or "disable" deviation detection between channels.	<ul style="list-style-type: none"> • Disable • Enable 	Disable
Deviation value for deviation detection between channels	Set the deviation value for deviation detection between channels.	0 to 65535	—
Target CH setting for deviation detection between channels: No.1 to 4, CH1, 2	Set whether to target each channel for deviation detection between channels.	<ul style="list-style-type: none"> • Non-target • Target 	Non-target

2. Click the item to be changed to enter the setting value.

- Item where a value is selected from the pull-down list

Click [▼] button of the item to be set, and from the pull-down list that appears, select the value.

- Item where a value is entered into the text box

Double-click the item to be set to enter the numeric value.

Basic settings (Output)

Setting procedure

Open "Basic Settings" of the GX Works3.

1. Start Module parameter.

Navigation window ⇒ [Parameter] ⇒ [Module Information] ⇒ Module model name ⇒ [Module Parameter] ⇒ "Basic Settings (Output)"

Window

Item	CH3	CH4
<input type="checkbox"/> D/A Conversion Enable/Disable Setting	Set D/A conversion method.	
D/A Conversion Enable/Disable Setting	Disable	Disable
<input type="checkbox"/> D/A Output Enable/Disable Setting	Set D/A output method.	
D/A Output Enable/Disable Setting	Disable	Disable
<input type="checkbox"/> Range switching function	The analog output range can be set. The output conversion characteristics can be changed.	
Output range setting	Output Voltage (0 to 10V)	Output Voltage (0 to 10V)

Displayed items

Item	Description	Setting range	Default
D/A Conversion Enable/Disable Setting	Set whether to "enable" or "disable" D/A conversion.	<ul style="list-style-type: none"> • Disable • Enable 	Disable
D/A Output Enable/Disable Setting	Set whether to "enable" or "disable" D/A output.	<ul style="list-style-type: none"> • Disable • Enable 	Disable
Output range setting	Setting area for output range setting.	<ul style="list-style-type: none"> • Output Voltage (0 to 10 V) • Output Voltage (0 to 5 V) • Output Voltage (1 to 5 V) • Output Voltage (-10 to 10 V) • Output Current (0 to 20 mA) • Output Current (4 to 20 mA) 	Output Voltage (0 to 10 V)

2. Click the item to be changed to enter the setting value.

- Item where a value is selected from the pull-down list

Click [▼] button of the item to be set, and from the pull-down list that appears, select the value.

- Item where a value is entered into the text box

Double-click the item to be set to enter the numeric value.

Application settings (Output)

Setting procedure

Open "Application Settings" of the GX Works3.

1. Start Module parameter.

Navigation window ⇒ [Parameter] ⇒ [Module Information] ⇒ Module model name ⇒ [Module Parameter] ⇒ "Application Settings (Output)"

Window

Item	CH3	CH4
Warning Output Function	Execute the setting related to D/A conversion warning.	
Warning Output Setting	Disable	Disable
Warning output upper limit value	0	0
Warning output lower limit value	0	0
Scaling Setting	Execute the setting related to D/A conversion scaling.	
Scaling Enable/Disable	Disable	Disable
Scaling Upper Limit Value	0	0
Scaling Lower Limit Value	0	0
Shift Function	Execute the setting related to D/A conversion shift function.	
Shifting amount to conversion value	0	0
Analog Output HOLD/CLEAR Setting	Set whether to HOLD the last value or setting value, or to CLEAR the digital value to be converted to analog value.	
HOLD/CLEAR Setting	Current Value (Hold)	Current Value (Hold)
HOLD Setting Value	0	0
Disconnection detection function	Execute the setting related to disconnection detection.	
Disconnection detection enable/disable setting	Disable	Disable
Disconnection recovery detection enable/disable setting	Disable	Disable

Displayed items

Item	Description	Setting range	Default
Warning Output Setting	Set whether to "enable" or "disable" warning output.	<ul style="list-style-type: none"> • Disable • Enable 	Disable
Warning output upper limit value	Set upper limit value of digital input value for warning output.	-32767 to +32767	—
Warning output lower limit value	Set lower limit value of digital input value for warning output.	-32768 to +32766	—
Scaling Enable/Disable	Set whether to "enable" or "disable" scaling.	<ul style="list-style-type: none"> • Disable • Enable 	Disable
Scaling Upper Limit Value	Set scaling conversion upper limit value.	-32768 to +32767	—
Scaling Lower Limit Value	Set scaling conversion lower limit value.	-32768 to +32767	—
Shifting amount to conversion value	Set shifting amount for shift function.	-32768 to +32767	0
HOLD/CLEAR Setting	Set output status at CLEAR or HOLD.	<ul style="list-style-type: none"> • CLEAR • Current Value (Hold) • Setting Value 	Current Value (Hold)
HOLD Setting Value	Set digital value that output at HOLD for each channel when "setting value" is selected in "HOLD/CLEAR setting".	-32768 to +32767	—
Disconnection detection enable/disable setting	Set whether to "enable" or "disable" disconnection detection.	<ul style="list-style-type: none"> • Disable • Enable 	Disable
Disconnection recovery detection enable/disable setting	Set whether to "enable" or "disable" disconnection recovery detection.	<ul style="list-style-type: none"> • Disable • Enable 	Disable

2. Click the item to be changed to enter the setting value.

- Item where a value is selected from the pull-down list

Click [▼] button of the item to be set, and from the pull-down list that appears, select the value.

- Item where a value is entered into the text box

Double-click the item to be set to enter the numeric value.

6.10 Troubleshooting

This section describes errors that may occur in the use of the FX5-4A-ADP and those troubleshooting.

Troubleshooting with the LEDs

Check the state of the LED to narrow down the possible causes of the trouble. This step is the first diagnostics.

A state of the FX5-4A-ADP can be checked with the PWR LED. The following table shows the correspondence of LED and a state of the FX5-4A-ADP.

Name	Description
PWR LED	Indicates the power supply status of the FX5-4A-ADP. On: The power supply is supplied. Off: The power supply is not supplied.

Checking the state of the module

Open the module diagnostics window of the GX Works3 to check the error codes (alarm codes) and error history of the FX5-4A-ADP.

[Diagnostics] ⇒ [Module Diagnostics (CPU Diagnostics)]

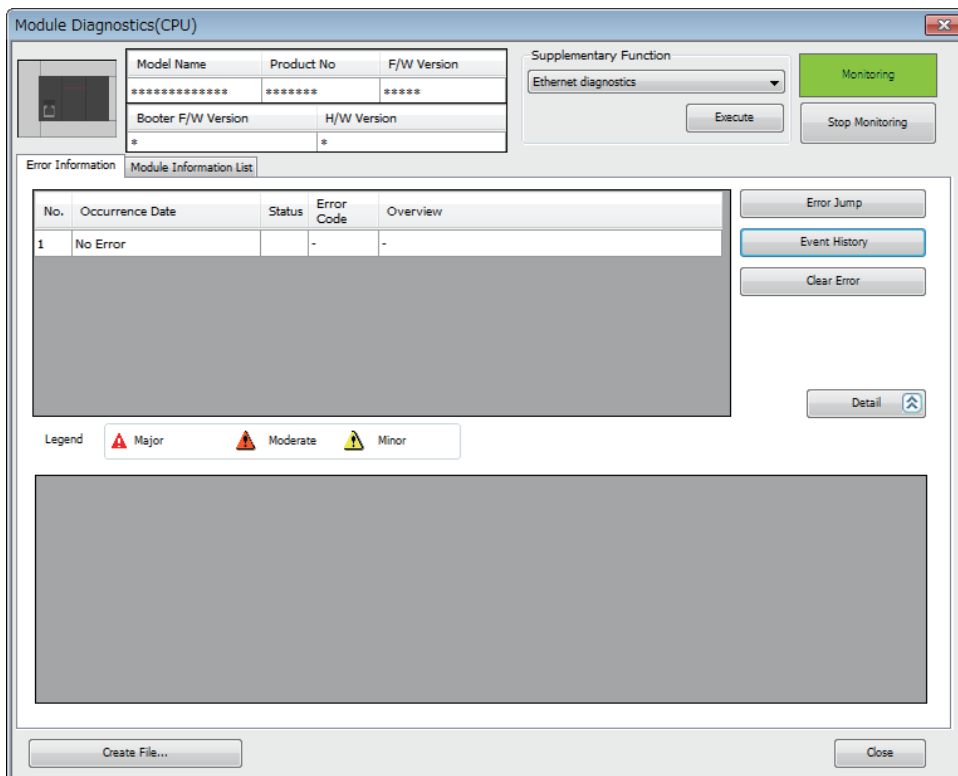

Error history, alarm history can be checked with the event history window of the GX Works3.

 [Diagnostics] ⇒ [[Module Diagnostics (CPU Diagnostics)] ⇒ [Event History] button

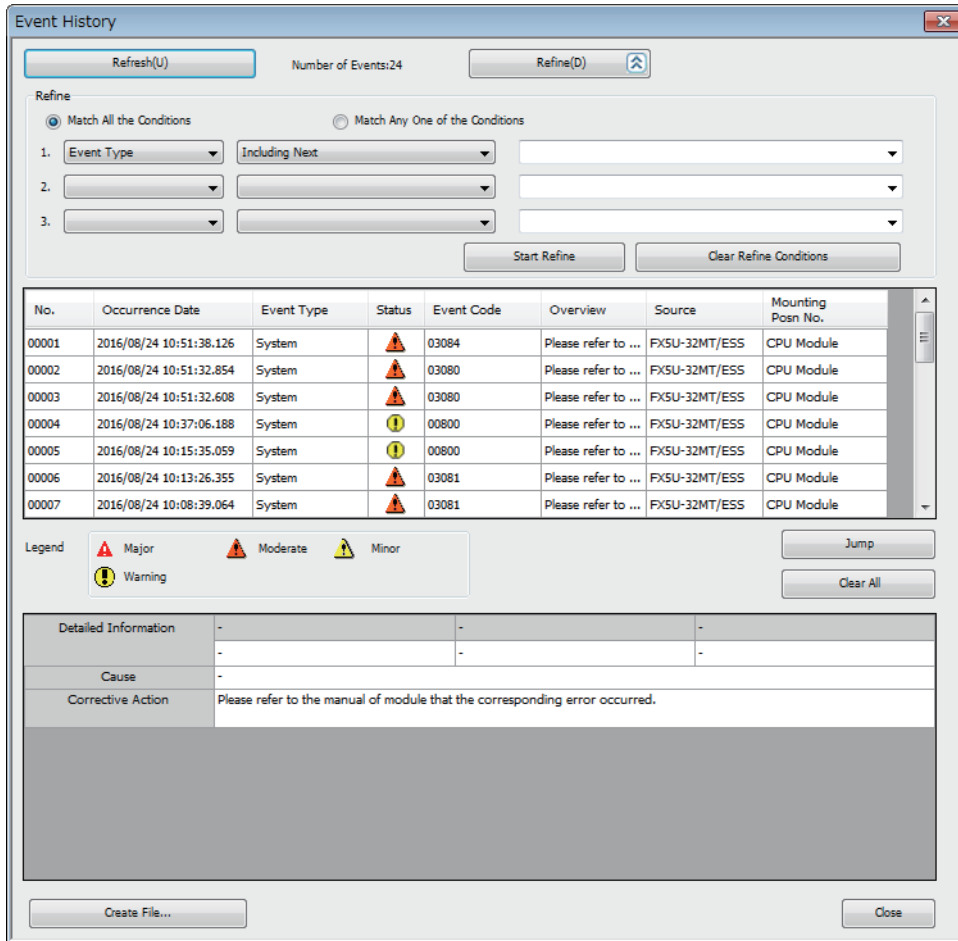

Event History

Refresh(U) Number of Events:24 Refine(D)

Refine







Match All the Conditions Match Any One of the Conditions

1. Event Type Including Next []



2. [] [] []

3. [] [] []

Start Refine Clear Refine Conditions

No.	Occurrence Date	Event Type	Status	Event Code	Overview	Source	Mounting Posn No.
00001	2016/08/24 10:51:38.126	System		03084	Please refer to ...	FX5U-32MT/ESS	CPU Module
00002	2016/08/24 10:51:32.854	System		03080	Please refer to ...	FX5U-32MT/ESS	CPU Module
00003	2016/08/24 10:51:32.608	System		03080	Please refer to ...	FX5U-32MT/ESS	CPU Module
00004	2016/08/24 10:37:06.188	System		00800	Please refer to ...	FX5U-32MT/ESS	CPU Module
00005	2016/08/24 10:15:35.059	System		00800	Please refer to ...	FX5U-32MT/ESS	CPU Module
00006	2016/08/24 10:13:26.355	System		03081	Please refer to ...	FX5U-32MT/ESS	CPU Module
00007	2016/08/24 10:08:39.064	System		03081	Please refer to ...	FX5U-32MT/ESS	CPU Module

Legend

 Major  Moderate  Minor

 Warning

Jump Clear All

Detailed Information	-	-	-
Cause	-	-	-
Corrective Action	Please refer to the manual of module that the corresponding error occurred.		

Create File... Close

Troubleshooting by Symptom

The following describes troubles classified by symptoms.



If the symptom is not improved even after the actions according to each check item are taken, the possible cause is the failure of the FX5-4A-ADP. Please consult your local Mitsubishi representative.

When the PWR LED does not turn ON

Check item	Action
Check whether the power is supplied.	Check whether the voltage supplied to the FX5-4A-ADP is within the rated range.
Whether the FX5-4A-ADP is attached normally to the CPU module.	Check the FX5-4A-ADP attachment status.

Troubleshooting of A/D conversion

■When a digital output value cannot be read

Check item	Action
Whether the analog signal cable is connected normally to the FX5-4A-ADP.	Check the signal cables visually, and wire the analog signal cable correctly.
Whether the external equipment is wired correctly.	Wire the external equipment correctly to the FX5-4A-ADP. <ul style="list-style-type: none"> • Check whether the shield wire of the channel to be used is grounded. • Check whether the V□+ terminal and I□+ terminal are connected to each other when the current is input.
Whether the 24 V DC power supply is supplied to the FX5-4A-ADP.	Supply the 24 V DC power supply to the FX5-4A-ADP.
Whether the offset/gain is set correctly.	Check whether the offset/gain is set correctly. Check whether A/D conversion is executed correctly. When A/D conversion is executed correctly, set the offset/gain again.
Check whether the input range setting is correct.	Check the input range setting in the parameter setting of GX Works3. If the contents of setting are wrong, set the input range again.
Whether the "A/D conversion enable/disable setting" is set to "enable" for the channel to be used.	Check the "A/D conversion enable/disable setting" for the channel to be used in the parameter setting of GX Works3, and set "enable" in the parameter of GX Works3 or in the program.

■When the digital output value does not change

Check item	Action
Whether disconnection is detected.	Remove the cause of disconnection by replacing the analog signal cable, etc., and then check the digital output value.
Whether over-scale is detected.	Remove the cause of over-scale, and then check the digital output value.
Whether the shift function is working with a proper setting value	Set the conversion value shift amount suitable for the system.

■When a value is not converted into the expected digital output value

Check item	Action
Check whether the input range setting is correct.	Check the input range setting in the parameter setting of GX Works3. If the contents of setting are wrong, set the input range again.
Check whether the offset/gain setting is correct.	Check whether the offset/gain is set correctly. Check whether A/D conversion is executed correctly. When A/D conversion is executed correctly, set the offset/gain again.
Whether the A/D conversion method is set correctly.	Check the A/D conversion method in the parameter setting of GX Works3. If the contents of setting are wrong, set the A/D conversion method again.
Whether the scaling function is set correctly.	When the scaling function is used, check the scaling function setting in the parameter setting of GX Works3. If the contents of setting are wrong, set the scaling function again.
Whether the shift function is working with a proper setting value.	Set the conversion value shift amount suitable for the system.
Check whether the power is supplied.	Check whether the voltage supplied to the FX5-4A-ADP is within the rated range.

■When the digital output value is dispersed

Check item	Action
Whether an A/D conversion method other than sampling processing is set.	Check the A/D conversion method in the parameter setting of GX Works3. Set the averaging processing to the A/D conversion method, and then check again for dispersion of the digital output value.

■When the A/D conversion completed flag does not turn ON

Check item	Action
Whether A/D conversion is disabled in every channel.	Check the channels for which A/D conversion is enabled in the parameter setting of GX Works3. If A/D conversion is not enabled in any channel, enable A/D conversion for 1 or more channels in the parameter of GX Works3 or in the program.
Whether disconnection is detected.	Remove the cause of disconnection by replacing the analog signal cable, etc., and then check the digital output value.

Troubleshooting of D/A conversion

■When the analog output value is not given

Check item	Action
Whether the analog signal cable is connected normally to the FX5-4A-ADP	Check the signal cables visually, and wire the analog signal cable correctly.
Whether the external equipment is wired correctly	Wire the external equipment correctly to the FX5-4A-ADP.
Whether 24 V DC is supplied as the external power to the FX5-4A-ADP	Supply 24 V DC to the FX5-4A-ADP.
Whether the "D/A conversion enable/disable setting" is set to "enable" for the channel to be used	Check the "D/A conversion enable/disable setting" for the channel to be used in the parameter setting of GX Works3, and set "enable" in the parameter of GX Works3 or in the program.
Whether the "D/A output enable/disable setting" is set to "enable" for the channel to be used for output	Check the "D/A output enable/disable setting" for the channel to be used in the parameter setting of GX Works3, and set "enable" in the parameter of GX Works3 or in the program.
Whether the digital value is written to the channel to be used for output	Check the digital value in GX Works3.

■When the analog output value does not change

Check item	Action
Whether the CPU module operation status is "STOP" or "STOP (by stop error)"	The analog output HOLD/CLEAR function is being executed. Set the CPU module to the "RUN" status, and check whether analog output is given normally. When an error causing stop occurs, remove the cause of the error, and then turn OFF and ON the CPU module or reset the CPU module.

■When a value is not converted into the expected analog output value

Check item	Action
Whether the output range is set correctly	Check the output range setting in the parameter setting of GX Works3. If the contents of setting are wrong, set the output range again.
Whether the offset/gain is set correctly	Check whether the offset/gain is set correctly. Check whether D/A conversion is executed correctly. When D/A conversion is executed correctly, set the offset/gain again.
Whether the scaling function is set correctly	When the scaling function is used, check the scaling function setting in the parameter setting of GX Works3. If the contents of setting are wrong, set the scaling function again.
Whether the shift function is working with a proper setting value	Set the input value shift amount suitable for the system.
Whether a digital value above the warning output upper limit value or below the warning output lower limit value is set	When the warning output function is used, check the warning output function setting in the parameter setting of GX Works3. When the contents of setting are all right, check whether the digital value is not set outside the warning output range.
Check whether the power is supplied.	Check whether the voltage supplied to the FX5-4A-ADP is within the rated range.

■When the analog output value is not held

Check item	Action
Whether the CPU module operation status is "STOP" or "STOP (by stop error)"	Check the CPU module operation status. The analog output HOLD/CLEAR function is enabled when the CPU module is in the "STOP" or "STOP (by stop error)" status.
Whether the analog output HOLD/CLEAR function is set correctly	Check the analog output HOLD/CLEAR function setting in the parameter setting of GX Works3. If the contents of setting are wrong, set the analog output HOLD/CLEAR function again.
Whether the PWR LED is lit	Reset the CPU module, and check whether the PWR LED turns ON.

6.11 List of Error Code

The following table lists the error codes that may be stored.

A/D conversion error code

□: This symbol indicates the number of the channel where a error has occurred. (1: CH1, 2: CH2)

Error code	Error name	Description and cause	Action
0000H	—	There is no error.	—
1A0□H	Averaging process specification setting range error	A value other than 0 to 3 was set in CH□ Averaging process specification.	Reset CH□ the Averaging process specification to 0 to 3.
1A1□H	Average time setting range error	When the time average is set to CH□ Averaging process specification, a value other than 1 to 10000 was set to CH□ time average/count average/moving average settings.	Reset CH□ time average/count average/moving average setting to the following value. 1 to 10000
1A2□H	Average count setting range error	When the count average is set to CH□ Averaging process specification, a value other than 4 to 32767 was set to CH□ time average/count average/moving average settings.	Reset CH□ time average/count average/moving average setting to the following value. 4 to 32767
1A3□H	Moving average count setting range error	When the moving average is set to CH□ Averaging process specification, the following value was set to CH□ moving average count setting. Value other than 2 to 64	Reset CH□ moving average process setting to the following value. 2 to 64
1A4□H	Process alarm upper-lower limit value setting range error	The value not meeting the following conditions was set to CH□ process alarm upper-upper limit value to CH□ process alarm lower-lower limit value. Upper-upper limit value ≥ Upper-lower limit value ≥ Lower-upper limit value ≥ Lower-lower limit value	Reset CH□ process alarm upper-upper limit value to CH□ process alarm lower-lower limit value to the value meeting the following conditions. Upper-upper limit value ≥ Upper-lower limit value ≥ Lower-upper limit value ≥ Lower-lower limit value
1A5□H	Rate alarm upper limit value/lower limit value setting inversion error	Lower limit value ≥ upper limit value was set to CH□ rate alarm upper limit value and CH□ rate alarm lower limit value.	Reset CH□ rate alarm upper limit value and CH□ rate alarm lower limit value to lower limit value < upper limit value.
1A6□H	Rate alarm warning detection period setting range error	A value other than 1 to 10000 was set to CH□ rate alarm warning detection period setting.	Reset the CH□ rate alarm warning detection period setting to the value within 1 to 10000.
1A7□H	Scaling upper and lower limit value setting error	CH□ Scaling upper limit value and CH□ Scaling lower limit value are equal.	Reset CH□ Scaling upper limit value or CH□ scaling lower limit value such that Scaling upper limit value ≠ Scaling lower limit value.
1A8□H	Range setting range error	A value outside the range was set to the CH□ range setting.	Reset the CH□ range setting to the following value. 0 to 6
1A9□H	Offset/Gain setting value range error	A value outside the range was set to CH□ Offset setting value or CH□ Gain setting value.	Reset CH□ Offset setting value or CH□ Gain setting value to the following value. ■Voltage Offset value: -10000 to +9000 Gain value: -9000 to +10000 ■Current Offset value: -20000 to +17000 Gain value: -17000 to +30000
1AA□H	Range setting range error with disconnection detection enabled	CH□ Disconnection detection functions were set to Enable and CH□ Input range is set to other than the following. • 1 to 5 V • 4 to 20 mA	For the channel detecting simple disconnection using the disconnection detection function, reset CH□ Input range to any of the following. • 1 to 5 V • 4 to 20 mA
1AC□H	Convergence detection time setting range error	A value other than 1 to 10000 was set to CH□ Convergence detection time setting.	Reset CH□ Convergence detection time setting to the value within 1 to 10000.
1AD□H	Convergence detection upper limit value/lower limit value setting inversion error	Lower limit value ≤ the upper limit value was set to CH□ Convergence detection upper limit value and CH□ Convergence detection lower limit value.	Reset CH□ Convergence detection upper limit value and CH□ Convergence detection lower limit value such that lower limit value > upper limit value.

Error code	Error name	Description and cause	Action
1AF□H	Offset/Gain setting write error	During CH□ Offset/Gain setting write or CH□ Offset/Gain setting initialization, 'CH□ A/D conversion enable/disable setting' was set to conversion enable.	Set 'CH□ A/D conversion enable/disable setting' to conversion disable and write CH□ Offset /Gain setting or initialize CH□ Offset/ Gain setting.
1D7□H	Offset/Gain computed value range error	CH□ Offset/Gain computed value became out of range.	Reset CH□ Offset value and CH□ Gain setting value.
3080H	Analog ADP Hardware error	Hardware error of analog ADP was detected.	After resetting the CPU module, carry out RUN. If the same error is displayed again, there is a possibility of hardware error of the analog ADP. Consult the nearest Mitsubishi Electric representative.
3081H	Analog ADP Power failure	The power is not supplied normally.	Confirm if the power is supplied properly.
3082H	Analog ADP Memory Error	Read error or damaged EEPROM.	After resetting the CPU module, carry out RUN. If the same error is displayed again, there is a possibility of damaged EEPROM. Consult the nearest Mitsubishi Electric representative.
3083H	Analog ADP Memory Error	There is some offset/gain data defect or setting defect in EEPROM.	After offset/gain initialization of the analog ADP is finished, set the data by offset/gain settings again.
3084H	Analog ADP Communication error	Communication error occurred between the analog ADP and the CPU module.	Confirm if ADP is connected properly to the CPU module. If not improved, consult the nearest Mitsubishi Electric representative.

D/A conversion error code

□: This symbol indicates the number of the channel where a error has occurred. (3: CH3, 4: CH4)

Error code	Error name	Description and cause	Action
0000H	—	There is no error.	—
1B0□H	Warning output upper and lower limit value inversion error	The value not meeting the following condition was set to CH□ Warning output upper limit value and CH□ Warning output lower limit value. Upper limit value > Lower limit value	Reset CH□ Warning output upper limit value and CH□ Warning output lower limit value such that upper limit value > lower limit value.
1B1□H	Output status setting range error during HOLD	A value other than 0, 1 or, 2 was set in the CH□ HOLD/CLEAR function setting.	Set a value between 0 and 2 to the CH□ HOLD/ CLEAR function setting.
1B2□H	Output setting value setting range error during HOLD	CH□ Output setting value during HOLD is set outside the range of scaling upper and lower limit value.	Set CH□ Output setting value during HOLD within the range of scaling upper and lower limit value.
1B7□H	Scaling upper and lower limit value setting error	CH□ Scaling upper limit value and CH□ Scaling lower limit value are equal.	Reset CH□ Scaling upper limit value or CH□ scaling lower limit value such that Scaling upper limit value ≠ Scaling lower limit value.
1B8□H	Range setting range error	A value outside the range was set to the CH□ range setting.	Reset the CH□ range setting to the following value. 0 to 5
1B9□H	Offset/Gain setting value range error	A value outside the range was set to CH□ Offset setting value or CH□ Gain setting value.	Reset CH□ Offset value or CH□ Gain setting value to the following value. ■Voltage Offset value: -10000 to +9000 Gain value: -9000 to +10000 ■Current Offset value: 0 to 17000 Gain value: 3000 to 30000
1BA□H	Range setting range error with disconnection detection enabled	CH□ Disconnection detection functions were set to Enable and CH□ Output range is set to other than the following. • 4 to 20 mA	For the channel detecting disconnection using the disconnection detection function, reset CH□ Output range to any of the following. • 4 to 20 mA
1BB□H	Disconnection detection error	In CH□, disconnection was detected.	Eliminate the cause of disconnection in appropriate channel and turn 'Error Clear Request' (SM50) ON.
1BF□H	Offset/Gain setting write error	During CH□ Offset/Gain setting write or CH□ Offset/Gain setting initialization, 'CH□ D/A conversion enable/disable setting' was set to conversion enable.	Set 'CH□ D/A conversion enable/disable setting' to conversion disable and write CH□ Offset /Gain setting or initialize CH□ Offset/ Gain setting.

Error code	Error name	Description and cause	Action
1D7□H	Offset/Gain computed value range error	CH□ Offset/Gain computed value became out of range.	Reset CH□ Offset value and CH□ Gain setting value.
3080H	Analog ADP Hardware error	Hardware error of analog ADP was detected.	After resetting the CPU module, carry out RUN. If the same error is displayed again, there is a possibility of hardware error of the analog ADP. Consult the nearest Mitsubishi Electric representative.
3081H	Analog ADP Power failure	The power is not supplied normally.	Confirm if the power is supplied properly.
3082H	Analog ADP Memory Error	Read error or damaged EEPROM.	After resetting the CPU module, carry out RUN. If the same error is displayed again, there is a possibility damaged EEPROM. Consult the nearest Mitsubishi Electric representative.
3083H	Analog ADP Memory Error	There is some offset/gain data defect or setting defect in EEPROM.	After offset/gain initialization of the analog ADP is finished, set the data by offset/gain settings again.
3084H	Analog ADP Communication error	Communication error occurred between the analog ADP and the CPU module.	Confirm if ADP is connected properly to the CPU module. If not improved, consult the nearest Mitsubishi Electric representative.

6.12 List of Alarm Code

The following table shows the list of the alarm codes stored.

A/D conversion alarm code

□: This symbol indicates the number of the channel where an alarm has occurred. (1: CH1, 2: CH2)

Alarm code	Alarm name	Description and cause	Action
0000H	—	There is no error.	—
080□H	Process alarm (upper limit)	The process alarm (upper limit) has occurred in CH□.	When the CH□ digital operation value returns from the warning output range, the alarm code automatically changes to "0: Normal".
081□H	Process alarm (lower limit)	The process alarm (lower limit) has occurred in CH□.	
082□H	Rate alarm (upper limit)	The rate alarm (upper limit) has occurred in CH□.	When the CH□ digital operation value change rate returns to the setting range, the alarm code automatically changes to "0: Normal".
083□H	Rate alarm (lower limit)	The rate alarm (lower limit) has occurred in CH□.	
090□H	Over scale (upper limit)	The over scale (upper limit) has occurred in CH□.	When the alarm clear request is set to ON after the analog input value returns to the setting range, all over-scale detection flags become "0: Normal", and the alarm code stored in the "A/D conversion latest alarm code" is cleared.
091□H	Over scale (lower limit)	The over scale (lower limit) has occurred in CH□.	
0A0□H	Disconnection detection	Disconnection is detected in the CH□.	When the alarm clear request is set to ON after the CH□ is recovered from disconnection, all CH□ disconnection detection flags become "0: Normal", and the alarm code stored in the "A/D conversion latest alarm code" is cleared.
0B0□H	Deviation detection	Deviation is detected in the CH□.	When the deviation between the CH□ becomes less than the deviation value for deviation between CH detection, the deviation between CH detection flag automatically becomes "0: Normal".
0C0□H	Offset/gain reading input range mismatch	The saved offset/gain input range is different from the currently set input range.	Change the currently set input range to the input range selected when the offset/gain was written, and then read the offset/gain.
0E0□H	Range change alarm during offset/gain writing or offset/gain initialization	The range was changed during offset/gain writing or offset/gain initialization.	Wait until offset/gain writing or offset/gain initialization is finished, and then change the range.
0E1□H	Offset/gain initialization execution alarm	Offset/gain initialization was executed during offset/gain writing.	Wait until offset/gain writing is finished, and then initialize the offset/gain.
0E2□H	Offset/gain writing execution alarm	Offset/gain writing was executed during offset/gain initialization.	Wait until offset/gain initialization is finished, and then write the offset/gain.

Alarm code	Alarm name	Description and cause	Action
0E3□H	Analog ADP memory access alarm	Offset/gain writing, offset/gain reading or offset/gain initialization was executed while the analog ADP memory error (Error code: 3082H) was detected. Or offset reading was executed while the analog ADP memory error (Error code: 3083H) was detected.	Reset the CPU module.
0F0□H	Setting change alarm	Special relays/registers for analog are changed while conversion is enabled.	Change the setting of special relays/registers while conversion is disabled.

D/A conversion alarm code

□: This symbol indicates the number of the channel where an alarm has occurred. (3: CH3, 4: CH4)

Alarm code	Alarm name	Description and cause	Action
0000H	—	There is no error.	—
080□H	Warning output (upper limit)	Warning output alarm (upper limit) has occurred in the CH□.	When the CH□ digital operation value returns from the warning output range, the alarm code automatically changes to "0: Normal".
081□H	Warning output (lower limit)	Warning output alarm (lower limit) has occurred in the CH□.	
0C0□H	Offset gain reading output range mismatch	The saved offset/gain output range is different from the currently set output range.	Change the currently set output range to the output range selected when the offset/gain was written, and then read the offset/gain.
0E0□H	Range change alarm during offset/gain writing or offset/gain initialization	The range was changed during offset/gain writing or offset/gain initialization.	Wait until offset/gain writing or offset/gain initialization is finished, and then change the range.
0E1□H	Offset/gain initialization execution alarm	Offset/gain initialization was executed during offset/gain writing.	Wait until offset/gain writing is finished, and then initialize the offset/gain.
0E2□H	Offset/gain writing execution alarm	Offset/gain writing was executed during offset/gain initialization.	Wait until offset/gain initialization is finished, and then write the offset/gain.
0E3□H	Analog ADP memory access alarm	Offset/gain writing, offset/gain reading or offset/gain initialization was executed while the analog ADP memory error (Error code: 3082H) was detected. Or offset reading was executed while the analog ADP memory error (Error code: 3083H) was detected.	Reset the CPU module.
0F0□H	Setting change alarm	Special relays/registers for analog are changed while conversion is enabled.	Change the setting of special relays/registers while conversion is disabled.

6.13 List of A/D Conversion Special Relays

The A/D conversion special relays are shown below.

1st analog expansion adapter

The special relays list for the 1st FX5-4A-ADP module is shown below.

Special relays		Name	Reference
CH1	CH2		
SM6300	SM6340	A/D conversion completed flag	Page 366
SM6301	SM6341	A/D conversion enable/disable setting	Page 366
SM6302	SM6342	Over scale upper limit detection flag	Page 366
SM6303	SM6343	Over scale lower limit detection flag	Page 367
SM6304	SM6344	Over scale detection enable/disable setting	Page 367
SM6305	SM6345	Maximum value/minimum value reset completed flag	Page 367
SM6306	SM6346	Maximum value reset request	Page 368
SM6307	SM6347	Minimum value reset request	Page 368
SM6308	SM6348	Scaling enable/disable setting	Page 368
SM6309	SM6349	Digital clipping enable/disable setting	Page 369
SM6311	SM6351	Warning output flag (process alarm upper limit)	Page 369
SM6312	SM6352	Warning output flag (process alarm lower limit)	Page 369
SM6313	SM6353	Warning output setting (process alarm)	Page 370
SM6315	SM6355	Warning output flag (rate alarm upper)	Page 370
SM6316	SM6356	Warning output flag (rate alarm lower)	Page 370
SM6317	SM6357	Warning output setting (rate alarm)	Page 371
SM6318	SM6358	Disconnection detection flag	Page 371
SM6319	SM6359	Disconnection detection enable/disable setting	Page 371
SM6320	SM6360	Disconnection recovery detection enable/disable setting	Page 372
SM6321	SM6361	Convergence detection flag	Page 372
SM6322	SM6362	Convergence detection enable/disable setting	Page 372
SM6325	SM6365	Deviation detection flag between channel	Page 373
SM6326	SM6366	Deviation detection trigger between channel	Page 373
SM6332	SM6372	Offset/gain reading	Page 373
SM6333	SM6373	Offset/gain writing	Page 374
SM6334	SM6374	Offset/gain initialization	Page 374
SM6337	SM6377	A/D conversion alarm clear request	Page 374
SM6338	SM6378	A/D conversion alarm flag	Page 375
SM6339	SM6379	A/D conversion error flag	Page 375

2nd analog expansion adapter

The special relays list for the 2nd FX5-4A-ADP module is shown below.

Special relays		Name	Reference
CH1	CH2		
SM6660	SM6700	A/D conversion completed flag	Page 366
SM6661	SM6701	A/D conversion enable/disable setting	Page 366
SM6662	SM6702	Over scale upper limit detection flag	Page 366
SM6663	SM6703	Over scale lower limit detection flag	Page 367
SM6664	SM6704	Over scale detection enable/disable setting	Page 367
SM6665	SM6705	Maximum value/minimum value reset completed flag	Page 367
SM6666	SM6706	Maximum value reset request	Page 368
SM6667	SM6707	Minimum value reset request	Page 368
SM6668	SM6708	Scaling enable/disable setting	Page 368
SM6669	SM6709	Digital clipping enable/disable setting	Page 369
SM6671	SM6711	Warning output flag (process alarm upper limit)	Page 369
SM6672	SM6712	Warning output flag (process alarm lower limit)	Page 369
SM6673	SM6713	Warning output setting (process alarm)	Page 370
SM6675	SM6715	Warning output flag (rate alarm upper)	Page 370
SM6676	SM6716	Warning output flag (rate alarm lower)	Page 370
SM6677	SM6717	Warning output setting (rate alarm)	Page 371
SM6678	SM6718	Disconnection detection flag	Page 371
SM6679	SM6719	Disconnection detection enable/disable setting	Page 371
SM6680	SM6720	Disconnection recovery detection enable/disable setting	Page 372
SM6681	SM6721	Convergence detection flag	Page 372
SM6682	SM6722	Convergence detection enable/disable setting	Page 372
SM6685	SM6725	Deviation detection flag between channel	Page 373
SM6686	SM6726	Deviation detection trigger between channel	Page 373
SM6692	SM6732	Offset/gain reading	Page 373
SM6693	SM6733	Offset/gain writing	Page 374
SM6694	SM6734	Offset/gain initialization	Page 374
SM6697	SM6737	A/D conversion alarm clear request	Page 374
SM6698	SM6738	A/D conversion alarm flag	Page 375
SM6699	SM6739	A/D conversion error flag	Page 375

3rd analog expansion adapter

The special relays list for the 3rd FX5-4A-ADP module is shown below.

Special relays		Name	Reference
CH1	CH2		
SM7020	SM7060	A/D conversion completed flag	Page 366
SM7021	SM7061	A/D conversion enable/disable setting	Page 366
SM7022	SM7062	Over scale upper limit detection flag	Page 366
SM7023	SM7063	Over scale lower limit detection flag	Page 367
SM7024	SM7064	Over scale detection enable/disable setting	Page 367
SM7025	SM7065	Maximum value/minimum value reset completed flag	Page 367
SM7026	SM7066	Maximum value reset request	Page 368
SM7027	SM7067	Minimum value reset request	Page 368
SM7028	SM7068	Scaling enable/disable setting	Page 368
SM7029	SM7069	Digital clipping enable/disable setting	Page 369
SM7031	SM7071	Warning output flag (process alarm upper limit)	Page 369
SM7032	SM7072	Warning output flag (process alarm lower limit)	Page 369
SM7033	SM7073	Warning output setting (process alarm)	Page 370
SM7035	SM7075	Warning output flag (rate alarm upper)	Page 370
SM7036	SM7076	Warning output flag (rate alarm lower)	Page 370
SM7037	SM7077	Warning output setting (rate alarm)	Page 371
SM7038	SM7078	Disconnection detection flag	Page 371
SM7039	SM7079	Disconnection detection enable/disable setting	Page 371
SM7040	SM7080	Disconnection recovery detection enable/disable setting	Page 372
SM7041	SM7081	Convergence detection flag	Page 372
SM7042	SM7082	Convergence detection enable/disable setting	Page 372
SM7045	SM7085	Deviation detection flag between channel	Page 373
SM7046	SM7086	Deviation detection trigger between channel	Page 373
SM7052	SM7092	Offset/gain reading	Page 373
SM7053	SM7093	Offset/gain writing	Page 374
SM7054	SM7094	Offset/gain initialization	Page 374
SM7057	SM7097	A/D conversion alarm clear request	Page 374
SM7058	SM7098	A/D conversion alarm flag	Page 375
SM7059	SM7099	A/D conversion error flag	Page 375

4th analog expansion adapter

The special relays list for the 4th FX5-4A-ADP module is shown below.

Special relays		Name	Reference
CH1	CH2		
SM7380	SM7420	A/D conversion completed flag	Page 366
SM7381	SM7421	A/D conversion enable/disable setting	Page 366
SM7382	SM7422	Over scale upper limit detection flag	Page 366
SM7383	SM7423	Over scale lower limit detection flag	Page 367
SM7384	SM7424	Over scale detection enable/disable setting	Page 367
SM7385	SM7425	Maximum value/minimum value reset completed flag	Page 367
SM7386	SM7426	Maximum value reset request	Page 368
SM7387	SM7427	Minimum value reset request	Page 368
SM7388	SM7428	Scaling enable/disable setting	Page 368
SM7389	SM7429	Digital clipping enable/disable setting	Page 369
SM7391	SM7431	Warning output flag (process alarm upper limit)	Page 369
SM7392	SM7432	Warning output flag (process alarm lower limit)	Page 369
SM7393	SM7433	Warning output setting (process alarm)	Page 370
SM7395	SM7435	Warning output flag (rate alarm upper)	Page 370
SM7396	SM7436	Warning output flag (rate alarm lower)	Page 370
SM7397	SM7437	Warning output setting (rate alarm)	Page 371
SM7398	SM7438	Disconnection detection flag	Page 371
SM7399	SM7439	Disconnection detection enable/disable setting	Page 371
SM7400	SM7440	Disconnection recovery detection enable/disable setting	Page 372
SM7401	SM7441	Convergence detection flag	Page 372
SM7402	SM7442	Convergence detection enable/disable setting	Page 372
SM7405	SM7445	Deviation detection flag between channel	Page 373
SM7406	SM7446	Deviation detection trigger between channel	Page 373
SM7412	SM7452	Offset/gain reading	Page 373
SM7413	SM7453	Offset/gain writing	Page 374
SM7414	SM7454	Offset/gain initialization	Page 374
SM7417	SM7457	A/D conversion alarm clear request	Page 374
SM7418	SM7458	A/D conversion alarm flag	Page 375
SM7419	SM7459	A/D conversion error flag	Page 375

6.14 Detail of A/D Conversion Special Relays

This section explains the details of special relays. Only the FX5U/FX5UC CPU module supports the special relays of the third and fourth modules.

R: Read only, R/W: Read/Write

A/D conversion completed flag

This flag monitors the A/D conversion status.

Monitor value	Display description	Default value	R/W
0: OFF	It turns OFF during the disable of an A/D conversion, and an A/D conversion.	0: OFF	R
1: ON	In the state of A/D conversion enable, if an A/D conversion is completed, it turns ON.		



The "A/D conversion completion flag" turns OFF when an error occurs.

Name	Connection part	Special relay	
		CH1	CH2
A/D conversion completed flag	1st adapter	SM6300	SM6340
	2nd adapter	SM6660	SM6700
	3rd adapter	SM7020	SM7060
	4th adapter	SM7380	SM7420

A/D conversion enable/disable setting

Set whether to enable or disable A/D conversion.

Setting value	Setting description	Default value	R/W
0: OFF	A/D conversion enable	1: ON	R/W
1: ON	A/D conversion disable		

For details A/D conversion enable/disable setting function, refer to the following.

Page 294 A/D Conversion Enable/Disable Setting Function

Name	Connection part	Special relay	
		CH1	CH2
A/D conversion enable/disable setting	1st adapter	SM6301	SM6341
	2nd adapter	SM6661	SM6701
	3rd adapter	SM7021	SM7061
	4th adapter	SM7381	SM7421

Over scale upper limit detection flag

This flag monitors the over-scale upper limit detection status in the over-scale detection function.

Monitor value	Display description	Default value	R/W
0: OFF	Normal	0: OFF	R
1: ON	Over scale upper limit detection		

For details over scale detection function, refer to the following.

Page 297 Over Scale Detection Function

Name	Connection part	Special relay	
		CH1	CH2
Over scale upper limit detection flag	1st adapter	SM6302	SM6342
	2nd adapter	SM6662	SM6702
	3rd adapter	SM7022	SM7062
	4th adapter	SM7382	SM7422

Over scale lower limit detection flag

This flag monitors the over-scale lower limit detection status in the over-scale detection function.

Monitor value	Display description	Default value	R/W
0: OFF	Normal	0: OFF	R
1: ON	Over scale lower limit detection		

For details over scale detection function, refer to the following.

☞ Page 297 Over Scale Detection Function

Name	Connection part	Special relay	
		CH1	CH2
Over scale lower limit detection flag	1st adapter	SM6303	SM6343
	2nd adapter	SM6663	SM6703
	3rd adapter	SM7023	SM7063
	4th adapter	SM7383	SM7423

Over scale detection enable/disable setting

Set whether to enable or disable over scale detection.

Setting value	Setting description	Default value	R/W
0: OFF	Over scale detection enable	1: ON	R/W
1: ON	Over scale detection disable		

For details over scale detection function, refer to the following.

☞ Page 297 Over Scale Detection Function

Name	Connection part	Special relay	
		CH1	CH2
Over scale detection enable/disable setting	1st adapter	SM6304	SM6344
	2nd adapter	SM6664	SM6704
	3rd adapter	SM7024	SM7064
	4th adapter	SM7384	SM7424

Maximum value/minimum value reset completed flag

This flag monitors the "maximum value/minimum value" reset status.

When the "maximum value reset request" or "minimum value reset request" is set from OFF to ON and then the value stored in the "maximum value" or "minimum value" is reset, the "maximum value/minimum value reset completion flag" turns ON.

Monitor value	Display description	Default value	R/W
0: OFF	Reset is not completed	0: OFF	R
1: ON	Reset is completed		

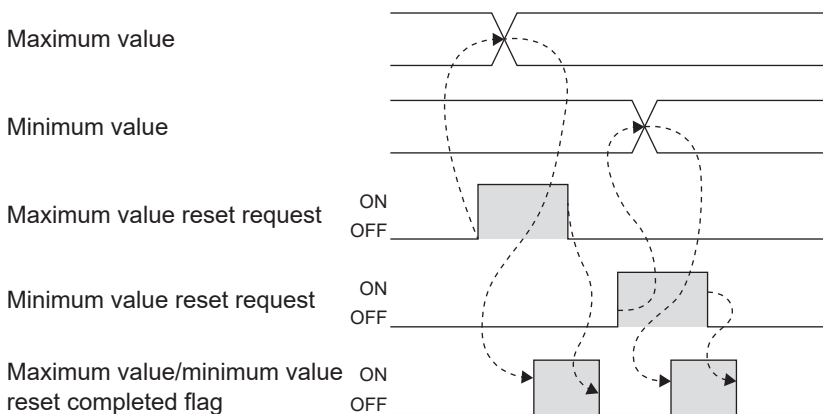

Name	Connection part	Special relay	
		CH1	CH2
Maximum value/minimum value reset completed flag	1st adapter	SM6305	SM6345
	2nd adapter	SM6665	SM6705
	3rd adapter	SM7025	SM7065
	4th adapter	SM7385	SM7425

Maximum value reset request

When the "maximum value reset request" is set from OFF to ON, the maximum value is updated to the "digital operation value".

Setting value	Setting description	Default value	R/W
0: OFF	No maximum value reset request	0: OFF	R/W
1: ON	Maximum value reset request		

For the timing of turning the signal on and off, refer to the following.

 Page 367 Maximum value/minimum value reset completed flag

Name	Connection part	Special relay	
		CH1	CH2
Maximum value reset request	1st adapter	SM6306	SM6346
	2nd adapter	SM6666	SM6706
	3rd adapter	SM7026	SM7066
	4th adapter	SM7386	SM7426

Minimum value reset request

When the "minimum value reset request" is set from OFF to ON, the minimum value is updated to the "digital operation value".

Setting value	Setting description	Default value	R/W
0: OFF	No minimum value reset request	0: OFF	R/W
1: ON	Maximum value reset request		

For the timing of turning the signal on and off, refer to the following.

 Page 367 Maximum value/minimum value reset completed flag

Name	Connection part	Special relay	
		CH1	CH2
Minimum value reset request	1st adapter	SM6307	SM6347
	2nd adapter	SM6667	SM6707
	3rd adapter	SM7027	SM7067
	4th adapter	SM7387	SM7427

Scaling enable/disable setting

Set whether to enable or disable the scaling function.

Setting value	Setting description	Default value	R/W
0: OFF	Scaling function enable	1: ON	R/W
1: ON	Scaling function disable		

For details scaling function, refer to the following.

 Page 299 Scaling Function

Name	Connection part	Special relay	
		CH1	CH2
Scaling enable/disable setting	1st adapter	SM6308	SM6348
	2nd adapter	SM6668	SM6708
	3rd adapter	SM7028	SM7068
	4th adapter	SM7388	SM7428

Digital clipping enable/disable setting

Set whether to enable or disable the digital clipping function.

Setting value	Setting description	Default value	R/W
0: OFF	Digital clipping function enable	1: ON	R/W
1: ON	Digital clipping function disable		

For details digital clipping, refer to the following.

 Page 303 Digital Clipping Function

Name	Connection part	Special relay	
		CH1	CH2
Digital clipping enable/disable setting	1st adapter	SM6309	SM6349
	2nd adapter	SM6669	SM6709
	3rd adapter	SM7029	SM7069
	4th adapter	SM7389	SM7429

Warning output flag (process alarm upper limit)

This flag monitors the upper limit value warning in the process alarm.

Monitor value	Display description	Default value	R/W
0: OFF	Normal	0: OFF	R
1: ON	Process alarm upper limit detection		

For details warning output function, refer to the following.

 Page 305 Process alarm

Name	Connection part	Special relay	
		CH1	CH2
Warning output flag (process alarm upper limit)	1st adapter	SM6311	SM6351
	2nd adapter	SM6671	SM6711
	3rd adapter	SM7031	SM7071
	4th adapter	SM7391	SM7431

Warning output flag (process alarm lower limit)

This flag monitors the lower limit value warning in the process alarm.

Monitor value	Display description	Default value	R/W
0: OFF	Normal	0: OFF	R
1: ON	Process alarm lower limit detection		

For details warning output function, refer to the following.

 Page 305 Process alarm

Name	Connection part	Special relay	
		CH1	CH2
Warning output flag (process alarm lower limit)	1st adapter	SM6312	SM6352
	2nd adapter	SM6672	SM6712
	3rd adapter	SM7032	SM7072
	4th adapter	SM7392	SM7432

Warning output setting (process alarm)

Set whether to enable or disable the warning output of process alarm.

Setting value	Setting description	Default value	R/W
0: OFF	Warning output of process alarm enable	1: ON	R/W
1: ON	Warning output of process alarm disable		

For details warning output function, refer to the following.

☞ Page 305 Process alarm

Name	Connection part	Special relay	
		CH1	CH2
Warning output setting (process alarm)	1st adapter	SM6313	SM6353
	2nd adapter	SM6673	SM6713
	3rd adapter	SM7033	SM7073
	4th adapter	SM7393	SM7433

Warning output flag (rate alarm upper)

This flag monitors the upper limit value warning in the rate alarm.

Monitor value	Display description	Default value	R/W
0: OFF	Normal	0: OFF	R
1: ON	Rate alarm upper limit detection		

For details warning output function, refer to the following.

☞ Page 307 Rate alarm

Name	Connection part	Special relay	
		CH1	CH2
Warning output flag (rate alarm upper)	1st adapter	SM6315	SM6355
	2nd adapter	SM6675	SM6715
	3rd adapter	SM7035	SM7075
	4th adapter	SM7395	SM7435

Warning output flag (rate alarm lower)

This flag monitors the lower limit value warning in the rate alarm.

Monitor value	Display description	Default value	R/W
0: OFF	Normal	0: OFF	R
1: ON	Rate alarm lower limit detection		

For details warning output function, refer to the following.

☞ Page 307 Rate alarm

Name	Connection part	Special relay	
		CH1	CH2
Warning output flag (rate alarm lower)	1st adapter	SM6316	SM6356
	2nd adapter	SM6676	SM6716
	3rd adapter	SM7036	SM7076
	4th adapter	SM7396	SM7436

Warning output setting (rate alarm)

Set whether to enable or disable the warning output of rate alarm.

Setting value	Setting description	Default value	R/W
0: OFF	Warning output of rate alarm enable	1: ON	R/W
1: ON	Warning output of rate alarm disable		

For details warning output function, refer to the following.

☞ Page 307 Rate alarm

Name	Connection part	Special relay	
		CH1	CH2
Warning output setting (rate alarm)	1st adapter	SM6317	SM6357
	2nd adapter	SM6677	SM6717
	3rd adapter	SM7037	SM7077
	4th adapter	SM7397	SM7437

Disconnection detection flag

This flag monitors the disconnection detection.

Monitor value	Display description	Default value	R/W
0: OFF	Normal	0: OFF	R
1: ON	Disconnection detection		

For details disconnection detection function, refer to the following.

☞ Page 310 Disconnection Detection Function

Name	Connection part	Special relay	
		CH1	CH2
Disconnection detection flag	1st adapter	SM6318	SM6358
	2nd adapter	SM6678	SM6718
	3rd adapter	SM7038	SM7078
	4th adapter	SM7398	SM7438

Disconnection detection enable/disable setting

Set whether to enable or disable the disconnection detection function.

Setting value	Setting description	Default value	R/W
0: OFF	Disconnection detection enable	1: ON	R/W
1: ON	Disconnection detection disable		

For details disconnection detection function, refer to the following.

☞ Page 310 Disconnection Detection Function

Name	Connection part	Special relay	
		CH1	CH2
Disconnection detection enable/disable setting	1st adapter	SM6319	SM6359
	2nd adapter	SM6679	SM6719
	3rd adapter	SM7039	SM7079
	4th adapter	SM7399	SM7439

Disconnection recovery detection enable/disable setting

Set whether to enable or disable the disconnection detection recovery.

Setting value	Setting description	Default value	R/W
0: OFF	Disconnection recovery detection enable	1: ON	R/W
1: ON	Disconnection recovery detection disable		

For details disconnection detection function, refer to the following.

 Page 310 Disconnection Detection Function

Name	Connection part	Special relay	
		CH1	CH2
Disconnection recovery detection enable/disable setting	1st adapter	SM6320	SM6360
	2nd adapter	SM6680	SM6720
	3rd adapter	SM7040	SM7080
	4th adapter	SM7400	SM7440

Convergence detection flag

This flag monitors the convergence detection.

Monitor value	Display description	Default value	R/W
0: OFF	Normal	0: OFF	R
1: ON	Convergence detection		

For details convergence detection function, refer to the following.

 Page 312 Convergence Detection Function

Name	Connection part	Special relay	
		CH1	CH2
Convergence detection flag	1st adapter	SM6321	SM6361
	2nd adapter	SM6681	SM6721
	3rd adapter	SM7041	SM7081
	4th adapter	SM7401	SM7441

Convergence detection enable/disable setting

Set whether to enable or disable the convergence detection.

Setting value	Setting description	Default value	R/W
0: OFF	Convergence detection enable	1: ON	R/W
1: ON	Convergence detection disable		

For details convergence detection function, refer to the following.

 Page 312 Convergence Detection Function

Name	Connection part	Special relay	
		CH1	CH2
Convergence detection enable/disable setting	1st adapter	SM6322	SM6362
	2nd adapter	SM6682	SM6722
	3rd adapter	SM7042	SM7082
	4th adapter	SM7402	SM7442

Deviation detection flag between channel

This flag monitors the deviation detection flag between channel.

Monitor value	Display description	Default value	R/W
0: OFF	Normal	0: OFF	R
1: ON	Deviation detection		

For details deviation detection between channel function, refer to the following.

 Page 313 Deviation Detection Between Channel Function

Name	Connection part	Special relay	
		CH1	CH2
Deviation detection flag between channel	1st adapter	SM6325	SM6365
	2nd adapter	SM6685	SM6725
	3rd adapter	SM7045	SM7085
	4th adapter	SM7405	SM7445

Deviation detection trigger between channel

Set whether to enable or disable the deviation detection flag between channel.

Setting value	Setting description	Default value	R/W
0: OFF	Deviation detection enable	1: ON	R/W
1: ON	Deviation detection disable		

For details deviation detection between channel function, refer to the following.

 Page 313 Deviation Detection Between Channel Function

Name	Connection part	Special relay	
		CH1	CH2
Deviation detection trigger between channel	1st adapter	SM6326	SM6366
	2nd adapter	SM6686	SM6726
	3rd adapter	SM7046	SM7086
	4th adapter	SM7406	SM7446

Offset/gain reading

An offset/gain setting value is read.

Setting value	Setting description	Default value	R/W
0: OFF	Offset/gain reading is not performed.	0: OFF	R/W
1: ON	Offset/gain reading is performed.		

For details offset/gain setting, refer to the following.

 Page 314 Offset/gain Setting Function

Name	Connection part	Special relay	
		CH1	CH2
Offset/gain reading	1st adapter	SM6332	SM6372
	2nd adapter	SM6692	SM6732
	3rd adapter	SM7052	SM7092
	4th adapter	SM7412	SM7452

Offset/gain writing

An offset/gain setting value is written in.

Setting value	Setting description	Default value	R/W
0: OFF	Offset/gain writing is not performed.	0: OFF	R/W
1: ON	Offset/gain writing is performed.		

For details offset/gain setting, refer to the following.

 Page 314 Offset/gain Setting Function

Name	Connection part	Special relay	
		CH1	CH2
Offset/gain writing	1st adapter	SM6333	SM6373
	2nd adapter	SM6693	SM6733
	3rd adapter	SM7053	SM7093
	4th adapter	SM7413	SM7453

Offset/gain initialization

An offset/gain setting value is initialized.

Setting value	Setting description	Default value	R/W
0: OFF	Offset/gain initialization is not performed.	0: OFF	R/W
1: ON	Offset/gain initialization is performed.		

For details offset/gain initialization, refer to the following.

 Page 319 Offset/gain Initialization Function

Name	Connection part	Special relay	
		CH1	CH2
Offset/gain initialization	1st adapter	SM6334	SM6374
	2nd adapter	SM6694	SM6734
	3rd adapter	SM7054	SM7094
	4th adapter	SM7414	SM7454

A/D conversion alarm clear request

An A/D conversion alarm clear request is performed.

Setting value	Setting description	Default value	R/W
0: OFF	With no A/D conversion alarm clear request.	0: OFF	R/W
1: ON	Those with an A/D conversion alarm clear request.		

For details A/D conversion alarm clear request, refer to the following.

 Page 340 A/D conversion function

Name	Connection part	Special relay	
		CH1	CH2
A/D conversion alarm clear request	1st adapter	SM6337	SM6377
	2nd adapter	SM6697	SM6737
	3rd adapter	SM7057	SM7097
	4th adapter	SM7417	SM7457

A/D conversion alarm flag

"A/D conversion alarm flag" turns on when an alarm occurs.

Monitor value	Display description	Default value	R/W
0: OFF	Normal	0: OFF	R
1: ON	A/D conversion alarm occur		

To turn OFF the "A/D conversion alarm flag" and clear the "A/D conversion latest alarm code", set the "A/D conversion alarm clear request" from OFF to ON.

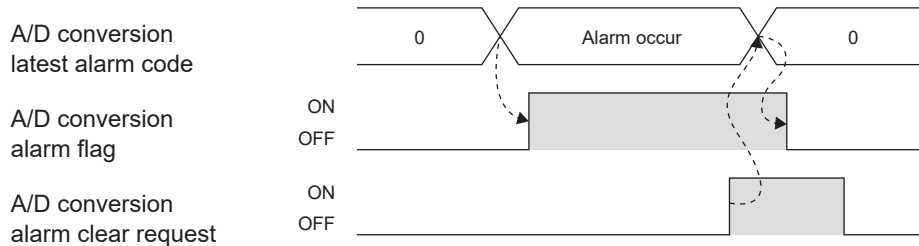

Name	Connection part	Special relay	
		CH1	CH2
A/D conversion alarm flag	1st adapter	SM6338	SM6378
	2nd adapter	SM6698	SM6738
	3rd adapter	SM7058	SM7098
	4th adapter	SM7418	SM7458

A/D conversion error flag

"A/D conversion error flag" turns on when an error occurs.

Monitor value	Display description	Default value	R/W
0: OFF	Normal	0: OFF	R
1: ON	A/D conversion error occur		

To turn OFF the "A/D conversion error flag" and clear the "A/D conversion latest error code", set the "error clear request" (SM50) of the CPU module from OFF to ON.

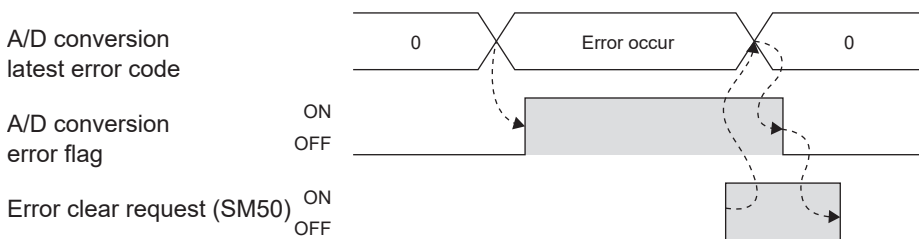

Name	Connection part	Special relay	
		CH1	CH2
A/D conversion error flag	1st adapter	SM6339	SM6379
	2nd adapter	SM6699	SM6739
	3rd adapter	SM7059	SM7099
	4th adapter	SM7419	SM7459

6.15 List of A/D Conversion Special Registers

The A/D conversion special registers are shown below.

1st analog expansion adapter

The special registers list for the 1st FX5-4A-ADP module is shown below.

Special registers		Name	Reference
CH1	CH2		
SD6280		Module Information	Page 380
SD6300	SD6340	Digital output value	Page 380
SD6301	SD6341	Digital operation value	Page 380
SD6302	SD6342	Analog input value monitor	Page 381
SD6303	SD6343	Average processing specify	Page 381
SD6304	SD6344	Time Average/Count Average/Moving Average setting	Page 382
SD6305	SD6345	Input range setting	Page 382
SD6306	SD6346	Maximum value	Page 383
SD6307	SD6347	Minimum value	Page 383
SD6308	SD6348	Scaling upper limit value	Page 383
SD6309	SD6349	Scaling lower limit value	Page 384
SD6310	SD6350	Conversion value shift amount	Page 384
SD6311	SD6351	Process alarm upper upper limit value	Page 384
SD6312	SD6352	Process alarm upper lower limit value	Page 385
SD6313	SD6353	Process alarm lower upper limit value	Page 385
SD6314	SD6354	Process alarm lower lower limit value	Page 386
SD6315	SD6355	Rate alarm upper limit value	Page 386
SD6316	SD6356	Rate alarm lower limit value	Page 387
SD6317	SD6357	Rate alarm warning detection period setting	Page 387
SD6322	SD6362	Convergence detection upper limit value	Page 388
SD6323	SD6363	Convergence detection lower limit value	Page 388
SD6324	SD6364	Detection time setting for convergence detection	Page 389
SD6325	SD6365	Deviation detection CH1	Page 389
SD6326	SD6366	Deviation detection CH2	Page 390
SD6327	SD6367	Deviation value for deviation detection between channel	Page 390
SD6328	SD6368	CH setting 1 for deviation detection between channel	Page 391
SD6329	SD6369	CH setting 2 for deviation detection between channel	Page 391
SD6332	SD6372	Offset setting value	Page 392
SD6333	SD6373	Gain setting value	Page 392
SD6334	SD6374	Offset/gain writing enable code	Page 392
SD6338	SD6378	A/D conversion latest alarm code	Page 393
SD6339	SD6379	A/D conversion latest error code	Page 393

2nd analog expansion adapter

The special registers list for the 2nd FX5-4A-ADP module is shown below.

Special registers		Name	Reference
CH1	CH2		
SD6640		Module Information	Page 380
SD6660	SD6700	Digital output value	Page 380
SD6661	SD6701	Digital operation value	Page 380
SD6662	SD6702	Analog input value monitor	Page 381
SD6663	SD6703	Average processing specify	Page 381
SD6664	SD6704	Time Average/Count Average/Moving Average setting	Page 382
SD6665	SD6705	Input range setting	Page 382
SD6666	SD6706	Maximum value	Page 383
SD6667	SD6707	Minimum value	Page 383
SD6668	SD6708	Scaling upper limit value	Page 383
SD6669	SD6709	Scaling lower limit value	Page 384
SD6670	SD6710	Conversion value shift amount	Page 384
SD6671	SD6711	Process alarm upper upper limit value	Page 384
SD6672	SD6712	Process alarm upper lower limit value	Page 385
SD6673	SD6713	Process alarm lower upper limit value	Page 385
SD6674	SD6714	Process alarm lower lower limit value	Page 386
SD6675	SD6715	Rate alarm upper limit value	Page 386
SD6676	SD6716	Rate alarm lower limit value	Page 387
SD6677	SD6717	Rate alarm warning detection period setting	Page 387
SD6682	SD6722	Convergence detection upper limit value	Page 388
SD6683	SD6723	Convergence detection lower limit value	Page 388
SD6684	SD6724	Detection time setting for convergence detection	Page 389
SD6685	SD6725	Deviation detection CH1	Page 389
SD6686	SD6726	Deviation detection CH2	Page 390
SD6687	SD6727	Deviation value for deviation detection between channel	Page 390
SD6688	SD6728	CH setting 1 for deviation detection between channel	Page 391
SD6689	SD6729	CH setting 2 for deviation detection between channel	Page 391
SD6692	SD6732	Offset setting value	Page 392
SD6693	SD6733	Gain setting value	Page 392
SD6694	SD6734	Offset/gain writing enable code	Page 392
SD6698	SD6738	A/D conversion latest alarm code	Page 393
SD6699	SD6739	A/D conversion latest error code	Page 393

3rd analog expansion adapter

The special registers list for the 3rd FX5-4A-ADP module is shown below.

Special registers		Name	Reference
CH1	CH2		
SD7000		Module Information	Page 380
SD7020	SD7060	Digital output value	Page 380
SD7021	SD7061	Digital operation value	Page 380
SD7022	SD7062	Analog input value monitor	Page 381
SD7023	SD7063	Average processing specify	Page 381
SD7024	SD7064	Time Average/Count Average/Moving Average setting	Page 382
SD7025	SD7065	Input range setting	Page 382
SD7026	SD7066	Maximum value	Page 383
SD7027	SD7067	Minimum value	Page 383
SD7028	SD7068	Scaling upper limit value	Page 383
SD7029	SD7069	Scaling lower limit value	Page 384
SD7030	SD7070	Conversion value shift amount	Page 384
SD7031	SD7071	Process alarm upper upper limit value	Page 384
SD7032	SD7072	Process alarm upper lower limit value	Page 385
SD7033	SD7073	Process alarm lower upper limit value	Page 385
SD7034	SD7074	Process alarm lower lower limit value	Page 386
SD7035	SD7075	Rate alarm upper limit value	Page 386
SD7036	SD7076	Rate alarm lower limit value	Page 387
SD7037	SD7077	Rate alarm warning detection period setting	Page 387
SD7042	SD7082	Convergence detection upper limit value	Page 388
SD7043	SD7083	Convergence detection lower limit value	Page 388
SD7044	SD7084	Detection time setting for convergence detection	Page 389
SD7045	SD7085	Deviation detection CH1	Page 389
SD7046	SD7086	Deviation detection CH2	Page 390
SD7047	SD7087	Deviation value for deviation detection between channel	Page 390
SD7048	SD7088	CH setting 1 for deviation detection between channel	Page 391
SD7049	SD7089	CH setting 2 for deviation detection between channel	Page 391
SD7052	SD7092	Offset setting value	Page 392
SD7053	SD7093	Gain setting value	Page 392
SD7054	SD7094	Offset/gain writing enable code	Page 392
SD7058	SD7098	A/D conversion latest alarm code	Page 393
SD7059	SD7099	A/D conversion latest error code	Page 393

4th analog expansion adapter

The special registers list for the 4th FX5-4A-ADP module is shown below.

Special registers		Name	Reference
CH1	CH2		
SD7360		Module Information	Page 380
SD7380	SD7420	Digital output value	Page 380
SD7381	SD7421	Digital operation value	Page 380
SD7382	SD7422	Analog input value monitor	Page 381
SD7383	SD7423	Average processing specify	Page 381
SD7384	SD7424	Time Average/Count Average/Moving Average setting	Page 382
SD7385	SD7425	Input range setting	Page 382
SD7386	SD7426	Maximum value	Page 383
SD7387	SD7427	Minimum value	Page 383
SD7388	SD7428	Scaling upper limit value	Page 383
SD7389	SD7429	Scaling lower limit value	Page 384
SD7390	SD7430	Conversion value shift amount	Page 384
SD7391	SD7431	Process alarm upper upper limit value	Page 384
SD7392	SD7432	Process alarm upper lower limit value	Page 385
SD7393	SD7433	Process alarm lower upper limit value	Page 385
SD7394	SD7434	Process alarm lower lower limit value	Page 386
SD7395	SD7435	Rate alarm upper limit value	Page 386
SD7396	SD7436	Rate alarm lower limit value	Page 387
SD7397	SD7437	Rate alarm warning detection period setting	Page 387
SD7402	SD7442	Convergence detection upper limit value	Page 388
SD7403	SD7443	Convergence detection lower limit value	Page 388
SD7404	SD7444	Detection time setting for convergence detection	Page 389
SD7405	SD7445	Deviation detection CH1	Page 389
SD7406	SD7446	Deviation detection CH2	Page 390
SD7407	SD7447	Deviation value for deviation detection between channel	Page 390
SD7408	SD7448	CH setting 1 for deviation detection between channel	Page 391
SD7409	SD7449	CH setting 2 for deviation detection between channel	Page 391
SD7412	SD7452	Offset setting value	Page 392
SD7413	SD7453	Gain setting value	Page 392
SD7414	SD7454	Offset/gain writing enable code	Page 392
SD7418	SD7458	A/D conversion latest alarm code	Page 393
SD7419	SD7459	A/D conversion latest error code	Page 393

6.16 Detail of A/D Conversion Special Registers

This section explains the details of special registers. Only the FX5U/FX5UC CPU module supports the third and fourth special register.

R: Read only, R/W: Read/Write

Module Information

Module information of FX5-4A-ADP is stored.

Stored value			R/W
6180H			R
Name	Connection part	Special register	
		CH1	CH2
Module Information	1st adapter	SD6280	
	2nd adapter	SD6640	
	3rd adapter	SD7000	
	4th adapter	SD7360	

Digital output value

The A/D-converted digital output value is stored.

Range	Default value	R/W
-8192 to +16383	0	R

Point

The value is updated in every averaging processing cycle when the averaging processing is executed, or in every sampling cycle when the averaging processing is not executed.

Name	Connection part	Special register	
		CH1	CH2
Digital output value	1st adapter	SD6300	SD6340
	2nd adapter	SD6660	SD6700
	3rd adapter	SD7020	SD7060
	4th adapter	SD7380	SD7420

Digital operation value

The digital operation value obtained by the scaling function, shift function and digital clipping function is stored.

Range	Default value	R/W
-32768 to +32767	0	R

Point

The value equivalent to the digital output value is stored when the scaling function, shift function and digital clipping function are not executed.

Name	Connection part	Special register	
		CH1	CH2
Digital operation value	1st adapter	SD6301	SD6341
	2nd adapter	SD6661	SD6701
	3rd adapter	SD7021	SD7061
	4th adapter	SD7381	SD7421

Analog input value monitor

The input analog value is stored.

Range	Default value	R/W
-20480 to +20479	0	R



The unit of the analog value is "mV" when the voltage is input, or "μA" when the current is input.

Name	Connection part	Special register	
		CH1	CH2
Analog input value monitor	1st adapter	SD6302	SD6342
	2nd adapter	SD6662	SD6702
	3rd adapter	SD7022	SD7062
	4th adapter	SD7382	SD7422

Average processing specify

Set which one between the sampling processing and the averaging processing is to be selected.

The averaging processing is classified into "time average", "count average" and "moving average".

Setting value	Description	Default value	R/W
0	Sampling processing	0	R/W
1	Time average		
2	Count average		
3	Moving average		



The averaging process specification setting range error (Error code: 1A0□H) occurs when any value other than the above values is set.

Name	Connection part	Special register	
		CH1	CH2
Average processing specify	1st adapter	SD6303	SD6343
	2nd adapter	SD6663	SD6703
	3rd adapter	SD7023	SD7063
	4th adapter	SD7383	SD7423

Time Average/Count Average/Moving Average setting

Set the average time, average counts and moving average counts in the averaging processing for each channel. The table below shows the available setting range.

Setting value	Description	Default value	R/W
1 to 10000 (ms)	Time average	0	R/W
4 to 32767 (times)	Count average		
2 to 64 (times)	Moving average		

Point

The average time setting range error (Error code: 1A1□H), average counts setting range error (Error code: 1A2□H) or moving average count setting range error (Error code: 1A3□H) occurs when any value other than the above values is set. In this case, the A/D conversion processing is executed using the setting set before the error occurs.

Name	Connection part	Special register	
		CH1	CH2
Time Average/Count Average/Moving Average setting	1st adapter	SD6304	SD6344
	2nd adapter	SD6664	SD6704
	3rd adapter	SD7024	SD7064
	4th adapter	SD7384	SD7424

Input range setting

Set the input range.

Setting value	Description	Default value	R/W
0	0 to 10 V	0	R/W
1	0 to 5 V		
2	1 to 5 V		
3	-10 to +10 V		
4	0 to 20 mA		
6	-20 to +20 mA		

Point

The range setting range error (Error code: 1A8□H) occurs when any value other than the above values is set.

Name	Connection part	Special register	
		CH1	CH2
Input range setting	1st adapter	SD6305	SD6345
	2nd adapter	SD6665	SD6705
	3rd adapter	SD7025	SD7065
	4th adapter	SD7385	SD7425

Maximum value

The maximum value of the digital operation value is stored. When the "maximum value reset request" is set from OFF to ON, the maximum value of the specified channel is updated to the "digital operation value".

Range	Default value	R/W
-32768 to +32767	0	R

For details maximum value/minimum value hold function, refer to the following.

 Page 304 Maximum Value/Minimum Value Hold Function

Name	Connection part	Special register	
		CH1	CH2
Maximum value	1st adapter	SD6306	SD6346
	2nd adapter	SD6666	SD6706
	3rd adapter	SD7026	SD7066
	4th adapter	SD7386	SD7426

Minimum value

The minimum value of the digital operation value is stored. When the "minimum value reset request" is set from OFF to ON, the minimum value of the specified channel is updated to the "digital operation value".

Range	Default value	R/W
-32768 to +32767	0	R

For details maximum value/minimum value hold function, refer to the following.

 Page 304 Maximum Value/Minimum Value Hold Function

Name	Connection part	Special register	
		CH1	CH2
Minimum value	1st adapter	SD6307	SD6347
	2nd adapter	SD6667	SD6707
	3rd adapter	SD7027	SD7067
	4th adapter	SD7387	SD7427

Scaling upper limit value

Set the upper limit value of the scaling conversion range.

Range	Default value	R/W
-32768 to +32767	0	R/W

For details scaling function, refer to the following.

 Page 299 Scaling Function

Name	Connection part	Special register	
		CH1	CH2
Scaling upper limit value	1st adapter	SD6308	SD6348
	2nd adapter	SD6668	SD6708
	3rd adapter	SD7028	SD7068
	4th adapter	SD7388	SD7428

Scaling lower limit value

Set the lower limit value of the scaling conversion range.

Range	Default value	R/W
-32768 to +32767	0	R/W

For details scaling function, refer to the following.

 Page 299 Scaling Function

Name	Connection part	Special register	
		CH1	CH2
Scaling lower limit value	1st adapter	SD6309	SD6349
	2nd adapter	SD6669	SD6709
	3rd adapter	SD7029	SD7069
	4th adapter	SD7389	SD7429

Conversion value shift amount

Set the "conversion value shift amount" used in the shift function.

The setting value is added to the "digital operation value".

Range	Default value	R/W
-32768 to +32767	0	R/W

For details shift function, refer to the following.

 Page 302 Shift Function

Name	Connection part	Special register	
		CH1	CH2
Conversion value shift amount	1st adapter	SD6310	SD6350
	2nd adapter	SD6670	SD6710
	3rd adapter	SD7030	SD7070
	4th adapter	SD7390	SD7430

Process alarm upper upper limit value

Set the upper upper limit value of the warning output function (process alarm).

Range	Default value	R/W
-32768 to +32767	0	R/W

Point

The process alarm upper-lower limit value setting range error (Error code: 1A4□H) occurs when the condition "Process alarm upper upper limit value \geq Process alarm upper lower limit value \geq Process alarm lower upper limit value \geq Process alarm lower lower limit value" is not satisfied.

For details warning output function, refer to the following.

 Page 305 Process alarm

Name	Connection part	Special register	
		CH1	CH2
Process alarm upper upper limit value	1st adapter	SD6311	SD6351
	2nd adapter	SD6671	SD6711
	3rd adapter	SD7031	SD7071
	4th adapter	SD7391	SD7431

Process alarm upper lower limit value

Set the upper lower limit value of the warning output function (process alarm).

Range	Default value	R/W
-32768 to +32767	0	R/W

Point

The process alarm upper-lower limit value setting range error (Error code: 1A4□H) occurs when the condition "Process alarm upper upper limit value \geq Process alarm upper lower limit value \geq Process alarm lower upper limit value \geq Process alarm lower lower limit value" is not satisfied.

For details warning output function, refer to the following.

 Page 305 Process alarm

Name	Connection part	Special register	
		CH1	CH2
Process alarm upper lower limit value	1st adapter	SD6312	SD6352
	2nd adapter	SD6672	SD6712
	3rd adapter	SD7032	SD7072
	4th adapter	SD7392	SD7432

6

Process alarm lower upper limit value

Set the lower upper limit value of the warning output function (process alarm).

Range	Default value	R/W
-32768 to +32767	0	R/W

Point

The process alarm upper-lower limit value setting range error (Error code: 1A4□H) occurs when the condition "Process alarm upper upper limit value \geq Process alarm upper lower limit value \geq Process alarm lower upper limit value \geq Process alarm lower lower limit value" is not satisfied.

For details warning output function, refer to the following.

 Page 305 Process alarm

Name	Connection part	Special register	
		CH1	CH2
Process alarm lower upper limit value	1st adapter	SD6313	SD6353
	2nd adapter	SD6673	SD6713
	3rd adapter	SD7033	SD7073
	4th adapter	SD7393	SD7433

Process alarm lower lower limit value

Set the lower lower limit value of the warning output function (process alarm).

Range	Default value	R/W
-32768 to +32767	0	R/W

Point

The process alarm upper-lower limit value setting range error (Error code: 1A4□H) occurs when the condition "Process alarm upper upper limit value \geq Process alarm upper lower limit value \geq Process alarm lower upper limit value \geq Process alarm lower lower limit value" is not satisfied.

For details warning output function, refer to the following.

 Page 305 Process alarm

Name	Connection part	Special register	
		CH1	CH2
Process alarm lower lower limit value	1st adapter	SD6314	SD6354
	2nd adapter	SD6674	SD6714
	3rd adapter	SD7034	SD7074
	4th adapter	SD7394	SD7434

Rate alarm upper limit value

Set the upper limit of the change rate of the digital output value for detecting rate alarms.

Range	Default value	R/W
-1000 to +1000	0	R/W

Point

- Set the rate alarm upper limit value in the unit "0.1 %".
- The rate alarm upper limit value/lower limit value setting inversion error (Error code: 1A5□H) occurs when the condition "Rate alarm upper limit value $>$ Rate alarm lower limit value" is not satisfied.

For details warning output function, refer to the following.

 Page 307 Rate alarm

Name	Connection part	Special register	
		CH1	CH2
Rate alarm upper limit value	1st adapter	SD6315	SD6355
	2nd adapter	SD6675	SD6715
	3rd adapter	SD7035	SD7075
	4th adapter	SD7395	SD7435

Rate alarm lower limit value

Set the lower limit of the change rate of the digital output value for detecting rate alarms.

Range	Default value	R/W
-1000 to +1000	0	R/W

Point

- Set the rate alarm lower limit value in the unit "0.1 %".
- The rate alarm upper limit value/lower limit value setting inversion error (Error code: 1A5□H) occurs when the condition "Rate alarm upper limit value > Rate alarm lower limit value" is not satisfied.

For details warning output function, refer to the following.

 Page 307 Rate alarm

Name	Connection part	Special register	
		CH1	CH2
Rate alarm lower limit value	1st adapter	SD6316	SD6356
	2nd adapter	SD6676	SD6716
	3rd adapter	SD7036	SD7076
	4th adapter	SD7396	SD7436

6

Rate alarm warning detection period setting

Set the cycle for checking the change rate of the digital output value.

The "rate alarm warning detection period setting" multiplied by the sampling cycle indicates the cycle for detecting rate alarms.

Range	Default value	R/W
1 to 10000 (ms)	1	R/W

Point

The rate alarm warning detection period setting range error (Error code: 1A6□H) occurs when any value other than the above values is set.

For details warning output function, refer to the following.

 Page 307 Rate alarm

Name	Connection part	Special register	
		CH1	CH2
Rate alarm warning detection period setting	1st adapter	SD6317	SD6357
	2nd adapter	SD6677	SD6717
	3rd adapter	SD7037	SD7077
	4th adapter	SD7397	SD7437

Convergence detection upper limit value

Set the upper limit of the digital output value used in the convergence detection function.

Range	Default value	R/W
-32768 to +32767	0	R/W

Point

The convergence detection upper limit value/lower limit value setting inversion error (Error code: 1AD□H) occurs when the condition "Convergence detection upper limit value > Convergence detection lower limit value" is not satisfied.

For details convergence detection function, refer to the following.

 Page 312 Convergence Detection Function

Name	Connection part	Special register	
		CH1	CH2
Convergence detection upper limit value	1st adapter	SD6322	SD6362
	2nd adapter	SD6682	SD6722
	3rd adapter	SD7042	SD7082
	4th adapter	SD7402	SD7442

Convergence detection lower limit value

Set the lower limit of the digital output value used in the convergence detection function.

Range	Default value	R/W
-32768 to +32767	0	R/W

Point

The convergence detection upper limit value/lower limit value setting inversion error (Error code: 1AD□H) occurs when the condition "Convergence detection upper limit value > Convergence detection lower limit value" is not satisfied.

For details convergence detection function, refer to the following.

 Page 312 Convergence Detection Function

Name	Connection part	Special register	
		CH1	CH2
Convergence detection lower limit value	1st adapter	SD6323	SD6363
	2nd adapter	SD6683	SD6723
	3rd adapter	SD7043	SD7083
	4th adapter	SD7403	SD7443

Detection time setting for convergence detection

Set the convergence detection time used in the convergence detection function.

Range	Default value	R/W
1 to 10000 (ms)	1	R/W

Point

- When a value outside the setting range is set, the convergence detection time setting range error occurs (Error code: 1AC□H).
- The setting value will be ignored when the convergence detection enable/disable setting is set to "disable".

For details convergence detection function, refer to the following.

☞ Page 312 Convergence Detection Function

Name	Connection part	Special register	
		CH1	CH2
Detection time setting for convergence detection	1st adapter	SD6324	SD6364
	2nd adapter	SD6684	SD6724
	3rd adapter	SD7044	SD7084
	4th adapter	SD7404	SD7444

Deviation detection CH1

Check the status of the deviation between CH detection flag in the 1st and 2nd FX5-4A-ADP, or FX5-4AD-ADP used in the deviation between CH detection function.

Monitor value	Display description	Default value	R/W
0: OFF	Normal	0: OFF	R
1: ON	Deviation detection		

■ When the deviation detection target is FX5-4A-ADP

■ When the deviation detection target is FX5-4AD-ADP

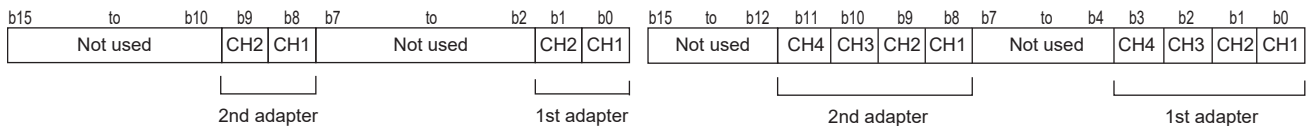

For details deviation detection between channel function, refer to the following.

☞ Page 313 Deviation Detection Between Channel Function

Name	Connection part	Special register	
		CH1	CH2
Deviation detection CH1	1st adapter	SD6325	SD6365
	2nd adapter	SD6685	SD6725
	3rd adapter	SD7045	SD7085
	4th adapter	SD7405	SD7445

Deviation detection CH2

Check the status of the deviation between CH detection flag in the 3rd and 4th FX5-4A-ADP, or FX5-4AD-ADP used in the deviation between CH detection function.

Only FX5U/FX5UC CPU module is supported.

Monitor value	Display description	Default value	R/W
0: OFF	Normal	0: OFF	R
1: ON	Deviation detection		

■ When the deviation detection target is FX5-4A-ADP

■ When the deviation detection target is FX5-4AD-ADP

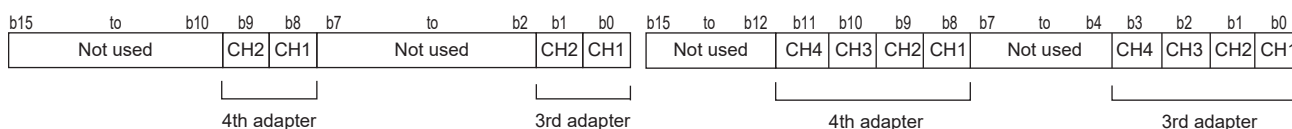

For details deviation detection between channel function, refer to the following.

☞ Page 313 Deviation Detection Between Channel Function

Name	Connection part	Special register	
		CH1	CH2
Deviation detection CH2	1st adapter	SD6326	SD6366
	2nd adapter	SD6686	SD6726
	3rd adapter	SD7046	SD7086
	4th adapter	SD7406	SD7446

Deviation value for deviation detection between channel

Set the deviation value between channels used in the deviation detection between channel function.

Range	Default value	R/W
0 to 65535	0	R/W

Name	Connection part	Special register	
		CH1	CH2
Deviation value for deviation detection between channel	1st adapter	SD6327	SD6367
	2nd adapter	SD6687	SD6727
	3rd adapter	SD7047	SD7087
	4th adapter	SD7407	SD7447

CH setting 1 for deviation detection between channel

Set the channels whose deviation will be checked in the 1st and 2nd FX5-4A-ADP, or FX5-4AD-ADP used in the deviation detection between channel function.

Monitor value	Display description	Default value	R/W
0: OFF	Non target	0	R/W
1: ON	Target		

■ When the deviation detection target is FX5-4A-ADP

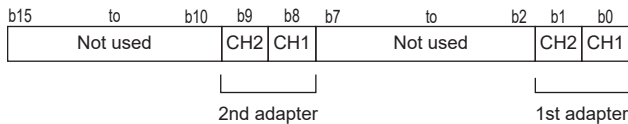

■ When the deviation detection target is FX5-4AD-ADP

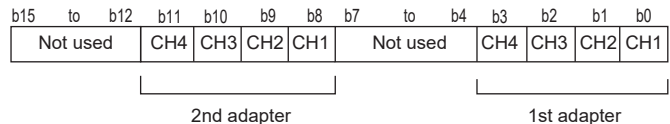

For details deviation detection between channel function, refer to the following.

☞ Page 313 Deviation Detection Between Channel Function

Name	Connection part	Special register	
		CH1	CH2
CH setting 1 for deviation detection between channel	1st adapter	SD6328	SD6368
	2nd adapter	SD6688	SD6728
	3rd adapter	SD7048	SD7088
	4th adapter	SD7408	SD7448

CH setting 2 for deviation detection between channel

Set the channels whose deviation will be checked in the 3rd and 4th FX5-4A-ADP, or FX5-4AD-ADP used in the deviation detection between channel function.

Only FX5U/FX5UC CPU module is supported.

Monitor value	Display description	Default value	R/W
0: OFF	Non target	0	R/W
1: ON	Target		

■ When the deviation detection target is FX5-4A-ADP

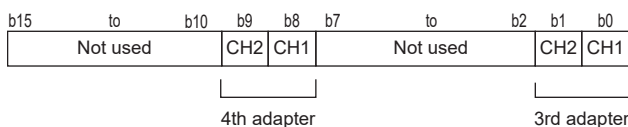

■ When the deviation detection target is FX5-4AD-ADP

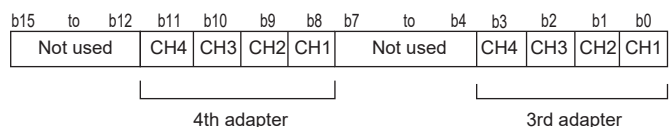

For details deviation detection between channel function, refer to the following.

☞ Page 313 Deviation Detection Between Channel Function

Name	Connection part	Special register	
		CH1	CH2
CH setting 2 for deviation detection between channel	1st adapter	SD6329	SD6369
	2nd adapter	SD6689	SD6729
	3rd adapter	SD7049	SD7089
	4th adapter	SD7409	SD7449

Offset setting value

Set the offset data used in the offset/gain setting function.

Range	Default value	R/W
Voltage: -10000 to +9000 Current: -20000 to +17000	0	R/W

For details offset/gain setting, refer to the following.

 Page 314 Offset/gain Setting Function

Name	Connection part	Special register	
		CH1	CH2
Offset setting value	1st adapter	SD6332	SD6372
	2nd adapter	SD6692	SD6732
	3rd adapter	SD7052	SD7092
	4th adapter	SD7412	SD7452

Gain setting value

Set the gain data used in the offset/gain setting function.

Range	Default value	R/W
Voltage: -9000 to +10000 Current: -17000 to +30000	Voltage input: 5000 Current input: 20000	R/W

For details offset/gain setting, refer to the following.

 Page 314 Offset/gain Setting Function

Name	Connection part	Special register	
		CH1	CH2
Gain setting value	1st adapter	SD6333	SD6373
	2nd adapter	SD6693	SD6733
	3rd adapter	SD7053	SD7093
	4th adapter	SD7413	SD7453

Offset/gain writing enable code

Set the offset/gain writing enable code used for changing the offset/gain.

Range	Default value	R/W
Offset/gain writing enable: E20FH Offset/gain writing disable: Other than E20FH	0	R/W

For details offset/gain setting, refer to the following.

 Page 314 Offset/gain Setting Function

Name	Connection part	Special register	
		CH1	CH2
Offset/gain writing enable code	1st adapter	SD6334	SD6374
	2nd adapter	SD6694	SD6734
	3rd adapter	SD7054	SD7094
	4th adapter	SD7414	SD7454

A/D conversion latest alarm code

The latest alarm code detected in the FX5-4A-ADP is stored.

Monitor value	Default value	R/W
—	0	R

For details alarm code, refer to the following.

 Page 360 A/D conversion alarm code

Name	Connection part	Special register	
		CH1	CH2
A/D conversion latest alarm code	1st adapter	SD6338	SD6378
	2nd adapter	SD6698	SD6738
	3rd adapter	SD7058	SD7098
	4th adapter	SD7418	SD7458



Set the "A/D conversion alarm clear request" from OFF to ON to clear the alarm code.

A/D conversion latest error code

The latest error code detected in the FX5-4A-ADP is stored.

Monitor value	Default value	R/W
—	0	R

For details error code, refer to the following.

 Page 358 A/D conversion error code

Name	Connection part	Special register	
		CH1	CH2
A/D conversion latest error code	1st adapter	SD6339	SD6379
	2nd adapter	SD6699	SD6739
	3rd adapter	SD7059	SD7099
	4th adapter	SD7419	SD7459



Set the "error clear request" (SM50) of CPU module from OFF to ON to clear the error code.

6.17 List of D/A Conversion Special Relays

The D/A conversion special relays are shown below.

1st analog expansion adapter

The special relays list for the 1st FX5-4A-ADP module is shown below.

Special relays		Name	Reference
CH3	CH4		
SM6380	SM6420	D/A conversion enable/disable setting	Page 396
SM6381	SM6421	D/A output enable/disable setting	Page 396
SM6388	SM6428	Scaling enable/disable setting	Page 397
SM6391	SM6431	Warning output upper limit value flag	Page 397
SM6392	SM6432	Warning output lower limit value flag	Page 397
SM6393	SM6433	Warning output setting	Page 398
SM6398	SM6438	Disconnection detection flag	Page 398
SM6399	SM6439	Disconnection detection enable/disable setting	Page 398
SM6400	SM6440	Disconnection recovery detection enable/disable setting	Page 399
SM6412	SM6452	Offset/gain reading	Page 399
SM6413	SM6453	Offset/gain writing	Page 399
SM6414	SM6454	Offset/gain initialization	Page 400
SM6417	SM6457	D/A conversion alarm clear request	Page 400
SM6418	SM6458	D/A conversion alarm flag	Page 400
SM6419	SM6459	D/A conversion error flag	Page 401

2nd analog expansion adapter

The special relays list for the 2nd FX5-4A-ADP module is shown below.

Special relays		Name	Reference
CH3	CH4		
SM6740	SM6780	D/A conversion enable/disable setting	Page 396
SM6741	SM6781	D/A output enable/disable setting	Page 396
SM6748	SM6788	Scaling enable/disable setting	Page 397
SM6751	SM6791	Warning output upper limit value flag	Page 397
SM6752	SM6792	Warning output lower limit value flag	Page 397
SM6753	SM6793	Warning output setting	Page 398
SM6758	SM6798	Disconnection detection flag	Page 398
SM6759	SM6799	Disconnection detection enable/disable setting	Page 398
SM6760	SM6800	Disconnection recovery detection enable/disable setting	Page 399
SM6772	SM6812	Offset/gain reading	Page 399
SM6773	SM6813	Offset/gain writing	Page 399
SM6774	SM6814	Offset/gain initialization	Page 400
SM6777	SM6817	D/A conversion alarm clear request	Page 400
SM6778	SM6818	D/A conversion alarm flag	Page 400
SM6779	SM6819	D/A conversion error flag	Page 401

3rd analog expansion adapter

The special relays list for the 3rd FX5-4A-ADP module is shown below.

Special relays		Name	Reference
CH3	CH4		
SM7100	SM7140	D/A conversion enable/disable setting	Page 396
SM7101	SM7141	D/A output enable/disable setting	Page 396
SM7108	SM7148	Scaling enable/disable setting	Page 397
SM7111	SM7151	Warning output upper limit value flag	Page 397
SM7112	SM7152	Warning output lower limit value flag	Page 397
SM7113	SM7153	Warning output setting	Page 398
SM7118	SM7158	Disconnection detection flag	Page 398
SM7119	SM7159	Disconnection detection enable/disable setting	Page 398
SM7120	SM7160	Disconnection recovery detection enable/disable setting	Page 399
SM7132	SM7172	Offset/gain reading	Page 399
SM7133	SM7173	Offset/gain writing	Page 399
SM7134	SM7174	Offset/gain initialization	Page 400
SM7137	SM7177	D/A conversion alarm clear request	Page 400
SM7138	SM7178	D/A conversion alarm flag	Page 400
SM7139	SM7179	D/A conversion error flag	Page 401

4th analog expansion adapter

The special relays list for the 4th FX5-4A-ADP module is shown below.

Special relays		Name	Reference
CH3	CH4		
SM7460	SM7500	D/A conversion enable/disable setting	Page 396
SM7461	SM7501	D/A output enable/disable setting	Page 396
SM7468	SM7508	Scaling enable/disable setting	Page 397
SM7471	SM7511	Warning output upper limit value flag	Page 397
SM7472	SM7512	Warning output lower limit value flag	Page 397
SM7473	SM7513	Warning output setting	Page 398
SM7478	SM7518	Disconnection detection flag	Page 398
SM7479	SM7519	Disconnection detection enable/disable setting	Page 398
SM7180	SM7520	Disconnection recovery detection enable/disable setting	Page 399
SM7492	SM7532	Offset/gain reading	Page 399
SM7493	SM7533	Offset/gain writing	Page 399
SM7494	SM7534	Offset/gain initialization	Page 400
SM7497	SM7537	D/A conversion alarm clear request	Page 400
SM7498	SM7538	D/A conversion alarm flag	Page 400
SM7499	SM7539	D/A conversion error flag	Page 401

6.18 Detail of D/A Conversion Special Relays

This section explains the details of special relays. Only the FX5U/FX5UC CPU module supports the special relays of the third and fourth modules.

R: Read only, R/W: Read/Write

D/A conversion enable/disable setting

Set whether to enable or disable D/A conversion.

Setting value	Setting description	Default value	R/W
0: OFF	D/A conversion enable	1: ON	R/W
1: ON	D/A conversion disable		

For details D/A conversion enable/disable function, refer to the following.

 Page 322 D/A Conversion Enable/Disable Function

Name	Connection part	Special relay	
		CH3	CH4
D/A conversion enable/disable setting	1st adapter	SM6380	SM6420
	2nd adapter	SM6740	SM6780
	3rd adapter	SM7100	SM7140
	4th adapter	SM7460	SM7500

D/A output enable/disable setting

Set whether to output the D/A conversion value or to output the offset value.

Setting value	Setting description	Default value	R/W
0: OFF	D/A conversion value	1: ON	R/W
1: ON	Offset value		

Point

The setting value will be ignored when the D/A conversion enable/disable setting is set to "disable".

For details D/A output enable/disable setting function, refer to the following.

 Page 322 D/A Output Enable/Disable Setting Function

Name	Connection part	Special relay	
		CH3	CH4
D/A output enable/disable setting	1st adapter	SM6381	SM6421
	2nd adapter	SM6741	SM6781
	3rd adapter	SM7101	SM7141
	4th adapter	SM7461	SM7501

Scaling enable/disable setting

Set whether to enable or disable the scaling function.

Setting value	Setting description	Default value	R/W
0: OFF	Scaling function enable	1: ON	R/W
1: ON	Scaling function disable		

For details scaling function, refer to the following.

 Page 325 Scaling Function

Name	Connection part	Special relay	
		CH3	CH4
Scaling enable/disable setting	1st adapter	SM6388	SM6428
	2nd adapter	SM6748	SM6788
	3rd adapter	SM7108	SM7148
	4th adapter	SM7468	SM7508

Warning output upper limit value flag

This flag monitors the upper limit value warning in the warning output.

Monitor value	Display description	Default value	R/W
0: OFF	Normal	0: OFF	R
1: ON	Warning output upper limit detection		

For details warning output function, refer to the following.

 Page 328 Warning Output Function

Name	Connection part	Special relay	
		CH3	CH4
Warning output upper limit value flag	1st adapter	SM6391	SM6431
	2nd adapter	SM6751	SM6791
	3rd adapter	SM7111	SM7151
	4th adapter	SM7471	SM7511

Warning output lower limit value flag

This flag monitors the lower limit value warning in the warning output.

Monitor value	Display description	Default value	R/W
0: OFF	Normal	0: OFF	R
1: ON	Warning output lower limit detection		

For details warning output function, refer to the following.

 Page 328 Warning Output Function

Name	Connection part	Special relay	
		CH3	CH4
Warning output lower limit value flag	1st adapter	SM6392	SM6432
	2nd adapter	SM6752	SM6792
	3rd adapter	SM7112	SM7152
	4th adapter	SM7472	SM7512

Warning output setting

Set whether to enable or disable the warning output.

Setting value	Setting description	Default value	R/W
0: OFF	Warning output enable	1: ON	R/W
1: ON	Warning output disable		

For details warning output function, refer to the following.

 Page 328 Warning Output Function

Name	Connection part	Special relay	
		CH3	CH4
Warning output setting	1st adapter	SM6393	SM6433
	2nd adapter	SM6753	SM6793
	3rd adapter	SM7113	SM7153
	4th adapter	SM7473	SM7513

Disconnection detection flag

This flag monitors the disconnection detection.

Monitor value	Display description	Default value	R/W
0: OFF	Normal	0: OFF	R
1: ON	Disconnection detection		

For details disconnection detection function, refer to the following.

 Page 330 Disconnection Detection Function

Name	Connection part	Special relay	
		CH3	CH4
Disconnection detection flag	1st adapter	SM6398	SM6438
	2nd adapter	SM6758	SM6798
	3rd adapter	SM7118	SM7158
	4th adapter	SM7478	SM7518

Disconnection detection enable/disable setting

Set whether to enable or disable the disconnection detection function.

Setting value	Setting description	Default value	R/W
0: OFF	Disconnection detection enable	1: ON	R/W
1: ON	Disconnection detection disable		

For details disconnection detection function, refer to the following.

 Page 330 Disconnection Detection Function

Name	Connection part	Special relay	
		CH3	CH4
Disconnection detection enable/disable setting	1st adapter	SM6399	SM6439
	2nd adapter	SM6759	SM6799
	3rd adapter	SM7119	SM7159
	4th adapter	SM7479	SM7519

Disconnection recovery detection enable/disable setting

Set whether to enable or disable the disconnection detection recovery.

Setting value	Setting description	Default value	R/W
0: OFF	Disconnection recovery detection enable	1: ON	R/W
1: ON	Disconnection recovery detection disable		

For details disconnection detection function, refer to the following.

☞ Page 330 Disconnection Detection Function

Name	Connection part	Special relay	
		CH3	CH4
Disconnection recovery detection enable/disable setting	1st adapter	SM6400	SM6440
	2nd adapter	SM6760	SM6800
	3rd adapter	SM7120	SM7160
	4th adapter	SM7480	SM7520

Offset/gain reading

An offset/gain setting value is read.

Setting value	Setting description	Default value	R/W
0: OFF	Offset/gain reading is not performed.	0: OFF	R/W
1: ON	Offset/gain reading is performed.		

For details offset/gain setting, refer to the following.

☞ Page 332 Offset/gain Setting Function

Name	Connection part	Special relay	
		CH3	CH4
Offset/gain reading	1st adapter	SM6412	SM6452
	2nd adapter	SM6772	SM6812
	3rd adapter	SM7132	SM7172
	4th adapter	SM7492	SM7532

Offset/gain writing

An offset/gain setting value is written in.

Setting value	Setting description	Default value	R/W
0: OFF	Offset/gain writing is not performed.	0: OFF	R/W
1: ON	Offset/gain writing is performed.		

For details offset/gain setting, refer to the following.

☞ Page 332 Offset/gain Setting Function

Name	Connection part	Special relay	
		CH3	CH4
Offset/gain writing	1st adapter	SM6413	SM6453
	2nd adapter	SM6773	SM6813
	3rd adapter	SM7133	SM7173
	4th adapter	SM7493	SM7533

Offset/gain initialization

An offset/gain setting value is initialized.

Setting value	Setting description	Default value	R/W
0: OFF	Offset/gain initialization is not performed.	0: OFF	R/W
1: ON	Offset/gain initialization is performed.		

For details offset/gain initialization, refer to the following.

☞ Page 337 Offset/gain Initialization Function

Name	Connection part	Special relay	
		CH3	CH4
Offset/gain initialization	1st adapter	SM6414	SM6454
	2nd adapter	SM6774	SM6814
	3rd adapter	SM7134	SM7174
	4th adapter	SM7494	SM7534

D/A conversion alarm clear request

A D/A conversion alarm clear request is performed.

Setting value	Setting description	Default value	R/W
0: OFF	With no D/A conversion alarm clear request.	0: OFF	R/W
1: ON	Those with D/A conversion alarm clear request.		

For details D/A conversion alarm clear request, refer to the following.

☞ Page 340 D/A conversion function

Name	Connection part	Special relay	
		CH3	CH4
D/A conversion alarm clear request	1st adapter	SM6417	SM6457
	2nd adapter	SM6777	SM6817
	3rd adapter	SM7137	SM7177
	4th adapter	SM7497	SM7537

D/A conversion alarm flag

"D/A conversion alarm flag" turns on when an alarm occurs.

Monitor value	Display description	Default value	R/W
0: OFF	Normal	0: OFF	R
1: ON	D/A conversion alarm occur		

To turn OFF the "D/A conversion alarm flag" and clear the "D/A conversion latest alarm code", set the "D/A conversion alarm clear request" from OFF to ON.

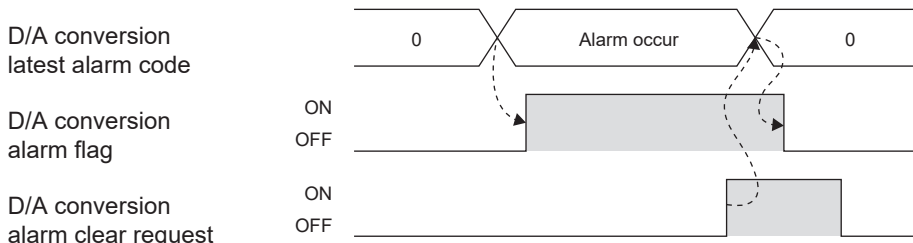

Name	Connection part	Special relay	
		CH3	CH4
D/A conversion alarm flag	1st adapter	SM6418	SM6458
	2nd adapter	SM6778	SM6818
	3rd adapter	SM7138	SM7178
	4th adapter	SM7498	SM7538

D/A conversion error flag

"D/A conversion error flag" turns on when an error occurs.

Monitor value	Display description	Default value	R/W
0: OFF	Normal	0: OFF	R
1: ON	D/A conversion error occur		

To turn OFF the "D/A conversion error flag" and clear the "D/A conversion latest error code", set the "error clear request" (SM50) of the CPU module from OFF to ON.

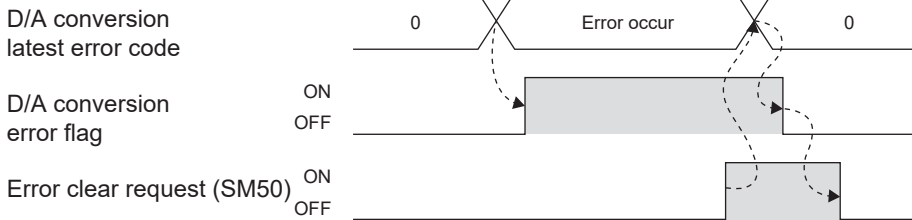

Name	Connection part	Special relay	
		CH3	CH4
D/A conversion error flag	1st adapter	SM6419	SM6459
	2nd adapter	SM6779	SM6819
	3rd adapter	SM7139	SM7179
	4th adapter	SM7499	SM7539

6.19 List of D/A Conversion Special Registers

The D/A conversion special registers are shown below.

1st analog expansion adapter

The special registers list for the 1st FX5-4A-ADP module is shown below.

Special registers		Name	Reference
CH3	CH4		
SD6380	SD6420	Digital value	Page 404
SD6381	SD6421	Digital operation value	Page 404
SD6382	SD6422	Analog output value monitor	Page 405
SD6383	SD6423	HOLD/CLEAR function setting	Page 405
SD6384	SD6424	HOLD setting value	Page 405
SD6385	SD6425	Output range setting	Page 406
SD6388	SD6428	Scaling upper limit value	Page 406
SD6389	SD6429	Scaling lower limit value	Page 406
SD6390	SD6430	Input value shift amount	Page 407
SD6391	SD6431	Warning output upper limit value	Page 407
SD6392	SD6432	Warning output lower limit value	Page 407
SD6412	SD6452	Offset setting value	Page 408
SD6413	SD6453	Gain setting value	Page 408
SD6414	SD6454	Offset/gain writing enable code	Page 408
SD6418	SD6458	D/A conversion latest alarm code	Page 409
SD6419	SD6459	D/A conversion latest error code	Page 409

2nd analog expansion adapter

The special registers list for the 2nd FX5-4A-ADP module is shown below.

Special registers		Name	Reference
CH3	CH4		
SD6740	SD6780	Digital value	Page 404
SD6741	SD6781	Digital operation value	Page 404
SD6742	SD6782	Analog output value monitor	Page 405
SD6743	SD6783	HOLD/CLEAR function setting	Page 405
SD6744	SD6784	HOLD setting value	Page 405
SD6745	SD6785	Output range setting	Page 406
SD6748	SD6788	Scaling upper limit value	Page 406
SD6749	SD6789	Scaling lower limit value	Page 406
SD6750	SD6790	Input value shift amount	Page 407
SD6751	SD6791	Warning output upper limit value	Page 407
SD6752	SD6792	Warning output lower limit value	Page 407
SD6772	SD6812	Offset setting value	Page 408
SD6773	SD6813	Gain setting value	Page 408
SD6774	SD6814	Offset/gain writing enable code	Page 408
SD6778	SD6818	D/A conversion latest alarm code	Page 409
SD6779	SD6819	D/A conversion latest error code	Page 409

3rd analog expansion adapter

The special registers list for the 3rd FX5-4A-ADP module is shown below.

Special registers		Name	Reference
CH3	CH4		
SD7100	SD7140	Digital value	Page 404
SD7101	SD7141	Digital operation value	Page 404
SD7102	SD7142	Analog output value monitor	Page 405
SD7103	SD7143	HOLD/CLEAR function setting	Page 405
SD7104	SD7144	HOLD setting value	Page 405
SD7105	SD7145	Output range setting	Page 406
SD7108	SD7148	Scaling upper limit value	Page 406
SD7109	SD7149	Scaling lower limit value	Page 406
SD7110	SD7150	Input value shift amount	Page 407
SD7111	SD7151	Warning output upper limit value	Page 407
SD7112	SD7152	Warning output lower limit value	Page 407
SD7132	SD7172	Offset setting value	Page 408
SD7133	SD7173	Gain setting value	Page 408
SD7134	SD7174	Offset/gain writing enable code	Page 408
SD7138	SD7178	D/A conversion latest alarm code	Page 409
SD7139	SD7179	D/A conversion latest error code	Page 409

4th analog expansion adapter

The special registers list for the 4th FX5-4A-ADP module is shown below.

Special registers		Name	Reference
CH3	CH4		
SD7460	SD7500	Digital value	Page 404
SD7461	SD7501	Digital operation value	Page 404
SD7462	SD7502	Analog output value monitor	Page 405
SD7463	SD7503	HOLD/CLEAR function setting	Page 405
SD7464	SD7504	HOLD setting value	Page 405
SD7465	SD7505	Output range setting	Page 406
SD7468	SD7508	Scaling upper limit value	Page 406
SD7469	SD7509	Scaling lower limit value	Page 406
SD7470	SD7510	Input value shift amount	Page 407
SD7471	SD7511	Warning output upper limit value	Page 407
SD7472	SD7512	Warning output lower limit value	Page 407
SD7492	SD7532	Offset setting value	Page 408
SD7493	SD7533	Gain setting value	Page 408
SD7494	SD7534	Offset/gain writing enable code	Page 408
SD7498	SD7538	D/A conversion latest alarm code	Page 409
SD7499	SD7539	D/A conversion latest error code	Page 409

6.20 Detail of D/A Conversion Special Registers

This section explains the details of special registers. Only the FX5U/FX5UC CPU module supports the third and fourth special register.

R: Read only, R/W: Read/Write

Digital value

Set the digital value for D/A conversion.

Output range setting		Digital value setting range	When the scaling function is enabled	Default value	R/W
Voltage	0 to 10 V	0 to 16000	Scaling lower limit value to Scaling upper limit value	0	R/W
	0 to 5 V				
	1 to 5 V				
	-10 to +10 V	-8000 to +8000			
Current	0 to 20 mA	0 to 16000			
	4 to 20 mA				



When the digital value is set outside the allowable setting range, D/A conversion will be executed within the allowable setting range.

Name	Connection part	Special register	
		CH3	CH4
Digital value	1st adapter	SD6380	SD6420
	2nd adapter	SD6740	SD6780
	3rd adapter	SD7100	SD7140
	4th adapter	SD7460	SD7500

Digital operation value

The digital operation value obtained by the scaling function and shift function is stored.

Monitor value	Default value	R/W
-32768 to +32767	0	R



The value equivalent to the digital value is stored when the scaling function and shift function are not used.

Name	Connection part	Special relay	
		CH3	CH4
Digital operation value	1st adapter	SD6381	SD6421
	2nd adapter	SD6741	SD6781
	3rd adapter	SD7101	SD7141
	4th adapter	SD7461	SD7501

Analog output value monitor

The D/A-converted analog value is stored.

Monitor value	Default value	R/W
-10240 to +20479	0	R

Point

- The unit is "1 V = 1000 mV" for voltage input, and "1 mA = 1000 μ A" for current input.
- The upper limit value or lower limit value is stored when the analog value is outside the output range.

Name	Connection part	Special relay	
		CH3	CH4
Analog output value monitor	1st adapter	SD6382	SD6422
	2nd adapter	SD6742	SD6782
	3rd adapter	SD7102	SD7142
	4th adapter	SD7462	SD7502

HOLD/CLEAR function setting

Set whether to hold or clear the analog output value when the CPU module is in the "STOP" or "STOP (by stop error)" status.

Setting value	Description	Default value	R/W
0	CLEAR	1	R/W
1	Current Value (Hold)		
2	HOLD setting value		

Point

- The output status setting range error in HOLD status (Error code: 1B1□H) occurs when any value other than the above values is set.
- Set a value to the "HOLD setting value" when setting "2" here.

For details analog output HOLD/CLEAR function, refer to the following.

 Page 323 Analog Output HOLD/CLEAR Function

Name	Connection part	Special relay	
		CH3	CH4
HOLD/CLEAR function setting	1st adapter	SD6383	SD6423
	2nd adapter	SD6743	SD6783
	3rd adapter	SD7103	SD7143
	4th adapter	SD7463	SD7503

HOLD setting value

Set the output value when "2: HOLD setting value" is set to the HOLD/CLEAR function setting.

Range	Default value	R/W
-32768 to +32767	0	R/W

For details analog output HOLD/CLEAR function, refer to the following.

 Page 323 Analog Output HOLD/CLEAR Function

Name	Connection part	Special relay	
		CH3	CH4
HOLD setting value	1st adapter	SD6384	SD6424
	2nd adapter	SD6744	SD6784
	3rd adapter	SD7104	SD7144
	4th adapter	SD7464	SD7504

Output range setting

Set the output range.

Setting value	Description	Default value	R/W
0	0 to 10 V	0	R/W
1	0 to 5 V		
2	1 to 5 V		
3	-10 to +10 V		
4	0 to 20 mA		
5	4 to 20 mA		



The range setting range error (Error code: 1B8□H) occurs when any value other than the above values is set.

Name	Connection part	Special relay	
		CH3	CH4
Output range setting	1st adapter	SD6385	SD6425
	2nd adapter	SD6745	SD6785
	3rd adapter	SD7105	SD7145
	4th adapter	SD7465	SD7505

Scaling upper limit value

Set the upper limit value of the scaling conversion range.

Range	Default value	R/W
-32768 to +32767	0	R/W

For details scaling function, refer to the following.

Page 325 Scaling Function

Name	Connection part	Special register	
		CH3	CH4
Scaling upper limit value	1st adapter	SD6388	SD6428
	2nd adapter	SD6748	SD6788
	3rd adapter	SD7108	SD7148
	4th adapter	SD7468	SD7508

Scaling lower limit value

Set the lower limit value of the scaling conversion range.

Range	Default value	R/W
-32768 to +32767	0	R/W

For details scaling function, refer to the following.

Page 325 Scaling Function

Name	Connection part	Special register	
		CH3	CH4
Scaling lower limit value	1st adapter	SD6389	SD6429
	2nd adapter	SD6749	SD6789
	3rd adapter	SD7109	SD7149
	4th adapter	SD7469	SD7509

Input value shift amount

Set the "input value shift amount" used in the shift function.
The value set here is added to the "digital value".

Range	Default value	R/W
-32768 to +32767	0	R/W

For details shift function, refer to the following.

 Page 327 Shift Function

Name	Connection part	Special register	
		CH3	CH4
Input value shift amount	1st adapter	SD6390	SD6430
	2nd adapter	SD6750	SD6790
	3rd adapter	SD7110	SD7150
	4th adapter	SD7470	SD7510

Warning output upper limit value

Set the upper limit value of the warning output function.

Range	Default value	R/W
-32768 to +32767	0	R/W

For details warning output function, refer to the following.

 Page 328 Warning Output Function

Name	Connection part	Special register	
		CH3	CH4
Warning output upper limit value	1st adapter	SD6391	SD6431
	2nd adapter	SD6751	SD6791
	3rd adapter	SD7111	SD7151
	4th adapter	SD7471	SD7511

Warning output lower limit value

Set the lower limit value of the warning output function.

Range	Default value	R/W
-32768 to +32767	0	R/W

For details warning output function, refer to the following.

 Page 328 Warning Output Function

Name	Connection part	Special register	
		CH3	CH4
Warning output lower limit value	1st adapter	SD6392	SD6432
	2nd adapter	SD6752	SD6792
	3rd adapter	SD7112	SD7152
	4th adapter	SD7472	SD7512

Offset setting value

Set the offset data used in the offset/gain setting function.

Range	Default value	R/W
Voltage: -10000 to +9000 Current: 0 to +17000	0	R/W

For details offset/gain setting, refer to the following.

 Page 332 Offset/gain Setting Function

Name	Connection part	Special register	
		CH3	CH4
Offset setting value	1st adapter	SD6412	SD6452
	2nd adapter	SD6772	SD6812
	3rd adapter	SD7132	SD7172
	4th adapter	SD7492	SD7532

Gain setting value

Set the gain data used in the offset/gain setting function.

Range	Default value	R/W
Voltage: -9000 to +10000 Current: 3000 to 30000	Voltage output: 5000 Current output: 20000	R/W

For details offset/gain setting, refer to the following.

 Page 332 Offset/gain Setting Function

Name	Connection part	Special register	
		CH3	CH4
Gain setting value	1st adapter	SD6413	SD6453
	2nd adapter	SD6773	SD6813
	3rd adapter	SD7133	SD7173
	4th adapter	SD7493	SD7533

Offset/gain writing enable code

Set the offset/gain writing enable code used for changing the offset/gain.

Range	Default value	R/W
Offset/gain writing enable: E210H Offset/gain writing disable: Other than E210H	0	R/W

For details offset/gain setting, refer to the following.

 Page 332 Offset/gain Setting Function

Name	Connection part	Special register	
		CH3	CH4
Offset/gain writing enable code	1st adapter	SD6414	SD6454
	2nd adapter	SD6774	SD6814
	3rd adapter	SD7134	SD7174
	4th adapter	SD7494	SD7534

D/A conversion latest alarm code

The latest alarm code detected in the FX5-4A-ADP is stored.

Monitor value	Default value	R/W
—	0	R

For details alarm code, refer to the following.

 Page 361 D/A conversion alarm code

Name	Connection part	Special register	
		CH3	CH4
D/A conversion latest alarm code	1st adapter	SD6418	SD6458
	2nd adapter	SD6778	SD6818
	3rd adapter	SD7138	SD7178
	4th adapter	SD7498	SD7538



Set the "D/A conversion alarm clear request" from OFF to ON to clear the alarm code.

D/A conversion latest error code

The latest error code detected in the FX5-4A-ADP is stored.

Monitor value	Default value	R/W
—	0	R

For details error code, refer to the following.

 Page 359 D/A conversion error code

Name	Connection part	Special register	
		CH3	CH4
D/A conversion latest error code	1st adapter	SD6419	SD6459
	2nd adapter	SD6779	SD6819
	3rd adapter	SD7139	SD7179
	4th adapter	SD7499	SD7539



Set the "error clear request" (SM50) of CPU module from OFF to ON to clear the error code.

7 FX5U CPU MODULE BUILT-IN ANALOG

This chapter describes the built into analog the FX5U CPU module.

7.1 Specifications

This section describes the specifications.

Generic specifications

For the general specification, refer to the following manual.

 MELSEC iQ-F FX5U User's Manual (Hardware)

Performance specifications

Analog input/output specification is shown below.

This section describes the performance specifications.

Analog input

Item		Specifications
No. of analog input points		2 points (2 channels)
Analog input	Voltage	0 to 10 V DC (input resistance 115.7 kΩ)
Digital output		Unsigned 12-bit binary
Device allocation		SD6020 (ch1 A/D converted input data) SD6060 (ch2 A/D converted input data)
Input characteristics, max. resolution	Digital output value	0 to 4000
	Max. resolution	2.5 mV
Precision (Accuracy for the full scale of the digital output value)	Ambient temperature 25 ±5°C	Within ±0.5 % (±20 digit ^{*2})
	Ambient temperature 0 to 55°C	Within ±1.0 % (±40 digit ^{*2})
	Ambient temperature -20 to 0°C ^{*1}	Within ±1.5 % (±60 digit ^{*2})
Conversion speed		30 μs /Channel (data refreshed every operation cycle)
Absolute max. input		-0.5 V, +15 V
Insulation method		Inside the CPU module and the analog input circuit are not insulated. Between input terminals (channels) is not insulated.
No. of occupied input/output points		0 point (does not pertain to the max. No. of input/output points of the CPU module.)

*1 This specification does not apply to products manufactured before June 2016.

*2 "Digit" refers to digital values.

Analog output

Item	Specifications	
No. of analog output points	1 point (1 channel)	
Digital input	Unsigned 12-bit binary	
Analog output	Voltage	0 to 10 V DC (external load resistance 2 k to 1 M Ω)
Device allocation	SD6180 (Output setting data)	
Output characteristics, max. resolution ^{*1}	Digital input value	0 to 4000
	Max. resolution	2.5 mV
Precision ^{*2} (Accuracy for the full scale of the analog output value)	Ambient temperature 25 \pm 5 $^{\circ}$ C	Within \pm 0.5 % (\pm 20 digit ^{*4})
	Ambient temperature 0 to 55 $^{\circ}$ C	Within \pm 1.0 % (\pm 40 digit ^{*4})
	Ambient temperature -20 to 0 $^{\circ}$ C ^{*3}	Within \pm 1.5 % (\pm 60 digit ^{*4})
Conversion speed	30 μ s (data refreshed every operation cycle)	
Insulation method	Inside the CPU module and the analog output circuit are not insulated.	
No. of occupied input/output points	0 point (does not pertain to the max. No. of input/output points of the CPU module.)	

*1 There is a dead band near 0 V output, which is an area where some digital input values do not reflect analog output values.

*2 External load resistance is set to 2 k Ω when shipped from the factory. Thus, output voltage will increase somewhat if the resistance is set higher than 2 k Ω . When the resistance is 1 M Ω , output voltage increases by a maximum 2 %.

*3 This specification does not apply to products manufactured before June 2016.

*4 "Digit" refers to digital values.

Accuracy

Built-in analog input

Accuracy of A/D conversion is determined by the accuracy for the full scale of digital output value.

\pm 0.5 % (\pm 20 digit) at ambient temperature of 25 \pm 5 $^{\circ}$ C; the accuracy is \pm 1.0 % (\pm 40 digit) at ambient temperature of 0 to 55 $^{\circ}$ C; the accuracy is \pm 1.5 % (\pm 60 digit) at ambient temperature of -20 to 0 $^{\circ}$ C (except for the conditions under noise influence).

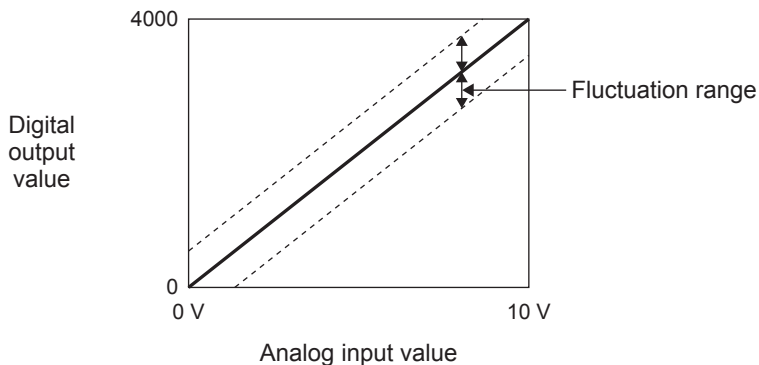

Built-in analog output

Accuracy of D/A conversion is determined by the accuracy for the full scale of analog output value.

\pm 0.5 % (\pm 20 digit) at ambient temperature of 25 \pm 5 $^{\circ}$ C; the accuracy is \pm 1.0 % (\pm 40 digit) at ambient temperature of 0 to 55 $^{\circ}$ C; the accuracy is \pm 1.5 % (\pm 60 digit) at ambient temperature of -20 to 0 $^{\circ}$ C (except for the conditions under noise influence).

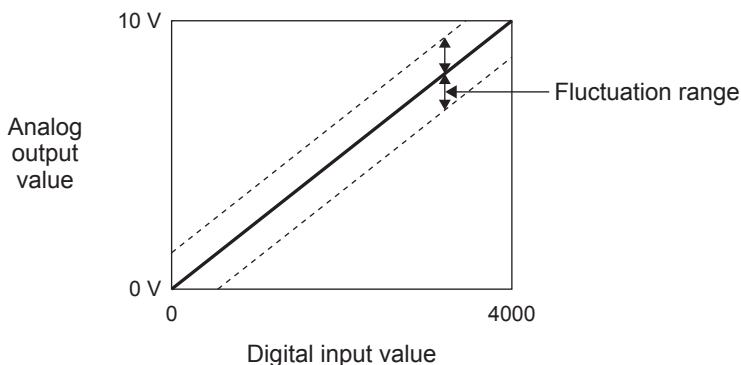

7.2 List of functions

The following table lists the functions.

Analog input

List of Functions	Description	Reference
A/D conversion enable/disable setting function	Function to enable or disable A/D conversion per channel. The conversion process time can be reduced by disabling conversion for unused channels.	Page 414
A/D conversion method	Sampling processing	Method of converting each analog input at END processing to generate the equivalent digital output.
	Time average	Method of averaging the time of A/D conversion values and outputting these average values as the digital signal.
	Count average	Method of averaging the count of A/D conversion values and outputting these average values as the digital signal.
	Moving average	Method of averaging the analog input for a specified count measured at every END process, and outputting these average values as the digital signal.
Over scale detection function	Function to detect analog input values that are over a input range.	Page 416
Scaling function	Function that converts user-defined maximum and minimum digital values in accordance with a configured scale.	Page 417
Shift function	Function that adds a specified amount to the A/D conversion value. Fine adjustments during system startup can be easily performed.	Page 418
Digital clipping function	Function that specifies the maximum A/D conversion value as 4000 and the minimum value as 0 when voltage is input that exceeds the input range.	Page 419
Maximum value/minimum value hold function	Function that holds the minimum and maximum digital operation values.	Page 419
Warning output function	Function to output warning when digital operation values exceed the specified range.	Page 420
Event history function	Collects errors from functions of the built into analog, and stores them as event information into the CPU module.	Page 421

Analog output

List of Functions	Description	Reference
D/A conversion enable/disable function	Function to enable or disable D/A conversion. When analog output is not used, the conversion process time can be reduced by disabling conversion.	Page 423
D/A output enable/disable setting function	Specifies whether to output the D/A conversion value or output an offset value (HOLD setting value).	Page 423
Analog output HOLD/CLEAR function	Sets the digital value before D/A conversion to the previous value or clears the value (0) depending on the operation status of the CPU module (RUN, STOP, and STOP error).	Page 424
Analog output test when CPU module is in STOP status function	Outputs a user-defined analog value by setting the output enable/disable flag to enabled when the CPU module is stopped, and changing the digital value.	Page 425
Scaling function	Function that converts user-defined maximum and minimum digital values in accordance with a configured scale.	Page 426
Shift function	Function that adds a specified amount to the digital value. Fine adjustments during system startup can be easily performed.	Page 427
Warning output function	Function to output warning when digital values exceed the specified range.	Page 427
Event history function	Collects errors from functions of the built into analog, and stores them as event information into the CPU module.	Page 429

7.3 Functions (Analog input)

This section describes the functions of the built into analog the FX5U CPU module and the setting procedures for those functions.

Point

This section describes the special relays and special registers for the CH1.

For checking the special relays and special registers for the CH2, refer to the following:

☞ Page 438 List of Special Relays, ☞ Page 439 List of Special Registers

Processing of each function

The functions are processed in the order shown below.

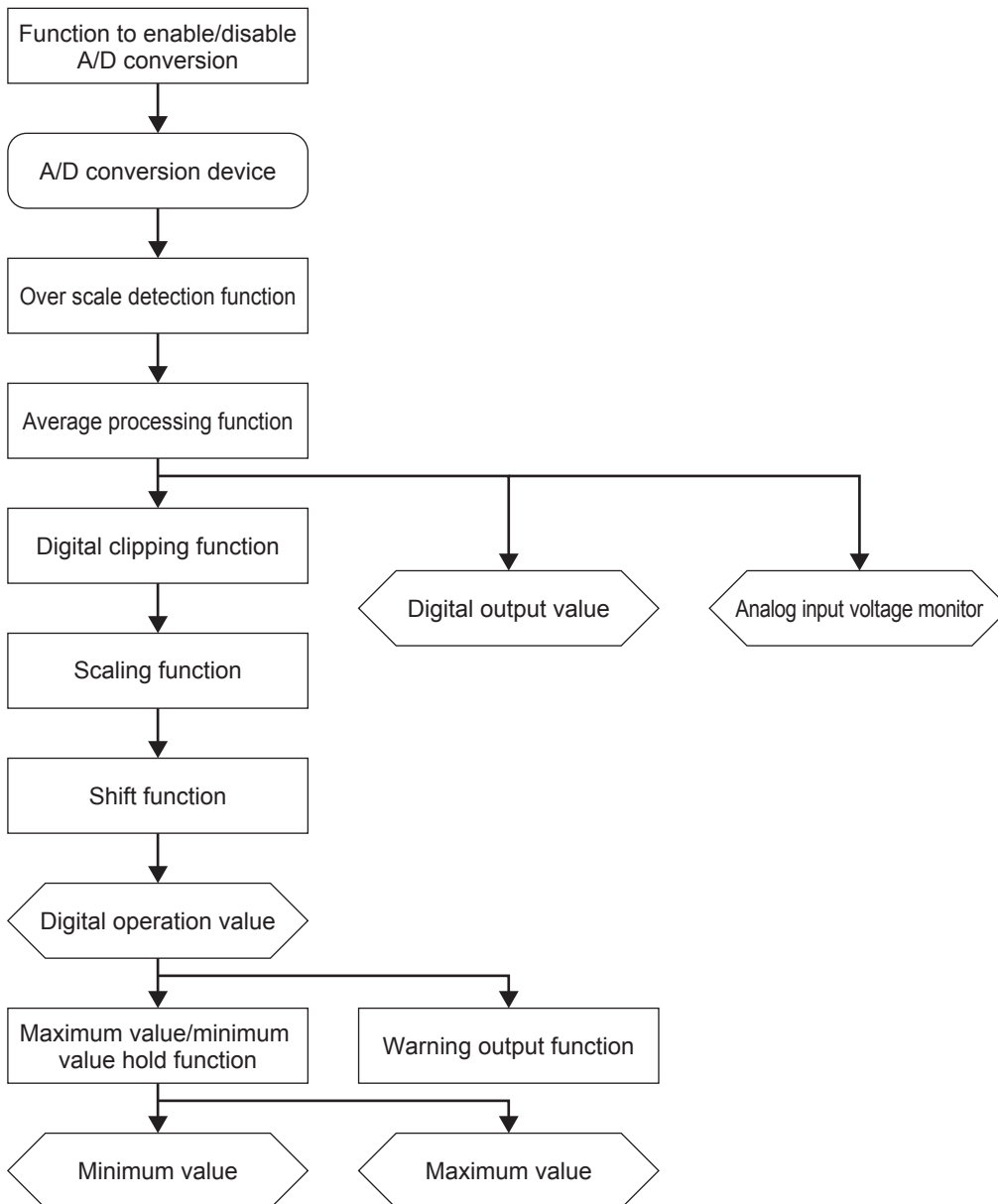

Digital output value

These values are the digital values after the sampling processing, or each averaging processing has been performed.

Digital operation value

These values are obtained by operating a digital output value using the digital clipping function, scaling function, or shift function. When each function is not used, the same value as the digital output value is stored.

Analog input voltage monitor

The input voltage value is displayed. Voltage is displayed in the following units.

Voltage: mV

Maximum and minimum value

The maximum and minimum values of the digital operation values are stored.

A/D Conversion Enable/Disable Setting Function

This function controls whether to enable or disable the A/D conversion for each channel.

The conversion process time can be reduced by disabling conversion for unused channels.

Corresponding devices

The devices in which the function to enable/disable A/D conversion can be used are listed below.

Name	CH1	CH2
A/D conversion enable/disable setting	SM6021	SM6061

Setting methods

A/D conversion is enabled/disabled for each channel by the setting to enable/disable A/D conversion.

Name	Allowable setting range	Default value
A/D conversion enable/disable setting	0: Enable A/D conversion	1: Disable A/D conversion
	1: Disable A/D conversion	

Point

Setting is enabled from the next END process that detected the change in the setting value. However, if there is a problem in the value set for the A/D conversion method, changing this setting from disabled to enabled will not result in an enabled status.

Operation

The analog input is converted to a digital signal only for the channel(s) which have been enabled for A/D conversion by the setting to enable/disable A/D conversion.

Point

While A/D conversion is disabled, the A/D conversion method setting can be changed.

A/D Conversion Method

Specify the method of A/D conversion for each channel.

The following A/D conversion methods are available.

Method	Description
Sampling processing	Method of converting each analog input with END processing to generate the equivalent digital output value.
Time average	Method of averaging the time of A/D conversion values and outputting these average values as the digital signal.
Count average	Method of averaging the count of A/D conversion values and outputting these average values as the digital signal.
Moving average	Method of averaging the analog input for a specified count measured at every END process, and outputting these average values as the digital signal.

Corresponding devices

The devices used by the A/D conversion method are listed below.

Name	CH1	CH2
Average processing specify	SD6023	SD6063
Time Average/Count Average/Moving Average setting	SD6024	SD6064

Setting methods

The procedure to change the A/D conversion method is described below.

1. Disable A/D conversion.
2. Specify the averaging process setting.

Use the averaging process setting for each channel to change the A/D conversion method.

Name	Allowable setting range	Default value
Averaging process setting	0: Sampling processing	0: Sampling processing
	1: Time average	
	2: Count average	
	3: Moving average	

3. Specify Time Average/Count Average/Moving Average setting.

When the averaging process (1 to 3) is specified by the averaging process setting, set the Time Average/Count Average/Moving Average setting with the relevant setting for the appropriate channel.

Name	Allowable setting range	Default value
Time average	1 to 10000 (ms)	0
Count average	4 to 32767 (times)	
Moving average	2 to 64 (times)	

4. Enable A/D conversion.

Operation

This section describes the operation of each A/D conversion method.

■Sampling processing

The analog input is sequentially converted into a digital signal by the END process to create the digital output, and the digital output values and digital operation values are stored.

■Time average

A/D conversion is performed for the specified time, the total values are averaged, and the digital output values and digital operation values are stored.

The processing count during the specified time changes depending on the number of channels enabled for conversion.

Number of processing times = Setting time ÷ Scan time

Point

If the setting time is smaller than the scan time, sampling values are output without the averaging process. For the initial output, however, the average of the first and second sampling values is output.

■Count average

The averaging process of the A/D conversion value is set to count, these average values are output as a digital signal, and the digital output values and digital operation values are stored.

The average values resulting from count average, digital output values, and time to store digital operation values depend on the scan time.

Processing time = Set number of times × Scan time

Point

Because the count average requires a sum of at least two counts excluding the maximum and minimum values, the set number of times should be four or more.

■ Moving average

The count of averaging process of the A/D conversion value is set to moving average, these average values are output as a digital signal, and the digital output values and digital operation values are stored.

The averaging process with specified count is performed for the A/D conversion value within while transitioning between each conversion cycle resulting in the most recent digital output values and digital operation values.

The following figure shows the moving average processing of when the set number of times is five.

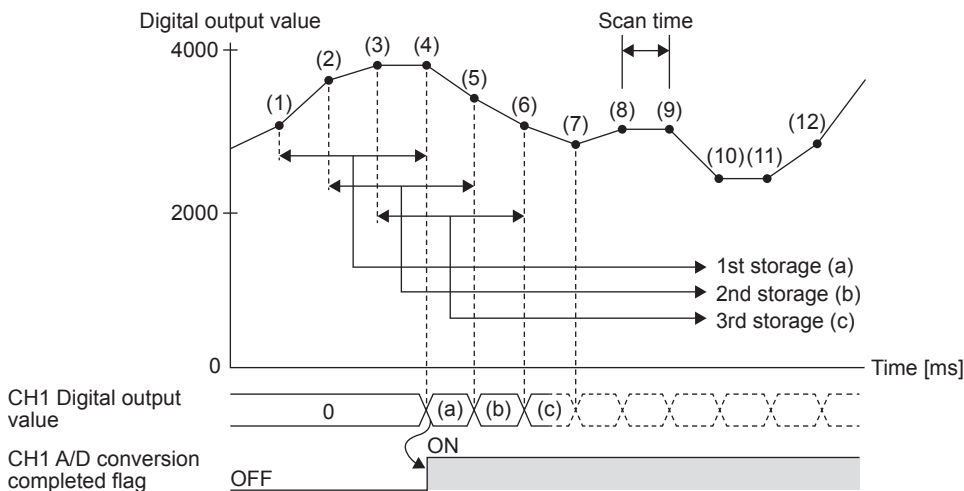

Over Scale Detection Function

Function to detect analog input values that are over a input range.

Corresponding devices

The devices which are used by the function to detect over scale are listed below.

Name	CH1	CH2
Over scale detection flag	SM6022	SM6062
Over scale detection enable/disable setting	SM6024	SM6064
A/D conversion alarm clear request	SM6057	SM6097
A/D conversion alarm flag	SM6058	SM6098
A/D conversion latest alarm code	SD6058	SD6098

Setting methods

Enables/disables the over scale detection setting for each channel.

Name	Allowable setting range	Default value
Over scale detection enable/disable setting	0: Enabled	0: Enabled
	1: Disabled	



Setting is enabled from the next END process that detected the change in the setting value.

Operation

Detected when the input analog voltage exceeds 10.2 V.

When an over-limit is detected, the digital value for this channel before the over-limit is stored, and the A/D conversion complete flag is turned off for this channel. Regardless of the over-limit detection flag reset, once the analog input value returns to 10.2 V, the A/D conversion complete flag will be turned on for this channel after the first update when A/D conversion restarts. When using the averaging function, the averaging process is cleared at the time of the over-limit detection. The averaging process is restarted after over-limit is cleared.

■Detection cycle

This function is executed during the END process.

■Clearing the over-scale

After the analog input value returns to 10.2 V, cycle the alarm clear flag through OFF → ON → OFF.

Clearing the over-limit will result in the following status.

- The over-limit detection flag is cleared.
- The alarm code stored for the latest alarm code is cleared.

Scaling Function

Function that converts user-defined maximum and minimum digital values in accordance with a configured scale.

Corresponding devices

The devices used with the scaling function are listed below.

Name	CH1	CH2
A/D conversion scaling enable/disable setting	SM6028	SM6068
A/D conversion error flag	SM6059	SM6099
Scaling upper limit value	SD6028	SD6068
Scaling lower limit value	SD6029	SD6069
A/D conversion latest error code	SD6059	SD6099

Setting methods

The procedure to use the scaling function is described below.

1. Disable scaling.

Name	Allowable setting range	Default value
Scaling enable/disable setting	0: Enabled	1: Disabled
	1: Disabled	

2. Set the scaling upper limit value/scaling lower limit value.

Set the scaling upper limit value to a value corresponding to the upper limit value for A/D conversion values (4000). Set the scaling lower limit value to a value corresponding to the lower limit value for A/D conversion values (0).

Name	Allowable setting range	Default value
Scaling upper limit value	-32768 to +32767 (upper limit value ≠ lower limit value)	0
Scaling lower limit value		

3. Enable scaling.

Operation

The output digital value is scaled within a range between the user-defined scaling upper limit value and the scaling lower limit value.

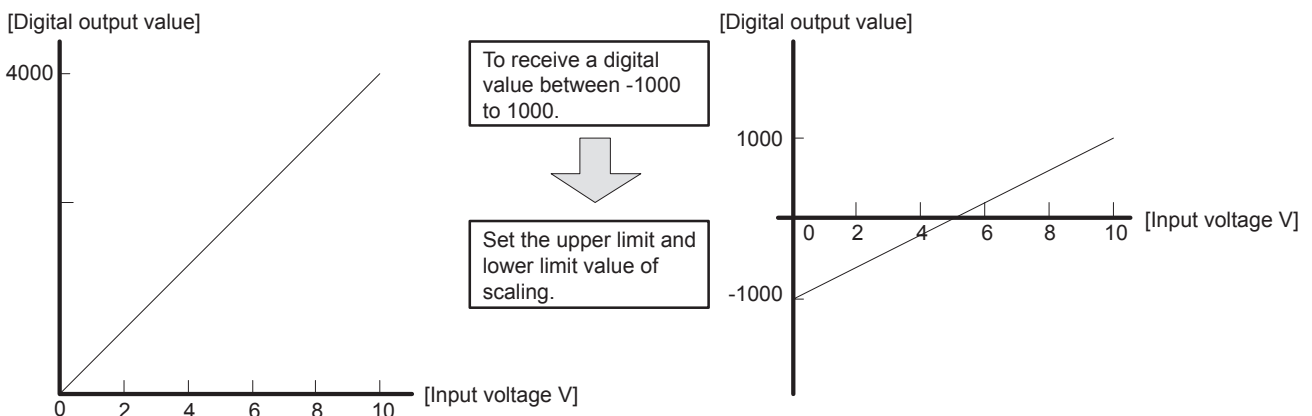

■ Calculation method of the scaling value

The value used is calculated from the following expression. (Values after the decimal point are rounded.)

$$\text{Value after scaling} = \frac{\text{Digital output value} \times (\text{scaling upper limit value} - \text{scaling lower limit value})}{4000} + \text{Scaling lower limit value}$$

Point

- The max. resolution will not increase even if the scaling upper limit value and the scaling lower limit value are set such that each digit is smaller than the max. resolution.
- When the scaling upper limit value is set lower than the scaling lower limit value, the digital operation value decreases as the input voltage increases.

Precautions

When both the scaling function and the digital clipping function are enabled at the same time, the scaling calculation will occur on the resulting digital value after digital clipping.

Shift Function

Function to add a user-definable shifting amount to the A/D conversion value and store the digital operation value. Changes to the shifting amount will be reflected in the digital operation value in real time, which enables fine adjustments to be easily made during system startup.

Corresponding devices

The devices which are used by the shift function are listed below.

Name	CH1	CH2
Conversion value shift amount	SD6030	SD6070

Setting methods

Sets the conversion value shift amount for the channel for which you want to use the conversion value shift.

Name	Allowable setting range	Default value
Conversion value shift amount	-32768 to +32767	0

Point

This function does not need to be set in advance. The user can perform conversion value shifts at any time.

Operation

Adds a shifting amount to the A/D conversion value. The A/D conversion value with the added shift is stored as the digital operation value.

When the digital operation value resulting from the shift processing exceeds the range between -32768 to +32767, the value is set to the lower limit (-32768) or the upper limit (32767).

When using the Sampling processing, the shift amount is added every conversion cycle. When using the averaging process, the shift amount is added every averaging process cycle. The results are stored as the digital operation value.

When using the scaling function at the same time, shift processing is performed on the resulting value after scaling processing.

Precautions

When the shift function, digital clipping function, and the scaling function are enabled simultaneously, the added shift is applied to the value after digital clipping and scaling, which results in a digital operation value range between -32,768 to 32,767.

Digital Clipping Function

Function that specifies the maximum A/D conversion value as 4000 and the minimum value as 0 when voltage is input that exceeds the input range.

Corresponding devices

The devices in which the digital clipping function can be used are listed below.

Name	CH1	CH2
Digital clipping enable/disable setting	SM6029	SM6069

Setting methods

Enable digital clipping for the channels for which you want to use the digital clipping function.

Name	Allowable setting range	Default value
Digital clipping enable/disable setting	0: Enabled	1: Disabled
	1: Disabled	

Point

- When the digital clipping function is disabled: digital output range (0 to 4095)
- When the digital clipping function is enabled: digital output range (0 to 4000)

Operation

This section describes the operation of the digital clipping function.

This function specifies the maximum A/D conversion value as 4000 and the minimum value as 0 when voltage is input that exceeds the input range.

Point

Scaling and shift processing occur after digital clipping.

Precautions

The scaling function operates as follows when not using the digital clipping function.

The value after scaling will exceed the scaling upper limit value when a voltage is input that exceeds the voltage range.

Maximum Value/Minimum Value Hold Function

Function that holds the minimum and maximum digital operation values.

Corresponding devices

The devices which are used by the function to hold minimum and maximum values are listed below.

Name	CH1	CH2
Maximum value/minimum value reset completed flag	SM6025	SM6065
Maximum value reset request	SM6026	SM6066
Minimum value reset request	SM6027	SM6067
Maximum value	SD6026	SD6066
Minimum value	SD6027	SD6067

Setting methods

The user does not need to configure any settings.

Operation

The maximum and minimum values for the digital operation value are stored in the maximum and minimum value special registers for each channel.

After the maximum and minimum value reset request is cycled OFF → ON, causing the maximum and minimum values for that channel to be reset, they will be updated with the current value. The maximum value/minimum value reset completed flag will turn on.

The maximum and minimum value reset requests are not turned off automatically. To reset the values again, it is necessary to turn the requests OFF.

When the averaging process, digital clipping function, the scaling function, and the shift function are enabled, the values resulting after the averaging process, digital clipping, scaling, and adding the shift are stored as the maximum and minimum values.

Warning Output Function

The warning output flag for the corresponding channel turns ON when the digital operation value exceeds the process alarm upper upper limit value, is below the process alarm lower lower limit value, or falls within the warning output range.

Corresponding devices

The devices which are used by the warning output function are listed below.

Name	CH1	CH2
Warning output flag (process alarm upper limit)	SM6031	SM6071
Warning output flag (process alarm lower limit)	SM6032	SM6072
Warning output setting (process alarm)	SM6033	SM6073
A/D conversion alarm clear request	SM6057	SM6097
A/D conversion alarm flag	SM6058	SM6098
Process alarm upper upper limit value	SD6031	SD6071
Process alarm lower upper limit value	SD6032	SD6072
Process alarm upper lower limit value	SD6033	SD6073
Process alarm lower lower limit value	SD6034	SD6074
A/D conversion latest alarm code	SD6058	SD6098

Setting methods

The procedure to use the warning output function is described below.

1. Disable the warning output setting (process alarm).

Name	Allowable setting range	Default value
Warning output setting (process alarm)	0: Enabled	1: Disabled
	1: Disabled	

2. Set the upper limit and lower limit values for the process alarm.

Four levels of values from the process alarm upper upper limit value to the process alarm lower lower limit value can be set for each channel using the warning output function (process alarm).

Name	Allowable setting range	Default value
Process alarm upper upper limit value	-32768 to +32767 (upper upper limit ≥ lower upper limit ≥ upper lower limit ≥ lower lower limit)	0
Process alarm lower upper limit value		
Process alarm upper lower limit value		
Process alarm lower lower limit value		

3. Enable the warning output setting (process alarm).

Operation

The warning output flag (process alarm upper limit) or the warning output flag (process alarm lower limit) turns ON when the digital operation value exceeds the process alarm upper upper limit value, or is below the process alarm lower lower limit value, and the conditions to output a warning are satisfied.

This function executes for each averaging time and averaging count configured when time average and count average are specified. This function executes every conversion cycle when other A/D conversion methods are specified (Sampling processing and moving average).

The warning output flag (process alarm upper limit) or the warning output flag (process alarm lower limit) turns OFF after the warning is output when the digital operation value is lower than the process alarm lower upper limit value, or is larger than the process alarm upper lower limit value, and the conditions to output a warning are no longer satisfied.

However, the alarm code stored for the A/D conversion latest alarm code is not cleared.

To clear the alarm code stored in the latest A/D conversion alarm code, cycle the A/D conversion alarm clear request through OFF → ON → OFF after all warning output flags (process alarm upper limit/process alarm lower limit) return to the OFF status. At this time, the A/D conversion alarm occurrence flag is also turned OFF.

Precautions

When using the digital clipping function, the scaling function, and the shift function, the digital operation value resulting after digital clipping, scaling, and adding the shift is detected for warning. Make sure to set the upper limits and lower limits for the process alarms with regard to digital clipping, scaling, and shift additions.

Event History Function

This function collects errors from built-in analog input of CPU module, and keeps them in the SD memory card, and data memory or battery backed built-in RAM of the CPU module.

The event information collected by the CPU module can be displayed on GX Works3 to check the occurrence history in chronological order.

Event type	Classification	Description
System	Error	An error detected by the self diagnostics in each module.

Setting procedure

The event history function can be set from the event history setting window of GX Works3. For the setting procedure, refer to the following.

 MELSEC iQ-F FX5 User's Manual (Application)

Displaying event history

Access the menu of GX Works3. For details on the operating procedure and how to view the contents, refer to the following.

 GX Works3 Operating Manual

7.4 Functions (Analog output)

This section describes the functions of the built into analog the FX5U CPU module and the setting procedures for those functions.

Processing of each function

The functions are processed in the order shown below.

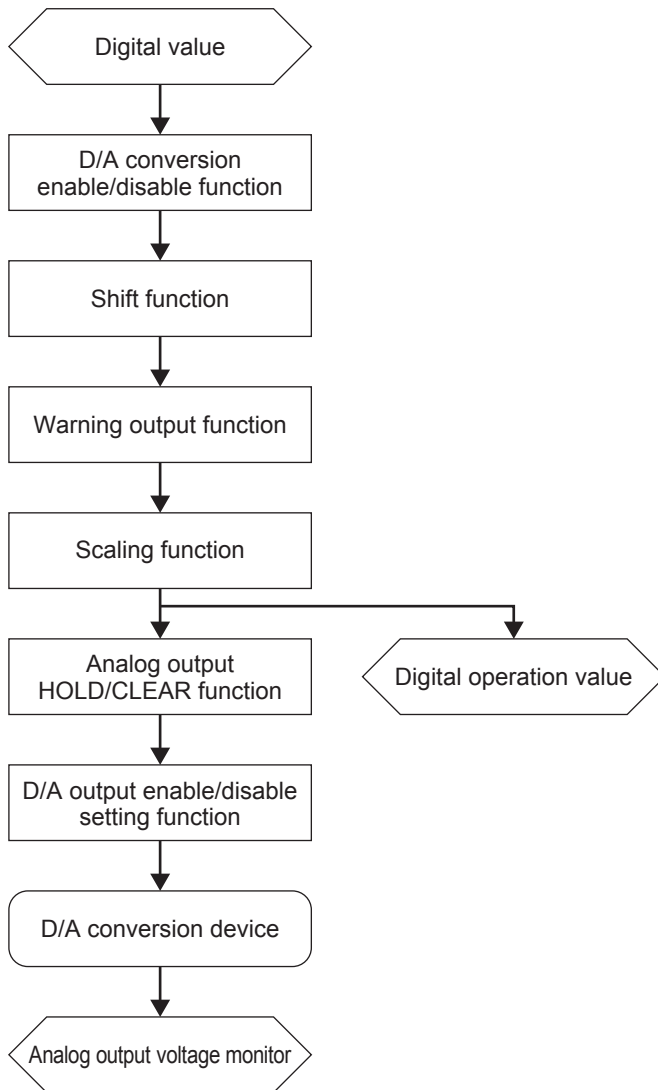

Digital value

Digital input values are stored.

Digital operation value

These values are obtained by operating a digital value using the scaling function or shift function. When neither function is used, the same value as the digital value is stored.

Analog output voltage monitor

The output analog value is displayed. Voltage and current are displayed in the following units.

Voltage: mV

D/A Conversion Enable/Disable Function

Function to enable or disable D/A conversion per channel.

When analog output is not used, the conversion process time can be reduced by disabling conversion.

Corresponding devices

The devices which are used by the function to enable/disable D/A conversion are listed below.

Name	CH1
D/A conversion enable/disable setting	SM6180

Setting methods

D/A conversion is enabled/disabled for each channel by the setting to enable/disable D/A conversion.

Name	Allowable setting range	Default value
D/A conversion enable/disable setting	0: Enable D/A conversion	1: Disable D/A conversion
	1: Disable D/A conversion	

Operation

The digital output is converted to an analog signal only for the channel(s) which have been enabled for D/A conversion by the setting to enable/disable D/A conversion, and the channels for which D/A output is turned on output on the basis of the converted analog values.

D/A Output Enable/Disable Setting Function

Specifies whether to output the D/A conversion value or output an offset value (HOLD setting value) for each channel.

Corresponding devices

The devices which are used by the function to enable/disable D/A output are listed below.

Name	CH1
D/A output enable/disable setting	SM6181

Setting methods

D/A output is enabled/disabled for each channel by the setting to enable/disable D/A output.

Name	Allowable setting range	Default value
D/A output enable/disable setting	0: Enable D/A output	1: Disable D/A output
	1: Disable D/A output	

Operation

Output is based on the digital output value only for the channel(s) which have been enabled for D/A output by the setting to enable/disable D/A output. An offset value (HOLD setting value) is output when the D/A output enable/disable flag is set to disable D/A output.

Analog Output HOLD/CLEAR Function

Sets the digital value of D/A conversion to the clears the value (0), previous value (hold) or setting value depending on the operation status of the CPU module (RUN, STOP, and STOP error).

Corresponding devices

The devices which are used by the analog output HOLD/CLEAR function are listed below.

Name	CH1
D/A conversion enable/disable setting	SM6180
HOLD/CLEAR setting	SD6183
HOLD setting value	SD6184

Setting methods

The procedure to use the analog output HOLD/CLEAR function is described below.

1. Disable D/A conversion.

Name	Allowable setting range	Default value
D/A conversion enable/disable setting	0: Enabled	1: Disabled
	1: Disabled	

2. Set the HOLD/CLEAR function setting.

Set for the HOLD/CLEAR function setting.

Name	Allowable setting range	Default value
HOLD/CLEAR function setting	0: CLEAR	0
	1: Previous Value (Hold)	
	2: Setting Value	

3. Set the HOLD setting value.

It is the above 2, and when "2: Setting Value" is chosen, a value is set to HOLD setting value.

Name	Allowable setting range	Default value
HOLD setting value	-32768 to +32767	0

4. Enable D/A conversion.

Operation

The following table lists the resulting analog output status depending on the combined configuration of the analog output HOLD/CLEAR function and the D/A output enable/disable flag.

CPU module status	D/A output enable/disable setting	HOLD/CLEAR setting	Output status
RUN	Enabled	All settings	Shift and scaling value
	Disabled	All settings	0
STOP	Enabled	CLEAR	0
	Enabled	Previous Value (Hold)	Shift and scaling value
	Enabled	Setting Value	Output the value set for the HOLD setting value
	Disabled	All settings	0
PAUSE	Enabled	All settings	Shift and scaling value
	Disabled	All settings	0
Error occurs when RUN state cannot operate	Enabled	All settings	0
	Disabled	All settings	0

Analog Output Test when CPU Module is in STOP Status Function

Outputs a user-defined analog value by setting the output enable/disable flag to enabled and changing the digital value, when the CPU module is stopped.

Corresponding devices

The devices that are used by analog test function when the CPU module is stopped are listed below.

Name	CH1
D/A conversion enable/disable setting	SM6180
D/A output enable/disable setting	SM6181
Digital value	SD6180

Setting methods

The procedure to use the analog test function is described below.

1. Change the operation conditions setting.

The following conditions must be satisfied to enable the analog output test.

Description	Setting value
D/A conversion enable/disable	Conversion enabled
D/A output enable/disable	Output enabled

2. Update the digital value.

Set the digital value corresponding to the analog value desired to be output as a digital value.

Operation

The digital input value will be converted to an analog signal and output regardless of whether the CPU module in the RUN state or STOP state.

The settings for the shift function, scaling function, and warning output function are valid during the analog output test.

Precautions

Even when the analog output HOLD/CLEAR function is operating, analog output can be changed by this function.

Scaling Function

Function that converts user-defined maximum and minimum digital values in accordance with a configured scale.

Corresponding devices

The devices which are used by the scaling function are listed below.

Name	CH1
Scaling enable/disable setting	SM6188
Scaling upper limit value	SD6188
Scaling lower limit value	SD6189

Setting methods

The procedure to use the scaling function is described below.

1. Disable scaling.

Name	Allowable setting range	Default value
Scaling enable/disable setting	0: Enabled	1: Disabled
	1: Disabled	

2. Set the scaling upper limit value/scaling lower limit value.

The allowable setting range is shown in the following table.

Name	Allowable setting range	Default value
Scaling upper limit value	-32768 to +32767	0
Scaling lower limit value	(upper limit value ≠ lower limit value)	

3. Enable scaling.

Operation

Scaling is performed on the resulting value after shift processing is performed on the set digital value using the scaling upper limit value and scaling lower limit value. The value resulting after scaling is used for the D/A conversion.

An example of scaling setting is shown below.

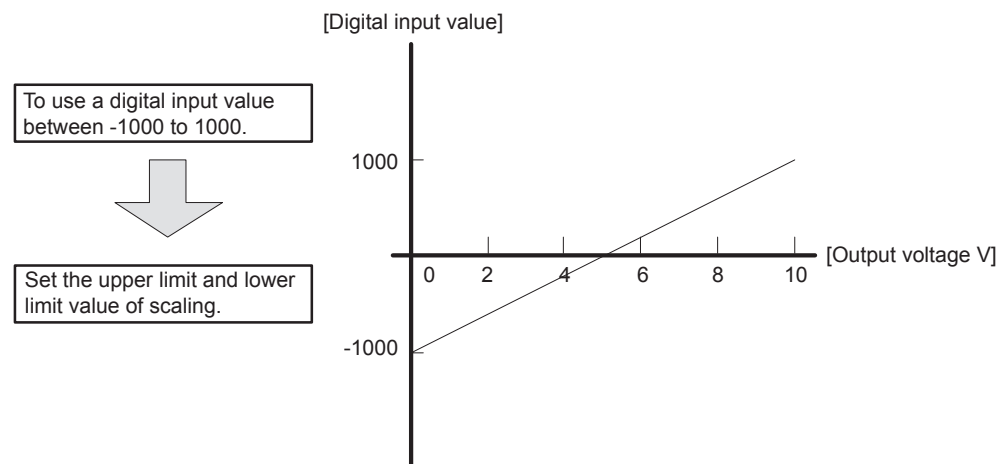

■ Calculation method of the scaling value

When using the factory settings for the output range.

$$\text{Value after scaling} = \frac{4000}{\text{Scaling upper limit value} - \text{scaling lower limit value}} \times (\text{digital input value} - \text{scaling lower limit value})$$

Shift Function

Function that adds the set input value shift amount to the digital value.

Changes to the input value shift amount will be reflected in the digital operation value in real time, which enables fine adjustments to be easily made during system startup.

Corresponding devices

The devices which are used by the shift function are listed below.

Name	CH1
Input value shift amount	SD6190

Setting methods

Set the desired input value shift amount when performing a shift addition.

Name	Allowable setting range	Default value
Input value shift amount	-32768 to +32767	0

Operation

When the added digital value resulting from the shift processing exceeds the range between -32768 to +32767, the value is set to the lower limit (-32768) or the upper limit (32767).

After the value is written for the input value shift amount, the input value shift amount is added to the digital value.

7

Precautions

The scaling function and the warning output function executes for the digital value with the added shift amount.

Warning Output Function

Function that checks the digital value set for output against the warning output upper limit and lower limit values previously configured for each channel, and outputs a warning when the value is outside the set range.

Corresponding devices

The devices which are used by the warning output function are listed below.

Name	CH1
Warning output upper limit value flag	SM6191
Warning output lower limit value flag	SM6192
Warning output setting	SM6193
D/A conversion alarm clear request	SM6217
D/A conversion alarm flag	SM6218
Warning output upper limit value	SD6191
Warning output lower limit value	SD6192
D/A conversion latest alarm code	SD6218

Setting methods

The procedure to use the warning output function is described below.

1. Disable the warning output setting.

Name	Allowable setting range	Default value
Warning output setting	0: Enabled	1: Disabled
	1: Disabled	

2. Set the warning output upper limit value and warning output lower limit value.

Warning output upper limit value and warning output lower limit value can be set for each channel using the warning output function.

Name	Allowable setting range	Default value
Warning output upper limit value	-32768 to +32767 (upper limit value > lower limit value)	0
Warning output lower limit value		

3. Enable the warning output setting.

Operation

The judgment to output a warning is based on the value resulting after shift processing is performed on the digital input value. The warning output upper limit value flag turns ON for the appropriate channel when the input digital value exceeds the warning output upper limit value, and the warning output lower limit value flag turns ON when the input digital value is less than the warning output lower limit value.

Details of the warning output upper limit value flag are shown in the table below.

Name	Allowable setting range
Warning output upper limit value flag	0: Normal
	1: Upper limit alarm ON

Details of the warning output lower limit value flag are shown in the table below.

Name	Allowable setting range
Warning output lower limit value flag	0: Normal
	1: Lower limit alarm ON

The set warning output upper and lower limit values are used as the digital values for D/A conversion when there is a warning. After a warning occurs and the digital value becomes less than the warning output upper limit value or larger than the warning output lower limit value, the analog output value returns to the normal value. However, the warning output upper limit flag, the warning output lower limit flag, D/A conversion alarm occurrence flag and alarm code stored in "D/A conversion latest alarm code" are not cleared.

The following describes the procedure to clear the warning output.

After setting the digital value to less than the warning output upper limit value or larger than the warning output lower limit value, cycle the D/A conversion alarm clear request through OFF → ON → OFF.

Precautions

- When using the scaling function and the shift function, the digital value resulting after scaling and adding the shift is detected for warning. Make sure to set the warning output upper limit and lower limit values with regard to scaling and shift additions.
- A warning will be output when the digital value exceeds the warning output upper limit value or when it is less than the warning output lower limit value.

Event History Function

This function collects errors from built-in analog output of CPU module, and keeps them in the SD memory card, and data memory or battery backed built-in RAM of the CPU module.

The event information collected by the CPU module can be displayed on GX Works3 to check the occurrence history in chronological order.

Event type	Classification	Description
System	Error	An error detected by the self diagnostics in each module.

Setting procedure

The event history function can be set from the event history setting window of GX Works3. For the setting procedure, refer to the following.

📖 MELSEC iQ-F FX5 User's Manual (Application)

Displaying event history

Access the menu of GX Works3. For details on the operating procedure and how to view the contents, refer to the following.

📖 GX Works3 Operating Manual

7.5 Procedure to Execute the Built-in Analog Function

The procedure to execute the built-in analog function is described below.

1. Confirm the specifications of the built-in analog function.

Confirm the specifications of the built-in analog function. (📖 Page 410 Specifications)

2. Connect the CPU module to the external device.

Wiring to external devices. (📖 Page 430 Wiring)

3. Set the parameters.

Set the parameters to configure the built-in analog function. (📖 Page 432 Parameter Setting)

4. Create the program.

Create the program to use the built-in analog function.

5. Run the program.

Precautions

Do not write to the special relay/special register in the user interrupt program.

7.6 Wiring

This section describes the wiring.

European-type terminal block

Wire the European-type terminal block in accordance with the following specifications.

Suitable wiring

Number of wires connected per terminal	Wire size		Tightening torque
	Solid wire, Stranded wire	Wire ferrule with insulation sleeve	
One wire	0.2 to 0.5 mm ² (AWG24 to 20)	0.2 to 0.5 mm ² (AWG24 to 20)	0.22 to 0.25 N·m
Two wires	0.2 mm ² (AWG24)	—	

Precautions

Do not tighten terminal screws with torque exceeding the specified range. Failure to do so may cause equipment failures or malfunctions.

Wire end treatment

Treat stranded and solid wires as they are or use wire ferrules with insulation sleeves for wiring terminals.

■When stranded and solid wires are treated as they are

- Twist the end of stranded wires and make sure that there are no loose wires.
- Do not solder-plate the electric wire ends.

Stripping dimensions of electric wire ends

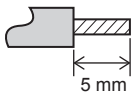

■When wire ferrules with insulation sleeves are used

Depending on the thickness of a wiring sheath used, it may be difficult to insert the sheath into an insulation sleeve. Refer to the external dimensions as a reference to select wires.

External dimension of wire ferrules with insulation sleeves

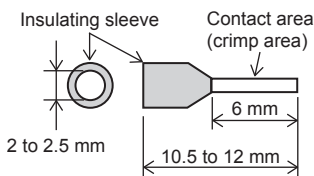

<Reference>

Manufacturer	Model	Crimp tool
Phoenix Contact GmbH & Co. KG	AI 0.5-6 WH	CRIMPFOX 6 CRIMPFOX 6T-F

■Tool

For tightening terminals, use a small, commercially-available screwdriver with a straight tip. The recommended shape is shown in the figure on the right.

■Precautions

When a precision screwdriver with a small grip is used, the specified tightening torque cannot be obtained. Use the following screwdriver or equivalent product (grip diameter: 25 mm) to obtain the tightening torque specified above.

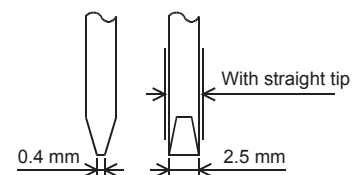

<Reference>

Manufacturer	Model
Phoenix Contact GmbH & Co. KG	SZS 0.4×2.5

Terminal layout

The following table shows the terminal layout.

Terminal block	Signal name	Function		
	Analog input	V1+	CH1	Voltage input (+)
		V2+	CH1	Voltage input (+)
		V-	CH1/CH2	Voltage input (-)
	Analog output	V+	CH1	Voltage output (+)
		V-	CH1	Voltage output (-)

Analog input wiring

The following figures show wiring of the analog input.

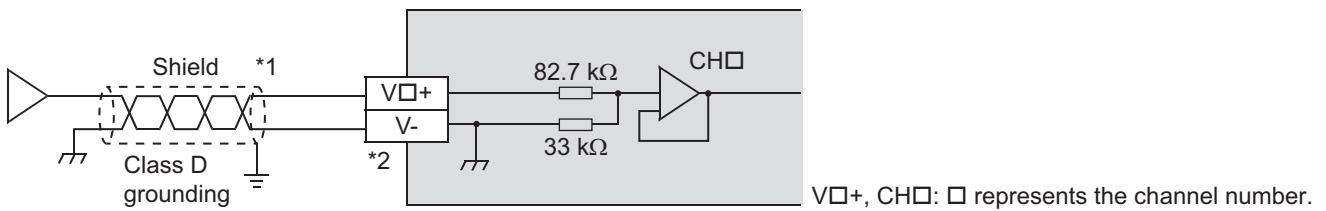

- *1 For analog input wiring, use shielded twisted-pair cables (double-core type). Separate them from other power lines or lines which can be induced by others.
- *2 For unused channels, short-circuit the "V□+" and "V-" terminals.

Analog output wiring

The following figures show wiring of the analog output.

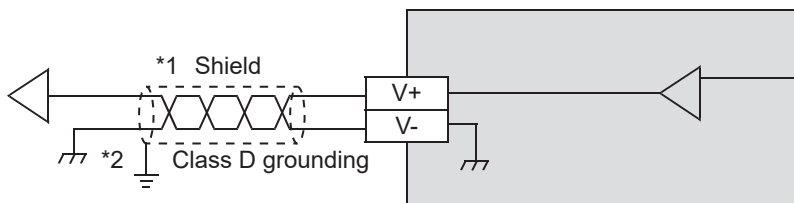

- *1 For analog output wiring, use shielded twisted-pair cables (double-core type). Separate them from other power lines or lines which can be induced by others.
- *2 Ground a shielded cable at one point on the signal receiving side.

Grounding

Perform the following.

- Perform class D grounding (Grounding resistance: 100 Ω or less).
- Ground the PLC independently when possible.

If the PLC cannot be grounded independently, perform the "Shared grounding" shown below.

For the details, refer to the following manual.

📖 MELSEC iQ-F FX5U User's Manual (Hardware)

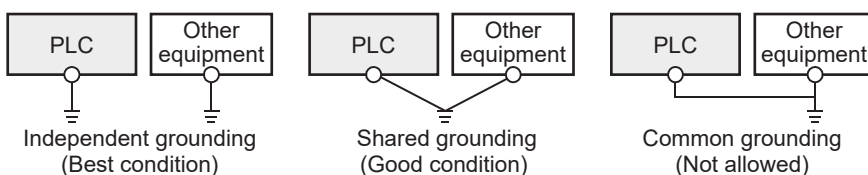

- Use a grounding wire with thickness of AWG 14 (2 mm²) or thicker.
- Bring the grounding point close to the PLC as much as possible so that the ground cable can be shortened.

7.7 Parameter Setting

Set the parameters of each channel.

Setting parameters here eliminates the need to program them.

Point

Parameters are enabled when the CPU module is powered ON or after a reset. In addition, operations different from the parameter settings are possible by transferring values to special relays and special registers while changing these values in the program.

Refer to Page 438 List of Special Relays or Page 439 List of Special Registers for details on the special relays and special registers.

Basic settings (Analog input)

Setting procedure

Open "Basic Settings" of the GX Works3.

1. Start Module parameter.

Navigation window ⇒ [Parameter] ⇒ [FX5UCPU] ⇒ [Module Parameter] ⇒ [Analog Input] ⇒ "Basic Settings"

Window

Item	CH1	CH2
A/D Conversion Enable/Disable Setting Function	Set AD conversion control method.	
A/D Conversion Enable/Disable Setting	Disable	Disable
A/D Conversion Method	Set AD conversion control method.	
Average Processing Specify	Sampling	Sampling
Time Average Counts Average Moving Average	0 Times	0 Times

Displayed items

Item	Description	Setting range	Default
A/D Conversion Enable/Disable Setting	Set whether to "enable" or "disable" A/D conversion value output.	<ul style="list-style-type: none"> • Enable • Disable 	Disable
Average Processing Specify	Execute whether to set "average process" or "sampling processing".	<ul style="list-style-type: none"> • Sampling • Time Average • Count Average • Moving average 	Sampling
Time Average Counts Average Moving average	Set time average, count average, moving average counts during specifying average process for each channel.	User-defined value for the allowable setting range	0

2. Click the item to be changed to enter the setting value.

- Item where a value is selected from the pull-down list

Click [▼] button of the item to be set, and from the pull-down list that appears, select the value.

- Item where a value is entered into the text box

Double-click the item to be set to enter the numeric value.

Application setting (Analog input)

Setting procedure

Open "Application Settings" of the GX Works3.

1. Start Module parameter.

Navigation window ⇒ [Parameter] ⇒ [FX5UCPU] ⇒ [Module Parameter] ⇒ [Analog Input] ⇒ "Application settings"

Window

Item	CH1	CH2
Warning Output Function	Execute the setting related to warning at A/D conversion.	
Process Alarm Warning Setting	Disable	Disable
Process Alarm Upper Upper Limit Value	0	0
Process Alarm Upper Lower Limit Value	0	0
Process Alarm Lower Upper Limit Value	0	0
Process Alarm Lower Lower Limit Value	0	0
Over Scale Detection	Execute the setting related to analog input value detection which exceeds the setting ra	
Over Scale Detection Enable/Disable	Enable	Enable
Scaling Setting	Execute the setting related to scaling at A/D conversion.	
Scaling Enable/Disable	Disable	Disable
Scaling Upper Limit Value	0	0
Scaling Lower Limit Value	0	0
Shift Function	Execute the setting related to shift function at A/D conversion.	
Shifting Amount	0	0
Digital Clip Setting	Execute the setting related to digital clip function at A/D conversion.	
Digital Clip Enable/Disable	Disable	Disable

Displayed items

Item	Description	Setting range	Default
Process Alarm Warning Setting	Set whether to "enable" or "disable" process alarm warning.	<ul style="list-style-type: none"> Enable Disable 	Disable
Process Alarm Upper Upper Limit Value	Set upper upper limit value of digital output value.	-32768 to +32767	0
Process Alarm Upper Lower Limit Value	Set upper lower limit value of digital output value.	-32768 to +32767	0
Process Alarm Lower Upper Limit Value	Set lower upper limit value of digital output value.	-32768 to +32767	0
Process Alarm Lower Lower Limit Value	Set lower lower limit value of digital output value.	-32768 to +32767	0
Over Scale Detection Enable/Disable	Set whether to "enable" or "disable" over scale detection.	<ul style="list-style-type: none"> Enable Disable 	Enable
Scaling Enable/Disable	Set whether to "enable" or "disable" scaling.	<ul style="list-style-type: none"> Enable Disable 	Disable
Scaling Upper Limit Value	Set scaling conversion upper limit value.	-32768 to +32767	0
Scaling Lower Limit Value	Set scaling conversion lower limit value.	-32768 to +32767	0
Shifting Amount	Set shifting amount for shifting function.	-32768 to +32767	0
Digital Clip Enable/Disable	Whether to "enable" or "disable" the digital clip.	<ul style="list-style-type: none"> Enable Disable 	Disable

2. Click the item to be changed to enter the setting value.

- Item where a value is selected from the pull-down list

Click [▼] button of the item to be set, and from the pull-down list that appears, select the value.

- Item where a value is entered into the text box

Double-click the item to be set to enter the numeric value.

Basic settings (Analog output)

Setting procedure

Open "Basic settings" of the GX Works3.

1. Start Module parameter.

Navigation window ⇒ [Parameter] ⇒ [FX5UCPU] ⇒ [Module Parameter] ⇒ [Analog Output] ⇒ "Basic Settings"

Window

Item	CH
<input type="checkbox"/> D/A Conversion Enable/Disable Setting Function D/A Conversion Enable/Disable Setting	Set D/A conversion control method. Disable
<input type="checkbox"/> D/A Output Enable/Disable Setting D/A Output Enable/Disable Setting	Set D/A output conversion control method. Disable

Displayed items

Item	Description	Setting range	Default
D/A Conversion Enable/Disable Setting	Set whether to "enable" or "disable" D/A conversion.	<ul style="list-style-type: none"> • Enable • Disable 	Disable
D/A Output Enable/Disable Setting	Set whether to "enable" or "disable" D/A output.	<ul style="list-style-type: none"> • Enable • Disable 	Disable

2. Click the item to be changed to enter the setting value.

- Item where a value is selected from the pull-down list

Click [▼] button of the item to be set, and from the pull-down list that appears, select the value.

- Item where a value is entered into the text box

Application setting (Analog output)

Setting procedure

Open "Application settings" of the GX Works3.

1. Start Module parameter.

Navigation window ⇒ [Parameter] ⇒ [FX5UCPU] ⇒ [Module Parameter] ⇒ [Analog Output] ⇒ "Application settings"

Window

Item	
Warning Output Function	Execute the setting related to warning at D/A conversion.
Warning Output Setting	Disable
Warning Upper Limit Value	0
Warning Lower Limit Value	0
Scaling Setting	Execute the setting related to scaling at D/A conversion.
Scaling Enable/Disable	Disable
Scaling Upper Limit Value	0
Scaling Lower Limit Value	0
Shift Function	Execute the setting related to shift function at D/A conversion.
Shift Value to Conversion Value	0
Analog Output HOLD/CLEAR Setting	It can be set whether to HOLD the last value, setting value or C
HOLD/CLEAR Setting	CLEAR
HOLD Setting Value	0

Displayed items

Item	Description	Setting range	Default
Warning Output Setting	Set whether to "enable" or "disable" warning output.	• Enable • Disable	Disable
Warning Upper Limit value	Set upper limit value of digital input value for warning output.	-32768 to +32767	0
Warning Lower Limit value	Set lower limit value of digital input value for warning output.	-32768 to +32767	0
Scaling Enable/Disable	Set whether to "enable" or "disable" scaling.	• Enable • Disable	Disable
Scaling Upper Limit Value	Set scaling conversion upper limit value.	-32768 to +32767	0
Scaling Lower Limit Value	Set scaling conversion lower limit value.	-32768 to +32767	0
Shift Value to Conversion Value	Set shifting amount for shifting function.	-32768 to +32767	0
HOLD/CLEAR Setting	Set output status at CLEAR or HOLD.	• CLEAR • Previous Value (Hold) • Setting Value	CLEAR
HOLD Setting Value	Set digital value that output at HOLD when "setting value" is selected in "HOLD/CLEAR Setting".	-32768 to +32767	0

2. Click the item to be changed to enter the setting value.

- Item where a value is selected from the pull-down list

Click [▼] button of the item to be set, and from the pull-down list that appears, select the value.

- Item where a value is entered into the text box

7.8 List of Error Code

The following table shows the error codes stored.

Analog input

□: This symbol indicates the number of the channel where a error has occurred. (1: CH1 to 2: CH2)

Error code	Error name	Description and cause	Action
0000H	—	There is no error.	—
1A0□H	Averaging process specification setting range error	A value other than 0 to 3 is set in CH□ Averaging process specification.	Set CH□ Averaging process specification to 0 to 3.
1A1□H	Time average setting range error	When the time average is selected in CH□ Averaging process specification, a value other than 1 to 10000 is set in CH□ Time average/Count average/Moving average setting.	Set CH□ Time average/Count average/Moving average setting to 1 to 10000.
1A2□H	Count average setting range error	When the count average is selected in CH□ Averaging process specification, a value other than 4 to 32767 is set in CH□ Time average/Count average/Moving average setting.	Set CH□ Time average/Count average/Moving average setting to 4 to 32767.
1A3□H	Moving average count setting range error	When the moving average is selected in CH□ Averaging process specification, a value other than 2 to 64 is set in CH□ Time average/Count average/Moving average setting.	Set CH□ Time average/Count average/Moving average setting to 2 to 64.
1A4□H	Process alarm upper lower limit value setting range error	The values set in CH□ Process alarm upper upper limit value to CH□ Process alarm lower lower limit value do not satisfy the following condition: Upper upper limit value ≥ Upper lower limit value ≥ Lower upper limit value ≥ Lower lower limit value	Set CH□ Process alarm upper upper limit value to CH□ Process alarm lower lower limit value so that the values satisfy the following condition: Upper upper limit value ≥ Upper lower limit value ≥ Lower upper limit value ≥ Lower lower limit value
1A7□H	Scaling upper and lower limit value setting error	CH□ Scaling upper limit value and CH□ Scaling lower limit value are equal.	Reset CH□ Scaling upper limit value or CH□ scaling lower limit value such that Scaling upper limit value ≠ Scaling lower limit value.

Analog output

Error code	Error name	Description and cause	Action
0000H	—	There is no error.	—
1B01H	Scaling upper/lower limit value setting error	Values that do not satisfy the following relation are set in warning output upper limit value and warning output lower limit value: Upper limit value > Lower limit value	Set the warning output upper limit value and warning output lower limit value so that upper limit value > lower limit value.
1B11H	HOLD output state setting range error	A value other than 0, 1 or, 2 was set in the HOLD/CLEAR function setting.	Set a value between 0 and 2 to the HOLD/CLEAR function setting.
1B21H	HOLD output set value range error	The HOLD output set value is outside the range between the scaling lower limit value and scaling upper limit value.	Specify the HOLD output set value to fall within the range between the scaling lower limit value and scaling upper limit value.
1B71H	Scaling upper and lower limit value setting error	Scaling upper limit value and Scaling lower limit value are equal.	Reset Scaling upper limit value or scaling lower limit value such that Scaling upper limit value ≠ Scaling lower limit value.

7.9 List of Alarm Code

The following table shows the list of the alarm codes stored.

Analog input

□: This symbol indicates the number of the channel where an alarm has occurred. (1: CH1 to 2: CH2)

Alarm code	Alarm name	Description and cause	Action
080□H	Process alarm (upper limit)	The process alarm (upper limit) has occurred in CH□.	When the digital operation value returns from the warning output range, the warning output flag automatically changes to "0: Normal". Afterwards, alarm can be cleared by turning ON the alarm clear request.
081□H	Process alarm (lower limit)	The process alarm (lower limit) has occurred in CH□.	
090□H	Over-limit detection flag	An over-limit has occurred in CH□.	If the alarm clear request is turned ON after the analog input value falls within the set range, all the over-limit detection flags are set to "0: Normal" and the alarm code in the A/D conversion latest alarm code is cleared.
0F0□H	Changing the setting with setting change not allowed	The setting was changed when setting change was not allowed.	Change the setting with setting change allowed.

Analog output

Alarm code	Alarm name	Description and cause	Action
0801H	Warning output alarm (upper limit)	The warning output alarm (upper limit) has occurred.	When the digital operation value returns from the warning output range, the warning output flag automatically changes to "0: Normal". Afterwards, alarm can be cleared by turning ON the alarm clear request.
0811H	Warning output alarm (lower limit)	The warning output alarm (lower limit) has occurred.	
0F01H	Changing the setting with setting change not allowed	The setting was changed when setting change was not allowed.	Change the setting with setting change allowed.

7.10 List of Special Relays

This section describes the special relays used for analog input and output.

Special relays for analog input

Special relays		Description	R/W
CH1	CH2		
SM6020	SM6060	A/D conversion completed flag	R
SM6021	SM6061	A/D conversion enable/disable setting	R/W
SM6022	SM6062	Scaling over detection flag	R
SM6024	SM6064	Over scale detection enable/disable setting	R/W
SM6025	SM6065	Maximum value/minimum value reset completed flag	R
SM6026	SM6066	Maximum value reset request	R/W
SM6027	SM6067	Minimum value reset request	R/W
SM6028	SM6068	Scaling enable/disable setting	R/W
SM6029	SM6069	Digital clipping enable/disable setting	R/W
SM6031	SM6071	Warning output flag (process alarm upper limit)	R
SM6032	SM6072	Warning output flag (process alarm lower limit)	R
SM6033	SM6073	Warning output setting (process alarm)	R/W
SM6057	SM6097	A/D conversion alarm clear request	R/W
SM6058	SM6098	A/D conversion alarm flag	R
SM6059	SM6099	A/D conversion error flag	R

R/W: Read/Write

R: Read only

Special relays for analog output

Special relays		Description	R/W
SM6180			
SM6181		D/A output enable/disable setting	R/W
SM6188		Scaling enable/disable setting	R/W
SM6191		Warning output upper limit value flag	R
SM6192		Warning output lower limit value flag	R
SM6193		Warning output setting	R/W
SM6217		D/A conversion alarm clear request	R/W
SM6218		D/A conversion alarm flag	R
SM6219		D/A conversion error flag	R

R/W: Read/Write

R: Read only

7.11 List of Special Registers

This section describes the special registers used for analog input and output.

Special registers for analog input

Special registers		Description	R/W
CH1	CH2		
SD6020	SD6060	Digital output value	R
SD6021	SD6061	Digital operation value	R
SD6022	SD6062	Analog input voltage monitor	R
SD6023	SD6063	Average processing specify	R/W
SD6024	SD6064	Time Average/Count Average/Moving Average setting	R/W
SD6026	SD6066	Maximum value	R
SD6027	SD6067	Minimum value	R
SD6028	SD6068	Scaling upper limit value	R/W
SD6029	SD6069	Scaling lower limit value	R/W
SD6030	SD6070	Conversion value shift amount	R/W
SD6031	SD6071	Process alarm upper upper limit value	R/W
SD6032	SD6072	Process alarm upper lower limit value	R/W
SD6033	SD6073	Process alarm lower upper limit value	R/W
SD6034	SD6074	Process alarm lower lower limit value	R/W
SD6058	SD6098	A/D Conversion latest alarm code	R
SD6059	SD6099	A/D Conversion latest error code	R

R/W: Read/Write

R: Read only

Special registers for analog output

Special registers		Description	R/W
SD6180			
SD6181		Digital operation value	R
SD6182		Analog output voltage monitor	R
SD6183		HOLD/CLEAR function setting	R/W
SD6184		HOLD setting value	R/W
SD6188		Scaling upper limit value	R/W
SD6189		Scaling lower limit value	R/W
SD6190		Input value shift amount	R/W
SD6191		Warning output upper limit value	R/W
SD6192		Warning output lower limit value	R/W
SD6218		D/A conversion latest alarm code	R
SD6219		D/A conversion latest error code	R

R/W: Read/Write

R: Read only

7.12 How to use analog inputs built in CPU module for current inputs

The analog input of the built-in analog can be used as the current input (4 to 20 mA DC) for the FX5U CPU module.

Method of using the FX5U CPU module for current inputs (4 to 20 mA DC)

The FX5U CPU module is designed to handle only voltage inputs.

However, the FX5U CPU module can be used for current inputs by connecting a 250 Ω resistor (Precise resistance: 0.5%) between the V□+ terminal and the V- terminal.

Example of wiring

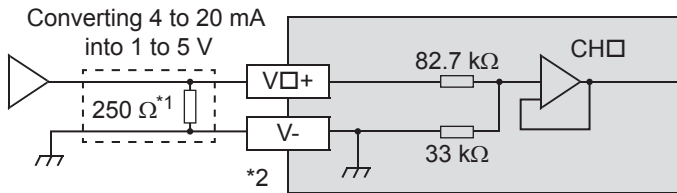

CH No. goes in □ of V□+, CH□.

- *1 Instead of a 250 Ω resistor, a 500 Ω resistor can be connected in parallel. When selecting a resistor, consider the maximum input current.
- *2 For unused channels, short-circuit the "V□+" and "V-" terminals.

Specifications

Item	Specifications
Analog input	4 to 20 mA DC
Digital output	400 to 2000*1
Resolution	10 μA
Absolute maximum input	-2 mA, +60 mA

*1 The digital output value can be changed using the scaling function.

Example of using the scaling signal

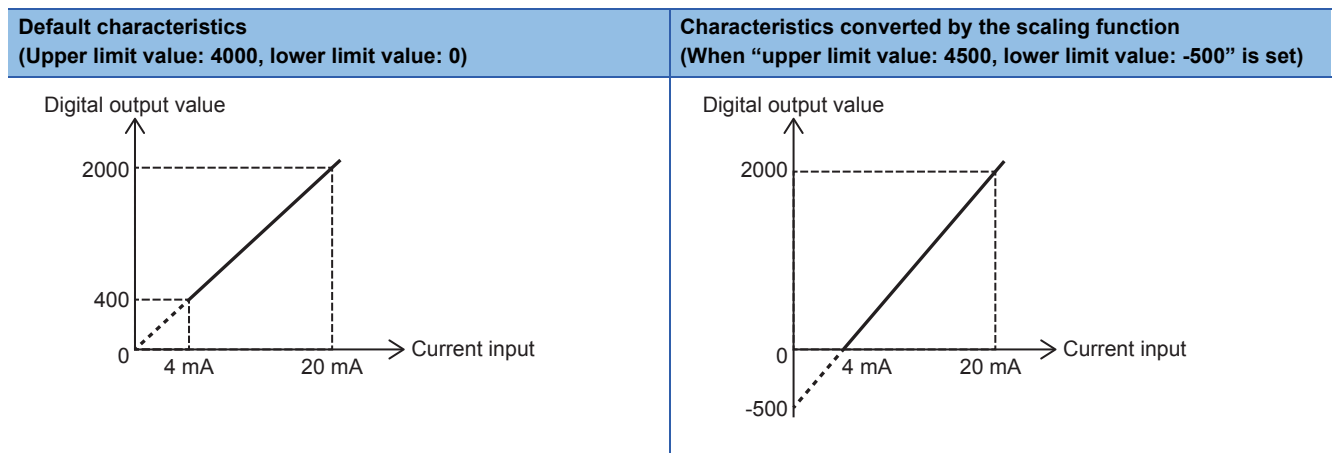

For details of the scaling function, refer to Page 417 Scaling Function.

APPENDIX

Appendix 1 Added and Enhanced Functions

The functions added or changed with the CPU module and engineering tool, and the supported CPU modules' firmware version and engineering tool software version are given below.

The firmware version can be confirmed with module diagnosis (CPU diagnosis). Refer to the following manuals for details on diagnosing the module (CPU diagnosis).

📖 MELSEC iQ-F FX5UJ User's Manual (Hardware)

📖 MELSEC iQ-F FX5U User's Manual (Hardware)

📖 MELSEC iQ-F FX5UC User's Manual (Hardware)

Refer to the 📖 GX Works3 Operating Manual for details on the software version.

FX5UJ CPU module

Add/Change Function	Supported CPU module firmware version	Supported engineering tool software version	Reference
FX5UJ CPU module is supported.	From the first	"1.060N" and above	—
FX5-4A-ADP is supported.	"1.010" and above	"1.075D" and above	Page 281

FX5U/FX5UC CPU module

Add/Change Function	Supported CPU module firmware version	Supported engineering tool software version	Reference
Event history function	"1.040" and above	"1.030G" and above	—
FX5-4AD-PT-ADP is supported.	"1.040" and above	"1.030G" and above	Page 102
FX5-4AD-TC-ADP is supported.	"1.040" and above	"1.030G" and above	Page 164
FX5-4A-ADP is supported.	"1.240" and above	"1.075D" and above	Page 281

A

INDEX

A

- A/D conversion enable/disable setting function
..... 33,294,414
- A/D conversion method 33,295,414
- Accuracy of A/D conversion 29,289,411
- Accuracy of D/A conversion 233,289
- Accuracy of temperature conversion
(resistance temperature detector) 103
- Accuracy of temperature conversion (thermocouple)
..... 165
- Alarm output function 112,174
- Analog output HOLD/CLEAR function . 237,323,424
- Analog output test when CPU module is in STOP status
function 238,324,425

C

- Convergence detection function 50,312
- Conversion enable/disable setting function . 106,168
- Current input characteristic 28,285
- Current output characteristic 232,288

D

- D/A conversion enable/disable function
..... 236,322,423
- D/A output enable/disable setting function
..... 236,322,423
- Deviation detection between channel function
..... 51,313
- Digital clipping function 41,303,419
- Digital operation value 32,235,293,321,413
- Digital output value 32,293,413
- Disconnection detection function
..... 48,110,172,243,310,330

E

- Event history function
..... 52,117,179,245,338,421,429
- External power supply disconnection detection function
..... 243,329

M

- Maximum value/minimum value hold function
..... 42,123,185,304,419
- Measured temperature value 105,167

O

- Offset/gain initialization function
..... 56,122,184,250,319,337
- Offset/gain setting function
..... 53,118,180,245,314,332
- Over scale detection function 35,297,416

P

- Process alarm 43,112,305

R

- Range switching function 32,235,293,321
- Rate alarm 45,114,307

S

- Scaling function 37,239,299,325,417,426
- Shift function 40,241,302,327,418,427

T

- Temperature conversion method 107,169
- Temperature resistance choice function 109
- Temperature unit choice function 106,168
- Thermocouple type choice function 171

V

- Voltage input characteristic 26,283
- Voltage output characteristic 230,286

W

- Warning output function. . 43,242,305,328,420,427

MEMO

REVISIONS

Revision date	Revision	Description
January 2015	A	First Edition
April 2015	B	A part of the cover design is changed.
May 2016	C	<ul style="list-style-type: none"> ■Added or modified parts RELEVANT MANUALS, TERMS, Section 2.1, 3.1, 4.1, 4.12
October 2016	D	<ul style="list-style-type: none"> ■Added models FX5-4AD-PT-ADP, FX5-4AD-TC-ADP ■Added functions Event history function ■Added or modified parts Terms, Chapter 1, Section 2.1, 2.2, 2.3, 2.4, 2.6, 2.7, Chapter 3, 4, Section 5.2, 5.3, 5.4, 5.5, 5.7, 6.1, 6.2, 6.3, 6.4, 6.9, Appendix 1
May 2017	E	<ul style="list-style-type: none"> ■Added or modified parts RELEVANT MANUALS, TERMS
October 2019	F	<ul style="list-style-type: none"> ■Added models FX5UJ CPU module ■Added or modified parts RELEVANT MANUALS, TERMS, Chapter 1, Section 2.1, 2.3, 2.4, 2.5, 2.6, 2.7, 2.8, 2.9, 2.10, 2.11, 2.12, 2.13, 2.14, 3.1, 3.4, 3.5, 3.6, 3.7, 3.8, 3.9, 3.10, 3.11, 3.12, 3.13, 3.14, 4.1, 4.3, 4.4, 4.5, 4.6, 4.7, 4.8, 4.9, 4.10, 4.11, 4.12, 4.13, 4.14, 5.1, 5.3, 5.4, 5.5, 5.6, 5.7, 5.8, 5.9, 5.10, 5.11, 5.12, 5.13, 5.14, 6.1, 6.3, 6.4, 6.5, 6.8, Appendix 1, TRADEMARKS
April 2021	G	<ul style="list-style-type: none"> ■Added models FX5-4A-ADP ■Added or modified parts RELEVANT MANUALS, TERMS, Chapter 1, Section 2.1, 2.3, 3.3, 4.3, 5.1, 5.3, Chapter 6, Appendix 1

This manual confers no industrial property rights or any rights of any other kind, nor does it confer any patent licenses. Mitsubishi Electric Corporation cannot be held responsible for any problems involving industrial property rights which may occur as a result of using the contents noted in this manual.

© 2015 MITSUBISHI ELECTRIC CORPORATION

WARRANTY

Please confirm the following product warranty details before using this product.

1. Gratis Warranty Term and Gratis Warranty Range

If any faults or defects (hereinafter "Failure") found to be the responsibility of Mitsubishi occurs during use of the product within the gratis warranty term, the product shall be repaired at no cost via the sales representative or Mitsubishi Service Company. However, if repairs are required onsite at domestic or overseas location, expenses to send an engineer will be solely at the customer's discretion. Mitsubishi shall not be held responsible for any re-commissioning, maintenance, or testing on-site that involves replacement of the failed module.

[Gratis Warranty Term]

The gratis warranty term of the product shall be for one year after the date of purchase or delivery to a designated place. Note that after manufacture and shipment from Mitsubishi, the maximum distribution period shall be six (6) months, and the longest gratis warranty term after manufacturing shall be eighteen (18) months. The gratis warranty term of repair parts shall not exceed the gratis warranty term before repairs.

[Gratis Warranty Range]

- (1) The range shall be limited to normal use within the usage state, usage methods and usage environment, etc., which follow the conditions and precautions, etc., given in the instruction manual, user's manual and caution labels on the product.
- (2) Even within the gratis warranty term, repairs shall be charged for in the following cases.
 1. Failure occurring from inappropriate storage or handling, carelessness or negligence by the user. Failure caused by the user's hardware or software design.
 2. Failure caused by unapproved modifications, etc., to the product by the user.
 3. When the Mitsubishi product is assembled into a user's device, Failure that could have been avoided if functions or structures, judged as necessary in the legal safety measures the user's device is subject to or as necessary by industry standards, had been provided.
 4. Failure that could have been avoided if consumable parts (battery, backlight, fuse, etc.) designated in the instruction manual had been correctly serviced or replaced.
 5. Relay failure or output contact failure caused by usage beyond the specified life of contact (cycles).
 6. Failure caused by external irresistible forces such as fires or abnormal voltages, and failure caused by force majeure such as earthquakes, lightning, wind and water damage.
 7. Failure caused by reasons unpredictable by scientific technology standards at time of shipment from Mitsubishi.
 8. Any other failure found not to be the responsibility of Mitsubishi or that admitted not to be so by the user.

2. Onerous repair term after discontinuation of production

- (1) Mitsubishi shall accept onerous product repairs for seven (7) years after production of the product is discontinued.
Discontinuation of production shall be notified with Mitsubishi Technical Bulletins, etc.
- (2) Product supply (including repair parts) is not available after production is discontinued.

3. Overseas service

Overseas, repairs shall be accepted by Mitsubishi's local overseas FA Center. Note that the repair conditions at each FA Center may differ.

4. Exclusion of loss in opportunity and secondary loss from warranty liability

Regardless of the gratis warranty term, Mitsubishi shall not be liable for compensation to:

- (1) Damages caused by any cause found not to be the responsibility of Mitsubishi.
- (2) Loss in opportunity, lost profits incurred to the user by Failures of Mitsubishi products.
- (3) Special damages and secondary damages whether foreseeable or not, compensation for accidents, and compensation for damages to products other than Mitsubishi products.
- (4) Replacement by the user, maintenance of on-site equipment, start-up test run and other tasks.

5. Changes in product specifications

The specifications given in the catalogs, manuals or technical documents are subject to change without prior notice.

6. Product application

- (1) In using the Mitsubishi MELSEC programmable controller, the usage conditions shall be that the application will not lead to a major accident even if any problem or fault should occur in the programmable controller device, and that backup and fail-safe functions are systematically provided outside of the device for any problem or fault.
- (2) The Mitsubishi programmable controller has been designed and manufactured for applications in general industries, etc. Thus, applications in which the public could be affected such as in nuclear power plants and other power plants operated by respective power companies, and applications in which a special quality assurance system is required, such as for railway companies or public service purposes shall be excluded from the programmable controller applications.
In addition, applications in which human life or property that could be greatly affected, such as in aircraft, medical applications, incineration and fuel devices, manned transportation, equipment for recreation and amusement, and safety devices, shall also be excluded from the programmable controller range of applications.
However, in certain cases, some applications may be possible, providing the user consults their local Mitsubishi representative outlining the special requirements of the project, and providing that all parties concerned agree to the special circumstances, solely at the user's discretion.

TRADEMARKS

Anywire and AnyWireASLINK are either registered trademarks or trademarks of Anywire Corporation.

The company names, system names and product names mentioned in this manual are either registered trademarks or trademarks of their respective companies.

In some cases, trademark symbols such as [™] or [®] are not specified in this manual.

Manual number: JY997D60501G
Model: FX5-U-ANALOG-E
Model code: 09R557

When exported from Japan, this manual does not require application to the Ministry of Economy, Trade and Industry for service transaction permission.

MITSUBISHI ELECTRIC CORPORATION

HEAD OFFICE: TOKYO BUILDING, 2-7-3 MARUNOUCHI, CHIYODA-KU, TOKYO 100-8310, JAPAN

Specifications are subject to change without notice.