



PROGRAMMABLE CONTROLLERS
MELSEC iQ-F
 MELSEC iQ-F FX5U CPU Module

Hardware Manual



Manual Number	JY997D53401
Revision	E
Date	July 2016

This manual describes the part names, dimensions, installation, cabling and specifications for the product. This manual is extracted from MELSEC iQ-F FX5U User's Manual (Hardware). Refer to MELSEC iQ-F FX5U User's Manual (Hardware) for more details. Before use, read this manual and manuals of relevant products fully to acquire proficiency in the handling and operating the product. Make sure to learn all the product information, safety information, and precautions.

And, store this manual in a safe place so that you can take it out and read it whenever necessary. Always forward it to the end user.

Registration: Ethernet is a trademark of Xerox Corporation. MODBUS® is a registered trademark of Schneider Electric SA. Phillips is a registered trademark of Phillips Screw Company. The company name and the product name to be described in this manual are the registered trademarks or trademarks of each company.

Effective July 2016
 Specifications are subject to change without notice.

© 2014 MITSUBISHI ELECTRIC CORPORATION

Safety Precaution (Read these precautions before use.)

This manual classifies the safety precautions into two categories:

WARNING and **CAUTION**

WARNING	Indicates that incorrect handling may cause hazardous conditions, resulting in death or severe injury.
CAUTION	Indicates that incorrect handling may cause hazardous conditions, resulting in minor or moderate injury or property damage.

Depending on the circumstances, procedures indicated by **CAUTION** may also cause severe injury. It is important to follow all precautions for personal safety.

STARTUP AND MAINTENANCE PRECAUTIONS	WARNING
<ul style="list-style-type: none"> Do not touch any terminal while the PLC's power is on. Doing so may cause electric shock or malfunctions. Before cleaning or retightening terminals, cut off all phases of the power supply externally. Failure to do so in the power ON status may cause electric shock. Before modifying the program in operation, forcing output, running or stopping the PLC, read through this manual carefully, and ensure complete safety. An operation error may damage the machinery or cause accidents. Do not change the program in the PLC from two or more peripheral equipment devices at the same time. (i.e. from an engineering tool and a GOT) Doing so may cause destruction or malfunction of the PLC program. Use the battery for memory backup in conformance to the MELSEC iQ-F FX5U User's Manual (Hardware). <ul style="list-style-type: none"> Use the battery for the specified purpose only. Connect the battery correctly. Do not charge, disassemble, heat, put in fire, short-circuit, connect reversely, weld, swallow or burn the battery, or apply excessive forces (vibration, impact, drop, etc.) to the battery. Do not store or use the battery at high temperatures or expose to direct sunlight. Do not expose to water, bring near fire or touch liquid leakage or other contents directly. 	
Incorrect handling of the battery may cause heat excessive generation, bursting, ignition, liquid leakage or deformation, and lead to injury, fire or failures and malfunction of facilities and other equipment.	

STARTUP AND MAINTENANCE PRECAUTIONS	CAUTION
<ul style="list-style-type: none"> Do not disassemble or modify the PLC. Doing so may cause fire, equipment failures, or malfunctions. For repair, contact your local Mitsubishi Electric representative. Turn off the power to the PLC before connecting or disconnecting any extension cable. Failure to do so may cause equipment failures or malfunctions. Turn off the power to the PLC before attaching or detaching the following devices. Failure to do so may cause equipment failures or malfunctions. <ul style="list-style-type: none"> Peripheral devices, expansion board, expansion adapter, and connector conversion adapter Extension modules, bus conversion module, and battery 	

DISPOSAL PRECAUTIONS	CAUTION
<ul style="list-style-type: none"> Please contact a certified electronic waste disposal company for the environmentally safe recycling and disposal of your device. When disposing of batteries, separate them from other waste according to local regulations. (For details on the Battery Directive in EU countries, refer to the MELSEC iQ-F FX5U User's Manual (Hardware).) 	

TRANSPORTATION PRECAUTIONS	CAUTION
<ul style="list-style-type: none"> When transporting the PLC with the optional battery, turn on the PLC before shipment, confirm that the battery mode is set using a parameter and the BAT LED is OFF, and check the battery life. If the PLC is transported with the BAT LED ON or the battery exhausted, the battery-backed data may be unstable during transportation. The PLC is a precision instrument. During transportation, avoid impacts larger than those specified in the general specifications (Section 2.1) by using dedicated packaging boxes and shock-absorbing palettes. Failure to do so may cause failures in the PLC. After transportation, verify operation of the PLC and check for damage of the mounting part, etc. When transporting lithium batteries, follow required transportation regulations. (For details on the regulated products, refer to the MELSEC iQ-F FX5U User's Manual (Hardware).) 	

Associated manuals

How to obtain manuals
For the necessary product manuals or documents, consult with your local Mitsubishi Electric representative.

Associated manuals
 FX5U CPU module comes with this document (hardware manual). For a detailed explanation of the FX5U CPU module hardware and information on instructions for PLC programming and intelligent function module, refer to the relevant documents.

Manual name	Manual No.	Description
MELSEC iQ-F FX5 User's Manual (Startup)	JY997D58201	Explains performance specifications, procedures before operation, and troubleshooting of the FX5 CPU module.
MELSEC iQ-F FX5U User's Manual (Hardware)	JY997D55301	Explains FX5U CPU module specification details for I/O, wiring, installation, and maintenance.
MELSEC iQ-F FX5 User's Manual (Serial Communication)	JY997D55901	Explains the N-N network, MELSEC Communication protocol, inverter communication, and non-protocol communication.
MELSEC iQ-F FX5 User's Manual (MODBUS Communication)	JY997D56101	Explains the MODBUS serial communication.
MELSEC iQ-F FX5 User's Manual (Ethernet Communication)	JY997D56201	Functions for communication via built-in Ethernet port

Certification of UL, cUL standards

Please consult with Mitsubishi Electric for information on UL, cUL standard practices and the corresponding types of equipment.

Compliance with EC directive (CE Marking)

This document does not guarantee that a mechanical system including this product will comply with the following standards. Compliance to EMC directive and LVD directive of the entire mechanical system should be checked by the user/manufacturer. For more details please contact the local Mitsubishi Electric sales site.

Attention
 This product is designed for use in industrial applications.

Caution for compliance with EC Directive

Installation in Enclosure

Programmable controllers are open-type devices that must be installed and used within conductive control boxes. Please use the FX5U CPU module programmable controllers while installed in conductive shielded control boxes. Please secure the control box lid to the control box (for conduction). Installation within a control box greatly affects the safety of the system and aids in shielding noise from the programmable controller. For other cautions, refer to the MELSEC iQ-F FX5U User's Manual (Hardware).

Incorporated Items

Check if the following product and items are included in the package:

	Included Items	
■ CPU module		
FX5U-DMR/ES, FX5U-DMT/ES, FX5U-DMT/ESS, FX5U-CMR/DS, FX5U-DMT/DS, FX5U-DMT/DSS (□: 32, 64, 80)	Product	1 module
	Dust proof protection sheet	1 sheet
	Manuals [Japanese /English]	1 manual
	Manuals [Chinese]	1 manual
■ I/O module		
FX5-DMX/ES, FX5-DEYR/ES, FX5-DMY/ES, FX5-DEYT/ESS (□: 8, 16)	Product	1 module
	Dust proof protection sheet	1 sheet
FX5-32ER/ES, FX5-32ET/ES, FX5-32ET/ESS, FX5-32ER/DS, FX5-32ET/DS, FX5-32ET/DSS	Product	1 module
	Dust proof protection sheet	1 sheet
	Extension cable	1 cable

1. Outline

1.1 Part names

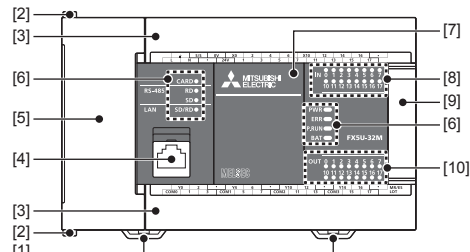

No.	Name	
[1]	DIN rail mounting hooks	
[2]	Expansion adapter connecting hooks	
[3]	Terminal block covers	
[4]	Built-in Ethernet communication connector (with cover)	
[5]	Top cover	
Operation status display LEDs		
[6]	PWR	Green On while the PLC is powered.
	ERR ¹	Red Lit/flashing when an error occurs.

No.	Name	
	P.RUN	Green On while the PLC is running.
	BAT	Red Lit when the battery voltage drops.
	CARD	Green Lit when the SD memory card is inserted.
[6]	RD	Green Lit when data is received through communication via built-in RS-485.
	SD	Green Lit when data is sent through communication via built-in RS-485.
	SD/RD	Green Lit when data is sent or received through communication via built-in Ethernet.
[7]	Expansion board connector cover	
[8]	Input display LEDs (Green)	
[9]	Extension connector cover	
[10]	Output display LEDs (Green)	

*1 When powered on in the factory default state, ERR LED starts flashing because there is no program. For details, refer to the following manual.
 → Refer to MELSEC iQ-F FX5U User's Manual (Hardware).

With cover open

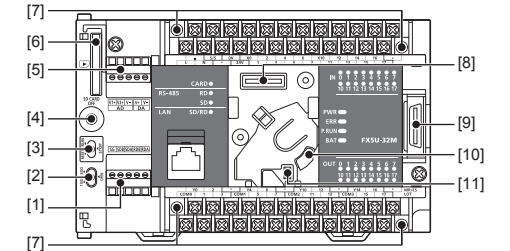

No.	Name	
[1]	Built-in RS-485 communication terminal block	
[2]	RS-485 terminal resistor selector switch	
[3]	RUN/STOP/RESET switch	
[4]	SD memory card disable switch	
[5]	Built-in analog I/O terminal block	
[6]	SD memory card slot	
[7]	Terminal block mounting screws	
[8]	Expansion board connector	
[9]	Extension connector	
[10]	Battery holder	
[11]	Battery connector	

Left side

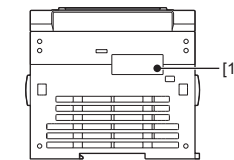

Right side

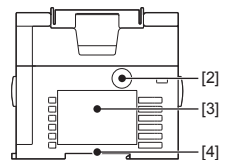

No.	Name	
[1]	Expansion adapter connector cover	
[2]	Genuine product certification label ¹	
[3]	Nameplate ¹	
[4]	DIN rail mounting groove	

*1 Products that do not have the genuine product certification label or nameplate are not covered by the warranty.

1.2 External dimensions and weight

2-φ4.5-diam mounting holes (FX5U-32M□)
4-φ4.5-diam mounting holes (FX5U-64M□, FX5U-80M□)
FX5U-32M□ do not have the (*)-marked mounting holes.

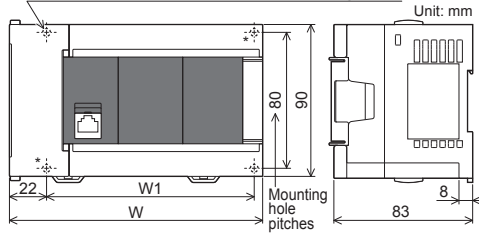

Model name	W: mm	W1: mm Mounting hole pitches	MASS (Weight): kg
FX5U-32M□	150	123	Approx. 0.7
FX5U-64M□	220	193	Approx. 1.0
FX5U-80M□	285	258	Approx. 1.2

Outer paint color Body: Munsell 0.6B7.6/0.2

2. Installation (general specifications)

As for installation of the I/O modules, expansion adapters and expansion boards, refer to MELSEC IQ-F FX5U User's Manual (Hardware).

INSTALLATION PRECAUTIONS **WARNING**

- Use the product within the generic environment specifications described in section 2.1 of this manual.
Never use the product in areas with excessive dust, oily smoke, conductive dusts, corrosive gas (salt air, Cl₂, H₂S, SO₂ or NO₂), flammable gas, vibration or impacts, or expose it to high temperature, condensation, or rain and wind.
If the product is used in such conditions, electric shock, fire, malfunctions, deterioration or damage may occur.

INSTALLATION PRECAUTIONS **CAUTION**

- Do not touch the conductive parts of the product directly. Doing so may cause device failures or malfunctions.
- When drilling screw holes or wiring, make sure that cutting and wiring debris do not enter the ventilation slits of the PLC.
Failure to do so may cause fire, equipment failures or malfunctions.
- For the product supplied together with a dust proof sheet, the sheet should be affixed to the ventilation slits before installation and wiring work to prevent foreign objects such as cutting and wiring debris. However, when the installation work is completed, make sure to remove the sheet to provide adequate ventilation.
Failure to do so may cause fire, equipment failures or malfunctions.
- Install the product on a flat surface. If the mounting surface is rough, undue force will be applied to the PC board, thereby causing nonconformities.
- Install the product securely using a DIN rail or mounting screws.
- Connect the extension cables, peripheral device cables, input/output cables and battery connecting cable securely to their designated connectors.
Loose connections may cause malfunctions.
- Turn off the power to the PLC before attaching or detaching the following devices.
Failure to do so may cause equipment failures or malfunctions.
 - Peripheral devices, expansion board, expansion adapter, and connector conversion adapter
 - Extension modules, bus conversion module, and battery

2.1 Generic specifications

Item	Specification
Operating ambient temperature ^{*1}	-20 to 55 °C (-4 to 131 °F), non-freezing ^{*2}
Storage ambient temperature	-25 to 75 °C (-13 to 167 °F), non-freezing
Operating ambient humidity	5 to 95%RH, non-condensing ^{*3}
Storage ambient humidity	5 to 95%RH, non-condensing

Item	Specification				
	Frequency (Hz)	Acceleration (m/s ²)	Half amplitude (mm)	Sweep count	
Vibration resistance ^{*4,5}	Installed on DIN rail	5 to 8.4 8.4 to 150	— 4.9	1.75 —	10 times each in X, Y, Z directions (80 min in each direction)
	Installed directly	5 to 8.4 8.4 to 150	— 9.8	— 3.5	
Shock resistance ^{*4}	147 m/s ² Acceleration, Action time: 11 ms, 3 times by half-sine pulse in each direction X, Y, and Z				
Noise durability	By noise simulator of 1000 Vp-p noise voltage, 1 μs noise width and 30 to 100 Hz noise frequency				
Dielectric withstand voltage ^{*6}	1.5 kV AC for 1 minute or 500 V AC for 1 minute		Between each terminal and ground terminal		
Insulation resistance ^{*6}	10 MΩ or higher by 500 V DC insulation resistance tester		Between each terminal and ground terminal		
Grounding	Class D grounding (Grounding resistance: 100 Ω or less) <Common grounding with a heavy electrical system is not allowed.> ^{*7}				
Working atmosphere	Free from corrosive or flammable gas and excessive conductive dusts				
Operating altitude ^{*8}	0 to 2000 m				
Installation location	Inside a control panel				
Overvoltage category ^{*9}	II or less				
Pollution degree ^{*10}	2 or less				
Equipment class	Class 2				

^{*1} The simultaneous ON ratio of available PLC inputs or outputs changes with respect to the ambient temperature. In the case where operating ambient temperature is lower than 0°C, the specifications are different from the above description. Refer to MELSEC IQ-F FX5U User's Manual (Hardware).

^{*2} The operating ambient temperature is 0 to 55°C (32 to 131°F) for products manufactured before June 2016. For intelligent function modules, refer to the manual for each product.

^{*3} When used in a low-temperature environment, use in an environment with no sudden temperature changes. If there are sudden temperature changes because of opening/closing of the control panel or other reasons, condensation may occur, which may cause a fire, fault, or malfunction. Furthermore, use an air conditioner in dehumidifier mode to prevent condensation.

^{*4} The criterion is shown in IEC61131-2.

^{*5} When the system has equipment which specification values are lower than above mentioned vibration resistance specification values, the vibration resistance specification of the whole system is corresponding to the lower specification.

^{*6} Dielectric withstand voltage and insulation resistance are shown in the following table.

Terminal	Dielectric strength	Insulation resistance
■ CPU modules, I/O modules		
Between power supply terminal (AC power) and ground terminal	1.5 kV AC for 1 minute	10 MΩ or higher by 500 V DC insulation resistance tester
Between power supply terminal (DC power) and ground terminal	500 V AC for 1 minute	
Between 24 V DC service power supply connected to input terminal (24 V DC) and ground terminal	500 V AC for 1 minute	10 MΩ or higher by 500 V DC insulation resistance tester
Between output terminal (relay) and ground terminal	1.5 kV AC for 1 minute	
Between output terminal (transistor) and ground terminal	500 V AC for 1 minute	10 MΩ or higher by 500 V DC insulation resistance tester
Between output terminal (transistor) and ground terminal	500 V AC for 1 minute	
■ Expansion boards, expansion adapters, intelligent function module		
Between terminal of expansion board and ground terminal	Not allowed	Not allowed
Between terminal of expansion adapter and ground terminal	500 V AC for 1 minute	10 MΩ or higher by 500 V DC insulation resistance tester
Intelligent function module	Each manual	

For dielectric withstand voltage test and insulation resistance test of each product, refer to the following manual.

→ Refer to MELSEC IQ-F FX5U User's Manual (Hardware).

^{*7} For grounding, refer to Section 3.3.

^{*8} The PLC cannot be used at a pressure higher than the atmospheric pressure to avoid damage.

^{*9} This indicates the section of the power supply to which the equipment is assumed to be connected between the public electrical power distribution network and the machinery within premises. Category II applies to equipment for which electrical power is supplied from fixed facilities. The surge voltage withstand level for up to the rated voltage of 300 V is 2500 V.

^{*10}This index indicates the degree to which conductive material is generated in the environment in which the equipment is used. Pollution level 2 is when only non-conductive pollution occurs. Temporary conductivity caused by condensation must be expected occasionally.

2.2 Installation location

Install the PLC in an environment conforming to the generic specifications (Section 2.1), installation precautions.

Installation location in enclosure

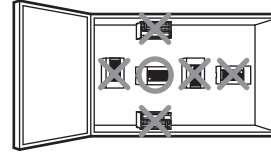

Space in enclosure

Extension devices can be connected on the left and right sides of the CPU module.

If you intend to add extension devices in the future, keep necessary spaces on the left and right sides.

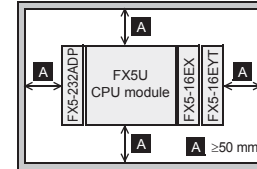

2.2.1 Affixing the dust proof sheet

The dust proof sheet should be affixed to the ventilation port before beginning the installation and wiring work.

→ For the affixing procedure, refer to the instructions on the dust proof sheet.

Be sure to remove the dust proof sheet when the installation and wiring work is completed.

2.3 Procedures for installing to and detaching from DIN rail

The products can be installed on a DIN46277 rail [35 mm wide]. This section explains the installations of the CPU modules.

2.3.1 Installation

- Connect the expansion boards and expansion adapters to the CPU module.
- Push out all DIN rail mounting hooks (right fig. A)

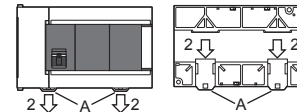

- Fit the upper edge of the DIN rail mounting groove (right fig. B) onto the DIN rail.

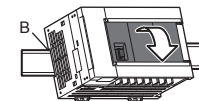

- Lock the DIN rail mounting hooks (below fig. C) while pressing the PLC against the DIN rail.

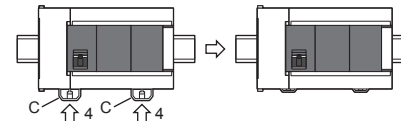

2.4 Procedures for installing directly (with M4 screws)

The product can be installed directly on the panel (with screws).

This section explains the installation of the CPU modules.

2.4.1 Mounting hole pitches

Refer to the External Dimensions (Section 1.2) for the product's mounting hole pitch information.

2.4.2 Installation

The FX5U-32M□ is used as the CPU module in this example.

- Make mounting holes in the mounting surface referring to the external dimensions diagram.
- Fit the CPU module (right fig. A) based on the holes, and secure it with M4 screws (right fig. B). (In the case of FX5U-64M□/80M□, there are four screw holes.)

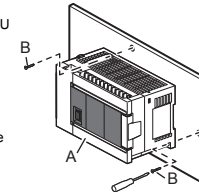

3. Specifications and examples of external wiring

As for the details of the power supply wiring and input/output wiring, refer to MELSEC IQ-F FX5U User's Manual (Hardware).

DESIGN PRECAUTIONS **WARNING**

- Make sure to set up the following safety circuits outside the PLC to ensure safe system operation even during external power supply problems or PLC failure. Otherwise, malfunctions may cause serious accidents.
 - Most importantly, set up the following: an emergency stop circuit, a protection circuit, an interlock circuit for opposite movements (such as normal vs. reverse rotation), and an interlock circuit (to prevent damage to the equipment at the upper and lower positioning limits).
 - Note that when the CPU module detects an error, such as a watchdog timer error, during self-diagnosis, all outputs are turned off. Also, when an error that cannot be detected by the CPU module occurs in an input/output control block, output control may be disabled.
- External circuits and mechanisms should be designed to ensure safe machinery operation in such a case.
 - Note that the output current of the 24 V DC service power supply varies depending on the model and the absence/presence of extension modules. If an overload occurs, the voltage automatically drops, inputs in the PLC are disabled, and all outputs are turned off.
 - External circuits and mechanisms should be designed to ensure safe machinery operation in such a case.
 - Note that when an error occurs in a relay or transistor of an output circuit, the output might stay on or off.
 - For output signals that may lead to serious accidents, external circuits and mechanisms should be designed to ensure safe machinery operation in such a case.
- Construct an interlock circuit in the program so that the whole system always operates on the safe side before executing the control (for data change) of the PLC in operation. Read the manual thoroughly and ensure complete safety before executing other controls (for program change, parameter change, forcible output and operation status change) of the PLC in operation. Otherwise, the machine may be damaged and accidents may occur due to erroneous operations.

DESIGN PRECAUTIONS **CAUTION**

- Simultaneously turn on and off the power supplies of the CPU module and extension modules.

WIRING PRECAUTIONS **WARNING**

- Make sure to cut off all phases of the power supply externally before attempting installation or wiring work.
Failure to do so may cause electric shock or damage to the product.
- Make sure to attach the terminal cover, provided as an accessory, before turning on the power or initiating operation after installation or wiring work.
Failure to do so may cause electric shock.
- The temperature rating of the cable should be 80°C or more.
- Make sure to wire the screw terminal block in accordance with the following precautions.
Failure to do so may cause electric shock, equipment failures, a short-circuit, wire breakage, malfunctions, or damage to the product.
 - The disposal size of the cable end should follow the dimensions described in the manual.
 - Tightening torque should follow the specifications in the manual.
 - Tighten the screws using a Phillips-head screwdriver No.2 (shaft diameter 6 mm or less). Make sure that the screwdriver does not touch the partition part of the terminal block.
- Make sure to properly wire to the terminal block (European type) in accordance with the following precautions.
Failure to do so may cause electric shock, equipment failures, a short-circuit, wire breakage, malfunctions, or damage to the product.
 - The disposal size of the cable end should follow the dimensions described in the manual.
 - Tightening torque should follow the specifications in the manual.
 - Twist the ends of stranded wires and make sure that there are no loose wires.
 - Do not solder-plate the electric wire ends.
 - Do not connect more than the specified number of wires or electric wires of unspecified size.
 - Affix the electric wires so that neither the terminal block nor the connected parts are directly stressed.

WIRING PRECAUTIONS **CAUTION**

- Perform class D grounding (grounding resistance: 100 Ω or less) of the grounding terminal on the CPU module and extension modules with a wire 2 mm² or thicker. Do not use common grounding with heavy electrical systems (refer to section 3.3).

WIRING PRECAUTIONS **CAUTION**

- Connect the power supply wiring to the dedicated terminals described in this manual.
- If an AC power supply is connected to a DC input/output terminal or DC power supply terminal, the PLC will burn out.
- Do not wire vacant terminals externally. Doing so may damage the product.
- Make sure to observe the following precautions in order to prevent any damage to the machinery or accidents due to malfunction of the PLC caused by abnormal data written to the PLC due to the effects of noise.
 - Do not bundle the power line, control line and communication cables together with or lay them close to the main circuit, high-voltage line, load line or power line. As a guideline, lay the power line, control line and communication cables at least 100 mm away from the main circuit, high-voltage line, load line or power line.
 - Ground the shield of the shielded wire or shielded cable at one point on the PLC. However, do not use common grounding with heavy electrical systems.
- Ground the shield of the analog input/output cable at one point on the signal receiving side. However, do not use common grounding with heavy electrical systems.

3.1 Cable end treatment and tightening torque

3.1.1 Screw type terminal block

For the terminals of FX5U CPU module and I/O module, M3 screws are used. The electric wire ends should be treated as shown below. Tighten the screws to a torque of 0.5 to 0.8 N·m. Do not tighten terminal screws with a torque outside the above-mentioned range. Failure to do so may cause equipment failures or malfunctions.

- When one wire is connected to one terminal

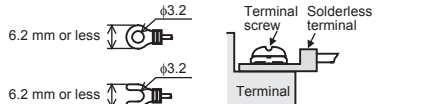

- When two wires are connected to one terminal

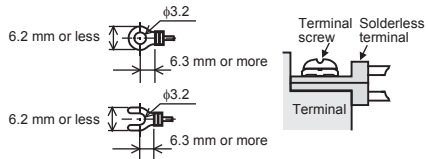

3.1.2 European type terminal block

1) Wire size

No. of wire per terminal	Wire size	
	Solid wire/Stranded wire	Ferrules with insulating sleeve
1	AWG24 to 20	AWG24 to 20
2	AWG24	—

2) Treatment of wire ends

Strip the coating of strand wire and twist the cable core before connecting it, or strip the coating of single wire before connecting it. An alternative connection is to use a ferrule with insulating sleeve.

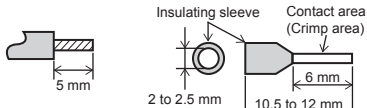

Manufacturer	Model	Caulking tool
Phoenix Contact GmbH & Co. KG	AI 0.5-6WH	CRIMPFOX 6

When using a wire ferrule with an insulating sleeve, choose a wire with proper cable sheath referring to the above outside dimensions, otherwise the wire cannot be inserted easily.

Tighten the screws to a torque of 0.22 to 0.25 N·m.

Do not tighten terminal screws exceeding with a torque outside the above-mentioned range.

Failure to do so may cause equipment failures or malfunctions.

3) Tool

For tightening the terminal, use a commercially available small screwdriver having a straight form that is not widened toward the end as shown right.

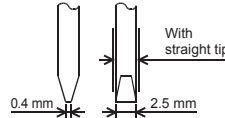

Note:

If the diameter of screwdriver grip is too small, tightening torque may not be achieved. To achieve the appropriate tightening torque shown in the table above, use the following screwdriver or appropriate replacement (grip diameter: approximately 25 mm).

Manufacturer	Model names
Phoenix Contact GmbH & Co. KG	SZS 0.4×2.5

3.2 Power supply specifications and external wiring

3.2.1 Power supply specifications [CPU module, FX5-32E□]

Item	Specification	
	AC power type	DC power type
Rated voltage	100 to 240 V AC	24 V DC
Voltage fluctuation range	85 to 264 V AC	16.8 to 28.8 V DC
Frequency rating	50/60 Hz	—
Allowable instantaneous power failure time	Operation can be continued upon occurrence of instantaneous power failure for 10 ms or less.*1	Operation can be continued upon occurrence of instantaneous power failure for 5 ms or less.
Power fuse	FX5U-32M□, FX5-32E□	250 V 3.15 A Time-lag Fuse
	FX5U-64M□, FX5U-80M□	250 V 5 A Time-lag Fuse
Rush current	FX5U-32M□	25 A max. 5 ms or less/100 V AC 50 A max. 5 ms or less/200 V AC
	FX5U-64M□, FX5U-80M□	30 A max. 5 ms or less/100 V AC 60 A max. 5 ms or less/200 V AC
Power consumption*2	FX5U-32M□	30 W
	FX5U-64M□, FX5U-80M□	40 W
24 V DC power supply capacity*3	FX5U-32M□	400 mA (480 mA) ⁴ [300 mA (380 mA)] ^{4,5}
	FX5U-64M□	600 mA (740 mA) ⁴ [300 mA (440 mA)] ^{4,5}
5 V DC built-in power supply capacity*7	FX5U-32M□	250 mA (310 mA) ⁴
	FX5U-64M□, FX5U-80M□	900 mA
FX5-32E□	FX5U-32M□	900 mA (775 mA) ⁶
	FX5U-64M□, FX5U-80M□	1100 mA
FX5-32E□	965 mA	1100 mA (975 mA) ⁶

- *1 When the supply voltage is 200 V AC, the time can be changed to 10 to 100 ms by editing the user program.
- *2 This item shows value when all 24 V DC power supplies are used in the maximum configuration connectable to the CPU module. (The current of the input circuit is included.)
- *3 The AC power type has 24 V DC service power supply, and the DC power type has 24 V DC built-in power supply. When I/O modules are connected, they consume current from the power supply.
- *4 Capacity of 24 V DC service power supply when service power supply is used for the input circuit. The value in () is capacity of 24 V DC service power supply when external power supply is used for the input circuit.
- *5 The value in () is capacity of 24 V DC power supply in the case where operating ambient temperature is lower than 0°C.
- *6 The value in () is capacity of power supply when the supply voltage is 16.8 to 19.2 V DC.
- *7 Power is supplied to I/O modules, intelligent function modules, expansion adapters and expansion boards. The following manual shows further information. → Refer to MELSEC IQ-F FX5U User's Manual (Hardware).

3.2.2 Example of external wiring [AC power type]

100 to 240 V AC power is supplied to the CPU module and FX5-32E□. For the details of wiring work, refer to Section 3.1.

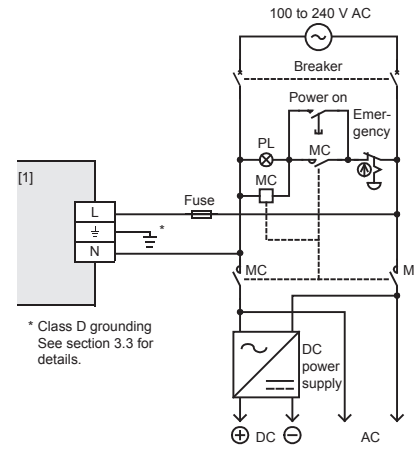

* Class D grounding
See section 3.3 for details.

[1]: CPU module, FX5-32E□

3.2.3 Example of external wiring [DC power type]

24 V DC power is supplied to the CPU module and FX5-32E□. For the details of wiring work, refer to Section 3.1.

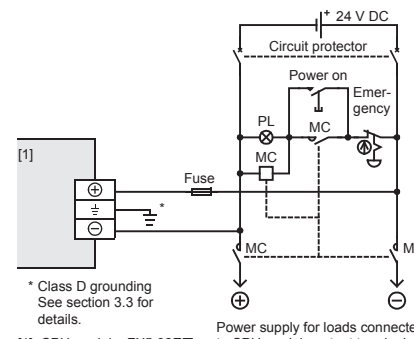

* Class D grounding
See section 3.3 for details.

[1]: CPU module, FX5-32E□

3.3 Grounding

Ground the PLC as stated below.

- Perform class D grounding. (Grounding resistance: 100 Ω or less)
 - Ground the PLC independently if possible.
- If it cannot be grounded independently, ground it jointly as shown below.

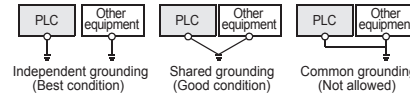

- Use ground wires thicker than AWG14 (2 mm²).
- Bring the grounding point close to the PLC as much as possible so that the ground cable can be shortened.

3.4 Input specifications and external wiring

3.4.1 Input specifications (24 V DC input type)

Item	Specification		
Input signal voltage	24 V DC +20%, -15%		
Input impedance	CPU module	X0 to X17	4.3 kΩ
	FX5 I/O module	X20 and subsequent	5.6 kΩ
		X0 to X17	5.6 kΩ

Item	Specification		
Input signal current	CPU module	X0 to X17	5.3 mA/24 V DC
	FX5 I/O module	X20 and subsequent	4.0 mA/24 V DC
ON input sensitivity current		CPU module	X0 to X17
	FX5 I/O module	X20 and subsequent	3.0 mA or more
OFF input sensitivity current		1.5 mA or less	
Input response time	Refer to MELSEC IQ-F FX5U User's Manual (Hardware)		
Input signal form	Sink input	No-voltage contact input NPN open collector transistor	
	Source input	No-voltage contact input PNP open collector transistor	
Input operation display	LED on panel turns on when input.		

3.4.2 Examples of input wiring [AC power type] (when 24 V DC service power supply is used)

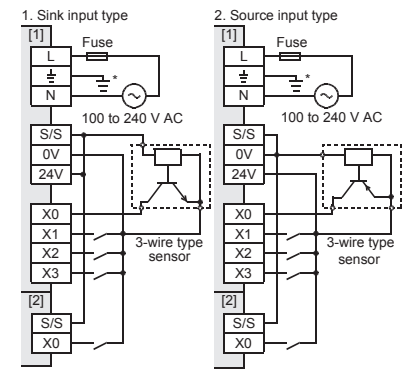

* Class D grounding
See section 3.3 for details.

[1]: CPU module, FX5-32E□

[2]: Input module

3.4.3 Examples of input wiring [DC power type]

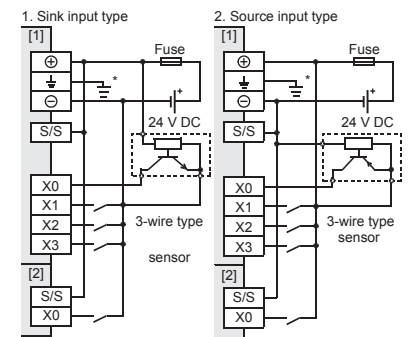

* Class D grounding
See section 3.3 for details.

[1]: CPU module, FX5-32E□

[2]: Input module

3.5 Relay output specifications and external wiring

3.5.1 Relay output specifications

Item	Specification
External power supply	30 V DC or less 240 V AC or less ("250 V AC or less" if not a CE, UL, cUL compliant item)

Item	Specification
Max. load	2 A/point ^{*1}
Min. load	5 V DC, 2 mA (reference value)
Open circuit leakage current	—
Response time	OFF↔ON Approx. 10 ms
Output operation display	LED on panel turns on when output.

*1 The total load current of resistance loads per common terminal should be the following value.
 - 4 output points/common terminal: 8 A or less
 - 8 output points/common terminal: 8 A or less
 As for the number of outputs per common terminal, refer to Chapter 4 and the following manual.
 → Refer to MELSEC IQ-F FX5U User's Manual (Hardware).

3.5.2 Example of relay output wiring

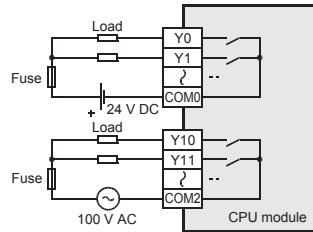

3.6 Transistor output specifications and external wiring

3.6.1 Transistor output specifications

Item	Specification
Output form	FX5U-□MT/□S, FX5-□EY/ES, FX5-32ET/□S Transistor (Sink) FX5U-□MT/□SS, FX5-□EY/ESS, FX5-32ET/□SS Transistor (Source)
External power supply	5 to 30 V DC
Max. load	0.5 A/point ^{*1}
Min. load	—
Open circuit leakage current	0.1 mA or less/30 V DC
ON voltage	CPU module Y0 to Y3 1.0 V or less Y4 and subsequent 1.5 V or less
	I/O module 1.5 V or less
Response time	CPU module Y0 to Y3 2.5 μs or less/10 mA or more (5 to 24 V DC) Y4 and subsequent 0.2 ms or less/200 mA or more (at 24 V DC)
	I/O module 0.2 ms or less/200 mA or more (at 24 V DC)
Output operation display	LED on panel turns on when output.

*1 The total load current of resistance loads per common terminal should be the following value.
 - 4 output point/common terminal: 0.8 A or less
 - 8 output point/common terminal: 1.6 A or less
 As for the number of outputs per common terminal, refer to Chapter 4 and the following manual.
 → Refer to MELSEC IQ-F FX5U User's Manual (Hardware).

3.6.2 External wiring of transistor output

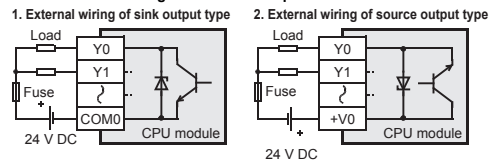

3.7 Built-in analog input/output specifications and external wiring

As for the details on the built-in analog input/output specifications and external wiring, refer to the following manual.
 → Refer to MELSEC IQ-F FX5U User's Manual (Hardware).

3.7.1 Analog input specifications

Item	Specifications
Analog input points	2 points (2 channels)
Analog input	0 to 10 V DC (Input resistance: 115.7 kΩ)
Digital output	12 bit unsigned binary
Device allocation	SD6020 (Input data of ch1) SD6060 (Input data of ch2)
Input characteristics	Digital output value 0 to 4000
	Maximum resolution 2.5 mV
Accuracy (Accuracy for the full scale of the digital output value)	When ambient temperature is 25 ±5°C (77 ±41°F) Within ±0.5% (±20 digit) ^{*1} When ambient temperature is 0 to 55°C (32 to 131°F) Within ±1.0% (±40 digit) ^{*1} When ambient temperature is -20 to 0°C (-4 to 32°F) Within ±1.5% (±60 digit) ^{*1}
Absolute maximum input	-0.5 V, +15 V
Insulation method	Inside the CPU module and the analog input circuit are not insulated. Between input terminals (channels) is not insulated.
Occupied points	0 point (Dose not occupy of input and output points of the CPU module.)

*1 Digit indicates a digital value.

3.7.2 Analog output specifications

Item	Specifications
Analog output points	1 point (1 channel)
Digital input	12 bit unsigned binary
Analog output	0 to 10 V DC (Input resistance: 2 k to 1 MΩ)
Device allocation	SD6180 (Output setting data of ch1)
Output characteristics	Digital input value 0 to 4000
	Maximum resolution 2.5 mV
Accuracy (Accuracy for the full scale of the analog output value)	When ambient temperature is 25 ±5°C (77 ±41°F) Within ±0.5% (±20 digit) ^{*1} When ambient temperature is 0 to 55°C (32 to 131°F) Within ±1.0% (±40 digit) ^{*1} When ambient temperature is -20 to 0°C (-4 to 32°F) Within ±1.5% (±60 digit) ^{*1}
Insulation method	Inside the CPU module and the analog output circuit are not insulated.
Occupied points	0 point (Dose not occupy any input and output points of the CPU module.)

*1 Digit indicates a digital value.

3.7.3 Example of analog input

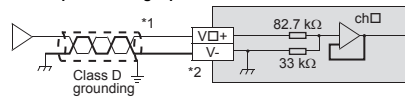

V□+, ch□: □ represents the channel number
 *1 Use 2-core shielded twisted pair cable for the analog input lines, and separate the analog input lines from other power lines or inductive lines.
 *2 Make sure to short-circuit the "V□+" and "V-" terminals when channel is not used.

3.7.4 Example of analog output

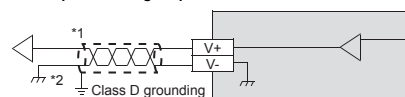

*1 Use 2-core shielded twisted pair cable for the analog output lines, and separate the analog output lines from other power lines or inductive lines.
 *2 Ground the shielded wire at one point on the signal receiving side.

3.7.5 Terminal block layouts

The terminals of the built-in analog input/output are arranged as follows:

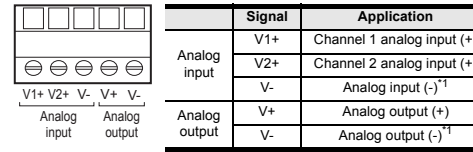

*1 The V- terminals are connected internally.

3.8 Built-in Ethernet communication specifications and external wiring

As for the details on the built-in Ethernet communication specifications and external wiring, refer to the following manual.
 → Refer to MELSEC IQ-F FX5U User's Manual (Ethernet Communication).

3.8.1 Communication specification

Item	Specification
Data transmission speed	100/10 Mbps
Communication mode	Full-duplex (FDX)/Half-duplex (HDx) ^{*1}
Interface	RJ45 connector
Transmission method	Base band
Maximum segment length (The distance between hub and node)	100 m
Cascade connection	100BASE-TX Max. 2 stages ^{*2}
	10BASE-T Max. 4 stages ^{*2}
Protocol type	MELSOFT connection, SLMP (3E frames), Socket communication, Predefined protocol support
Number of simultaneously open connections allowed	Total of 8 for socket communication, MELSOFT connection, SLMP, and Predefined protocol support
Hub ^{*1}	Hubs with 100BASE-TX or 10BASE-T ports can be used.
Insulation method	Pulse transformer
IP address	Initial value: 192.168.3.250

*1 IEEE802.3x flow control is not supported.

*2 The value indicates the number of connectable stages when a repeater hub is used.
 Contact the manufacturer of the switching hub for the number of connectable stages when using a switching hub.

3.8.2 Wiring

For the wiring, refer to the following manual.
 → Refer to MELSEC IQ-F FX5U User's Manual (Ethernet Communication).

3.8.3 Pin Configuration

The connector of the built-in Ethernet communication are arranged as follows:

Pin No.	Signal	Contents
1	TXD+	Transmit data (+)
2	TXD-	Transmit data (-)
3	RXD+	Receive data (+)
4	Not used	—
5	Not used	—
6	RXD-	Receive data (-)
7	Not used	—
8	Not used	—

Applicable cable

10BASE-T	Cable conforming to Ethernet standard practice: Category 3 or higher (STP cable)
100BASE-TX	Cable conforming to Ethernet standard practice: Category 5 or higher (STP cable)

A straight cable is used. A cross cable can also be used when using direct connection between a personal computer and the FX5U CPU module.

3.9 Built-in RS-485 communication specifications and external wiring

3.9.1 Communication specification

Item	Specification
Transmission standard	In conformance to RS-485/RS-422

Item	Specification
Data transmission speed	Max. 115.2 kbps
Communication method	Full-duplex/Half-duplex
Maximum total extension distance	50 m
Protocol type	MELSOFT connection, MELSEC Communication protocol (3C/4C frames), Non-protocol communication, MODBUS RTU, Inverter communication, N:N network, Predefined protocol support
Insulation method	No insulation between the PLC.
Terminal resistors	Built-in (OPEN/110 Ω/330 Ω)
Connection method	European terminal block

3.9.2 Wiring

For the wiring, refer to the following manual.
 → Refer to MELSEC IQ-F FX5U User's Manual (Serial Communication).
 → Refer to MELSEC IQ-F FX5U User's Manual (MODBUS Communication).

3.9.3 Terminal block layouts

The terminals of the built-in RS-485 communication are arranged as follows:

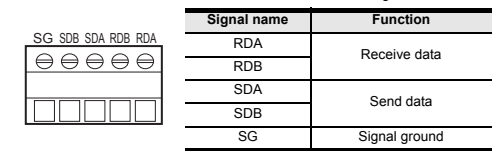

4. Terminal block layouts

For details on the terminal block layout, refer to the following manual.
 → Refer to MELSEC IQ-F FX5U User's Manual (Hardware).

Interpretation of partition

The partition of the output terminals (see following figure) indicates the range of the output connected to the same common.

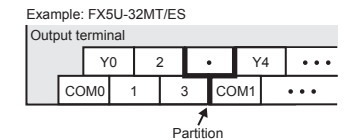

This manual confers no industrial property rights or any rights of any other kind, nor does it confer any patent licenses. Mitsubishi Electric Corporation cannot be held responsible for any problems involving industrial property rights which may occur as a result of using the contents noted in this manual.

Warranty

Exclusion of loss in opportunity and secondary loss from warranty liability
 Regardless of the gratis warranty term, Mitsubishi shall not be liable for compensation to: (1) Damages caused by any cause found not to be the responsibility of Mitsubishi. (2) Loss in opportunity, lost profits incurred to the user by Failures of Mitsubishi products. (3) Special damages and secondary damages whether foreseeable or not, compensation for accidents, and compensation for damages to products other than Mitsubishi products. (4) Replacement by the user, maintenance of on-site equipment, start-up test run and other tasks.

For safe use

- This product has been manufactured as a general-purpose part for general industries, and has not been designed or manufactured to be incorporated in a device or system used in purposes related to human life.
- Before using the product for special purposes such as nuclear power, electric power, aerospace, medicine or passenger movement vehicles, consult with Mitsubishi Electric.
- This product has been manufactured under strict quality control. However when installing the product where major accidents or losses could occur if the product fails, install appropriate backup or failsafe functions in the system.