

Programmable Controller



MELSEC iQ-F
series



Transition from MELSEC FX3U, FX3UC Series to
MELSEC iQ-F Series Handbook

SAFETY PRECAUTIONS

(Read these precautions before use.)

Before using this product, please read this manual and the relevant manuals introduced in this manual carefully and pay full attention to safety in order to handle the product correctly.

This manual classifies the safety precautions into two categories:  WARNING and  CAUTION.

 WARNING	Indicates that incorrect handling may cause hazardous conditions, resulting in death or severe injury.
 CAUTION	Indicates that incorrect handling may cause hazardous conditions, resulting in minor or moderate injury or property damage.

Depending on the circumstances, procedures indicated by  CAUTION may also cause severe injury.

It is important to follow all precautions for personal safety.

Store this manual in a safe place so that it can be read whenever necessary. Always forward it to the end user.

[DESIGN PRECAUTIONS]

WARNING

- Make sure to set up the following safety circuits outside the PLC to ensure safe system operation even during external power supply problems or PLC failure. Otherwise, malfunctions may cause serious accidents.
 - Most importantly, set up the following: an emergency stop circuit, a protection circuit, an interlock circuit for opposite movements (such as normal vs. reverse rotation), and an interlock circuit (to prevent damage to the equipment at the upper and lower positioning limits).
 - Note that when the CPU module detects an error, such as a watchdog timer error, during self-diagnosis, all outputs are turned off. Also, when an error that cannot be detected by the CPU module occurs in an input/output control block, output control may be disabled. External circuits and mechanisms should be designed to ensure safe machinery operation in such a case.
 - Note that the output current of the 24 V DC service power supply varies depending on the model and the absence/presence of extension modules. If an overload occurs, the voltage automatically drops, inputs in the PLC are disabled, and all outputs are turned off. External circuits and mechanisms should be designed to ensure safe machinery operation in such a case.
 - Note that when an error occurs in a relay, triac or transistor of an output circuit, the output might stay on or off. For output signals that may lead to serious accidents, external circuits and mechanisms should be designed to ensure safe machinery operation in such a case.
 - Construct an interlock circuit in the program so that the whole system always operates on the safe side before executing the control (for data change) of the PLC in operation.

Read the manual thoroughly and ensure complete safety before executing other controls (for program change, parameter change, forcible output and operation status change) of the PLC in operation. Otherwise, the machine may be damaged and accidents may occur due to erroneous operations.
 - In an output circuit, when a load current exceeding the current rating or an overcurrent caused by a load short-circuit flows for a long time, it may cause smoke and fire. To prevent this, configure an external safety circuit, such as a fuse.
 - For the operating status of each station after a communication failure of the network, refer to relevant manuals for the network. Incorrect output or malfunction may result in an accident.
 - To maintain the safety of the programmable controller system against unauthorized access from external devices via the network, take appropriate measures. To maintain the safety against unauthorized access via the Internet, take measures such as installing a firewall.
-

[DESIGN PRECAUTIONS]

CAUTION

- When an inductive load such as a lamp, heater, or solenoid valve is controlled, a large current (approximately ten times greater than normal) may flow when the output is turned from off to on. Take proper measures so that the flowing current does not exceed the value corresponding to the maximum load specification of the resistance load.
 - After the CPU module is powered on or is reset, the time taken to enter the RUN status varies depending on the system configuration, parameter settings, and/or program size.
Design circuits so that the entire system will always operate safely, regardless of this variation in time.
 - Simultaneously turn on and off the power supplies of the CPU module and extension modules.
 - If a long-time power failure or an abnormal voltage drop occurs, the PLC stops, and output is turned off. When the power supply is restored, it will automatically restart (when the RUN/STOP/RESET switch is on the RUN side).
-

[INSTALLATION PRECAUTIONS]

WARNING

- Make sure to cut off all phases of the power supply externally before attempting installation or wiring work. Failure to do so may cause electric shock or damage to the product.
 - Use the product within the generic environment specifications described in the User's Manual (Hardware) for the CPU module to be used.
Never use the product in areas with excessive dust, oily smoke, conductive dusts, corrosive gas (salt air, Cl₂, H₂S, SO₂ or NO₂), flammable gas, vibration or impacts, or expose it to high temperature, condensation, or rain and wind.
If the product is used in such conditions, electric shock, fire, malfunctions, deterioration or damage may occur.
-

[INSTALLATION PRECAUTIONS]

CAUTION

- Do not touch the conductive parts of the product directly. Doing so may cause device failures or malfunctions.
 - When drilling screw holes or wiring, make sure that cutting and wiring debris do not enter the ventilation slits of the PLC. Failure to do so may cause fire, equipment failures or malfunctions.
 - For the product supplied together with a dust proof sheet, the sheet should be affixed to the ventilation slits before the installation and wiring work to prevent foreign objects such as cutting and wiring debris.
However, when the installation work is completed, make sure to remove the sheet to provide adequate ventilation. Failure to do so may cause fire, equipment failures or malfunctions.
 - Install the product on a flat surface. If the mounting surface is rough, undue force will be applied to the PC board, thereby causing nonconformities.
 - Install the product securely using a DIN rail or mounting screws.
 - Connect the expansion board and expansion adapter securely to their designated connectors. Loose connections may cause malfunctions.
 - Make sure to affix the expansion board with tapping screws.
Tightening torque should follow the specifications in the manual.
If the screws are tightened outside of the specified torque range, poor connections may cause malfunctions.
 - Work carefully when using a screwdriver such as installation of the product. Failure to do so may cause damage to the product or accidents.
 - Connect the extension cables, peripheral device cables, input/output cables and battery connecting cable securely to their designated connectors. Loose connections may cause malfunctions.
 - When using an SD memory card, insert it into the SD memory card slot. Check that it is inserted completely. Poor contact may cause malfunction.
 - Turn off the power to the PLC before attaching or detaching the following devices. Failure to do so may cause equipment failures or malfunctions.
 - Peripheral devices, expansion board, expansion adapter, and connector conversion adapter
 - Extension modules, bus conversion module and connector conversion module
 - Battery
-

[WIRING PRECAUTIONS]

WARNING

- Make sure to cut off all phases of the power supply externally before attempting installation or wiring work. Failure to do so may cause electric shock or damage to the product.
 - Make sure to attach the terminal cover, provided as an accessory, before turning on the power or initiating operation after installation or wiring work. Failure to do so may cause electric shock.
 - The temperature rating of the cable should be 80°C or more. It may differ depending on the extension devices. For details, refer to the user's manual of the extension devices.
 - Make sure to wire the screw terminal block in accordance with the following precautions. Failure to do so may cause electric shock, equipment failures, a short-circuit, wire breakage, malfunctions, or damage to the product.
 - The disposal size of the cable end should follow the dimensions described in the manual.
 - Tightening torque should follow the specifications in the manual.
 - Tighten the screws using a Phillips-head screwdriver No. 2 (shaft diameter 6 mm or less). Make sure that the screwdriver does not touch the partition part of the terminal block.
 - Make sure to properly wire to the terminal block (European type) in accordance with the following precautions. Failure to do so may cause electric shock, equipment failures, a short-circuit, wire breakage, malfunctions, or damage to the product.
 - The disposal size of the cable end should follow the dimensions described in the manual.
 - Tightening torque should follow the specifications in the manual.
 - Twist the ends of stranded wires and make sure that there are no loose wires.
 - Do not solder-plate the electric wire ends.
 - Do not connect more than the specified number of wires or electric wires of unspecified size.
 - Affix the electric wires so that neither the terminal block nor the connected parts are directly stressed.
 - Make sure to properly wire to the spring clamp terminal block in accordance with the following precautions. Failure to do so may cause electric shock, equipment failures, a short-circuit, wire breakage, malfunctions, or damage to the product.
 - The disposal size of the cable end should follow the dimensions described in the manual.
 - Twist the ends of stranded wires and make sure that there are no loose wires.
 - Do not solder-plate the electric wire ends.
 - Do not connect more than the specified number of wires or electric wires of unspecified size.
 - Affix the electric wires so that neither the terminal block nor the connected parts are directly stressed.
-

[WIRING PRECAUTIONS]

CAUTION

- Do not supply power to the [24+] and [24V] terminals (24 V DC service power supply) on the CPU module or extension modules. Doing so may cause damage to the product.
 - Perform class D grounding (grounding resistance: 100 Ω or less) to the grounding terminal on the CPU module or extension modules with a wire 2 mm² or thicker.
Do not use common grounding with heavy electrical systems (refer to the User's Manual (Hardware) for the CPU module to be used).
 - Connect the power supply wiring to the dedicated terminals described in this manual. If an AC power supply is connected to a DC input/output terminal or DC power supply terminal, the PLC will burn out.
 - Do not wire vacant terminals externally. Doing so may cause damage to the product.
 - Install module so that excessive force will not be applied to terminal blocks, power connectors, I/O connectors, communication connectors, or communication cables. Failure to do so may result in wire damage/breakage or PLC failure.
 - Make sure to observe the following precautions in order to prevent any damage to the machinery or accidents due to malfunction of the PLC caused by abnormal data written to the PLC due to the effects of noise.
 - Do not bundle the power line, control line and communication cables together with or lay them close to the main circuit, high-voltage line, load line or power line. As a guideline, lay the power line, control line and communication cables at least 100 mm away from the main circuit, high-voltage line, load line or power line.
 - Ground the shield of the shielded wire or shielded cable at one point on the PLC. However, do not use common grounding with heavy electrical systems.
 - Ground the shield of the analog input/output cable at one point on the signal receiving side. However, do not use common grounding with heavy electrical systems.
-

[STARTUP AND MAINTENANCE PRECAUTIONS]

WARNING

- Do not touch any terminal while the PLC's power is on. Doing so may cause electric shock or malfunctions.
 - Before cleaning or retightening terminals, cut off all phases of the power supply externally. Failure to do so in the power ON status may cause electric shock.
 - Before modifying the program in operation, forcible output, running or stopping the PLC, read through this manual carefully, and ensure complete safety. An operation error may damage the machinery or cause accidents.
 - Do not change the program in the PLC from two or more peripheral equipment devices at the same time. (i.e. from an engineering tool and a GOT) Doing so may cause destruction or malfunction of the PLC program.
 - Use the battery for memory backup in conformance to the User's Manual (Hardware) for the CPU module to be used.
 - Use the battery for the specified purpose only.
 - Connect the battery correctly.
 - Do not charge, disassemble, heat, put in fire, short-circuit, connect reversely, weld, swallow or burn the battery, or apply excessive forces (vibration, impact, drop, etc.) to the battery.
 - Do not store or use the battery at high temperatures or expose to direct sunlight.
 - Do not expose to water, bring near fire or touch liquid leakage or other contents directly.Incorrect handling of the battery may cause heat excessive generation, bursting, ignition, liquid leakage or deformation, and lead to injury, fire or failures and malfunction of facilities and other equipment.
-

[STARTUP AND MAINTENANCE PRECAUTIONS]

CAUTION

- Do not disassemble or modify the PLC. Doing so may cause fire, equipment failures, or malfunctions. For repair, contact your local Mitsubishi Electric representative.
 - After the first use of the SD memory card, do not insert/remove the memory card more than 500 times. 500 times or more may cause malfunction.
 - Turn off the power to the PLC before connecting or disconnecting any extension cable. Failure to do so may cause equipment failures or malfunctions.
 - Turn off the power to the PLC before attaching or detaching the following devices. Failure to do so may cause equipment failures or malfunctions.
 - Peripheral devices, expansion board, expansion adapter, and connector conversion adapter
 - Extension modules, bus conversion module and connector conversion module
 - Battery
-

[OPERATION PRECAUTIONS]

CAUTION

- Construct an interlock circuit in the program so that the whole system always operates on the safe side before executing the control (for data change) of the PLC in operation. Read the manual thoroughly and ensure complete safety before executing other controls (for program change, parameter change, forcible output and operation status change) of the PLC in operation. Otherwise, the machine may be damaged and accidents may occur due to erroneous operations.
-

[DISPOSAL PRECAUTIONS]

CAUTION

- Please contact a certified electronic waste disposal company for the environmentally safe recycling and disposal of your device.
 - When disposing of batteries, separate them from other waste according to local regulations. For details of the Battery Directive in EU countries, refer to the User's Manual (Hardware) for the CPU module to be used.
-

[TRANSPORTATION PRECAUTIONS]

CAUTION

- When transporting the PLC with the optional battery, turn on the PLC before shipment, confirm that the battery mode is set using a parameter and the BAT LED is OFF, and check the battery life. If the PLC is transported with the BAT LED ON or the battery exhausted, the battery-backed data may be unstable during transportation.
 - The PLC is a precision instrument. During transportation, avoid impacts larger than those specified in the general specifications of the User's Manual (Hardware) for the CPU module to be used by using dedicated packaging boxes and shock-absorbing palettes. Failure to do so may cause failures in the PLC. After transportation, verify operation of the PLC and check for damage of the mounting part, etc.
 - When transporting lithium batteries, follow required transportation regulations. For details on the regulated products, refer to the User's Manual (Hardware) for the CPU module to be used.
 - When fumigants that contain halogen materials such as fluorine, chlorine, bromine, and iodine are used for disinfecting and protecting wooden packaging from insects, they cause malfunction when entering our products. Please take necessary precautions to ensure that remaining materials from fumigant do not enter our products, or treat packaging with methods other than fumigation (heat method). Additionally, disinfect and protect wood from insects before packing products.
-

INTRODUCTION

This Replacement Manual describes CPU module and extension device model selection for replacement from the MELSEC FX3U/FX3UC Series to the MELSEC iQ-F Series.

When replacing from the MELSEC FX3U/FX3UC Series to the MELSEC iQ-F Series, some items will be necessary to consider beforehand such as the replacement procedure, installation location, comparing specifications of the existing module and the planned replacing module, and how to replace the network. For smooth replacement, please carefully consider beforehand.

Regarding use of this product

- This product has been manufactured as a general-purpose part for general industries, and has not been designed or manufactured to be incorporated in a device or system used in purposes related to human life.
- Before using the product for special purposes such as nuclear power, electric power, aerospace, medicine or passenger movement vehicles, consult Mitsubishi Electric.
- This product has been manufactured under strict quality control. However when installing the product where major accidents or losses could occur if the product fails, install appropriate backup or failsafe functions in the system.

Note

- If in doubt at any stage during the installation of the product, always consult a professional electrical engineer who is qualified and trained in the local and national standards. If in doubt about the operation or use, please consult the nearest Mitsubishi Electric representative.
- Since the examples indicated by this manual, technical bulletin, catalog, etc. are used as a reference, please use it after confirming the function and safety of the equipment and system. Mitsubishi Electric will accept no responsibility for actual use of the product based on these illustrative examples.
- This manual content, specification etc. may be changed, without a notice, for improvement.
- The information in this manual has been carefully checked and is believed to be accurate; however, if you notice a doubtful point, an error, etc., please contact the nearest Mitsubishi Electric representative. When doing so, please provide the manual number given at the end of this manual.

MEMO

CONTENTS

SAFETY PRECAUTIONS	1
INTRODUCTION	8
RELEVANT MANUALS	12
TERMS	14
CHAPTER 1 Outline	16
1.1 Outline of the MELSEC iQ-F Series	16
Outstanding Performance	16
Superior Drive Control	16
Improved Programming Environment	16
1.2 Substitute Models	17
Selection and Replacement of the Models	17
Replacement of the Projects	17
CHAPTER 2 Replacement from FX3U to FX5U	18
2.1 Outline	18
2.2 Replacement Procedure	18
2.3 Selection of Substitute Models	19
Recommended Substitute Models	19
Precautions Regarding the Hardware	23
2.4 Conversion of the Projects	24
2.5 Replacement of the PLC	24
CHAPTER 3 Replacement from FX3UC to FX5UC	25
3.1 Outline	25
3.2 Replacement Procedure	25
3.3 Selection of Substitute Models	26
Recommended Substitute Models	26
Precautions Regarding the Hardware	30
3.4 Conversion of the Projects	32
3.5 Replacement of the PLC	32
CHAPTER 4 Conversion of the Projects	33
4.1 Operation Method for Replacing Projects	33
4.2 Precautions when Converting the Projects	38
Instruction Replacement List	38
Precautions for Instruction Replacement	46
Device Replacement List	48
Precautions for Device Replacement	50
4.3 Precautions when Replacing the Parameters	50
4.4 Precautions when Replacing Other Functions	51
Precautions when Using the High-speed Counters	51
Precautions when Using the Routine Timer	53

INDEX

54

REVISIONS56
WARRANTY57
TRADEMARKS58

RELEVANT MANUALS

MELSEC iQ-F Series

Manual name <manual number>	Description
MELSEC iQ-F FX5 User's Manual (Startup) <JY997D58201>	Performance specifications, procedures before operation, and troubleshooting of the CPU module.
MELSEC iQ-F FX5U User's Manual (Hardware) <JY997D55301>	Describes the details of hardware of the FX5U CPU module, including input/output specifications, wiring, installation, and maintenance.
MELSEC iQ-F FX5UC User's Manual (Hardware) <JY997D61401>	Describes the details of hardware of the FX5UC CPU module, including input/output specifications, wiring, installation, and maintenance.
MELSEC iQ-F FX5 User's Manual (Application) <JY997D55401>	Describes basic knowledge required for program design, functions of the CPU module, devices/labels, and parameters.
MELSEC iQ-F FX5 Programming Manual (Program Design) <JY997D55701>	Describes specifications of ladders, ST, FBD/LD, and other programs and labels.
MELSEC iQ-F FX5 Programming Manual (Instructions, Standard Functions/Function Blocks) <JY997D55801>	Describes specifications of instructions and functions that can be used in programs.
MELSEC iQ-F FX5 User's Manual (Serial Communication) <JY997D55901>	Describes N:N network, Parallel link, MELSEC Communication protocol, inverter communication, non-protocol communication, and predefined protocol support.
MELSEC iQ-F FX5 User's Manual (MELSEC Communication Protocol) <JY997D60801>	Explains methods for the device that is communicating with the CPU module by MC protocol to read and write the data of the CPU module.
MELSEC iQ-F FX5 User's Manual (MODBUS Communication) <JY997D56101>	Describes MODBUS serial communication and MODBUS/TCP communication.
MELSEC iQ-F FX5 User's Manual (PROFIBUS) <SH-081910ENG>	Describes the function of the PROFIBUS-DP master module.
MELSEC iQ-F FX5 User's Manual (Ethernet Communication) <JY997D56201>	Describes the Ethernet communication functions of the CPU module built-in and the Ethernet module.
MELSEC iQ-F FX5-ENET User's Manual <SH-082026ENG>	Describes the functions of the Ethernet module.
MELSEC iQ-F FX5 User's Manual (SLMP) <JY997D56001>	Explains methods for the device that is communicating with the CPU module by SLMP to read and write the data of the CPU module.
MELSEC iQ-F FX5 User's Manual (CC-Link IE) <JY997D64201>	Describes CC-Link IE field network module.
MELSEC iQ-F FX5 User's Manual (CC-Link) <SH-081793ENG>	Describes CC-Link system master/intelligent device module.
MELSEC iQ-F FX5 User's Manual (ASLINK) <SH-081796ENG>	Describes AnyWireASLINK system master module.
MELSEC iQ-F FX5 User's Manual (Positioning Control - CPU module built-in, High-speed pulse input/output module) <JY997D56301>	Describes the positioning function of the CPU module built-in and the high-speed pulse input/output module.
MELSEC iQ-F FX5 User's Manual (Positioning Control - Intelligent function module) <SH-081805ENG>	Describes the positioning module.
MELSEC iQ-F FX5 Simple Motion Module User's Manual (Startup) <IB0300251>	Specifications, procedures before operation, system configuration, wiring, and operation examples of the Simple Motion module.
MELSEC iQ-F FX5 Simple Motion Module User's Manual (Application) <IB0300253>	Functions, input/output signals, buffer memories, parameter settings, programming, and troubleshooting of the Simple Motion module.
MELSEC iQ-F FX5 Simple Motion Module User's Manual (Advanced Synchronous Control) <IB0300255>	Functions and programming for the synchronous control of the Simple Motion module.
MELSEC iQ-F FX5 User's Manual (Analog Control - CPU module built-in, Expansion adapter) <JY997D60501>	Describes the analog function of the CPU module built-in and the analog adapter.
MELSEC iQ-F FX5 User's Manual (Analog Control - Intelligent function module) <SH-081802ENG>	Describes the analog input module, analog output module, and multiple input module.
MELSEC iQ-F FX5 User's Manual (Temperature Control) <SH-081799ENG>	Describes the temperature control module.
GX Works3 Operating Manual <SH-081215ENG>	System configuration, parameter settings, and online operations of GX Works3.

Manual name <manual number>	Description
Transition from MELSEC FX3U, FX3UC Series to MELSEC iQ-F Series Handbook <JY997D66201> (This manual)	Describes the transition from MELSEC FX3U/FX3UC series to MELSEC iQ-F series.

MELSEC FX3U/FX3UC Series

Manual name <manual number>	Description
FX3U Series User's Manual [Hardware Edition] <JY997D16501>	Describes hardware of FX3U Series, including input/output specifications, wiring, installation and maintenance.
FX3UC Series User's Manual [Hardware Edition] <JY997D28701>	Describes hardware of FX3UC Series, including input/output specifications, wiring, installation and maintenance.
FX2N-CNV-BC User's Guide <JY992D66601>	Describes the connection procedure for system configuration of the FX2N-CNV-BC type connector conversion adapter.
FX3S/FX3G/FX3GC/FX3U/FX3UC Series Programming Manual [Basic & Applied Instruction Edition] <JY997D16601>	Describes sequence programming for FX3S-FX3G-FX3GC-FX3U-FX3UC Series, including explanation for basic instructions, applied instructions and various devices.
MELSEC-Q-L-F Structured Programming Manual (Fundamentals) <SH080782>	Programming methods, specifications, functions, etc. required to create structured programs.
FX CPU Structured Programming Manual [Device & Common] <JY997D26001>	Devices, parameters, etc. provided in structured projects of GX Works2.
FX CPU Structured Programming Manual [Sequence instruction] <JY997D34701>	Sequence instructions provided in structured projects of GX Works2.
FX CPU Structured Programming Manual [Application Functions] <JY997D34801>	Application functions provided in structured projects of GX Works2.
FX3S/FX3G/FX3GC/FX3U/FX3UC Series User's Manual [Analog Control Edition] <JY997D16701>	Describes handling for analog control of the FX3S-FX3G-FX3GC-FX3U-FX3UC Series.
FX3U-4LC User's Manual <JY997D39101>	Describes the component names, external dimensions, specifications, and handling of the FX3U-4LC type temperature control module.
FX3U-2HC User's Manual <JY997D36701>	Describes the component names, external dimensions, specifications, and handling of the FX3U-2HC type high-speed counter module.
FX3S/FX3G/FX3GC/FX3U/FX3UC Series User's Manual [Positioning Control] <JY997D16801>	Describes handling for positioning control of the FX3S-FX3G-FX3GC-FX3U-FX3UC Series.
FX3U-1PG User's Manual <JY997D47301>	Describes detailed information regarding the 1-axis pulse output module.
FX3U-20SSC-H User's Manual <JY997D21301>	Describes the component names, external dimensions, specifications, and handling of the FX3U-20SSC-H type SSCNETⅢ positioning control module.
FX Configurator-FP Operation Manual <JY997D21801>	Describes handling and operation of the software for the FX Configurator-FP type positioning module.
FX Series User's Manual [Data Communication Edition] <JY997D16901>	Describes the device configuration, function description, and program of the N:N network/parallel link/computer link/inverter communication/non-protocol communication/programming communication.
FX3U-16CCL-M User's Manual <JY997D43601>	Describes detailed information regarding the CC-Link master module.
FX3U-64CCL User's Manual <JY997D30401>	Describes detailed information regarding the CC-Link interface module.
FX3U-128ASL-M User's Manual <JY997D52101>	Describes detailed information regarding the FX3U-128ASL-M type AnyWireASLINK master module.
FX3U-64DP-M User's Manual <JY997D19201>	Describes detailed information regarding the FX3U-64DP-M type PROFIBUS-DP master module.
FX3U-32DP User's Manual <JY997D25201>	Describes detailed information regarding the FX3U-32DP type PROFIBUS-DP interface module.
FX3U-ENET User's Manual <JY997D18101>	Describes detailed information regarding the Ethernet extension module.
FX3U-ENET-ADP User's Manual <JY997D45801>	Describes detailed information regarding the FX3U-ENET-ADP type Ethernet communication extension adapter.
FX3U-1PSU-5V Installation Manual <JY997D22501>	Describes the specification and handling procedures of the extension power module.
GX Works2 Version 1 Operating Manual (Common) <SH-080779>	Explains system configuration, parameter settings, and online operations of GX Works2.

TERMS

Unless otherwise specified, this manual uses the following terms.

For details on the FX3 devices that can be connected with the FX5, refer to User's Manual (Hardware) of the CPU module to be used.

Terms	Description
■Devices	
FX5	Generic term for FX5U and FX5UC PLCs
FX3	Generic term for FX3S, FX3G, FX3GC, FX3U, and FX3UC PLCs
FX5 CPU module	Generic term for FX5U CPU module and FX5UC CPU module
FX5U CPU module	Generic term for FX5U-32MR/ES, FX5U-32MT/ES, FX5U-32MT/ESS, FX5U-64MR/ES, FX5U-64MT/ES, FX5U-64MT/ESS, FX5U-80MR/ES, FX5U-80MT/ES, FX5U-80MT/ESS, FX5U-32MR/DS, FX5U-32MT/DS, FX5U-32MT/DSS, FX5U-64MR/DS, FX5U-64MT/DS, FX5U-64MT/DSS, FX5U-80MR/DS, FX5U-80MT/DS, and FX5U-80MT/DSS
FX5UC CPU module	Generic term for FX5UC-32MT/D, FX5UC-32MT/DSS, FX5UC-64MT/D, FX5UC-64MT/DSS, FX5UC-96MT/D, FX5UC-96MT/DSS, FX5UC-32MT/DS-TS, and FX5UC-32MT/DSS-TS
Extension module	Generic term for FX5 extension modules and FX3 function modules
• FX5 extension module	Generic term for I/O modules, FX5 extension power supply modules, and FX5 intelligent function modules
• FX3 extension module	Generic term for FX3 extension power supply module and FX3 intelligent function module
• Extension module (extension cable type)	Generic term for Input modules (extension cable type), Output modules (extension cable type), Input/output modules (extension cable type), Powered input/output module, High-speed pulse input/output module, Extension power supply module (extension cable type), Connector conversion module (extension cable type), Intelligent function modules, and Bus conversion module (extension cable type)
• Extension module (extension connector type)	Generic term for Input modules (extension connector type), Output modules (extension connector type), Input/output modules (extension connector type), Extension power supply module (extension connector type), Connector conversion module (extension connector type), and Bus conversion module (extension connector type)
I/O module	Generic term for Input modules, Output modules, Input/output modules, Powered input/output modules, and High-speed pulse input/output modules
Input module	Generic term for Input modules (extension cable type) and Input modules (extension connector type)
• Input module (extension cable type)	Generic term for FX5-8EX/ES and FX5-16EX/ES
• Input module (extension connector type)	Generic term for FX5-C16EX/D, FX5-C16EX/DS, FX5-C32EX/D, FX5-C32EX/DS, and FX5-C32EX/DS-TS
Output module	Generic term for Output modules (extension cable type) and Output modules (extension connector type)
• Output module (extension cable type)	Generic term for FX5-8EYR/ES, FX5-8EYT/ES, FX5-8EYT/ESS, FX5-16EYR/ES, FX5-16EYT/ES, and FX5-16EYT/ESS
• Output module (extension connector type)	Generic term for FX5-C16EYT/D, FX5-C16EYT/DSS, FX5-C32EYT/D, FX5-C32EYT/DSS, FX5-C32EYT/D-TS, and FX5-C32EYT/DSS-TS
Input/output module	Generic term for Input/output modules (extension cable type) and Input/output modules (extension connector type)
• Input/output module (extension cable type)	Generic term for FX5-16ER/ES, FX5-16ET/ES, and FX5-16ET/ESS
• Input/output module (extension connector type)	Generic term for FX5-C32ET/D, FX5-C32ET/DSS, FX5-C32ET/DS-TS, and FX5-C32ET/DSS-TS
Powered input/output module	Generic term for FX5-32ER/ES, FX5-32ET/ES, FX5-32ET/ESS, FX5-32ER/DS, FX5-32ET/DS, and FX5-32ET/DSS
High-speed pulse input/output module	Generic term for FX5-16ET/ES-H and FX5-16ET/ESS-H
Extension power supply module	Generic term for FX5 extension power supply module and FX3 extension power supply module
• FX5 extension power supply module	Generic term for FX5 extension power supply module (extension cable type) and FX5 extension power supply module (extension connector type)
• FX5 extension power supply module (extension cable type)	Different name for FX5-1PSU-5V
• FX5 extension power supply module (extension connector type)	Different name for FX5-C1PS-5V
• FX3 extension power supply module	Different name for FX3U-1PSU-5V
Intelligent module	The abbreviation for intelligent function modules
Intelligent function module	Generic term for FX5 intelligent function modules and FX3 intelligent function modules
• FX5 intelligent function module	Generic term for FX5-4AD, FX5-4DA, FX5-8AD, FX5-4LC, FX5-20PG-P, FX5-20PG-D, FX5-40SSC-S, FX5-80SSC-S, FX5-ENET, FX5-CCLIEF, FX5-CCL-MS, FX5-ASL-M, and FX5-DP-M

Terms	Description
• FX3 intelligent function module	Generic term for FX3U-4AD, FX3U-4DA, FX3U-4LC, FX3U-1PG, FX3U-2HC, FX3U-16CCL-M, FX3U-64CCL, FX3U-128ASL-M, and FX3U-32DP
Expansion board	Generic term for board for FX5U CPU module
• Communication board	Generic term for FX5-232-BD, FX5-485-BD, and FX5-422-BD-GOT
Expansion adapter	Generic term for adapter for FX5 CPU module
• Communication adapter	Generic term for FX5-232ADP and FX5-485ADP
• Analog adapter	Generic term for FX5-4AD-ADP, FX5-4DA-ADP, FX5-4AD-PT-ADP, and FX5-4AD-TC-ADP
Bus conversion module	Generic term for Bus conversion module (extension cable type) and Bus conversion module (extension connector type)
• Bus conversion module (extension cable type)	Different name for FX5-CNV-BUS
• Bus conversion module (extension connector type)	Different name for FX5-CNV-BUSC
Connector conversion module	Generic term for Connector conversion module (extension cable type) and Connector conversion module (extension connector type)
• Connector conversion module (extension cable type)	Different name for FX5-CNV-IF
• Connector conversion module (extension connector type)	Different name for FX5-CNV-IFC
Extended extension cable	Generic term for FX5-30EC and FX5-65EC
Connector conversion adapter	Different name for FX5-CNV-BC
Battery	Different name for FX3U-32BL
SD memory card	Generic term for NZ1MEM-2GBSD, NZ1MEM-4GBSD, NZ1MEM-8GBSD, NZ1MEM-16GBSD, L1MEM-2GBSD and L1MEM-4GBSD SD memory cards Abbreviation of Secure Digital Memory Card. Device that stores data using flash memory.
Peripheral device	Generic term for engineering tools and GOTs
GOT	Generic term for Mitsubishi Electric Graphic Operation Terminal GOT1000 and GOT2000 series
■Software packages	
Engineering tool	The product name of the software package for the MELSEC programmable controllers
GX Works3	The product name of the software package, SWnDND-GXW3, for the MELSEC programmable controllers (The 'n' represents a version.)

1 Outline

1.1 Outline of the MELSEC iQ-F Series

Designed on the concepts of outstanding performance, superior drive control and user centric programming, Mitsubishi Electric MELSEC-F Series has been reborn as the MELSEC iQ-F Series.

From stand alone use to networked system applications, MELSEC iQ-F Series brings your business to the next level of industry.

Outstanding Performance

CPU Performance

A new sequence execution engine is at the core of MELSEC iQ-F, capable of running structured programs and multiple programs, and supports structured text and function blocks, etc.

High-speed System Bus Communication

MELSEC iQ-F realizes high-speed system bus communication at speeds of 1.5 k words/ms (approx. 150-times faster than FX3U). Achieve maximum performance even when using intelligent function module with large amounts of data.

Security

MELSEC iQ-F has advanced security functions (file password, remote password, security key) to prevent data theft and illegal operations by unauthorized persons.

Superior Drive Control

Built-in Positioning

MELSEC iQ-F features powerful positioning functionality with 8 ch high-speed pulse input and 4-axis pulse output. Positioning operations including interrupt, variable speed, and simple interpolation can easily be set up in tables and executed.

Simple Motion Module

By connecting the Simple Motion module equipped with positioning function compatible with SSCNETⅢ/H, and combining linear interpolation, 2-axis circular interpolation, and continuous trajectory control in the program set by table method, a smooth trajectory can be easily drawn.

By starting with parameter settings and the PLC program, the Simple Motion modules can realize a variety of motion control including positioning control, advanced synchronous control, cam control and speed-torque control.

Improved Programming Environment

User-friendly Programming Software (GX Works3)

■System design with a convenient parts library

With GX Works3, designing a system is as easy as preparing the module configuration diagram by dragging and dropping selected parts.

■Auto-generation of module parameters

When preparing the module configuration diagram, simply double-click the module to automatically generate the module parameters. A window with an easy-to-use parameter settings screen opens, enabling module parameters to be modified as needed.

■Main programming languages supported

The main IEC languages are supported by GX Works3. Various different programming languages can be used within the same project simultaneously, and the labels and devices used in each program can be shared.

1.2 Substitute Models

The recommended substitute models (MELSEC iQ-F Series) introduced in this manual are general substitute models considered from the number of input/output points, program capacity, product and input/output terminal type (terminal block/connector etc.). According to usage and service condition, other substitute models different from those described may be suitable. Please plan replacement to a substitute model with the following procedures.

Procedure to Replace to Substitute Model

1. Investigation of the existing system

List the installed places, number of units, and the type of PLCs. Investigate the programs and wiring diagram etc.

2. Diagnosis of the facilities

Make a diagnosis of the facility's importance and duration of service, usage environment etc., and set priorities and plan the replacement procedure.

3. Selection of the models

Select the replacement models according to the number of input/output points and the availability of extension modules etc. Select from the latest MELSEC iQ-F Series.

4. Reuse of the program

Consider either to reuse the program of the existing system, or create new program. When reusing, convert and correct the read out program to the new PLC's format.

5. Replacement of the models

Arrange the selected models and replace on-site.

6. Debug of the system

Test the system after replacement and adjust bugs and timing.

7. Completion

After debugging, migrate to live operation.

Selection and Replacement of the Models

The CPU modules and extension modules of FX3U/FX3UC can be replaced by selecting models from the successor models FX5U/FX5UC that match the system.

- FX3U

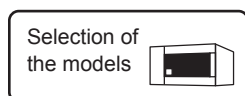

☞ Page 18 Replacement from FX3U to FX5U

- FX3UC

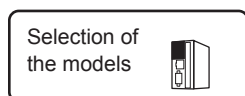

☞ Page 25 Replacement from FX3UC to FX5UC

Replacement of the Projects

FX3U/FX3UC projects created by GX Works2 can be converted to MELSEC iQ-F projects by GX Works3. (GX Works2 must also be installed)

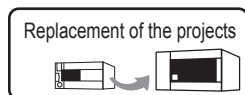

☞ Page 33 Conversion of the Projects

2 Replacement from FX3U to FX5U

2.1 Outline

FX5U, which is the successor model of the FX3U, is equipped with analog functions, communication and high-speed input/output etc., and can easily be expanded with expansion boards and expansion adapters. The high-speed system bus communication brings out the maximum performance of extension modules equipped with intelligent functions.

The procedures and points for replacing to the successor model FX5U are shown below. Please consider replacement with the information.

Points to Consider

- The “recommended substitute models” are described for individual FX3U and extension modules that can be replaced by iQ-F Series models. According to usage and system configuration (connection status of the extension modules), and cases when the I/O numbers actually used are small, other models than the described “recommended substitute models” may be suitable for replacement.
- The recommended substitute models for extension modules, function expansion boards and built-in batteries are described with those that can be connected to the FX5U CPU module.
- Contents that require special caution when replacing each model are described in “Special notes”. Most recommended substitute models have various differences in specifications other than those in “Special notes” such as the dimension becoming smaller than the current models. Therefore, when considering usage, please check not only the “Special notes” but also the details of each specification for the dimension and power specifications etc., in the manual.
- Based on the above conditions, “No recommended substitute models” is described for those without a recommended substitute model, but there are cases that can be replaced with an FX5U system configuration according to usage and system configuration. Check the necessary functions and features when considering the replacement with FX5U system configuration.

2.2 Replacement Procedure

The replacement procedure is shown below.

The successor model FX5U is recommended when replacing from FX3U.

1. Selection of the models

Select the substitute models.

 Page 19 Selection of Substitute Models

2. Conversion of the program

Convert the program used in FX3U to be able to use in FX5U.

 Page 33 Conversion of the Projects

3. Replacement to the substitute models

Replace the PLCs.

 Page 24 Replacement of the PLC

2.3 Selection of Substitute Models

Recommended Substitute Models

Recommended Substitute Models for CPU Modules

The recommended substitute models of FX5U compatible with FX3U are introduced.

Please consider to replace the currently used CPU modules to the following recommended substitute models.

■FX3U and recommended substitute models list (CPU modules)

FX3U Series		Recommended Substitute Models	Special notes
Device name	Model name	Model name	
CPU module	FX3U-16MR/ES	FX5U-32MR/ES	The number of I/O increases in the recommended substitute models.
	FX3U-16MT/ES	FX5U-32MT/ES	The number of I/O increases in the recommended substitute models.
	FX3U-16MT/ESS	FX5U-32MT/ESS	The number of I/O increases in the recommended substitute models.
	FX3U-32MR/ES	FX5U-32MR/ES	
	FX3U-32MS/ES	No recommended substitute models	
	FX3U-32MT/ES	FX5U-32MT/ES	
	FX3U-32MT/ESS	FX5U-32MT/ESS	
	FX3U-48MR/ES	FX5U-64MR/ES	The number of I/O increases in the recommended substitute models.
	FX3U-48MT/ES	FX5U-64MT/ES	The number of I/O increases in the recommended substitute models.
	FX3U-48MT/ESS	FX5U-64MT/ESS	The number of I/O increases in the recommended substitute models.
	FX3U-64MR/ES	FX5U-64MR/ES	
	FX3U-64MS/ES	No recommended substitute models	
	FX3U-64MT/ES	FX5U-64MT/ES	
	FX3U-64MT/ESS	FX5U-64MT/ESS	
	FX3U-80MR/ES	FX5U-80MR/ES	
	FX3U-80MT/ES	FX5U-80MT/ES	
	FX3U-80MT/ESS	FX5U-80MT/ESS	
	FX3U-128MR/ES	FX5U-80MR/ES+FX5-16ER/ES	
	FX3U-128MT/ES	FX5U-80MT/ES+FX5-16ET/ES	
	FX3U-128MT/ESS	FX5U-80MT/ESS+FX5-16ET/ESS	
	FX3U-16MR/DS	FX5U-32MR/DS	The number of I/O increases in the recommended substitute models.
	FX3U-16MT/DS	FX5U-32MT/DS	The number of I/O increases in the recommended substitute models.
	FX3U-16MT/DSS	FX5U-32MT/DSS	The number of I/O increases in the recommended substitute models.
	FX3U-32MR/DS	FX5U-32MR/DS	
	FX3U-32MT/DS	FX5U-32MT/DS	
	FX3U-32MT/DSS	FX5U-32MT/DSS	
	FX3U-48MR/DS	FX5U-64MR/DS	The number of I/O increases in the recommended substitute models.
	FX3U-48MT/DS	FX5U-64MT/DS	The number of I/O increases in the recommended substitute models.
	FX3U-48MT/DSS	FX5U-64MT/DSS	The number of I/O increases in the recommended substitute models.
	FX3U-64MR/DS	FX5U-64MR/DS	

FX3U Series		Recommended Substitute Models	Special notes
Device name	Model name	Model name	
CPU module	FX3U-64MT/DS	FX5U-64MT/DS	
	FX3U-64MT/DSS	FX5U-64MT/DSS	
	FX3U-80MR/DS	FX5U-80MR/DS	
	FX3U-80MT/DS	FX5U-80MT/DS	
	FX3U-80MT/DSS	FX5U-80MT/DSS	
	FX3U-32MR/UA1	No recommended substitute models	
	FX3U-64MR/UA1	No recommended substitute models	

Recommended Substitute Models for Extension Devices

The following list shows the extension devices that will be necessary to replace simultaneously when replacing the CPU module from FX3U to FX5U.

For products without a substitute model of the same function, check the contents described in the Special notes and please consider system reconfiguration.

■List of extension devices required to replace when replacing the CPU module from FX3U to FX5U

Extension device		Recommended Substitute Models	Special notes
Device name	Model name	Model name	
Extension I/O	FX2N-8ER	FX5-16ER/ES	The number of I/O increases in the recommended substitute models.
	FX2N-8ER-ES/UL	FX5-16ER/ES	The number of I/O increases in the recommended substitute models.
	FX2N-8EX	FX5-8EX/ES	
	FX2N-8EX-ES/UL	FX5-8EX/ES	
	FX2N-8EX-UA1/UL	No recommended substitute models	
	FX2N-16EX	FX5-16EX/ES	
	FX2N-16EX-ES/UL	FX5-16EX/ES	
	FX2N-16EX-C	FX5-CNV-IF+FX5-C16EX/D	Only a connector type module can be connected after (on the right side of) FX5-CNV-IF.
	FX2N-16EXL-C	No recommended substitute models	
	FX2N-8EYR	FX5-8EYR/ES	
	FX2N-8EYR-ES/UL	FX5-8EYR/ES	
	FX2N-8EYR-S-ES/UL	No recommended substitute models	
	FX2N-8EYT	FX5-8EYT/ES	
	FX2N-8EYT-ESS/UL	FX5-8EYT/ESS	
	FX2N-8EYT-H	No recommended substitute models	
	FX2N-16EYR	FX5-16EYR/ES	
	FX2N-16EYR-ES/UL	FX5-16EYR/ES	
	FX2N-16EYT	FX5-16EYT/ES	
	FX2N-16EYT-ESS/UL	FX5-16EYT/ESS	
	FX2N-16EYT-C	FX5-CNV-IF+FX5-C16EYT/D	Only a connector type module can be connected after (on the right side of) FX5-CNV-IF.
	FX2N-16EYS	No recommended substitute models	
	FX2N-32ER	FX5-32ER/ES	
	FX2N-32ER-ES/UL	FX5-32ER/ES	
	FX2N-32ET	FX5-32ET/ES	
	FX2N-32ET-ESS/UL	FX5-32ET/ESS	
	FX2N-32ES	No recommended substitute models	
	FX2N-48ER	FX5-32ER/ES+FX5-16ER/ES	
	FX2N-48ER-ES/UL	FX5-32ER/ES+FX5-16ER/ES	
	FX2N-48ET	FX5-32ET/ES+FX5-16ET/ES	
	FX2N-48ET-ESS/UL	FX5-32ET/ESS+FX5-16ET/ESS	

Extension device		Recommended Substitute Models	Special notes
Device name	Model name	Model name	
Extension I/O	FX2N-48ER-D	FX5-32ER/DS+FX5-16ER/ES	
	FX2N-48ER-DS	FX5-32ER/DS+FX5-16ER/ES	
	FX2N-48ET-D	FX5-32ET/DS+FX5-16ET/ES	
	FX2N-48ET-DSS	FX5-32ET/DSS+FX5-16ET/ESS	
	FX2N-48ER-UA1/UL	No recommended substitute models	
Extension device	FX3U-1PSU-5V	FX5-1PSU-5V	
	FX2N-5A	FX5-4AD+FX5-4DA	The wiring must be replaced from the screw terminal block to the spring clamp terminal block.
	FX2N-2AD	FX5-4AD	The wiring must be replaced from the screw terminal block to the spring clamp terminal block.
	FX2N-8AD	FX5-8AD	The wiring must be replaced from the screw terminal block to the spring clamp terminal block.
	FX2N-2LC	FX5-4LC	The wiring must be replaced from the screw terminal block to the spring clamp terminal block.
	FX2N-2DA	FX5-4DA	The wiring must be replaced from the screw terminal block to the spring clamp terminal block.
	FX2N-1HC	FX3U-2HC ^{*1}	Replacement of the wiring from the screw terminal block to the connector is necessary.
	FX2N-10PG	FX5-20PG-D	Replacement is necessary due to the difference of the connector type.
	FX3U-20SSC-H	FX5-40SSC-S	Replacement is necessary due to the difference of the connector type for external input connection.
	FX2N-232IF	No recommended substitute models	
	FX2N-32CCL	FX5-CCL-MS	Set to the intelligent device station in the recommended substitute models. ^{*2}
	FX2N-64CL-M	No recommended substitute models	
	FX3U-ENET	No recommended substitute models	Ethernet port is built into FX5U CPU module.
	FX3U-64DP-M	FX5-DP-M	
	FX3U-CAN	No recommended substitute models	
	FX3U-J1939	No recommended substitute models	
	FX2N-10GM	FX5-20PG-P	It cannot be used alone. Replacement is necessary due to the difference of the connector type.
	FX2N-20GM	FX5-20PG-P	It cannot be used alone. Replacement is necessary due to the difference of the connector type.
	FX2N-1RM-SET(-E)	No recommended substitute models	
	FX2N-32DP-IF(-D)	No recommended substitute models	
FX2N-64DNET	No recommended substitute models		
Expansion board	FX3U-232-BD	FX5-232-BD	
	FX3U-485-BD	FX5-485-BD	
	FX3U-422-BD	FX5-422-BD-GOT	GOT can only be connected to FX5-422-BD-GOT.
	FX3U-CNV-BD	—	Not necessary for FX5U CPU module.
	FX3U-8AV-BD	No recommended substitute models	
	FX3U-USB-BD	No recommended substitute models	

Extension device		Recommended Substitute Models	Special notes
Device name	Model name	Model name	
Expansion adapter	FX3U-232ADP(-MB)	FX5-232ADP	
	FX3U-485ADP(-MB)	FX5-485ADP	
	FX3U-ENET-ADP	No recommended substitute models	Ethernet port is built into FX5U CPU module.
	FX3U-3A-ADP	FX5-4AD-ADP+FX5-4DA-ADP	
	FX3U-4AD-ADP	FX5-4AD-ADP	
	FX3U-4DA-ADP	FX5-4DA-ADP	
	FX3U-4AD-PT-ADP	FX5-4AD-PT-ADP	
	FX3U-4AD-PTW-ADP	No recommended substitute models	
	FX3U-4AD-PNK-ADP	No recommended substitute models	
	FX3U-4AD-TC-ADP	FX5-4AD-TC-ADP	
	FX3U-4HSX-ADP	No recommended substitute models	
	FX3U-2HSY-ADP	No recommended substitute models	
	FX3U-CF-ADP	No recommended substitute models	
	Option	FX3U-FLROM-16	No recommended substitute models
FX3U-FLROM-64		No recommended substitute models	Substituted by an SD memory card.
FX3U-FLROM-64L		No recommended substitute models	Substituted by an SD memory card.
FX3U-FLROM-1M		No recommended substitute models	Substituted by an SD memory card.
FX3U-7DM		No recommended substitute models	
FX-30P		No recommended substitute models	
FX0N-30EC		FX5-30EC	
FX0N-65EC		FX5-65EC	
FX2N-CNV-BC		FX5-CNV-BC	

*1 It is possible to connect to the system of FX5U CPU module by connecting the bus conversion module (FX5-CNV-BUS).

*2 FX5-CCL-MS can be used as a master station.

Extension devices that can be reused when the CPU module is replaced to FX5U

The following extension modules can be used by connecting the bus conversion module (FX5-CNV-BUS) even when the CPU module is replaced from the FX3U to FX5U.

■ Extension devices that can be used even when the CPU module is replaced from the FX3U to FX5U

Extension power supply	Analog	Positioning	High-speed counter	Network	Terminal module ^{*1}	
FX3U-1PSU-5V	FX3U-4AD FX3U-4DA FX3U-4LC	FX3U-1PG	FX3U-2HC	FX3U-16CCL-M ^{*2} FX3U-64CCL FX3U-128ASL-M ^{*2} FX3U-32DP	FX-16E-TB FX-32E-TB FX-16EX-A1-TB FX-16EYR-TB FX-16EYS-TB FX-16EYT-TB	FX-16E-TB/UL FX-32E-TB/UL FX-16EYR-ES-TB/UL FX-16EYS-ES-TB/UL FX-16EYT-ES-TB/UL FX-16EYT-ESS-TB/UL

*1 The terminal module can be used without connecting a bus conversion module.

*2 It is necessary to set the parameter with the PLC program.

Battery

The battery (FX3U-32BL) used in FX3U can also be used with FX5U.

Precautions Regarding the Hardware

Comparison of FX3U and FX5U and Precautions for Replacement

The following list shows precautions of the hardware. Check details in the manuals of each model when replacing.

■Difference and precautions regarding the main hardware of FX3U and FX5U

Item	Difference		Precautions
	FX3U	FX5U	
Extension of FX2N and FX3U	Extension possible	Extension is possible only for certain modules. FX5-CNV-BUS is required for extension.	Connection is not possible for some intelligent modules of FX3U.
Input hardware filter (When the digital filter is 0) • High-speed counter • Input interruption function • Pulse catch function	X0 to X5: 5 μs X6 to X7: 50 μs X10 to X17: 200 μs	<p>■In the case of FX5U-32M</p> X0 to X5: • ON: 2.5 μs or less • OFF: 2.5 μs or less X6 to X17: • ON: 30 μs or less • OFF: 50 μs or less <p>■In the case of FX5U-64M and FX5U-80M</p> X0 to X7: • ON: 2.5 μs or less • OFF: 2.5 μs or less X10 to X17: • ON: 30 μs or less • OFF: 50 μs or less X20 or later: • ON: 50 μs or less • OFF: 150 μs or less	Noises that were not detected by FX3U may possibly be captured as an input. Take measures against noise on the outside, or set an appropriate input response time parameter.
Input signal current	X0 to X5: 6 mA X6 to X7: 7 mA X10 or later: 5 mA	X0 to X17: 5.3 mA X20 or later: 4 mA	The input signal current has been lowered, so it is necessary to check the specification of the external devices when replacing.

■External dimension drawing

There is some difference in the external dimension of FX3U and the successor model FX5U. Be careful when replacing the modules.

- FX3U

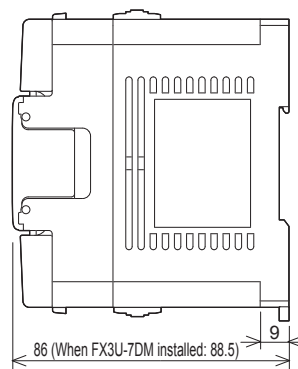
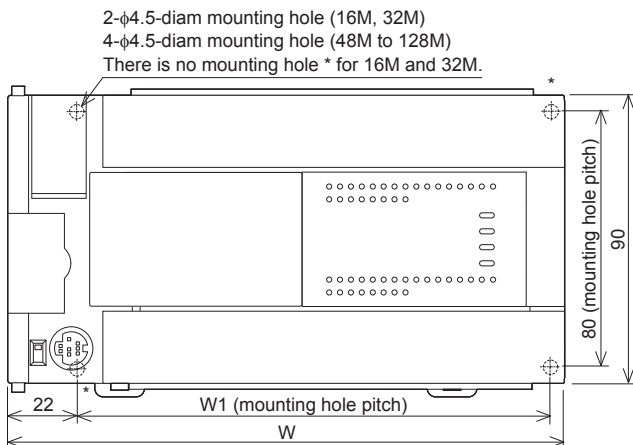

External color: Munsell 0.08GY/7.64/
0.81
Top cover: Munsell N1.5
Unit: mm
The terminal block uses M3 terminal
screws
35 mm width DIN rail can be
installed

Model name	W: mm	W1: mm	Weight: kg
FX3U-16M	130	103	0.60
FX3U-32M	150	123	0.65
FX3U-48M, FX3U-32MR/UA1	182	155	0.85
FX3U-64M	220	193	1.00
FX3U-80M, FX3U-64MR/UA1	285	258	1.20
FX3U-128M	350	323	1.80

• FX5U

2-φ4.5-diam mounting hole (32M)
 4-φ4.5-diam mounting hole (64M, 80M)
 There is no mounting hole * for 32M.

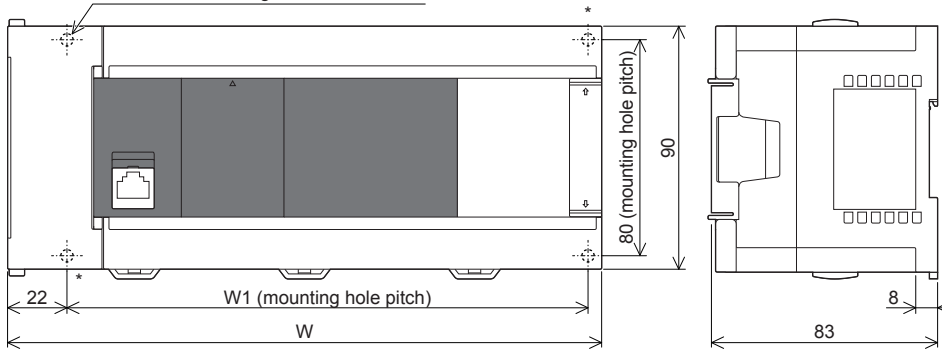

External color: Munsell 0.6B7.6/0.2
 Unit: mm
 The terminal block uses M3 terminal screws
 35 mm width DIN rail can be installed

Model name	W: mm	W1: mm	Weight: kg
FX5U-32M	150	123	0.70
FX5U-64M	220	193	1.00
FX5U-80M	285	258	1.20

■ Cable sizes for European type terminal block

Suitable wiring and tightening torque are described below.

	Wire size for one wire	Wire size for two wires	Wire ferrule with insulation sleeve (wire size)	Tightening torque	Stripping dimensions of electric wire ends
Built-in RS-485 communication terminal block Built-in analog I/O terminal block	AWG24 to AWG20	AWG24	AWG24 to AWG20	0.22 to 0.25 N·m	5 mm
FX3U-485-BD, FX3U-485ADP FX5-485-BD, FX5-485ADP FX5-4AD-ADP, FX5-4DA-ADP, FX5-4AD-PT-ADP, FX5-4AD-TC-ADP	AWG22 to AWG20	AWG22	AWG22 to AWG20	0.22 to 0.25 N·m 0.20 N·m	9 mm

2.4 Conversion of the Projects

For the conversion method of the project, refer to Page 33 Conversion of the Projects.

2.5 Replacement of the PLC

The main points to consider during replacement of the CPU module and extension modules are explained below.

For details of each item, check the reference pages in this document, and related manuals such as the PLC Hardware Manual and Programming Manual.

Device classification	Item	Operation content and points of attention	Reference page
CPU module	Reuse of the input/output wiring	Perform rewiring for the connection part of the terminal block type.	Page 19
Other extension modules	Wiring to each module		
Verifying operation of the equipment	Operation and test of the PLC program	Operate the converted PLC program and hardware devices, and check and adjust the device function and operation timing. Be aware of the precautions described on the reference page for replacing the project, and check that the devices operate as they are designed.	Page 33

3 Replacement from FX3UC to FX5UC

3.1 Outline

FX5UC, the successor model of FX3UC, has compact and easy-to-use compatible extension modules, which makes downsizing of various devices possible. Connect to the FX5 and FX3 extension modules with the variety of conversion modules available.

The procedures and points for replacing to the successor model FX5UC are shown below. Please consider replacement with the information.

Points to Consider

- The “recommended substitute models” are described for individual FX3UC and extension modules that can be replaced by iQ-F Series models. According to usage and system configuration (connection status of the extension modules), and cases when the I/O numbers actually used are small, other models than the described “recommended substitute models” may be suitable for replacement.
- The recommended substitute models for extension modules and built-in batteries are described with those that can be connected to the FX5UC CPU module.
- Contents that require special caution when replacing each models are described in “Special notes”. Most recommended substitute models have various differences in the specifications other than those in “Special notes” such as the dimension becoming smaller than the current models. Therefore, when considering usage, please check not only the “Special notes” but also the details of each specification for the dimension and power specifications etc., in the manual.
- Based on the above conditions, “No recommended substitute models” is described for those without a recommended substitute model, but there are cases that can be replaced with an FX5UC system configuration according to usage and system configuration. Check the necessary functions and features when considering the replacement with FX5UC system configuration.

3.2 Replacement Procedure

The replacement procedure is shown below.

The successor model FX5UC is recommended when replacing from FX3UC.

1. Selection of the models

Select the substitute models.

 Page 26 Selection of Substitute Models

2. Conversion of the program

Convert the program used in FX3UC to be able to use in FX5UC.

 Page 33 Conversion of the Projects

3. Replacement to the substitute models

Replace the PLCs.

 Page 32 Replacement of the PLC

3.3 Selection of Substitute Models

Recommended Substitute Models

Recommended Substitute Models for CPU Modules

The recommended substitute models of FX5UC compatible with FX3UC are introduced below.

Please consider to replace the currently used CPU modules to the following recommended substitute models.

■FX3UC and recommended substitute models list (CPU modules)

FX3UC Series		Recommended Substitute Models	Special notes
Device name	Model name	Model name	
CPU module	FX3UC-16MR/D-T	No recommended substitute models	
	FX3UC-16MT/D	FX5UC-32MT/D	The number of I/O increases in the recommended substitute models.
	FX3UC-32MT/D	FX5UC-32MT/D	
	FX3UC-64MT/D	FX5UC-64MT/D	
	FX3UC-96MT/D	FX5UC-96MT/D	
	FX3UC-16MR/DS-T	No recommended substitute models	
	FX3UC-16MT/DSS	FX5UC-32MT/DSS	The number of I/O increases in the recommended substitute models.
	FX3UC-32MT/DSS	FX5UC-32MT/DSS	
	FX3UC-64MT/DSS	FX5UC-64MT/DSS	
	FX3UC-96MT/DSS	FX5UC-96MT/DSS	
	FX3UC-32MT-LT-2	No recommended substitute models	

Recommended Substitute Models for Extension Devices

The following list shows the extension devices that will be necessary to replace simultaneously when replacing the CPU module from FX3UC to FX5UC.

For products without a substitute model of the same function, check the contents described in the Special notes and please consider system reconfiguration.

■List of extension devices required to replace when replacing the CPU module from FX3UC to FX5UC

Extension device		Recommended Substitute Models	Special notes
Device name	Model name	Model name	
Extension I/O	FX2NC-16EX	FX5-C16EX/D	
	FX2NC-16EX-DS	FX5-C16EX/DS	
	FX2NC-16EX-T	FX5-C32EX/DS-TS	The number of I/O increases in the recommended substitute models. The wiring must be replaced from the European terminal block to the spring clamp terminal block.
	FX2NC-16EYT	FX5-C16EYT/D	
	FX2NC-16EYT-DSS	FX5-C16EYT/DSS	
	FX2NC-16EYR-T	No recommended substitute models	
	FX2NC-32EX	FX5-C32EX/D	
	FX2NC-32EX-DS	FX5-C32EX/DS	
	FX2NC-32EYT	FX5-C32EYT/D	
	FX2NC-32EYT-DSS	FX5-C32EYT/DSS	
	FX2N-8ER	FX5-16ER/ES	The number of I/O increases in the recommended substitute models.
	FX2N-8ER-ES/UL	FX5-16ER/ES	The number of I/O increases in the recommended substitute models.
	FX2N-8EX	FX5-8EX/ES	
	FX2N-8EX-ES/UL	FX5-8EX/ES	
	FX2N-8EX-UA1/UL	No recommended substitute models	
	FX2N-16EX	FX5-16EX/ES	
	FX2N-16EX-ES/UL	FX5-16EX/ES	
	FX2N-16EX-C	FX5-C16EX/D	
	FX2N-16EXL-C	No recommended substitute models	
	FX2N-8EYR	FX5-8EYR/ES	
	FX2N-8EYR-ES/UL	FX5-8EYR/ES	
	FX2N-8EYR-S-ES/UL	No recommended substitute models	
	FX2N-8EYT	FX5-8EYT/ES	
	FX2N-8EYT-ESS/UL	FX5-8EYT/ESS	
	FX2N-8EYT-H	No recommended substitute models	
	FX2N-16EYR	FX5-16EYR/ES	
	FX2N-16EYR-ES/UL	FX5-16EYR/ES	
	FX2N-16EYT	FX5-16EYT/ES	
	FX2N-16EYT-ESS/UL	FX5-16EYT/ESS	
	FX2N-16EYT-C	FX5-C16EYT/D	
FX2N-16EYS	No recommended substitute models		

Extension device		Recommended Substitute Models	Special notes
Device name	Model name	Model name	
Extension device	FX2NC-1HC	FX3U-2HC ^{*1}	The European terminal block must be replaced to the 40-pin connector.
	FX3UC-4AD	FX5-4AD	The wiring must be replaced from the European terminal block to the spring clamp terminal block.
	FX2N-5A	FX5-4AD+FX5-4DA	The wiring must be replaced from the screw terminal block to the spring clamp terminal block.
	FX2N-2AD	FX5-4AD	The wiring must be replaced from the screw terminal block to the spring clamp terminal block.
	FX2N-8AD	FX5-8AD	The wiring must be replaced from the screw terminal block to the spring clamp terminal block.
	FX2N-2LC	FX5-4LC	The wiring must be replaced from the screw terminal block to the spring clamp terminal block.
	FX2N-2DA	FX5-4DA	The wiring must be replaced from the screw terminal block to the spring clamp terminal block.
	FX2N-1HC	FX3U-2HC ^{*1}	Replacement of the wiring from the screw terminal block to the connector is necessary.
	FX2N-10PG	FX5-20PG-D	Replacement is necessary due to the difference of the connector type.
	FX3U-20SSC-H	FX5-40SSC-S	Replacement is necessary due to the difference of the connector type for external input connection.
	FX2N-232IF	No recommended substitute models	
	FX2N-32CCL	FX5-CCL-MS	Set to the intelligent device station in the recommended substitute models.*2
	FX2N-64CL-M	No recommended substitute models	
	FX3U-ENET	No recommended substitute models	Ethernet port is built into FX5UC CPU module.
	FX3U-64DP-M	FX5-DP-M	
	FX3U-CAN	No recommended substitute models	
	FX3U-J1939	No recommended substitute models	
	FX2N-10GM	FX5-20PG-P	It cannot be used alone. Replacement is necessary due to the difference of the connector type.
	FX2N-20GM	FX5-20PG-P	It cannot be used alone. Replacement is necessary due to the difference of the connector type.
	FX2N-1RM-SET(-E)	No recommended substitute models	
FX2N-32DP-IF(-D)	No recommended substitute models		
FX2N-64DNET	No recommended substitute models		
Expansion adapter	FX3U-232ADP(-MB)	FX5-232ADP	
	FX3U-485ADP(-MB)	FX5-485ADP	
	FX3U-ENET-ADP	No recommended substitute models	Ethernet port is built into FX5UC CPU module.
	FX3U-3A-ADP	FX5-4AD-ADP+FX5-4DA-ADP	
	FX3U-4AD-ADP	FX5-4AD-ADP	
	FX3U-4DA-ADP	FX5-4DA-ADP	
	FX3U-4AD-PT-ADP	FX5-4AD-PT-ADP	
	FX3U-4AD-PTW-ADP	No recommended substitute models	
	FX3U-4AD-PNK-ADP	No recommended substitute models	
	FX3U-4AD-TC-ADP	FX5-4AD-TC-ADP	
	FX3U-CF-ADP	No recommended substitute models	

Extension device		Recommended Substitute Models	Special notes
Device name	Model name	Model name	
Option	FX2NC-CNV-IF	FX5-CNV-IFC	
	FX3UC-1PS-5V	FX5-C1PS-5V	
	FX3U-FLROM-16	No recommended substitute models	Substituted by an SD memory card.
	FX3U-FLROM-64	No recommended substitute models	Substituted by an SD memory card.
	FX3U-FLROM-64L	No recommended substitute models	Substituted by an SD memory card.
	FX3U-FLROM-1M	No recommended substitute models	Substituted by an SD memory card.
	FX-30P	No recommended substitute models	
	FX0N-30EC	FX5-30EC	
	FX0N-65EC	FX5-65EC	
	FX2N-CNV-BC	FX5-CNV-BC	

*1 It is possible to connect to the system of FX5UC CPU module by connecting a bus conversion module (FX5-CNV-BUSC or FX5-CNV-BUS).

*2 FX5-CCL-MS can be used as a master station.

Extension devices that can be reused when the CPU module is replaced to FX5UC

The following extension devices can be used by connecting a bus conversion module (FX5-CNV-BUSC or FX5-CNV-BUS) even when the CPU module is replaced from the FX3UC to FX5UC.

■ Extension devices that can be used even when the CPU module is replaced from the FX3UC to FX5UC

Analog	Positioning	High-speed counter	Network	Terminal module ^{*1}	
FX3U-4AD FX3U-4DA FX3U-4LC	FX3U-1PG	FX3U-2HC	FX3U-16CCL-M ^{*2} FX3U-64CCL FX3U-128ASL-M ^{*2} FX3U-32DP	FX-16E-TB FX-32E-TB FX-16EX-A1-TB FX-16EYR-TB FX-16EYS-TB FX-16EYT-TB	FX-16E-TB/UL FX-32E-TB/UL FX-16EYR-ES-TB/UL FX-16EYS-ES-TB/UL FX-16EYT-ES-TB/UL FX-16EYT-ESS-TB/UL

*1 The terminal module can be used without connecting a bus conversion module.

*2 It is necessary to set the parameter with the PLC program.

Battery

The battery (FX3U-32BL) used in FX3UC can also be used with FX5UC.

Precautions Regarding the Hardware

Comparison of FX3UC and FX5UC and Precautions for Replacement

The following list shows precautions of the hardware. Check details in the manuals of each models when replacing.

■Difference and precautions regarding the main hardware of FX3UC and FX5UC

Item	Difference		Precautions
	FX3UC	FX5UC	
Extension of FX2N, FX2NC, FX3U, and FX3UC	Extension possible	Extension is possible only for certain modules. FX5-CNV-BUSC or FX5-CNV-BUS is required for extension.	Connection is not possible for some intelligent modules of FX3U.
Input hardware filter (When the digital filter is 0) • High-speed counter • Input interruption function • Pulse catch function	X0 to X5: 5 μ s X6 to X7: 50 μ s X10 to X17: 200 μ s	<p>■In the case of FX5UC-32M</p> <p>X0 to X5:</p> <ul style="list-style-type: none"> • ON: 2.5 μs or less • OFF: 2.5 μs or less <p>X6 to X17:</p> <ul style="list-style-type: none"> • ON: 30 μs or less • OFF: 50 μs or less <p>■In the case of FX5UC-64M and FX5UC-96M</p> <p>X0 to X7:</p> <ul style="list-style-type: none"> • ON: 2.5 μs or less • OFF: 2.5 μs or less <p>X10 to X17:</p> <ul style="list-style-type: none"> • ON: 30 μs or less • OFF: 50 μs or less <p>X20 or later:</p> <ul style="list-style-type: none"> • ON: 50 μs or less • OFF: 150 μs or less 	Noises that were not detected by FX3UC may possibly be captured as an input. Take measures against noise on the outside, or set an appropriate input response time parameter.
Input signal current	X0 to X5: 6 mA X6 to X7: 7 mA X10 or later: 5 mA	X0 to X17: 5.3 mA X20 or later: 4 mA	The input signal current has been lowered, so it is necessary to check the specification of the external devices when replacing.

External dimension drawing

There is some difference in the external dimension of FX3UC and the successor model FX5UC. Be careful when replacing the modules.

• FX3UC

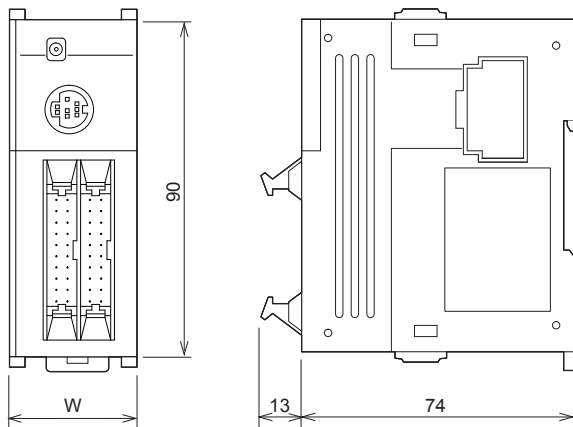

External color: Munsell 0.08GY/7.64/0.81
Unit: mm
35 mm width DIN rail can be installed

[Accessories]
FX2NC-100MPCB power cable
FX2NC-100BPCB power cable (only FX3UC-□MT/D)

Model name	W: mm	Weight: kg
FX3UC-16MT/D, DSS, FX3UC-32MT/D, DSS	34.0	0.20
FX3UC-64MT/D, DSS	59.7	0.30
FX3UC-96MT/D, DSS	85.4	0.35

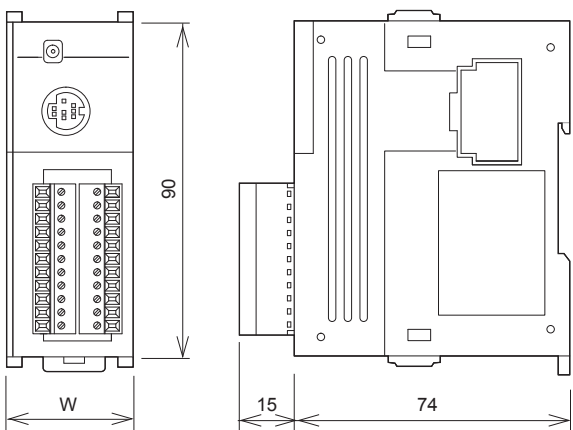

External color: Munsell 0.08GY/7.64/0.81
Unit: mm
35 mm width DIN rail can be installed

[Accessories]
FX2NC-100MPCB power cable
FX2NC-100BPCB power cable (only FX3UC-16MR/D-T)

Model name	W: mm	Weight: kg
FX3UC-16MR/D-T, FX3UC-16MR/DS-T	34.0	0.25

• FX5UC

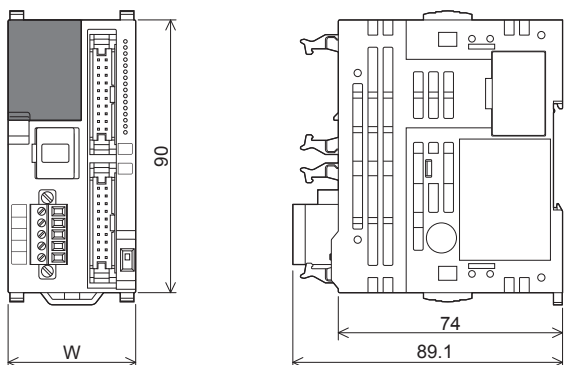

External color: Munsell 0.6B7.6/0.2
Unit: mm
35 mm width DIN rail can be installed

[Accessories]
FX2NC-100MPCB power cable
FX2NC-100BPCB power cable (only FX5UC-□MT/D)

Model name	W: mm	Weight: kg
FX5UC-32MT/D, DSS	42.1	0.20
FX5UC-64MT/D, DSS	62.2	0.30
FX5UC-96MT/D, DSS	82.3	0.35

■ Cable sizes for European type terminal block

Suitable wiring and tightening torque are described below.

	Wire size for one wire	Wire size for two wires	Wire ferrule with insulation sleeve (wire size)	Tightening torque	Stripping dimensions of electric wire ends
Built-in RS-485 communication terminal block	AWG22 to AWG20	AWG22	AWG22 to AWG20	0.22 to 0.25 N·m	9 mm
FX3U-485ADP					
FX5-485ADP					
FX5-4AD-ADP, FX5-4DA-ADP, FX5-4AD-PT-ADP, FX5-4AD-TC-ADP				0.20 N·m	



3.4 Conversion of the Projects

For the conversion method of the project, refer to  Page 33 Conversion of the Projects.

3.5 Replacement of the PLC

The main points to consider during replacement of the CPU module and extension devices are explained below.

For details of each item, check the reference pages in this document, and related manuals such as the PLC Hardware Manual and Programming Manual.

Device classification	Item	Operation content and points of attention	Reference page
CPU module	Connector connection of the input/output wiring	The input/output connector and 24 V DC connector types and signal names are the same for FX3UC and FX5UC. Reconnect the cable removed from FX3UC to FX5UC. Perform rewiring for the connection part of the terminal block type.	 Page 26
	Connector connection of the 24 V DC power cable		
Other extension modules	Wiring to each module	The input/output connector and 24 V DC connector and signal names are the same for FX2NC and FX5UC. Reconnect the cable removed from FX2NC to FX5UC. Perform rewiring for the connection part of the terminal block type.	
Verifying operation of the equipment	Operation and test of the PLC program	Operate the converted PLC program and hardware devices, and check and adjust the device function and operation timing. Be aware of the precautions described on the reference page for replacing the project, and check that the devices operate as they are designed.	 Page 33

4 Conversion of the Projects

When converting the projects of FX3U/FX3UC to MELSEC iQ-F project, perform the conversion by using GX Works3. After converting the projects, it may be necessary to adjust the programs (instructions, devices) and parameters.

4.1 Operation Method for Replacing Projects

For converting the projects of FX3U/FX3UC to MELSEC iQ-F, perform by using GX Works3.

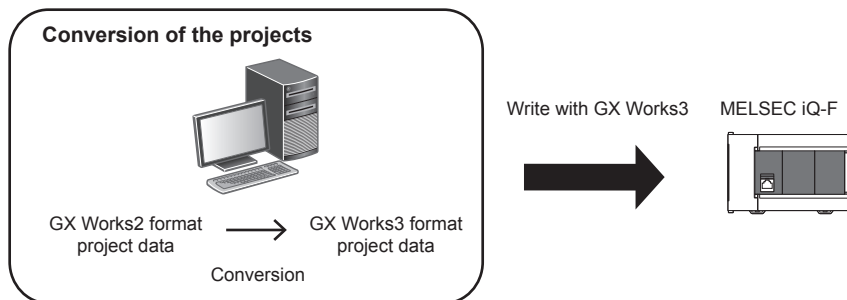

To convert the projects, install the engineering tool of the following version.

Engineering tool	Version	Remarks
GX Works3	1.020W or higher	—
GX Works2	1.519R or higher	Supplied with GX Works3.

Point

When converting project data other than FX3U/FX3UC, change the PLC type to FX3U/FX3UC using GX Works2. After changing the PLC type, check that there is no error using GX Works2, and then convert to MELSEC iQ-F using GX Works3.

Precautions

- To read out projects of GX Works2 using GX Works3, convert beforehand using GX Works2, and then read out the projects. Even for projects converted using GX Works2, conversion may not be performed according to the state of the project. If there is an error in the program, read out will be canceled.
- To read out projects of GX Works2 using GX Works3, administrator rights are required.

Operating procedure

1. Start up GX Works3.
2. Open the project of FX3U/FX3UC.
Select [Project]⇒[Open Other Format File]⇒[GX Works2 Format]⇒[Open Project]⇒Project (***.gxw).

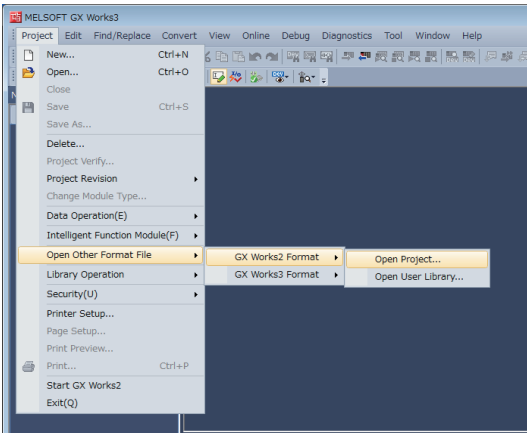

3. The following display is shown.
 - For GX Works3 version 1.040S and laterA selection screen of the following conversion method is shown. Select the conversion method and press the [Execute] button.

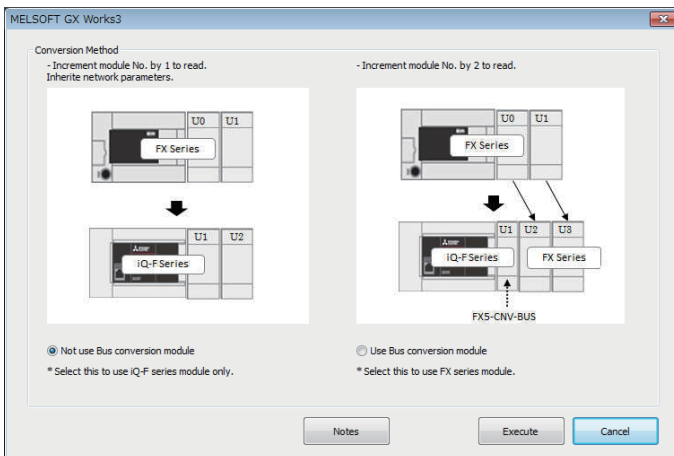

- For GX Works3 version 1.038Q and earlier

The following message is shown. After checking the contents, press the [OK] button.

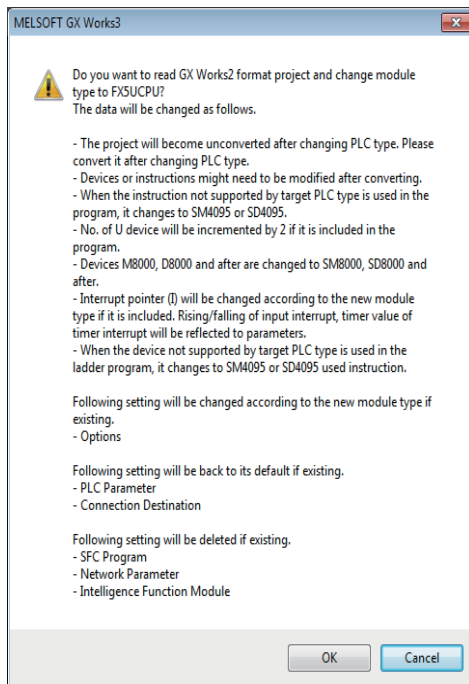

Point

- The display contents may vary depending on the version of the software.
- Precautions for the converted project are displayed. Please read carefully through the contents before use.

4. When conversion is completed, the following message is shown.

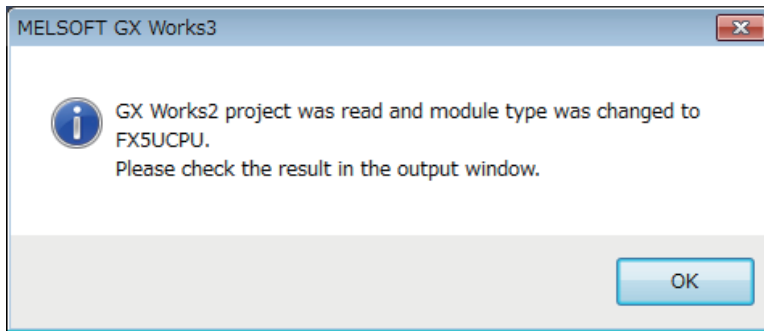

5. Check the contents of the model change result in the “Output window”.

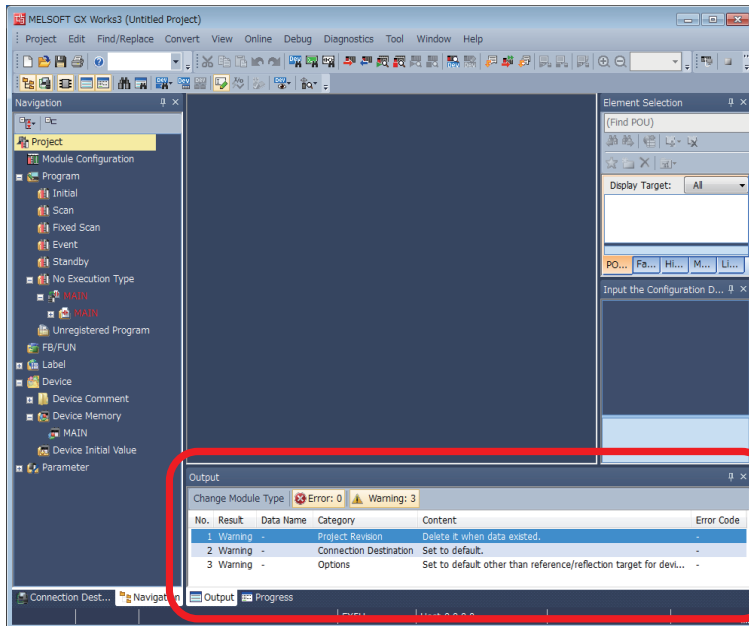

→ Output window

6. Set the converted program to “Scan”. (In GX Works3 version 1.025B or later, the converted program is set to “Scan”.)
The converted program is stored in “No Execution Type”. Set to scan by any of the following methods.

- When setting in the “Navigation window”

Drag using the mouse and move to “Scan”.

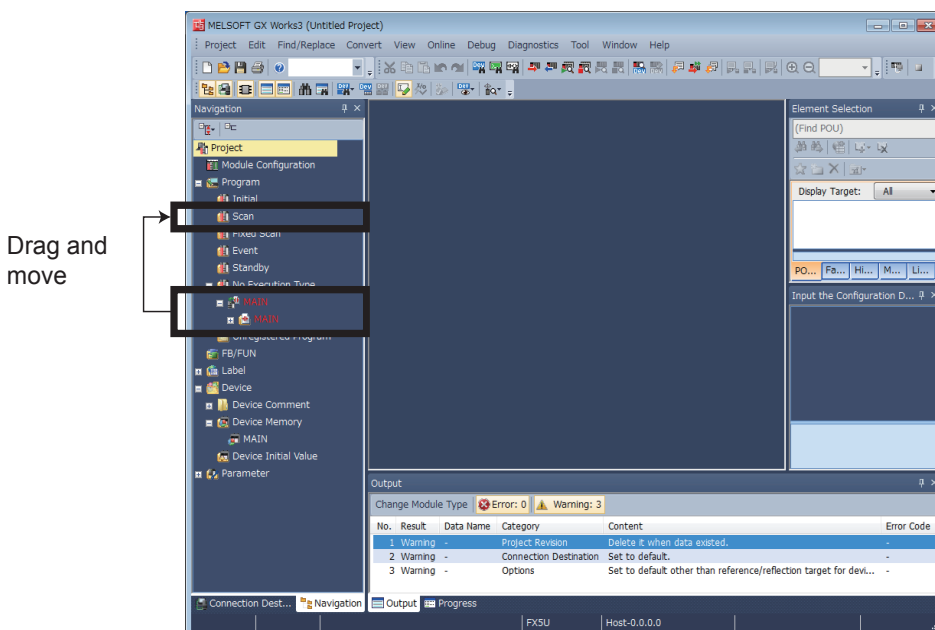

- When setting “Scan” by parameter

[CPU parameter]⇒”Program setting”⇒”Program setting”⇒”Detail setting”⇒Program Name

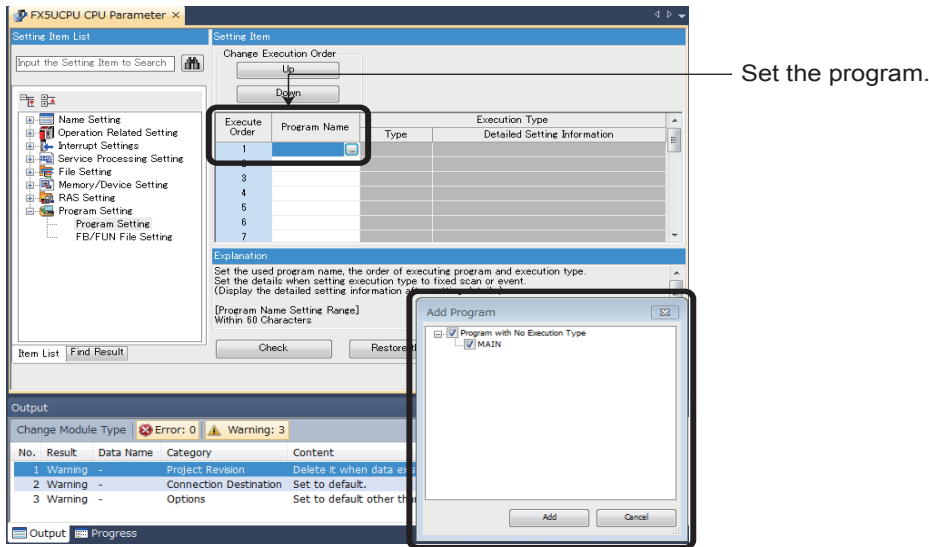

Precautions

- The program must be changed from “No Execution Type”. (Change to Scan, etc.)
- The program instructions and devices may have changed. Check the contents of the project. Parameters other than the network parameter of CC-Link*1 will be deleted. Set the parameters if necessary.

*1 For the network parameter of CC-Link, refer to Page 50 Precautions when Replacing the Parameters.

7. Set the model name of the CPU for the system parameter.

[System Parameter]⇒[I/O Assignment Setting]⇒Model Name

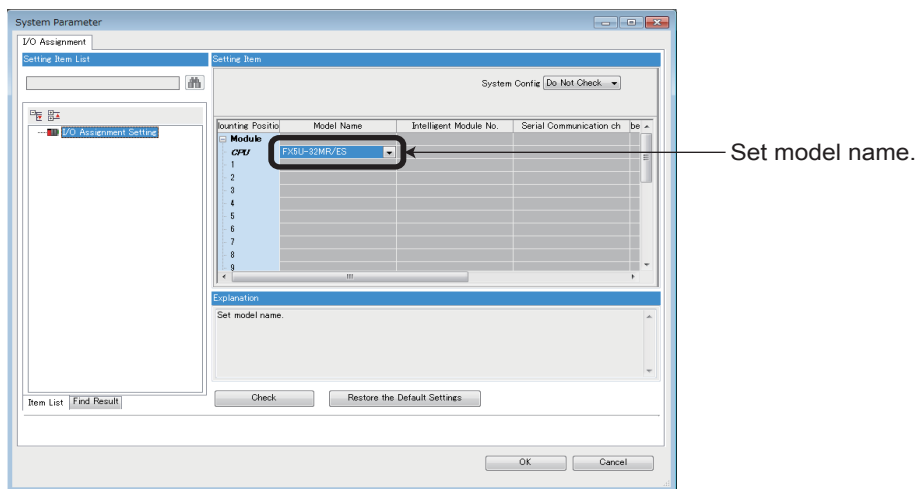

8. Perform conversion.

[Convert]⇒[Rebuild All]

4.2 Precautions when Converting the Projects

- When converting projects of the FX3 Series using GX Works3, be careful because the program (instructions and devices) may be changed.
- When converting projects, the number of steps may increase and writing to the FX5 CPU module may be impossible. Check the number of steps after replacement.
- Characters used for the label name in GX Works2 may correspond to reserved words or illegal characters in GX Works3. In that case, change the label name.

Instruction Replacement List

Instruction Replacement List of Ladder Programs

■ Replaced instructions

The following instructions will be replaced to GX Works3 compatible instructions when converting the project.

FX3 Series	→	MELSEC IQ-F	Remarks
OUT T	→	OUT T/ST, OUTH T/ST, OUTHS T/ST • When the timer is 1 ms, it will be replaced to the OUTHS T/ST instruction. • When the timer is 10 ms, it will be replaced to the OUTH T/ST instruction. • When the timer is 100 ms, it will be replaced to the OUT T/ST instruction.	When a label is used instead of a timer device, the instructions will not be replaced.*1
INT	→	FLT2INT	—
INTP	→	FLT2INTP	—
DINT	→	FLT2DINT	—
DINTP	→	FLT2DINTP	—
RET	→	RETSTL	—
FLT	→	INT2FLT	—
FLTP	→	INT2FLTP	—
DFLT	→	DINT2FLT	—
DFLTP	→	DINT2FLTP	—
DTBL	→	TBL	—
SQR	→	SQRT	—
SER	→	SERMM	—
RAMP	→	RAMPF	—
SORT	→	SORTTBL	—
HEX	→	HEXA	—
SORT2	→	SORTTBL2	—
HOUR	→	HOURM	—
SQRP	→	SQRTP	—
DSQR	→	DSQRT	—
DSQRP	→	DSQRTP	—
SERP	→	SERMMP	—
DSER	→	DSERMM	—
DSERP	→	DSERMMP	—
HEXP	→	HEXAP	—
DSORT2	→	DSORTTBL2	—
DHOUR	→	DHOURM	—

FX3 Series	→	MELSEC iQ-F	Remarks	
IVCK	→	IVCK	SM4095 is added to parameters of instructions. Change to an appropriate device or label.	
IVDR	→	IVDR		
IVRD	→	IVRD		
IVWR	→	IVWR		
IVBWR	→	IVBWR		
IVMC	→	IVMC		
ADPRW	→	ADPRW		
PR	→	OUT SM4095		These instructions are not supported by MELSEC iQ-F. Therefore, it will be replaced to OUT SM4095.
COMRD	→	OUT SM4095		
COMRDP	→	OUT SM4095		
REFF	→	OUT SM4095		
REFFP	→	OUT SM4095		
DHSCT	→	OUT SM4095		
PLSR	→	OUT SM4095		
DPLSR	→	OUT SM4095		
RS	→	OUT SM4095		
VRRD	→	OUT SM4095		
VRRDP	→	OUT SM4095		
VRSC	→	OUT SM4095		
VRSCP	→	OUT SM4095		
ZRN	→	OUT SM4095		
DZRN	→	OUT SM4095		
HKY	→	OUT SM4095		
DHKY	→	OUT SM4095		
TKY	→	OUT SM4095		
DTKY	→	OUT SM4095		
ARWS	→	OUT SM4095		
RD3A	→	OUT SM4095		
RD3AP	→	OUT SM4095		
WR3A	→	OUT SM4095		
WR3AP	→	OUT SM4095		
LOADR	→	ERREAD* ²	—	
SAVER	→	OUT SM4095	These instructions are not supported by MELSEC iQ-F. Therefore, it will be replaced to OUT SM4095.	
INITR	→	OUT SM4095		
INITRP	→	OUT SM4095		
LOGR	→	OUT SM4095		
LOGRP	→	OUT SM4095		
RWER	→	ERWRITE* ²	—	
RWERP	→	ERWRITE* ²	—	
INITER	→	ERINIT* ²	—	
INITERP	→	ERINIT* ²	—	
FLCRT	→	OUT SM4095	These instructions are not supported by MELSEC iQ-F. Therefore, it will be replaced to OUT SM4095.	
FLDEL	→	OUT SM4095		
FLWR	→	OUT SM4095		
FLRD	→	OUT SM4095		
FLCMD	→	OUT SM4095		
FLSTRD	→	OUT SM4095		
ASC	→	OUT SM4095		

*1 For GX Works3 version 1.032J and later, the instructions will be replaced when a timer device is assigned to the global label.

*2 For GX Works3 version 1.038Q and earlier, the instructions will be replaced with OUT SM4095.

Precautions

When inline ST is used with the ladder program, instructions and devices can be replaced like ST programs. However, readout of the program may fail depending on the following conditions.

- If a syntax error exists
- If the program exceeds 2048 characters

If there is an instruction that is not supported by the MELSEC iQ-F Series in the program created using GX Works2, the instruction will be changed to the instruction using SM4095/SD4095.

Instruction Replacement List of Structured Ladder to FBD/LD

■ Replaced instructions

The following instructions will be replaced to GX Works3 compatible instructions when converting the project.

FX3 Series	→	MELSEC iQ-F	Remarks
OUT_T	→	OUT_T, OUTH, OUTHS • When the timer is 1 ms, it will be replaced to the OUTHS instruction. • When the timer is 10 ms, it will be replaced to the OUTH instruction. • When the timer is 100 ms, it will be replaced to the OUT_T instruction.	When a label is used instead of a timer device, the instructions will not be replaced.*1
SQRP	→	SQRTP	—
DSQR	→	DSQRT	—
DSQRP	→	DSQRTP	—
FLT	→	INT2FLT	—
FLTP	→	INT2FLTP	—
DFLT	→	DINT2FLT	—
DFLTP	→	DINT2FLTP	—
SER	→	SERMM	—
SERP	→	SERMMP	—
DSER	→	DSERMM	—
DSERP	→	DSERMMP	—
RAMP	→	RAMPF	—
SORT	→	SORTTBL	—
HEX	→	HEXA	—
HEXP	→	HEXAP	—
INT	→	FLT2INT	—
INTP	→	FLT2INTP	—
DINT	→	FLT2DINT	—
DINTP	→	FLT2DINTP	—
SORT2	→	SORTTBL2	—
DSORT2	→	DSORTTBL2	—
HOUR	→	HOURM	—
DHOUR	→	DHOURM	—
BK+	→	BKPLUS	—
BK+P	→	BKPLUSP	—
DBK+	→	DBKPLUS	—
DBK+P	→	DBKPLUSP	—
BK-	→	BKMINUS	—
BK-P	→	BKMINUSP	—
DBK-	→	DBKMINUS	—
DBK-P	→	DBKMINUSP	—
BKCMP=	→	BKCMP_EQ	—
BKCMP=P	→	BKCMP_EQP	—
DBKCMP=	→	DBKCMP_EQ	—
DBKCMP=P	→	DBKCMP_EQP	—

FX3 Series	→	MELSEC IQ-F	Remarks
BKCOMP>	→	BKCOMP_GT	—
BKCOMP>P	→	BKCOMP_GTP	—
DBKCOMP>	→	DBKCOMP_GT	—
DBKCOMP>P	→	DBKCOMP_GTP	—
BKCOMP<	→	BKCOMP_LT	—
BKCOMP<P	→	BKCOMP_LTP	—
DBKCOMP<	→	DBKCOMP_LT	—
DBKCOMP<P	→	DBKCOMP_LTP	—
BKCOMP<>	→	BKCOMP_NE	—
BKCOMP<>P	→	BKCOMP_NEP	—
DBKCOMP<>	→	DBKCOMP_NE	—
DBKCOMP<>P	→	DBKCOMP_NEP	—
BKCOMP<=	→	BKCOMP_LE	—
BKCOMP<=P	→	BKCOMP_LEP	—
DBKCOMP<=	→	DBKCOMP_LE	—
DBKCOMP<=P	→	DBKCOMP_LEP	—
BKCOMP>=	→	BKCOMP_GE	—
BKCOMP>=P	→	BKCOMP_GEP	—
DBKCOMP>=	→	DBKCOMP_GE	—
DBKCOMP>=P	→	DBKCOMP_GEP	—
\$+	→	STRINGPLUS	—
\$+P	→	STRINGPLUSP	—
\$MOV	→	STRINGMOV	—
\$MOV P	→	STRINGMOV P	—
LD=	→	LD_EQ	—
LDD=	→	LDD_EQ	—
LD>	→	LD_GT	—
LDD>	→	LDD_GT	—
LD<	→	LD_LT	—
LDD<	→	LDD_LT	—
LD<>	→	LD_NE	—
LDD<>	→	LDD_NE	—
LD<=	→	LD_LE	—
LDD<=	→	LDD_LE	—
LD>=	→	LD_GE	—
LDD>=	→	LDD_GE	—
AND=	→	AND_EQ	—
ANDD=	→	ANDD_EQ	—
AND>	→	AND_GT	—
ANDD>	→	ANDD_GT	—
AND<	→	AND_LT	—
ANDD<	→	ANDD_LT	—
AND<>	→	AND_NE	—
ANDD<>	→	ANDD_NE	—
AND<=	→	AND_LE	—
ANDD<=	→	ANDD_LE	—
AND>=	→	AND_GE	—
ANDD>=	→	ANDD_GE	—
OR=	→	OR_EQ	—
ORD=	→	ORD_EQ	—
OR>	→	OR_GT	—
ORD>	→	ORD_GT	—
OR<	→	OR_LT	—

FX3 Series	→	MELSEC IQ-F	Remarks	
ORD<	→	ORD_LT	—	
OR<>	→	OR_NE	—	
ORD<>	→	ORD_NE	—	
OR<=	→	OR_LE	—	
ORD<=	→	ORD_LE	—	
OR>=	→	OR_GE	—	
ORD>=	→	ORD_GE	—	
IVCK	→	IVCK	SM4095 is added to parameters of instructions. Change to an appropriate device or label.	
IVDR	→	IVDR		
IVRD	→	IVRD		
IVWR	→	IVWR		
IVBWR	→	IVBWR		
IVMC	→	IVMC		
ADPRW	→	ADPRW		
LOADR	→	ERREAD*2		—
LOADRP	→	ERREAD*2	—	
RWER	→	ERWRITE*2	—	
RWERP	→	ERWRITE*2	—	
INITER	→	ERINIT*2	—	
INITERP	→	ERINIT*2	—	
SQR	→	SQRT_E	These instructions will be converted to standard functions.	
LEN	→	LEN_E		
RIGHT	→	RIGHT_E		
LEFT	→	LEFT_E		
LIMIT	→	LIMIT_E		
DLIMIT	→	LIMIT_E		
BOOL_TO_STR	→	BOOL_TO_STRING		—
BOOL_TO_STR_E	→	BOOL_TO_STRING_E		—
INT_TO_STR	→	INT_TO_STRING	—	
INT_TO_STR_E	→	INT_TO_STRING_E	—	
DINT_TO_STR	→	DINT_TO_STRING	—	
DINT_TO_STR_E	→	DINT_TO_STRING_E	—	
REAL_TO_STR	→	REAL_TO_STRING	—	
REAL_TO_STR_E	→	REAL_TO_STRING_E	—	
STR_TO_BOOL	→	STRING_TO_BOOL	—	
STR_TO_BOOL_E	→	STRING_TO_BOOL_E	—	
STR_TO_INT	→	STRING_TO_INT	—	
STR_TO_INT_E	→	STRING_TO_INT_E	—	
STR_TO_DINT	→	STRING_TO_DINT	—	
STR_TO_DINT_E	→	STRING_TO_DINT_E	—	
STR_TO_REAL	→	STRING_TO_REAL	—	
STR_TO_REAL_E	→	STRING_TO_REAL_E	—	
STR_TO_TIME	→	STRING_TO_TIME	—	
STR_TO_TIME_E	→	STRING_TO_TIME_E	—	
TIME_TO_STR	→	TIME_TO_STRING	—	
TIME_TO_STR_E	→	TIME_TO_STRING_E	—	
MAXIMUM	→	MAX	—	
MAXIMUM_E	→	MAX_E	—	
MINIMUM	→	MIN	—	
MINIMUM_E	→	MIN_E	—	
LIMITATION	→	LIMIT	—	
LIMITATION_E	→	LIMIT_E	—	

*1 For GX Works3 version 1.032J and later, the instructions will be replaced when a timer device is assigned to the global label.

*2 These instructions are supported by GX Works3 version 1.040S and later.

■Instructions that are not supported by GX Works3

The following instructions are not supported by GX Works3. The instructions are left as is when converting the projects, but an error will occur when compiling.

Instruction list			
OUT_C_32	REFFP	DTBL	FLCRT
STL	PLSR	ZRN	FLDEL
RET	DPLSR	DZRN	FLWR
CJ	TKY	RD3A	FLRD
CJP	DTKY	RD3AP	FLCMD
CALL	HKY	WR3A	FLSTRD
CALLP	DHKY	WR3AP	GET_BIT_OF_INT
SRET	ARWS	COMRD	GET_BIT_OF_INT_E
IRET	ASC	COMRDP	SET_BIT_OF_INT
FEND	PR	DHSCT	SET_BIT_OF_INT_E
ROR	RS	SAVER	CPY_BIT_OF_INT
DROR	VRRD	INITR	CPY_BIT_OF_INT_E
ROL	VRRDP	INITRP	
DROL	VRSC	LOGR	
REFF	VRSCP	LOGRP	

Precautions

Even if the instructions are supported by GX Works3, a conversion error may occur due to the difference of the setting range of FX3U/FX3UC.

Instructions/FB/FUN that are not supported by the FBD/LD program will be undefined instructions/FB/FUN.

Instruction Replacement List of ST Programs

■Replaced instructions

The following instructions will be replaced to GX Works3 compatible instructions when converting the project.

FX3 Series	→	MELSEC IQ-F	Remarks
OUT_T	→	OUT_T, OUTH, OUTHS <ul style="list-style-type: none"> When the timer is 1 ms, it will be replaced to the OUTHS instruction. When the timer is 10 ms, it will be replaced to the OUTH instruction. When the timer is 100 ms, it will be replaced to the OUT_T instruction. 	When a label is used instead of a timer device, the instructions will not be replaced.*1
SQRP	→	SQRTP	—
DSQR	→	DSQRT	—
DSQRP	→	DSQRTP	—
SER	→	SERMM	—
SERP	→	SERMMP	—
DSER	→	DSERMM	—
DSERP	→	DSERMMP	—
RAMP	→	RAMPF	—
SORT	→	SORTTBL	—
HEX	→	HEXA	—
HEXP	→	HEXAP	—
SORT2	→	SORTTBL2	—
DSORT2	→	DSORTTBL2	—
HOUR	→	HOURM	—
DHOUR	→	DHOURM	—

FX3 Series	→	MELSEC IQ-F	Remarks
IVCK	→	IVCK	SM4095 is added to parameters of instructions. Change to an appropriate device or label.
IVDR	→	IVDR	
IVRD	→	IVRD	
IVWR	→	IVWR	
IVBWR	→	IVBWR	
IVMC	→	IVMC	
ADPRW	→	ADPRW	
LOADR	→	ERREAD ^{*2}	
LOADRP	→	ERREAD ^{*2}	—
RWER	→	ERWRITE ^{*2}	—
RWERP	→	ERWRITE ^{*2}	—
INITER	→	ERINIT ^{*2}	—
INITERP	→	ERINIT ^{*2}	—
SQR	→	SQRT_E	These instructions will be converted to standard functions.
LEN	→	LEN_E	
RIGHT	→	RIGHT_E	
LEFT	→	LEFT_E	
LIMIT	→	LIMIT_E	
DLIMIT	→	LIMIT_E	—
BOOL_TO_STR	→	BOOL_TO_STRING	—
BOOL_TO_STR_E	→	BOOL_TO_STRING_E	—
INT_TO_STR	→	INT_TO_STRING	—
INT_TO_STR_E	→	INT_TO_STRING_E	—
DINT_TO_STR	→	DINT_TO_STRING	—
DINT_TO_STR_E	→	DINT_TO_STRING_E	—
REAL_TO_STR	→	REAL_TO_STRING	—
REAL_TO_STR_E	→	REAL_TO_STRING_E	—
STR_TO_BOOL	→	STRING_TO_BOOL	—
STR_TO_BOOL_E	→	STRING_TO_BOOL_E	—
STR_TO_INT	→	STRING_TO_INT	—
STR_TO_INT_E	→	STRING_TO_INT_E	—
STR_TO_DINT	→	STRING_TO_DINT	—
STR_TO_DINT_E	→	STRING_TO_DINT_E	—
STR_TO_REAL	→	STRING_TO_REAL	—
STR_TO_REAL_E	→	STRING_TO_REAL_E	—
STR_TO_TIME	→	STRING_TO_TIME	—
STR_TO_TIME_E	→	STRING_TO_TIME_E	—
TIME_TO_STR	→	TIME_TO_STRING	—
TIME_TO_STR_E	→	TIME_TO_STRING_E	—
MAXIMUM	→	MAX	—
MAXIMUM_E	→	MAX_E	—
MINIMUM	→	MIN	—
MINIMUM_E	→	MIN_E	—
LIMITATION	→	LIMIT	—
LIMITATION_E	→	LIMIT_E	—

*1 For GX Works3 version 1.032J and later, the instructions will be replaced when a timer device is assigned to the global label.

*2 These instructions are supported by GX Works3 version 1.040S and later.

■ Instructions that are not supported by GX Works3

The following instructions are not supported by GX Works3. The instructions are left as is when converting the projects, but an error will occur when compiling.

Instruction list			
OUT_C_32	DPLSR	INTP	INITR
IRET	TKY	DINT	INITRP
FEND	DTKY	DINTP	LOGR
ROR	HKY	DTBL	LOGRP
DROR	DHKY	ZRN	FLCRT
ROL	ARWS	DZRN	FLDEL
DROL	ASC	RD3A	FLWR
FLT	PR	RD3AP	FLRD
FLTP	RS	WR3A	FLCMD
DFLT	VRRD	WR3AP	FLSTRD
DFLTP	VRRDP	COMRD	MOD
REFF	VRSC	COMRDP	
REFFP	VRSCP	DHSCT	
PLSR	INT	SAVER	

Precautions

Even if the instructions are supported by GX Works3, a conversion error may occur due to the difference of the setting range of FX3U/FX3UC.

When a character string constant is used in the GX Works2 program, be aware of the following points.

- When the character string is enclosed with a double quotation ("), it will be replaced with a single quotation (').
- When using a (') and (") in the character string constant of GX Works3, it must be input as (\$') and (\$").

Precautions for Instruction Replacement

When converting the projects of the FX3 Series to MELSEC iQ-F projects, the instructions may be changed or correction required. The details are explained below.

Arguments

Arguments of function with "_E"

For functions with "_E", the positions of the arguments are different between GX Works2 and GX Works3. Therefore the projects must be modified after conversion.

- GX Works2: EN is specified by the first argument and "ENO" is the return value.
- GX Works3: EN is specified by the first argument, ENO is specified by the second argument, and the result is the return value. (The value is the same as function without "_E".)

Data type of arguments

The required data type of arguments for some instructions, functions, function blocks of GX Works2, and the required data type of arguments for the instructions, functions, function blocks of GX Works3 are different. Therefore, an error may occur because of data type mismatch when reusing the program of GX Works2. In that case, modify the instruction name or arguments.

Ex.

INC instruction

- When handling a value exceeding 32767 (maximum value of word [signed]), replace to "INC_U".
- When word [unsigned]/bit array [16-bit] type label is specified for the parameter, replace to "INC_U".

The number and order of arguments

The number and order of arguments of some instructions in GX Works2 is different from those of GX Works3. In that case, modify the arguments.

Ex.

(D)TO instruction

- GX Works2: (S)(n1)(n2)(n3)
- GX Works3: (UnHn)(s1)(s2)(n)

When the order of the arguments in GX Works2 is 1, 2, 3, and 4, the order in GX Works3 is 2, 3, 1, and 4.

Argument requiring multiple points

When using a label as an argument that requires multiple points, use an array label having at least as many elements as required of the argument.

Instructions/FB/FUN that are not supported by the MELSEC iQ-F Series

For the instructions/FB/FUN that are not supported by the MELSEC iQ-F Series, refer to the following manual to correct the program so that the instructions/FB/FUN will be equivalent to the one in the manual.

 MELSEC iQ-F FX5 Programming Manual (Instructions, Standard Functions/Function Block)

Instructions Requiring Special Action When Replacing Structured Ladder to FBD/LD

Instructions

The following instructions require action after the project conversion.

Instruction list			Action content
DHSCR	DSWAP	PLSV	The connecting position of the parameter is different from GX Works2. After replacing to FX5, select the appropriate instruction and perform "Edit"→"FB/FUN update" in the right-click menu, and then adjust the connecting position.
PLSY	DSWAPP	DPLSV	
DPLSY	DSZR	DRVI	
PWM	DVIT	DDRVI	
SWAP	DDVIT	DRVA	
SWAPP	DABS	DDRVA	
DHSCS_I			When an out of range "I" device is specified as parameter "i", parameter "i" will be replaced with P4095.

Correction of structured ladder/FBD program

- The method of thinking for execution order is different for the GX Works2 structured ladder/FBD and GX Works3 FBD/LD language. Display the execution order and check the contents.
- The operation of the return element is different for the GX Works2 structured ladder/FBD and GX Works3 FBD/LD language. For details of the return element of GX Works3, refer to the following.

GX Works3 Operating Manual

- For the GX Works2 structured ladder/FBD and GX Works3 FBD/LD language, there are different cases in the input/output parameter numbers of the function parts/function block parts and the order. In this case, it will be displayed as an undefined FB/FUN. Select [Edit]→[FB/FUN update] to update the definition information, and correct the program.
- When the program is made to refer to a standard FB member in the GX Works2 structured ladder/FBD, a conversion error may occur after opening with GX Works3. In this case, check the member name and class of the standard FB, and correct the program.
- For the GX Works3 FBD/LD language, the input/output parameter of the function parts/function block elements can only be inverted. When elements other than the above are inverted for GX Works2 structured ladder/FBD, the connecting line of that element will be deleted. Correct the program so that the operation will be equal to GX Works2 structured ladder/FBD.
- For the GX Works3 FBD/LD language, the wired OR of the FBD elements are not supported. Correct the program so that the operation will be equal to GX Works2 structured ladder/FBD, or a conversion error will occur.
- When using the pointer branch instructions (CJ), jump, and sub routine program, a conversion error may occur. For details, refer to the following.

MELSEC iQ-F FX5 Programming Manual (Program Design)

- According to the difference of the GX Works2 structured ladder/FBD editor and GX Works3 FBD/LD editor, the layout of the program may change. Correct the layout appropriately.
- Ladder block label used in the GX Works2 structured ladder/FBD will be defined as a pointer type in local label.
- For GX Works3 FBD/LD language, the timer and counter device cannot reset by coil. Use the RST instruction.
- When the output of a function that executes on a pulse is connected to the input of another function, an error occurs. Receive the output by a device or label and then connect to the input.

Instructions Requiring Special Action When Replacing Instructions of ST programs



The following instructions require settings after the project conversion.

FX3 Series	→	MELSEC iQ-F	Action content
DHSCS_I	→	DHSCS_I	When an out of range "I" device is specified as the fourth parameter, it will be replaced with OUT instructions.

Device Replacement List

The following describes the device list when replacing the FX3U/FX3UC projects to MELSEC iQ-F projects. Actions such as replacing the device will be necessary according to the content of precautions.

Device name		FX3U/FX3UC	After replacing to MELSEC iQ-F	Precautions	
Input relay		X0 to X367	X0 to X367	—	
Output relay		Y0 to Y367	Y0 to Y367	—	
Auxiliary relay	For general use	M0 to M499	M0 to M499	—	
	For keep ^{*1}	M500 to M7679	M500 to M7679	—	
	For special use	M8000 to M8511	SM0 to SM8511	Refer to  Page 50 SM/SD Device Replacement.	
State	For initial state	S0 to S9	S0 to S9	—	
	For general use	S10 to S499	S10 to S499	—	
	For keep ^{*1}	S500 to S4095	S500 to S4095	—	
	For annunciator (when using ANS instructions)	ANS S900 to S999	ANS F900 to F999	If necessary, replace the device number. (When the ANS instruction is not used, but it is used as an annunciator, replacement to the F device is necessary.)	
	For annunciator (when not using ANS instructions)	S900 to S999	S900 to S999		
Timer	100 ms	OUT T T0 to T191	OUT T T0 to T191	—	
	100 ms Routine timer	OUT T T192 to T199	OUT T T192 to T199	The routine timer must be set by the parameter. (Refer to  Page 53 Precautions when Using the Routine Timer.)	
	10 ms	OUT T T200 to T245	OUTH T T200 to T245	—	
	1 ms accumulated type	OUT T T246 to T249	OUTH ST ST0 to ST3	—	
	100 ms accumulated type	OUT T T250 to T255	OUT ST ST4 to ST9	—	
	1 ms	OUT T T256 to T511	OUTH T T256 to T511	—	
	Contact		TS0 to TS245 and TS256 to TS511	TS0 to TS245 and TS256 to TS511	—
			TS246 to TS255	STS0 to STS9	
	Coil		TC0 to TC245 and TC256 to TC511	TC0 to TC245 and TC256 to TC511	—
			TC246 to TC255	STC0 to STC9	
	Current value		TN0 to TN245 and TN256 to TN511	TN0 to TN245 and TN256 to TN511	—
			TN246 to TN255	STN0 to STN9	
	Counter	16-bit up counter for general use	C0 to C99	C0 to C99	—
16-bit up counter for keep ^{*1}		C100 to C199	C100 to C199	—	
32-bit bidirectional counter for general use		C200 to C219	LC0 to LC19	—	
32-bit bidirectional counter for keep ^{*1}		C220 to C234	LC20 to LC34	—	
Contact			CS0 to CS199	CS0 to CS199	—
			CS200 to CS234	LCS0 to LCS34	—
Coil			CC0 to CC199	CC0 to CC199	—
			CC200 to CC234	LCC0 to LCC34	—
Current value			CN0 to CN199	CN0 to CN199	—
			CN200 to CN234	LCN0 to LCN34	—

Device name		FX3U/FX3UC	After replacing to MELSEC iQ-F	Precautions	
High-speed counter	1-phase 1-count input	C235 to C245	C235 to C245	Setting of the FX3 Series compatibility assignment and replacement of the device number are necessary by the parameter. (Refer to  Page 51 Precautions when Using the High-speed Counters.)	
	1-phase 2-count input	C246 to C250	C246 to C250		
	2-phase 2-count input	C251 to C255	C251 to C255		
	Contact	CS235 to CS255	CS235 to CS255		—
	Coil	CC235 to CC255	CC235 to CC255		—
	Current value	CN235 to CN255	CN235 to CN255		—
Data register	For general use	D0 to D199	D0 to D199	—	
	For keep ^{*1}	D200 to D7999	D200 to D7999	—	
	For special use	D8000 to D8511	SD0 to SD8511	Refer to  Page 50 SM/SD Device Replacement.	
	File register	File register D1000 to D7999	—	Substitution is possible by using the device initial value function.	
Index register	16-bit Z device	Z0 to Z7	Z0 to Z7	—	
	16-bit V device	V0 to V7	Z10 to Z17	—	
	32-bit Z device (at modification of direct value)	Z0 to Z7	Z0 to Z7	If necessary, replace the direct value modification to the LZ device.	
Extension register		R0 to R32767	R0 to R32767	The battery mode setting is necessary. ^{*2}	
Extension file register		ER0 to ER32767	ER0 to ER32767 ^{*6}	Replaced to OUT SM4095. ^{*6}	
Pointer	Normal pointer	P0 to P4095 (except P63)	P0 to P4095 (except P63)	—	
	END pointer	P63	GOEND	—	
Interrupt pointer ^{*3}	Input interrupt (delay interrupt)	I00□ I10□ I20□ I30□ I40□ I50□	I0 to I15	Replaced as follows. ^{*4} I00□→I0 I10□→I1 I20□→I2 I30□→I3 I40□→I4 I50□→I5 □=1: Rise interrupt □=0: Fall interrupt □When □ is 2 to 9, it will be replaced with P4095.	
	Timer interrupt	I6□□ I7□□ I8□□	I28 to I31	Replaced as follows. ^{*5} I6□□→I28 I7□□→I29 I8□□→I30 □□=1 to 99: Timer value	
	Counter interrupt	I010 I020 I030 I040 I050 I060	I16 to I21	Replaced as follows. I010→I16 I020→I17 I030→I18 I040→I19 I050→I20 I060→I21	
Module access device		Module number (0 to 7) BFM number (0 to 32766)	Module number (1 to 16) BFM number (0 to 65535)	The module number will be replaced increasing by +2. ^{*7}	
Decimal constant		16-bit: K-32,768 to K32,767 32-bit: K-2,147,483,648 to K2,147,483,647	16-bit: K-32,768 to K32,767 32-bit: K-2,147,483,648 to K2,147,483,647	—	
Hexadecimal constant		16-Bit: H0 to HFFFF 32-Bit: H0 to HFFFFFFF	16-Bit: H0 to HFFFF 32-Bit: H0 to HFFFFFFF	—	
Real constant		-1.0×2 ¹²⁸ to -1.0×2 ⁻¹²⁶ , 0, 1.0×2 ⁻¹²⁶ to 1.0×2 ¹²⁸	-1.0×2 ¹²⁸ to -1.0×2 ⁻¹²⁶ , 0, 1.0×2 ⁻¹²⁶ to 1.0×2 ¹²⁸	—	
Character string constant		32 single-byte characters	255 single-byte characters	—	

*1 When the latch range of the device for keep of the FX3 Series is changed, the latch range must be changed.

*2 Set the parameter at [Parameter] → [FX5UCPU] → [CPU Parameter] → [Memory/Device Setting] → "Option Battery Setting" in [Device/Label Memory Area Setting].

*3 Set the interrupt setting by the parameter accordingly.

*4 The parameter is reflected at [Parameter] → [FX5UCPU] → [Module Parameter] → [High Speed I/O] → [Input Function] → [General/Interrupt/Pulse Catch]. Also, the parameter is reflected to [Module Parameter] → [Input Response Time].

*5 The parameter is reflected at [Parameter] → [FX5UCPU] → [CPU Parameter] → [Interrupt Settings] → [Fixed Interval Setting].

- *6 For GX Works3 version 1.040S and later, the device number will be replaced with the numbers ranging from ER0 to ER32767.
- *7 For GX Works3 version 1.040S and later, the conversion method can be selected. (Page 33 Operation Method for Replacing Projects)

Precautions for Device Replacement

Precautions for Device Replacement

Index modification of the S device (state) cannot be made on the MELSEC iQ-F. Replace as follows.

- When the S device without state management has its index modified, replace to M device to use.
- When the S device used for state management has its index modified and used for the ZRST instructions, program the ZRST instructions for each batch-clear pattern.

For GX Works3 whose version is earlier than 1.030G, the assigned device of the global label cannot be read out.

- Information of the assigned device in GX Works2 is input in the comment field. Refer to the comment field to assign the device again.
- When special M and special D have been assigned, they will be replaced and assigned to SM and SD.

If S device is set to the device memory data or device initial data created using GX Works2, it will be deleted.

If there is a device that is not supported by the MELSEC iQ-F Series in the program created using GX Works2, the device will be changed to SM4095/SD4095.

The default value is set to the parameter setting of device points.

SM/SD Device Replacement

Devices, M8000 and later and D8000 and later of FX3U/FX3UC, will be changed to devices, SM8000 and later and SD8000 and later. However, some devices may be changed depending on the version of GX Works3. For details, refer to the following.

FX3U/ FX3UC	After replacing to MELSEC iQ-F		FX3U/ FX3UC	After replacing to MELSEC iQ-F	
	GX Works3 version 1.032J and earlier	GX Works3 version 1.035M and later		GX Works3 version 1.032J and earlier	GX Works3 version 1.035M and later
M8004	SM8004	SM0	M8240	SM8240	SM4585
M8009	SM8009	SM0	M8241	SM8241	SM4580
M8061	SM8061	SM0	M8242	SM8242	SM4582
M8064	SM8064	SM0	M8243	SM8243	SM4584
M8065	SM8065	SM0	M8244	SM8244	SM4580
M8066	SM8066	SM0	M8245	SM8245	SM4582
M8091	SM8091	SM701	M8318	SM8318	SM0
M8131	SM8131	SM5001	M8489	SM8489	SM0
M8133	SM8133	SM5001	D8004	SD8004	SD0
M8138	SM8138	SM5001	D8009	SD8009	SD0
M8139	SM8139	SM5000	D8061	SD8061	SD0
M8165	SM8165	SM703	D8064	SD8064	SD0
M8235	SM8235	SM4580	D8065	SD8065	SD0
M8236	SM8236	SM4581	D8066	SD8066	SD0
M8237	SM8237	SM4582	D8101	SD8101	SD8001
M8238	SM8238	SM4583	D8166	SD8166	SD83
M8239	SM8239	SM4584	D8489	SD8489	SD0

4.3 Precautions when Replacing the Parameters

When converting projects of the FX3 Series to MELSEC iQ-F projects, the setting data of the parameters (PLC parameter and network parameter) and special module (intelligent function module) will be deleted. Therefore, it is necessary to reset the data with GX Works3.

Also, GX Works3 does not support the following parameters of FX3 Series, so it is necessary to set with GX Works3 again.

- Network parameter (CC-Link)*1
- Intelligent function module parameter (AnyWireASLINK)

*1 For GX Works3 version 1.040S and later, the decision can be made to take over the network parameter (CC-Link) or not.

4.4 Precautions when Replacing Other Functions

Precautions when Using the High-speed Counters

When the high-speed counters (C235 to C255) are used with FX3U/FX3UC, it will not operate by just replacing to MELSEC iQ-F. It is necessary to set the FX3 Series compatible high-speed counters and change the program by the parameter. For the setting procedure, refer to the following.

Parameter Setting Procedure of the FX3 Series Compatible High-speed Counters

1. Select "Long Counter Specification" at the specification for High-speed counters.

[Parameter] ⇒ [FX5UCPU] ⇒ [Module Parameter] ⇒ [High Speed I/O] ⇒ "Input Function" ⇒ "High Speed Counter" ⇒ "Detailed Setting" ⇒ "Other"

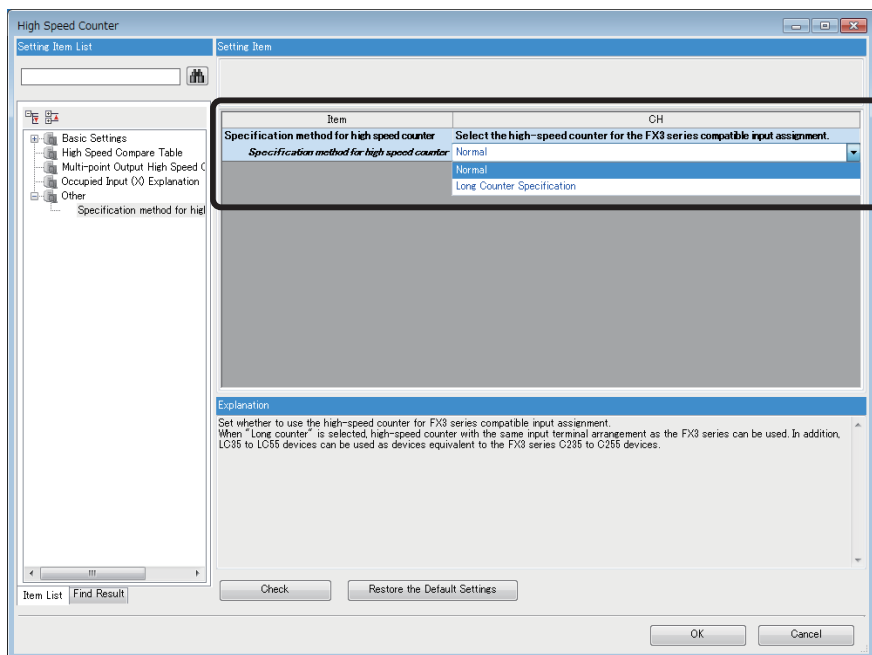

2. Set the function of the high-speed counters used at FX3U/FX3UC.

Select the input comparison enable/disable of the counter device and preset input compatible with the FX3 Series, and select the control switch.

Item	CH1	CH2	
Use/Do Not Use Counter	Set whether to use counter or not.		
Use/Not Use	Enable	Disable	Disable
Counter device	Select the high-speed counter for the FX3 series compatible input assignment.		
Counter device	LC35 (Operation equivalent to C235)	LC36 (Operation equivalent to C236)	LC37 (Operation equivalent to C237)
Operation Mode	Set operation mode.		
Operation Mode	Normal Mode	Normal Mode	Normal Mode
Pulse Input Mode	Set pulse input mode.		
Pulse Input Mode	1-Phase 1 Input (S/W Up/Down Switch)	1-Phase 1 Input (S/W Up/Down Switch)	1-Phase 1 Input (S/W Up/Down Switch)
Preset Input	Set preset input.		
Preset Input Enable/Disable	Disable	Disable	Disable
Input Logic	Positive Logic	Positive Logic	Positive Logic
Preset Value	0	0	0
Input Comparison Enable/Disable	Enable	Enable	Enable
Control Switch	Rising	Rising	Rising
Enable Input	Set enable input.		
Enable Input Enable/Disable	Disable	Disable	Disable
Input Logic	Positive Logic	Positive Logic	Positive Logic
Ring Length Setting	Set ring length.		
Ring Length Enable/Disable	Disable	Disable	Disable
Ring Length	2147483648	2147483648	2147483648
Measurement Unit Time	Set the measurement unit time (ms) for the pulse density measurement mode and rotation speed measurement mode.		
Measurement Unit Time	1000	1000	1000
No. of Pulse per Rotation	Set the number of pulses per rotation when using the rotation speed measurement mode.		
No. of Pulse per Rotation	1000	1000	1000

Changing the Program

Change the high-speed counter program by referring to the following program example.

[Example of program]

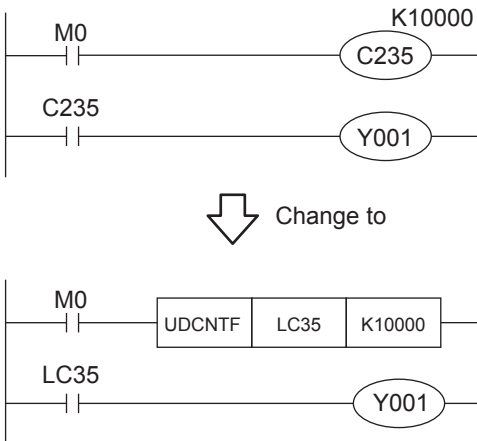

Precautions when Using the Routine Timer

When the routine timer (T192 to T199) is used with FX3U/FX3UC, it will not operate by just replacing to MELSEC iQ-F. The routine timer must be set by the parameter. For the setting procedure, refer to the following.

Parameter Setting Procedure of the Routine Timer

1. Set the use of the routine timer and the leading device number.

[Parameter] ⇒ [FX5UCPU] ⇒ [CPU Parameter] ⇒ “Memory/Device Setting” ⇒ “Device/Label Memory Area Setting”

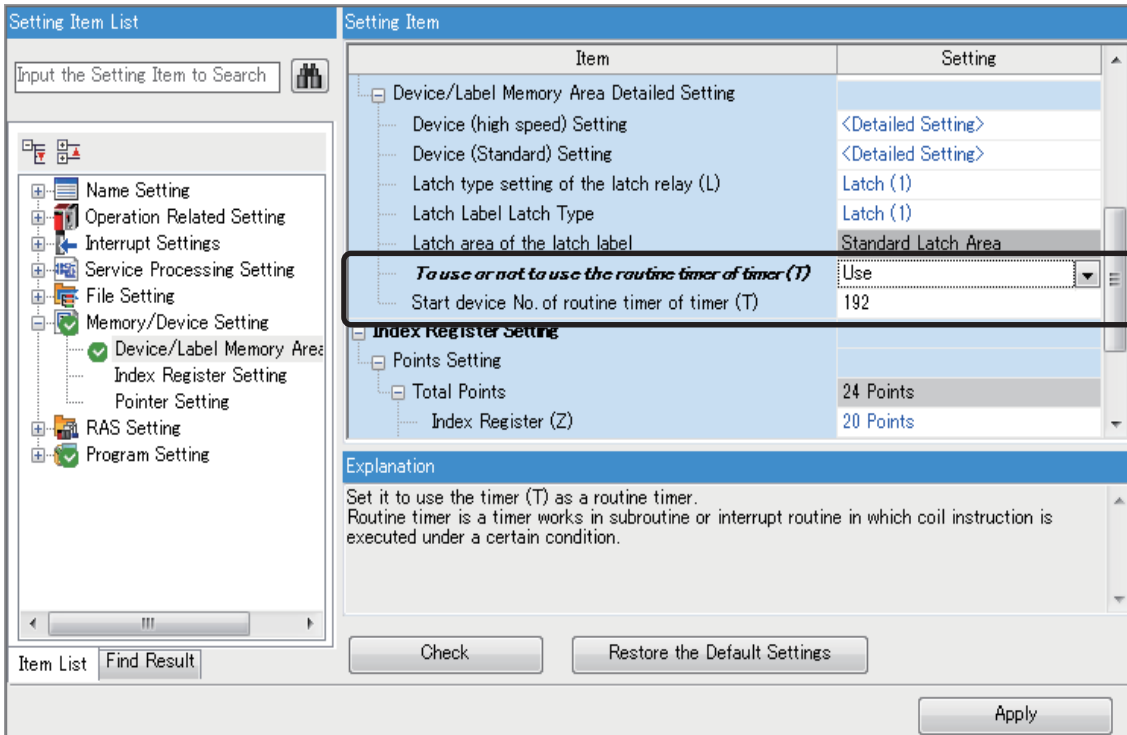

INDEX

A

Auxiliary relay 48

C

Character string constant 49

Counter 48

D

Data register 49

Decimal constant 49

E

Extension file register 49

Extension register 49

H

Hexadecimal constant 49

High-speed counter 49

I

Index register 49

Input hardware filter 23,30

Input relay 48

Input signal current 23,30

Interrupt pointer 49

M

Module access device 49

O

Output relay 48

P

Pointer 49

R

Real constant 49

S

State 48

T

Timer 48

MEMO

REVISIONS

Revision date	Revision	Description
December 2015	A	First edition
May 2016	B	<p>■Added models FX5U-32MR/DS, FX5U-32MT/DS, FX5U-32MT/DSS, FX5U-64MR/DS, FX5U-64MT/DS, FX5U-64MT/DSS, FX5U-80MR/DS, FX5U-80MT/DS, FX5U-80MT/DSS, FX5-32ER/DS, FX5-32ET/DS, FX5-32ET/DSS, FX5-CNV-IF, FX5-30EC, FX5-65EC, and FX5-CNV-BC</p> <p>■Added and revised parts RELEVANT MANUALS, TERMS, Section 2.3, 3.3, 4.1, and 4.2</p>
October 2016	C	<p>■Added models FX5-4AD-PT-ADP, FX5-4AD-TC-ADP, FX5-16ER/ES, FX5-16ET/ES, and FX5-16ET/ESS</p> <p>■Added and revised parts RELEVANT MANUALS, TERMS, Section 2.3, 3.3, and 4.2</p>
April 2017	D	<p>■Added models FX5-8AD, FX5-4LC, FX5-20PG-P, FX5-CCL-MS</p> <p>■Added and revised parts SAFETY PRECAUTIONS, RELEVANT MANUALS, TERMS, Section 2.3, 3.3, 4.2</p>
October 2017	E	<p>■Added models FX5-4AD, FX5-4DA, FX5-C32EX/DS-TS</p> <p>■Added and revised parts RELEVANT MANUALS, TERMS, Section 2.3, 3.3, 4.1, 4.2, 4.3</p>
October 2018	F	<p>■Added models FX5-20PG-D, FX5-DP-M</p> <p>■Added and revised parts RELEVANT MANUALS, TERMS, Sections 2.3, 3.3</p>

This manual confers no industrial property rights of any other kind, nor does it confer any patent licenses. Mitsubishi Electric Corporation cannot be held responsible for any problems involving industrial property rights which may occur as a result of using the contents noted in this manual.

©2015 MITSUBISHI ELECTRIC CORPORATION

WARRANTY

Please confirm the following product warranty details before using this product.

1. Gratis Warranty Term and Gratis Warranty Range

If any faults or defects (hereinafter "Failure") found to be the responsibility of Mitsubishi occurs during use of the product within the gratis warranty term, the product shall be repaired at no cost via the sales representative or Mitsubishi Service Company. However, if repairs are required onsite at domestic or overseas location, expenses to send an engineer will be solely at the customer's discretion. Mitsubishi shall not be held responsible for any re-commissioning, maintenance, or testing on-site that involves replacement of the failed module.

[Gratis Warranty Term]

The gratis warranty term of the product shall be for one year after the date of purchase or delivery to a designated place. Note that after manufacture and shipment from Mitsubishi, the maximum distribution period shall be six (6) months, and the longest gratis warranty term after manufacturing shall be eighteen (18) months. The gratis warranty term of repair parts shall not exceed the gratis warranty term before repairs.

[Gratis Warranty Range]

- (1) The range shall be limited to normal use within the usage state, usage methods and usage environment, etc., which follow the conditions and precautions, etc., given in the instruction manual, user's manual and caution labels on the product.
- (2) Even within the gratis warranty term, repairs shall be charged for in the following cases.
 1. Failure occurring from inappropriate storage or handling, carelessness or negligence by the user. Failure caused by the user's hardware or software design.
 2. Failure caused by unapproved modifications, etc., to the product by the user.
 3. When the Mitsubishi product is assembled into a user's device, Failure that could have been avoided if functions or structures, judged as necessary in the legal safety measures the user's device is subject to or as necessary by industry standards, had been provided.
 4. Failure that could have been avoided if consumable parts (battery, backlight, fuse, etc.) designated in the instruction manual had been correctly serviced or replaced.
 5. Relay failure or output contact failure caused by usage beyond the specified life of contact (cycles).
 6. Failure caused by external irresistible forces such as fires or abnormal voltages, and failure caused by force majeure such as earthquakes, lightning, wind and water damage.
 7. Failure caused by reasons unpredictable by scientific technology standards at time of shipment from Mitsubishi.
 8. Any other failure found not to be the responsibility of Mitsubishi or that admitted not to be so by the user.

2. Onerous repair term after discontinuation of production

- (1) Mitsubishi shall accept onerous product repairs for seven (7) years after production of the product is discontinued.
Discontinuation of production shall be notified with Mitsubishi Technical Bulletins, etc.
- (2) Product supply (including repair parts) is not available after production is discontinued.

3. Overseas service

Overseas, repairs shall be accepted by Mitsubishi's local overseas FA Center. Note that the repair conditions at each FA Center may differ.

4. Exclusion of loss in opportunity and secondary loss from warranty liability

Regardless of the gratis warranty term, Mitsubishi shall not be liable for compensation to:

- (1) Damages caused by any cause found not to be the responsibility of Mitsubishi.
- (2) Loss in opportunity, lost profits incurred to the user by Failures of Mitsubishi products.
- (3) Special damages and secondary damages whether foreseeable or not, compensation for accidents, and compensation for damages to products other than Mitsubishi products.
- (4) Replacement by the user, maintenance of on-site equipment, start-up test run and other tasks.

5. Changes in product specifications

The specifications given in the catalogs, manuals or technical documents are subject to change without prior notice.

6. Product application

- (1) In using the Mitsubishi MELSEC programmable controller, the usage conditions shall be that the application will not lead to a major accident even if any problem or fault should occur in the programmable controller device, and that backup and fail-safe functions are systematically provided outside of the device for any problem or fault.
- (2) The Mitsubishi programmable controller has been designed and manufactured for applications in general industries, etc. Thus, applications in which the public could be affected such as in nuclear power plants and other power plants operated by respective power companies, and applications in which a special quality assurance system is required, such as for railway companies or public service purposes shall be excluded from the programmable controller applications.
In addition, applications in which human life or property that could be greatly affected, such as in aircraft, medical applications, incineration and fuel devices, manned transportation, equipment for recreation and amusement, and safety devices, shall also be excluded from the programmable controller range of applications.
However, in certain cases, some applications may be possible, providing the user consults their local Mitsubishi representative outlining the special requirements of the project, and providing that all parties concerned agree to the special circumstances, solely at the user's discretion.

TRADEMARKS

Microsoft® and Windows® are either registered trademarks or trademarks of Microsoft Corporation in the United States and/or other countries.

Ethernet is a trademark of Xerox Corporation.

PROFIBUS is a trademark of PROFIBUS Nutzerorganisation e.V.

Anywire and ANYWIREASLINK are registered trademarks of the Anywire Corporation.

MODBUS® is a registered trademark of Schneider Electric SA.

Phillips is a registered trademark of Phillips Screw Company.

SD logo and SDHC logo are trademarks or registered trademarks of SD-3C, LLC.



The company name and the product name to be described in this manual are the registered trademarks or trademarks of each company.

Manual number: JY997D66201F

When exported from Japan, this manual does not require application to the Ministry of Economy, Trade and Industry for service transaction permission.

MITSUBISHI ELECTRIC CORPORATION

HEAD OFFICE: TOKYO BUILDING, 2-7-3 MARUNOUCHI, CHIYODA-KU, TOKYO 100-8310, JAPAN

Specifications are subject to change without notice.