



FX3U-485ADP-MB

Installation Manual



Manual Number	JY997D26301
Revision	G
Date	November 2016

This manual describes the part names, dimensions, mounting, and specifications of the product. Before use, read this manual and manuals of relevant products fully to acquire proficiency in handling and operating the product. Make sure to learn all the product information, safety information, and precautions. And, store this manual in a safe place so that you can take it out and read it whenever necessary. Always forward it to the end user.

Registration:  
MODBUS® is a registered trademark of Schneider Electric SA. The company name and the product name to be described in this manual are the registered trademarks or trademarks of each company.

Effective November 2016  
Specifications are subject to change without notice.  
© 2007 Mitsubishi Electric Corporation

**Safety Precautions** (Read these precautions before use.)

This manual classify the safety precautions into two categories:

**WARNING** and **CAUTION**

<b>WARNING</b>	Indicates that incorrect handling may cause hazardous conditions, resulting in death or severe injury.
<b>CAUTION</b>	Indicates that incorrect handling may cause hazardous conditions, resulting in medium or slight personal injury or physical damage.

Depending on circumstances, procedures indicated by **CAUTION** may also be linked to serious results. In any case, it is important to follow the directions for usage.

**Associated Manuals**

Manual name	Manual No.	Description
FX3S Series User's Manual - Hardware Edition	JY997D48601 MODEL CODE: 09R535	Explains FX3S Series PLC specification details for I/O, wiring, installation, and maintenance.
FX3G Series User's Manual - Hardware Edition	JY997D31301 MODEL CODE: 09R521	Explains FX3G Series PLC specification details for I/O, wiring, installation, and maintenance.
FX3GC Series User's Manual - Hardware Edition	JY997D45401 MODEL CODE: 09R533	Explains FX3GC Series PLC specification details for I/O, wiring, installation, and maintenance.
FX3U Series User's Manual - Hardware Edition	JY997D16501 MODEL CODE: 09R516	Explains FX3U Series PLC specification details for I/O, wiring, installation, and maintenance.
FX3UC Series User's Manual - Hardware Edition	JY997D28701 MODEL CODE: 09R519	Explains FX3UC Series PLC specification details for I/O, wiring, installation, and maintenance.
FX3S/FX3G/FX3GC/FX3U/FX3UC Series Programming Manual - Basic & Applied Instruction Edition	JY997D16601 MODEL CODE: 09R517	Describes PLC programming for basic/applied instructions and devices.
FX Series User's Manual - Data Communication Edition	JY997D16901 MODEL CODE: 09R715	Describes N:N link, parallel link, computer link, no protocol communication by RS instructions/FX2N-232IF.

Manual name	Manual No.	Description
FX3S/FX3G/FX3GC/FX3U/FX3UC Series User's Manual - MODBUS Serial Communication Edition	JY997D26201	Explains the MODBUS serial communication network.

**How to obtain manuals**  
For the necessary product manuals or documents, consult with the Mitsubishi Electric dealer from where you purchase your product.

**Applicable standards**

FX3U-485ADP-MB units made in April, 2007 or later comply with the EC Directive (EMC Directive) and UL standards (UL, cUL). Further information can be found in the following manual.

- FX3S Series Hardware Manual (Manual No. JY997D48301)
- FX3G Series Hardware Manual (Manual No. JY997D46001)
- FX3GC Series Hardware Manual (Manual No. JY997D45201)
- FX3U Series Hardware Manual (Manual No. JY997D50301)
- FX3UC (D, DS, DSS) Series Hardware Manual (Manual No. JY997D50501)
- FX3UC-32MT-LT-2 Hardware Manual (Manual No. JY997D31601)

Regarding the standards that relate to the main unit, please refer to either the FX series product catalog or consult with your nearest Mitsubishi product provider.

**Attention**  
This product is designed for use in industrial applications.

**1. Outline**

The FX3U-485ADP-MB communication special adapter (hereinafter called 485ADP-MB) is a special adapter for RS-485 communication with a terminal block (European type). 485ADP-MB is an isolated signal exchange unit of RS-485 serial data communication between the PLC and RS-485 device. The FX3U-485ADP-MB features all functionality that is available with the FX3U-485ADP, except that it also has MODBUS communication available.

**1.1 Communication Function**

Communication type	Function
N:N network	Data transfer between up to eight FX Series PLCs by the simple program.
Parallel link	Data transfer between two FX Series PLCs specifying master/slave station.
Computer link	Data transfer via dedicated protocol between PLC and computer (specified as the master station).
Non-protocol communication	Serial communication via non-protocol between PLC and RS-485 device.
Inverter communication	Controlling Mitsubishi's FREQROL inverter using inverter communication instruction.
MODBUS communication	Data transfer for up to 32 slaves controlled by one master.

**1.2 Incorporated Items**

Verify that the following product and items are included in the package:

Product	FX3U-485ADP-MB communication special adapter
Accessories	Label for indication of link station number Installation manual (This manual)

The label should be applied on the front of 485ADP-MB for checking station numbers in N:N network, computer link, MODBUS communication, etc.

**1.3 External Dimensions and Part Names**

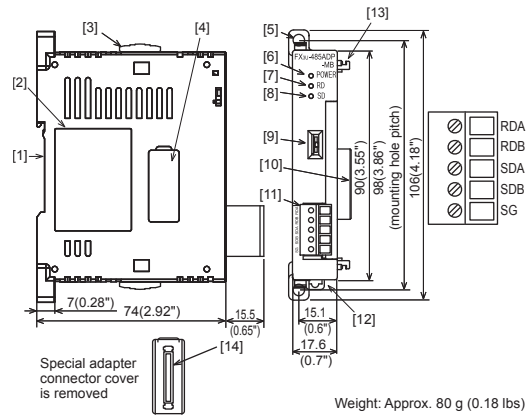

- [1] DIN rail mounting groove (DIN rail: DIN46277)
- [2] Name plate
- [3] Special adapter slide lock: Used to connect special adapter on left side of this special adapter.
- [4] Special adapter connector cover: Remove this cover for connecting special adapter on the left side.
- [5] Direct mounting hole: 2 holes of  $\phi 4.5$  (0.18") (mounting screw: M4 screw) Not used when connecting to FX3GC/FX3UC Series PLC.
- [6] POWER LED (green): Lit while 5 V DC power is supplied from main unit.
- [7] RD LED (red): Lit while receiving data from connected RS-485 device.
- [8] SD LED (red): Lit while sending data to connected RS-485 device.
- [9] Terminal resistor selector switch (330 $\Omega$ /OPEN/110 $\Omega$ )
- [10] Special adapter connector: Used to connect this special adapter to PLC main unit or special adapter.
- [11] Terminal block (European type) for connecting RS-485 device Use to connect RS-485 device to 485ADP-MB.
- [12] DIN rail mounting hook
- [13] Special adapter fixing hook
- [14] Special adapter connector: Used to connect communication special adapter or analog special adapter to this adapter on left side.

**1.4 Terminal Configuration**

The terminal configuration of the RS-485 terminal on the 485ADP-MB is shown below. Note that the terminal configuration is different from that of the FX3U-485BD.

Terminal screws	Signal name	Function	Signal direction	
			485ADP-MB	RS-485 equipment
RDA (RXD+)	RDA	Receive data	←	
	RDB (RXD-)			
SDA (TXD+)	SDA	Send data	→	
	SDB (TXD-)			
SG (GND)	SG	Signal ground	-	

**1.5 Terminal Resistor Selector Switch**

485ADP-MB has a built-in terminal resistor. A terminal resistor may be required depending on the communication type. Refer to the following manual for the terminal resistor setting.

→ FX Series User's Manual - Data Communication Edition  
→ FX3S/FX3G/FX3GC/FX3U/FX3UC Series User's Manual - MODBUS Serial Communication Edition

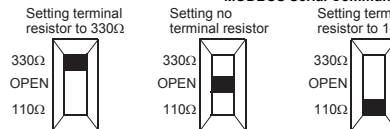

**1.6 Operation of Terminal Resistor Selector Switch**

Use the tip of tweezers, tip of mechanical pencil, minute screwdriver, or the tool whose tip width is about 0.8 mm (0.03") when operating the terminal resistor selector switch.

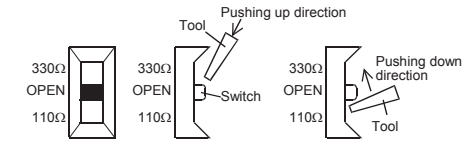

Either 'push down' or 'push up' the switch to change the setting as indicated in the figure above. Confirm the clicking noise when setting the switch.

**2. Channel Allocation**

Up to two communication ports can be added to the main unit. Refer to the following manual for equipment that occupies communication ports.  
→ FX Series User's Manual - Data Communication Edition

**FX3S Series PLC**

Communication port channels are automatically allocated.

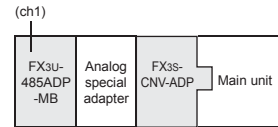

**FX3G Series PLC**

Communication port channels are automatically allocated.

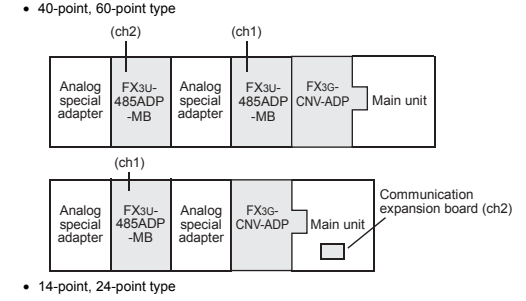

**FX3GC Series PLC**

Communication port channels are automatically allocated. The communication special adapter closer to the main unit is ch1.

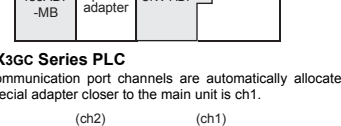

**FX3U/FX3UC-32MT-LT(-2) Series PLC**

Communication port channels are automatically allocated. The communication special adapter closer to the main unit is ch1.

• Using one communication special adapter + communication expansion board

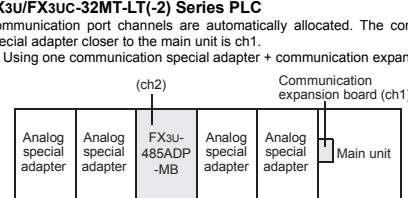

- Using two communication special adapters

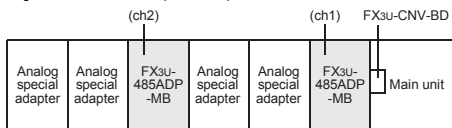

### FX3UC (D, DS, DSS) Series PLC

Communication port channels are automatically allocated. The communication special adapter closer to the main unit is ch1.

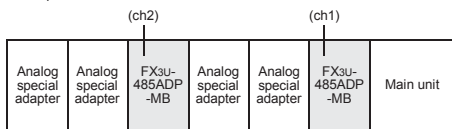

### 3. Installation

For installation/uninstallation details, refer to the respective PLC User's manual Hardware Edition.

INSTALLATION PRECAUTIONS	WARNING
<ul style="list-style-type: none"> <li>Make sure to cut off all phases of the power supply externally before attempting installation or wiring work. Failure to do so may cause electric shock or damage to the product.</li> </ul>	

INSTALLATION PRECAUTIONS	CAUTION
<ul style="list-style-type: none"> <li>Use the product within the generic environment specifications described in PLC main unit manual (Hardware Edition). Never use the product in areas with excessive dust, oily smoke, conductive dusts, corrosive gas (salt air, Cl<sub>2</sub>, H<sub>2</sub>S, SO<sub>2</sub>, or NO<sub>2</sub>), flammable gas, vibration or impacts, or expose it to high temperature, condensation, or rain and wind. If the product is used in such conditions, electric shock, fire, malfunctions, deterioration or damage may occur.</li> <li>When drilling screw holes or wiring, make sure cutting or wire debris does not enter the ventilation slits. Failure to do so may cause fire, equipment failures or malfunctions.</li> <li>Do not touch the conductive parts of the product directly. Doing so may cause device failures or malfunctions.</li> <li>Connect special adapter securely to their designated connectors. Loose connections may cause malfunctions.</li> </ul>	

### 3.1 Connection to the PLC

This section describes the connection method to the PLC (FX3U Series PLC is used for the following example).

For installation method to other PLCs, refer to the respective PLC User's manual Hardware Edition.

#### Procedure

- Turn off the power. Disconnect all the cables connected to the PLC main unit and special adapter. Dismount the main unit and special adapter mounted on DIN rail or mounted directly using screws.
- Install an expansion board to the main unit. For installation of expansion board, refer to the following manual: → **FX3U Series User's Manual - Hardware Edition**
- Remove the special adapter connector cover on the expansion board (Right fig.A). In case of connecting this product to another special adapter, please replace the 'expansion board' in the above description with a 'special adapter' and perform the procedure as indicated.
- Slide the special adapter slide lock (Right fig.B) of the main unit. In case of connecting this product to another special adapter, please replace the 'main unit' in the above description with a 'special adapter' and perform the procedure as indicated. (Please replace the following procedures similarly.)

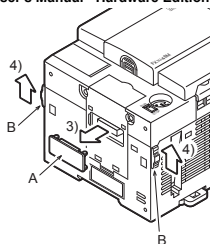

- Connect the special adapter (Right fig.C) to the main unit as shown on the right.
- Slide back the special adapter slide lock (Right fig.B) of the main unit to fix the special adapter (Right fig.C).

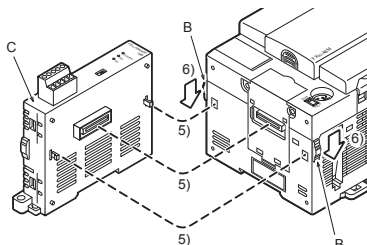

#### Connection precautions

Connect all the high-speed I/O special adapters before connecting other special adapters when they are used in combination.  
**Do not connect a high-speed I/O special adapter on the left side of a communication or analog special adapter.**

### 4. Wiring

For wiring details, refer to the following manual.

→ **FX Series User's Manual - Data Communication Edition**  
 → **FX3s/FX3g/FX3gc/FX3u/FX3uc Series User's Manual - MODBUS Serial Communication Edition**

WIRING PRECAUTIONS	WARNING
<ul style="list-style-type: none"> <li>Make sure to cut off all phases of the power supply externally before attempting installation or wiring work. Failure to do so may cause electric shock or damage to the product.</li> </ul>	

WIRING PRECAUTIONS	CAUTION
<ul style="list-style-type: none"> <li>When drilling screw holes or wiring, make sure cutting or wire debris does not enter the ventilation slits. Failure to do so may cause fire, equipment failures or malfunctions.</li> <li>Make sure to observe the following precautions in order to prevent any damage to the machinery or accidents due to abnormal data written to the PLC under the influence of noise:           <ol style="list-style-type: none"> <li>Do not bundle the main circuit line together with or lay it close to the main circuit, high-voltage line or load line. Otherwise, noise disturbance and/or surge induction are likely to take place. As a guideline, lay the control line at least 100mm (3.94") or more away from the main circuit or high-voltage lines.</li> <li>Ground the shield wire or shield of the shielded cable at one point on the PLC. However, do not use common grounding with heavy electrical systems.</li> </ol> </li> <li>Make sure to properly wire to the terminal block (European type) in accordance with the following precautions. Failure to do so may cause electric shock, equipment failures, a short-circuit, wire breakage, malfunctions, or damage to the product.           <ul style="list-style-type: none"> <li>The disposal size of the cable end should follow the dimensions described in the manual of the PLC main unit.</li> <li>Tightening torque should follow the specifications in the manual of the PLC main unit.</li> <li>Twist the end of strand wire and make sure that there are no loose wires.</li> <li>Do not solder-plate the electric wire ends.</li> <li>Do not connect more than the specified number of wires or electric wires of unspecified size.</li> <li>Affix the electric wires so that neither the terminal block nor the connected parts are directly stressed.</li> </ul> </li> </ul>	

#### Wiring precaution

- Do not attach the terminal block (replacement European terminal block) for connecting RS-485 device which is already wired to FX3U-485-BD. If attached as its left and right are confused, the terminal configuration becomes upside down and no communication is performed.

### 5. Specification

STARTUP AND MAINTENANCE PRECAUTIONS	CAUTION
<ul style="list-style-type: none"> <li>Do not disassemble or modify the unit. Doing so may cause fire, equipment failures, or malfunctions.           <ul style="list-style-type: none"> <li>For repair, contact your local Mitsubishi Electric representative.</li> </ul> </li> <li>Do not drop the product or exert strong impact to it. Doing so may cause damage.</li> </ul>	

DISPOSAL PRECAUTIONS	CAUTION
<ul style="list-style-type: none"> <li>Please contact a certified electronic waste disposal company for the environmentally safe recycling and disposal of your device.</li> </ul>	

TRANSPORTATION AND STORAGE PRECAUTIONS	CAUTION
<ul style="list-style-type: none"> <li>The product is a precision instrument. During transportation, avoid impacts larger than those specified in the general specifications by using dedicated packaging boxes and shock-absorbing pallets. Failure to do so may cause failures in the product. After transportation, verify operation of the product and check for damage of the mounting part, etc.</li> </ul>	

### 5.1 Applicable PLC

Model name	Applicability
FX3S Series PLC	Ver. 1.00 or later for all communication functions
FX3G Series PLC	Ver. 1.30 or later for MODBUS communication Ver. 1.10 or later for inverter communication Ver. 1.00 or later for all communication functions except MODBUS and inverter
FX3GC Series PLC	Ver. 1.40 or later for all communication functions
FX3U Series PLC	Ver. 2.40 or later for MODBUS communication Ver. 2.20 or later for all communication functions except MODBUS
FX3UC Series PLC	Ver. 2.40 or later for MODBUS communication Ver. 1.00 or later for all communication functions except MODBUS

The version number can be checked by monitoring D8001/D8101, as well as the last three digits indicate the version number.

### 5.2 General Specifications

Items other than the following are equivalent to the those of the PLC main unit. For general specifications, refer to the respective PLC User's manual Hardware Edition.

Item	Specification
<b>Dielectric withstand voltage</b>	500 V AC, one minute Between all external terminals and ground terminal of PLC main unit
<b>Insulation resistance</b>	5 MΩ or higher by 500 V DC insulation resistance tester

### 5.3 Power Supply Specification

Item	Specification
<b>Current consumption</b>	20 mA 5 V DC power is supplied from the internal power supply of main unit.

### 5.4 Performance Specification

Item	Specification
<b>Transmission standard</b>	Conforming to RS-485/RS-422
<b>Type of isolation</b>	Photocoupler isolation
<b>Transmission distance</b>	Total extension distance: 500 m (1640' 5") or less [50 m (164' 0") or less if FX1N-485-BD, FX2N-485-BD or FX3U-485-BD is installed to connected equipment]
<b>Connection method</b>	European type terminal block, AWG 22-20 (when inserting one twisted pair cable), AWG 22 (when inserting two twisted pair cables) Tightening torque: 0.22 to 0.25 N·m
<b>Number of occupied I/O points</b>	0 point (This number is not related to the maximum number of input/output points of the PLC.)
<b>Communication method</b>	Half-duplex
<b>Baud rate</b>	N:N network: 38400 bps Parallel link: 115200 bps Computer link, Non-protocol communication: 300/600/1200/2400/4800/9600/19200/38400 <sup>1</sup> bps Inverter communication: 4800/9600/19200/38400 <sup>1</sup> bps MODBUS communication <sup>2</sup> : 300/600/1200/2400/4800/9600/19200/38400 <sup>3</sup> /57600 <sup>3</sup> /115200 <sup>3</sup> bps
<b>Number of Slaves (MODBUS)</b>	16 Slaves, 32 Slaves <sup>3</sup>
<b>Communication format</b>	N:N network, Parallel link, Computer link (dedicated protocol: format 1/format 4), Non-protocol, Inverter, and MODBUS communication
<b>LED display: LED color</b>	Power: green, RD: red, SD: red

<sup>1</sup> Applicable for FX3u/FX3uc Series PLC Ver. 2.41 or later and FX3s/FX3g/FX3gc Series PLC.

<sup>2</sup> When you set the baud rate to 38400 bps or more in a FX3s/FX3g/FX3gc Series PLC, please set D8411 (D8431) to be 3 ms or more. When D8411 (D8431) is set to be less than 3 ms, it may not be able to communicate normally.

<sup>3</sup> Applicable for products manufactured in July, 2012 or later (manufacturer's serial number: 127\*\*\*\* or later). The year and month of production of the special adapter can be checked from the manufacturer's serial number "S/ N" indicated on the label. For manufacturer's serial number, refer to the following manual.

→ **FX3s/FX3g/FX3gc/FX3u/FX3uc Series User's Manual - MODBUS Serial Communication Edition**

### 6. 「电器电子产品有害物质限制使用标识要求」的表示方式

Note: This symbol mark is for China only.

含有有害6物质的名称, 含有量, 含有部品  
 本产品中所含有的有害6物质的名称, 含有量, 含有部品如下表所示。

部件名称	产品中有害物质的名称及含量					
	铅 (Pb)	汞 (Hg)	镉 (Cd)	六价铬 (Cr (VI))	多溴联苯 (PBB)	多溴二苯醚 (PBDE)
可编程控制装置	外壳	○	○	○	○	○
	印刷基板	×	○	○	○	○

本表格依据SJ/T 11364的规定编制。

○:表示该有害物质在该部件所有均质材料中的含量均在GB/T 26572规定的限量要求以下。  
 ×:表示该有害物质至少在该部件的某一均质材料中的含量超出GB/T 26572规定的限量要求。

This manual confers no industrial property rights or any rights of any other kind, nor does it confer any patent licenses. Mitsubishi Electric Corporation cannot be held responsible for any problems involving industrial property rights which may occur as a result of using the contents noted in this manual.

#### Warranty

Exclusion of loss in opportunity and secondary loss from warranty liability  
 Regardless of the gratis warranty term, Mitsubishi Electric Corporation cannot be held responsible for any damages caused by any cause found not to be the responsibility of Mitsubishi. (1) Damages caused by any cause found not to be the responsibility of Mitsubishi products. (2) Loss in opportunity, lost profits incurred to the user by Failures of Mitsubishi products. (3) Special damages and secondary damages whether foreseeable or not, compensation for accidents, and compensation for damages to products other than Mitsubishi products. (4) Replacement by the user, maintenance of on-site equipment, start-up test run and other tasks.

For safe use
<ul style="list-style-type: none"> <li>This product has been manufactured as a general-purpose part for general industries, and has not been designed or manufactured to be incorporated in a device or system used in purposes related to human life.</li> <li>Before using the product for special purposes such as nuclear power, electric power, aerospace, medicine or passenger movement vehicles, consult with Mitsubishi Electric.</li> <li>This product has been manufactured under strict quality control. However when installing the product where major accidents or losses could occur if the product fails, install appropriate backup or failsafe functions in the system.</li> </ul>

## MITSUBISHI ELECTRIC CORPORATION

HEAD OFFICE : TOKYO BUILDING, 2-7-3 MARUNOUCHI, CHIYODA-KU, TOKYO 100-8310, JAPAN



Side A JAPANESE  
Side B ENGLISH

FX3U-485ADP-MB

Installation Manual



Manual Number	JY997D26301
Revision	G
Date	November 2016

This manual describes the part names, dimensions, mounting, and specifications of the product. Before use, read this manual and manuals of relevant products fully to acquire proficiency in handling and operating the product. Make sure to learn all the product information, safety information, and precautions. And, store this manual in a safe place so that you can take it out and read it whenever necessary. Always forward it to the end user.

Registration:  
MODBUS® is a registered trademark of Schneider Electric SA. The company name and the product name to be described in this manual are the registered trademarks or trademarks of each company.

Effective November 2016  
Specifications are subject to change without notice.  
© 2007 Mitsubishi Electric Corporation

Safety Precautions (Read these precautions before use.)

This manual classifies the safety precautions into two categories:

⚠ WARNING and ⚠ CAUTION

<b>WARNING</b>	Indicates that incorrect handling may cause hazardous conditions, resulting in death or severe injury.
<b>CAUTION</b>	Indicates that incorrect handling may cause hazardous conditions, resulting in medium or slight personal injury or physical damage.

Depending on circumstances, procedures indicated by ⚠ CAUTION may also be linked to serious results.  
In any case, it is important to follow the directions for usage.

Associated Manuals

Manual name	Manual No.	Description
FX3S Series User's Manual - Hardware Edition	JY997D48601 MODEL CODE: 09R535	Explains FX3S Series PLC specification details for I/O, wiring, installation, and maintenance.
FX3G Series User's Manual - Hardware Edition	JY997D31301 MODEL CODE: 09R521	Explains FX3G Series PLC specification details for I/O, wiring, installation, and maintenance.
FX3GC Series User's Manual - Hardware Edition	JY997D45401 MODEL CODE: 09R533	Explains FX3GC Series PLC specification details for I/O, wiring, installation, and maintenance.
FX3U Series User's Manual - Hardware Edition	JY997D16501 MODEL CODE: 09R516	Explains FX3U Series PLC specification details for I/O, wiring, installation, and maintenance.
FX3UC Series User's Manual - Hardware Edition	JY997D28701 MODEL CODE: 09R519	Explains FX3UC Series PLC specification details for I/O, wiring, installation, and maintenance.
FX3S/FX3G/FX3GC/FX3U/FX3UC Series Programming Manual - Basic & Applied Instruction Edition	JY997D16601 MODEL CODE: 09R517	Describes PLC programming for basic/applied instructions and devices.
FX Series User's Manual - Data Communication Edition	JY997D16901 MODEL CODE: 09R715	Describes N:N link, parallel link, computer link, no protocol communication by RS instructions/FX2N-232IF.

Using two communication special adapters

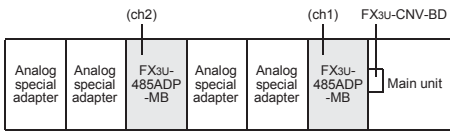

FX3UC (D, DS, DSS) Series PLC

Communication port channels are automatically allocated. The communication special adapter closer to the main unit is ch1.

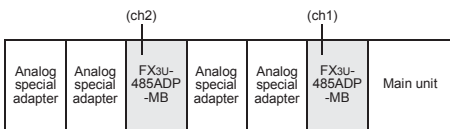

3. Installation

For installation/uninstallation details, refer to the respective PLC User's manual Hardware Edition.

**INSTALLATION PRECAUTIONS** ⚠ WARNING

- Make sure to cut off all phases of the power supply externally before attempting installation or wiring work. Failure to do so may cause electric shock or damage to the product.

**INSTALLATION PRECAUTIONS** ⚠ CAUTION

- Use the product within the generic environment specifications described in PLC main unit manual (Hardware Edition). Never use the product in areas with excessive dust, oily smoke, conductive dusts, corrosive gas (salt air, Cl<sub>2</sub>, H<sub>2</sub>S, SO<sub>2</sub>, or NO<sub>2</sub>), flammable gas, vibration or impacts, or expose it to high temperature, condensation, or rain and wind. If the product is used in such conditions, electric shock, fire, malfunctions, deterioration or damage may occur.
- When drilling screw holes or wiring, make sure cutting or wire debris does not enter the ventilation slits. Failure to do so may cause fire, equipment failures or malfunctions.
- Do not touch the conductive parts of the product directly. Doing so may cause device failures or malfunctions.
- Connect special adapter securely to their designated connectors. Loose connections may cause malfunctions.

3.1 Connection to the PLC

This section describes the connection method to the PLC (FX3U Series PLC is used for the following example). For installation method to other PLCs, refer to the respective PLC User's manual Hardware Edition.

- Procedure**
- Turn off the power. Disconnect all the cables connected to the PLC main unit and special adapter. Dismount the main unit and special adapter mounted on DIN rail or mounted directly using screws.
  - Install an expansion board to the main unit. For installation of expansion board, refer to the following manual: → FX3U Series User's Manual - Hardware Edition

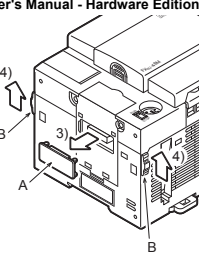

- Remove the special adapter connector cover on the expansion board (Right fig.A). In case of connecting this product to another special adapter, please replace the 'expansion board' in the above description with a 'special adapter' and perform the procedure as indicated.
- Slide the special adapter slide lock (Right fig.B) of the main unit. In case of connecting this product to another special adapter, please replace the 'main unit' in the above description with a 'special adapter' and perform the procedure as indicated. (Please replace the following procedures similarly.)

Manual name	Manual No.	Description
FX3S/FX3G/FX3GC/FX3U/FX3UC Series User's Manual - MODBUS Serial Communication Edition	JY997D26201	Explains the MODBUS serial communication network.

How to obtain manuals

For the necessary product manuals or documents, consult with the Mitsubishi Electric dealer from where you purchase your product.

Applicable standards

FX3U-485ADP-MB units made in April, 2007 or later comply with the EC Directive (EMC Directive) and UL standards (UL, cUL). Further information can be found in the following manual.

- FX3S Series Hardware Manual (Manual No. JY997D48301)
- FX3G Series Hardware Manual (Manual No. JY997D46001)
- FX3GC Series Hardware Manual (Manual No. JY997D45201)
- FX3UC (D, DS, DSS) Series Hardware Manual (Manual No. JY997D50301)
- FX3UC-32MT-LT-2 Hardware Manual (Manual No. JY997D31601)

Regarding the standards that relate to the main unit, please refer to either the FX series product catalog or consult with your nearest Mitsubishi product provider.

Attention

This product is designed for use in industrial applications.

1. Outline

The FX3U-485ADP-MB communication special adapter (hereinafter called 485ADP-MB) is a special adapter for RS-485 communication with a terminal block (European type). 485ADP-MB is an isolated signal exchange unit of RS-485 serial data communication between the PLC and RS-485 device.

The FX3U-485ADP-MB features all functionality that is available with the FX3U-485ADP, except that it also has MODBUS communication available.

1.1 Communication Function

Communication type	Function
N:N network	Data transfer between up to eight FX Series PLCs by the simple program.
Parallel link	Data transfer between two FX Series PLCs specifying master/slave station.
Computer link	Data transfer via dedicated protocol between PLC and computer (specified as the master station).
Non-protocol communication	Serial communication via non-protocol between PLC and RS-485 device.
Inverter communication	Controlling Mitsubishi's FREQROL inverter using inverter communication instruction.
MODBUS communication	Data transfer for up to 32 slaves controlled by one master.

1.2 Incorporated Items

Verify that the following product and items are included in the package:

Product	FX3U-485ADP-MB communication special adapter
Accessories	Label for indication of link station number Installation manual (This manual)

The label should be applied on the front of 485ADP-MB for checking station numbers in N:N network, computer link, MODBUS communication, etc.

1.3 External Dimensions and Part Names

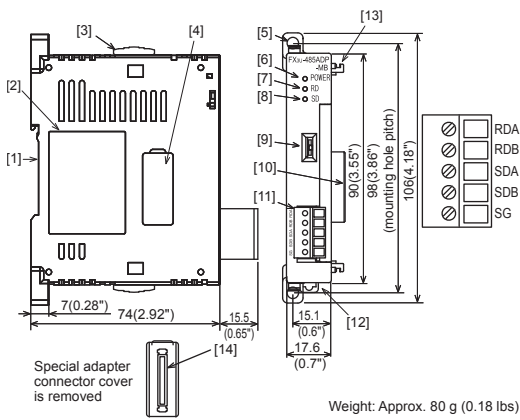

- DIN rail mounting groove (DIN rail: DIN46277)
- Name plate
- Special adapter slide lock: Used to connect special adapter on left side of this special adapter.
- Special adapter connector cover: Remove this cover for connecting special adapter on the left side.
- Direct mounting hole: 2 holes of φ4.5 (0.18") (mounting screw: M4 screw) Not used when connecting to FX3GC/FX3UC Series PLC.
- POWER LED (green): Lit while 5 V DC power is supplied from main unit.
- RD LED (red): Lit while receiving data from connected RS-485 device.
- SD LED (red): Lit while sending data to connected RS-485 device.
- Terminal resistor selector switch (330Ω/OPEN/110Ω)
- Special adapter connector: Used to connect this special adapter to PLC main unit or special adapter.
- Terminal block (European type) for connecting RS-485 device: Used to connect RS-485 device to 485ADP-MB.
- DIN rail mounting hook
- Special adapter fixing hook
- Special adapter connector: Used to connect communication special adapter or analog special adapter to this adapter on left side.

1.4 Terminal Configuration

The terminal configuration of the RS-485 terminal on the 485ADP-MB is shown below. Note that the terminal configuration is different from that of the FX3U-485-BD.

Terminal screws	Signal name	Function	Signal direction	
			485ADP-MB	RS-485 equipment
RDA	RDA(RXD+)	Receive data	←	
RDB	RDB(RXD-)			←
SDA	SDA(TXD+)			→
SDB	SDB(TXD-)	Send data	→	
SG	SG(GND)	Signal ground	-	

1.5 Terminal Resistor Selector Switch

485ADP-MB has a built-in terminal resistor. A terminal resistor may be required depending on the communication type. Refer to the following manual for the terminal resistor setting.

→ FX Series User's Manual - Data Communication Edition  
→ FX3S/FX3G/FX3GC/FX3U/FX3UC Series User's Manual - MODBUS Serial Communication Edition

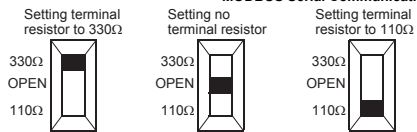

1.6 Operation of Terminal Resistor Selector Switch

Use the tip of tweezers, tip of mechanical pencil, minute screwdriver, or the tool whose tip width is about 0.8 mm (0.03") when operating the terminal resistor selector switch.

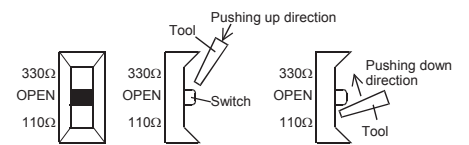

Either 'push down' or 'push up' the switch to change the setting as indicated in the figure above.  
Confirm the clicking noise when setting the switch.

2. Channel Allocation

Up to two communication ports can be added to the main unit. Refer to the following manual for equipment that occupies communication ports.  
→ FX Series User's Manual - Data Communication Edition

FX3S Series PLC

Communication port channels are automatically allocated.

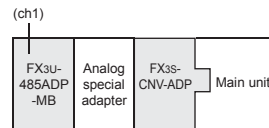

FX3G Series PLC

Communication port channels are automatically allocated.

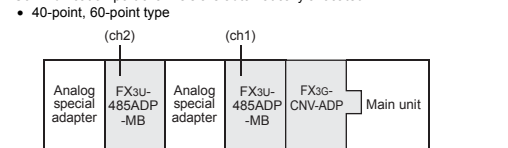

FX3U Series PLC

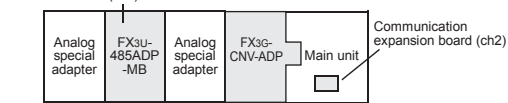

FX3UC Series PLC

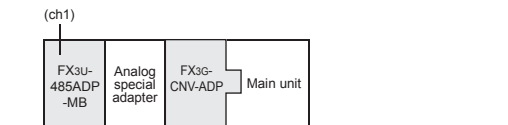

FX3GC Series PLC

Communication port channels are automatically allocated. The communication special adapter closer to the main unit is ch1.

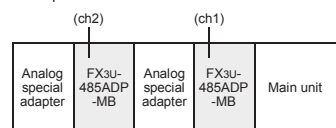

FX3U/FX3UC-32MT-LT(-2) Series PLC

Communication port channels are automatically allocated. The communication special adapter closer to the main unit is ch1.

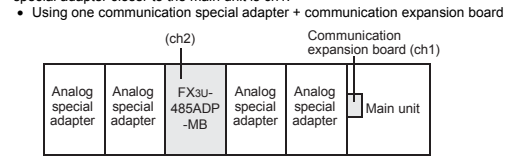

- Connect the special adapter (Right fig.C) to the main unit as shown on the right.
- Slide back the special adapter slide lock (Right fig.B) of the main unit to fix the special adapter (Right fig.C).

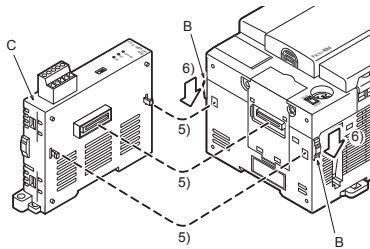

Connection precautions

Connect all the high-speed I/O special adapters before connecting other special adapters when they are used in combination.  
**Do not connect a high-speed I/O special adapter on the left side of a communication or analog special adapter.**

4. Wiring

For wiring details, refer to the following manual.  
→ FX Series User's Manual - Data Communication Edition  
→ FX3S/FX3G/FX3GC/FX3U/FX3UC Series User's Manual - MODBUS Serial Communication Edition

**WIRING PRECAUTIONS** ⚠ WARNING

- Make sure to cut off all phases of the power supply externally before attempting installation or wiring work. Failure to do so may cause electric shock or damage to the product.

**WIRING PRECAUTIONS** ⚠ CAUTION

- When drilling screw holes or wiring, make sure cutting or wire debris does not enter the ventilation slits. Failure to do so may cause fire, equipment failures or malfunctions.
- Make sure to observe the following precautions in order to prevent any damage to the machinery or accidents due to abnormal data written to the PLC under the influence of noise:
  - Do not bundle the main circuit line together with or lay it close to the main circuit, high-voltage line or load line. Otherwise, noise disturbance and/or surge induction are likely to take place. As a guideline, lay the control line at least 100mm (3.94") or more away from the main circuit or high-voltage lines.
  - Ground the shield wire or shield of the shielded cable at one point on the PLC. However, do not use common grounding with heavy electrical systems.
- Make sure to properly wire to the terminal block (European type) in accordance with the following precautions. Failure to do so may cause electric shock, equipment failures, a short-circuit, wire breakage, malfunctions, or damage to the product.
  - The disposal size of the cable end should follow the dimensions described in the manual of the PLC main unit.
  - Tightening torque should follow the specifications in the manual of the PLC main unit.
  - Twist the end of strand wire and make sure that there are no loose wires.
  - Do not solder-plate the electric wire ends.
  - Do not connect more than the specified number of wires or electric wires of unspecified size.
  - Affix the electric wires so that neither the terminal block nor the connected parts are directly stressed.

- Wiring precaution**
- Do not attach the terminal block (replacement European terminal block) for connecting RS-485 device which is already wired to FX3U-485-BD. If attached as its left and right are confused, the terminal configuration becomes upside down and no communication is performed.

5. Specification

**STARTUP AND MAINTENANCE PRECAUTIONS** ⚠ CAUTION

- Do not disassemble or modify the unit. Doing so may cause fire, equipment failures, or malfunctions. For repair, contact your local Mitsubishi Electric representative.
- Do not drop the product or exert strong impact to it. Doing so may cause damage.

**DISPOSAL PRECAUTIONS** ⚠ CAUTION

- Please contact a certified electronic waste disposal company for the environmentally safe recycling and disposal of your device.

**TRANSPORTATION AND STORAGE PRECAUTIONS** ⚠ CAUTION

- The product is a precision instrument. During transportation, avoid impacts larger than those specified in the general specifications by using dedicated packaging boxes and shock-absorbing pallets. Failure to do so may cause failures in the product. After transportation, verify operation of the product and check for damage of the mounting part, etc.

5.1 Applicable PLC

Model name	Applicability
FX3S Series PLC	Ver. 1.00 or later for all communication functions
FX3G Series PLC	Ver. 1.30 or later for MODBUS communication Ver. 1.10 or later for inverter communication Ver. 1.00 or later for all communication functions except MODBUS and inverter
FX3GC Series PLC	Ver. 1.40 or later for all communication functions
FX3U Series PLC	Ver. 2.40 or later for MODBUS communication Ver. 2.20 or later for all communication functions except MODBUS
FX3UC Series PLC	Ver. 2.40 or later for MODBUS communication Ver. 1.00 or later for all communication functions except MODBUS

The version number can be checked by monitoring D8001/D8101, as well as the last three digits indicate the version number.

5.2 General Specifications

Items other than the following are equivalent to the those of the PLC main unit. For general specifications, refer to the respective PLC User's manual Hardware Edition.

Item	Specification
Dielectric withstand voltage	500 V AC, one minute
Insulation resistance	Between all external terminals and ground terminal of PLC main unit 5 MΩ or higher by 500 V DC insulation resistance tester

5.3 Power Supply Specification

Item	Specification
Current consumption	20 mA 5 V DC power is supplied from the internal power supply of main unit.

5.4 Performance Specification

Item	Specification
Transmission standard	Conforming to RS-485/RS-422
Type of isolation	Photocoupler isolation
Transmission distance	Total extension distance: 500 m (1640' 5") or less [50 m (164' 0") or less if FX1N-485-BD, FX2N-485-BD or FX3U-485-BD is installed to connected equipment]
Connection method	European type terminal block, AWG 22-20 (when inserting one twisted pair cable), AWG 22 (when inserting two twisted pair cables) Tightening torque: 0.22 to 0.25 N·m
Number of occupied I/O points	0 point (This number is not related to the maximum number of input/output points of the PLC.)
Communication method	Half-duplex
Baud rate	N:N network: 38400 bps Parallel link: 115200 bps Computer link, Non-protocol communication: 300/600/1200/2400/4800/9600/19200/38400 <sup>1)</sup> bps Inverter communication: 4800/9600/19200/38400 <sup>1)</sup> bps MODBUS communication <sup>2)</sup> : 300/600/1200/2400/4800/9600/19200/38400 <sup>3)</sup> /57600 <sup>3)</sup> /115200 <sup>3)</sup> bps
Number of Slaves (MODBUS)	16 Slaves, 32 Slaves <sup>3)</sup>
Communication format	N:N network, Parallel link, Computer link (dedicated protocol: format 1/format 4), Non-protocol, Inverter, and MODBUS communication
LED display: LED color	Power: green, RD: red, SD: red

<sup>1)</sup> Applicable for FX3U/FX3UC Series PLC Ver. 2.41 or later and FX3S/FX3G/FX3GC Series PLC.

<sup>2)</sup> When you set the baud rate to 38400 bps or more in a FX3S/FX3G/FX3GC Series PLC, please set D8411 (D8431) to be 3 ms or more. When D8411 (D8431) is set at less than 3 ms, it may not be able to communicate normally.

<sup>3)</sup> Applicable for products manufactured in July, 2012 or later (manufacturer's serial number: 127\*\*\*\* or later). The year and month of production of the special adapter can be checked from the manufacturer's serial number "S/N" indicated on the label.  
For manufacturer's serial number, refer to the following manual.  
→ FX3S/FX3G/FX3GC/FX3U/FX3UC Series User's Manual - MODBUS Serial Communication Edition

6. 「电器电子产品有害物质限制使用标识要求」的表示方式

Note: This symbol mark is for China only.

含有有害6物质的名称, 含有量, 含有部品  
本产品中所含有的有害6物质的名称, 含有量, 含有部品如下表所示。

部件名称	有害物质					
	铅 (Pb)	汞 (Hg)	镉 (Cd)	六价铬 (Cr(VI))	多溴联苯 (PBB)	多溴二苯醚 (PBDE)
可编程控制器	○	○	○	○	○	○
印刷基板	×	○	○	○	○	○

本表格依据SJ/T 11364的规定编制。

○: 表示该有害物质在该部件所有均质材料中的含量均在GB/T 26572规定的限量要求以下。  
×: 表示该有害物质至少在该部件的某一均质材料中的含量超出GB/T 26572规定的限量要求。

This manual confers no industrial property rights or any rights of any other kind, nor does it confer any patent licenses. Mitsubishi Electric Corporation cannot be held responsible for any problems involving industrial property rights which may occur as a result of using the contents noted in this manual.

**Warranty**  
Exclusion of loss in opportunity and secondary loss from warranty liability  
Regardless of the gratis warranty term, Mitsubishi shall not be liable for compensation to:  
(1) Damages caused by any cause found not to be the responsibility of Mitsubishi.  
(2) Loss in opportunity, lost profits incurred to the user by Failures of Mitsubishi products.  
(3) Special damages and secondary damages whether foreseeable or not, compensation for accidents, and compensation for damages to products other than Mitsubishi products.  
(4) Replacement by the user, maintenance of on-site equipment, start-up test run and other tasks.

**For safe use**

- This product has been manufactured as a general-purpose part for general industries, and has not been designed or manufactured to be incorporated in a device or system used in purposes related to human life.
- Before using the product for special purposes such as nuclear power, electric power, aerospace, medicine or passenger movement vehicles, consult with Mitsubishi Electric.
- This product has been manufactured under strict quality control. However when installing the product where major accidents or losses could occur if the product fails, install appropriate backup or failsafe functions in the system.