



**Side A** JAPANESE  
**Side B** ENGLISH

## CC-Link/LT Master Block Model FX<sub>2N</sub>-64CL-M User's Manual (Hardware Volume)



Manual Number	JY997D05401
Revision	K
Date	March 2018

This manual describes the name of each part, external dimensions and specifications of the CC-Link/LT master block for the Mitsubishi FX series Programmable Logic Controller (PLC).  
For the design and construction of the CC-Link/LT system, refer to the CC-Link/LT Master Block Users Manual.

Effective March 2018  
Specifications are subject to change without notice.  
© 2002 Mitsubishi Electric Corporation

### SAFETY PRECAUTIONS

These SAFETY PRECAUTIONS are classified into two categories: "WARNING" and "CAUTION".

**WARNING** Procedures which may lead to dangerous conditions or cause death or serious injury if not carried out properly.

**CAUTION** Procedures which may lead to dangerous conditions or cause minor to medium injury, or physical damage, if not carried out properly.

Depending on certain circumstances, procedures indicated by

**CAUTION** may also be linked to serious ramifications. It is important to follow the directions for usage.

### DESIGN PRECAUTIONS

#### WARNING

- Construct an interlock circuit in the sequence program so that the system works correctly using the communication information when an error in the data link occurs.  
If such an interlock circuit is not provided, accidents may be caused by erroneous output or malfunction.
- When a remote I/O unit fails, inputs/outputs may randomly become ON or OFF, therefore build an external monitoring circuit that will monitor any input signals that could cause a serious accident.  
Accident may be caused by erroneous output or malfunction.

#### CAUTION

- Use the master block without applying any force on the master block and the CC-Link/LT connection cable.  
Otherwise, such cables may break or fail.

### INSTALLATION PRECAUTIONS

#### WARNING

- Make sure to cut off all phases of the power supply externally before attempting installation work.  
Failure to do so may cause electric shock or damage to the product.

#### CAUTION

- Use the product within the generic environment specifications described in PLC main unit manual (Hardware Edition).  
Never use the product in areas with excessive dust, oily smoke, conductive dusts, corrosive gas (salt air, Cl<sub>2</sub>, H<sub>2</sub>S, SO<sub>2</sub>, or NO<sub>2</sub>), flammable gas, vibration or impacts, or expose it to high temperature, condensation, or rain and wind.  
If the product is used in such conditions, electric shock, fire, malfunctions, deterioration or damage may occur.
- Install the product securely using a DIN rail or mounting screws.

### CAUTION

- When drilling screw holes or wiring, make sure that cutting and wiring debris do not enter the ventilation slits.  
Failure to do so may cause fire, equipment failures or malfunctions.
- During installation and wiring works, adhere dust-proof sheets supplied together with the master block on the sides of the master block so that foreign objects such as cutting chips and wiring chips do not enter the inside.  
Otherwise, foreign objects may cause fire, failure or malfunction.
- Be sure to remove the dust proof sheet from the PLC's ventilation port when installation work is completed.  
Failure to do so may cause fire, equipment failures or malfunctions.

### WIRING PRECAUTIONS

#### WARNING

- Make sure to cut off all phases of the power supply externally before attempting installation or wiring work.  
Failure to do so may cause electric shock or damage to the product.

#### CAUTION

- CC-Link/LT network wiring uses the CC-Link/LT connection cable specified by CC-Link Partner Association (CLPA), and perform wiring in accordance with the specifications described in this manual.  
If any cable other than the connection cable is used or if wiring is performed in a method not conforming to the specifications, normal data transmission cannot be assured.
- Do not bind the CC-Link/LT connection cable together with major circuits or power cables. Keep the connection cable away from major circuits and power cables by 100 mm (3.93") or more.  
It may cause malfunction due to noise interference.
- Accommodate the CC-Link/LT connection cable inside a duct, or fix it with clamps. If the connection cable is loose or is pulled for movement or carelessness, the master block and the connection cable may be damaged or malfunction due to imperfect connection.
- Correctly wire the master block while confirming the rated voltage and terminal arrangement of the master block. It may cause fire or product failure.
- Hold the connector area when disconnecting the CC-Link/LT connection cable from the master block.  
If the cable area is pulled, the master block or the dedicated cable may be damaged or malfunction.

### STARTING AND MAINTENANCE PRECAUTIONS

#### WARNING

- Do not touch any terminal while the PLC's power is ON. It may cause an electric shock or malfunction.
- Make sure to shut down all phases of the power supply outside the master block before starting cleaning. If all phases of the power supply are not shut down, the master block may be seriously damaged or malfunction.

#### CAUTION

- Do not disassemble or modify the master block. Doing so may cause fire, equipment failures, or malfunctions.  
For repair, contact your local Mitsubishi Electric representative.
- The case of the master block is made of resin. Do not drop or apply strong impacts to the master block.

### DISPOSAL PRECAUTIONS

#### CAUTION

- Please contact a certified electronic waste disposal company for the environmentally safe recycling and disposal of your device.

### Notification of CE marking

This notification does not guarantee that an entire mechanical module produced in accordance with the contents of the notification comply with the following standards. Compliance to EMC standards of the entire mechanical module should be checked by the user / manufacturer.

#### Attention

This product is designed for use in industrial applications.

### Standards with which this product complies

Type : Programmable Controller (Open Type Equipment)  
Models : Products manufactured from February 1st, 2003

Electromagnetic Compatibility Standards (EMC)	Remark
EN61000-6-4:2007 -Generic emission standard Industrial environment	Compliance with all relevant aspects of the standard. • Emission-Enclosure port • Emission-Low voltage AC mains port • Emission-Telecommunications/network port
EN61131-2:2007 Programmable controllers -Equipment requirements and tests	Compliance with all relevant aspects of the standard. EMI • Radiated Emission • Conducted Emission EMS • Radiated electromagnetic field • Fast transient burst • Electrostatic discharge • High-energy surge • Voltage drops and interruptions • Conducted RF • Power frequency magnetic field

For more details please contact the local Mitsubishi Electric sales site.

- Notes for compliance to EMC regulation.  
The FX<sub>2N</sub>-64CL-M must be installed in a shielded metal control panel.
- Use the CC-Link/LT module in Zone A<sup>1</sup> as defined in EN61131-2.  
The terminal and the wiring for the following table can be used in Zone B<sup>1</sup>.

Classification	Model	Terminal that can be used in Zone B	Rated load voltage
Relay output <sup>2</sup>	CL1Y4-R1B1 CL1Y4-R1B2	Terminal to connect output signals and load power supply.	240 V AC or less <sup>3</sup> 30 V DC or less
DC input/ Relay output <sup>2</sup>	CL1XY4-DR1B2 CL1XY8-DR1B2	Terminal to connect output signals and load power supply.	240 V AC or less <sup>3</sup> 30 V DC or less
CC-Link/LT Dedicated Power Supply	CL1PSU-2A	Terminal block to connect power supply.	100/120/200/230/ 240 V AC

<sup>1</sup> Zone defined in EN61131-2  
Separation defined in EN61131-2 for EMC LVD regulation decided depending on condition in industrial setting.

Zone C = Factory mains which is isolated from public mains by dedicated transformers.

Zone B = Dedicated power distribution which is protected by secondary surge protection. (300 V or less in the rated voltage is assumed.)

Zone A = Local power distribution which is isolated from dedicated power distribution by AC/DC converters, isolation transformers, etc. (120 V or less in the rated voltage is assumed.)

<sup>2</sup> Terminal block connection type.

<sup>3</sup> 250 V AC or less when the unit does not comply with UL or cUL standards.

- When the following models use the CC-Link/LT power adapter model (CL1PAD1), a power line connecting to the external power supply terminal of the CL1PAD1 must be 30 m (98' 5") or less.  
- CL2AD4-B  
- CL2DA2-B

### Associated Manuals

Manual name	Manual No.	Description
CC-Link/LT Master Block Model FX <sub>2N</sub> -64CL-M User's Manual (Detailed Volume)	JY997D08501	This manual explains the specifications, wiring, handling, etc. of the CC-Link/LT master block.

### 1. Product Outline

The CC-Link/LT master block FX<sub>2N</sub>-64CL-M can be connected to the FX Series PLC.  
By using this master block, a CC-Link/LT system can be constructed with the FX Series PLC as the master station.

### 2. Part Name and Setting

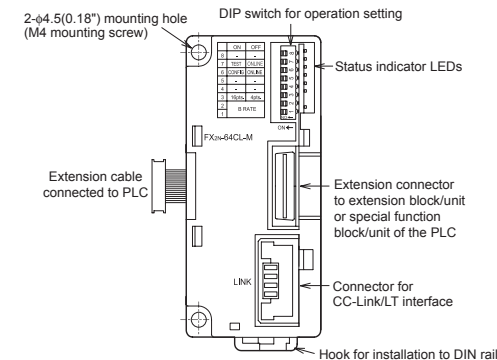

Name	Description
POWER	<ONLINE mode/CONFIG mode/TEST mode> ON: Power is being supplied OFF: Power is not being supplied
	<ONLINE mode> ON: Master block is operating normally OFF: Master block is abnormal Power has been interrupted EEPROM read error (sum mismatch) occurred
RUN	<CONFIG mode> ON: Master block is operating normally OFF: Master block is abnormal Power has been interrupted
	<TEST mode> ON: Master block is operating normally OFF: Master block is abnormal Power has been interrupted
ERR.	<ONLINE mode> ON: Communication speed setting error occurred EEPROM read error (sum mismatch) occurred Flickering: Power supplied for communication is abnormal DIP switch for operation setting was changed during operation OFF: Master block is operating normally
	<CONFIG mode> ON: Communication speed setting error occurred EEPROM write error occurred Flickering: Power supplied for communication is abnormal DIP switch for operation setting was changed during operation OFF: Master block is operating normally
L RUN	<TEST mode> ON: Communication speed setting error occurred Flickering: Power supplied for communication is abnormal DIP switch for operation setting was changed during operation OFF: Master block is operating normally
	<ONLINE mode/CONFIG mode> ON: Data link is being executed OFF: Data link is stopped
L ERR.	<TEST mode> ON: Self-loop back Test finished normally OFF: Self-loop back Test finished abnormally (LED is OFF while the self-loop back Test is being executed)
	<ONLINE mode> ON: Station number discrepancy (when BFM #32(20h) to #95(5Fh) is edited, the station numbers are checked.) Outside-control-range station error occurred Flickering: Stations are abnormal OFF: Data link is being executed normally
L ERR.	<CONFIG mode> ON: Station number discrepancy (when BFM #32(20h) to #95(5Fh) is edited, the station numbers are checked.) Flickering: All stations are abnormal OFF: Data link is being executed normally

Name		Description															
Status indicator LEDs	L ERR.	<TEST mode> ON: Self-loop back Test finished abnormally OFF: Self-loop back Test finished normally (LED is OFF while the self-loop back Test is being executed)															
	SD	<ONLINE mode/CONFIG mode/TEST mode> ON: Data is being sent															
	RD.	<ONLINE mode/CONFIG mode/TEST mode> ON: Data is being received															
Interface																	
CC-Link/LT connection cable connector (24G/DB/DA/+24 V)																	
DIP switch for operation setting	1	Communication speed setting															
		<table border="1"> <thead> <tr> <th>Communication speed</th> <th>SW1</th> <th>SW2</th> </tr> </thead> <tbody> <tr> <td>156 kbps</td> <td>OFF</td> <td>OFF</td> </tr> <tr> <td>625 kbps</td> <td>ON</td> <td>OFF</td> </tr> <tr> <td>2.5 Mbps</td> <td>OFF</td> <td>ON</td> </tr> <tr> <td>Setting disabled</td> <td>ON</td> <td>ON</td> </tr> </tbody> </table>	Communication speed	SW1	SW2	156 kbps	OFF	OFF	625 kbps	ON	OFF	2.5 Mbps	OFF	ON	Setting disabled	ON	ON
		Communication speed	SW1	SW2													
	156 kbps	OFF	OFF														
	625 kbps	ON	OFF														
	2.5 Mbps	OFF	ON														
	Setting disabled	ON	ON														
	2	B RATE															
<table border="1"> <thead> <tr> <th>Communication speed</th> <th>SW1</th> <th>SW2</th> </tr> </thead> <tbody> <tr> <td>156 kbps</td> <td>OFF</td> <td>OFF</td> </tr> <tr> <td>625 kbps</td> <td>ON</td> <td>OFF</td> </tr> <tr> <td>2.5 Mbps</td> <td>OFF</td> <td>ON</td> </tr> <tr> <td>Setting disabled</td> <td>ON</td> <td>ON</td> </tr> </tbody> </table>		Communication speed	SW1	SW2	156 kbps	OFF	OFF	625 kbps	ON	OFF	2.5 Mbps	OFF	ON	Setting disabled	ON	ON	
Communication speed	SW1	SW2															
156 kbps	OFF	OFF															
625 kbps	ON	OFF															
2.5 Mbps	OFF	ON															
Setting disabled	ON	ON															
3	16pts/4pts																
	Point mode setting (Select the number of I/O points per station.) OFF : 4-point mode (4 input points and 4 output points in each station) ON : 16-point mode (16 input points and 16 output points in each station)																
4	--	Setting is disabled. (Make sure that this is OFF during operation.)															
5	--	Setting is disabled. (Make sure that this is OFF during operation.)															
6	CONFIG/ONLINE	CONFIG mode OFF : ONLINE mode (normal operation) ON : CONFIG mode (The information on connected stations is saved in the EEPROM.)															
7	TEST/ONLINE	TEST mode OFF : ONLINE mode (normal operation) ON : TEST mode (Self-loop back Test)															
8	--	Setting is disabled. (Make sure that this is OFF during operation.)															

- Factory default, all bits of the DIP switch are set to OFF.
- Test mode is selected when both the CONFIG and TEST modes are set to ON simultaneously.
- For each setting, the status at time of power ON is valid. (If a setting is changed after the power is turned ON, the change is invalid.)

#### CONFIGMODE

- BFM #32 (20h) to #95 (5Fh) changed value while online will cause a L ERR.
- If no remote modules are attached during power ON, no L ERR shown.
- If a remote module is removed during operation, no L ERR will be shown.

### 3. Handling Cautions

The master block can be mounted on a DIN rail or directly with screws. The installation procedure in each case is described below. Use the master block without applying any force on the cable. Refer to the FX2N-64CL-M USER'S MANUAL (Detailed Volume).

#### 3.1 Mounting direction

- Do not install the master block on the floor, ceiling or horizontally within the cabinet. If the master block is installed in such a way, its temperature may rise. Install the master block vertically on the back wall of the cabinet.
- Leave a space of 50 mm (1.96") or more between the master block and other equipment or structures. Keep the master block away from high voltage cables, high voltage equipment and other power equipment as much as possible.

#### 3.2 DIN rail mounting

Align the upper DIN rail installation groove in the module with the DIN rail, and press the module on to the DIN rail. When removing the module, pull the installation hook downwards, and remove the module.

#### DIN rail mounting screw pitch

When mounting the module on the DIN rail, tighten the mounting screws at a pitch of 200 mm (7.87") or less.

Applicable DIN rail | TH35-7.5Fe and TH35-7.5Al

### 3.3 Direct mounting

Fix the master block on the panel surface by tightening the M4 screws inserted in the two (upper and lower) mounting holes provided on the master block. Install the module so that a clearance of 1 to 2 mm (0.04" to 0.08") is assured for each module.

Applicable screw	M4 height: 16 mm(0.63") or more (Tightening torque range: 0.78 to 1.08 N·m)
------------------	--------------------------------------------------------------------------------

### 4. Connection of External Equipment

Connect the master block to a remote I/O unit or power adapter using the connection cable and the dedicated CC-Link/LT connector.

- The connection order of the CC-Link/LT connection cable has no relevance to the station No.
- Make sure to install the master block on one side of the trunk line.
- In the CC-Link/LT system, terminating resistors should be connected to both ends of the trunk line. Connect the terminating resistor on the master block side within 200 mm (7.87") of the master block.
- For the CC-Link/LT connection cable point of contact, the connection cable connector and terminating resistors, refer to the homepage of the CC-Link Partner Association (CLPA) "http://www.cc-link.org/".

### 5. Specifications

#### 5.1 General specifications

The general specifications except for the following are the same as the PLC main unit. (For the general specifications except for the following, refer to the PLC main unit manual.)

Item	Specification	
Dielectric withstand voltage	500 V AC for 1 min	Between case and PLC grounding terminal
Isolation resistance	5 MΩ or higher by 500 V DC insulation resistance tester	

#### 5.2 Network wiring specifications

Item	Specification			Remarks
Communication speed	2.5 Mbps	625 kbps	156 kbps	--
Distance between stations	No restriction			--
Maximum number of modules connected in 1 drop line	8 units			--
Maximum trunk length	35 m (114' 9")	100 m (328' 1")	500 m (1640' 5")	Cable length between terminating resistors
T-branch interval	No restriction			--
Maximum drop length	4 m (13' 1")	16 m (52' 5")	60 m (196' 10")	Cable length per branch
Cumulative drop line length	15 m (49' 2")	50 m (164' 0")	200 m (656' 2")	Sum of all drop lines

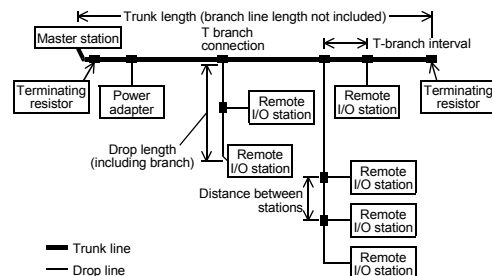

### 5.3 Performance specifications

Item	Specification			
Applicable PLC	FX1N/FX2N/FX2NC/FX3G/FX3GC/FX3U/FX3UC Series PLC (FX2NC-CNV-IF is required when FX2NC Series PLC is connected.) (FX2NC-CNV-IF or FX3UC-1PS-5V is required when an FX3GC/FX3UC Series PLC is connected.)			
Number of connectable master blocks	FX1N Series : Up to 4 <sup>1</sup> FX2N Series : Up to 8 <sup>2</sup> FX2NC Series: Up to 3 <sup>2</sup> FX3G/FX3U Series: Up to 8 <sup>2</sup> FX3GC/FX3UC Series: Up to 5 <sup>2</sup>			
Applicable point mode	4-point mode and 16-point mode (selectable by DIP switch)			
Maximum number of link points	4-point mode	16-point mode		
	Connected to FX1N/FX3G/FX3GC Series PLC: 128 points Connected to FX2N/FX2NC/FX3U/FX3UC Series PLC: 256 points (including I/O points in PLC in each case)			
Number of link points per station ( ) shows the number of link points when composite I/O module is used.	4 points (8 points)	16 points (32 points)		
Link scan time	32 stations	2.5 Mbps	0.7 ms	1.0 ms
		625 kbps	2.2 ms	3.8 ms
	64 stations	156 kbps	8.0 ms	14.1 ms
		2.5 Mbps	1.2 ms	2.0 ms
64 stations	625 kbps	4.3 ms	7.4 ms	
	156 kbps	15.6 ms	27.8 ms	
Communication speed	2.5 Mbps, 625 kbps and 156 kbps (selectable by DIP switch)			
Protocol	BITR method (Broadcastpolling + Interval Timed Response)			
Network topology	T-branch			
Error control method	CRC			
Number of connected stations	64 stations maximum			
Remote station numbers	1 to 64			
Master station connection position	Connected at the end of the trunk line			
RAS function	Communication error detection, automatic return to system, slave station disconnection and internal loop back diagnosis			
Connection cable	<ul style="list-style-type: none"> <li>• Dedicated flat cable (0.75 mm<sup>2</sup> x 4)</li> <li>• VCTF cable (0.75 mm<sup>2</sup> x 4)<sup>3</sup></li> <li>• High flexible cable (0.75 mm<sup>2</sup> x 4)</li> </ul>			
Number of occupied I/O points	8 points (fixed) + Number of connected remote I/O points			
Current consumption inside 5 V DC	190 mA (Supplied from PLC via extension connector)			
24 V DC power supply	Voltage	20.4 to 28.8 V DC	Supplied from power adapter via CC-Link/LT interface connector.	
	Current consumption	25 mA		
	Initial current	35 mA		
Mass (weight)	Approx. 0.15 kg (0.33 lbs)			

\*1 When connected to the FX1N Series PLC, up to two FX2N-64CL-M units can be connected to the main unit and another two on the extension unit.

\*2 FX2N-64CL-M draws 190 mA from the 5 V DC source. The total 5 V consumption of all special function blocks connected to the main unit or extension unit must not exceed the 5 V source capacity of the system. (Refer to the Hardware manual of the PLC)

\*3 For the VCTF cable specifications, refer to the FX2N-64CL-M USER'S MANUAL (Detailed Volume).

### 6. External Dimensions

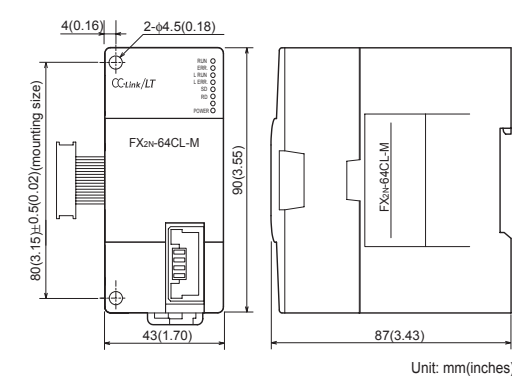

「电器电子产品有害物质限制使用标识要求」的表示方式



Note: This symbol mark is for China only.

含有有害6物质的名称, 含有量, 含有部品  
本产品中所含有的有害6物质的名称, 含有量, 含有部品如下表所示。

产品中有害物质的名称及含量

部件名称	有害物质					
	铅 (Pb)	汞 (Hg)	镉 (Cd)	六价铬 (Cr (VI))	多溴联苯 (PBB)	多溴二苯醚 (PBDE)
可编程控制器	○	○	○	○	○	○
外壳	○	○	○	○	○	○
印刷基板	×	○	○	○	○	○

本表格依据SJ/T 11364的规定编制。

- : 表示该有害物质在该部件所有均质材料中的含量均在GB/T 26572规定的限量要求以下。
- ×: 表示该有害物质至少在该部件的某一均质材料中的含量超出GB/T 26572规定的限量要求。

基于中国标准法的参考规格: GB/T15969.2

This manual confers no industrial property rights or any rights of any other kind, nor does it confer any patent licenses. Mitsubishi Electric Corporation cannot be held responsible for any problems involving industrial property rights which may occur as a result of using the contents noted in this manual.

#### Warranty

Exclusion of loss in opportunity and secondary loss from warranty liability  
Regardless of the gratis warranty term, Mitsubishi shall not be liable for compensation to:  
(1) Damages caused by any cause found not to be the responsibility of Mitsubishi.  
(2) Loss in opportunity, lost profits incurred to the user by Failures of Mitsubishi products.  
(3) Special damages and secondary damages whether foreseeable or not, compensation for accidents, and compensation for damages to products other than Mitsubishi products.  
(4) Replacement by the user, maintenance of on-site equipment, start-up test run and other tasks.

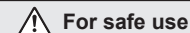

For safe use

- This product has been manufactured as a general-purpose part for general industries, and has not been designed or manufactured to be incorporated in a device or system used in purposes related to human life.
- Before using the product for special purposes such as nuclear power, electric power, aerospace, medicine or passenger movement vehicles, consult with Mitsubishi Electric.
- This product has been manufactured under strict quality control. However when installing the product where major accidents or losses could occur if the product fails, install appropriate backup or failsafe functions in the system.

MITSUBISHI ELECTRIC CORPORATION

HEAD OFFICE : TOKYO BUILDING, 2-7-3 MARUNOUCHI, CHIYODA-KU, TOKYO 100-8310, JAPAN





Programmable Controller MELSEC-F

CC-Link/LT Master Block Model FX2N-64CL-M User's Manual (Hardware Volume)



Table with 2 columns: Field (Manual Number, Revision, Date) and Value (JY997D05401, K, March 2018)

This manual describes the name of each part, external dimensions and specifications of the CC-Link/LT master block for the Mitsubishi FX series Programmable Logic Controller (PLC).

For the design and construction of the CC-Link/LT system, refer to the CC-Link/LT Master Block Users Manual.

Effective March 2018

Specifications are subject to change without notice.

© 2002 Mitsubishi Electric Corporation

SAFETY PRECAUTIONS are classified into two categories: "WARNING" and "CAUTION".

- WARNING: Procedures which may lead to dangerous conditions or cause death or serious injury if not carried out properly.
CAUTION: Procedures which may lead to dangerous conditions or cause minor to medium injury, or physical damage, if not carried out properly.

Depending on certain circumstances, procedures indicated by

CAUTION may also be linked to serious ramifications. It is important to follow the directions for usage.

DESIGN PRECAUTIONS

WARNING

- Construct an interlock circuit in the sequence program so that the system works correctly using the communication information when an error in the data link occurs.
When a remote I/O unit fails, inputs/outputs may randomly become ON or OFF, therefore build an external monitoring circuit that will monitor any input signals that could cause a serious accident.

CAUTION

- Use the master block without applying any force on the master block and the CC-Link/LT connection cable.
Otherwise, such cables may break or fail.

INSTALLATION PRECAUTIONS

WARNING

- Make sure to cut off all phases of the power supply externally before attempting installation work.
Failure to do so may cause electric shock or damage to the product.

CAUTION

- Use the product within the generic environment specifications described in PLC main unit manual (Hardware Edition).
Never use the product in areas with excessive dust, oily smoke, conductive dusts, corrosive gas (salt air, Cl2, H2S, SO2, or NO2), flammable gas, vibration or impacts, or expose it to high temperature, condensation, or rain and wind.

CAUTION

- When drilling screw holes or wiring, make sure that cutting and wiring debris do not enter the ventilation slits.
Failure to do so may cause fire, equipment failures or malfunctions.
During installation and wiring works, adhere dust-proof sheets supplied together with the master block on the sides of the master block so that foreign objects such as cutting chips and wiring chips do not enter the inside.

WIRING PRECAUTIONS

WARNING

- Make sure to cut off all phases of the power supply externally before attempting installation or wiring work.
Failure to do so may cause electric shock or damage to the product.

CAUTION

- CC-Link/LT network wiring uses the CC-Link/LT connection cable specified by CC-Link Partner Association (CLPA), and perform wiring in accordance with the specifications described in this manual.
Do not bind the CC-Link/LT connection cable together with major circuits or power cables.
Accommodate the CC-Link/LT connection cable inside a duct, or fix it with clamps.

STARTING AND MAINTENANCE PRECAUTIONS

WARNING

- Do not touch any terminal while the PLC's power is ON. It may cause an electric shock or malfunction.
Make sure to shut down all phases of the power supply outside the master block before starting cleaning.

CAUTION

- Do not disassemble or modify the master block. Doing so may cause fire, equipment failures, or malfunctions.
The case of the master block is made of resin. Do not drop or apply strong impacts to the master block.

DISPOSAL PRECAUTIONS

CAUTION

- Please contact a certified electronic waste disposal company for the environmentally safe recycling and disposal of your device.

Notification of CE marking

This notification does not guarantee that an entire mechanical module produced in accordance with the contents of the notification comply with the following standards.

Attention

This product is designed for use in industrial applications.

Standards with which this product complies

Type : Programmable Controller (Open Type Equipment)
Models : Products manufactured from February 1st, 2003

Table with 2 columns: Electromagnetic Compatibility Standards (EMC) and Remark. Includes EN61000-6-4:2007 and EN61131-2:2007.

For more details please contact the local Mitsubishi Electric sales site.

Notes for compliance to EMC regulation. The FX2N-64CL-M must be installed in a shielded metal control panel.

Use the CC-Link/LT module in Zone A as defined in EN61131-2. The terminal and the wiring for the following table can be used in Zone B.

Table with 4 columns: Classification, Model, Terminal that can be used in Zone B, Rated load voltage. Lists Relay output, DC input/Relay output, and CC-Link/LT Dedicated Power Supply.

\*1 Zone defined in EN61131-2. Separation defined in EN61131-2 for EMC LVD regulation decided depending on condition in industrial setting.

- Zone C = Factory mains which is isolated from public mains by dedicated transformers.
Zone B = Dedicated power distribution which is protected by secondary surge protection.
Zone A = Local power distribution which is isolated from dedicated power distribution by AC/DC converters, isolation transformers, etc.

\*2 Terminal block connection type. \*3 250 V AC or less when the unit does not comply with UL or cUL standards.

When the following models use the CC-Link/LT power adapter model (CL1PAD1), a power line connecting to the external power supply terminal of the CL1PAD1 must be 30 m (98' 5") or less.

CL2AD4-B, CL2DA2-B

Associated Manuals

Table with 3 columns: Manual name, Manual No., Description. Lists CC-Link/LT Master Block Model FX2N-64CL-M User's Manual (Detailed Volume).

1. Product Outline

The CC-Link/LT master block FX2N-64CL-M can be connected to the FX Series PLC. By using this master block, a CC-Link/LT system can be constructed with the FX Series PLC as the master station.

2. Part Name and Setting

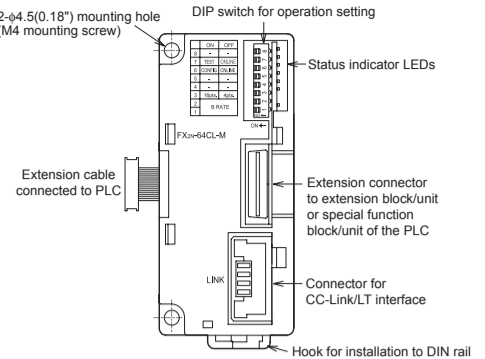

Table with 2 columns: Name and Description. Lists POWER, RUN, ERR, L RUN, and L ERR status indicators and their meanings.

Table with 2 columns: Name and Description. Lists Status indicator LEDs (L ERR, SD, RD), Interface (Communication speed setting), DIP switch for operation setting (B RATE, 16pts/4pts, CONFIG/ONLINE, TEST/ONLINE), and DIP switch for operation setting (Setting is disabled).

- Factory default, all bits of the DIP switch are set to OFF.
Test mode is selected when both the CONFIG and TEST modes are set to ON simultaneously.
For each setting, the status at time of power ON is valid.

CONFIGMODE
BFM #32 (20h) to #95 (5Fh) changed value while online will cause a L ERR.
If no remote modules are attached during power ON, no L ERR shown.
If a remote module is removed during operation, no L ERR will be shown.

3. Handling Cautions

- The master block can be mounted on a DIN rail or directly with screws.
The installation procedure in each case is described below.
Use the master block without applying any force on the cable.
Refer to the FX2N-64CL-M USER'S MANUAL (Detailed Volume).

3.1 Mounting direction

- Do not install the master block on the floor, ceiling or horizontally within the cabinet.
Install the master block vertically on the back wall of the cabinet.
Leave a space of 50 mm (1.96") or more between the master block and other equipment or structures.

3.2 DIN rail mounting

Align the upper DIN rail installation groove in the module with the DIN rail, and press the module on to the DIN rail. When removing the module, pull the installation hook downwards, and remove the module.

DIN rail mounting screw pitch

When mounting the module on the DIN rail, tighten the mounting screws at a pitch of 200 mm (7.87") or less.

Applicable DIN rail TH35-7.5Fe and TH35-7.5Al

3.3 Direct mounting

Fix the master block on the panel surface by tightening the M4 screws inserted in the two (upper and lower) mounting holes provided on the master block. Install the module so that a clearance of 1 to 2 mm (0.04" to 0.08") is assured for each module.

Table with 2 columns: Applicable screw and Specification (M4 height: 16 mm (0.63") or more, Tightening torque range: 0.78 to 1.08 N-m)

4. Connection of External Equipment

Connect the master block to a remote I/O unit or power adapter using the connection cable and the dedicated CC-Link/LT connector.
The connection order of the CC-Link/LT connection cable has no relevance to the station No.
Make sure to install the master block on one side of the trunk line.
In the CC-Link/LT system, terminating resistors should be connected to both ends of the trunk line.
Connect the terminating resistor on the master block side within 200 mm (7.87") of the master block.
For the CC-Link/LT connection cable point of contact, the connection cable connector and terminating resistors, refer to the homepage of the CC-Link Partner Association (CLPA).

5. Specifications

5.1 General specifications
The general specifications except for the following are the same as the PLC main unit. (For the general specifications except for the following, refer to the PLC main unit manual.)

Table with 2 columns: Item and Specification. Lists Dielectric withstand voltage, Isolation resistance, and Specification details.

5.2 Network wiring specifications

Table with 3 columns: Item, Specification, Remarks. Lists Communication speed, Distance between stations, Maximum number of modules connected in 1 drop line, Maximum trunk length, T-branch interval, Maximum drop length, Cumulative drop line length.

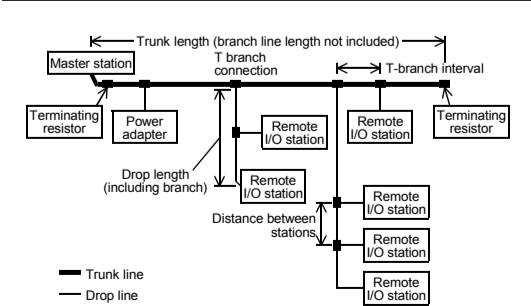

5.3 Performance specifications

Table with 2 columns: Item and Specification. Lists Applicable PLC, Number of connectable master blocks, Applicable point mode, Control specifications, Link scan time, Communication speed, Protocol, Network topology, Error control method, Number of connected stations, Remote station numbers, Master station connection position, RAS function, Connection cable, Number of occupied I/O points, Current consumption inside 5 V DC, 24 V DC power supply, Mass (weight).

- \*1 When connected to the FX1N Series PLC, up to two FX2N-64CL-M units can be connected to the main unit and another two on the extension unit.
\*2 FX2N-64CL-M draws 190 mA from the 5 V DC source.
\*3 For the VCTF cable specifications, refer to the FX2N-64CL-M USER'S MANUAL (Detailed Volume).

6. External Dimensions

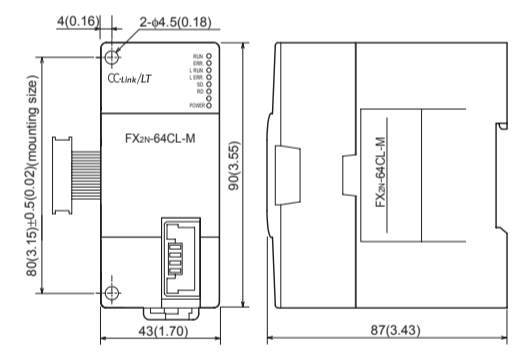

「电器电子产品有害物质限制使用标识要求」的表示方式

Note: This symbol mark is for China only.
含有有害物质的名称, 含有量, 含有部品.
本产品中所含有的有害物质名称, 含有量, 含有部品如下表所示.

Table with 2 columns: 有害物质 (Hazardous Substances) and 部件名称 (Component Name). Lists Lead, Mercury, Cadmium, Hexavalent Chromium, Polybrominated Biphenyls, and Polybrominated Diphenyl Ethers.

本表格依据SJ/T 11364的规定编制.
表示该有害物质在该部件所有均质材料中的含量均在GB/T 26572规定的限量要求以下.
表示该有害物质至少在该部件的某一均质材料中的含量超出GB/T 26572规定的限量要求.

基于中国标准法的参考规格: GB/T15969.2

This manual confers no industrial property rights or any rights of any other kind, nor does it confer any patent licenses. Mitsubishi Electric Corporation cannot be held responsible for any problems involving industrial property rights which may occur as a result of using the contents noted in this manual.

Warranty
Exclusion of loss in opportunity and secondary loss from warranty liability.
Regardless of the gratis warranty term, Mitsubishi shall not be liable for compensation for:
(1) Damages caused by any cause found not to be the responsibility of Mitsubishi.
(2) Loss in opportunity, lost profits incurred to the user by Failures of Mitsubishi products.
(3) Special damages and secondary damages whether foreseeable or not, compensation for accidents, and compensation for damages to products other than Mitsubishi products.
(4) Replacement by the user, maintenance of on-site equipment, start-up test run and other tasks.

For safe use

- This product has been manufactured as a general-purpose part for general industries, and has not been designed or manufactured to be incorporated in a device or system used in purposes related to human life.
Before using the product for special purposes such as nuclear power, electric power, aerospace, medicine or passenger movement vehicles, consult with Mitsubishi Electric.
This product has been manufactured under strict quality control. However when installing the product where major accidents or losses could occur if the product fails, install appropriate backup or failsafe functions in the system.