

Programmable Controller
MELSEC-F

USER'S MANUAL

FX2N-5A Special function block

FX2N

Foreword

- This manual contains text, diagrams and explanations which will guide the reader in the correct installation and operation of the FX2N-5A Special function block. It should be read and understood before attempting to install or use the unit.
 - Further information can be found in the FX0N/FX1N/FX2N/FX2NC/FX3G/FX3GC/FX3U/FX3UC Series Hardware Manual for connecting main unit, and the FX Series Programming Manual(II).
 - If in doubt at any stage of the installation of FX2N-5A Special function block always consult a professional electrical engineer who is qualified and trained to the local and national standards that applies to the installation site.
 - If in doubt about the operation or use of FX2N-5A Special function block please consult your local Mitsubishi Electric representative.
 - This manual is subject to change without notice.
-

FX2N-5A Special function block

USER'S MANUAL

Manual number : JY997D11401

Manual revision : H

Date : August 2017

This manual confers no industrial property rights or any rights of any other kind, nor does it confer any patent licenses. Mitsubishi Electric Corporation cannot be held responsible for any problems involving industrial property rights which may occur as a result of using the contents noted in this manual.

Guidelines for the Safety of the User and Protection of the FX2N-5A Special function block.

This manual provides information for the use of the FX2N-5A Special function block. The manual has been written to be used by trained and competent personnel. The definition of such a person or persons is as follows:

- a) Any engineer who is responsible for the planning, design and construction of automatic equipment using the product associated with this manual, should be of a competent nature, trained and qualified to the local and national standards required to fulfill that role. These engineers should be fully aware of all aspects of safety with regards to automated equipment.
- b) Any commissioning or service engineer must be of a competent nature, trained and qualified to the local and national standards required to fulfill that job. These engineers should also be trained in the use and maintenance of the completed product. This includes being completely familiar with all associated documentation for said product. All maintenance should be carried out in accordance with established safety practices.
- c) All operators of the completed equipment (see Note) should be trained to use this product in a safe manner in compliance to established safety practices. The operators should also be familiar with documentation which is associated with the actual operation of the completed equipment.

Note : The term ‘completed equipment’ refers to a third party constructed device which contains or uses the product associated with this manual.

Notes on the Symbols Used in this Manual

At various times throughout this manual certain symbols will be used to highlight points which are intended to ensure the users personal safety and protect the integrity of equipment. Whenever any of the following symbols are encountered its associated note must be read and understood. Each of the symbols used will now be listed with a brief description of its meaning.

Hardware Warnings



1) Indicates that the identified danger **WILL** cause physical and property damage.



2) Indicates that the identified danger could **POSSIBLY** cause physical and property damage.



3) Indicates a point of further interest or further explanation.

Software Warnings



4) Indicates special care must be taken when using this element of software.



5) Indicates a special point which the user of the associate software element should be aware.



6) Indicates a point of interest or further explanation.

- Under no circumstances will Mitsubishi Electric be liable responsible for any consequential damage that may arise as a result of the installation or use of this equipment.
- All examples and diagrams shown in this manual are intended only as an aid to understanding the text, not to guarantee operation. Mitsubishi Electric will accept no responsibility for actual use of the product based on these illustrative examples.
- Please contact your local Mitsubishi Electric representative for more information concerning applications in life critical situations or high reliability.

Note Concerning the CE Marking

This document does not guarantee that a mechanical system including this product will comply with the following standards. Compliance to EMC standards of the entire mechanical system should be checked by the user / manufacturer. Compliance to LVD standards of the entire mechanical system should be checked by the user / manufacturer.

EMC

The following products have shown compliance through direct testing (of the identified standards below) and design analysis (through the creation of a technical construction file) to the European Directive for Electromagnetic Compatibility (2014/30/EU) when used as directed by the appropriate documentation. Refer to a manual or related material of each product other than the following.

Attention

This product is designed for use in industrial applications.

Type : Programmable Controller (Open Type Equipment)

Models : FX_{2N}-5A manufactured

from November 1st, 2003 to April 30th, 2006 are
compliant with EN50081-2 and EN61131-2:1994+A11:1996+A12:2000
after May 1st, 2006 are compliant with EN61131-2:2003

Standard	Remark
EN50081-2:1993 Electromagnetic compatibility - Generic emission standard Industrial environment	Compliance with all relevant aspects of the standard. (Emission-Enclosure port, Emission-Low voltage AC mains port, Emission-Telecommunications/network port)
EN61131-2:1994 Programmable controllers /A11:1996 - Equipment requirements /A12:2000 and tests	Compliance with all relevant aspects of the standard. (Radiated electromagnetic field, Fast transient burst, Electrostatic discharge, Damped oscillatory wave)
EN61131-2:2007 Programmable controllers - Equipment requirements and tests	Compliance with all relevant aspects of the standard. (Radiated Emission, Conducted Emission, Radiated electromagnetic field, Fast transient burst, Electrostatic discharge, High- energy surge, Voltage drops and interruptions, Conducted RF, Power frequency magnetic field)

For more details, please contact the local Mitsubishi Electric sales site.

- Note for compliance with EN61131-2:2007
General note on the use of the power supply cable.
 - The FX_{2N}-5A unit requires that the cable used for power supply is 30 m or less.

Guideline.....	iii
1. Introduction	1-1
2. External Dimensions and Parts.....	2-1
3. Installation	3-1
4. Connection to PLC	4-1
5. Wiring.....	5-1
5.1 Caution.....	5-1
5.2 Input Wiring.....	5-2
5.3 Output Wiring.....	5-3
6. Specifications	6-1
7. Buffer Memory (BFM).....	7-1
7.1 Buffer Memories (BFM) lists	7-2
7.2 Details of buffer memories	7-12
7.2.1 BFM 0 input mode specification (READ/WRITE)	7-12
7.2.2 BFM 1 output mode specification (READ/WRITE).....	7-14
7.2.3 BFM 2 to BFM 5 Number of averaging times (READ/WRITE)	7-16
7.2.4 BFM 6 to BFM 9 Averaged Input Channel data (READ only)	7-17
7.2.5 BFM 10 to BFM 13 Immediate Input Channel data (READ only).....	7-17
7.2.6 BFM 14 Analog Output data (READ/WRITE).....	7-17
7.2.7 BFM 15 Calculated Analog output data (when direct control function is active) (READ only)	7-17
7.2.8 BFM 16 to BFM 17 Reserved.....	7-17
7.2.9 BFM 18 hold/ reset analog output when PLC is stopped (READ/WRITE)	7-18
7.2.10 BFM 19 setting change enable/disable (READ/WRITE)	7-19
7.2.11 BFM 20 Initialization function (reset all values to default) (READ/WRITE)	7-20

7.2.12	BFM 21 Writes I/O characteristics (offset/gain Scaling function setting) (READ/WRITE)	7-21
7.2.13	BFM 22 Convenient functions setting (READ/WRITE).....	7-22
7.2.14	BFM 23 Set parameter for direct control between the input channel and output channel (READ/WRITE).....	7-23
7.2.15	BFM 24 Reserved	7-24
7.2.16	BFM 25 Filter-level selection register (READ/WRITE)	7-25
7.2.17	BFM 26 Upper/lower limit value alarm status (READ only).....	7-28
7.2.18	BFM 27 A/D data sudden change detection status (READ only)	7-30
7.2.19	BFM 28 Scale over status (READ/WRITE)	7-32
7.2.20	BFM 29 Error status	7-34
7.2.21	BFM 30 Model ID code (READ only).....	7-37
7.2.22	BFM 31 to BFM 40 reserved	7-37
7.2.23	BFM 41 to BFM 44 Analog input Offset data (READ/WRITE).....	7-37
7.2.24	BFM 45 Analog output Offset data (READ/WRITE).....	7-37
7.2.25	BFM 51 to BFM 54 Analog Input Gain data (READ/WRITE)	7-38
7.2.26	BFM 55 Analog output Gain data (READ/WRITE)	7-40
7.2.27	BFM 71 to BFM 74 Lower limit, alarm set value (READ/WRITE).....	7-41
7.2.28	BFM 81 to BFM 84 Upper limit, alarm set value (READ/WRITE).....	7-41
7.2.29	BFM 91 to BFM 94 Sudden change detection set value (READ/WRITE)	7-43
7.2.30	BFM 99: Clears upper/lower limit value error and sudden change detection error (READ/WRITE)	7-44
7.2.31	BFM 101 to BFM 108 Peak value (minimum value) (READ only).....	7-45
7.2.32	BFM 111 to BFM 118 Peak value (maximum value) (READ only).....	7-45
7.2.33	BFM 109: Peak value reset flag (minimum value) (READ/WRITE).....	7-46
7.2.34	BFM 119: Peak value reset flag (maximum value) (READ/WRITE).....	7-46
7.2.35	BFM 200 to BFM 249 Scaling function (READ/WRITE).....	7-47

8.	Adjustment of I/O Characteristics.....	8-1
8.1	Standard I/O characteristics.....	8-1
8.2	Adjustment of I/O characteristics	8-8
9.	Example program.....	9-1
9.1	Program example for analog input/output.....	9-1
9.2	Outline of FROM/TO commands	9-4
	Associated Manuals List.....	A-1

1. Introduction

The FX2N-5A analog special function block has four input channels and one output channel. The input channels receive analog signals and converts them to the comparable digital values. The output channel takes a digital value and outputs an equivalent analog signal.

1) Analog signal inputs can be selected from either voltage or current input. The applicable analog signal input is set using the TO instruction supplied by the PLC main unit. This PLC instruction is used to select different analog input signal types for each corresponding channel.

2) The FX2N-5A can be connect to FX0N/FX1N/FX2N/FX2NC/FX3G/FX3GC/FX3U/FX3UC series PLC

3) Up to 2 FX2N-5A units can be connected to FX0N main unit, FX0N extension unit, FX1N Main unit.

Up to 8 FX2N-5A units can be connected to FX2N/FX3G/FX3GC/FX3U/FX3UC^{*1} Series PLC.

Up to 4 FX2N-5A units can be connected to one FX2NC Series PLC.

For connection to the FX2NC Series PLC, an FX2NC-CNV-IF is required.

For connection to the FX3GC/FX3UC Series PLC, an FX2NC-CNV-IF or FX3UC-1PS-5V is required.

Data transfer with the PLC is performed via buffer memories of the FX2N-5A using FROM/TO Instructions.

*1 Up to 7 units can be connected to an FX3UC-32MT-LT(-2) PLC.

MEMO

2. External Dimensions and Parts

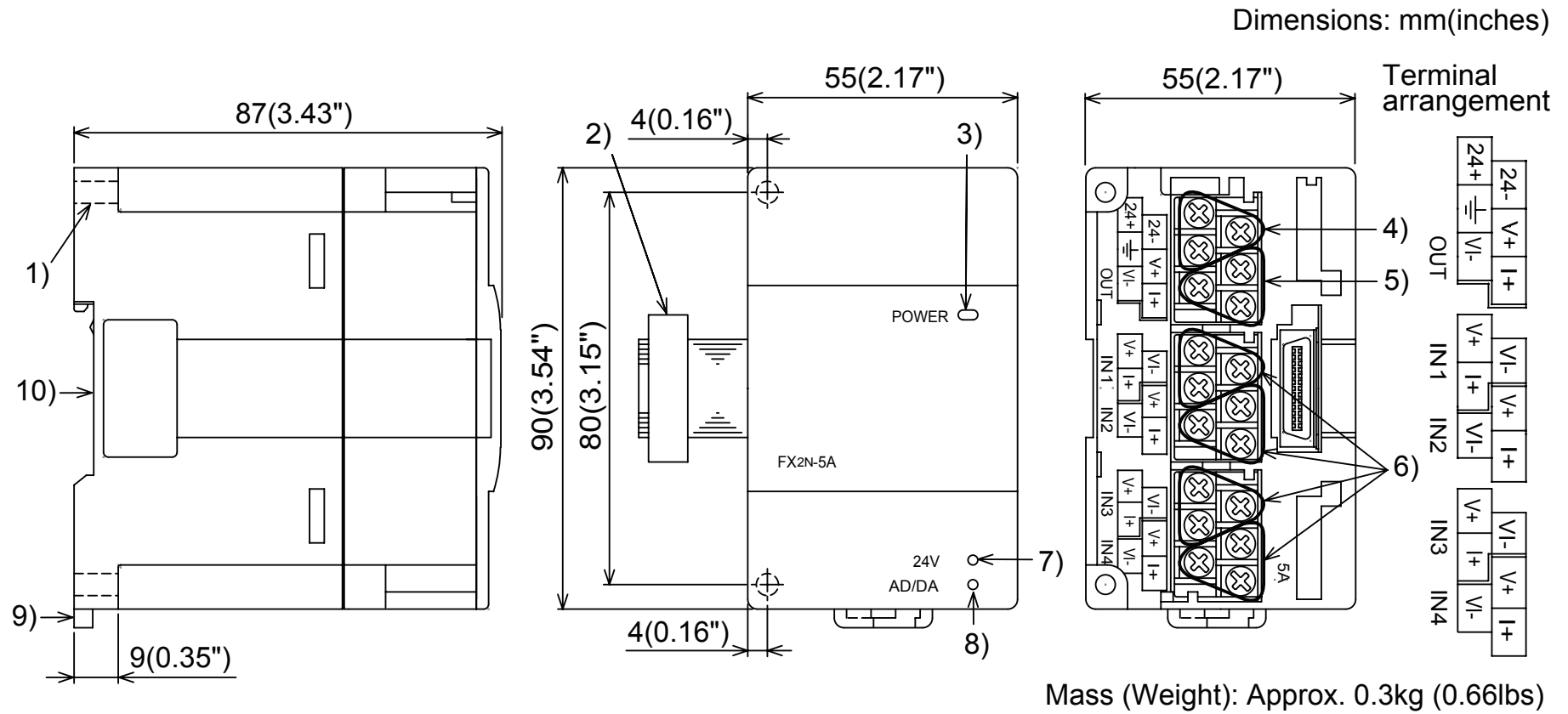

- 1) Direct mounting hole (2- ϕ 4.5) (0.18)
- 2) Extension cable
- 3) Power indicator lamp (LED)
5V power is supplied from the programmable controller to light this indicator lamp.
- 4) Power supply terminals (Screw terminal: M3 (0.12))
- 5) Analog output terminals (Screw terminal: M3 (0.12))
- 6) Analog input terminals (Screw terminal: M3 (0.12))
- 7) 24V power indicator lamp (LED) 24V DC power is supplied to the terminals of the FX_{2N}-5A to light this indicator lamp.
- 8) AD/DA conversion indicator lamp (LED)
Flashes at a high speed if AD/DA conversion is performing without a problem.
- 9) DIN rail mounting clip
- 10) DIN rail mounting slot (width of DIN rail: 35mm 1.38")

3. Installation

Install the FX_{2N}-5A to the right side of a main unit, extension unit, extension block or special block of the FX_{0N}/FX_{1N}/FX_{2N}/FX_{2NC}/FX_{3G}/FX_{3GC}/FX_{3U}/FX_{3UC} Series PLC.

The FX_{2N}-5A can be installed with DIN rail (DIN46277 of 35 mm in width) or directly installed with screws M4. For the details, refer to the handy manual supplied together with the PLC main unit.)

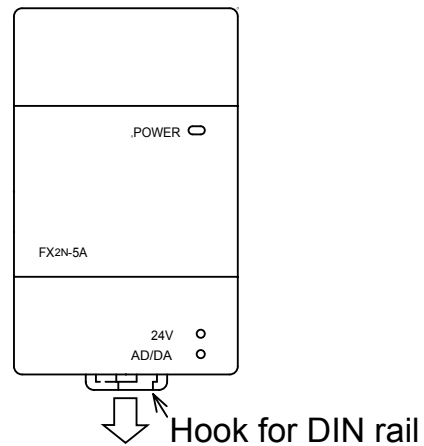
Figure 3.1: Installation with DIN rail

- The FX_{2N}-5A can be installed on DIN rail (DIN46277) of 35 mm in width as it is. For removal, pull down on the DIN rail mounting hook, then remove the FX_{2N}-5A.

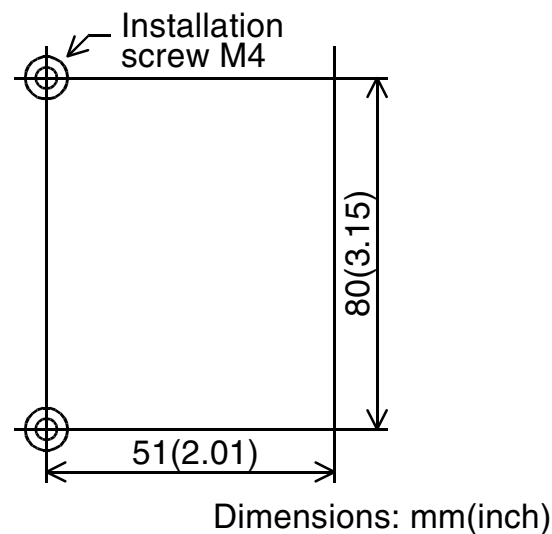
Figure 3.2: Direct installation

- The FX_{2N}-5A can be installed directly by inserting screws (M4) into installation holes. For the pitch and the position of installation holes, refer to the figure on the left.

4. Connection to PLC

Connect the FX2N-5A to the right side of a main unit, extension unit or extension block of FX0N/FX1N/FX2N/FX2NC/FX3G/FX3GC/FX3U/FX3UC Series PLC with an extension cable.

For connection to a basic unit or extension block of the FX2NC Series PLC, use an FX2NC-CNV-IF.

For connection to a basic unit or extension block of the FX3GC/FX3UC Series PLC, use an FX2NC-CNV-IF or FX3UC-1PS-5V.

Please check the power supply availability to determine the number of FX2N-5A blocks that can be connected to the FX0N/FX1N/FX2N/FX2NC/FX3G/FX3GC/FX3U/FX3UC PLCs.

A unit No. 0 to 7 is automatically assigned to each special unit or special block connected to a PLC basic unit from the one nearest to the basic unit.*1

The data is read from and written to the FX2N-5A by FROM/TO instructions supplied by the main unit.

*1 Because the unit No.0 is assigned to the built-in CC-Link/LT master in the FX3UC-32MT-LT(-2), unit numbers assigned to special extension units/blocks begins with No.1.

MEMO

5. Wiring

5.1 Caution



- 1) Do not lay signal cabling near to high voltage power cabling or house them in the same trunking duct. Effects of noise or surge induction may occur. Keep signal cables at safe distance of more than 100 mm (3.94") from these power cables.
- 2) The terminal screws of the FX₂N-5A are M3 (0.12"), therefore crimp style terminals (see drawing) suitable for use with these screws should be fitted to the cable for wiring.

Figure 5.1: Crimp Terminals





- 3) Tighten the terminals to a torque of 0.5 to 0.8 N·m.
Do not tighten terminal screws with a torque outside the above-mentioned range.
Failure to do so may cause equipment failures or malfunctions.
- 4) Cut off all phases of power source before installation or performing wiring work in order to avoid electric shock or product damage.
- 5) Remount the provided terminal cover before supplying power and operating the unit after installation or wiring work in order to avoid electric shock.

5.2 Input Wiring

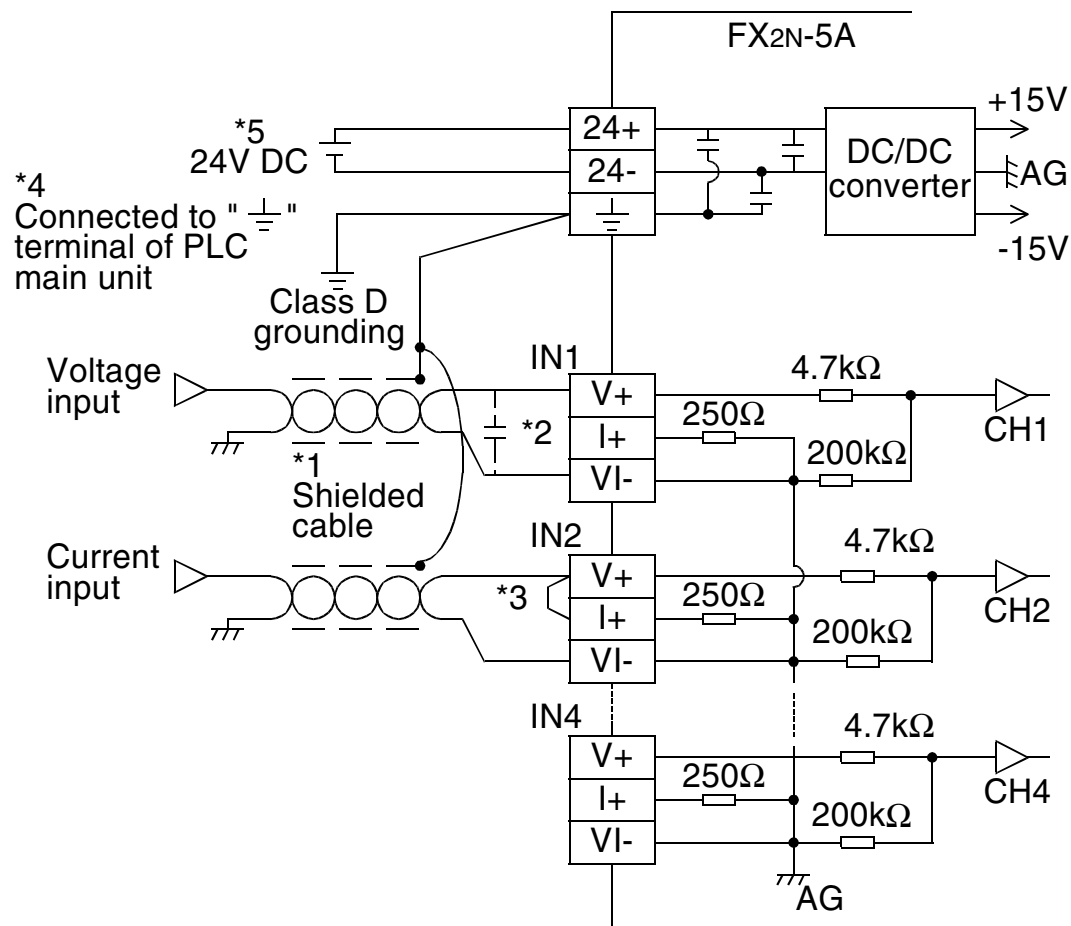
Figure 5.2: Input Wiring



- *1 Use a two-core, shielded twisted pair for the analog input line, and separate it from other power lines or a lines easily induced.
 - *2 If there is voltage ripple in the input signal or there is noise in the external wiring, connect a bipolar capacitor of approximately 0.1 to 0.47 μF , 25 V.
 - *3 For the current input, short-circuit the "V+" terminal and the "I+" terminal.
 - *4 Make sure to connect the  terminal to the  terminal of the PLC basic unit to which Class D grounding (100 Ω or less) is performed.
 - *5 The 24 V DC service power supply of the PLC is also available.
- For the terminal arrangement, refer to Chapter 2.

5.3 Output Wiring

Please refer to 5.2 for the wiring for "24+", "24-" terminals.

Figure 5.3: Output Wiring

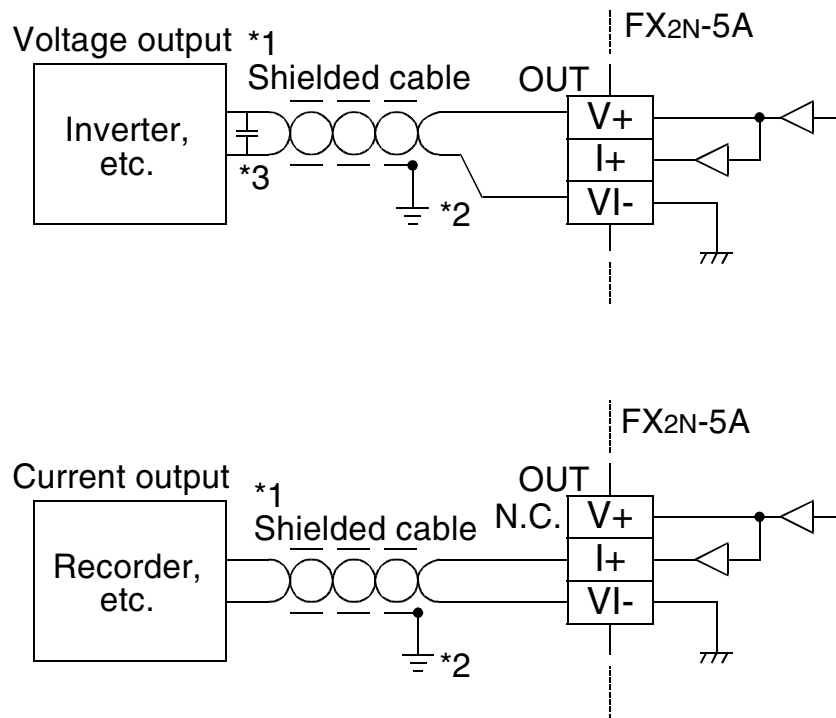

*1 Use a twisted pair shielded cable for the analog output. This cable should be wired away from power lines or any other lines which could induce noise.

*2 Apply 1-point grounding at the load side of the output cable (grounding: 100Ω or less).

*3 If electrical noise or a voltage ripple exists at the output, connect a smoothing capacitor of 0.1 to 0.47μF, 25V.

- Shorting the voltage output terminal or connecting the current output load to the voltage output terminal may damage the FX2N-5A.

- For the terminal arrangement, refer to Chapter 2.

Figure 5.4: Crimp Terminals

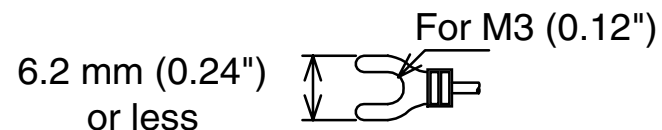
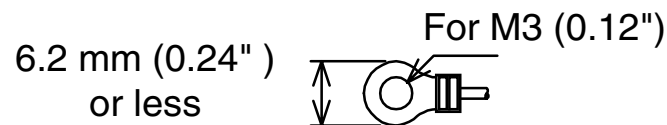

MEMO

6. Specifications

Table 6.1: General specifications

Item	Specifications
Ambient temperature range	0 to +55 °C during operation, -20 to +70 °C during storage
Ambient humidity	35 to 85 % RH during operation (Dew condensation shall not be allowed.)
Vibration resistance*1	Frequency 10 to 57 Hz, half amplitude 0.075 mm, 57 to 150 Hz, acceleration 9.8 m/s ² , 10 times in each of X, Y and Z directions (80 min. in each direction) (For product installed with DIN rail: Frequency 10 to 57 Hz, half amplitude 0.035 mm, 57 to 150 Hz, acceleration 4.9 m/s ²)
Impact resistance*1	147 m/s ² for 11 ms, 3 times in each of X, Y and Z directions with half-sine pulses
Noise resistance	By noise simulator of noise voltage 1,000 Vp-p, noise width 1 μs and frequency 30 to 100 Hz
Withstand voltage	500 V AC for 1 min (between analog input terminal and each terminal of PLC main unit)
Insulation resistance	5 MΩ or more by 500 V DC Megger (between all terminals as a whole and earth)
Operating atmosphere	Corrosive gas and much dusts shall not be detected.
Working altitude	<2000m*2

*1 The criterion is shown in IEC61131-2.

*2 If the pressure is higher than the atmospheric pressure, do not use FX_{2N}-5A.
Malfunctions may occur.

Table 6.2: Power supply specifications

Item	Specifications
Interface driving power supply	24 V DC \pm 10%, 90 mA (maximum), externally supplied
CPU driving power supply	5 V DC, 70 mA, supplied via extension cable from PLC main unit

Table 6.3: Performance specifications

Item	Specifications
Conversion speed	Channel for voltage/current input: 1 ms x Number of used channels Channel for voltage/current output: 2 ms (See BFM 25)
Insulation method	Photocoupler insulates the analog input/output area from PLC. DC/DC converter insulates the power supply from analog I/O. Channels are not insulated against each other.
Number of occupied I/O points	8 points (including input and output points)
Applicable PLC	FX _{0N} , FX _{1N} , FX _{2N} , FX _{2NC} , FX _{3G} , FX _{3GC} , FX _{3U} , FX _{3UC} Series PLC For connection to the FX _{2NC} Series PLC, an FX _{2NC} -CNV-IF is required. For connection to the FX _{3GC} /FX _{3UC} Series PLC, an FX _{2NC} -CNV-IF or FX _{3UC} -1PS-5V is required.
Built-in memory	EEPROM

Table 6.4: Voltage/current input specifications

Item	Voltage input	Current input
Analog input range	<p>-10 to +10 V DC (input resistance: 200 kΩ) Adjustment is enabled with the following conditions: Offset value: -32000 to +5000 mV Gain value: -5000 to +32000 mV "Gain - Offset": > 1000 mV</p> <p>-100 to +100mV DC (input resistance: 200kΩ) Adjustment is enabled with the following conditions: Offset value: -320000 to +50000μV Gain value: -50000 to +320000μV "Gain - Offset": > 10000 μV (Resolution is constant.) Change is disabled while the Voltmeter display mode is used. Maximum absolute input: \pm15 V</p>	<p>-20 to +20 mA DC, +4 to +20 mA DC (input resistance: 250 Ω) Adjustment is enabled with the following conditions: Offset value: -32000 to +10000 μA Gain value: -10000 to +32000 μA "Gain - Offset": > 1000 μA (Resolution is constant.) Change is disabled while the Amperemeter display mode is used. Maximum absolute input: \pm30 mA</p>
Digital output	<p>Signed 16-bit binary (-10 to +10V at input) Signed 12-bit binary (-100 to +100mV at input)</p>	Signed 15-bit binary

Table 6.4: Voltage/current input specifications

Item	Voltage input	Current input
Resolution	<ul style="list-style-type: none"> • 312.5 μV ($20\text{ V} \times 1/64000$) -10 to +10 V at input • 50 μV ($200\text{ mV} \times 1/4000$) -100 to +100 mV at input 	<ul style="list-style-type: none"> • 10 μA ($40\text{ mA} \times 1/4000$) -20 to +20 mA at input • 1.25 μA ($40\text{ mA} \times 1/32000$) -20 to +20 mA at input • 10 μA ($40\text{ mA} \times 1/4000$) 4 to 20 mA at input • 1.25 μA ($40\text{ mA} \times 1/32000$) 4 to 20 mA at input
Total accuracy	<p>Ambient temperature: $25\text{ }^\circ\text{C} \pm 5\text{ }^\circ\text{C}$ -10 to +10V DC : $\pm 0.3\%$ ($\pm 60\text{ mV}$) against full scale 20 V -100 to +100 mV DC : $\pm 0.5\%$ ($\pm 1\text{ mV}$) against full scale 200 mV Ambient temperature: $0\text{ to }+55\text{ }^\circ\text{C}$ -10 to +10 V DC : $\pm 0.5\%$ ($\pm 100\text{ mV}$) against full scale 20 V -100 to +100mV DC : $\pm 1.0\%$ ($\pm 2\text{ mV}$) against full scale 200 mV</p>	<p>Ambient temperature: $25\text{ }^\circ\text{C} \pm 5\text{ }^\circ\text{C}$ -20 to +20 mA DC : $\pm 0.3\%$ ($\pm 120\text{ }\mu\text{A}$) against full scale 40 mA 4 to 20 mA input is same ($\pm 120\text{ }\mu\text{A}$) Ambient temperature: $0\text{ to }+55\text{ }^\circ\text{C}$ -20 to +20 mA DC : $\pm 0.5\%$ ($\pm 200\text{ }\mu\text{A}$) against full scale 40 mA 4 to 20 mA input is same ($\pm 200\text{ }\mu\text{A}$)</p>

Table 6.5: Voltage/current output specifications

Item	Voltage output	Current output
Analog output range	-10 to +10 V DC (External load resistance:5 k Ω to 1 M Ω) Adjustment is enabled with the following conditions: Offset value: -10000 to +5000 mV Gain value: -9000 to +5000 mV "Gain - Offset": > 1000 mV (Resolution is constant.) Change is disabled while absolute voltage output mode is used.	0 to 20 mA DC, 4 to 20 mA DC (External load resistance:500 Ω or less) Adjustment is enabled with the following conditions: Offset value: 0 to 10000 μ A Gain value: 3000 to 30000 μ A "Gain - Offset": > 3000 μ A (Resolution is constant.) Change is disabled while absolute current output mode is used.
Digital input	Signed 12-bit binary	10-bit binary
Resolution	5 mV (10 V \times 1/4000) -10 to +10 V at output	20 μ A (20 mA \times 1/1000) 0 to 20 mA at output 4 to 20 mA at output
Total accuracy	Ambient temperature: 25 $^{\circ}$ C \pm 5 $^{\circ}$ C \pm 0.5% (\pm 100 mV) against full scale 20 V Ambient temperature: 0 to +55 $^{\circ}$ C \pm 1.0% (\pm 200 mV) against full scale 20 V	Ambient temperature: 25 $^{\circ}$ C \pm 5 $^{\circ}$ C 0 to 20 mA DC: \pm 0.5% (\pm 200 μ A) against full scale 40 mA 4 to 20 mA output is same (\pm 200 μ A) Ambient temperature: 0 to +55 $^{\circ}$ C 0 to 20 mA DC: \pm 1.0% (\pm 400 μ A) against full scale 40 mA 4 to 20 mA output is same (\pm 400 μ A)

MEMO

7. Buffer Memory (BFM)



Caution

- 1) Do not access the “Reserved” buffer memories “Reserved” (BFM #16, #17, #24, #31 to #40, #46 to #50, #56 to #70, #75 to #80, #85 to #90, #95 to #98, #100, #110, #120 to #199) using FROM/TO instructions. Accessing the reserved buffer memories may cause abnormal behavior in the FX_{2N}-5A module.

Data transfer between the FX_{2N}-5A and the PLC main unit is performed through buffer memories (hereafter referred to as "BFM") of the FX_{2N}-5A.

Each BFM consists of 1 word, 16 bits. The BFM No. 0 to 249 and a function are assigned to each BFM.

Use FROM/TO instructions or direct specification of buffer memory^{*1} to read and write data between the BFM and the PLC.

When the power is turned on, the initial value is written to each BFM. When you would like to use different contents of the BFM, create a program for the PLC so that the desired contents are written to the BFM every time the power of the PLC is turned on.

(The contents stored in BFM #0, #1, #18, #19, #22, #25, #41 to #45, #51 to #55, #71 to #74, #81 to #84, #200 to #249 are stored in the built-in EEPROM, and held against power failure.)

*1 This function is supported only in FX_{3U}/FX_{3UC} PLCs.

7.1 Buffer Memories (BFM) lists

Table 7.1: BFM Lists

BFM No.	Description	Hold against power failure	Initial value
#0	Specifies input mode of CH1 to CH4.	○	H0000 at shipment
#1	Specifies output mode of CH1.	○	H0000 at shipment
#2	Number of averaging times for CH1 Setting range: 1 to 256 times	—	8
#3	Number of averaging times for CH2 Setting range: 1 to 256 times	—	8
#4	Number of averaging times for CH3 Setting range: 1 to 256 times	—	8
#5	Number of averaging times for CH4 Setting range: 1 to 256 times	—	8
#6	CH1 Data (average data)	—	—
#7	CH2 Data (average data)	—	—
#8	CH3 Data (average data)	—	—
#9	CH4 Data (average data)	—	—
#10	CH1 data (immediate data)	—	—
#11	CH2 data (immediate data)	—	—
#12	CH3 data (immediate data)	—	—
#13	CH4 data (immediate data)	—	—
#14	CH1 output data	—	—
#15	Calculated Analog output data if direct output control function is active (= BFM 14 + effective direct output value)	—	—
#16	Reserved	—	—
#17	Reserved	—	—

Table 7.1: BFM Lists

BFM No.	Description	Hold against power failure	Initial value
#18	Hold last value / reset output to offset value when PLC is stopped	○	K0
#19	Disables setting change of I/O characteristics and convenient functions. The following BFM's are protected: BFM 0 (input channel mode settings) BFM 1 (output channel mode settings) BFM 18 (hold/reset last value output) BFM 20 (reset all values to default) BFM 21 (offset/gain adjustment settings) BFM 22 (convenient function settings) BFM 25 (digital filter selection) BFM 41 to 45 (offset data settings) BFM 51 to 55 (gain data settings) BFM 200 to 249 (Scaling function settings) Disables change.: K2, Enables change.: K1	○	K1 at shipment
#20	Initialize function. (Initialize function at K1, then returns automatically to K0 after initialization is completed.)	—	K0
#21	Writes I/O characteristics. (Returns automatically to K0 after write of offset/gain value or Scaling function value is finished.)	—	K0
#22	Sets convenient functions (upper/lower limit value detection, immediate data and average data peak value hold, switch off function for range over error for each channel).	○	K0 at shipment
#23	Set parameter for direct control function between input and output	—	H0000
#24	Reserved	—	—

Table 7.1: BFM Lists

BFM No.	Description	Hold against power failure	Initial value
#25	Filter mode selection register	○	K0
#26	Upper/lower limit value alarm status (valid while BFM #22 b0 or b1 is ON)	—	K0
#27	A/D data sudden change detection status (valid while BFM #91 to #94 are different to 0)	—	K0
#28	Scale over status and disconnection detection	—	K0
#29	Error status	—	K0
#30	Model code (K1010)	—	K1010
#31	Reserved	—	—
#32	Reserved	—	—
#33	Reserved	—	—
• • •	Reserved	—	—
#41	CH1 offset data (mV, 10 μ V or μ A)	○	K0 at shipment
#42	CH2 offset data (mV, 10 μ V or μ A)	○	K0 at shipment
#43	CH3 offset data (mV, 10 μ V or μ A)	○	K0 at shipment
#44	CH4 offset data (mV, 10 μ V or μ A)	○	K0 at shipment
#45	Output CH1 offset data (mV or μ A)	○	K0 at shipment
#46	Reserved	—	—
#47	Reserved	—	—
#48	Reserved	—	—

Table 7.1: BFM Lists

BFM No.	Description	Hold against power failure	Initial value
• • •	Reserved	—	—
#51	CH1 gain data (mV, 10 μ V or μ A)	○	K5000 at shipment
#52	CH2 gain data (mV, 10 μ V or μ A)	○	K5000 at shipment
#53	CH3 gain data (mV, 10 μ V or μ A)	○	K5000 at shipment
#54	CH4 gain data (mV, 10 μ V or μ A)	○	K5000 at shipment
#55	Output CH1 gain data (mV or μ A)	○	K5000 at shipment
#56	Reserved	—	—
#57	Reserved	—	—
#58	Reserved	—	—
#59 #60	Reserved	—	—
#61	Reserved	—	—
#62	Reserved	—	—
#63	Reserved	—	—
#64	Reserved	—	—
#65	Reserved	—	—
#66	Reserved	—	—
#67	Reserved	—	—
#68	Reserved	—	—

Table 7.1: BFM Lists

BFM No.	Description	Hold against power failure	Initial value
• • •	Reserved	—	—
#71	CH1 lower limit value alarm set value (valid while BFM #22 b0 or b1 is ON)	○	K-32000
#72	CH2 lower limit value alarm set value (valid while BFM #22 b0 or b1 is ON)	○	K-32000
#73	CH3 lower limit value alarm set value (valid while BFM #22 b0 or b1 is ON)	○	K-32000
#74	CH4 lower limit value alarm set value (valid while BFM #22 b0 or b1 is ON)	○	K-32000
#75	Reserved	—	—
#76	Reserved	—	—
#77	Reserved	—	—
#78	Reserved	—	—
• • •	Reserved	—	—
#81	CH1 upper limit value alarm set value (valid while BFM #22 b0 or b1 is ON)	○	K32000
#82	CH2 upper limit value alarm set value (valid while BFM #22 b0 or b1 is ON)	○	K32000
#83	CH3 upper limit value alarm set value (valid while BFM #22 b0 or b1 is ON)	○	K32000

Table 7.1: BFM Lists

BFM No.	Description	Hold against power failure	Initial value
#84	CH4 upper limit value alarm set value (valid while BFM #22 b0 or b1 is ON)	○	K32000
#85	Reserved	—	—
#86	Reserved	—	—
#87	Reserved	—	—
#88	Reserved	—	—
• • •	Reserved	—	—
#91	CH1 sudden change detection set value Setting range: 0 to 32000 (0 means function is disabled)	—	K0
#92	CH2 sudden change detection set value Setting range: 0 to 32000 (0 means function is disabled)	—	K0
#93	CH3 sudden change detection set value Setting range: 0 to 32000 (0 means function is disabled)	—	K0
#94	CH4 sudden change detection set value Setting range: 0 to 32000 (0 means function is disabled)	—	K0
#95	Reserved	—	—
#96	Reserved	—	—
#97	Reserved	—	—
#98	Reserved	—	—

Table 7.1: BFM Lists

BFM No.	Description	Hold against power failure	Initial value
#99	Clear upper and lower limit value alarm and sudden change detection alarm	—	K0
• • •	Reserved	—	—
#101	CH1 average data peak value (minimum value) (valid while BFM #22 b2 is ON)	—	—
#102	CH2 average data peak value (minimum value) (valid while BFM #22 b2 is ON)	—	—
#103	CH3 average data peak value (minimum value) (valid while BFM #22 b2 is ON)	—	—
#104	CH4 average data peak value (minimum value) (valid while BFM #22 b2 is ON)	—	—
#105	CH1 immediate data peak value (minimum value) (valid while BFM #22 b3 is ON)	—	—
#106	CH2 immediate data peak value (minimum value) (valid while BFM #22 b3 is ON)	—	—
#107	CH3 immediate data peak value (minimum value) (valid while BFM #22 b3 is ON)	—	—
#108	CH4 immediate data peak value (minimum value) (valid while BFM #22 b3 is ON)	—	—
#109	Peak value (minimum value) reset flags	—	K0
#110	Reserved	—	—

Table 7.1: BFM Lists

BFM No.	Description	Hold against power failure	Initial value
#111	CH1 average data peak value (maximum value) (valid while BFM #22 b2 is ON)	—	—
#112	CH2 average data peak value (maximum value) (valid while BFM #22 b2 is ON)	—	—
#113	CH3 average data peak value (maximum value) (valid while BFM #22 b2 is ON)	—	—
#114	CH4 average data peak value (maximum value) (valid while BFM #22 b2 is ON)	—	—
#115	CH1 immediate data peak value (maximum value) (valid while BFM #22 b3 is ON)	—	—
#116	CH2 immediate data peak value (maximum value) (valid while BFM #22 b3 is ON)	—	—
#117	CH3 immediate data peak value (maximum value) (valid while BFM #22 b3 is ON)	—	—
#118	CH4 immediate data peak value (maximum value) (valid while BFM #22 b3 is ON)	—	—
#119	Peak value (maximum value) reset flags	—	K0
• • •	Reserved	—	—
#198	Reserved	—	—
#199	Reserved	—	—

Table 7.1: BFM Lists

BFM No.	Description	Hold against power failure	Initial value
#200	CH1 Scaling function Analog Value 1	○	K-10200
#201	CH1 Scaling function Digital Value 1	○	K-32640
#202	CH1 Scaling function Analog Value 2	○	K10200
#203	CH1 Scaling function Digital Value 2	○	K32640
• • •			
#208	CH1 Scaling function Analog Value 5	○	K0
#209	CH1 Scaling function Digital Value 5	○	K0
#210	CH2 Scaling function Analog Value 1	○	K-10200
#211	CH2 Scaling function Digital Value 1	○	K-32640
• • •			
#218	CH2 Scaling function Analog Value 5	○	K0

This function defines a Scaling input curve (similar to a look up table) for each channel.

Table 7.1: BFM Lists

BFM No.	Description	Hold against power failure	Initial value
#219	CH2 Scaling function Digital Value 5	○	K0
• • •			
#238	CH4 Scaling function Analog Value 5	○	K0
#239	CH4 Scaling function Digital Value 5	○	K0
#240	Output CH1 Scaling function Digital output Value 1	○	K-32640
#241	Output CH1 Scaling function Analog output Value 1	○	K-10200
#242	Output CH1 Scaling function Digital output Value 2	○	K32640
#243	Output CH1 Scaling function Analog output Value 2	○	K10200
• • •			
#248	Output CH1 Scaling function Digital output Value 5	○	K0
#249	Output CH1 Scaling function Analog output Value 5	○	K0

This function defines a Scaling input curve (similar to a look up table) for each channel.

7.2 Details of buffer memories

7.2.1 BFM 0 input mode specification (READ/WRITE)

BFM 0 specifies the input mode of CH1 to CH4. The BFM consists of a 4-digit hexadecimal code, where one digit is assigned to each input channel. The range for each digit is a Hex value between 0 to F.

The highest digit corresponds to input ch4, whereas the lowest digit corresponds to input ch1.

BFM#0

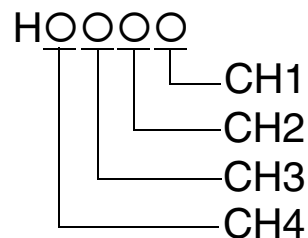

The meaning of the digits is as follows:

- 0: Voltage input mode (-10 to +10 V) (Display range -32000 to +32000)
- 1: Current input mode (4 to 20 mA) (Display range 0 to +32000) if current is less than 2mA, a range error alarm will be set in BFM 28
- 2: Current input mode (-20 to +20 mA) (Display range -32000 to +32000)
- 3: Voltage input mode (-100 to +100 mV) (Display range -32000 to +32000)
- 4: Voltage input mode (-100 to +100 mV) (Display range -2000 to +2000)
- 5: Voltmeter display mode (-10V to + 10V) (Display range -10000 to +10000)
- 6: Amperemeter display mode (4mA to +20mA) (Display range 2000 to +20000 = 2mA to 20mA) if current is less than 2mA, a range error alarm will be set in BFM 28
- 7: Amperemeter display mode (-20mA to +20mA) (Display range -20000 to +20000)

- 8: Voltmeter display mode (-100mV to + 100mV) (Display range -10000 to +10000)
- 9: Scaling function Voltage input mode (-10 to +10 V) (maximum Display range -32768 to +32767); default = -32640 to +32640
- A: Scaling function Current input mode (4 to +20 mA) (maximum Display range -32768 to +32767); default = -32640 to +32640
- B: Scaling function Voltage input mode (-100 to +100 mV) (maximum Display range -32768 to +32767); default = -32640 to +32640
- F: channel disabled, channel returns always 0.
- C to E: not valid; the module will automatically restore the last valid setting.

The input characteristics such as the offset and gain settings are automatically changed depending on the settings of BFM 0. A mode change in BFM 0 will also affect the settings of BFM 41 to 44 (offset data), BFM 51 to 54 (gain data), and BFM 200 to 239 (Scaling function data). Before changing offset/gain or Scaling function data, the appropriate input mode specification must be set in BFM 0, otherwise, the offset/gain or Scaling function data will be overwritten by the default data of the selected input mode.

The scale over status (BFM 28) value present before the mode change will not automatically be cleared when performing a mode change.

Disabling a channel will increase the scanning frequency of the other channels.

The default value of BFM 0 is H0000.

The value of BFM 0 is stored in the internal EEPROM (non-volatile). The module contains a safety function to protect the internal EEPROM from being destroyed when the same value is accidentally written continuously to BFM 0.

7.2.2 BFM 1 output mode specification (READ/WRITE)

BFM 1 specifies the output mode of the analog output CH1. The BFM consists of a 4-digit hexadecimal code, where only the lowest digit is assigned to the analog output channel. The range for the digit is a Hex value between 0 to A.

BFM#1

HO
└─ Specify of output mode

The meaning of the digits is as follows:

- 0: Voltage output mode (-10 to +10 V) (output range -32000 to +32000)
- 1: Voltage output mode (-10 to +10 V) (output range -2000 to +2000)
- 2: Current output mode (4 to 20 mA) (output range 0 to 32000)
- 3: Current output mode (4 to 20 mA) (output range 0 to 1000)
- 4: Current output mode (0 to 20 mA) (output range 0 to 32000)
- 5: Current output mode (0 to 20 mA) (output range 0 to 1000)
- 6: Absolute Voltage output mode (-10 to +10 V) (output range -10000 to +10000)
- 7: Absolute Current output mode (4 to 20mA) (output range 4000 to 20000)
- 8: Absolute Current output mode (0 to 20mA) (output range 0 to 20000)
- 9: Scaling Voltage output mode (-10 to +10 V) (maximum output range -32768 to +32767)
- A: Scaling Current output mode (0 to 20 mA) (maximum output range 0 to 32767)
- B to F: not valid; the module will automatically restore the last valid setting.

The output characteristics such as the offset and gain settings are automatically changed depending on the settings of BFM 1. A mode change in BFM 1 will also affect the settings of BFM 45 (offset data), BFM 55 (gain data), and BFM 240 to 249 (Scaling function data). Before changing offset/gain or Scaling function data, the appropriate output mode specification must be set, otherwise, the offset/gain or Scaling function data will be overwritten by the default data of the selected output mode.

The scale over status (BFM 28) value present before the mode change will not automatically be cleared when performing a mode change.

The default value of BFM 1 is H0000.

The value of BFM 1 is stored in the internal EEPROM (non-volatile). The module contains a safety function to protect the internal EEPROM from being destroyed when the same value is accidentally written continuously to BFM 1.

7.2.3 BFM 2 to BFM 5 Number of averaging times (READ/WRITE)

The number of averaging times of BFM 2 to BFM 5 specify the number of samples that is used to calculate the average values which are displayed in BFM 6 to BFM 9.

The setting range of the number of averaging times is 1 to 256.

When the number is set to K1, the immediate data (current values) are stored in BFM 6 to BFM 9. This data is the same as those data displayed in BFM 10 to BFM13.

When the number of averaging times is set to K0, the value is automatically changed to K1. If the value is set to K257 or more it is also changed to K1 automatically. In either case, a number of averaging times setting error (BFM 29 b10) occurs.

The initial value of BFM 2 to BFM 5 is K8.

Update of average data

The average data of (BFM 6 to BFM 9) are updated every time the A/D conversion processing is performed.

BFM 6 to 9 will always contain the most recent average sum of the number of samples specified in BFM 2 to BFM5 divided by this number. For example the formula for BFM 6 is as follows:

If the averaging process has just started or when the number of average samples has been changed during operation, the sampling values that have not been converted until that time are not considered for the calculation. In that case the number of samples used to calculate the average value is calculated based on the number of available samples at this time.

7.2.4 BFM 6 to BFM 9 Averaged Input Channel data (READ only)

The average A/D conversion data of each input channel is displayed in BFM 6 to BFM 9. The number of samples to calculate the average data is influenced by the setting in BFM 2 to BFM 5) described above. The data displayed is "processed data", therefore, offset and gain calculations and Scaling function calculations and digital filtering (if selected) are already performed before the average value is calculated.

7.2.5 BFM 10 to BFM 13 Immediate Input Channel data (READ only)

The immediate A/D conversion data of each channel is displayed BFM 10 to BFM 13. The data displayed "processed data", therefore, offset and gain calculations, Scaling function calculations and digital filtering (if selected) are already performed.

7.2.6 BFM 14 Analog Output data (READ/WRITE)

BFM 14 receives the analog output data for the DA (Digital Analog) converter. For this data, offset/gain calculations or the Scaling function calculation will be performed, and direct output function calculation. Thus, "processed" data will be sent to the DA converter.

7.2.7 BFM 15 Calculated Analog output data (when direct control function is active) (READ only)

If the direct output control function (see BFM 23) is enabled, the result of the calculation process that is written to the analog output is read back to the PLC via BFM 15.

7.2.8 BFM 16 to BFM 17 Reserved

7.2.9 BFM 18 hold/ reset analog output when PLC is stopped (READ/WRITE)

If BFM 18 is 0, while the PLC base unit is in Stop mode the value of BFM15 (value of BFM14 + direct output function) will be output. If the direct output function is active, the output value will be continuously updated, when the input channel values are changing.

If BFM18 is set to K1, and there is no TO instruction access for more than 200 ms from the main unit to the FX_{2N}-5A, consequently, the output will be stopped. In this case the last value of BFM 15 (value of BFM14 + direct output function) will be output.

If BFM18 is set to K2, and there is no TO instruction access for more than 200 ms from the main unit to the FX_{2N}-5A, consequently, the output will be reset to the defined offset value.

If BFM18 is set to K1 or K2, a FROM/TO-Watchdog-Timer will be activated. If there is no FROM/TO access for longer than 200ms, the action described above will be taken. (FROM/TO Watchdog timer has barked, bit 8 of BFM18 is set.) This can be checked by monitoring BFM 18 or reading it by a FROM command. The FROM/TO Watchdog timer will automatically be reset by a TO access to BFM 14.

The value of BFM 18 is stored non-volatile in the internal EEPROM. There is a safety function to protect the internal EEPROM from being destroyed by accidentally writing the same value continuously to BFM 18.

7.2.10 BFM 19 setting change enable/disable (READ/WRITE)

BFM 19 permits or prohibits the change of the I/O characteristics for the following functions:

BFM 0 (input channel mode settings)

BFM 1 (output channel mode settings)

BFM18 (hold/reset last value output)

BFM 20 (reset all values to default)

BFM 21 (offset/gain adjustment settings)

BFM 22 (convenient function settings)

BFM 25 (digital filter mode)

BFM 41 to 45 (offset data settings)

BFM 51 to 55 (gain data settings)

BFM 200 to 249 (Scaling function settings)

The permitted values are as follows:

K1: Enables change (selected at shipment from factory).

K2: Disables change.

On fault input, the module will return to the last valid input saved in EEPROM (values other than K1 or K2 will be ignored).

The value of BFM 19 is stored as non-volatile in the internal EEPROM. There is a safety function to protect the internal EEPROM from being destroyed by accidentally writing the same value continuously to BFM 19.

7.2.11 BFM 20 Initialization function (reset all values to default) (READ/WRITE)

BFM 20 will reset the FX_{2N}-5A to the factory default.

By initialization, the modes, average numbers, offset/gain settings, direct output control function, lower/upper-limit settings, Scaling function and sudden change function are all reset to factory default (voltage input/output, default offset/gain values).

Permitted values are as follows:

K0: Normal state, nothing is performed

K1: initialization will be executed. After writing K1, the BFM will return automatically to K0 when initialization is completed.

On fault input, the module will ignore other values than K1 and perform nothing except keeping K0 as content of BFM 20.

Writing to BFM 20 triggers several data items to be written to the internal EEPROM. To protect the internal EEPROM from damage by permanently writing K1 to BFM 20, there is a safety function, which will memorize the reset in order to protect the internal EEPROM from being destroyed by accidentally writing K1 continuously to BFM 20.

Writing K1 to BFM 20 will set the following BFM to their default values as stated below:

BFM 0 to 5, BFM 18, BFM 22, BFM 23, BFM 25, BFM 41 to 45, BFM 51 to 55, BFM 71 to 74, BFM 81 to 84, BFM 91 to 94, BFM 200 to 249.

7.2.12 BFM 21 Writes I/O characteristics (offset/gain Scaling function setting) (READ/WRITE)

The b0 to b4 bits of BFM 21 are assigned to each channel of the FX_{2N}-5A. (Bit 4 is assigned to the analog output channel, bit 3 is assigned to input channel 4, bit 0 is assigned to input channel 1.)

When a bit is set to ON, the offset data (BFM 41 to BFM 45) and the gain data (BFM 51 to BFM 55) or the Scaling function data (BFM 200 to BFM 249) of the assigned channel are written to the built-in memory (EEPROM).

It is possible to adjust the settings for two or more channels at the same time (writing "H1F", will set the new offset/gain data for all channels). After writing is completed, BFM 21 returns automatically to K0.

On fault input, the module will ignore other bits than b0 to b4 and perform nothing except keeping K0 as content of BFM21.

Scale over status (BFM 28) data existing before a change of the I/O characteristics will not be automatically cleared by performing a change of the I/O characteristics.

Writing to BFM 21 triggers data to be written to the internal EEPROM. To protect the internal EEPROM from being destroyed by permanently writing the same value to BFM 21, there is a safety function which will memorize the value of BFM 21 to protect the internal EEPROM from being destroyed by accidentally writing the same value continuously to BFM 21.

BFM21

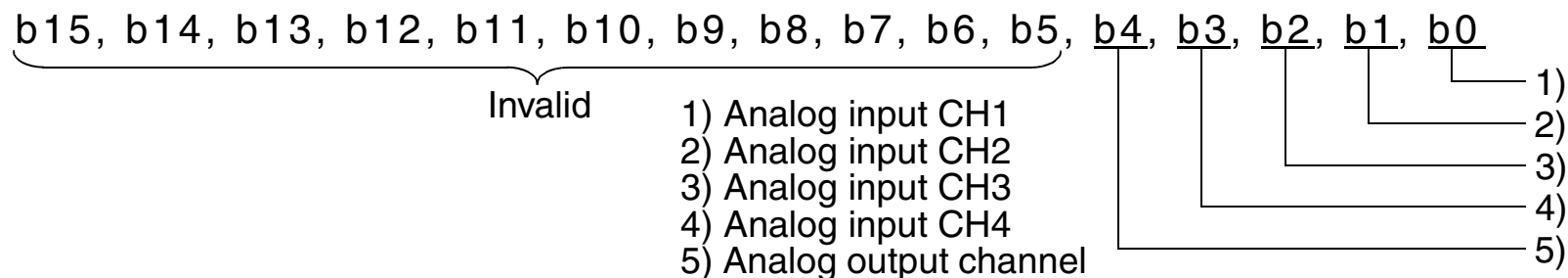

7.2.13 BFM 22 Convenient functions setting (READ/WRITE)

The functions described below are assigned to b0 to b3 of BFM 22. When a bit is set ON, the assigned functions become valid. Other bits, not specified by the values below, will simply be ignored by the module if they are accidentally set by the user.

When a bit is set OFF, the assigned functions become invalid.

b0: Upper/lower limit average value detection function

If the A/D averaged conversion data of a channel (BFM 6 to BFM 9) is outside the range set between the lower limit value (BFM 71 to BFM 74) and the upper limit value (BFM 81 to BFM 84), corresponding alarm bits for each channel (lower limit alarm or higher limit alarm) are set in BFM 26.

b1: Upper/lower limit immediate value detection function

If the A/D immediate conversion data of a channel (BFM 10 to BFM 13) is outside the range set between the lower limit value (BFM 71 to BFM 74) and the upper limit value (BFM 81 to BFM 84), corresponding alarm bits for each channel (lower limit alarm or higher limit alarm) are set in BFM 26.

b2: Average data Peak value hold function

The minimum value of the average data (BFM 6 to BFM 9) of each channel is written to BFM 101 to BFM 104, and the maximum value is written to BFM 111 to BFM 114.

b3: Immediate data Peak value hold function

The minimum value of the immediate data (BFM 10 to BFM 13) of each channel is written to BFM 105 to BFM 108, and the maximum value is written to BFM 115 to BFM 118.

b8 to b11: switch off range over/range under alarm for corresponding input channel

The value of BFM 22 is stored non-volatile in the internal EEPROM. There is a safety function to protect the internal EEPROM from being destroyed by accidentally writing the same value continuously to BFM 22.

7.2.14 **BFM 23 Set parameter for direct control between the input channel and output channel (READ/WRITE)**

In BFM 23, the user can specify direct control feedback between all 4 analog input channels and the analog output channel.

The format of BFM 23 is a 4 digit hex value and each digit is represents the operation of one input channel.

The values of the Hex digits are as follows:

H0: The corresponding analog input channel has no influence on the analog output value.

H1: The average input value (BFM 6 to BFM 9) of the corresponding analog input channel is added to the analog output value in BFM 14.

H2: The immediate input value (BFM 10 to BFM 13) of the corresponding analog input channel is added to the analog output value in BFM 14.

H3: The average input value (BFM 6 to BFM 9) of the corresponding analog input channel is subtracted from the analog output value in BFM 14.

H4: The immediate input value (BFM 10 to BFM 13) of the corresponding analog input channel is subtracted from the analog output value in BFM 14.

H5 to HF: The corresponding analog input channel has no influence on the analog output value, however, the direct output control error bit (bit 15) in BFM 29 will be switched on.

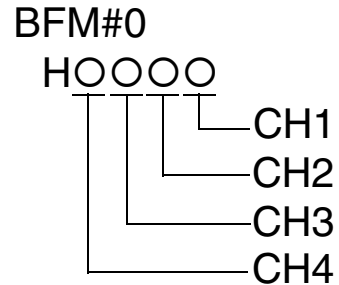

Example: Value in BFM 23 is set to H1234.

Output value (BFM 15) = BFM 14(TO) - BFM 10 - BFM 7 + BFM 12 + BFM 9

If at least one Hex digit in BFM 23 is set to a Hex number between 1 and 4, after calculating of the digital output value in BFM 15, the offset/gain setting calculation or the Scaling function calculation is applied to these digital data in order to achieve the real analog output. If the direct control function is switched off for all channels, BFM 14 will be regarded as the analog output value.

The settings of BFM 25 will also influence the direct control function values.

7.2.15 BFM 24 Reserved

7.2.16 BFM 25 Filter-level selection register (READ/WRITE)

The following Table shows the possible values of BFM 25 for using the digital Filter of the FX_{2N}-5A-Device:

Table 7.2: Bit assignment in BFM 25

Bit No.	Channel No.	Description
b0	CH1 to CH4	Filter: 0 = off 1 = 2nd level 2 = 5th level 3 = 7th level
b1		
b2		
b3		
b4	CH1 to CH4	Cut-off frequency factor F1: 0 = no cut-off frequency selected 1 = (0.1×1/sampling time)Hz 2 = (0.05×1/sampling time)Hz 3 = (0.025×1/sampling time)Hz 4 = (0.01×1/sampling time)Hz
b5		
b6		
b7		
b8		reserved
b9		reserved
b10		reserved
b11		reserved
b12		reserved
b13		reserved
b14		reserved
b15		reserved

Formula for filter cut-off frequency f_L : $f_L = F_1 / (\text{sampling time} \times \text{no. of active channels})$ [Hz] with cut-off frequency factor $F_1=0.1, 0.05, 0.025$ or 0.01 .

There are two filter parameters that can be changed, the filter-level and the cut-off frequency. This selection is done in bit0 to bit7. The selected filter values apply to all channels 1 through 4 in the same way. Selecting a non existing filter mode or selecting a filter mode without specifying a cut-off frequency will lead to an error in BFM 29. In this case the previously valid settings will be kept.

The filter settings for the module also have a direct influence on the sampling rate and conversion speed of the module. The relation between selected filter level and sampling rate is as follows:

Table 7.3: Setting range

Filter Level (value in BFM25, b0 to b3)	sampling time per input channel	refresh rate of analog output channel
filter off (K0)	1ms / ch	update every 2 ms
2nd level digital filter (K1)*	3ms / ch	update every 6 ms
5th level digital filter (K2)*	4ms / ch	update every 8 ms
7th level digital filter (K3)*	4.5ms / ch	update every 9 ms

* In these cases b4 to b7 must be set to a value between K1 to K4.

The value of BFM 25 is stored non-volatile in the internal EEPROM. There is a safety function to protect the internal EEPROM from being destroyed by accidentally writing the same value continuously to BFM 25.

A/D conversion value when input filter is used.

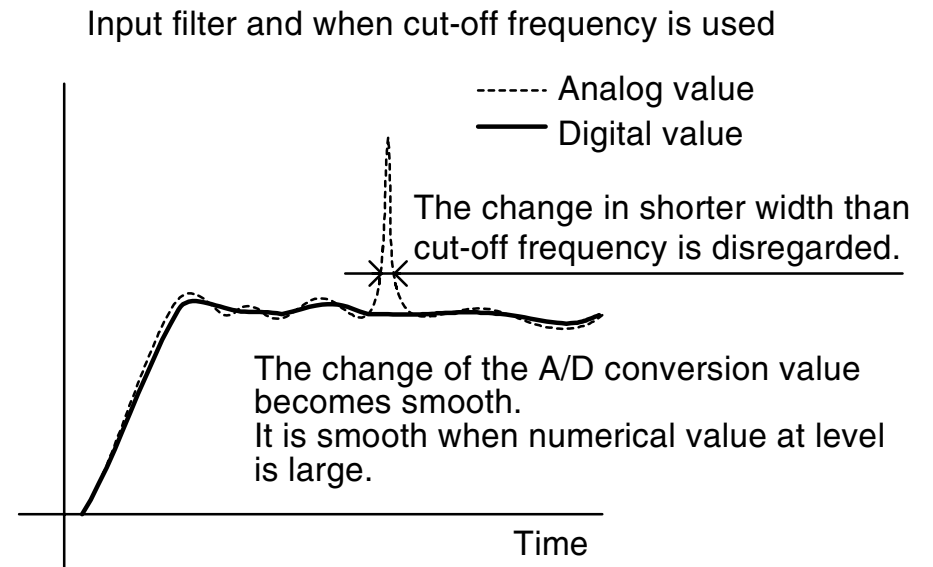
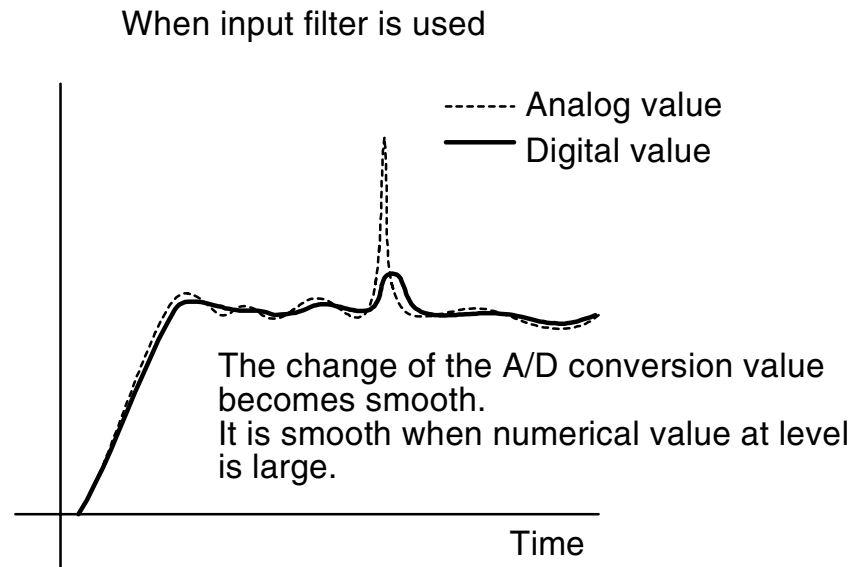

7.2.17 BFM 26 Upper/lower limit value alarm status (READ only)

If the upper/lower limit value detection function (BFM 22 b0, b1) is used, the detection results are written to BFM 26.

The lower limit value alarm or the upper limit value alarm of each channel is assigned to each bit of BFM 26.

If the A/D averaged conversion data of a channel (BFM 6 to BFM 9) is outside the range set between the lower limit value (BFM 71 to BFM 74) and the upper limit value (BFM 81 to BFM 84), the corresponding alarm bits b0 to b7 for each channel (lower limit alarm or higher limit alarm) are set in BFM 26.

If the A/D immediate conversion data of a channel (BFM 10 to BFM 13) is outside the range set between the lower limit value (BFM 71 to BFM 74) and the upper limit value (BFM 81 to BFM 84), the corresponding alarm bits b8 to b15 for each channel (lower limit alarm or higher limit alarm) are set in BFM 26.

Once a bit turns ON, it remains ON until it is reset by BFM 99 or the power is turned off.

Even while an upper/lower limit value alarm is detected, the data (BFM 6 to BFM 13) of each channel are continuously updated.

Table 7.4: Bit assignment in BFM 26

Bit No.	Channel No.	Description
b0	CH1	average data lower limit value alarm
b1		average data upper limit value alarm
b2	CH2	average data lower limit value alarm
b3		average data upper limit value alarm
b4	CH3	average data lower limit value alarm
b5		average data upper limit value alarm
b6	CH4	average data lower limit value alarm
b7		average data upper limit value alarm
b8	CH1	immediate data lower limit value alarm
b9		immediate data upper limit value alarm
b10	CH2	immediate data lower limit value alarm
b11		immediate data upper limit value alarm
b12	CH3	immediate data lower limit value alarm
b13		immediate data upper limit value alarm
b14	CH4	immediate data lower limit value alarm
b15		immediate data upper limit value alarm

7.2.18 BFM 27 A/D data sudden change detection status (READ only)

When the sudden change detection function is used, the detection result is written to BFM 27. The sudden change detection is activated, if the values in BFM 91 to BFM 94 are bigger than 0.

The sudden change detection in + direction or the sudden change detection in - direction of each channel is assigned to each corresponding bit of BFM 27. When the immediate data (BFM 10 to BFM 13) of each channel is updated, if the difference between the previous value and the new value is larger than the sudden change detection set value (BFM 91 to BFM 94), the corresponding bit turns ON.

When the new value is larger than the previous value, a bit for the + direction turns ON. If, the new value is smaller than the previous value, a bit for the - direction turns ON.

Once a bit turns ON, it remains ON until it is reset by BFM 99 or the power is turned off.

Even while a sudden change alarm is detected, the data (BFM 6 to BFM 13) of each channel is continuously updated.

Table 7.5: Bit assignment in BFM27

Bit No.	Channel No.	Description
b0	CH1	average data sudden change error in - direction
b1		average data sudden change error in + direction
b2	CH2	average data sudden change error in - direction
b3		average data sudden change error in + direction
b4	CH3	average data sudden change error in - direction
b5		average data sudden change error in + direction
b6	CH4	average data sudden change error in - direction
b7		average data sudden change error in + direction
b8	CH1	immediate date sudden change error in - direction
b9		immediate date sudden change error in + direction
b10	CH2	immediate date sudden change error in - direction
b11		immediate date sudden change error in + direction
b12	CH3	immediate date sudden change error in - direction
b13		immediate date sudden change error in + direction
b14	CH4	immediate date sudden change error in - direction
b15		immediate date sudden change error in + direction

7.2.19 BFM 28 Scale over status (READ/WRITE)

When the analog input value of each channel (BFM 10 to BFM 13) is outside the maximum range of the A/D converter, a range error alarm is written to BFM 28. This will also happen if a sensor is disconnected and $\pm 100\text{mV}$ mode has been selected.

Additionally, the alarm is set if the Scaling function is used and the conversion result is outside the specified values for this channel.

To avoid the alarm being set for unused channels, they should be completely disabled in BFM 0. It is also possible to inhibit only the scale over alarm by setting the corresponding bits of BFM22.

Once a bit turns ON, it remains ON until it is overwritten with the OFF status using a TO instruction to BFM 28 or the power is turned off. Single alarm bits can be masked, by writing a bit mask code to BFM 28. For example, HFFF0 will only clear the lowest 4 bits.

Even while a scale over error is detected, the data (BFM 6 to BFM 13) of each channel is continuously updated.

Table 7.6: Bit assignment in BFM28

Bit No.	Channel No.	Description
b0	CH1	Scale over: Less than lower limit and disconnection detection
b1		Scale over: More than upper limit
b2	CH2	Scale over: Less than lower limit and disconnection detection
b3		Scale over: More than upper limit
b4	CH3	Scale over: Less than lower limit and disconnection detection
b5		Scale over: More than upper limit
b6	CH4	Scale over: Less than lower limit and disconnection detection
b7		Scale over: More than upper limit
b8	output CH	Scale over: Less than lower limit
b9		Scale over: More than upper limit
b10		reserved
b11		reserved
b12		reserved
b13		reserved
b14		reserved
b15		reserved

7.2.20 BFM 29 Error status

The error information is assigned to each bit of BFM 29.

Table 7.7: Bit assignment in BFM 29

Bit No.	Assignment	Description
b0	Error detected	b0 is ON if at least one output of b1 to b5 is ON.
b1	Offset/gain set value error or Scaling function setting error.	Offset/gain value or Scaling function value is outside setting range. Set a correct value. Previously valid values or default values are used.
b2	Power error	External 24 V power is not supplied.
b3	Hardware error	FX2N-5A hardware error (EEPROM, MCU periphery)
b4	A/D conversion value error	A/D conversion value is out of range / wire break. See scale over data (BFM 28)
b5	D/A conversion value error	D/A conversion value is out of range, value in BFM 14/BFM 15 is too large.
b6	reserved	
b7	reserved	
b8	Set value error detected	This bit is ON while either bit among b9 to b15 is ON.
b9	Input/output mode setting error	Input/output mode (BFM 0, BFM 1) is incorrectly set. Set it within range from 0 to B or F (BFM 0) or 0 to A (BFM 1).

Table 7.7: Bit assignment in BFM 29

Bit No.	Assignment	Description
b10	Number of averaging times setting error	Number of averaging times is incorrectly set. Set it within range from 1 to 256. If the no. of average data was set to a value outside the range of 1 to 256, the corresponding BFM was set to 1. In this case, the direct conversion value will be displayed for the corresponding channel.
b11	Attempt of setting change while BFM19 was locked	Although the value in BFM 19 prohibits to change the setting, a write access to a protected BFM was registered. No setting changes have been executed.
b12	Sudden change detection set value error	The sudden change detection value is set to an incorrect value. (valid range 0 to 32000)
b13	Upper/lower limit value set value error	Upper/lower limit alarm value is set to an incorrect value (valid range: $-32000 \leq X \leq +32000$).
b14	Filter mode setting error	Filter mode (BFM 25) is incorrectly set. Set the lowest two digits to a valid range according to the description of BFM 25.
b15	Direct output control function setting error	The direct output control function is set to an undefined value. Set each digit between a range of 0 and 4. The number was reset to the previous value.

The error b1 appears when:

- in voltage-mode:	offset data	> 5000
	gain data	< -5000
	gain data - offset data	< 1000
- in current-mode:	offset data	> 10000
	gain data	< -10000
	gain data - offset data	< 1000

All errors except b2 and b3 will be cleared automatically, when the error is not existing any more, or when the corresponding alarm/error bits in other BFM's (sudden change/ scale over/ upper/lower limit) are cleared.

In case of a power error or a hardware error, the error bits are latched, until K0 or another mask value i. e. HFFF3 to clear the bits is written to BFM 29, or until the power is turned off.

7.2.21 BFM 30 Model ID code (READ only)

BFM 30 stores the fixed value K1010.
Write attempts by TO instruction are ignored.

7.2.22 BFM 31 to BFM 40 reserved**7.2.23 BFM 41 to BFM 44 Analog input Offset data (READ/WRITE)**

Input Offset data: Analog input value when the digital value is "0".
For default values and setting ranges, see table below (BFM 51 to BFM 54).
The values of BFM 41 to 44 are stored non-volatile in the internal EEPROM. There is a safety function to protect the internal EEPROM from being destroyed by accidentally writing the same value continuously to a BFM.

7.2.24 BFM 45 Analog output Offset data (READ/WRITE)

Output Offset data: Analog output voltage or current if digital input in BFM 14 is 0.
Default offset value for voltage mode (-10V/+10V) is 0V(=K0), for current mode (4 - 20mA) is 4mA(=K4000) and for current mode (0 - 20mA) is 0mA(=K0).
The value of BFM 45 is stored non-volatile in the internal EEPROM. There is a safety function to protect the internal EEPROM from being destroyed by accidentally writing the same value continuously to BFM 45.

7.2.25 BFM 51 to BFM 54 Analog Input Gain data (READ/WRITE)

Input Gain data: Analog input value when the digital value is 16000 (or 1000 in mode 4).

The offset data and the gain data for each channel can be set independently.

The set value is written in "mV" for voltage input (-10V/+10V), in "μA" for current input and in 10μV units for ±100mV input.

The values of BFM 51 to 54 are stored non-volatile in the internal EEPROM. There is a safety function to protect the internal EEPROM from being destroyed by accidentally writing the same value continuously to a BFM.

Initial offset/gain value (Unit: mV for voltage input, μA for current input and 10μV for ±100mV input)

Table 7.8: Initial offset/gain input value

Input mode (BFM 0)	0 (-10 to +10V)	1 (4 to 20mA)	2 (-20 to +20mA)	3 (-100 to +100mV)	4 (-100 to +100mV)
Initial offset value	0	4000	0	0	0
Initial gain value	5000 unit:mV	12000 unit:μA	10000 unit:μA	5000 unit:10μV	5000 unit:10μV

Input mode (BFM 0)	5 Voltmeter mode (-10 to +10V)	6 Amperemeter mode (4 to 20mA)	7 Amperemeter mode (-20 to +20mA)	8 Voltmeter mode (-100 to +100mV)
Initial offset value	0 fixed	0 fixed	0 fixed	0 fixed
Initial gain value	16000 fixed unit:mV	16000 fixed unit:μA	16000 fixed unit:μA	16000 fixed unit:10μV

Note: This table is not applicable for modes 9 to B (see Scaling function settings.)

Setting range**Table 7.9: Setting range**

	Voltage input (+/-10V)	Current input	Voltage input (+/-100mV)
Offset data	-32000 to +5000 (mV)	-32000 to +10000 (μA)	-32000 to +5000 (*10 μV)
Gain data	-5000 to +32000 (mV)	-10000 to +32000 (μA)	-5000 to +32000 (*10 μV)
Gain data - offset data	Gain value - Offset value > 1000 (mV)	Gain value - Offset value > 1000 (μA)	Gain value - Offset value > 1000 (* 10 μV)

However, the actual effective input range is "-10 to +10 V", "-20 to +20 mA", "4 to +20 mA" or "-100 to +100mV".

7.2.26 BFM 55 Analog output Gain data (READ/WRITE)

Output Gain data: Analog output voltage or current if digital input in BFM 14 is 16000 (or 1000 as stated in table below) default gain value for voltage mode (-10V/+10V) is 5V (=K5000), for current mode (4 - 20mA) is 12mA(=K12000) and for current mode (0 - 20mA) is 10mA (=K10000).

The value of BFM 55 is stored non-volatile in the internal EEPROM. There is a safety function to protect the internal EEPROM from being destroyed by accidentally writing the same value continuously to BFM 55.

Table 7.10: Initial offset/gain value(Unit: mV for voltage output, μ A for current output)

BFM 14 value for gain output	16000	1000	16000	500	16000	500	(16000*)	16000	16000
Output mode (BFM 1)	0 (-10V to +10V)	1 (-10V to +10V)	2 (4 to 20mA)	3 (4 to 20mA)	4 (0 to 20mA)	5 (0 to 20mA)	6 absolute voltage mode	7 absolute current mode	8 absolute current mode
Initial offset value	0	0	4000	4000	0	0	0 fixed	0 fixed	0 fixed
Initial gain value	5000 unit:mV	5000 unit:mV	12000 unit: μ A	12000 unit: μ A	10000 unit: μ A	10000 unit: μ A	16000 fixed unit:mV	16000 fixed unit: μ A	16000 fixed unit: μ A

Note: This table is not applicable for modes 9 to A (see Scaling function settings).

* In absolute voltage output mode, the theoretical value is 16000, however in reality it is not possible to exceed 10V output voltage (BFM14=10000).

7.2.27 BFM 71 to BFM 74 Lower limit, alarm set value (READ/WRITE)**7.2.28 BFM 81 to BFM 84 Upper limit, alarm set value (READ/WRITE)**

The upper/lower limit value of the alarm detection function (BFM 22 b0, b1) is written to the lower limit value of each channel from BFM 71 to BFM 74 and the upper limit value of each channel from BFM 81 to BFM 84.

The values of BFM 71 to 74 and BFM 81 to 84 are stored non-volatile in the internal EEPROM. There is a safety function to protect the internal EEPROM from being destroyed by accidentally writing the same value continuously to a BFM.

The range of setting is different according to setting the input mode. Please write a set value in a digital value.

Input mode (BFM#0)	Range of setting
0: Voltage input mode	-32000 to +32000
1: Current input mode	0 to 32000
2: Current input mode	-32000 to +32000
3: Voltage input mode	-32000 to +32000
4: Voltage input mode	-2000 to +2000
5: Voltmeter display mode	-10000 to +10000
6: Amperemeter display mode	2000 to 20000
7: Amperemeter display mode	-20000 to +20000
8: Voltmeter display mode	-10000 to +10000
9: Scaling function voltage input mode	-32768 to +32767

Input mode (BFM#0)	Range of setting
A: Scaling function current input mode	-32768 to +32767
B: Scaling function voltage input mode	-32768 to +32767
C to E: It is not possible to set.	Invalid
F: No input channel use	Invalid

7.2.29 BFM 91 to BFM 94 Sudden change detection set value (READ/WRITE)

When using the sudden change detection functions, the set value to judge the sudden change is written to BFM 91 to 94. If the value is 0, the function is disabled. The valid setting range is between 0 and 32000.

When the immediate or average data (BFM 6 to BFM 13) of each channel is updated, and the difference between the previous value and the new value is larger than the sudden change detection value (BFM 91 to BFM 94), the result is written to the sudden change detection status (BFM 27).

The range of setting is different according to setting the input mode.
Please write a set value in a digital value.

Input mode (BFM#0)	Range of setting
0: Voltage input mode	0 to 32000
1: Current input mode	0 to 32000
2: Current input mode	0 to 32000
3: Voltage input mode	0 to 32000
4: Voltage input mode	0 to 2000
5: Voltmeter display mode	0 to 10000
6: Amperemeter display mode	0 to 20000
7: Amperemeter display mode	0 to 20000
8: Voltmeter display mode	0 to 10000
9: Scaling function voltage input mode	0 to 32000
A: Scaling function current input mode	0 to 32000

Input mode (BFM#0)	Range of setting
B: Scaling function voltage input mode	0 to 32000
C to E: It is not possible to set.	Invalid
F: No input channel use	Invalid

7.2.30 BFM 99: Clears upper/lower limit value error and sudden change detection error (READ/WRITE)

The commands to clear the lower limit value error, upper limit value error and sudden change detection error are assigned to the lower three bits of BFM 99.

When a bit is set ON, the flag of the corresponding error status (BFM 26, BFM 27) is reset for all channels at a time.

After the reset is finished, each bit of BFM 99 automatically sets OFF.

It is possible to set two or more clear commands ON at a time.

Table 7.11: Bit assignment in BFM 99

Bit No.	Description
b0	Clears lower limit value error.
b1	Clears upper limit value error.
b2	Clears sudden change detection error.
b3 to b15	Unused

7.2.31 BFM 101 to BFM 108 Peak value (minimum value) (READ only)**7.2.32 BFM 111 to BFM 118 Peak value (maximum value) (READ only)**

When the peak value hold function (BFM 22 b2,b3) is used the minimum average values of the data (BFM 6 to BFM 9) of each channel is written from BFM 101 to BFM 104, the immediate value minimums (BFM 10 to BFM 13) are written from BFM 105 to 108. The maximum average values are written from BFM 111 to BFM 114 and the immediate maximum values are written from BFM 115 to 118.

Initial value

When the peak hold function is not used: K0

When the peak hold function is used: Digital value when the function is set ON

7.2.33 BFM 109: Peak value reset flag (minimum value) (READ/WRITE)**7.2.34 BFM 119: Peak value reset flag (maximum value) (READ/WRITE)**

When the peak value hold function (BFM 22 b2, b3) is used, BFM 109 clears the peak value (minimum value) stored in BFM 101 to BFM 108, and BFM 119 clears the peak value (maximum value) stored in BFM 111 to BFM 118.

The channel No. to be reset is assigned to each bit of BFM 109 and BFM 119. When a bit is set ON, the peak value of the assigned channel is cleared.

Table 7.12: Bit assignment

BFM 109	Bit No.	b15 to b8	b7	b6	b5	b4	b3	b2	b1	b0
	Channel No. (BFM No.)	Unusable	CH4 im (#108)	CH3 im (#107)	CH2 im (#106)	CH1 im (#105)	CH4 av (#104)	CH3 av (#103)	CH2 av (#102)	CH1 av (#101)
BFM 119	Bit No.	b15 to b8	b7	b6	b5	b4	b3	b2	b1	b0
	Channel No. (BFM No.)	Unusable	CH4 im (#118)	CH3 im (#117)	CH2 im (#116)	CH1 im (#115)	CH4 av (#114)	CH3 av (#113)	CH2 av (#112)	CH1 av (#111)

7.2.35 BFM 200 to BFM 249 Scaling function (READ/WRITE)

The Scaling function enables an analog input or output curve, for processes that are not linear over the whole data range. The user can specify up to 5 analog/digital values, that will define an input characteristic curve.

If the Scaling function is used, the offset/gain settings will become meaningless for this channel, as the input/output will be calculated by the Scaling function given by the user. Analog scale value and digital value outside the range selected by BFM 0 and 1 is set. Offset/gain set value becomes error (BFM 29 b1).

Table 7.13: Allocation of BFM #200 to #249

Channel No.	Set value kind	BFM No.				
		Change point 1	Change point 2	Change point 3	Change point 4	Change point 5
Analog input channel CH1	Analog scale value	#200	#202	#204	#206	#208
	Digital value	#201	#203	#205	#207	#209
Analog input channel CH2	Analog scale value	#210	#212	#214	#216	#218
	Digital value	#211	#213	#215	#217	#219
Analog input channel CH3	Analog scale value	#220	#222	#224	#226	#228
	Digital value	#221	#223	#225	#227	#229
Analog input channel CH4	Analog scale value	#230	#232	#234	#236	#238
	Digital value	#231	#233	#235	#237	#239
Analog output channel	Digital value	#240	#242	#244	#246	#248
	Analog scale value	#241	#243	#245	#247	#249

The order of allocating an analog value and a digital value differs for in the input channels and the output channel.

Scaling function setting procedures

The Scaling function is set according to the following procedure.

1) Please make a set change in the I/O characteristic permission (BFM19=K1).



2) Please write the mode which uses the Scaling function in BFM0 and BFM1.



3) Please write the value of BFM200 to 249 allocated to the analog input/output channel.



4) Make the value of BFM200 to 249 effective by analog input channel of writes I/O characteristics.

Program example when Scaling function is used

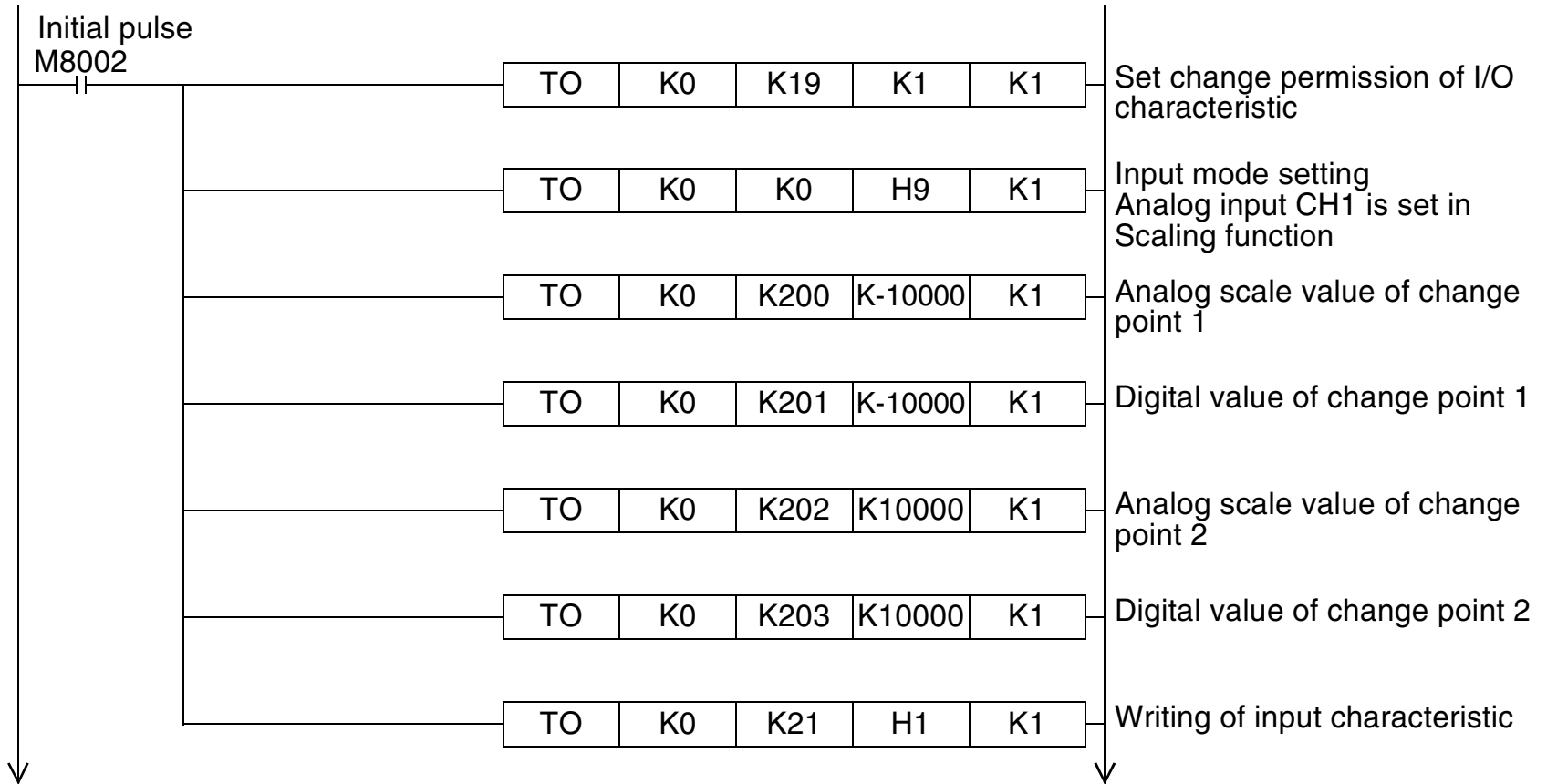

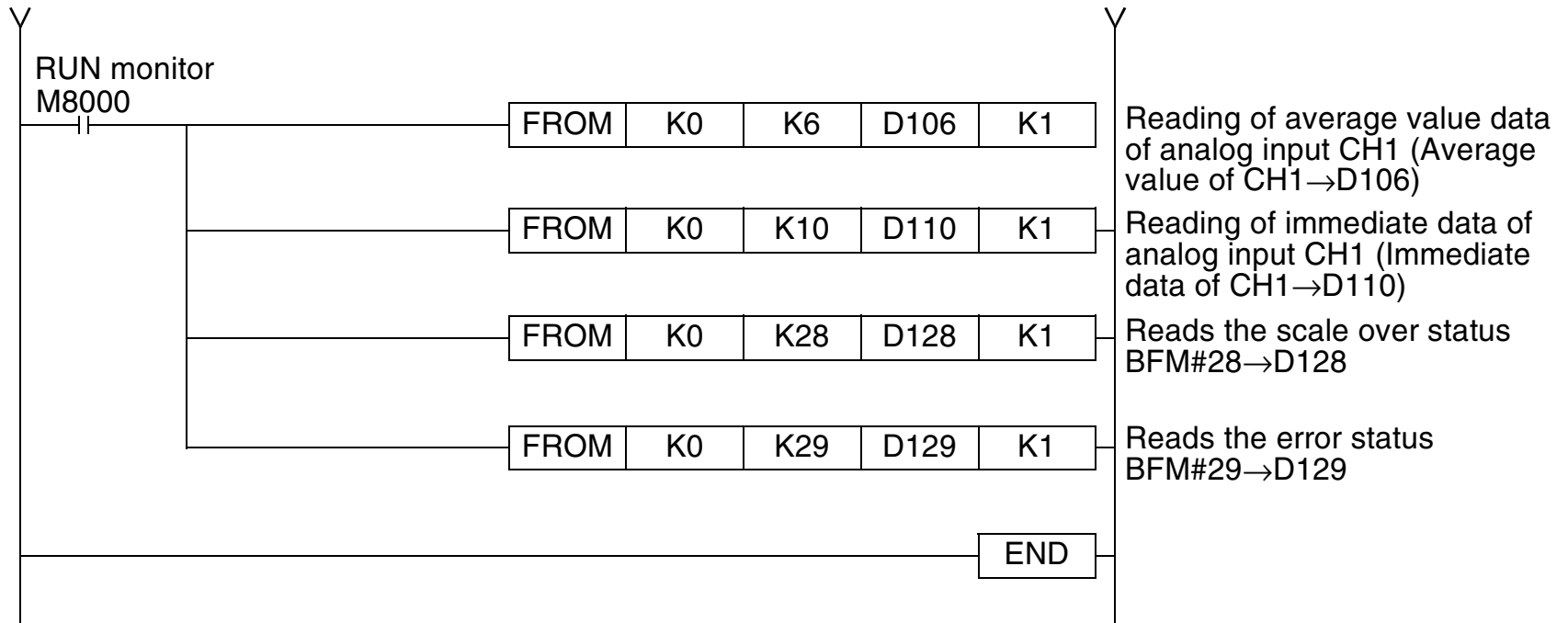

- The range in which the analog scale value and digital value can be set varies according to the I/O mode selected for BFM0 and BFM1.
When setting the analog scale value, write the value converted to percentage (1/100).

$$\text{analog scale value} = \left[\frac{\text{analog value}}{\text{maximum analog value}} \times 100 \right] \times 100$$

Example: When input mode 9 (scaling-function voltage input mode: -10 to +10V) is chosen in BFM 0

Analog value	-10V	-5V	0V	5V	10V
Associated analog value	-100%	-50%	0%	50%	100%
Analog scale value	-10000	-5000	0	5000	10000

If the analog scale value and digital value are outside the selected range set in BFM 0 and BFM 1, the offset / gain set value errors (BFM 29 b1).

Setting range of analog input

Set BFM 0 to 9

Analog scale value: -10000 to +10000

Digital value : -32768 to +32767

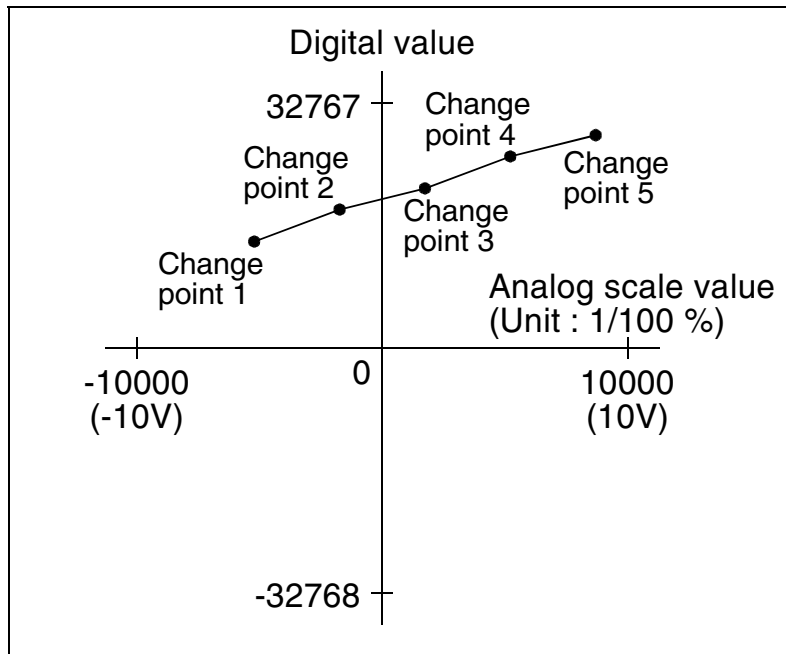

Set BFM 0 to A

Analog scale value: 2000 to 10000

Digital value : -32768 to +32767

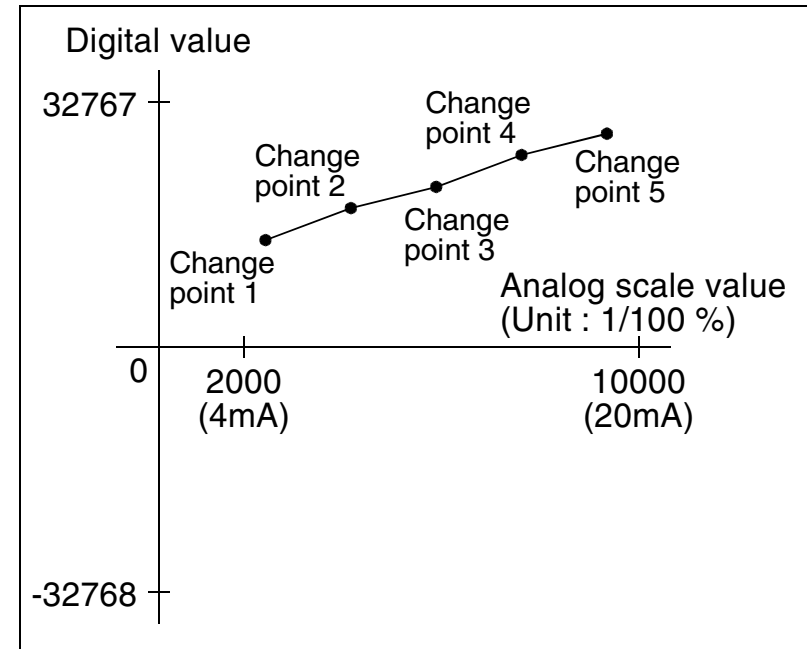

Set BFM 0 to B

Analog scale value: -10000 to +10000

Digital value : -32768 to +32767

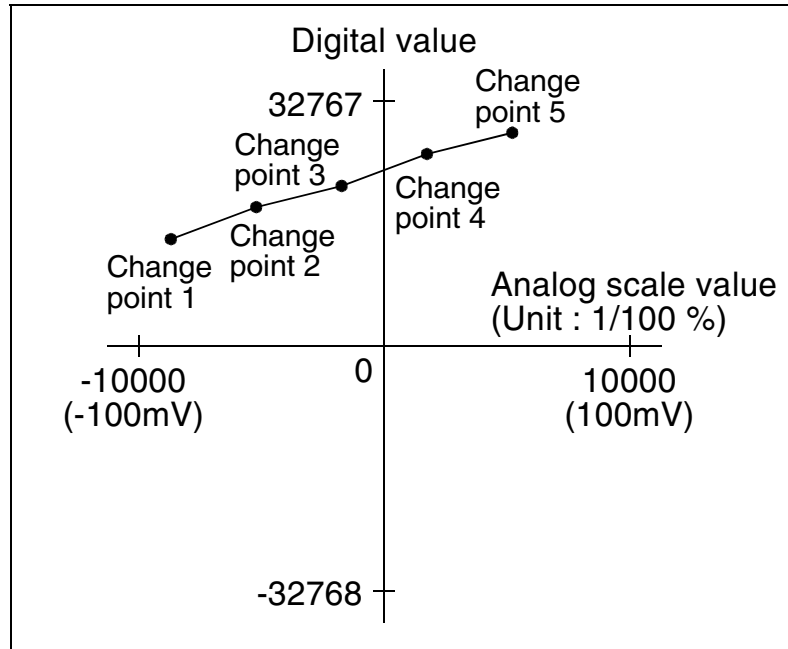

Setting range of analog output

Set BFM 1 to 9

Analog scale value: -10000 to +10000

Digital value : -32768 to +32767

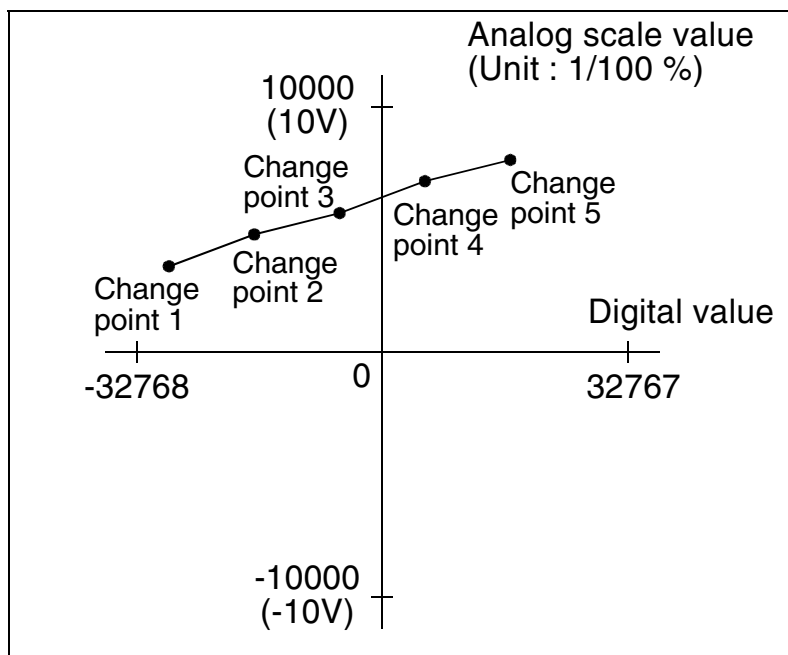

Set BFM 1 to A

Analog scale value: 0 to 10000

Digital value : -32768 to +32767

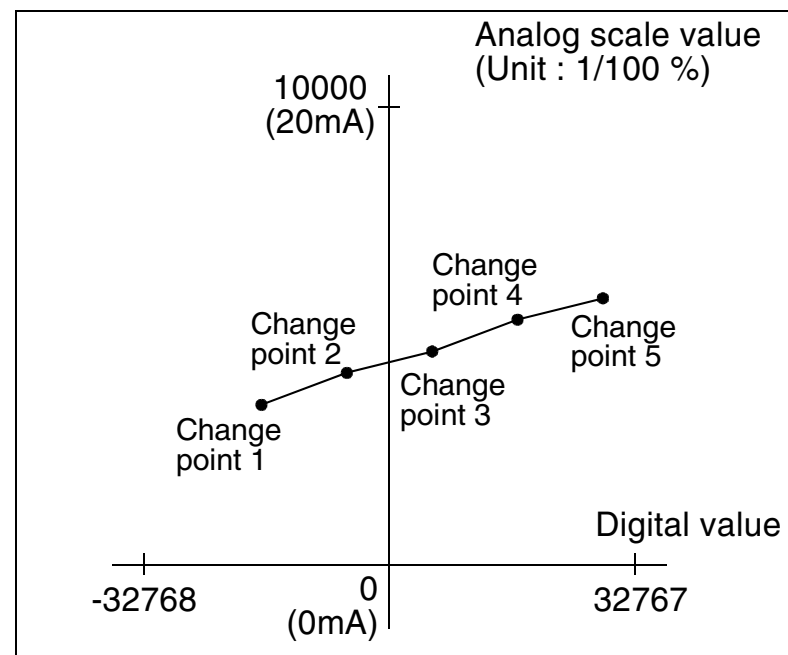

- The value which can be set depends on the selection of BFM 0 and 1. Analog values and digital values outside the range selected by BFM 0 and 1 are set, thus, offset/gain set value error (BFM 29 b1) will occur.

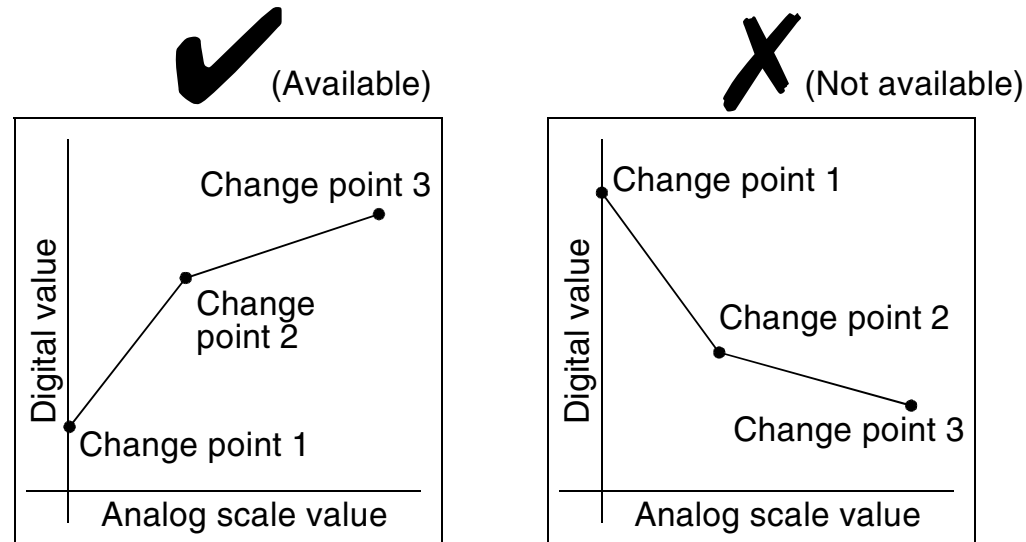

Figure 1

- Please set analog values and digital values in Change point 1 < Change point 2 < Change point 3. When "The small number change point" \leq "The large number change point" is set, offset/gain set value error (BFM 29 b1). (See figure 1.)
- When using less than three change points, please specify an analog scale and a digital value for those change points not used as K0 (initial value). (See figure 1.)

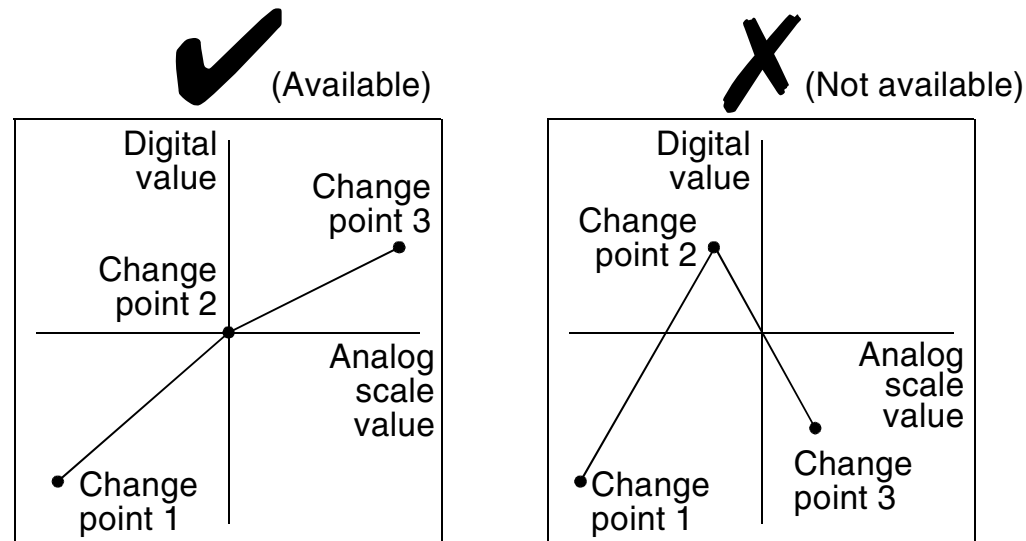

Figure 2

- When using K0 as a change point setting value, the subsequent change point value must be larger in both the "Digital value" and "Analog scale value". (See figure 2.)
- The I/O to be entered for each channel should fall within the range of the analog scale value of Change point 1 (minimum value) to that of Change point 3 (maximum value). When an analog value outside this range is entered, scale over error (BFM 28) occurs.
- As for scale over less than lower limit and disconnection detection, a minimum analog value of change point 1 to 3 is stored in analog input value (BFM 6 to 9, 10 to 13). As for scale over more than upper limit, a maximum analog value of change point 1 to 3 is stored in analog input value (BFM 6 to 9, 10 to 13).
- Offset data (BFM 41 to 45) and gain data (BFM 51 to 55) of the channel which uses Scaling function is disregarded.

The figure below shows the example for an analog input.

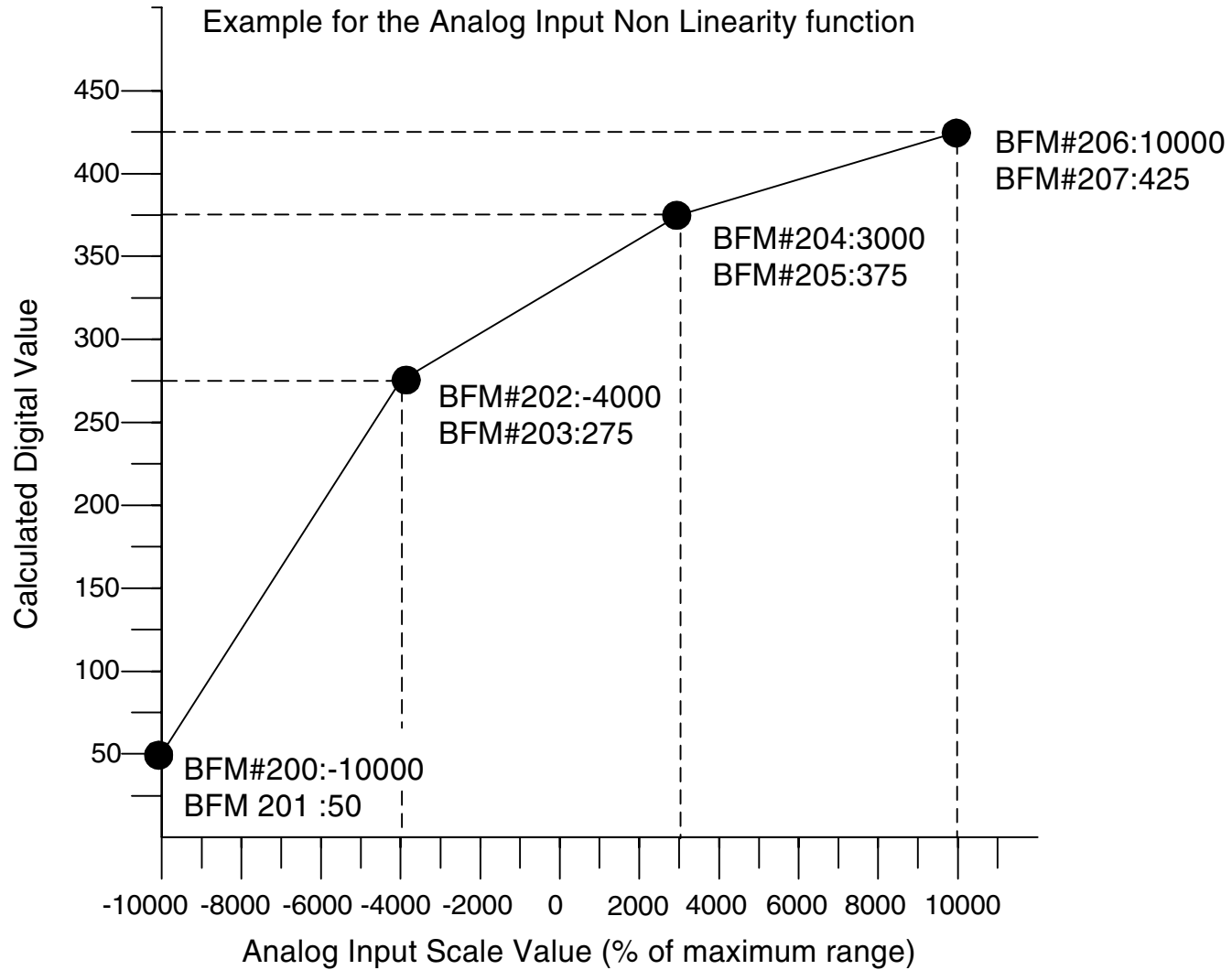

Table 7.14:

	Change point 1	Change point 2	Change point 3	Change point 4	Change point 5
Analog Input Scale Value	BFM#200:-10000	BFM#202:-4000	BFM#204:3000	BFM#206:10000	BFM#208: K0
Calculated Digital Value	BFM#201:50	BFM#203:275	BFM#205:375	BFM#207:425	BFM#209: K0

If the Scaling function is selected, the analog module will return the following values in BFM 10:

analog input value: $x < -10000$:

$y = \text{const. } 50$ (range error is entered in BFM28)

analog input value: $-10000 < x < -4000$

$y = 0.0375 * x + 425$

analog input value: $-4000 < x < 3000$

$y = 0.0143 * x + 332,15$

analog input value: $3000 < x < 10000$

$y = 0.0071 * x + 353.85$

analog input value: $x > 10000$

$y = \text{const. } 425$ (range error is entered in BFM28)

The same principle applies for the analog output, however, the first value in BFM 240 must be a digital value and the second value must be the corresponding analog output value. The dimension of the values is specified by the mode in BFM 0 and BFM 1.

If a mode-change is set and a Scaling function setting error appears the default-value will be taken. If only a Scaling function setting error appears, the previous correct value will be take.

At least the first two analog/digital values must be set. If the other three analog/digital values are set to 0 they will not be used by the Scaling function. By setting the first three analog/digital value and resetting the last two analog/digital values, three parameter will be used by the Scaling function etc.

8. Adjustment of I/O Characteristics

The factory, the FX2N-5A has standard I/O characteristics in accordance with each input mode (BFM #0, BFM #1) set as the factory default.

In the voltage input mode and current input mode, adjust the standard I/O characteristics for each channel. (The user cannot adjust the standard I/O characteristics in the analog value direct input mode and the analog value direct output mode.)

8.1 Standard I/O characteristics

Explanation

The I/O mode of the standard I/O characteristics is abbreviated as shown below:

0. Voltage input, -10 to $10V \rightarrow -32000$ to 32000

1)	2)	3)
1) Input mode set in BFM #0, BFM #1	2) Input mode or output mode	3) Analog input range or Analog output range

In the Voltmeter/Amperemeter analog input mode, Absolute Voltage/Current output mode and the Scaling function, 3) Digital value of Analog input range or Analog output range is omitted.

Input characteristics

0. Voltage input, -10 to 10V → -32000 to +32000

1. Current input, 4 to 20mA → 0 to 32000

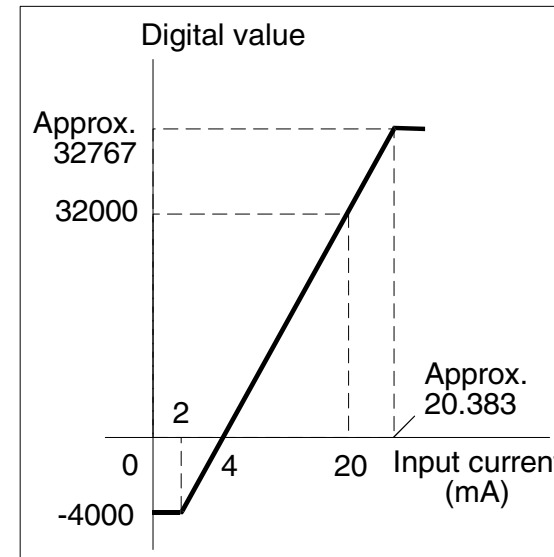
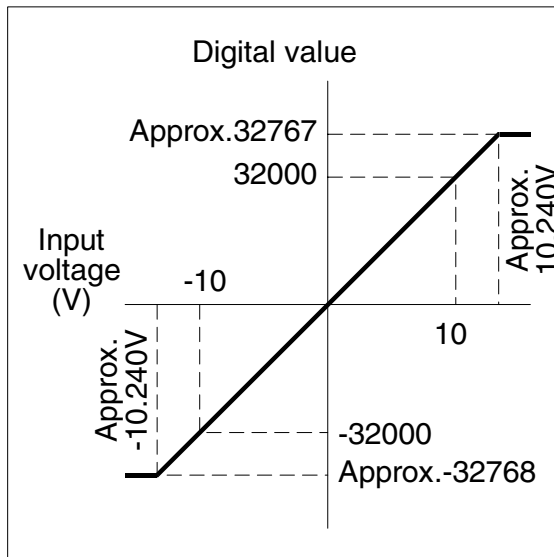

2. Current input, -20 to 20mA → -32000 to +32000 3. Voltage input, -100 to 100mV → -32000 to +32000

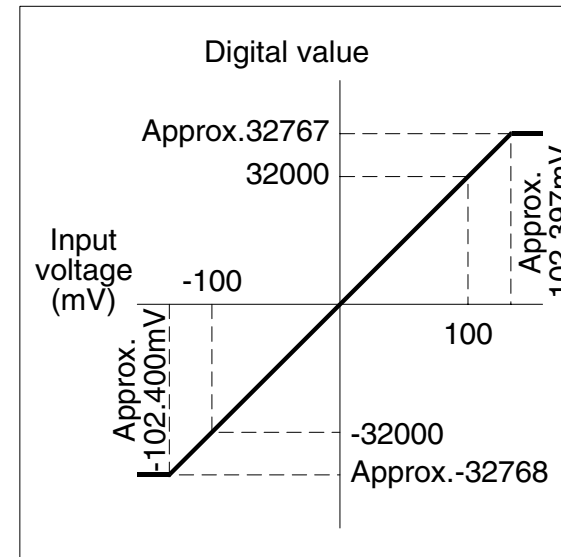
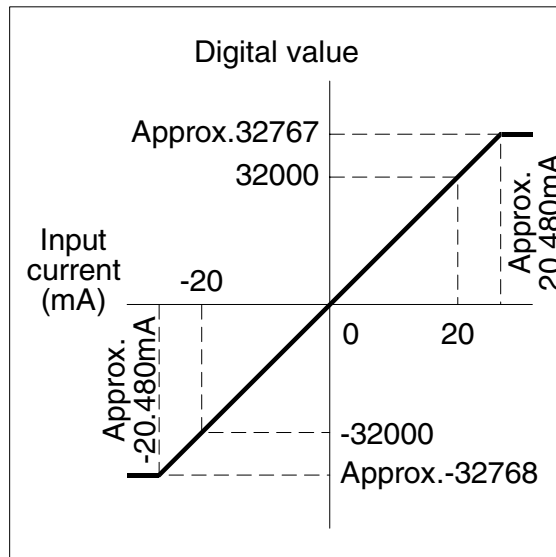

4. Voltage input, -100 to 100mV → -2000 to +2000 5. Voltmeter mode, direct display, -10 to 10V

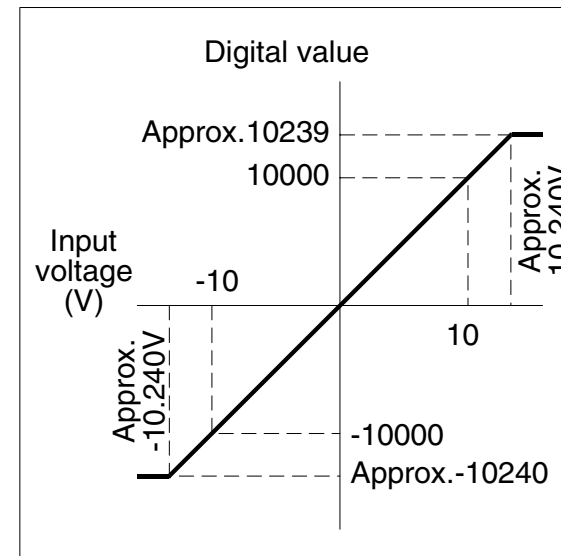
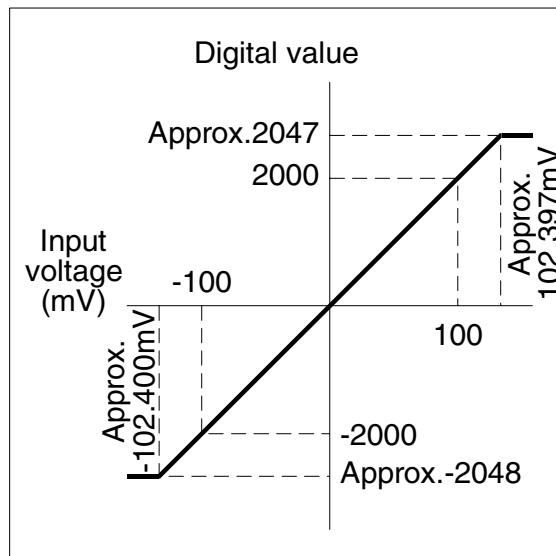

6. Direct current input, 2 to 20mA

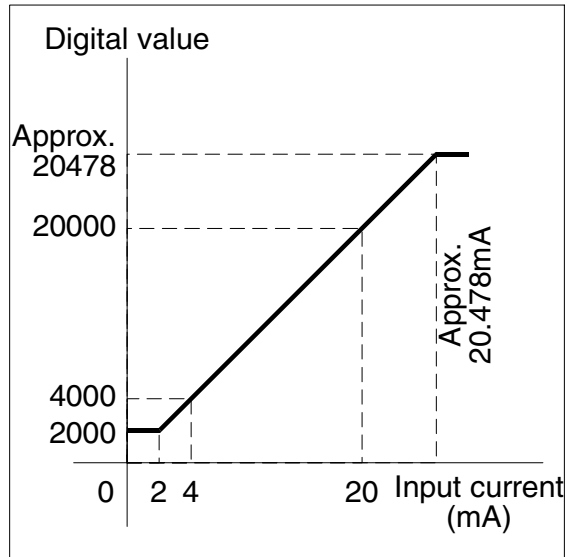

7. Direct current input, -20 to 20mA

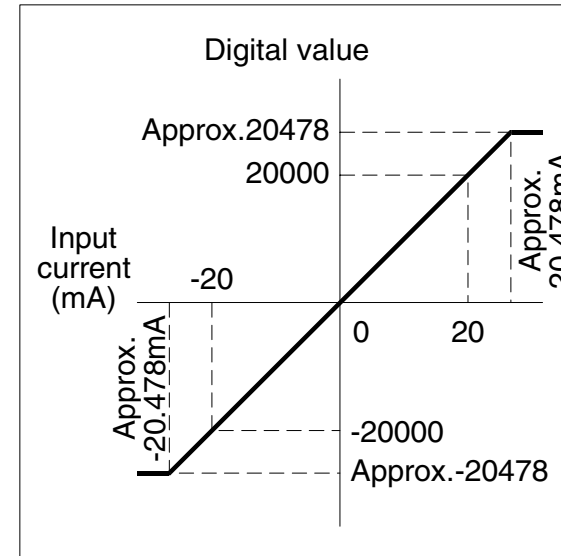

8. Direct voltage input, -100 to 100mV

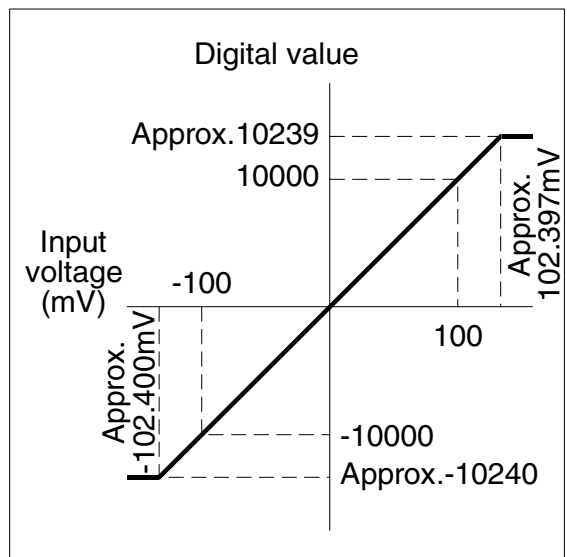

Output characteristics

0. Voltage output, -32000 to +32000 → -10 to 10V 1. Voltage output, -2000 to +2000 → -10 to 10V

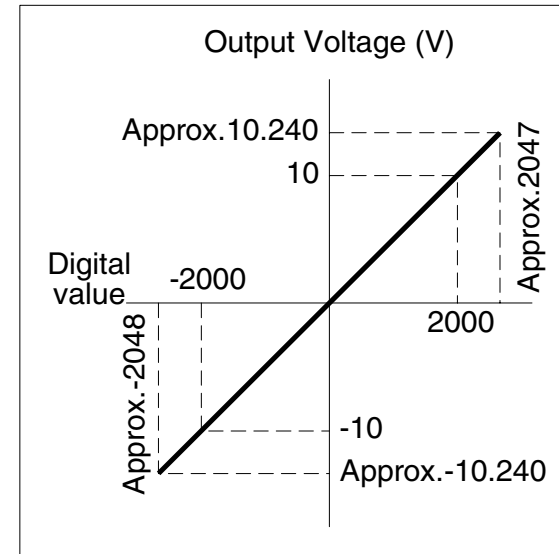
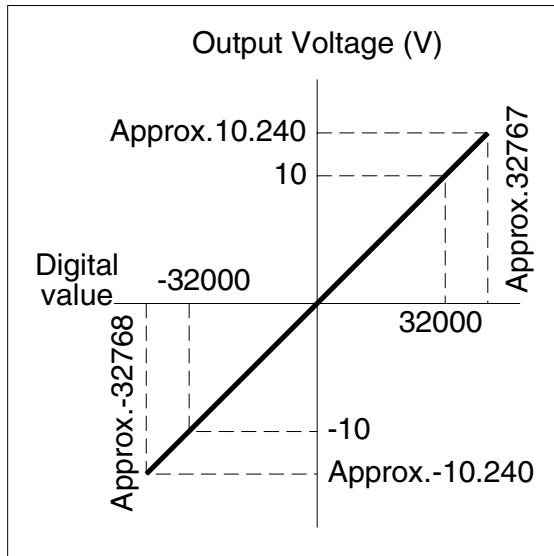

2. Current output, 0 to 32000 → 4 to 20mA

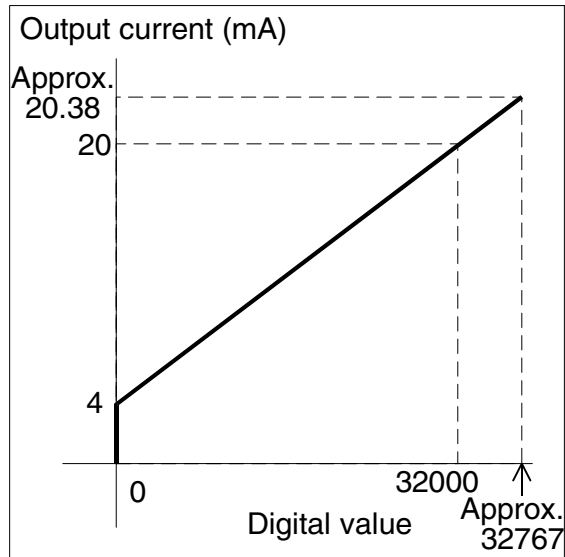

3. Current output, 0 to 1000 → 4 to 20mA

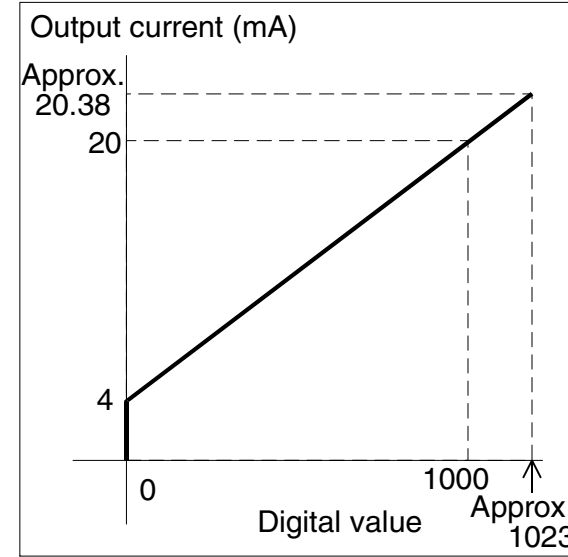

4. Current output, 0 to 32000 → 0 to 20mA

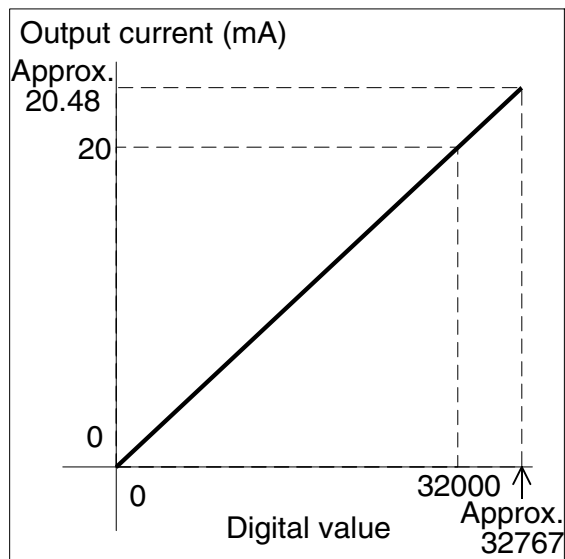

5. Current output, 0 to 1000 → 0 to 20mA

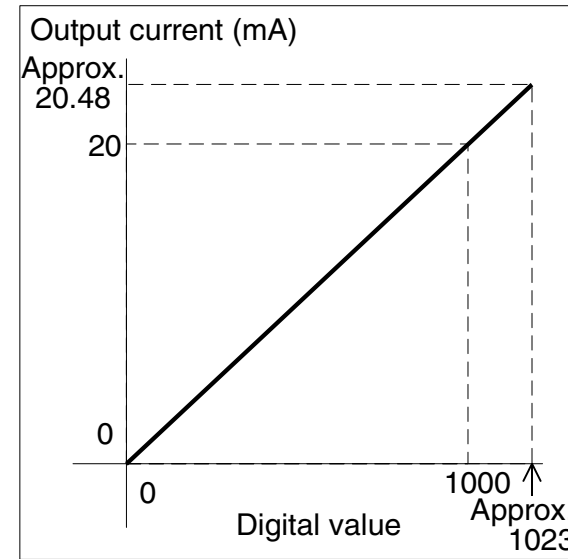

6. Analog value direct output, -10 to 10V

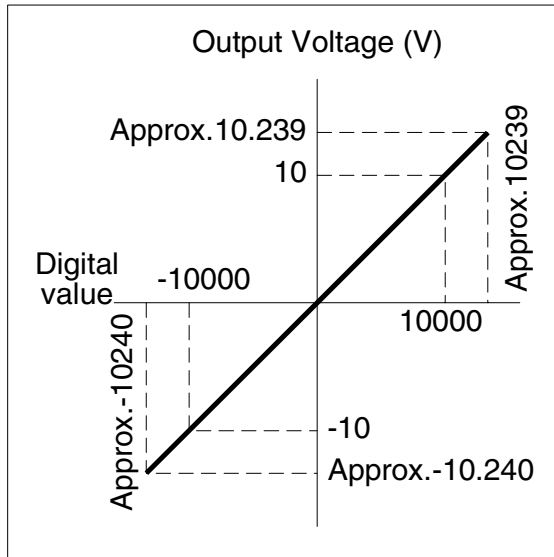

7. Analog value direct output, 4 to 20mA

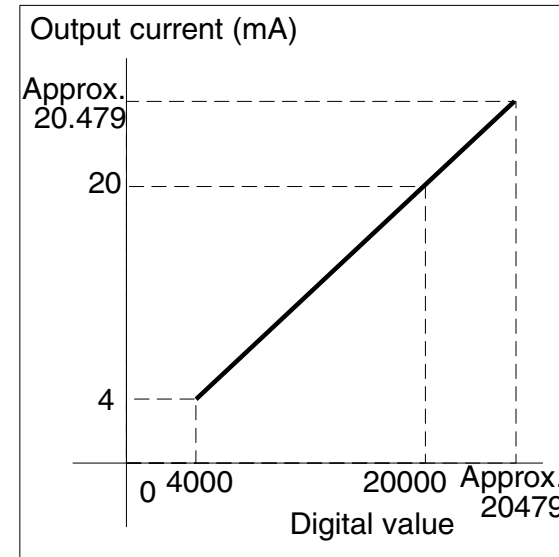

8. Analog value direct output, 0 to 20mA

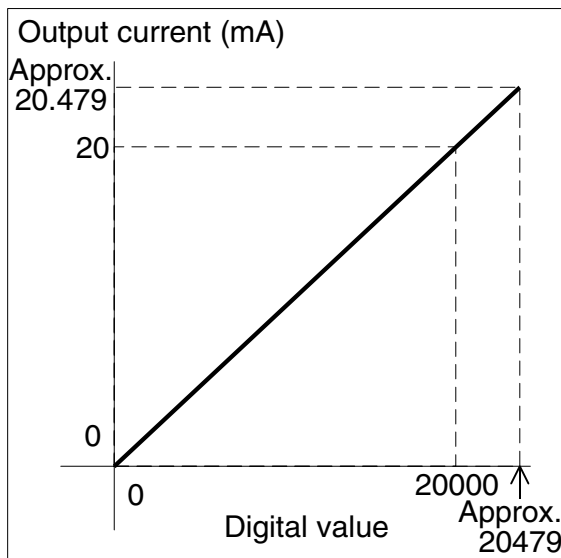

8.2 Adjustment of I/O characteristics

Adjust the I/O characteristics using the buffer memories in the FX2N-5A.

At first, write the input/output mode to BFM #0 and BFM #1, write the offset data to BFM #41 to BFM #45, then write the gain data to BFM #51 to BFM #55. Finally, update the offset data and the gain data of each channel using BFM #21.

Figure 8.1: Example program

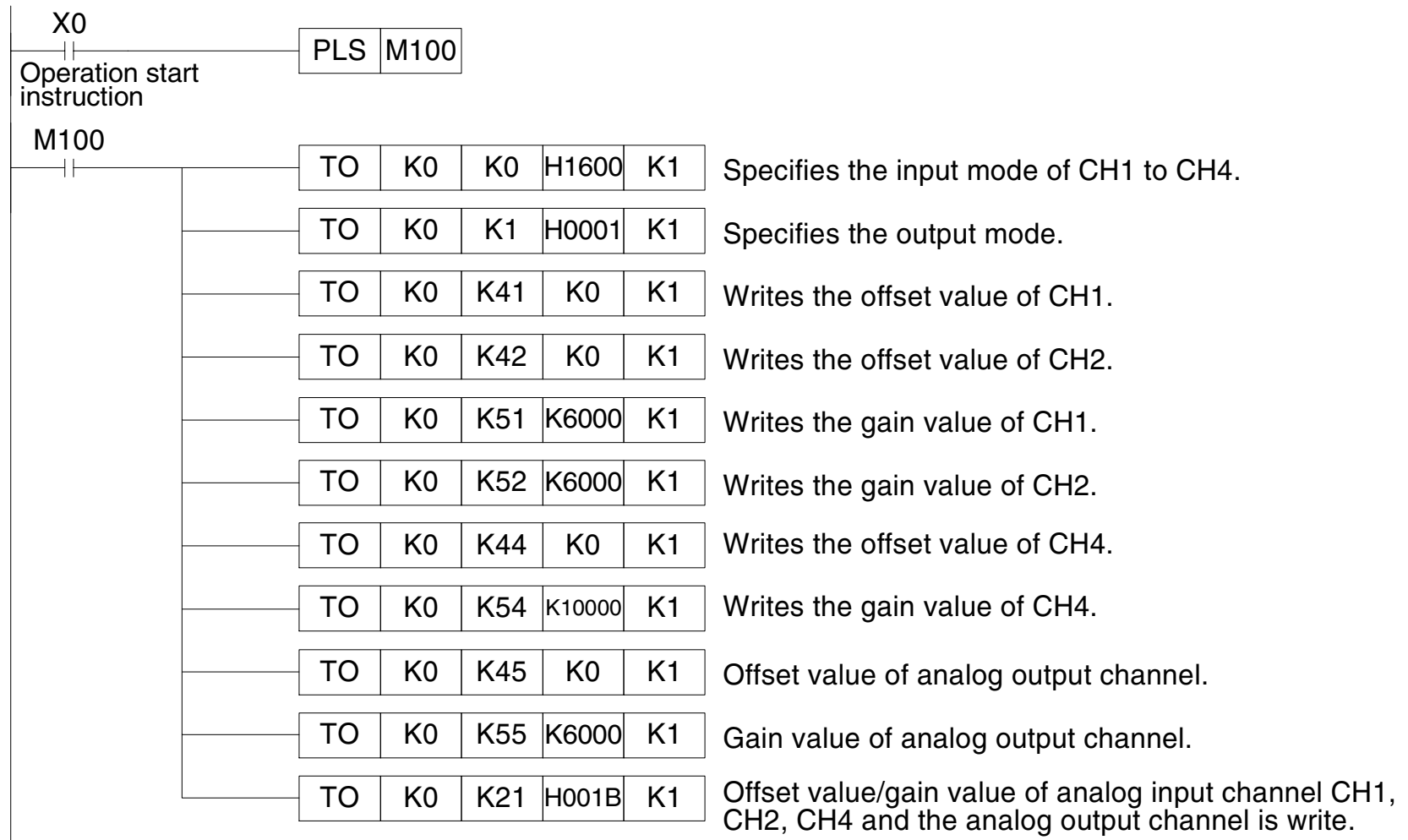

The I/O characteristics can be written (BFM #21) to one channel at a time, or two or more channels at a time.

MEMO

9. Example program

9.1 Program example for analog input/output

The section introduces an example program to manipulate analog input/output using the FX2N-5A.

Condition

System configuration:

The FX2N-5A (unit No. 0) is connected as a special function block nearest to the FX0N/FX1N/FX2N/FX2NC Series PLC^{*1} main unit.

Input mode:

CH1 and CH2 : Mode 0 (voltage input, -10 to +10 V → -32000 to +32000)
CH3 and CH4 : Mode 1 (current input, 4 to 20 mA → 0 to 32000)

Output mode:

Analog output channel: Mode 0 (voltage output, -32000 to +32000 → -10 to +10 V)

Number of times of averaging:

10 in each input channel

I/O characteristics:

Standard I/O characteristics (initial value) in each channel

Convenient function:

Not used.

I/O assignment:

X000 : Change of analog output value.
X001 : Clears the scale over error.
Y000 to Y007 : Output scale over status of each channel.
Y010 to Y027 : Output of error status.

*1 FX3U/FX3UC Series PLC can use direct specification of buffer memory.
Refer to the FX3S/FX3G/FX3GC/FX3U/FX3UC Series Programming Manual - Basic & Applied Instruction Edition for details.

Figure 9.1: Example program

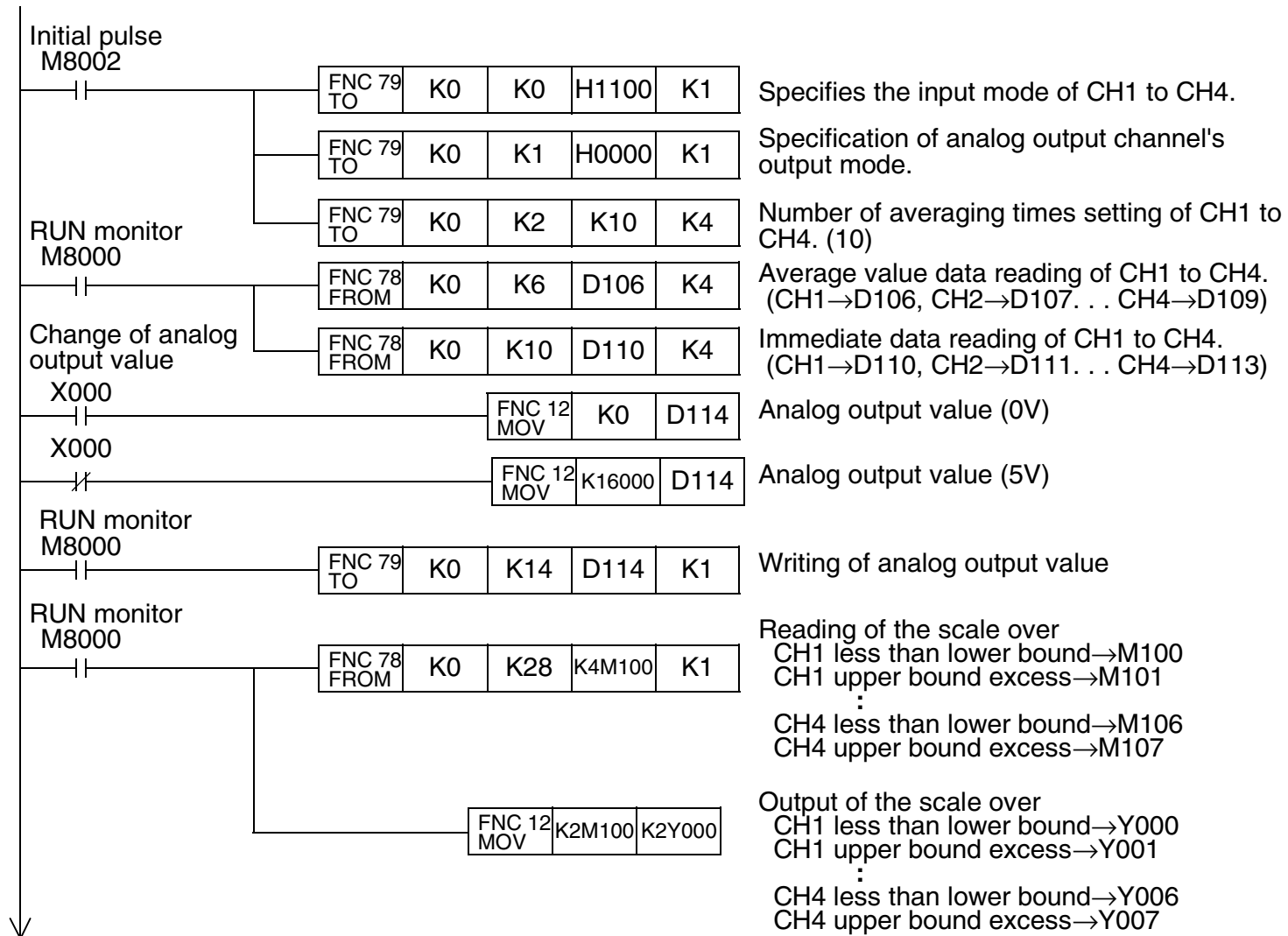

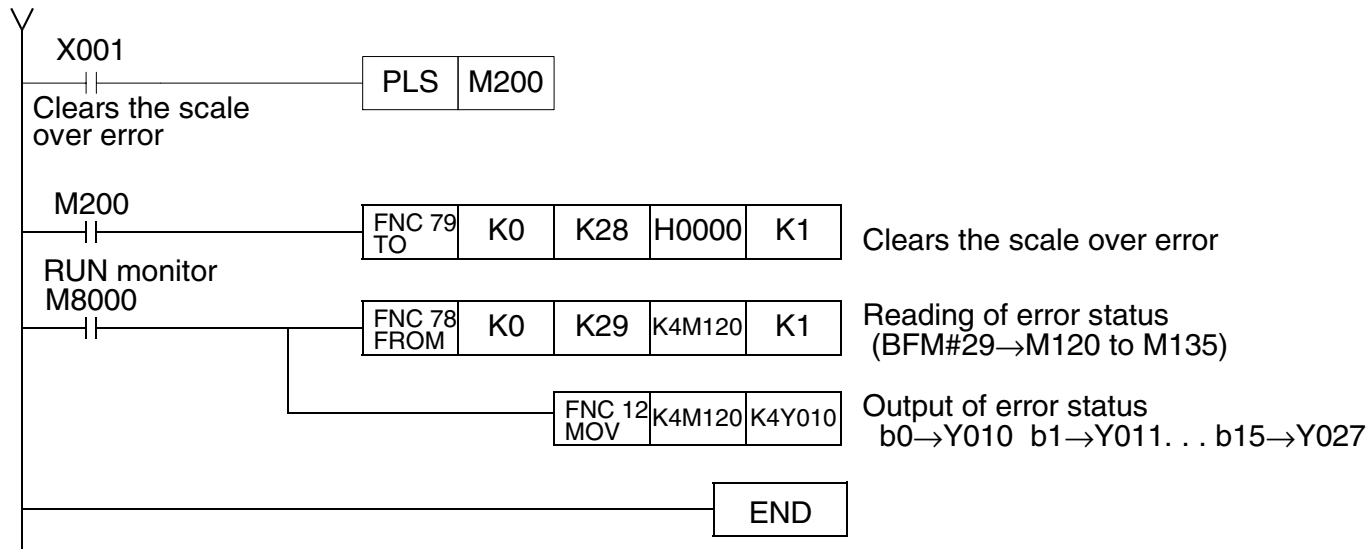

9.2 Outline of FROM/TO commands

FX2N-5A reads and writes FROM/TO commands of PLC.
FROM/TO commands are outlined as follows.

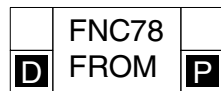

BFM reading

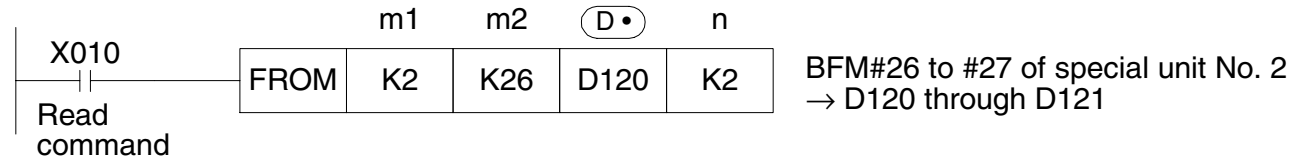

m1 : Special unit or block No. (K0 to K7 numbered from the unit nearest to the basic unit)

m2 : Head instructed number (m2=K0 to K31) of buffer memory

D• : It is the head element No. of the transfer destination, and can be designated T, C, D, KnM, KnY, KnS, V and Z. It can be provided with the modifier of the element No..

n : Number of transfer points (n=K1 to K32, but n=K1 to K16 for 32-bit command)



BFM writing

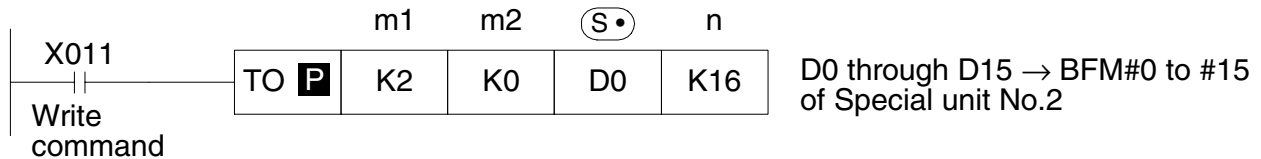

m1,m2,n : Same as above

S• : It is the head element No. of the transfer source, and can be designated T, C, D, KnX, KnM, KnY, KnS, V, Z, K and H. It can be provided with the modifier of the element No. by the index.

P An instruction modified to use pulse (single) operation.

D An instruction modified to use operate in 32 bit operation.

- When X010 and X011 are OFF, the transfer is not executed and the data of the transfer destination does not vary. For details, refer to the FX Series programming manual II.
- FX3U/FX3UC Series PLC can use direct specification of buffer memory. Refer to the FX3S/FX3G/FX3GC/FX3U/FX3UC Series Programming Manual - Basic & Applied Instruction Edition for details.

Appendix A: Associated Manuals List

For further information manual about FX Series, refer to following table:

Table A-1: Further Information Manual

Manual Name	Manual No.	Description
FX ₀ /FX _{0N} Hardware Manual	JY992D47501	This manual contains hardware explanations of wiring, installation and specifications for FX ₀ and FX _{0N} Series programmable controllers.
FX _{1N} Hardware Manual	JY992D88201	This manual contains hardware explanations of wiring, installation and specifications for FX _{1N} Series programmable controllers.
FX _{2N} Hardware Manual	JY992D66301	This manual contains hardware explanations of wiring, installation and specifications for FX _{2N} Series programmable controllers.
FX _{2NC} Hardware Manual	JY992D76401	This manual contains hardware explanations of wiring, installation and specifications for FX _{2NC} Series programmable controllers.
FX _{3G} Series User's Manual - Hardware Edition	JY997D31301	This manual explains the wiring, installation and specification for FX _{3G} Series programmable controllers.
FX _{3GC} Series User's Manual - Hardware Edition	JY997D45401	This manual explains the wiring, installation and specification for FX _{3GC} Series programmable controllers.

Table A-1: Further Information Manual

Manual Name	Manual No.	Description
FX _{3U} Series User's Manual - Hardware Edition	JY997D16501	This manual explains the wiring, installation and specification for FX _{3U} Series programmable controllers.
FX _{3UC} Series User's Manual - Hardware Edition	JY997D28701	This manual explains the wiring, installation and specification for FX _{3UC} Series programmable controllers.
FX Programming Manual	JY992D48301	This manual contains instruction explanations for the FX ₀ , FX _{0S} , FX _{0N} , FX, FX _{2C} , FX _{2N} and FX _{2NC} Series programmable controllers.
FX Programming Manual II	JY992D88101	This manual contains instruction explanations for the FX _{1S} , FX _{1N} , FX _{2N} and FX _{2NC} Series programmable controllers.
FX _{3S} /FX _{3G} /FX _{3GC} /FX _{3U} /FX _{3UC} Series Programming Manual - Basic & Applied Instruction Edition	JY997D16601	This manual explains the instructions for FX _{3S} /FX _{3G} /FX _{3GC} /FX _{3U} /FX _{3UC} Series programmable controller.

「电器电子产品有害物质限制使用标识要求」的表示方式



Note: This symbol mark is for China only.

含有有害6物质的名称，含有量，含有部品

本产品中所含有的有害6物质的名称，含有量，含有部品如下表所示。

产品中有害物质的名称及含量

部件名称		有害物质					
		铅 (Pb)	汞 (Hg)	镉 (Cd)	六价铬 (Cr (VI))	多溴联苯 (PBB)	多溴 二苯醚 (PBDE)
可编程 控制器	外壳	○	○	○	○	○	○
	印刷基板	×	○	○	○	○	○

本表格依据SJ/T 11364的规定编制。

○:表示该有害物质在该部件所有均质材料中的含量均在GB/T 26572规定的限量要求以下。

×:表示该有害物质至少在该部件的某一均质材料中的含量超出GB/T 26572规定的限量要求。

MEMO

USER'S MANUAL

FX₂N-5A Special function block

mitsubishi electric corporation

HEAD OFFICE: TOKYO BUILDING, 2-7-3 MARUNOUCHI, CHIYODA-KU, TOKYO 100-8310, JAPAN

MODEL	FX2N-5A-U-E
MODEL CODE	09R616

JY997D11401H
(MEE)



Effective August 2017

Specifications are subject to change without notice.