

Industrial PC

MELIPC

MELIPC MI3000 User's Manual



-MI3321G-W
-MI3315G-W

Safety Precautions

(Always read these precautions before using this product.)

Before using this product, read this manual and the relevant manuals introduced in this manual carefully and pay full attention to safety to handle the product properly.

In this manual, the safety precautions are ranked as " WARNING" and " CAUTION".

 WARNING	Indicates that incorrect handling may cause hazardous conditions, resulting in death or severe injury.
 CAUTION	Indicates that incorrect handling may cause hazardous conditions, resulting in minor or moderate injury or property damage.

Note that the  CAUTION level may lead to a serious accident according to the circumstances.

Always follow the instructions of both levels because they are important to personal safety.

Save this manual to make it accessible when required and always forward it to the end user.

[Design Precautions]

WARNING

- Create safety circuits externally to ensure that the entire system operates safely even if the external power supply or the product is in failure.
Not doing so may cause an accident due to a false output or malfunction.
Create the following circuits externally: emergency stop circuits, protection circuits, interlock circuits that prevent an invert operation (such as a forward/reverse rotation), and interlock circuits that prevent a machine breakage (such as positioning at the upper or lower limit).
 - Before operating the product connected with a peripheral, read the peripheral manual carefully to ensure safety.
 - Some failures of the product, expansion board, or cables may keep the outputs on or off.
Some failures of the touch panel may cause a malfunction of input objects such as a touch switch.
Create an external monitoring circuit to check for output signals which may lead to a serious accident.
Not doing so may cause an accident due to a false output or malfunction.
 - Do not use the product as a warning device that warns you of danger, or a serious accident may occur.
For the device that displays or outputs a serious warning, provide an independently redundant hardware or mechanical interlock.
Not doing so may cause an accident due to an incorrect output or malfunction.
 - The product cannot detect a failure of its backlight.
In the event of a backlight failure, do not touch the touch panel because touch switches are operable.
Doing so may cause an unintended operation.
-

[Design Precautions]

CAUTION

- Do not run the control line cables and communication cables together with or near the main circuit cables, power line cables, or other cables. Keep a distance of 100 mm or more between them as a guide.
Not doing so may cause a malfunction due to noise.
 - When selecting a fuse or breaker for the external circuit, consider the specification values of fusing, detection characteristics, and inrush current.
 - When using an uninterruptible power supply (UPS), do not use the one that outputs square waves.
 - Do not press the display section of the product with a pointed material such as a pen or screwdriver.
Doing so may cause a breakage or failure.
 - Turn on the controllers and the network devices to make them ready for communication before they communicate with the product.
Not doing so may cause a communication error on the product.
 - When the product is subject to vibrations or impacts or when the product screen displays a specific color, the screen may flicker.
-

[Security Precautions]

WARNING

- To maintain the security (confidentiality, integrity, and availability) of this product and the system against unauthorized access, denial-of-service (DoS) attacks, computer viruses, and other cyberattacks from unreliable networks and devices via network, take appropriate measures such as firewalls, virtual private networks (VPNs), and antivirus solutions.
-

[Mounting Precautions]

WARNING

- Before installing or removing the product on or from the control panel, shut off all phases of the external power supply used by the system.
Not doing so may cause a product failure or malfunction.
 - Before installing or removing an expansion board, shut off all phases of the external power supply used by the system.
Not doing so may cause a failure or malfunction of the product and expansion board.
-

[Mounting Precautions]

CAUTION

- Use the product in the environment that satisfies the general specifications described in this manual.
Not doing so may cause an electric shock, fire, malfunction, product damage, or product deterioration.
 - Do not touch the conductive or electronic parts of the product.
Doing so may cause a failure or malfunction.
 - When mounting the product on the control panel, tighten the mounting screws to the specified torque (0.44 N•m to 0.54 N•m) with a Phillips-head screwdriver No. 2.
Undertightening may cause the product to drop, short circuit, or malfunction.
Overtightening may break the screw or product, resulting in a drop, short circuit, or malfunction.
 - Tighten the following screws to the specified torque.
 - SSD slot fixing screw: 0.29 N•m
 - SSD fixing screw: 0.2 N•m
 - Power supply connector screw: 0.2 N•m
 - Functional grounding screw: 0.49 N•mUndertightening may cause a drop, failure, or malfunction.
Overtightening may break the screw or product, resulting in a drop, failure, or malfunction.
 - Do not use or store the product in an environment subject to direct sunlight, high temperatures, dust, high humidity, or frequent vibration.
 - Do not operate the product with its display section frozen.
The water droplets on the display section may freeze at a low temperature.
Touch switches and other input objects may malfunction if the display section is frozen.
 - Do not operate the touch screen when it is wet.
Doing so may cause touch switches and other input objects to malfunction.
Before turning on the product, wipe the touch screen dry with a soft cloth.
-

[Wiring Precautions]

WARNING

- Before installation or wiring, make sure to shut off all phases of the external power supply used by the system.
Not doing so may cause an electric shock, product failure, or malfunction.
 - After installation, wiring, or other work, make sure to attach the back cover to the product before turning on the power and starting operation.
Not doing so may cause an electrical shock.
-

[Wiring Precautions]

CAUTION

- Make sure to ground the FG terminal of the power supply section solely for the product (ground resistance: 100 Ω or less, cross-sectional area of the ground cable: 2.0 mm² or more).
Not doing so may cause an electric shock or malfunction.
 - Securely connect the connector of an external controller to the product.
Not doing so may cause a malfunction due to poor contact.
 - Do not run the control line cables and communication cables together with or near the main circuit cables, power line cables, or other cables.
Keep a distance of 100 mm or more between them as a guide.
Not doing so may cause a malfunction due to noise.
 - House the wires and cables connected to the product in ducts, or fix them with clamps or nylon bands.
Not doing so may cause the following to occur, resulting in a malfunction.
 - Cable dangling or swinging
 - Damage to the product or cables due to accidental pulling of the cables
 - Poor cable connection
 - Check the interface type, and perform wiring correctly.
Incorrect wiring (such as connecting a cable to an improper interface) may cause the failure of the product or external device.
 - Make sure that no foreign matter, such as chips and wire offcuts, enters the product.
Not doing so may cause a fire, failure, or malfunction.
 - When removing a cable from the product, do not pull the cable portion.
For the cable with a connector, hold the connector to remove the cable.
 - Wiring must be performed by qualified maintenance persons who have been trained to avoid electric shocks.
For the wiring method, refer to this manual.
 - Tighten the terminal screws in the power supply section of the product to the specified torque (0.20 N·m).
Undertightening may cause a short circuit or malfunction.
Overtightening may break the screw or product, resulting in a short circuit or malfunction.
 - When connecting a wire to the power supply section of the product, directly connect a stranded wire or a single wire, or use a rod terminal with an insulation sleeve.
-

[Startup and Maintenance Precautions]

WARNING

- Do not touch the terminals while power is on.
Doing so may cause an electric shock or malfunction.
 - Never charge, disassemble, heat, short-circuit, solder, or strike the battery, and never expose the battery to liquid.
Doing so may cause the battery to heat up, explode, ignite, or leak, resulting in injury or fire.
 - Before retightening the terminal screws, connector screws, or product fixing screws, or cleaning the product, shut off all phases of the external power supply used by the system.
Not doing so may cause an electric shock.
-

[Startup and Maintenance Precautions]

CAUTION

- Do not disassemble or modify the product.
Doing so may cause a failure, malfunction, injury, or fire.
 - When using a wireless communication device such as a cell phone or PHS phone, keep a distance of 25 cm or more away from the product.
Not doing so may cause a malfunction.
 - Do not touch the conductive or electronic parts of the product.
Doing so may cause a product malfunction or failure.
 - Before touching the product, make sure to touch a grounded metal or other conductive material to discharge static electricity.
Not doing so may cause a product failure or malfunction.
 - When removing a cable from the product, do not pull the cable portion.
Doing so may break the product or cable, or cause a malfunction due to poor contact of the cable.
 - Do not drop or strike the product.
Doing so may break the product.
-

[Touch Panel Precautions]

WARNING

- Noise may cause unstable touch operation or incorrect detection of the touched position.
In the case of incorrect detection, an untouched object may operate, causing an incorrect output or malfunction. An unexpected operation may occur accordingly.
 - The display section of the product is made of glass. If it is broken, pieces of glass may scatter.
Prevent possible injury.
 - The adhesion of water or other conductive substances to the touch panel may cause an incorrect input or incorrect detection of the touched position.
-

[Precautions for Shutting Off the Power]

CAUTION

- Before turning off the product, shut down Windows.
Not doing so may corrupt the data on the SSD.
 - Do not turn off the product upon Windows shutdown.
Doing so may corrupt the data on the SSD as it may be in the process of being accessed.
Make sure that the POWER LED has turned orange, wait 15 seconds or more, and then turn off the product.
The access time to the SSD depends on the usage environment.
-

[Precautions for Cycling the Power]

CAUTION

- Before cycling the power to the input power supply, turn off the product and wait 10 seconds or more.
-

[Precautions for Using a Data Storage]

CAUTION

- Do not remove the data storage from the product while the data storage is being accessed, or the data storage and files may be damaged.
 - When installing a USB device into the USB interface of the product, insert the device into place. Not doing so may cause a malfunction due to poor contact.
 - Before installing an expansion board or SSD, make sure to shut off all phases of the external power supply used by the system. Not doing so may cause an electric shock, product damage, or malfunction even if the product is shut down.
 - When installing an SSD into the product, tighten the screws firmly.
-

[Disposal Precautions]

CAUTION

- Dispose of the product as industrial waste. When disposing of batteries, separate them from other wastes according to the local regulations. For the details of the battery regulations in the EU member states, refer to "Handling of batteries and devices with built-in batteries in the EU member states" in this manual.
-

[Transportation Precautions]

CAUTION

- When transporting lithium batteries, follow the transportation regulations. For the details of regulated models, refer to "Precautions for transporting batteries" in this manual.
 - The product is a precision device. During transportation, make sure that the product will not be subject to shocks beyond the general specifications described in this manual. Not doing so may cause a product failure. Check if the product operates correctly after transportation.
 - Prevent the entry of halogens (including fluorine, chlorine, bromine, and iodine) contained in fumigants used for fumigating wood packaging materials, or a product failure may occur. Make sure that fumigant residues will not enter the product, or use an alternative (heat treatment or others) to fumigation. Before packing the product, disinfect wood packaging materials and eliminate insects from the materials.
-

Precautions regarding Warranty

This product was jointly developed and manufactured by Mitsubishi Electric Corporation and Advantech Co., Ltd.
For the warranty, pay attention to the following remarks.

Warranty

Item	MI3321G-W MI3315G-W
Gratis warranty term	18 months after delivery or 24 months from manufacture
Repair term after discontinuation of production	5 years

- For repairs during the gratis warranty term, refer to "Warranty" in this manual.
- If replacement parts become unavailable, some specifications may change or the product may not be repaired even within the repair term.
- It may take some time to respond to the problem or repair the product depending on the condition and timing.

Product Application

(1) In using the Mitsubishi Electric Corporation industrial personal computer (MELIPC), the usage conditions shall be that the application will not lead to a major accident even if any problem or fault should occur in the MELIPC, and that backup and fail-safe functions are systematically provided outside the MELIPC for any problem or fault.

(2) MELIPC is designed and manufactured for applications in general industries and others.

Thus, the following special applications shall be excluded from the MELIPC applications.

Mitsubishi Electric Corporation shall have no responsibility or liability (including, but not limited to any and all responsibility or liability based on contract, warranty, quality assurance, tort, and product liability) for any damage of any kind caused by use of the MELIPC in any application unintended or excluded.

- Nuclear power plants and any other power plants operated by power companies, and applications in which the public could be affected
- Railway companies, public service, and applications in which establishment of a special quality assurance system is required
- Aircraft, medical, railway applications, incineration and fuel devices, manned transportation equipment, recreation and amusement devices, safety devices, and applications in which human life or property could be greatly affected

(3) Mitsubishi Electric shall have no responsibility or liability for any problems involving MELIPC trouble and system trouble by unauthorized access, denial-of-service (DoS) attacks, computer viruses, and other cyberattacks.

Precautions for Use

Precautions for products manufactured by Microsoft Corporation

This product comes with Windows 10 IoT Enterprise preinstalled.

Mitsubishi Electric Corporation will not be responsible for any problem or damage caused by products manufactured by Microsoft Corporation.

For information on problems related to products manufactured by Microsoft Corporation and product specifications, refer to the product manual or contact Microsoft Corporation.

For the contact information of Microsoft Corporation, refer to the following website:

support.microsoft.com/en-us/contactus

Introduction

Thank you for purchasing the MELIPC.

This manual describes the system configuration, specifications, installation, wiring, maintenance and inspection, and troubleshooting of the product.

Before using the product, read this manual and relevant manuals thoroughly and fully understand the functions and performance of the product for correct use.

Make sure to forward this manual to the end user.

Applicable products

MI3321G-W

MI3315G-W

Contents

Safety Precautions	1
Precautions regarding Warranty	7
Product Application	7
Precautions for Use	8
Introduction	9
Relevant Manuals	13
Terms	14

Part 1 Preparation

1	Preparation Steps	16
2	Installing the Product	18
2.1	Mounting the product on the control panel	19
	Installation environment	19
	Installation position	20
	Mounting the product on the control panel	22
2.2	Wiring the power supply	24
2.3	Installing an expansion board	26
3	Setting Up Windows	31
3.1	Setting up Windows	31
	Setup procedure	32
3.2	Recovering the Windows system	35
	Creating a system image	35
	Recovering the system	36
3.3	Changing the default settings	37
	Windows Update settings	37
	IP address settings	39
	Keyboard layout setting	39
	Time zone setting	39
	Automatic time setting	39
3.4	Restrictions	40
	Changing the default partition	40
4	Connections	41
4.1	Connection diagram	41
4.2	Connectable devices	42
5	GT SoftGOT2000	43
5.1	Starting GT SoftGOT2000	44
5.2	Starting GT SoftGOT2000 automatically	45
5.3	Exiting GT SoftGOT2000	47
5.4	Changing the display language of GT SoftGOT2000	48
5.5	Precautions	49

Part 2 Inspection and Maintenance

6	Inspection and Maintenance	54
6.1	Daily inspection	54
6.2	Periodic inspection	54
6.3	Cleaning the screen	54
6.4	Calibrating the touch screen	55
6.5	Creating a system image and recovering the system	55

Part 3 Troubleshooting

7	Troubleshooting	58
7.1	Symptom-based troubleshooting	59
	POWER LED not turning on	59
	Screen display not normal	59
	RS-232, RS-422, or RS-485 connection unable to establish communication	60
	Ethernet connection unable to establish communication	61
	Touch operation unable to work properly	62
	Keyboard layout not of the selected language	62
	Unable to register the Edgecross basic software user	62

Part 4 Appendices

Appendices	64
Appendix 1 Parts names	64
Appendix 2 Product specifications	66
General specifications	66
Performance specifications	67
Power supply specifications	68
Appendix 3 Turning off the product	69
Appendix 4 Preinstalled software	70
Setting when using CC-Link IE TSN Communication Software	71
Appendix 5 Interface specifications	72
Ethernet interface	72
RS-232 interface (COM1)	73
RS-232/RS-422/RS-485 interface (COM2)	74
Appendix 6 EMC Directive	77
EMC Directive requirements	77
Conforming standards in the EMC Directive	77
Installation on a control panel	78
Noise filter (power supply line filter)	79
Appendix 7 Precautions for transporting batteries	80
Perchlorate regulations for the State of California	80
Appendix 8 Batteries in EU member states	81
Appendix 9 Labelling based on local electromagnetic interference laws	82
Appendix 10 Precautions for repairing the product	84
Appendix 11 External dimensions	85
Revisions	86

Warranty87
Intellectual Property Rights88

Relevant Manuals

For the latest e-Manuals and PDF manuals, contact your local distributor.

Manual name [Manual number]	Description	Format
MELIPC MI3000 Series User's Manual [SH-082063ENG]	Explains the steps for MELIPC MI3000 preparation, troubleshooting, and product specifications.	e-Manual PDF
Safety Guidelines [IB-0800622]	Explains the precautions for using MELIPC MI3000 safely.	PDF
GT SoftGOT2000 Version1 Operating Manual [SH-081201ENG]	Explains the performance specifications of GT SoftGOT2000, preparation steps, and troubleshooting.	e-Manual PDF
SLMP Data Collector User's Manual [SH-081919ENG]	Explains the specifications of the SLMP data collector, preparation steps, and troubleshooting.	e-Manual PDF
CC-Link IE TSN Communication Software for Windows User's Manual [SH-082271ENG]	Explains the specifications of CC-Link IE TSN Communication Software for Windows, preparation steps, and troubleshooting.	e-Manual PDF
CC-Link IE TSN Data Collector User's Manual [SH-082275ENG]	Explains the specifications of CC-Link IE TSN Data Collector, preparation steps, and troubleshooting.	e-Manual PDF



e-Manual refers to the Mitsubishi Electric FA electronic book manuals that can be browsed using a dedicated tool.

e-Manual has the following features:

- Required information can be cross-searched in multiple manuals.
- Other manuals can be accessed from the links in the manual.
- Pages that users often browse can be bookmarked.

Terms

Unless otherwise specified, this manual uses the following terms.

Term	Description
Edgecross	Software platform for edge computing that facilitates collaboration between FA and IT systems to achieve new manufacturing solutions.
Edgecross basic software	Software to perform Edgecross functions.
GOT	Abbreviation of Mitsubishi Electric Graphic Operation Terminal.
GT SoftGOT2000	Software that performs GOT functions on a personal computer or panel computer. The software functions the same as GOT2000 series devices, and monitors various FA devices.
MELIPC	Abbreviation of Mitsubishi Electric Industrial PC.
MI3000	Generic term for MI3321G-W and MI3315G-W.
PCAP	Abbreviation of Projected Capacitive. PCAP indicates a projected capacitive touch panel.
SLMP	Abbreviation of Seamless Message Protocol. SLMP is used to access an SLMP-compatible device or the PLC connected to an SLMP-compatible device.
SSD	Abbreviation of Solid State Drive. An SSD is a solid-state storage device.

Part 1

Preparation

Part 1 explains the steps required for product preparation.

Page 16 Preparation Steps

Page 18 Installing the Product

Page 31 Setting Up Windows

Page 41 Connections

Page 43 GT SoftGOT2000

1 Preparation Steps

The following outlines the steps for product preparation.
Follow the steps below for the first startup of the product.

1. Installing the product ( Page 18 Installing the Product)

Do the following:

- Install the product.
- Wire the power supply.

2. Setting up Windows ( Page 31 Setting Up Windows)

Do the following:

- Set up Windows, and change the default settings.

3. Connecting devices according to the connection diagram ( Page 41 Connections)

4. Using GT SoftGOT2000 ( Page 43 GT SoftGOT2000)

Configure the settings on GT SoftGOT2000 or operate it.

- Starting GT SoftGOT2000
- Starting GT SoftGOT2000 automatically upon startup of the MI3000
- Exiting GT SoftGOT2000
- Changing the display language of GT SoftGOT2000

2 Installing the Product

The following outlines how to install the product.

- 1.** Mounting the product on the control panel ( Page 19 Mounting the product on the control panel)

Mount the product on the control panel.

- 2.** Wiring the power supply ( Page 24 Wiring the power supply)

Connect power cables and a ground cable to the product.

- 3.** Installing an expansion board ( Page 26 Installing an expansion board)

Install an expansion board on the product.

Before mounting the product on the control panel, install an expansion board.

2.1 Mounting the product on the control panel

The following explains how to mount the product on the control panel.

Mount the product on the control panel with due consideration of operability, maintainability, and environmental resistance.

Installation environment

Install the product in the environment that is specified in the general specifications. (☞ Page 66 Product specifications)

Do not install or store the product in the following locations.

Doing so may cause a fire, failure, or deterioration in performance.

- Location where the ambient temperature is outside the range of 0 to 55 °C
- Location where the ambient humidity is outside the range of 10 to 90% RH
- Location where condensation may occur due to a sudden change in temperature or humidity
- Location where corrosive gas or chemicals, flammable gas, or radioactive materials may be present
- Location where a large amount of dust, iron powder or other conductive powder, oil mist, salt, or organic solvent is present
- Location subject to direct sunlight
- Location where a strong electric field or magnetic field may exist
- Location where strong electromagnetic noise may be superimposed on the power supply cables
- Location where the product is subject to continuous vibrations or strong impacts

Installation position

Control panel inside dimensions

Install the product with consideration of the control panel inside dimensions and the installation prohibited area. Depending on the types of cables connected to the product, the distance more than the described dimensions may be required. Install the product with consideration of the connector dimensions and the cable bend radius.

Panel cutting dimensions

The following shows the panel cutting dimensions for the product.

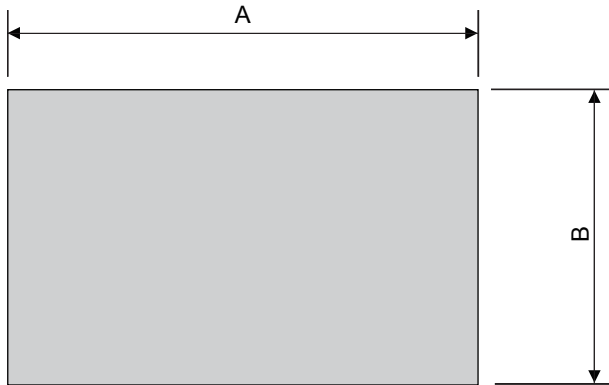

Unit: mm

Item	MI3321G-W	MI3315G-W
A	550.3 (+0.75, -0.75)	374.5 (+0.75, -0.75)
B	341.8 (+0, -0.8)	298.5 (+0, -0.8)

Installation position

The product requires some distance from other structures and devices.

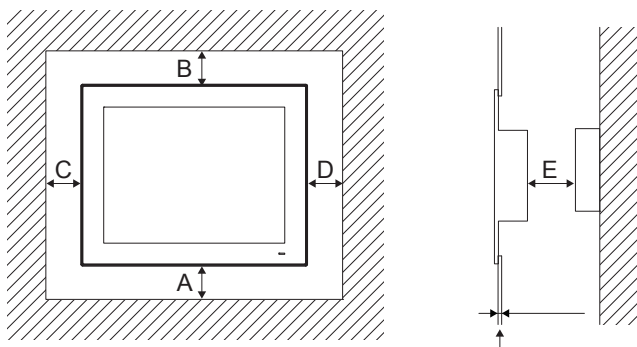

Panel thickness: 2 to 6 mm (0.08 to 0.24 inch)

Unit: mm

Item	MI3321G-W	MI3315G-W
A	20	
B	20	
C	20	
D	20	
E	3	

Positions of fittings

Use fittings to fix the product on the control panel.

- MI3321G-W: 12 places
- MI3315G-W: 10 places

The following shows the positions of the fittings.

■MI3321G-W

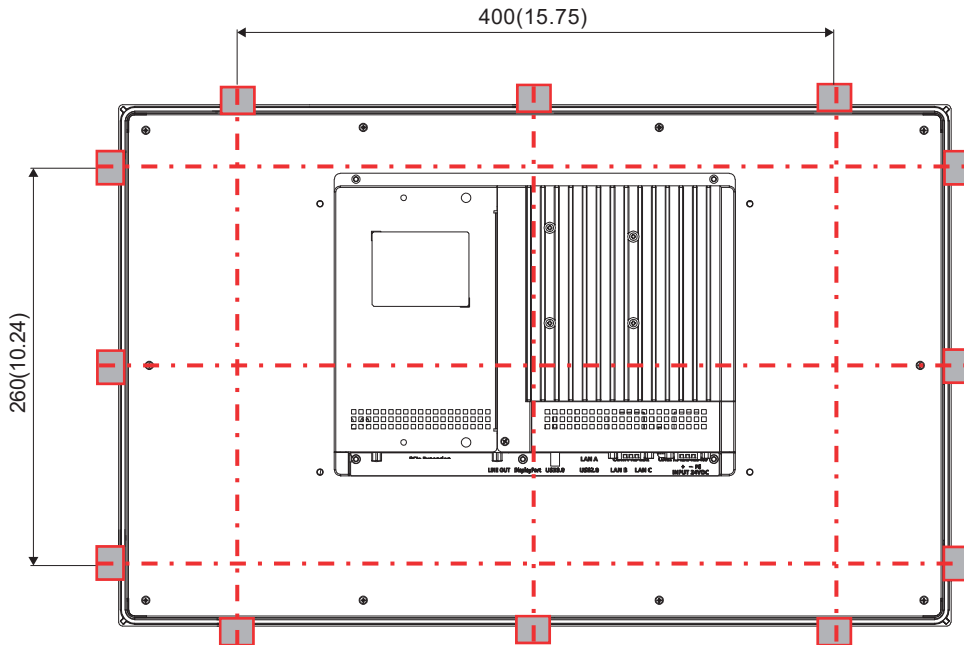

Unit : mm (inch)

■MI3315G-W

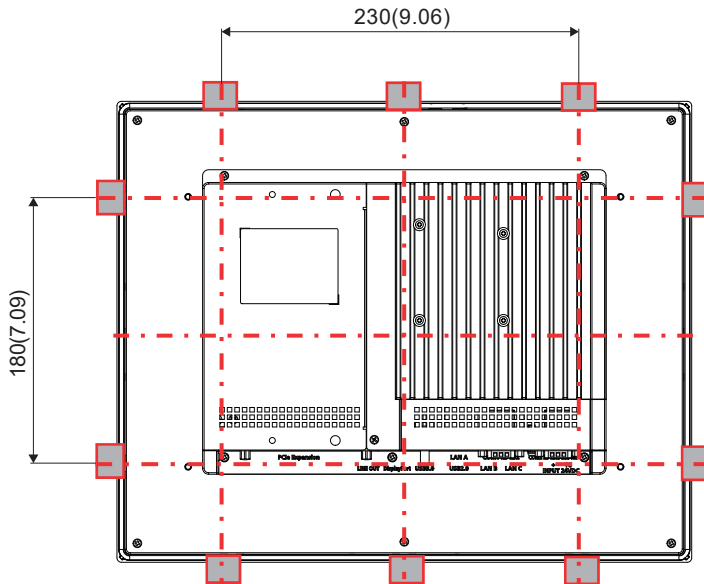

Unit : mm (inch)

Mounting the product on the control panel

The following shows how to mount the product on the control panel.

Installation procedure

The following explains how to mount MI3315G-W as an example.

1. Insert each screw into the screw hole of a fitting included with the product.

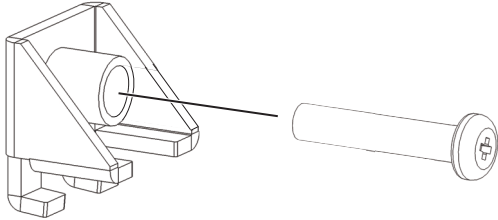

2. Make sure that the waterproof gasket is in place, and align the product with the opening in the control panel.

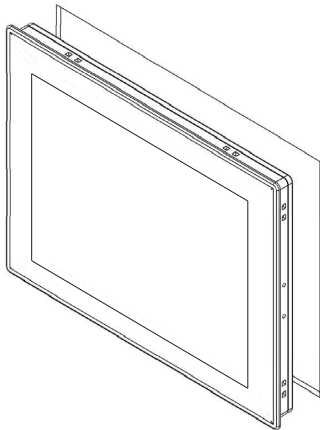

3. Install the fittings on the product from the back of the control panel.

For the installation positions of the fittings and the number of the fittings, refer to the following.

☞ Page 21 Installation position

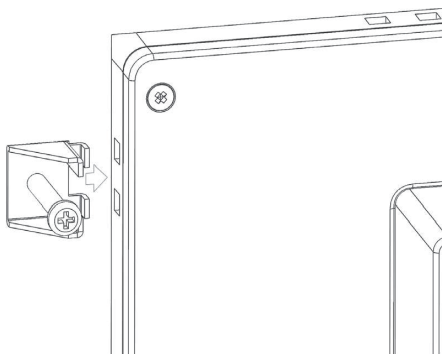

4. Tighten each screw to the specified torque (0.44 N•m to 0.54 N•m) with a No. 2 Phillips screwdriver to fix the product.

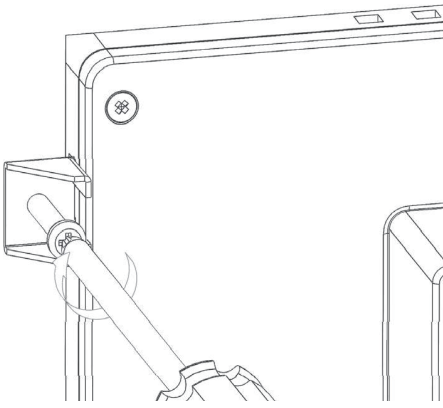

2.2 Wiring the power supply

The following explains wiring the power supply of the product.

Connecting a power cable or ground cable

1. Insert power cables and a ground cable into each terminal of the power supply connector, and tighten the screws to the specified torque (0.2 N•m).

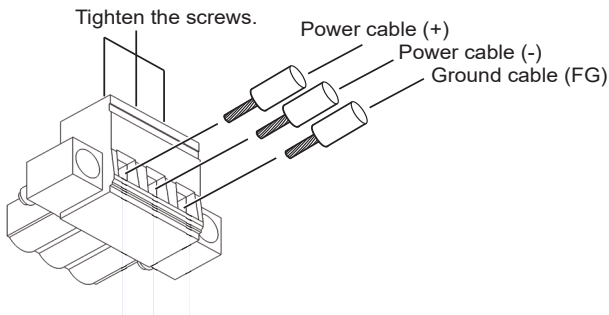

2. Insert the power supply connector into the power supply terminal of the product, and tighten the screws to the specified torque (0.2 N•m).

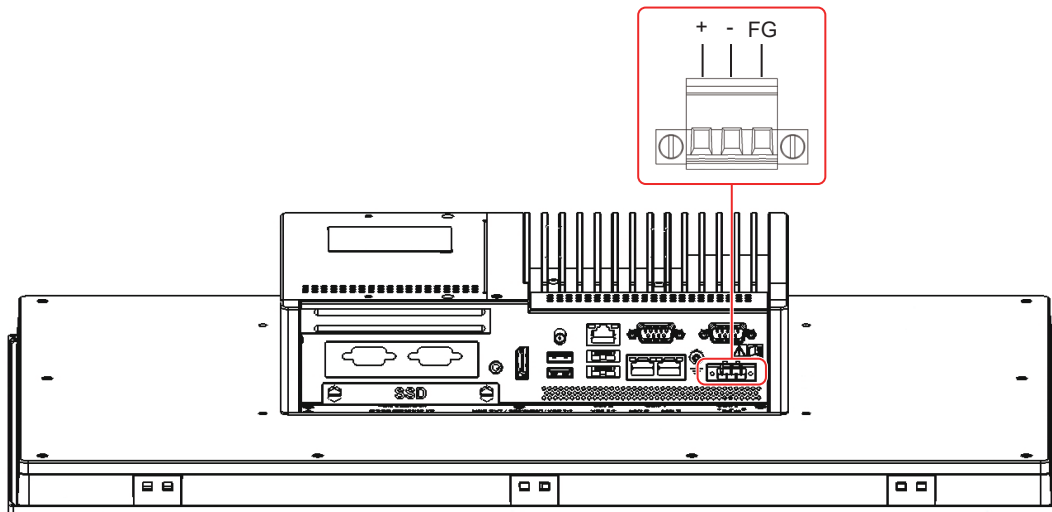

3. Connect the power cables to the power supply of the system, and connect the ground cable to the control panel.

Point

- Use an uninterruptible power supply (UPS) to safeguard against instantaneous power failure.
- Do not use a UPS that outputs square waves.

Grounding

- Ground the product independently if possible. The ground resistance must be $100\ \Omega$ or less, and the cross-sectional area of the ground cable must be $2.0\ \text{mm}^2$ or more.
- Use the thickest ground cable possible ($2.5\ \text{mm}^2$ maximum). Install the product as close as possible to the ground point to shorten the ground cable.
- If the product cannot be grounded independently, perform shared grounding using ground cables in the same length.

2

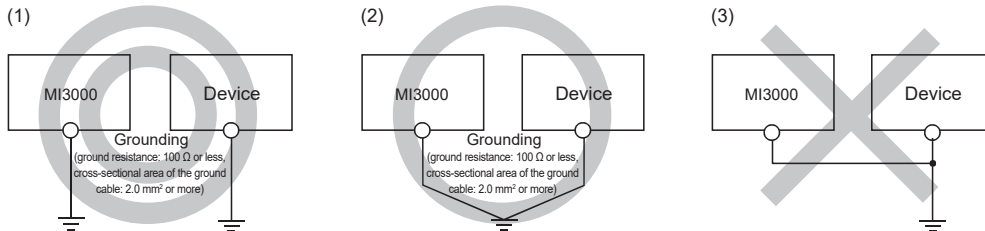

2.3 Installing an expansion board

You can install an expansion board on the M.2 (2280) SATA interface, mini PCI Express interfaces, or PCI Express interface. The following shows how to install an expansion board.

Removing the cover from the product

Remove the two screws that fix the cover on the back of the product, and slide the cover to remove.

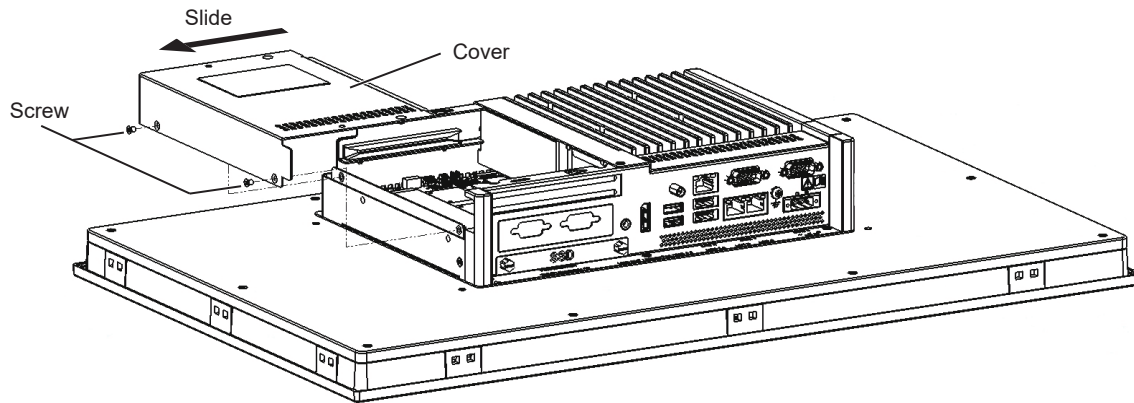

Installing an expansion board on the M.2 (2280) SATA interface

1. Remove the screw for fixing an expansion board from the M.2 (2280) SATA interface, and install an expansion board.
2. Fix the expansion board with the screw.

M.2(2280) SATA interface

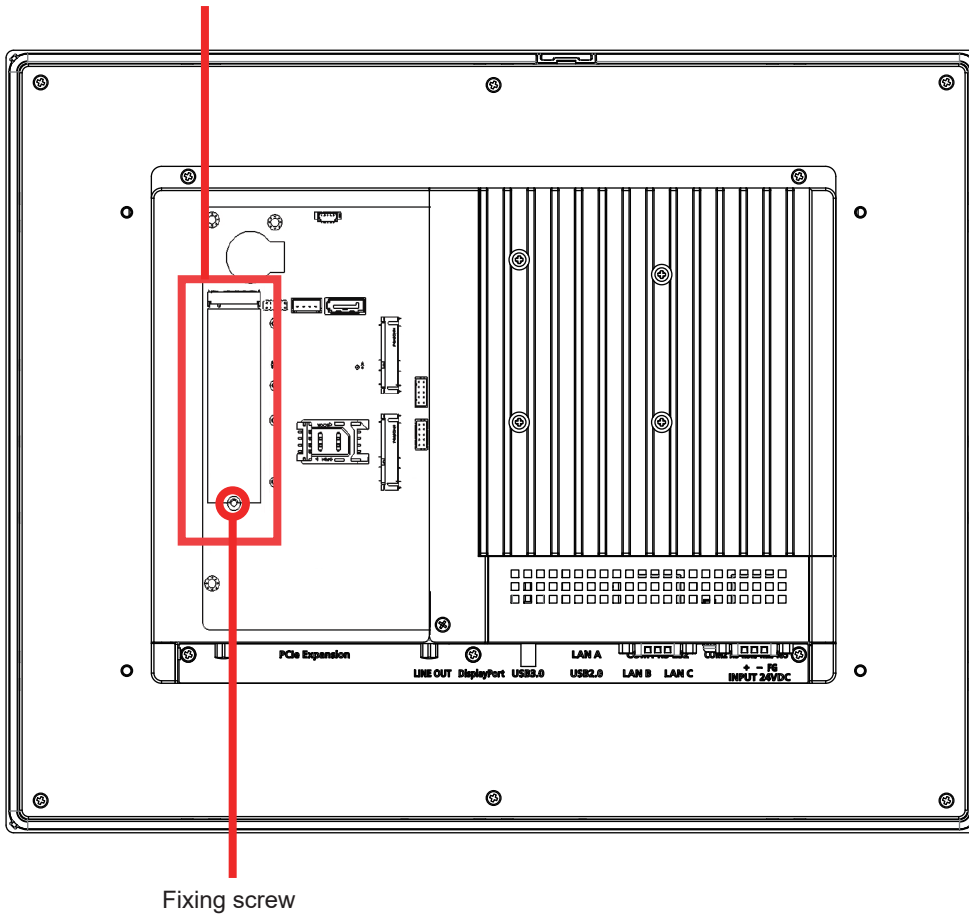

Installing expansion boards on the mini PCI Express interface

1. Remove the screws for fixing an expansion board from each mini PCI Express interface, and install full-size expansion boards (2 max.).
2. Fix the expansion board with the screws.

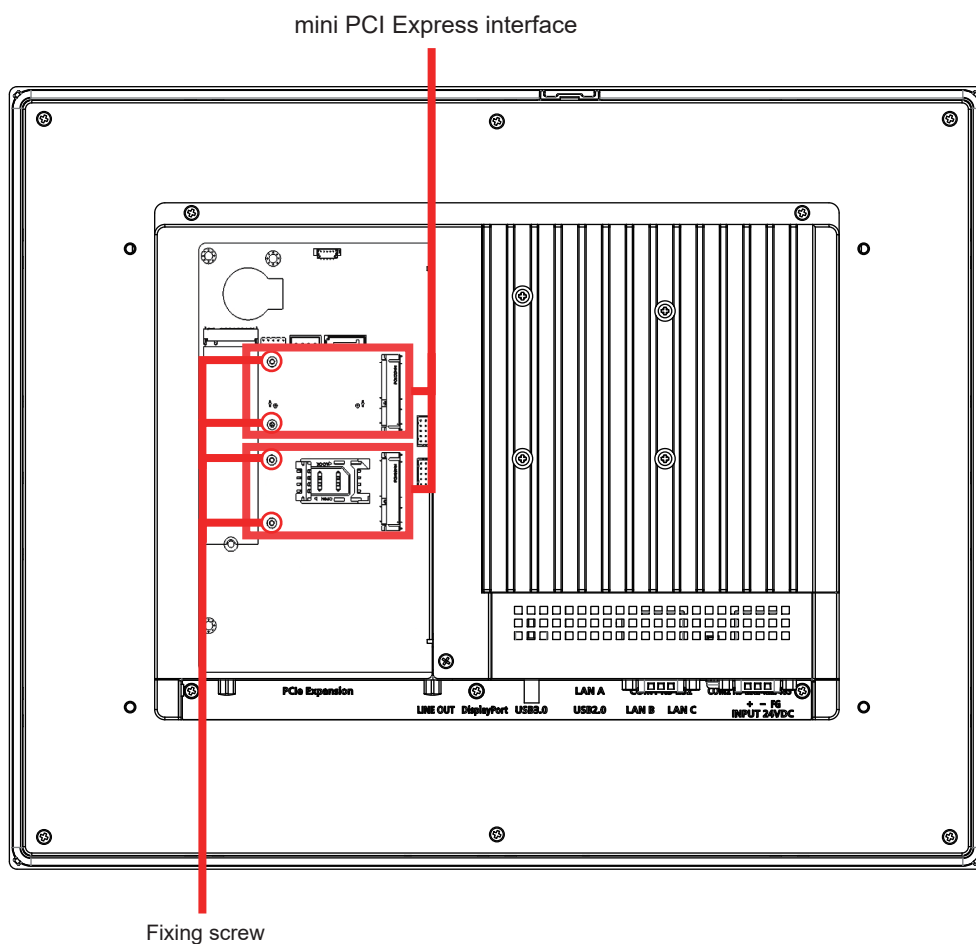

Installing an expansion board on the PCI Express interface

1. Remove the screw for fixing the PCI slot cover, and remove the cover.

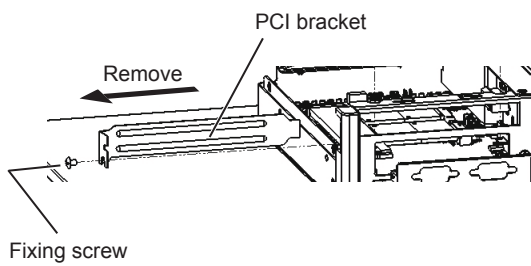

2. Install a half-size expansion board.
3. Fix the board with the screw.

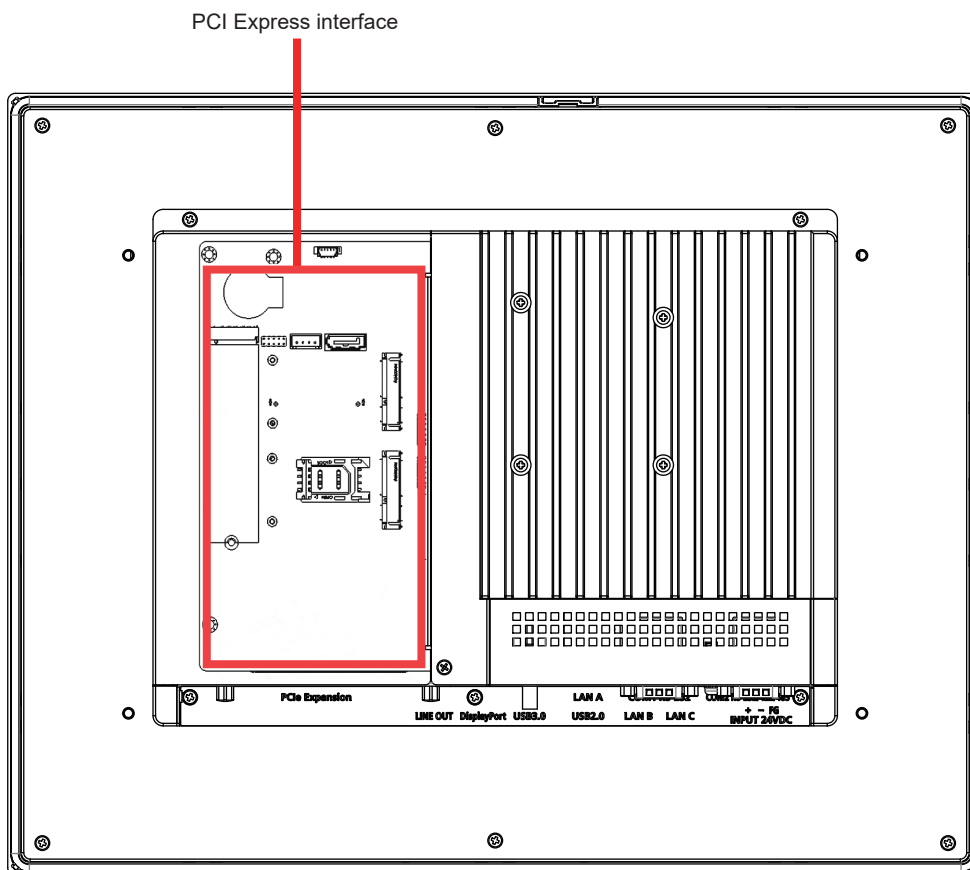

Installing the cover on the product

Install the removed cover on the product in the reverse of the removal procedure.

3 Setting Up Windows

The following outlines how to set up Windows.

1. Turning on the MI3000

Turn on the MI3000.

2. Setting up Windows (🔗 Page 31 Setting up Windows)

Set up Windows.

3. Creating a system image (🔗 Page 35 Recovering the Windows system)

Create a system image, and recover the Windows system.

4. Changing the default settings (🔗 Page 37 Changing the default settings)

Change the default settings of Windows as necessary.

Restart the MI3000 after you change the settings.

3.1 Setting up Windows

When you turn on the MI3000 for the first time or after Windows recovery, the Windows Setup starts.

Follow the setup wizard, and set up Windows.

Afterward, change the default settings of Windows as necessary. (🔗 Page 37 Changing the default settings)

Point

Even if you select a display language other than English, the US keyboard layout (101 keys) will be applied.

To use any other keyboard, change the keyboard layout setting.

(🔗 Page 39 Keyboard layout setting)

Precautions

- Do not shut down or restart Windows, or do not turn off the MI3000 until the setup is complete. Otherwise, Windows may not be set up properly. *1

*1 Excluding when the system restarts automatically.

Setup procedure

1. Select a language to be used in Windows.

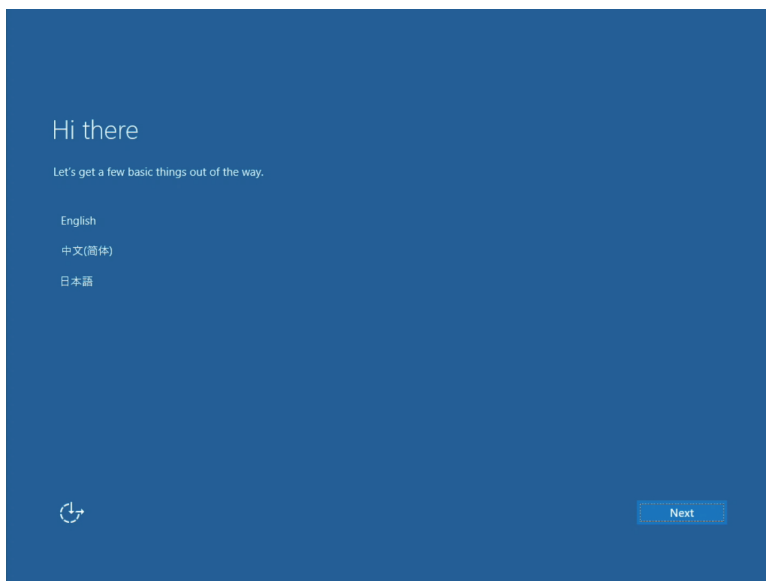

2. Set the following, and select the [Next] button.

- Select your home country or region.
- Select your preferred application language according to the language selected in step 1.
- If you have selected any language other than [Japanese] in step 1, select a keyboard layout.
- If you have selected [Japanese] in step 1, the US keyboard layout is applied.

For changing the keyboard layout to the Japanese layout, refer to the following.

 [Page 39 Keyboard layout setting](#)

- Select your time zone.

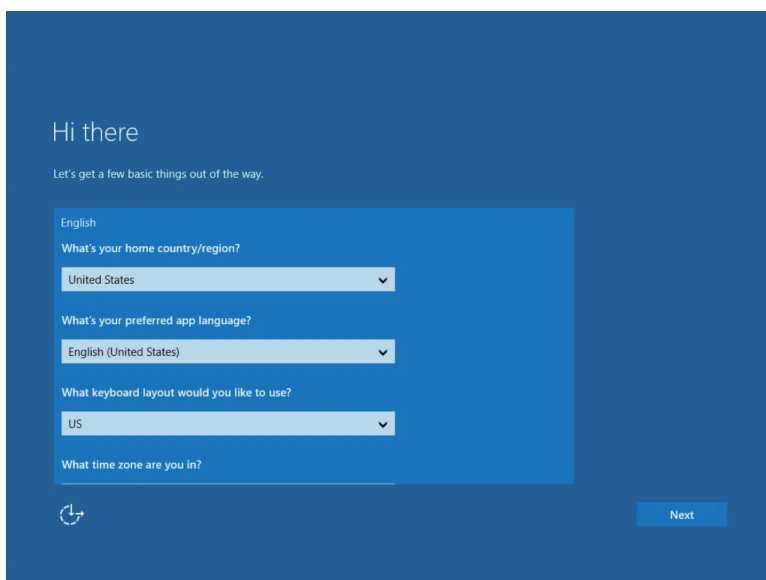

3. Check the license terms, and select the [Accept] button.

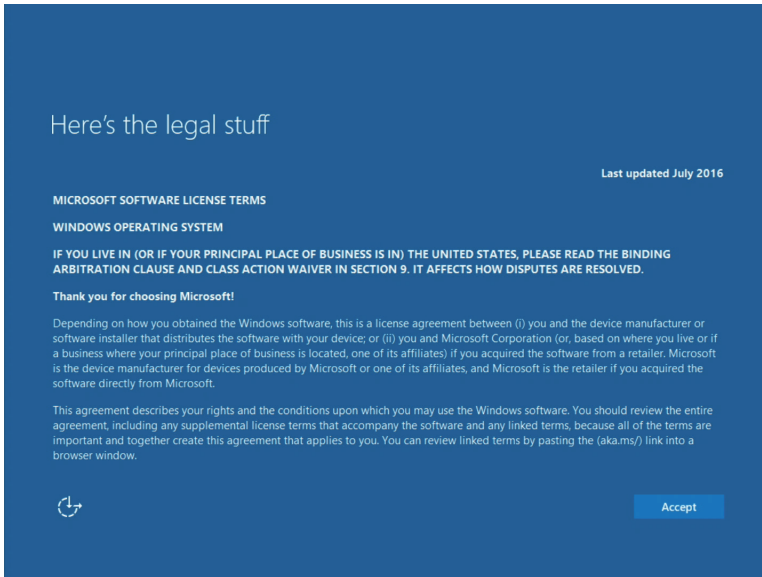

4. Select whether to use Express settings.

- To use Express settings, select the [Use Express settings] button.
- To customize the settings, select the [Customize] button.

Point 

If you select the [Customize] button, you can customize the following settings.

- [Personalization]
- [Location]
- [Connectivity and error reporting]
- [Browser, protection, and update]

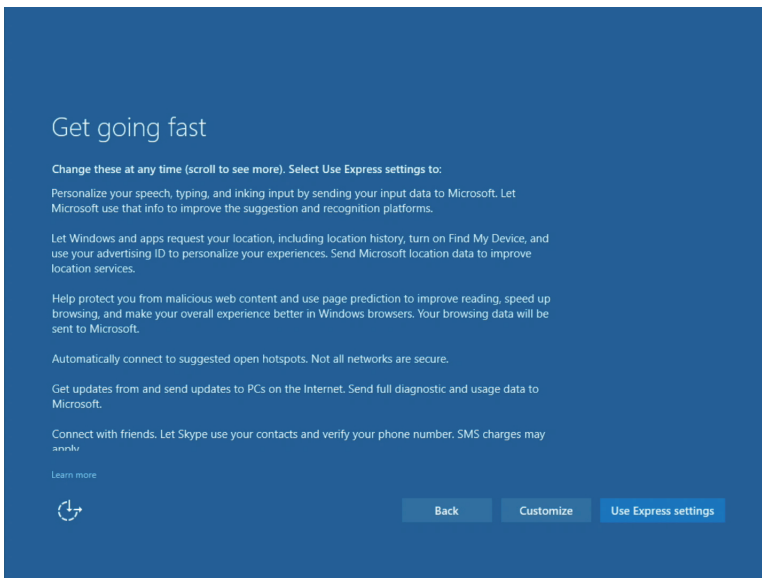



5. Set a user name and a password, and select the [Next] button.

Point 

You can proceed to the next setting without setting a password.

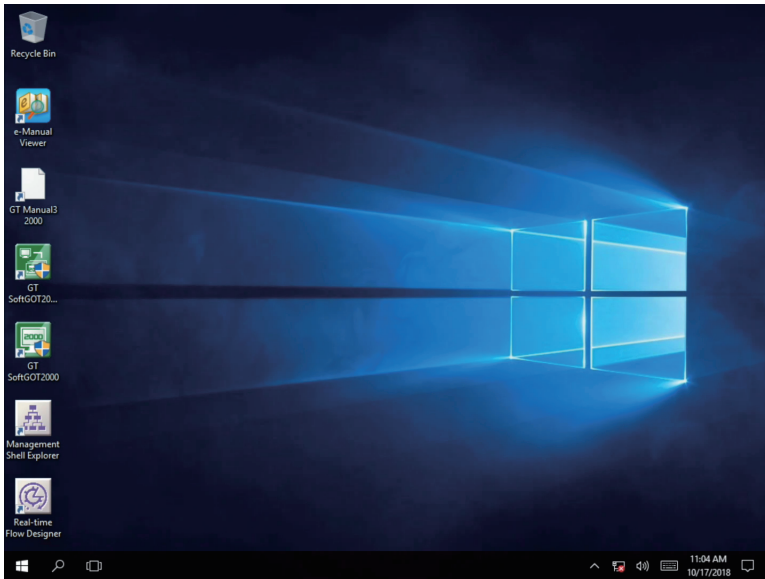
6. Wait for the desktop to appear.



7. The Windows setup has been completed.
8. Create a system image to recover the Windows system. ( Page 35 Recovering the Windows system)

Point 

When connecting to the Internet, performing a manual Windows Update is recommended to apply Security Update for Windows.

After Windows Update, restart Windows manually if Windows recommends to do so.

Otherwise, Security Update content may not be applied since an automatic restart after Windows Update is disabled in this product.

3.2 Recovering the Windows system

The following shows how to recover the Windows system.

Recover the system if Windows does not work.

Create a system image before recovering the system.

Precautions

Use the system image created from the MI3000 to recover the Windows system.

Do not turn off the MI3000 during Windows recovery.

Otherwise, Windows may not start properly.

In such a case, recover the Windows system again.

Creating a system image

The following shows how to create a system image.

1. Connect an external drive such as an HDD to the USB port of the MI3000.
2. Select the Start button, [Windows System], and then [Control Panel].
3. Select [Backup and Restore (Windows 7)].
4. Select [Create a system image], and save the system image to the external drive.
5. To create a system repair disc, connect an external DVD drive and insert a blank disc.
6. Select [Create a system repair disc], and select the DVD drive.
7. Select [Create disc] to create a system repair disc.

Recovering the system

The following shows how to recover the system.

- 1.** Prepare the external HDD that stores the system image of the MI3000.
- 2.** Insert the system repair disc into an external DVD drive.
- 3.** Connect the HDD and the DVD drive to the USB ports of the MI3000, and start the MI3000.
- 4.** On the BIOS screen appearing upon startup, press the [Delete] key.
- 5.** Select the [Boot] tab. In [Boot Option Priority], select the external DVD drive as the first drive, and the SSD built in the MI3000 as the second drive.
- 6.** On the [Save & Exit] tab, execute [Save Changes and Reset].
- 7.** The MI3000 restarts and displays a message saying [Press any key]. Press any key, and wait a few minutes for the next step.
- 8.** On the [Choose your keyboard layout] screen, select a keyboard layout.
- 9.** On the [Choose an option] screen, select [Troubleshoot].
- 10.** On the [Advanced options] screen, select [System image recovery].
- 11.** On the [System image recovery] screen, select [Windows 10].
- 12.** On the [Select a system image backup] screen, select [Use the latest available system image (recommended)] and select [Next].
- 13.** On the [Choose additional restore options] screen, select [Next].
- 14.** A message appears saying [Your computer will be restored from the following system image:]. Check the creation date and time of the system image for restoring the system, the computer on which the image is created and the drive to be restored, and then select [Finish].
- 15.** A message appears saying [All data on the drives to be restored will be replaced with the data in the system image. Are you sure you want to continue?]. Select [Yes].
- 16.** A message appears saying [Windows is restoring your computer from the system image. This might take from a few minutes to a few hours.]. Restoring the selected drive starts. Wait for a while.
- 17.** The MI3000 restarts. Check that the specified drive has been restored.

3.3 Changing the default settings

After setting up Windows, change the default settings of Windows as necessary. Afterward, restart the MI3000.

Windows Update settings

To prevent a forced restart of Windows after the automatic updating of Windows Update while the MI3000 is running, the following group policy is enabled.

Group policy	Setting
No auto-restart with logged on users for scheduled automatic updates installations	Enabled

Changing the settings

Change the Windows Update settings in the following procedure.

1. Perform one of the following operations to open the Local Group Policy Editor.
 - On the [Run] screen, enter "gpedit.msc" for [Open] and execute the file.
 - In the search box on the taskbar, enter "gpedit.msc" and execute the file.
 - In Command Prompt, enter "gpedit.msc", and execute the file.
2. On the Local Group Policy Editor, select [Local Computer Policy] ⇒ [Computer Configuration] ⇒ [Administrative Templates] ⇒ [Windows Components] ⇒ [Windows Update] ⇒ [No auto-restart with logged on users for scheduled automatic updates installations].

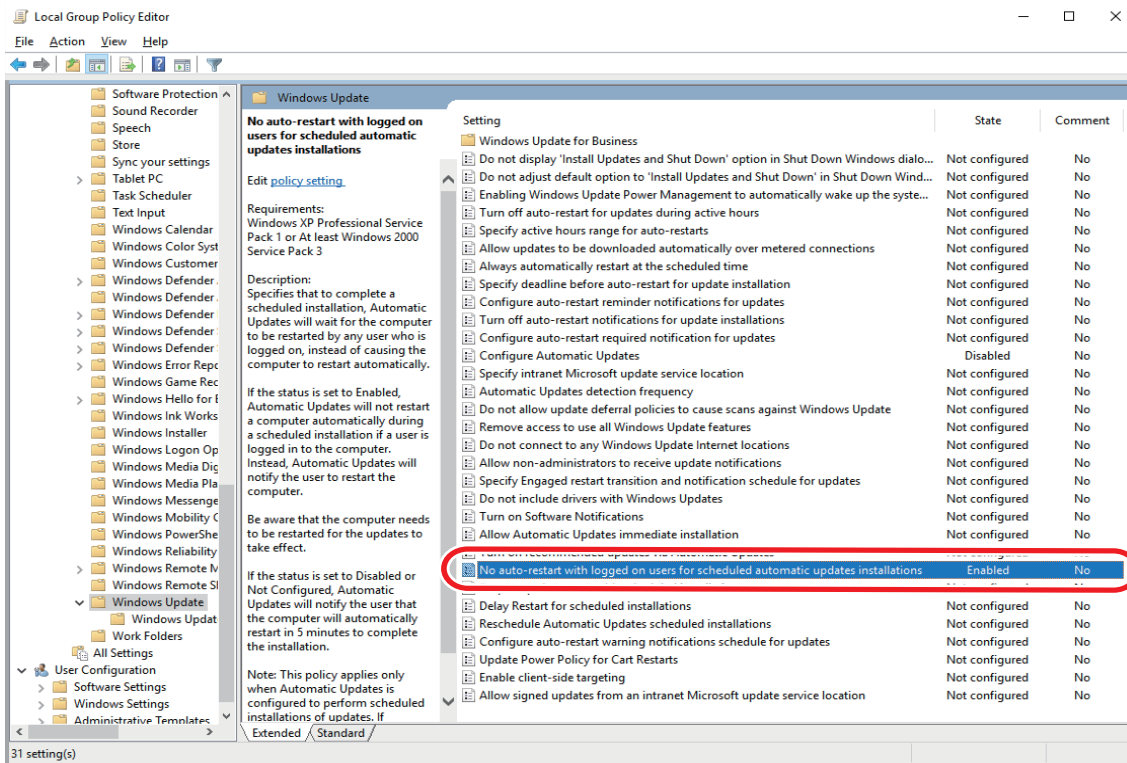

3. Select [Action] ⇒ [Edit] to open an editing screen, and change the settings as necessary.

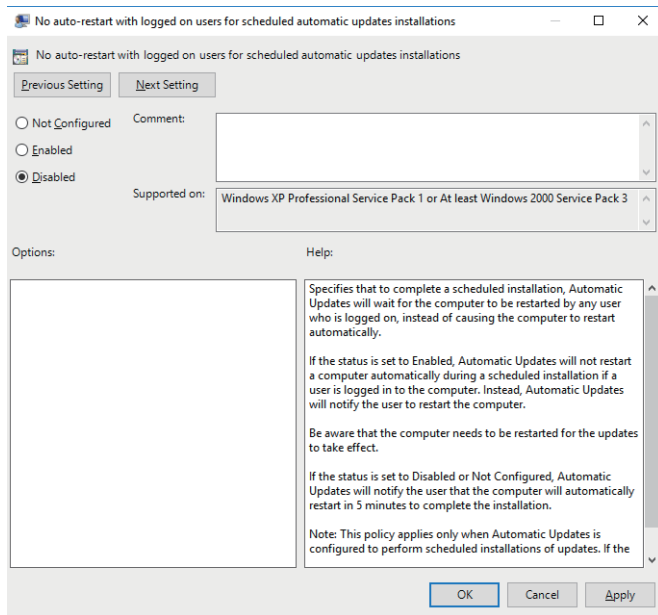

IP address settings

The IP address of the connected Ethernet port is acquired at the initial startup of Windows.
The IP address settings of the Ethernet port are user-changeable in [Ethernet].
Change the IP address settings of the Ethernet port as necessary.

Setting method

Start button ⇒ [Windows System] ⇒ [Control Panel] ⇒ [View network status and tasks] ⇒ [Change adapter settings].

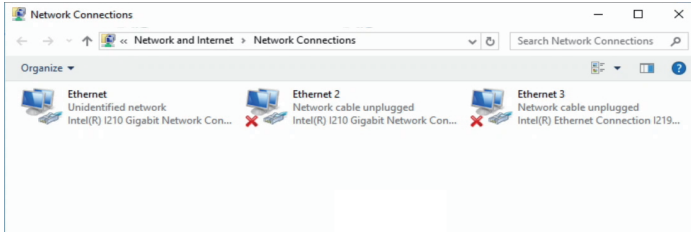

Precautions

If the Ethernet cable is connected improperly, the [Ethernet] icon is marked with an X. Connect the Ethernet cable properly.

Keyboard layout setting

Even though you select a language other than English, the US keyboard layout (101 keys) is applied.
To use any other keyboard layout, change the keyboard layout setting.

Setting method

Start button ⇒ [Settings] ⇒ [Time & language] ⇒ [Region & language] ⇒ [Languages] ⇒ [Windows display language] ⇒ [Options] ⇒ [Hardware keyboard layout]

Time zone setting

Change the setting as necessary.

Setting method

Start button ⇒ [Settings] ⇒ [Time & language] ⇒ [Date & time] ⇒ [Time zone]

Automatic time setting

[Set time automatically] is disabled by default.
Change the setting as necessary, for example, to use the clock data synchronization function of the MI3000.

Setting method

Start button ⇒ [Settings] ⇒ [Time & language] ⇒ [Date & time] ⇒ [Set time automatically]

3.4 Restrictions

The following shows restrictions on using Windows.

Changing the default partition

Do not change the default partition on drive C where Windows is installed. For example, do not resize or divide the partition. Otherwise, the product may not operate properly.

4 Connections

4.1 Connection diagram

The following shows connectable devices and the corresponding interfaces of the MI3000.
Connect the following devices according to the usage environment.

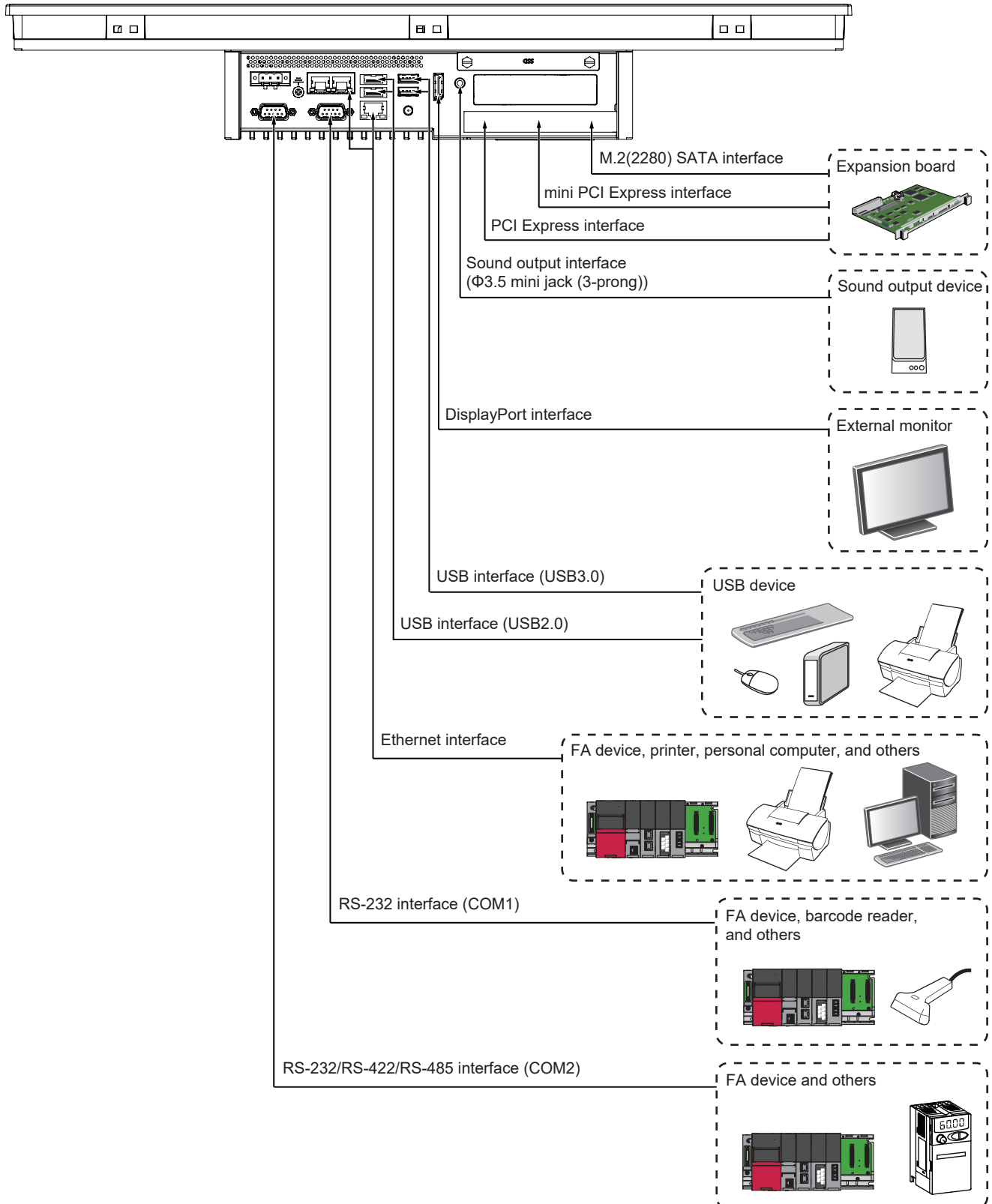

4.2 Connectable devices

The followings shows devices connectable to the MI3000.

Peripherals

■Expansion board

An expansion board that is compatible with PCI Express, mini PCI Express, or M.2(2280) SATA is connectable.

■Sound output device

A sound output device such as a speaker with a built-in amplifier is connectable.

■External monitor

A DisplayPort-compatible monitor is connectable.

■USB device

Devices compatible with USB 2.0 or USB 3.0 are connectable.

FA devices

FA devices that are compatible with the Ethernet connection or the serial connection (RS-232, RS-422, or RS-485) are connectable.







For the connectable devices and system configuration when using GT SoftGOT2000, refer to the following.

GT SoftGOT2000 Version1 Operating Manual

To view the above manual, start e-Manual Viewer.

5 GT SoftGOT2000

The following outlines how to start or exit GT SoftGOT2000 and how to change the language of GT SoftGOT2000.

- 1.** Starting GT SoftGOT2000 ( Page 44 Starting GT SoftGOT2000)
Start GT SoftGOT2000.
- 2.** Starting GT SoftGOT2000 automatically ( Page 45 Starting GT SoftGOT2000 automatically)
Configure the settings on GT SoftGOT2000 so that it starts automatically upon startup of the MI3000.
- 3.** Exiting GT SoftGOT2000 ( Page 47 Exiting GT SoftGOT2000)
Exit GT SoftGOT2000.
- 4.** Changing the display language of GT SoftGOT2000 ( Page 48 Changing the display language of GT SoftGOT2000)
Change the display language of GT SoftGOT2000.

Point

For the details of GT SoftGOT2000, refer to the following.

 GT SoftGOT2000 Version1 Operating Manual

To view the above manual, start e-Manual Viewer.

5.1 Starting GT SoftGOT2000

The following shows how to start GT SoftGOT2000.

Point

GT SoftGOT2000 is usable without a USB license key on the MI3000.

There is no risk of a USB license key being stolen or damaged, and no USB port is used for a USB license key.

1. Select the Start button → [MELSOFT] → [GT Works3] → [GT SoftGOT2000]. The software license agreement screen appears at the first startup. Select the [Agree] button if you agree to the agreement.
2. In the dialog requesting the administrator authority, select the [OK] button.

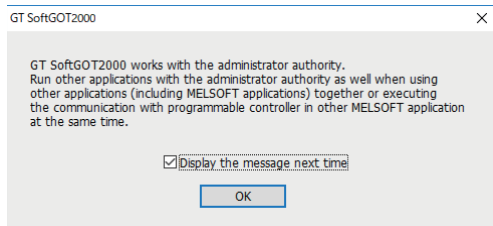

3. GT SoftGOT2000 starts.

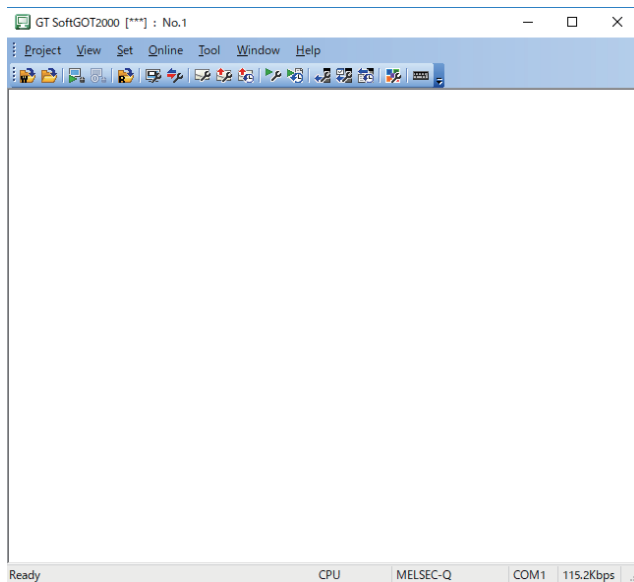

4. Open a project created with GT Designer3.

Point

- For the details of GT SoftGOT2000, refer to the following.

 GT SoftGOT2000 Version1 Operating Manual

To view the above manual, start e-Manual Viewer.

- For the details of GT Designer3, refer to the following.

 GT Designer3 (GOT2000) Screen Design Manual

5.2 Starting GT SoftGOT2000 automatically

The following shows how to configure the settings with [Task Scheduler] of Windows to start GT SoftGOT2000 automatically upon startup of the MI3000.

Point

To use this automatic startup, make sure to turn on the device to be monitored, and then start the MI3000.

1. Start GT SoftGOT2000, and read the project data to be used at automatic startup of GT SoftGOT2000.
2. In the [Environment Setup] dialog, select the [Auxiliary Setup] tab, and clear [Display the dialog about administrator authority when starting GT SoftGOT2000].
3. Select [Online] → [Startup in Online Mode] to set GT SoftGOT2000 into the mode.
4. Exit GT SoftGOT2000.
5. Search for "task" in the search box on the right of the Start button, and select [Task Scheduler] from the search results.

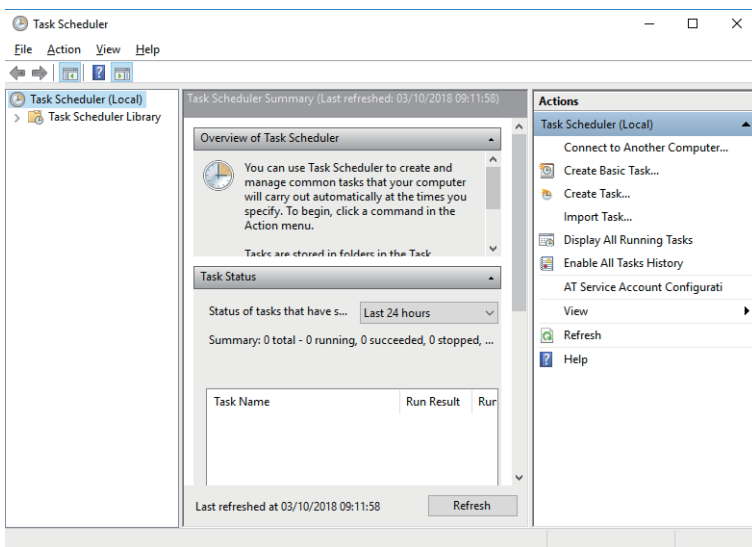

6. Select [Actions] → [Create Task] to display the [Create Task] dialog. On the [General] tab, configure the following settings.
 - Enter a name for [Name].
 - Select [Run with highest privileges].
 - Select [Windows 10] for [Configure for].

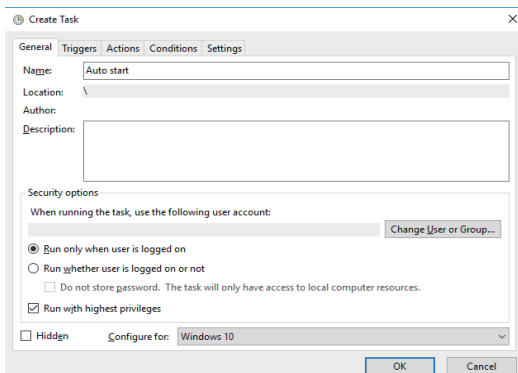

- 7.** On the [Triggers] tab, select the [New] button to display the [New Trigger] dialog. Configure the following settings.
- Select [At log on] for [Begin the task].
 - Select [Delay task for], and select [30 seconds]. (Set a time according to the MI3000 environment.)
 - Select [Enabled].

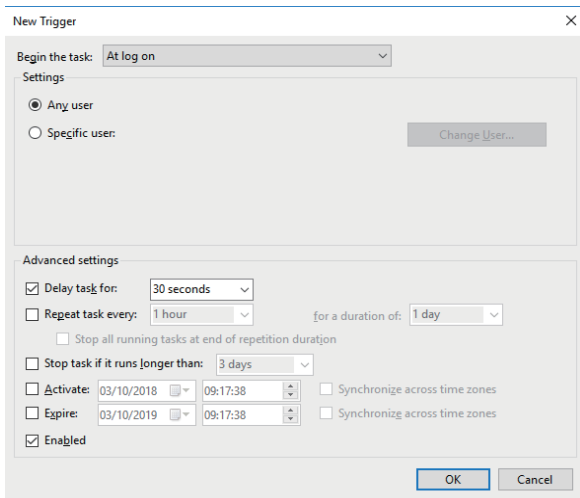

- 8.** On the [Actions] tab, select the [New] button to display the [New Action] dialog. Configure the following settings.
- Select [Start a program] for [Action].
 - Specify the executable file of GT SoftGOT2000 for [Program/script]. (Default: C:\Program Files (x86)\MELSOFT\SGT2000\SGT2000.exe)

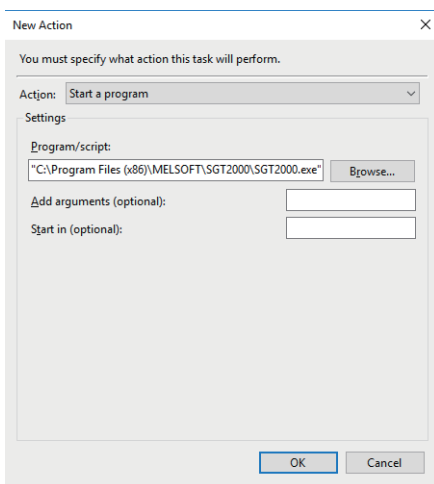

- 9.** On the [Settings] tab, configure the following settings.
- Select [If the task fails, restart every] as necessary.
 - Change the setting of [Stop the task if it runs longer than] as necessary. (Default: 3 days)

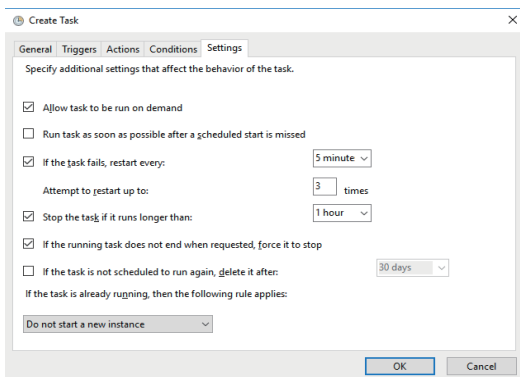

- 10.** Select the [OK] button to complete the settings.

5.3 Exiting GT SoftGOT2000

The following shows how to exit GT SoftGOT2000.

1. Perform one of the following operations.
 - Select [Project] → [Exit] from the menu.
 - Select [×] on the title bar.
2. GT SoftGOT2000 exits.

5.4 Changing the display language of GT SoftGOT2000

The following shows how to change the display language of GT SoftGOT2000.

How to change the display language

The following shows how to change the display language of GT SoftGOT2000.

1. Select [View] → [Switch Display Language] from the menu.

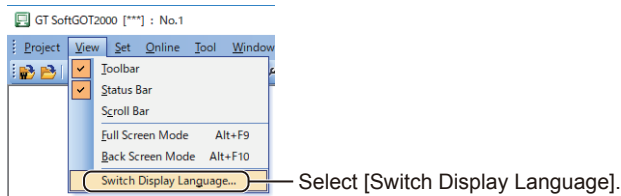

2. In the [Switch Display Language] dialog, set the following item and select the [OK] button.

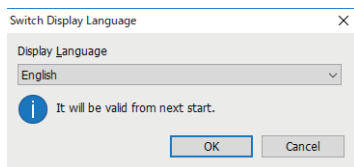

Item	Description
[Display Language]	Select a display language. <ul style="list-style-type: none"> • [English] • [Japanese(日本語)] • [Chinese Simplified(简体中文)]

3. Restart GT SoftGOT2000 to display the menu items, dialogs, messages, and others in the set language.

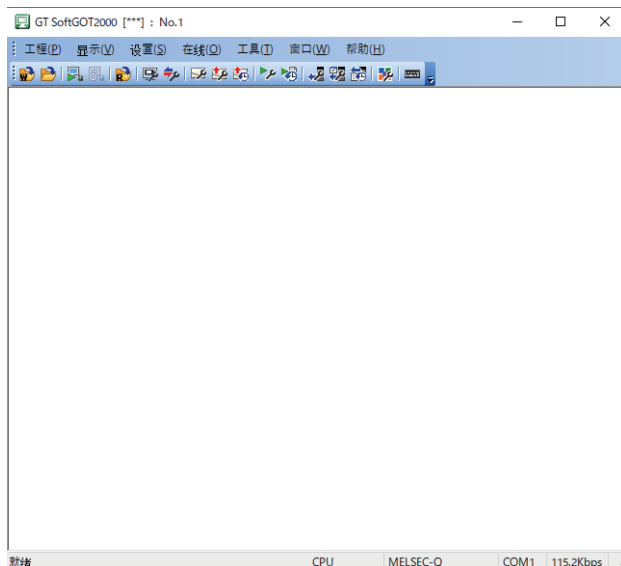

Items to which the display language switching is not applied

The display language switching is not applied to the following items.

Item	Display specifications
Some context menu items	The display language depends on the OS language.
Setting items and buttons in some dialogs	The display language depends on the OS language.
Advanced APP setup ^{*1}	The display language depends on the OS language.
Advanced APP setup files	
Log file for checking the settings	

*1 To display the setting, select [Set] → [Application Setup] → [Application Start-up Setting] → [Advanced APP Setup] tab in [Application Start-up Setting] dialog.

5.5 Precautions

Starting an application while GT SoftGOT2000 is running

Run an application according to the User Account Control (UAC) setting of Windows.

■When the User Account Control (UAC) is disabled

You do not need to select [Run as administrator] to run an application.

■When the User Account Control (UAC) is enabled

Select [Run as administrator] to run an application.

1. On the Windows start menu, perform one of the following operations to select an application to run.
 - On the touch screen, press and hold an application.
 - With your mouse, right-click an application.
2. Select [More] → [Run as administrator] to run the application.

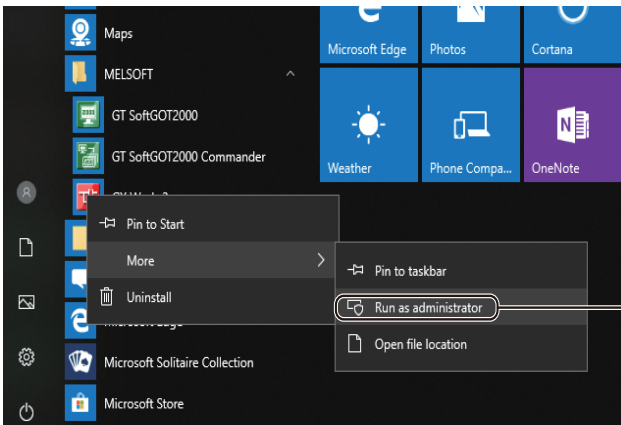

Select [Run as administrator].

■ Always running an application as an administrator

To always run an application as an administrator, configure the following settings.

1. Perform one of the following operations to select an application to run.
 - On the touch screen, press and hold an application, and select [Properties].
 - With your mouse, right-click an application and select [Properties].

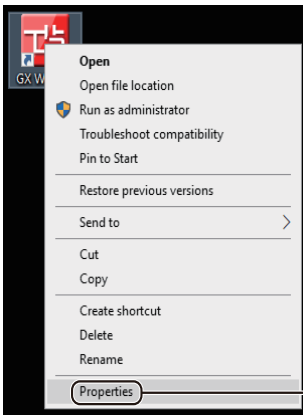

Select [Properties].

2. In the properties dialog, select the [Compatibility] tab, and select [Run this program as an administrator] in [Settings].

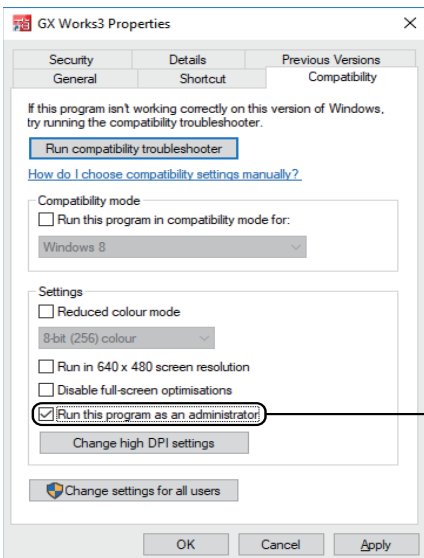

Select [Run this program as an administrator].

3. Select the [OK] button to close the dialog.

Updating GT SoftGOT2000

To update GT SoftGOT2000 preinstalled on the MI3000, use the latest version (English) of the installer.



For the installer, contact your local distributor.

MEMO

Part 2

Inspection and Maintenance

Part 2 explains the inspection and maintenance of the product.

Page 54 Inspection and Maintenance

6 Inspection and Maintenance

The following explains daily and periodic inspection items.

Point

- If you do not operate the product for a long time, make sure to turn off the product to prevent accidents such as electric leakage or insulation failure due to the end of the product life or product deterioration.
- Replace the battery periodically. For details on replacing the battery, consult your local sales office.

6.1 Daily inspection

The following shows daily inspection items.

Item	Method	Criteria	Action
Product installation status	Check for loose screws.	Securely tightened.	Retighten the screws.
Connection status of the connectors	Check for loose cable connectors.	Not loose	Firmly connect the connectors.
Adherence of dust or foreign matter on the product	Check visually.	No dust or foreign matter adhered.	Remove dust or foreign matter and clean the product.

6.2 Periodic inspection

The following shows half-yearly or yearly inspection items.

Inspect these items when moving or modifying equipment as well.

Item	Method	Criteria	Action
Operating ambient temperature *1	Measure with a thermometer.	0 to 55°C	Operate the product in the environment that meets the criteria.
Operating ambient humidity *1	Measure with a hygrometer.	10 to 90% RH	
Presence of corrosive gas in the surrounding environment *1	Measure corrosive gas.	No corrosive gas	
Power supply voltage check	Measure the voltage across 24 V DC terminals.	19.2 V DC to 28.8 V DC	Change the supply power.
Product installation status	Check for loose screws.	Securely tightened.	Retighten the screws.
Adherence of dust or foreign matter on the product	Check visually.	No dust or foreign matter adhered.	Remove dust or foreign matter and clean the product.
Connection status of the connectors	Check for loose cable connectors.	Not loose	Firmly connect the connectors.
Battery life	Check the elapsed years from when the product is purchased.	Within four years	Replace the battery within four years after the purchase of the product.

*1 Environment inside the control panel enclosure on which the product is installed

6.3 Cleaning the screen

Keep the product clean for use. Before cleaning the product, make sure to turn off the product, and wipe the dirty part with a soft cloth using neutral detergent or ethanol.

6.4 Calibrating the touch screen

If you receive inaccurate touch responses, calibrate the touch screen.
The following shows how to calibrate the touch screen.

1. Select [Control Panel] → [Hardware and Sound] → [Tablet PC Settings].

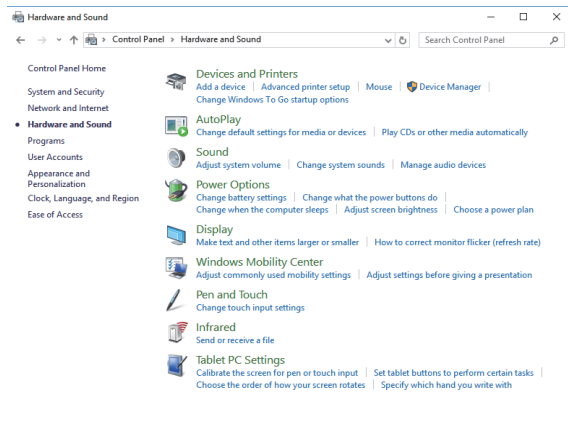

2. In the [Tablet PC Settings] dialog, select the [Display] tab, and then select the [Calibrate] button under [Display options].

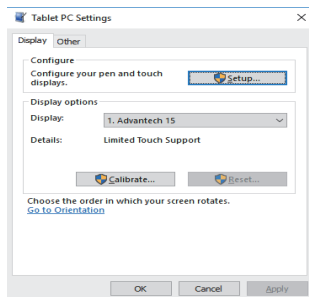

3. Follow the on-screen instruction that appears to calibrate.



6.5 Creating a system image and recovering the system

If Windows does not work, recover the system.

To recover the Windows system, a system image is required. Before recovering the system, create a system image.

(👉 Page 35 Recovering the Windows system)

Part 3

Troubleshooting

Part 3 explains troubleshooting for the product.

Page 58 Troubleshooting

7 Troubleshooting

The following explains troubles that may occur in using the product, check items, and corrective actions.
If a malfunction or any other problem occurs even after troubleshooting, consult your local sales office.

Troubleshooting a problem

If any problem occurs, an error message appears on the product.
Troubleshoot a problem as shown below.

1. When a GT SoftGOT2000 error message is displayed

Refer to the following and eliminate the cause of the error.

 GT SoftGOT2000 Version1 Operating Manual

To view the above manual, start e-Manual Viewer.

2. When a Windows error message is displayed

Check the event log using Event Viewer, and eliminate the cause of the error.

3. When any error other than the above occurs

Perform troubleshooting for each symptom. ( Page 59 Symptom-based troubleshooting)

7.1 Symptom-based troubleshooting

When the product does not operate properly, check the following items and troubleshoot the product.

Trouble type	Symptom
Exterior	The POWER LED does not turn on.
	The screen display is not normal.
Communication	The RS-232, RS-422, or RS-485 connection does not establish communication.
	The Ethernet connection does not establish communication.
Operation	Touch operations do not work properly.
Windows	The keyboard layout is not the keyboard layout of the selected language for Windows.

POWER LED not turning on

Check the following items.

Check item	Corrective action
Is the power supply wiring correct?	Insert the power cables in the power supply connector correctly. For the power supply wiring method, refer to the following. ☞ Page 24 Wiring the power supply
Is the power supply voltage within the specifications?	Change the power supply voltage to within the specifications. For the specifications of the power supply voltage, refer to the following. ☞ Page 68 Power supply specifications

If the power supply wiring and power supply voltage are appropriate, the hardware may be faulty. Consult your local sales office.

Screen display not normal

Check the following items.

When the screen goes black

Check item	Corrective action
Is the power supply wiring correct?	Insert the power cables in the power supply connector correctly. For the power supply wiring method, refer to the following. ☞ Page 24 Wiring the power supply
Is the power supply voltage within the specifications?	Change the power supply voltage to within the specifications. For the specifications of the power supply voltage, refer to the following. ☞ Page 68 Power supply specifications
Is the POWER LED lit in orange (standby mode)?	If the POWER LED is lit in orange, the product is in standby mode. ■When GT SoftGOT2000 is used Setting any function or mode shown below may set the product into standby mode. <ul style="list-style-type: none"> • Resume function • Suspending function • Power saving function • Standby mode Ensure that the product does not enter standby mode. ■When GT SoftGOT2000 is not used Touch the screen of the product to exit standby mode.

If the problem remains after the above corrective actions, the hardware may be faulty. Consult your local sales office.

When the screen goes white, or lines appear on the screen

The hardware may be faulty. Consult your local sales office.

When the screen freezes

Check item	Corrective action
Has only GT SoftGOT2000 frozen?	Restart GT SoftGOT2000. If the screen freezes even after GT SoftGOT2000 is restarted, refer to the following.  GT SoftGOT2000 Version1 Operating Manual To view the above manual, start e-Manual Viewer.
Has any program other than GT SoftGOT2000 frozen?	Restart the product.





If the problem remains after the above corrective actions, the hardware may be faulty. Consult your local sales office.

Other unusual screen display

The hardware may be faulty. Consult your local sales office.

RS-232, RS-422, or RS-485 connection unable to establish communication

Check the following items.

Check item	Corrective action
Are the settings of the communication port correct?	Configure the settings of the communication port (COM1 or COM2) correctly in the device manager.
Are the settings of the RS-232/RS-422/RS-485 interface (COM2) the same as the settings of the communication method of the controller?	Configure the settings of the RS-232/RS-422/RS-485 interface according to the communication method of the controller. For setting the communication method, refer to the following.  Page 74 RS-232/RS-422/RS-485 interface (COM2)
Is the wiring correct?	For the correct wiring, refer to the following.  Page 73 RS-232 interface (COM1)  Page 74 RS-232/RS-422/RS-485 interface (COM2)  Manual of each controller

Ethernet connection unable to establish communication

Run the ping command on a personal computer within the same network as the product to check the Ethernet connection

When the ping command is not responded

Check item	Corrective action
Is the right side LED of the Ethernet interface turned off?	The Ethernet cable may not be connected to the Ethernet interface correctly. Connect the Ethernet cable correctly.
Is the Ethernet cable compatible with the product?	Connect an Ethernet cable compatible with the product. For the specifications of Ethernet cables, refer to the following. ☞ Page 72 Ethernet cable
Is the Ethernet cable broken?	The Ethernet cable may be broken. Replace the Ethernet cable.
Is the IP address of the product correct?	Set the correct IP address to the product.
Is there a controller having the same IP address as the product within the same network?	Request the network administrator to manage the network without IP address duplication.
Is the segment of the IP address the same between the controller and the product?	<ul style="list-style-type: none"> • Set the same segment to the IP address of the product and the IP address of the controller. • When the network of other segment is connected via gateway, consult the administrator of the connected network. • Set the subnet mask correctly. • Set the default gateway correctly.
Has the product been replaced?	If the product has been replaced, reset all the controllers connected to the network.
Is the network load high?	<ul style="list-style-type: none"> • Consult the network administrator, and remove the controllers that increase the network load from the network. • Change the product and controller to other network.
Is the network connection prohibited by Windows Firewall?	Consult the administrator of the connected network, and change the settings of Windows Firewall.
Is the network connection prohibited by the antivirus software installed in the product?	Consult the administrator of the connected network, and change the settings of the antivirus software.
If LAN A of the LAN ports is used, is [Ultra Low Power Mode when cable is disconnected] for the Ethernet controller ([Power Management]) deselected?	If [Ultra Low Power Mode when cable is disconnected] is selected, Ethernet communication link-up attempts may fail. Deselect [Ultra Low Power Mode when cable is disconnected]. For the setting procedure, refer to the following. ☞ Page 71 Setting when using CC-Link IE TSN Communication Software

When the ping command is responded

Check item	Corrective action
If the server is relayed, is it operating?	Request the administrator of the connected server to check the state of the server.
Is the network connection prohibited by Windows Firewall?	Consult the administrator of the connected network, and change the settings of Windows Firewall.
Is the network connection prohibited by the antivirus software installed in the product?	Consult the network administrator, and change the setting of the antivirus software.

Touch operation unable to work properly

Check the following items.

Receiving no touch responses

Check item	Corrective action
Is the power supply wiring correct?	Insert the power cables to the power supply connector correctly. For the power supply wiring method, refer to the following. ☞ Page 24 Wiring the power supply
Is the power supply voltage within the specification?	Change the power supply voltage to within the specifications. For the specifications of the power supply voltage, refer to the following. ☞ Page 68 Power supply specifications
Only GT SoftGOT2000 does not operate, or a GT SoftGOT2000 error is displayed	Restart GT SoftGOT2000. If GT SoftGOT2000 does not operate properly after it is restarted, refer to the following. 📖 GT SoftGOT2000 Version1 Operating Manual Use e-Manual Viewer to refer to the GT SoftGOT2000 Version1 Operating Manual.
Has Windows frozen?	Restart the product.

If the trouble remains after the above corrective actions, the hardware might be faulty. Consult your local sales office.

Receiving inaccurate touch responses

Check item	Corrective action
Do you receive inaccurate touch responses at any position on the touch screen?	Calibrate the touch screen. For details of calibrating the touch screen, refer to the following. ☞ Page 55 Calibrating the touch screen
Do you receive inaccurate touch responses at a specific position on the touch screen?	Moisture or dust may be attached around that specific position. Clean the screen. For details of screen cleaning, refer to the following. ☞ Page 54 Cleaning the screen
Is the screen surface wet or dirty?	Clean the screen. For details of screen cleaning, refer to the following. ☞ Page 54 Cleaning the screen
Is the product installed in a proper location?	Install the product in the environment indicated in the general specifications. For the installation environment, refer to the following.
Is the screen surface frozen?	☞ Page 19 Installation environment

If the trouble remains after the above corrective actions, the hardware might be faulty. Consult your local sales office.

Keyboard layout not of the selected language

Check the following items.

Check item	Corrective action
Is the keyboard layout set to the keyboard layout of the selected language?	Change the keyboard layout to the keyboard layout of the selected language in the keyboard layout setting. Start button → [Settings] → [Time & language] → Region & language] → [Languages] → [Windows display language] → [Options] → [Hardware keyboard layout]

Unable to register the Edgexross basic software user

Check the following items.

Failing to register the Edgexross basic software user

Check item	Corrective action
Is the product ID indicated in the License Certificate (enclosed with the MI3000) used?	Use the product ID indicated in the License Certificate (enclosed with the MI3000) to register the user.

Part 4 Appendices

Part 4 explains the specifications of the product.

Page 64 Parts names

Page 66 Product specifications

Page 69 Turning off the product

Page 70 Preinstalled software

Page 72 Interface specifications

Page 77 EMC Directive

Page 80 Precautions for transporting batteries

Page 81 Batteries in EU member states

Page 82 Labelling based on local electromagnetic interference laws

Page 84 Precautions for repairing the product

Page 85 External dimensions

Appendices

Appendix 1 Parts names

The following shows the parts names of the product.

- MI3321G-W

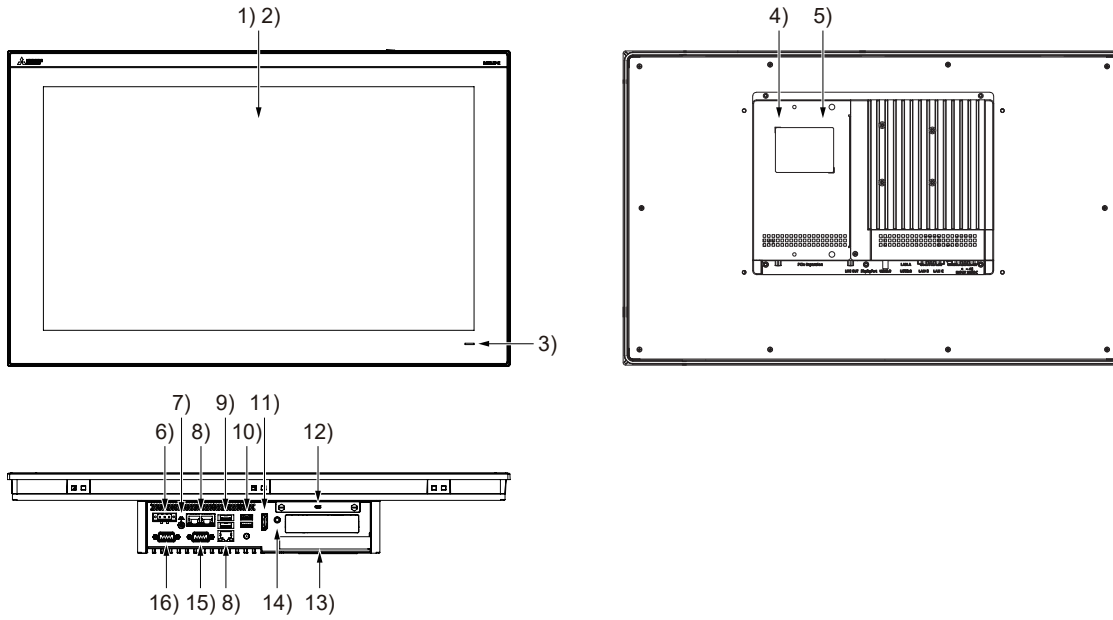

- MI3315G-W

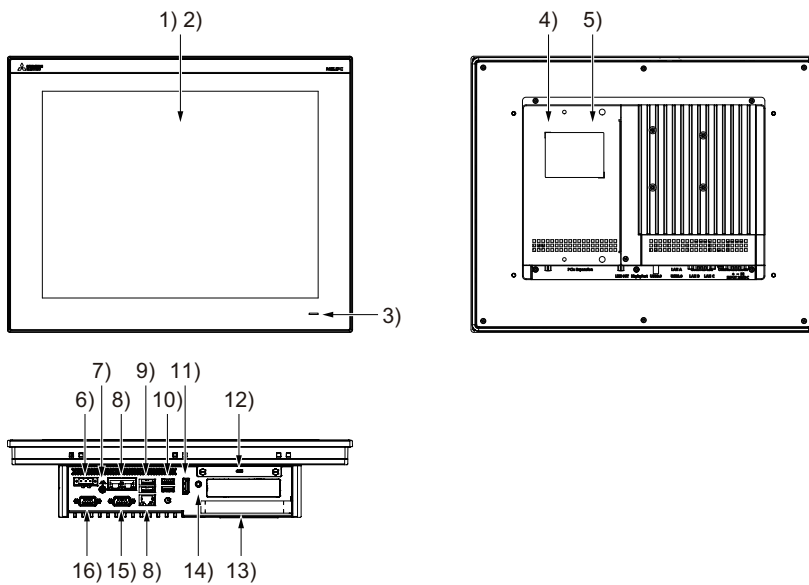

No.	Name	Description
1)	Display section	For displaying the Windows screen
2)	Touch panel	For operating the touch screen
3)	POWER LED	Lit in blue: Power is properly supplied Lit in orange: Standby Not lit: Power is not supplied
4)	M.2 (2280) SATA interface (inside the cover)	For installing an M.2 (2280) SATA expansion board
5)	Mini PCI Express interface (inside the cover)	For installing an expansion board Mini PCI Express (full size)
6)	Power supply terminal	Power supply input terminal, FG terminal
7)	Ground terminal	For grounding
8)	Ethernet interface (LAN A, LAN B, LAN C)	Connector shape: RJ45 (modular jack)
9)	USB interface	USB version: USB 2.0 Connector shape: Type-A
10)	USB interface	USB version: USB 3.0 Connector shape: Type-A
11)	DisplayPort interface	For outputting data to an external monitor
12)	SATA interface	For a 2.5-inch SSD (occupied)
13)	PCI Express interface	For installing an expansion board PCI Express (half size)
14)	Sound output interface	For outputting sounds (Ø3.5 mini jack (3-prong))
15)	RS-232 interface	Connector shape: D-sub 9-pin (male)
16)	RS-232/422/485 interface	Connector shape: D-sub 9-pin (male) Specify a connection type with the BIOS.

Appendix 2 Product specifications

The following shows the specifications of the product.

General specifications

The following shows the general specifications of the product.

Item	Specifications
Operating ambient temperature	0 to 55°C
Storage ambient temperature	-20 to 60°C
Operating ambient humidity	10 to 90% RH, non-condensing
Storage ambient humidity	10 to 90% RH, non-condensing
Vibration resistance	Random vibration
	IEC 60068-2-64 5 to 500 Hz, 1 hour per axis (X, Y, and Z)
	3 Grms
Shock resistance	IEC 60068-2-27 10 G, half-sine wave, 11 msec
Operating atmosphere	No greasy fumes, corrosive gas, flammable gas, excessive conductive dust, and direct sunlight (as well as at storage)
Operating altitude ^{*3*4}	—
Installation location	Inside control panel
Overvoltage category ^{*1}	II or less
Pollution degree ^{*2}	2 or less
Cooling method	Self-cooling
Grounding	Grounding with a ground resistance of 100 Ω or less by using a ground cable that has a cross-sectional area of 2 mm ² or more.

*1 This indicates the power distribution section to which the product is assumed to be connected, between the public power grid and the machinery within the premises.

Category II applies to equipment that is supplied with power from fixed facilities.

The withstand surge voltage is 2500 V for the equipment with the rated voltage up to 300 V.

*2 This indicates the extent to which conductive substances are found in the operating environment of the product.

Pollution level 2 indicates an environment in which normally only nonconductive pollution occurs and the temporary conductivity caused by condensation is to be expected.

*3 Do not use nor store the product under pressure higher than the atmospheric pressure of altitude 0 m. Doing so may cause malfunction.

*4 No limitations to altitude.

When used at a high altitude, the upper limits of the permissible voltage and the operating ambient temperature become lower.

Please check performance before use at the customer side.

Performance specifications

The following shows the operational specifications of the product.

Item		Specifications		
		MI3321G-W	MI3315G-W	
Display specifications ^{*1*2}	Display device	TFT color LCD		
	Screen size	21.5" wide screen	15"	
	Resolution	Full HD: 1920 × 1080	XGA: 1024 × 768	
	Display colors	16.77 million		
	Backlight specification	LED backlight (Not replaceable)		
	Life	50,000 hours		
Touch key specification	Type	PCAP (Projected Capacitive)		
	Simultaneous press	Max. 10 keys ^{*3}		
	Transmittance	90%±3%		
POWER LED specification		2 colors (blue and orange)		
Protective structure		IP66 (front face)		
Hardware	MPU	Intel Core i3-6100U 2.30GHz Dual Core		
	Memory capacity	RAM	8GB DDR4	
		ROM	64GB SSD	
	Battery life	Replacement	Not replaceable ^{*4}	
Life		4 years		
Software	OS	Windows 10 IoT Enterprise 2016 LTSB (64bit)		
	System language	At initial startup: English		
Additional storage	Interface	M.2(2280) SATA SSD: 1		
Extension interface	PCI Express	x1 slot, (half size) × 1		
	mini PCI Express	Full size × 2		
Built-in interface	Display (for external monitor output)	Interface	DisplayPort 1.4	
		Connector	DisplayPort connector	
		Number of ports	1	
		Resolution ^{*5}	Max. 3840 × 2160	
	Ethernet	Interface	10BASE-T, 100BASE-TX, 1000BASE-T	
		Number of ports	3	
		Connector for external wiring	RJ45	
		Support function	AUTO MDI/MDI-X function (automatic recognition of straight/cross)	
	RS-232	Number of ports	1	
		Transmission speed	300 to 115200 bps	
		Connector for external wiring	D-sub 9-pin (male)	
	RS-232/RS-422/RS-485	Interface	RS-232, RS-422, RS-485(Two wire system) Default: RS-232	
		Number of ports	1 ^{*6}	
		Transmission speed	300 to 115200 bps	
		Connector for external wiring	D-sub 9-pin (male)	
	USB	Number of ports	<ul style="list-style-type: none"> • USB3.0: 2 • USB2.0: 2 	
		Connector	USB Type-A	
	Sound output	Interface	Audio Line-Out	
		Number of ports	1	
Connector		Φ3.5 mini jack (3-prong)		
Built-in clock precision		<ul style="list-style-type: none"> • Daily difference: -2 seconds to +2 seconds • Monthly difference: -60 seconds to +60 seconds 		
External dimensions		349.8(13.77) (H) × 558.4(21.98) (W) × 88.8(3.50) (D) mm(inch)	307.3(12.10) (H) × 383.2(15.09) (W) × 86(3.39) (D) mm(inch)	
Panel cutting dimensions		341.8(13.46) (H) × 550.3(21.67) (W) mm(inch)	298.5(11.75) (H) × 374.5(14.74) (W) mm(inch)	

Item	Specifications	
	MI3321G-W	MI3315G-W
Weight	9.8(21.6) kg(lb)	7.0(15.4) kg(lb)

- *1 As a characteristic of liquid crystal display panels, bright dots (always lit) and dark dots (never lit) may appear on the panel. Since liquid crystal display panels comprise a great number of display elements, the appearance of bright and dark dots cannot be reduced to zero. Individual differences in liquid crystal display panels may cause differences in color, uneven brightness and flickering. Note that these phenomena are characteristics of liquid crystal display panels and it does not mean the products are defective or damaged.
- *2 Flickering may occur due to vibration, shock, or the display colors.
- *3 Multiple touch keys cannot be pressed simultaneously while GT SoftGOT2000 is used.
- *4 The battery cannot be removed by users. For the battery replacement, consult your local sales office.
- *5 Maximum resolution at 60 Hz.
- *6 The interface can be switched between RS-232, RS-422, and RS-485 with the BIOS.

Power supply specifications

The following shows the power supply specifications of this product.

Item	Specifications
Rated input voltage	24 V DC
Input voltage variable range	19.2 to 28.8 V DC
Power consumption	Under the maximum load
	Stand alone
Applicable wire size	Single wiring (single wire, stranded wire): 0.2 to 2.5 mm ² (AWG24 to AWG14) Rod terminal with an insulation sleeve: 0.25 to 2.5 mm ² (AWG22 to AWG14) Double wiring (single wire, stranded wire): 0.2 to 1.5 mm ² (AWG24 to AWG16)
Applicable solderless terminal	DN00508D (AWG20), DN00708D (AWG18), DN01508D (AWG16) (manufactured by DINKLE) Crimp tool: DNT13-0101 (manufactured by DINKLE)
Applicable tightening torque (for terminal block terminal screws)	0.20 N·m (M2.5)

Appendix 3 Turning off the product

The following shows how to turn off the product.

Precautions

- Make sure to follow the procedure for turning off the product. Not doing so may cause an improper startup of Windows, a data corruption, or a file system error.
- Do not turn off the product upon Windows shutdown. Doing so may corrupt the data on the SSD as it may be in the process of being accessed. Make sure that the POWER LED has turned orange, wait 15 seconds or more, and then turn off the product. The access time to the SSD depends on the usage environment.

Operating procedure

1. Exit all running applications on the product.
2. Shut down Windows from the Windows start menu.
3. Turn off the product.
4. Check that the POWER LED is off.

Point

The POWER LED indicates the power status.

- Blue: Powered on
 - Orange: Standby
 - Not lit: Powered off
-

Appendix 4 Preinstalled software

The following software applications are preinstalled on the product.

The software may be updated after shipment of the product.

Download the latest version from the Mitsubishi Electric FA Global Website or Edgecross Consortium website (Edgecross basic software only).

- Edgecross basic software (📖 Edgecross Basic Software for Windows User's Manual)
- SLMP data collector (📖 SLMP Data Collector User's Manual)
- CC-Link IE TSN Communication Software ^{*1}(📖 CC-Link IE TSN Communication Software for Windows User's Manual)
- CC-Link IE TSN Data Collector (📖 CC-Link IE TSN Data Collector User's Manual)
- GT SoftGOT2000 Version1 (English version)(📖 GT SoftGOT2000 Version1 Operating Manual)
- e-Manual Viewer

*1 The software (including the License Certificate) is preinstalled in the products manufactured in April 2022 or later.
When using a product manufactured in March 2022 or earlier, download the software from MITSUBISHI ELECTRIC FA Global Website.
(The software can be installed to MELIPC for free.)

Point

- Use e-Manual Viewer to view the GT SoftGOT2000 Version1 Operating Manual.
- To register the Edgecross basic software user, use the product ID indicated in the License Certificate which is enclosed with the MI3000.

Restoring the preinstalled software

If you accidentally uninstall any preinstalled software, you can reinstall the software using the corresponding installer in the location shown below.

If the installer is deleted, restore the software using a system image.

📖 Page 36 Recovering the system

Software	Installer location	Remarks
Edgecross basic software ^{*2*3}	C:\MELIPC\Installer\BasicSoftware	—
SLMP data collector ^{*3}	C:\MELIPC\Installer\DataCollector\SLMP	—
CC-Link IE TSN Communication Software ^{*3*4}	C:\MELIPC\Installer\CC-Link IE TSN Communication Software	—
CC-Link IE TSN Data Collector ^{*5}	C:\MELIPC\Installer\DataCollector\CC-LINK IE TSN	—
GT SoftGOT2000 Version1	C:\MELIPC\Installer\GTSoftGOT2000	—
e-Manual Viewer	C:\MELIPC\Installer\e-Manual Viewer	—
GT Manual ^{*1*2}	C:\MELIPC\Installer\GT Manual3 2000	English (preinstalled)
	C:\MELIPC\Installer\GT Manual3 2000_jp	Japanese (for language switching)
	C:\MELIPC\Installer\GT Manual3 2000_cn	Simplified Chinese (for language switching)

*1 Installer for PDF manuals.

The product manuals are provided in e-Manual format, and viewable with e-Manual Viewer.

To view the manuals in PDF format, install GT Manual shown above.

The English version of GT Manual is preinstalled.

To view PDF manuals in any other language, uninstall the English version of GT Manual, and then install your preferred language version of GT Manual.

*2 Adobe Reader is not preinstalled on the product.

To view PDF manuals, install Adobe Reader.

*3 For the product ID of the preinstalled software, check the License Certificate enclosed with the MI3000.

*4 When using CC-Link IE TSN Communication Software, configure the Ethernet controller ([Power Management]) setting.

For details, refer to the following.

📖 Page 71 Setting when using CC-Link IE TSN Communication Software

*5 The software is supplied with CC-Link IE TSN Communication Software.

Precautions

Do not turn off the product while the preinstalled software is being restored.

Setting when using CC-Link IE TSN Communication Software

When using CC-Link IE TSN Communication Software, configure the following setting for LAN A of the LAN ports. Otherwise, Ethernet communication link-up attempts may fail.

1. Open Control Panel and click [View network status and tasks].
2. Click [Change adapter settings] to display [Network Connections].
3. Right-click on the target Ethernet controller (default: [Ethernet]) and select [Properties].
4. Select the [Power Management] tab.
5. Deselect [Ultra Low Power Mode when cable is disconnected] in [Power Saver Options].
6. Click the [OK] button.

Appendix 5 Interface specifications

The following shows the specifications of the interfaces on the product.

Ethernet interface

The following shows the specifications of the Ethernet interfaces.



The MI3000 determines the communication speed (1000BASE-T, 100BASE-TX, or 10BASE-T) and duplex mode (full duplex or half duplex) according to the hub connected. To use a hub that does not support the auto-negotiation function, set the communication speed and duplex mode of the MI3000 for the hub.

Ethernet cable

Use an Ethernet cable that satisfies the following conditions.

Standard	Specifications	Communication speed	Connector
1000BASE-T	Category 5e or higher, shielded (STP) straight cable	1000 Mbps	RJ45
	Category 5e or higher, shielded (STP) cross cable		
100BASE-TX	Category 5 or higher, shielded (STP) straight cable	100 Mbps	
	Category 5 or higher, shielded (STP) cross cable		
10BASE-T	Category 3 or higher, shielded (STP) straight cable	10 Mbps	
	Category 3 or higher, shielded (STP) cross cable		

Hub

If you connect the MI3000 to an Ethernet network via a hub, use a hub that supports the communication speed of the MI3000.

Checking the operation status

Check the LEDs on the Ethernet interfaces to check operation status.

Communication speed	Color of the left LED	Color of the right LED
1000 Mbps	Green	Green
100 Mbps	Orange	Green
10 Mbps	Not lit	Green



- The time from when an Ethernet cable is connected until when the LEDs turn on may vary. The LEDs normally turn on in a few seconds. The MI3000 may try to connect to an Ethernet network repeatedly depending on the status of the devices on the network, taking a longer time to turn on the LEDs.
- If the LEDs do not turn on, make sure that the Ethernet cable has no abnormalities.
- When the MI3000 communicates with any device on an Ethernet network at 10 Mbps, the left LED turns off. Check the communication status using the Ping command or other methods.

RS-232 interface (COM1)

The following shows the specifications of the RS-232 interface (COM1).

Pin layout

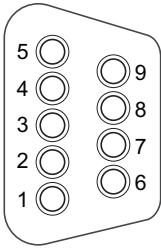

Pin No.	Signal name
1	CD (DCD)
2	RD (RXD)
3	SD (TXD)
4	ER (DTR)
5	SG (GND)
6	DR (DSR)
7	RS (RTS)
8	CS (CTS)
9	CI (RI)

Connector

Use a D-sub connector (female) (solder connection type) for the connection cable.

A

RS-232/RS-422/RS-485 interface (COM2)

The following shows the specifications of the RS-232/RS-422/RS-485 interface (COM2).

Pin layout

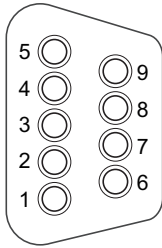

■RS-232

Pin No.	Signal name
1	CD (DCD)
2	RD (RXD)
3	SD (TXD)
4	ER (DTR)
5	SG (GND)
6	DR (DSR)
7	RS (RTS)
8	CS (CTS)
9	CI (RI)

■RS-422

Pin No.	Signal name
1	TX-
2	TX+
3	RX+
4	RX-
5	SG (GND)

■RS-485

Pin No.	Signal name
1	D-
2	D+
5	SG (GND)

Connector

Use a D-sub connector (female) (solder connection type) for the connection cable.

Switching between the RS-232, RS-422, and RS-485 interfaces

For the RS-232/RS-422/RS-485 interface, you can switch between RS-232 mode and RS-422/RS-485 mode with the BIOS on Windows.

The following shows how to switch RS-232 mode to RS-422/RS-485 mode.

1. Start the OS, and select [Settings] from the start menu to display the [Windows Settings] screen.

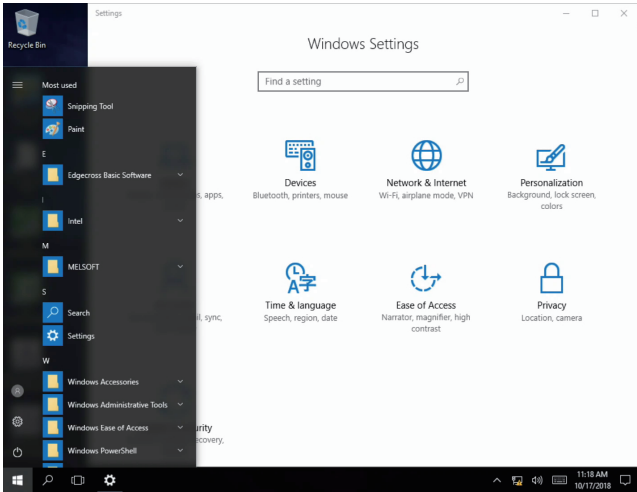

2. Select [Update & security], and select [Recovery] from the menu on the left.

3. In [Advanced startup], select [Restart now].

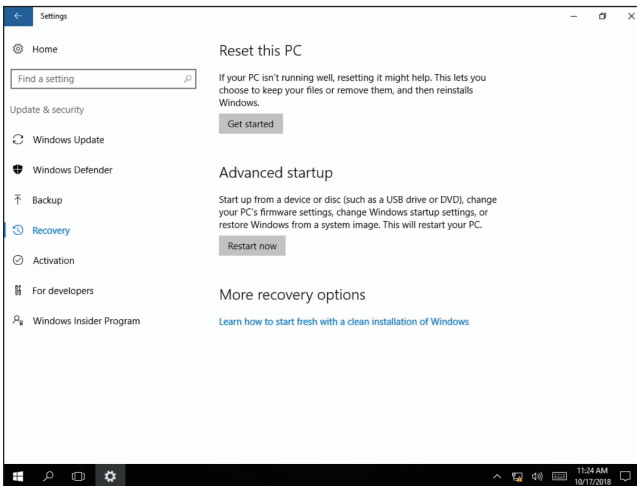

4. In the [Choose an option] screen, select [Troubleshoot].

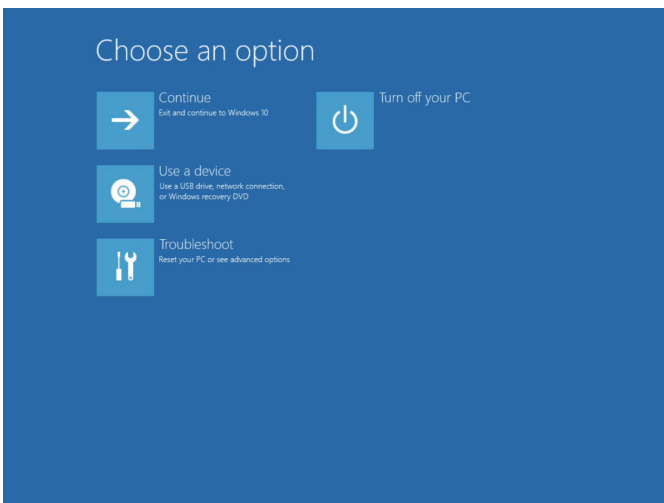

A

5. Select [Advanced options], [UEFI Firmware Settings], and then [Restart] to restart the OS and display the BIOS screen (UEFI screen).

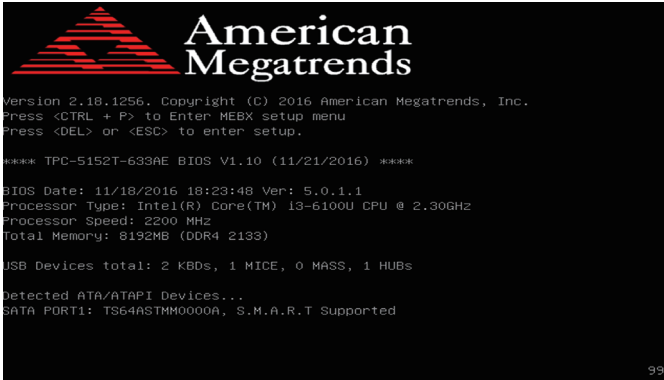

6. On the [Advanced] tab, select [IT8768E Super IO Configuration].

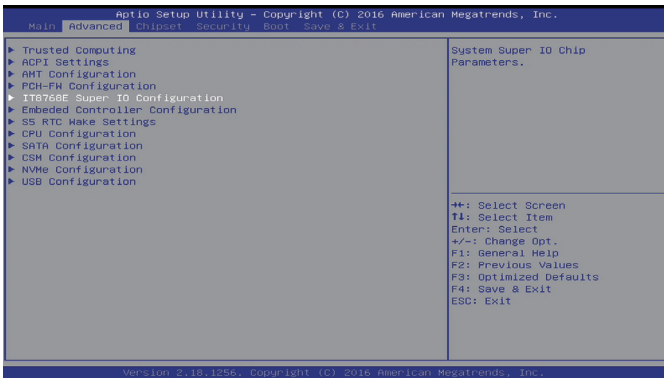

7. Select [Serial Port 2 Configuration].

8. For [COM2 Uart mode setting], select [RS422/RS485 mode].

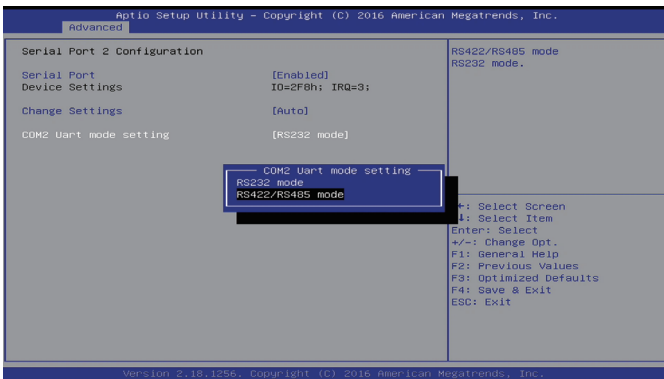

9. For [COM2 RS422/RS485 type setting], select the master or slave.

For [COM2 RS422/485 120 ohm setting] and [COM2 RS422 120 ohm setting], enable or disable the terminating resistors for signals.

10. Press the [Esc] key to return to the initial menu screen, and select [Save Changes and Reset] on the [Save & Exit] tab.

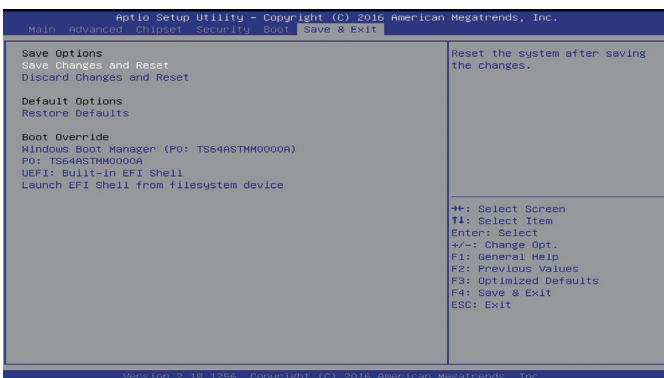

Appendix 6 EMC Directive

For the products to be sold in European countries, conformance to the EMC Directive, which is one of the European Directives, has been mandatory as the EMC standards since 1996.

In European countries, if a product meets the requirements of the EMC Directive, the manufacturer of the product must declare conformity of the product and affix the "CE mark" to the product.

In some countries or regions other than European countries, the product's manufacturer also must declare conformity of the product and affix a designated mark to the product (example: UKCA mark in the UK).

The authorized representative in the EU and the UK is shown below.

Company: Mitsubishi Electric Europe B.V.

Address: Mitsubishi-Electric-Platz 1, 40882 Ratingen, Germany

This section describes the EMC Directive as an example for conformance to EMC standards. EMC standards in each country are stipulated to be consistent with the corresponding international standards. When the requirements are consistent, common measures are taken to conform to the standards in different countries.

For the EMC Directive, regulatory compliance with equivalent EMC standards is required for example in the UK and Korea.

EMC Directive requirements

The EMC Directive requires that equipment does not emit strong electromagnetic waves (Emissions: electromagnetic interference), and the equipment is not disturbed by external electromagnetic waves (Immunity: electromagnetic sensitivity).

This product is compliant with the standards shown below.

The manufacturer of equipment incorporating this product must determine how to make the equipment compliant with the EMC Directive and carry out the conformity assessment.

Conforming standards in the EMC Directive

Item	Standards
Emissions	EN55011:2016 +A1:2017 Group 1, Class A EN55032:2015 +AC:2016 Class A CISPR32:2015 +C1:2016 Class A EN61000-6-4:2007 +A1:2011
Immunity	EN55024:2010 +A1:2015 EN IEC 61000-6-2:2019 EN55035:2017 +A11:2020

Installation on a control panel

This product is an open type device (designed to be integrated into equipment) and must be installed on a control panel. This restriction ensures safety and has a large effect of suppressing noise from this product.

Control panel

- The control panel must be conductive.
- When bolting the top or bottom plate of the control panel enclosure, do not coat the plate and bolt surfaces so that they contact each other. Connect the control panel enclosure and its door using a thick ground cable to ensure a low impedance under high frequency.
- When bolting an inner plate to the inside of the control panel enclosure, ensure the largest conductive area possible on the plate surface. For example, do not coat the bolting area on the plate.
- Ground the control panel enclosure using a thick ground cable to ensure a low impedance under high frequency.
- The diameter of a cable hole on the control panel must be 10 cm or less. If the diameter of the hole is more than 10 cm, radio waves may leak. To reduce the chance of radio waves leaking out, minimize the space between the control panel enclosure and its door. Pasting an EMI gasket directly on the painted surface can seal the space, reducing the leak of radio waves. Our test has been carried out on a control panel enclosure having the damping characteristics of 52 dB max. and 37 dB mean (measured by 3 m method with 30 to 300 MHz).

Connection of a power cable or ground cable

- Provide a ground point near the product to ground the product via the control panel, short-circuit the frame ground (FG) terminal of the product, and ground it with the thickest and shortest cable possible. (The cable length must be 30 cm or shorter.) As the FG terminal transmits the noise generated in the product to the ground, ensure the lowest impedance possible accordingly. As the ground cable transmits noise, the cable itself carries a large amount of noise accordingly. Short wiring prevents the cable from acting as an antenna.
- Twist the ground cable from the ground point and the power cable together. Doing so can transmit a larger amount of noise from the power cable to the ground.

Noise filter (power supply line filter)

A noise filter is a part to effectively reduce conducted noise.

Although installing a noise filter on the power supply cable is not mandatory, doing so can suppress a larger amount of noise. (The noise filter is effective to reduce conducted noise in the band of 10 MHz or less.)

Use a noise filter equivalent to the following noise filters.

Model	RSMN-2006	NBH-06-432
Manufacturer	TDK-Lambda Corporation	COSEL Co., Ltd.
Rated current	6 A	
Rated voltage	250 V	

The following shows the precautions for installing a noise filter.

- Do not bundle the input and output cables of the noise filter together. Doing so inducts noise from the output-side cable to the input-side cable where noise has been eliminated by the noise filter.

Wire the input and output cables separately.

Bundling the input and output cables inducts noise.

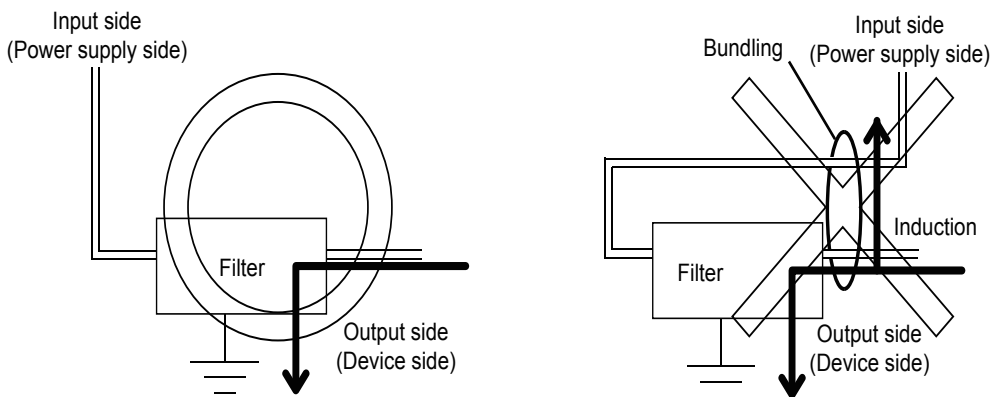

- Ground the ground terminal of the noise filter via the control panel with the shortest cable possible (approximately 10 cm).

A

Appendix 7 Precautions for transporting batteries

When transporting lithium batteries, follow the transportation regulations.

For details on the regulations, refer to the following Technical News.

 Precautions for transportation regulations on lithium batteries (FA-A-0259)

Regulated models

The battery for this product is classified as shown below.

Model	Battery type	Lithium content	Weight	Handled as
BR2032	Lithium metal battery	0.06 g	2.5 g	Non-dangerous goods

Transportation guidelines

Before shipment, this product has been packed at Mitsubishi Electric Corporation in compliance with the transportation regulations. When transporting the product unpacked or repacked, make sure to observe the IATA Dangerous Goods Regulations, International Maritime Dangerous Goods Code (IMDG Code), and other local transportation regulations.

For details, consult your shipping company.

Perchlorate regulations for the State of California

From December 31, 2006, California's perchlorate regulations require labeling the warning note on the packages for products that have lithium primary batteries containing 6 ppb or more of perchlorate. However, the battery for this product does not contain perchlorate.

There is no special handling required.

Appendix 8 Batteries in EU member states

The following describes the precautions for disposing of waste batteries in the EU member states and for exporting batteries and devices with built-in batteries to the EU member states.

Precautions for disposal

As the EU member states have a separate collection system for waste batteries, dispose of batteries properly at the local community waste collection or recycling center accordingly.

The following symbol is printed on batteries and packaging of devices with built-in batteries.

The symbol indicates that batteries need to be disposed of separately from other wastes.



The symbol is valid in the EU member states only.

The symbol is specified in Article 20 "Information for end-users" and ANNEX II of the new EU Battery Directive (2006/66/EC).

Precautions for export

The new EU Battery Directive (2006/66/EC) requires the following when batteries and/or devices with built-in batteries are sold and exported to the EU member states.

- To print the symbol on batteries, devices, or their packaging
- To explain the symbol in the product manual

■ Labelling the symbol

To market or export batteries and/or devices with built-in batteries, which have no symbol, to the EU member states, print the symbol shown above on the device or its packaging.

■ Adding an explanation of the symbol to the relevant manual

If you export equipment incorporating this product to EU member states, supply the equipment with the latest version of the Safety Guidelines and the MELIPC MI3000 Series User's Manual that have an explanation of the symbol.

If these manuals are not included with the equipment, add an explanation of the symbol to the equipment manual.

Appendix 9 Labelling based on local electromagnetic interference laws

Federal Communications Commission (FCC) Statement

This equipment has been tested and complies with the limits for a Class A digital device, pursuant to Part 15 of the FCC Rules. These limits are designed to provide reasonable protection against harmful interference when the equipment is operated in a commercial environment.

This equipment generates, uses, and can radiate radio frequency energy and, if not installed and used in accordance with the instruction manual, may cause harmful interference to radio communications.

Operation of this equipment in a residential area is likely to cause harmful interference, in which case the user will be required to correct the interference at his own expense.

CE Statement

This is a Class A product. In domestic environment this product may cause radio interference in which case the user may be required to take adequate measures.

CCC Statement / CCC认证 警告

此为A级产品，在生活环境中，该产品可能会造成无线电干扰。
在这种情况下，可能需要用户对其干扰采取切实可行的措施。

BSMI Statement / BSMI警告

這是甲類的資訊產品，在居住的環境中使用時，可能會造成射頻干擾，在這種情況下，使用者會被要求採取某些適當的對策。

KC Statement

기종별	사용자안내문
A 급 기기	이 기기는 업무용(A 급)으로 전자파적합등록을 한 기기이오니 판매자또는 사용자는 이 점을 주의하시기 바라며, 가정외의 지역에서 사용하는 것을 목적으로 합니다.

Labelling based on Taiwan RoHS (Restriction of Hazardous Substances)

限用物質含有情況標示聲明書

Declaration of the Presence Condition of the Restricted Substances Marking

設備名稱：電腦 Equipment name	型號(型式)：MI3321G-W, MI3315G-W(系列型號參見說明書) Type designation(Type)					
單元 Unit	限用物質及其化學符號 Restricted substances and its chemical symbols					
	鉛 Lead (Pb)	汞 Mercury (Hg)	鎘 Cadmium (Cd)	六價鉻 Hexavalent chromium (Cr ⁺⁶)	多溴聯苯 Polybrominated biphenyls (PBB)	多溴二苯醚 Polybrominated diphenyl ethers (PBDE)
電路板	—	○	○	○	○	○
面板	—	○	○	○	○	○
內外殼 (外殼、內部框架…等)	—	○	○	○	○	○
其它固定組件 (螺絲、夾具、卡榫)	—	○	○	○	○	○
配件(線材)	—	○	○	○	○	○
記憶卡	—	○	○	○	○	○

備考1. "超出0.1wt%"及"超出0.01wt%"係指限用物質之百分比含量超出百分比含量基準值。

Note 1: "Exceeding 0.1 wt%" and "exceeding 0.01 wt%" indicate that the percentage content of the restricted substance exceeds the reference percentage value of presence condition.

備考2. "○"係指該項限用物質之百分比含量未超出百分比含量基準值。

Note 2: "○" indicates that the percentage content of the restricted substance does not exceed the percentage of reference value of presence.

備考3. "—"係指該項限用物質為排除項目。

Note 3: The "—" indicates that the restricted substance corresponds to the exemption.

A

Appendix 10 Precautions for repairing the product

The following shows precautions for repairing the product.

- During repair, the software and data contained on the product may be deleted, and the product may be reset to its factory defaults. Mitsubishi Electric Corporation will not be responsible for any loss or damage of the data stored in memory incurred by a failure, malfunction, theft during transportation, or any other reasons.
- Before sending your product for repair, you should maintain a separate backup copy of the product's data. Once your product is received, it is determined that the data has been backed up.
- If you send your product from outside Japan, remove the following software applications and data from the product beforehand. Software subject to export control laws or regulations (e.g. encryption software)
Software or data that is your trade secret
- Mitsubishi Electric Corporation will take responsibility to erase or destroy the data stored in the memory removed during repair. Note that Mitsubishi Electric Corporation will not return the removed memory and will not issue a certificate of data erasure and destruction.

Appendix 11 External dimensions

The following shows the external dimensions of the product.

- MI3321G-W

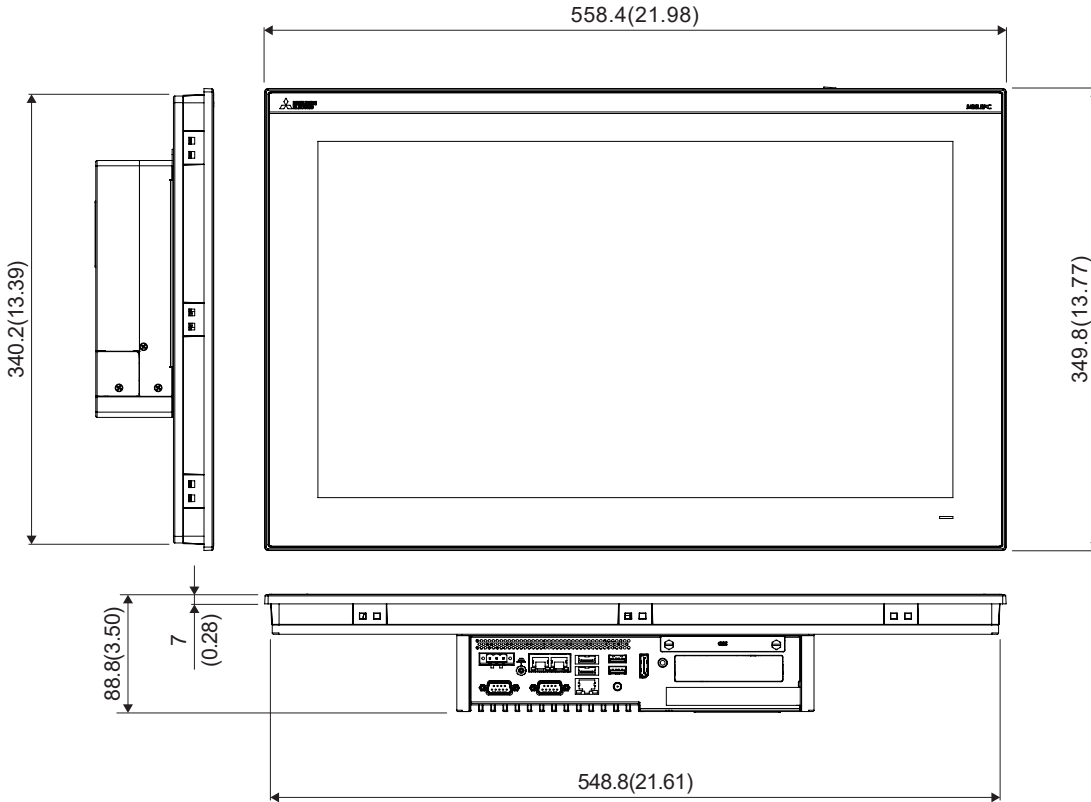

Unit : mm (inch)

- MI3315G-W

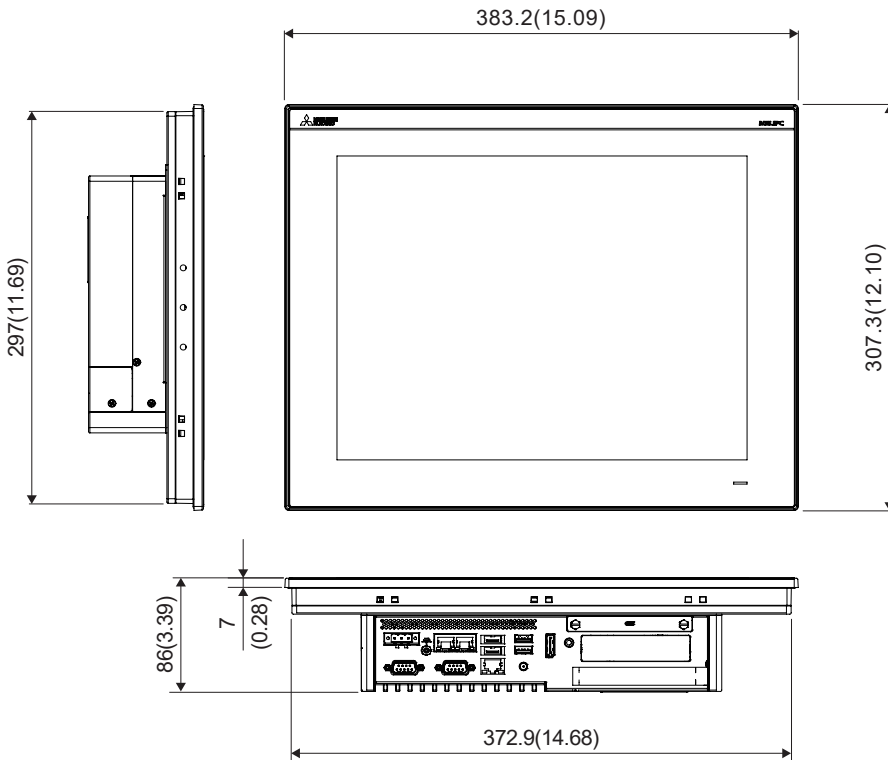

Unit : mm (inch)

A

Revisions

* The manual number is given on the bottom left of the back cover.

Revision date	* Manual No.	Revisions
January 2019	SH(NA)-082063ENG-A	First edition
February 2019	SH(NA)-082063ENG-B	Partial corrections
August 2020	SH(NA)-082063ENG-C	Partial corrections
October 2020	SH(NA)-082063ENG-D	Corrected: External dimension drawings and display specifications
February 2021	SH(NA)-082063ENG-E	Partial corrections
February 2022	SH(NA)-082063ENG-F	Partial corrections
April 2022	SH(NA)-082063ENG-G	<ul style="list-style-type: none">• Added: CC-Link IE TSN Communication Software and CC-Link IE TSN Data Collector to preinstalled software• Partial corrections
March 2023	SH(NA)-082063ENG-H	Partial corrections

This manual confers no industrial property rights or any rights of any other kind, nor does it confer any patent licenses. Mitsubishi Electric Corporation cannot be held responsible for any problems involving industrial property rights which may occur as a result of using the contents noted in this manual.

© 2019 MITSUBISHI ELECTRIC CORPORATION

Warranty

Please check the following product warranty details before using this product.

1. Gratis Warranty Term and Gratis Warranty Range

If any faults or defects (hereinafter "Failure") found to be the responsibility of Mitsubishi Electric occurs during use of the product within the gratis warranty term, the product shall be repaired at no cost via the sales representative or Mitsubishi Electric Service Company. However, if repairs are required onsite at domestic or overseas location, expenses to send an engineer will be solely at the customer's discretion.

Mitsubishi Electric shall not be held responsible for any re-commissioning, maintenance, or testing on-site that involves replacement of the failed module.

[Gratis Warranty Term]

The gratis warranty term of the product shall be for eighteen (18) months after the date of purchase or delivery to a designated place.

Note that after manufacture and shipment from Mitsubishi Electric, the maximum distribution period shall be six (6) months, and the longest gratis warranty term after manufacturing shall be twenty-four (24) months.

The gratis warranty term of repair parts shall not exceed the gratis warranty term before repairs.

[Gratis Warranty Range]

- (1) The customer shall be responsible for the primary failure diagnosis unless otherwise specified.
If requested by the customer, Mitsubishi Electric Corporation or its representative firm may carry out the primary failure diagnosis at the customer's expense.
The primary failure diagnosis will, however, be free of charge should the cause of failure be attributable to Mitsubishi Electric Corporation.
- (2) The range shall be limited to normal use within the usage state, usage methods, and usage environment, etc., which follow the conditions and precautions, etc., given in the instruction manual, user's manual and caution labels on the product.
- (3) Even within the gratis warranty term, repairs shall be charged in the following cases.
 1. Failure occurring from inappropriate storage or handling, carelessness or negligence by the user. Failure caused by the user's hardware or software design.
 2. Failure caused by unapproved modifications, etc., to the product by the user.
 3. When the Mitsubishi Electric product is assembled into a user's device, Failure that could have been avoided if functions or structures, judged as necessary in the legal safety measures the user's device is subject to or as necessary by industry standards, had been provided.
 4. Failure that could have been avoided if consumable parts designated in the instruction manual had been correctly serviced or replaced.
 5. Replacing consumable parts such as a battery, relay, and fuse.
 6. Failure caused by external irresistible forces such as fires or abnormal voltages, and Failure caused by force majeure such as earthquakes, lightning, wind and water damage.
 7. Failure caused by reasons that could not be predicted by scientific technology standards at the time of shipment from Mitsubishi Electric.
 8. Any other failure found not to be the responsibility of Mitsubishi Electric or that admitted not to be so by the user.

2. Onerous repair term after discontinuation of production

- (1) Mitsubishi Electric shall accept onerous product repairs for five (5) years after production of the product is discontinued. Discontinuation of production shall be notified with Mitsubishi Electric Technical Bulletins, etc.
- (2) Mitsubishi Electric shall not accept a request for product supply (including spare parts) after production is discontinued.

3. Overseas service

Overseas, repairs shall be accepted by Mitsubishi Electric's local overseas FA Center.

Note that the repair conditions at each FA Center may differ.

4. Exclusion of loss in opportunity and secondary loss from warranty liability

Regardless of the gratis warranty term, Mitsubishi Electric shall not be liable for compensation to:

- (1) Damages caused by any cause found not to be the responsibility of Mitsubishi Electric.
- (2) Loss in opportunity, lost profits incurred to the user by Failures of Mitsubishi Electric products.
- (3) Special damages and secondary damages whether foreseeable or not, compensation for accidents, and compensation for damages to products other than Mitsubishi Electric products.
- (4) Replacement by the user, maintenance of on-site equipment, start-up test run and other tasks.

5. Changes in product specifications

The specifications given in the catalogs, manuals, or technical documents are subject to change without prior notice.

Intellectual Property Rights

■Trademarks

Microsoft and Windows are registered trademarks or trademarks of Microsoft Corporation in the United States and other countries.

Intel and Intel Core are trademarks or registered trademarks of Intel Corporation in the United States and other countries.

DisplayPort is a trademark or registered trademark of Video Electronics Standards Association in the United States and other countries.

PCI Express is a registered trademark of PCI-SIG.

Names mentioned herein, such as company, system, and product names, are registered trademarks or trademarks of their respective companies.

■Copyrights

The screens (screenshots) are used in accordance with the Microsoft Corporation guideline.

SH(NA)-082063ENG-H(2303)MEE

MODEL: MELIPC-MI3000-U-E

MITSUBISHI ELECTRIC CORPORATION

HEAD OFFICE: TOKYO BLDG., 2-7-3, MARUNOUCHI, CHIYODA-KU, TOKYO 100-8310, JAPAN
NAGOYA WORKS: 1-14, YADA-MINAMI 5-CHOME, HIGASHI-KU, NAGOYA 461-8670, JAPAN

When exported from Japan, this manual does not require application to the
Ministry of Economy, Trade and Industry for service transaction permission.

Specifications subject to change without notice.