

Numerical Control (CNC)

## **Specifications and Instruction Manual**

### **MDS-EX-CVP Series**

# Introduction

Thank you for selecting the Mitsubishi numerical control unit. This instruction manual describes the handling and caution points for using this AC servo/spindle. Incorrect handling may lead to unforeseen accidents, so always read this instruction manual thoroughly to ensure correct usage.

Make sure that this instruction manual is delivered to the end user. Always store this manual in a safe place.

In order to confirm if all function specifications described in this manual are applicable, refer to the specifications for each CNC.

## Notes on Reading This Manual

- (1) Since the description of this specification manual deals with NC in general, for the specifications of individual machine tools, refer to the manuals issued by the respective machine tool builders. The "restrictions" and "available functions" described in the manuals issued by the machine tool builders have precedence to those in this manual.
- (2) This manual describes as many special operations as possible, but it should be kept in mind that items not mentioned in this manual cannot be performed.
- (3) The characteristic values and numerical values without tolerances mentioned in this manual are representative values.

In this manual, the following abbreviations might be used.

MTB: Machine tool builder

## Precautions for Safety

Please read this manual and auxiliary documents before starting installation, operation, maintenance or inspection to ensure correct usage. Thoroughly understand the device, safety information and precautions before starting operation.

The safety precautions in this instruction manual are ranked as "WARNING" and "CAUTION".

### **DANGER**

When there is a potential risk of fatal or serious injuries if handling is mistaken.

### **WARNING**

When a dangerous situation, or fatal or serious injuries may occur if handling is mistaken.

### **CAUTION**

When a dangerous situation may occur if handling is mistaken leading to medium or minor injuries, or physical damage.











Note that some items described as " CAUTION" may lead to major results depending on the situation. In any case, important information that must be observed is described

The signs indicating prohibited and mandatory matters are explained below.

	<p><b>Indicates a prohibited matter.</b></p> <p>For example, "Fire Prohibited" is indicated as  .</p>
---	--

	<p><b>Indicates a mandatory matter.</b></p> <p>For example, grounding is indicated as  .</p>
---	---

The meaning of each pictorial sign is as follows.

 <b>CAUTION</b>	 <b>CAUTION rotated object</b>	 <b>CAUTION HOT</b>	 <b>Danger Electric shock risk</b>	 <b>Danger explosive</b>
 <b>Prohibited</b>	 <b>Disassembly is prohibited</b>	 <b>KEEP FIRE AWAY</b>	 <b>General instruction</b>	 <b>Earth ground</b>

After reading this specifications and instructions manual, store it where the user can access it easily for reference.

The numeric control unit is configured of the control unit, operation board, servo drive unit, spindle drive unit, power supply, servo motor and spindle motor, etc.

In this section "Precautions for safety", the following items are generically called the "motor".

- ♦ Servo motor
- ♦ Linear servo motor
- ♦ Spindle motor
- ♦ Direct-drive motor

In this section "Precautions for safety", the following items are generically called the "unit".

- ♦ Servo drive unit
- ♦ Spindle drive unit
- ♦ Power supply unit
- ♦ Scale interface unit
- ♦ Magnetic pole detection unit













 <p><b>POINT</b></p> <p><b>Important matters that should be understood for operation of this machine are indicated as a POINT in this manual.</b></p>
--

**■ For Safe Use**

Mitsubishi CNC is designed and manufactured solely for applications to machine tools to be used for industrial purposes. Do not use this product in any applications other than those specified above, especially those which are substantially influential on the public interest or which are expected to have significant influence on human lives or properties.



## **WARNING**

### ■ **Electric shock prevention**

-  **Make sure the power is shut OFF before connecting a unit and a motor to the power.**
-  **Do not open the front cover while the power is ON or during operation. Failure to observe this could lead to electric shocks.**
-  **Do not operate the unit with the front cover removed. The high voltage terminals and charged sections will be exposed, and can cause electric shocks.**
-  **Since the high voltage is supplied to the main circuit connector while the power is ON or during operation, do not touch the main circuit connector with an adjustment screwdriver or the pen tip. Failure to observe this could lead to electric shocks.**
-  **Do not remove the front cover and connector even when the power is OFF unless carrying out wiring work or periodic inspections. The inside of the units is charged, and can cause electric shocks.**
-  **Wait at least 20 minutes after turning the power OFF, confirm that the CHARGE lamp has gone out, and check the voltage between P and N terminals with a tester, etc., before starting wiring, maintenance or inspections. Failure to observe this could lead to electric shocks.**
-  **Ground the unit and motor. For the motor, ground it via the drive unit.**
-  **Wiring, maintenance and inspection work must be done by a qualified technician.**
-  **Wire the servo drive unit and servo motor after installation. Failure to observe this could lead to electric shocks.**
-  **Do not touch the switches with wet hands. Failure to observe this could lead to electric shocks.**
-  **Do not damage, apply forcible stress, place heavy items on the cables or get them caught. Failure to observe this could lead to electric shocks.**
-  **Always insulate the power terminal connection section. Failure to observe this could lead to electric shocks.**
-  **After assembling the built-in IPM/SPM spindle motor, if the rotor is rotated by hand etc., voltage occurs between the terminals of lead. Take care not to get electric shocks.**

## **WARNING**

### ■ Injury prevention

-  **When handling a motor, perform operations in safe clothing.**
-  **In the system where the optical communication with CNC is executed, do not see directly the light generated from CN1A/CN1B connector of drive unit or the end of cable. When the light gets into eye, you may feel something is wrong for eye.  
(The light source of optical communication corresponds to class1 defined in JISC6802 or IEC60825-1.)**
-  **The linear servo motor, direct-drive motor and built-in IPM/SPM spindle motor uses permanent magnets in the rotor, so observe the following precautions.**

#### **[Handling]**

- The linear servo motor, direct-drive motor and built-in IPM/SPM spindle motor could adversely affect medical electronics such as pacemakers, etc., therefore, do not approach the rotor.
- Do not place magnetic materials as iron.
- When a magnetic material as iron is placed, take safety measure not to pinch fingers or hands due to the magnetic attraction force.
- Remove metal items such as watch, piercing jewelry, necklace, etc.
- Do not place portable items that could malfunction or fail due to the influence of the magnetic force.
- When the rotor is not securely fixed to the machine or device, do not leave it unattended but store it in the package properly.
- When installing the motor to the machine, take it out from the package one by one, and then install it.
- It is highly dangerous to lay out the motor or magnetic plates together on the table or pallet, therefore never do so.

#### **[Transportation and storage]**

- Correctly store the rotor in the package to transport and store.
- During transportation and storage, draw people's attention by applying a notice saying "Strong magnet-Handle with care" to the package or storage shelf.
- Do not use a damaged package.







#### **[Installation]**

- Take special care not to pinch fingers, etc., when installing (and unpacking) the linear servo motor.







-  **Incorrect wiring could lead to smoke or fire in the unit and the reactor, resulting in faults. Be careful when wiring.**

## CAUTION

### ■ Fire prevention

-  Install the units, motors and regenerative resistor on non-combustible material. Direct installation on combustible material or near combustible materials could lead to fires.
-  Always install a circuit protector and contactor on the servo drive unit power input as explained in this manual. Refer to this manual and select the correct circuit protector and contactor. An incorrect selection could result in fire.
-  Shut off the power on the unit side if a fault occurs in the units. Fires could be caused if a large current continues to flow.
-  When using a regenerative resistor, provide a sequence that shuts off the power with the regenerative resistor's error signal. The regenerative resistor could abnormally overheat and cause a fire due to a fault in the regenerative transistor, etc.
-  The battery unit could heat up, ignite or rupture if submerged in water, or if the poles are incorrectly wired.
-  Cut off the main circuit power with the contactor when an alarm or emergency stop occurs.

### ■ Injury prevention

-  Do not apply a voltage other than that specified in this manual, on each terminal. Failure to observe this item could lead to ruptures or damage, etc.
-  Do not mistake the terminal connections. Failure to observe this item could lead to ruptures or damage, etc.
-  Do not mistake the polarity (+,- ). Failure to observe this item could lead to ruptures or damage, etc.
-  Do not touch the radiation fin on unit back face, regenerative resistor or motor, etc., or place parts (cables, etc.) while the power is turned ON or immediately after turning the power OFF. These parts may reach high temperatures, and can cause burns or part damage.
-  Structure the cooling fan on the unit back face, etc., so that it cannot be touched after installation. Touching the cooling fan during operation could lead to injuries.
-  Take care not to suck hair, clothes, etc. into the cooling fan.

## ⚠ CAUTION

### ■ Various precautions

Observe the following precautions. Incorrect handling of the unit could lead to faults, injuries and electric shocks, etc.

#### (1) Transportation and installation

- ⚠ Correctly transport the product according to its weight.
- ❗ Use the motor's hanging bolts only when transporting the motor itself.  
Do not use the motor's hanging bolts to transport a motor with other parts installed, or to transport a machine with a motor installed.
- ⚠ Do not stack the products above the tolerable number.
- ⚠ Follow this manual and install the unit or motor securely in a place where it can be borne and noncombustible. Insufficient fixing could lead to the unit or the motor slipping off during operation.
- ⚠ Do not get on top of or place heavy objects on the unit.

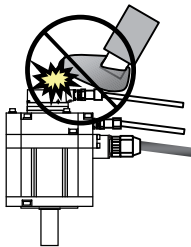

- ⚠ Do not hold the cables, axis or encoder when transporting the motor.

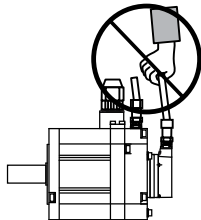

- ⚠ Do not hold the connected wires or cables when transporting the units.
- ⚠ Do not hold the front cover when transporting the unit. The unit could drop.
- ⚠ Always observe the installation directions of the units or motors.
- ⚠ Secure the specified distance between the units and control panel, or between the servo drive unit and other devices.
- ⚠ Do not install or run a unit or motor that is damaged or missing parts.
- ⚠ Do not block the intake or exhaust ports of the motor provided with a cooling fan.
- ⚠ Do not let foreign objects enter the units or motors. In particular, if conductive objects such as screws or metal chips, etc., or combustible materials such as oil enter, rupture or breakage could occur.
- ⚠ Provide adequate protection using a material such as connector for conduit to prevent screws, metallic detritus, water and other conductive matter or oil and other combustible matter from entering the motor through the power line lead-out port.
- ⚠ The units, motors and encoders are precision devices, so do not drop them or apply strong impacts to them.
- ⚠ Always operate the motor, which has a shaft with keyway, with the key attached.



**⚠ CAUTION**

**⚠ Store and use the units under the following environment conditions.**

Environment	Unit	Servo motor	Spindle motor
<b>Ambient temperature</b>	Operation: Operation 0 to +55°C (with no freezing), Storage / Transportation: -15°C to +70°C (with no freezing)	Operation: 0 to +40°C (with no freezing), Storage: -15°C to +70°C (with no freezing)	Operation: 0 to +40°C (with no freezing), Storage: -20°C to +65°C (with no freezing)
<b>Ambient humidity</b>	Storage: 90% RH or less (with no dew condensation), Storage / Transportation: 90% RH or less (with no dew condensation)	Operation: 80% RH or less (with no dew condensation), Storage: 90% RH or less (with no dew condensation)	Operation: 90% RH or less (with no dew condensation), Storage: 90% RH or less (with no dew condensation)
<b>Atmosphere</b>	Indoors (no direct sunlight) With no corrosive gas, inflammable gas, oil mist, dust or conductive fine particles		
<b>Altitude</b>	Operation/Storage: 1000 meters or less above sea level, Transportation: 13000 meters or less above sea level	Operation/Storage: 1000 meters or less above sea level, Transportation: 10000 meters or less above sea level	
<b>Vibration / impact</b>	According to each unit or motor specification		

(\*) For details, confirm each unit or motor specifications in addition.

**⚠ When disinfectants or insecticides must be used to treat wood packaging materials, always use methods other than fumigation (for example, apply heat treatment at the minimum wood core temperature of 56 °C for a minimum duration of 30 minutes (ISPM No. 15 (2009))).**

**If products such as units are directly fumigated or packed with fumigated wooden materials, halogen substances (including fluorine, chlorine, bromine and iodine) contained in fumes may contribute to the erosion of the capacitors.**

**When exporting the products, make sure to comply with the laws and regulations of each country.**

- ⚠ Do not use the products in conjunction with any components that contain halogenated flame retardants (bromine, etc). Failure to observe this may cause the erosion of the capacitors.**
- ⚠ Securely fix the servo motor to the machine. Insufficient fixing could lead to the servo motor slipping off during operation.**
- ⚠ Always install the servo motor with reduction gear in the designated direction. Failure to do so could lead to oil leaks.**
- ⚠ Structure the rotary sections of the motor so that it can never be touched during operation. Install a cover, etc., on the shaft.**
- ⚠ When installing a coupling to a servo motor shaft end, do not apply an impact by hammering, etc. The encoder could be damaged.**
- ⚠ Do not apply a load exceeding the tolerable load onto the servo motor shaft. The shaft could break.**
- ⚠ Store the motor in the package box.**
- ⚠ When inserting the shaft into the built-in IPM/SPM spindle motor, do not heat the rotor higher than 130°C. The magnet could be demagnetized, and the specifications characteristics will not be ensured.**
- ⚠ Always use a nonmagnetic tool (explosion-proof beryllium copper alloy safety tool: NGK Insulators, etc.) when installing the built-in IPM/SPM spindle motor, direct-drive motor and linear servo motor.**
- ⚠ Always provide a mechanical stopper on the end of the linear servo motor's travel path.**
- ❗ If the unit has been stored for a long time, always check the operation before starting actual operation. Please contact the Service Center, Sales Office or dealer.**
- ⚠ Install the heavy peripheral devices to the lower part in the panel and securely fix it not to be moved due to vibration.**

## ⚠ CAUTION

### (2) Wiring

- ⚠ Correctly and securely perform the wiring. Failure to do so could lead to abnormal operation of the motor.
- ⚠ Do not install a condensing capacitor, surge absorber or radio noise filter on the output side of the drive unit.
- ⚠ Correctly connect the output side of the drive unit (terminals U, V, W). Failure to do so could lead to abnormal operation of the motor.
- ⚠ When using a power regenerative power supply unit, always install an AC reactor for each power supply unit.
- ⚠ In the main circuit power supply side of the unit, always install an appropriate circuit protector or contactor for each unit. Circuit protector or contactor cannot be shared by several units.
- ⚠ Always connect the motor to the drive unit's output terminals (U, V, W).
- ⚠ Do not directly connect a commercial power supply to the servo motor. Failure to observe this could result in a fault.
- ⚠ When using an inductive load such as a relay, always connect a diode as a noise measure parallel to the load.
- ⚠ When using a capacitance load such as a lamp, always connect a protective resistor as a noise measure serial to the load.
- ⚠ Do not reverse the direction of a diode which connect to a DC relay for the control output signals such as contractor and motor brake output, etc. to suppress a surge. Connecting it backwards could cause the drive unit to malfunction so that signals are not output, and emergency stop and other safety circuits are inoperable.
- ⚠ Do not connect/disconnect the cables connected between the units while the power is ON.
- ⚠ Securely tighten the cable connector fixing screw or fixing mechanism. An insecure fixing could cause the cable to fall off while the power is ON.
- ⚠ When using a shielded cable instructed in the instruction manual, always ground the cable with a cable clamp, etc. (Refer to "EMC Installation Guidelines")
- ⚠ Always separate the signals wires from the power line.
- ⚠ Use wires and cables that have a wire diameter, heat resistance and flexibility that conforms to the system.

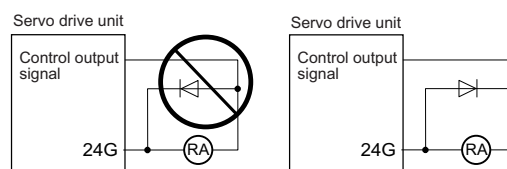



















### (3) Trial operation and adjustment



- ⚠ Check and adjust each program and parameter before starting operation. Failure to do so could lead to unforeseen operation of the machine.
- ⚠ Do not make remarkable adjustments and changes of parameter as the operation could become unstable.
- ⚠ The usable motor and unit combination is predetermined. Always check the combinations and parameters before starting trial operation.
- ⚠ The direct-drive motor and linear servo motor do not have a stopping device such as magnetic brakes. Install a stopping device on the machine side.
- ⚠ When using the linear servo motor for an unbalance axis, adjust the unbalance weight to 0 by installing an air cylinder, etc. on the machine side. The unbalance weight disables the initial magnetic pole adjustment.

## CAUTION

### (4) Usage methods







-  In abnormal state, install an external emergency stop circuit so that the operation can be stopped and power shut off immediately.
-  Turn the power OFF immediately if smoke, abnormal noise or odors are generated from the unit or motor.
-  Do not disassemble or repair this product.
-  Never make modifications.
-  When an alarm occurs, the machine will start suddenly if an alarm reset (RST) is carried out while an operation start signal (ST) is being input. Always confirm that the operation signal is OFF before carrying out an alarm reset. Failure to do so could lead to accidents or injuries.
-  Reduce magnetic damage by installing a noise filter. The electronic devices used near the unit could be affected by magnetic noise. Install a line noise filter, etc., if there is a risk of magnetic noise.
-  Use the unit, motor and regenerative resistor with the designated combination. Failure to do so could lead to fires or trouble.
-  The brake (magnetic brake) of the servo motor are for holding, and must not be used for normal braking.
-  There may be cases when holding is not possible due to the magnetic brake's life, the machine construction (when ball screw and servo motor are coupled via a timing belt, etc.) or the magnetic brake's failure. Install a stop device to ensure safety on the machine side.
-  After changing the programs/parameters or after maintenance and inspection, always test the operation before starting actual operation.
-  Do not enter the movable range of the machine during automatic operation. Never place body parts near or touch the spindle during rotation.
-  Follow the power supply specification conditions given in each specification for the power (input voltage, input frequency, etc.).
-  Set all bits to "0" if they are indicated as not used or empty in the explanation on the bits.
-  Do not use the dynamic brakes except during the emergency stop. Continued use of the dynamic brakes could result in brake damage.
-  If a circuit protector for the main circuit power supply is shared by several units, the circuit protector may not activate when a short-circuit fault occurs in a small capacity unit. This is dangerous, so never share the circuit protector.
-  Mitsubishi spindle motor is dedicated to machine tools. Do not use for other purposes.
-  This unit is not intended for use in low voltage public networks that supply power to households. Using this unit in such networks may cause radio frequency interference.
-  Do not use this unit in residential areas.
-  There is a maximum of 5 second standby time when READY is turned ON after it is turned OFF.

### (5) Troubleshooting





-  If a hazardous situation is predicted during power failure or product trouble, use a servo motor with magnetic brakes or install an external brake mechanism.
-  Always turn the main circuit power of the motor OFF when an alarm occurs.
-  If an alarm occurs, remove the cause, and secure the safety before resetting the alarm.

## CAUTION



### (6) Maintenance, inspection and part replacement

-  Always backup the programs and parameters before starting maintenance or inspections.
-  The capacity of the electrolytic capacitor will drop over time due to self-discharging, etc. To prevent secondary disasters due to failures, replacing this part every five years when used under a normal environment is recommended. Contact the Service Center, Service Station, Sales Office or dealer for repairs or part replacement.
-  Never perform a megger test (measure the insulation resistance) of the drive unit. Failure to observe this could lead to faults.
-  If the battery low warning is issued, immediately replace the battery. Replace the batteries while applying the drive unit's control power.
-  Do not short circuit, charge, overheat, incinerate or disassemble the battery.
-  For after-purchase servicing of the built-in motor, only the servicing parts for MITSUBISHI encoder can be supplied. For the motor body, prepare the spare parts at the machine tool builders.
-  For maintenance, part replacement, and services in case of failures in the built-in motor (including the encoder), take necessary actions at the machine tool builders. For drive unit, Mitsubishi can offer the after-purchase servicing as with the general drive unit.

### (7) Disposal

-  Take the batteries and backlights for LCD, etc., off from the controller, drive unit and motor, and dispose of them as industrial wastes.
-  Do not disassemble the unit or motor.
-  Dispose of the battery according to local laws.
-  Dispose of the primary side of the linear servo motor as industrial waste. For the secondary side, dispose of it as industrial waste after demagnetizing it by heating it to 300°C or higher.
-  When incinerating optical communication cable, hydrogen fluoride gas or hydrogen chloride gas which is corrosive and harmful may be generated. For disposal of optical communication cable, request for specialized industrial waste disposal services that has incineration facility for disposing hydrogen fluoride gas or hydrogen chloride gas.

### (8) Transportation

-  The unit and motor are precision parts and must be handled carefully.
-  According to a United Nations Advisory, the battery unit and battery must be transported according to the rules set forth by the International Civil Aviation Organization (ICAO), International Air Transportation Association (IATA), International Maritime Organization (IMO), and United States Department of Transportation (DOT), etc.

### (9) General precautions

The drawings given in this manual show the covers and safety partitions, etc., removed to provide a clearer explanation. Always return the covers or partitions to their respective places before starting operation, and always follow the instructions given in this manual.

## Treatment of waste

The following two laws will apply when disposing of this product. Considerations must be made to each law. The following laws are in effect in Japan. Thus, when using this product overseas, the local laws will have a priority. If necessary, indicate or notify these laws to the final user of the product.

- (1) Requirements for "Law for Promotion of Effective Utilization of Resources"
  - (a) Recycle as much of this product as possible when finished with use.
  - (b) When recycling, often parts are sorted into steel scraps and electric parts, etc., and sold to scrap contractors. Mitsubishi Electric recommends sorting the product and selling the members to appropriate contractors.
  
- (2) Requirements for "Law for Treatment of Waste and Cleaning"
  - (a) Mitsubishi Electric recommends recycling and selling the product when no longer needed according to item (1) above. The user should make an effort to reduce waste in this manner.
  - (b) When disposing a product that cannot be resold, it shall be treated as a waste product.
  - (c) The treatment of industrial waste must be commissioned to a licensed industrial waste treatment contractor, and appropriate measures, including a manifest control, must be taken.
  - (d) Batteries correspond to "primary batteries", and must be disposed of according to local disposal laws.

## Disposal



(Note) This symbol mark is for EU countries only.  
This symbol mark is according to the directive 2006/66/EC Article 20 Information for end-users and Annex II.

Your MITSUBISHI ELECTRIC product is designed and manufactured with high quality materials and components which can be recycled and/or reused.

This symbol means that batteries and accumulators, at their end-of-life, should be disposed of separately from your household waste.

If a chemical symbol is printed beneath the symbol shown above, this chemical symbol means that the battery or accumulator contains a heavy metal at a certain concentration. This will be indicated as follows:

Hg: mercury (0,0005%), Cd: cadmium (0,002%), Pb: lead (0,004%)

In the European Union there are separate collection systems for used batteries and accumulators.

Please, dispose of batteries and accumulators correctly at your local community waste collection/recycling centre.

Please, help us to conserve the environment we live in!

## **Trademarks**

MELDAS, MELSEC, EZSocket, EZMotion, iQ Platform, MELSOFT, GOT, CC-Link, CC-Link/LT and CC-Link IE are either trademarks or registered trademarks of Mitsubishi Electric Corporation in Japan and/or other countries.

Other company and product names that appear in this manual are trademarks or registered trademarks of the respective companies.

## 本製品の取扱いについて

(日本語 /Japanese)

本製品は工業用(クラス A)電磁環境適合機器です。販売者あるいは使用者はこの点に注意し、住商業環境以外での使用をお願いいたします。

## Handling of our product

(English)

This is a class A product. In a domestic environment this product may cause radio interference in which case the user may be required to take adequate measures.

## 본 제품의 취급에 대해서

(한국어 /Korean)

이 기기는 업무용(A급) 전자파적합기기로서 판매자 또는 사용자는 이 점을 주의하시기 바라며 가정외의 지역에서 사용하는 것을 목적으로 합니다.



# WARRANTY

Please confirm the following product warranty details before using Mitsubishi Electric CNC.

## **1. Warranty Period and Coverage**

Should any fault or defect (hereafter called "failure") for which we are liable occur in this product during the warranty period, we shall provide repair services at no cost through the distributor from which the product was purchased or through a Mitsubishi Electric service provider. Note, however that this shall not apply if the customer was informed prior to purchase of the product that the product is not covered under warranty. Also note that we are not responsible for any on-site readjustment and/or trial run that may be required after a defective unit is replaced.

### [Warranty Term]

The term of warranty for this product shall be twenty-four (24) months from the date of delivery of product to the end user, provided the product purchased from us in Japan is installed in Japan (but in no event longer than thirty (30) months, including the distribution time after shipment from Mitsubishi Electric or its distributor).

Note that, for the case where the product purchased from us in or outside Japan is exported and installed in any country other than where it was purchased; please refer to "2. Service in overseas countries" as will be explained.

### [Limitations]

- (1) The customer is requested to conduct an initial failure diagnosis by him/herself, as a general rule. It can also be carried out by us or our service provider upon the customer's request and the actual cost will be charged.
- (2) This warranty applies only when the conditions, method, environment, etc., of use are in compliance with the terms and conditions and instructions that are set forth in the instruction manual, user's manual, and the caution label affixed to the product, etc.
- (3) Even during the term of warranty, repair costs shall be charged to the customer in the following cases:
  - (a) a failure caused by improper storage or handling, carelessness or negligence, etc., or a failure caused by the customer's hardware or software problem
  - (b) a failure caused by any alteration, etc., to the product made by the customer without Mitsubishi Electric's approval
  - (c) a failure which may be regarded as avoidable, if the customer's equipment in which this product is incorporated is equipped with a safety device required by applicable laws or has any function or structure considered to be indispensable in the light of common sense in the industry
  - (d) a failure which may be regarded as avoidable if consumable parts designated in the instruction manual, etc. are duly maintained and replaced
  - (e) any replacement of consumable parts (including a battery, relay and fuse)
  - (f) a failure caused by external factors such as inevitable accidents, including without limitation fire and abnormal fluctuation of voltage, and acts of God, including without limitation earthquake, lightning, and natural disasters
  - (g) a failure which is unforeseeable under technologies available at the time of shipment of this product from our company
  - (h) any other failures which we are not responsible for or which the customer acknowledges we are not responsible for

## **2. Service in Overseas Countries**

If the customer installs the product purchased from us in his/her machine or equipment, and export it to any country other than where he/she bought it, the customer may sign a paid warranty contract with our local FA center.

This falls under the case where the product purchased from us in or outside Japan is exported and installed in any country other than where it was purchased.

For details please contact the distributor from which the customer purchased the product.

## **3. Exclusion of Loss in Opportunity and Secondary Loss from Warranty Liability**

Regardless of the gratis warranty term, Mitsubishi Electric shall not be liable for compensation to:

- (1) Damages caused by any cause found not to be the responsibility of Mitsubishi Electric.
- (2) Loss in opportunity, lost profits incurred to the user by Failures of Mitsubishi Electric products.
- (3) Special damages and secondary damages whether foreseeable or not, compensation for accidents, and compensation for damages to products other than Mitsubishi Electric products.
- (4) Replacement by the user, maintenance of on-site equipment, start-up test run and other tasks.

## **4. Changes in Product Specifications**

Specifications shown in our catalogs, manuals or technical documents are subject to change without notice.

## **5. Product Application**

- (1) For the use of this product, its applications should be those that may not result in a serious damage even if any failure or malfunction occurs in the product, and a backup or fail-safe function should operate on an external system to the product when any failure or malfunction occurs.
- (2) Mitsubishi Electric CNC is designed and manufactured solely for applications to machine tools to be used for industrial purposes.  
Do not use this product in any applications other than those specified above, especially those which are substantially influential on the public interest or which are expected to have significant influence on human lives or properties.

# Contents

<b>1 Introduction</b>	<b>1</b>
1.1 Features	2
1.2 System Configuration	2
1.3 Explanation of Type	3
1.3.1 Unit Type	3
1.3.2 Rating Nameplate	3
<b>2 Specifications</b>	<b>5</b>
2.1 Power Supply Unit	6
2.2 AC Reactor	8
2.3 Spindle Drive Unit	10
2.4 Explanation of Each Part	11
<b>3 Function Specifications</b>	<b>15</b>
Function Specifications List	16
<b>4 Characteristics</b>	<b>17</b>
4.1 Environmental Conditions	18
4.2 Heating Value	18
<b>5 Installation</b>	<b>19</b>
5.1 Installation Direction and Clearance	20
5.2 Panel Installation Hole Work Drawings (Panel Cut Drawings)	23
<b>6 Wiring and Connection</b>	<b>25</b>
6.1 Part System Connection Diagram	26
6.2 Main Circuit Terminal Block/Control Circuit Connector	27
6.2.1 Names and Applications of Main Circuit Terminal Block Signals and Control Circuit Connectors	27
6.2.2 Connector Pin Assignment	28
6.2.3 Connection of MDS-EX-ALC-1100H Main Circuit Terminal	31
6.3 Connection of Power Supply	32
6.3.1 Power Supply Input Connection	32
6.3.2 Wiring of the Grounding Cable	33
6.4 Peripheral Control Wiring	33
6.4.1 Input/Output Circuit Wiring	33
<b>7 Setup</b>	<b>35</b>
7.1 Setting the Initial Parameters for the Drive Unit	36
7.1.1 Servo Parameter	36
7.1.2 Spindle Parameter	37
7.2 Initial Setup	38
7.2.1 Setting the Rotary Switch	38
7.2.2 Transition of LED Display after Power Is Turned ON	39
<b>8 Selection</b>	<b>41</b>
8.1 Selection of the Power Supply Unit	42
8.2 Selection of Power Supply	43
<b>9 Specifications of Peripheral Devices</b>	<b>45</b>
9.1 Selection of Wire	46
9.1.1 Wire Selection Standards and Maximum Allowable Wiring Length for Each Product	46
9.1.2 Example of Wires by Unit	48
9.1.3 Selection of Link Bar	48
9.2 Selection of Circuit Protector and Contactor	49
9.2.1 Selection of Circuit Protector	49
9.2.2 Selection of Contactor	49
<b>10 Cable and Connector Specifications</b>	<b>51</b>
10.1 Cable Connection Diagram	52
10.2 Connector Outline Dimension Drawings	53
<b>11 Troubleshooting</b>	<b>55</b>
11.1 Points of Caution and Confirmation	56
11.1.1 LED Display When Alarm or Warning Occurs	57
11.2 Protective Functions List of Units	57
11.2.1 List of Alarms	57
11.2.2 List of Warnings	58

11.3 Troubleshooting .....	58
<b>12 Appx.1: Maintenance .....</b>	<b>65</b>
12.1 Periodic Inspections.....	66
12.2 Service Parts .....	66
12.3 Adding and Replacing Units and Parts .....	67
<b>13 Appx.2: Compliance to EC Directives .....</b>	<b>71</b>
13.1 European EC Directives .....	72
13.2 Cautions for EC Directive Compliance .....	72
<b>14 Appx.3: EMC Installation Guidelines.....</b>	<b>75</b>
14.1 Introduction .....	76
14.2 EMC Directives/Electromagnetic Compatibility Regulations.....	76
14.3 EMC Measures .....	76
14.4 Measures for Panel Structure .....	77
14.4.1 Measures for Control Panel Unit.....	77
14.4.2 Measures for Door .....	78
14.4.3 Measures for Operation Board Panel.....	78
14.4.4 Shielding of the Power Supply Input Section .....	78
14.5 EMC Countermeasure Parts.....	79
14.5.1 Shield Clamp Fitting .....	79
14.5.2 Ferrite Core .....	79
<b>15 Appx.4: Higher Harmonic Suppression Measure Guidelines .....</b>	<b>81</b>
15.1 Higher Harmonic Suppression Measure Guidelines .....	82



---

# Introduction

1 Introduction

1.1 Features

This manual is a power supply unit "MDS-EX-CVP Series" specifications and instruction manual. Before using the unit, read the following instruction manuals thoroughly to ensure correct usage.

- MDS-E/EH Series Specifications Manual (IB-1501226(ENG))
- MDS-E/EH Series Instruction Manual (IB-1501229(ENG))

1.1 Features

For a high-speed and high-output spindle motor drive system, in addition to a large capacity drive unit, a stabilized DC voltage supply to the drive unit by the power supply unit is also required.

Power supply unit "MDS-EX-CVP Series" is a product of the "PWM converter" series which has a "stabilizing DC voltage function and boost function". MDS-EX-CVP Series reduces the output deceleration of the spindle motor and improves output in the high-speed range.

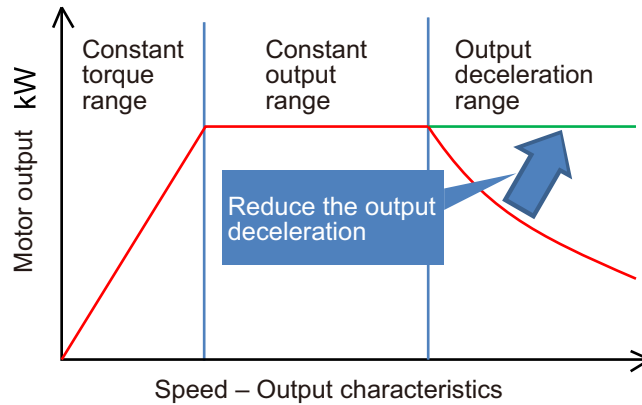

1.2 System Configuration

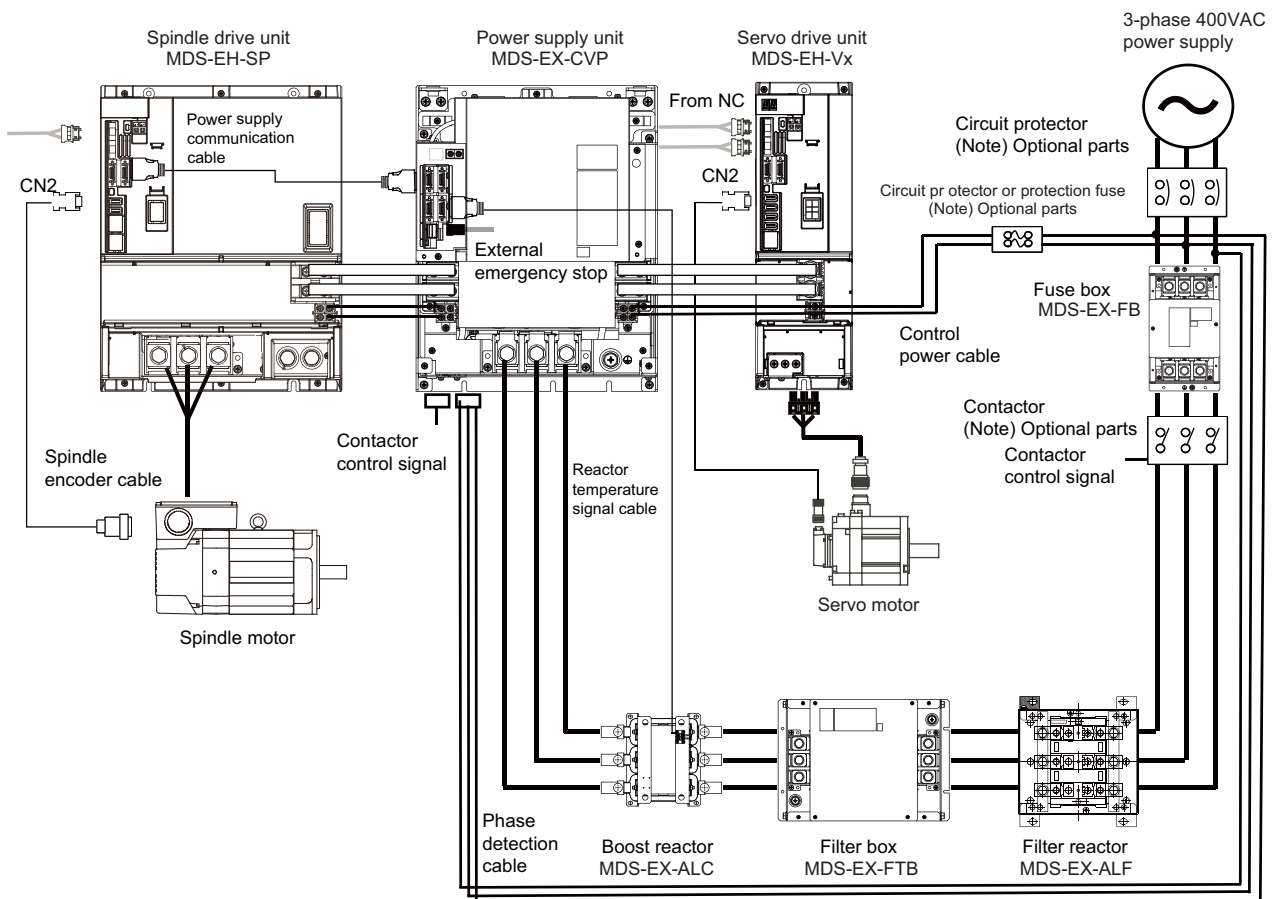

1 Introduction

1.3 Explanation of Type

1.3 Explanation of Type

1.3.1 Unit Type

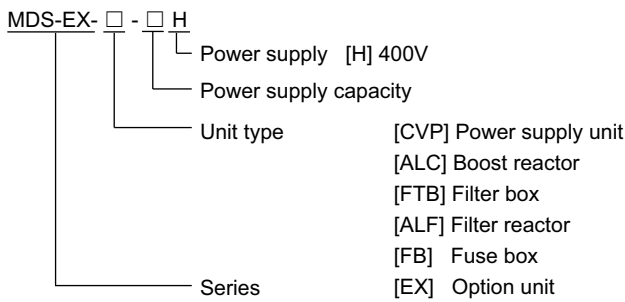

1.3.2 Rating Nameplate

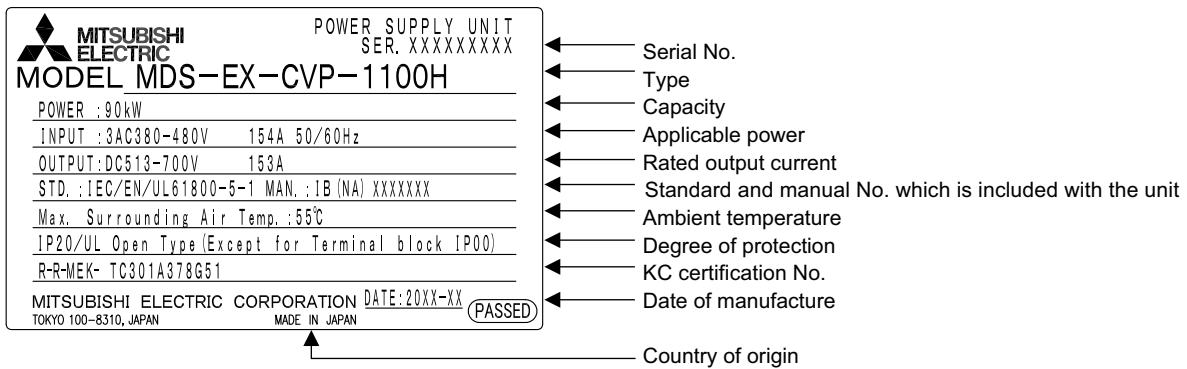

**1 Introduction**

1.3 Explanation of Type

# 2

---

## Specifications



2 Specifications

2.1 Power Supply Unit

2.1 Power Supply Unit

		Power supply unit MDS-EX-CVP Series		
Power supply unit type MDS-EX-		CVP-1100H	FTB-1100H	FB-1100H
Nominal power supply voltage		400		
Continuous rated output [kW]		90		
30-minute rated output [kW]		110		
Short-time maximum output [kW]		220		
Power supply capacity [kVA]		130		
Input	Rated voltage [V]	380 to 480 3AC		
	Frequency [Hz]	50/60 (Allowable range: 47 to 63)		
	Rated current [A]	154		
Output	Rated voltage [V]	513 to 700 DC (Setting range: 648 to 700 DC)	380 to 480 3AC	
	Rated current [A]	153	154	
Control power	Voltage [V]	380 to 480 AC	-	
	Frequency [Hz]	50/60 (Allowable range: 47 to 63)	-	
	Rated current [A]	0.3	-	
	Maximum rush current [A]	18	-	
	Maximum rush conductivity time [ms]	12	-	
Main circuit method		PWM converter	Filter circuit	Fuse circuit
Configuration (degree of protection)		Open IP20 (excluding terminal block)		
Cooling method		Forced air cooling	Natural-cooling	
Mass [kg]		36.0	11.5	5.8
Heat radiated at rated output [W]		1,750	320	40
Unit outline dimension drawing		Refer to the following.		

Outline Dimension Drawing

[Unit: mm]

■ MDS-EX-CVP-1100H

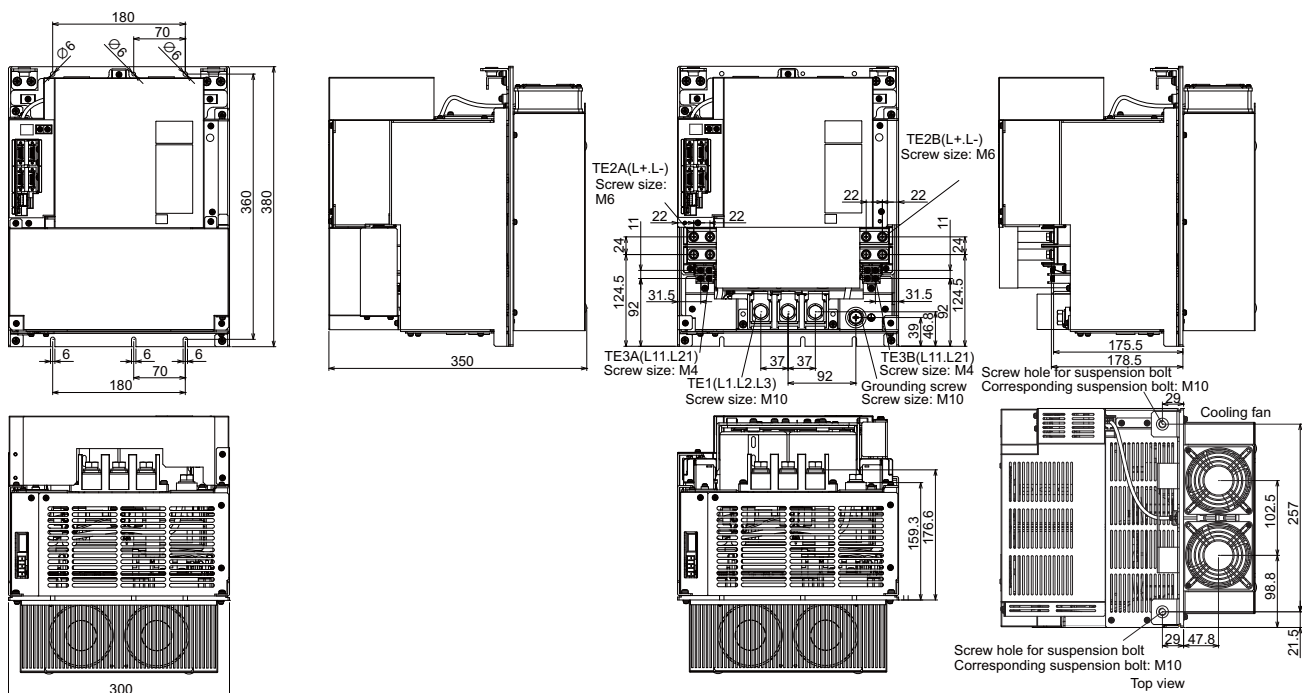

2 Specifications

2.1 Power Supply Unit

■ MDS-EX-FTB-1100H

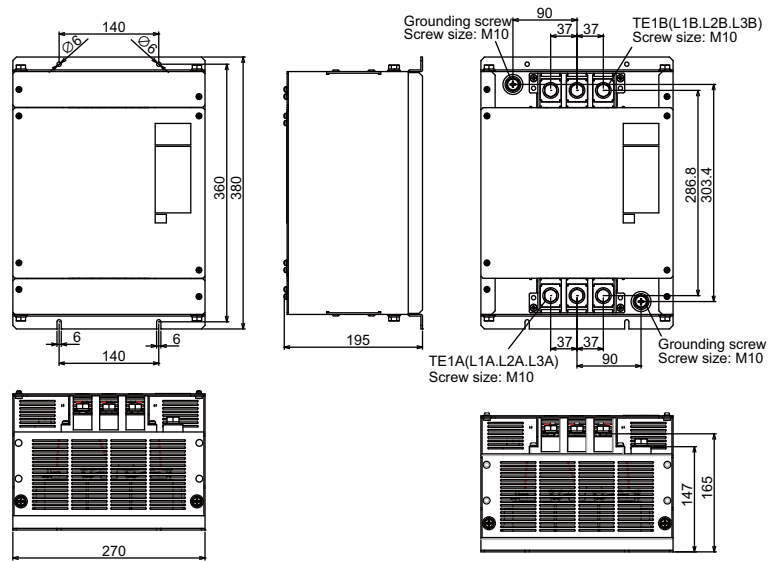

■ MDS-EX-FB-1100H

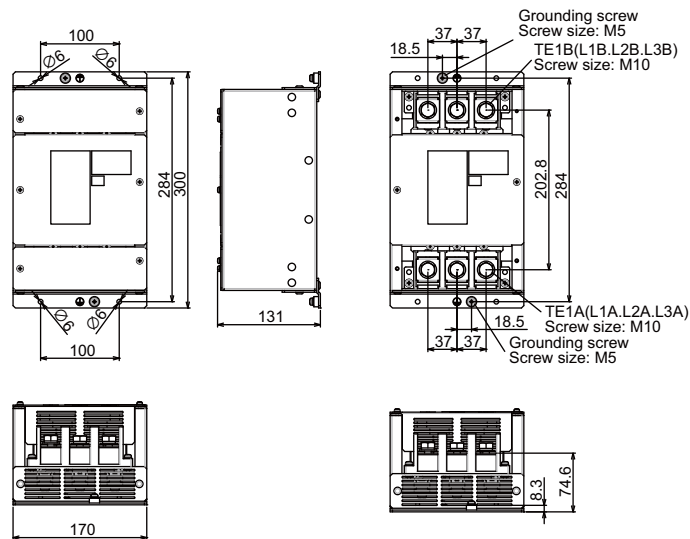

2 Specifications

2.2 AC Reactor

## 2.2 AC Reactor

An AC reactor must be installed for a power supply unit.

		AC reactor	
AC reactor model		MDS-EX-ALC-1100H	MDS-EX-ALF-1100H
30-minute rated output [kW]		110	
Continuous rated output [kW]		90	
Rated voltage [V]		380 to 480 3AC	
Rated current [A]		154	
Frequency [Hz]		50/60 (Allowable range: 47 to 63)	
Environment	Ambient temperature	Operation: -10°C to 60°C (with no freezing), Storage/Transportation: -10°C to 60°C (with no freezing)	
	Ambient humidity	Operation: 80 %RH or less (with no dew condensation), Storage/Transportation: 80 %RH or less (with no dew condensation)	
	Atmosphere	Indoors (no direct sunlight) With no corrosive gas, inflammable gas, oil mist, or dust	
	Altitude	Operation/Storage: 1000 meters or less above sea level, Transportation: 10000 meters or less above sea level	
	Vibration / impact	9.8m/s <sup>2</sup> (1G) / 98m/s <sup>2</sup> (10G)	
Reactor function		Boost reactor	Filter reactor
Mass [kg]		90.0	24.5
Heat radiated at rated output [W]		520	210
Unit outline dimension drawing		Refer to the following.	

Outline dimension drawing

[Unit: mm]

■ MDS-EX-ALC-1100H

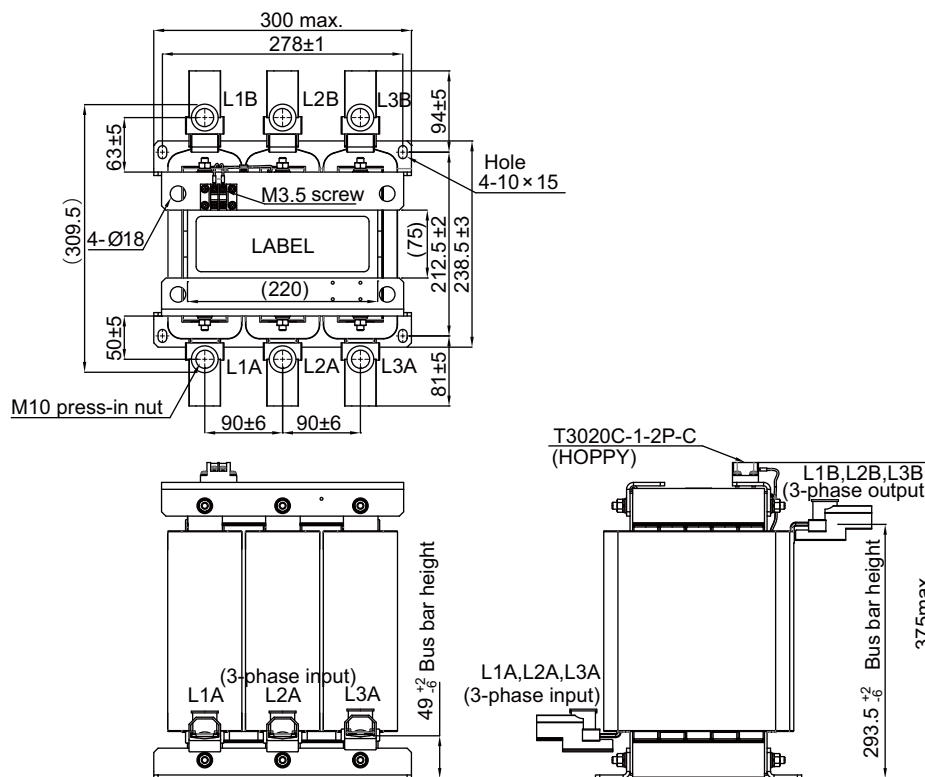

■ MDS-EX-ALF-1100H

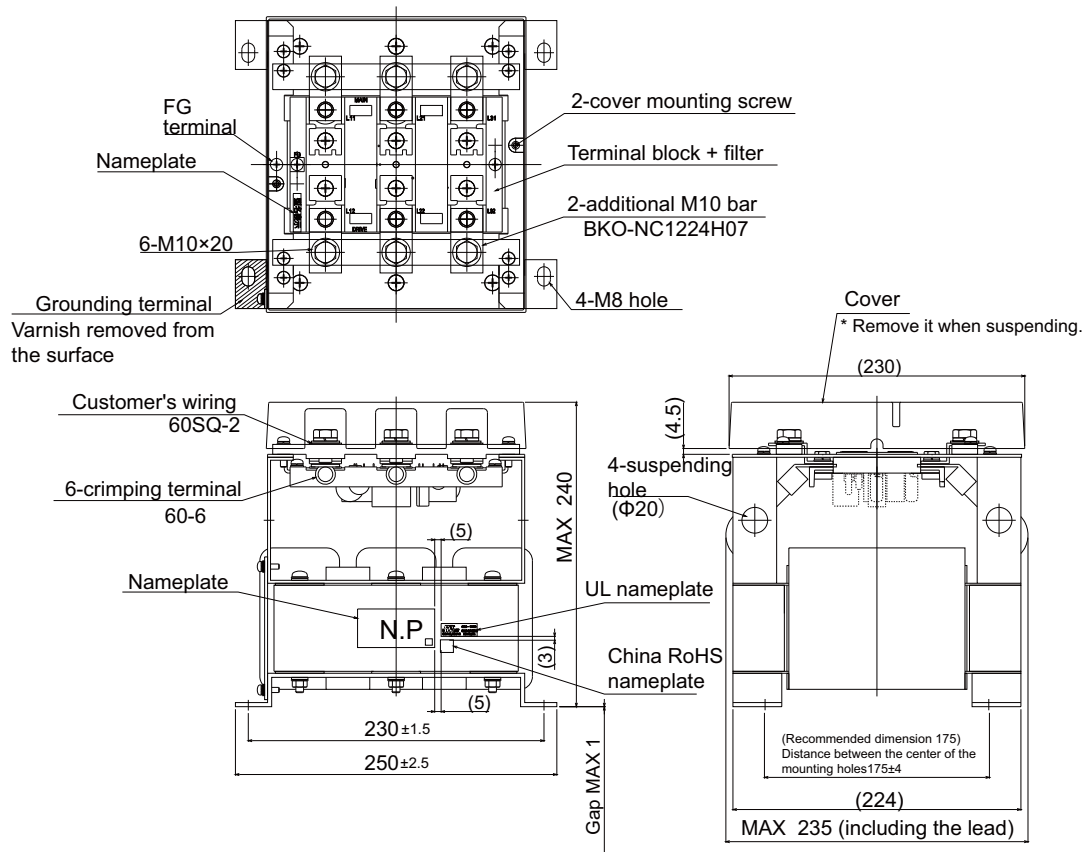

2 Specifications

2.3 Spindle Drive Unit

## 2.3 Spindle Drive Unit

The output voltage can be set to "648V or higher" in systems that only use the spindle drive unit "MDS-EH-SP-600" to connect the power supply unit "MDS-EX-CVP-1100H".

		1-axis spindle drive unit MDS-EH-SP Series
Spindle drive unit type MDS-EH-SP-		600
Nominal maximum current (peak) [A]		600
Output	Rated voltage [V]	323 AC
	Rated current [A]	200
Input	Rated voltage [V]	513 to 700 DC
	Rated current [A]	200
Control power	Voltage [V]	380 to 480 AC Tolerable fluctuation: between +10 % and -15 %
	Frequency [Hz]	50/60 (tolerable fluctuation: ±5 %)
	Maximum current [A]	0.3
	Maximum rush current [A]	18
	Maximum rush conductivity time [ms]	18
Maximum earth leakage current [mA]		15
Control method		Sine wave PWM control method
Braking		Regenerative braking
External analog output		0 to 5 V, 2 ch (data for various adjustments)
Degree of protection		IP20 (excluding terminal block)
Cooling method		Forced air cooling
Mass [kg]		20.1
Heat radiated at continuous rated output [W]		2349
Unit outline dimension drawing		Refer to the following.

Outline dimension drawing

[Unit: mm]

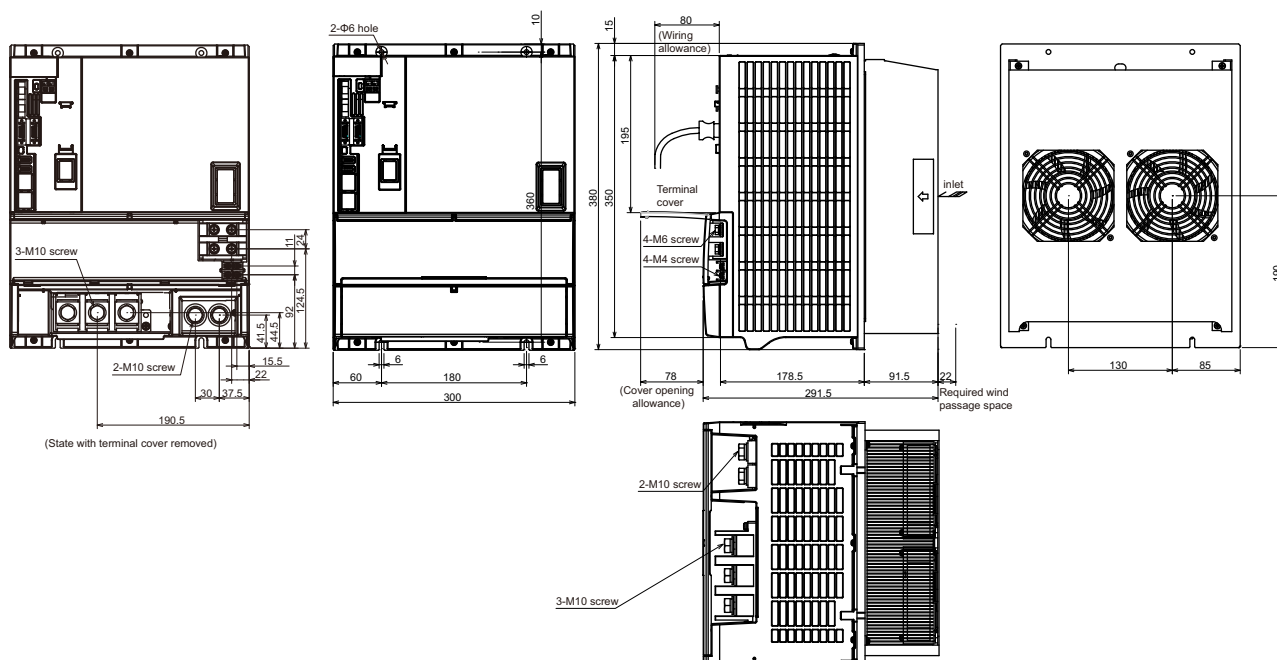

Refer to the latest version of "MDS-E/EH Series Specifications Manual" (IB-1501226(ENG)) and "MDS-E/EH Series Instruction Manual" (IB-1501229(ENG)) for details about the unit above.

2 Specifications

2.4 Explanation of Each Part

2.4 Explanation of Each Part

■ Explanation of each MDS-EX-CVP-1100H power supply unit part

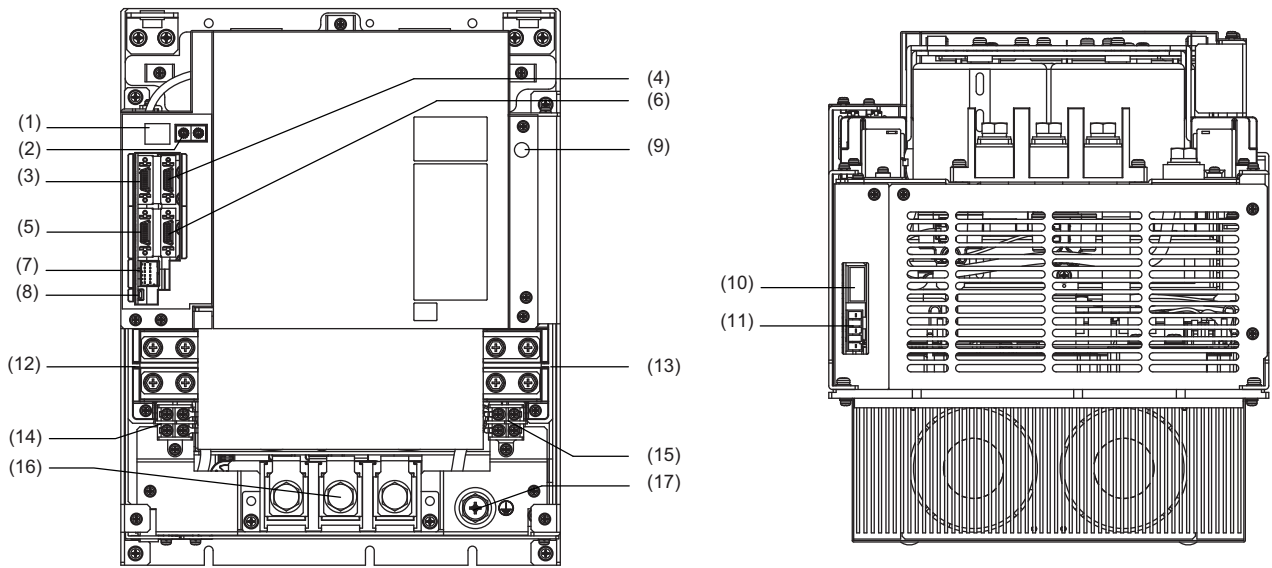

		Name		Description
(1)	Control circuit	LED	---	Power supply status indication LED
(2)		SW1, SW2	---	Power supply setting rotary switch
(3)		CN4	---	Servo/spindle communication connector (primary)
(4)		CN41	---	Power backup unit communication connector
(5)		CN9	---	Servo/spindle communication connector (secondary)
(6)		CN91	---	Reactor thermal protector input
(7)		CN24	---	External emergency stop input connector
(8)		CN5	---	USB maintenance connector (usually not used)
(9)		---	CHARGE	TE2 output charging/discharging circuit indication LED
(10)		CN23	---	External contactor control connector
(11)		CN48	---	Power supply input connector for detecting power supply phase (3-phase AC input)
(12)	Main circuit	TE2A	L+	Converter voltage output terminal (DC output)
(13)		TE2B	L-	
(14)		TE3A	L11	Control power input terminal (single-phase AC input)
(15)		TE3B	L21	
(16)		TE1	L1, L2, L3	Power input terminal (3-phase AC input)
(17)		PE	⊕	Grounding terminal

[Screw size]

Type	Power supply unit
Unit width (mm)	MDS-EX-CVP-1100H 300
(16) TE1	M10 × 20
(12) TE2A, (13) TE2B	M6 × 16
(14) TE3A, (15) TE3B	M4 × 10
(17) ⊕	M10 × 20

2 Specifications

2.4 Explanation of Each Part

■ Explanation of each MDS-EX-FTB-1100H filter box part

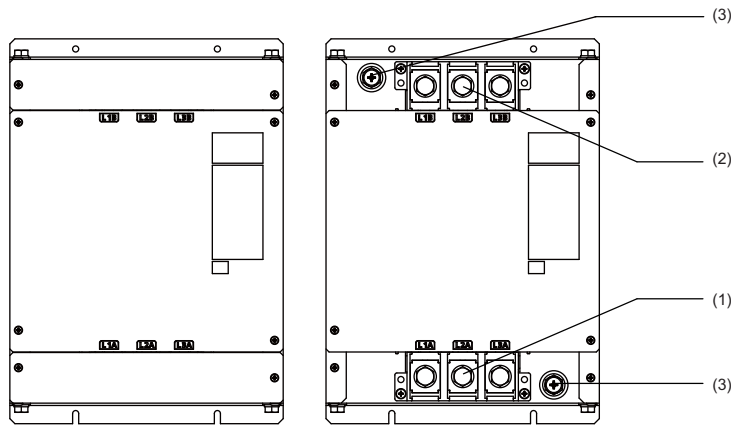

		Name		Description
(1)	Main circuit	TE1A	L1A, L2A, L3A	Power input terminal (3-phase AC input)
(2)		TE1B	L1B, L2B, L3B	Power output terminal (3-phase AC output)
(3)		PE	⊕	Grounding terminal

■ Explanation of each MDS-EX-FB-1100H fuse box part

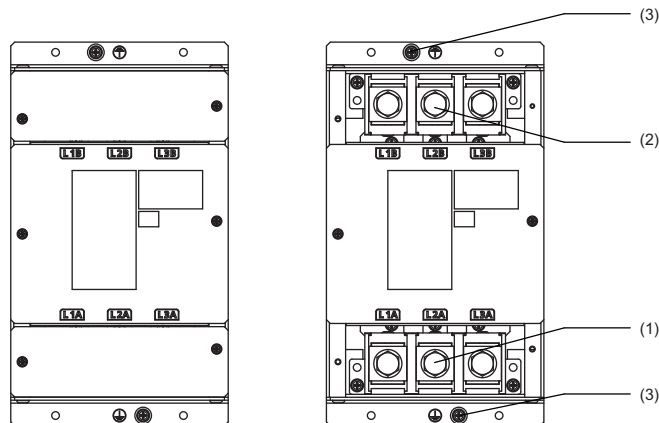

		Name		Description
(1)	Main circuit	TE1A	L1A, L2A, L3A	Power input terminal (3-phase AC input)
(2)		TE1B	L1B, L2B, L3B	Power output terminal (3-phase AC output)
(3)		PE	⊕	Grounding terminal

[Screw size]

Type	Filter box		Fuse box
	MDS-EX-FTB-1100H		MDS-EX-FB-1100H
Unit width (mm)	270		170
(1) TE1A	M10 × 20		M10 × 20
(2) TE1B	M10 × 20		M10 × 20
(3) ⊕	M10 × 20		M5 × 10

2 Specifications

2.4 Explanation of Each Part

■ Explanation of each MDS-EX-ALC-1100H boost reactor part

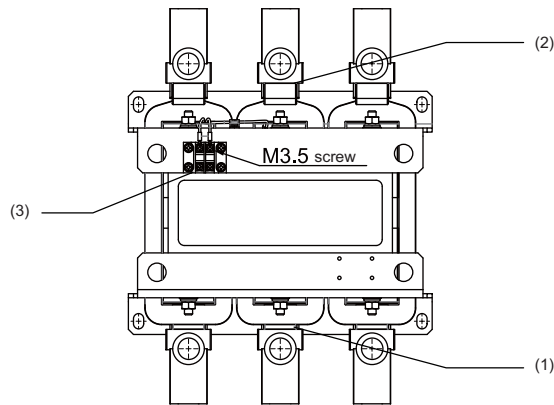

		Name		Description
(1)	Main circuit	TE1A	L1A, L2A, L3A	Power input terminal (3-phase AC input)
(2)		TE1B	L1B, L2B, L3B	Power output terminal (3-phase AC output)
(3)		TE_TH	TH1, TH2	Reactor thermal protector terminal block

■ Explanation of each MDS-EX-ALF-1100H filter reactor part

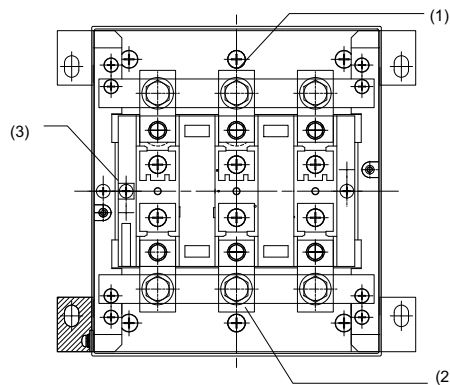

		Name		Description
(1)	Main circuit	TE1A	L11, L21, L31	Power input terminal (3-phase AC input)
(2)		TE1B	L12, L22, L32	Power output terminal (3-phase AC output)
(3)		FG	Ground	Grounding terminal

[Screw size]

Type	Boost reactor		Filter reactor
	MDS-EX-ALC-1100H		MDS-EX-ALF-1100H
Unit width (mm)	300		250
(1) TE1A	M10 × 20		M10 × 20
(2) TE1B	M10 × 20		M10 × 20
(3) TE_TH , FG	M3.5 × 8		M5 × 12



## 2 Specifications

### 2.4 Explanation of Each Part

## **Function Specifications**

## Function Specifications List

### [Power supply specification]

Item		MDS-E-CV	MDS-EH-CV	MDS-EM/ EMH-SPV3 built-in converter	MDS-EJ- V1/V2 built-in converter	MDS-EJH- V1 built-in converter	MDS-EJ- SP/SP2 built-in converter	MDS-EX- CVP Se- ries
1 Base control functions	1.14 Power regeneration control	●	●	●	-	-	-	-
	1.15 Resistor regeneration control	-	-	-	●	●	●	-
	1.16 PWM control	-	-	-	-	-	-	●
4 Protection function	4.5 Fan stop detection	●	●	●	●	●	●	●
	4.6 Open-phase detection	●	●	●	-	-	-	●
	4.7 Contactor weld detection	●	●	●	●	●	●	●
	4.10 Deceleration and stop function at power failure (*1)	●	●	-	-	-	-	●
	4.11 Retraction function at power failure (*2)	●	●	-	-	-	-	●
5 Sequence function	5.1 Contactor control function	●	●	●	●	●	●	●
	5.3 External emergency stop function	●	●	●	●	●	●	●
	5.5 High-speed READY ON sequence	●	●	●	-	-	-	●
6 Diagnosis function	6.6 Power supply diagnosis display function	●	●	●	-	-	-	●
	6.7 Drive unit diagnosis display function	●	●	●	●	●	●	●

(\*1) The power backup unit and resistor unit option are required.

(\*2) The power backup unit and capacitor unit option are required.

(\*3) Refer to "MDS-E/EH Series Specifications Manual" (IB-1501226(ENG)) for details of each function.

# 4

---

## Characteristics

**4 Characteristics**

## 4.1 Environmental Conditions

**4.1 Environmental Conditions**

Environment	Conditions
Ambient temperature	0 °C to +55 °C (with no freezing)
Ambient humidity	90 % RH or less (with no dew condensation)
Storage temperature	-15°C to +70 °C (with no freezing)
Storage humidity	90 % RH or less (with no dew condensation)
Atmosphere	Indoors (no direct sunlight); no corrosive gas, inflammable gas, oil mist, dust or conductive fine particles
Altitude	Operation/storage: 1000 m or less above sea level Transportation: 13000 m or less above sea level
Vibration	Operation/storage: 4.9 m/s <sup>2</sup> (0.5 G) or less, Transportation: 49 m/s <sup>2</sup> (5 G) or less

**4.2 Heating Value**

The values apply for the continuous rated output.

Power supply unit		
Type	Heating value [W]	
	Inside panel	Outside panel
MDS-EX-CVP-1100H	490	1260

# 5

---

## Installation

5 Installation

5.1 Installation Direction and Clearance

### 5.1 Installation Direction and Clearance

Wire each unit in consideration of the maintainability and the heat dissipation, as well as secure sufficient space for ventilation.

#### ■ Installation of PWM converter

The units must be installed in a control panel with IP54 degree of protection.

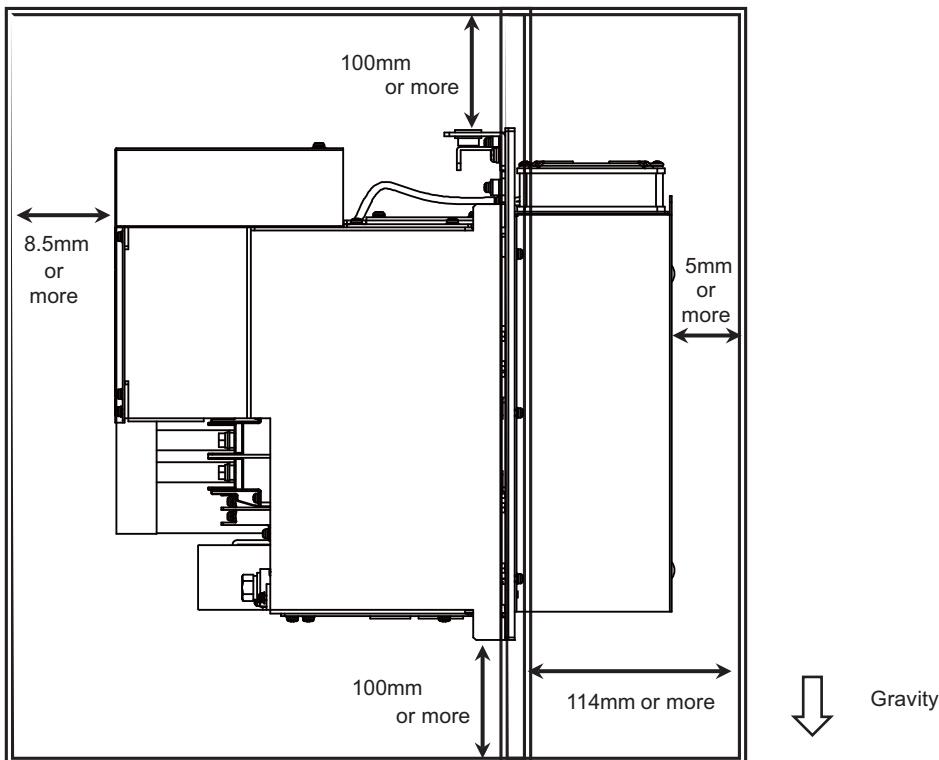
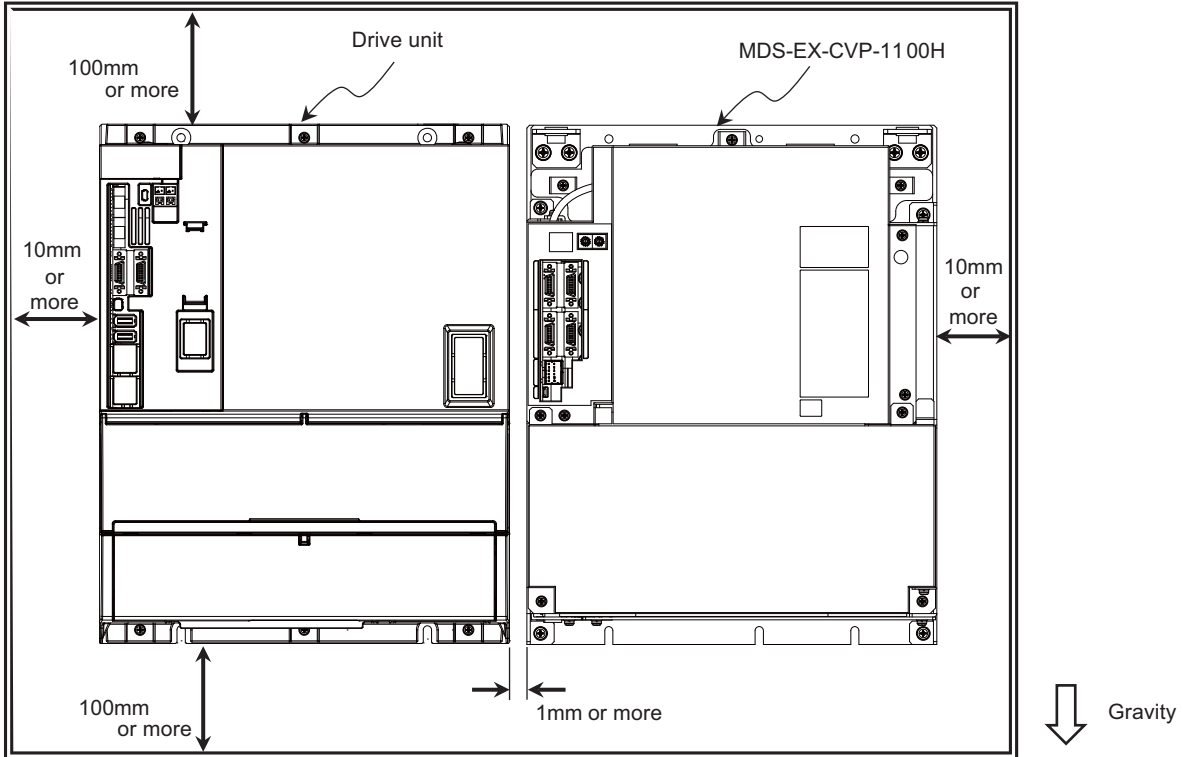

5 Installation

5.1 Installation Direction and Clearance

**⚠ CAUTION**

- (1) The ambient temperature condition for the power supply unit or the drive unit is 55 °C or less.
- (2) Because heat can easily accumulate in the upper portion of the units, give sufficient consideration to heat dissipation when designing the panel. If required, install a fan in the panel to agitate the heat in the upper portion of the units.
- (3) Cable wiring is restricted by the clearance of the front of the unit.  
8.5 mm to less than 80 mm: Wire the units in a clearance other than the front of the unit (wiring at the front of the unit is not possible). 80 mm or more: Wiring at the front of the unit is possible.
- (4) Provide a clearance above the unit for replacing fans. When wiring above the unit, cables that can be connected and disconnected easily are recommended.

(a) Back face inlet type

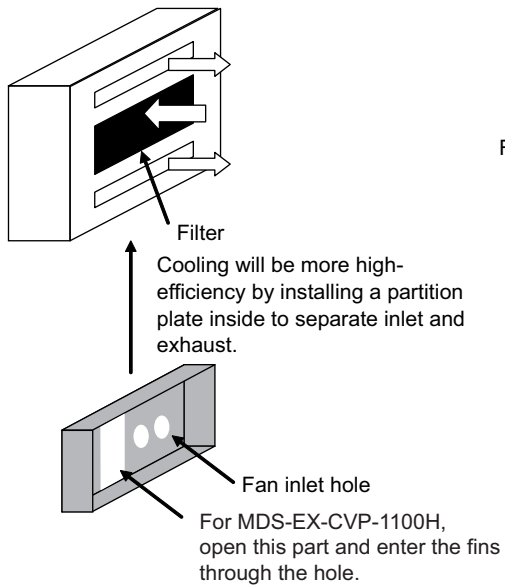

(b) Side face inlet type

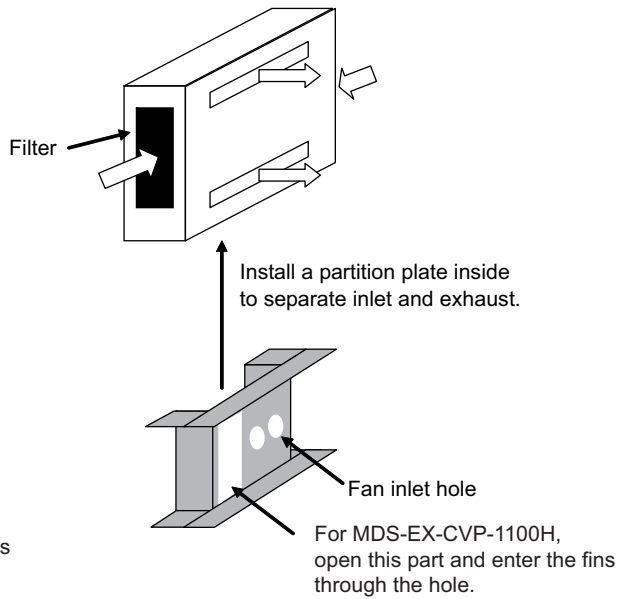



5 Installation

5.1 Installation Direction and Clearance

■ Installation of boost reactor and filter box

The boost reactor and filter box can be installed in a control panel with IP33 degree of protection.

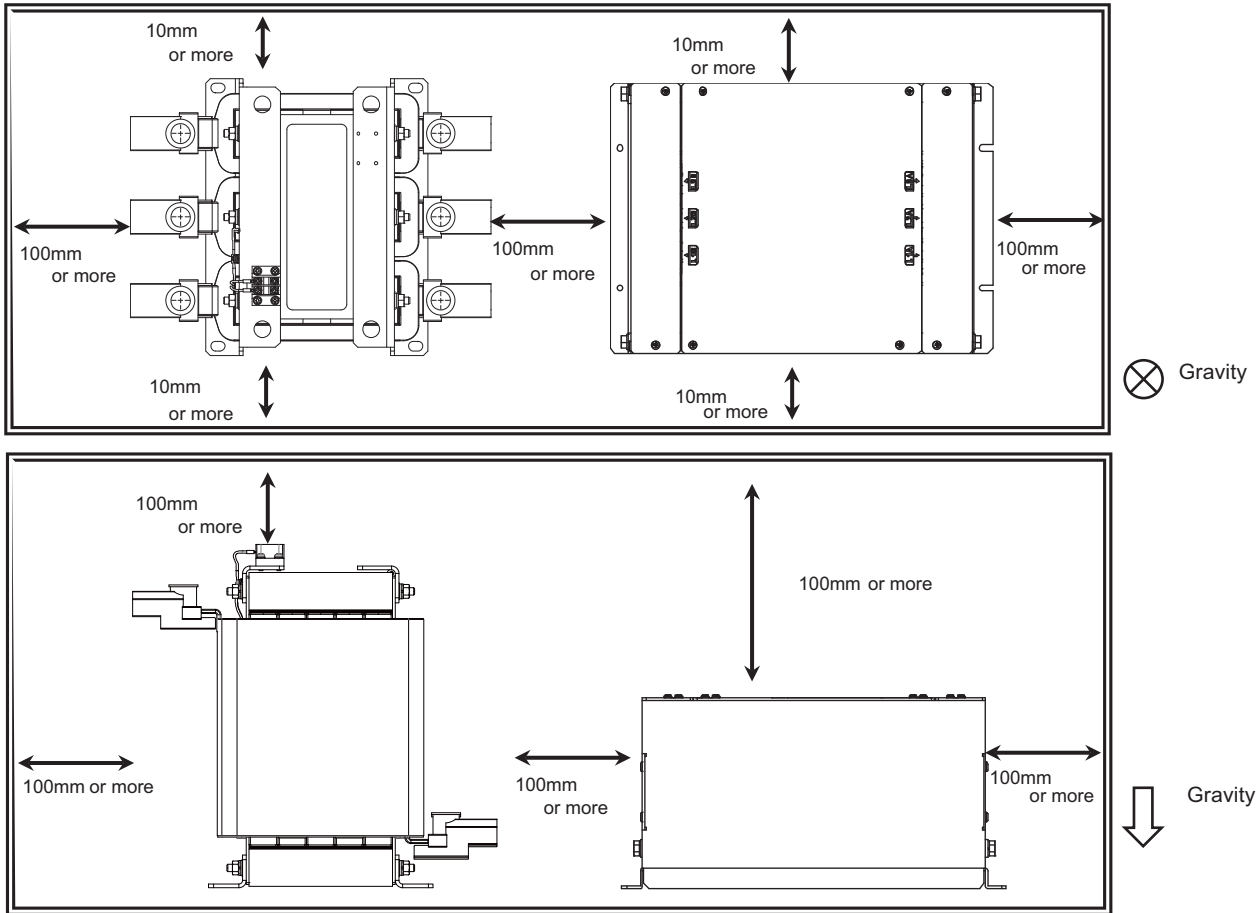

■ Installation of filter reactor and fuse box

- ♦ Install the units in a control panel with IP54 degree of protection.
- ♦ Keep a sufficient insulation distance from the terminal area of optional parts (such as a contactor and a circuit protector) when installing the units.
- ♦ As these parts generate heat, be careful of how the heat may affect the surrounding parts.

**⚠ CAUTION**

- (1) As the weight of MDS-EX-CVP-1100H, MDS-EX-ALC-1100H, and MDS-EX-ALF-1100H exceeds 20 kg, safely use suspension bolts and suspending holes to move the units with a crane. Also, when carrying the units by hand, hold the fins so that the covers are not damaged by the force of the weight.
- (2) Make sure that the control panel and fixing screws can safely support the weight of each unit and reactor.

**⚠ WARNING**

Incorrect wiring could lead to smoke or fire in the unit and the reactor, resulting in faults. Be careful when wiring.

5 Installation

5.2 Panel Installation Hole Work Drawings (Panel Cut Drawings)

### 5.2 Panel Installation Hole Work Drawings (Panel Cut Drawings)

[Unit: mm]

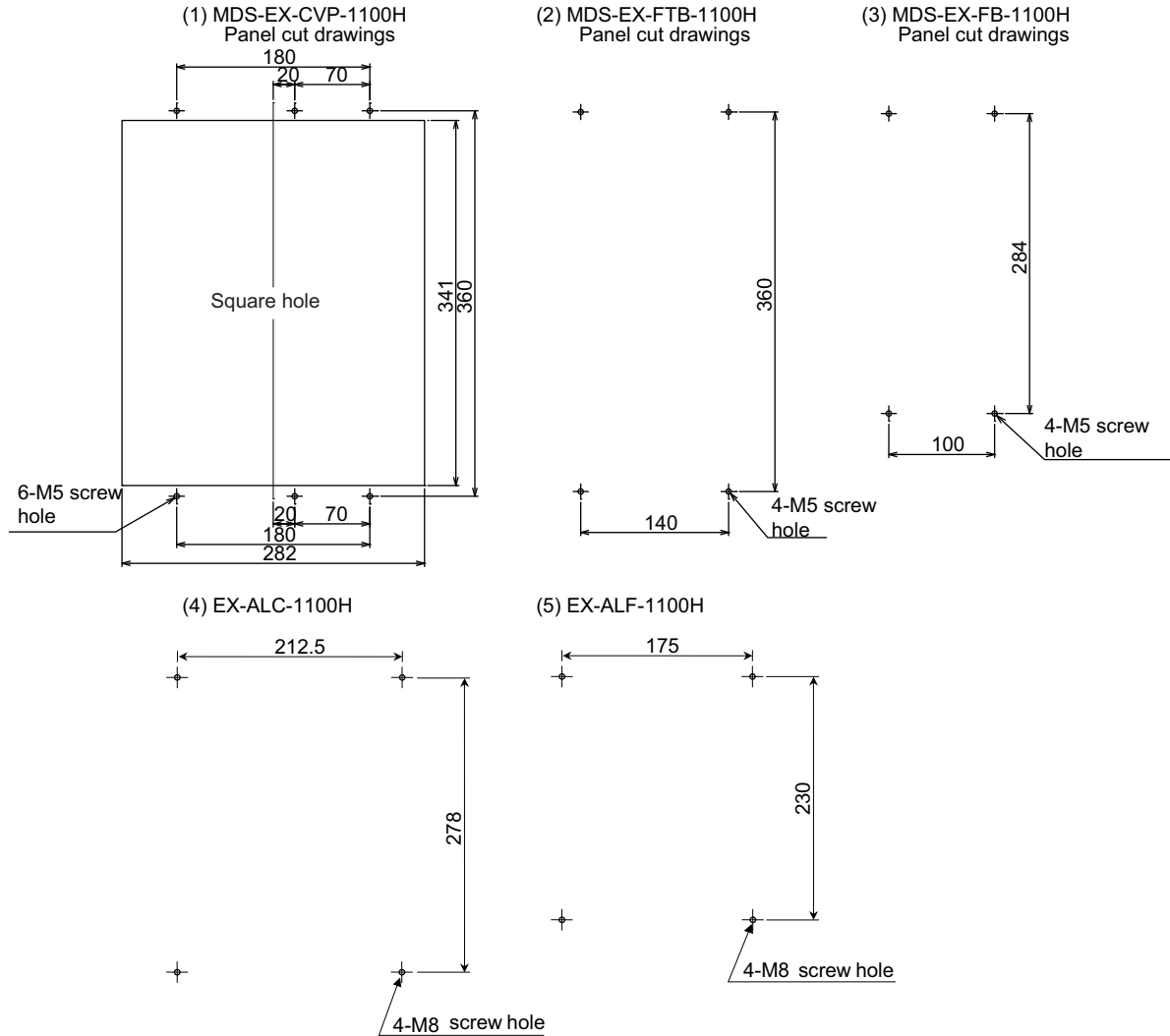

**POINT**

Attach packing around the square hole to provide a seal.

**5 Installation**

5.2 Panel Installation Hole Work Drawings (Panel Cut Drawings)

# 6

---

## Wiring and Connection

6 Wiring and Connection

6.1 Part System Connection Diagram

### 6.1 Part System Connection Diagram

Install the boost reactor, the filter box, the filter reactor, the fuse box and the contactor to the power supply unit.

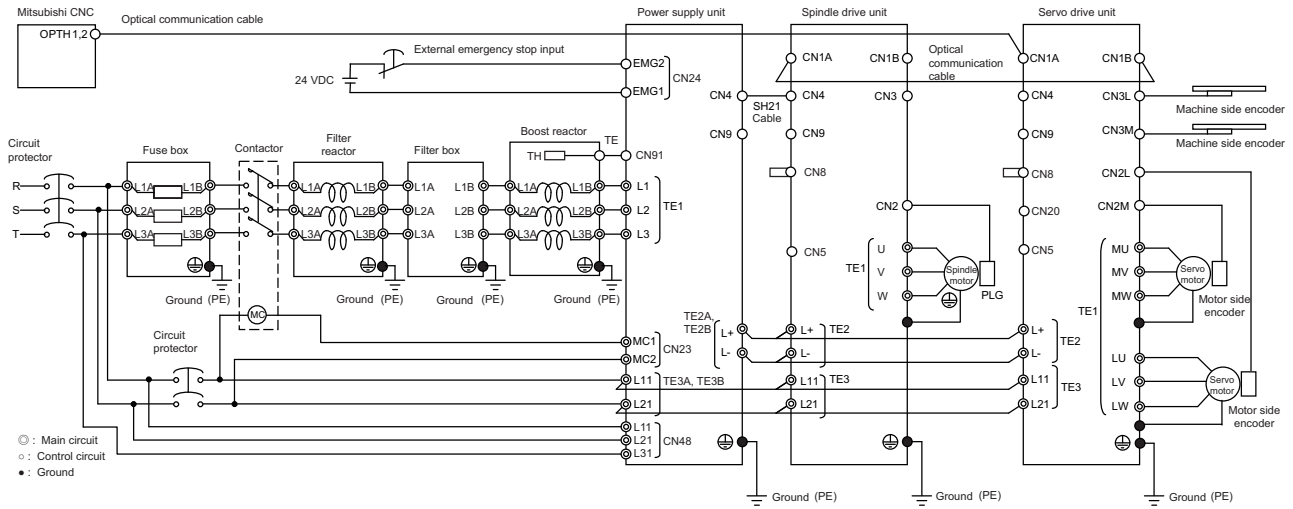

**CAUTION**

Always install a boost reactor, filter box, filter reactor, and fuse box to the PWM converter.

**WARNING**

Incorrect wiring could lead to smoke or fire in the unit and the reactor, resulting in faults. Be careful when wiring.

## 6 Wiring and Connection

## 6.2 Main Circuit Terminal Block/Control Circuit Connector

## 6.2 Main Circuit Terminal Block/Control Circuit Connector

## 6.2.1 Names and Applications of Main Circuit Terminal Block Signals and Control Circuit Connectors

Name	Signal name	Description
<b>TE1A</b> (L1A, L2A, L3A)	Main circuit power supply <ul style="list-style-type: none"> <li>♦ MDS-EX-FB-1100H</li> <li>♦ MDS-EX-ALF-1100H</li> <li>♦ MDS-EX-FTB-1100H</li> <li>♦ MDS-EX-ALC-1100H</li> </ul>	Main circuit power supply input terminal <ul style="list-style-type: none"> <li>♦ MDS-EX-FB-1100H: Connect a 3-phase 380 to 480 VAC (50 / 60 Hz) power supply.</li> <li>♦ MDS-EX-ALF-1100H: Connect a contactor main circuit power supply output terminal.</li> <li>♦ MDS-EX-FTB-1100H: Connect to "MDS-EX-ALF-1100H" main circuit power supply output terminal TE1B.</li> <li>♦ MDS-EX-ALC-1100H: Connect to "MDS-EX-FTB-1100H" main circuit power supply output terminal TE1B.</li> </ul>
<b>TE1B</b> (L1B, L2B, L3B)	Main circuit power supply <ul style="list-style-type: none"> <li>♦ MDS-EX-FB-1100H</li> <li>♦ MDS-EX-ALF-1100H</li> <li>♦ MDS-EX-FTB-1100H</li> <li>♦ MDS-EX-ALC-1100H</li> </ul>	Main circuit power supply output terminal <ul style="list-style-type: none"> <li>♦ MDS-EX-FB-1100H: Connect a contactor main circuit power supply input terminal.</li> <li>♦ MDS-EX-ALF-1100H: Connect to "MDS-EX-FTB-1100H" main circuit power supply input terminal TE1A.</li> <li>♦ MDS-EX-FTB-1100H: Connect to "MDS-EX-ALC-1100H" main circuit power supply input terminal TE1A.</li> <li>♦ MDS-EX-ALC-1100H: Connect to "MDS-EX-CVP-1100H" main circuit power supply input terminal TE1A.</li> </ul>
<b>TE1</b> (L1, L2, L3)	Main circuit power supply <ul style="list-style-type: none"> <li>♦ MDS-EX-CVP-1100H</li> </ul>	Main circuit power supply input terminal <ul style="list-style-type: none"> <li>♦ Connect to "MDS-EX-ALC-1100H" main circuit power supply output terminal TE1B.</li> </ul>
<b>TE2A, TE2B</b> (L+,L-)	Converter output	Converter power supply output terminal <ul style="list-style-type: none"> <li>♦ Connect to "Drive unit" converter voltage input terminal TE2 (DC input).</li> </ul>
<b>TE3A, TE3B</b> (L11, L21)	Control circuit power supply	Control circuit power supply input terminal Connect a Single-phase 380 to 480 VAC (50 / 60 Hz) power supply.
	Protective grounding (PE)	Grounding terminal The grounding terminals of the power supply unit, the filter box, and the fuse box are connected and grounded.

### 6.2.2 Connector Pin Assignment

■ Main circuit terminal block and connector

PWM converter

Terminal		Unit	MDS-EX-CVP-1100H				
Terminal position							
Terminal specification/ Pin assignment	[1] TE1		<table border="1"> <tr> <td>Screw size</td> <td>M10 × 20</td> </tr> <tr> <td>Tightening torque</td> <td>11.0Nm</td> </tr> </table>	Screw size	M10 × 20	Tightening torque	11.0Nm
	Screw size	M10 × 20					
	Tightening torque	11.0Nm					
	[2] TE2A, TE2B		<table border="1"> <tr> <td>Screw size</td> <td>M6 × 16</td> </tr> <tr> <td>Tightening torque</td> <td>4.0Nm</td> </tr> </table>	Screw size	M6 × 16	Tightening torque	4.0Nm
Screw size	M6 × 16						
Tightening torque	4.0Nm						
[3] TE3A, TE3B		<table border="1"> <tr> <td>Screw size</td> <td>M4 × 10</td> </tr> <tr> <td>Tightening torque</td> <td>1.2Nm</td> </tr> </table>	Screw size	M4 × 10	Tightening torque	1.2Nm	
Screw size	M4 × 10						
Tightening torque	1.2Nm						
[4] Ⓧ	Screw size M10× 20 Tightening torque 11.0 Nm						

6 Wiring and Connection

6.2 Main Circuit Terminal Block/Control Circuit Connector

Filter box/Fuse box

Terminal		Unit	MDS-EX-FTB-1100H	MDS-EX-FB-1100H				
Terminal position								
Terminal specification/ Pin assignment	[1] TE1A			<table border="1"> <tr> <td>Screw size</td> <td>M10 × 20</td> </tr> <tr> <td>Tightening torque</td> <td>11.0Nm</td> </tr> </table>	Screw size	M10 × 20	Tightening torque	11.0Nm
	Screw size	M10 × 20						
	Tightening torque	11.0Nm						
[2] TE1B			<table border="1"> <tr> <td>Screw size</td> <td>M10 × 20</td> </tr> <tr> <td>Tightening torque</td> <td>11.0Nm</td> </tr> </table>	Screw size	M10 × 20	Tightening torque	11.0Nm	
Screw size	M10 × 20							
Tightening torque	11.0Nm							
[3] Ⓧ		<p>Screw size M10× 20 Tightening torque 11.0 Nm</p>	<p>Screw size M5× 10 Tightening torque 2.0 Nm</p>					



■ Control circuit connector

Power supply unit

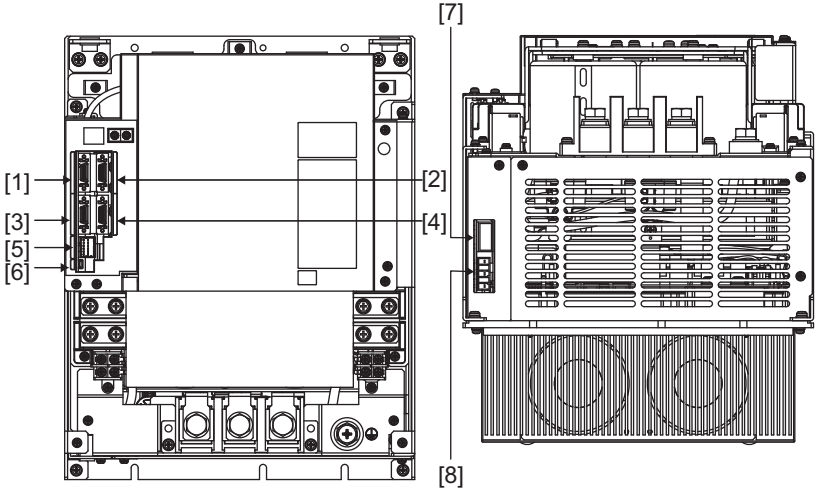
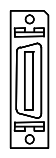
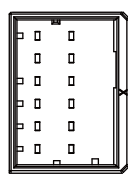
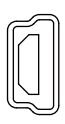
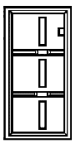
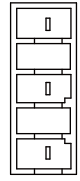
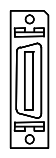
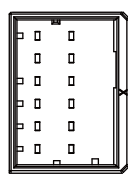
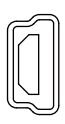
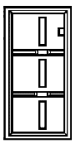
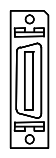
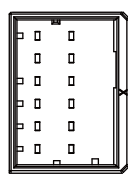
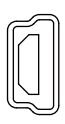
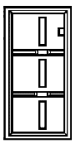
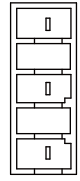
Terminal	Unit											
<p>Connector position</p>	<p style="text-align: center;"><b>MDS-EX-CVP-1100H</b></p> 											
	<table border="1"> <thead> <tr> <th data-bbox="544 884 837 981"></th> <th data-bbox="837 884 1444 981">Pin No.</th> </tr> </thead> <tbody> <tr> <td data-bbox="544 981 837 1115"> <p>[1] CN4</p> <p>[2] CN41</p> <p>[3] CN9</p> <p>[4] CN91</p> </td> <td data-bbox="837 981 1444 1115">  </td> </tr> <tr> <td data-bbox="544 1115 837 1361"> <p>[5] CN24</p> </td> <td data-bbox="837 1115 1444 1361"> <p style="text-align: center;">A B</p>  </td> </tr> <tr> <td data-bbox="544 1361 837 1525"> <p>[6] CN5</p> </td> <td data-bbox="837 1361 1444 1525">  </td> </tr> <tr> <td data-bbox="544 1525 837 1711"> <p>[7] CN23</p> </td> <td data-bbox="837 1525 1444 1711">  </td> </tr> <tr> <td data-bbox="544 1711 837 1915"> <p>[8] CN48</p> </td> <td data-bbox="837 1711 1444 1915">  </td> </tr> </tbody> </table>		Pin No.	<p>[1] CN4</p> <p>[2] CN41</p> <p>[3] CN9</p> <p>[4] CN91</p>		<p>[5] CN24</p>	<p style="text-align: center;">A B</p> 	<p>[6] CN5</p>		<p>[7] CN23</p>		<p>[8] CN48</p>
	Pin No.											
<p>[1] CN4</p> <p>[2] CN41</p> <p>[3] CN9</p> <p>[4] CN91</p>												
<p>[5] CN24</p>	<p style="text-align: center;">A B</p> 											
<p>[6] CN5</p>												
<p>[7] CN23</p>												
<p>[8] CN48</p>												
<p>Connector specification</p>												

### 6.2.3 Connection of MDS-EX-ALC-1100H Main Circuit Terminal

Terminal covers are included with the main circuit terminals of MDS-EX-ALC-1100H. When connecting the wires to the main circuit terminals, attach the terminal covers according the following procedures.

#### ■ Terminal cover outline dimension drawing

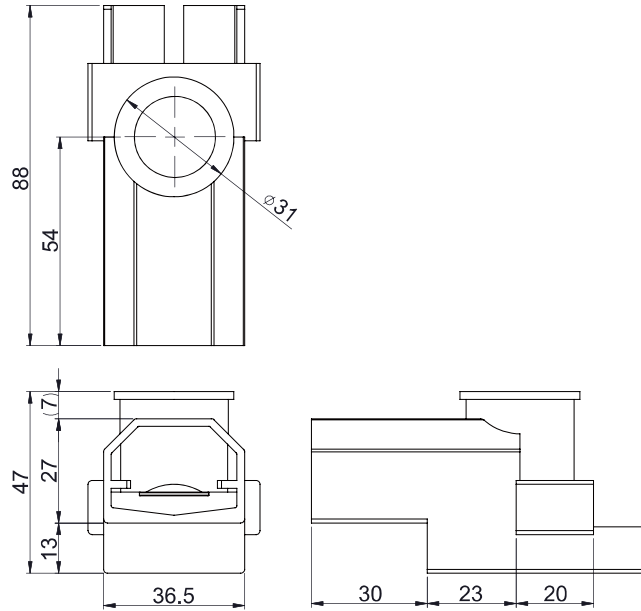

#### ■ Installing terminal covers

(1) Remove the cap of the terminal cover and insert the lead wire.

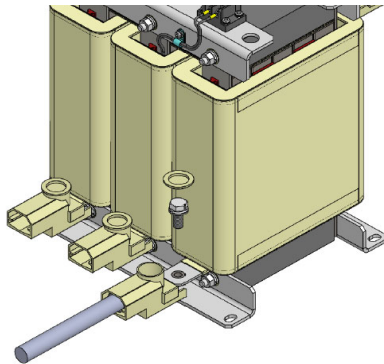

(2) Attach the terminal cover to the reactor terminal.

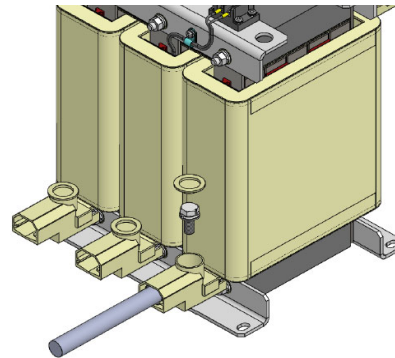

(3) Insert and tighten the screw in the terminal cover screw hole.

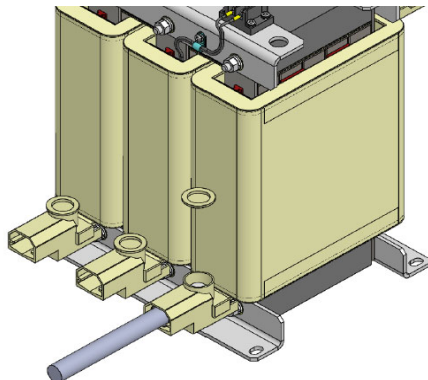

(4) Attach the terminal cover cap.

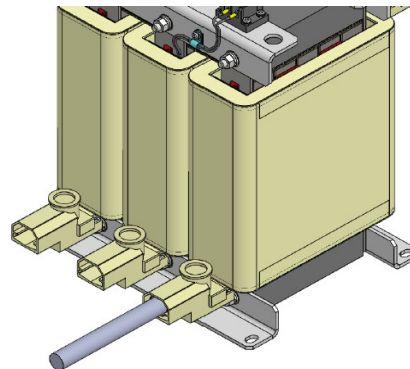

6 Wiring and Connection

6.3 Connection of Power Supply

6.3 Connection of Power Supply

**CAUTION**

- (1) Make sure that the power supply voltage is within the specified range of each unit. Failure to observe this could lead to damage or faults.
- (2) For safety purposes, always install a circuit protector, and make sure that the circuit is cut off when an error occurs or during inspections.
- (3) The wire size will differ according to each drive unit capacity.
- (4) For safety purposes, always install a magnetic contactor (contactor) on the main circuit power supply input. Large rush currents will flow when the power is turned ON.

6.3.1 Power Supply Input Connection

Install the unit so that the total wiring length of DC power supply terminals TE2 (L+, L-) is 1,500 mm or less. The spindle drive unit should be installed adjacent to the power supply unit.

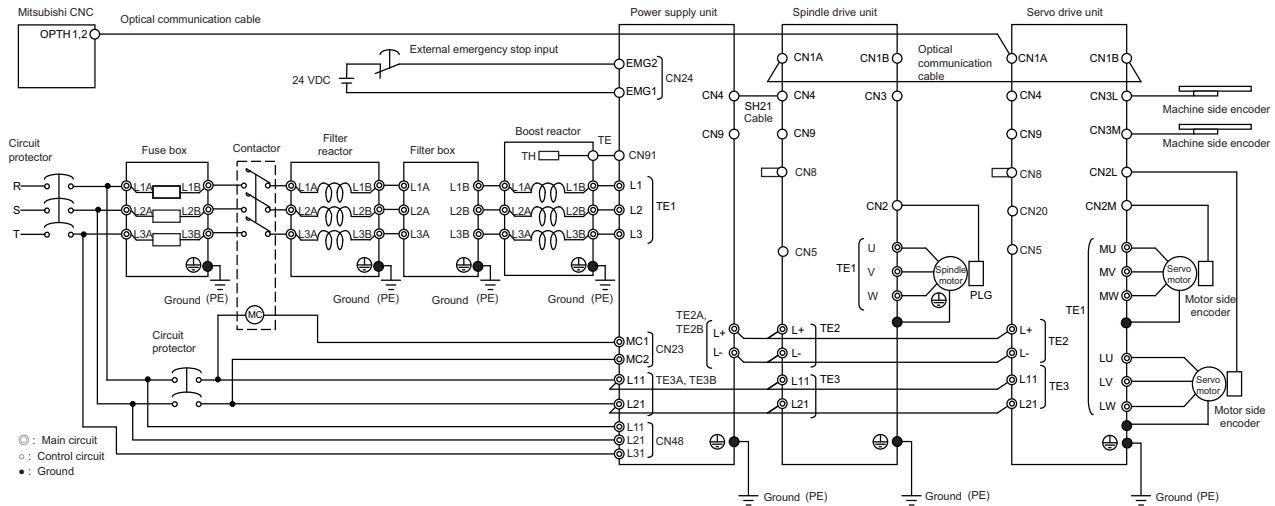

**CAUTION**

- (1) The boost reactor, the filter box, the filter reactor, and the fuse box must be installed when installing the PWM converter.
- (2) When connecting to the TE3 terminal, connect to the power supply side (primary side) of the fuse box.
- (3) Connect the power supply unit's CN4 connector with the spindle drive unit of the maximum capacity. If there is no spindle drive unit, connect to the servo drive unit which is the unbalance axis.
- (4) When installing the units dispersed install the spindle drive unit adjacent to the power supply unit, and connections for other drive units should be such that the total TE2 wiring length is 1,500 mm or less.

6 Wiring and Connection

6.4 Peripheral Control Wiring

6.3.2 Wiring of the Grounding Cable

■ Connecting the protective grounding (PE) and frame ground (FG)

Each unit has a terminal or mounting hole to connect PE or FG.

Please connect a grounding cable to the main ground of a cabinet or a machine frame at one point.

Ground each device according to the grounding conditions set forth by each country. (Typically, a Y-connection neutral point ground is used in Europe.)

PE: Grounding to provide protection from electric shock, etc.

FG: Grounding to stabilize the operation of the devices, etc. (Suppress noise)

**POINT**

Do not connect the grounding cable from each unit directly to the grounding plate. Noise from other units could result in malfunctions.

6.4 Peripheral Control Wiring

6.4.1 Input/Output Circuit Wiring

CN9 connector is equipped with 24 V input/output circuit for the control of external devices and the control by an external signal. Set the relevant parameters and use them with care for the wiring since some signals are changeover type, which can be switched over by parameters. Refer to the description of each function in relevant sections for details on the function specifications and settings.

Connector	Input condition	
CN24	Switch ON	18 VDC to 25.2 VDC 4.3 mA or more
	Switch OFF	4 VDC or less 2 mA or less

For a switch or relay to be wired, use a switch or relay that satisfies the input/output (voltage, current) conditions.

Interface name	Selection example
For digital input signal (CN24)	Use a minute signal switch which is stably contacted and operated even with low voltage or current. < Example > OMRON: G2A, G6B type, MY type, LY type

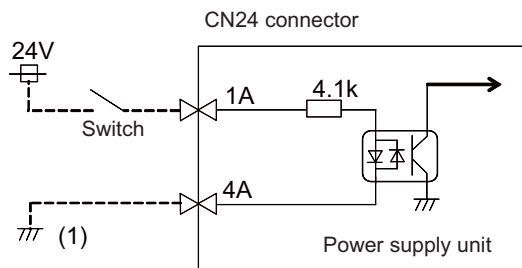

- If a ground of the external 24 V power is same as the 24 V power in the drive unit, a fault or abnormal operation could occur.
- The maximum rising / falling edge transmission delay time is 500 μs.

**6 Wiring and Connection**

6.4 Peripheral Control Wiring

# 7

---

## Setup

7 Setup

7.1 Setting the Initial Parameters for the Drive Unit

## 7.1 Setting the Initial Parameters for the Drive Unit

The servo and spindle related parameters must be set before the servo and spindle system can be started up. The servo and spindle related parameters are input from the NC. The input method differs according to the NC being used, so refer to each NC Instruction Manual.

### 7.1.1 Servo Parameter

(PR)	#2236	SV036	PTYP	Power supply type/ Regenerative resistor type
------	-------	-------	------	---

**MDS-E/EH Series: Power supply type**

When connecting a power supply unit, set a code for each power supply unit.

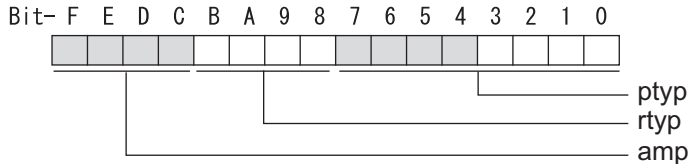

**bit F-C : amp**

Set the power backup function to be used.

- No function used : 0
- Deceleration and stop function at power failure : 8
- Retraction function at power failure : C

**bit B-8 : rtp**

Not used. Set to "0".

**bit 7-0 : ptyp External emergency stop setting**

When the emergency stop input signal of the power supply unit is "disabled"

- Power supply unit is not connected : 00
- MDS-E-CV-37/ MDS-EH-CV-37 : 04
- MDS-E-CV-75/ MDS-EH-CV-75 : 08
- MDS-E-CV-110/ MDS-EH-CV-110 : 11
- MDS-E-CV-185/ MDS-EH-CV-185 : 19
- MDS-E-CV-300/ MDS-EH-CV-300 : 30
- MDS-E-CV-370/ MDS-EH-CV-370 : 37
- MDS-E-CV-450/ MDS-EH-CV-450 : 45
- MDS-E-CV-550/ MDS-EH-CV-550 : 55
- MDS-EH-CV-750 : 75
- MDS-EX-CVP-1100H : A0

When the emergency stop input signal of the power supply unit is "enabled"

(\*) Set the power supply rotary switch to "4".

- Power supply unit is not connected : 00
- MDS-E-CV-37/ MDS-EH-CV-37 : 44
- MDS-E-CV-75/ MDS-EH-CV-75 : 48
- MDS-E-CV-110/ MDS-EH-CV-110 : 51
- MDS-E-CV-185/ MDS-EH-CV-185 : 59
- MDS-E-CV-300/ MDS-EH-CV-300 : 70
- MDS-E-CV-370/ MDS-EH-CV-370 : 77
- MDS-E-CV-450/ MDS-EH-CV-450 : 85
- MDS-E-CV-550/ MDS-EH-CV-550 : 95
- MDS-EH-CV-750 : B5
- MDS-EX-CVP-1100H : E0

7 Setup

7.1 Setting the Initial Parameters for the Drive Unit

7.1.2 Spindle Parameter

(PR)	#13032	SP032	PTYP	Power supply type/ Regenerative resistor type
------	--------	-------	------	---

MDS-E/EH Series: Power supply type

When connecting a power supply unit, set a code for each power supply unit.

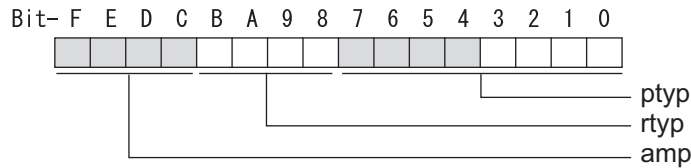

bit F-C : amp

Set the power backup function to be used.

- No function used : 0
- Deceleration and stop function at power failure : 8
- Retraction function at power failure : C

bit B-8 : rtp

Not used. Set to "0".

bit 7-0 : ptyp External emergency stop setting

When the emergency stop input signal of the power supply unit is "disabled"

- Power supply unit is not connected : 00
- MDS-E-CV-37/ MDS-EH-CV-37 : 04
- MDS-E-CV-75/ MDS-EH-CV-75 : 08
- MDS-E-CV-110/ MDS-EH-CV-110 : 11
- MDS-E-CV-185/ MDS-EH-CV-185 : 19
- MDS-E-CV-300/ MDS-EH-CV-300 : 30
- MDS-E-CV-370/ MDS-EH-CV-370 : 37
- MDS-E-CV-450/ MDS-EH-CV-450 : 45
- MDS-E-CV-550/ MDS-EH-CV-550 : 55
- MDS-EH-CV-750 : 75
- MDS-EX-CVP-1100H : A0

When the emergency stop input signal of the power supply unit is "enabled"

(\*) Set the power supply rotary switch to "4".

- Power supply unit is not connected : 00
- MDS-E-CV-37/ MDS-EH-CV-37 : 44
- MDS-E-CV-75/ MDS-EH-CV-75 : 48
- MDS-E-CV-110/ MDS-EH-CV-110 : 51
- MDS-E-CV-185/ MDS-EH-CV-185 : 59
- MDS-E-CV-300/ MDS-EH-CV-300 : 70
- MDS-E-CV-370/ MDS-EH-CV-370 : 77
- MDS-E-CV-450/ MDS-EH-CV-450 : 85
- MDS-E-CV-550/ MDS-EH-CV-550 : 95
- MDS-EH-CV-750 : B5
- MDS-EX-CVP-1100H : E0

Refer to the latest version of "MDS-E/EH Series Specifications Manual" (IB-1501226(ENG)) and "MDS-E/EH Series Instruction Manual" (IB-1501229(ENG)) for details about the unit above.



## 7.2 Initial Setup

### 7.2.1 Setting the Rotary Switch

#### PWM converter

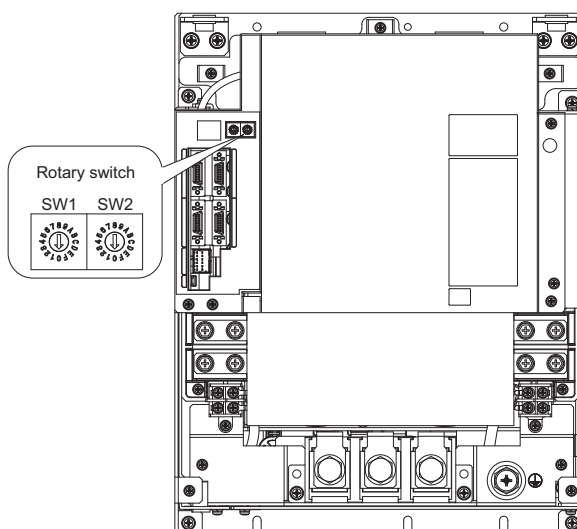

Rotary switch SW1 setting	Setting items
0	Normal setting
1 to 3	Setting prohibited
4	External emergency stop setting
5 to F	Setting prohibited

Rotary switch SW2 setting	Setting items
0	PWM control function ON Bus voltage setting: 648 V
1	PWM control function ON Bus voltage setting: 660 V
2	PWM control function ON Bus voltage setting: 680 V
3	PWM control function ON Bus voltage setting: 700 V
4 to F	Setting prohibited

#### **CAUTION**

- (1) When using the converter in combination with a drive unit (including MDS-DH-PFU) other than MDS-EH-SP-600, set the bus voltage to 648 V.
- (2) Make sure that the bus voltage of the power supply unit on the drive monitor on the NC Diagnosis screen is equivalent to the bus voltage set by the rotary switch. If the bus voltage is different from the bus voltage set by the rotary switch by  $\pm 5$  V or more when the motor is not running, the rotary switch setting may be incorrect or the power supply unit may be broken. Take remedies according to the causes of the abnormality.
- (3) Set the rotary switch while the power supply is turned OFF. Setting the rotary switch while the power supply is turned ON may lead to unit faults.

## 7.2.2 Transition of LED Display after Power Is Turned ON

### Power supply unit

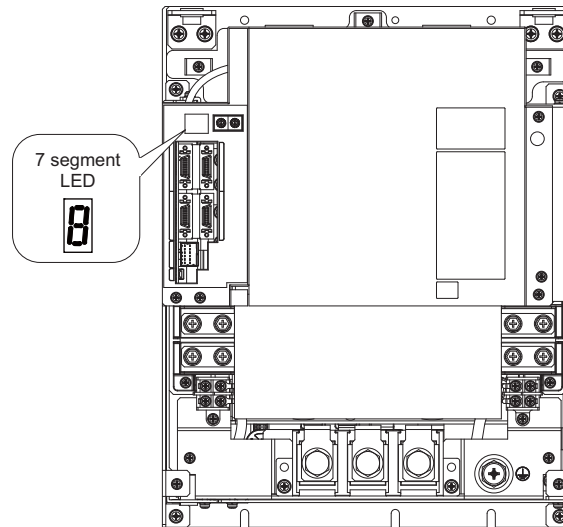

When the power of the NC and each drive unit/power supply unit is turned ON, each unit will automatically execute self diagnosis and initial settings for operation, etc. The LEDs on the front of the units will change as shown below according to the progression of these processes. If an alarm occurs, the alarm No. will appear on the LEDs. Refer to section “11.1.1 LED Display When Alarm or Warning Occurs” for details on the alarm displays.

Power supply unit  
LED display

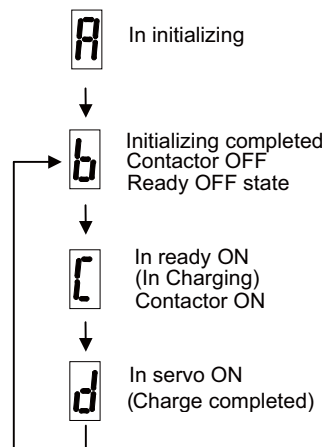

### CAUTION

- (1) Always input emergency stop when starting the servo system.
- (2) Do not insert or extract the external STO input connector (CN8) of the drive unit after starting the servo system. Motor power will be shut off and it may cause the collision of machine.
- (3) There is a maximum of 5 second standby time when READY is turned ON after it is turned OFF.

**7 Setup**

7.2 Initial Setup

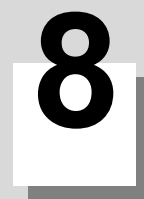

## **Selection**

**8 Selection****8.1 Selection of the Power Supply Unit**

Calculate both the spindle motor output and the servo motor output, and check that the required rated capacity and the maximum momentary output are less than the specifications of the power supply unit.

**8.1 Selection of the Power Supply Unit****(1) Calculation of required continuous rated output**

**Power supply unit rated output >  $\Sigma$  (Spindle motor continuous rated output) + 0.3  $\Sigma$  (Servo motor rated output)**

Calculate the total sum of "the spindle motor continuous rated output" and "servo motor rated output" with the above expression.

**(2) Calculation of required 30-minute rated output**

**Power supply unit 30-minute rated output >  $\Sigma$  (MAX(spindle motor short time rated output and output during acceleration/deceleration) + 0.3  $\Sigma$  (servo motor rated output)**

Calculate the total sum of the "spindle motor short time rated output and output during acceleration/deceleration" and the "servo motor rated output" with the above expression.

**(3) Calculation of required maximum momentary output**

**Maximum momentary rated capacity of power supply unit  $\geq \Sigma$  (Spindle maximum momentary output) +  $\Sigma$  (Maximum momentary output of servo motor accelerating/decelerating simultaneously)**

Calculate the total sum of the "spindle maximum momentary output" and "output of servo motor accelerating/decelerating simultaneously" with the above expression.

**(4) Selection of power supply unit**

Select the power supply unit of which the rated capacity and maximum momentary rated capacity are larger than those selected in the item (1), (2), and (3). When the capacity is smaller than the item (1), (2), and (3), add the power supply unit.

Unit	MDS-EX-CVP	1100H
Continuous rated output [kW]		90
30-minute rated output [kW]		110
Maximum momentary rated capacity [kW]		220

**⚠ CAUTION**

- (1) When reducing the time constant replacing the conventional motor with the HG or HG-H Series motor, the power supply capacity may rise because the motor maximum momentary output increases more than the conventional motor. Therefore, make sure to check the selection with maximum momentary rated capacity.
- (2) When the large capacity drive unit (MDS-E-SP-400/640, MDS-EH-SP-200/320/480/600, MDS-EH-V1-200) is connected to the power supply unit, always install the drive unit proximally in the left side of the power supply unit and connect PN terminal with the dedicated DC connection bar.
- (3) When using two large capacity drive units or more, the power supply unit is required for each drive unit.



Refer to the latest version of "MDS-E/EH Series Specifications Manual" (IB-1501226(ENG)) for calculation method of the spindle motor output and the servo motor output.

## 8 Selection

## 8.2 Selection of Power Supply

## 8.2 Selection of Power Supply

For the power supply capacity, calculate both the required spindle motor rated output and the servo motor rated output, and select the power supply capacity satisfying them.

### (1) Calculation of rated output required for power supply

**Rated output required for power supply =  $\Sigma$  (Spindle motor rated output required for power supply) + 0.3  $\Sigma$  (servo motor rated output required for power supply)**

Calculate the total sum of "Spindle motor rated output" and "servo motor rated output" required for the power supply with the above expression.

### (2) Calculation of required power supply capacity

**Power supply capacity (kVA) =  $\Sigma$  {(Required rated output calculated in the item (1) (kW) / Continuous rated output of power supply unit (kW)} × Power supply capacity base value (kVA)**

Calculate "the required power supply capacity" with the above expression.

The power supply capacity base value corresponding to the capacity of the power supply unit "MDS-EX-CVP-1100H" is as the following table.

Unit	MDS-EX-CVP	1100H
Power supply capacity base value [kVA]		130



Refer to the latest version of "MDS-E/EH Series Specifications Manual" (IB-1501226(ENG)) for calculation method of spindle motor rated output and the servo motor rated output required for power supply.

**8 Selection**

8.2 Selection of Power Supply

---

## Specifications of Peripheral Devices



## 9.1 Selection of Wire

Selected wires must be able to tolerate each unit and motor terminal part to which the wire is connected. How to calculate tolerable current of an insulated wire or cable is shown in "Tolerable current of electric cable" (1) of Japanese Cable Makers' Association Standard (JCS)-168-E (1995), its electric equipment technical standards or JEAC regulates tolerable current, etc. wire. When exporting wires, select them according to the related standards of the country or area to export. Wire's tolerable current is different depending on conditions such as its material, structure, ambient temperature, etc. Check the tolerable current described in the specification of the wire to use.

### 9.1.1 Wire Selection Standards and Maximum Allowable Wiring Length for Each Product

Refer to the following table to select the wire which tolerates the selection-standard current of each product.

Product	Target	Standard	Maximum allowable wiring length
Power supply unit	Main circuit power cable (L1, L2, L3, earth)	Input rated current	10 [m]
	Link bar (L+,L-)	Output rated current	1.5 [m]
Filter box	Main circuit power cable (L1A, L2A, L3A, L1B, L2B, L3B, earth)	Input/output rated current	10 [m]
Fuse box	Main circuit power cable (L1A, L2A, L3A, L1B, L2B, L3B, earth)	Input/output rated current	10 [m]
Boost reactor Filter reactor	Main circuit power cable (L1A, L2A, L3A, L1B, L2B, L3B)	Input/output rated current	10 [m]
Common to each unit	Control power cable (L11, L21)	Control power maximum current	10 [m]

(\*1) In the UL standards, certification conditions are to use wires of 60 °C and 75 °C product. (UL61800-5-1)

9 Specifications of Peripheral Devices

9.1 Selection of Wire

< Power supply communication cable and connector >

Item		Model	Contents	
CN4/ CN41/ CN9	Power supply communication cable	SH21 Length: 0.35, 0.5, 1, 2, 3m	Drive unit side connector (3M) Connector: 10120-6000EL Shell kit: 10320-3210-000	Power supply unit side connector (3M) Connector: 10120-6000EL Shell kit: 10320-3210-000
CN4/ CN41/ CN9/ CN91	Power supply communication cable connector set	FCUA-CS000	Drive unit side connector (3M) Connector: 10120-3000VE Shell kit: 10320-52F0-008	Power supply unit side connector (3M) Connector: 10120-3000VE Shell kit: 10320-52F0-008
			Compatible part (*1) (J.S.T) Connector: MS-P20-L Shell kit: MS20-2B-28	Compatible part (*1) (J.S.T) Connector: MS-P20-L Shell kit: MS20-2B-28
For CN23	Contactor control output connector	CNU23SCV2(AWG14) These connectors are supplied for each power supply unit.  Applicable cable size: 0.85 mm <sup>2</sup> to 3.5 mm <sup>2</sup> Cable finish outside diameter: to Φ4.2 mm	Power supply unit side connector (J.S.T) 03JFAT-SAXGSA-L	
			Connection lever J-FAT-OT-EXL (J.S.T)	
For CN24	External emergency stop connector	CNU24S(AWG24)	Power supply unit side connector (DDK) Connector: DK-2100-12R Contact: DK-2RECSLP1-100 (*2)	
For CN48	Power supply phase detection connector	MDS-EX-PSCN-01 These connectors are supplied for MDS-EX-CVP-1100H.  Applicable cable size: 0.8 mm <sup>2</sup> to 2.1 mm <sup>2</sup> Cable finish outside diameter: to Φ3.9 mm	Power supply unit side connector (J.S.T) Connector: 03JFAT-SAXGDK-HT10.5	
			Connection lever J-FAT-OT-EXL (J.S.T)	

(\*1) The names of compatible parts may be changed at the manufacturer's discretion. Contact each manufacturer for more information.

(\*2) Hand crimping tools: 357J-22733

9 Specifications of Peripheral Devices

9.1 Selection of Wire

9.1.2 Example of Wires by Unit

The following are examples of wire selections for each unit based on the certification standards. The relation between wire size and tolerable current conforms to the requirements specified in IEC/EN60204-1, UL61800-5-1. However, the tolerable current is different depending on the wire specifications of each manufacturer even among the wires of the same size.

Type	Unit Type	Terminal name							
		TE1, TE1A, TE1B (L1, L2, L3)		⊕		TE2A, TE2B (L+,L-)		TE3A, TE3B (L11, L21)	
		mm <sup>2</sup>	AWG	mm <sup>2</sup>	AWG	mm <sup>2</sup>	AWG	mm <sup>2</sup>	AWG
600 V vinyl insulated wire (IV wire) 60 °C product (Example according to IEC/EN60204-1 and UL61800-5-1)	MDS-EX-CVP-1100H	-	-	-	-	Use the link bar that is suitable for the current.		2	14
	MDS-EX-FTB-1100H	-	-	-	-	-	-	-	-
	MDS-EX-FB-1100H	-	-	-	-	-	-	-	-
	MDS-EX-ALC-1100H	-	-	-	-	-	-	-	-
	MDS-EX-ALF-1100H	-	-	-	-	-	-	-	-
600 V double (heat proof) vinyl insulated wire (HIV wire) 75 °C product (Example according to IEC/EN60204-1 and UL61800-5-1)	MDS-EX-CVP-1100H	80	3/0	80	3/0	Use the link bar that is suitable for the current.		2	14
	MDS-EX-FTB-1100H	80	3/0	80	3/0	-	-	-	-
	MDS-EX-FB-1100H	80	3/0	22	4	-	-	-	-
	MDS-EX-ALC-1100H	80	3/0	-	-	-	-	-	-
	MDS-EX-ALF-1100H	80	3/0	-	-	-	-	-	-

9.1.3 Selection of Link Bar

When installing MDS-EX-CVP-1100H and the drive unit adjacently, only the link bar can be used for connecting TE2. Refer to the latest version of "MDS-E/EH Series Specifications Manual" (IB-1501226(ENG)) for the selection method.

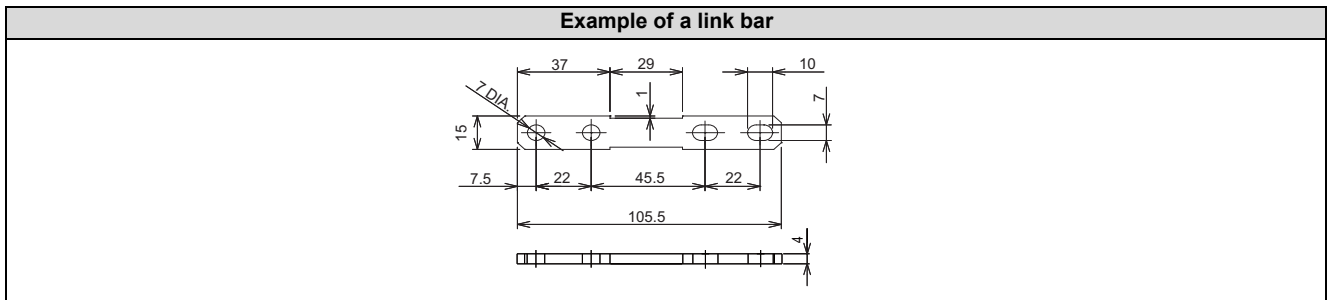

## 9.2 Selection of Circuit Protector and Contactor

Always select the circuit protector and contactor properly, and install them to each power supply unit to prevent disasters.

### 9.2.1 Selection of Circuit Protector

Calculate a circuit protector selection current from the nominal input voltage (voltage supplied to the power supply unit) as in the expression below. And then select the minimum capacity circuit protector whose rated current meets the circuit protector selection current.

Circuit protector selection current [A] =

(Circuit protector selection current for 380 V input [A] / Nominal input voltage [V]) × 380 [V]

#### Selection of circuit protector for 380 V input

Unit Type MDS-EX-CVP-	1100H
Circuit protector selection current for 380 V input	193
Selection example of circuit protector (Mitsubishi Electric Corp.)	NF250-HVU
Rated current of the selection example of circuit protector	200

Optional part: A circuit protector is not prepared as an NC unit accessory, so purchase the part from your dealer, etc.

### 9.2.2 Selection of Contactor

Select the contactor selection current that is calculated from the nominal input voltage (voltage supplied to the power supply unit) as in the expression below. And then select the contactor whose conventional free-air thermal current meets the contactor selection current.

Contactor selection current [A] =

(Contactor selection current for 380 V input [A] / Nominal input voltage [V]) × 380 [V]

#### Selection of contactor for 380V input

Unit Type MDS-EX-CVP-	1100H
Contactor selection current for 380 V input	193
Selection example of contactor (Mitsubishi Electric Corp.)	S-N150-400 VAC
Conventional freeair thermal current of the selection example of contactor	200

Optional part: A contactor is not prepared as an NC unit accessory, so purchase the part from your dealer, etc.



#### POINT

- (1) Use an alternating contactor.
- (2) If the contactor selection current is 20 A or less, select the S-T12 product for the contactor.
- (3) Select a contactor whose excitation coil does not operate at 15 mA or less.

**9 Specifications of Peripheral Devices**

---

9.2 Selection of Circuit Protector and Contactor

## Cable and Connector Specifications

10 Cable and Connector Specifications

10.1 Cable Connection Diagram

10.1 Cable Connection Diagram

[SH21 cable connection diagram]

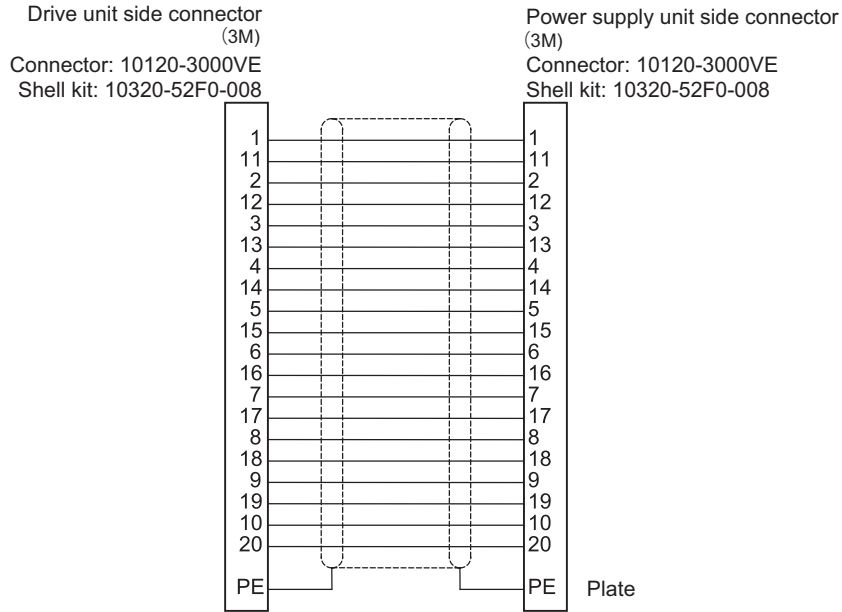

[CN23 contactor control output connector connection diagram]

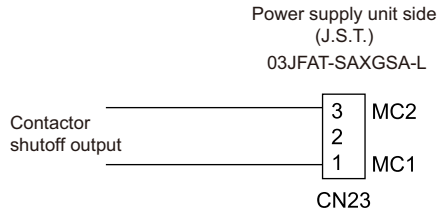

[CN24 external emergency stop connector connection diagram]

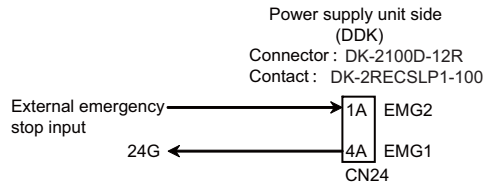

[CN91 reactor thermal protector input connector connection diagram]

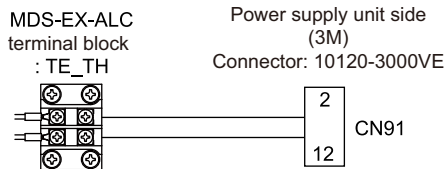

[CN48 connector for detecting power supply phase (3-phase AC input) connection diagram]

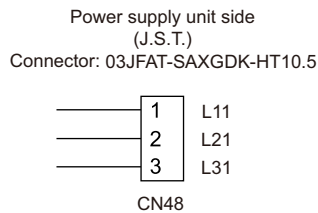

## 10.2 Connector Outline Dimension Drawings

### Connector for CN4 / CN41 / CN9 / CN91

<p><b>Connector for CN4 / CN41 / CN9 / CN91</b></p> <p style="text-align: right;"><b>[Unit: mm]</b></p> <p><b>Manufacturer: 3M</b>  <b>&lt; Type &gt;</b>  <b>Connector: 10120-3000VE</b>  <b>Shell kit: 10320-52F0-008</b></p> <p><b>Compatible part (*1)</b>  <b>(J.S.T)</b>  <b>Connector: MS-P20-L</b>  <b>Shell kit: MS20-2B-28</b></p>	
<p><b>Manufacturer: 3M</b>  <b>&lt; Type &gt;</b>  <b>Connector: 10120-6000EL</b>  <b>Shell kit: 10320-3210-000</b></p>	<p style="text-align: right;"><b>[Unit: mm]</b></p>
<p><b>Manufacturer: J.S.T.</b>  <b>&lt; Type &gt;</b>  <b>Connector: MS-P20-L</b>  <b>Shell kit: MS20-2A-28</b></p>	<p style="text-align: right;"><b>[Unit: mm]</b></p>

(\*1) The names of compatible parts may be changed at the manufacturer's discretion. Contact each manufacturer for more information.



10 Cable and Connector Specifications

10.2 Connector Outline Dimension Drawings

Connector for CN23 (Connector for contactor control output)

Power supply unit connector for CN23 (Connector for contactor control output)		[Unit: mm]
<p>Manufacturer: J.S.T. &lt; Type &gt; 03JFAT-SAXGSA-L</p>		<p>[Unit: mm]</p>

Connector for CN24 (Connector for external emergency stop)

Power supply unit connector for CN24 (Connector for external emergency stop)		[Unit: mm]
<p>Manufacturer: DDK &lt; Type &gt; Connector: DK-2100D-12R</p>		<p>[Unit: mm]</p>

Connector for CN48 (Connector for detecting power supply phase)

Power supply unit connector for CN48 (Connector for detecting power supply phase)		[Unit: mm]
<p>Manufacturer: J.S.T. &lt; Type &gt; Connector: 03JFAT-SAXGDK-HT10.5</p>		<p>[Unit: mm]</p>

## Troubleshooting

## 11 Troubleshooting

### 11.1 Points of Caution and Confirmation

If an error occurs in the power supply unit, the warning or alarm will occur. When a warning or alarm occurs, check the state while observing the following points, and inspect or remedy the unit according to the details given in this section.

#### [Points of confirmation]

- (1) What is the alarm code display?
- (2) Can the error or trouble be repeated? (Check alarm history)
- (3) Is the motor and servo drive unit temperature and ambient temperature normal?
- (4) Are the servo drive unit, control unit and motor grounded?
- (5) Was the unit accelerating, decelerating or running at a set speed? What was the speed?
- (6) Is there any difference during forward and backward run?
- (7) Was there a momentary power failure?
- (8) Did the trouble occur during a specific operation or command?
- (9) At what frequency does the trouble occur?
- (10) Is a load applied or removed?
- (11) Has the drive unit been replaced, parts replaced or emergency measures taken?
- (12) How many years has the unit been operating?
- (13) Is the power supply voltage normal? Does the state change greatly according to the time band?

#### CAUTION

- (1) **This power supply unit uses a large capacity electrolytic capacitor. When the CHARGE lamp on the front of the power supply unit is lit, voltage is still present at the PN terminal (TE2). Do not touch the terminal block in this state.**
- (2) **Before replacing the unit, etc., always confirm that there is no voltage at the PN terminal (TE2) with a tester or wait at least 20 minutes after turning the main power OFF.**
- (3) **The conductivity in the unit cannot be checked.**
- (4) **Never carry out a megger test on the drive unit or power supply unit as the unit could be damaged.**
- (5) **Do not touch the radiation fin on unit back face, regenerative resistor or motor, etc., or place parts (cables, etc.) while the power is turned ON or immediately after turning the power OFF. These parts may reach high temperatures, and can cause burns or part damage.**
- (6) **There is a maximum of 5 second standby time when READY is turned ON after it is turned OFF.**

#### POINT

**When MDS-EX-CVP-1100H which uses two cooling fans is in an emergency stop or alarm, one of fans is stopped and power-saving operation is performed. If the suspended fan is restarted by canceling the emergency stop, it is not a problem with the fan.**

11 Troubleshooting

11.2 Protective Functions List of Units

11.1.1 LED Display When Alarm or Warning Occurs

For the power supply unit, the alarm/warning No. is alternately displayed by one digit. The display flickers when an alarm or a warning occurs.



11.2 Protective Functions List of Units

11.2.1 List of Alarms

When an alarm occurs, the servo drive unit will make the motor stop by the deceleration control or dynamic brake. The spindle drive unit will coast to a stop or will decelerate to a stop. At the same time, the alarm No. will appear on the NC monitor screen and with the LEDs on the front of each drive unit. Check the alarm No., and remove the cause of the alarm by following this list.

List of alarms

No.	Name	Details	Reset method
61	Power supply: Power module overcurrent	Overcurrent protection function in the power module has started its operation.	PR
62	Power supply: Frequency error	The input power supply frequency increased above the specification range. Or, incorrect wiring of the power supply wire was detected.	PR
64	Power supply: Overload	Excessive load current was detected. Or, overheating of the boost reactor was detected.	NR
66	Power supply: Process error	An error occurred in the process cycle.	PR
67	Power supply: Phase interruption	An open-phase condition was detected in input power supply circuit.	PR
68	Power supply: Watchdog	The system does not operate correctly. LED display is fixed as "8".	AR
69	Power supply: Grounding	The motor power cable is in contact with FG (Frame Ground).	PR
6A	Power supply: External contactor welding	A contact of the external contactor is welding.	PR
6B	Power supply: Rush circuit error	An error was detected in the rush circuit.	PR
6C	Power supply: Main circuit error	An error was detected in charging operation of the main circuit capacitor.	PR
6D	Parameter setting error	An error was detected in the parameter sent from the drive unit.	PR
6E	Power supply: H/W error	An error was detected in the internal memory.	AR
	A/D error	An error was detected in the A/D converter.	
	Unit ID error	An error was detected in the unit identification.	
6F	Power supply error	No power supply is connected to the drive unit, or a communication error was detected.	AR
70	Power supply: External emergency stop error	A mismatch of the external emergency stop input and NC emergency stop input continued for 30 seconds.	PR
71	Power supply: Instantaneous power interruption	The power was momentarily interrupted.	NR
72	Power supply: Fan stop	A cooling fan built in the power supply unit stopped, and overheat occurred in the power module.	PR
74	Power supply: Option unit error	An alarm was detected in the power backup unit (power supply option unit).	NR
75	Power supply: Overvoltage	L+ and L- bus voltage in main circuit or the input voltage exceeded the allowable value. As the voltage between L+ and L- may be high immediately after this alarm, another alarm may occur if this alarm is reset in a short time. Wait more than 5 min before resetting so that the voltage drops.	NR
76	Power supply: Function setting error	The rotary switch setting of external emergency stop is not correct, or a wrong external emergency stop signal is input.	AR
	Power supply: Function selection error	"Setting prohibited" for the rotary switch 1 and 2 is selected.	
77	Power supply: Power module overheat	Thermal protection function in the power module has started its operation.	PR

AR: Drive unit power ON/OFF, PR: NC power ON/OFF, NR: NC reset (NR\*: The cause of the warning is distinguished), \*: Reset once the cause of the warning is removed.

## 11 Troubleshooting

## 11.3 Troubleshooting

## 11.2.2 List of Warnings

When a warning occurs, a warning No. will appear on the NC monitor screen and with the LEDs on the front of each unit. Check the warning No., and remove the cause of the warning by following this list.

## List of Warnings

No.	Name	Details	Reset method
E9	Instantaneous power interruption warning	The power was momentarily interrupted.	NR
EA	In external emergency stop state	External emergency stop signal was input.	*
EC	Power supply: Overload warning	Overload detection level exceeded 80 %.	*
EE	Power supply: Fan stop warning	A cooling fan built in the power supply unit stopped.	*
EF	Power supply: Option unit warning	A warning was detected in the power backup unit (power supply option unit).	*

## 11.3 Troubleshooting

If the NC system does not start up correctly and a system error occurs when the NC power is turned ON, the drive unit may not have been started up properly. Check the LED display on the power supply unit, and take measures according to this section.

## Power supply unit alarm

Alarm No.		Power supply: Power module overcurrent	
61		Overcurrent protection function in the power module of power supply has started its operation.	
	Investigation details	Investigation results	Remedies
1	Check the state of the operation when the alarm occurs, and check the repeatability.	The alarm occurs immediately after 400 VAC is supplied or after READY is turned ON.	Replace the unit.
		The alarm occurs occasionally during READY ON.	Check the investigation item No. 3.
		The alarm occurs after continuous operation for a long time. The unit is hot.	Check the investigation item No. 2.
2	Check the load state of all motors (during stopped).	The total load of all motors exceeds the rated capacity of the power supply unit.	Lower the motor load and operation frequency.
		The total does not exceed the capacity.	Check the investigation item No. 3.
3	Check the power capacity of the facility. Check the capacity of the step-down transformer (KVA).	The power capacity of the facility is insufficient.	Increase the power capacity of the facility.
		The specified power capacity is secured.	Check the investigation item No. 4.
4	Measure the voltage across wires. Is the voltage 380 V or more even when the motor is accelerating?	The voltage drops to less than 380 V occasionally.	Increase the power capacity of the facility.
		The difference of the voltage across wires is 10 V or more.	Improve the power phase balance.
		The difference of the voltage across wires is less than 10 V.	Check the investigation item No. 5.
5	Check whether there is any device (machine) causing the power distortion.	The power supply waveform is distorted when measuring the input voltage waveform during servo OFF.	Improve the power phase balance. For example, when the power supply waveform is distorted when another machine is in operation, move the wiring to the power which is far from the machine's power supply.
		The power supply waveform is not distorted.	Check the investigation item No. 6.
6	Check if there is any abnormality in the unit's ambient environment. (Ex. Noise, grounding, etc.)	Take remedies according to the causes of the abnormality in the ambient environment.	

11 Troubleshooting

11.3 Troubleshooting

Alarm No. 62		Power supply: Frequency error	
		The input power supply frequency increased above the specification range, or a wiring error of a power line was detected.	
	Investigation details	Investigation results	Remedies
1	Check the state of the operation when the alarm occurs, and check the repeatability.	The alarm occurs each time immediately after the power is turned ON. Or, the alarm occurs occasionally regardless of the operation state.	Check the investigation item No. 2, 3.
		The alarm occurs only while the motor is accelerating/decelerating.	Check the investigation item No. 4.
2	Check the power cable connection (phase sequence).	The connection is incorrect.	Correct the power cable connection.
3	Measure the power voltage waveform during normal operation.	The frequency is deviated from 50 Hz ± 3 % or 60 Hz ± 3 %.	Review the power facilities.
		The voltage waveform dips at some sections.	Improve the source of the distortion. Install an EMC filter.
		There is no problem.	Check the investigation item No. 5.
4	Measure the power voltage when the motor is accelerating/decelerating.	The frequency greatly fluctuates during acceleration/deceleration.	Review the power facilities.
		The voltage waveform during deceleration dips in some sections.	Improve the source of the distortion. Install an EMC filter.
		There is no problem.	Check the investigation item No. 5.
5	Check if there is any abnormality in the unit's ambient environment. (Ex. Noise, grounding, etc.)	Take remedies according to the causes of the abnormality in the ambient environment.	

Alarm No. 64		Power supply: Overload	
		Excessive load current was detected or overheating of the boost reactor occurred.	
	Investigation details	Investigation results	Remedies
1	Check the load state of all motors (during stopped).	The total load of all motors exceeds the rated capacity of the power supply unit.	Lower the motor load and operation frequency.
		The total does not exceed the capacity.	Check the investigation item No. 3.
2	Check if there is any abnormality in the unit's ambient environment. (Ex. Noise, grounding, etc.)	Take remedies according to the causes of the abnormality in the ambient environment.	
3	Replace the power supply unit and the reactor.	Fixed the problem.	Continue to use.
		Did not fix the problem.	Check the drive unit and the motor.

Alarm No. 66		Power supply: Process error	
		An error occurred in the process cycle.	
	Investigation details	Investigation results	Remedies
1	Check the repeatability.	The alarm occurs each time after the power is turned ON.	Replace the unit.
		The alarm occurs occasionally.	Check the investigation item No. 2.
2	Check if there is any abnormality in the unit's ambient environment. (Ex. Noise, grounding, etc.)	Take remedies according to the causes of the abnormality in the ambient environment.	

Alarm No. 67		Power supply: Phase interruption	
		An open-phase condition was detected in input power supply circuit.	
	Investigation details	Investigation results	Remedies
1	Check the voltage for each input phase.	There are phases with no voltage.	Correct the power supply.
		There is no problem.	Check the investigation item No. 2.
2	Check the alarm No. "71" items.		

11 Troubleshooting

11.3 Troubleshooting

Alarm No. 68		Power supply: Watchdog	
		The system does not operate correctly. LED display is fixed as "8".	
	Investigation details	Investigation results	Remedies
1	Check the repeatability.	The alarm occurs each time READY is turned ON.	Replace the unit.
		The alarm occurs occasionally.	Check the investigation item No. 2.
2	Check if there is any abnormality in the unit's ambient environment. (Ex. Noise, grounding, etc.)	Take remedies according to the causes of the abnormality in the ambient environment.	

Alarm No. 69		Power supply: Grounding	
		The motor power cable is in contact with FG (Frame Ground).	
	Investigation details	Investigation results	Remedies
1	Measure the insulation across the power cables (U,V,W) for all motors and the ground. (Carry out a megger test.)	Less than 1 MΩ. (Grounding)	The motor or power cable may be ground faulted.
		1 MΩ or more. (Normal)	Check the investigation item No. 2.
2	Has oil adhered on the motor or power cable?	Oil has adhered.	Take measures so that oil does not come in contact. Check the motor's cannon connector and the inside of the terminal box, and clean as necessary.
		Oil has not adhered.	Check the investigation item No. 3.
3	Measure the insulation again.	Less than 1 MΩ. (Grounding)	Replace the motor or cable.
		1 MΩ or more. (Normal)	Check the investigation item No. 2.
4	Measure the resistance across the U, V, W phase terminals of the servo/spindle drive unit and the ground. (Note) Do not measure the insulation as the unit is damaged.	Less than 100 kΩ.	Replace the drive unit.
		100 kΩ or more.	Replace the power supply unit.
5	Check whether there is any axis in which alarm 24 has occurred.	There is an axis in which alarm has occurred.	Check the alarm No. "24" items.
		There is no axis in which alarm has occurred.	Check the investigation item No. 2.

Alarm No. 6A		Power supply: External contactor welding	
		A contact of the external contactor is welding.	
	Investigation details	Investigation results	Remedies
1	Check whether any alarm has occurred on the drive unit side.	An alarm has occurred.	Remove the cause of the alarm on the drive side, and check the investigation item No. 2.
		An alarm has not occurred.	Check the investigation item No. 2.
2	Check whether the contactor's contact has melted.	The contactor has melted.	Replace the contactor.
		The contactor has not melted.	Check the investigation item No. 3.
3	Check that the contactor excitation wiring is correctly connected from the power supply unit's MC1 terminal.	The connection is correct.	Correctly connect.
		The connection is incorrect.	Replace the power supply unit.

11 Troubleshooting

11.3 Troubleshooting

Alarm No. 6B		Power supply: Rush circuit error	
		A thyristor for rush short circuit is ON when rushing.	
	Investigation details	Investigation results	Remedies
1	Check whether any alarm has occurred on the drive unit side.	An alarm has occurred.	Remove the cause of the alarm on the drive side, and check the investigation item No. 2.
		An alarm has not occurred.	Check the investigation item No. 2.
2	Check the repeatability.	The alarm occurs each time READY is turned ON.	Replace the unit.
		The alarm occurs occasionally.	Check the investigation item No. 3.
3	Check if there is any ground fault in the motor.	Check the investigation item of Alarm No. 69.	Take remedies of Alarm No. 69.
		No ground fault.	Check the investigation item No. 4.
4	Check if there is any abnormality in the unit's ambient environment. (Ex. Noise, grounding, etc.)	Take remedies according to the causes of the abnormality in the ambient environment.	

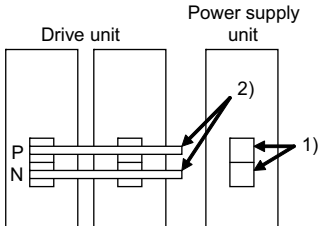
Alarm No. 6C		Power supply: Main circuit error																										
		An error was detected in charging operation of the main circuit capacitor.																										
	Investigation details	Investigation results	Remedies																									
1	Check the CHARGE lamp state when the alarm occurs.	[1] The light of the lamp becomes faint. [2] An alarm occurs when ready is turned ON again	Replace the power supply unit.																									
		The lamp turns ON instantly, but when the alarm occurs and the contactor turns OFF, the lamp turns OFF immediately.	Check the investigation item No. 2.																									
		The lamp never turns ON.	Check the investigation item No. 2. Then replace the unit.																									
2	Disconnect the power supply unit's PN terminal block wiring, and measure the resistance value at 1) and 2) shown below.  	1) The power supply unit side is abnormal.	Replace the power supply unit.																									
		2) The drive unit side is abnormal.	Disconnect the PN wiring, and then check the drive unit side.																									
		1) and 2) are both normal.	Replace the power supply unit.																									
		<table border="1"> <thead> <tr> <th rowspan="2">Tester measurement point</th> <th colspan="2">Polarity</th> <th rowspan="2">Normal</th> <th rowspan="2">Abnormal</th> </tr> <tr> <th>+</th> <th>-</th> </tr> </thead> <tbody> <tr> <td rowspan="2">1)</td> <td>P</td> <td>N</td> <td>Several 100Ω</td> <td>Short-circuit/∞Ω</td> </tr> <tr> <td>N</td> <td>P</td> <td>∞Ω</td> <td>Several 100Ω</td> </tr> <tr> <td rowspan="2">2)</td> <td>P</td> <td>N</td> <td>Several 100Ω</td> <td>Short-circuit/∞Ω</td> </tr> <tr> <td>N</td> <td>P</td> <td>∞Ω</td> <td>Several 100Ω</td> </tr> </tbody> </table>	Tester measurement point	Polarity		Normal	Abnormal	+	-	1)	P	N	Several 100Ω	Short-circuit/∞Ω	N	P	∞Ω	Several 100Ω	2)	P	N	Several 100Ω	Short-circuit/∞Ω	N	P	∞Ω	Several 100Ω	
Tester measurement point	Polarity			Normal	Abnormal																							
	+	-																										
1)	P	N	Several 100Ω	Short-circuit/∞Ω																								
	N	P	∞Ω	Several 100Ω																								
2)	P	N	Several 100Ω	Short-circuit/∞Ω																								
	N	P	∞Ω	Several 100Ω																								
3	Measure the voltage across wires. Is the voltage 380 V or more even when the motor is accelerating?	The voltage drops to less than 380 V occasionally.	Increase the power capacity.																									

Alarm No. 6D		Parameter setting error:	
		An error was detected in the parameter sent from the drive unit.	
	Investigation details	Investigation results	Remedies
1	Check the repeatability.	The alarm occurs each time after the power is turned ON.	Replace the unit.
		The alarm occurs occasionally.	Check the investigation item No. 2.
2	Check if there is any abnormality in the unit's ambient environment. (Ex. Noise, grounding, etc.)	Take remedies according to the causes of the abnormality in the ambient environment.	



11 Troubleshooting

11.3 Troubleshooting

Alarm No. 6E		Power supply: H/W error/AD error	
		An error was detected in the internal memory or A/D converter.	
	Investigation details	Investigation results	Remedies
1	Check the repeatability.	The alarm occurs each time READY is turned ON.	Replace the unit.
		The alarm occurs occasionally.	Check the investigation item No. 2.
2	Check if there is any abnormality in the unit's ambient environment. (Ex. Noise, grounding, etc.)	Take remedies according to the causes of the abnormality in the ambient environment.	

Alarm No. 6F		Power supply error:	
		No power supply is connected to the drive unit, or a communication error was detected.	
	Investigation details	Investigation results	Remedies
1	Check the time from when the unit power is turned OFF till when it is turned ON.	Within 3 seconds	Assure more than 3 seconds for the time from when the power is turned OFF till when it is turned ON.
		More than 3 seconds	Check the investigation item No. 2.
2	Check the LED display on the power supply unit.	"F" is flickering.	An A/D converter error has occurred. Check the alarm No. "6E" items.
		Another alarm code is flickering.	Check items of each alarm No.
		"0" is displayed.	Check the investigation item No. 3.
		"F" is displayed.	Check the investigation item No. 3.
		"8" is displayed.	Check the alarm No. "68" items.
		"b", "C", "d" is displayed.	Check the investigation item No. 4.
3	Check the rotary switch setting.	0 or 4 is set.	Check the investigation item No. 4.
		A value other than the above is set.	Correctly set the rotary switch.
4	Check the communication cable (CN4) connected with the drive unit.	There is a problem with the wiring or shield.	Replace the cable.
		There is no problem.	Replace the unit.

(\*) Alarm 6F is detected at the same time other power supply alarms occur.

Alarm No. 70		Power supply: External emergency stop error	
		A mismatch of the external emergency stop input and CNC emergency stop input continued for 30 seconds.	
	Investigation details	Investigation results	Remedies
1	Check the connection between external emergency stop and NC emergency stop.	Not wired.	Correctly wire the external emergency stop and NC emergency stop.
2	Check if there is any abnormality in the unit's ambient environment.	No abnormality is found in particular.	Replace the drive unit.
		The grounding is incomplete.	Take remedies according to the causes of the abnormality. Additionally ground and review.

## 11 Troubleshooting

## 11.3 Troubleshooting

Alarm No. 71		Power supply: Instantaneous power interruption	
		The power was momentarily interrupted.	
	Investigation details	Investigation results	Remedies
1	Investigate the sequence to check whether the contactor has been turned OFF with an emergency stop button, etc.	The contactor has been turned OFF externally.	Review the machine sequence. When turning the contactor OFF with external means, such as an emergency stop button, this alarm can be avoided by inputting NC emergency stop at the same time.
		The contactor has not been turned OFF.	Check the investigation item No. 2.
2	Check the repeatability.	The alarm occurs each time READY is turned ON.	Check the investigation item No. 3.
		The alarm occurs at a certain operation.	Check the investigation item No. 1. If there is no problem, check the investigation item No. 3.
		The alarm occurs occasionally during operation.	Check the investigation item No. 4.
3	Check whether the power input wire and contactor are correctly wired.	The wiring is incorrect.	Correctly connect.
		There is no problem.	Check the investigation item No. 4.
4	Check the power voltage waveform with a synchroscope.	An instantaneous power failure or voltage drop occurs frequently.	Correct the power facility.
		There is no problem.	Replace the unit.

Alarm No. 72		Power supply: Fan stop	
		A cooling fan built in the power supply unit stopped, and overheat occurred in the power module.	
	Investigation details	Investigation results	Remedies
1	Turn the unit power ON again, and confirm the rotation of the fan. Note) Assure more than 10 seconds for the time from when the power is turned OFF till when it is turned ON. For the fan used for the drive unit, assuring more than 10 seconds for the time from when the power is turned OFF till when it is turned ON is required.	The fan is rotating, and an alarm did not occur again.	Continue to use. The power may be turned ON without assuring more than 10 seconds for the time from when the power is turned OFF till when it is turned ON. Leave for more than 10 seconds, and turn the power ON again.
		The fan did not rotate. Or, an alarm occurred again.	Check the investigation item No. 2.
2	Check if the connector connected to a fan is disconnected.	The connector is disconnected.	Correctly connect the connector.
		The connector is not disconnected.	Check the investigation item No. 3.
3	Check if oil or cutting chips are adhered to the fan.	Oil or cutting chips are adhered.	Improve the use environment and replace the drive unit.
		Oil or cutting chips are not adhered. The cable may be broken.	Replace the drive unit.

Alarm No. 74		Power supply option unit error	
		An alarm was detected in the power backup unit (an option unit for the power supply).	
	Investigation details	Investigation results	Remedies
1	Check the LED display on the power backup unit.	Check the LED display on the power backup unit to identify what alarm is occurring to the unit.	Fix the error occurring to the power backup unit and remove the alarm. Refer to MDS-E/EH Series Instruction Manual (IB-1501229(ENG)) "List of power backup function alarms".

11 Troubleshooting

11.3 Troubleshooting

Alarm No. 75		Power supply: Overvoltage	
		L+ and L- bus voltage or the input voltage in main circuit exceeded the allowable value. As the voltage between L+ and L- is high immediately after this alarm, another alarm may occur if this alarm is reset in a short time. Wait more than 5 min before resetting so that the voltage drops.	
	Investigation details	Investigation results	Remedies
1	Check the repeatability.	The alarm occurs each time the motor decelerates.	Check the investigation item No. 3.
		The alarm occurs occasionally.	Check the investigation item No. 2.
2	Check the power supply's alarm history.	Auxiliary regeneration frequency over (E8) occurs just before the over-voltage occurs.	Limit the occurrence of the excessive instantaneous regeneration by not decelerating multiple axes at the same time.
		Others.	Check the investigation item No. 3.
3	Check the power capacity.	The power capacity is insufficient.	Increase the power capacity.
		The specified power capacity is secured.	Check the investigation item No. 4.
4	Measure the voltage across wires. [1] Is the voltage 380 V or more even when the motor is accelerating?	The voltage drops to less than 380 V occasionally.	Increase the power capacity.
		The voltage exceeds to 480 V occasionally.	Lower the input voltage.
		The difference of the voltage across wires is 10 V or more.	Improve the power phase balance.
		The difference of the voltage across wires is less than 10 V.	Check the investigation item No. 5.
5	Measure the power voltage with a synchroscope, and check whether there is any distortion. [1] Are there any other devices causing the power distortion?	The power voltage is distorted.	Improve the source of the distortion. Install an AC reactor.
		The power voltage waveform is not abnormal.	Check the investigation item No. 6.
6	Check if there is any abnormality in the unit's ambient environment. (Ex. Noise, grounding, etc.)	Take remedies according to the causes of the abnormality in the ambient environment.	

Alarm No. 76		Power supply: Function setting error	
		The rotary switch setting of external emergency stop is not correct, or a wrong external emergency stop signal is input.	
	Investigation details	Investigation results	Remedies
1	Check the rotary switch 1 setting.	When using external emergency stop, rotary switch is not set to "4".	Set the rotary switch 1 to "4".
2	Check the rotary switch 2 setting.	Rotary switch is set to other than "0" to "3".	Set rotary switch 2 to "0" to "3".
3	Check if there is any abnormality in the unit's ambient environment.	No abnormality is found in particular.	Replace the drive unit.
		The grounding is incomplete.	Take remedies according to the causes of the abnormality. Additionally ground and review.

Alarm No. 77		Power supply: Power module overheat	
		Thermal protection function in the power module has started its operation.	
	Investigation details	Investigation results	Remedies
1	Confirm that the fan is properly rotating.	Large amounts of cutting oil or cutting chips, etc., are adhered, or the rotation is slow.	Clean or replace the fan.
		The fan is properly rotating.	Check the investigation item No. 2.
2	Check whether the heat dissipating fins are dirty.	Cutting oil or cutting chips, etc., are adhered, and the fins are clogged.	Clean the fins.
		The fins are normal.	Check the investigation item No. 3.
3	Measure the power supply unit's ambient temperature.	55 °C or more	Improve the ventilation and cooling for the power distribution panel.
		Less than 55 °C.	Check the investigation item No. 4.
4	Check if there is any abnormality in the unit's ambient environment. (Ex. Ambient temperature, noise, grounding)	Take remedies according to the causes of the abnormality in the ambient environment.	

## Appx.1: Maintenance

## 12.1 Periodic Inspections

Periodic inspection of the following items is recommended.

- ♦ Are any of the screws on the terminal block loose? If loose, tighten them.
- ♦ Are any of the cables damaged or cracked? If the cables move with the machine, periodically inspect the cables according to the working conditions.

## 12.2 Service Parts

A guide to the part replacement cycle is shown below. Note that these will differ according to the working conditions or environmental conditions, so replace the parts if any abnormality is found. Contact Mitsubishi branch or your dealer for repairs or part replacements.

Part name		Standard replacement time	Remarks
MDS-EX-CVP	Smoothing capacitor	10 years	The standard replacement time is a reference. Even if the standard replacement time is not reached, the part must be replaced if any abnormality is found.
	Cooling fan	10,000 to 30,000 hours (2 to 3 years)	

- ♦ Power smoothing capacitor:  
The characteristics of the power smoothing capacitor will deteriorate due to the effect of ripple currents, etc. The capacitor life is greatly affected by the ambient temperature and working conditions. However, when used continuously in a normal air-conditioned environment (ambient temperature is an average of 40 °C or less), the service life will be ten years.
- ♦ Relays:  
Contact faults will occur due to contact wear caused by the switching current. The service life will be reached after 100,000 cumulative switches (switching life) although this will differ according to the power capacity.

## 12.3 Adding and Replacing Units and Parts

### CAUTION

- (1) Correctly transport the product according to its weight. Failure to do so could result in injury.
- (2) Do not stack the product above the indicated limit.
- (3) Installation directly on or near combustible materials could result in fires.
- (4) Install the unit as indicated at a place which can withstand the weight.
- (5) Do not get on or place heavy objects on the unit. Failure to observe this could result in injury.
- (6) Always use the units within the designated environment condition range.
- (7) Do not allow conductive foreign matter such as screws or metal chips, or combustible foreign matter such as oil enter the units.
- (8) Do not block the intake or exhaust ports of the units. Failure to observe this could result in faults.
- (9) The units are precision devices. Do not drop them or apply strong impacts.
- (10) Do not install or operate the units that are damaged or missing parts.
- (11) When the unit has been stored for a long time, contact the Service Center.

## ■ Replacing the Fan Unit

### [Replacing parts]

Power supply unit type	Fan type
MDS-EX-CVP-1100H	MDS-EX-FANU-301

### [Replacement procedure]

Replace the fan unit with the following procedures.

- (1) Remove the fixing screws from the fan unit and the connector on the top. (2) Pull the fan unit upward diagonally to remove it.

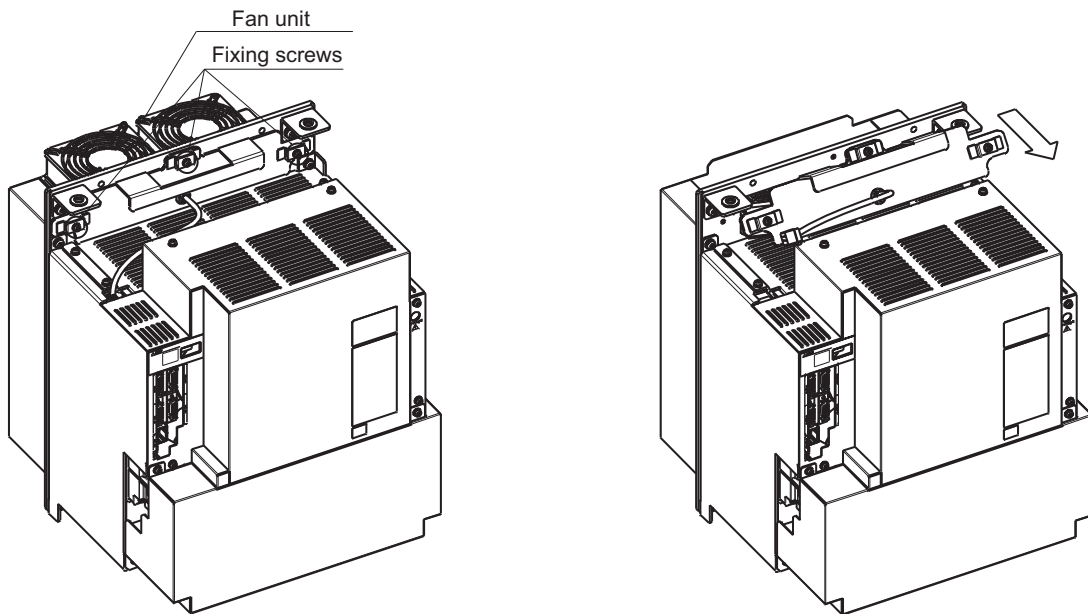

- (3) When installing the fan unit, follow the above procedures in reverse order.

### **⚠ CAUTION**

- (1) There are screws other than the fixing screws near the fan unit. Ensure that the correct screws are removed when removing the fixing screws.

■ Replacing the Fuse

[Replacing parts]

Fuse box type	Fuse type
MDS-EX-FB-1100H	BUSSMANN 170M2671

[Replacement procedure]

Replace the fuse with the following procedures.

(1) Remove the panel.

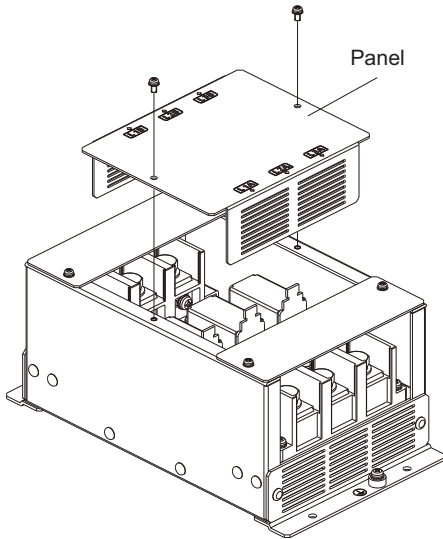

(2) Remove the attachments and replace the fuse.

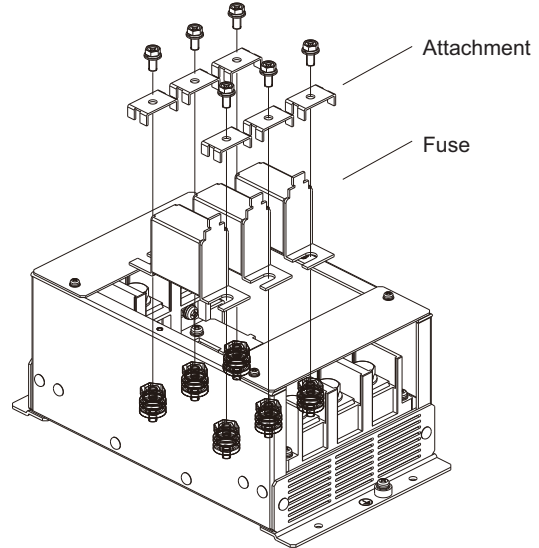

(3) When installing the fuse, follow the above procedures in reverse order.



**12 Appx.1: Maintenance**

12.3 Adding and Replacing Units and Parts

## **Appx.2: Compliance to EC Directives**

### 13.1 European EC Directives

In the EU Community and UK, the attachment of a CE mark and a UKCA mark (European CE marking/UK UKCA Regulations) is mandatory to indicate that the basic safety conditions of the Machine Directives (issued Jan. 1995), EMC Directives (issued Jan. 1996), Electromagnetic Compatibility Regulations (issued Jan.2021), the Low-voltage Directives (issued Jan. 1997), and the Electrical Equipment (Safety) Regulations (issued Jan. 2021) are satisfied. The machines and devices in which the servo and spindle drive are assembled are the targets for European CE marking and UK UKCA Regulations.

#### ■ Compliance to EMC Directives/Electromagnetic Compatibility Regulations

The servo and spindle drive are components designed to be used in combination with a machine or device. These are not directly targeted by the Directives, but a CE mark and a UKCA mark must be attached to machines and devices in which these components are assembled. The next section " Appx.3: EMC Installation Guidelines", which explains the unit installation and control panel manufacturing method, etc., has been prepared to make compliance to the EMC Directives/ Electromagnetic Compatibility Regulations easier.

#### ■ Compliance to Low-voltage Directives/Electrical Equipment (Safety) Regulations

Each unit is targeted for the Low-voltage Directives/Electrical Equipment (Safety) Regulations. An excerpt of the precautions given in this specification is given below. Please read this section thoroughly before starting use. For the EMC Directives/Electromagnetic Compatibility Regulations and Low-voltage Directives/Electrical Equipment (Safety) Regulations, Self-Declaration Documents has been prepared. Contact Mitsubishi or your dealer when required.

### 13.2 Cautions for EC Directive Compliance

Use the Low-voltage Directive/Electrical Equipment (Safety) Regulations compatible parts for the servo/spindle drive and servo/spindle motor. In addition to the items described in this instruction manual, observe the items described below.

#### ■ Configuration

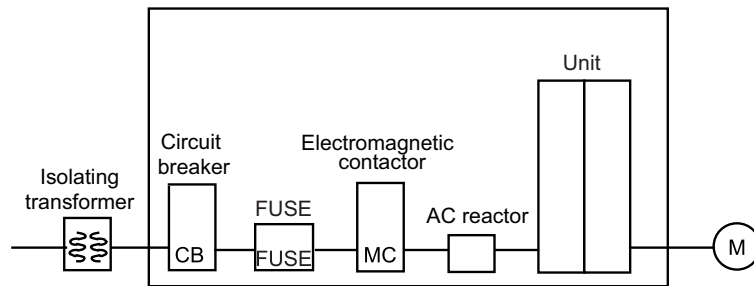

Insert a type B circuit breaker (RCD) in the power supply side of the unit.

■ Environment

Use the units under an Overvoltage Category III and Pollution Class of 2 or less environment as stipulated in IEC60664.

- ♦ Install MDS-EX-CVP-1100H, MDS-EX-ALF-1100H, and MDS-EX-FB-1100H in a control panel with an IP54 structure or higher, and MDS-EX-FTB-1100H and MDS-EX-ALC-1100H in a control panel with an IP33 structure or higher.

Environment	Unit	Servo motor	Spindle motor
Ambient temperature	Operation: Operation 0 to +55°C (with no freezing), Storage / Transportation: -15°C to +70°C (with no freezing)	Operation: 0 to +40°C (with no freezing), Storage: -15°C to +70°C (with no freezing)	Operation: 0 to +40°C (with no freezing), Storage: -20°C to +65°C (with no freezing)
Ambient humidity	Storage: 90% RH or less (with no dew condensation), Storage / Transportation: 90% RH or less (with no dew condensation)	Operation: 80% RH or less (with no dew condensation), Storage: 90% RH or less (with no dew condensation)	Operation: 90% RH or less (with no dew condensation), Storage: 90% RH or less (with no dew condensation)
Atmosphere	Indoors (no direct sunlight) With no corrosive gas, inflammable gas, oil mist, dust or conductive fine particles		
Altitude	Operation/Storage: 1000 meters or less above sea level, Transportation: 13000 meters or less above sea level	Operation/Storage: 1000 meters or less above sea level, Transportation: 10000 meters or less above sea level	
Vibration / impact	According to each unit or motor specification		

(\*) For details, confirm each unit or motor specifications in addition.

■ Power supply

- ♦ Use the power supply and servo/spindle drive unit under an Overvoltage Category III as stipulated in IEC60664.
- ♦ Earth the PE terminal of the units to the neutral point of the star connection.
- ♦ Do not omit the circuit breaker and electromagnetic contactor.

■ Earthing

- ♦ To prevent electric shocks, always connect the servo/spindle drive unit protective earth (PE) terminal (terminal with mark) to the protective earth (PE) on the control panel.
- ♦ When connecting the earthing wire to the protective earth (PE) terminal, do not tighten the wire terminals together. Always connect one wire to one terminal.



13 Appx.2: Compliance to EC Directives  
 13.2 Cautions for EC Directive Compliance

■ Wiring

- Always use crimp terminals with insulation tubes so that the connected wire does not contact the neighboring terminals.

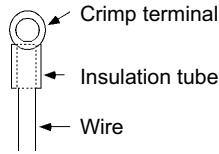

- Do not connect the wires directly.

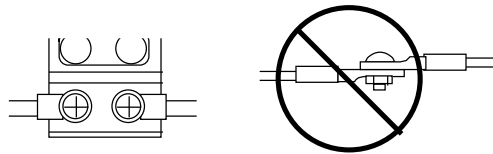

- Always install the power supply unit and servo/spindle drive unit on the metal panel.

■ Peripheral devices

- Use EN/IEC Standards compliant parts for the circuit protector and contactor.
- Select type B circuit protector manufactured by RCD.  
 Apply Annex C of EN60204-1 for sizing of the circuit protector.

■ Miscellaneous

- Refer to the next section "Appx.3: EMC Installation Guidelines" for methods on complying with the EMC Directives/Electromagnetic Compatibility Regulations.
- Ground the facility according to each country's requirements.
- The control circuit connector (○) is safely separated from the main circuit (◎) and ground (●).
- Inspect the appearance before installing the unit. Carry out a performance inspection of the final unit, and save the inspection records.

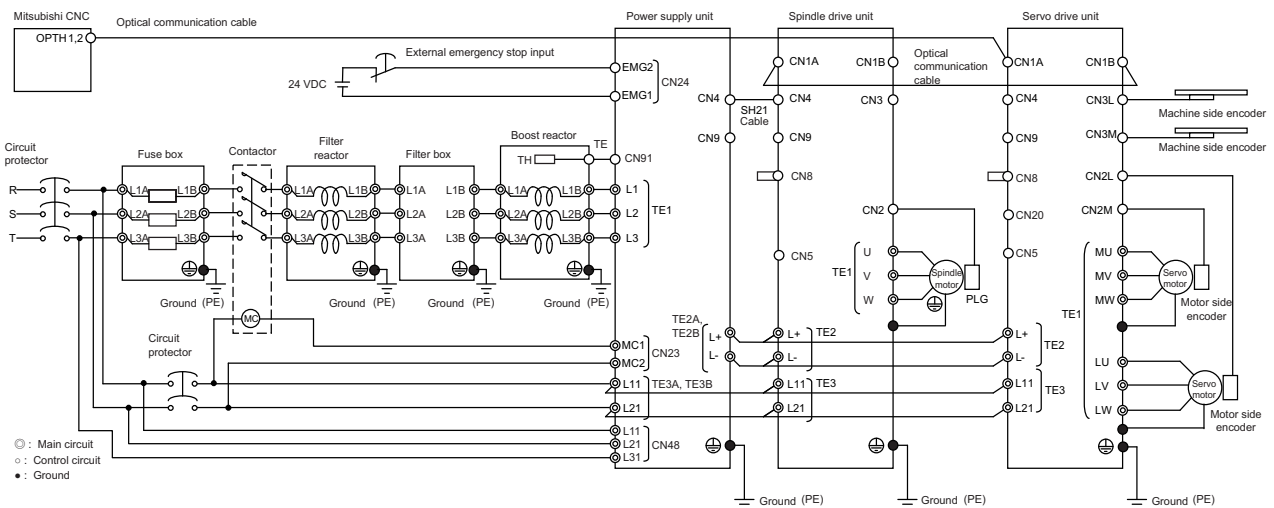

## **Appx.3: EMC Installation Guidelines**

## 14.1 Introduction

As the NC unit is a component designed to control machine tools, it is believed to be out of the direct EMC Directives/Electromagnetic Compatibility Regulations subject. However, we would like to introduce the following measure plans to backup EMC Directives/Electromagnetic Compatibility Regulations compliance of the machine tool as the NC unit is a major component of the machine tools.

- ♦ Methods for installation in control/operation panel
- ♦ Introduction of countermeasure parts

Mitsubishi is carrying out tests to confirm the compliance to the EMC Directives/Electromagnetic Compatibility Regulations under the environment described in this manual. However, the level of the noise will differ according to the equipment type and layout, control panel structure and wiring lead-in, etc. Thus, we ask that the final noise level be confirmed by the machine tool builder. For measures for CNC, refer to "EMC INSTALLATION GUIDELINES" of each NC Connection Manual.

## 14.2 EMC Directives/Electromagnetic Compatibility Regulations

The EMC Directives/Electromagnetic Compatibility Regulations regulate mainly the following two withstand levels.

- ♦ Emission ..... Capacity to prevent output of obstructive noise that adversely affects external sources.
- ♦ Immunity ..... Capacity not to malfunction due to obstructive noise from external sources.

The details of each level are classified in the table below. It is assumed that the Standards and test details required for a machine tool are about the same as these.

Class	Name	Details	Generic Standard	Standards for determining test and measurement
Emission	Radiated noise	Electromagnetic noise radiated through the air	EN61000-6-4 (General industrial machine) EN61800-3 (Motor control unit)	-----
	Conductive noise	Electromagnetic noise discharged from power line		
Immunity	Static electricity electrical discharge immunity test	(Example) Withstand level of discharge of electricity charged in a human body.	EN61000-6-2 (General industrial machine) EN61800-3 (Motor control unit)	EN61000-4-2
	Radiated radio-frequency magnetic field immunity test	(Example) Simulation of immunity from digital wireless transmitters		EN61000-4-3
	Electrical fast transient/burst immunity test	(Example) Withstand level of noise from relays or connecting/disconnecting live wires		EN61000-4-4
	Immunity to conducted disturbance induced by radio frequency magnetic field	(Example) Withstand level of noise entering through power line, etc.		EN61000-4-6
	Power supply frequency field immunity test	(Example) 50/60Hz power frequency noise		EN61000-4-8
	Immunity test for voltage dip, short-time power failure and voltage fluctuation	(Example) Power voltage drop withstand level		EN61000-4-11
	Surge immunity test	(Example) Withstand level of noise caused by lightning		EN61000-4-5

## 14.3 EMC Measures

The main items relating to EMC measures include the following.

- ♦ Store the device in an electrically sealed metal panel.
- ♦ Earth all conductors that are floating electrically. (Lower the impedance.)
- ♦ Wire the power line separated from the signal wire as far as possible.
- ♦ Use shielded wires for the cables wired outside of the panel.
- ♦ Install a noise filter.

Ensure the following items to suppress noise radiated outside of the panel.

- ♦ Accurately ground the devices.
- ♦ Clamp shielded wires in the control panel.
- ♦ Increase the panel's electrical seal. Reduce the gap and hole size. Note that the electromagnetic noise radiated in the air is greatly affected by the clearance of the panel and the quality of the cable shield.

## 14.4 Measures for Panel Structure

The design of the panel is a very important factor for the EMC measures, so take the following measures into consideration.

### 14.4.1 Measures for Control Panel Unit

- Use metal for all materials configuring the panel.
- For the joining of the top plate and side plates, etc., mask the contact surface with paint, and fix with welding or screws so that the impedance is reduced. In either case, keep the joining clearance to a max. of 20cm for a better effect. Note that if the plate warps due to the screw fixing, etc., creating a clearance, noise could leak from that place.

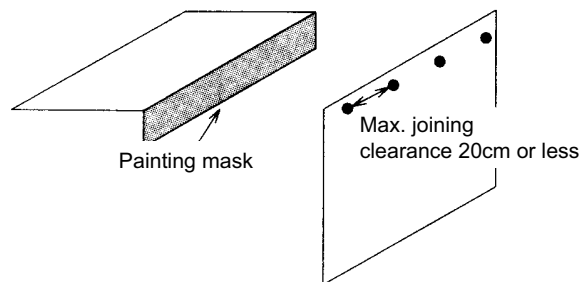

- Plate the earth plate (with nickel, tin), and connect the connections with a low impedance.
- If there is an opening on the panel surface, such as the ventilation holes, cover it with a metal plate or expanded metal. Make sure not to connect using metal or a conductor without peeling off the surface, which results in an insufficient electrical connection. (ex. connection by putting painted surfaces together)

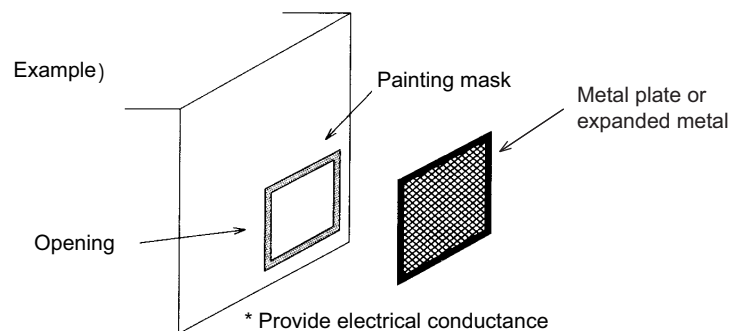



14 Appx.3: EMC Installation Guidelines

14.4 Measures for Panel Structure

14.4.2 Measures for Door

- Use metal for all materials configuring the door.
  - Use an EMI gasket or conductive packing for the contact between the door and control panel unit.
  - The EMI gasket or conductive packing must contact at a uniform and correct position of the metal surface of the control panel unit.
  - The surface of the control panel unit contacted with the EMI gasket or conductive packing must have conductance treatment.
- (Example) Weld (or screw) a plate that is plated (with nickel, tin).

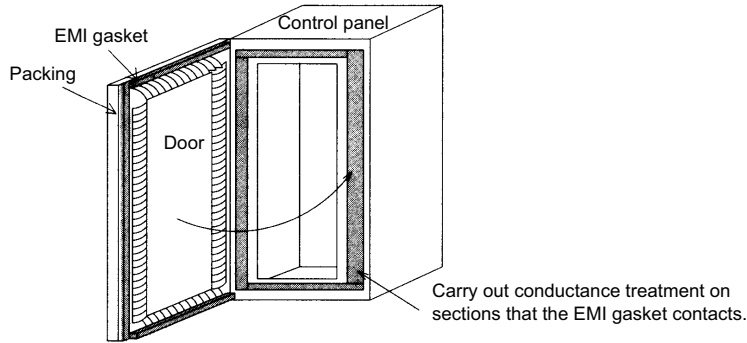

- As a method other than the above, the control panel unit and door can be connected with a plain braided wire. In this case, the panel and door should be contacted at as many points as possible.

14.4.3 Measures for Operation Board Panel

- Always connect the operation board and indicator with an earthing wire.
- If the operation board panel has a door, use an EMI gasket or conductive packing between the door and panel to provide electrical conductance in the same manner as the control panel.
- Connect the operation board panel and control panel with a sufficiently thick and short earthing wire.

14.4.4 Shielding of the Power Supply Input Section

- Separate the input power supply section from other parts in the control panel so that the input power supply cable will not be contaminated by radiated noise.
- Do not lead the power line through the panel without passing it through a filter.

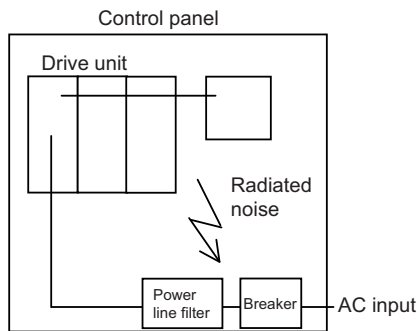

The power supply line noise is eliminated by the filter, but cable contains noise again because of the noise radiated in the control panel.

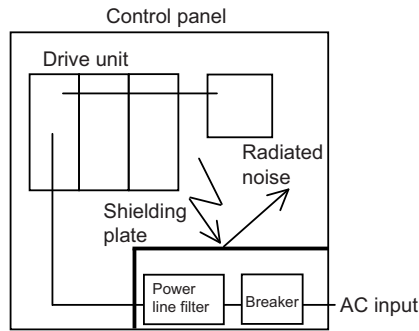

Use a metal plate, etc., for the shielding partition. Make sure not to create a clearance.

## 14.5 EMC Countermeasure Parts

### 14.5.1 Shield Clamp Fitting

The effect can be enhanced by connecting the cable directly to the earthing plate. Install an earthing plate near each panel's outlet (within 10 cm), and press the cable against the earthing plate with the clamp fitting. If the cables are thin, several can be bundled and clamped together. Securely earth the earthing plate with the frame ground. Install directly on the cabinet or connect with an earthing wire.

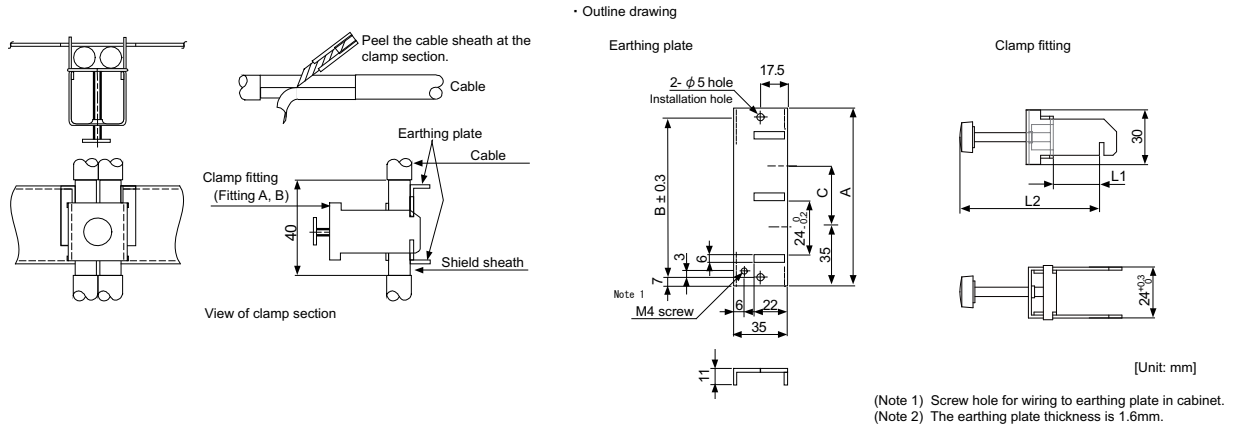

	A	B	C	Enclosed fittings
Ground Plate #D	100	86	30	Clamp fitting A x 2
Ground Plate #E	70	56	-	Clamp fitting B x 1

	L1 (maximum dimension when it is open)	L2 (reference dimension)
Clamp fitting A	25	(77)
Clamp fitting B	12	(54)

### 14.5.2 Ferrite Core

Noise can be suppressed by installing a ferrite core to the cable if the power cable and encoder cable, which are led from outside of the control panel, are the noise sources.

Specify the frequency of radiated noise and select the ferrite with high impedance corresponding to the frequency.

By wrapping the cable around the ferrite core according to the cable diameter as shown in the example, the impedance rises, obtaining a better effect.

#### < Example of use >

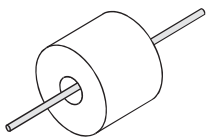

Lead through one time (one turn)

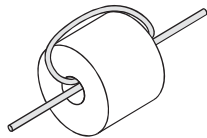

Lead through two times (two turns)

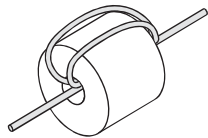

Lead through three times (three turns)

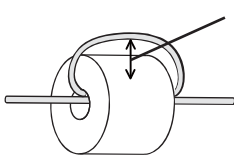

The clearance between the ferrite core and cable must be as narrow as possible when winding a cable.

14 Appx.3: EMC Installation Guidelines

14.5 EMC Countermeasure Parts

< Recommended ferrite core >

A ferrite core is integrated and mounted on the plastic case. Quick installation is possible without cutting the interface cable or power cable. This ferrite core is effective against common mode noise, allowing measures against noise to be taken without affecting the signal quality.

Kitagawa Industries GRFC Series

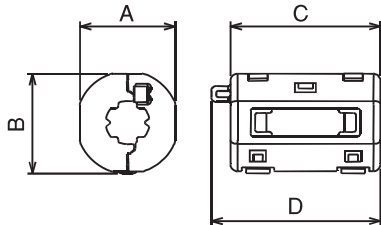

[Unit: mm]

Part number	A	B	C	D	Applicable bundle diameter	Impedance *Ω/100 MHz (1 turn)
RFC-H13	31.7	29.4	41.0	-	Φ12.5 to 13.5	≥ 170
RFC-20	40.0	40.0	47.0	-	Max.Φ20	≥ 180

Contact:

KITAGAWA INDUSTRIES CO.,LTD.

<http://www.kitagawa-ind.com/eng/>

Hitachi Metals, Ltd. FT-3KM F Series

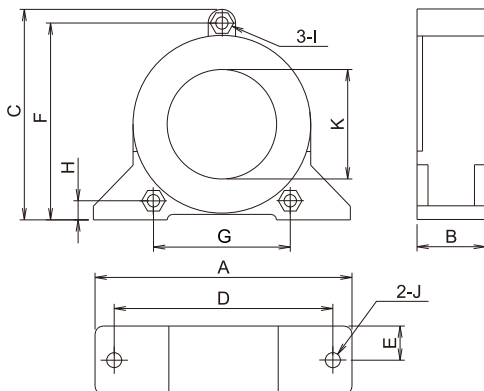

[Unit: mm]

Part number	Dimension										Screw diameter		AL (μH/N <sup>2</sup> )
	A	B	C	D	E	F	G	H	K	3-I	2-J		
FT-3KM F11080GB	181.0	26.0	131.0	150.0	12.5	124.0	100.0	20.0	74.0	M5	M6	40.2 to 95.0	

Contact:

Hitachi Metals, Ltd.

<https://www.hitachi-metals.co.jp/e/index.html>

## **Appx.4: Higher Harmonic Suppression Measure Guidelines**

## 15.1 Higher Harmonic Suppression Measure Guidelines

Since the power supply unit has a rectifier circuit, it may affect the generator and the leading capacitor by generating a power supply higher harmonic. Power supply harmonics differ from noise and leakage current in their generating source, frequency range and transmission method.

However, it is assumed to generate no harmonics because higher harmonic is suppressed by PWM converter "MDS-EX-CVP Series" control and the converter is classified as "the self-excitation three-phase bridge circuit" in the compliance with the harmonic suppression guideline.

(Conversion coefficient for each circuit type:  $K5=0$ )

## Revision History

Date of revision	Manual No.	Revision details
Jun. 2020	IB(NA)1501587-A	First edition created.
Jul. 2021	IB(NA)1501587-B	<ul style="list-style-type: none"><li>- "Precautions for Safety" was revised</li><li>- "Power Supply Unit" was revised</li><li>- "AC Reactor" was revised</li><li>- Function Specifications List was added</li><li>- "Transition of LED Display after Power Is Turned ON" was revised</li><li>- "Wire Selection Standards and Maximum Allowable Wiring Length for Each Product" was revised</li><li>- "Example of Wires by Unit" was revised</li><li>- "Points of Caution and Confirmation" was revised</li><li>- "Compliance to EC Directives" was revised</li><li>- "EMC Installation Guidelines" was revised</li></ul>

# Global Service Network

## AMERICA

### **mitsubishi electric automation inc. (america fa center)**

**Central Region Service Center (Chicago)**  
500 CORPORATE WOODS PARKWAY, VERNON HILLS, ILLINOIS 60061, U.S.A.  
TEL: +1-847-478-2500 / FAX: +1-847-478-2650

**Minneapolis, MN Service Satellite**

**Detroit, MI Service Satellite**

**Grand Rapids, MI Service Satellite**

**Milwaukee, WI Service Satellite**

**Cleveland, OH Service Satellite**

**Indianapolis, IN Service Satellite**

**St. Louis, MO Service Satellite**

### **South/East Region Service Center (Georgia)**

1845 SATELLITE BOULEVARD STE. 450, DULUTH, GEORGIA 30097, U.S.A.  
TEL: +1-678-258-4529 / FAX: +1-678-258-4519

**Charleston, SC Service Satellite**

**Charlotte, NC Service Satellite**

**Raleigh, NC Service Satellite**

**Dallas, TX Service Satellite**

**Houston, TX Service Satellite**

**Hartford, CT Service Satellite**

**Knoxville, TN Service Satellite**

**Nashville, TN Service Satellite**

**Baltimore, MD Service Satellite**

**Pittsburg, PA Service Satellite**

**Tampa, FL Service Satellite**

**Syracuse, NY Service Satellite**

**Orlando, FL Service Satellite**

**Lafayette, LA Service Satellite**

**Philadelphia, PA Service Satellite**

### **Western Region Service Center (California)**

5900-B KATELLA AVE. - 5900-A KATELLA AVE. CYPRESS, CALIFORNIA 90630, U.S.A.  
TEL: +1-714-699-2625 / FAX: +1-847-478-2650

**San Jose, CA Service Satellite**

**Seattle, WA Service Satellite**

**Denver, CO Service Satellite**

### **Canada Region Service Center (Tronto)**

4299 14TH AVENUE MARKHAM, ONTARIO L3R 0J2, CANADA  
TEL: +1-905-475-7728 / FAX: +1-905-475-7935

**Edmonton, AB Service Satellite**

**Montreal, QC Service Satellite**

### **Mexico Region Service Center (Queretaro)**

Parque Tecnológico Innovación Querétaro, Lateral Carretera Estatal 431, Km 2+200, Lote 91 Modulos 1 y 2  
Hacienda la Machorra, CP 76246, El Marqués, Querétaro, México  
TEL: +52-442-153 6050

**Monterrey, NL Service Satellite**

**Mexico City, DF Service Satellite**

## BRAZIL

### **mitsubishi electric do brasil comércio e serviços ltda.**

**Votorantim Office**  
AV. GISELE CONSTANTINO,1578, PARQUE BELA VISTA, VOTORANTIM-SP, BRAZIL CEP:18.110-650  
TEL: +55-15-3023-9000

**Blumenau, Santa Catarina office**

## EUROPE

### **mitsubishi electric europe b.v.**

**European Service Headquarters (Dusseldorf, GERMANY)**  
Mitsubishi-Electric-Platz 1 40882 RATINGEN, GERMANY  
TEL: +49-2102-486-5000 / FAX: +49-2102-486-5910

### **South Germany Service Center (Stuttgart)**

SCHELMENWASENSTRASSE 16-20, 70567 STUTTGART, GERMANY  
TEL: + 49-711-770598-123 / FAX: +49-711-770598-141

### **France Service Center (Paris)**

2 RUE DE L'UNION, 92565 RUEIL-MALMAISON CEDEX, FRANCE  
TEL: +33-1-41-02-83-13 / FAX: +33-1-49-01-07-25

### **France Service Satellite (Lyon)**

120, ALLEE JACQUES MONOD 69800 SAINT PRIEST FRANCE  
TEL: +33-1-41-02-83-13 / FAX: +33-1-49-01-07-25

### **Italy Service Center (Milan)**

CENTRO DIR. COLLEONI, PALAZZO SIRIO, VIALE COLLEONI 7, 20864 AGRATE BRIANZA (MB) ITALY  
TEL: +39-039-6053-342 / FAX: +39-039-6053-206

### **Italy Service Satellite (Padova)**

VIA G. SAVELLI, 24 - 35129 PADOVA, ITALY  
TEL: +39-039-6053-342 / FAX: +39-039-6053-206

### **U.K. Service Center**

TRAVELLERS LANE, HATFIELD, HERTFORDSHIRE, AL10 8XB, U.K.  
TEL: +49-2102-486-5000 / FAX: +49-2102-486-5910

### **Spain Service Center**

CTRA. RUBI, 76-80 8174 SAINT CUGAT DEL VALLES, BARCELONA SPAIN  
TEL: +34-935-65-2236 / FAX: +34-935-89-1579

### **Poland Service Center**

UL.KRAKOWSKA 50, 32-083 BALICE, POLAND  
TEL: +48-12-347-6500 / FAX: +48-12-630-4701

### **Hungary Service Center**

BUDAÖRS OFFICE PARK, SZABADSÁG ÚT 117., 2040 BUDAÖRS, HUNGARY  
TEL: +48-12-347-6500 / FAX: +48-12-630-4701

### **Turkey Service Center**

**MITSUBISHI ELECTRIC TURKEY A.Ş**  
SERIFALI MAHALLESİ NUTUK SOKAK. NO.41 34775  
UMRANIYE, ISTANBUL, TURKEY  
TEL: +90-216-969-2500 / FAX: +90-216-526-3995

### **Czech Republic Service Center**

**AutoCont Control Systems s.r.o (Service Partner)**  
KAFKOVA 1853/3, 702 00 OSTRAVA 2, CZECH REPUBLIC  
TEL: +420-59-5691-185 / FAX: +420-59-5691-199

### **Russia Service Center**

**MITSUBISHI ELECTRIC RUSSIA LLC**  
LETNIKOVSKAYA STREET 2, BLD.1, 5TH 115114 MOSCOW, RUSSIA  
TEL: +7-495-721-2070 / FAX: +7-495-721-2071

### **Sweden Service Center**

HAMMARBACKEN 14, P.O.BOX 750 SE-19127, SOLLENTUNA, SWEDEN  
TEL: +46-8-6251000 / FAX: +46-8-6251014

### **Bulgaria Service Center**

**AKHNATON Ltd. (Service Partner)**  
4 ANDREJ LJAPCHEV BLVD. POB 21, BG-1756 SOFIA, BULGARIA  
TEL: +359-2-8176009 / FAX: +359-2-9744061

### **Ukraine Service Center (Kiev)**

**CSC Automation Ltd. (Service Partner)**  
4 B. YEVHENA SVERSTYUKA STR., 02002 KIEV, UKRAINE  
TEL: +380-44-494-3344 / FAX: +380-44-494-3366

### **Belarus Service Center**

**TECHNIKON Ltd. (Service Partner)**  
NEZAVISIMOSTI PR.177, 220125 MINSK, BELARUS  
TEL: +375-17-393-1177 / FAX: +375-17-393-0081

### **South Africa Service Center**

**Adroit Technologies (Service Partner)**  
20 WATERFORD OFFICE PARK, WATERFORD DRIVE, CNR OF WITKOPPEN ROAD,  
FOURWAYS JOHANNESBURG SOUTH AFRICA  
TEL: +27-11-658-6100 / FAX: +27-11- 658-8101

**ASEAN****MITSUBISHI ELECTRIC ASIA PTE. LTD. (ASEAN FA CENTER)**

**Singapore Service Center**  
307 ALEXANDRA ROAD #05-01/02 MITSUBISHI ELECTRIC BUILDING SINGAPORE 159943  
TEL: +65-6473-2308 / FAX: +65-6476-7439

**PHILIPPINE****MELCO FACTORY AUTOMATION PHILIPPINES INC.**

**Head Office**  
128 LOPEZ RIZAL STREET, BRGY., HIGHWAY HILLS, MANDALUYONG CITY, MM PHILIPPINES 1550  
TEL: +63-2-8256-8042 / FAX: +63-2-8637-2294

**Philippines Service Center**  
KM.23 WEST SERVICE ROAD SSH, CUPANG, MUNTINLUPA CITY PHILIPPINES  
TEL: +63-2-8807-0420 / FAX: +63-2-8842-5202

**VIETNAM****MITSUBISHI ELECTRIC VIETNAM CO., LTD.**

**Vietnam Ho Chi Minh Service Center**  
11TH & 12TH FLOOR, VIETTEL TOWER B, 285 CACH MANG THANG 8 STREET, WARD 12, DISTRICT 10, HO CHI MINH CITY, VIETNAM  
TEL: +84-28-3910 5945 / FAX: +84-28-3910 5947

**Vietnam Hanoi Service Center**  
24TH FLOOR, HANDICO TOWER, PHAM HUNG ROAD, ME TRI HA, ME TRI WARD, NAM TU LIEM DISTRICT, HA NOI CITY, VIETNAM  
TEL: +84-24-3937-8075 / FAX: +84-24-3937-8076

**INDONESIA****PT. MITSUBISHI ELECTRIC INDONESIA**

**Indonesia Service Center (Cikarang)**  
JL. KENARI RAYA BLOK G2-07A, DELTA SILICON 5, LIPPO CIKARANG - BEKASI 17550, INDONESIA  
TEL: +62-21-2961-7797 / FAX: +62-21-2961-7794

**MALAYSIA****MITSUBISHI ELECTRIC SALES MALAYSIA SDN. BHD.**

**Malaysia Service Center (Kuala Lumpur Service Center)**  
LOT 11, JALAN 219, P.O BOX 1036, 46880 PETALING JAYA, SELANGOR DARUL EHSAN, MALAYSIA  
TEL: +60-3-7960-2628 / FAX: +60-3-7960-2629  
**Johor Bahru Service Satellite**  
**Pulau Pinang Service Satellite**

**THAILAND****MITSUBISHI ELECTRIC FACTORY AUTOMATION (THAILAND) CO., LTD.**

**Thailand Service Center (Bangkok)**  
101, TRUE DIGITAL PARK OFFICE, 5TH FLOOR, SUKHUMVIT ROAD, BANGCHAK, PHRAKHANONG, BANGKOK, 10260 THAILAND  
TEL: +66-2-092-8600 / FAX: +66-2-043-1231-33  
**Bowin Service Center (Chonburi)**  
**Korat Service Center**

**INDIA****MITSUBISHI ELECTRIC INDIA PVT., LTD.**

**CNC Technical Center (Bangalore)**  
PLOT NO. 56, 4TH MAIN ROAD, PEENYA PHASE 3, PEENYA INDUSTRIAL AREA, BANGALORE 560058, KARNATAKA, INDIA  
TEL: +91-80-4655-2121 / FAX: +91-80-4655-2147  
**Chennai Service Satellite**  
**Coimbatore Service Satellite**  
**Hyderabad Service Satellite**

**North India Service Center (Gurgaon)**  
PLOT 517, GROUND FLOOR, UDYOG VIHAR PHASE-III, GURUGRAM 122008, HARYANA, INDIA  
TEL: +91-124-463-0300 / FAX: +91-124-463-0399  
**Ludhiana Service Satellite**  
**Panthnagar Service Satellite**  
**Delhi Service Satellite**  
**Jamshedpur Service Satellite**  
**Manesar Service Satellite**

**West India Service Center (Pune)**  
ICC-Devi GAURAV TECHNOLOGY PARK, UNIT NO.402, FOURTH FLOOR, NORTH WING, SURVEY NUMBER 191-192 (P), NEXT to INDIAN CARD CLOTHING COMPANY Ltd, OPP. VALLABH NAGAR, PIMPRI, PUNE- 411 018, MAHARASHTRA, INDIA  
TEL: +91-20-6819 2274 / FAX: +91-20-4624 2100  
**Kolhapur Service Satellite**  
**Aurangabad Service Satellite**  
**Mumbai Service Satellite**

**West India Service Center (Ahmedabad)**  
204-209, 2ND FLOOR, 31FIVE, CORPORATE ROAD PRAHLADNAGAR, AHMEDABAD -390015, GUJARAT, INDIA  
TEL: + 91-79-6777 7888  
**Rajkot Service Satellite**

**CHINA****MITSUBISHI ELECTRIC AUTOMATION (CHINA) LTD. (CHINA FA CENTER)**

**CNC Call Center**  
TEL: +86-400-921-5130

**Shanghai Service Center**  
1-3,5-10,18-23/F, NO.1386 HONG QIAO ROAD, CHANG NING QU, SHANGHAI 200336, CHINA  
TEL: +86-21-2322-3030 / FAX: +86-21-2322-3000\*8422

**Qingdao Service Center**  
**Suzhou Service Center**  
**Wuhan Service Center**  
**Ningbo Service Center**  
**Hefei Service Center**  
**Beijing Service Center**  
**Tianjin Service Center**  
**Xian Service Center**  
**Dalian Service Center**  
**Chengdu Service Center**

**Shenzhen Service Center**  
LEVEL8, GALAXY WORLD TOWER B, 1 YABAO ROAD, LONGGANG DISTRICT, SHENZHEN 518129, CHINA  
TEL: +86-755-2399-8272 / FAX: +86-755-8229-3686  
**Dongguan Service Center**  
**Xiamen Service Center**

**KOREA****MITSUBISHI ELECTRIC AUTOMATION KOREA CO., LTD. (KOREA FA CENTER)**

**Korea Service Center**  
8F GANGSEO HANGANG XI-TOWER A, 401 YANGCHEON-RO, GANGSEO-GU, SEOUL 07528 KOREA  
TEL: +82-2-3660-9609 / FAX: +82-2-3664-8668  
**Korea Daegu Service Satellite**

**TAIWAN****MITSUBISHI ELECTRIC TAIWAN CO., LTD. (TAIWAN FA CENTER)**

**Taiwan Taichung Service Center**  
NO.8-1, GONGYEQU 16TH RD., XITUN DIST., TAICHUNG CITY 40768, TAIWAN  
TEL: +886-4-2359-0688 / FAX: +886-4-2359-0689

**Taiwan Taipei Service Center**  
11F, NO.88, SEC.6, ZHONGSHAN N. RD., SHILIN DIST., TAIPEI CITY 11155, TAIWAN  
TEL: +886-2-2833-5430 / FAX: +886-2-2833-5433

**Taiwan Tainan Service Center**  
11F.-1, NO.30, ZHONGZHENG S. RD., YONGKANG DIST., TAINAN CITY 71067, TAIWAN  
TEL: +886-6-252-5030 / FAX: +886-6-252-5031

**OCEANIA****MITSUBISHI ELECTRIC AUSTRALIA PTY. LTD.**

**Oceania Service Center**  
348 VICTORIA ROAD, RYDALMERE, N.S.W. 2116 AUSTRALIA  
TEL: +61-2-9684-7269/ FAX: +61-2-9684-7245



**Notice**

Every effort has been made to keep up with software and hardware revisions in the contents described in this manual.

However, please understand that in some unavoidable cases simultaneous revision is not possible.

**Duplication Prohibited**

This manual may not be reproduced in any form, in part or in whole, without written permission from Mitsubishi Electric Corporation.

COPYRIGHT 2020-2021 MITSUBISHI ELECTRIC CORPORATION ALL RIGHTS RESERVED

# MITSUBISHI ELECTRIC CORPORATION

HEAD OFFICE : TOKYO BLDG.,2-7-3 MARUNOUCHI,CHIYODA-KU,TOKYO 100-8310,JAPAN

MODEL	MDS-EX-CVP Series
MODEL CODE	100-713
Manual No.	IB-1501587