

Numerical Control (CNC)

Instruction Manual

MDS-EM/EMH Series

Introduction

Thank you for selecting the Mitsubishi numerical control unit. This instruction manual describes the handling and caution points for using this AC servo/spindle. Incorrect handling may lead to unforeseen accidents, so always read this instruction manual thoroughly to ensure correct usage.

Make sure that this instruction manual is delivered to the end user. Always store this manual in a safe place.

In order to confirm if all function specifications described in this manual are applicable, refer to the specifications for each CNC.

Notes on Reading This Manual

- (1) Since the description of this specification manual deals with NC in general, for the specifications of individual machine tools, refer to the manuals issued by the respective machine tool builders. The "restrictions" and "available functions" described in the manuals issued by the machine tool builders have precedence to those in this manual.
- (2) This manual describes as many special operations as possible, but it should be kept in mind that items not mentioned in this manual cannot be performed.
- (3) The characteristic values and numerical values without tolerances mentioned in this manual are representative values.

In this manual, the following abbreviations might be used.

MTB: Machine tool builder

Precautions for Safety

Please read this manual and auxiliary documents before starting installation, operation, maintenance or inspection to ensure correct usage. Thoroughly understand the device, safety information and precautions before starting operation.

The safety precautions in this instruction manual are ranked as "WARNING" and "CAUTION".

DANGER

When there is a potential risk of fatal or serious injuries if handling is mistaken.

WARNING



When a dangerous situation, or fatal or serious injuries may occur if handling is mistaken.



CAUTION

When a dangerous situation may occur if handling is mistaken leading to medium or minor injuries, or physical damage.











Note that some items described as " CAUTION" may lead to major results depending on the situation. In any case, important information that must be observed is described.

The signs indicating prohibited and mandatory matters are explained below.

	Indicates a prohibited matter. For example, "Fire Prohibited" is indicated as  .
---	---

	Indicates a mandatory matter. For example, grounding is indicated as  .
---	--

The meaning of each pictorial sign is as follows.

 CAUTION	 CAUTION rotated object	 CAUTION HOT	 Danger Electric shock risk	 Danger explosive
 Prohibited	 Disassembly is prohibited	 KEEP FIRE AWAY	 General instruction	 Earth ground

After reading this specifications and instructions manual, store it where the user can access it easily for reference.

The numeric control unit is configured of the control unit, operation board, servo drive unit, spindle drive unit, power supply, servo motor and spindle motor, etc.

In this section "Precautions for safety", the following items are generically called the "motor".

- Servo motor
- Linear servo motor
- Spindle motor
- Direct-drive motor

In this section "Precautions for safety", the following items are generically called the "unit".

- Servo drive unit
- Spindle drive unit
- Power supply unit
- Scale interface unit
- Magnetic pole detection unit



POINT

Important matters that should be understood for operation of this machine are indicated as a POINT in this manual.













For Safe Use

Mitsubishi CNC is designed and manufactured solely for applications to machine tools to be used for industrial purposes.

Do not use this product in any applications other than those specified above, especially those which are substantially influential on the public interest or which are expected to have significant influence on human lives or properties.





 **WARNING**

1. Electric shock prevention

-  **Make sure the power is shut OFF before connecting a unit and a motor to the power.**
-  **Do not open the front cover while the power is ON or during operation. Failure to observe this could lead to electric shocks.**
-  **Do not operate the unit with the front cover removed. The high voltage terminals and charged sections will be exposed, and can cause electric shocks.**
-  **Do not remove the front cover and connector even when the power is OFF unless carrying out wiring work or periodic inspections. The inside of the units is charged, and can cause electric shocks.**
-  **Since the high voltage is supplied to the main circuit connector while the power is ON or during operation, do not touch the main circuit connector with an adjustment screwdriver or the pen tip. Failure to observe this could lead to electric shocks.**
-  **Wait at least 15 minutes after turning the power OFF, confirm that the CHARGE lamp has gone out, and check the voltage between P and N terminals with a tester, etc., before starting wiring, maintenance or inspections. Failure to observe this could lead to electric shocks.**
-  **Ground the unit and motor. For the motor, ground it via the drive unit.**
-  **Wiring, maintenance and inspection work must be done by a qualified technician.**
-  **Wire the servo drive unit and servo motor after installation. Failure to observe this could lead to electric shocks.**
-  **Do not touch the switches with wet hands. Failure to observe this could lead to electric shocks.**
-  **Do not damage, apply forcible stress, place heavy items on the cables or get them caught. Failure to observe this could lead to electric shocks.**
-  **Always insulate the power terminal connection section. Failure to observe this could lead to electric shocks.**
-  **After assembling the built-in IPM/SPM spindle motor, if the rotor is rotated by hand etc., voltage occurs between the terminals of lead. Take care not to get electric shocks.**







 **WARNING**

2. Injury prevention







-  When handling a motor, perform operations in safe clothing.
-  In the system where the optical communication with CNC is executed, do not see directly the light generated from CN1A/CN1B connector of drive unit or the end of cable. When the light gets into eye, you may feel something is wrong for eye.
(The light source of optical communication corresponds to class1 defined in JISC6802 or IEC60825-1.)
-  The linear servo motor, direct-drive motor and built-in IPM/SPM spindle motor uses permanent magnets in the rotor, so observe the following precautions.
 - (1)Handling
 - The linear servo motor, direct-drive motor and built-in IPM/SPM spindle motor could adversely affect medical electronics such as pacemakers, etc., therefore, do not approach the rotor.
 - Do not place magnetic materials as iron.
 - When a magnetic material as iron is placed, take safety measure not to pinch fingers or hands due to the magnetic attraction force.
 - Remove metal items such as watch, piercing jewelry, necklace, etc.
 - Do not place portable items that could malfunction or fail due to the influence of the magnetic force.
 - When the rotor is not securely fixed to the machine or device, do not leave it unattended but store it in the package properly.
 - When installing the motor to the machine, take it out from the package one by one, and then install it.
 - It is highly dangerous to lay out the motor or magnetic plates together on the table or pallet, therefore never do so.
 - (2)Transportation and storage
 - Correctly store the rotor in the package to transport and store.
 - During transportation and storage, draw people's attention by applying a notice saying "Strong magnet-Handle with care" to the package or storage shelf.
 - Do not use a damaged package.
 - (3)Installation
 - Take special care not to pinch fingers, etc., when installing (and unpacking) the linear servo motor.
-  Incorrect wiring could lead to smoke or fire in the unit and the reactor, resulting in faults. Be careful when wiring.

CAUTION

1. Fire prevention

-  Install the units, motors and regenerative resistor on non-combustible material. Direct installation on combustible material or near combustible materials could lead to fires.
-  Always install a circuit protector and contactor on the servo drive unit power input as explained in this manual. Refer to this manual and select the correct circuit protector and contactor. An incorrect selection could result in fire.
-  Shut off the power on the unit side if a fault occurs in the units. Fires could be caused if a large current continues to flow.
-  When using a regenerative resistor, provide a sequence that shuts off the power with the regenerative resistor's error signal. The regenerative resistor could abnormally overheat and cause a fire due to a fault in the regenerative transistor, etc.
-  The battery unit could heat up, ignite or rupture if submerged in water, or if the poles are incorrectly wired.
-  Cut off the main circuit power with the contactor when an alarm or emergency stop occurs.

2. Injury prevention

-  Do not apply a voltage other than that specified in this manual, on each terminal. Failure to observe this item could lead to ruptures or damage, etc.
-  Do not mistake the terminal connections. Failure to observe this item could lead to ruptures or damage, etc.
-  Do not mistake the polarity (+,-). Failure to observe this item could lead to ruptures or damage, etc.
-  Do not touch the radiation fin on unit back face, regenerative resistor or motor, etc., or place parts (cables, etc.) while the power is turned ON or immediately after turning the power OFF. These parts may reach high temperatures, and can cause burns or part damage.
-  Structure the cooling fan on the unit back face, etc., so that it cannot be touched after installation. Touching the cooling fan during operation could lead to injuries.
-  Take care not to suck hair, clothes, etc. into the cooling fan.

⚠ CAUTION

3. Various precautions

Observe the following precautions. Incorrect handling of the unit could lead to faults, injuries and electric shocks, etc.

(1) Transportation and installation

- ⚠ Correctly transport the product according to its weight.
- ❗ Use the motor's hanging bolts only when transporting the motor itself. Do not use the motor's hanging bolts to transport a motor with other parts installed, or to transport a machine with a motor installed.
- ⚠ Do not stack the products above the tolerable number.
- ⚠ Follow this manual and install the unit or motor securely in a place where it can be borne and noncombustible. Insufficient fixing could lead to the unit or the motor slipping off during operation.
- ⚠ Do not get on top of or place heavy objects on the unit.

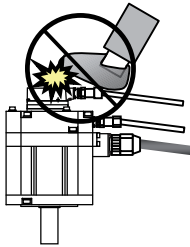

- ⚠ Do not hold the cables, axis or encoder when transporting the motor.

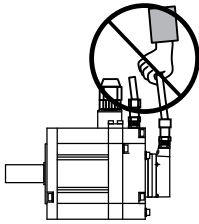

- ⚠ Do not hold the connected wires or cables when transporting the units.
- ⚠ Do not hold the front cover when transporting the unit. The unit could drop.
- ⚠ Always observe the installation directions of the units or motors.
- ⚠ Secure the specified distance between the units and control panel, or between the servo drive unit and other devices.
- ⚠ Do not install or run a unit or motor that is damaged or missing parts.
- ⚠ Do not block the intake or exhaust ports of the motor provided with a cooling fan.
- ⚠ Do not let foreign objects enter the units or motors. In particular, if conductive objects such as screws or metal chips, etc., or combustible materials such as oil enter, rupture or breakage could occur.
- ⚠ Provide adequate protection using a material such as connector for conduit to prevent screws, metallic detritus, water and other conductive matter or oil and other combustible matter from entering the motor through the power line lead-out port.
- ⚠ The units, motors and encoders are precision devices, so do not drop them or apply strong impacts to them.
- ⚠ Always operate the motor, which has a shaft with keyway, with the key attached.













⚠ CAUTION

⚠ Store and use the units under the following environment conditions.

Environment	Unit	Servo motor	Spindle motor
Ambient temperature	Operation: 0 to +55°C (with no freezing), Storage / Transportation: -15°C to +70°C (with no freezing)	Operation: 0 to +40°C (with no freezing), Storage: -15°C to +70°C (with no freezing)	Operation: 0 to +40°C (with no freezing), Storage: -20°C to +65°C (with no freezing)
Ambient humidity	Operation: 90%RH or less (with no dew condensation) Storage / Transportation: 90%RH or less (with no dew condensation)	Operation: 80%RH or less (with no dew condensation), HK(-H) Series: 10 to 90%RH or less (with no dew condensation) Storage: 90%RH or less (with no dew condensation) HK(-H) Series: 10 to 90%RH or less (with no dew condensation)	Operation: 90%RH or less (with no dew condensation) Storage: 90%RH or less (with no dew condensation)
Atmosphere	Indoors (no direct sunlight) With no corrosive gas, inflammable gas, oil mist, dust or conductive fine particles No object generating a strong magnetic field External magnetic field: 10 mT or less		
Altitude	Operation/Storage: 1000 meters or less above sea level, Transportation: 13000 meters or less above sea level	Operation/Storage: 1000 meters or less above sea level, Transportation: 10000 meters or less above sea level	
Vibration/impact	According to each unit or motor specification		

(Note) For details, confirm each unit or motor specifications in addition.

CAUTION

-  **When disinfectants or insecticides must be used to treat wood packaging materials, always use methods other than fumigation (for example, apply heat treatment at the minimum wood core temperature of 56 °C for a minimum duration of 30 minutes (ISPM No. 15 (2009))).**
If products such as units are directly fumigated or packed with fumigated wooden materials, halogen substances (including fluorine, chlorine, bromine and iodine) contained in fumes may contribute to the erosion of the capacitors.
When exporting the products, make sure to comply with the laws and regulations of each country.
-  **Do not use the products in conjunction with any components that contain halogenated flame retardants (bromine, etc). Failure to observe this may cause the erosion of the capacitors.**
-  **Securely fix the servo motor to the machine. Insufficient fixing could lead to the servo motor slipping off during operation.**
-  **Always install the servo motor with reduction gear in the designated direction. Failure to do so could lead to oil leaks.**
-  **Structure the rotary sections of the motor so that it can never be touched during operation. Install a cover, etc., on the shaft.**
-  **When installing a coupling to a servo motor shaft end, do not apply an impact by hammering, etc. The encoder could be damaged.**
-  **Do not apply a load exceeding the tolerable load onto the servo motor shaft. The shaft could break.**
-  **Store the motor in the package box.**
-  **When inserting the shaft into the built-in IPM/SPM spindle motor, do not heat the rotor higher than 130°C. The magnet could be demagnetized, and the specifications characteristics will not be ensured.**
-  **Always use a nonmagnetic tool (explosion-proof beryllium copper alloy safety tool: NGK Insulators, etc.) when installing the built-in IPM/SPM spindle motor, direct-drive motor and linear servo motor.**
-  **Always provide a mechanical stopper on the end of the linear servo motor's travel path.**
-  **If the unit has been stored for a long time, always check the operation before starting actual operation. Please contact the Service Center, Sales Office or dealer.**
-  **Install the heavy peripheral devices to the lower part in the panel and securely fix it not to be moved due to vibration.**

⚠ CAUTION

(2) Wiring

- ⚠ Correctly and securely perform the wiring. Failure to do so could lead to abnormal operation of the motor.
- ⚠ Do not install a condensing capacitor, surge absorber or radio noise filter on the output side of the drive unit.
- ⚠ Correctly connect the output side of the drive unit (terminals U, V, W). Failure to do so could lead to abnormal operation of the motor.
- ⚠ When using a power regenerative power supply unit, always install an AC reactor for each power supply unit.
- ⚠ In the main circuit power supply side of the unit, always install an appropriate circuit protector or contactor for each unit. Circuit protector or contactor cannot be shared by several units.
- ⚠ Always connect the motor to the drive unit's output terminals (U, V, W).
- ⚠ Do not directly connect a commercial power supply to the servo motor. Failure to observe this could result in a fault.
- ⚠ When using an inductive load such as a relay, always connect a diode as a noise measure parallel to the load.
- ⚠ When using a capacitance load such as a lamp, always connect a protective resistor as a noise measure serial to the load.
- ⚠ Do not reverse the direction of a diode which connect to a DC relay for the control output signals such as contractor and motor brake output, etc. to suppress a surge. Connecting it backwards could cause the drive unit to malfunction so that signals are not output, and emergency stop and other safety circuits are inoperable.
- ⚠ Do not connect/disconnect the cables connected between the units while the power is ON.
- ⚠ Securely tighten the cable connector fixing screw or fixing mechanism. An insecure fixing could cause the cable to fall off while the power is ON.
- ⚠ When using a shielded cable instructed in the instruction manual, always ground the cable with a cable clamp, etc. (Refer to "EMC Installation Guidelines")
- ⚠ Always separate the signals wires from the power line.
- ⚠ Use wires and cables that have a wire diameter, heat resistance and flexibility that conforms to the system.

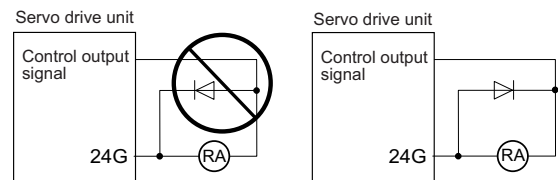



















(3) Trial operation and adjustment



- ⚠ Check and adjust each program and parameter before starting operation. Failure to do so could lead to unforeseen operation of the machine.
- ⚠ Do not make remarkable adjustments and changes of parameter as the operation could become unstable.
- ⚠ The usable motor and unit combination is predetermined. Always check the combinations and parameters before starting trial operation.
- ⚠ The direct-drive motor and linear servo motor do not have a stopping device such as magnetic brakes. Install a stopping device on the machine side.
- ⚠ When using the linear servo motor for an unbalance axis, adjust the unbalance weight to 0 by installing an air cylinder, etc. on the machine side. The unbalance weight disables the initial magnetic pole adjustment.

CAUTION

(4) Usage methods







-  In abnormal state, install an external emergency stop circuit so that the operation can be stopped and power shut off immediately.
-  Turn the power OFF immediately if smoke, abnormal noise or odors are generated from the unit or motor.
-  Do not disassemble or repair this product.
-  Never make modifications.
-  When an alarm occurs, the machine will start suddenly if an alarm reset (RST) is carried out while an operation start signal (ST) is being input. Always confirm that the operation signal is OFF before carrying out an alarm reset. Failure to do so could lead to accidents or injuries.
-  Reduce magnetic damage by installing a noise filter. The electronic devices used near the unit could be affected by magnetic noise. Install a line noise filter, etc., if there is a risk of magnetic noise.
-  Use the unit, motor and regenerative resistor with the designated combination. Failure to do so could lead to fires or trouble.
-  The brake (magnetic brake) of the servo motor are for holding, and must not be used for normal braking.
-  There may be cases when holding is not possible due to the magnetic brake's life, the machine construction (when ball screw and servo motor are coupled via a timing belt, etc.) or the magnetic brake's failure. Install a stop device to ensure safety on the machine side.
-  After changing the programs/parameters or after maintenance and inspection, always test the operation before starting actual operation.
-  Do not enter the movable range of the machine during automatic operation. Never place body parts near or touch the spindle during rotation.
-  Follow the power supply specification conditions given in each specification for the power (input voltage, input frequency, etc.).
-  Set all bits to "0" if they are indicated as not used or empty in the explanation on the bits.
-  Do not use the dynamic brakes except during the emergency stop. Continued use of the dynamic brakes could result in brake damage.
-  If a circuit protector for the main circuit power supply is shared by several units, the circuit protector may not activate when a short-circuit fault occurs in a small capacity unit. This is dangerous, so never share the circuit protector.
-  Mitsubishi spindle motor is dedicated to machine tools. Do not use for other purposes.
-  This unit is not intended for use in low voltage public networks that supply power to households. Using this unit in such networks may cause radio frequency interference.
-  Do not use this unit in residential areas.

(5) Troubleshooting





-  If a hazardous situation is predicted during power failure or product trouble, use a servo motor with magnetic brakes or install an external brake mechanism.
-  Always turn the main circuit power of the motor OFF when an alarm occurs.
-  If an alarm occurs, remove the cause, and secure the safety before resetting the alarm.

CAUTION



(6) Maintenance, inspection and part replacement

-  Always backup the programs and parameters before starting maintenance or inspections.
-  The capacity of the electrolytic capacitor will drop over time due to self-discharging, etc. To prevent secondary disasters due to failures, replacing this part every five years when used under a normal environment is recommended. Contact the Service Center, Service Station, Sales Office or dealer for repairs or part replacement.
-  Never perform a megger test (measure the insulation resistance) of the drive unit. Failure to observe this could lead to faults.
-  If the battery low warning is issued, immediately replace the battery. Replace the batteries while applying the drive unit's control power.
-  Do not short circuit, charge, overheat, incinerate or disassemble the battery.
-  For after-purchase servicing of the built-in motor, only the servicing parts for MITSUBISHI encoder can be supplied. For the motor body, prepare the spare parts at the machine tool builders.
-  For maintenance, part replacement, and services in case of failures in the built-in motor (including the encoder), take necessary actions at the machine tool builders. For drive unit, Mitsubishi can offer the after-purchase servicing as with the general drive unit.

(7) Disposal

-  Take the batteries and backlights for LCD, etc., off from the controller, drive unit and motor, and dispose of them as industrial wastes.
-  Do not disassemble the unit or motor.
-  Dispose of the battery according to local laws.
-  Dispose of the primary side of the linear servo motor as industrial waste. For the secondary side, dispose of it as industrial waste after demagnetizing it by heating it to 300 °C or higher.
-  When incinerating optical communication cable, hydrogen fluoride gas or hydrogen chloride gas which is corrosive and harmful may be generated. For disposal of optical communication cable, request for specialized industrial waste disposal services that has incineration facility for disposing hydrogen fluoride gas or hydrogen chloride gas.

(8) Transportation

-  The unit and motor are precision parts and must be handled carefully.
-  According to a United Nations Advisory, the battery unit and battery must be transported according to the rules set forth by the International Civil Aviation Organization (ICAO), International Air Transportation Association (IATA), International Maritime Organization (IMO), and United States Department of Transportation (DOT), etc.

(9) General precautions

The drawings given in this manual show the covers and safety partitions, etc., removed to provide a clearer explanation. Always return the covers or partitions to their respective places before starting operation, and always follow the instructions given in this manual.

Treatment of waste

The following two laws will apply when disposing of this product. Considerations must be made to each law. The following laws are in effect in Japan. Thus, when using this product overseas, the local laws will have a priority. If necessary, indicate or notify these laws to the final user of the product.

- (1) Requirements for "Law for Promotion of Effective Utilization of Resources"
 - (a) Recycle as much of this product as possible when finished with use.
 - (b) When recycling, often parts are sorted into steel scraps and electric parts, etc., and sold to scrap contractors. Mitsubishi Electric recommends sorting the product and selling the members to appropriate contractors.

- (2) Requirements for "Law for Treatment of Waste and Cleaning"
 - (a) Mitsubishi Electric recommends recycling and selling the product when no longer needed according to item (1) above. The user should make an effort to reduce waste in this manner.
 - (b) When disposing a product that cannot be resold, it shall be treated as a waste product.
 - (c) The treatment of industrial waste must be commissioned to a licensed industrial waste treatment contractor, and appropriate measures, including a manifest control, must be taken.
 - (d) Batteries correspond to "primary batteries", and must be disposed of according to local disposal laws.

Disposal



(Note) This symbol mark is for EU countries only.
This symbol mark is according to the directive 2006/66/EC Article 20 Information for end-users and Annex II.

Your MITSUBISHI ELECTRIC product is designed and manufactured with high quality materials and components which can be recycled and/or reused.

This symbol means that batteries and accumulators, at their end-of-life, should be disposed of separately from your household waste.

If a chemical symbol is printed beneath the symbol shown above, this chemical symbol means that the battery or accumulator contains a heavy metal at a certain concentration. This will be indicated as follows:

Hg: mercury (0.0005%), Cd: cadmium (0.002%), Pb: lead (0.004%)

In the European Union there are separate collection systems for used batteries and accumulators.

Please, dispose of batteries and accumulators correctly at your local community waste collection/recycling centre.

Please, help us to conserve the environment we live in!

Trademarks

MELDAS, MELSEC, EZSocket, EZMotion, iQ Platform, MELSOFT, GOT, CC-Link, CC-Link/LT and CC-Link IE are either trademarks or registered trademarks of Mitsubishi Electric Corporation in Japan and/or other countries.

Other company and product names that appear in this manual are trademarks or registered trademarks of the respective companies.

本製品の取扱いについて

(日本語 /Japanese)

本製品は工業用 (クラス A) 電磁環境適合機器です。販売者あるいは使用者はこの点に注意し、住商業環境以外での使用をお願いいたします。

Handling of our product

(English)

This is a class A product. In a domestic environment this product may cause radio interference in which case the user may be required to take adequate measures.

본 제품의 취급에 대해서

(한국어 /Korean)

이 기기는 업무용 (A 급) 전자파적합기기로서 판매자 또는 사용자는 이 점을 주의하시기 바라며 가정외의 지역에서 사용하는 것을 목적으로 합니다 .

Contents

1 Installation	1
1.1 Installation of Servo Motor	2
1.1.1 Environmental Conditions	2
1.1.2 Quakeproof Level	3
1.1.3 Cautions for Mounting Load (Prevention of Impact on Shaft)	4
1.1.4 Installation Direction	4
1.1.5 Shaft Characteristics	5
1.1.6 Machine Accuracy	6
1.1.7 Coupling with the Load	7
1.1.8 Oil/Water Standards	8
1.1.9 Installation of Servo Motor	10
1.1.10 Cable Stress	11
1.2 Installation of Spindle Motor	12
1.2.1 Environmental Conditions	12
1.2.2 Balancing the Spindle Motor (Unit)	13
1.2.3 Shaft Characteristics	15
1.2.4 Machine Accuracy	15
1.2.5 Coupling with the Fittings	16
1.2.6 Ambient Environment	16
1.2.7 Installation of Spindle Motor	16
1.2.8 Connection	17
1.2.9 Cable	18
1.3 Installation of the Drive Unit	19
1.3.1 Environmental Conditions	19
1.3.2 Installation Direction and Clearance	20
1.3.3 Prevention of Entering of Foreign Matter	23
1.3.4 Panel Installation Hole Work Drawings (Panel Cut Drawings)	24
1.3.5 Heating Value	26
1.3.6 Heat Radiation Countermeasures	27
1.4 Installation of the Machine End Encoder	29
1.4.1 Spindle Side ABZ Pulse Output Encoder (OSE-1024 Series)	29
1.4.2 Spindle Side PLG Serial Output Encoder (TS5690, MU1606 Series)	30
1.5 Noise Measures	36
2 Wiring and Connection	39
2.1 Part System Connection Diagram	41
2.2 Main Circuit Terminal Block/Control Circuit Connector	43
2.2.1 Names and Applications of Main Circuit Terminal Block Signals and Control Circuit Connectors	43
2.2.2 Connector Pin Assignment	44
2.2.3 Servo Motor Power Supply Connector Wiring Method	48
2.3 NC and Drive Unit Connection	50
2.3.1 Connection of Optical Communication Cables	50
2.4 Motor and Encoder Connection	52
2.4.1 Connection of the Servo Motor	52
2.4.2 Connection of the Full-closed Loop System	58
2.4.3 Connection of the Spindle Motor	60
2.5 Connection of Power Supply	62
2.5.1 Power Supply Input Connection	62
2.5.2 Connection of the Grounding Cable	64
2.6 Wiring of the Motor Brake	65
2.6.1 Wiring of the Motor Magnetic Brake	65
2.7 Peripheral Control Wiring	68
2.7.1 Input/output Circuit Wiring	68
2.7.2 Specified Speed Output	70
2.7.3 Spindle Coil Changeover	72
2.7.4 Proximity Switch Orientation	76
3 Safety Function	81
3.1 Safety Function	82
3.1.1 Harmonized Standard	82
3.1.2 Outline of Safety Function	82
3.2 STO (Safe Torque Off) Function	83
3.3 SBC (Safe Brake Control) Function	85

4 Setup	87
4.1 Initial Setup	88
4.1.1 Setting the Rotary Switch.....	88
4.1.2 Transition of LED Display After Power Is Turned ON.....	89
4.2 Setting the Initial Parameters for the Servo Drive Unit	90
4.2.1 Setting of Servo Specification Parameters.....	91
4.2.2 Setting of Machine Side Encoder	92
4.2.3 Setting of Distance-coded Reference Scale.....	96
4.2.4 List of Standard Parameters for Each Servo Motor.....	98
4.2.5 Servo Parameters	107
4.3 Setting the Initial Parameters for the Spindle Drive Unit	142
4.3.1 Setting of Parameters Related to the Spindle	142
4.3.2 List of Standard Parameters for Each Spindle Motor.....	148
4.3.3 Spindle Parameters.....	181
5 Servo Adjustment	217
5.1 Servo Adjustment Procedure	218
5.2 Gain Adjustment.....	219
5.2.1 Current Loop Gain	219
5.2.2 Speed Loop Gain.....	220
5.2.3 Position Loop Gain	226
5.2.4 OMR-FF Function	229
5.3 Characteristics Improvement	235
5.3.1 Optimal Adjustment of Cycle Time.....	235
5.3.2 Vibration Suppression Measures	238
5.3.3 Improving the Cutting Surface Precision	245
5.3.4 Improvement of Characteristics during Acceleration/Deceleration.....	248
5.3.5 Improvement of Protrusion at Quadrant Changeover	252
5.3.6 Improvement of Overshooting.....	256
5.3.7 Improvement of the Interpolation Control Path	259
5.4 Adjustment during Full Closed Loop Control	261
5.4.1 Outline.....	261
5.4.2 Speed Loop Delay Compensation	262
5.4.3 Dual Feedback Control	263
5.4.4 Full-closed Torsion Compensation Function.....	265
5.5 Settings for Emergency Stop	268
5.5.1 Deceleration Control.....	268
5.5.2 Vertical Axis Drop Prevention Control.....	271
5.5.3 Vertical Axis Pull-up Control.....	275
5.6 Protective Functions	276
5.6.1 Overload Detection	276
5.6.2 Excessive Error Detection.....	277
5.6.3 Collision Detection Function	278
5.7 Servo Control Signal	282
5.7.1 Servo Control Input (NC to Servo).....	282
5.7.2 Servo Control Output (Servo to NC).....	285
6 Spindle Adjustment	289
6.1 Adjustment Procedures for Each Control	290
6.1.1 Basic Adjustments.....	290
6.1.2 Gain Adjustment	291
6.1.3 Adjusting the Acceleration/Deceleration Operation	295
6.1.4 Orientation Adjustment	302
6.1.5 Synchronous Tapping Adjustment	306
6.1.6 High-speed Synchronous Tapping.....	309
6.1.7 Spindle C Axis Adjustment (For Lathe System).....	315
6.1.8 Spindle Synchronization Adjustment (For Lathe System).....	320
6.1.9 Deceleration Coil Changeover Valid Function by Emergency Stop.....	322
6.1.10 High-response Acceleration/Deceleration Function.....	323
6.1.11 Spindle Cutting Withstand Level Improvement	324
6.1.12 Spindle Motor Temperature Compensation Function	325
6.2 Settings for Emergency Stop	330
6.2.1 Deceleration Control.....	330
6.3 Spindle Control Signal	331
6.3.1 Spindle Control Input (NC to Spindle).....	331
6.3.2 Spindle Control Output (Spindle to NC).....	336

7 Troubleshooting	341
7.1 Points of Caution and Confirmation.....	342
7.1.1 LED Display When Alarm or Warning Occurs	342
7.2 Protective Functions List of Units.....	343
7.2.1 List of Alarms	343
7.2.2 List of Warnings	352
7.3 Troubleshooting.....	354
7.3.1 Troubleshooting at Power ON.....	354
7.3.2 Troubleshooting for Each Alarm No.....	355
7.3.3 Troubleshooting for Each Warning No.....	381
7.3.4 Parameter Numbers during Initial Parameter Error	384
7.3.5 Troubleshooting the Spindle System When There Is No Alarm or Warning	387
7.3.6 Details of Alarm 4D	389
8 Maintenance	391
8.1 Periodic Inspections	392
8.1.1 Inspections	392
8.1.2 Cleaning of Spindle Motor.....	392
8.2 Service Parts	404
8.3 Adding and Replacing Units and Parts.....	405
8.3.1 Replacing the Drive Unit.....	405
8.3.2 Replacing the Fan Unit	406
8.3.3 Replacing the Battery	407
9 Appx. 1: Cable and Connector Assembly	411
9.1 CMV1-xPxxS-xx Plug Connector	412
9.2 1747464-1 Plug Connector	418
9.2.1 Applicable Products.....	418
9.2.2 Applicable Cable	418
9.2.3 Related Documents	418
9.2.4 Assembly Procedure.....	418
10 Appx. 2: D/A Output Specifications for Drive Unit	421
10.1 D/A Output Specifications.....	422
10.2 Output Data Settings	423
10.2.1 Servo Drive Unit Settings	423
10.2.2 Spindle Drive Unit Settings	425
10.3 Setting the Output Magnification.....	428
10.3.1 Servo Drive Unit Settings	428
10.3.2 Spindle Drive Unit Settings	429
11 Appx. 3: Protection Function	431
11.1 Protection Function	432
11.1.1 Outline of Protection Function.....	432
11.2 Emergency Stop Observation.....	433
11.3 SLS (Safely Limited Speed) function	436
12 Appx. 4: Compliance to EC Directives	441
12.1 Compliance to EC Directives	442
12.1.1 European EC Directives.....	442
12.1.2 Cautions for EC Directive Compliance.....	442
13 Appx. 5: EMC Installation Guidelines	447
13.1 Introduction	448
13.2 EMC Directives/Electromagnetic Compatibility Regulations.....	448
13.3 EMC Measures.....	449
13.4 Measures for Panel Structure	449
13.4.1 Measures for Control Panel Unit.....	449
13.4.2 Measures for Door	450
13.4.3 Measures for Operation Board Panel	450
13.4.4 Shielding of the Power Supply Input Section.....	450
13.5 Measures for Various Cables.....	451
13.5.1 Measures for Wiring in Panel	451
13.5.2 Measures for Shield Treatment.....	451
13.5.3 Servo/Spindle Motor Power Cable	452
13.5.4 Servo/Spindle Motor Encoder Cable	453
13.6 EMC Countermeasure Parts.....	454
13.6.1 Shield Clamp Fitting.....	454
13.6.2 Ferrite Core	454

13.6.3 Power Line Filter	456
13.6.4 Surge Absorber	457
14 Appx. 6: Higher Harmonic Suppression Measure Guidelines	459
14.1 Higher Harmonic Suppression Measure Guidelines	460
14.1.1 Calculating the Equivalent Capacity of the Higher Harmonic Generator	461

Outline for MDS-EM/EMH Series Specifications Manual (IB-1501238-N)

1 Introduction

- 1.1 Servo/Spindle Drive System Configuration
 - 1.1.1 System Configuration
- 1.2 Explanation of Type
 - 1.2.1 Servo Motor Type
 - 1.2.2 Drive Unit Type
 - 1.2.3 Spindle Motor Type
 - 1.2.4 AC Reactor Type

2 Specifications

- 2.1 Servo Motor
 - 2.1.1 Specifications List
 - 2.1.2 Torque Characteristics
- 2.2 Spindle Motor
 - 2.2.1 Specifications
 - 2.2.2 Output Characteristics
- 2.3 Drive Unit
 - 2.3.1 Installation Environment Conditions
 - 2.3.2 Multi Axis Unit
 - 2.3.3 Unit Outline Dimension Drawing
 - 2.3.4 AC Reactor
 - 2.3.5 Explanation of Each Part

3 Function Specifications

- Function Specifications List
- 3.1 Base Control Functions
 - 3.1.1 Full Closed Loop Control
 - 3.1.2 Position Command Synchronous Control
 - 3.1.3 Speed Command Synchronous Control
 - 3.1.4 Common Encoder Current Command Synchronous Control
 - 3.1.5 Distance-coded Reference Position Control
 - 3.1.6 Spindle's Continuous Position Loop Control
 - 3.1.7 Coil Changeover Control
 - 3.1.8 Gear Changeover Control
 - 3.1.9 Orientation Control
 - 3.1.10 Indexing Control
 - 3.1.11 Synchronous Tapping Control
 - 3.1.12 Spindle Synchronous Control
 - 3.1.13 Spindle/C Axis Control
 - 3.1.14 Proximity Switch Orientation Control
 - 3.1.15 Power Regeneration Control
 - 3.1.16 Resistor Regeneration Control
 - 3.1.17 PWM Control
- 3.2 Servo/Spindle Control Functions
 - 3.2.1 Torque Limit Function
 - 3.2.2 Variable Speed Loop Gain Control
 - 3.2.3 Gain Changeover for Synchronous Tapping Control
 - 3.2.4 Speed Loop PID Changeover Control
 - 3.2.5 Disturbance Torque Observer
 - 3.2.6 Smooth High Gain Control (SHG Control)
 - 3.2.7 High-speed Synchronous Tapping Control (OMRDD Control)
 - 3.2.8 Dual Feedback Control
 - 3.2.9 HAS Control
 - 3.2.10 OMR-FF Control
 - 3.2.11 Control Loop Gain Changeover
 - 3.2.12 Spindle Output Stabilizing Control
 - 3.2.13 High-response Spindle Acceleration/Decelera-

- tion Function
- 3.3 Compensation Control Function
 - 3.3.1 Jitter Compensation
 - 3.3.2 Notch Filter
 - 3.3.3 Adaptive Tracking-type Notch Filter
 - 3.3.4 Overshooting Compensation
 - 3.3.5 Machine End Compensation Control
 - 3.3.6 Lost Motion Compensation Type 2
 - 3.3.7 Lost Motion Compensation Type 3
 - 3.3.8 Spindle Motor Temperature Compensation Function
 - 3.3.9 Real-time Tuning I
 - 3.3.10 Full-closed Torsion Compensation Function
- 3.4 Protection Function
 - 3.4.1 Deceleration Control at Emergency Stop
 - 3.4.2 Vertical Axis Drop Prevention/Pull-up Control
 - 3.4.3 Earth Fault Detection
 - 3.4.4 Collision Detection Function
 - 3.4.5 Fan Stop Detection
 - 3.4.6 Open-phase Detection
 - 3.4.7 Contactor Weld Detection
 - 3.4.8 STO (Safe Torque Off) Function
 - 3.4.9 SBC (Safe Brake Control) Function
 - 3.4.10 Deceleration and Stop Function at Power Failure
 - 3.4.11 Retraction Function at Power Failure
- 3.5 Sequence Functions
 - 3.5.1 Contactor Control Function
 - 3.5.2 Motor Brake Control Function
 - 3.5.3 External Emergency Stop Function
 - 3.5.4 Specified Speed Output
 - 3.5.5 Quick READY ON Sequence
- 3.6 Diagnosis Function
 - 3.6.1 Monitor Output Function
 - 3.6.2 Machine Resonance Frequency Display Function
 - 3.6.3 Machine Inertia Display Function
 - 3.6.4 Motor Temperature Display Function
 - 3.6.5 Load Monitor Output Function
 - 3.6.6 Power Supply Diagnosis Display Function
 - 3.6.7 Drive Unit Diagnosis Display Function

4 Characteristics

- 4.1 Servo Motor
 - 4.1.1 Environmental Conditions
 - 4.1.2 Quakeproof Level
 - 4.1.3 Shaft Characteristics
 - 4.1.4 Machine Accuracy
 - 4.1.5 Oil/Water Standards
 - 4.1.6 Installation of Servo Motor
 - 4.1.7 Overload Protection Characteristics
 - 4.1.8 Magnetic Brake
 - 4.1.9 Dynamic Brake Characteristics
- 4.2 Spindle Motor
 - 4.2.1 Environmental Conditions
 - 4.2.2 Shaft Characteristics
 - 4.2.3 Machine Accuracy
 - 4.2.4 Installation of Spindle Motor
- 4.3 Drive Unit
 - 4.3.1 Environmental Conditions
 - 4.3.2 Heating Value

5 Dedicated Options

- 5.1 Servo Options
 - 5.1.1 Battery Option (MDS-BAT6V1SET, MR-BAT6V1SET, MDSBTBOX-LR2060)
 - 5.1.2 Ball Screw Side Encoder (OSA405ET2AS)

- 5.1.3 Machine Side Encoder
- 5.2 Spindle Options
 - 5.2.1 Spindle Side ABZ Pulse Output Encoder (OSE-1024 Series)
 - 5.2.2 Spindle Side PLG Serial Output Encoder (TS5690, MU1606 Series)
 - 5.2.3 Spindle Side Accuracy Serial Output Encoder (Other Manufacturer's Product)
- 5.3 Encoder Interface Unit
 - 5.3.1 Serial Output Interface Unit for ABZ Analog Encoder MDS-EX-HR
 - 5.3.2 Serial Output Interface Unit for ABZ Analog Encoder EIB192M
(Other Manufacturer's Product)
 - 5.3.3 Serial Output Interface Unit for ABZ Analog Encoder EIB392M
(Other Manufacturer's Product)
 - 5.3.4 Serial Output Interface Unit for ABZ Analog Encoder ADB-K70M
(Other Manufacturer's Product)
- 5.4 Drive Unit Option
 - 5.4.1 Side Protection Cover
- 5.5 Cables and Connectors
 - 5.5.1 Cable Connection Diagram
 - 5.5.2 List of Cables and Connectors
 - 5.5.3 Optical Communication Cable Specifications

6 Specifications of Peripheral Devices

- 6.1 Selection of Wire
 - 6.1.1 Wire Selection Standards for Each Product
 - 6.1.2 Example of Wires by Unit
- 6.2 Selection of Circuit Protector and Contactor
 - 6.2.1 Selection of Circuit Protector
 - 6.2.2 Selection of Contactor
- 6.3 Selection of Earth Leakage Breaker
- 6.4 Noise Filter
- 6.5 Surge Absorber
- 6.6 Relay
- 6.7 Selection of Link Connection
 - 6.7.1 Connection for L11 and L21 Link
 - 6.7.2 Connection for L+ and L- Link

7 Selection

- 7.1 Selection of the Servo Motor

- 7.1.1 Outline
- 7.1.2 Selection of Servo Motor Capacity
- 7.1.3 Motor Shaft Conversion Load Torque
- 7.1.4 Expressions for Load Inertia Calculation
- 7.2 Selection of the Spindle Motor
- 7.3 Selection of the Additional Axis Drive Unit
 - 7.3.1 Calculation of Spindle Output
 - 7.3.2 Calculation of Servo Motor Output
 - 7.3.3 Selection of the Additional Axis Drive Unit
 - 7.3.4 Required Capacity of Power Supply
 - 7.3.5 Example for Additional Axis Drive Unit and Power Supply Facility Capacity

8 Appx. 1: Cable and Connector Specifications

- 8.1 Selection of Cable
 - 8.1.1 Cable Wire and Assembly
- 8.2 Cable Connection Diagram
 - 8.2.1 Battery Cable
 - 8.2.2 Servo Encoder Cable
 - 8.2.3 Spindle Encoder Cable
- 8.3 Main Circuit Cable Connection Diagram
- 8.4 Connector Outline Dimension Drawings
 - 8.4.1 Connector for Drive Unit
 - 8.4.2 Connector for Servo
 - 8.4.3 Connector for Spindle

9 Appx. 2: Restrictions for Lithium Batteries

- 9.1 Restriction for Packing
 - 9.1.1 Target Products
 - 9.1.2 Handling by User
 - 9.1.3 Reference
- 9.2 Products Information Data Sheet (ER Battery)
- 9.3 Forbiddance of Transporting Lithium Battery by Passenger Aircraft Provided in the Code of Federal Regulation
- 9.4 California Code of Regulation "Best Management Practices for Perchlorate Materials"
- 9.5 Restriction Related to EU Battery Directive
 - 9.5.1 Important Notes
 - 9.5.2 Information for End-user



For outline dimension drawings, refer to "DRIVE SYSTEM DATA BOOK" (IB-1501252(ENG)).

Function Specifications List

< Power supply specification >

Item		MDS-E/EH-CV	MDS-EM/EMH-SPV3 built-in converter	MDS-EJ/EJH-V1/V2/SP/SP2 built-in converter	MDS-EX-CVP Series
1 Base control functions	1.15 Power regeneration control	●	●	-	-
	1.16 Resistor regeneration control	-	-	●	-
	1.17 PWM control (Note 1)	-	-	-	●
4 Protection function	4.5 Fan stop detection	●	●	●	●
	4.6 Open-phase detection	●	●	-	●
	4.7 Contactor weld detection	●	●	●	●
	4.10 Deceleration and stop function at power failure (Note 2)	●	-	-	●
	4.11 Retraction function at power failure (Note 3)	●	-	-	●
5 Sequence function	5.1 Contactor control function	●	●	●	●
	5.3 External emergency stop function	●	●	●	●
	5.5 High-speed READY ON sequence	●	●	-	●
6 Diagnosis function	6.6 Power supply diagnosis display function	●	●	-	●
	6.7 Drive unit diagnosis display function	●	●	●	●

(Note 1) Refer to "MDS-EX-CVP Series Specifications and Instruction Manual"(IB-1501587(ENG)) for details.

(Note 2) The power backup unit and resistor unit option are required.

(Note 3) The power backup unit and capacitor unit option are required.

< Servo specification >

Item		MDS-E-V1/V2/ V3	MDS-EH-V1/ V2	MDS-EM/EMH- SPV3	MDS-EJ/EJH- V1	MDS-EJ-V2
1 Base control functions	1.1 Full closed loop control	●	●	●	●	●
	1.2 Position command synchronous control	●	●	●	●	●
	1.3 Speed command synchronous control	● (Note 1)	●	-	-	●
	1.4 Common encoder current command synchronous control (Note 5)	●	●	-	-	●
	1.5 Distance-coded reference position control	●	●	●	●	●
2 Servo control function	2.1 Torque limit function (stopper function)	●	●	●	●	●
	2.2 Variable speed loop gain control	●	●	●	●	●
	2.3 Gain changeover for synchronous tapping control	●	●	●	●	●
	2.4 Speed loop PID changeover control	●	●	●	●	●
	2.5 Disturbance torque observer	●	●	●	●	●
	2.6 Smooth High Gain control (SHG control)	●	●	●	●	●
	2.7 High-speed synchronous tapping control (OMR-DD control)	●	●	●	●	●
	2.8 Dual feedback control	●	●	●	●	●
	2.9 HAS control	●	●	●	●	●
	2.10 OMR-FF control	●	●	●	●	●
3 Compensation control function	3.1 Jitter compensation	●	●	●	●	●
	3.2 Notch filter	Variable frequency: 4 Fixed frequency: 1	Variable frequency: 4 Fixed frequency: 1	Variable frequency: 4 Fixed frequency: 1	Variable frequency: 4 Fixed frequency: 1	Variable frequency: 4 Fixed frequency: 1
	3.3 Adaptive tracking-type notch filter	●	●	●	●	●
	3.4 Overshooting compensation	●	●	●	●	●
	3.5 Machine end compensation control	●	●	●	●	●
	3.6 Lost motion compensation type 2	●	●	●	●	●
	3.7 Lost motion compensation type 3	●	●	●	●	●
	3.9 Real-time tuning I	●	●	●	●	●
3.10 Full-closed torsion compensation function	●	●	●	●	●	
4 Protection function	4.1 Deceleration control at emergency stop	●	●	●	●	●
	4.2 Vertical axis drop prevention/pull-up control	●	●	●	●	●
	4.3 Earth fault detection	●	●	●	●	●
	4.4 Collision detection function	●	●	●	●	●
	4.5 Fan stop detection	●	●	●	●	●
	4.8 STO (Safe Torque Off) function	●	●	● (Note 2)	●	●
	4.9 SBC (Safe Brake Control) function	●	●	●	●	●
	4.10 Deceleration and stop function at power failure (Note 3)	●	●	●	-	-
4.11 Retraction function at power failure (Note 4)	●	●	-	-	-	
5 Sequence function	5.2 Motor brake control function	●	●	●	●	●
	5.4 Specified speed output	●	●	●	-	-
	5.5 Quick READY ON sequence	●	●	●	-	-
6 Diagnosis function	6.1 Monitor output function	●	●	●	●	●
	6.2 Machine resonance frequency display function	●	●	●	●	●
	6.3 Machine inertia display function	●	●	●	●	●

(Note 1) Always set L-axis as primary axis and M-axis as secondary axis for the speed command synchronous control using MDS-E-V3. Other settings cause the initial parameter error alarm.

(Note 2) The dedicated wiring STO is not supported by MDS-EM/EMH Series.

(Note 3) The power backup unit and resistor unit option are required.

(Note 4) The power backup unit and capacitor unit option are required.

(Note 5) When using common encoder current command synchronous control with a multi axes integrated type drive unit, only M-axis can be set as the secondary axis.

< Spindle specifications >

Item		MDS-E/EH-SP	MDS-E-SP2	MDS-EM/EMH-SPV3	MDS-EJ-SP	MDS-EJ-SP2	
1 Base control functions	1.1 Full closed loop control	●	●	●	●	●	
	1.6 Spindle's continuous position loop control	●	●	●	●	●	
	1.7 Coil changeover control	●	●	●	-	-	
	1.8 Gear changeover control	●	●	●	●	●	
	1.9 Orientation control	●	●	●	●	●	
	1.10 Indexing control	●	●	●	●	●	
	1.11 Synchronous tapping control	●	●	●	●	●	
	1.12 Spindle synchronous control	●	●	●	●	●	
	1.13 Spindle/C axis control	●	●	●	●	●	
	1.14 Proximity switch orientation control	●	● (Note 1)	●	●	● (Note 1)	
	2 Spindle control functions	2.1 Torque limit function	●	●	●	●	●
		2.2 Variable speed loop gain control	●	●	●	●	●
		2.5 Disturbance torque observer	●	●	●	●	●
		2.6 Smooth High Gain control (SHG control)	●	●	●	●	●
2.7 High-speed synchronous tapping control (OMR-DD control)		●	●	●	●	●	
2.8 Dual feedback control		●	●	●	●	●	
2.10 OMR-FF control		●	●	●	●	●	
2.11 Control loop gain changeover		●	●	●	●	●	
2.12 Spindle output stabilizing control		●	●	●	●	●	
2.13 High-response spindle acceleration/deceleration function		●	●	●	●	●	
3 Compensation control function	3.1 Jitter compensation	●	●	●	●	●	
	3.2 Notch filter	Variable frequency: 4 Fixed frequency: 1	Variable frequency: 4 Fixed frequency: 1	Variable frequency: 4 Fixed frequency: 1	Variable frequency: 4 Fixed frequency: 1	Variable frequency: 4 Fixed frequency: 1	
	3.3 Adaptive tracking-type notch filter	●	●	●	●	●	
	3.4 Overshooting compensation	●	●	●	●	●	
	3.6 Lost motion compensation type 2	●	●	●	●	●	
	3.8 Spindle motor temperature compensation function	●	●	●	●	●	
	3.9 Real-time tuning I	●	●	●	●	●	
4 Protection function	4.1 Deceleration control at emergency stop	●	●	●	●	●	
	4.3 Earth fault detection	●	●	●	●	●	
	4.5 Fan stop detection	●	●	●	●	●	
	4.8 STO (Safe Torque Off) function	●	●	● (Note 2)	●	●	
	4.10 Deceleration and stop function at power failure (Note 3)	●	●	●	-	-	
	4.11 Retraction function at power failure (Note 4)	●	●	-	-	-	
5 Sequence functions	5.4 Specified speed output	●	●	●	-	-	
	5.5 Quick READY ON sequence	●	●	●	-	-	
6 Diagnosis functions	6.1 Monitor output function	●	●	●	●	●	
	6.2 Machine resonance frequency display function	●	●	●	●	●	
	6.3 Machine inertia display function	●	●	●	●	●	
	6.4 Motor temperature display function	●	●	●	●	●	
	6.5 Load monitor output function	●	●	●	●	●	

(Note 1) As for 2-axis spindle drive unit, setting is available only for one of the axes.

(Note 2) The dedicated wiring STO is not supported by MDS-EM/EMH Series.

(Note 3) The power backup unit and resistor unit option are required.

(Note 4) The power backup unit and capacitor unit option are required.



Installation

1.1 Installation of Servo Motor

CAUTION

1. Do not hold the cables, axis or encoder when transporting the motor. Failure to observe this could lead to faults or injuries.
2. Securely fix the motor to the machine. Insufficient fixing could lead to the motor deviating during operation. Failure to observe this could lead to injuries.
3. When coupling to a servo motor shaft end, do not apply an impact by hammering, etc. The encoder could be damaged.
4. Never touch the rotary sections of the motor during operations. Install a cover, etc., on the shaft.
5. Do not apply a load exceeding the tolerable load onto the servo motor shaft. The shaft could break. Failure to observe this could lead to injuries.
6. Do not connect or disconnect any of the connectors while the power is ON.

1.1.1 Environmental Conditions

Environment	Conditions
Ambient temperature	0°C to +40°C (with no freezing)
Ambient humidity	80% RH or less (with no dew condensation) HK(-H) Series: 10 to 90% RH or less (with no dew condensation)
Storage temperature	-15°C to +70°C (with no freezing)
Storage humidity	90% RH or less (with no dew condensation) HK(-H) Series: 10 to 90% RH or less (with no dew condensation)
Atmosphere	Indoors (no direct sunlight) No corrosive gas, inflammable gas, oil mist or dust No object generating a strong magnetic field External magnetic field: 10 mT or less
Altitude	Operation / storage: 1000m or less above sea level Transportation: 10000m or less above sea level

1.1.2 Quakeproof Level

Series	Motor type	Acceleration direction	
		Axis direction (X)	Direction at right angle to axis (Y)
200V series	HG96	49m/s ² (5G) or less	49m/s ² (5G) or less
	HG75, 105	24.5m/s ² (2.5G) or less	24.5m/s ² (2.5G) or less
	HG54, 104, 154, 224, 123, 223, 142 HK105		
	HG204, 354, 303, 453, 702, 302 HK302, 303, 354, 453, 702	24.5m/s ² (2.5G) or less	29.4m/s ² (3G) or less
	HK76, 55, 104, 123, 142, 154, 223, 224, 204	24.5m/s ² (2.5G) or less	49m/s ² (5G) or less
400V series	HG-H54, 104, 154	24.5m/s ² (2.5G) or less	24.5m/s ² (2.5G) or less
	HG-H204, 354, 453 HK-H354, 453	24.5m/s ² (2.5G) or less	29.4m/s ² (3G) or less
	HK-H55, 104, 154, 204	24.5m/s ² (2.5G) or less	49m/s ² (5G) or less

The vibration conditions are as shown below.

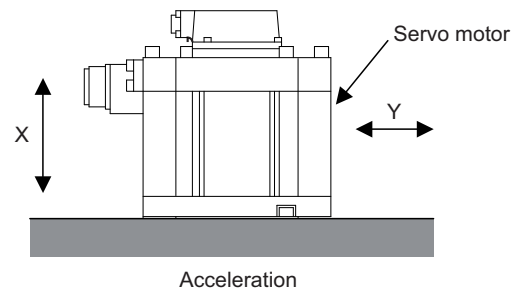
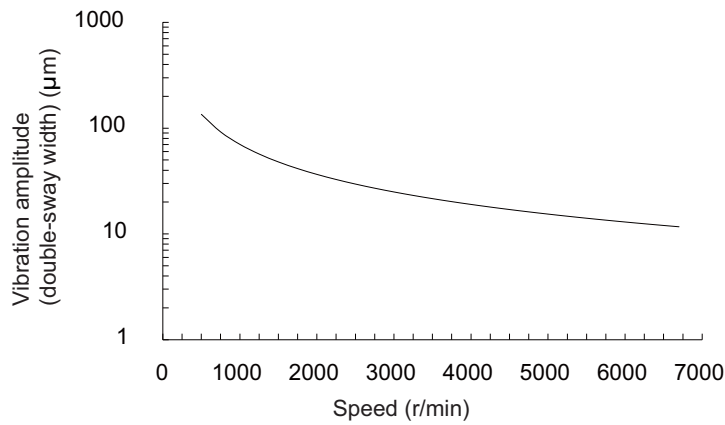

1.1.3 Cautions for Mounting Load (Prevention of Impact on Shaft)

- [1] When using the servo motor with key way, use the screw hole at the end of the shaft to mount the pulley onto the shaft. To install, first place the double-end stud into the shaft screw holes, contact the coupling end surface against the washer, and press in as if tightening with a nut. When the shaft does not have a key way, use a frictional coupling, etc.
- [2] When removing the pulley, use a pulley remover, and make sure not to apply an impact on the shaft.
- [3] Install a protective cover on the rotary sections such as the pulley installed on the shaft to ensure safety.
- [4] The direction of the encoder installed on the servo motor cannot be changed.

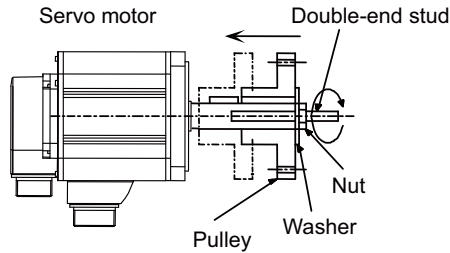

CAUTION

Never hammer the end of the shaft during assembly.

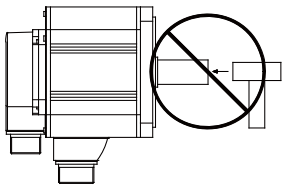

1.1.4 Installation Direction

- [1] There are no restrictions on the installation direction. Installation in any direction is possible, but as a standard the motor is installed so that the motor power line and encoder cable cannot plugs (lead-in wires) face downward. Installation in the standard direction is effective against dripping. Measure to prevent oil and water must be taken when not installing in the standard direction. When the motor is not installed in the standard direction, refer to section "Oil/Water Standards" and take the appropriate measures. The brake plates may make a sliding sound when a servo motor with magnetic brake is installed with the shaft facing upward, but this is not a fault.

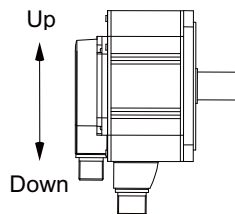

Standard installation direction

1.1.5 Shaft Characteristics

There is a limit to the load that can be applied on the motor shaft. Make sure that the load applied on the radial direction and thrust direction, when mounted on the machine, is below the tolerable values given below. These loads may affect the motor output torque, so consider them when designing the machine.

Series	Servo motor	Tolerable radial load	Tolerable thrust load
200V series	HG96S (Straight shaft)	392N (L=40)	147N
	HG75T, 105T (Taper shaft)	245N (L=33)	147N
	HG75S, 105S (Straight shaft)	245N (L=33)	147N
	HG54T, 104T, 154T, 224T, 123T, 223T, 142T (Taper shaft)	392N (L=58)	490N
	HG54S, 104S, 154S, 224S, 123S, 223S, 142S (Straight shaft)	980N (L=55)	490N
	HG204S, 354S, 303S, 453S, 702S, 302S HK204S, 302S, 303S, 354S, 453S, 702S (Straight shaft)	2058N (L=79)	980N
	HK76T, 105T (Taper shaft)	245N (L=35)	147N
	HK76S, 105S (Straight shaft)	392N (L=36)	147N
	HK55T, 104T, 123T, 142T, 154T, 223T, 224T (Taper shaft)	392N (L=46)	490N
	HK55S, 104S, 123S, 142S, 154S, 223S, 224S (Straight shaft)	980N (L=55)	490N
400V series	HG-H54T, 104T, 154T (Taper shaft)	392N (L=58)	490N
	HG-H54S, 104S, 154S (Straight shaft)	980N (L=55)	490N
	HG-H204S, 354S, 453S HK-H204S, 354S, 453S (Straight shaft)	2058N (L=79)	980N
	HK-H55T, 104T, 154T (Taper shaft)	392N (L=46)	490N
	HK-H55S, 104S, 154S (Straight shaft)	980N (L=55)	490N

(Note 1) The tolerable radial load and thrust load in the above table are values applied when each motor is used independently.

(Note 2) The symbol L in the table refers to the value of L below.

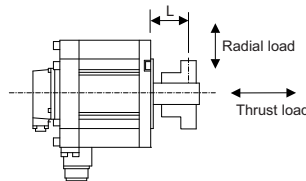

L: Length from flange installation surface to center of load mass [mm]

CAUTION

1. Use a flexible coupling when connecting with a ball screw, etc., and keep the shaft core deviation to below the tolerable radial load of the shaft.
2. When directly installing the gear on the motor shaft, the radial load increases as the diameter of the gear decreases. This should be carefully considered when designing the machine.
3. When directly installing the pulley on the motor shaft, carefully consider so that the radial load (double the tension) generated from the timing belt tension is less than the values shown in the table above.
4. In machines where thrust loads such as a worm gear are applied, carefully consider providing separate bearings, etc., on the machine side so that loads exceeding the tolerable thrust loads are not applied to the motor.
5. Do not apply the loads exceeding the tolerable level. Failure to observe this may lead to the axis or bearing damage.

1.1.6 Machine Accuracy

Machine accuracy of the servo motor's output shaft and around the installation part is as below.

(Excluding special products)

Accuracy	Measurement point	Flange size [mm]			
		Less than 100 SQ.	100 SQ., 130 SQ.	176 SQ. - 250 SQ.	280 SQ. or over
Run-out of the flange surface to the output shaft	a	0.05mm	0.06mm	0.08mm	0.08mm
Run-out of the flange surface's fitting outer diameter	b	0.04mm	0.04mm	0.06mm	0.08mm
Run-out of the output shaft end	c	0.02mm	0.02mm	0.03mm	0.03mm

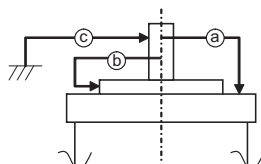

1.1.7 Coupling with the Load

There are several ways to couple the motor shaft and machine, such as direct coupling with flexible coupling or rigid coupling, gear connection, timing belt connection, etc.

Summarized comparison is as follows.

	Noise	No lubrication	Backlash	Rigidity	Reliability in coupling	Life	Torque increased at deceleration	Degree of freedom in motor installation	Cautions in motor installation
Direct coupling with flexible coupling	○	○	○	○	○ Looseness of bolt	○	×	△	Shaft core deviation (In the case of single)
Direct coupling with rigid coupling	○	○	○	○	○ Looseness of bolt	○	×	×	Shaft core deviation Angle deviation
Gear	×	×	△	△	△ Tooth chipping	△	○	○	Backlash too small Pitch diameter too small
Timing belt	△	○	○	×	×	×	○	○	Belt stretched too much Pitch diameter too small

⚠ CAUTION

If the cautions in motor installation in the above table are not observed, the motor will have a broken shaft, or the bearing will have a shorter life. Carry out design and installation adjustment so that the load on the motor shaft will be below the tolerable loads mentioned in "Shaft Characteristics".

(1) Direct coupling - Flexible coupling

When coupling the load directly, a flexible coupling is recommended. The benefits of a flexible coupling are as below.

- (a) Shaft's angle deviation and core deviation can be absorbed to some extent, so adjustment in motor installation is easier.

However, in the case of single, shaft core deviation cannot be allowed, so it is required to design and adjust so that the shaft cores of the motor and ball screw align. Check the specification of the coupling to use. If the shaft core deviation exceeds the coupling's tolerable level, the motor will have a broken shaft, or the bearing will have a shorter life. Thus, in order to simplify the installation adjustment, use a double flexible coupling.

- (b) Less looseness produces less vibration and less noise at the coupling part.

On the other hand, if assembling is loose, lower rigidity may be caused. When using a coupling with lower rigidity, the accuracy in centering the core doesn't have to be high, however, it is undesirable for servo. In order to fully utilize the servo's efficiency to ensure the maximum durability of the equipments, it is required to use a highly rigid coupling, and to fully align the shaft cores in the initial installation. It is also required to select the optimum flexible coupling according to the working conditions, and use it correctly according to the manufacturer's specification manual.

Example of direct coupling with load

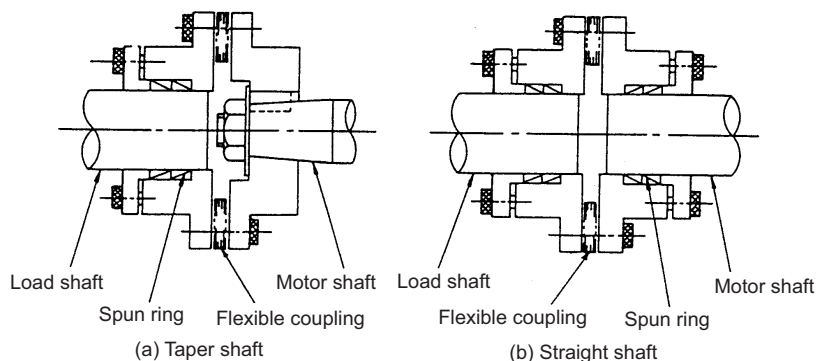

(2) Direct coupling - Rigid coupling

A rigid coupling has benefits such as high rigidity, and relatively lower price. However, shaft core deviation and angle deviation of the motor shaft and ball screw are not allowed, so full attention is required in installing the rigid coupling. Shaft core deviation is desired to be 0.01mm or less. If enough accuracy cannot be ensured, the motor will have a broken shaft, or the bearing will have a shorter life.

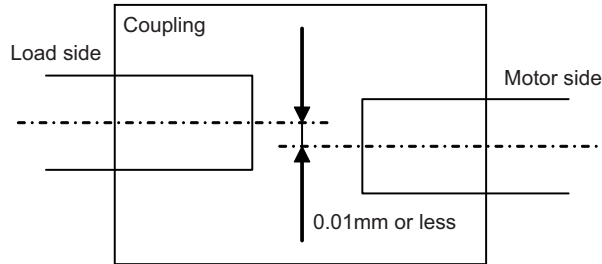

Also note that the motor side ball screw bearing must be locked so that to avoid the thrust load on the motor shaft due to expansion and contraction of the ball screw.

(3) Gear connection

Gear's accuracy and backlash amount greatly affect on the machine's positioning accuracy and noise during operation.

Thus, according to the machine's specification, appropriately select the accuracy and backlash amount.

In gear connection, it is required to take measures against oil to enter the motor.

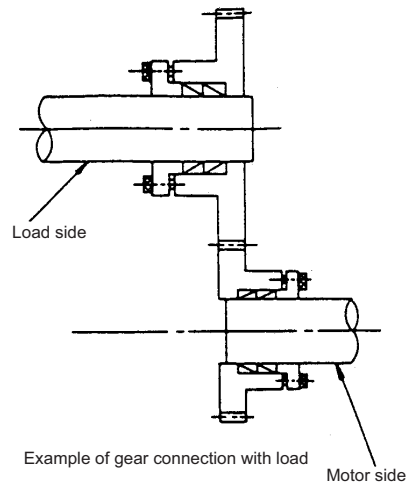

1.1.8 Oil/Water Standards

(1) The motor protective format uses the IP type, which complies with IEC Standard.

However, these Standards are short-term performance specifications. They do not guarantee continuous environmental protection characteristics. Measures such as covers, etc., must be taken if there is any possibility that oil or water will fall on the motor, and the motor will be constantly wet and permeated by water. Note that the motor's IP-type is not indicated as corrosion-resistant.

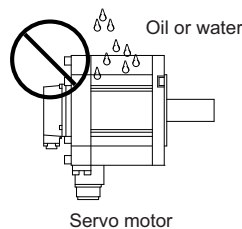

1 Installation

- (2) When a gear box is installed on the servo motor, make sure that the oil level height from the center of the shaft is higher than the values given below. Open a breathing hole on the gear box so that the inner pressure does not rise.

Series	Servo motor	Oil level (mm)
200V series	HG96	15
	HG75, 105	15
	HK76, 105	16
	HG54, 104, 154, 224, 123, 223, 142	22.5
	HK55, 104, 123, 142, 154, 223, 224	22.5
400V series	HG204, 354, 303, 453, 702, 302	30
	HK204, 302, 303, 354, 453, 702	30
	HG-H54, 104, 154	22.5
	HK-H55, 104, 154	22.5
	HG-H204, 354, 453	30
HK-H204, 354, 453	30	

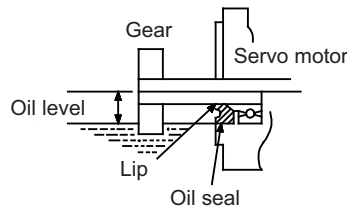

- (3) When installing the servo motor horizontally, set the connector to face downward. When installing vertically or on an inclination, provide a cable trap because the liquid such as oil or water may enter the motor from the connector by running along the cable.

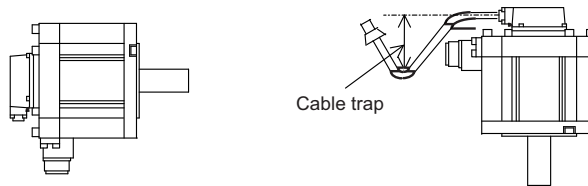

- (4) Do not use the unit with the cable submerged in oil or water. (Refer to following drawing.)

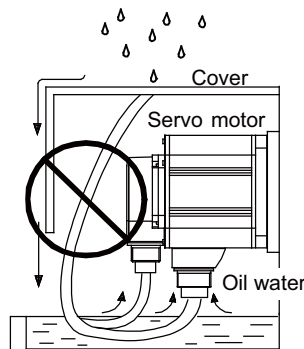

<Fault> Capillary tube phenomenon

1 Installation

- (5) Make sure that oil and water do not flow along the cable into the motor or encoder.
(Refer to following drawing.)

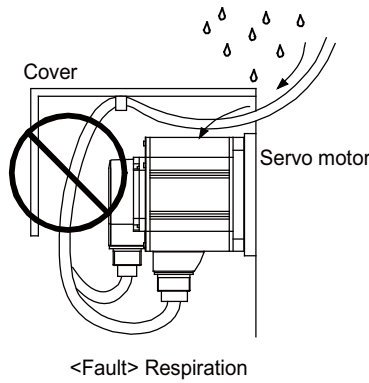

- (6) When installing on the top of the shaft end, make sure that oil from the gear box, etc., does not enter the servo motor.
The servo motor does not have a waterproof structure.

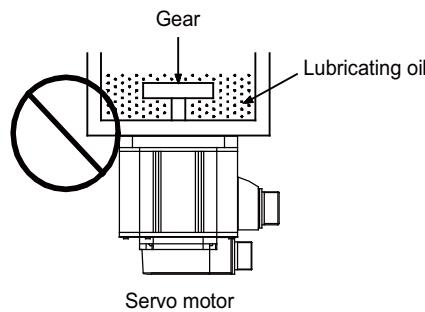

CAUTION

1. The servo motors, including those having IP67 specifications, do not have a completely waterproof (oil-proof) structure. Do not allow oil or water to constantly contact the motor, enter the motor, or accumulate on the motor. Oil can also enter the motor through cutting chip accumulation, so be careful of this also.
2. Oil may enter the motor from the clearance between the cable and connector. Protect with silicon not to make the clearance.
3. When the motor is installed facing upwards, take measures on the machine side so that gear oil, etc., does not flow onto the motor shaft.

1.1.9 Installation of Servo Motor

Mount the servo motor on a flange which has the following size or produces an equivalent or higher heat dissipation effect:

Flange size (mm)	Servo motor capacity
150×150×6	100W
250×250×6	200 to 400W
250×250×12	0.5 to 1.5kW
300×300×12	0.75 to 2.2kW
300×300×20	1.0 to 7.0kW
650×650×35	3.0 to 7.0kW
800×800×35	9.0 to 11.0kW

- (Note 1) These flange sizes are recommended dimensions when the flange material is an aluminum.
- (Note 2) If enough flange size cannot be ensured, ensure the cooling performance by a cooling fan or operate the motor in the state that the motor overheat alarm does not occur.

1.1.10 Cable Stress

- [1] Sufficiently consider the cable clamping method so that bending stress and the stress from the cable's own weight is not applied on the cable connection part.
- [2] In applications where the servo motor moves, make sure that excessive stress is not applied on the cable. If the encoder cable and servo motor wiring are stored in a cable bear and the servo motor moves, make sure that the cable bending part is within the range of the optional encoder cable. Fix the encoder cable and power cable enclosed with the servo motor.
- [3] Make sure that the cable sheathes will not be cut by sharp cutting chips, worn or stepped on by workers or vehicles.

The bending life of the encoder cable is as shown below. Regard this with a slight allowance. If the servo motor/spindle motor is installed on a machine that moves, make the bending radius as large as possible.

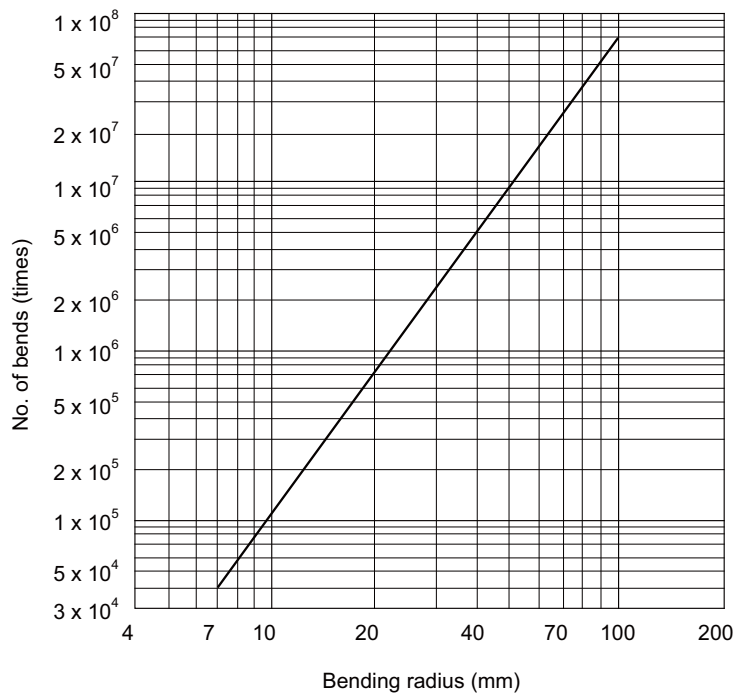

Encoder cable bending life
 (Material of Mitsubishi optional encoder cable: A14B2343)

(Note) The values in this graph are calculated values and are not guaranteed.

1.2 Installation of Spindle Motor

⚠ CAUTION

1. Do not hold the cables, axis or encoder when transporting the motor. Failure to observe this could lead to faults or injuries.
2. Securely fix the motor to the machine. Insufficient fixing could lead to the motor deviating during operation. Failure to observe this could lead to injuries.
3. When coupling to a motor shaft end, do not apply an impact by hammering, etc. Failure to observe this could lead to motor failures such as the shaft distortion or bearing/encoder damage.
4. Never touch the motor during operations or right after the stop. Install a cover, etc., on the rotary sections.
5. Do not apply a load exceeding the tolerable load onto the servo motor shaft. The shaft could break. Failure to observe this could lead to injuries.
6. Do not connect or disconnect any of the connectors while the power is ON.
7. When coupling the motor directly with the spindle, perform the adequate centering and parallel correcting with the axis to be coupled. The vibration of the motor should be 4.9m/s^2 (0.5G) or less after balancing the spindle unit.
8. Perform a running-in before operating the machine.

1.2.1 Environmental Conditions

Environment	Conditions
Ambient temperature	0°C to +40°C (with no freezing)
Ambient humidity	90%RH or less (with no dew condensation)
Storage temperature	-20°C to +65°C (with no freezing)
Storage humidity	90%RH or less (with no dew condensation)
Atmosphere	Indoors (Where unit is not subject to direct sunlight) No corrosive gases, flammable gases, oil mist or dust
Altitude	Operation/storage: 1000m or less above sea level Transportation: 10000m or less above sea level
Vibration	X: 29.4m/s^2 (3G) Y: 29.4m/s^2 (3G)

1.2.2 Balancing the Spindle Motor (Unit)

When a spindle motor is driven at a high speed with unbalance generated on the rotor, the whirling load is generated and the load to the motor's internal bearings is increased. Thus abnormal vibration, and/or damages known as fretting or flaking occurs to the bearings, which may result in shorter bearing life. Therefore, it is important to balance the rotation so that great vibration does not occur during rotation at high speed.

When balancing the spindle motor, perform to the entire rotational objects including the gear, pulley, coupling, etc. that are attached directly on the motor shaft. Provide a balancing mechanism including screw holes on the fittings while measuring the vibration so that the vibration is suppressed to the specified level or lower during high speed rotation.

(1) Fittings for the motor shaft

When you select fittings for the motor shaft, such as a gear, pulley, and coupling, choose those that meet the motor specifications (shaft diameter, rotation speed and output torque).

CAUTION

1. We consider key-less shaft as standard in order to simplify balancing procedure of such as gear, pulley, and coupling. We recommend you to choose a gear, pulley and coupling that have a fully symmetric shape, and arrange screw holes on their end faces at short and equal intervals in the circumferential direction.
2. Use a fastener such as a shaft lock element to fix those fittings to the motor shaft.
3. When you attach fittings to the motor shaft, be careful not to apply excessive impact by striking with a hammer, etc. This may cause the shaft distortion and bearing damage.
4. When using screws for balancing, apply thread locker on the screws after balancing.

(2) How to measure the unbalance

After attaching the fittings such as gear, pulley, and coupling, carry out no-load operation, and use an accelerometer or vibrometer compatible with frequency analysis to confirm the vibration on the points as illustrated below (on the brackets where the bearings are stored).

Make sure to place the motor on a cushioning mat to avoid vibration to the spindle from external sources during measurement. Reaction torque is generated when accelerating/decelerating the motor, so securely fix the motor with a belt, etc. to avoid rolling during measurement.

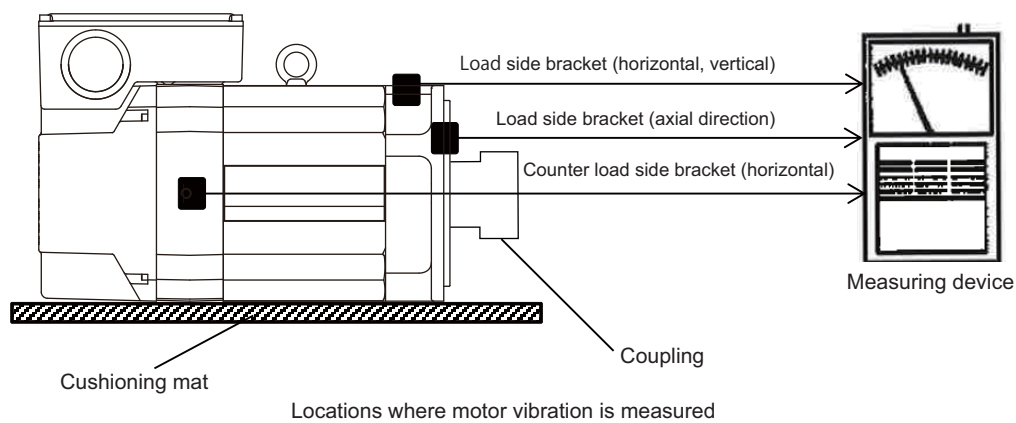

CAUTION

1. Make sure to place the motor on a cushioning mat to avoid resonance with surrounding devices during measurement.
2. Always secure the spindle motor body with a belt, etc. because it may roll due to the reaction torque generated during acceleration/deceleration operation.

(3) How to balance the rotation

Find out the rotation speed at which the vibration reaches the maximum, within the actual rotation speed range of the spindle motor. Run the motor at the speed found above and perform balancing to minimize the vibration. When balancing is decided, measure the vibration at different rotation speeds and make a further fine adjustment so that the vibration acceleration generated is always 0.5G (4.9m/s²) or less.

(The vibration acceleration of 0.5G is about 4.7μm when expressed in terms of the amplitude at the rotation speed of 10,000r/min. The higher the rotation speed is, the smaller the corresponding amplitude becomes.)

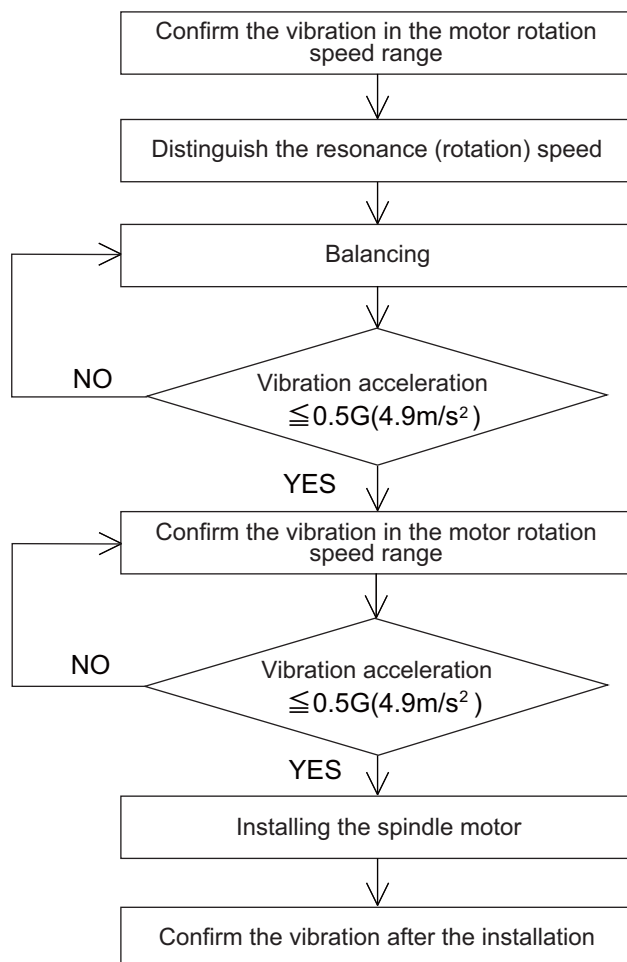

1.2.3 Shaft Characteristics

There is a limit to the load that can be applied on the motor shaft. Make sure that the load applied on the radial direction, when mounted on the machine, is below the tolerable values given below. These loads may affect the motor output torque, so consider them when designing the machine.

Series	Spindle motor	Tolerable radial load
200V series	SJ-D5.5/120-02T-S, SJ-DL3.7/240-01T, SJ-DG11/120-03T-S, SJ-DG11/120-12T-KS, SJ-DG11/150-06T-S, SJ-DG11/150-15T-KS, SJ-DG15/120-02T-KS	Not permitted
	SJ-VL11-05FZT-S01	98N
	SJ-DL5.5/150-01T, SJ-DL5.5/240-05T, SJ-VL11-02FZT	245N
	SJ-DM11/120-01T	490N
	SJ-D5.5/120-02, SJ-DJ5.5/100-01, SJ-DJ5.5/120-01, SJ-DL7.5/150-01T, SJ-DG3.7/120-03T, SJ-DG11/150-06T, SJ-DG11/150-15T-K	980N
	SJ-D5.5/100-01, SJ-D5.5/120-01, SJ-DJ7.5/100-01, SJ-DJ7.5/120-01, SJ-DG5.5/120-04T	1470N
	SJ-D7.5/100-01, SJ-D7.5/120-01, SJ-D11/100-01 SJ-DJ11/100-01, SJ-DJ15/80-01, SJ-V11-01T, SJ-DG7.5/120-05T, SJ-DG11/100-03T, SJ-DG11/120-03T, SJ-DG11/120-12T-K, SJ-DG15/120-02T-K, SJ-DN7.5/80-01	1960N
	SJ-V15-09ZT, SJ-V18.5-01ZT, SJ-V11-09T, SJ-V15-03T	2940N
	SJ-D15/80-01, SJ-D18.5/80-01, SJ-DN11/80-01	3430N
	SJ-D22/80-01, SJ-D26/80-01, SJ-DN15/80-01, SJ-DN18.5/80-01	3920N
400V series	SJ-4-V7.5-13ZT	980N
	SJ-4-V11-18T	1960N
	SJ-4-V18.5-14T, SJ-4-V15-20T	2940N

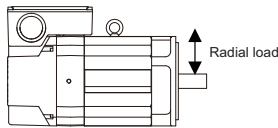

(Note) The load point is at the one-half of the shaft length.

CAUTION

Consider on the machine side so that the thrust loads are not applied to the spindle motor.

1.2.4 Machine Accuracy

Machine accuracy of the spindle motor's output shaft and around the installation part is as below.
(Excluding special products)

Accuracy	Measurement point	Frame No.	
		B71, C71, B90, C90, D90, A112, B112	A160, B160, C160, D160
Run-out of the flange surface to the output shaft	a	0.03mm	0.05mm
Run-out of the flange surface's fitting outer diameter	b	0.02mm	0.04mm
Run-out of the output shaft end	c	0.01mm	0.02mm

(Note) Refer to Specifications Manual for the frame number of each spindle motor.

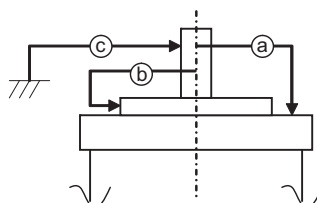

1.2.5 Coupling with the Fittings

- [1] We recommend you to adjust the dynamic balance (field balance) before fastening a belt.
- [2] The position deviation in the axial direction between the motor pulley and spindle side pulley should be as small as possible and perform parallel correcting carefully.
- [3] If the selection or tension of belt is incorrect, an excessive force is applied to the shaft end and bearings, which may result in shorter life or damages.
- [4] When the load by the belt exceeds the tolerable radial load of the motor, reselect the motor or belt/pulley.
- [5] Use an appropriate tension gauge to measure a belt tension.

1.2.6 Ambient Environment

If you continue to use the spindle motor with dirt such as oil mist and dust adhered, its cooling performance degrades and the motor is unable to fully exercise its performance, which may cause the spindle motor overheat alarm. In some cases this may result in damage to the bearing or cooling fan. Use a filter, etc. to protect the motor from oil mist and dust.

1.2.7 Installation of Spindle Motor

Make sure that the spindle motor is installed so that the motor shaft points from downward to 90° as shown below. When installing upward more than 90°, contact your Mitsubishi Electric dealer.

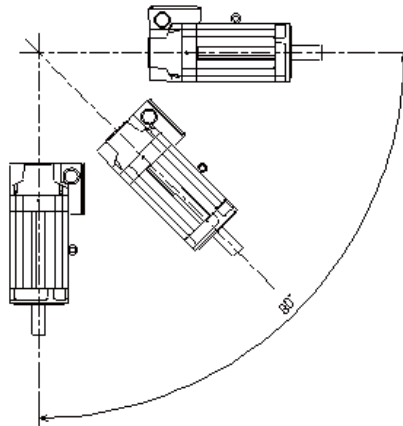

CAUTION

- 1. Rubber packing for waterproof is attached on the inner surface of the top cover of terminal block, and on the fan lead. After checking that the packing is installed, install the top cover so that no foreign objects are stuck in between.
- 2. When installing a motor on a flange, chamfer(C1) the part of flange that touches inside low part of the motor.

To yield good cooling performance, provide a space of at least 30mm between the cooling fan and wall. If the motor is covered by a structure and the air is not exchanged, its cooling performance degrades and the motor is unable to fully exercise its performance, which may cause the spindle motor overheat alarm. Do not use the spindle motor in an enclosed space with little ventilation.

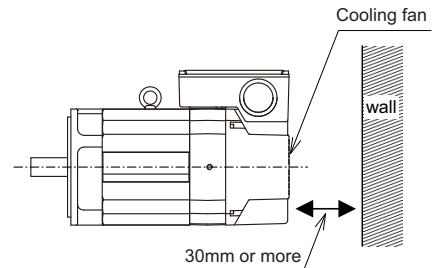

1.2.8 Connection

(1) Cable wiring

When connecting the power line to the terminal block, tighten the screws with proper torque as shown below.

Screw size	Proper torque [N•m]
M4	2.0
M5	2.5
M6	3.0
M8	10.0

CAUTION

1. When connecting the power line to the terminal block, tighten the screws with proper torque described in this section.
2. Make sure to connect the terminal to the terminal block. If running the motor with the terminal loosened, fires could be caused by motor overheat, and earth fault, short circuit and electric shocks could be caused by disconnection of the terminal.
3. To keep the insulation distance, always cover crimp terminals with insulation tubes when connecting crimp terminals at the end of the power line.

(2) Connection of conduit connector

When installing a connector to a terminal box, select a water proof connector with rubber packing and prevent conductive foreign matter and other combustible foreign matter from entering through the wiring hole on the terminal box.

Use a smaller nut than the following size to fix the connector on the terminal box.

For the wiring hole diameter, refer to "DRIVE SYSTEM DATA BOOK (IB-1501252)".

Prepare a bushing, nut, and O-ring when using a connector smaller than the wiring hole on the terminal box.

SJ-V/SJ-VL/SJ-PMF/SJ-4-V Series

Wiring hole diameter [mm]	Outer diameter [mm]
Φ35	Φ58
Φ44	Φ58
Φ51	Φ93
Φ61	Φ93
Φ63	Φ93

SJ-D/DJ/DL/DG/DM/DN Series

Wiring hole diameter [mm]	Outer diameter [mm]
Φ44	Φ56
Φ61	Φ80

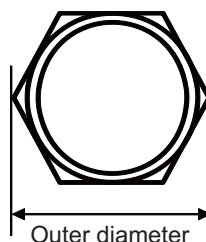

Connection method to a screwless terminal block for fan motor

(1) Lead-out length

Strip the sheath of the cable in the range of 8 to 9mm with an appropriate tool.

Applicable cable size: 0.08mm² to 2.5mm² (28AWG to 12AWG)

(2) Tool

Use a flat-blade screwdriver whose blade edge size is 0.6×3.5mm for connecting.

(3) Work procedure

- (a) Insert the edge of screwdriver into the insertion point (small square hole) in a diagonal direction. When the spring touches the blade edge, push the screwdriver down to the position that hits a conductive plate, tilting it in the inside direction of terminal block. In this state, the spring is completely opened and the screwdriver is held to the terminal block. Make sure that the screwdriver is completely held, not to create difficulties in inserting the cable for the next procedure.
- (b) Check the stripped length of cable (8 to 9mm) and insert the cable end slowly along the outside of the insertion point (big square hole) as far as it will go, not to unravel wires. Make sure not to push thin cables too much.
- (c) Release the screwdriver while holding one hand against the inserted cable. The spring will be closed and the cable will be connected.
- (d) Gently pull the cable to make sure the connection. No need for a strong pull.

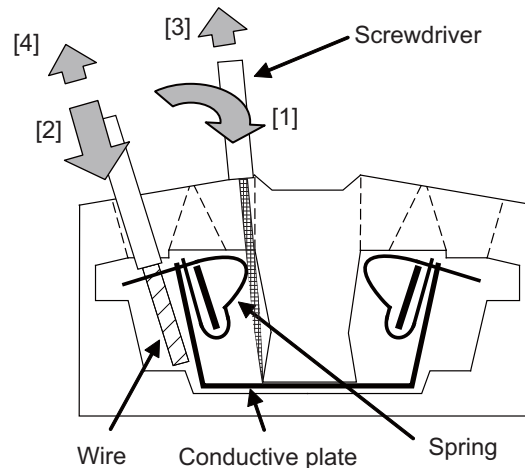
**⚠ CAUTION**

1. Connection of a cable is restricted to one to one spring.
2. For connecting a cable, both twisted wire and solid wire can be used as it is without termination after the sheath has been stripped. The cable attached with bar terminal can also be connected.

1.2.9 Cable

- [1] Do not apply the bending stress and the stress from the cable's own weight on the cable connection part.
- [2] Make sure that the cable sheathes will not be cut by sharp cutting chips, worn or stepped on by workers or vehicles.
- [3] Provide a cable trap because the liquid such as oil or water may enter the motor from the connector by running along the cable.

1.3 Installation of the Drive Unit

CAUTION

1. Install the unit on noncombustible material. Direct installation on combustible material or near combustible materials may lead to fires.
2. Follow the instructions in this manual and install the unit while allowing for the unit mass.
3. Do not get on top of the units or motor, or place heavy objects on the unit.
Failure to observe this could lead to injuries.
4. Always use the unit within the designated environment conditions.
5. Do not let conductive objects such as screws or metal chips, etc., or combustible materials such as oil enter the units.
6. Do not block the units intake and outtake ports. Doing so could lead to failure.
7. The units and servo motor are precision devices, so do not drop them or apply strong impacts to them.
8. Do not install or run units or servo motor that is damaged or missing parts.
9. When storing for a long time, please contact your dealer.
10. Always observe the installation directions. Failure to observe this could lead to faults.
11. Secure the specified distance between the units and panel, or between the units and other devices. Failure to observe this could lead to faults.

1.3.1 Environmental Conditions

Environment	Conditions
Ambient temperature	0°C to +55°C (with no freezing)
Ambient humidity	90% RH or less (with no dew condensation)
Storage temperature	-15°C to +70°C (with no freezing)
Storage humidity	90% RH or less (with no dew condensation)
Atmosphere	Indoors (no direct sunlight); no corrosive gas, inflammable gas, oil mist, dust or conductive fine particles
Altitude	Operation/storage: 1000m or less above sea level Transportation: 13000m or less above sea level
Vibration	Operation/storage: 4.9m/s ² (0.5G) or less Transportation: 49m/s ² (5G) or less

(Note) When installing the machine at 1,000m or more above sea level, the heat dissipation characteristics will drop as the altitude increases in proportion to the air density. The ambient temperature drops 1% with every 100m increase in altitude.

When installing the machine at 1,800m altitude, the heating value of the drive unit must be reduced to 92% or less. The heating value is proportional to the square of the current, and required current decreasing rate follows the expression below.

$$\text{Required current decreasing rate} = \sqrt{0.92} = 0.95$$

Therefore, use the unit with the reduced effective load rate to 95% or less.

1.3.2 Installation Direction and Clearance

Wire each unit in consideration of the maintainability and the heat dissipation, as well as secure sufficient space for ventilation.

Installation clearance

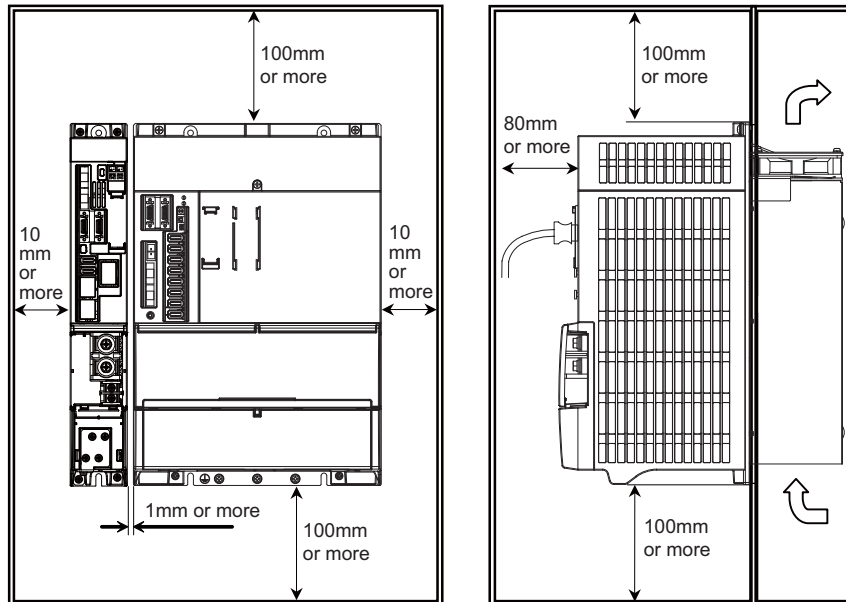

⚠ CAUTION

1. The ambient temperature condition for the drive units is 55°C or less.
2. Because heat can easily accumulate in the upper portion of the units, give sufficient consideration to heat dissipation when designing the panel. If required, install a fan in the panel to agitate the heat in the upper portion of the units.

Cooling fan position

< MDS-EM-SPV3-10040 to 200120 >

< MDS-EMH-SPV3-8040 to 10060 >

[Unit : mm]

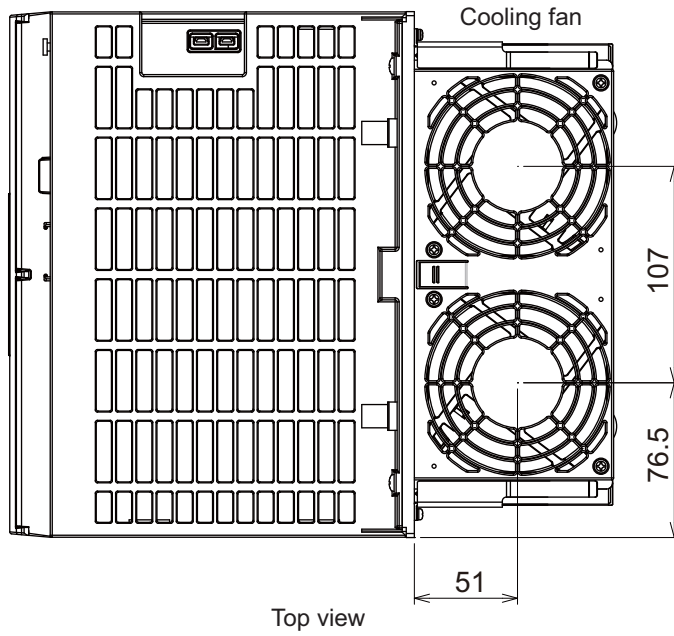

< MDS-EM-SPV3-16040S >

[Unit : mm]

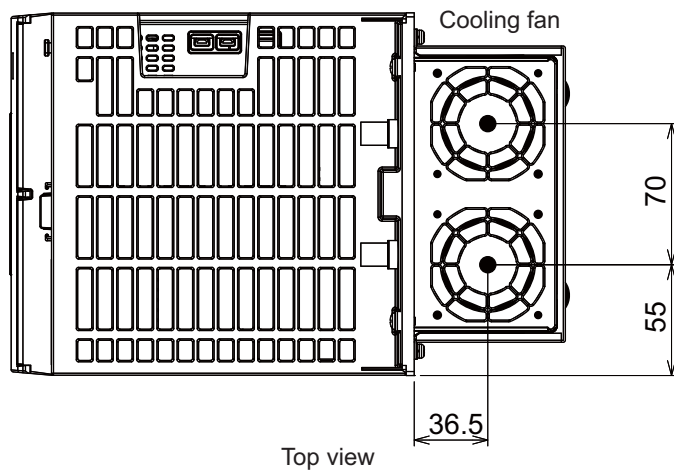

< MDS-EM-SPV3-320120 >

[Unit : mm]

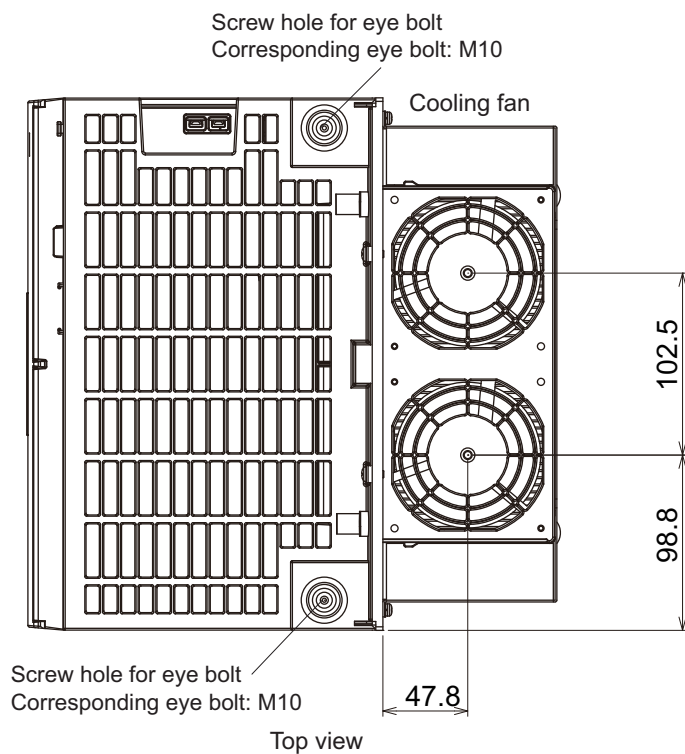
**⚠ CAUTION**

1. Design the exhaust so that it is the position of the cooling fan.
2. Make the inlet and exhaust size more than the area that is a total of the cooling fan area.
3. There are screw holes (M10) for eye bolts on the top of MDS-EM-SPV3-320120.
Use eye bolts as required.

1.3.3 Prevention of Entering of Foreign Matter

Treat the cabinet with the following items.

- (1) Make sure that the cable inlet is dust and oil proof by using packing, etc.
- (2) Make sure that the external air does not enter inside by using head radiating holes, etc.
- (3) Close all clearances of the cabinet.
- (4) Securely install door packing.
- (5) If there is a rear cover, always apply packing.
- (6) Oil will tend to accumulate on the top. Take special measures such as oil-proofing to the top so that oil does not enter the cabinet from the screw holds.
- (7) After installing each unit, avoid machining in the periphery. If cutting chips, etc., stick onto the electronic parts, trouble may occur.
- (8) When using the unit in an area with toxic gases or high levels of dust, protect the unit with air purging (system to blow clean air so that the panel's inner pressure is higher than the outer pressure).

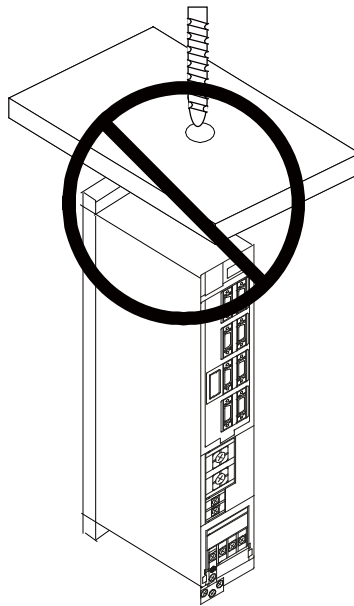

1.3.4 Panel Installation Hole Work Drawings (Panel Cut Drawings)

Prepare a square hole to match the unit width.

< MDS-EM-SPV3-10040 to 200120 >

< MDS-EMH-SPV3-8040 to 10060 >

[Unit: mm]

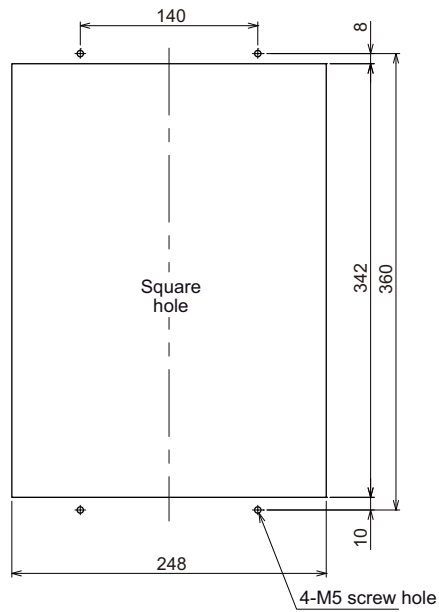

< MDS-EM-SPV3-16040S >

[Unit: mm]

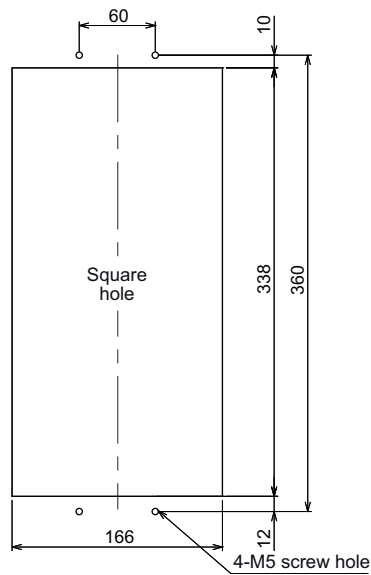

< MDS-EM-SPV3-320120 >

[Unit: mm]

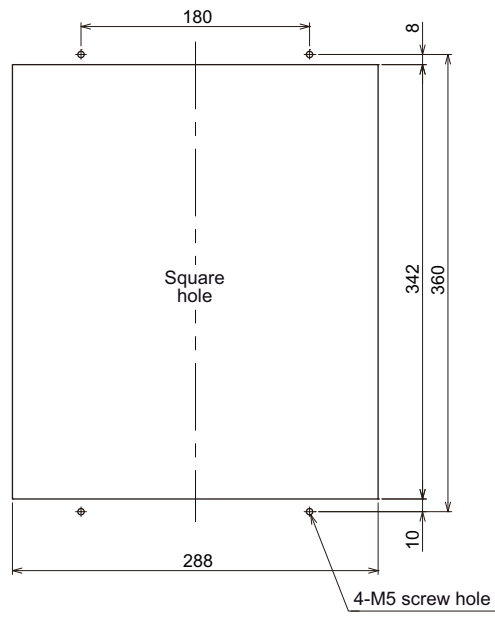

POINT

Attach packing around the square hole to provide a seal.

1.3.5 Heating Value

The values for the servo drive unit apply for load rate 50%. The values for the spindle drive unit apply for the continuous rated output. The following values include the AC reactor's heating value.

< MDS-EM Series >

Multi axis unit		
Type MDS-EM-	Heating value [W]	
	Inside panel	Outside panel
SPV3-16040S	255	485
SPV3-10040	130	560
SPV3-10080	140	590
SPV3-16040	145	620
SPV3-16080	150	650
SPV3-20080	175	815
SPV3-200120	235	1025
SPV3-320120	630	1020

< MDS-EMH Series >

Multi axis unit		
Type MDS-EMH-	Heating value [W]	
	Inside panel	Outside panel
SPV3-8040	150	650
SPV3-10040	175	815
SPV3-10060	235	1025



POINT

1. Design the panel's heating value taking the actual axis operation (load rate) into consideration.
2. The heating values in the above tables are calculated with the following load rates.

Unit	Load rate
Servo drive unit	50%
Spindle drive unit	100%
Power supply unit	100%

1.3.6 Heat Radiation Countermeasures

(1) Heat radiation countermeasures in the control panel

In order to secure reliability and life, design the temperature in the panel so that the ambient temperature of each unit is 55°C or less.

If the heat accumulates at the top of the unit, etc., install a fan or heat exchanger so that the temperature in the panel remains constant.

Please refer to following method for heat radiation countermeasures.

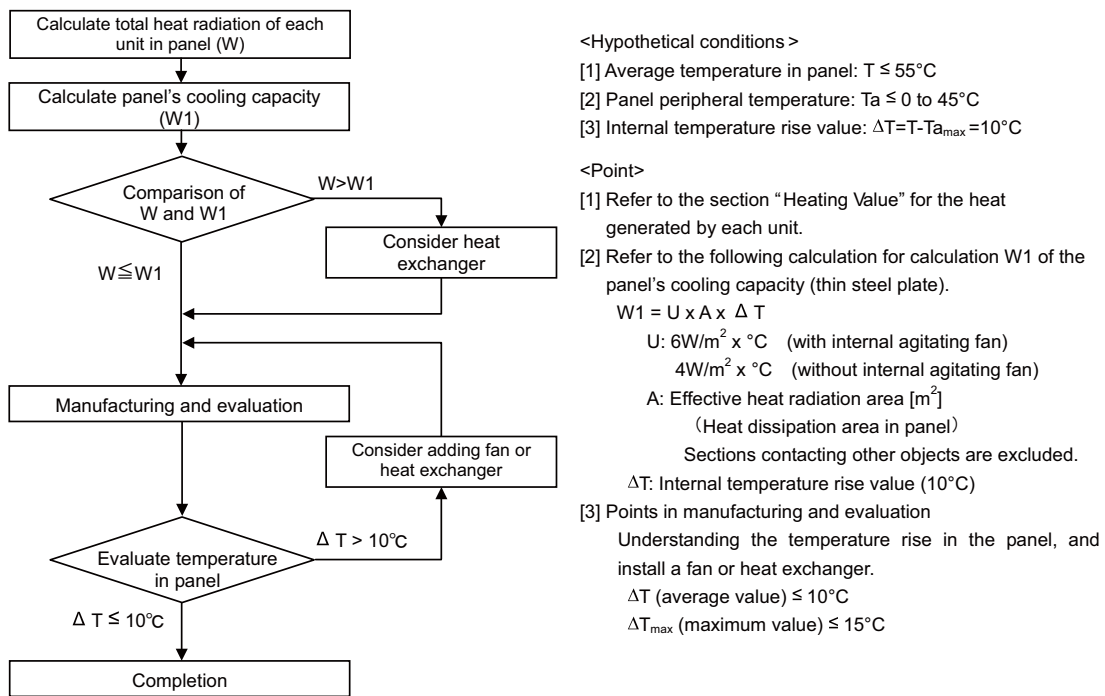

Examples of mounting heat exchanger and temperature measurement positions (reference)

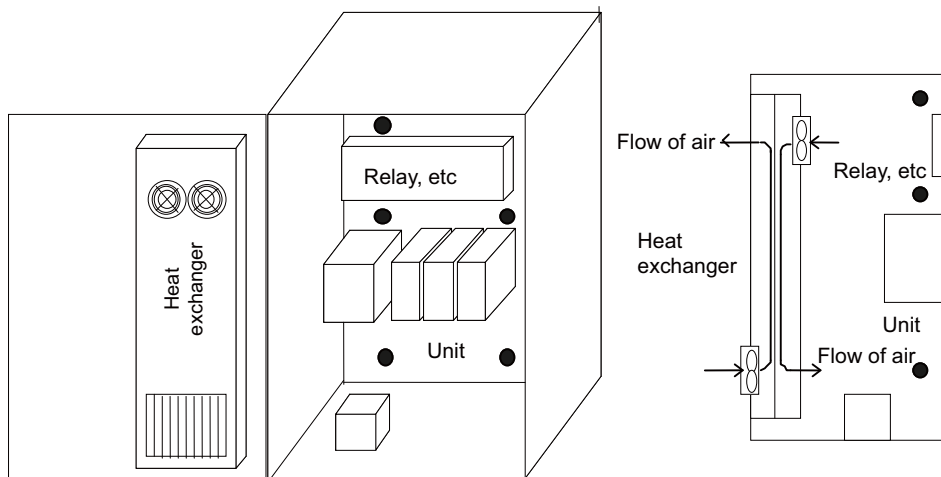

● Temperature measurement positions

The following shows a calculation example for considering heat radiation countermeasures.

< Control panel outline dimension (assumption) >

When installing four units which have the heating value in the panel of 15W

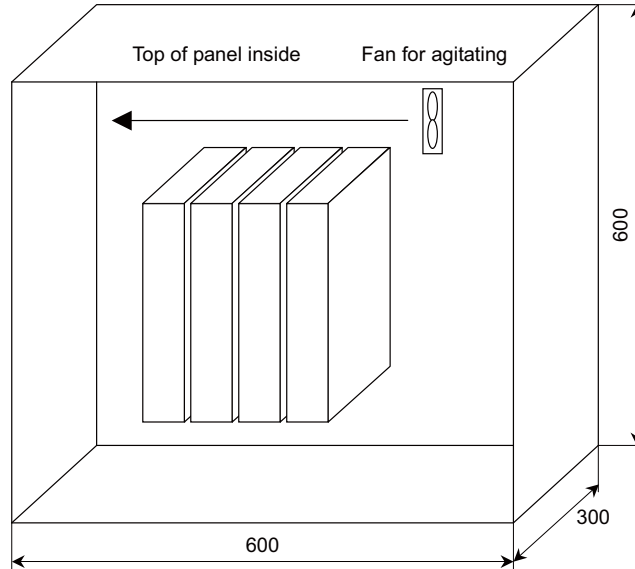

Heat radiation area (A): When a bottom section contacts with a machine

$$A = \underbrace{0.6 \times 0.3}_{\text{(Top face)}} + \underbrace{0.6 \times 0.6 \times 2}_{\text{(Front/back face)}} + \underbrace{0.6 \times 0.3 \times 2}_{\text{(Side face)}} = 1.26 \text{ (m}^2\text{)}$$

(Note) Actually, sections contacting other objects are excluded.

Heating value in panel (W): when installing four units which are 15W

$$W = 15 \times 4 = 60 \text{ (W)}$$

< Considering necessity of agitating fan >

1 Temperature standard

- (1) Standard of temperature in panel (around each unit) $T \leq 55^\circ\text{C}$
- (2) External peripheral temperature $T_a = 0 \text{ to } 45^\circ\text{C}$
- (3) Internal temperature rise value $DT = T - T_a \text{ (MAX) } = 10^\circ\text{C}$

2 Cooling capacity of control panel (W1)

$$W1 = U \times A \times DT \quad DT = \text{Internal temperature rise value (=}10^\circ\text{C)}$$

$$U = 6\text{W/m}^2 \cdot ^\circ\text{C} \text{ (with internal agitating fan)}$$

$$4\text{W/m}^2 \cdot ^\circ\text{C} \text{ (without internal agitating fan)}$$

$$A = \text{Effective heat radiation area (m}^2\text{)}$$

- (1) With internal agitating fan $W1 = 6 \times 1.26 \times 10 = 75.6 \text{ (W)} > 60 \text{ (W)}$
- (2) Without internal agitating fan $W1 = 4 \times 1.26 \times 10 = 50.4 \text{ (W)} < 60 \text{ (W)}$ -- Internal fan is required.



POINT

Measure an actual internal temperature, and install a fan or heat exchanger which agitates the heat at the top of the unit if the temperature rise exceeds 10°C.

1.4 Installation of the Machine End Encoder

1.4.1 Spindle Side ABZ Pulse Output Encoder (OSE-1024 Series)

To maintain the encoder life and performance, a flexible coupling should be used to couple the spindle side encoder and C-axis encoder with the spindle.

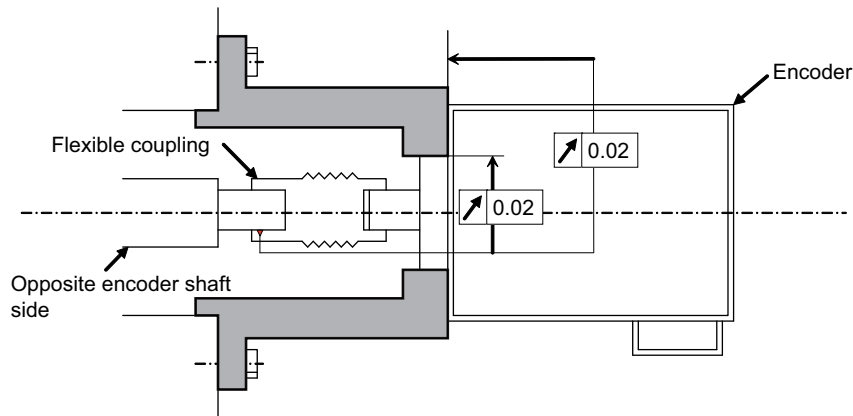

Encoder and coupling installation accuracy

Recommended coupling

		Recommendation 1	Recommendation 2
Manufacturer		Tokushu Seiko	Eagle
Model		Model M1	FCS38A
Resonance frequency		1374Hz	3515Hz
Position detection error		$0.8 \times 10^{-3} \text{ }^\circ$	$1.2 \times 10^{-3} \text{ }^\circ$
Tolerable speed		20,000r/min	10,000r/min
Mis-alignment	Core deviation	0.7mm	0.16mm
	Angle displacement	1.5°	1.5°
Outline dimensions	Max. length	74.5mm	33mm
	Max. diameter	Φ57mm	Φ38mm

CAUTION

Confirm that the gear ratio (pulley ratio) of the spindle end to the encoder is 1:1.



Refer to the coupling catalog, etc., for details on the coupling.

1.4.2 Spindle Side PLG Serial Output Encoder (TS5690, MU1606 Series)

(1) Part configuration

The encoder is configured of a sensor and detection gear. The sensor and detection gear must be used in the designated combination.

These are precision parts, and require care when handling. Do not apply an excessive force on the sensor's detection surface, as this could result in faults. Do not pull and apply a load on the lead wires. Make sure that foreign matters (iron chips, etc.) do not get on the sensor's detection surface or detection gears. If any foreign matter should get on these parts, carefully remove while taking care not to damage the parts. When handling the detection gears, take care not to damage or deform the teeth.

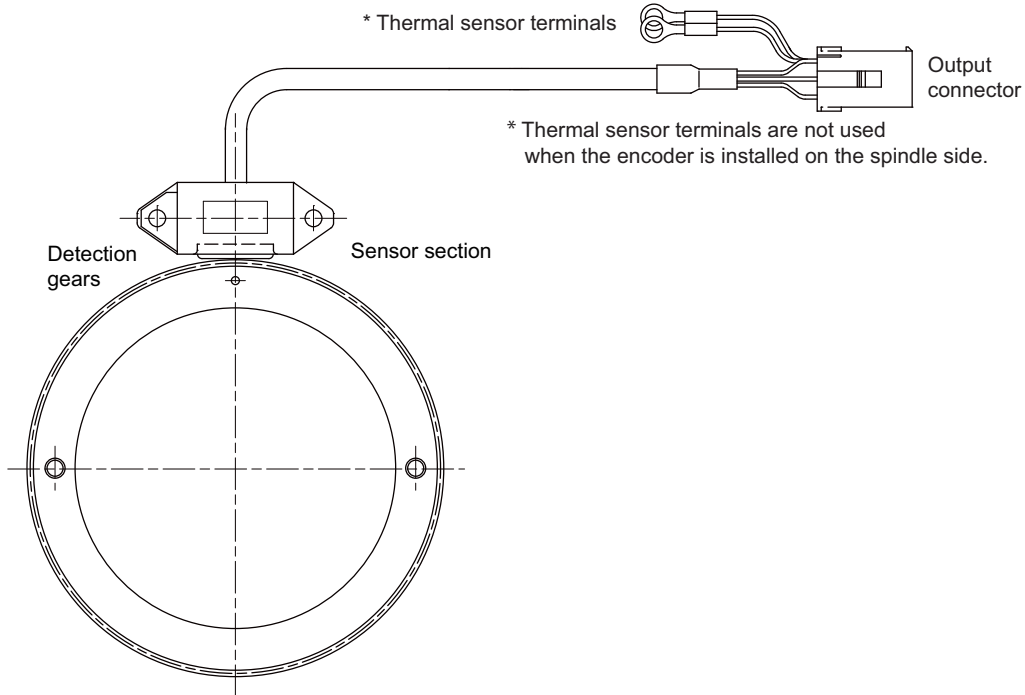

Spindle side PLG serial output encoder TS5690 Series

(2) Installing the detection gears

- [1] Install the detection gears so that the first gear's teeth side (Z phase) face the sensor's lead side.
- [2] The detection gears and shaft or sleeve should be fixed with shrink fitting. Refer to the following table for the shrink fitting values. The detection gears should be heated evenly between 120 and 150°C using an electric furnace, etc.

Guideline for detection gear shrink fitting values

Inner diameter (mm)	Shrink fitting (mm)	Inner diameter (mm)	Shrink fitting (mm)
Φ40	0.020 to 0.040	Φ140	0.050 to 0.085
Φ70	0.030 to 0.055	Φ160	0.060 to 0.090
Φ80	0.030 to 0.055	Φ215	0.080 to 0.110
Φ125	0.050 to 0.085		

- [3] Keep the run-out of the outer diameter, when the detection gears are installed on the shaft, to 0.02mm or less.
- [4] To remove a detection gear fixed with shrink fitting, use the screw holes opened in the axial direction for pulling (two M5 screw holes or two M8 screw holes), or push the end with a jig. Carry out this work carefully. Applying excessive force when pulling out the gears could cause the inner diameter of the detection gears to deform.
- [5] Before reusing detection gears which have been removed, always measure the inner diameter dimensions, and carefully check that the inner diameter is not deformed, and that the sufficient tightening amount can be secured. Do not reuse the detection gears if the inner diameter is deformed, or if any abnormality such as damage to the teeth is found.

(3) Installing the sensor section

- [1] Prepare the notched fitting section at the machine side's installation position to be of the specified dimensions in advance.
- [2] With the sensor installation seat's R section butted against the notched fitting section, fix the sensor installation seat with a mounting screw (M4 × 0.8 screws). A locking agent should be applied on the mounting screw before it is tightened.
- [3] Fix the sensor with its R section butted against the notched fitting section so that the position relation between the detection gear and sensor is kept constant. This ensures favorable accuracy of the sensor installation.
- [4] Keep the deviation of the sensor center and outer diameter center of the detection gear to ±0.25mm or less. If the center deviation cannot be directly measured, set so that the dimension from the sensor installing surface to the outer diameter edge of the detection gears is 19.0±0.25mm. (Some detection gears have thickness at the inner diameter section.)
- [5] Make sure that force is not constantly applied on the sensor's lead wires.
- [6] Check the gap between the encoder sensor and the gear (0.3±0.05mm).

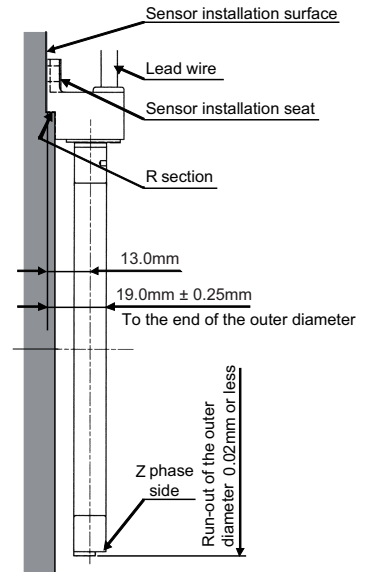

Installing the detector

POINT

To install the sensor section, the notched fitting section on the machine side must have the specified dimensions. The sensor's installation accuracy is assured by adjusting the outside dimensions of the notched fitting section.

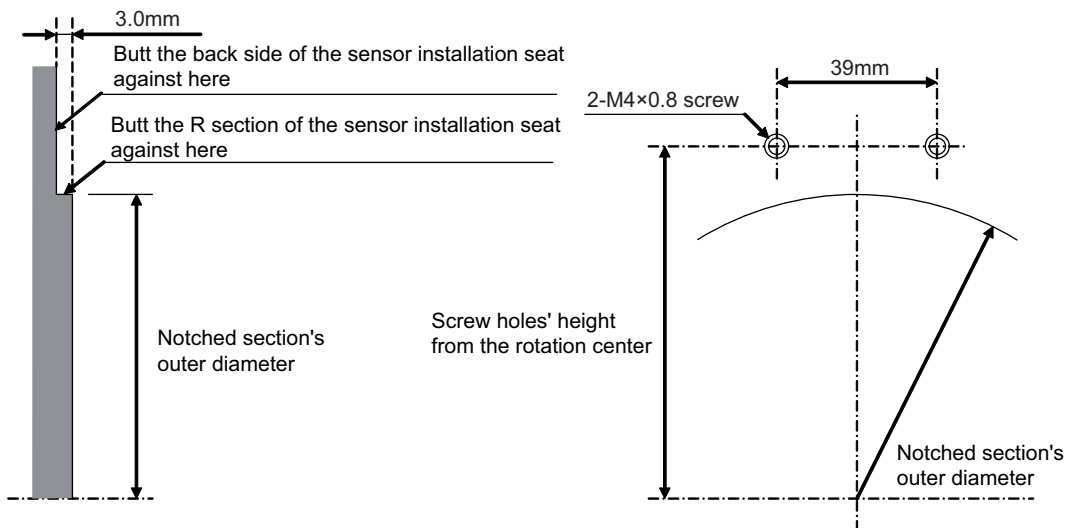

Shape of notched fitting section

Installing dimension of the sensor section

Sensor series type	Screw holes' height from the rotation center (mm)	Notched fitting section's outer diameter (mm)
TS5690N64xx	36.7	Φ59.4 -0.030 -0.070
TS5690N90xx	47.1	Φ79.2 0 -0.040
TS5690N12xx	62.3	Φ108.8 +0.025 -0.015
TS5690N19xx	87.9	Φ159.4 +0.005 -0.035
TS5690N25xx	113.5	Φ210.2 +0.040 0

(4) Installation accuracy diagnosis for spindle side PLG encoder** CAUTION**

Do not operate the spindle before performing this installation accuracy diagnosis.

If operated with an improperly installed spindle side PLG encoder, the spindle motor may rotate at high speed.

Always perform this diagnosis before normal operation.

[1] Outline

In this section, check if the installation polarity of spindle side PLG encoder corresponds to the parameter setting, and the gap between the gear and the sensor is appropriate. In a full-closed loop control where the encoder is also installed on the spindle side, it is controlled based on the feedback of the spindle side encoder during the speed command operation (S command). Do not command a normal spindle operation before confirming the installation accuracy of the spindle side encoder. Spindle side PLG encoders (TS5690 Series) have the specified gap from the gear by installing the sensor section on the machine-notched fitting section. Whether a signal is detected correctly or not can be confirmed using the servo diagnosis screen on NC while rotating the spindle motor in an open loop control.

[2] Confirmation of encoder installation polarity

Open the drive monitor/spindle unit on the NC Diagnosis screen, and display "Machine position", "Motor end FB" and "FB error". Confirm that "Machine position" and "Motor end FB" are counted on the same polarity, and that "FB error" is not cumulated while rotating the spindle by hand. When the polarity of "Machine position" and "Motor end FB" is different and "FB error" is cumulated, change the setting of #13017/bit4 (SP017/bit4). Set the spindle parameter so that the spindle system is in a full-closed loop control during this confirmation.

- #13019 (SP019) Set the encoder resolution of spindle side PLG encoder correctly
- #13031 (SP031) Set to full closed loop control (6200)

[3] Confirmation of encoder installation accuracy

Whether the gap between the sensor section and the gear is ensured correctly or not can be confirmed using the servo diagnosis screen, [PLG diagn] on NC while rotating the spindle motor in an open loop control. Confirm it according to the following procedures.

- 1) Set the spindle parameter #13018/bit1 (SP018/bit1) to 1 to enable an open loop control.
- 2) Turn the NC and drive unit power OFF and disconnect the motor side encoder cable only. After that, turn the power ON again.
- 3) Rotate the spindle by inputting 100r/min command. Although this is the same as normal S command operation, neither the spindle side encoder feed back or the motor side encoder feed back is used for the motor control on the spindle drive unit since the open loop control is set with the spindle parameter.
- 4) Switch to the [Servo diagn] menu on the NC maintenance screen and change from [Spindle unit] to [PLG diagn]. When all the diagnosis signal bits are constantly at "0", the installation of PLG encoder is normal. When the diagnosis signal bit is "1", the result of diagnosis is abnormal. Perform troubleshooting following "[4] Diagnosis and remedy" by reference to the error details and main cause.
- 5) Set the spindle parameter #13018/bit1 (SP018/bit1) to 0 again and finish the open loop control after stopping the spindle with stop command.
- 6) Turn the NC and spindle drive unit power OFF, and reconnect the motor side encoder cable as it was.

 CAUTION

The spindle PLG diagnosis is only performed during the open loop control operation. Diagnosis screen is displayed even during the normal operation, however, the error detection ("1" display) will not be performed.

<Display of spindle PLG diagnosis>

720V MEMORY / Monitr Setup Edit Diagn Mainte									
		S1		S2		S3		S4	
Alarm times	1	13	2000	13	2000	13	2000	13	2000
Alarm times	2	18	11110	18	11110	18	11110	18	11110
Alarm times	3	1F	0	1F	0	1F	0	1F	0
Alarm times	4	21	200	21	200	21	200	21	200
Alarm times	5	2F	2000	2F	2000	2F	2000	2F	2000
Alarm times	6	34	10	34	10	34	10	34	10
Alarm times	7	35	500	35	500	35	500	35	500
Alarm times	8	36	1000	36	1000	36	1000	36	1000
Alarm times	9	38	0	38	0	38	0	38	0
Alarm times	10	3A	0	3A	0	3A	0	3A	0
Encoder Diagn L			00000000		00000000		00000000		00000000
Encoder Diagn H			00000000		00000000		00000000		00000000
Sub Encoder Diagn L			00000000		00000000		00000000		00000000
Sub Encoder Diagn H			00000000		00000000		00000000		00000000

When an error is detected with spindle PLG diagnosis → "1" is displayed on the corresponding diagnosis signal bit

Information for spindle PLG diagnosis (For details of each diagnosis signal bit, refer to the next page.)

Item	Details
Encoder Diagn L	Display the motor end PLG diagnosis signal bit 7 to 0. *
Encoder Diagn H	Display the motor end PLG diagnosis signal bit F to 8. *
Sub Encoder Diagn L	Display the spindle side PLG diagnosis signal bit 7 to 0.
Sub Encoder Diagn H	Display the spindle side PLG diagnosis signal bit F to 8.

* Used when adjusting a built-in motor.

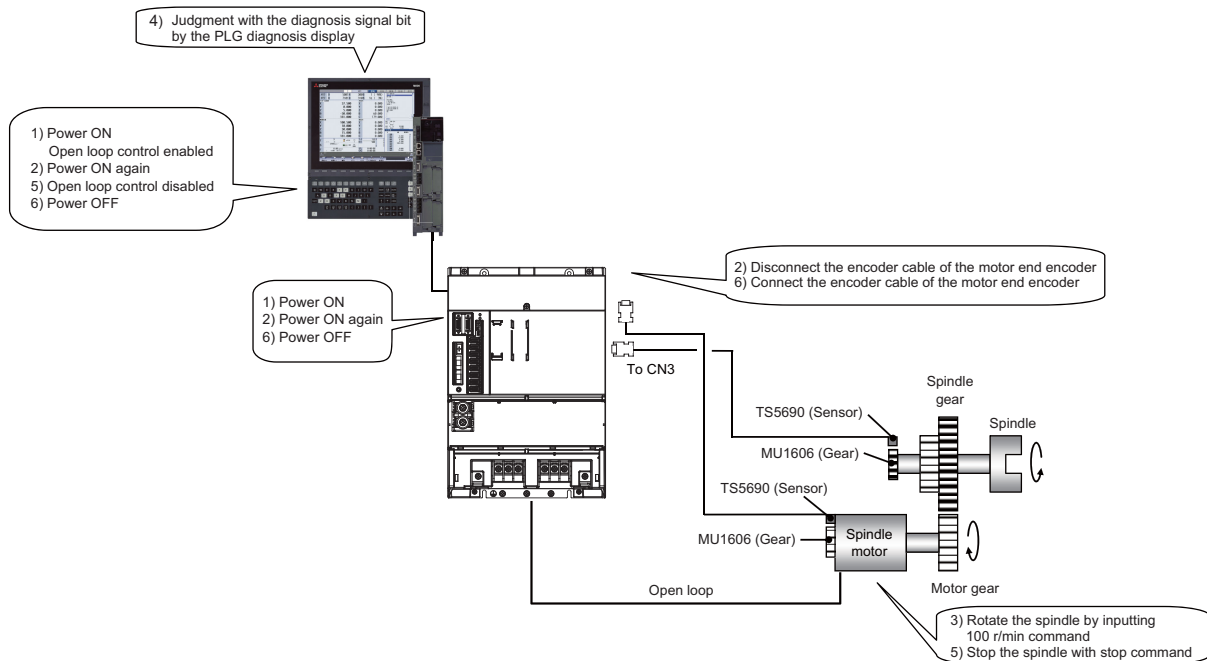

Installation diagnosis for spindle side PLG encoder

Details of each diagnosis signal bit which is displayed as information for spindle PLG diagnosis are shown in the following table.

Diagnosis signal bit	Error details	Description	Main factor
0	A-phase amplitude excessive	The A-phase amplitude is larger than the specified value.	Too small gap
1	A-phase amplitude too small	The A-phase amplitude is smaller than the specified value.	Excessive gap
2	A-phase offset excessive +	The A-phase offset is larger than the specified value to + side.	The deviation between the sensor and the center of the gear
3	A-phase offset excessive -	The A-phase offset is larger than the specified value to - side.	The deviation between the sensor and the center of the gear
4	B-phase amplitude excessive	The B-phase amplitude is larger than the specified value.	Too small gap
5	B-phase amplitude too small	The B-phase amplitude is smaller than the specified value.	Excessive gap
6	B-phase offset excessive +	The B-phase offset is larger than the specified value to + side.	The deviation between the sensor and the center of the gear
7	B-phase offset excessive -	The B-phase offset is larger than the specified value to - side.	The deviation between the sensor and the center of the gear
8	Z-phase width excessive	The Z-phase width is larger than the specified value. [AL2C factor]	Too small gap
9	Z-phase width too small	The Z-phase width is smaller than the specified value.	Excessive gap
A	Z-phase error incorrect output	The relation of the phases between AB and Z is abnormal. [AL2C factor]	The deviation between the sensor and the center of the gear
B	Z-phase error sliver waveform	The relation of the phases between AB and Z is abnormal. [AL2C factor]	The deviation between the sensor and the center of the gear
C	Z-phase error no signal	The Z-phase signal is not detected. [AL2C factor]	Excessive gap, detection gear error
D	-	-	-
E	Z-phase error logic reversed	The Z-phase logic (normally positive) is reversed. [AL2C factor]	Detection gear error
F	-	-	-

[4] Diagnosis and remedy

When the diagnosis signal bit on [PLG diagn] is "1", check the installation of the PLG encoder again.

<When the waveform of spindle side PLG installation gap diagnosis is abnormal>

The gap between the sensor section and the gear may deviate from the specified value. Confirm that the sensor section is installed on the notched fitting section properly. Also confirm that the notched fitting section is machined properly based on the specified dimensions for each PLG encoder.

<When the waveform of spindle side PLG installation all errors diagnosis is abnormal>

The sensor section may deviate from the center of the gear. Confirm the installation of the sensor section and the gear.

CAUTION

1. When finely adjusting the sensor installation position, adjust after turning the power of the drive unit OFF.
2. "00000000" is also displayed in the following cases.
 - (1) When the spindle parameter #13018/bit1(SP018/bit1) is 0 (open loop disabled)
 - (2) When an encoder other than TS5690 Series is connected

#13017(PR) SP017 SPEC1 Spindle specification 1**bit 4 : fdir Position feedback**

Set the machine side encoder's installation polarity.
0: Forward polarity 1: Reverse polarity

#13018(PR) SP018 SPEC2 Spindle specification 2**bit 1 : oplp Open loop control**

This allows the operation in which no encoder feedback signals are used.
It is used when adjusting the encoder, etc.
0: Disable 1: Enable

#13113 SP113 OPLP Current command value for open loop

Set the current command value for when the open loop control is enabled.
When "0" is set, the state will be the same as when "50" is set.
When not using, set to "0".
The open loop control is enabled when "SP018/bit1" is set to "1".

---Setting range---

0 to 999 (Short-time rated %)

1.5 Noise Measures

Noise includes "propagation noise" generated from the relay, etc., and propagated along a cable causing the drive unit to malfunction, and "radiated noise" propagated through air from a peripheral device, etc., and causing the power supply unit or drive unit to malfunction.

Always implement these noise measures to prevent the peripheral devices and unit from malfunctioning. The measures differ according to the noise propagation path, so refer to the following explanation and take appropriate measures.

(1) General noise measures

- (a) Avoid laying the drive unit's power line and signal wire in a parallel or bundled state. Always separate these wires. Use a twisted pair shielded wire for the encoder cable and signal wires such as the communication cable connected with the NC unit, and accurately ground the devices.
- (b) Use one-point grounding for the drive unit and motor.
- (c) Accurately ground the AC reactor.

(2) Propagation noise measures

Take the following measures when noise generating devices are installed and the drive unit could malfunction.

- (a) Install a surge killer on devices (magnetic contacts, relays, etc.) which generate high levels of noise.
- (b) Install a power line filter in the stage before the drive unit.
- (c) Install a ferrite core on the signal wire.
- (d) Ground the shield of the servo encoder's cable with a cable clamp.
- (e) Wire the spindle PLG encoder cable away from other wires.

(3) Measures against radiated noise

The types of propagation paths of the noise and the noise measures for each propagation path are shown below.

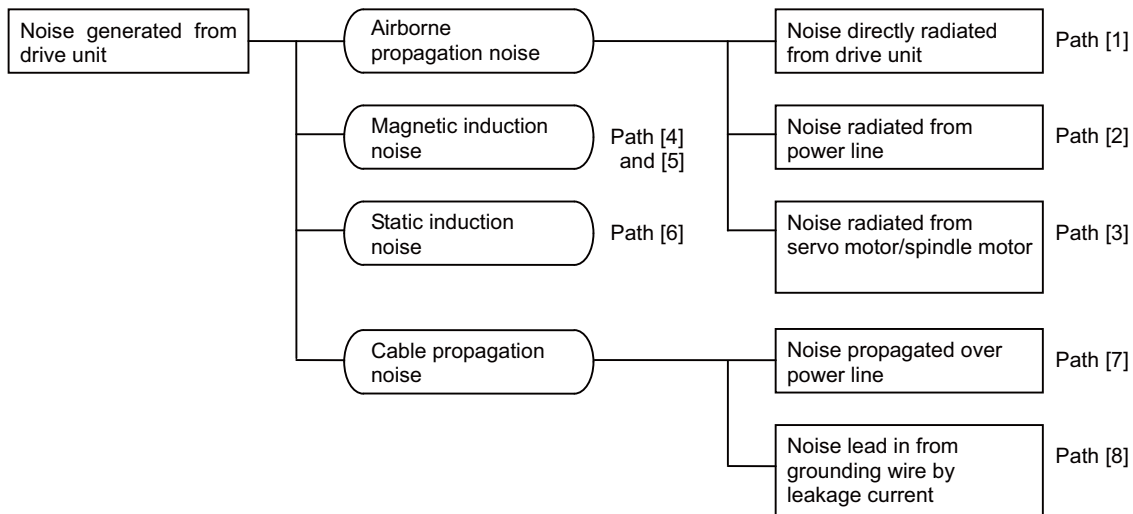

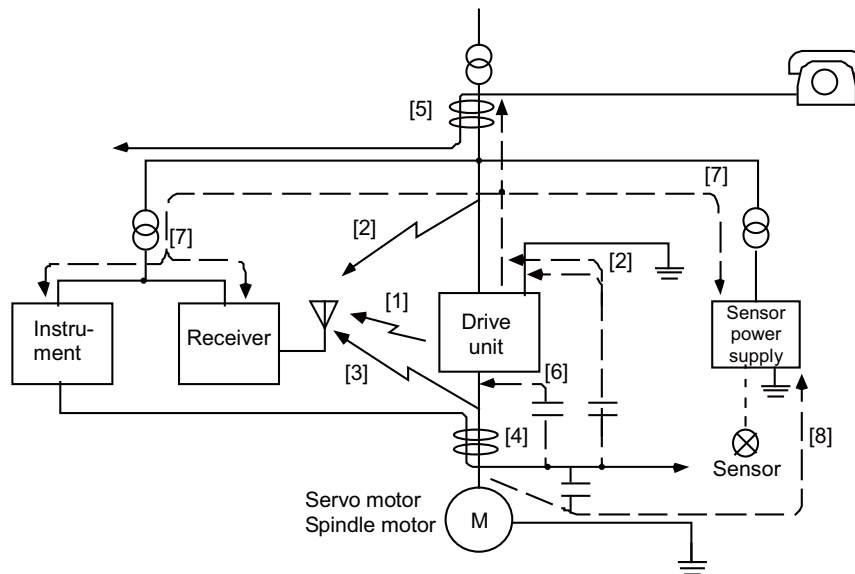

Generated noise of drive system

Noise propagation path	Measures
[1] [2] [3]	<p>When devices such as instrument, receiver or sensor, which handle minute signals and are easily affected by noise, or the signal wire of these devices, are stored in the same panel as the drive units and the wiring is close, the device could malfunction due to airborne propagation of the noise. In this case, take the following measures.</p> <p>(a) Install devices easily affected as far away from the drive units as possible.</p> <p>(b) Lay devices easily affected as far away from the signal wire of the drive unit as possible.</p> <p>(c) Avoid laying the signal wire and power line in a parallel or bundled state.</p> <p>(d) Insert a line noise filter on the input/output wire or a radio filter on the input to suppress the noise radiated from the wires.</p> <p>(e) Use a shield wire for the signal wire and power line, or place in separate metal ducts.</p>
[4] [5] [6]	<p>If the signal wire is laid in parallel to the power line, or if it is bundled with the power line, the noise could be propagated to the signal wire and cause malfunction because of the magnetic induction noise or static induction noise. In this case, take the following measures.</p> <p>(a) Install devices easily affected as far away from the drive unit as possible.</p> <p>(b) Lay devices easily affected as far away from the signal wire of the drive unit as possible.</p> <p>(c) Avoid laying the signal wire and power line in a parallel or bundled state.</p> <p>(d) Use a shield wire for the signal wire and power line, or place in separate metal ducts.</p>
[7]	<p>If the power supply for the peripheral devices is connected to the drive unit in the same system as the drive units, the noise generated from the power supply unit could back flow over the power line and cause the devices to malfunction. In this case, take the following measures.</p> <p>(a) Install a radio filter on the drive unit's power line.</p> <p>(b) Install a power filter on the drive unit's power line.</p>
[8]	<p>If a closed loop is created by the peripheral device and drive unit's grounding wire, a leakage current could flow and cause the device to malfunction. In this case, change the device grounding methods and the grounding place.</p>

2

Wiring and Connection

WARNING

1. Wiring work must be done by a qualified technician.
2. Wait at least 15 minutes after turning the power OFF and check the voltage with a tester, etc., before starting wiring. Failure to observe this could lead to electric shocks.
3. Securely ground the drive units and servo/spindle motor.
4. Wire the drive units and servo/spindle motor after installation. Failure to observe this could lead to electric shocks.
5. Do not damage, apply forcible stress, place heavy items on the cables or get them caught. Failure to observe this could lead to electric shocks.
6. Always insulate the power terminal connection section. Failure to observe this could lead to electric shocks.

CAUTION

1. Correctly and securely perform the wiring. Failure to do so could result in runaway of the servo/spindle motor or injury.
2. Do not mistake the terminal connections.
3. Do not mistake the polarity (+ , -). Failure to observe this item could lead to ruptures or damage, etc.
4. Adjust the cable not to have an excess length. The excessive length could generate noise.
5. Do not mistake the direction of the diodes for the surge absorption installed on the DC relay for the motor brake and contactor (magnetic contactor) control. The signal might not be output when a failure occurs.

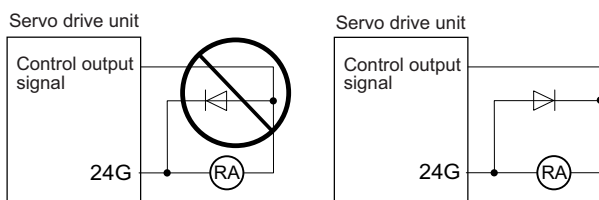

6. Electronic devices used near the drive units may receive magnetic obstruction. Reduce the effect of magnetic obstacles by installing a noise filter, etc.
7. Do not install a phase advancing capacitor, surge absorber or radio noise filter on the power line (U, V, W) of the servo/spindle motor.
8. Do not modify this unit.
9. If the connectors are connected incorrectly, faults could occur. Make sure that the connecting position and the connection are correct.
10. When grounding the motor, connect to the protective grounding terminal on the drive units, and ground from the other protective grounding terminal. (Use one-point grounding)
Do not separately ground the connected motor and drive unit as noise could be generated.
11. When the main grounding plate or the part to install a grounding cable is painted, remove the paint before grounding the cable. The electrical connection becomes insufficient and noise could be generated.

2.1 Part System Connection Diagram

< When using MDS-EM/EMH-SPV3 together with MDS-E/EH >

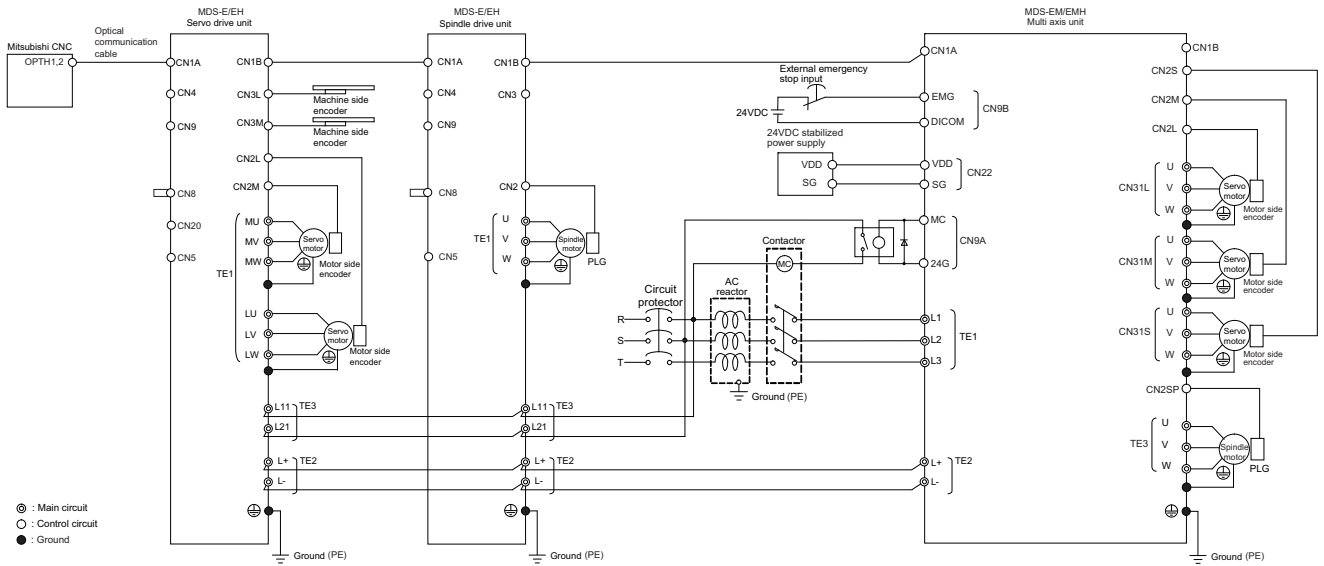

- (Note 1) The total length of the optical communication cable from the NC must be within 30m and the specified bending radius (for wiring inside panel: 25mm, and for wiring outside panel: 50mm) or more.
- (Note 2) The connection method will differ according to the used motor.
- (Note 3) Battery for the encoder back up is built-in the drive unit. (An external battery is available as an option.)
- (Note 4) The main circuit (⊙), control circuit (○) and ground (●) are safely separated.
- (Note 5) Connect the ground of the motor to the ground of the connected drive unit.

< When connecting two MDS-EM/EMH-SPV3 units >

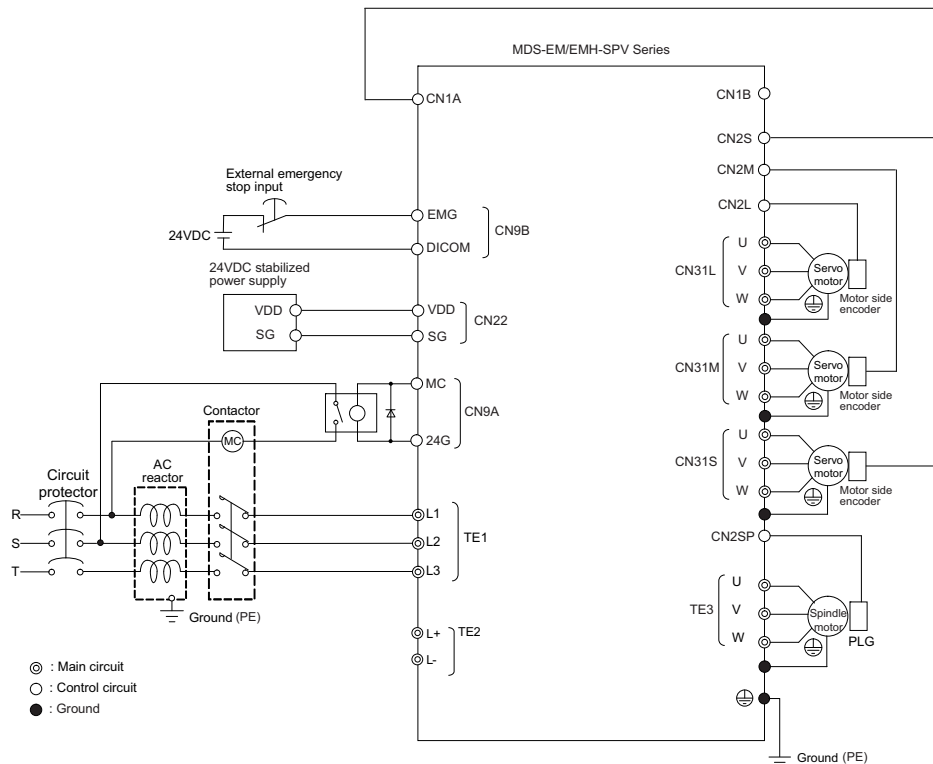
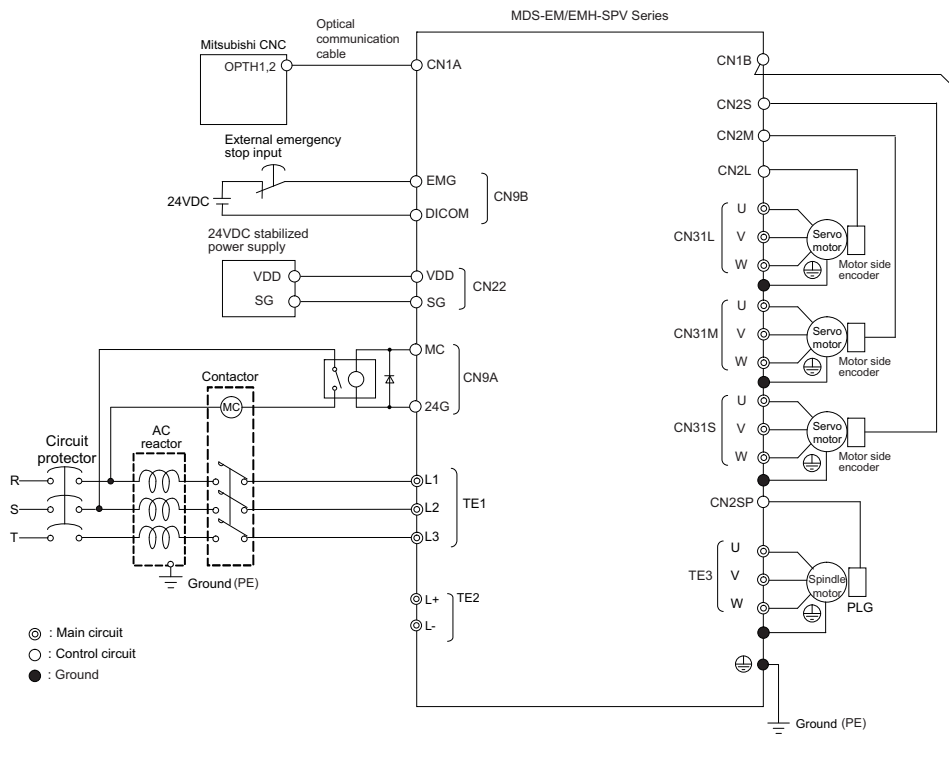

- (Note 1) The total length of the optical communication cable from the NC must be within 30m and the specified bending radius (for wiring inside panel: 25mm, and for wiring outside panel: 50mm) or more.
- (Note 2) The connection method will differ according to the used motor.
- (Note 3) Battery for the encoder back up is built-in the drive unit. (An external battery is available as an option.)
- (Note 4) The main circuit (⊙), control circuit (○) and ground (●) are safely separated.
- (Note 5) Connect the ground of the motor to the ground of the connected drive unit.

2.2 Main Circuit Terminal Block/Control Circuit Connector

2.2.1 Names and Applications of Main Circuit Terminal Block Signals and Control Circuit Connectors

The following table shows the details for each terminal block signal.

Name	Connector name	Description
TE1 (L1, L2, L3)	Main circuit power supply input	Main circuit power supply input terminal For MDS-EM : Connect a 3-phase 200 to 240VAC (50Hz/60Hz) power supply. For MDS-EMH : Connect a 3-phase 380 to 480VAC (50Hz/60Hz) power supply.
TE2 (L+, L-)	Converter power supply output	Converter power supply output terminal Connected when using an additional axis drive unit.
TE3 (U, V, W)	Spindle motor power supply output	Spindle motor power supply output terminal The spindle motor power supply terminal (U, V, W) is connected.
CN22	Control circuit power supply	Control circuit power supply input terminal Connect 24VDC power supply.
CN31L CN31M CN31S	Servo motor power supply output	Servo motor power supply output terminal (L-axis/M-axis/S-axis) The servo motor power supply terminal (U, V, W) is connected.
	Protective grounding (PE)	Grounding terminal The servo motor/spindle motor grounding terminal is connected and grounded.

CAUTION

1. When sharing a circuit protector for several drive units, if a short-circuit fault occurs in a small capacity unit, the circuit protector could trip. This can be hazardous, so do not share the circuit protector.
2. Be sure to use the circuit protector of proper capacity for each unit.

2.2.2 Connector Pin Assignment

⚠ CAUTION

Do not apply a voltage other than that specified in Instruction Manual on each terminal. Failure to observe this item could lead to rupture or damage, etc.

(1) Main circuit terminal block and connector

Terminal		Unit					
		MDS-EM-SPV3-10040 to 200120 MDS-EMH-SPV3-8040 to 10060					
Terminal position							
Terminal specification /Pin assignment	[1] TE1 [3] TE3	<p>[1] L1 L2 L3 [3] U V W</p>	<table border="1"> <tr> <td>Screw size</td> <td>M5 x 12</td> </tr> <tr> <td>Tightening torque</td> <td>2.0Nm</td> </tr> </table>	Screw size	M5 x 12	Tightening torque	2.0Nm
	Screw size	M5 x 12					
	Tightening torque	2.0Nm					
	[2] TE2	<p>L+ L-</p>	<table border="1"> <tr> <td>Screw size</td> <td>M6 x 18</td> </tr> <tr> <td>Tightening torque</td> <td>4.0Nm</td> </tr> </table>	Screw size	M6 x 18	Tightening torque	4.0Nm
	Screw size	M6 x 18					
Tightening torque	4.0Nm						
[4] CN31L [5] CN31M [6] CN31S	<p>U V W</p>						
[7] ⊕		Screw size: M5 × 8 Tightening torque: 2.0Nm					
[8] ⊕		Screw size: M5 × 12 Tightening torque: 2.0Nm					

Terminal		Unit					
		MDS-EM-SPV3-16040S					
Terminal position							
Terminal specification /Pin assignment	[1] TE1 [3] TE3	<p>[1] L1 L2 L3 [3] U V W</p>	<table border="1"> <tr> <td>Screw size</td> <td>M5 x 12</td> </tr> <tr> <td>Tightening torque</td> <td>2.0Nm</td> </tr> </table>	Screw size	M5 x 12	Tightening torque	2.0Nm
	Screw size	M5 x 12					
	Tightening torque	2.0Nm					
	[2] TE2	<p>L+ L-</p>	<table border="1"> <tr> <td>Screw size</td> <td>M6 x 18</td> </tr> <tr> <td>Tightening torque</td> <td>4.0Nm</td> </tr> </table>	Screw size	M6 x 18	Tightening torque	4.0Nm
	Screw size	M6 x 18					
Tightening torque	4.0Nm						
[4] CN31L [5] CN31M [6] CN31S	<p>U V W</p>						
[7] ⊕		Screw size: M5 × 12 Tightening torque: 2.0Nm					
[8] ⊕		Screw size: M4 × 12 Tightening torque: 1.2Nm					

Terminal		Unit					
		MDS-EM-SPV3-320120					
Terminal position							
Terminal specification /Pin assignment	[1] TE1 [3] TE3	<p>[1] L1 L2 L3 [3] U V W</p>	<table border="1"> <tr> <td>Screw size</td> <td>M8 × 16</td> </tr> <tr> <td>Tightening torque</td> <td>6.0Nm</td> </tr> </table>	Screw size	M8 × 16	Tightening torque	6.0Nm
	Screw size	M8 × 16					
	Tightening torque	6.0Nm					
	[2] TE2	<p>L+ L-</p>	<table border="1"> <tr> <td>Screw size</td> <td>M6 × 18</td> </tr> <tr> <td>Tightening torque</td> <td>4.0Nm</td> </tr> </table>	Screw size	M6 × 18	Tightening torque	4.0Nm
	Screw size	M6 × 18					
Tightening torque	4.0Nm						
[4] CN31L [5] CN31M [6] CN31S	<p>U V W</p>						
[7] ⊕		Screw size: M5 × 12 Tightening torque: 2.0Nm					
[8] ⊕		Screw size: M8 × 16 Tightening torque: 6.0Nm					

(2) Control circuit connector

Terminal		Unit	MDS-EM-SPV3-10040 to 320120,16040S MDS-EMH-SPV3-8040 to 10060
Terminal position			
Connector specification	[1] CN9A [2] CN9B	Pin No. No.20 No.10 No.11 No.1	
	[3] CN22	 1 VDD 2 SG	
	[4] CN1A [5] CN1B	Optical communication connector 	
	[6] BTI		
	[7] BTO		
	[8] CN2SP [9] CN3SP [10] CN2L [11] CN2M [12] CN2S [13] CN3L [14] CN3M [15] CN3S	No.9 No.1 No.10 No.2	
	[16] CN5A [17] CN5B	 No.1 No.5	

(Note) The illustrations of drive units are shown as an example. The connector and terminal block layout may differ according to the unit being used. Refer to each unit outline drawing for details.

2.2.3 Servo Motor Power Supply Connector Wiring Method

(1) Connector configuration

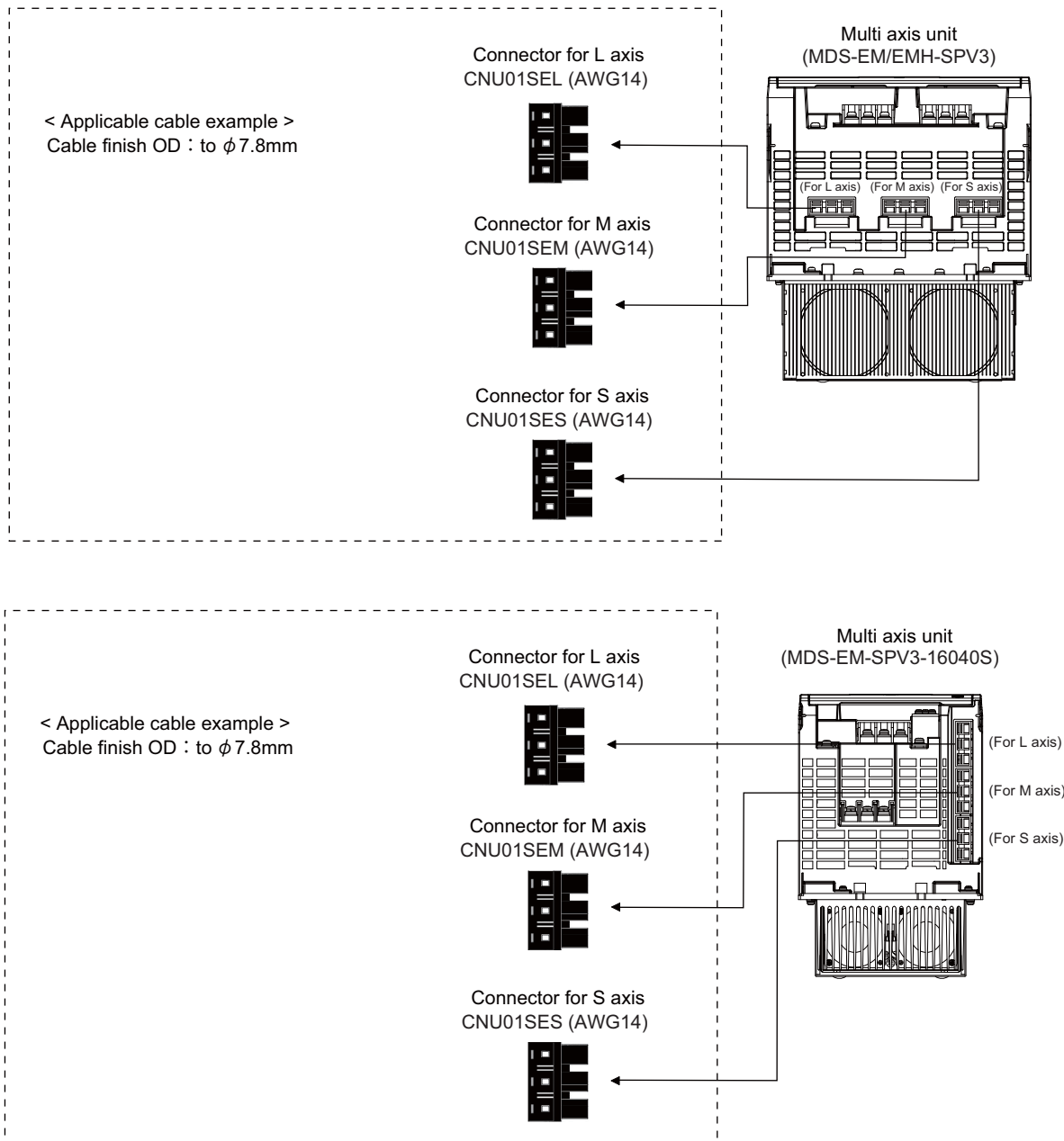

Axis name	Connector model name	Applicable cable		Strip length [mm]	Connection lever	Manufacturer
		Size	Insulator outer dimension			
L axis	CNU01SEL (AWG14)	AWG16 to 8	7.8mm or less	12mm	J-FAT-OT-P	J.S.T
M axis	CNU01SEM (AWG14)					
S axis	CNU01SES (AWG14)					
Common	CNU01SEF (AWG14)					

POINT

The servo motor power supply connector is equipped with an anti-misinsertion mechanism, and can be connected only to the power supply output of each certain axis. The connector without the anti-misinsertion mechanism (CNU01SEF (AWG14)) can be connected to the power supply output of all axes.

(2) Cable connection procedure

(a) Processing of power insulator

Since the strip length of wire depends on the types of wire, etc., decide the optimum length according to the machining state.

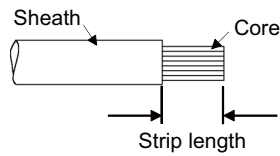

Retwist and straighten the core as shown below.

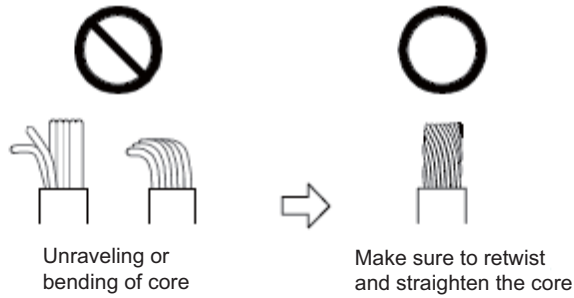

(3) Insertion of the cable

Insert the connection lever as shown in the following illustration, and push it down to open the spring. Keep the connection lever pushed down and insert the stripped wire to the insert hole. Confirm the insert depth so that the wire insulator is not caught.

Release the connection lever to fix the wire. Pulling the wire for confirming the secure connection.

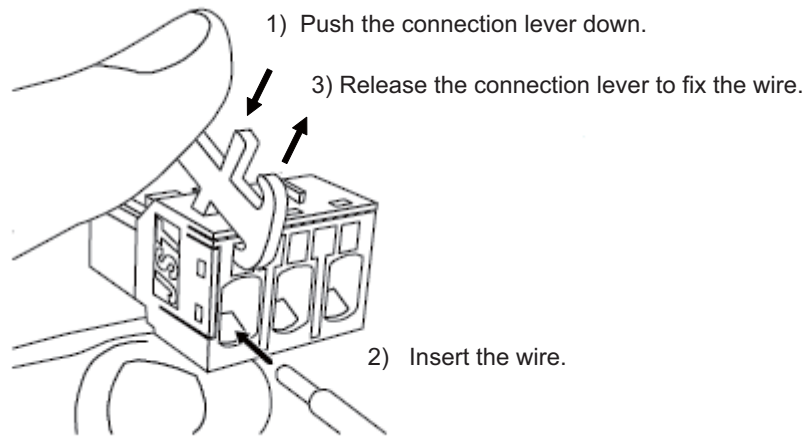

2.3 NC and Drive Unit Connection

2.3.1 Connection of Optical Communication Cables

Connect the optical communication cables from the NC to the each drive unit so that they run in a straight line from the NC to the drive unit that is a final axis. And up to 16 axes can be connected per system.

Note that the number of connected axes is limited by the NC.

CAUTION

Connect the NC and the drive units by the optical communication cables. The distance between the NC and the final drive unit must be within 30m and the specified bending radius (for wiring inside panel: 25mm, and for wiring outside panel: 50mm) or more.

POINT

Axis Nos. are determined by the rotary switch for setting the axis No. (Refer to section "Setting the rotary switch".) The axis No. has no relation to the order for connecting to the NC.

(1) When using only MDS-EM/EMH-SPV Series

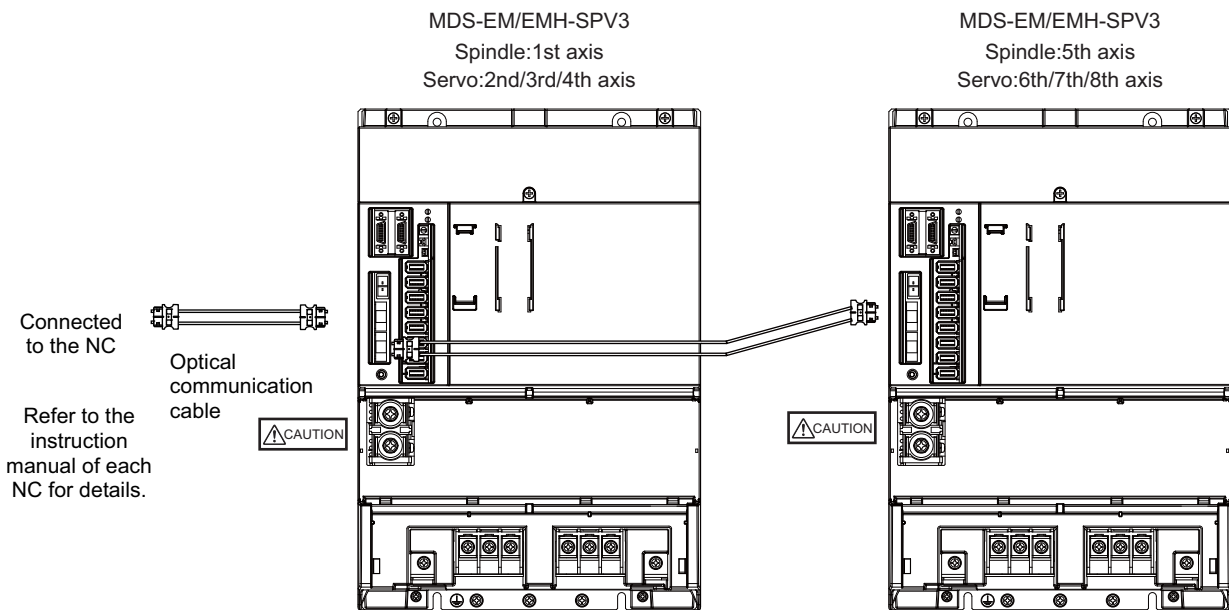

CAUTION

Confirm that the TE2 (L+, L-) wiring is not connected to other power supply before turning the power ON.

(2) When using the MDS-E/EH unit together

The power (L+, L-) can be supplied to the additional axis drive unit by using the power supply part which is built into MDS-EM/EMH. For the additional axis unit receiving power (L+,L-) from the MDS-EM/EMH unit, the optical cable must be connected at the NC side of the MDS-EM/EMH unit.

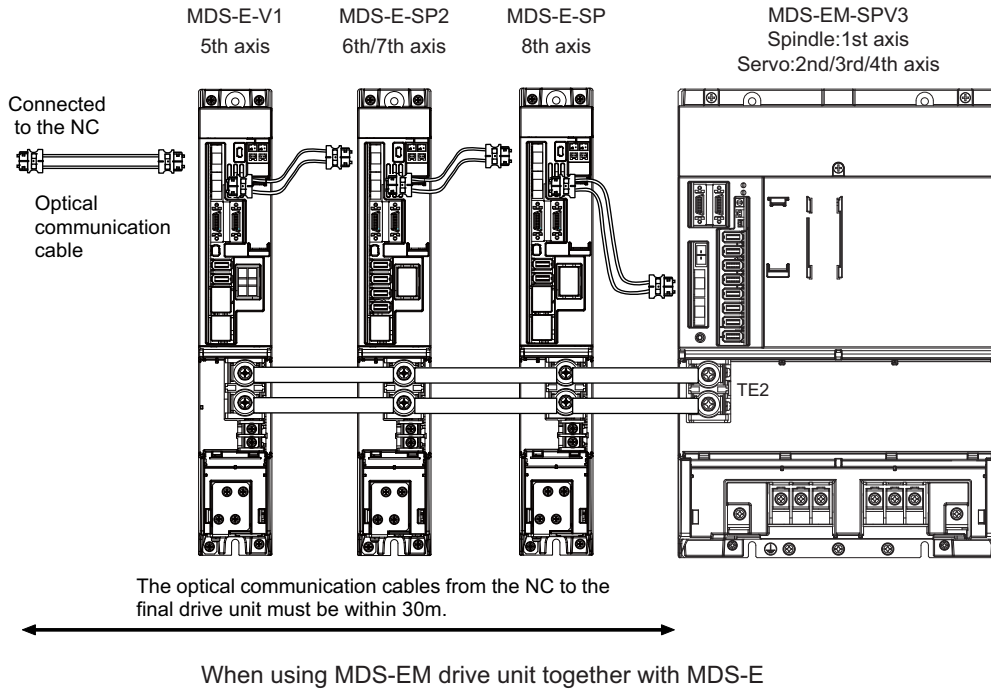

CAUTION

There is a limit to the combination of the drive unit.

Refer to "7.3 Selection of the Additional Axis Drive Unit" in MDS-EM/EMH Series Specifications Manual (IB-1501238(ENG)).

2.4 Motor and Encoder Connection

2.4.1 Connection of the Servo Motor

(1) Connecting the HG96(B)

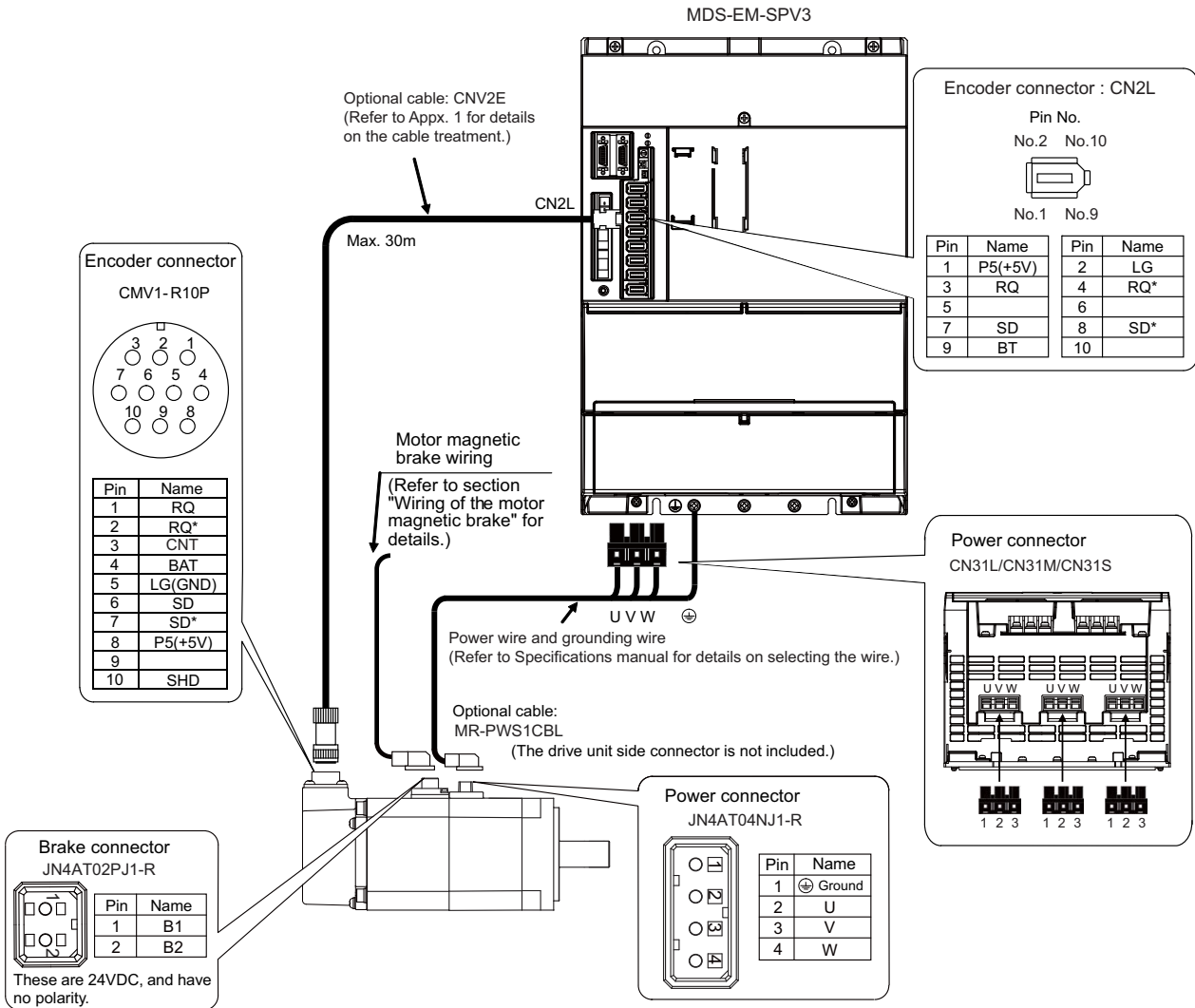

(2) Connecting the HG75(B) / HG105(B) / HG54(B) / HG104(B) / HG154(B) / HG224(B) / HG123(B) / HG223(B) / HG142(B) / HG-H54(B) / HG-H104(B) / HG-H154(B)

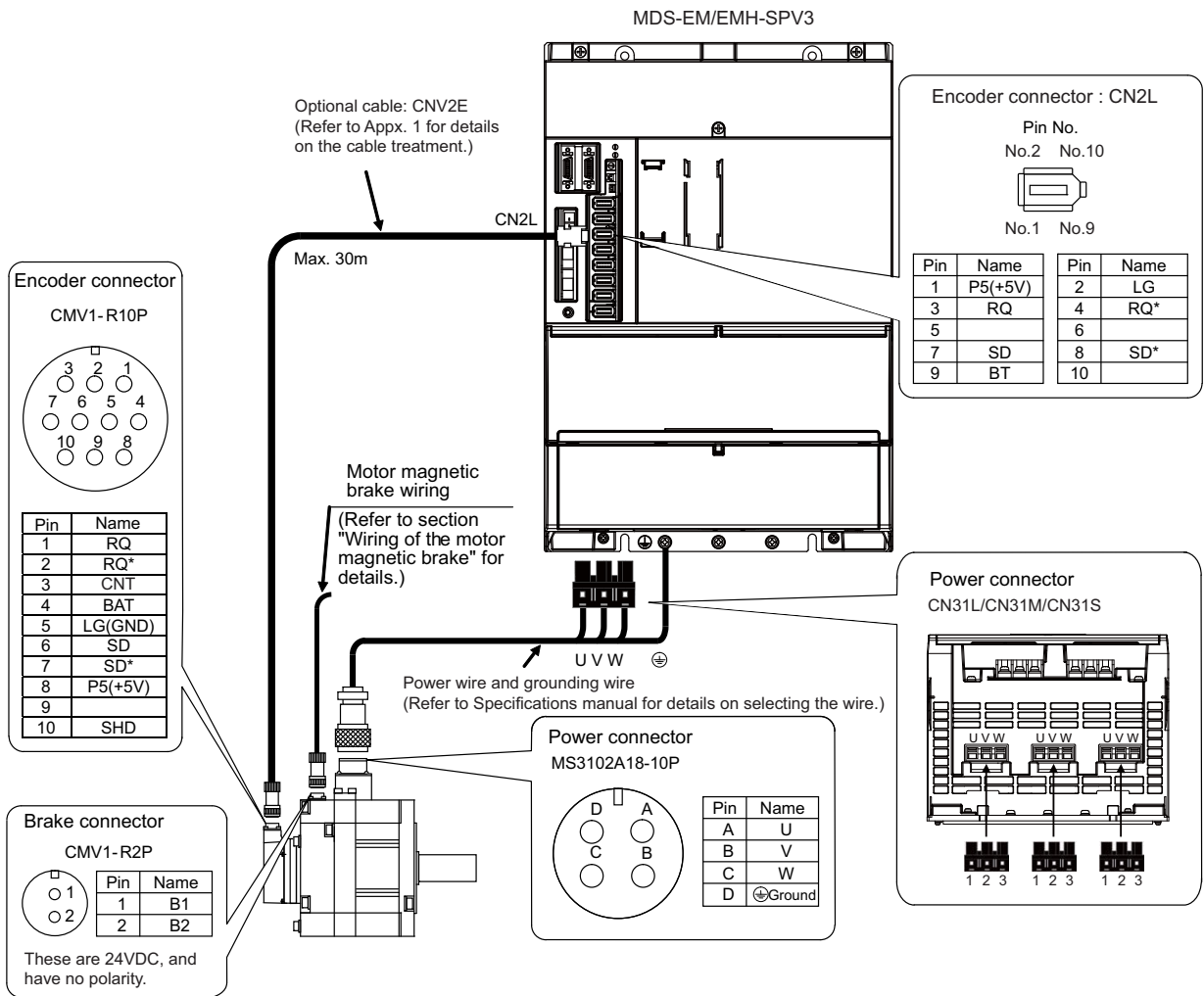

(3) Connecting the HG204(B) / HG354(B) / HG303(B) / HG453(B) / HG302(B) / HG-H204(B) / HG-H354(B) / HG-H453(B)

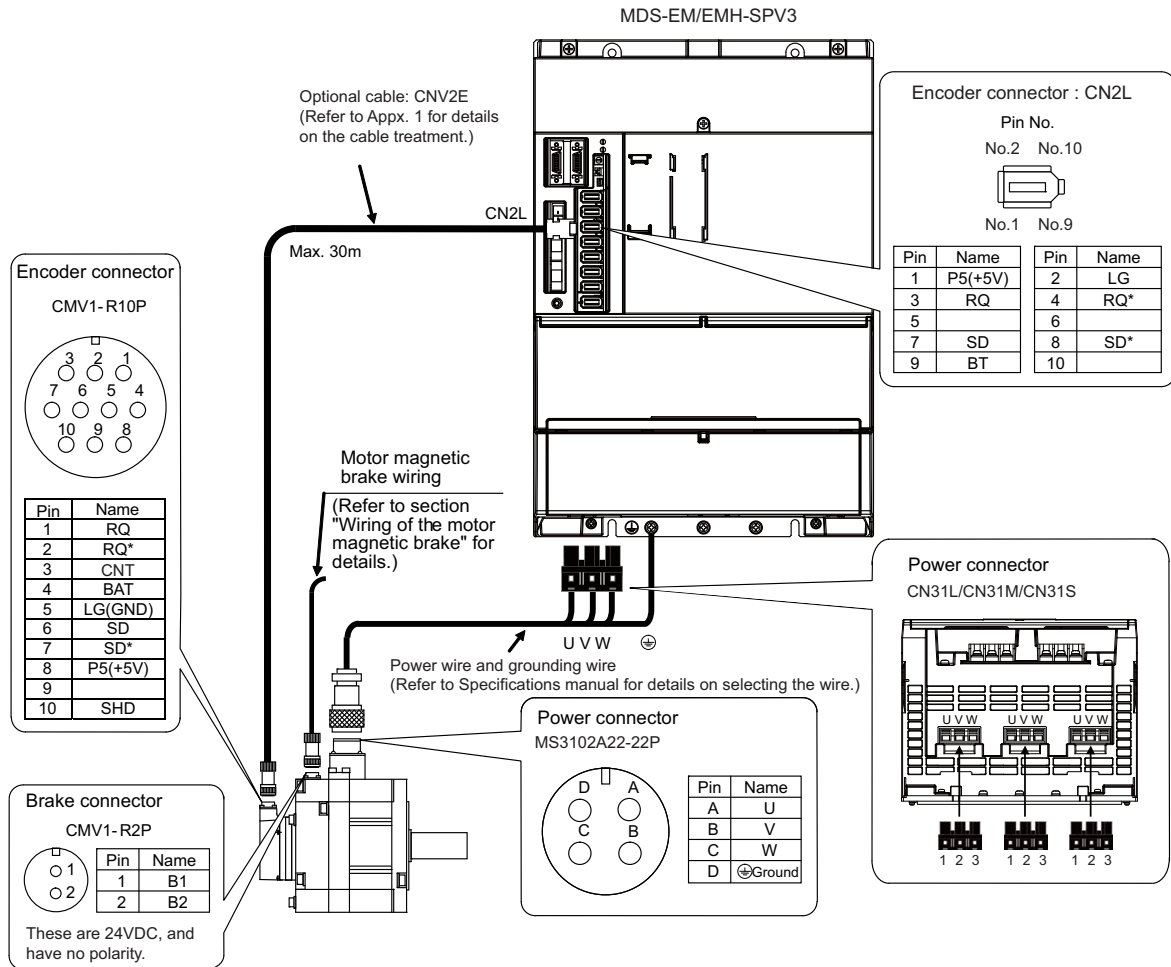

(4) Connecting the HG702(B)

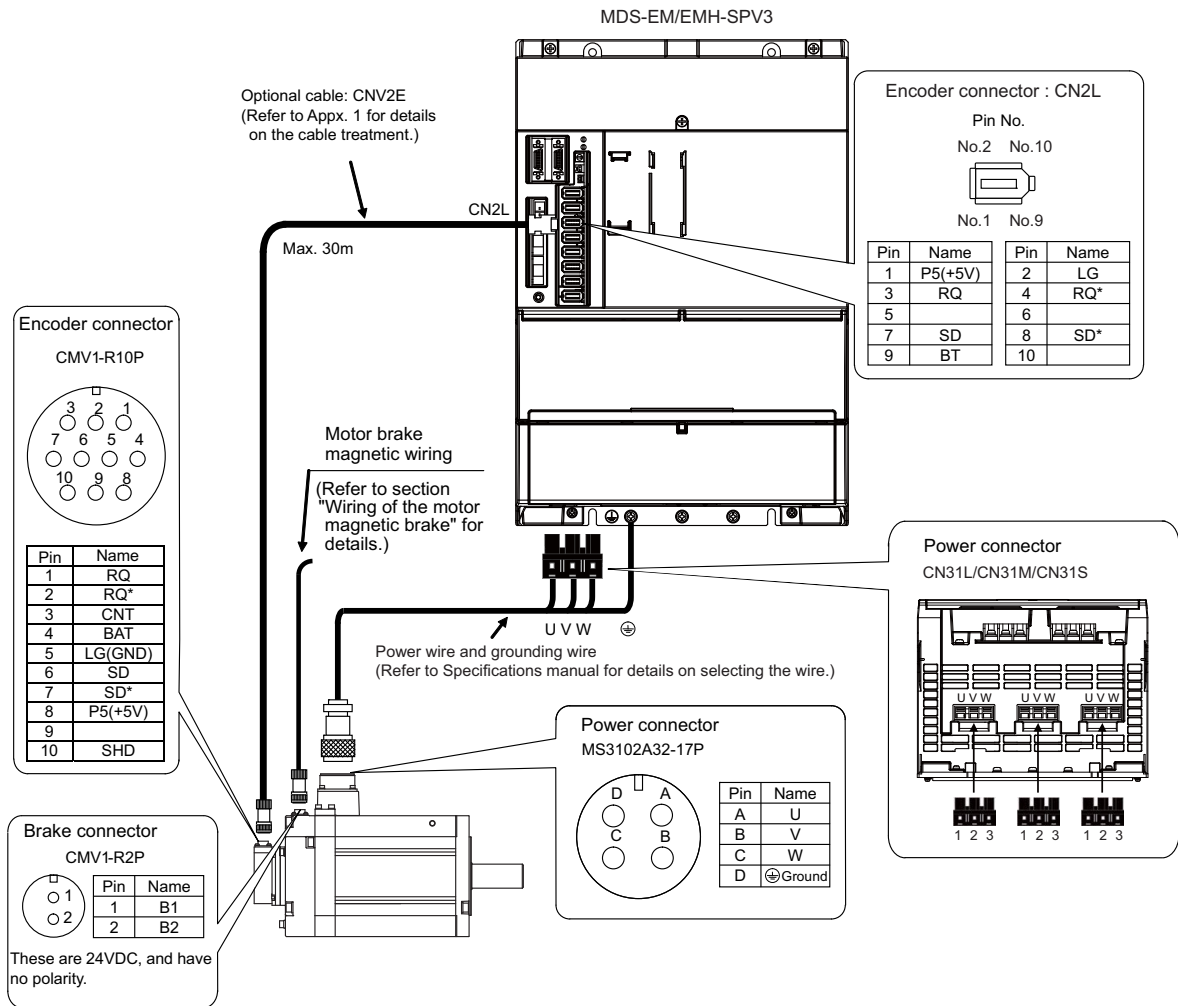

(5) Connecting the HK76(B) / HK105(B) / HK55(B) / HK104(B) / HK123(B) / HK142(B) / HK154(B) / HK223(B) / HK224(B)
 HK-H55(B) / HK-H104(B) / HK-H154(B)

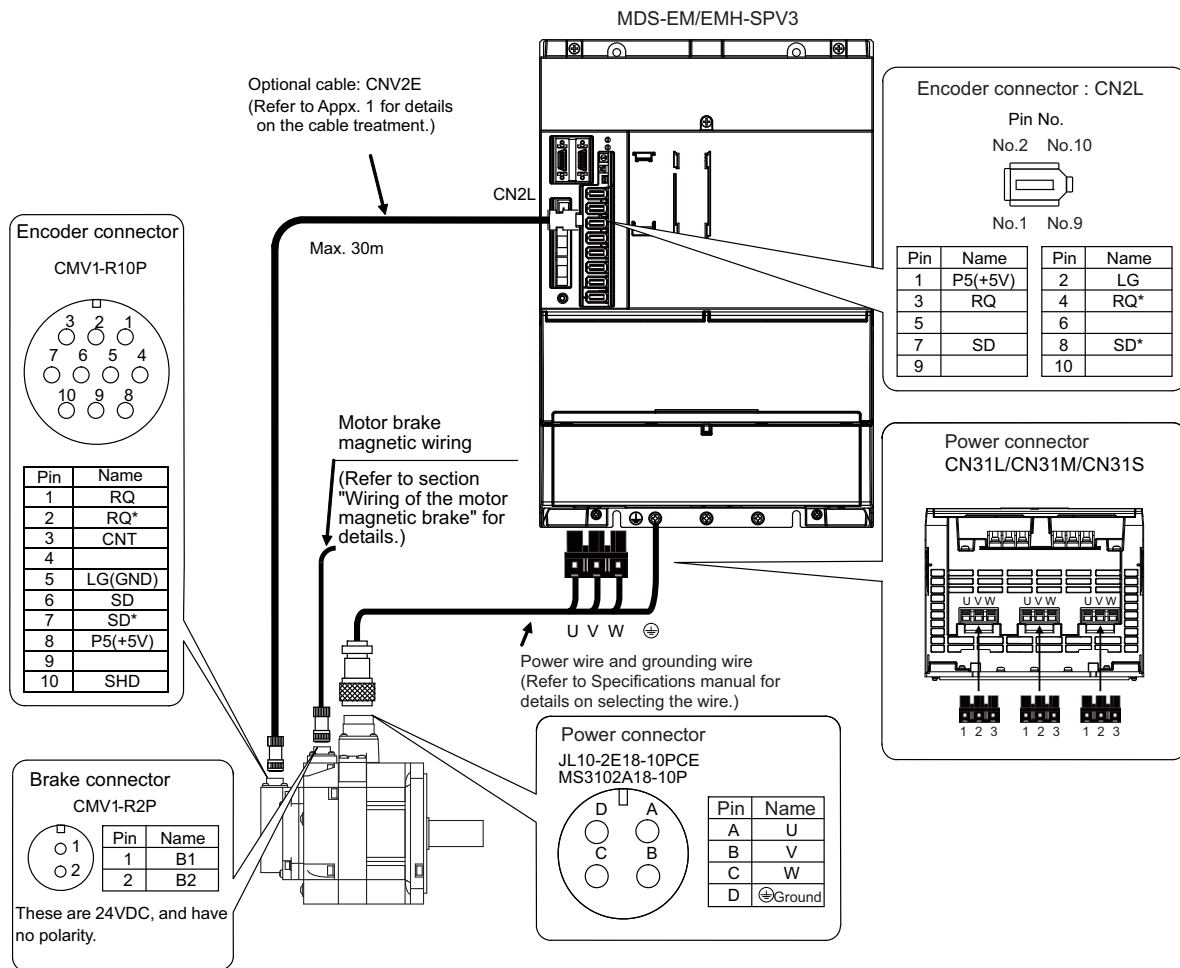

(6) Connecting the HK204(B) / HK302(B) / HK303(B) / HK354(B) / HK453(B) / HK702(B)
 HK-H204(B) / HK-H354(B) / HK-H453(B)

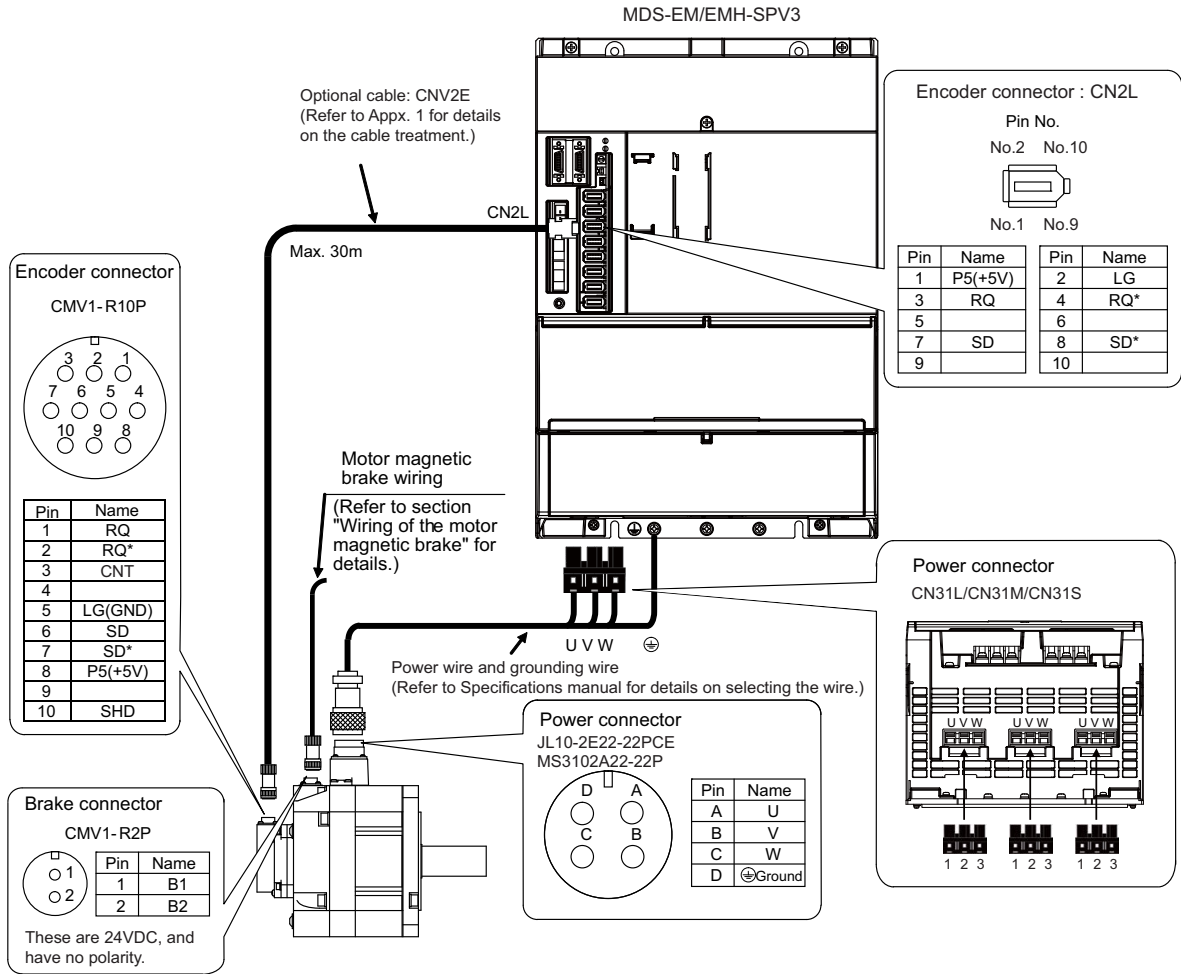

2.4.2 Connection of the Full-closed Loop System

Refer to the section "Connection of the servo motor" for details on connecting each motor type and wiring the power line or the motor magnetic brake.

(1) Connecting the ball screw side encoder

Connect the ball screw side encoder cable to CN3L(CN3M for M axis of dual-axis unit). Option battery is required for the absolute position system.

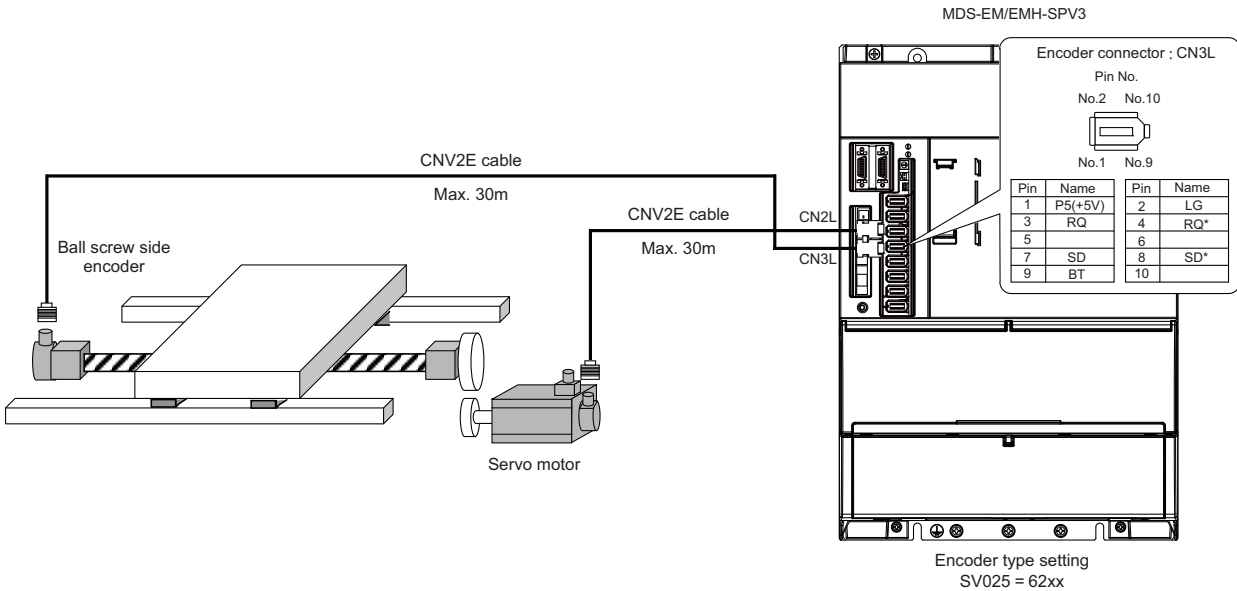

(2) Connecting the linear scale (For Mitsubishi serial signal output)

Mitsubishi serial signal output (including when SIN wave signal output is converted to Mitsubishi serial signal output with a scale manufacturer encoder interface unit) can directly connect to the drive unit.

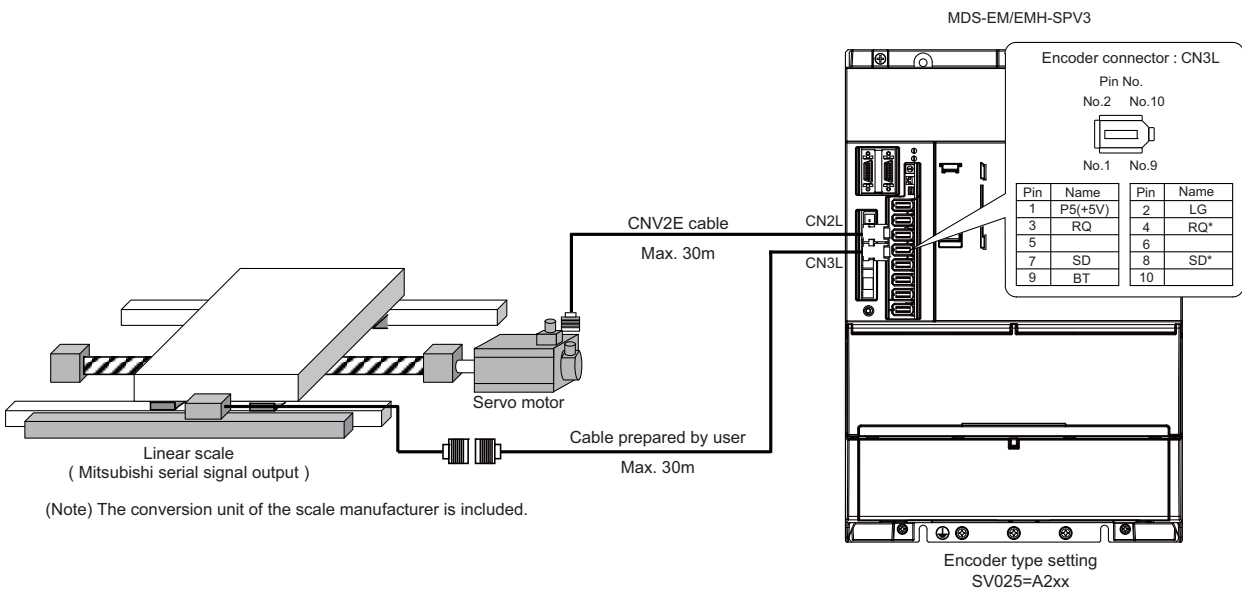

(Note) The conversion unit of the scale manufacturer is included.

(3) Connecting the linear scale (for rectangular wave signal output)

Rectangular wave signal output (including when SIN wave signal output is converted to the rectangular wave signal output with a scale manufacturer encoder interface unit) can directly input to the drive unit.

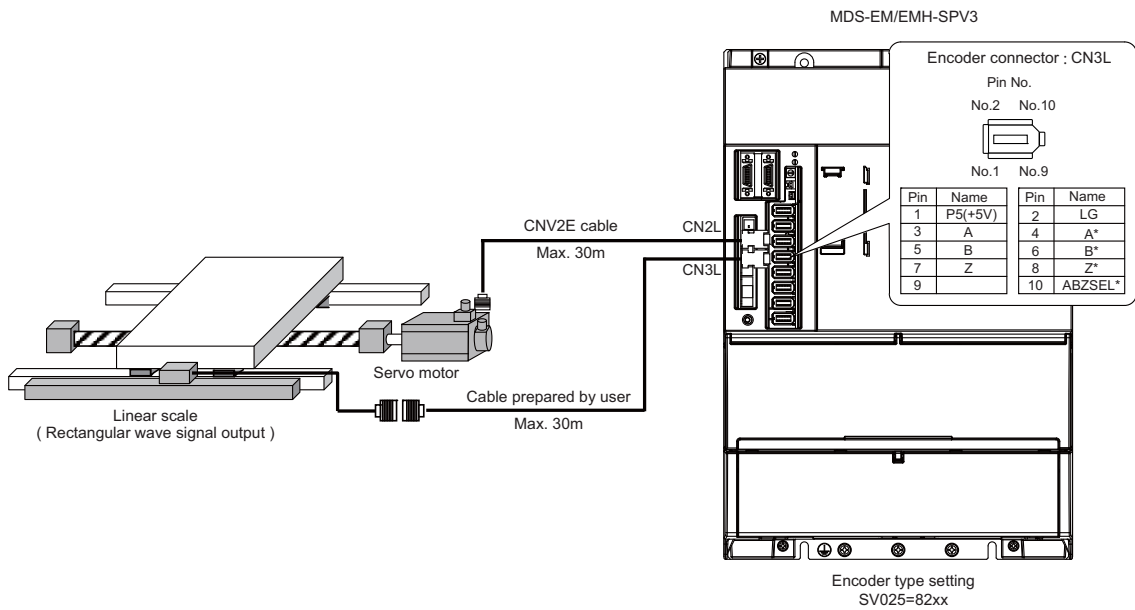

(4) Connecting the linear scale (for SIN wave signal output)

SIN wave signal output is converted to Mitsubishi serial signal output with the encoder interface unit (MDS-EX-HR). The distance-coded reference scale interface is also available.

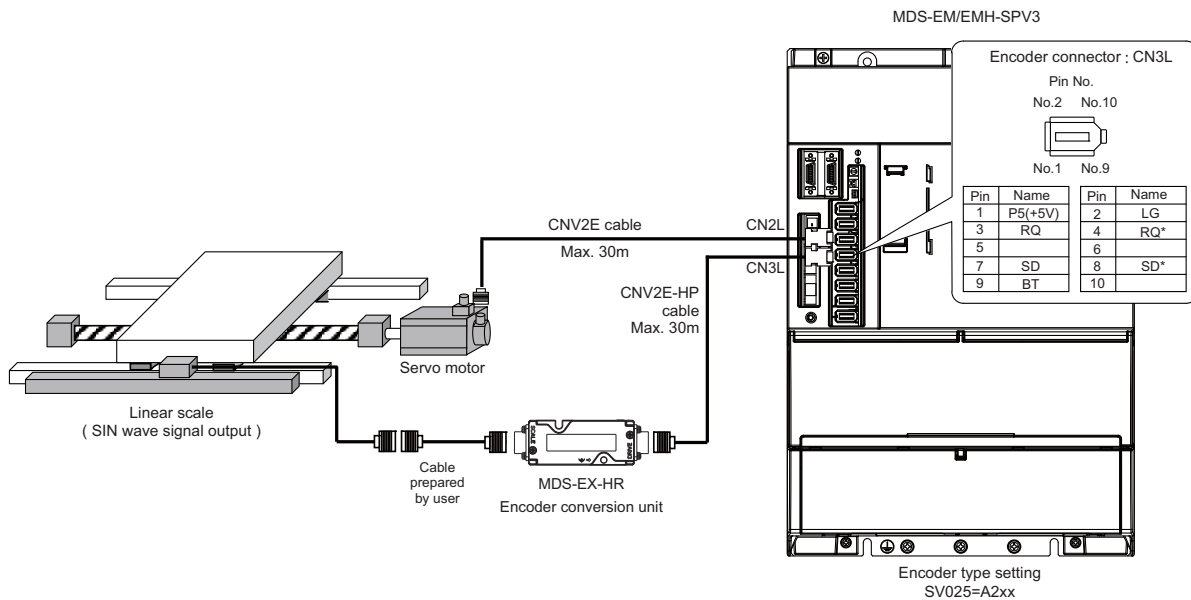

2.4.3 Connection of the Spindle Motor

Refer to each motor specifications for details on the motor side connection destination, specifications and outline, and for the spindle PLG encoder specifications.

(1) Connecting the motor built-in PLG

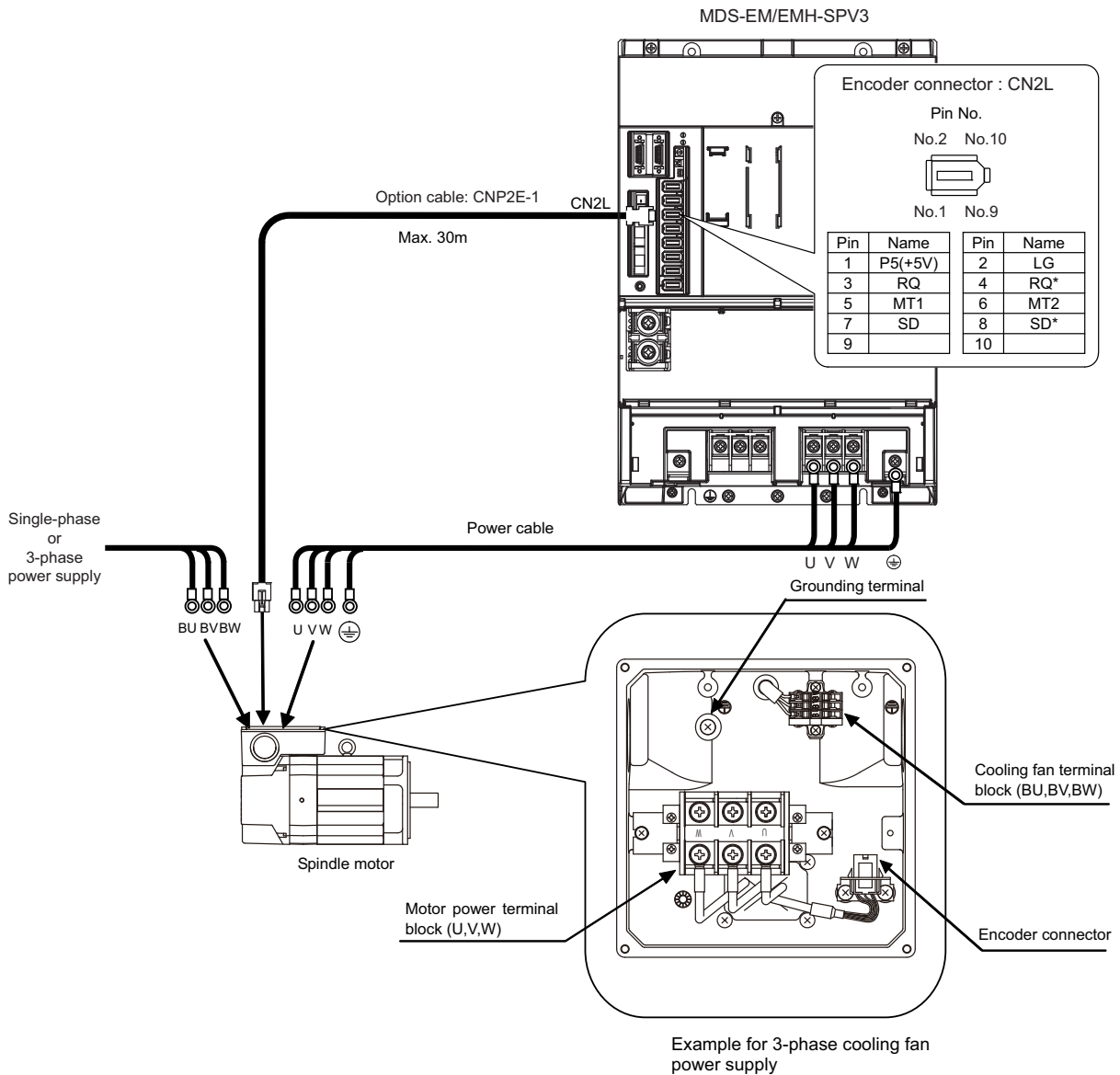

(Note) Either a single-phase or 3-phase power supply is used for the cooling fan. Refer to the Spindle Motor Specifications for details.

⚠ CAUTION

For a 3-phase cooling fan, when the phase sequence of the 3-phase power supply is connected reversely, its cooling capacity degrades due to the reversed rotation direction. Make sure the air blowoff direction.

When the fan rotates reversely, reconnect BU and BW reversely, and then check the blowoff direction.

(2) Connecting the spindle side ABZ pulse output encoder (OSE-1024-3-15-68, OSE-1024-3-15-68-8)

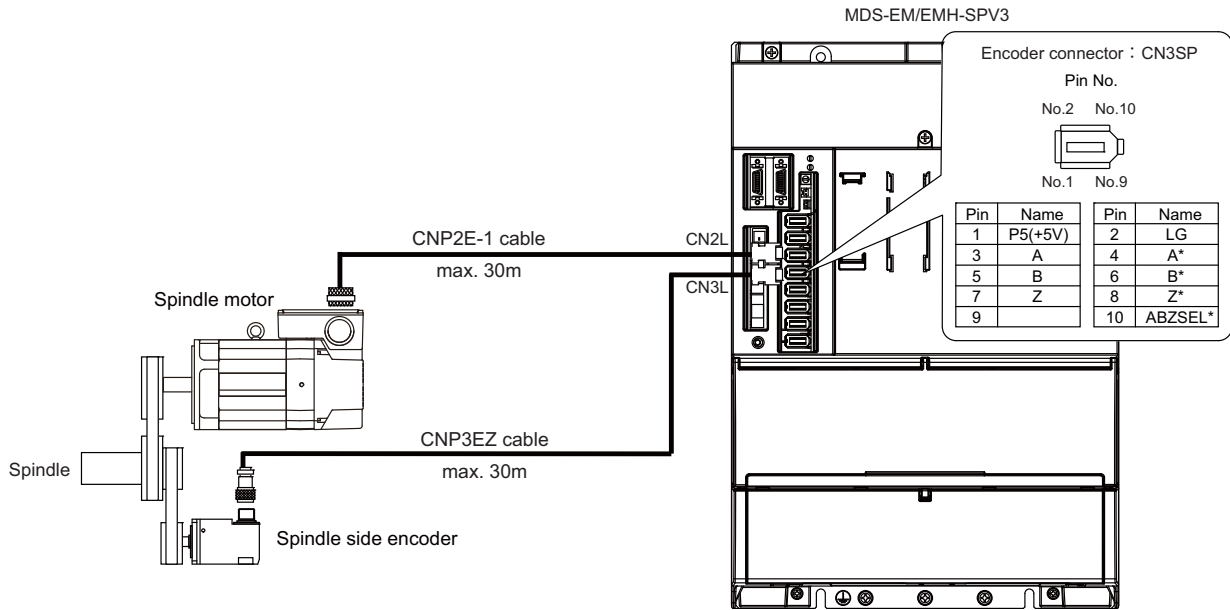

(Note) Confirm that the gear ratio (pulley ratio) of the spindle end to the encoder is 1:1. Use a timing belt for connecting.

(3) Connecting the spindle side PLG serial output encoder (TS5690)

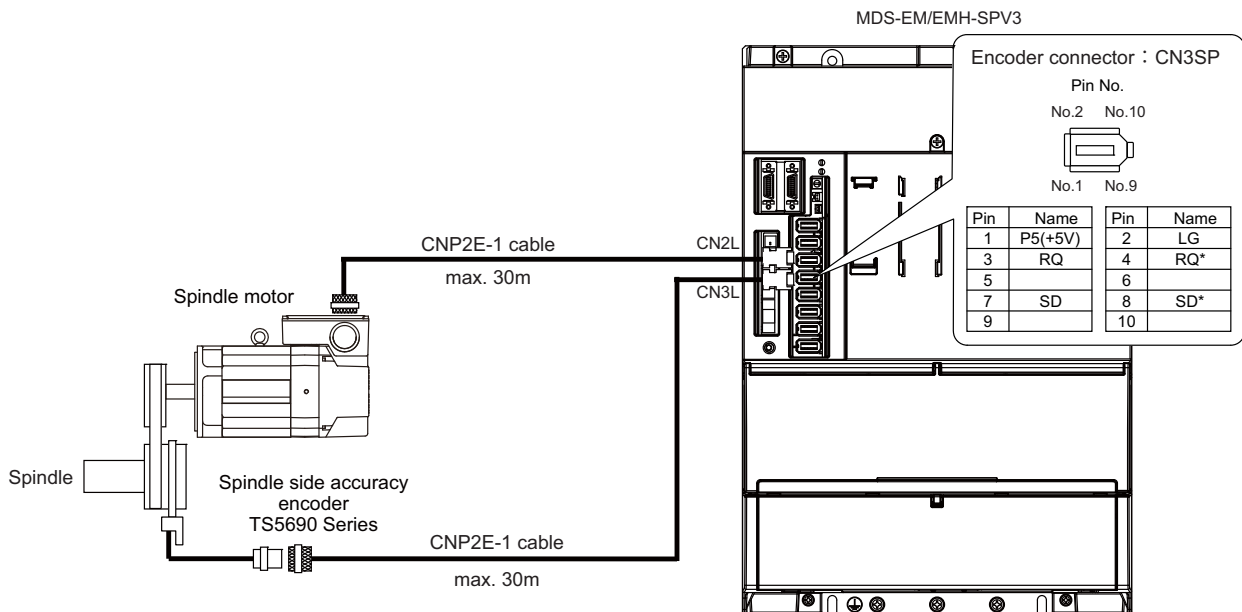

2.5 Connection of Power Supply

⚠ CAUTION

1. Make sure that the power supply voltage is within the specified range of each unit. Failure to observe this could lead to damage or faults.
2. For safety purposes, always install a circuit protector, and make sure that the circuit is cut off when an error occurs or during inspections.
3. The wire size will differ according to each drive unit capacity.
4. For safety purposes, always install a magnetic contactor (contactor) on the main circuit power supply input. Large rush currents will flow when the power is turned ON.

2.5.1 Power Supply Input Connection

(1) When using one MDS-EM/EMH-SPV3

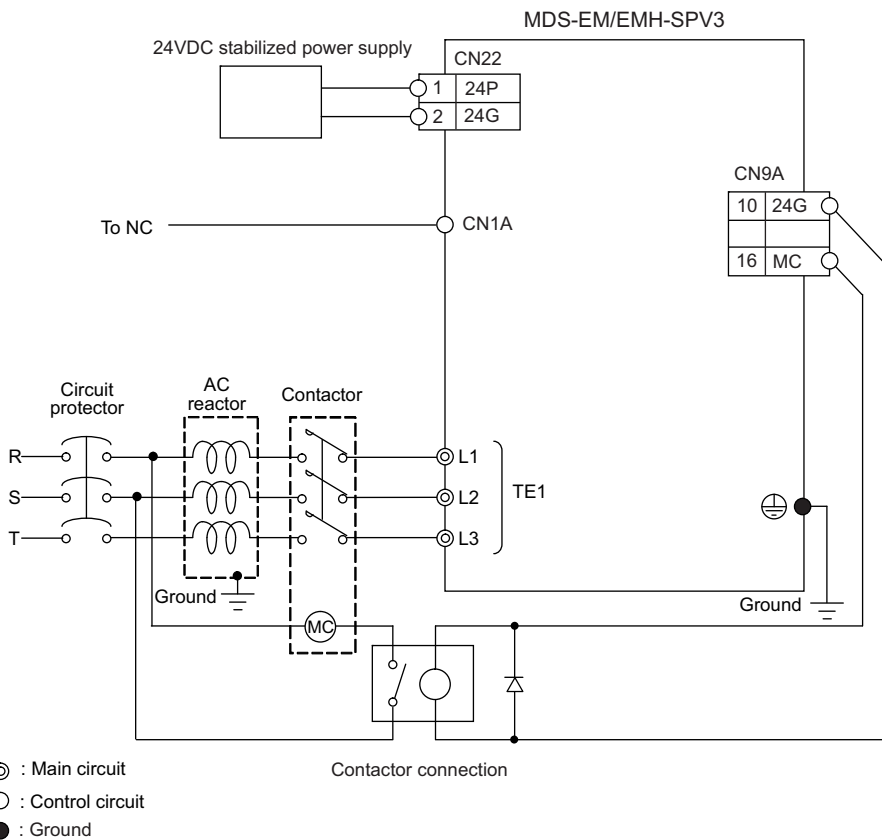

⚠ CAUTION

Multi axis unit is equipped with a power supply regenerative type converter; an AC reactor is surely installed in the power supply line.

(2) When using MDS-EM/EMH-SPV3 together with MDS-E/EH

Install the unit so that the total wiring length of DC power supply terminals TE2 (L+, L-) is 800mm or less.

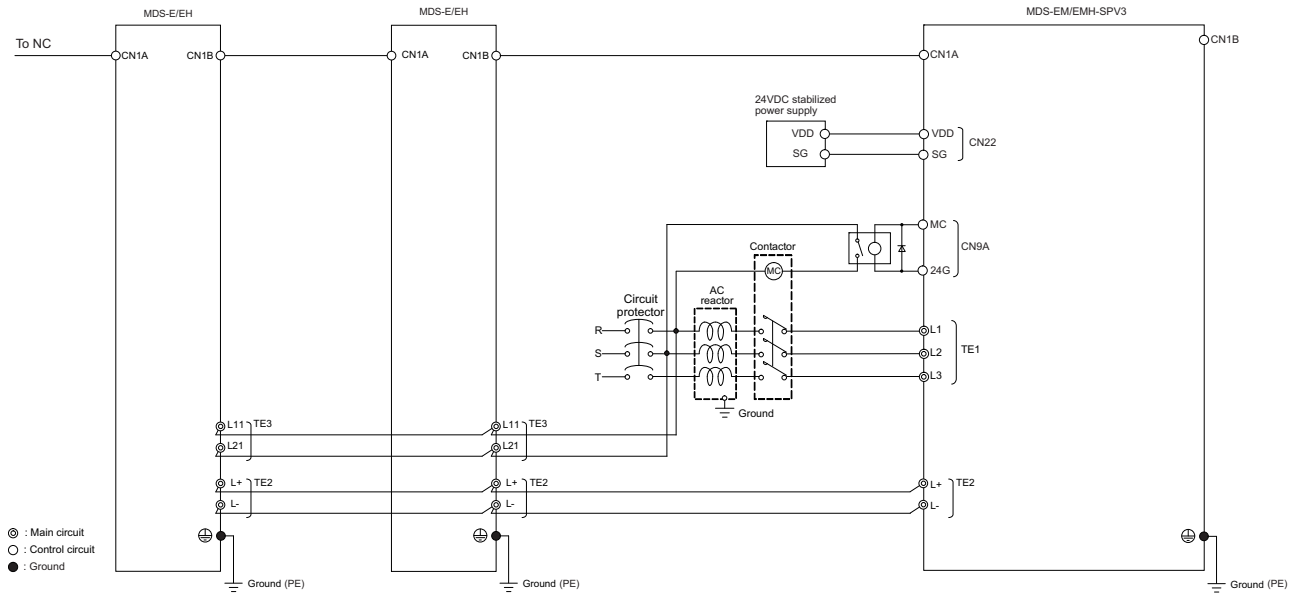

(3) When using two MDS-EM/EMH-SPV3 units

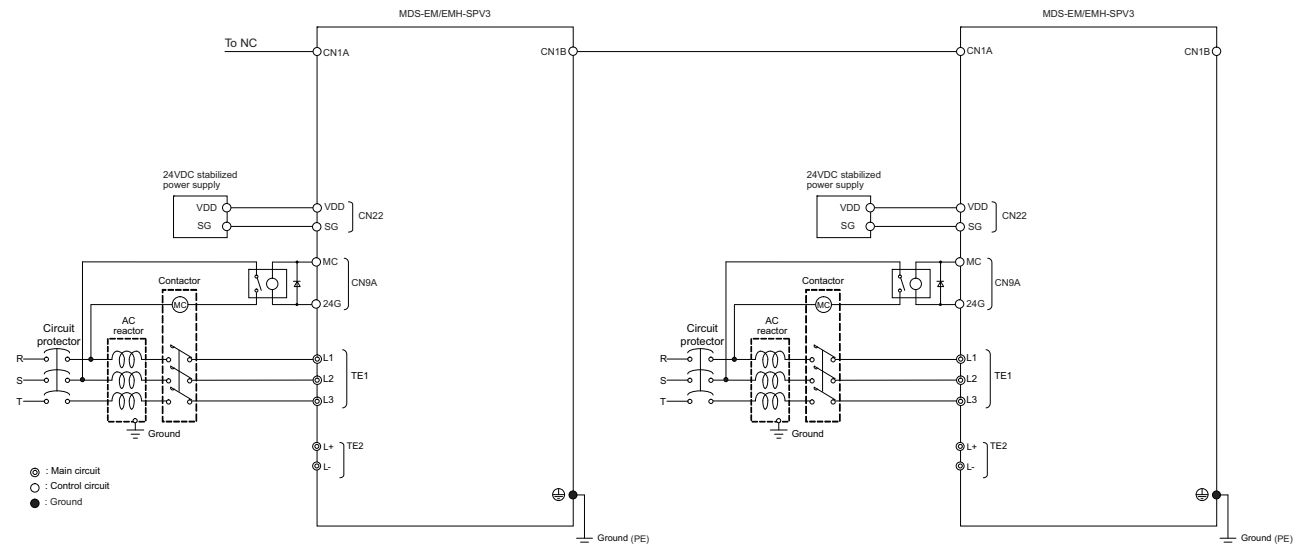

CAUTION

1. When installing the additional axis unit, install the spindle drive unit with maximum capacity adjacent to the MDS-EM/EMH-SPV3, and connections for other drive units should be such that the total TE2 wiring length is 800mm or less.
2. Make sure that the total capacity of the drive units connected to the same MDS-EM/EMH-SPV3 unit meets the unit's selected capacity.
3. Confirm that the TE2 (L+, L-) wiring is not connected to other power supply before turning the power ON.

2.5.2 Connection of the Grounding Cable

(1) Connecting the protective grounding (PE) and frame ground (FG)

Each unit has a terminal or mounting hole to connect PE(⊕) or FG.

Please connect a grounding cable to the main ground of a cabinet or a machine frame at one point.

Ground each device according to the grounding conditions set forth by each country. (Typically, a Y-connection neutral point ground is used in Europe.)

PE: Grounding to provide protection from electric shock, etc.

FG: Grounding to stabilize the operation of the devices, etc. (Suppress noise)

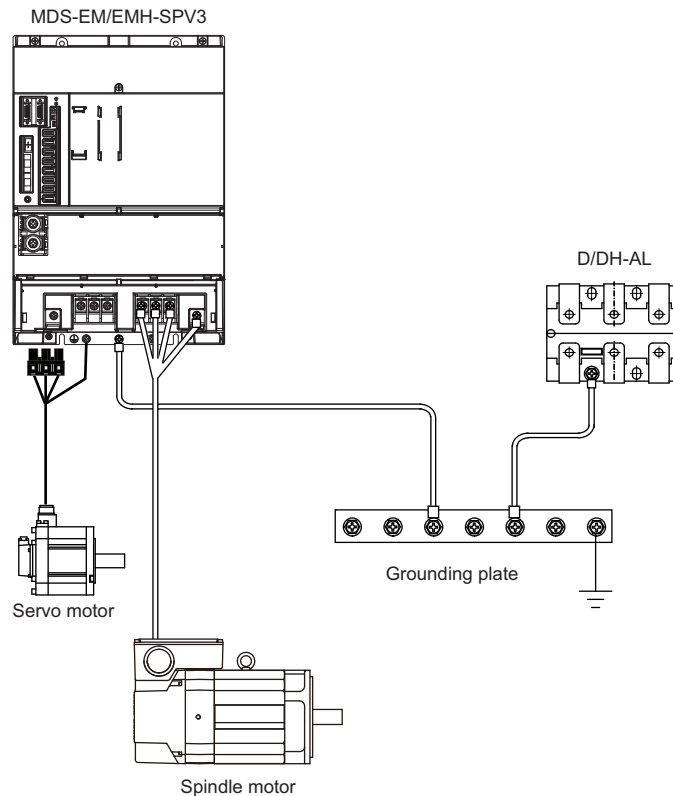

POINT

Do not connect the grounding cable from each unit directly to the grounding plate. Noise from other units could result in malfunctions.

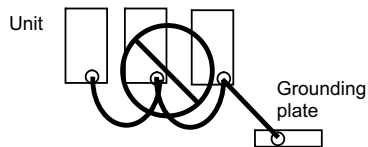

(2) Grounding cable size

Earth wire size should follow the following table.

Type	Grounding cable size (Required grounding)
MDS-EM/EMH-SPV3 Unit	Larger than thickness of wire connected to TE1 (L1/L2/L3). (PE)
D/DH-AL (AC Reactor)	5.5 mm ² (AWG10) or more (FG)

2.6 Wiring of the Motor Brake

This section "2.6 Wiring of the Motor Brake" explains motor brake control when not using safe brake control (SBC).

When using safe brake control (SBC), refer to "3.3. SBC (Safe Brake Control)". Note that for safe brake control the wiring and control sequence are different to the contents in this section.

2.6.1 Wiring of the Motor Magnetic Brake

The magnetic brake of servo motors with a magnetic brake is controlled by the motor brake control connector (CN9B-8 pin) on the servo drive unit. The servo drive unit releases the brake when the motor is ON. (Servo ON means when torque is generated in the motor.)

(1) Motor brake control output circuit

As shown in the illustration below, a power supply for motor brake is controlled by the DO output of CN9B through the relay. Always install the diode as shown below.

(Tolerable current: 40mA or less, Rush current: 100mA or less)

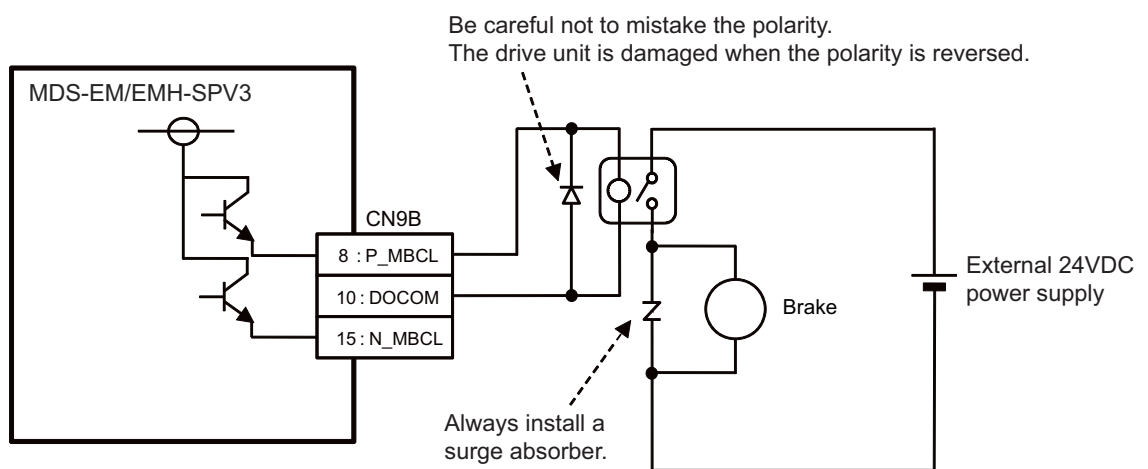

CAUTION

1. Always install a surge absorber near the motor's brake terminal to eliminate noise and protect the contacts.
2. The brakes cannot be released just by connecting the CN9B and motor brake terminal. 24VDC must be supplied.
3. When using brakes in multiple servo axes in a drive unit, apply parallel circuit for the output circuit of CN9B.
4. For the 24V power supply used in the motor brake circuit, use the one separated from the 24V power supply for the control circuit.

(2) Motor brake release sequence

The motor brake control connector (CN9B) releases the magnetic brake in the following sequences after the start of the power ON to the servo motor when canceling the emergency stop.

If the power supply part has been charged by the servo parameter setting, the time to the Ready completion can be reduced.

#2217(PR) SV017 SPEC1 Servo specification 1

bit 2 : seqh Ready on sequence

0: Normal 1: High-speed

#13017(PR) SP017 SPEC1 Spindle specification 1

bit 2 : seqh READY ON sequence

0: Normal 1: High-speed

[1] When SV017 is set to bit2 = 0:

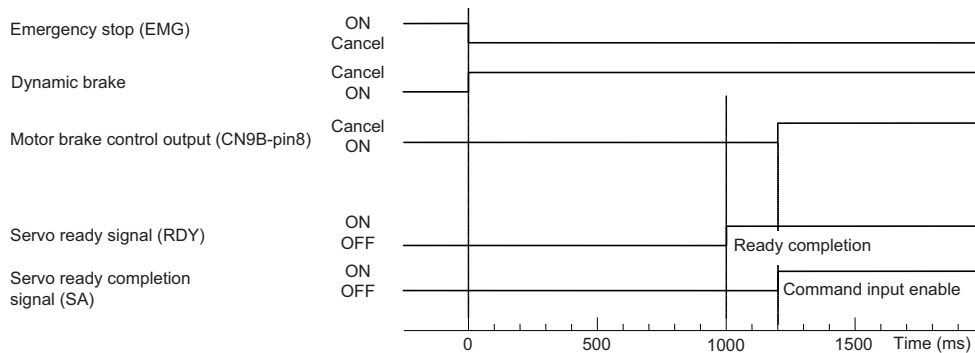

Motor brake control sequences when an emergency stop is canceled 1

[2] When SV017 is set to bit2 = 1:

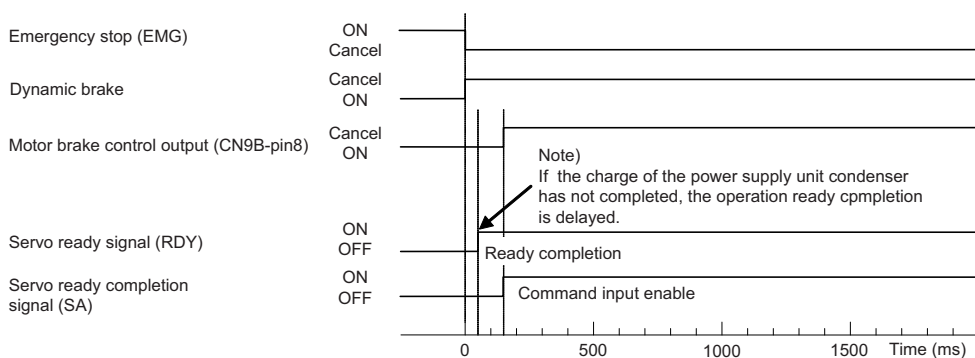

Motor brake control sequences when an emergency stop is canceled 2



POINT

Using the Quick READY ON sequence, set the parameter for all the axes including the spindle. Especially when it is not set for the power supply control axis, power supply will not work at high-speed sequence.

(3) Control during the servo OFF command

When a servo OFF command is input by an NC sequence input, the motor brake turns ON simultaneously when the motor ON is shut off. Note that the vertical axis drop prevention control is not validated, so a drop due to the brake operation lag occurs. When the servo OFF is canceled, a drop due to an uncontrolled state does not occur.

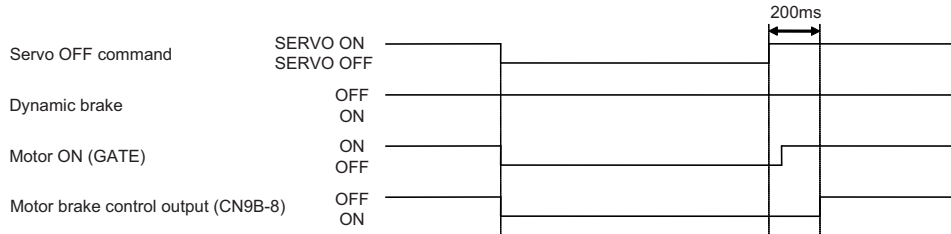

Motor brake control sequences when a servo OFF command is output

CAUTION

The vertical axis drop prevention control only is performed during an emergency stop (including alarms and power failures). It is not performed when a servo OFF command is input.

< Caution in use of MDS-EM/EMH Series >

When not using safe brake control (SBC), it is required to input a servo OFF command to all axes of a drive unit in order to turn the brake ON with a motor brake control output. Inputting the servo OFF command to one or two axes cannot turn the brake ON. Therefore, when performing a control to fix the position with the motor brake by the servo OFF command during the motor stop for PLC axis, use 1-axis drive unit. During emergency stop, the servo OFF is applied to all axes at same time, so a brake control is not affected.

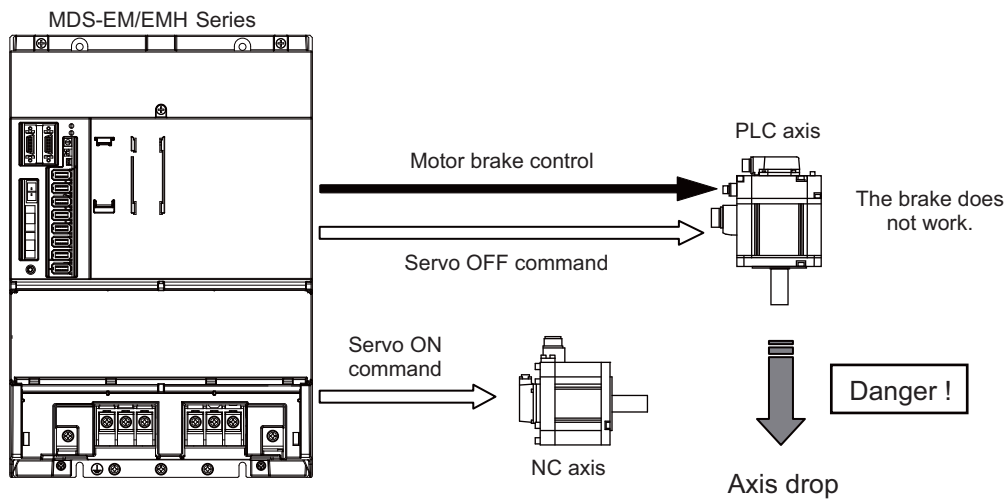

(4) Operation sequences when an emergency stop occurs

The motor brake control output operation when an emergency stop occurs differs according to the motor deceleration stop method. Refer to section "Settings for emergency stop" for details on the operation sequences for each stop method.

2.7 Peripheral Control Wiring

2.7.1 Input/output Circuit Wiring

CN9A/CN9B connector is equipped with 24V input/output circuit for the control of external devices and the control by an external signal.

Set the relevant parameters and use them with care for the wiring since some signals are changeover type, which can be switched over by parameters. Refer to the description of each function in relevant sections for details on the function specifications and settings.

Connector	Input condition		Connector	Output condition	
CN9A CN9B	Switch ON	18VDC to 25.2VDC 4.3mA or more	CN9A CN9B	Output voltage	24VDC ±5%
	Switch OFF	4VDC or less 2mA or less		Tolerable output current	50mA or less

For a switch or relay to be wired, use a switch or relay that satisfies the input/output (voltage, current) conditions.

Interface name	Selection example
For digital input signal (CN9A/CN9B)	Use a minute signal switch which is stably contacted and operated even with low voltage or current <Example> OMRON: G2A, G6B type, MY type, LY type
For digital output signal (CN9A/CN9B)	Use a compact relay operated with rating of 24VDC, 50mA or less. <Example> OMRON: G6B type, MY type

Input circuit

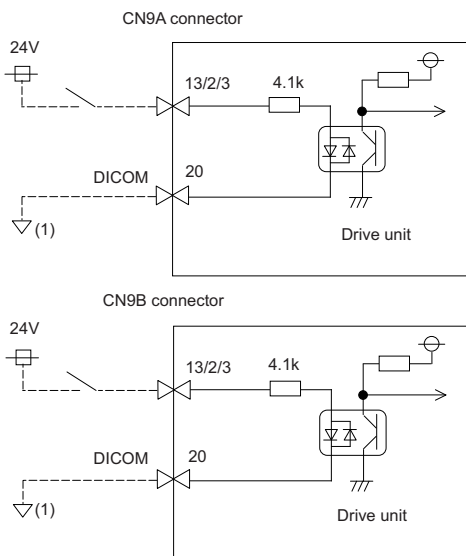

Output circuit

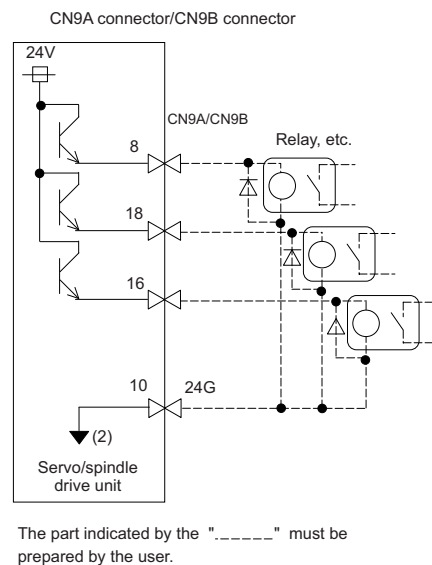

(Note) Do not connect "(1)" or "(2)".

If a ground of the external 24V power is same as the 24V power in the drive unit, a fault or abnormal operation could occur.

Servo input/output signal (CN9A,CN9B connector)

	Device name	Connector pin No.	Signal name	Signal changeover parameter
Servo input signal	MPI1	CN9B-13	(Reservation)	
	MPI2	CN9A-2	(Reservation)	
	MPI3	CN9A-3	(Reservation)	
Servo output signal	P_MBCL	CN9B-8	SBC1 Relay control signal	
	N_MBCL	CN9B-15	SBC2 Relay control signal	
	MPO4	CN9A-8	Servo specified speed signal	SV082/bit9,8=01
	MPO5	CN9A-18	(Reservation)	

Spindle input/output signal (CN9A,CN9B connector)

	Device name	Connector pin No.	Signal name	Signal changeover parameter
Spindle input signal	MPI1	CN9B-2	Orientation function Proximity switch signal	SP227/bitF-C=4
	MPI2	CN9A-13	(Reservation)	
	MPI3	CN9B-3	External emergency stop signal	SP032/bit7-0=59
Spindle output signal	MPO2	CN9B-18	Coil changeover signal	
	MPO3	CN9B-16	Spindle specified speed signal	SP229/bitC=1
	MPO6	CN9A-16	Contact control signal	

Input/output signal (CN9A,CN9B connector)

	Pin No.	CN9A	CN9B
Input signal	2	-	Proximity switch
	3	-	EXEMG
	13	-	-
	20	DICOM	DICOM
Output signal	8	SV specified speed	SBC
	10	24G	24G
	15	-	SBC
	16	MC	SP specified speed
	18	-	Coil changeover

2.7.2 Specified Speed Output

Specified speed output function turns the output signal ON when the machine-end speed is below the speed specified with the parameter. This function enables the safety door, etc., to be locked to secure the machine operator when the machine-end speed has exceeded the specified speed. This function can also be used for judging whether the current machine-end speed reaches the specified speed.

The specified speed output signal is output to the digital signal output 2 (MPO3, MPO4). Refer to the next page for details, because the configuration of the parameters differs from the servo to spindle. For the 2-axis or 3-axis drive unit, it is required to set the parameter to all axes. The signal output turns ON when all axes satisfy the conditions (theoretical product output).

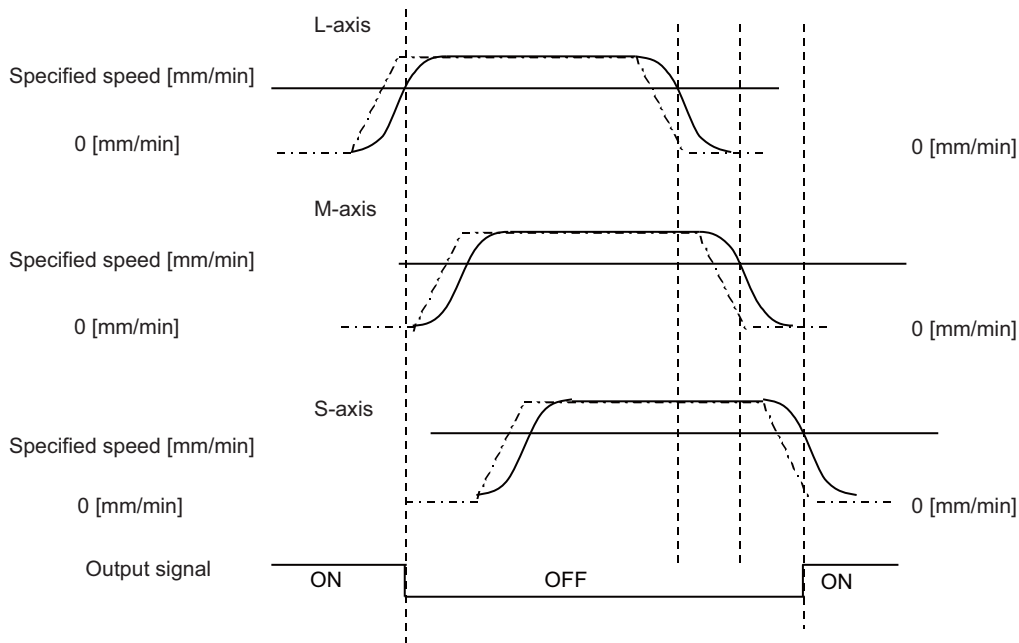

As for 3-axis drive unit, the output signal turns OFF when one of the axes exceed the specified speed, and it turns ON when all axes are within the specified speed.

For 3-axis drive unit

Specified speed signal output sequence

< Servo drive unit >

#2233 SV033 SSF2 Servo function 2**bit D : rps Safely limited speed setting increment**

Change the setting units of the specified speed signal output speed (SV073) and safely limited speed (SV238).

0: mm/min 1: 100mm/min

#2273(PR) SV073 FEEDout Specified speed output speed

Set the specified speed.
Also set SV082/bit9,8 to output digital signal.

---Setting range---

0 to 32767 (mm/min)

However, when SV033/bitD=1, the setting range is from 0 to 32767(100mm/min).

#2282 SV082 SSF5 Servo function 5**bit 9-8 : dos2 Digital signal output 2 selection**

00: Disable 01: Specified speed output

< Spindle drive unit >

#13018(PR) SP018 SPEC2 Spindle specification 2**bit 8 : spsu Command speed limit value**

0: 33,750 r/min 1: 135,000 r/min

#13030 SP030 SDT2 2nd speed detection setting value

Set the specified speed of the specified speed output.
When carrying out digital output of the specified speed output, set SP229/bitC to "1".

---Setting range---

0 to 32767 (r/min)

#13229 SP229 SFNC9 Spindle function 9**bit C : sdt2 Specified speed output digital signal 2 output**

0: Normal 1: Enable

2.7.3 Spindle Coil Changeover

There are spindle motors capable of coil changeover control, which enables favorable characteristics to be attained from low speeds to high speeds by changing two types of coils.

(1) Coil changeover control

The speed at which to change the coils is detected by the spindle drive according to the value set with spindle parameter SP028. This is conveyed to the NC with a speed detection (SD) signal. The NC judges the other conditions (coil fixed, etc.), and issue a coil changeover command to the spindle drive with the L coil selection command (LCS).

To prevent the contactor from varying, the hysteresis set with SP029 is applied on the speed when changing from the low-speed coil to the high-speed coil and the high-speed coil to the low-speed coil.

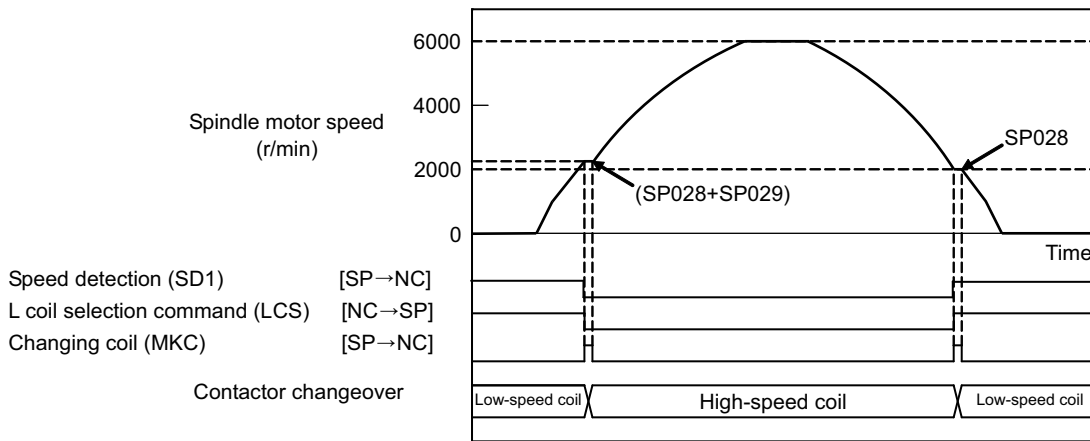

Spindle motor coil changeover control

#13028 SP028 SDTS Speed detection set value

Set the motor speed for detecting the speed.
 If the motor speed drops below the set speed, the speed detection signal turns ON.
 The standard setting is 10% of the maximum motor speed.

---Setting range---
 10 to 32767 (r/min)

#13029 SP029 SDTR Speed detection reset width

Set the hysteresis width in which the speed detection changes from ON to OFF.
 If the setting value is small, the speed detection will chatter easily.
 The standard setting is "30".

---Setting range---
 10 to 1000 (r/min)

(2) Protective functions**[1] Gate shutoff after a winding changeover**

When the L-coil selection command (LCS) is used to perform low-speed winding -> high-speed winding switching, or vice-versa, the gate is shut off during contactor operation time in order to protect the spindle drive unit's main circuit. The gate shutoff time is determined by the "Coil changeover gate cutoff timer" (SP114) setting. The standard time setting should be used, as a shorter time can cause contactor burn damage. (Refer to "Spindle control output 5" Coil changing (bit 6) for details.)

#13114 SP114 MKT Coil changeover gate cutoff timer

Set the time required to cut off the gate when turning OFF/ON the coil switch contactor. The value should be longer than the coil switch contactor's OFF/ON time. The standard setting is "150".

---Setting range---
0 to 3500 (ms)

[2] Current limit after coil changeover

Following a coil changeover, the current is limited (SP116) for the period specified by the current limit timer (SP115) in order to stabilize control. Because position loop control (synchronous tap, C-axis control, etc.) that occurs immediately after a coil changeover will result in unstable control, be sure that position commands specified by the sequence is input after the current limit is cancelled.

#13115 SP115 MKT2 Coil changeover current limit timer

Set the time required to limit the current immediately after the coil switch contactor ON/OFF is completed and the gate is turned ON. The standard setting is "250".

---Setting range---
0 to 3500 (ms)

#13116 SP116 MKIL Coil changeover current limit value

Set the time required to limit the current immediately after the coil switch contactor ON/OFF is completed and the gate is turned ON. The standard setting is "120".

---Setting range---
0 to 999 (Short-time rated %)

(3) Wiring

The illustration below shows the 2 types of changeover that occur after a coil changeover, (a) \star (star) - Δ (delta) changeover, and (b) \star (star)- \star (star) changeover. As shown in (c), one of the contactors (MC1 or MC2) is turned ON and the other is turned OFF at all of the coil changeover control circuits.

(a) \star (star) - Δ (delta) changeover circuit

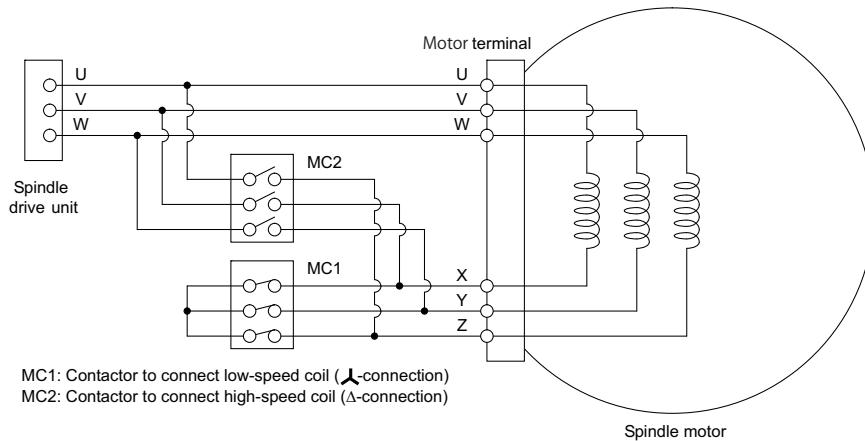

Coil changeover circuit

<Wiring of motor coil>

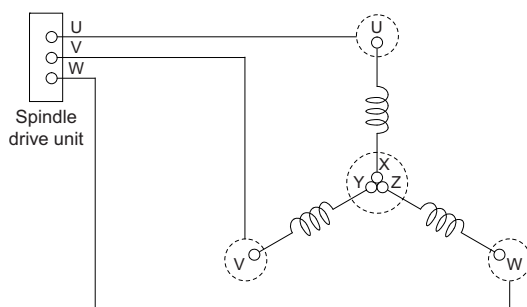

\circ :The terminal which is assembled at the contactor ON

\star connection (MC1:ON MC2:OFF)

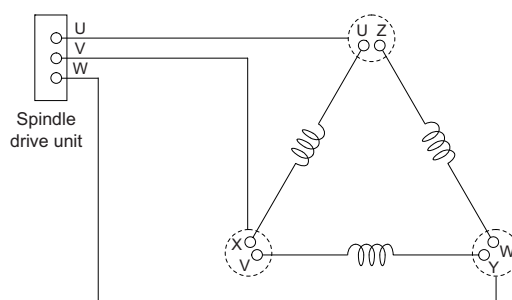

\circ :The terminal which is assembled at the contactor ON

Δ connection (MC1:OFF MC2:ON)



POINT

Wire it according to each 6 terminal's sign (U, V, W, X, Y, Z) of spindle motor for the coil changeover.

(b) Δ(star) - Y(star) changeover circuit

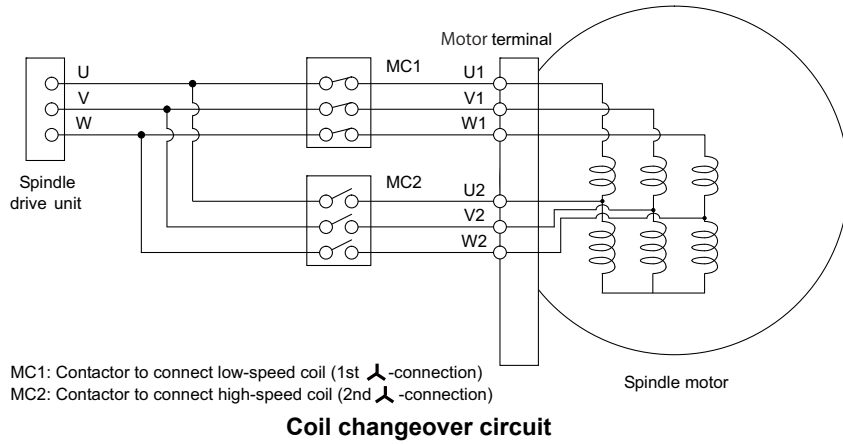

<Wiring of motor coil>

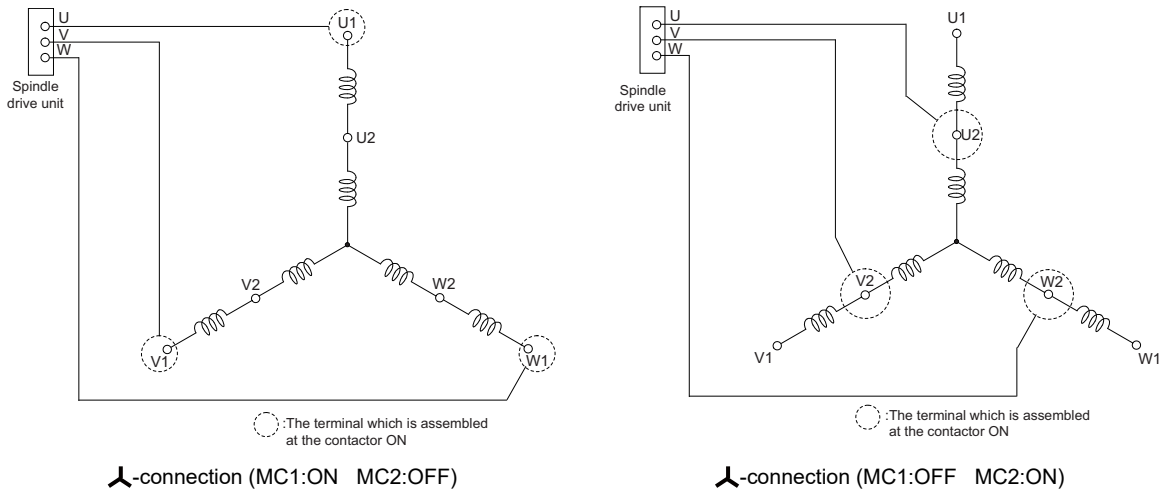

POINT

Wire it according to each 6 terminal's sign (U1, V1, W1, U2, V2, W2) of spindle motor for the coil changeover.

(c) Coil changeover control circuit (common)

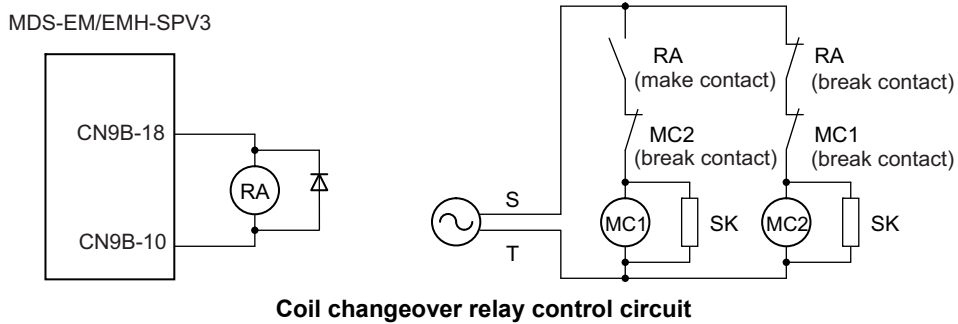

2.7.4 Proximity Switch Orientation

(1) Electrical specifications

Use a proximity switch which satisfies the following specifications.

Item	Specification
Output method	DC double wire system /three wire system
Power supply voltage	24V DC
Response frequency	400Hz or more
Load current	14mA or more
Residual voltage	4V or less
Leakage current	1mA or less

(2) Connection with drive unit

(a) When DICOM is connected to 24V

< Connection details: For proximity switch of two wire system >

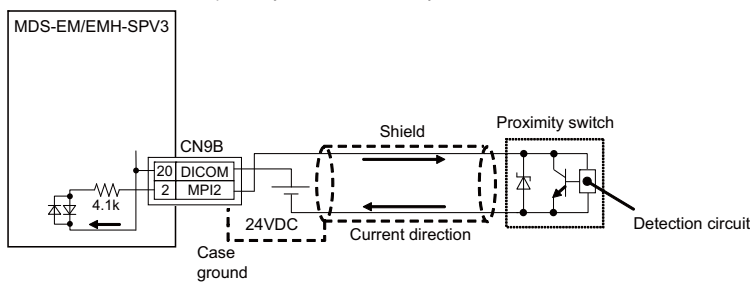

< Connection details: For proximity switch of three wire system >

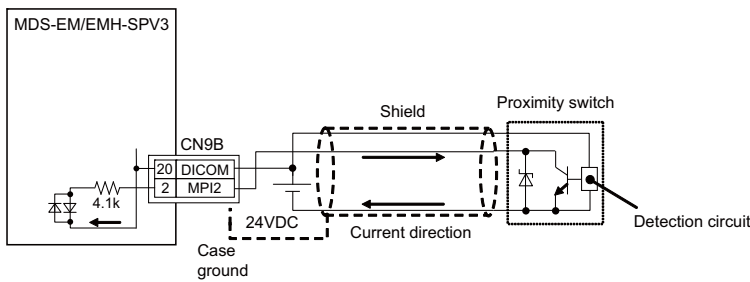

Select the polarity of DICOM

(b) When DICOM is connected to 24G

< Connection details: For proximity switch of two wire system >

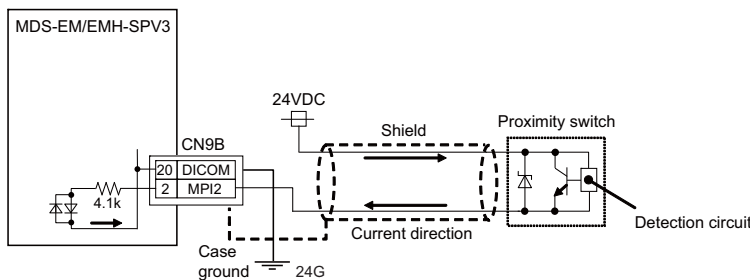

< Connection details: For proximity switch of three wire system >
Not usable.

CAUTION

1. Supply the 24VDC power externally.
2. Install a proximity switch at the spot that rotates in the ratio of 1:1 to the spindle.
3. Set the spindle parameter to the pulley ratio for belt drive or to the gear ratio for gear drive.

(3) Detection signal polarity

The table below is the polarities of the detections signals. According to the polarity, select the enable edge of the signals with the spindle parameter (SP225/bit5).

Sensor operation	Enable detection	Drive unit input signal polarity (CN9B MPI2)	Enable edge selection (SP225/bit5)
Normal open (NO)	Rising part		Falling edge (0)
Normal close (NC)	Falling part		
Normal open (NO)	Falling part		Rising edge (1)
Normal close (NC)	Rising part		

(4) Parameter setting

When using the proximity switch, set the following parameters to the spindle to be used.

When the proximity switch detection is enabled, the rotation direction of the orientation follows Z-phase detection direction (#3106/bit0), and the rotation speed follows Z-phase detection speed (#3109).

#3106 zrn_typ Zero point return specifications

Select the zero point return specification.

bit F : Spindle zero point detection with contactless switch

- 0: Normal
- 1: Enable spindle zero point detection using proximity switch

bit E : Control mode selection in orientation

Select non-interpolation mode when vibration occurs since the gain is high during the orientation.

- 0: Interpolation mode (Use the interpolation mode gain "SP002".)
- 1: Non-interpolation mode (Use the non-interpolation mode gain "SP001")

bit D : Interpolation mode selection 1 (zero point return initiated during rotation)

- 0: Non-interpolation mode
- 1: Interpolation mode

bit C : Z phase detection method

- 0: Follows Z phase detection direction (bit0).
 - 1: Rotates in the commanded direction at Z phase detection speed to detect Z phase.
- * To enable Z phase detection operation, set the parameter "#3106 zrn_typ bit3 (Z phase detection operation ON)" to "1".

bit B :

Not used. Set to "0".

bit A-9 : Spindle/C axis zero point return direction

- bitA,9=
- 00: Short-cut
- 01: Forward run
- 10: Reverse run

bit 8 : Designate zero point return

- 0: Compatible operation with our conventional series (Automatically return to zero point simultaneously with C-axis changeover)
- 1: Standard setting

bit 7 : Synchronous tapping command polarity

- 0: Forward direction
- 1: Reverse direction (The standard setting when spindle and motor are directly coupled)

bit 6-5 : Synchronous tapping zero point return direction

- bit 6,5=
- 00: Short-cut
- 01: Forward run
- 10: Reverse run

bit 4 : Designate zero point return

- 0: Automatically return to zero point before synchronous tapping is started (tapping phase alignment)
- 1: Not return to zero point and immediately synchronous tapping is started

bit 3 : Z phase detection operation ON

- 0: When Z phase is not detected, detect Z phase during the rotation executed by a rotation command without performing the detection operation.
- 1: When Z phase is not detected, perform the detection operation according to the settings of bitC and bit0, and then rotate the motor according to a rotation command.

bit 2-1 : Orientation direction

- bit 2,1=
- 00: Short-cut
- 01: Forward run
- 10: Reverse run

bit 0 : Z phase detection direction

- 0: Forward direction
- 1: Reverse direction

#3108 ori_sft Position shift amount for orientation

The orientation stop position can be moved with this parameter setting although normally the position is Z-phase position. During multi-point orientation control, the stop position is determined by the total value of this parameter and the position data for multi-point orientation of PLC input.

- Setting range---
- 35999 to 35999 (0.01°)

#3109 zdetspd Z phase detection speed

For the first S command after power is turned ON, the spindle rotates at the speed of setting value for this parameter.
When "#3106/bitF = 1" (Spindle zero point proximity switch detection enabled), also proximity switch is detected.

(Note) When spindle zero point return proximity switch detection is enabled, the rotation direction of the orientation/zero point return (synchronous tapping, spindle/C axis, etc.) will follow Z phase detection direction. And the speed will follow Z phase detection speed (In order to prevent the influences of the delayed detection of the signal pulse edges).

#13225 SP225 SFNC5 Spindle function 5**bit 5 : ddir Proximity switch signal enable edge**

- 0: Falling edge 1: Rising edge

#13227 SP227 SFNC7 Spindle function 7**bit F-C : dis Digital signal input selection**

- 0: No signal
- 4: Proximity switch signal detection
- Other settings: setting prohibited

< Related control signals >

Control input 5 bitD. Zero point re-detection request (ORC)

When ORC is changed from 0 to 1, the Z phase passed will be 0(control output2/bit0).

Control output 5 bitD. Zero point re-detection complete (ORF)

If the zero point re-detection is completed after the zero point re-detection request (control input5/bitD) is set to 1, ORF=1 is set. If the zero point re-detection request is set to 0, ORF=0 is set.

Safety Function

3.1 Safety Function

This drive unit offers the safety function which satisfies the following harmonized standard can be offered with this drive unit.

Each function can be available in the system consisting of the safety function compliant NC control unit and drive unit, and various communication cables, sensors, and contactors. This section describes the safety function controlled directly by the drive unit.

3.1.1 Harmonized Standard

Machinery Directive (2006/42/EC)	IEC60204-1: 2009
	IEC62061: 2015 (SIL2)
	IEC ISO13849-1: 2015 (Cat.3, PL d)
	IEC61800-5-1: 2007
	IEC61800-5-2: 2007
	IEC61326-3-1: 2008

3.1.2 Outline of Safety Function

Function	Details
STO (Safe Torque Off)	The torque is shut off by shutting off the energy supply to the motor. The motor power is electronically shut off inside the drive unit.
SBC (Safe Brake Control)	Using this function enables to enhance the reliability of the brake start. In this function, the brake start signal is output redundantly and it enhances the reliability of signal path to the brake start and also diagnosis the brake signal output end. It detects the brake start circuit defect and wiring defect etc.

WARNING

Precautions for the safety function described in this manual are as follows.

Read carefully all the following fundamental precautions for safety to prevent human injury or property damage.

1. Only a qualified person is authorized to perform the installation, start, repair, or adjustment of the device in which these equipment are installed.
2. The qualified person must be familiar with the laws of the country where the device into which this product is built is installed, especially the standards described in this book, and the requirements which are listed in EN ISO 13849-1, IEC/EN 61508, IEC 61,800-5-2 and IEC 60,204-1.
3. To perform the start, programming, setting and maintenance of the device in accordance with the safety standards, the staff who undertakes these work should obtain permission from the company it belongs to.

3.2 STO (Safe Torque Off) Function

CAUTION

Device manufacturer accepts responsibility for all the risk assessments and related residual risks. The followings are the residual risks relevant to the STO function. Mitsubishi Electric will not accept liability for any accidents such as damage or injury caused by such residual risks.

1. STO function is a function to remove the energy of the motor electronically and not the function to shut off the input power to the drive unit or the connection between the drive unit and the motor physically. Therefore, the risk for electric shocks cannot be eliminated with the STO function. To prevent electric shocks, use the EMG function.
2. STO function is a function to disable the energy to the motor electronically. It does not guarantee the shutoff or the procedure for the deceleration control of the motor.
Read carefully the manual of each safety-related device for the correct installation, wiring, and adjustment.
For all the safety-related relay, sensor, etc., use the one which satisfies the safety standards. TUV SUD has confirmed that the safety-related parts by Mitsubishi Electric described in this manual satisfy EN ISO13849-1 Category 3, PL d.
3. Even though the STO function is enabled by the STO switch, voltage may still be residual at the servo motor for the delay specific to the device.
4. Safety is not guaranteed until the installation or adjustment for the safety-related parts in the system has been completed.
5. When replacing the drive unit, make sure that the new product is the same as the one before the replacement. After the installation, be sure to confirm the performance of the safety function before operating the system.
6. Perform all the risk assessments and safety level certifications for the whole device and system. The use of a third-party certifier such as TUV SUD is recommended as a final safety certification of the system.
7. To prevent the accumulation of failure, perform an appropriate safety confirmation check at regular intervals as required by the safety standards. The safety confirmation check must be performed at least once a day regardless of the safety level of the system.
8. When up-and-down short circuit is occurred to the power module of the drive unit, the servo motor shaft rotates for up to 0.5 revolution.
9. Be sure to supply the STO input signal (STO1, STO2) from one power supply. If the power is divided, STO shutoff state may not be realized due to a malfunction of the STO function caused by a sneak current.

DANGER

Improper installation of a safety-related device or a system could cause a operation state without safety guaranteed and may lead to a serious or fatal accident.

Preventive measure against the above danger

As described in IEC 61800-5-2, the STO (Safe Torque Off) function is a function not to supply a energy from a drive unit to a motor and does not guarantee that a motor is not moved by an external force and other influence.

Take safety measure such as brake or counter balance additionally when the external force is acted on by the motor itself.

Safe Torque Off function is a shutoff function which does not provide the energy to the motor capable of generating torque and it shuts off an energy supply electronically inside the drive unit. STO function can be used in the following ways.

(1) Network STO function

[1] System configuration and wiring

STO function shuts off the motor power of all axes or the designated axis in the system.

Warning A4 (sub-number 0001) is detected while STO function is shutting off the motor power.

< A system configuration example when using network STO function >

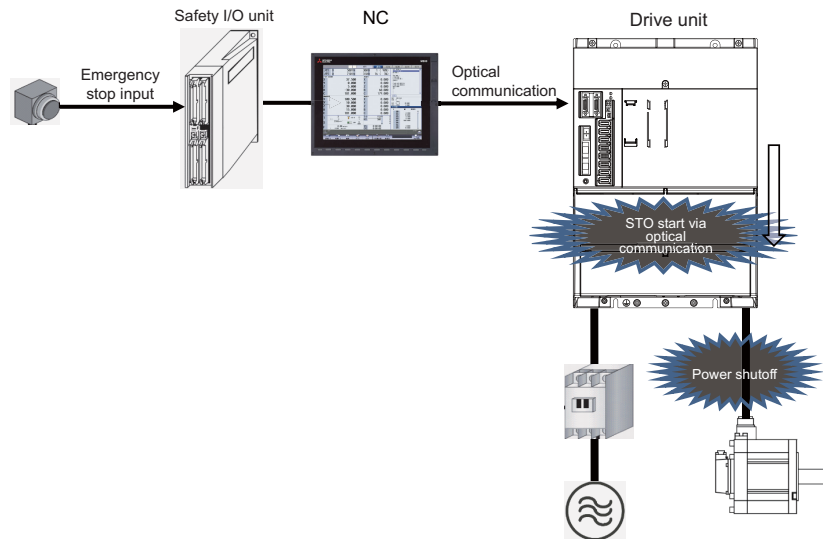

CAUTION

This function is set with the NC. Refer to the smart safety observation function for details of the setup and control method.

3.3 SBC (Safe Brake Control) Function

(1) Base specifications

The communication path of NC unit and Drive unit, and the safe brake control circuit which is redundant inside the drive unit are diagnosed. When the communication error between NC unit and Drive unit occurs, the safety communication alarm is issued. Additionally, when status is inconsistent with the crosscheck in the safe brake control circuit inside the drive unit, the V07 DRV safe circuit error (SBC circuit diagnosis error) alarm is detected. Refer to the NC function "smart safety observation function" for details.

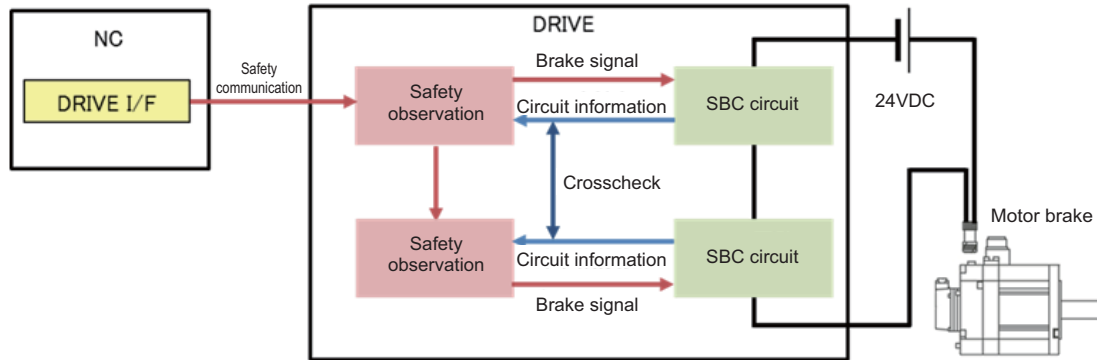

(2) Wiring of the motor magnetic brake

The magnetic brake of servo motors with a magnetic brake is controlled by the motor brake control connector (CN9B-8, CN9B-15 pin) on the servo drive unit. The servo drive unit releases the brake when the motor is ON. (Servo ON means when torque is generated in the motor.) It also contains duplex contacts for motor magnetic brake control to support the safe brake control (SBC).

Motor brake control output circuit

As shown in the illustration below, a power supply for motor brake is controlled by the DO output of CN9B through the relay. Always install the diode as shown below.

(Tolerable current: 40mA or less, Rush current: 100mA or less)

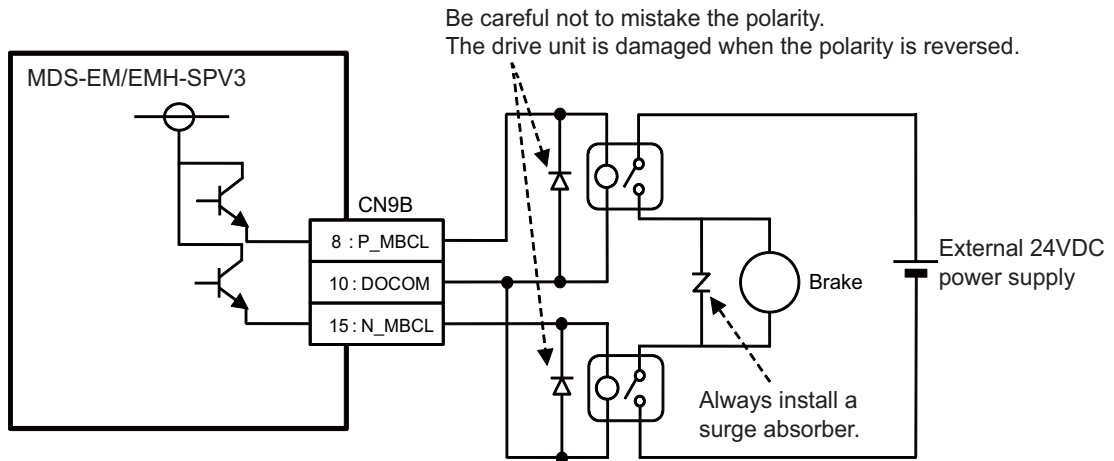
**⚠ CAUTION**

1. For SBC, the brake control of the CN9B connector is dedicated to the L axis. There are no separate brake controls for the M axis or the S axis.
2. When connecting two or more brake axes, a servo OFF command must be input simultaneously with the L axis. Receive the CN9B DO output with an external relay and connect the brake axes in parallel with the L axis brake.
3. The brakes cannot be released just by connecting motor brake terminal and CN9B. 24VDC must be supplied.
4. For the 24V power supply used in the motor brake circuit, use the one separated from the 24V power supply for the control circuit.

4

Setup

4.1 Initial Setup

4.1.1 Setting the Rotary Switch

Before turning on the power, the axis No. must be set with the rotary switch. The rotary switch settings will be validated when the drive units are turned ON.

< Drive unit >

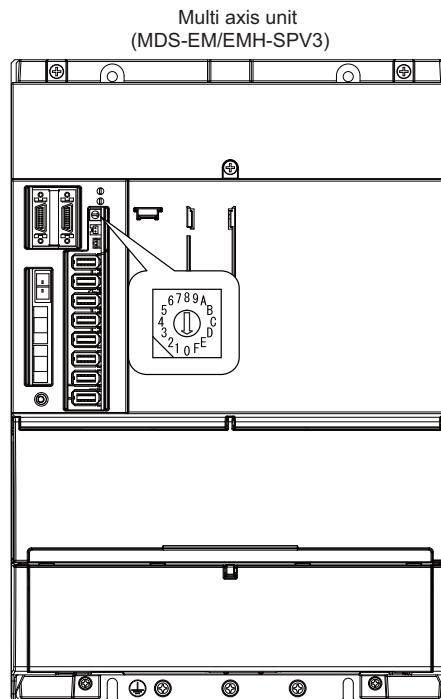

MDS-EM/EMH-SPV3 setting

Rotary switch setting	Axis configuration	Spindle	Servo		
			L-axis	M-axis	S-axis
0	Spindle + Servo 3 axes	1st axis	2nd axis	3rd axis	4th axis
1		5th axis	6th axis	7th axis	8th axis
2		9th axis	10th axis	11th axis	12th axis
3		13th axis	14th axis	15th axis	16th axis
4	Spindle + Servo 2 axes	1st axis	2nd axis	3rd axis	-
5		5th axis	6th axis	7th axis	-
6		9th axis	10th axis	11th axis	-
7		13th axis	14th axis	15th axis	-
8	Setting impossible	-	-	-	-
9	Setting impossible	-	-	-	-
A	Setting impossible	-	-	-	-
B	Setting impossible	-	-	-	-
C	Setting impossible	-	-	-	-
D	Setting impossible	-	-	-	-
E	Setting impossible	-	-	-	-
F	Setting impossible	-	-	-	-

CAUTION

The axis configuration "Spindle + Servo 2 axes" is the state where the servo axis S is disabled.
Set the NC parameter (#1021) according to the axis numbers.

4.1.2 Transition of LED Display After Power Is Turned ON

When the NC power is turned ON and the initial communication with the NC is started, each unit will automatically execute self-diagnosis and initial settings for operation, etc. The LEDs on the front of the units will change as shown below according to the progression of these processes.

If an alarm occurs, the alarm No. will appear on the LEDs. Refer to section "LED display when alarm or warning occurs" for details on the alarm displays.

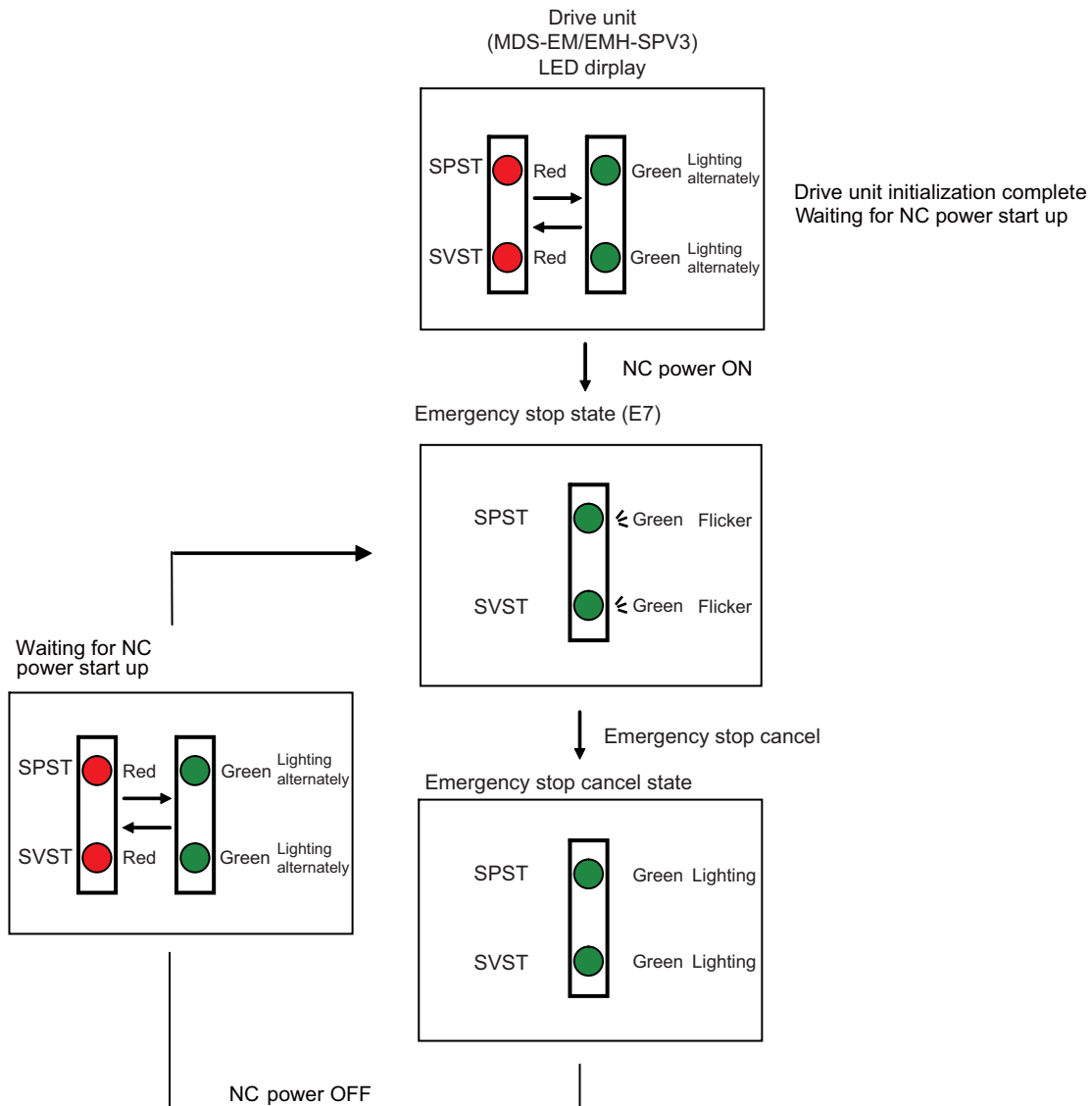

LED display during a spindle alarm occurs

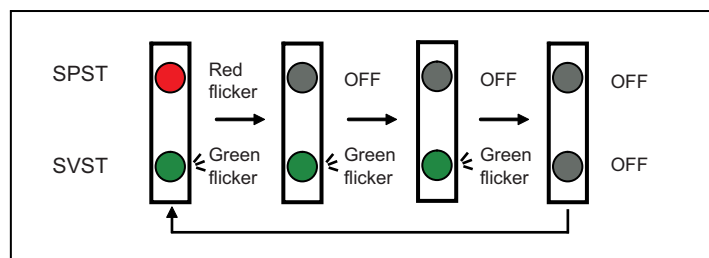

CAUTION

Always input emergency stop when starting the servo system.

4.2 Setting the Initial Parameters for the Servo Drive Unit

The servo parameters must be set before the servo system can be started up. The servo parameters are input from the NC. The input method differs according to the NC being used, so refer to each NC Instruction Manual.

When setting the initial setting parameters, perform the following settings in each system.

< For semi closed loop control (single-axis control) >

- (1) Set the standard parameters in the section "4.2.4 List of Standard Parameters for Each Servo Motor".
- (2) "4.2.1 Setting of Servo Specification Parameters"

< For full closed loop control (single-axis control) >

- (1) Set the standard parameters in the section "4.2.4 List of Standard Parameters for Each Servo Motor".
- (2) "4.2.1 Setting of Servo Specification Parameters"
- (3) "4.2.2 Setting of Machine Side Encoder"

< For full closed loop control with a distance-coded reference scale (single-axis control) >

- (1) Set the standard parameters in the section "4.2.4 List of Standard Parameters for Each Servo Motor".
- (2) "4.2.1 Setting of Servo Specification Parameters"
- (3) "4.2.2 Setting of Machine Side Encoder"
- (4) "4.2.3 Setting of Distance-coded Reference Scale"

Setting the initial parameters above enables the test operation for the servo axis (Ex. manual pulse feed, low-speed JOG feed). When machine resonance occurs, check the machine resonance frequency at AFLT frequency on the drive monitor screen and set to the following servo parameters. The display sensitivity can be adjusted in the "sensitivity of estimated resonance frequency" setting. (When the AFLT frequency displays "0", vibration at high frequency or vibration due to the machine system may be the reason.)

#2238 SV038 FHz1 Notch filter frequency 1

Set the vibration frequency to suppress when machine vibration occurs.
(Normally, do not set 80 or less.)

---Setting range---
0 to 5000 (Hz)

4.2.1 Setting of Servo Specification Parameters

(1) Basic specification parameters

When performing absolute position control, set the axis specification parameter #2049. When the setting value of #2049 is "1 to 4", "SV017/bit7" is automatically set to the absolute position control.

It is not possible to set SV017/bit7 directly.

#2049(PR) type Absolute position detection method

Select the absolute position zero point alignment method.

- 0: Not absolute position detection (Incremental control)
- 1: Stopper method (push against mechanical stopper)
- 2: Marked point alignment method I (The grid point is the reference position.)
- 3: Dog-type (align with dog and near point detection switch)
- 4: Marked point alignment method II
(The position with which the mark was aligned is the reference position.)
- 9: Simple absolute position (Not absolute position detection, but the position when the power is turned off is registered.)

#2217(PR) SV017 SPEC1 Servo specification 1

bit 7 : abs Position control

These parameters are set automatically by the NC system.

0: Incremental 1: Absolute position control

(2) Electronic gear related parameters

Servo control is performed by changing NC command unit to servo control unit with the following parameters (electric gear). Even if each parameter is within the setting range, overflow of the electric gear coefficient may be occur. When the overflow of the electric gear occurs, initial parameter error (servo alarm 37) will occur.

#2201(PR) SV001 PC1 Motor side gear ratio

#2202(PR) SV002 PC2 Machine side gear ratio

Set the gear ratio in the machine side when there is the gear between the servo motor's shaft and machine (ball screw, etc.).

For the rotary axis, set the total deceleration (acceleration) ratio.

Even if the gear ratio is within the setting range, the electronic gears may overflow and an initial parameter error (servo alarm 37) may occur.

#2218(PR) SV018 PIT Ball screw pitch/Magnetic pole pitch

Set the ball screw pitch. For the rotary axis, set to "360".

#2219(PR) SV019 RNG1 Sub side encoder resolution

Normally, set to "0".

For the full-closed loop control, refer to "Setting of Machine Side Encoder".

#2220(PR) SV020 RNG2 Main side encoder resolution

Normally, set to "0".

(3) Parameter set for C80 system

For C80 system, set the parameter as to ignore unnecessary alarm histories that is recorded when the NC power is turned OFF.

#2314 SV114 SSF9 Servo function 9

bit 8 : nohis History of communication error alarm between NC and DRV (34, 36, 38, 39)

0: Enable 1: Disable

4.2.2 Setting of Machine Side Encoder

(1) Setting of the machine side encoder specification

#2225(PR) SV025 MTYP Motor/Encoder type

Set the position encoder type, according to the machine side encoder specifications.

bit F-C: pen Position encoder

Rectangular wave signal output rotary scale	:	pen=4
OSA405ET2AS	:	pen=6
Serial signal output rotary scale	:	pen=6
Rectangular wave signal output linear scale	:	pen=8
Serial signal output linear scale	:	pen=A

#2219(PR) SV019 RNG1 Sub side encoder resolution

For a ball screw end encoder

OSA405ET2AS: RNG1=0

For a linear scale

Set the number of pulses per ball screw lead in one "kp" increments.

For a rotary scale

Set the number of pulses per revolution in one "kp" increments.

Note that the value must be input in increments of 10K pulses (the 1st digit of the setting value is "0").

If any restriction is imposed due to the above condition, also set SV117 in one pulse increments.

#2317(PR) SV117 RNG1ex Expansion sub side encoder resolution

To set the resolution of the machine side encoder in one pulse increments, set the number of pulses of the encoder by 4-byte data in total to SV117 (high-order 16bit) and SV019 (low-order 16bit).

SV117= Quotient of the number of pulses divided by 65536 (If the quotient is 0, set SV117 to -1).

SV019= Remainder of the number of pulses divided by 65536
(SV019 can be set in one pulse increments).

(2) Setting table for each encoder
Rectangular wave signal output encoder

Manufacturer	Encoder type	Interface unit type	Control resolution	SV025	SV019	SV117
MAGNESCALE	SR74 SR84	Not required	1.0 μ m	82 □□	(SV018×1000/1.0)/65536= remainder	quotient
			0.5 μ m	82 □□	(SV018×1000/0.5)/65536= remainder	quotient
			0.1 μ m	82 □□	(SV018×1000/0.1)/65536= remainder	quotient
			0.05 μ m	82 □□	(SV018×1000/0.05)/65536= remainder	quotient
HEIDENHAIN	LS187 LS487	IBV 101 (10 divisions)	0.5 μ m	82 □□	(SV018×1000/0.5)/65536= remainder	quotient
		IBV 102 (100 divisions)	0.05 μ m	82 □□	(SV018×1000/0.05)/65536= remainder	quotient
		IBV 660B (400 divisions)	0.0125 μ m	82 □□	(SV018×1000/0.0125)/65536= remainder	quotient
Other manufacturers	Rectangular wave output scale	Not required	Signal frequency μ m/4	82 □□	(SV018×1000/(signal cycle μ m/4)) /65536 = remainder	quotient

(Note) When the quotient is "0", "SV117 = -1" is applied.

Mitsubishi serial signal output encoder (Incremental)

Manufacturer	Encoder type	Interface unit type	Control resolution	SV025	SV019	SV117
MAGNESCALE	SR75 SR85	Not required	0.1 μ m	A2 □□	SV018/0.1	0
			0.05 μ m	A2 □□	SV018/0.05	0
			0.01 μ m	A2 □□	SV018/0.01	0
HEIDENHAIN	LS187 LS487	EIB192M A4 20 μ m	(20/16384) μ m	A2 □□	(SV018×819200)/65536 = remainder	quotient
		EIB392M A4 20 μ m				
	ERM280 1200	EIB192M C4 1200	19,660,800p/rev	62 □□	0	300
		EIB392M C4 1200				
	ERM280 2048	EIB192M C6 2048	33,554,432p/rev	62 □□	0	512
		EIB392M C6 2048				
LS187C LS487C	EIB192M A5 4 μ m	Signal cycle μ m/ 16384	A2 □□	(SV018×16384000/signal cycle μ m)/65536= remainder	quotient	
	EIB392M A5 4 μ m					
GUBOA	MHS-04B Series	Not required	0.000343° (1,048,576p/rev)	62 □□	0	16
Other manufacturers	SIN wave output linear scale	MDS-EX-HR	Signal cycle μ m/ 16384	A2 □□	(SV018×16384000/signal cycle μ m) /65536 = remainder	quotient
	SIN wave output rotary scale	MDS-EX-HR	Signal frequency ×16384p/rev	62 □□	(Signal frequency×16384)/65536 = remainder	quotient

(Note 1) When the quotient is "0", "SV117 = -1" is applied.

(Note 2) The communication specification of EIB192M/392M is "Mitsu02-4".

Mitsubishi serial signal output encoder (Absolute position)

Manufacturer	Encoder type	Interface unit type	Control resolution	SV025	SV019	SV117
Mitsubishi Electric	OSA405ET2AS	Not required	4,194,304p/rev	62 □□	0	0
MAGNESCALE	SR67A SR77 SR87	Not required	0.1μm	A2 □□	SV018/0.1	0
			0.05μm	A2 □□	SV018/0.05	0
			0.01μm	A2 □□	SV018/0.01	0
	RU77	Not required	8,000,000p/rev	62 □□	8000	0
			32,000,000p/rev	62 □□	32000	0
RS87	Not required	8,000,000p/rev	62 □□	8000	0	
HEIDENHAIN	LC195M	Not required	0.01μm	A2 □□	SV018/0.01	0
	LC495M		0.001μm	A2 □□	SV018/0.001	0
	LC291M	Not required	0.01μm	A2 □□	SV018/0.01	0
	LIC2197M	Not required	0.05μm	A2 □□	SV018/0.05	0
			0.1μm	A2 □□	SV018/0.1	0
	LIC2199M	Not required	0.05μm	A2 □□	SV018/0.05	0
			0.1μm	A2 □□	SV018/0.1	0
	MC15M	Not required	0.05μm	A2 □□	SV018/0.05	0
	RCN2590M	Not required	268,435,456p/rev	62 □□	0	4096
	RCN5390M	Not required	67,108,864p/rev	62 □□	0	1024
	RCN5590M	Not required	268,435,456p/rev	62 □□	0	4096
	RCN8390M	Not required	536,870,912p/rev	62 □□	0	8192
	ROC425M	Not required	32,000,000p/rev	62 □□	32000	0
	ROC2390M	Not required	67,108,864p/rev	62 □□	0	1024
ECA4000 Series	Not required	134,217,728p/rev	62 □□	0	2048	
Mitutoyo	AT343	Not required	0.05μm	A2 □□	SV018/0.05	0
	AT543	Not required	0.05μm	A2 □□	SV018/0.05	0
	AT545	Not required	(20/4096) μm	A2 □□	(SV018×204800)/65536 = remainder	quotient
	AT1143	Not required	0.05μm	A2 □□	SV018/0.05	0
	ST748	Not required	0.1μm	A2 □□	SV018/0.1	0
NIDEC MACHINE TOOL CORPORATION	MPRZ Series	ADB-K70M	8,000,000p/rev	62 □□	8000	0
FAGOR	SAM Series	Not required	0.05μm	A2 □□	SV018/0.05	0
	SVAM Series	Not required	0.05μm	A2 □□	SV018/0.05	0
	GAM Series	Not required	0.05μm	A2 □□	SV018/0.05	0
	G2AM Series	Not required	0.05μm	A2 □□	SV018/0.05	0
	LAM Series	Not required	0.1μm	A2 □□	SV018/0.1	0
	G3BM Series	Not required	0.01μm	A2 □□	SV018/0.01	0
	HAM Series	Not required	8,000,000p/rev	62 □□	8000	0
			134,217,728p/rev	62 □□	0	2048
H2AM Series	Not required	67,108,864p/rev	62 □□	0	1024	
Renishaw	RL40N Series	Not required	0.05μm	A2 □□	SV018/0.05	0
			0.001μm	A2 □□	SV018/0.001	0
	RA Series	Not required	8,000,000p/rev	62 □□	8000	0
			134,217,728p/rev	62 □□	0	2048
FORTIS Series	Not required	0.001μm	A2 □□	SV018/0.001	0	

(Note 1) When the quotient is "0", "SV117 = -1" is applied.

(Note 2) The communication specification of LC195M/LC495M/LC291M is "Mitsu03-4".

(3) Setting of the installation polarity of the machine side encoder

Since the installation polarity may not be judged from the encoder appearance, confirm the installation polarity of the machine side encoder with moving the axis by hand after the installation.

If "Motor end FB" or "Machine end FB" on the NC drive monitor screen changes to the opposite polarity when the axis is moved, set "SV017/bit4" to "Reverse polarity".

#2217(PR) SV017 SPEC1 Servo specification 1**bit 4 : sdir Sub side encoder feedback**

0: Forward polarity 1: Reverse polarity

(4) Setting of the machine side encoder alarm detection

When using a rectangular wave linear scale, set the following parameters.

The rectangular wave scale determined no signal by the difference from the motor end FB. Set no signal 2 special detection width considering a delay of machine end position generated by the torsion of the ball screw.

#2235 SV035 SSF4 Servo function 4**bit 7 : ckab No signal detection 2**

Set this to use rectangular wave output linear scale.
This enables the detection of No signal 2 (alarm 21).
0: Disable 1: Enable

#2398 SV198 NSE No signal 2 special detection width

Set the special detection width for the no signal 2 (alarm 21).
When "0" is set, the detection will be performed with a 15 μ m width.

---Setting range---
0 to 32767 (μ m)

4.2.3 Setting of Distance-coded Reference Scale

(1) **Setting of the base specifications**

In order to set the distance-coded reference scale, the following setting follows "Setting of Machine Side Encoder".

#2281(PR) SV081 SPEC2 Servo specification 2

bit 7 : szchk Distance-coded reference scale reference mark

Set the number of reference marks to be passed during the reference position calculation. If an error occurs in passing the reference mark, the neighboring mark is checked. When an error is detected three times in total, the alarm "42" will occur.

0: Check at 4 points (standard) 1: Check at 3 points

bit 3 : absc Distance-coded reference scale

0: Disable 1: Enable

#2330(PR) SV130 RPITS Base reference mark interval

Set the interval between the base reference marks arranged at regular intervals on the distance-coded reference scale. When the base reference mark interval (SV130) and the reference mark's auxiliary interval are in the specified relationship, the distance-coded reference scale is judged to be connected.

Following is the specified relationship.

$$(SV130 \times 1000) / SV131 \geq 4 \text{ (No remainder)}$$

---Setting range---
0 to 32767 (mm)

#2331(PR) SV131 DPITS Auxiliary reference mark interval

Set the auxiliary interval of reference mark in the distance-coded reference scale.

---Setting range---
0 to 32767 (μm)

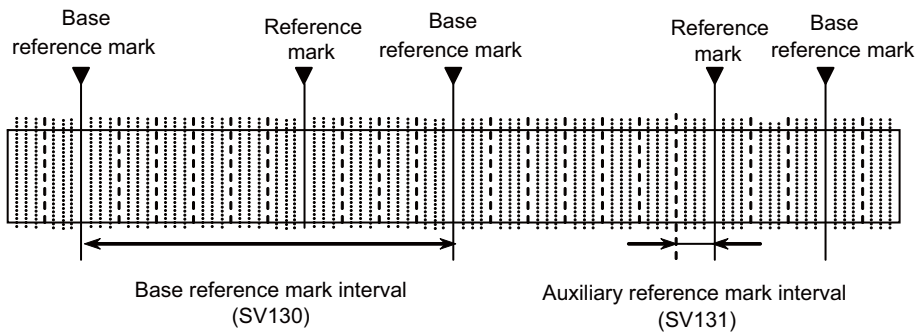

Incremental scale of distance-coded reference scale

(2) Setting of the distance-coded reference check function

If The reference marks are checked at four points by the basic point computer processing, the basic point can be recreated almost certainly. If you would like to strengthen the check further, set the distance-coded reference check function, which executes the relation check with a coordinate of the motor side encoder during the basic point calculation after the power-on.

When an error occurs, "Alarm 42" is detected. The battery option is required to use this function since the motor side encoder is under the absolute position control.

< Initial setup of the distance-coded reference check >

Performed this initial setup at the start of the system setup, linear scale exchange, or motor exchange.

- (1) Complete the setup of the distance-coded reference scale.
(Complete the base specification setting, and enable the basic point establishment.)
- (2) Turn the power ON again after setting "SV137 = -1".
(Under a state of the distance-coded reference check initial setup warning "A3".)
- (3) Perform the reference point return.
- (4) Conform that the warning "A3" turns OFF.
- (5) Set the value of "Rn", "Pn" and "MPOS" to "SV134", "SV135" and "SV136" on the drive monitor.
- (6) When SV137=32767, the distance-coded reference check function is disabled.

#2334 SV134 RRn0 Distance-coded reference check / revolution counter**#2335 SV135 RPn0H Distance-coded reference check /position within one rotation High****#2336 SV136 RPn0L Distance-coded reference check / position within one rotation Low**

Set this parameter to operate distance-coded reference check when using distance-coded reference scale.

During the distance-coded reference check initial setup (SV137:RAER=-1), set the following items on the NC drive monitor screen after the distance-coded reference check initial setup warning A3 turns OFF.

SV134=Rn, SV135=Pn, SV136=MPOS

#2337 SV137 RAER Distance-coded reference check allowable width

For the distance-coded reference check function when using distance-coded reference scale, set the allowable gap from the reference point position data calculated by the main side encoder. When the gap exceeds the allowable range, reference point created by distance-code is judged as wrong and detects alarm 42.

The standard setting value is "basic reference mark interval (SV130) / 4".

SV137=0 setting carries out the same operation as the standard setting value.

SV137=-1 setting enables the distance-coded reference initial set up mode and displays setting values of SV134 to SV136 on NC drive monitor.

To enable the distance-coded reference check function, SV081/bit3=1setting and a battery option are needed.

---Setting range---

-1 to 32767 (mm)

4.2.4 List of Standard Parameters for Each Servo Motor

(1) 200V Standard motor HG Series

Motor				200V Standard motor HG Series												
Parameter		Details	Unit capacity	HG96	HG75	HG105	HG54		HG104		HG154		HG224		HG204	
No.	Abbrev.			40	40	40	40	80	40	80	80	120	80	120	80	120
SV001	PC1	Motor side gear ratio	-	-	-	-	-	-	-	-	-	-	-	-	-	
SV002	PC2	Machine side gear ratio	-	-	-	-	-	-	-	-	-	-	-	-	-	
SV003	PGN1	Position loop gain 1	33	33	33	33	33	33	33	33	33	33	33	33	33	
SV004	PGN2	Position loop gain 2	0	0	0	0	0	0	0	0	0	0	0	0	0	
SV005	VGN1	Speed loop gain 1	10	100	100	100	100	100	100	100	100	100	100	100	100	
SV006	VGN2	Speed loop gain 2	0	0	0	0	0	0	0	0	0	0	0	0	0	
SV007	VIL	Speed loop delay compensation	0	0	0	0	0	0	0	0	0	0	0	0	0	
SV008	VIA	Speed loop lead compensation	1364	1364	1364	1364	1364	1364	1364	1364	1364	1364	1364	1364	1364	
SV009	IQA	Current loop q axis lead compensation	6144	20480	10240	20480	10240	10240	10240	10240	8192	8192	8192	8192	8192	
SV010	IDA	Current loop d axis lead compensation	6144	20480	10240	20480	10240	10240	10240	10240	8192	8192	8192	8192	8192	
SV011	IQG	Current loop q axis gain	512	768	512	3072	1280	1536	1280	1536	1280	1280	2048	2048	2048	
SV012	IDG	Current loop d axis gain	512	768	512	3072	1280	1536	1280	1536	1280	1280	2048	2048	2048	
SV013	ILMT	Current limit value	800	800	800	800	800	800	800	800	800	800	800	800	800	
SV014	ILMTsp	Current limit value in special control	800	800	800	800	800	800	800	800	800	800	800	800	800	
SV015	FFC	Acceleration rate feed forward gain	0	0	0	0	0	0	0	0	0	0	0	0	0	
SV016	LMC1	Lost motion compensation 1	0	0	0	0	0	0	0	0	0	0	0	0	0	
SV017	SPEC1	Servo specification 1	1400	1400	1400	1000	1400	1000	1400	1000	1400	1000	1400	1000	1400	
SV018	PIT	Ball screw pitch/Magnetic pole pitch	-	-	-	-	-	-	-	-	-	-	-	-	-	
SV019	RNG1	Sub side encoder resolution	0	0	0	0	0	0	0	0	0	0	0	0	0	
SV020	RNG2	Main side encoder resolution	0	0	0	0	0	0	0	0	0	0	0	0	0	
SV021	OLT	Overload detection time constant	60	60	60	60	60	60	60	60	60	60	60	60	60	
SV022	OLL	Overload detection level	150	150	150	150	150	150	150	150	150	150	150	150	150	
SV023	OD1	Excessive error detection width during servo ON	6	6	6	6	6	6	6	6	6	6	6	6	6	
SV024	INP	In-position detection width	50	50	50	50	50	50	50	50	50	50	50	50	50	
SV025	MTYP	Motor/Encoder type	22BC	2241	2242	2243	2244	2245	2246	2247	2248	2249	2250	2251	2252	
SV026	OD2	Excessive error detection width during servo OFF	6	6	6	6	6	6	6	6	6	6	6	6	6	
SV027	SSF1	Servo function 1	4000	4000	4000	4000	4000	4000	4000	4000	4000	4000	4000	4000	4000	
SV028	:	:	:	:	:	:	:	:	:	:	:	:	:	:	:	
SV032	TOF	Torque offset	0	0	0	0	0	0	0	0	0	0	0	0	0	
SV033	SSF2	Servo function 2	0000	0000	0000	0000	0000	0000	0000	0000	0000	0000	0000	0000	0000	
SV034	SSF3	Servo function 3	0000	0000	0000	0000	0000	0000	0000	0000	0000	0000	0000	0000	0000	
SV035	SSF4	Servo function 4	0000	0000	0000	0000	0000	0000	0000	0000	0000	0000	0000	0000	0000	
SV036	PTYP	Power supply type/ Regenerative resistor type	0000	0000	0000	0000	0000	0000	0000	0000	0000	0000	0000	0000	0000	
SV037	JL	Load inertia scale	0	0	0	0	0	0	0	0	0	0	0	0	0	
SV046	FHz2	Notch filter frequency 2	0	0	0	0	0	0	0	0	0	0	0	0	0	
SV047	EC	Inductive voltage compensation gain	100	100	100	100	100	100	100	100	100	100	100	100	100	
SV048	EMGr	Vertical axis drop prevention time	0	0	0	0	0	0	0	0	0	0	0	0	0	
SV049	PGN1sp	Position loop gain 1 in spindle synchronous control	15	15	15	15	15	15	15	15	15	15	15	15	15	
SV050	PGN2sp	Position loop gain 2 in spindle synchronous control	0	0	0	0	0	0	0	0	0	0	0	0	0	
SV065	TLC	Machine end compensation gain	0	0	0	0	0	0	0	0	0	0	0	0	0	
(System parameter area)																
SV073	FEEDout	Specified speed output speed	0	0	0	0	0	0	0	0	0	0	0	0	0	
(System parameter area)																
SV081	SPEC2	Servo specification 2	0200	0200	0200	0200	0200	0200	0200	0200	0200	0200	0200	0200	0200	
SV082	SSF5	Servo function 5	0000	0000	0000	0000	0000	0000	0000	0000	0000	0000	0000	0000	0000	
SV083	SSF6	Servo function 6	0000	0000	0000	0000	0000	0000	0000	0000	0000	0000	0000	0000	0000	
SV084	SSF7	Servo function 7	0000	0000	0000	0000	0000	0000	0000	0000	0000	0000	0000	0000	0000	
SV085	LMck	Lost motion compensation 3 spring constant	0	0	0	0	0	0	0	0	0	0	0	0	0	
SV093	:	:	:	:	:	:	:	:	:	:	:	:	:	:	:	
SV094	MPV	Magnetic pole position error detection speed	10	10	10	10	10	10	10	10	10	10	10	10	10	
SV095	ZUPD	Vertical axis pull up distance	0	0	0	0	0	0	0	0	0	0	0	0	0	
SV113	SSF8	Servo function 8	0000	0000	0000	0000	0000	0000	0000	0000	0000	0000	0000	0000	0000	
SV114	SSF9	Servo function 9	8080	0080	0080	0080	0080	0080	0080	0080	0080	0080	0080	0080	0080	
SV115	SSF10	Servo function 10	0000	0000	0000	0000	0000	0000	0000	0000	0000	0000	0000	0000	0000	
SV236	:	:	:	:	:	:	:	:	:	:	:	:	:	:	:	
SV237	TCF	Torque command filter	3000	0	0	0	0	0	0	0	0	0	0	0	0	
SV238	:	:	:	:	:	:	:	:	:	:	:	:	:	:	:	
SV256	:	:	:	:	:	:	:	:	:	:	:	:	:	:	:	

4 Setup

Motor				200V Standard motor HG Series											
				HG354		HG123		HG223		HG303		HG453		HG702	
No.	Abbrev.	Details	Unit capacity	120	40	40	80	80	120	120	120	120	40	40	80
SV001	PC1	Motor side gear ratio		-	-	-	-	-	-	-	-	-	-	-	-
SV002	PC2	Machine side gear ratio		-	-	-	-	-	-	-	-	-	-	-	-
SV003	PGN1	Position loop gain 1		33	33	33	33	33	33	33	33	33	33	33	33
SV004	PGN2	Position loop gain 2		0	0	0	0	0	0	0	0	0	0	0	0
SV005	VGN1	Speed loop gain 1		100	100	100	60	100	80	100	80	100	100	100	100
SV006	VGN2	Speed loop gain 2		0	0	0	0	0	0	0	0	0	0	0	0
SV007	VIL	Speed loop delay compensation		0	0	0	0	0	0	0	0	0	0	0	0
SV008	VIA	Speed loop lead compensation		1364	1364	1364	1364	1364	1364	1364	1364	1364	1364	1364	1364
SV009	IQA	Current loop q axis lead compensation		15360	10240	8192	10240	10240	10240	10240	10240	15360	8192	8192	8192
SV010	IDA	Current loop d axis lead compensation		15360	10240	8192	10240	10240	10240	10240	10240	15360	8192	8192	8192
SV011	IQG	Current loop q axis gain		4096	1536	1280	2048	3072	3072	2048	2048	2048	2048	2048	2048
SV012	IDG	Current loop d axis gain		4096	1536	1280	2048	3072	3072	2048	2048	2048	2048	2048	2048
SV013	ILMT	Current limit value		800	800	800	800	800	800	800	800	800	800	800	800
SV014	ILMTsp	Current limit value in special control		800	800	800	800	800	800	800	800	800	800	800	800
SV015	FFC	Acceleration rate feed forward gain		0	0	0	0	0	0	0	0	0	0	0	0
SV016	LMC1	Lost motion compensation 1		0	0	0	0	0	0	0	0	0	0	0	0
SV017	SPEC1	Servo specification 1		0000	1400	1000	1400	1000	1400	0000	1000	1400	1000	1400	1400
SV018	PIT	Ball screw pitch/Magnetic pole pitch		-	-	-	-	-	-	-	-	-	-	-	-
SV019	RNG1	Sub side encoder resolution		0	0	0	0	0	0	0	0	0	0	0	0
SV020	RNG2	Main side encoder resolution		0	0	0	0	0	0	0	0	0	0	0	0
SV021	OLT	Overload detection time constant		60	60	60	60	60	60	60	60	60	60	60	60
SV022	OLL	Overload detection level		150	150	150	150	150	150	150	150	150	150	150	150
SV023	OD1	Excessive error detection width during servo ON		6	6	6	6	6	6	6	6	6	6	6	6
SV024	INP	In-position detection width		50	50	50	50	50	50	50	50	50	50	50	50
SV025	MTYP	Motor/Encoder type		2248	2264	2266	2268	2249	226A	2265	2265	2265	2267	2267	2267
SV026	OD2	Excessive error detection width during servo OFF		6	6	6	6	6	6	6	6	6	6	6	6
SV027	SSF1	Servo function 1		4000	4000	4000	4000	4000	4000	4000	4000	4000	4000	4000	4000
SV028				0	0	0	0	0	0	0	0	0	0	0	0
:				:	:	:	:	:	:	:	:	:	:	:	:
SV032	TOF	Torque offset		0	0	0	0	0	0	0	0	0	0	0	0
SV033	SSF2	Servo function 2		0000	0000	0000	0000	0000	0000	0000	0000	0000	0000	0000	0000
SV034	SSF3	Servo function 3		0000	0000	0000	0000	0000	0000	0000	0000	0000	0000	0000	0000
SV035	SSF4	Servo function 4		0000	0000	0000	0000	0000	0000	0000	0000	0000	0000	0000	0000
SV036	PTYP	Power supply type/ Regenerative resistor type		0000	0000	0000	0000	0000	0000	0000	0000	0000	0000	0000	0000
SV037	JL	Load inertia scale		0	0	0	0	0	0	0	0	0	0	0	0
:				:	:	:	:	:	:	:	:	:	:	:	:
SV046	FHz2	Notch filter frequency 2		0	0	0	0	0	0	0	0	0	0	0	0
SV047	EC	Inductive voltage compensation gain		100	100	100	100	100	100	100	100	100	100	100	100
SV048	EMGr	Vertical axis drop prevention time		0	0	0	0	0	0	0	0	0	0	0	0
SV049	PGN1sp	Position loop gain 1 in spindle synchronous control		15	15	15	15	15	15	15	15	15	15	15	15
SV050	PGN2sp	Position loop gain 2 in spindle synchronous control		0	0	0	0	0	0	0	0	0	0	0	0
:				:	:	:	:	:	:	:	:	:	:	:	:
SV065	TLC	Machine end compensation gain		0	0	0	0	0	0	0	0	0	0	0	0
(System parameter area)															
SV073	FEEDout	Specified speed output speed		0	0	0	0	0	0	0	0	0	0	0	0
(System parameter area)															
SV081	SPEC2	Servo specification 2		0200	0200	0200	0200	0200	0200	0200	0200	0200	0200	0200	0200
SV082	SSF5	Servo function 5		0000	0000	0000	0000	0000	0000	0000	0000	0000	0000	0000	0000
SV083	SSF6	Servo function 6		0000	0000	0000	0000	0000	0000	0000	0000	0000	0000	0000	0000
SV084	SSF7	Servo function 7		0000	0000	0000	0000	0000	0000	0000	0000	0000	0000	0000	0000
SV085	LMCk	Lost motion compensation 3 spring constant		0	0	0	0	0	0	0	0	0	0	0	0
:				:	:	:	:	:	:	:	:	:	:	:	:
SV093				0	0	0	0	0	0	0	0	0	0	0	0
SV094	MPV	Magnetic pole position error detection speed		10	10	10	10	10	10	10	10	10	10	10	10
SV095	ZUPD	Vertical axis pull up distance		0	0	0	0	0	0	0	0	0	0	0	0
:				:	:	:	:	:	:	:	:	:	:	:	:
SV113	SSF8	Servo function 8		0000	0000	0000	0000	0000	0000	0000	0000	0000	0000	0000	0000
SV114	SSF9	Servo function 9		0080	0080	0080	0080	0080	0080	0080	0080	0080	0080	0080	0080
SV115	SSF10	Servo function 10		0000	0000	0000	0000	0000	0000	0000	0000	0000	0000	0000	0000
:				:	:	:	:	:	:	:	:	:	:	:	:
SV256				0	0	0	0	0	0	0	0	0	0	0	0

(2) 200V Standard motor HK Series

Motor				200V Standard motor HK Series							
Parameter				HK76	HK105	HK55		HK104		HK123	HK142
No.	Abbrev.	Details	Unit capacity	40	40	40	80	40	80	40	40
SV001	PC1	Motor side gear ratio		-	-	-	-	-	-	-	-
SV002	PC2	Machine side gear ratio		-	-	-	-	-	-	-	-
SV003	PGN1	Position loop gain 1		33	33		33		33	33	33
SV004	PGN2	Position loop gain 2		0	0		0		0	0	0
SV005	VGN1	Speed loop gain 1		37	55		43		75	52	52
SV006	VGN2	Speed loop gain 2		0	0		0		0	0	0
SV007	VIL	Speed loop delay compensation		0	0		0		0	0	0
SV008	VIA	Speed loop lead compensation		1364	1364		1364		1364	1364	1364
SV009	IQA	Current loop q axis lead compensation		10240	10240		20480		10240	15364	20480
SV010	IDA	Current loop d axis lead compensation		10240	10240		20480		10240	15364	20480
SV011	IQG	Current loop q axis gain		640	512		2432		1536	2560	3584
SV012	IDG	Current loop d axis gain		640	512		2432		1536	2560	3584
SV013	ILMT	Current limit value		800	800		800		800	800	800
SV014	ILMTsp	Current limit value in special control		800	800		800		800	800	800
SV015	FFC	Acceleration rate feed forward gain		0	0		0		0	0	0
SV016	LMC1	Lost motion compensation 1		0	0		0		0	0	0
SV017	SPEC1	Servo specification 1		0400	0400	0000	0400	0000	0400	0400	0400
SV018	PIT	Ball screw pitch/Magnetic pole pitch		-	-		-		-	-	-
SV019	RNG1	Sub side encoder resolution		0	0		0		0	0	0
SV020	RNG2	Main side encoder resolution		0	0		0		0	0	0
SV021	OLT	Overload detection time constant		60	60		60		60	60	60
SV022	OLL	Overload detection level		150	150		150		150	150	150
SV023	OD1	Excessive error detection width during servo ON		6	6		6		6	6	6
SV024	INP	In-position detection width		50	50		50		50	50	50
SV025	MTYP	Motor/Encoder type		2251	2252		2253		2254	2264	2265
SV026	OD2	Excessive error detection width during servo OFF		6	6		6		6	6	6
SV027	SSF1	Servo function 1		4000	4000		4000		4000	4000	4000
SV028	:	:		0	0		0		0	0	0
SV032	TOF	Torque offset		0	0		0		0	0	0
SV033	SSF2	Servo function 2		0000	0000		0000		0000	0000	0000
SV034	SSF3	Servo function 3		0000	0000		0000		0000	0000	0000
SV035	SSF4	Servo function 4		0000	0000		0000		0000	0000	0000
SV036	PTYP	Power supply type/ Regenerative resistor type		0000	0000		0000		0000	0000	0000
SV037	JL	Load inertia scale		0	0		0		0	0	0
SV046	FHz2	Notch filter frequency 2		0	0		0		0	0	0
SV047	EC	Inductive voltage compensation gain		100	100		100		100	100	100
SV048	EMGrt	Vertical axis drop prevention time		0	0		0		0	0	0
SV049	PGN1sp	Position loop gain 1 in spindle synchronous control		15	15		15		15	15	15
SV050	PGN2sp	Position loop gain 2 in spindle synchronous control		0	0		0		0	0	0
SV065	TLC	Machine end compensation gain		0	0		0		0	0	0
(System parameter area)											
SV073	FEEDout	Specified speed output speed		0	0		0		0	0	0
(System parameter area)											
SV081	SPEC2	Servo specification 2		0200	0200		0200		0200	0200	0200
SV082	SSF5	Servo function 5		0000	0000		0000		0000	0000	0000
SV083	SSF6	Servo function 6		0000	0000		0000		0000	0000	0000
SV084	SSF7	Servo function 7		0000	0000		0000		0000	0000	0000
SV085	LMCK	Lost motion compensation 3 spring constant		0	0		0		0	0	0
SV093	:	:		0	0		0		0	0	0
SV094	MPV	Magnetic pole position error detection speed		10	10		10		10	10	10
SV095	ZUPD	Vertical axis pull up distance		0	0		0		0	0	0
SV113	SSF8	Servo function 8		0000	0000		0000		0000	0000	0000
SV114	SSF9	Servo function 9		0080	0080		0080		0080	0080	0080
SV115	SSF10	Servo function 10		0000	0000		0000		0000	0000	0000
SV256	:	:		0	0		0		0	0	0

4 Setup

Parameter				200V Standard motor HK Series					
				HK154		HK223		HK224	
No.	Abbrev.	Details	Unit capacity	80	120	40	80	80	120
SV001	PC1	Motor side gear ratio		-	-	-	-	-	-
SV002	PC2	Machine side gear ratio		-	-	-	-	-	-
SV003	PGN1	Position loop gain 1			33		33		33
SV004	PGN2	Position loop gain 2			0		0		0
SV005	VGN1	Speed loop gain 1			53		92		72
SV006	VGN2	Speed loop gain 2			0		0		0
SV007	VIL	Speed loop delay compensation			0		0		0
SV008	VIA	Speed loop lead compensation			1364		1364		1364
SV009	IQA	Current loop q axis lead compensation			10240		10240		8192
SV010	IDA	Current loop d axis lead compensation			10240		10240		8192
SV011	IQG	Current loop q axis gain			1792		1536		1280
SV012	IDG	Current loop d axis gain			1792		1536		1280
SV013	ILMT	Current limit value			800		800		800
SV014	ILMTsp	Current limit value in special control			800		800		800
SV015	FFC	Acceleration rate feed forward gain			0		0		0
SV016	LMC1	Lost motion compensation 1			0		0		0
SV017	SPEC1	Servo specification 1		0000	0400	0000	0400	0000	0400
SV018	PIT	Ball screw pitch/Magnetic pole pitch			-		-		-
SV019	RNG1	Sub side encoder resolution			0		0		0
SV020	RNG2	Main side encoder resolution			0		0		0
SV021	OLT	Overload detection time constant			60		60		60
SV022	OLL	Overload detection level			150		150		150
SV023	OD1	Excessive error detection width during servo ON			6		6		6
SV024	INP	In-position detection width			50		50		50
SV025	MTYP	Motor/Encoder type			2255		2266		2256
SV026	OD2	Excessive error detection width during servo OFF			6		6		6
SV027	SSF1	Servo function 1			4000		4000		4000
SV028					0		0		0
:					:		:		:
SV032	TOF	Torque offset			0		0		0
SV033	SSF2	Servo function 2			0000		0000		0000
SV034	SSF3	Servo function 3			0000		0000		0000
SV035	SSF4	Servo function 4			0000		0000		0000
SV036	PTYP	Power supply type/ Regenerative resistor type			0000		0000		0000
SV037	JL	Load inertia scale			0		0		0
:					:		:		:
SV046	FHz2	Notch filter frequency 2			0		0		0
SV047	EC	Inductive voltage compensation gain			100		100		100
SV048	EMGrT	Vertical axis drop prevention time			0		0		0
SV049	PGN1sp	Position loop gain 1 in spindle synchronous control			15		15		15
SV050	PGN2sp	Position loop gain 2 in spindle synchronous control			0		0		0
:					:		:		:
SV065	TLC	Machine end compensation gain			0		0		0
(System parameter area)									
SV073	FEEDout	Specified speed output speed			0		0		0
(System parameter area)									
SV081	SPEC2	Servo specification 2			0200		0200		0200
SV082	SSF5	Servo function 5			0000		0000		0000
SV083	SSF6	Servo function 6			0000		0000		0000
SV084	SSF7	Servo function 7			0000		0000		0000
SV085	LMCk	Lost motion compensation 3 spring constant			0		0		0
:					:		:		:
SV093					0		0		0
SV094	MPV	Magnetic pole position error detection speed			10		10		10
SV095	ZUPD	Vertical axis pull up distance			0		0		0
:					:		:		:
SV113	SSF8	Servo function 8			0000		0000		0000
SV114	SSF9	Servo function 9			0080		0080		0080
SV115	SSF10	Servo function 10			0000		0000		0000
:					:		:		:
SV256					0		0		0

4 Setup

Parameter				200V Standard motor HK Series						
				HK204		HK302		HK303		HK354
No.	Abbrev.	Details	Unit capacity	80	120	40	80	80	120	120
SV001	PC1	Motor side gear ratio		-	-	-	-	-	-	-
SV002	PC2	Machine side gear ratio		-	-	-	-	-	-	-
SV003	PGN1	Position loop gain 1			33		33		33	33
SV004	PGN2	Position loop gain 2			0		0		0	0
SV005	VGN1	Speed loop gain 1			106		220		145	94
SV006	VGN2	Speed loop gain 2			0		0		0	0
SV007	VIL	Speed loop delay compensation			0		0		0	0
SV008	VIA	Speed loop lead compensation			1364		1364		1364	1364
SV009	IQA	Current loop q axis lead compensation			5120		4096		4096	7040
SV010	IDA	Current loop d axis lead compensation			5120		4096		4096	7040
SV011	IQG	Current loop q axis gain			1536		1408		1536	1920
SV012	IDG	Current loop d axis gain			1536		1408		1536	1920
SV013	ILMT	Current limit value			800		800		800	800
SV014	ILMTsp	Current limit value in special control			800		800		800	800
SV015	FFC	Acceleration rate feed forward gain			0		0		0	0
SV016	LMC1	Lost motion compensation 1			0		0		0	0
SV017	SPEC1	Servo specification 1		0000	0400	0000	0400	0000	0400	0000
SV018	PIT	Ball screw pitch/Magnetic pole pitch			-		-		-	-
SV019	RNG1	Sub side encoder resolution			-		-		-	-
SV020	RNG2	Main side encoder resolution			-		-		-	-
SV021	OLT	Overload detection time constant			60		60		60	60
SV022	OLL	Overload detection level			150		150		150	150
SV023	OD1	Excessive error detection width during servo ON			6		6		6	6
SV024	INP	In-position detection width			50		50		50	50
SV025	MTYP	Motor/Encoder type			2257		2267		2268	2258
SV026	OD2	Excessive error detection width during servo OFF			6		6		6	6
SV027	SSF1	Servo function 1			4000		4000		4000	4000
SV028					0		0		0	0
:					:		:		:	:
SV032	TOF	Torque offset			0		0		0	0
SV033	SSF2	Servo function 2			0000		0000		0000	0000
SV034	SSF3	Servo function 3			0000		0000		0000	0000
SV035	SSF4	Servo function 4			0000		0000		0000	0000
SV036	PTYP	Power supply type/ Regenerative resistor type			0000		0000		0000	0000
SV037	JL	Load inertia scale			0		0		0	0
:					:		:		:	:
SV046	FHz2	Notch filter frequency 2			0		0		0	0
SV047	EC	Inductive voltage compensation gain			100		100		100	100
SV048	EMGr	Vertical axis drop prevention time			0		0		0	0
SV049	PGN1sp	Position loop gain 1 in spindle synchronous control			15		15		15	15
SV050	PGN2sp	Position loop gain 2 in spindle synchronous control			0		0		0	0
:					:		:		:	:
SV065	TLC	Machine end compensation gain			0		0		0	0
(System parameter area)										
SV073	FEEDout	Specified speed output speed			0		0		0	0
(System parameter area)										
SV081	SPEC2	Servo specification 2			0000		0000		0000	0000
SV082	SSF5	Servo function 5			0000		0000		0000	0000
SV083	SSF6	Servo function 6			0000		0000		0000	0000
SV084	SSF7	Servo function 7			0000		0000		0000	0000
SV085	LMCK	Lost motion compensation 3 spring constant			0		0		0	0
:					:		:		:	:
SV093					0		0		0	0
SV094	MPV	Magnetic pole position error detection speed			0		0		0	0
SV095	ZUPD	Vertical axis pull up distance			0		0		0	0
:					:		:		:	:
SV113	SSF8	Servo function 8			0000		0000		0000	0000
SV114	SSF9	Servo function 9			0080		0080		0080	0080
SV115	SSF10	Servo function 10			0000		0000		0000	0000
:					:		:		:	:
SV256					0		0		0	0

4 Setup

Parameter				Motor	
				200V Standard motor HK Series	
				HK453	HK702
No.	Abbrev.	Details	Unit capacity	120	120
SV001	PC1	Motor side gear ratio		-	-
SV002	PC2	Machine side gear ratio		-	-
SV003	PGN1	Position loop gain 1		33	33
SV004	PGN2	Position loop gain 2		0	0
SV005	VGN1	Speed loop gain 1		127	108
SV006	VGN2	Speed loop gain 2		0	0
SV007	VIL	Speed loop delay compensation		0	0
SV008	VIA	Speed loop lead compensation		1364	1364
SV009	IQA	Current loop q axis lead compensation		5120	6144
SV010	IDA	Current loop d axis lead compensation		5120	6144
SV011	IQG	Current loop q axis gain		1536	2560
SV012	IDG	Current loop d axis gain		1536	2560
SV013	ILMT	Current limit value		800	800
SV014	ILMTsp	Current limit value in special control		800	800
SV015	FFC	Acceleration rate feed forward gain		0	0
SV016	LMC1	Lost motion compensation 1		0	0
SV017	SPEC1	Servo specification 1		0000	0000
SV018	PIT	Ball screw pitch/Magnetic pole pitch		-	-
SV019	RNG1	Sub side encoder resolution		-	-
SV020	RNG2	Main side encoder resolution		-	-
SV021	OLT	Overload detection time constant		60	60
SV022	OLL	Overload detection level		150	150
SV023	OD1	Excessive error detection width during servo ON		6	6
SV024	INP	In-position detection width		50	50
SV025	MTYP	Motor/Encoder type		2259	226A
SV026	OD2	Excessive error detection width during servo OFF		6	6
SV027	SSF1	Servo function 1		4000	4000
SV028				0	0
:				:	:
SV032	TOF	Torque offset		0	0
SV033	SSF2	Servo function 2		0000	0000
SV034	SSF3	Servo function 3		0000	0000
SV035	SSF4	Servo function 4		0000	0000
SV036	PTYP	Power supply type/ Regenerative resistor type		0000	0000
SV037	JL	Load inertia scale		0	0
:				:	:
SV046	FHz2	Notch filter frequency 2		0	0
SV047	EC	Inductive voltage compensation gain		100	100
SV048	EMGr	Vertical axis drop prevention time		0	0
SV049	PGN1sp	Position loop gain 1 in spindle synchronous control		15	15
SV050	PGN2sp	Position loop gain 2 in spindle synchronous control		0	0
:				:	:
SV065	TLC	Machine end compensation gain		0	0
(System parameter area)					
SV073	FEEDout	Specified speed output speed		0	0
(System parameter area)					
SV081	SPEC2	Servo specification 2		0000	0000
SV082	SSF5	Servo function 5		0000	0000
SV083	SSF6	Servo function 6		0000	0000
SV084	SSF7	Servo function 7		0000	0000
SV085	LMCk	Lost motion compensation 3 spring constant		0	0
:				:	:
SV093				0	0
SV094	MPV	Magnetic pole position error detection speed		0	0
SV095	ZUPD	Vertical axis pull up distance		0	0
:				:	:
SV113	SSF8	Servo function 8		0000	0000
SV114	SSF9	Servo function 9		0080	0080
SV115	SSF10	Servo function 10		0000	0000
:				:	:
SV256				0	0

(3) 400V Standard motor HG-H Series

Motor				400V Standard motor HG-H Series							
Parameter				HG-H54	HG-H104	HG-H154		HG-H204		HG-H354	HG-H453
No.	Abbrev.	Details	Unit capacity	40	40	40	60	40	60	60	60
SV001	PC1	Motor side gear ratio		-	-	-	-	-	-	-	-
SV002	PC2	Machine side gear ratio		-	-	-	-	-	-	-	-
SV003	PGN1	Position loop gain 1		33	33	33	33	33	33	33	33
SV004	PGN2	Position loop gain 2		0	0	0	0	0	0	0	0
SV005	VGN1	Speed loop gain 1		100	100	100	100	100	100	100	100
SV006	VGN2	Speed loop gain 2		0	0	0	0	0	0	0	0
SV007	VIL	Speed loop delay compensation		0	0	0	0	0	0	0	0
SV008	VIA	Speed loop lead compensation		1364	1364	1364	1364	1364	1364	1364	1364
SV009	IQA	Current loop q axis lead compensation		20480	10240	15360	8192	8192	8192	8192	6144
SV010	IDA	Current loop d axis lead compensation		20480	10240	15360	8192	8192	8192	8192	6144
SV011	IQG	Current loop q axis gain		3072	1280	2048	2048	2048	2048	2048	2048
SV012	IDG	Current loop d axis gain		3072	1280	2048	2048	2048	2048	2048	2048
SV013	ILMT	Current limit value		800	800	800	800	800	800	800	800
SV014	ILMTsp	Current limit value in special control		800	800	800	800	800	800	800	800
SV015	FFC	Acceleration rate feed forward gain		0	0	0	0	0	0	0	0
SV016	LMC1	Lost motion compensation 1		0	0	0	0	0	0	0	0
SV017	SPEC1	Servo specification 1		3000	3000	3000	3400	3000	3400	3000	3000
SV018	PIT	Ball screw pitch/Magnetic pole pitch		-	-	-	-	-	-	-	-
SV019	RNG1	Sub side encoder resolution		0	0	0	0	0	0	0	0
SV020	RNG2	Main side encoder resolution		0	0	0	0	0	0	0	0
SV021	OLT	Overload detection time constant		60	60	60	60	60	60	60	60
SV022	OLL	Overload detection level		150	150	150	150	150	150	150	150
SV023	OD1	Excessive error detection width during servo ON		6	6	6	6	6	6	6	6
SV024	INP	In-position detection width		50	50	50	50	50	50	50	50
SV025	MTYP	Motor/Encoder type		2243	2244	2245	2247	2247	2248	2248	2249
SV026	OD2	Excessive error detection width during servo OFF		6	6	6	6	6	6	6	6
SV027	SSF1	Servo function 1		4000	4000	4000	4000	4000	4000	4000	4000
:	:	:		:	:	:	:	:	:	:	:
SV031	OVS1	Overshooting compensation 1		0	0	0	0	0	0	0	0
SV032	TOF	Torque offset		0	0	0	0	0	0	0	0
SV033	SSF2	Servo function 2		0000	0000	0000	0000	0000	0000	0000	0000
SV034	SSF3	Servo function 3		0000	0000	0000	0000	0000	0000	0000	0000
SV035	SSF4	Servo function 4		0000	0000	0000	0000	0000	0000	0000	0000
SV036	PTYP	Power supply type/ Regenerative resistor type		0000	0000	0000	0000	0000	0000	0000	0000
:	:	:		:	:	:	:	:	:	:	:
SV045	TRUB	Friction torque		0	0	0	0	0	0	0	0
SV046	FHz2	Notch filter frequency 2		0	0	0	0	0	0	0	0
SV047	EC	Inductive voltage compensation gain		100	100	100	100	100	100	100	100
SV048	EMGrt	Vertical axis drop prevention time		0	0	0	0	0	0	0	0
SV049	PGN1sp	Position loop gain 1 in spindle synchronous control		15	15	15	15	15	15	15	15
:	:	:		:	:	:	:	:	:	:	:
SV064	DA2MPY	D/A output ch2 output scale		0	0	0	0	0	0	0	0
SV065	TLC	Machine end compensation gain		0	0	0	0	0	0	0	0
(System parameter area)											
SV073	FEEDout	Specified speed output speed		0	0	0	0	0	0	0	0
(System parameter area)											
SV081	SPEC2	Servo specification 2		0200	0200	0200	0200	0200	0200	0200	0200
SV082	SSF5	Servo function 5		0000	0000	0000	0000	0000	0000	0000	0000
SV083	SSF6	Servo function 6		0000	0000	0000	0000	0000	0000	0000	0000
SV084	SSF7	Servo function 7		0000	0000	0000	0000	0000	0000	0000	0000
SV085	LMck	Lost motion compensation 3 spring constant		0	0	0	0	0	0	0	0
:	:	:		:	:	:	:	:	:	:	:
SV093	:	:		0	0	0	0	0	0	0	0
SV094	MPV	Magnetic pole position error detection speed		10	10	10	10	10	10	10	10
SV095	ZUPD	Vertical axis pull up distance		0	0	0	0	0	0	0	0
:	:	:		:	:	:	:	:	:	:	:
SV113	SSF8	Servo function 8		0000	0000	0000	0000	0000	0000	0000	0000
SV114	SSF9	Servo function 9		0080	0080	0080	0080	0080	0080	0080	0080
SV115	SSF10	Servo function 10		0000	0000	0000	0000	0000	0000	0000	0000
:	:	:		:	:	:	:	:	:	:	:
SV256	:	:		0	0	0	0	0	0	0	0

(4) 400V Standard motor HK-H Series

Motor				400V Standard motor HK-H Series			
				HK-H55		HK-H104	
No.	Abbrev.	Details	Unit capacity	40	40	40	60
SV001	PC1	Motor side gear ratio		-	-	-	-
SV002	PC2	Machine side gear ratio		-	-	-	-
SV003	PGN1	Position loop gain 1		33	33		33
SV004	PGN2	Position loop gain 2		0	0		0
SV005	VGN1	Speed loop gain 1		21	37		54
SV006	VGN2	Speed loop gain 2		0	0		0
SV007	VIL	Speed loop delay compensation		0	0		0
SV008	VIA	Speed loop lead compensation		1364	1364		1364
SV009	IQA	Current loop q axis lead compensation		20480	16384		15360
SV010	IDA	Current loop d axis lead compensation		20480	16384		15360
SV011	IQG	Current loop q axis gain		4096	2560		2048
SV012	IDG	Current loop d axis gain		4096	2560		2048
SV013	ILMT	Current limit value		800	800		800
SV014	ILMTsp	Current limit value in special control		800	800		800
SV015	FFC	Acceleration rate feed forward gain		0	0		0
SV016	LMC1	Lost motion compensation 1		0	0		0
SV017	SPEC1	Servo specification 1		2400	2400	2000	2400
SV018	PIT	Ball screw pitch/Magnetic pole pitch		-	-		-
SV019	RNG1	Sub side encoder resolution		0	0		0
SV020	RNG2	Main side encoder resolution		0	0		0
SV021	OLT	Overload detection time constant		60	60		60
SV022	OLL	Overload detection level		150	150		150
SV023	OD1	Excessive error detection width during servo ON		6	6		6
SV024	INP	In-position detection width		50	50		50
SV025	MTYP	Motor/Encoder type		2253	2254		2255
SV026	OD2	Excessive error detection width during servo OFF		6	6		6
SV027	SSF1	Servo function 1		4000	4000		4000
:				0	0		0
SV031	OVS1	Overshooting compensation 1		:	:		:
SV032	TOF	Torque offset		0	0		0
SV033	SSF2	Servo function 2		0000	0000		0000
SV034	SSF3	Servo function 3		0000	0000		0000
SV035	SSF4	Servo function 4		0000	0000		0000
SV036	PTYP	Power supply type/ Regenerative resistor type		0000	0000		0000
:				0	0		0
SV045	TRUB	Friction torque		:	:		:
SV046	FHz2	Notch filter frequency 2		0	0		0
SV047	EC	Inductive voltage compensation gain		100	100		100
SV048	EMGrT	Vertical axis drop prevention time		0	0		0
SV049	PGN1sp	Position loop gain 1 in spindle synchronous control		15	15		15
:				0	0		0
SV064	DA2MPY	D/A output ch2 output scale		:	:		:
SV065	TLC	Machine end compensation gain		0	0		0
(System parameter area)							
SV073	FEEDout	Specified speed output speed		0	0		0
(System parameter area)							
SV081	SPEC2	Servo specification 2		0200	0200		0200
SV082	SSF5	Servo function 5		0000	0000		0000
SV083	SSF6	Servo function 6		0000	0000		0000
SV084	SSF7	Servo function 7		0000	0000		0000
SV085	LMCk	Lost motion compensation 3 spring constant		0	0		0
:				:	:		:
SV093				0	0		0
SV094	MPV	Magnetic pole position error detection speed		10	10		10
SV095	ZUPD	Vertical axis pull up distance		0	0		0
:				:	:		:
SV113	SSF8	Servo function 8		0000	0000		0000
SV114	SSF9	Servo function 9		0080	0080		0080
SV115	SSF10	Servo function 10		0000	0000		0000
:				:	:		:
SV256				0	0		0

4 Setup

Motor				400V Standard motor HK-H Series			
Parameter				HK-H204		HK-H354	HK-H453
No.	Abbrev.	Details	Unit capacity	40	60	60	60
SV001	PC1	Motor side gear ratio		-	-	-	-
SV002	PC2	Machine side gear ratio		-	-	-	-
SV003	PGN1	Position loop gain 1			33	33	33
SV004	PGN2	Position loop gain 2			0	0	0
SV005	VGN1	Speed loop gain 1			102	93	127
SV006	VGN2	Speed loop gain 2			0	0	0
SV007	VIL	Speed loop delay compensation			0	0	0
SV008	VIA	Speed loop lead compensation			1364	1364	1364
SV009	IQA	Current loop q axis lead compensation			8192	7040	4096
SV010	IDA	Current loop d axis lead compensation			8192	7040	4096
SV011	IQG	Current loop q axis gain			1536	1920	1536
SV012	IDG	Current loop d axis gain			1536	1920	1536
SV013	ILMT	Current limit value			800	800	800
SV014	ILMTsp	Current limit value in special control			800	800	800
SV015	FFC	Acceleration rate feed forward gain			0	0	0
SV016	LMC1	Lost motion compensation 1			0	0	0
SV017	SPEC1	Servo specification 1		2000	2400	2000	2000
SV018	PIT	Ball screw pitch/Magnetic pole pitch			-	-	-
SV019	RNG1	Sub side encoder resolution			-	-	-
SV020	RNG2	Main side encoder resolution			-	-	-
SV021	OLT	Overload detection time constant			60	60	60
SV022	OLL	Overload detection level			150	150	150
SV023	OD1	Excessive error detection width during servo ON			6	6	6
SV024	INP	In-position detection width			50	50	50
SV025	MTYP	Motor/Encoder type			2257	2258	2259
SV026	OD2	Excessive error detection width during servo OFF			6	6	6
SV027	SSF1	Servo function 1			4000	4000	4000
:					0	0	0
SV031	OVS1	Overshooting compensation 1			:	:	:
SV032	TOF	Torque offset			0	0	0
SV033	SSF2	Servo function 2			0000	0000	0000
SV034	SSF3	Servo function 3			0000	0000	0000
SV035	SSF4	Servo function 4			0000	0000	0000
SV036	PTYP	Power supply type/ Regenerative resistor type			0000	0000	0000
:					0	0	0
SV045	TRUB	Friction torque			:	:	:
SV046	FHz2	Notch filter frequency 2			0	0	0
SV047	EC	Inductive voltage compensation gain			100	100	100
SV048	EMGr	Vertical axis drop prevention time			0	0	0
SV049	PGN1sp	Position loop gain 1 in spindle synchronous control			15	15	15
:					0	0	0
SV064	DA2MPY	D/A output ch2 output scale			:	:	:
SV065	TLC	Machine end compensation gain			0	0	0
(System parameter area)							
SV073	FEEDout	Specified speed output speed			0	0	0
(System parameter area)							
SV081	SPEC2	Servo specification 2			0000	0000	0000
SV082	SSF5	Servo function 5			0000	0000	0000
SV083	SSF6	Servo function 6			0000	0000	0000
SV084	SSF7	Servo function 7			0000	0000	0000
SV085	LMck	Lost motion compensation 3 spring constant			0	0	0
:					:	:	:
SV093					0	0	0
SV094	MPV	Magnetic pole position error detection speed			0	0	0
SV095	ZUPD	Vertical axis pull up distance			0	0	0
:					:	:	:
SV113	SSF8	Servo function 8			0000	0000	0000
SV114	SSF9	Servo function 9			0080	0080	0080
SV115	SSF10	Servo function 10			0000	0000	0000
:					:	:	:
SV256					0	0	0

4.2.5 Servo Parameters

The parameters with "(PR)" requires the CNC to be turned OFF after the settings. Turn the power OFF and ON to enable the parameter settings.

(PR)	#2201	SV001 PC1	Motor side gear ratio
			<p>Set the gear ratio in the motor side when there is the gear between the servo motor's shaft and machine (ball screw, etc.). For the rotary axis, set the total deceleration (acceleration) ratio. Even if the gear ratio is within the setting range, the electronic gears may overflow and an initial parameter error (servo alarm 37) may occur.</p> <p>For linear servo system Set to "1".</p> <p>---Setting range--- 1 to 32767</p>
(PR)	#2202	SV002 PC2	Machine side gear ratio
			<p>Set the gear ratio in the machine side when there is the gear between the servo motor's shaft and machine (ball screw, etc.). For the rotary axis, set the total deceleration (acceleration) ratio. Even if the gear ratio is within the setting range, the electronic gears may overflow and an initial parameter error (servo alarm 37) may occur.</p> <p>For linear servo system Set to "1".</p> <p>---Setting range--- 1 to 32767</p>
	#2203	SV003 PGN1	Position loop gain 1
			<p>Set the position loop gain. The standard setting is "33". The higher the setting value is, the more accurately the command can be followed, and the shorter the settling time in positioning gets, however, note that a bigger shock will be applied to the machine during acceleration/deceleration. When using the SHG control, also set SV004 (PGN2) and SV057 (SHGC).</p> <p>When using the OMR-FF control, set the servo rigidity against quadrant projection or cutting load, etc. For the tracking ability to the command, set by SV106(PGM).</p> <p>---Setting range--- 1 to 200 (rad/s)</p>
	#2204	SV004 PGN2	Position loop gain 2
			<p>When performing the SHG control, set the value of "SV003 x 8/3" to "SV004". When not using the SHG control, set to "0". When using the OMR-FF control, set to "0".</p> <p>Related parameters: SV003, SV057</p> <p>---Setting range--- 0 to 999 (rad/s)</p>
	#2205	SV005 VGN1	Speed loop gain 1
			<p>Set the speed loop gain. The higher the setting value is, the more accurate the control will be, however, vibration tends to occur. If vibration occurs, adjust by lowering by 20 to 30%. The value should be determined to the 70 to 80% of the value at which the vibration stops. The value differs depending on servo motors. Aim at the standard value determined by the servo motor type and load inertia ratio to adjust.</p> <p>---Setting range--- 1 to 30000</p>

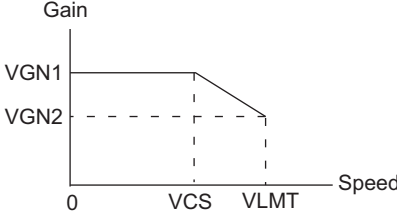
#2206	SV006 VGN2	Speed loop gain 2
<p>Set the speed loop gain at the motor limitation speed VLMT with "VCS(SV029: Speed at the change of speed loop gain)". Use this to suppress noise at high speed rotation during rapid traverse, etc. Then, the speed loop gain decreases at faster speed than the setting value of VCS. When not using, set to "0".</p>		
 <p>The graph plots Gain on the vertical axis and Speed on the horizontal axis. The gain starts at a constant value VGN1 from speed 0 up to VCS. At VCS, the gain begins to decrease linearly, reaching a value VGN2 at the motor limitation speed VLMT. Dashed lines indicate the levels VGN1 and VGN2 on the y-axis and the transition points VCS and VLMT on the x-axis.</p>		
<p>---Setting range---</p> <p>-1000 to 30000</p>		
#2207	SV007 VIL	Speed loop delay compensation
<p>Set this when the limit cycle occurs in the full-closed loop, or overshooting occurs in positioning. The speed loop delay compensation method can be selected with SV027/bit1,0. Normally, use "Changeover type 2". Changeover type 2 controls the occurrence of overshooting by lowering the speed loop lead compensation after the position droop gets 0. When setting this parameter, make sure to set the torque offset (SV032).</p>		
<p>---Setting range---</p> <p>0 to 32767</p>		
#2208	SV008 VIA	Speed loop lead compensation
<p>Set the gain of the speed loop integral control. Standard setting: 1364 Standard setting in the SHG control: 1900 Adjust the value by increasing/decreasing this by about 100 at a time. Raise this value to improve contour tracking accuracy in high-speed cutting. Lower this value when the position droop does not stabilize (when the vibration of 10 to 20Hz occurs).</p>		
<p>---Setting range---</p> <p>1 to 9999</p>		
#2209	SV009 IQA	Current loop q axis lead compensation
<p>Set the fixed value of each motor. Set the standard value for each motor described in the standard parameter list.</p>		
<p>---Setting range---</p> <p>1 to 20480</p>		
#2210	SV010 IDA	Current loop d axis lead compensation
<p>Set the fixed value of each motor. Set the standard value for each motor described in the standard parameter list.</p>		
<p>---Setting range---</p> <p>1 to 20480</p>		
#2211	SV011 IQG	Current loop q axis gain
<p>Set the fixed value of each motor. Set the standard value for each motor described in the standard parameter list.</p>		
<p>---Setting range---</p> <p>1 to 8192</p>		

#2212	SV012 IDG	Current loop d axis gain
		Set the fixed value of each motor. Set the standard value for each motor described in the standard parameter list.
	---Setting range---	
	1 to 8192	
#2213	SV013 ILMT	Current limit value
		Set the current (torque) limit value in a normal operation. This is a limit value in forward run and reverse run (for linear motors: forward and reverse direction). When the standard setting value is "800", the maximum torque is determined by the specification of the motor. Set this parameter as a proportion (%) to the stall current.
	---Setting range---	
	0 - 999 (Stall current %)	
#2214	SV014 ILMTsp	Current limit value in special control
		Set the current (torque) limit value in a special operation (absolute position initial setting, stopper control and etc.). This is a limit value in forward and reverse directions. Set to "800" when not using. Set this parameter as a proportion (%) to the stall current.
	---Setting range---	
	0 - 999 (Stall current %) However, when SV084/bitB=1, the setting range is from 0 to 32767 (Stall current 0.01%).	
#2215	SV015 FFC	Acceleration rate feed forward gain
		When a relative error in synchronous control is too large, set this parameter to the axis that is delaying. The standard setting is "0". The standard setting in the SHG control is "100". To adjust a relative error in acceleration/deceleration, increase the value by 50 at a time.
	---Setting range---	
	0 to 999 (%)	
#2216	SV016 LMC1	Lost motion compensation 1
		Set this parameter when the protrusion (that occurs due to the non-sensitive band by friction, torsion, backlash, etc.) at quadrant change is too large. This sets the compensation torque at quadrant change (when an axis feed direction is reversed) by the proportion (%) to the stall torque. Whether to enable the lost motion compensation and the method can be set with other parameters.
	Type 2: When SV027/bit9, 8=10 (Compatible with obsolete type) Set the type 2 method compensation torque. The standard setting is double the friction torque. Related parameters: SV027/bit9,8, SV033/bitF, SV039, SV040, SV041, SV082/bit2	
	Type 3: When SV082/bit1=1 Set the compensation torque equivalent of dynamic friction amount of the type 3 method compensation amount. The standard setting is double the dynamic friction torque. Related parameters: SV041, SV082/bit2,1, SV085, SV086	
	To vary compensation amount according to the direction. When SV041 (LMC2) is "0", compensate with the value of SV016 (LMC1) in both +/-directions. If you wish to change the compensation amount depending on the command direction, set this and SV041 (LMC2). (SV016: + direction, SV041: - direction. However, the directions may be opposite depending on other settings.) When "-1" is set, the compensation will not be performed in the direction of the command.	
	---Setting range---	
	-1 to 200 (Stall current %) Note that when SV082/bit2 is "1", the setting range is between -1 and 20000 (Stall current 0.01%).	

(PR) #2217 SV017 SPEC1 Servo specification 1

Select the servo specifications.
A function is allocated to each bit.
Set this in hexadecimal format.

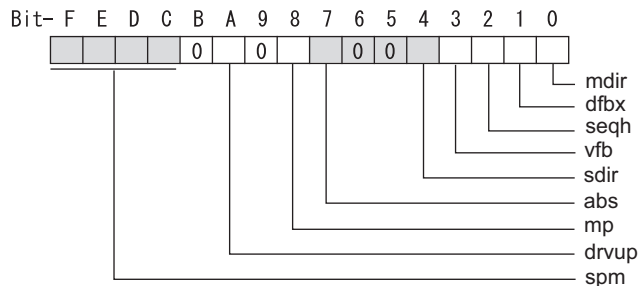
**bit F-C : smp Motor series selection**

- 0: 200V HK motor (Standard)
- 1: 200V HG motor (Standard)
- 2: 400V HK-H motor (Standard)
- 3: 400V HG-H, HQ-H motor (Standard)
- 6: 200V LM-F linear motor
- 7: 200V direct-drive motor
- 8: 400V LM-F linear motor
- 9: 400V direct-drive motor

bit B :

Not used. Set to "0".

bit A : drvup Combined drive unit:

- 0: Normal setting (Combined drive unit: normal)
 - 1: Combined drive unit: one upgrade
- (Note) It is not available for MDS-EJ/EJH Series.

bit 9 :

Not used. Set to "0".

bit 8 : mp MPI scale pole number setting

- 0: 360 poles 1: 720 poles

bit 7 : abs Position control

These parameters are set automatically by the NC system.
0: Incremental 1: Absolute position control

bit 6-5 :

Not used. Set to "0".

bit 4 : sdir Sub side encoder feedback

Set the machine side encoder's installation polarity.
0: Forward polarity 1: Reverse polarity

bit 3 : vfb Speed feedback filter

- 0: Stop 1: Start (4500Hz)

bit 2 : seqh Ready on sequence

- 0: Normal 1: High-speed

bit 1 : dfbx Dual feedback control

Control the position FB signal in full closed control by the combination of a motor side encoder and machine side encoder.
0: Stop 1: Start

Related parameters: SV051, SV052

bit 0 : mdir Machine side encoder feedback (for Linear/direct-drive motor)

Set the encoder installation polarity in the linear servo and direct-drive motor control.

0: Forward polarity 1: Reverse polarity

(PR)	#2218	SV018 PIT	Ball screw pitch/Magnetic pole pitch
			<p>For servo motor: Set the ball screw pitch. For the rotary axis, set to "360".</p> <p>For direct-drive motor Set to "360".</p> <p>For linear motor Set the ball screw pitch. (For LM-F series, set to "48")</p> <p>---Setting range---</p> <p>For general motor: 1 to 32767 (mm/rev) - For linear motor 1 to 32767 (mm)</p>
(PR)	#2219	SV019 RNG1	Sub side encoder resolution
			<p>For semi-closed loop control Set the same value as SV020.</p> <p>For full-closed loop control Set the number of pulses per ball screw pitch.</p> <p>For direct-drive motor Set the same value as SV020.</p> <p>For 1000 pulse unit resolution encoder, set the number of pulses in SV019 in increments of 1000 pulse (kp). The value must be input in increments of 10K pulses (the 1st digit of the setting value is "0"). In this case, make sure to set "0" to SV117.</p> <p>For high-accuracy binary resolution encoder, set the number of pulses to four bite data of SV117 (high-order) and SV019 (low-order) in pulse (p) unit. SV117 = number of pulses / 65536 (when =0, set "-1" to SV117) SV019 = the remainder of number of "pulses / 65536"</p> <p>---Setting range---</p> <p>When SV117 = 0, the setting range is from 0 to 32767 (kp) When SV117≠0, the setting range is from 0 to 65535 (p)</p>
(PR)	#2220	SV020 RNG2	Main side encoder resolution
			<p>Normally, set to "0".</p> <p>For linear motor Set the number of pulses of the encoder per magnetic pole pitch with SV118.</p> <p>For direct-drive motor Set the number of pulses per revolution of the motor side encoder.</p> <p>For 1000 pulse unit resolution encoder, set the number of pulses to SV020 in increments of 1000 pulse(kp). The value must be input in increments of 10K pulses (the 1st digit of the setting value is "0"). In this case, make sure to set SV118 to "0". For high-accuracy binary resolution encoder, set the number of pulses to four bite data of SV118 (high-order) and SV020 (low-order) in pulse(p) unit. SV118 = number of pulses / 65536 (when =0, set "-1" to SV118) SV020 = the remainder of "number of pulses / 65536"</p> <p>---Setting range---</p> <p>When SV118 = 0, the setting range is from 0 to 32767 (kp) When SV118≠0, the setting range is from 0 to 65535 (p)</p>

#2221	SV021 OLT	Overload detection time constant
		Normally, set to "60". (For Mitsubishi Electric adjustment.)
		Related parameters: SV022
		---Setting range---
		1 to 999 (s)
#2222	SV022 OLL	Overload detection level
		Set the "Overload 1" (Alarm 50) current detection level as percentage to the stall current. Normally set this parameter to "150". (For Mitsubishi Electric adjustment.)
		Related parameters: SV021
		---Setting range---
		110 to 500 (Stall current %)
#2223	SV023 OD1	Excessive error detection width during servo ON
		Set the excessive error detection width in servo ON. When set to "0", the excessive error alarm detection will be ignored, so do not set to "0". <Standard setting value> $OD1=OD2= (\text{Rapid traverse rate [mm/min]} / (60 \times \text{PGN1}) / 2 [\text{mm}]$
		Related parameters: SV026
		---Setting range---
		0 to 32767 (mm) However, when SV084/bitC=1, the setting range is from 0 to 32767 (μm).
#2224	SV024 INP	In-position detection width
		Set the in-position detection width. Set the positioning accuracy required for the machine. The lower the setting is, the higher the positioning accuracy will be. However the cycle time (settling time) becomes longer. The standard setting value is "50".
		---Setting range---
		1 to 32767 (μm)

(PR)	#2225	SV025 MTYP	Motor/Encoder type
------	-------	------------	--------------------

Set the position encoder type, speed encoder type and motor type.
The setting value is a four-digit hex (HEX).

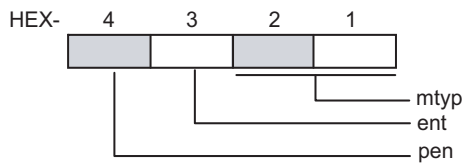

bit F-C: pen(HEX-4) Position encoder

Semi-closed loop control by general motor
pen=2

Full-closed loop control by general motor

- Ball screw end encoder (OSA405ET2AS, OSA676ET2AS)
pen=6
- For serial signal output rotary scale (including MDS-EX-HR)
pen=6
- For rectangular wave signal output linear scale
pen=8
- For serial signal output linear scale (including MDS-EX-HR and MPI scale)
pen=A
- For speed command synchronization control
Primary axis pen=A
Secondary axis pen=D
- For common encoder current command synchronous control
Primary axis pen=2 (Rotary motor)
pen=A (Linear motor)
Secondary axis pen=D

For a linear motor
pen=A

For a direct-drive motor
pen=2

bit B-8: ent(HEX-3) Speed encoder

For a general motor: ent=2

For common encoder current command synchronous control

Primary axis pen=2 (Rotary motor)

pen=A (Linear motor)

Secondary axis pen=D

For a linear motor: ent=A

For a direct-drive motor: ent=2

bit 7-0: mtyp(HEX-2,1) Motor type

Set the motor type. Set this with SV017/bitF-C.

For SV017/bitF-C = 0 (200V HK motor series)

HK76	: 51h	HK154 (E-V3-80)	: 91h	HK303	: 68h
HK105	: 52h	HK154 (E-V3-40)	: 98h	HK354	: 58h
HK55	: 53h	HK223	: 66h	HK453	: 59h
HK104	: 54h	HK224	: 56h	HK603	: 69h
HK123	: 64h	HK224 (E-V1/V2-160)	: 81h	HK702	: 6Ah
HK142	: 65h	HK204	: 57h	HK703	: 5Ah
HK154	: 55h	HK302	: 67h		

For SV017/bitF-C = 1 (200V standard motor series)

HG46	: BAh	HG154 (E-V3-40)	: 4Fh	HG603	: 69h
HG56	: BBh	HG224	: 46h	HG702	: 6Ah
HG96	: BCh	HG204	: 47h	HG703	: 4Ah
HG75	: 41h	HG354	: 48h	HG903	: 4Bh
HG105	: 42h	HG123	: 64h	HG1103	: 4Ch
HG54	: 43h	HG223	: 66h	HG142	: 65h
HG104	: 44h	HG303	: 68h	HG302	: 67h
HG154	: 45h	HG453	: 49h		

For SV017/bitF-C = 2 (400V HK-H motor series)

HK-H76	: 51h	HK-H223	: 66h	HK-H453	: 59h
HK-H105	: 52h	HK-H224	: 56h	HK-H603	: 69h
HK-H55	: 53h	HK-H224 (EH-V1/V2-80)	: 81h	HK-H702	: 6Ah
HK-H104	: 54h	HK-H204	: 57h	HK-H703	: 5Ah
HK-H123	: 64h	HK-H302	: 67h		
HK-H154	: 55h	HK-H303	: 68h		
HK-H154 (EH-V3-40)	: 91h	HK-H354	: 58h		

For SV017/bitF-C = 3 (400V standard motor series)

HG-H75	: 41h	HG-H224	: 46h	HG-H903	: 4Bh
HG-H105	: 42h	HG-H204	: 47h	HG-H1502	: 4Dh
HG-H54	: 43h	HG-H354	: 48h	HQ-H903	: 58h
HG-H104	: 44h	HG-H453	: 49h	HQ-H1103	: 59h
HG-H154	: 45h	HG-H703	: 4Ah		

For linear motor and direct-drive motor, follow the settings stated in respective materials.

#2226	SV026 OD2	Excessive error detection width during servo OFF
-------	-----------	--

Set the excessive error detection width during servo OFF.

When set to "0", the excessive error alarm detection will be ignored, so do not set to "0".

<Standard setting value>

$$OD1=OD2= (\text{Rapid traverse rate [mm/min]}) / (60 \times \text{PGN1}) / 2 \text{ [mm]}$$

Related parameters: SV023

---Setting range---

0 to 32767 (mm)

However, when SV084/bitC=1, the setting range is from 0 to 32767 (μm).

#2227 **SV027 SSF1** **Servo function 1**

Select the servo functions.
 A function is assigned to each bit.
 Set this in hexadecimal format.

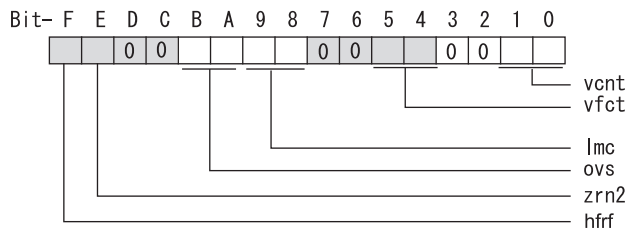

bit F : hfrf Higher harmonic suppression filter

0: Stop
 1: Start

bit E : zrn2

Set to "1". (Fixed)

bit D :

Not used. Set to "0".

bit C :

Not used. Set to "0".

bit B-A : ovs Overshooting compensation

Set this if overshooting occurs during positioning.

bitB,A=
 00: Compensation stop
 01: Setting prohibited
 10: Setting prohibited
 11: Type 3

Set the compensation amount in SV031(OVS1) and SV042(OVS2).

Related parameters: SV031, SV042, SV034/bitF-C

bit 9-8 : lmc Lost motion compensation type

Set this parameter when the protrusion at quadrant change is too large.

Type 2 has an obsolete type compatible control.

bit9,8=
 00: Compensation stop
 01: Setting prohibited
 10: Type 2
 11: Setting prohibited

Set the compensation amount in SV016(LMC1) and SV041(LMC2).

(Note) When "SV082/bit1=1", the lost motion compensation type 3 will be selected regardless of this setting.

bit 7 :

Not used. Set to "0".

bit 6 :

Not used. Set to "0".

bit 5-4 : vfct Jitter compensation pulse number

Suppress vibration by machine backlash when axis stops.

bit5,4=
 00: Disable
 01: 1 pulse
 10: 2 pulse
 11: 3 pulses

bit 3 :

Not used. Set to "0".

bit 2 :

Not used. Set to "0".

bit 1-0 : vcnt Speed loop delay compensation changeover type selection

Normally, use "Changeover type 2".

bit1,0=

00: Disable

01: Changeover type 1

10: Changeover type 2

11: Setting prohibited

Related parameters: SV007

(PR)	#2228	SV028 MSFT	Magnetic pole shift amount (for linear/direct-drive motor)
			<p>Set this parameter to adjust the motor magnetic pole position and encoder's installation phase when using linear motors or direct-drive motors. During the DC excitation of the initial setup (SV034/bit4=1), set the same value displayed in "AFLT gain" on the NC monitor screen.</p> <p>Related parameters: SV034/bit4, SV061, SV062, SV063</p> <p>For general motor: Not used. Set to "0".</p> <p>---Setting range---</p> <p>-18000 to 18000 (electrical angle 0.01°)</p>
#2229	SV029 VCS	Speed at the change of speed loop gain	
			<p>Noise at high speed rotation including rapid traverse can be reduced by lowering the speed loop gain at high speeds. Set the speed at which the speed loop gain changes. Use this with SV006 (VGN2). When not using, set to "0".</p> <p>---Setting range---</p> <p>0 to 9999 (r/min)</p>
#2230	SV030 IVC	Voltage non-sensitive band compensation	
			<p>When 100% is set, the voltage reduction amount equivalent to the logical non-energization in the PWM control will be compensated. When "0" is set, 100% compensation will be performed. Adjust in increments of 10% from the default value of 100%. If increased too much, vibration or vibration noise may be generated.</p> <p>---Setting range---</p> <p>0 to 255 (%)</p>

#2231	SV031 OVS1	Overshooting compensation 1
<p>This compensates the motor torque when overshooting occurs during positioning. This is valid only when the overshooting compensation (SV027/bitB,A) is selected.</p>		
<p>Type 3 SV027/bitB,A=11 Set the compensation amount based on the motor stall current. Observing positioning droop waveform, increase in increments of 1% and find the value where overshooting does not occur.</p>		
<p>To vary compensation amount depending on the direction. When SV042 (OVS2) is "0", change the SV031 (OVS1) value in both of the +/- directions to compensate. To vary the compensation amount depending on the command direction, set this and SV042 (OVS2). (SV031: + direction, SV042: - direction. However, the directions may be opposite depending on other settings.) When "-1" is set, the compensation will not be performed in the direction of the command.</p>		
<p>Related parameters: SV027/bitB,A, SV034/bitF-C, SV042, SV082/bit2</p>		
<p>---Setting range---</p>		
<p>-1 to 100 (Stall current %) Note that the range will be "-1 - 10000" (Stall current 0.01%) when SV082/bit2 is "1".</p>		
#2232	SV032 TOF	Torque offset
<p>Set the unbalance torque on vertical axis and inclined axis. When the vertical axis pull up function is enabled, the pull up compensation direction is determined by this parameter's sign. When set to "0", and the pull up function is enabled (SV033/bitE=1), the alarm "S02 2233 Initial parameter error" occurs. This can be used for speed loop delay compensation and collision detection function. To use load inertia estimation function (drive monitor display), set this parameter, friction torque (SV045) and load inertia display enabling flag(SV035/bitF).</p>		
<p>Related parameters: SV007, SV033/bitE, SV059</p>		
<p>---Setting range---</p>		
<p>-100 to 100 (Stall current %)</p>		

#2233

SV033 SSF2

Servo function 2

Select the servo functions.
A function is assigned to each bit.
Set this in hexadecimal format.

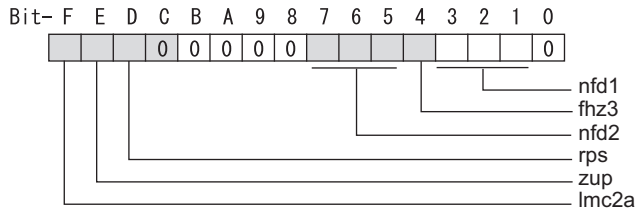
**bit F : lmc2a Lost motion compensation 2 timing**

0: Normal 1: Change

bit E : zup Vertical axis pull up function

0: Stop 1: Enable

Related parameters: SV032, SV095

bit D : rps Safely limited speed setting increment

Change the setting units of the specified speed signal output speed (SV073).

0: mm/min 1: 100mm/min

Related parameters: SV073

bit C-8 :

Not used. Set to "0".

bit 7-5 : nfd2 Depth of Notch filter 2

Set the depth of Notch filter 2 (SV046).

bit7,6,5=

000: -∞

001: -18.1[dB]

010: -12.0[dB]

011: -8.5[dB]

100: -6.0[dB]

101: -4.1[dB]

110: -2.5[dB]

111: -1.2[dB]

bit 4 : fhz3 Notch filter 3

0: Stop 1: Start (1125Hz)

bit 3-1 : nfd1 Depth of Notch filter 1

Set the depth of Notch filter 1 (SV038).

bit3,2,1=

000: -∞

001: -18.1[dB]

010: -12.0[dB]

011: -8.5[dB]

100: -6.0[dB]

101: -4.1[dB]

110: -2.5[dB]

111: -1.2[dB]

bit 0 :

Not used. Set to "0".

#2234 **SV034 SSF3** **Servo function 3**

Select the servo functions.
 A function is assigned to each bit.
 Set this in hexadecimal format.

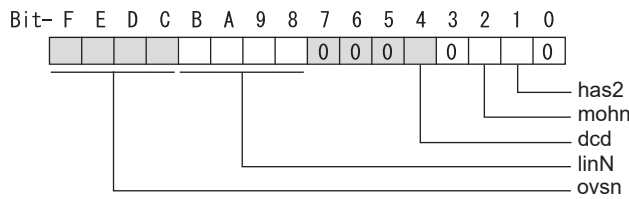

bit F-C: ovsn Overshooting compensation type 3 Non-sensitive band

Set the non-sensitive band of the model position droop overshooting amount in increments of 2µm. In the feed forward control, set the non-sensitive band of the model position droop and ignore the overshooting of the model.
 0 : 0 µm, 1: 2 µm, 2: 4µm,---, E : 28 µm, F: 30µm

bit B-8 : linN The number of parallel connections when using linear motors (for linear)

Set to "2" to perform 1 amplifier 2 motor control by linear servo.

bit 7-5 :

Not used. Set to "0".

bit 4 : dcd (linear/direct-drive motor)

0: Normal setting 1: DC excitation mode

Related parameters: SV061, SV062, SV063

bit 3 :

Not used. Set to "0".

bit 2 : mohn Thermistor temperature detection (linear/direct-drive motor)

0: Normal setting 1: Disable

bit 1 : has HAS control

This stabilizes the speed overshooting by torque saturation phenomenon.
 0: Normal setting 1: Enable

Related parameters: SV084/bitF

bit 0 :

Not used. Set to "0".

#2235 SV035 SSF4 Servo function 4

Select the servo functions.
 A function is assigned to each bit.
 Set this in hexadecimal format.

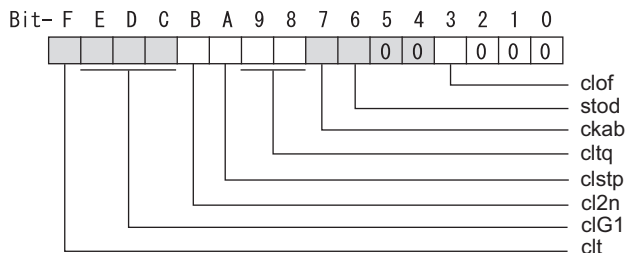

bit F: clt Inertia ratio display

- 0: Setting for normal use
- 1: Display the total inertia ratio estimated at acceleration/deceleration at the inertia ratio on the servo monitor screen
 To display it on the screen, set an imbalance torque and friction torque to both SV032 and SV045 and repeat acceleration/deceleration operations for several times.

bit E-C: clG1 G1 Collision detection level

Set the collision detection level in the collision detection method 1 during cutting feed (G1) in multiples of that of rapid traverse (G0). When set to "0", detection of collision detection method 1 during cutting feed will be ignored.
 $G1 \text{ Collision detection level} = G0 \text{ collision detection level (SV060)} \times clG1$

bit B: cl2n Collision detection method 2

- 0: Enable 1: Disable

bit A: clstp Collision detection method 1 disabled during stop

- 0: Collision detection method 1 enabled during stop
- 1: Collision detection method 1 disabled during stop

bit 9-8: cltq Retract torque in collision detection

Set the retract torque in collision detection using the ratio of motor's maximum torque.
 bit9,8=
 00: 100%
 01: 90%
 10: 80% (Standard)
 11: 70%

bit 7: ckab No signal detection 2

Set this to use rectangular wave output linear scale.
 This enables the detection of No signal 2 (alarm 21).
 0: Disable 1: Enable

bit 6: stod Alarm 4D-2 detection disabled during deceleration and stop

- 0: Normal 1: Alarm 4D-2 detection disabled during deceleration and stop

bit 5-4:

Not used. Set to "0".

bit 3: clof Collision detection estimated disturbance torque offset

- 0: Disable 1: Enable

bit 2-0:

Not used. Set to "0".

(PR)	#2236	SV036 PTYP	Power supply type/ Regenerative resistor type
------	-------	------------	---

MDS-E/EH Series: Power supply type

When connecting a power supply unit, set a code for each power supply unit.

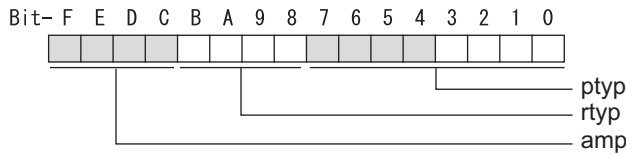

bit F-C : amp

Set the power backup function to be used.
 No function used : 0
 Deceleration and stop function at power failure : 8
 Retraction function at power failure : C

bit B-8 : rtyp

Not used. Set to "0".

bit 7-0 : ptyp External emergency stop setting

When the emergency stop input signal of the power supply unit is "disabled"

- Power supply unit is not connected : 00
- MDS-E-CV-37 / MDS-EH-CV-37 : 04
- MDS-E-CV-75 / MDS-EH-CV-75 : 08
- MDS-E-CV-110 / MDS-EH-CV-110 : 11
- MDS-E-CV-185 / MDS-EH-CV-185 : 19
- MDS-E-CV-300 / MDS-EH-CV-300 : 30
- MDS-E-CV-370 / MDS-EH-CV-370 : 37
- MDS-E-CV-450 / MDS-EH-CV-450 : 45
- MDS-E-CV-550 / MDS-EH-CV-550 : 55
- MDS-EH-CV-750 : 75

When the emergency stop input signal of the power supply unit is "enabled"

(Note) Set the power supply rotary switch to "4".

- Power supply unit is not connected : 00
- MDS-E-CV-37 / MDS-EH-CV-37 : 44
- MDS-E-CV-75 / MDS-EH-CV-75 : 48
- MDS-E-CV-110 / MDS-EH-CV-110 : 51
- MDS-E-CV-185 / MDS-EH-CV-185 : 59
- MDS-E-CV-300 / MDS-EH-CV-300 : 70
- MDS-E-CV-370 / MDS-EH-CV-370 : 77
- MDS-E-CV-450 / MDS-EH-CV-450 : 85
- MDS-E-CV-550 / MDS-EH-CV-550 : 95
- MDS-EH-CV-750 : B5

MDS-EM/EMH Series

Not used. Set to "0000".
 External emergency stop power supply type is set by spindle parameter (SP032).

MDS-EJ/EJH Series: Regenerative resistor type

Set the regenerative resistor type.

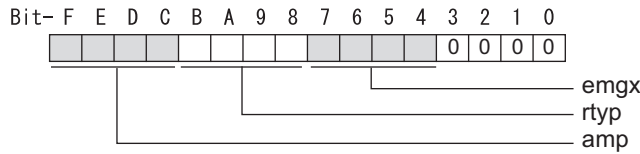

bit F-8 : amp(bit F-C) / rtp(bit B-8)

- Resistor built-in drive unit : 10
- Setting prohibited : 11
- MR-RB032 : 12
- MR-RB12 or GZG200W39OHMK : 13
- MR-RB32 or GZG200W120OHMK 3 units connected in parallel : 14
- MR-RB30 or GZG200W39OHMK 3 units connected in parallel : 15
- MR-RB50 or GZG300W39OHMK 3 units connected in parallel : 16
- MR-RB31 or GZG200W20OHMK 3 units connected in parallel : 17
- MR-RB51 or GZG300W20OHMK 3 units connected in parallel : 18
- Setting prohibited : 19-1F

- Setting prohibited : 20-23
- FCUA-RB22 : 24
- FCUA-RB37 : 25
- FCUA-RB55 : 26
- FCUA-RB75/2 : 27
- Setting prohibited : 28
- R-UNIT2 : 29
- Setting prohibited : 2A-2C
- FCUA-RB75/2 2 units connected in parallel : 2D
- FCUA-RB55 2 units connected in parallel : 2E
- Setting prohibited : 2F

- MR-RB1H-4 : 33
- MR-RB3M-4 : 34
- MR-RB3G-4 : 35
- MR-RB5G-4 : 36

bit 7-4 : emgx External emergency stop function

Set the external emergency stop function.
0: Disable 4: Enable

bit 3-0 :

Not used. Set to "0".

#2237	SV037 JL	Load inertia scale
	Set the motor axis conversion total load inertia including motor itself in proportion to the motor inertia. SV037(JL)=(Jm+Jl)/Jm×100 Jm: Motor inertia Jl: Motor axis conversion load inertia	
	For linear motor, set the gross mass of the moving sections in kg unit.	
	<<Drive monitor load inertia ratio display>> Set SV035/bitF=1 and imbalance torque and friction torque to both SV032 and SV045, and then repeat acceleration/deceleration for several times.	
	---Setting range--- For general motor: 0 to 5000 (%) For linear motor 0 to 5000 (kg)	

#2238	SV038 FHZ1	Notch filter frequency 1
<p>Set the vibration frequency to suppress when machine vibration occurs. (Normally, do not set 80 or less.) Set to "0" when not using.</p> <p>Related parameters: SV033/bit3-1, SV115</p> <p>---Setting range--- 0 to 5000 (Hz)</p>		
#2239	SV039 LMCD	Lost motion compensation timing
<p>Set this when the timing of lost motion compensation type 2 does not match. Adjust increments of 10 at a time.</p> <p>---Setting range--- 0 to 2000 (ms)</p>		
#2240	SV040 LMCT	Lost motion compensation non-sensitive band
<p>Set the non-sensitive band of the lost motion compensation in the feed forward control. When "0" is set, 2μm is the actual value to be set. Adjust increments of 1μm.</p> <p>---Setting range--- 0 to 255 (μm)</p>		
#2241	SV041 LMC2	Lost motion compensation 2
<p>Set this with SV016 (LMC1) only when you wish to vary the lost motion compensation amount depending on the command directions. Normally, set to "0".</p> <p>---Setting range--- -1 to 200 (Stall current %) Note that when SV082/bit2 is "1", the setting range is between -1 and 20000 (Stall current 0.01%).</p>		
#2242	SV042 OVS2	Overshooting compensation 2
<p>Set this with SV031 (OVS1) only when you wish to vary the overshooting compensation amount depending on the command directions. Normally, set to "0".</p> <p>---Setting range--- -1 to 100 (Stall current %) Note that when SV082/bit2 is "1", the setting range is between -1 and 10000 (Stall current 0.01%).</p>		
#2243	SV043 OBS1	Disturbance observer filter frequency
<p>Set the disturbance observer filter band. Normally, set to "100". Setting values of 49 or less is equal to "0" setting. To use the disturbance observer, also set SV037 (JL) and SV044 (OBS2). When disturbance observer related parameters are changed, lost motion compensation needs to be readjusted. Set to "0" when not using.</p> <p>---Setting range--- 0 to 1000 (rad/s)</p>		
#2244	SV044 OBS2	Disturbance observer gain
<p>Set the disturbance observer gain. The standard setting is "100 to 300". To use the disturbance observer, also set SV037 (JL) and SV043 (OBS1). When disturbance observer related parameters are changed, lost motion compensation needs to be readjusted. Set to "0" when not using.</p> <p>---Setting range--- 0 to 500 (%)</p>		

#2245	SV045 TRUB	Friction torque
<p>Set the frictional torque when using the collision detection function. To use load inertia estimation function (drive monitor display), set this parameter, imbalance torque (SV032) and load inertia display enabling flag (SV035/bitF).</p> <p>---Setting range---</p> <p>0 to 255 (Stall current %)</p>		
#2246	SV046 FHZ2	Notch filter frequency 2
<p>Set the vibration frequency to suppress when machine vibration occurs. (Normally, do not set 80 or less.) Set to "0" when not using.</p> <p>Related parameters: SV033/bit7-5, SV115</p> <p>---Setting range---</p> <p>0 to 5000 (Hz)</p>		
#2247	SV047 EC	Inductive voltage compensation gain
<p>Set the inductive voltage compensation gain. Standard setting value is "100". If the current FB peak exceeds the current command peak, lower the gain.</p> <p>---Setting range---</p> <p>0 to 200 (%)</p>		
#2248	SV048 EMGrT	Vertical axis drop prevention time
<p>Input the time required to prevent the vertical axis from dropping by delaying READY OFF until the brake works at an emergency stop. Increase in increments of 100ms at a time, find and set the value where the axis does not drop. When using a motor with a break of HG(-H) Series, HQ-H Series, and HK(-H) Series set to "200ms" as a standard. When the pull up function is enabled (SV033/bitE=1), the pull up is established during the drop prevention time.</p> <p>(Note) When not using the spindle drive unit, use the servo axis that controls vertical axis drop prevention control to control the power supply (connect with CN4).</p> <p>Related parameters: SV033/bitE, SV055, SV056</p> <p>---Setting range---</p> <p>0 to 20000 (ms) When set to "0", and the pull up function is enabled (SV033/bitE=1), the alarm "S02 2233 Initial parameter error" occurs.</p>		
#2249	SV049 PGN1sp	Position loop gain 1 in spindle synchronous control
<p>Set the position loop gain during spindle synchronization control (synchronous tapping and synchronization control with spindle C-axis). Set the same value as that of the position loop gain for spindle synchronous tapping control. When performing the SHG control, set this parameter with SV050 (PGN2sp) and SV058 (SHGCsp). When changing the value, change the value of "#2017 tap_g Axis servo gain".</p> <p>---Setting range---</p> <p>1 to 200 (rad/s)</p>		
#2250	SV050 PGN2sp	Position loop gain 2 in spindle synchronous control
<p>When using SHG control during spindle synchronous control (synchronous tapping and synchronization control with spindle C-axis), set this parameter with SV049 (PGN1sp) and SV058 (SHGCsp). Make sure to set the value 8/3 times that of SV049. When not using the SHG control, set to "0".</p> <p>---Setting range---</p> <p>0 to 999 (rad/s)</p>		

#2251	SV051 DFBT	Dual feedback control time constant
		<p>Set the control time constant in dual feed back. When "0" is set, it operates at 1ms. The higher the time constant is, the closer it gets to the semi-closed control, so the limit of the position loop gain will be raised.</p> <p>For linear servo/direct-drive motor system Not used. Set to "0".</p> <p>Related parameters: SV017/bit1, SV052</p> <p>---Setting range--- 0 to 9999 (ms)</p>
#2252	SV052 DFBN	Dual feedback control non-sensitive band
		<p>Set the non-sensitive band in the dual feedback control. Normally, set to "0".</p> <p>For linear servo/direct-drive motor system Not used. Set to "0".</p> <p>Related parameters: SV017/bit1, SV052</p> <p>---Setting range--- 0 to 9999 (μm)</p>
#2253	SV053 OD3	Excessive error detection width in special control
		<p>Set the excessive error detection width when servo ON in a special control (initial absolute position setting, stopper control and etc.). When "0" is set, excessive error detection will not be performed when servo ON during a special control.</p> <p>---Setting range--- 0 to 32767 (mm) However, when SV084/bitC=1, the setting range is from 0 to 32767 (μm).</p>
#2254	SV054 ORE	Overrun detection width in closed loop control
		<p>Set the overrun detection width in the full-closed loop control. When the gap between the motor side encoder and the linear scale (machine side encoder) exceeds the value set by this parameter, it will be judged as overrun and "Alarm 43" will be detected. When "-1" is set, if the differential velocity between the motor side encoder and the machine side encoder exceeds the 30% of the maximum motor speed, it will be judged as overrun and "Alarm 43" will be detected. When "0" is set, overrun will be detected with a 2mm width.</p> <p>For linear servo/direct-drive motor system Not used. Set to "0".</p> <p>---Setting range--- -1 to 32767 (mm) However, when SV084/bitD=1, the setting range is from -1 to 32767 (μm).</p>
#2255	SV055 EMGx	Max. gate off delay time after emergency stop
		<p>Set the time required between an emergency stop and forced READY OFF. Set the maximum value "+ 100ms" of the SV056 setting value of the servo drive unit electrified by the same power supply unit. When executing the vertical axis drop prevention, the gate off will be delayed for the length of time set at SV048 even when SV055's is smaller than that of SV048.</p> <p>Related parameters: SV048, SV056</p> <p>---Setting range--- 0 to 20000 (ms)</p>

#2256	SV056 EMGt	Deceleration time constant at emergency stop
		<p>Set the time constant used for the deceleration control at emergency stop. Set the time required to stop from rapid traverse rate (rapid). The standard setting value is $EMGt \leq G0tL \times 0.9$. However, note that the standard setting value differs from the above-mentioned value when the setting value of "#2003:smgst Acceleration and deceleration modes bit 3-0:Rapid traverse acceleration/deceleration type" is 8 or F. Refer to Instruction Manual of the drive unit (section "5.5.1 Deceleration Control") for details.</p> <p>Related parameters: SV048, SV055</p> <p>---Setting range---</p> <p>0 to 20000 (ms)</p>
#2257	SV057 SHGC	SHG control gain
		<p>When performing the SHG control, set to $SV003(PGN1) \times 6$. When not using the SHG control, set to "0". When using the OMR-FF control, set to "0".</p> <p>Related parameters: SV003, SV004</p> <p>---Setting range---</p> <p>0 to 1200 (rad/s)</p>
#2258	SV058 SHGCsp	SHG control gain in spindle synchronous control
		<p>When using SHG control during spindle synchronization control (synchronous tapping and synchronous control with spindle C-axis), set this parameter with SV049 (PGN1sp) and SV050 (PGN2sp). Make sure to set the value 6 times that of SV049. When not using the SHG control, set to "0".</p> <p>---Setting range---</p> <p>0 to 1200 (rad/s)</p>
#2259	SV059 TCNV	Collision detection torque estimated gain
		<p>Set the torque estimated gain when using the collision detection function. The standard setting value is the same as the load inertia ratio (SV037 setting value) including motor inertia. Set to "0" when not using the collision detection function.</p> <p>Related parameters: SV032, SV035/bitF-8, SV037, SV045, SV060</p> <p><<Drive monitor load inertia ratio display>> Set SV035/bitF=1 and imbalance torque and friction torque to both SV032 and SV045, and then repeat acceleration/deceleration for several times.</p> <p>---Setting range---</p> <p>For general motor: 0 to 5000 (%) For linear motor: 0 to 5000 (kg)</p>
#2260	SV060 TLMT	Collision detection level
		<p>When using the collision detection function, set the collision detection level at the G0 feeding. When "0" is set, none of the collision detection function will work.</p> <p>Related parameters: SV032, SV035/bitF-8, SV037, SV045, SV059</p> <p>---Setting range---</p> <p>0 to 999 (Stall current %)</p>

#2261	SV061 DA1NO	D/A output ch1 data No. / Initial DC excitation level
		<p>Input the data number you wish to output to the D/A output channel 1. When using the 2-axis drive unit, set "-1" to the axis that the data will not be output.</p> <p>When the DC excitation is running (SV034/bit4=1): Use this when the DC excitation is running (SV034/bit4=1) to adjust the initial magnetic pole position (when measuring the magnetic pole shift amount) for linear motor and direct-drive motor. Set the initial excitation level in DC excitation control. Set 10% as standard. Related parameters: SV062, SV063</p> <p>---Setting range--- -32768 to 32767 When the DC excitation is running (SV034/bit4=1): 0 to 100 (Stall current %)</p>
#2262	SV062 DA2NO	D/A output ch2 data No. / Final DC excitation level
		<p>Input the data number you wish to output to the D/A output channel 2. When using the 2-axis drive unit, set "-1" to the axis that the data will not be output.</p> <p>When the DC excitation is running (SV034/bit4=1): Use this when the DC excitation is running (SV034/bit4=1) to adjust the initial magnetic pole position (when measuring the magnetic pole shift amount) for linear motor and direct-drive motor. Set the final excitation level in DC excitation control. Set 10% as standard. When the magnetic pole shift amount measurement value is unsteady, adjust the value in increments of 5%. Related parameters: SV061, SV063</p> <p>---Setting range--- -32768 to 32767 When the DC excitation is running (SV034/bit4=1): 0 to 100 (Stall current %)</p>
#2263	SV063 DA1MPY	D/A output ch1 output scale / Initial DC excitation time
		<p>Set output scale of the D/A output channel 1 in increment of 1/100. When "0" is set, the magnification is the same as when "100" is set.</p> <p>When the DC excitation is running (SV034/bit4=1): Use this when the DC excitation is running (SV034/bit4=1) to adjust the initial magnetic pole position (when measuring the magnetic pole shift amount) for linear motor and direct-drive motor. Set the initial excitation time in DC excitation control. Set 1000ms as standard. When the magnetic pole shift amount measurement value is unsteady, adjust the value in increments of 500ms. Related parameters: SV061, SV062</p> <p>---Setting range--- -32768 to 32767 (1/100-fold) When the DC excitation is running (SV034/bit4=1): 0 to 10000 (ms)</p>
#2264	SV064 DA2MPY	D/A output ch2 output scale
		<p>Set output scale of the D/A output channel 2 in increment of 1/100. When "0" is set, the magnification is the same as when "100" is set.</p> <p>---Setting range--- -32768 to 32767 (1/100-fold)</p>

#2265	SV065 TLC	Machine end compensation gain																																	
<p>The shape of the machine end is compensated by compensating the spring effect from the machine end to the motor end. Set the machine end compensation gain. Measure the error amount by roundness measurement and estimate the setting value by the following formula.</p> $\text{Compensation amount } (\mu\text{m}) = \text{Command speed } F(\text{mm/min})^2 * \text{SV065} / (\text{Radius } R(\text{mm}) * \text{SV003} * 16,200,000)$ <p>Set to "0" when not using.</p> <p>---Setting range---</p> -30000 to 30000 (Acceleration ratio 0.1%)																																			
#2266-2272	SV066 - SV072																																		
<p>This parameter is set automatically by the NC system.</p>																																			
(PR)	#2273	SV073 FEEDout	Specified speed output speed																																
<p>Set the specified speed. Also set SV082/bit9,8 to output digital signal.</p> <p>---Setting range---</p> 0 to 32767 (mm/min) However, when SV033/bitD=1, the setting range is from 0 to 32767 (100mm/min). (Only for MDS-E/EH and MDS-EM/EMH)																																			
#2274-2280	SV074 - SV080																																		
<p>This parameter is set automatically by the NC system.</p>																																			
(PR)	#2281	SV081 SPEC2	Servo specification 2																																
<p>Select the servo functions. A function is assigned to each bit. Set this in hexadecimal format.</p> <div style="display: flex; align-items: center;"> <div style="margin-right: 10px;">Bit-</div> <table border="1" style="border-collapse: collapse; text-align: center;"> <tr> <td>F</td><td>E</td><td>D</td><td>C</td><td>B</td><td>A</td><td>9</td><td>8</td><td>7</td><td>6</td><td>5</td><td>4</td><td>3</td><td>2</td><td>1</td><td>0</td> </tr> <tr> <td>0</td><td>0</td><td>0</td><td>0</td><td>0</td><td>0</td><td>0</td><td>0</td><td>0</td><td>0</td><td>0</td><td>0</td><td>0</td><td>0</td><td>0</td><td>0</td> </tr> </table> <div style="margin-left: 10px; margin-top: 10px;"> <p>absc</p> <p>szchk</p> <p>cbc</p> <p>npg</p> </div> </div> <p>bit F-A: Not used. Set to "0".</p> <p>bit 9: npg Earth fault detection 0: Disable 1: Enable (standard) Set "0" and it is constantly "Enable" for MDS-EJ/EJH Series.</p> <p>bit 8: cbc motor brake axis selection control 0: Standard 1: Motor brake axis selection control enabled (Only for MDS-EJ-V2)</p> <p>bit 7: szchk Distance-coded reference scale reference mark 0: Check at 4 points (standard) 1: Check at 3 points</p> <p>bit 6-4: Not used. Set to "0".</p> <p>bit 3: absc Distance-coded reference scale 0: Disable 1: Enable</p> <p>bit 2-0: Not used. Set to "0".</p>				F	E	D	C	B	A	9	8	7	6	5	4	3	2	1	0	0	0	0	0	0	0	0	0	0	0	0	0	0	0	0	0
F	E	D	C	B	A	9	8	7	6	5	4	3	2	1	0																				
0	0	0	0	0	0	0	0	0	0	0	0	0	0	0	0																				

#2282 SV082 SSF5 Servo function 5

Select the servo functions.
 A function is assigned to each bit.
 Set this in hexadecimal format.

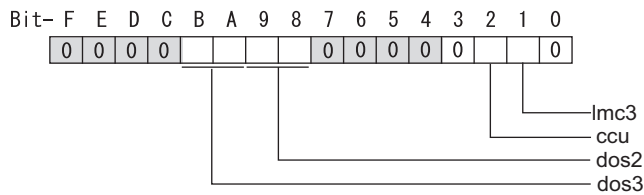

bit F-C:

Not used. Set to "0".

bit B-A: dos3 Digital signal output 3 selection

- bitB,A=
 00: Disable
 01: Setting prohibited
 10: Contactor control signal output (For MDS-EJ/EJH)
 11: Setting prohibited

bit 9-8: dos2 Digital signal output 2 selection

- bit9,8=
 00: Disable
 01: Specified speed output
 10: Setting prohibited
 11: Setting prohibited

bit 7-3:

Not used. Set to "0".

bit 2: ccu Lost motion overshoot compensation compensation amount setting increment

- 0: Stall current % 1: Stall current 0.01%

bit 1: lmc3 Lost motion compensation type 3

Set this when protrusion at a quadrant change is too big.

- 0: Stop 1: Start

Related parameters: SV016, SV041, SV085, SV086

bit 0:

Not used. Set to "0".

#2283

SV083 SSF6

Servo function 6

Select the servo functions.
A function is assigned to each bit.
Set this in hexadecimal format.

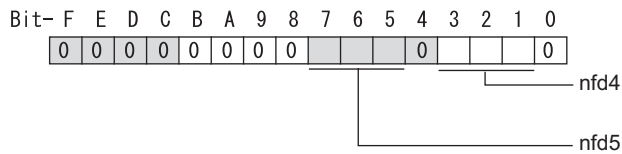
**bit F-8 :**

Not used. Set to "0".

bit 7-5 : nfd5 Depth of Notch filter 5

Set the depth of Notch filter 5 (SV088).

bit7,6,5=

000: $-\infty$

001: -18.1[dB]

010: -12.0[dB]

011: -8.5[dB]

100: -6.0[dB]

101: -4.1[dB]

110: -2.5[dB]

111: -1.2[dB]

bit 4 :

Not used. Set to "0".

bit 3-1 : nfd4 Depth of Notch filter 4

Set the depth of Notch filter 4 (SV087).

bit3,2,1=

000: $-\infty$

001: -18.1[dB]

010: -12.0[dB]

011: -8.5[dB]

100: -6.0[dB]

101: -4.1[dB]

110: -2.5[dB]

111: -1.2[dB]

bit 0 :

Not used. Set to "0".

#2284	SV084 SSF7	Servo function 7
	<p>Select the servo functions. A function is assigned to each bit. Set this in hexadecimal format.</p>	
	<p>Bit- F E D C B A 9 8 7 6 5 4 3 2 1 0</p> <p>irms ilm2u odu oru h2c</p>	
	<p>bit F : h2c HAS control cancel amount 0: 1/4 (standard) 1: 1/2 Related parameters: SV034/bit1</p>	
	<p>bit E : Not used. Set to "0".</p>	
	<p>bit D : oru Overrun detection width unit 0: mm (normal setting) 1: μm</p>	
	<p>bit C : odu Excessive error detection width unit 0: mm (normal setting) 1: μm</p>	
	<p>bit B : ilm2u Current limit value (SV014) in special control setting unit 0: Stall current % (normal setting) 1: Stall current 0.01%</p>	
	<p>bit A-1 : Not used. Set to "0".</p>	
	<p>bit 0 : irms Motor current display 0: Motor q axis current display (normal) 1: Motor effective current display</p>	
#2285	SV085 LMCK	Lost motion compensation 3 spring constant
	<p>Set the machine system's spring constant when selecting lost motion compensation type 3. When not using, set to "0".</p> <p>Related parameters: SV016, SV041, SV082/bit2,1, SV086</p> <p>---Setting range--- 0 to 32767 (0.01%/μm)</p>	
#2286	SV086 LMCC	Lost motion compensation 3 viscous coefficient
	<p>Set the machine system's viscous coefficient when selecting lost motion compensation type 3. When not using, set to "0".</p> <p>Related parameters: SV016, SV041, SV082/bit2,1, SV086</p> <p>---Setting range--- 0 to 32767 (0.01%\cdots/mm)</p>	
#2287	SV087 FHZ4	Notch filter frequency 4
	<p>Set the vibration frequency to suppress when machine vibration occurs. (Normally, do not set 80 or less.) Set to "0" when not using.</p> <p>Related parameters: SV083/bit3-1, SV115</p> <p>---Setting range--- 0 to 5000 (Hz)</p>	

#2288	SV088 FHz5	Notch filter frequency 5
<p>Set the vibration frequency to suppress when machine vibration occurs. (Normally, do not set 80 or less.) Set to "0" when not using.</p> <p>Related parameters: SV083/bit7-5, SV115</p> <p>---Setting range--- 0 to 5000 (Hz)</p>		
#2289	SV089	
Not used. Set to "0".		
#2290	SV090	
Not used. Set to "0".		
#2291	SV091 LMC4G	Lost motion compensation 4 gain
<p>Use this with LMC compensation type 3. As the delay in path tracking is monitored and compensated, the delay in path tracking will be minimized even if machine friction amount changes by aging. Use the lost motion compensation amount (SV016) * 5 (10% of the dynamic friction torque) as the target. The higher the setting value is, the more accurate the quadrant change be; however, the more likely vibrations occur.</p> <p>---Setting range--- 0 to 20000 (Stall current 0.01%)</p>		
#2292	SV092	
Not used. Set to "0".		
#2293	SV093	
Not used. Set to "0".		
#2294	SV094 MPV	Magnetic pole position error detection speed
<p>The magnetic pole position detection function monitors the command speed and motor speed at the position command stop and detects the magnetic pole position error alarm (3E) if any. Set the error detection level for the command speed and motor speed at the position command stop. Be aware when setting the parameter as the setting units for general motors and linear motors are different.</p> <p><<For general motor>> When the command speed error detection level is set to "0", the magnetic pole position error (3E) is detected at 10r/min. Set "10" as standard. This detects the magnetic pole position error (3E) when the motor rotation speed is 100r/min and more.</p> <p><<For linear motor>> When the command motor speed level is set to "0", the magnetic pole position error (3E) is detected at 1mm/s. Set "10" as standard. This detects the magnetic pole position error (3E) when the motor speed is 10mm/s and more.</p> <p>---Setting range--- 0 to 31999</p> <p><<For general motor>> Ten-thousands digit, Thousands digit ----- Command speed error detection level (10r/min) Hundreds digit, Tens digit, Ones digit ----- Motor speed error detection level (10r/min)</p> <p><<For linear motor>> Ten-thousands digit, Thousands digit ----- Command speed error detection speed level (1mm/s) Hundreds digit, Tens digit, Ones digit ----- Motor speed error detection level (1mm/s)</p>		

#2295	SV095 ZUPD	Vertical axis pull up distance																																
<p>Set this parameter to adjust the pull up distance when the vertical axis pull up function is enabled. When the pull up function is enabled and this parameter is set to "0", for a rotary motor, 8/1000 of a rotation at the motor end is internally set as the pull up distance, and for a linear motor, 80[μm] is set.</p> <p>Related parameters: SV032 : The pull up direction is determined. When "0" is set, the alarm occurs. SV033/bitE : Start-up of the pull up function SV048 : Set the drop prevention time. When "0" is set, the alarm occurs.</p> <p>---Setting range--- 0 to 2000 (μm)</p>																																		
#2296-2305	SV096 - SV105																																	
<p>Not used. Set to "0".</p>																																		
#2306	SV106 PGM	OMR-FF scale model gain																																
<p>Set the scale model gain (position response) in OMR-FF control. Set the same value as SV003(PGN1). Increase the setting value to perform a high-speed machining such as a fine arc or to improve the path error. Lower the value when vibration occurs during acceleration/deceleration. Set to "0" when not using OMR-FF control.</p> <p>---Setting range--- 0 to 300 (rad/s)</p>																																		
#2307-2311	SV107 - SV111																																	
<p>Not used. Set to "0".</p>																																		
#2312	SV112 IFF	OMR-FF current feed forward gain																																
<p>Set the current feed forward rate in OMR-FF control. The standard setting is "10000". Setting value of "0" is equal to "10000(100%)" setting. Set to "0" when not using OMR-FF control.</p> <p>---Setting range--- 0 to 32767 (0.01%)</p>																																		
#2313	SV113 SSF8	Servo function 8																																
<p>Select the servo functions. A function is assigned to each bit. Set this in hexadecimal format.</p> <div style="display: flex; align-items: center;"> <div style="margin-right: 10px;">Bit-</div> <table border="1" style="border-collapse: collapse; text-align: center;"> <tr> <td>F</td><td>E</td><td>D</td><td>C</td><td>B</td><td>A</td><td>9</td><td>8</td><td>7</td><td>6</td><td>5</td><td>4</td><td>3</td><td>2</td><td>1</td><td>0</td> </tr> <tr> <td>0</td><td>0</td><td>0</td><td>0</td><td>0</td><td>0</td><td>0</td><td>0</td><td></td><td></td><td>0</td><td>0</td><td>0</td><td>0</td><td>0</td><td>0</td> </tr> </table> <div style="margin-left: 10px; margin-top: 10px;"> <p>└── omrffon</p> <p>└── nmerc</p> <p>└── sto</p> </div> </div>			F	E	D	C	B	A	9	8	7	6	5	4	3	2	1	0	0	0	0	0	0	0	0	0			0	0	0	0	0	0
F	E	D	C	B	A	9	8	7	6	5	4	3	2	1	0																			
0	0	0	0	0	0	0	0			0	0	0	0	0	0																			
<p>bit F-9 : Not used. Set to "0".</p> <p>bit 8 : sto Dedicated wiring STO function Set this parameter to use dedicated wiring STO function. 0: Dedicated wiring STO function unused 1: Dedicated wiring STO function used (Only for MDS-E/EH and MDS-EJ/EJH)</p> <p>bit 7 : nmerc Machine error compensation amount (Note) Do not turn ON the NC power supply with the setting as disable (set to "1"). The initial parameter error alarm is detected. 0: Enable (Normal setting) 1: Disable</p> <p>bit 0 : omrffon OMR-FF control enabled 0: Disable 1: Enable</p>																																		

#2314 SV114 SSF9 Servo function 9

Select the servo functions.
 A function is assigned to each bit.
 Set this in hexadecimal format.

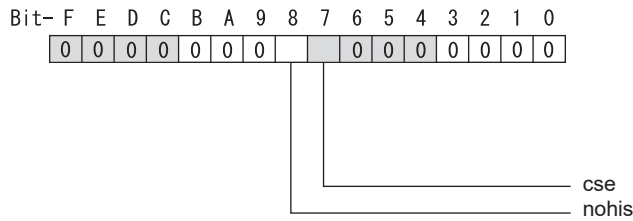

bit F-9 :

Set to "8" when HG46, 56, 96 motors are driven by MDS-E-V3.
 Set to "0" for other cases.

bit 8 : nohis History of communication error alarm between NC and DRV (34, 36, 38, 39)

0: Enable 1: Disable

bit 7 : cse Command speed monitoring function

0: Disable 1: Enable (Normal setting)

bit 6-0 :

Not used. Set to "0".

#2315

SV115 SSF10

Servo function 10

Select the servo functions.
A function is assigned to each bit.
Set this in hexadecimal format.

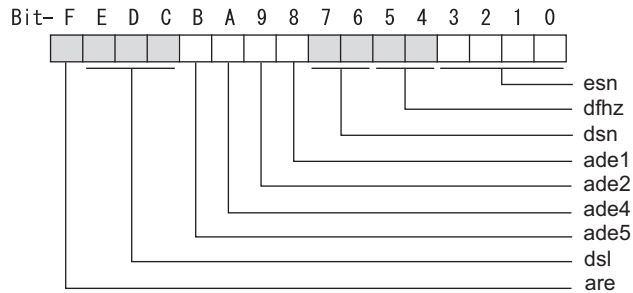
**bit F : are Notch filter5 all frequencies adapted**

When enabled, Notch filter5 all frequencies adaptive range is not limited regardless of SV115/bit4,5 setting.
0: Disable 1: Enable

bit E-C: dsl Notch filter frequency display

Switch the "AFLT frequency" display on drive monitor screen to check every notch filter frequency.
When the selected notch filter is not used, "0" is displayed.

bitE,D,C=
000 : Estimated resonance frequency (Normal display)
001 : Notch filter 1 frequency
010 : Notch filter 2 frequency
011 : Notch filter 3 frequency (always displays 1125Hz)
100 : Notch filter 4 frequency
101 : Notch filter 5 frequency
Other settings: setting prohibited

bit B : ade5 Notch filter 5 / Adaptive follow-up function

0: Disable 1: Enable

bit A : ade4 Notch filter 4 / Adaptive follow-up function

0: Disable 1: Enable

bit 9 : ade2 Notch filter 2 / Adaptive follow-up function

0: Disable 1: Enable

bit 8 : ade1 Notch filter 1 / Adaptive follow-up function

0: Disable 1: Enable

bit 7-6 : dsn Estimated resonance frequency display holding time

Set the estimated resonance frequency display holding time to the "AFLT frequency" display on drive monitor screen.

bit7,6=
00: 4 [s]
01: 8 [s]
10: 12 [s]
11: 16 [s]

bit 5-4 : dfhz Notch filter frequency range

Set the adaptive range of the notch filter frequency. When the adaptive follow-up function is enabled and if the estimated resonance frequency exists in the set range, the notch filter will be adapted. Normally set this parameter to "00".

bit5,4=
 00: -10 to 10 [%]
 01: -20 to 20 [%]
 10: -30 to 30 [%]
 11: -40 to 40 [%]

bit 3-0 : esn Sensitivity of estimated resonance frequency

Set the sensitivity of the estimated resonance frequency. When the notch filter adaptive follow-up function is enabled, smaller setting value enables to detect smaller vibration component, however, adaptive movement will be repeated frequently. Normally set this parameter to "0".

0 : Normal setting (same sensitivity as A) 1 : Sensitivity high to F : Sensitivity low

#2316	SV116 SSF11	Servo function 11
bit1: fctcfw Full-closed torsion compensation function forward direction compensation enabled		
Compensate the torsion amount in the forward direction with the full-closed torsion compensation function. When compensating the torsion amount in the reverse direction only, set to "0".		
0: Stop 1: Start		
(PR) #2317	SV117 RNG1ex	Expansion sub side encoder resolution
For high-accuracy binary resolution encoder, set the number of pulses to four bite data of SV117 (high-order) and SV019 (low-order) by pulse (p). When SV117=0, the setting unit of SV019 is (kp). Refer to SV019 for details.		
Related parameters: SV019, SV020, SV118		
---Setting range---		
-1 to 32767		
(PR) #2318	SV118 RNG2ex	Expansion main side encoder resolution
When using high-accuracy binary resolution encoder, set the number of pulses to four bite data of SV118 (high-order) and SV020 (low-order) by pulse (p). When SV118=0, the setting unit of SV020 is (kp). Refer to SV020 for details.		
Related parameters: SV019, SV020, SV117		
---Setting range---		
-1 to 32767		
#2319-2328	SV119 - SV128	
Not used. Set to "0".		
#2329	SV129 Kwf	Synchronous control feed forward filter frequency
Set the acceleration rate feed forward filter frequency in high-speed synchronous tapping control. The standard setting is "600".		
Related parameters: SV244		
---Setting range---		
0 to 32767 (rad/s)		

(PR)	#2330	SV130 RPITS	Base reference mark interval
			<p>Set the base reference mark intervals of distance-coded reference scale. When the distance-coded reference scale is not used, set to "0". The interval of basic reference mark (SV130) and auxiliary interval (SV131) must be in the specified relationship. Other settings cause the initial parameter error (alarm 37). Following is the specified relationship.</p> <p>The quotient of $(SV130 \times 1000) / SV131$ must be 4 or more and leaves no remainder.</p> <p>Related parameters: SV081/bit7,3, SV131, SV134 to SV137</p> <p>---Setting range--- 0 to 32767 (mm)</p>
(PR)	#2331	SV131 DPITS	Auxiliary reference mark interval
			<p>Set the auxiliary interval of reference mark in the distance-coded reference scale. When the distance-coded reference scale is not used, set to "0". The interval of basic reference mark (SV130) and auxiliary interval (SV131) must be in the specified relationship. Other settings cause the initial parameter error (alarm 37). Following is the specified relationship.</p> <p>The quotient of $(SV130 \times 1000) / SV131$ must be 4 or more and leaves no remainder.</p> <p>Related parameters: SV081/bit7,3, SV130, SV134 to SV137</p> <p>---Setting range--- 0 to 32767 (μm)</p>
#2332	SV132		Not used. Set to "0".
#2333	SV133		Not used. Set to "0".
#2334	SV134 RRn0	Distance-coded reference check / revolution counter	<p>Set this parameter to operate distance-coded reference check when using distance-coded reference scale. During the distance-coded reference check initial setup (SV137:RAER=-1), set the following items on the NC drive monitor screen after the distance-coded reference check initial setup warning A3 turns OFF.</p> <p>SV134=Rn, SV135=Pn, SV136=MPOS</p> <p>When reference point is set, the warning A3 turns OFF. To enable the distance-coded reference check function, SV081/bit3=1setting and a battery option are needed.</p> <p>Related parameters: SV081/bit3,7, SV130, SV131, SV134 to SV137</p> <p>---Setting range--- -32768 to 32767</p>
#2335	SV135 RPn0H	Distance-coded reference check / position within one rotation High	<p>Set this parameter to operate distance-coded reference check when using distance-coded reference scale. During the distance-coded reference check initial setup (SV137:RAER=-1), set the following items on the NC drive monitor screen after the distance-coded reference check initial setup warning A3 turns OFF.</p> <p>SV134=Rn, SV135=Pn, SV136=MPOS</p> <p>When reference point is set, the warning A3 turns OFF. To enable the distance-coded reference check function, SV081/bit3=1setting and a battery option are needed.</p> <p>Related parameters: SV081/bit3,7, SV130, SV131, SV134 to SV137</p> <p>---Setting range--- -32768 to 32767</p>

#2336	SV136 RPN0L	Distance-coded reference check / position within one rotation Low
		<p>Set this parameter to operate distance-coded reference check when using distance-coded reference scale. During the distance-coded reference check initial setup (SV137:RAER=-1), set the following items on the NC drive monitor screen after the distance-coded reference check initial setup warning A3 turns OFF.</p> <p>SV134=Rn, SV135=Pn, SV136=MPOS</p> <p>When reference point is set, the warning A3 turns OFF. To enable the distance-coded reference check function, SV081/bit3=1 setting and a battery option are needed.</p> <p>Related parameters: SV081/bit3,7, SV130, SV131, SV134 to SV137</p> <p>---Setting range--- -32768 to 32767</p>
#2337	SV137 RAER	Distance-coded reference check allowable width
		<p>For the distance-coded reference check function when using distance-coded reference scale, set the allowable gap from the reference point position data calculated by the main side encoder. When the gap exceeds the allowable range, reference point created by distance-code is judged as wrong and detects alarm 42. The standard setting value is "basic reference mark interval (SV130) / 4". SV137=0 setting carries out the same operation as the standard setting value. SV137=-1 setting enables the distance-coded reference initial set up mode and displays setting values of SV134 to SV136 on NC drive monitor. To enable the distance-coded reference check function, SV081/bit3=1 setting and a battery option are needed. When SV137=32767, the distance-coded reference check function is disabled.</p> <p>Related parameters: SV081/bit3,7, SV130, SV131, SV134 to SV136</p> <p>---Setting range--- -1 to 32767 (mm)</p>
#2338-2397	SV138 - SV197	Not used. Set to "0".
#2398	SV198 NSE	No signal 2 special detection width
		<p>Set the special detection width for the no signal 2 (alarm 21). This detects no signal 2 (alarm 21) when machine side feedback is not invoked even if the motor side encoder feedback exceeds this setting in the rectangular wave signal output linear scale. When "0" is set, the detection will be performed with a 15µm width.</p> <p>---Setting range--- 0 to 32767 (µm)</p>

#2399 SV199 RTGM Real-time tuning: maximum adaptive gain multiplier

In case that machine resonance is induced when mounting a workpiece, the speed loop gain is switched automatically in response to inertia by setting the speed loop gain and workpiece inertia multiplier in advance. The speed loop gain SV199(RTGM) changes in response to the estimated inertia ratio SV200(RTJX) based on the speed loop gain SV005(VGN1) and the inertia multiplier SV037(JL) which were adjusted when no workpiece was mounted.

When SV199 is set to "0", the adaptation of the speed loop gain will be disabled.

Speed control gain multiplier [%]

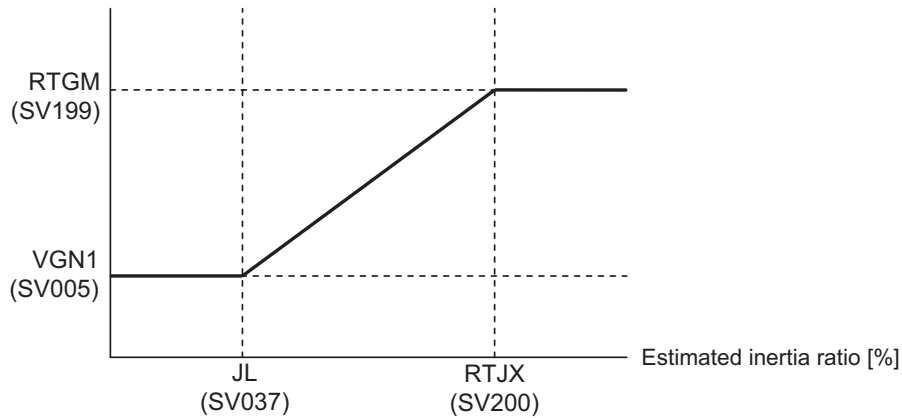

Related parameters: SV005, SV037, SV200

---Setting range---

0 to 5000 (%)

#2400 SV200 RTJX Real-time tuning: maximum adaptive inertia ratio

In case that machine resonance is induced when mounting a workpiece, the speed loop gain is switched automatically in response to inertia by setting the speed loop gain and workpiece inertia multiplier in advance. The speed loop gain SV199(RTGM) changes in response to the estimated inertia ratio SV200(RTJX) based on the speed loop gain SV005(VGN1) and the inertia multiplier SV037(JL) which were adjusted when no workpiece was mounted.

When SV199 is set to "0", the adaptation of the speed loop gain will be disabled.

Speed control gain multiplier [%]

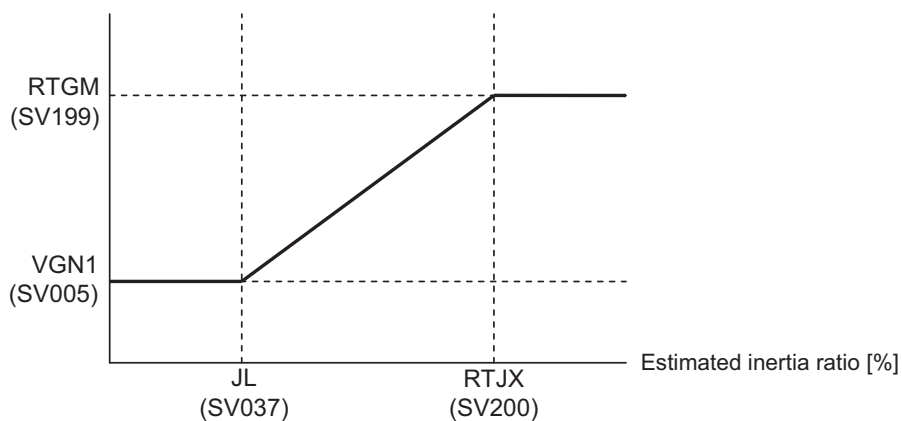

Related parameters: SV005, SV037, SV199

---Setting range---

0 to 32767 (%)

#2401-2405 SV201 - SV205

Not used. Set to "0".

	#2406	SV206 FCTC	Full-closed torsion compensation control torsion amount
	<p>Set the compensation amount of full-closed torsion compensation function.</p> <p>Set the torsion amount between the motor-end position and the machine-end position right after the stop as a standard setting value.</p> <p>When not using, set to "0".</p> <p>---Setting range---</p> <p>0 to 32767 (0.01μm)</p>		
	#2407-2436	SV207 - SV236	
	Not used. Set to "0".		
(PR)	#2437	SV237 TCF	Torque command filter
	<p>Set the filter for the torque command.</p> <p>The standard value is "3000" when using HG46, HG56, or HG96.</p> <p>---Setting range---</p> <p>0 to 5000 (rad/s)</p>		
	#2438	SV238 SSCFEED	Safely limited speed
	<p>Set the machine's safely limited speed for the SLS (Safely Limited Speed) function.</p> <p>Set this parameter within the following setting ranges.</p> <p>For linear axis: 2000mm/min or less</p> <p>For rotary axis: 18000°/min (50r/min) or less</p> <p>When not using, set to "0".</p> <p>---Setting range---</p> <p>0 to 18000 (mm/min) or (°/min)</p> <p>However, when SV033/bitD = 1, the setting range is from -32768 to 32767 (100mm/min) or (100°/min).</p>		
	#2439	SV239 SSCRPM	Safely limited motor speed
	<p>Set the motor's safely limited speed for the SLS (Safely Limited Speed) function.</p> <p>Set a value to hold the following relationship.</p> <p>Be aware when setting the parameter as the setting units for general motors and linear motors are different.</p> <p><<For general motor>></p> $SV239 = (SV238/SV018) \times (SV002/SV001)$ <p>Only when the product is 0, set to "1".</p> <p><<For linear motor>></p> $SV239 = SV238/60$ <p>Only when the product is 0, set to "1".</p> <p>When not using, set to "0".</p> <p>---Setting range---</p> <p>For general motor: 0 to 32767 (r/min)</p> <p>For linear motor: 0 to 32767 (mm/s)</p> <p>(Note) The value of the safely limited speed and safely limited motor speed must satisfy the above relation. If this relation is not satisfied, the parameter error (37 or E4) will occur. (Error parameter No. is 239.)</p> <p>Checking this relation is executed when the drive unit is turned ON and parameter is changed and speed observation mode (states when a speed observation command is turned ON) is entered.</p> $\frac{SV238 :SSCFEED}{SV018 :PIT} \times \frac{SV002 :PC2}{SV001 :PC1} = SV239 :SSCRPM$ <p>Note that "1 (r/min)" is applied when the calculation result is "0 (r/min)"</p>		

#2440-2443 SV240 - SV243

Not used. Set to "0".

(PR) #2444 SV244 DUNIT Communication interpolation unit for communication among drive units

Set the communication interpolation unit among drive units in high-speed synchronous tapping control. When set to "0", it will be regarded as 20 (0.05 μ m) is set.

Related parameters: SV129

---Setting range---0 to 2000 (1/ μ m)

#2445-2456 SV245 - SV256

Not used. Set to "0".

4.3 Setting the Initial Parameters for the Spindle Drive Unit

The spindle specification parameters and spindle parameters must be set before the spindle system can be started up. The spindle related parameters are input from the NC. The input method differs according to the NC being used, so refer to each NC Instruction Manual.

4.3.1 Setting of Parameters Related to the Spindle

The spindle specification parameters "#3001-#3138" and spindle parameters "#13001-#13256" must be set before the spindle is started up. Set the parameters depending on the spindle motor equipped to the machine and the machine specifications. The following parameters must be set for startup, so check the setting values.

< Common parameters set for starting >

Set the command time constant etc. up to the maximum rotation speed of the spindle end and the maximum rotation speed of the motor.

Especially the maximum rotation speed should be set not to exceed the machine specifications. In addition, acceleration/deceleration of the spindle is executed with the constant torque control, so the time depends on the inertia size.

(1) Setting of the maximum rotation speed

Set the maximum rotation speed of S commands (synchronous tapping, etc.).

#3001 slimit 1 Limit rotation speed (Gear: 00)

Set the spindle rotation speed for maximum motor speed when gear 00 is selected.
Set the spindle rotation speed for the S analog output=10V during analog spindle control.

---Setting range---

0 to 999999 (r/min)

#3005 smax 1 Maximum rotation speed (Gear: 00)

Set the maximum spindle rotation speed which is actually commanded when gear 00 is selected.
Set this as $smax1(\#3005) \leq slimit1(\#3001)$.
By comparing the S command value and the values of gear 1 - 4, a spindle gear shift command will be output automatically.

---Setting range---

0 to 999999 (r/min)

(2) Time constant settings during acceleration/deceleration

Set the time constant from the stopped state to reach S commands of smax.

#3101 sp_t 1 Acceleration/deceleration time constant with S command (Gear: 00)

Set the acceleration/deceleration time constant with S command (speed operation mode) when gear 00 is selected. Set the linear acceleration/deceleration time up to limit rotation speed (slimit1). Set the short time constant that the motor torque at acceleration is always saturated, however, when an abnormal noise or V-belt slip occurs, increase the time constant.

---Setting range---

0 to 30000 (ms)

(3) Spindle speed settings for Z-phase detection when starting

At the first spindle rotation after the power ON (including turning the power ON again only for NC), the spindle rotates at the speed of setting parameters during Z-phase detection for the encoder. Set the rotation speed.

#3106 zrn_typ Zero point return specifications**bit F : Spindle zero point detection with contactless switch**

- 0: Normal
- 1: Enable spindle zero point detection using proximity switch

#3109 zdetspd Z phase detection speed

For the first S command after power is turned ON, the spindle rotates at the speed of setting value for this parameter until Z phase is detected twice.

When "#3106/bitF = 1" (Spindle zero point proximity switch detection enabled), also proximity switch is detected.

(Note) When spindle zero point proximity switch detection is enabled, the rotation direction of the orientation/zero point return (synchronous tapping, spindle/C axis) will follow Z phase detection direction. And the speed will follow Z phase detection speed.

---Setting range---
1 to 99999 (r/min)

(4) Parameter set for C80 system

For C80 system, set the parameter as to ignore unnecessary alarm histories that is recorded when the NC power is turned OFF.

#13230 SP230 SFNC10 Spindle function 10**bit 8 : nohis History of communication error alarm between NC and DRV(34,36,38,39)**

- 0: Enable 1: Disable

< Initial parameters set depending on the machine specifications >

Set the following parameters depending on the spindle drive method (direct, gear drive, etc.) or inertia size of rotary sections for machine specifications.

(1) Adjustment parameters in orientation mode

When the inertia ratio is large for the spindle motor such as large lathes, set the following parameters so that abnormal noise or machine sway does not occur during orientation control.

#3106 zrn_typ Zero point return specifications**bit E : Control mode selection in orientation**

Select non-interpolation mode when vibration occurs since the gain is high during the orientation.

0: Interpolation mode (Use the interpolation mode gain "SP002".)

1: Non-interpolation mode (Use the non-interpolation mode gain "SP001")

(2) Setting of the gear ratio

Set the following parameters depending on the spindle drive method (direct, gear drive, belt drive) for the machine.

#13057(PR) SP057 GRA1 Spindle side gear ratio 1

Set the number of gear teeth on the spindle side when "the gear selection command (control input 4/bit6, 5)" is set to "00".

---Setting range---

1 to 32767

#13061(PR) SP061 GRB1 Motor side gear ratio 1

Set the number of gear teeth on the spindle side when "the gear selection command (control input 4/bit6, 5)" is set to "00".

---Setting range---

1 to 32767

< Setting parameters for the encoder with semi/full-closed loop control >

Set parameters depending on the encoder configured in the machine. For semi-closed loop, set the same value to the main side and the sub side. For full-closed loop, set the encoder of the main side and the sub side.

#13019(PR) SP019 RNG1 Sub side encoder resolution

[For semi-closed loop]

Set the same value as SP020 (RNG2). (Refer to the explanation of SP020.)

[For full-closed loop]

Set the number of pulses per revolution of the machine side encoder.

When using the encoder interface unit MDS-EX-HR, use this with SP097 (RNG1ex).

Encoder

OSE-1024 (ABZ pulse): SP019=4096, SP097=-1

TS5690(64 teeth): SP019 = 2000, SP097=0

TS5690(90 teeth): SP019 = 2880, SP097=0

TS5690(128 teeth): SP019 = 4000, SP097=0

TS5690(192 teeth): SP019 = 6000, SP097=0

TS5690(256 teeth): SP019 = 8000, SP097=0

TS5690(384 teeth): SP019 =12000, SP097=0

ERM280(1200 teeth): SP019 = 4800, SP097=0

ERM280(2048 teeth): SP019 = 8000, SP097=0

MPCI : SP019 = 7200, SP097=0

MBE205: SP019 = 2000, SP097=0

GEL2449M(524,288(p/rev)): SP019=0, SP097=8

MHS-04B Series(1,048,576(p/rev)): SP019=0, SP097=16

---Setting range---

When SP097=0, the setting range is from 0 to 32767 (kp)

When SP097≠0, the setting range is from 0 to 65535 (p)

#13020(PR) SP020 RNG2 Main side encoder resolution

Set the number of pulses per revolution of the motor side encoder. Set the standard parameters for the motor with frame.

---Setting range---

When SP098=0, the setting range is from 0 to 32767 (kp)

When SP098≠0, the setting range is from 0 to 65535 (p)

#13097 SP097 RNG1ex Extension sub side encoder resolution

When setting the machine side encoder resolution in pulse (p) unit, set the number of pulses to four bite data of SP097 (high-order) and SP019 (low-order) in pulse (p) unit.

When SP097=0, the setting unit of SP019 is (kp).

Refer to SP019 for details.

Related parameters: SP019, SP020, SP098

---Setting range---

-1 to 32767

#13098 SP098 RNG2ex Extension main side encoder resolution

When setting the motor side encoder resolution in pulse (p) unit, set the number of pulses to four bite data of SP098 (high-order) and SP020 (low-order) in pulse (p) unit.

When SP098=0, the setting unit of SP020 is (kp).
Refer to SP020 for details.
Related parameters: SP019, SP020, SP097

---Setting range---

-1 to 32767

#13031(PR) SP031 MTYP Motor type

Set the control system of the spindle drive unit.
2200: Semi closed loop control
4200: Full closed loop control by using spindle side ABZ pulse output encoder
6200: Full closed loop control by using spindle side serial output encoder

#13054 SP054 ORE Overrun detection width in closed loop control

Set the overrun detection width in the full-closed loop control.
When the gap between the motor side encoder and the machine side encoder exceeds the set value, it is judged as an overrun and "Alarm 43" is detected.
When "-1" is set, if the differential velocity between the motor side encoder and the machine side encoder exceeds the 30% of the maximum motor speed, it will be judged as overrun and "Alarm 43" will be detected.
When "0" is set, overrun will be detected with 2°.
In the full-closed loop control, normally set this parameter to "360". During V-belt drive, set to "-1".

---Setting range---

-1 to 32767 (°)

< Setting parameters of a proximity switch >

Set the following parameters when a proximity switch is equipped with the spindle end.

#13227 SP227 SFNC7 Spindle function 7**bit F-C : dis Digital signal input selection**

0: No signal
4: Proximity switch signal detection
Other settings: setting prohibited

#13225 SP225 SFNC5 Spindle function 5**bit 5 : ddir Proximity switch signal enable edge**

0: Falling edge 1: Rising edge

#3106 zrn_typ Zero point return specifications**bit F : Spindle zero point detection with contactless switch**

0: Normal
1: Enable spindle zero point detection using proximity switch

< Cautions for starting the spindle >

The test operation (acceleration/deceleration, orientation) of the spindle can be executed by setting the initial parameters, however, check the spindle operation with caution.

- Check the wiring and ensure the safety of the surroundings before starting the operation.
- Do not operate at high-speed rotation at first. After checking that there are no problems as abnormal noise, vibration, etc. from the spindle at start up with no-load and small S commands, raise the S commands gradually.
- When vibration or abnormal noise occurs during the test operation, adjust or set the speed gain or the notch filter.
- For the first check of the orientation, the orientation should be executed gradually from small S commands.

4.3.2 List of Standard Parameters for Each Spindle Motor

(1) 200V Standard motor SJ-D Series (Normal)

Parameter				200V Standard motor SJ-D Series (Normal)						
				SJ-D5.5/ 100-01		SJ-D5.5/ 120-01		SJ-D5.5/ 120-02		
No.	Abbrev.	Details	Unit capacity	100	16040S	100	16040S	100	160	200
SP001	PGV	Position loop gain non-interpolation mode		15	15	15	15	15	15	15
SP002	PGN	Position loop gain interpolation mode		33	33	33	33	33	33	33
SP003	PGS	Position loop gain spindle synchronization		15	15	15	15	15	15	15
SP004		Not used		0	0	0	0	0	0	0
SP005	VGN1	Speed loop gain 1		150	150	150	150	150	150	150
SP006	VIA1	Speed loop lead compensation 1		1900	1900	1900	1900	1900	1900	1900
SP007	VIL1	Speed loop delay compensation 1		0	0	0	0	0	0	0
SP008	VGN2	Speed loop gain 2		150	150	150	150	150	150	150
SP009	VIA2	Speed loop lead compensation 2		1900	1900	1900	1900	1900	1900	1900
SP010	VIL2	Speed loop delay compensation 2		0	0	0	0	0	0	0
:				:	:	:	:	:	:	:
SP013		Not used		0	0	0	0	0	0	0
SP014	PY1	Minimum excitation rate 1		50	50	50	50	50	50	50
SP015	PY2	Minimum excitation rate 2		100	100	100	100	100	100	100
SP016	DDT	Phase alignment deceleration rate		20	20	20	20	20	20	20
SP017	SPEC1	Spindle specification 1		000C	000C	000C	000C	000C	000C	000C
SP018	SPEC2	Spindle specification 2		0200	0200	0200	0200	0200	0200	0200
SP019	RNG1	Sub side encoder resolution		-	-	-	-	-	-	-
SP020	RNG2	Main side encoder resolution		-	-	-	-	-	-	-
SP021	OLT	Overload detection time constant		60	60	60	60	60	60	60
SP022	OLL	Overload detection level		120	120	120	120	120	120	120
SP023	OD1	Excessive error detection width (interpolation mode - spindle synchronization)		120	120	120	120	120	120	120
SP024	INP	In-position width		875	875	875	875	875	875	875
SP025	INP2	2nd in-position width		875	875	875	875	875	875	875
SP026	TSP	Maximum motor speed		10000	10000	12000	12000	12000	12000	12000
SP027	ZSP	Motor zero speed		25	25	25	25	25	25	25
SP028	SDTS	Speed detection set value		1000	1000	1200	1200	1200	1200	1200
SP029	SDTR	Speed detection reset width		30	30	30	30	30	30	30
SP030	SDT2	2nd speed detection setting value		0	0	0	0	0	0	0
SP031	MTYP	Motor type		2200	2200	2200	2200	2200	2200	2200
SP032	PTYP	Power supply type/ Regenerative resistor type		-	-	-	-	-	-	-
SP033	SFNC1	Spindle function 1		0000	0000	0000	0000	0000	0000	0000
SP034	SFNC2	Spindle function 2		0000	0000	0000	0000	0000	0000	0000
SP035	SFNC3	Spindle function 3		1600	1600	1600	1600	1600	1600	1600
SP036	SFNC4	Spindle function 4		0000	0000	0000	0000	0000	0000	0000
SP037	JL	Load inertia scale		100	100	100	100	100	100	100
SP038	FHz1	Notch filter frequency 1		0	0	0	0	0	0	0
:				:	:	:	:	:	:	:
SP046	FHz2	Notch filter frequency 2		0	0	0	0	0	0	0
SP047	EC	Inductive voltage compensation gain		100	100	100	100	100	100	100
SP048	LMC1	Lost motion compensation 1		0	0	0	0	0	0	0
:				:	:	:	:	:	:	:
SP052	DFBN	Dual feedback control non-sensitive band		0	0	0	0	0	0	0
SP053	ODS	Excessive error detection width (non-interpolation mode)		2000	2000	2400	2400	2400	2400	2400
SP054	ORE	Overrun detection width in closed loop control		0	0	0	0	0	0	0
SP055	EMGx	Max. gate off delay time after emergency stop		5000	5000	5000	5000	5000	5000	5000
SP056	EMGt	Deceleration time constant at emergency stop		300	300	300	300	300	300	300
SP057	GRA1	Spindle side gear ratio 1		1	1	1	1	1	1	1
SP058	GRA2	Spindle side gear ratio 2		1	1	1	1	1	1	1
SP059	GRA3	Spindle side gear ratio 3		1	1	1	1	1	1	1
SP060	GRA4	Spindle side gear ratio 4		1	1	1	1	1	1	1
SP061	GRB1	Motor side gear ratio 1		1	1	1	1	1	1	1
SP062	GRB2	Motor side gear ratio 2		1	1	1	1	1	1	1
SP063	GRB3	Motor side gear ratio 3		1	1	1	1	1	1	1
SP064	GRB4	Motor side gear ratio 4		1	1	1	1	1	1	1
SP065	TLM1	Torque limit 1		10	10	10	10	10	10	10
SP066	TLM2	Torque limit 2		10	10	10	10	10	10	10
SP067	TLM3	Torque limit 3		10	10	10	10	10	10	10
SP068	TLM4	Torque limit 4		10	10	10	10	10	10	10
SP069	PCMP	Phase alignment completion width		875	875	875	875	875	875	875
SP070	KDDT	Phase alignment deceleration rate scale		0	0	0	0	0	0	0
SP071	DIQM	Variable current limit during deceleration, lower limit value		60	60	50	50	40	30	15
SP072	DIQN	Variable current limit during deceleration, break point speed		6000	6000	6000	6000	5000	3700	2200
SP073	VGVN	Variable speed gain target value		0	0	0	0	0	0	0
SP074	VGVS	Variable speed gain change start speed		0	0	0	0	0	0	0
SP075	DWSH	Slip compensation scale during regeneration high-speed coil		0	0	0	0	0	0	0

4 Setup

Parameter				200V Standard motor SJ-D Series (Normal)						
				SJ-D5.5/ 100-01		SJ-D5.5/ 120-01		SJ-D5.5/ 120-02		
No.	Abbrev.	Details	Unit capacity	100	16040S	100	16040S	100	160	200
SP076	DWSL	Slip compensation scale during regeneration low-speed coil		0	0	0	0	0	0	0
SP077	IQA	Q axis current lead compensation		4096	4096	4096	4096	4096	4096	4096
SP078	IDA	D axis current lead compensation		4096	4096	4096	4096	4096	4096	4096
SP079	IQG	Q axis current gain		1024	1024	1024	1024	1024	1024	1024
SP080	IDG	D axis current gain		1024	1024	1024	1024	1024	1024	1024
SP081	IQAL	Q axis current lead compensation low-speed coil		0	0	0	0	0	0	0
:				:	:	:	:	:	:	:
SP088	FHz5	Notch filter frequency 5		0	0	0	0	0	0	0
SP089	TMKQ	Spindle output stabilizing gain Q axis		100	100	100	100	100	100	100
SP090	TMKD	Spindle output stabilizing gain D axis		0	0	0	0	0	0	0
:				:	:	:	:	:	:	:
SP112				0	0	0	0	0	0	0
SP113	OPLP	Current command value for open loop		0	0	0	0	0	0	0
SP114	MKT	Coil changeover gate cutoff timer		150	150	150	150	150	150	150
SP115	MKT2	Coil changeover current limit timer		250	250	250	250	250	250	250
SP116	MKIL	Coil changeover current limit value		120	120	120	120	120	120	120
SP117	SETM	Excessive speed deviation timer		12	12	12	12	12	12	12
SP118	MSFT	Magnetic pole shift amount		0	0	0	0	0	0	0
:				:	:	:	:	:	:	:
SP128	DA2MPY	D/A output ch2 output scale		0	0	0	0	0	0	0
SP129		Motor unique constants (H)		2	2	2	2	2	2	2
SP130		Motor unique constants (H)		13	13	13	13	8	8	8
SP131		Motor unique constants (H)		100	160	100	160	100	160	200
SP132		Motor unique constants (H)		0	0	0	0	0	0	0
SP133		Motor unique constants (H)		10000	10000	12000	12000	12000	12000	12000
SP134		Motor unique constants (H)		1800	1800	1800	1800	2000	2000	1700
SP135		Motor unique constants (H)		1800	1800	1800	1800	3200	3200	3400
SP136		Motor unique constants (H)		1234	1234	1234	1234	722	722	757
SP137		Motor unique constants (H)		67	67	67	67	49	40	36
SP138		Motor unique constants (H)		3330	3330	3330	3330	3111	3111	2975
SP139		Motor unique constants (H)		2345	2345	2345	2345	2550	2550	2755
SP140		Motor unique constants (H)		1961	1961	1961	1961	1934	1934	1907
SP141		Motor unique constants (H)		98	98	98	98	83	83	77
SP142		Motor unique constants (H)		0	0	0	0	0	0	0
SP143		Motor unique constants (H)		0	0	0	0	0	0	0
SP144		Motor unique constants (H)		0	0	0	0	0	0	0
SP145		Motor unique constants (H)		335	335	467	467	343	436	478
SP146		Motor unique constants (H)		428	428	433	433	423	423	422
SP147		Motor unique constants (H)		66	66	66	66	73	73	78
SP148		Motor unique constants (H)		1186	1186	1186	1186	691	691	682
SP149		Motor unique constants (H)		2837	2837	2837	2837	4959	6083	7718
SP150		Motor unique constants (H)		1228	1228	1228	1228	1368	1368	1557
SP151		Motor unique constants (H)		167	167	167	167	128	128	128
SP152		Motor unique constants (H)		110	110	110	110	90	90	90
SP153		Motor unique constants (H)		120	120	120	120	120	120	120
SP154		Motor unique constants (H)		150	150	150	150	150	150	150
SP155		Motor unique constants (H)		1083	1083	1083	1083	1065	969	870
SP156		Motor unique constants (H)		0	0	0	0	0	0	0
SP157		Motor unique constants (H)		0	0	0	0	0	0	0
SP158		Motor unique constants (H)		1500	1500	1500	1500	0	0	0
SP159		Motor unique constants (H)		1500	1500	1500	1500	1467	1196	899
SP160		Motor unique constants (H)		0	0	0	0	0	0	0
:				:	:	:	:	:	:	:
SP224				0	0	0	0	0	0	0
SP225	SFNC5	Spindle function 5		0000	0000	0000	0000	0000	0000	0000
SP226	SFNC6	Spindle function 6		1000	1000	1000	1000	1000	1000	1000
SP227	SFNC7	Spindle function 7		0000	0000	0000	0000	0000	0000	0000
:				:	:	:	:	:	:	:
SP232		Not used		0000	0000	0000	0000	0000	0000	0000
SP233	IVC	Voltage non-sensitive band compensation		0	0	0	0	0	0	0
SP234				0	0	0	0	0	0	0
SP235	R2H	Temperature compensation gain		0	0	0	0	0	0	0
SP236	WIH	Temperature compensation time constant		0	0	0	0	0	0	0
SP237	TCF	Torque command filter		500	500	500	500	500	500	500
SP238	SSCFEED	Safely limited speed		0	0	0	0	0	0	0
SP239	SSCRPM	Safely limited motor speed		0	0	0	0	0	0	0
SP240		Not used		0	0	0	0	0	0	0
:				:	:	:	:	:	:	:
SP256				0	0	0	0	0	0	0

Parameter				200V Standard motor SJ-D Series (Normal)								
				SJ-D7.5/ 100-01		SJ-D7.5/ 120-01		SJ-D11/ 100-01	SJ-D15/ 80-01	SJ- D18.5/ 80-01	SJ-D22/ 80-01	SJ-D26/ 80-01
				100	16040S	100	16040S	160	200	320	320	320
No.	Abbrev.	Details	Unit capacity									
SP001	PGV	Position loop gain non-interpolation mode		15	15	15	15	15	15	15	15	15
SP002	PGN	Position loop gain interpolation mode		33	33	33	33	33	33	33	33	33
SP003	PGS	Position loop gain spindle synchronization		15	15	15	15	15	15	15	15	15
SP004		Not used		0	0	0	0	0	0	0	0	0
SP005	VGN1	Speed loop gain 1		150	150	150	150	150	150	150	150	150
SP006	VIA1	Speed loop lead compensation 1		1900	1900	1900	1900	1900	1900	1900	1900	1900
SP007	VIL1	Speed loop delay compensation 1		0	0	0	0	0	0	0	0	0
SP008	VGN2	Speed loop gain 2		150	150	150	150	150	150	150	150	150
SP009	VIA2	Speed loop lead compensation 2		1900	1900	1900	1900	1900	1900	1900	1900	1900
SP010	VIL2	Speed loop delay compensation 2		0	0	0	0	0	0	0	0	0
:				:	:	:	:	:	:	:	:	:
SP013		Not used		0	0	0	0	0	0	0	0	0
SP014	PY1	Minimum excitation rate 1		50	50	50	50	50	50	50	50	50
SP015	PY2	Minimum excitation rate 2		100	100	100	100	100	100	100	100	100
SP016	DDT	Phase alignment deceleration rate		20	20	20	20	20	20	20	20	20
SP017	SPEC1	Spindle specification 1		000C	000C	000C	000C	000C	000C	000C	000C	000C
SP018	SPEC2	Spindle specification 2		0200	0200	0200	0200	0200	0200	0200	0200	0200
SP019	RNG1	Sub side encoder resolution		-	-	-	-	-	-	-	-	-
SP020	RNG2	Main side encoder resolution		-	-	-	-	-	-	-	-	-
SP021	OLT	Overload detection time constant		60	60	60	60	60	60	60	60	60
SP022	OLL	Overload detection level		120	120	120	120	120	120	120	120	120
SP023	OD1	Excessive error detection width (interpolation mode - spindle synchronization)		120	120	120	120	120	120	120	120	120
SP024	INP	In-position width		875	875	875	875	875	875	875	875	875
SP025	INP2	2nd in-position width		875	875	875	875	875	875	875	875	875
SP026	TSP	Maximum motor speed		10000	10000	12000	12000	10000	8000	8000	8000	8000
SP027	ZSP	Motor zero speed		25	25	25	25	25	25	25	25	25
SP028	SDTS	Speed detection set value		1000	1000	1200	1200	1000	800	800	800	800
SP029	SDTR	Speed detection reset width		30	30	30	30	30	30	30	30	30
SP030	SDT2	2nd speed detection setting value		0	0	0	0	0	0	0	0	0
SP031	MTYP	Motor type		2200	2200	2200	2200	2200	2200	2200	2200	2200
SP032	PTYP	Power supply type/ Regenerative resistor type		-	-	-	-	-	-	-	-	-
SP033	SFNC1	Spindle function 1		0000	0000	0000	0000	0000	0000	0000	0000	0000
SP034	SFNC2	Spindle function 2		0000	0000	0000	0000	0000	0000	0000	0000	0000
SP035	SFNC3	Spindle function 3		1600	1600	1600	1600	1600	1600	1600	1600	1600
SP036	SFNC4	Spindle function 4		0000	0000	0000	0000	0000	0000	0000	0000	0000
SP037	JL	Load inertia scale		100	100	100	100	100	100	100	100	100
SP038	FHz1	Notch filter frequency 1		0	0	0	0	0	0	0	0	0
:				:	:	:	:	:	:	:	:	:
SP046	FHz2	Notch filter frequency 2		0	0	0	0	0	0	0	0	0
SP047	EC	Inductive voltage compensation gain		100	100	100	100	100	100	100	100	100
SP048	LMC1	Lost motion compensation 1		0	0	0	0	0	0	0	0	0
:				:	:	:	:	:	:	:	:	:
SP052	DFBN	Dual feedback control non-sensitive band		0	0	0	0	0	0	0	0	0
SP053	ODS	Excessive error detection width (non-interpolation mode)		2000	2000	2400	2400	2000	1600	1600	1600	1600
SP054	ORE	Overrun detection width in closed loop control		0	0	0	0	0	0	0	0	0
SP055	EMGx	Max. gate off delay time after emergency stop		5000	5000	5000	5000	5000	5000	5000	5000	5000
SP056	EMGt	Deceleration time constant at emergency stop		300	300	300	300	300	300	300	300	300
SP057	GRA1	Spindle side gear ratio 1		1	1	1	1	1	1	1	1	1
SP058	GRA2	Spindle side gear ratio 2		1	1	1	1	1	1	1	1	1
SP059	GRA3	Spindle side gear ratio 3		1	1	1	1	1	1	1	1	1
SP060	GRA4	Spindle side gear ratio 4		1	1	1	1	1	1	1	1	1
SP061	GRB1	Motor side gear ratio 1		1	1	1	1	1	1	1	1	1
SP062	GRB2	Motor side gear ratio 2		1	1	1	1	1	1	1	1	1
SP063	GRB3	Motor side gear ratio 3		1	1	1	1	1	1	1	1	1
SP064	GRB4	Motor side gear ratio 4		1	1	1	1	1	1	1	1	1
SP065	TLM1	Torque limit 1		10	10	10	10	10	10	10	10	10
SP066	TLM2	Torque limit 2		10	10	10	10	10	10	10	10	10
SP067	TLM3	Torque limit 3		10	10	10	10	10	10	10	10	10
SP068	TLM4	Torque limit 4		10	10	10	10	10	10	10	10	10
SP069	PCMP	Phase alignment completion width		875	875	875	875	875	875	875	875	875
SP070	KDDT	Phase alignment deceleration rate scale		0	0	0	0	0	0	0	0	0
SP071	DIQM	Variable current limit during deceleration, lower limit value		60	60	50	50	45	60	55	55	55
SP072	DIQN	Variable current limit during deceleration, break point speed		6000	6000	6000	6000	4500	4900	4500	4500	4500
SP073	VGVN	Variable speed gain target value		0	0	0	0	0	0	0	0	0
SP074	VGVS	Variable speed gain change start speed		0	0	0	0	0	0	0	0	0
SP075	DWSH	Slip compensation scale during regeneration high-speed coil		0	0	0	0	0	0	0	0	0
SP076	DWSL	Slip compensation scale during regeneration low- speed coil		0	0	0	0	0	0	0	0	0
SP077	IQA	Q axis current lead compensation		4096	4096	4096	4096	4096	4096	4096	4096	4096

4 Setup

Parameter				200V Standard motor SJ-D Series (Normal)								
				SJ-D7.5/100-01		SJ-D7.5/120-01		SJ-D11/100-01	SJ-D15/80-01	SJ-D18.5/80-01	SJ-D22/80-01	SJ-D26/80-01
No.	Abbrev.	Details	Unit capacity	100	16040S	100	16040S	160	200	320	320	320
SP078	IDA	D axis current lead compensation		4096	4096	4096	4096	4096	4096	4096	4096	4096
SP079	IQG	Q axis current gain		1024	1024	1024	1024	1024	1024	1024	1024	1024
SP080	IDG	D axis current gain		1024	1024	1024	1024	1024	1024	1024	1024	1024
SP081	IQAL	Q axis current lead compensation low-speed coil		0	0	0	0	0	0	0	0	0
:				:	:	:	:	:	:	:	:	:
SP088	FHz5	Notch filter frequency 5		0	0	0	0	0	0	0	0	0
SP089	TMKQ	Spindle output stabilizing gain Q axis		100	100	100	100	100	100	100	100	100
SP090	TMKD	Spindle output stabilizing gain D axis		0	0	0	0	0	0	0	0	0
:				:	:	:	:	:	:	:	:	:
SP112				0	0	0	0	0	0	0	0	0
SP113	OPLP	Current command value for open loop		0	0	0	0	0	0	0	0	0
SP114	MKT	Coil changeover gate cutoff timer		150	150	150	150	150	150	150	150	150
SP115	MKT2	Coil changeover current limit timer		250	250	250	250	250	250	250	250	250
SP116	MKIL	Coil changeover current limit value		120	120	120	120	120	120	120	120	120
SP117	SETM	Excessive speed deviation timer		12	12	12	12	12	12	12	12	12
SP118	MSFT	Magnetic pole shift amount		0	0	0	0	0	0	0	0	0
:				:	:	:	:	:	:	:	:	:
SP128	DA2MPY	D/A output ch2 output scale		0	0	0	0	0	0	0	0	0
SP129		Motor unique constants (H)		2	2	2	2	2	2	2	2	2
SP130		Motor unique constants (H)		24	24	24	24	29	85	103	138	160
SP131		Motor unique constants (H)		100	160	100	160	160	200	320	320	320
SP132				0	0	0	0	0	0	0	0	0
SP133		Motor unique constants (H)		10000	10000	12000	12000	10000	8000	8000	8000	8000
SP134		Motor unique constants (H)		1800	1800	1800	1800	1800	1650	1500	1575	1500
SP135		Motor unique constants (H)		1800	1800	1800	1800	1800	1500	1500	1500	1500
SP136		Motor unique constants (H)		1262	1262	1262	1262	1338	1432	1438	1634	1762
SP137		Motor unique constants (H)		73	73	73	73	68	59	60	62	63
SP138		Motor unique constants (H)		3252	3252	3252	3252	3208	3072	2920	2993	2518
SP139		Motor unique constants (H)		2427	2427	2427	2427	2468	2560	2755	2673	2376
SP140		Motor unique constants (H)		1947	1947	1947	1947	1942	1936	1913	1921	2001
SP141		Motor unique constants (H)		145	145	145	145	145	183	148	197	155
SP142		Motor unique constants (H)		0	0	0	0	0	0	0	0	0
SP143				0	0	0	0	0	0	0	0	0
SP144		Motor unique constants (H)		0	0	0	0	0	0	0	0	0
SP145		Motor unique constants (H)		369	369	460	460	440	321	320	315	334
SP146		Motor unique constants (H)		434	434	437	437	435	430	431	433	437
SP147		Motor unique constants (H)		74	74	74	74	75	50	52	49	59
SP148		Motor unique constants (H)		969	969	969	969	811	492	365	341	332
SP149		Motor unique constants (H)		3785	3785	3785	3785	5233	8225	11064	11691	12648
SP150		Motor unique constants (H)		1742	1742	1742	1742	2214	2532	3570	4070	5502
SP151		Motor unique constants (H)		105	105	105	105	81	55	38	32	24
SP152		Motor unique constants (H)		90	90	90	90	120	90	90	90	90
SP153		Motor unique constants (H)		120	120	120	120	120	120	120	120	120
SP154		Motor unique constants (H)		150	150	150	150	150	150	150	150	150
SP155		Motor unique constants (H)		1067	1067	1067	1067	1072	1038	1080	1060	1070
SP156		Motor unique constants (H)		0	0	0	0	0	0	0	0	0
SP157				0	0	0	0	0	0	0	0	0
SP158		Motor unique constants (H)		1500	1500	1500	1500	1500	1500	0	1500	0
SP159		Motor unique constants (H)		1500	1500	1500	1500	1500	1500	0	1500	0
SP160		Motor unique constants (H)		0	0	0	0	0	0	0	0	0
:				:	:	:	:	:	:	:	:	:
SP224				0	0	0	0	0	0	0	0	0
SP225	SFNC5	Spindle function 5		0000	0000	0000	0000	0000	0000	0000	0000	0000
SP226	SFNC6	Spindle function 6		1000	1000	1000	1000	1000	1000	1000	1000	1000
SP227	SFNC7	Spindle function 7		0000	0000	0000	0000	0000	0000	0000	0000	0000
:				:	:	:	:	:	:	:	:	:
SP232		Not used		0000	0000	0000	0000	0000	0000	0000	0000	0000
SP233	IVC	Voltage non-sensitive band compensation		0	0	0	0	0	0	0	0	0
SP234				0	0	0	0	0	0	0	0	0
SP235	R2H	Temperature compensation gain		0	0	0	0	0	0	0	0	0
SP236	WIH	Temperature compensation time constant		0	0	0	0	0	0	0	0	0
SP237	TCF	Torque command filter		500	500	500	500	500	500	500	500	500
SP238	SSCFEED	Safely limited speed		0	0	0	0	0	0	0	0	0
SP239	SSCRPM	Safely limited motor speed		0	0	0	0	0	0	0	0	0
SP240		Not used		0	0	0	0	0	0	0	0	0
:				:	:	:	:	:	:	:	:	:
SP256				0	0	0	0	0	0	0	0	0

(2) 200V Standard motor SJ-D Series (Hollow shaft)

Motor				200V Standard motor SJ-D Series (Hollow shaft)		
Parameter				SJ-D5.5/120-02T-S		
No.	Abbrev.	Details	Unit capacity	100	160	200
SP001	PGV	Position loop gain non-interpolation mode		15	15	15
SP002	PGN	Position loop gain interpolation mode		33	33	33
SP003	PGS	Position loop gain spindle synchronization		15	15	15
SP004		Not used		0	0	0
SP005	VGN1	Speed loop gain 1		150	150	150
SP006	VIA1	Speed loop lead compensation 1		1900	1900	1900
SP007	VIL1	Speed loop delay compensation 1		0	0	0
SP008	VGN2	Speed loop gain 2		150	150	150
SP009	VIA2	Speed loop lead compensation 2		1900	1900	1900
SP010	VIL2	Speed loop delay compensation 2		0	0	0
:				:	:	:
SP013		Not used		0	0	0
SP014	PY1	Minimum excitation rate 1		50	50	50
SP015	PY2	Minimum excitation rate 2		100	100	100
SP016	DDT	Phase alignment deceleration rate		20	20	20
SP017	SPEC1	Spindle specification 1		000C	000C	000C
SP018	SPEC2	Spindle specification 2		0200	0200	0200
SP019	RNG1	Sub side encoder resolution		-	-	-
SP020	RNG2	Main side encoder resolution		-	-	-
SP021	OLT	Overload detection time constant		60	60	60
SP022	OLL	Overload detection level		120	120	120
SP023	OD1	Excessive error detection width (interpolation mode - spindle synchronization)		120	120	120
SP024	INP	In-position width		875	875	875
SP025	INP2	2nd in-position width		875	875	875
SP026	TSP	Maximum motor speed		12000	12000	12000
SP027	ZSP	Motor zero speed		25	25	25
SP028	SDTS	Speed detection set value		1200	1200	1200
SP029	SDTR	Speed detection reset width		30	30	30
SP030	SDT2	2nd speed detection setting value		0	0	0
SP031	MTYP	Motor type		2200	2200	2200
SP032	PTYP	Power supply type/ Regenerative resistor type		-	-	-
SP033	SFNC1	Spindle function 1		0000	0000	0000
SP034	SFNC2	Spindle function 2		0000	0000	0000
SP035	SFNC3	Spindle function 3		1600	1600	1600
SP036	SFNC4	Spindle function 4		0000	0000	0000
SP037	JL	Load inertia scale		100	100	100
SP038	FHz1	Notch filter frequency 1		0	0	0
:				:	:	:
SP046	FHz2	Notch filter frequency 2		0	0	0
SP047	EC	Inductive voltage compensation gain		100	100	100
SP048	LMC1	Lost motion compensation 1		0	0	0
:				:	:	:
SP052	DFBN	Dual feedback control non-sensitive band		0	0	0
SP053	ODS	Excessive error detection width (non-interpolation mode)		2400	2400	2400
SP054	ORE	Overrun detection width in closed loop control		0	0	0
SP055	EMGx	Max. gate off delay time after emergency stop		5000	5000	5000
SP056	EMGt	Deceleration time constant at emergency stop		300	300	300
SP057	GRA1	Spindle side gear ratio 1		1	1	1
SP058	GRA2	Spindle side gear ratio 2		1	1	1
SP059	GRA3	Spindle side gear ratio 3		1	1	1
SP060	GRA4	Spindle side gear ratio 4		1	1	1
SP061	GRB1	Motor side gear ratio 1		1	1	1
SP062	GRB2	Motor side gear ratio 2		1	1	1
SP063	GRB3	Motor side gear ratio 3		1	1	1
SP064	GRB4	Motor side gear ratio 4		1	1	1
SP065	TLM1	Torque limit 1		10	10	10
SP066	TLM2	Torque limit 2		10	10	10
SP067	TLM3	Torque limit 3		10	10	10
SP068	TLM4	Torque limit 4		10	10	10
SP069	PCMP	Phase alignment completion width		875	875	875
SP070	KDDT	Phase alignment deceleration rate scale		0	0	0
SP071	DIQM	Variable current limit during deceleration, lower limit value		40	30	15
SP072	DIQN	Variable current limit during deceleration, break point speed		5000	3700	2200
SP073	VGVN	Variable speed gain target value		0	0	0
SP074	VGVS	Variable speed gain change start speed		0	0	0
SP075	DWSH	Slip compensation scale during regeneration high-speed coil		0	0	0
SP076	DWSL	Slip compensation scale during regeneration low-speed coil		0	0	0
SP077	IQA	Q axis current lead compensation		4096	4096	4096
SP078	IDA	D axis current lead compensation		4096	4096	4096

4 Setup

Motor				200V Standard motor SJ-D Series (Hollow shaft)		
Parameter				SJ-D5.5/120-02T-S		
No.	Abbrev.	Details	Unit capacity	100	160	200
SP079	IQG	Q axis current gain		1024	1024	1024
SP080	IDG	D axis current gain		1024	1024	1024
SP081	IQAL	Q axis current lead compensation low-speed coil		0	0	0
:				:	:	:
SP088	FHz5	Notch filter frequency 5		0	0	0
SP089	TMKQ	Spindle output stabilizing gain Q axis		100	100	100
SP090	TMKD	Spindle output stabilizing gain D axis		0	0	0
:				:	:	:
SP112				0	0	0
SP113	OPLP	Current command value for open loop		0	0	0
SP114	MKT	Coil changeover gate cutoff timer		150	150	150
SP115	MKT2	Coil changeover current limit timer		250	250	250
SP116	MKIL	Coil changeover current limit value		120	120	120
SP117	SETM	Excessive speed deviation timer		12	12	12
SP118	MSFT	Magnetic pole shift amount		0	0	0
:				:	:	:
SP128	DA2MPY	D/A output ch2 output scale		0	0	0
SP129		Motor unique constants (H)		2	2	2
SP130		Motor unique constants (H)		8	8	8
SP131		Motor unique constants (H)		100	160	200
SP132		Motor unique constants (H)		0	0	0
SP133		Motor unique constants (H)		12000	12000	12000
SP134		Motor unique constants (H)		2000	2000	1700
SP135		Motor unique constants (H)		3200	3200	3400
SP136		Motor unique constants (H)		722	722	757
SP137		Motor unique constants (H)		49	40	36
SP138		Motor unique constants (H)		3111	3111	2975
SP139		Motor unique constants (H)		2550	2550	2755
SP140		Motor unique constants (H)		1934	1934	1907
SP141		Motor unique constants (H)		83	83	77
SP142		Motor unique constants (H)		0	0	0
SP143		Motor unique constants (H)		0	0	0
SP144		Motor unique constants (H)		0	0	0
SP145		Motor unique constants (H)		343	436	478
SP146		Motor unique constants (H)		423	423	422
SP147		Motor unique constants (H)		73	73	78
SP148		Motor unique constants (H)		691	691	682
SP149		Motor unique constants (H)		4959	6083	7718
SP150		Motor unique constants (H)		1368	1368	1557
SP151		Motor unique constants (H)		128	128	128
SP152		Motor unique constants (H)		90	90	90
SP153		Motor unique constants (H)		120	120	120
SP154		Motor unique constants (H)		150	150	150
SP155		Motor unique constants (H)		1065	969	870
SP156		Motor unique constants (H)		0	0	0
SP157		Motor unique constants (H)		0	0	0
SP158		Motor unique constants (H)		0	0	0
SP159		Motor unique constants (H)		1467	1196	899
SP160		Motor unique constants (H)		0	0	0
:				:	:	:
SP224				0	0	0
SP225	SFNC5	Spindle function 5		0000	0000	0000
SP226	SFNC6	Spindle function 6		1000	1000	1000
SP227	SFNC7	Spindle function 7		0000	0000	0000
:				:	:	:
SP232		Not used		0000	0000	0000
SP233	IVC	Voltage non-sensitive band compensation		0	0	0
SP234				0	0	0
SP235	R2H	Temperature compensation gain		0	0	0
SP236	WIH	Temperature compensation time constant		0	0	0
SP237	TCF	Torque command filter		500	500	500
SP238	SSCFEED	Safely limited speed		0	0	0
SP239	SSCRPM	Safely limited motor speed		0	0	0
SP240		Not used		0	0	0
:				:	:	:
SP256				0	0	0

(3) 200V Standard motor SJ-DG Series (High-output) / (Hollow shaft)

Parameter				200V Standard motor SJ-DG Series (High-output) / (Hollow shaft)							
				Motor		SJ-DG3.7/120-03T		SJ-DG5.5/120-04T	SJ-DG7.5/120-05T	SJ-DG11/100-03T	SJ-DG11/120-03T(-S)
No.	Abbrev.	Details	Unit capacity	100	16040S	160	160	200	160	200	200
SP001	PGV	Position loop gain non-interpolation mode		15	15	15	15	15	15	15	15
SP002	PGN	Position loop gain interpolation mode		33	33	33	33	33	33	33	33
SP003	PGS	Position loop gain spindle synchronization		15	15	15	15	15	15	15	15
SP004		Not used		0	0	0	0	0	0	0	0
SP005	VGN1	Speed loop gain 1		150	150	150	150	150	150	150	150
SP006	VIA1	Speed loop lead compensation 1		1900	1900	1900	1900	1900	1900	1900	1900
SP007	VIL1	Speed loop delay compensation 1		0	0	0	0	0	0	0	0
SP008	VGN2	Speed loop gain 2		150	150	150	150	150	150	150	150
SP009	VIA2	Speed loop lead compensation 2		1900	1900	1900	1900	1900	1900	1900	1900
SP010	VIL2	Speed loop delay compensation 2		0	0	0	0	0	0	0	0
:				:	:	:	:	:	:	:	:
SP013		Not used		0	0	0	0	0	0	0	0
SP014	PY1	Minimum excitation rate 1		50	50	50	50	50	50	50	50
SP015	PY2	Minimum excitation rate 2		100	100	100	100	100	100	100	100
SP016	DDT	Phase alignment deceleration rate		20	20	20	20	20	20	20	20
SP017	SPEC1	Spindle specification 1		000C	000C	000C	000C	000C	000C	000C	000C
SP018	SPEC2	Spindle specification 2		0200	0200	0200	0200	0200	0200	0200	0220
SP019	RNG1	Sub side encoder resolution		-	-	-	-	-	2000	2000	2000
SP020	RNG2	Main side encoder resolution		-	-	-	-	-	2000	2000	2000
SP021	OLT	Overload detection time constant		60	60	60	60	60	60	60	60
SP022	OLL	Overload detection level		120	120	120	120	120	120	120	120
SP023	OD1	Excessive error detection width (interpolation mode - spindle synchronization)		120	120	120	120	120	120	120	120
SP024	INP	In-position width		875	875	875	875	875	875	875	875
SP025	INP2	2nd in-position width		875	875	875	875	875	875	875	875
SP026	TSP	Maximum motor speed		12000	12000	12000	12000	10000	12000	12000	12000
SP027	ZSP	Motor zero speed		25	25	25	25	25	25	25	25
SP028	SDTS	Speed detection set value		1200	1200	1200	1200	1000	1200	1200	3000
SP029	SDTR	Speed detection reset width		30	30	30	30	30	30	30	30
SP030	SDT2	2nd speed detection setting value		0	0	0	0	0	0	0	0
SP031	MTYP	Motor type		2200	2200	2200	2200	2200	2200	2200	2200
SP032	PTYP	Power supply type/ Regenerative resistor type		-	-	-	-	-	-	-	-
SP033	SFNC1	Spindle function 1		0000	0000	0000	0000	0000	0000	0000	0000
SP034	SFNC2	Spindle function 2		0000	0000	0000	0000	0000	0000	0000	0000
SP035	SFNC3	Spindle function 3		1600	1600	1600	1600	1600	1600	1600	1600
SP036	SFNC4	Spindle function 4		0000	0000	0000	0000	0000	0000	0000	0000
SP037	JL	Load inertia scale		100	100	100	100	100	100	100	100
SP038	FHz1	Notch filter frequency 1		0	0	0	0	0	0	0	0
:				:	:	:	:	:	:	:	:
SP046	FHz2	Notch filter frequency 2		0	0	0	0	0	0	0	0
SP047	EC	Inductive voltage compensation gain		100	100	100	100	100	100	100	100
SP048	LMC1	Lost motion compensation 1		0	0	0	0	0	0	0	0
:				:	:	:	:	:	:	:	:
SP052	DFBN	Dual feedback control non-sensitive band		0	0	0	0	0	0	0	0
SP053	ODS	Excessive error detection width (non-interpolation mode)		2400	2400	2400	2400	2000	2400	2400	2400
SP054	ORE	Overrun detection width in closed loop control		0	0	0	0	0	0	0	0
SP055	EMGx	Max. gate off delay time after emergency stop		5000	5000	5000	5000	5000	5000	5000	5000
SP056	EMGt	Deceleration time constant at emergency stop		300	300	300	300	300	300	300	300
SP057	GRA1	Spindle side gear ratio 1		1	1	1	1	1	1	1	1
SP058	GRA2	Spindle side gear ratio 2		1	1	1	1	1	1	1	1
SP059	GRA3	Spindle side gear ratio 3		1	1	1	1	1	1	1	1
SP060	GRA4	Spindle side gear ratio 4		1	1	1	1	1	1	1	1
SP061	GRB1	Motor side gear ratio 1		1	1	1	1	1	1	1	1
SP062	GRB2	Motor side gear ratio 2		1	1	1	1	1	1	1	1
SP063	GRB3	Motor side gear ratio 3		1	1	1	1	1	1	1	1
SP064	GRB4	Motor side gear ratio 4		1	1	1	1	1	1	1	1
SP065	TLM1	Torque limit 1		10	10	10	10	10	10	10	10
SP066	TLM2	Torque limit 2		10	10	10	10	10	10	10	10
SP067	TLM3	Torque limit 3		10	10	10	10	10	10	10	10
SP068	TLM4	Torque limit 4		10	10	10	10	10	10	10	10
SP069	PCMP	Phase alignment completion width		875	875	875	875	875	875	875	875
SP070	KDDT	Phase alignment deceleration rate scale		0	0	0	0	0	0	0	0
SP071	DIQM	Variable current limit during deceleration, lower limit value		50	50	35	35	45	45	35	80
SP072	DIQN	Variable current limit during deceleration, break point speed		6200	6200	4500	4500	4500	5400	4500	10000
SP073	VGVN	Variable speed gain target value		0	0	0	0	0	0	0	0
SP074	VGVS	Variable speed gain change start speed		0	0	0	0	0	0	0	0
SP075	DWSH	Slip compensation scale during regeneration high-speed coil		0	0	0	0	0	0	0	0
SP076	DWSL	Slip compensation scale during regeneration low-speed coil		0	0	0	0	0	0	0	0

4 Setup

Parameter				200V Standard motor SJ-DG Series (High-output) / (Hollow shaft)							
				SJ-DG3.7/120-03T		SJ-DG5.5/120-04T	SJ-DG7.5/120-05T	SJ-DG11/100-03T	SJ-DG11/120-03T(-S)		SJ-DG11/120-12T-K(S)
No.	Abbrev.	Details	Unit capacity	100	16040S	160	160	200	160	200	200
SP077	IQA	Q axis current lead compensation		4096	4096	4096	4096	4096	4096	4096	4096
SP078	IDA	D axis current lead compensation		4096	4096	4096	4096	4096	4096	4096	4096
SP079	IQG	Q axis current gain		1024	1024	1024	1024	1024	1024	1024	1024
SP080	IDG	D axis current gain		1024	1024	1024	1024	1024	1024	1024	1024
SP081	IQAL	Q axis current lead compensation low-speed coil		0	0	0	0	0	0	0	4096
SP082	IDAL	D axis current lead compensation low-speed coil		0	0	0	0	0	0	0	4096
SP083	IQGL	Q axis current gain low-speed coil		0	0	0	0	0	0	0	1024
SP084	IDGL	D axis current gain low-speed coil		0	0	0	0	0	0	0	1024
SP085				0	0	0	0	0	0	0	0
:				:	:	:	:	:	:	:	:
SP088	FHz5	Notch filter frequency 5		0	0	0	0	0	0	0	0
SP089	TMKQ	Spindle output stabilizing gain Q axis		100	100	100	100	100	100	100	100
SP090	TMKD	Spindle output stabilizing gain D axis		0	0	0	0	0	0	0	0
:				:	:	:	:	:	:	:	:
SP112				0	0	0	0	0	0	0	0
SP113	OPLP	Current command value for open loop		0	0	0	0	0	0	0	0
SP114	MKT	Coil changeover gate cutoff timer		150	150	150	150	150	150	150	150
SP115	MKT2	Coil changeover current limit timer		250	250	250	250	250	250	250	250
SP116	MKIL	Coil changeover current limit value		120	120	120	120	120	120	120	120
SP117	SETM	Excessive speed deviation timer		12	12	12	12	12	12	12	12
SP118	MSFT	Magnetic pole shift amount		0	0	0	0	0	0	0	0
:				:	:	:	:	:	:	:	:
SP128	DA2MPY	D/A output ch2 output scale		0	0	0	0	0	0	0	0
SP129		Motor unique constants (H)		2	2	2	2	2	2	2	2
SP130		Motor unique constants (H)		6	6	13	20	29	29	29	30
SP131		Motor unique constants (H)		100	160	160	160	200	160	200	200
SP132		Motor unique constants (H)		0	0	0	0	0	0	0	0
SP133		Motor unique constants (H)		12000	12000	12000	12000	10000	12000	12000	12000
SP134		Motor unique constants (H)		1875	1875	1500	1500	1500	1400	1500	3600
SP135		Motor unique constants (H)		2100	2100	1800	1800	1500	1540	1500	3600
SP136		Motor unique constants (H)		810	810	1082	1120	1244	1273	1244	706
SP137		Motor unique constants (H)		40	40	49	50	50	68	50	50
SP138		Motor unique constants (H)		3252	3252	3344	3326	3252	3148	3252	3195
SP139		Motor unique constants (H)		2427	2427	2355	2376	2427	2499	2427	2458
SP140		Motor unique constants (H)		1947	1947	1956	1953	1947	1942	1947	1946
SP141		Motor unique constants (H)		87	87	98	148	148	144	148	146
SP142		Motor unique constants (H)		0	0	0	0	0	0	0	0
SP143		Motor unique constants (H)		0	0	0	0	0	0	0	0
SP144		Motor unique constants (H)		0	0	0	0	0	0	0	0
SP145		Motor unique constants (H)		473	473	467	463	464	462	462	219
SP146		Motor unique constants (H)		427	427	433	437	436	438	438	295
SP147		Motor unique constants (H)		70	70	66	73	74	75	74	74
SP148		Motor unique constants (H)		936	936	907	796	721	717	721	228
SP149		Motor unique constants (H)		4320	4320	4411	6255	7678	5895	7678	8336
SP150		Motor unique constants (H)		1088	1088	1410	1845	2285	2412	2285	4157
SP151		Motor unique constants (H)		176	176	128	84	68	68	68	22
SP152		Motor unique constants (H)		90	90	90	90	90	90	90	90
SP153		Motor unique constants (H)		120	120	120	120	120	120	120	120
SP154		Motor unique constants (H)		150	150	150	150	150	150	150	150
SP155		Motor unique constants (H)		1055	1055	1075	1095	1110	1075	1110	1095
SP156		Motor unique constants (H)		0	0	0	0	0	0	0	0
SP157		Motor unique constants (H)		0	0	0	0	0	0	0	0
SP158		Motor unique constants (H)		1500	1500	0	0	0	0	0	3000
SP159		Motor unique constants (H)		1500	1500	0	0	0	0	0	3000
SP160		Motor unique constants (H)		0	0	0	0	0	0	0	0
:				:	:	:	:	:	:	:	:
SP164		Motor unique constants (L)		0	0	0	0	0	0	0	0
SP165		Motor unique constants (L)		0	0	0	0	0	0	0	3700
SP166		Motor unique constants (L)		0	0	0	0	0	0	0	1480
SP167		Motor unique constants (L)		0	0	0	0	0	0	0	1480
SP168		Motor unique constants (L)		0	0	0	0	0	0	0	1262
SP169		Motor unique constants (L)		0	0	0	0	0	0	0	49
SP170		Motor unique constants (L)		0	0	0	0	0	0	0	3136
SP171		Motor unique constants (L)		0	0	0	0	0	0	0	2570
SP172		Motor unique constants (L)		0	0	0	0	0	0	0	1926
SP173		Motor unique constants (L)		0	0	0	0	0	0	0	140
SP174		Motor unique constants (L)		0	0	0	0	0	0	0	0
SP175		Motor unique constants (L)		0	0	0	0	0	0	0	0
SP176		Motor unique constants (L)		0	0	0	0	0	0	0	0
SP177		Motor unique constants (L)		0	0	0	0	0	0	0	232
SP178		Motor unique constants (L)		0	0	0	0	0	0	0	304
SP179		Motor unique constants (L)		0	0	0	0	0	0	0	77
SP180		Motor unique constants (L)		0	0	0	0	0	0	0	676
SP181		Motor unique constants (L)		0	0	0	0	0	0	0	9455
SP182		Motor unique constants (L)		0	0	0	0	0	0	0	2589

4 Setup

Parameter				200V Standard motor SJ-DG Series (High-output) / (Hollow shaft)									
				Motor		SJ-DG3.7/120-03T		SJ-DG5.5/120-04T	SJ-DG7.5/120-05T	SJ-DG11/100-03T	SJ-DG11/120-03T(-S)		SJ-DG11/120-12T-K(S)
				No.	Abbrev.	Details	Unit capacity	100	16040S	160	160	200	160
SP183		Motor unique constants (L)		0	0	0	0	0	0	0	0	66	
SP184				0	0	0	0	0	0	0	0	90	
SP185		Motor unique constants (L)		0	0	0	0	0	0	0	0	120	
SP186		Motor unique constants (L)		0	0	0	0	0	0	0	0	150	
SP187		Motor unique constants (L)		0	0	0	0	0	0	0	0	1090	
SP188		Motor unique constants (L)		0	0	0	0	0	0	0	0	0	
:				:	:	:	:	:	:	:	:	:	
SP191		Motor unique constants (L)		0	0	0	0	0	0	0	0	0	
SP192		Motor unique constants (L)		0	0	0	0	0	0	0	0	1500	
SP193		Motor unique constants (L)		0	0	0	0	0	0	0	0	0	
:				:	:	:	:	:	:	:	:	:	
SP224				0	0	0	0	0	0	0	0	0	
SP225	SFNC5	Spindle function 5		0000	0000	0000	0000	0000	0000	0000	0000	0000	
SP226	SFNC6	Spindle function 6		1000	1000	1000	1000	1000	1000	1000	1000	1000	
SP227	SFNC7	Spindle function 7		0000	0000	0000	0000	0000	0000	0000	0000	0000	
:				:	:	:	:	:	:	:	:	:	
SP232		Not used		0000	0000	0000	0000	0000	0000	0000	0000	0000	
SP233	IVC	Voltage non-sensitive band compensation		0	0	0	0	0	0	0	0	0	
SP234				0	0	0	0	0	0	0	0	0	
SP235	R2H	Temperature compensation gain		0	0	0	0	0	0	0	0	0	
SP236	WIH	Temperature compensation time constant		0	0	0	0	0	0	0	0	0	
SP237	TCF	Torque command filter		500	500	500	500	500	500	500	500	500	
SP238	SSCFEED	Safely limited speed		0	0	0	0	0	0	0	0	0	
SP239	SSCRPM	Safely limited motor speed		0	0	0	0	0	0	0	0	0	
SP240		Not used		0	0	0	0	0	0	0	0	0	
:				:	:	:	:	:	:	:	:	:	
SP256				0	0	0	0	0	0	0	0	0	

Parameter				200V Standard motor SJ-DG Series (High-output) / (Hollow shaft)					
				SJ-DG11/ 150-06T(-S)		SJ-DG11/150- 15T-K(S)		SJ-DG15/ 120-02T-K(S)	
				160	200	200	200	240	
No.	Abbrev.	Details	Unit capacity						
SP001	PGV	Position loop gain non-interpolation mode	15	15	15	15	15		
SP002	PGN	Position loop gain interpolation mode	33	33	33	33	33		
SP003	PGS	Position loop gain spindle synchronization	15	15	15	15	15		
SP004		Not used	0	0	0	0	0		
SP005	VGN1	Speed loop gain 1	150	150	150	150	150		
SP006	VIA1	Speed loop lead compensation 1	1900	1900	1900	1900	1900		
SP007	VIL1	Speed loop delay compensation 1	0	0	0	0	0		
SP008	VGN2	Speed loop gain 2	150	150	150	150	150		
SP009	VIA2	Speed loop lead compensation 2	1900	1900	1900	1900	1900		
SP010	VIL2	Speed loop delay compensation 2	0	0	0	0	0		
:			:	:	:	:	:		
SP013		Not used	0	0	0	0	0		
SP014	PY1	Minimum excitation rate 1	50	50	50	50	50		
SP015	PY2	Minimum excitation rate 2	100	100	100	100	100		
SP016	DDT	Phase alignment deceleration rate	20	20	20	20	20		
SP017	SPEC1	Spindle specification 1	000C	000C	000C	000C	000C		
SP018	SPEC2	Spindle specification 2	0200	0200	0220	0220	0220		
SP019	RNG1	Sub side encoder resolution	2000	2000	2000	2000	2000		
SP020	RNG2	Main side encoder resolution	2000	2000	2000	2000	2000		
SP021	OLT	Overload detection time constant	60	60	60	60	60		
SP022	OLL	Overload detection level	120	120	120	120	120		
SP023	OD1	Excessive error detection width (interpolation mode - spindle synchronization)	120	120	120	120	120		
SP024	INP	In-position width	875	875	875	875	875		
SP025	INP2	2nd in-position width	875	875	875	875	875		
SP026	TSP	Maximum motor speed	15000	15000	15000	12000	12000		
SP027	ZSP	Motor zero speed	25	25	25	25	25		
SP028	SDTS	Speed detection set value	1500	1500	3000	4000	3571		
SP029	SDTR	Speed detection reset width	30	30	30	30	30		
SP030	SDT2	2nd speed detection setting value	0	0	0	0	0		
SP031	MTYP	Motor type	2200	2200	2200	2200	2200		
SP032	PTYP	Power supply type/ Regenerative resistor type	-	-	-	-	-		
SP033	SFNC1	Spindle function 1	0000	0000	0000	0000	0000		
SP034	SFNC2	Spindle function 2	0000	0000	0000	0000	0000		
SP035	SFNC3	Spindle function 3	1600	1600	1600	1600	1600		
SP036	SFNC4	Spindle function 4	0000	0000	0000	0000	0000		
SP037	JL	Load inertia scale	100	100	100	100	100		
SP038	FHz1	Notch filter frequency 1	0	0	0	0	0		
:			:	:	:	:	:		
SP046	FHz2	Notch filter frequency 2	0	0	0	0	0		
SP047	EC	Inductive voltage compensation gain	100	100	100	100	100		
SP048	LMC1	Lost motion compensation 1	0	0	0	0	0		
:			:	:	:	:	:		
SP052	DFBN	Dual feedback control non-sensitive band	0	0	0	0	0		
SP053	ODS	Excessive error detection width (non-interpolation mode)	3000	3000	3000	2400	2400		
SP054	ORE	Overrun detection width in closed loop control	0	0	0	0	0		
SP055	EMGx	Max. gate off delay time after emergency stop	5000	5000	5000	5000	5000		
SP056	EMGt	Deceleration time constant at emergency stop	300	300	300	300	300		
SP057	GRA1	Spindle side gear ratio 1	1	1	1	1	1		
SP058	GRA2	Spindle side gear ratio 2	1	1	1	1	1		
SP059	GRA3	Spindle side gear ratio 3	1	1	1	1	1		
SP060	GRA4	Spindle side gear ratio 4	1	1	1	1	1		
SP061	GRB1	Motor side gear ratio 1	1	1	1	1	1		
SP062	GRB2	Motor side gear ratio 2	1	1	1	1	1		
SP063	GRB3	Motor side gear ratio 3	1	1	1	1	1		
SP064	GRB4	Motor side gear ratio 4	1	1	1	1	1		
SP065	TLM1	Torque limit 1	10	10	10	10	10		
SP066	TLM2	Torque limit 2	10	10	10	10	10		
SP067	TLM3	Torque limit 3	10	10	10	10	10		
SP068	TLM4	Torque limit 4	10	10	10	10	10		
SP069	PCMP	Phase alignment completion width	875	875	875	875	875		
SP070	KDDT	Phase alignment deceleration rate scale	0	0	0	0	0		
SP071	DIQM	Variable current limit during deceleration, lower limit value	30	30	50	75	50		
SP072	DIQN	Variable current limit during deceleration, break point speed	4500	4500	8000	9000	6000		
SP073	VGVN	Variable speed gain target value	0	0	0	0	0		
SP074	VGVS	Variable speed gain change start speed	0	0	0	0	0		
SP075	DWSH	Slip compensation scale during regeneration high-speed coil	0	0	0	0	0		
SP076	DWSL	Slip compensation scale during regeneration low-speed coil	0	0	0	0	0		
SP077	IQA	Q axis current lead compensation	4096	4096	4096	4096	4096		
SP078	IDA	D axis current lead compensation	4096	4096	4096	4096	4096		

4 Setup

Parameter				200V Standard motor SJ-DG Series (High-output) / (Hollow shaft)					
				SJ-DG11/ 150-06T(-S)		SJ-DG11/150- 15T-K(S)		SJ-DG15/ 120-02T-K(S)	
				160	200	200	200	240	240
No.	Abbrev.	Details	Unit capacity						
SP079	IQG	Q axis current gain		1024	1024	1024	1024	1024	
SP080	IDG	D axis current gain		1024	1024	1024	1024	1024	
SP081	IQAL	Q axis current lead compensation low-speed coil		0	0	4096	4096	4096	
SP082	IDAL	D axis current lead compensation low-speed coil		0	0	4096	4096	4096	
SP083	IQGL	Q axis current gain low-speed coil		0	0	1024	1024	1024	
SP084	IDGL	D axis current gain low-speed coil		0	0	1024	1024	1024	
SP085				0	0	0	0	0	
:				:	:	:	:	:	
SP088	FHz5	Notch filter frequency 5		0	0	0	0	0	
SP089	TMKQ	Spindle output stabilizing gain Q axis		100	100	100	100	100	
SP090	TMKD	Spindle output stabilizing gain D axis		0	0	0	0	0	
:				:	:	:	:	:	
SP112				0	0	0	0	0	
SP113	OPLP	Current command value for open loop		0	0	0	0	0	
SP114	MKT	Coil changeover gate cutoff timer		150	150	150	150	150	
SP115	MKT2	Coil changeover current limit timer		250	250	250	250	250	
SP116	MKIL	Coil changeover current limit value		120	120	120	120	120	
SP117	SETM	Excessive speed deviation timer		12	12	12	12	12	
SP118	MSFT	Magnetic pole shift amount		0	0	0	0	0	
:				:	:	:	:	:	
SP128	DA2MPY	D/A output ch2 output scale		0	0	0	0	0	
SP129		Motor unique constants (H)		2	2	2	2	2	
SP130		Motor unique constants (H)		29	29	28	86	86	
SP131		Motor unique constants (H)		160	200	200	200	240	
SP132		Motor unique constants (H)		0	0	0	0	0	
SP133		Motor unique constants (H)		15000	15000	15000	12000	12000	
SP134		Motor unique constants (H)		2100	2100	3600	4000	4000	
SP135		Motor unique constants (H)		2100	2100	3600	4000	4000	
SP136		Motor unique constants (H)		1273	1244	659	657	696	
SP137		Motor unique constants (H)		68	50	68	59	39	
SP138		Motor unique constants (H)		3135	3252	3471	4030	3809	
SP139		Motor unique constants (H)		2488	2427	2284	2099	2140	
SP140		Motor unique constants (H)		1945	1947	1964	1873	1976	
SP141		Motor unique constants (H)		144	148	142	198	194	
SP142		Motor unique constants (H)		0	0	0	0	0	
SP143		Motor unique constants (H)		0	0	0	0	0	
SP144		Motor unique constants (H)		0	0	0	0	0	
SP145		Motor unique constants (H)		437	464	305	133	191	
SP146		Motor unique constants (H)		436	436	423	176	256	
SP147		Motor unique constants (H)		75	74	70	40	41	
SP148		Motor unique constants (H)		717	721	232	174	173	
SP149		Motor unique constants (H)		5895	7678	8932	6720	9605	
SP150		Motor unique constants (H)		2412	2285	3596	2635	2842	
SP151		Motor unique constants (H)		68	68	22	20	20	
SP152		Motor unique constants (H)		90	90	90	90	90	
SP153		Motor unique constants (H)		120	120	120	120	120	
SP154		Motor unique constants (H)		150	150	150	150	150	
SP155		Motor unique constants (H)		1075	1110	1135	1110	1100	
SP156		Motor unique constants (H)		0	0	0	0	0	
SP157		Motor unique constants (H)		0	0	0	0	0	
SP158		Motor unique constants (H)		1400	1500	3000	0	0	
SP159		Motor unique constants (H)		1400	1500	3000	0	0	
SP160		Motor unique constants (H)		0	0	0	0	0	
:				:	:	:	:	:	
SP164		Motor unique constants (L)		0	0	0	0	0	
SP165		Motor unique constants (L)		0	0	15000	12000	12000	
SP166		Motor unique constants (L)		0	0	1500	1500	1500	
SP167		Motor unique constants (L)		0	0	1500	1500	1500	
SP168		Motor unique constants (L)		0	0	1321	1522	1579	
SP169		Motor unique constants (L)		0	0	59	59	44	
SP170		Motor unique constants (L)		0	0	2952	3023	2883	
SP171		Motor unique constants (L)		0	0	2785	2652	2826	
SP172		Motor unique constants (L)		0	0	1904	1922	1904	
SP173		Motor unique constants (L)		0	0	117	157	147	
SP174		Motor unique constants (L)		0	0	0	0	0	
SP175		Motor unique constants (L)		0	0	0	0	0	
SP176		Motor unique constants (L)		0	0	0	0	0	
SP177		Motor unique constants (L)		0	0	460	464	464	
SP178		Motor unique constants (L)		0	0	440	436	436	
SP179		Motor unique constants (L)		0	0	82	49	52	
SP180		Motor unique constants (L)		0	0	665	504	501	
SP181		Motor unique constants (L)		0	0	8913	7736	10079	
SP182		Motor unique constants (L)		0	0	2949	2586	2863	
SP183		Motor unique constants (L)		0	0	66	59	59	
SP184		Motor unique constants (L)		0	0	90	90	90	
SP185		Motor unique constants (L)		0	0	120	120	120	

4 Setup

Parameter				200V Standard motor SJ-DG Series (High-output) / (Hollow shaft)					
				SJ-DG11/ 150-06T(-S)		SJ-DG11/150- 15T-K(S)		SJ-DG15/ 120-02T-K(S)	
No.	Abbrev.	Details	Unit capacity	160	200	200	200	240	
SP186		Motor unique constants (L)		0	0	150	150	150	
SP187		Motor unique constants (L)		0	0	1135	1120	1100	
SP188		Motor unique constants (L)		0	0	0	0	0	
:				:	:	:	:	:	
SP191		Motor unique constants (L)		0	0	0	0	0	
SP192		Motor unique constants (L)		0	0	0	0	0	
SP193		Motor unique constants (L)		0	0	0	0	0	
:				:	:	:	:	:	
SP224				0	0	0	0	0	
SP225	SFNC5	Spindle function 5		0000	0000	0000	0000	0000	
SP226	SFNC6	Spindle function 6		1000	1000	1000	1000	1000	
SP227	SFNC7	Spindle function 7		0000	0000	0000	0000	0000	
:				:	:	:	:	:	
SP232		Not used		0000	0000	0000	0000	0000	
SP233	IVC	Voltage non-sensitive band compensation		0	0	0	0	0	
SP234				0	0	0	0	0	
SP235	R2H	Temperature compensation gain		0	0	0	0	0	
SP236	WIH	Temperature compensation time constant		0	0	0	0	0	
SP237	TCF	Torque command filter		500	500	500	500	500	
SP238	SSCFEED	Safely limited speed		0	0	0	0	0	
SP239	SSCRPM	Safely limited motor speed		0	0	0	0	0	
SP240		Not used		0	0	0	0	0	
:				:	:	:	:	:	
SP256				0	0	0	0	0	

(4) 200V Standard motor SJ-DJ Series (Compact & Lightweight output)

Parameter				200V Standard motor SJ-DJ Series (Compact & Lightweight output)							
				Motor		SJ-DJ5.5/ 100-01		SJ-DJ5.5/ 120-01		SJ-DJ7.5/ 100-01	
						100	16040S	100	16040S	100	16040S
No.	Abbrev.	Details	Unit	capacity							
SP001	PGV	Position loop gain non-interpolation mode			15	15	15	15	15	15	
SP002	PGN	Position loop gain interpolation mode			33	33	33	33	33	33	
SP003	PGS	Position loop gain spindle synchronization			15	15	15	15	15	15	
SP004		Not used			0	0	0	0	0	0	
SP005	VGN1	Speed loop gain 1			150	150	150	150	150	150	
SP006	VIA1	Speed loop lead compensation 1			1900	1900	1900	1900	1900	1900	
SP007	VIL1	Speed loop delay compensation 1			0	0	0	0	0	0	
SP008	VGN2	Speed loop gain 2			150	150	150	150	150	150	
SP009	VIA2	Speed loop lead compensation 2			1900	1900	1900	1900	1900	1900	
SP010	VIL2	Speed loop delay compensation 2			0	0	0	0	0	0	
:					:	:	:	:	:	:	
SP013		Not used			0	0	0	0	0	0	
SP014	PY1	Minimum excitation rate 1			50	50	50	50	50	50	
SP015	PY2	Minimum excitation rate 2			100	100	100	100	100	100	
SP016	DDT	Phase alignment deceleration rate			20	20	20	20	20	20	
SP017	SPEC1	Spindle specification 1			000C	000C	000C	000C	000C	000C	
SP018	SPEC2	Spindle specification 2			0200	0200	0200	0200	0200	0200	
SP019	RNG1	Sub side encoder resolution			-	-	-	-	-	-	
SP020	RNG2	Main side encoder resolution			-	-	-	-	-	-	
SP021	OLT	Overload detection time constant			60	60	60	60	60	60	
SP022	OLL	Overload detection level			120	120	120	120	120	120	
SP023	OD1	Excessive error detection width (interpolation mode - spindle synchronization)			120	120	120	120	120	120	
SP024	INP	In-position width			875	875	875	875	875	875	
SP025	INP2	2nd in-position width			875	875	875	875	875	875	
SP026	TSP	Maximum motor speed			10000	10000	12000	12000	10000	10000	
SP027	ZSP	Motor zero speed			50	50	25	25	50	50	
SP028	SDTS	Speed detection set value			1000	1000	1200	1200	1000	1000	
SP029	SDTR	Speed detection reset width			30	30	30	30	30	30	
SP030	SDT2	2nd speed detection setting value			0	0	0	0	0	0	
SP031	MTYP	Motor type			2200	2200	2200	2200	2200	2200	
SP032	PTYP	Power supply type/ Regenerative resistor type			-	-	-	-	-	-	
SP033	SFNC1	Spindle function 1			0000	0000	0000	0000	0000	0000	
SP034	SFNC2	Spindle function 2			0000	0000	0000	0000	0000	0000	
SP035	SFNC3	Spindle function 3			1600	1600	1600	1600	1600	1600	
SP036	SFNC4	Spindle function 4			0000	0000	0000	0000	0000	0000	
SP037	JL	Load inertia scale			100	100	100	100	100	100	
SP038	FHz1	Notch filter frequency 1			0	0	0	0	0	0	
:					:	:	:	:	:	:	
SP046	FHz2	Notch filter frequency 2			0	0	0	0	0	0	
SP047	EC	Inductive voltage compensation gain			100	100	100	100	100	100	
SP048	LMC1	Lost motion compensation 1			0	0	0	0	0	0	
:					:	:	:	:	:	:	
SP052	DFBN	Dual feedback control non-sensitive band			0	0	0	0	0	0	
SP053	ODS	Excessive error detection width (non-interpolation mode)			2000	2000	2400	2400	2000	2000	
SP054	ORE	Overrun detection width in closed loop control			0	0	0	0	0	0	
SP055	EMGx	Max. gate off delay time after emergency stop			5000	5000	5000	5000	5000	5000	
SP056	EMGt	Deceleration time constant at emergency stop			300	300	300	300	300	300	
SP057	GRA1	Spindle side gear ratio 1			1	1	1	1	1	1	
SP058	GRA2	Spindle side gear ratio 2			1	1	1	1	1	1	
SP059	GRA3	Spindle side gear ratio 3			1	1	1	1	1	1	
SP060	GRA4	Spindle side gear ratio 4			1	1	1	1	1	1	
SP061	GRB1	Motor side gear ratio 1			1	1	1	1	1	1	
SP062	GRB2	Motor side gear ratio 2			1	1	1	1	1	1	
SP063	GRB3	Motor side gear ratio 3			1	1	1	1	1	1	
SP064	GRB4	Motor side gear ratio 4			1	1	1	1	1	1	
SP065	TLM1	Torque limit 1			10	10	10	10	10	10	
SP066	TLM2	Torque limit 2			10	10	10	10	10	10	
SP067	TLM3	Torque limit 3			10	10	10	10	10	10	
SP068	TLM4	Torque limit 4			10	10	10	10	10	10	
SP069	PCMP	Phase alignment completion width			875	875	875	875	875	875	
SP070	KDDT	Phase alignment deceleration rate scale			0	0	0	0	0	0	
SP071	DIQM	Variable current limit during deceleration, lower limit value			35	35	35	35	45	45	
SP072	DIQN	Variable current limit during deceleration, break point speed			3700	3700	4500	4500	4500	4500	
SP073	VGVN	Variable speed gain target value			0	0	0	0	0	0	
SP074	VGVS	Variable speed gain change start speed			0	0	0	0	0	0	
SP075	DWSH	Slip compensation scale during regeneration high-speed coil			0	0	0	0	0	0	
SP076	DWSL	Slip compensation scale during regeneration low- speed coil			0	0	0	0	0	0	
SP077	IQA	Q axis current lead compensation			4096	4096	4096	4096	4096	4096	

4 Setup

Parameter				200V Standard motor SJ-DJ Series (Compact & Lightweight output)					
				SJ-DJ5.5/ 100-01		SJ-DJ5.5/ 120-01		SJ-DJ7.5/ 100-01	
				100	16040S	100	16040S	100	16040S
No.	Abbrev.	Details	Unit capacity						
SP078	IDA	D axis current lead compensation	4096	4096	4096	4096	4096	4096	
SP079	IQG	Q axis current gain	1024	1024	1024	1024	1024	1024	
SP080	IDG	D axis current gain	1024	1024	1024	1024	1024	1024	
SP081	IQAL	Q axis current lead compensation low-speed coil	0	0	0	0	0	0	
:			:	:	:	:	:	:	
SP088	FHz5	Notch filter frequency 5	0	0	0	0	0	0	
SP089	TMKQ	Spindle output stabilizing gain Q axis	100	100	100	100	100	100	
SP090	TMKD	Spindle output stabilizing gain D axis	0	0	0	0	0	0	
:			:	:	:	:	:	:	
SP112			0	0	0	0	0	0	
SP113	OPLP	Current command value for open loop	0	0	0	0	0	0	
SP114	MKT	Coil changeover gate cutoff timer	150	150	150	150	150	150	
SP115	MKT2	Coil changeover current limit timer	250	250	250	250	250	250	
SP116	MKIL	Coil changeover current limit value	120	120	120	120	120	120	
SP117	SETM	Excessive speed deviation timer	12	12	12	12	12	12	
SP118	MSFT	Magnetic pole shift amount	0	0	0	0	0	0	
:			:	:	:	:	:	:	
SP128	DA2MPY	D/A output ch2 output scale	0	0	0	0	0	0	
SP129		Motor unique constants (H)	2	2	2	2	2	2	
SP130		Motor unique constants (H)	8	8	8	8	13	13	
SP131		Motor unique constants (H)	100	160	100	160	100	160	
SP132		Motor unique constants (H)	0	0	0	0	0	0	
SP133		Motor unique constants (H)	10000	10000	12000	12000	10000	10000	
SP134		Motor unique constants (H)	1800	1800	1800	1800	1800	1800	
SP135		Motor unique constants (H)	1800	1800	1800	1800	1800	1800	
SP136		Motor unique constants (H)	1123	1123	1123	1123	1352	1352	
SP137		Motor unique constants (H)	67	67	67	67	73	73	
SP138		Motor unique constants (H)	2880	2880	2880	2880	3023	3023	
SP139		Motor unique constants (H)	2939	2939	2939	2939	2652	2652	
SP140		Motor unique constants (H)	1882	1882	1884	1884	1922	1922	
SP141		Motor unique constants (H)	72	72	72	72	88	88	
SP142		Motor unique constants (H)	0	0	0	0	0	0	
SP143		Motor unique constants (H)	0	0	0	0	0	0	
SP144		Motor unique constants (H)	0	0	0	0	0	0	
SP145		Motor unique constants (H)	460	460	473	473	424	424	
SP146		Motor unique constants (H)	423	423	427	427	429	429	
SP147		Motor unique constants (H)	82	82	82	82	73	73	
SP148		Motor unique constants (H)	1405	1405	1405	1405	1165	1165	
SP149		Motor unique constants (H)	3118	3118	3118	3118	3532	3532	
SP150		Motor unique constants (H)	1189	1189	1189	1189	1525	1525	
SP151		Motor unique constants (H)	259	259	259	259	167	167	
SP152		Motor unique constants (H)	90	90	90	90	90	90	
SP153		Motor unique constants (H)	120	120	120	120	120	120	
SP154		Motor unique constants (H)	150	150	150	150	150	150	
SP155		Motor unique constants (H)	1100	1100	1100	1100	1065	1065	
SP156		Motor unique constants (H)	0	0	0	0	0	0	
SP157		Motor unique constants (H)	0	0	0	0	0	0	
SP158		Motor unique constants (H)	1500	1500	1500	1500	1500	1500	
SP159		Motor unique constants (H)	1500	1500	1500	1500	1500	1500	
SP160		Motor unique constants (H)	0	0	0	0	0	0	
:			:	:	:	:	:	:	
SP224			0	0	0	0	0	0	
SP225	SFNC5	Spindle function 5	0000	0000	0000	0000	0000	0000	
SP226	SFNC6	Spindle function 6	1000	1000	1000	1000	1000	1000	
SP227	SFNC7	Spindle function 7	0000	0000	0000	0000	0000	0000	
:			:	:	:	:	:	:	
SP232		Not used	0000	0000	0000	0000	0000	0000	
SP233	IVC	Voltage non-sensitive band compensation	0	0	0	0	0	0	
SP234			0	0	0	0	0	0	
SP235	R2H	Temperature compensation gain	0	0	0	0	0	0	
SP236	WIH	Temperature compensation time constant	0	0	0	0	0	0	
SP237	TCF	Torque command filter	500	500	500	500	500	500	
SP238	SSCFEED	Safely limited speed	0	0	0	0	0	0	
SP239	SSCRPM	Safely limited motor speed	0	0	0	0	0	0	
SP240		Not used	0	0	0	0	0	0	
:			:	:	:	:	:	:	
SP256			0	0	0	0	0	0	

Parameter				200V Standard motor SJ-DJ Series (Compact & Lightweight output)					
				Motor		SJ-DJ7.5/ 120-01		SJ-DJ11/ 100-01	SJ-DJ15/ 80-01
				No.	Abbrev.	Details	Unit capacity	100	16040S
SP001	PGV	Position loop gain non-interpolation mode		15	15	15	15		
SP002	PGN	Position loop gain interpolation mode		33	33	33	33		
SP003	PGS	Position loop gain spindle synchronization		15	15	15	15		
SP004		Not used		0	0	0	0		
SP005	VGN1	Speed loop gain 1		150	150	150	150		
SP006	VIA1	Speed loop lead compensation 1		1900	1900	1900	1900		
SP007	VIL1	Speed loop delay compensation 1		0	0	0	0		
SP008	VGN2	Speed loop gain 2		150	150	150	150		
SP009	VIA2	Speed loop lead compensation 2		1900	1900	1900	1900		
SP010	VIL2	Speed loop delay compensation 2		0	0	0	0		
:				:	:	:	:		
SP013		Not used		0	0	0	0		
SP014	PY1	Minimum excitation rate 1		50	50	50	50		
SP015	PY2	Minimum excitation rate 2		100	100	100	100		
SP016	DDT	Phase alignment deceleration rate		20	20	20	20		
SP017	SPEC1	Spindle specification 1		000C	000C	000C	000C		
SP018	SPEC2	Spindle specification 2		0200	0200	0200	0200		
SP019	RNG1	Sub side encoder resolution		-	-	-	-		
SP020	RNG2	Main side encoder resolution		-	-	-	-		
SP021	OLT	Overload detection time constant		60	60	60	60		
SP022	OLL	Overload detection level		120	120	120	120		
SP023	OD1	Excessive error detection width (interpolation mode - spindle synchronization)		120	120	120	120		
SP024	INP	In-position width		875	875	875	875		
SP025	INP2	2nd in-position width		875	875	875	875		
SP026	TSP	Maximum motor speed		12000	12000	10000	8000		
SP027	ZSP	Motor zero speed		25	25	25	25		
SP028	SDTS	Speed detection set value		1200	1200	1000	800		
SP029	SDTR	Speed detection reset width		30	30	30	30		
SP030	SDT2	2nd speed detection setting value		0	0	0	0		
SP031	MTYP	Motor type		2200	2200	2200	2200		
SP032	PTYP	Power supply type/ Regenerative resistor type		-	-	-	-		
SP033	SFNC1	Spindle function 1		0000	0000	0000	0000		
SP034	SFNC2	Spindle function 2		0000	0000	0000	0000		
SP035	SFNC3	Spindle function 3		1600	1600	1600	1600		
SP036	SFNC4	Spindle function 4		0000	0000	0000	0000		
SP037	JL	Load inertia scale		100	100	100	100		
SP038	FHz1	Notch filter frequency 1		0	0	0	0		
:				:	:	:	:		
SP046	FHz2	Notch filter frequency 2		0	0	0	0		
SP047	EC	Inductive voltage compensation gain		100	100	100	100		
SP048	LMC1	Lost motion compensation 1		0	0	0	0		
:				:	:	:	:		
SP052	DFBN	Dual feedback control non-sensitive band		0	0	0	0		
SP053	ODS	Excessive error detection width (non-interpolation mode)		2400	2400	2000	1600		
SP054	ORE	Overrun detection width in closed loop control		0	0	0	0		
SP055	EMGx	Max. gate off delay time after emergency stop		5000	5000	5000	5000		
SP056	EMGt	Deceleration time constant at emergency stop		300	300	300	300		
SP057	GRA1	Spindle side gear ratio 1		1	1	1	1		
SP058	GRA2	Spindle side gear ratio 2		1	1	1	1		
SP059	GRA3	Spindle side gear ratio 3		1	1	1	1		
SP060	GRA4	Spindle side gear ratio 4		1	1	1	1		
SP061	GRB1	Motor side gear ratio 1		1	1	1	1		
SP062	GRB2	Motor side gear ratio 2		1	1	1	1		
SP063	GRB3	Motor side gear ratio 3		1	1	1	1		
SP064	GRB4	Motor side gear ratio 4		1	1	1	1		
SP065	TLM1	Torque limit 1		10	10	10	10		
SP066	TLM2	Torque limit 2		10	10	10	10		
SP067	TLM3	Torque limit 3		10	10	10	10		
SP068	TLM4	Torque limit 4		10	10	10	10		
SP069	PCMP	Phase alignment completion width		875	875	875	875		
SP070	KDDT	Phase alignment deceleration rate scale		0	0	0	0		
SP071	DIQM	Variable current limit during deceleration, lower limit value		35	35	45	40		
SP072	DIQN	Variable current limit during deceleration, break point speed		4500	4500	4500	3300		
SP073	VGVN	Variable speed gain target value		0	0	0	0		
SP074	VGVS	Variable speed gain change start speed		0	0	0	0		
SP075	DWSH	Slip compensation scale during regeneration high-speed coil		0	0	0	0		
SP076	DWSL	Slip compensation scale during regeneration low- speed coil		0	0	0	0		
SP077	IQA	Q axis current lead compensation		4096	4096	4096	4096		
SP078	IDA	D axis current lead compensation		4096	4096	4096	4096		

4 Setup

Parameter				200V Standard motor SJ-DJ Series (Compact & Lightweight output)			
				SJ-DJ7.5/120-01		SJ-DJ11/100-01	SJ-DJ15/80-01
No.	Abbrev.	Details	Unit capacity	100	16040S	160	200
SP079	IQG	Q axis current gain		1024	1024	1024	1024
SP080	IDG	D axis current gain		1024	1024	1024	1024
SP081	IQAL	Q axis current lead compensation low-speed coil		0	0	0	0
:				:	:	:	:
SP088	FHz5	Notch filter frequency 5		0	0	0	0
SP089	TMKQ	Spindle output stabilizing gain Q axis		100	100	100	100
SP090	TMKD	Spindle output stabilizing gain D axis		0	0	0	0
:				:	:	:	:
SP112				0	0	0	0
SP113	OPLP	Current command value for open loop		0	0	0	0
SP114	MKT	Coil changeover gate cutoff timer		150	150	150	150
SP115	MKT2	Coil changeover current limit timer		250	250	250	250
SP116	MKIL	Coil changeover current limit value		120	120	120	120
SP117	SETM	Excessive speed deviation timer		12	12	12	12
SP118	MSFT	Magnetic pole shift amount		0	0	0	0
:				:	:	:	:
SP128	DA2MPY	D/A output ch2 output scale		0	0	0	0
SP129		Motor unique constants (H)		2	2	2	2
SP130		Motor unique constants (H)		13	13	24	31
SP131		Motor unique constants (H)		100	160	160	200
SP132		Motor unique constants (H)		0	0	0	0
SP133		Motor unique constants (H)		12000	12000	10000	8000
SP134		Motor unique constants (H)		1800	1800	1800	1500
SP135		Motor unique constants (H)		1800	1800	1800	1800
SP136		Motor unique constants (H)		1352	1352	1377	1355
SP137		Motor unique constants (H)		73	73	68	73
SP138		Motor unique constants (H)		3023	3023	2963	2952
SP139		Motor unique constants (H)		2652	2652	2796	2785
SP140		Motor unique constants (H)		1922	1922	1900	1904
SP141		Motor unique constants (H)		88	88	127	130
SP142		Motor unique constants (H)		0	0	0	0
SP143		Motor unique constants (H)		0	0	0	0
SP144		Motor unique constants (H)		0	0	0	0
SP145		Motor unique constants (H)		468	468	466	404
SP146		Motor unique constants (H)		432	432	434	432
SP147		Motor unique constants (H)		73	73	83	82
SP148		Motor unique constants (H)		1165	1165	940	701
SP149		Motor unique constants (H)		3532	3532	5085	7045
SP150		Motor unique constants (H)		1525	1525	2197	2867
SP151		Motor unique constants (H)		167	167	105	68
SP152		Motor unique constants (H)		90	90	110	90
SP153		Motor unique constants (H)		120	120	120	120
SP154		Motor unique constants (H)		150	150	150	150
SP155		Motor unique constants (H)		1065	1065	1075	1041
SP156		Motor unique constants (H)		0	0	0	0
SP157		Motor unique constants (H)		0	0	0	0
SP158		Motor unique constants (H)		1500	1500	1500	0
SP159		Motor unique constants (H)		1500	1500	1500	0
SP160		Motor unique constants (H)		0	0	0	0
:				:	:	:	:
SP224		Motor unique constants (H)		0	0	0	0
SP225	SFNC5	Spindle function 5		0000	0000	0000	0000
SP226	SFNC6	Spindle function 6		1000	1000	1000	1000
SP227	SFNC7	Spindle function 7		0000	0000	0000	0000
:				:	:	:	:
SP232		Not used		0000	0000	0000	0000
SP233	IVC	Voltage non-sensitive band compensation		0	0	0	0
SP234		Motor unique constants (H)		0	0	0	0
SP235	R2H	Temperature compensation gain		0	0	0	0
SP236	WIH	Temperature compensation time constant		0	0	0	0
SP237	TCF	Torque command filter		500	500	500	500
SP238	SSCFEED	Safely limited speed		0	0	0	0
SP239	SSCRPM	Safely limited motor speed		0	0	0	0
SP240		Not used		0	0	0	0
:				:	:	:	:
SP256		Motor unique constants (H)		0	0	0	0

(5) 200V Standard motor SJ-DL Series (Low-inertia)

Motor				200V Standard motor SJ-DL Series (Low-inertia)			
Parameter				SJ-DL3.7/240-01T	SJ-DL5.5/150-01T	SJ-DL5.5/240-05T	SJ-DL7.5/150-01T
No.	Abbrev.	Details	Unit capacity	200	160	200	160
SP001	PGV	Position loop gain non-interpolation mode		15	15	15	15
SP002	PGN	Position loop gain interpolation mode		33	33	33	33
SP003	PGS	Position loop gain spindle synchronization		15	15	15	15
SP004				0	0	0	0
SP005	VGN1	Speed loop gain 1		150	150	150	150
SP006	VIA1	Speed loop lead compensation 1		1900	1900	1900	1900
SP007	VIL1	Speed loop delay compensation 1		0	0	0	0
SP008	VGN2	Speed loop gain 2		150	150	150	150
SP009	VIA2	Speed loop lead compensation 2		1900	1900	1900	1900
SP010	VIL2	Speed loop delay compensation 2		0	0	0	0
:				:	:	:	:
SP013		Not used		0	0	0	0
SP014	PY1	Minimum excitation rate 1		50	50	30	50
SP015	PY2	Minimum excitation rate 2		100	100	100	100
SP016	DDT	Phase alignment deceleration rate		20	20	20	20
SP017	SPEC1	Spindle specification 1		000C	000C	000C	000C
SP018	SPEC2	Spindle specification 2		0200	0200	0220	0200
SP019	RNG1	Sub side encoder resolution		-	-	2000	-
SP020	RNG2	Main side encoder resolution		-	-	2000	-
SP021	OLT	Overload detection time constant		60	60	60	60
SP022	OLL	Overload detection level		120	120	120	120
SP023	OD1	Excessive error detection width (interpolation mode - spindle synchronization)		120	120	120	120
SP024	INP	In-position width		875	875	875	875
SP025	INP2	2nd in-position width		875	875	875	875
SP026	TSP	Maximum motor speed		24000	15000	24000	15000
SP027	ZSP	Motor zero speed		25	50	25	25
SP028	SDTS	Speed detection set value		2400	1500	12000	1500
SP029	SDTR	Speed detection reset width		30	30	30	30
SP030	SDT2	2nd speed detection setting value		0	0	0	0
SP031	MTYP	Motor type		2200	2200	2200	2200
SP032	PTYP	Power supply type/ Regenerative resistor type		-	-	-	-
SP033	SFNC1	Spindle function 1		0000	0000	0000	0000
SP034	SFNC2	Spindle function 2		0100	0000	0000	0000
SP035	SFNC3	Spindle function 3		1600	1600	1600	1600
SP036	SFNC4	Spindle function 4		0000	0000	0000	0000
SP037	JL	Load inertia scale		100	100	100	100
SP038	FHz1	Notch filter frequency 1		0	0	0	0
:				:	:	:	:
SP046	FHz2	Notch filter frequency 2		0	0	0	0
SP047	EC	Inductive voltage compensation gain		100	100	100	100
SP048	LMC1	Lost motion compensation 1		0	0	0	0
:				:	:	:	:
SP052	DFBN	Dual feedback control non-sensitive band		0	0	0	0
SP053	ODS	Excessive error detection width (non-interpolation mode)		4800	3000	4800	3000
SP054	ORE	Overrun detection width in closed loop control		0	0	0	0
SP055	EMGx	Max. gate off delay time after emergency stop		5000	5000	5000	5000
SP056	EMGt	Deceleration time constant at emergency stop		300	300	300	300
SP057	GRA1	Spindle side gear ratio 1		1	1	1	1
SP058	GRA2	Spindle side gear ratio 2		1	1	1	1
SP059	GRA3	Spindle side gear ratio 3		1	1	1	1
SP060	GRA4	Spindle side gear ratio 4		1	1	1	1
SP061	GRB1	Motor side gear ratio 1		1	1	1	1
SP062	GRB2	Motor side gear ratio 2		1	1	1	1
SP063	GRB3	Motor side gear ratio 3		1	1	1	1
SP064	GRB4	Motor side gear ratio 4		1	1	1	1
SP065	TLM1	Torque limit 1		10	10	10	10
SP066	TLM2	Torque limit 2		10	10	10	10
SP067	TLM3	Torque limit 3		10	10	10	10
SP068	TLM4	Torque limit 4		10	10	10	10
SP069	PCMP	Phase alignment completion width		875	875	875	875
SP070	KDDT	Phase alignment deceleration rate scale		0	0	0	0
SP071	DIQM	Variable current limit during deceleration, lower limit value		80	75	55	40
SP072	DIQN	Variable current limit during deceleration, break point speed		20000	11400	14000	6600
SP073	VGVN	Variable speed gain target value		0	0	0	0
SP074	VGVS	Variable speed gain change start speed		0	0	0	0
SP075	DWSH	Slip compensation scale during regeneration high-speed coil		0	0	0	0
SP076	DWSL	Slip compensation scale during regeneration low-speed coil		0	0	0	0
SP077	IQA	Q axis current lead compensation		4096	4096	4096	4096
SP078	IDA	D axis current lead compensation		4096	4096	4096	4096

4 Setup

Parameter				200V Standard motor SJ-DL Series (Low-inertia)			
				Motor		SJ-DL3.7/240-01T	SJ-DL5.5/150-01T
No.	Abbrev.	Details	Unit capacity	200	160	200	160
SP079	IQG	Q axis current gain		1024	1024	1024	1024
SP080	IDG	D axis current gain		1024	1024	1024	1024
SP081	IQAL	Q axis current lead compensation low-speed coil		0	0	4096	0
SP082	IDAL	D axis current lead compensation low-speed coil		0	0	4096	0
SP083	IQGL	Q axis current gain low-speed coil		0	0	1024	0
SP084	IDGL	D axis current gain low-speed coil		0	0	1024	0
SP085				0	0	0	0
:				:	:	:	:
SP088	FHz5	Notch filter frequency 5		0	0	0	0
SP089	TMKQ	Spindle output stabilizing gain Q axis		100	100	100	100
SP090	TMKD	Spindle output stabilizing gain D axis		0	0	0	0
:				:	:	:	:
SP113	OPLP	Current command value for open loop		0	0	0	0
SP114	MKT	Coil changeover gate cutoff timer		150	150	0	150
SP115	MKT2	Coil changeover current limit timer		250	250	0	250
SP116	MKIL	Coil changeover current limit value		120	120	120	120
SP117	SETM	Excessive speed deviation timer		12	12	12	12
SP118	MSFT	Magnetic pole shift amount		0	0	0	0
:				:	:	:	:
SP128	DA2MPY	D/A output ch2 output scale		0	0	0	0
SP129		Motor unique constants (H)		2	2	2	2
SP130		Motor unique constants (H)		2	5	4	16
SP131		Motor unique constants (H)		200	160	200	160
SP132		Motor unique constants (H)		0	0	0	0
SP133		Motor unique constants (H)		24000	15000	24000	15000
SP134		Motor unique constants (H)		10000	3200	6550	1800
SP135		Motor unique constants (H)		10000	4200	6550	2160
SP136		Motor unique constants (H)		214	429	323	963
SP137		Motor unique constants (H)		73	50	34	50
SP138		Motor unique constants (H)		3482	2959	3005	3060
SP139		Motor unique constants (H)		2232	2642	2591	2550
SP140		Motor unique constants (H)		1981	1931	1937	1940
SP141		Motor unique constants (H)		30	56	58	91
SP142		Motor unique constants (H)		0	0	0	0
SP143		Motor unique constants (H)		0	0	0	0
SP144		Motor unique constants (H)		0	0	0	0
SP145		Motor unique constants (H)		197	253	427	460
SP146		Motor unique constants (H)		261	340	439	440
SP147		Motor unique constants (H)		106	84	83	80
SP148		Motor unique constants (H)		127	296	174	559
SP149		Motor unique constants (H)		6693	5831	9919	6061
SP150		Motor unique constants (H)		3320	2222	2809	2508
SP151		Motor unique constants (H)		31	56	32	58
SP152		Motor unique constants (H)		90	90	90	90
SP153		Motor unique constants (H)		120	120	120	120
SP154		Motor unique constants (H)		150	150	150	150
SP155		Motor unique constants (H)		1065	1050	1095	1050
SP156		Motor unique constants (H)		0	0	0	0
SP157		Motor unique constants (H)		0	0	0	0
SP158		Motor unique constants (H)		0	0	0	0
SP159		Motor unique constants (H)		2467	2100	1650	1227
SP160		Motor unique constants (H)		0	0	0	0
SP161		Motor unique constants (H)		0	0	0	0
:				:	:	:	:
SP164		Motor unique constants (L)		0	0	0	0
SP165		Motor unique constants (L)		0	0	24000	0
SP166		Motor unique constants (L)		0	0	6550	0
SP167		Motor unique constants (L)		0	0	6550	0
SP168		Motor unique constants (L)		0	0	351	0
SP169		Motor unique constants (L)		0	0	34	0
SP170		Motor unique constants (L)		0	0	2741	0
SP171		Motor unique constants (L)		0	0	2980	0
SP172		Motor unique constants (L)		0	0	1894	0
SP173		Motor unique constants (L)		0	0	50	0
SP174		Motor unique constants (L)		0	0	0	0
SP175		Motor unique constants (L)		0	0	0	0
SP176		Motor unique constants (L)		0	0	0	0
SP177		Motor unique constants (L)		0	0	379	0
SP178		Motor unique constants (L)		0	0	438	0
SP179		Motor unique constants (L)		0	0	94	0
SP180		Motor unique constants (L)		0	0	171	0
SP181		Motor unique constants (L)		0	0	9137	0
SP182		Motor unique constants (L)		0	0	3535	0
SP183		Motor unique constants (L)		0	0	32	0
SP184		Motor unique constants (L)		0	0	90	0
SP185		Motor unique constants (L)		0	0	120	0
SP186		Motor unique constants (L)		0	0	150	0

Parameter				200V Standard motor SJ-DL Series (Low-inertia)			
				SJ-DL3.7/240-01T	SJ-DL5.5/150-01T	SJ-DL5.5/240-05T	SJ-DL7.5/150-01T
No.	Abbrev.	Details	Unit capacity	200	160	200	160
SP187		Motor unique constants (L)		0	0	1040	0
SP188		Motor unique constants (L)		0	0	0	0
SP189				0	0	0	0
SP190		Motor unique constants (L)		0	0	0	0
SP191		Motor unique constants (L)		0	0	1650	0
SP192		Motor unique constants (L)		0	0	0	0
:				:	:	:	:
SP224				0	0	0	0
SP225	SFNC5	Spindle function 5		0000	0000	0000	0000
SP226	SFNC6	Spindle function 6		1000	1000	1000	1000
SP227	SFNC7	Spindle function 7		0000	0000	0000	0000
:				:	:	:	:
SP232		Not used		0000	0000	0000	0000
SP233	IVC	Voltage non-sensitive band compensation		0	0	0	0
SP234				0	0	0	0
SP235	R2H	Temperature compensation gain		0	0	0	0
SP236	WIH	Temperature compensation time constant		0	0	0	0
SP237	TCF	Torque command filter		500	500	500	500
SP238	SSCFEED	Safely limited speed		0	0	0	0
SP239	SSCRPM	Safely limited motor speed		0	0	0	0
SP240		Not used		0	0	0	0
:				:	:	:	:
SP256				0	0	0	0

(6) 200V Standard motor SJ-DM Series (Magnet)

Parameter		Motor	200V Standard motor SJ-DM Series (Magnet)
No.	Abbrev.	Details	SJ-DM11/120-01T
		Unit capacity	320
SP001	PGV	Position loop gain non-interpolation mode	15
SP002	PGN	Position loop gain interpolation mode	33
SP003	PGS	Position loop gain spindle synchronization	15
SP004			0
SP005	VGN1	Speed loop gain 1	150
SP006	VIA1	Speed loop lead compensation 1	1900
SP007	VIL1	Speed loop delay compensation 1	0
SP008	VGN2	Speed loop gain 2	150
SP009	VIA2	Speed loop lead compensation 2	1900
SP010	VIL2	Speed loop delay compensation 2	0
:			:
SP013			0
SP014	PY1	Minimum excitation rate 1	0
SP015	PY2	Minimum excitation rate 2	0
SP016	DDT	Phase alignment deceleration rate	20
SP017	SPEC1	Spindle specification 1	100C
SP018	SPEC2	Spindle specification 2	0200
SP019	RNG1	Sub side encoder resolution	2000
SP020	RNG2	Main side encoder resolution	2000
SP021	OLT	Overload detection time constant	300
SP022	OLL	Overload detection level	100
SP023	OD1	Excessive error detection width (interpolation mode - spindle synchronization)	120
SP024	INP	In-position width	875
SP025	INP2	2nd in-position width	875
SP026	TSP	Maximum motor speed	12000
SP027	ZSP	Motor zero speed	25
SP028	SDTS	Speed detection set value	1200
SP029	SDTR	Speed detection reset width	30
SP030	SDT2	2nd speed detection setting value	0
SP031	MTYP	Motor type	2200
SP032	PTYP	Power supply type/ Regenerative resistor type	-
SP033	SFNC1	Spindle function 1	0000
SP034	SFNC2	Spindle function 2	0000
SP035	SFNC3	Spindle function 3	1600
SP036	SFNC4	Spindle function 4	0000
SP037	JL	Load inertia scale	100
SP038	FHz1	Notch filter frequency 1	0
:			:
SP046	FHz2	Notch filter frequency 2	0
SP047	EC	Inductive voltage compensation gain	100
SP048	LMC1	Lost motion compensation 1	0
:			:
SP052	DFBN	Dual feedback control non-sensitive band	0
SP053	ODS	Excessive error detection width (non-interpolation mode)	2400
SP054	ORE	Overrun detection width in closed loop control	0
SP055	EMGx	Max. gate off delay time after emergency stop	5000
SP056	EMGt	Deceleration time constant at emergency stop	300
SP057	GRA1	Spindle side gear ratio 1	1
SP058	GRA2	Spindle side gear ratio 2	1
SP059	GRA3	Spindle side gear ratio 3	1
SP060	GRA4	Spindle side gear ratio 4	1
SP061	GRB1	Motor side gear ratio 1	1
SP062	GRB2	Motor side gear ratio 2	1
SP063	GRB3	Motor side gear ratio 3	1
SP064	GRB4	Motor side gear ratio 4	1
SP065	TLM1	Torque limit 1	10
SP066	TLM2	Torque limit 2	10
SP067	TLM3	Torque limit 3	10
SP068	TLM4	Torque limit 4	10
SP069	PCMP	Phase alignment completion width	875
SP070	KDDT	Phase alignment deceleration rate scale	0
SP071	DIQM	Variable current limit during deceleration, lower limit value	100
SP072	DIQN	Variable current limit during deceleration, break point speed	3000
SP073	VGVN	Variable speed gain target value	0
SP074	VGVS	Variable speed gain change start speed	0
SP075	DWSH	Slip compensation scale during regeneration high-speed coil	0
SP076	DWSL	Slip compensation scale during regeneration low-speed coil	0
SP077	IQA	Q axis current lead compensation	4096
SP078	IDA	D axis current lead compensation	4096

4 Setup

Parameter		Motor	200V Standard motor SJ-DM Series (Magnet)
No.	Abbrev.	Details	Unit capacity
			SJ-DM11/120-01T
			320
SP079	IQG	Q axis current gain	2048
SP080	IDG	D axis current gain	2048
SP081	IQAL	Q axis current lead compensation low-speed coil	0
:			:
SP088	FHz5	Notch filter frequency 5	0
SP089	TMKQ	Spindle output stabilizing gain Q axis	30
SP090	TMKD	Spindle output stabilizing gain D axis	30
SP091			0
:			:
SP112			0
SP113	OPLP	Current command value for open loop	0
SP114	MKT	Coil changeover gate cutoff timer	150
SP115	MKT2	Coil changeover current limit timer	250
SP116	MKIL	Coil changeover current limit value	120
SP117	SETM	Excessive speed deviation timer	12
SP118	MSFT	Magnetic pole shift amount	0
SP119			0
SP120			0
SP121	MP Kpp	Magnetic pole detection position loop gain	6
SP122	MP Kvp	Magnetic pole detection speed loop gain	1500
SP123	MP Kvi	Magnetic pole detection speed loop lead compensation	2000
SP124	ILMTsp	Magnetic pole detection current limit value	5
SP125	DA1NO	D/A output ch1 data No./Initial DC excitation level	0
:			:
SP128	DA2MPY	D/A output ch2 output scale	0
SP129		Motor unique constants (H)	2
SP130		Motor unique constants (H)	2
SP131		Motor unique constants (H)	320
SP132		Motor unique constants (H)	0
SP133		Motor unique constants (H)	12000
SP134		Motor unique constants (H)	7000
SP135		Motor unique constants (H)	0
SP136		Motor unique constants (H)	447
SP137		Motor unique constants (H)	2048
SP138		Motor unique constants (H)	451
SP139		Motor unique constants (H)	1029
SP140		Motor unique constants (H)	297
SP141		Motor unique constants (H)	226
SP142		Motor unique constants (H)	111
SP143		Motor unique constants (H)	29
SP144		Motor unique constants (H)	0
SP145		Motor unique constants (H)	899
SP146		Motor unique constants (H)	899
SP147		Motor unique constants (H)	1000
SP148		Motor unique constants (H)	720
SP149		Motor unique constants (H)	10377
SP150		Motor unique constants (H)	5991
SP151		Motor unique constants (H)	25
SP152		Motor unique constants (H)	110
SP153		Motor unique constants (H)	120
SP154		Motor unique constants (H)	150
SP155		Motor unique constants (H)	1150
SP156		Motor unique constants (H)	58
SP157		Motor unique constants (H)	18
SP158		Motor unique constants (H)	0
SP159		Motor unique constants (H)	0
:			:
SP224			0
SP225	SFNC5	Spindle function 5	0000
SP226	SFNC6	Spindle function 6	0000
SP227	SFNC7	Spindle function 7	0000
:			:
SP232			0000
SP233	IVC	Voltage non-sensitive band compensation	0
SP234			0
SP235	R2H	Temperature compensation gain	0
SP236	WIH	Temperature compensation time constant	0
SP237	TCF	Torque command filter	500
SP238	SSCFEED	Safely limited speed	0
SP239	SSCRPM	Safely limited motor speed	0
SP240			0
:			:
SP256			0

(7) 200V Standard motor SJ-DN Series (High-torque)

Motor				200V Standard motor SJ-DN Series (High-torque)					
				SJ-DN7.5/80-01		SJ-DN11/80-01		SJ-DN15/80-01	SJ-DN18.5/80-01
Parameter	No.	Abbrev.	Details	Unit capacity	100	160	200	200	200
	SP001	PGV	Position loop gain non-interpolation mode		15	15	15	15	15
	SP002	PGN	Position loop gain interpolation mode		33	33	33	33	33
	SP003	PGS	Position loop gain spindle synchronization		15	15	15	15	15
	SP004				0	0	0	0	0
	SP005	VGN1	Speed loop gain 1		150	150	150	150	150
	SP006	VIA1	Speed loop lead compensation 1		1900	1900	1900	1900	1900
	SP007	VIL1	Speed loop delay compensation 1		0	0	0	0	0
	SP008	VGN2	Speed loop gain 2		150	150	150	150	150
	SP009	VIA2	Speed loop lead compensation 2		1900	1900	1900	1900	1900
	SP010	VIL2	Speed loop delay compensation 2		0	0	0	0	0
	:				:	:	:	:	:
	SP013				0	0	0	0	0
	SP014	PY1	Minimum excitation rate 1		50	50	50	50	50
	SP015	PY2	Minimum excitation rate 2		100	100	100	100	100
	SP016	DDT	Phase alignment deceleration rate		20	20	20	20	20
	SP017	SPEC1	Spindle specification 1		000C	000C	000C	000C	000C
	SP018	SPEC2	Spindle specification 2		0200	0200	0200	0200	0200
	SP019	RNG1	Sub side encoder resolution		2000	2000	2000	2000	2000
	SP020	RNG2	Main side encoder resolution		2000	2000	2000	2000	2000
	SP021	OLT	Overload detection time constant		60	60	60	60	60
	SP022	OLL	Overload detection level		120	120	120	120	120
	SP023	OD1	Excessive error detection width (interpolation mode - spindle synchronization)		120	120	120	120	120
	SP024	INP	In-position width		875	875	875	875	875
	SP025	INP2	2nd in-position width		875	875	875	875	875
	SP026	TSP	Maximum motor speed		8000	8000	8000	8000	8000
	SP027	ZSP	Motor zero speed		25	25	25	25	25
	SP028	SDTS	Speed detection set value		800	800	800	800	800
	SP029	SDTR	Speed detection reset width		30	30	30	30	30
	SP030	SDT2	2nd speed detection setting value		0	0	0	0	0
	SP031	MTYP	Motor type		2200	2200	2200	2200	2200
	SP032	PTYP	Power supply type/ Regenerative resistor type		-	-	-	-	-
	SP033	SFNC1	Spindle function 1		0000	0000	0000	0000	0000
	SP034	SFNC2	Spindle function 2		0000	0000	0000	0000	0000
	SP035	SFNC3	Spindle function 3		1600	1600	1600	1600	1600
	SP036	SFNC4	Spindle function 4		0000	0000	0000	0000	0000
	SP037	JL	Load inertia scale		100	100	100	100	100
	SP038	FHz1	Notch filter frequency 1		0	0	0	0	0
	:				:	:	:	:	:
	SP046	FHz2	Notch filter frequency 2		0	0	0	0	0
	SP047	EC	Inductive voltage compensation gain		100	100	100	100	100
	SP048	LMC1	Lost motion compensation 1		0	0	0	0	0
	:				:	:	:	:	:
	SP052	DFBN	Dual feedback control non-sensitve band		0	0	0	0	0
	SP053	ODS	Excessive error detection width (non-interpolation mode)		1600	1600	1600	1600	1600
	SP054	ORE	Overrun detection width in closed loop control		0	0	0	0	0
	SP055	EMGx	Max. gate off delay time after emergency stop		5000	5000	5000	5000	5000
	SP056	EMGt	Deceleration time constant at emergency stop		300	300	300	300	300
	SP057	GRA1	Spindle side gear ratio 1		1	1	1	1	1
	SP058	GRA2	Spindle side gear ratio 2		1	1	1	1	1
	SP059	GRA3	Spindle side gear ratio 3		1	1	1	1	1
	SP060	GRA4	Spindle side gear ratio 4		1	1	1	1	1
	SP061	GRB1	Motor side gear ratio 1		1	1	1	1	1
	SP062	GRB2	Motor side gear ratio 2		1	1	1	1	1
	SP063	GRB3	Motor side gear ratio 3		1	1	1	1	1
	SP064	GRB4	Motor side gear ratio 4		1	1	1	1	1
	SP065	TLM1	Torque limit 1		10	10	10	10	10
	SP066	TLM2	Torque limit 2		10	10	10	10	10
	SP067	TLM3	Torque limit 3		10	10	10	10	10
	SP068	TLM4	Torque limit 4		10	10	10	10	10
	SP069	PCMP	Phase alignment completion width		875	875	875	875	875
	SP070	KDDT	Phase alignment deceleration rate scale		0	0	0	0	0
	SP071	DIQM	Variable current limit during deceleration, lower limit value		25	25	75	65	35
	SP072	DIQN	Variable current limit during deceleration, break point speed		2300	2300	6000	5500	2900
	SP073	VGVN	Variable speed gain target value		0	0	0	0	0
	SP074	VGVS	Variable speed gain change start speed		0	0	0	0	0
	SP075	DWSH	Slip compensation scale during regeneration high-speed coil		0	0	0	0	0

4 Setup

Motor				200V Standard motor SJ-DN Series (High-torque)				
Parameter				SJ-DN7.5/80-01		SJ-DN11/80-01	SJ-DN15/80-01	SJ-DN18.5/80-01
No.	Abbrev.	Details	Unit capacity	100	160	200	200	200
SP076	DWSL	Slip compensation scale during regeneration low-speed coil		0	0	0	0	0
SP077	IQA	Q axis current lead compensation		4096	4096	4096	4096	4096
SP078	IDA	D axis current lead compensation		4096	4096	4096	4096	4096
SP079	IQG	Q axis current gain		1024	1024	1024	1024	1024
SP080	IDG	D axis current gain		1024	1024	1024	1024	1024
SP081	IQAL	Q axis current lead compensation low-speed coil		0	0	0	0	0
:				:	:	:	:	:
SP088	FHz5	Notch filter frequency 5		0	0	0	0	0
SP089	TMKQ	Spindle output stabilizing gain Q axis		100	100	100	100	100
SP090	TMKD	Spindle output stabilizing gain D axis		0	0	0	0	0
:				:	:	:	:	:
SP113	OPLP	Current command value for open loop		0	0	0	0	0
SP114	MKT	Coil changeover gate cutoff timer		150	150	150	150	150
SP115	MKT2	Coil changeover current limit timer		250	250	250	250	250
SP116	MKIL	Coil changeover current limit value		120	120	120	120	120
SP117	SETM	Excessive speed deviation timer		12	12	12	12	12
SP118	MSFT	Magnetic pole shift amount		0	0	0	0	0
:				:	:	:	:	:
SP128	DA2MPY	D/A output ch2 output scale		0	0	0	0	0
SP129		Motor unique constants (H)		2	2	2	2	2
SP130		Motor unique constants (H)		31	31	103	138	163
SP131		Motor unique constants (H)		100	160	200	200	200
SP132		Motor unique constants (H)		0	0	0	0	0
SP133		Motor unique constants (H)		8000	8000	8000	8000	8000
SP134		Motor unique constants (H)		863	863	910	825	975
SP135		Motor unique constants (H)		900	900	910	750	900
SP136		Motor unique constants (H)		2341	2341	2233	2396	2607
SP137		Motor unique constants (H)		73	73	68	73	81
SP138		Motor unique constants (H)		2908	2908	2684	2850	2867
SP139		Motor unique constants (H)		2908	2908	3441	2908	2867
SP140		Motor unique constants (H)		1886	1886	1827	1893	1899
SP141		Motor unique constants (H)		124	124	144	182	191
SP142		Motor unique constants (H)		0	0	0	0	0
SP143		Motor unique constants (H)		0	0	0	0	0
SP144		Motor unique constants (H)		0	0	0	0	0
SP145		Motor unique constants (H)		469	469	407	420	466
SP146		Motor unique constants (H)		431	431	429	433	434
SP147		Motor unique constants (H)		84	84	60	51	50
SP148		Motor unique constants (H)		1975	1975	687	642	648
SP149		Motor unique constants (H)		4080	4080	7238	7971	9036
SP150		Motor unique constants (H)		1822	1822	3463	3319	3497
SP151		Motor unique constants (H)		200	200	79	62	59
SP152		Motor unique constants (H)		90	90	90	90	90
SP153		Motor unique constants (H)		120	120	120	120	120
SP154		Motor unique constants (H)		150	150	150	150	150
SP155		Motor unique constants (H)		1085	1085	1081	1100	1110
SP156		Motor unique constants (H)		0	0	0	0	0
SP157		Motor unique constants (H)		0	0	0	0	0
SP158		Motor unique constants (H)		750	750	650	750	750
SP159		Motor unique constants (H)		750	750	650	750	750
SP160		Motor unique constants (H)		0	0	0	0	0
:				:	:	:	:	:
SP224		Spindle function 5		0000	0000	0000	0000	0000
SP225	SFNC5	Spindle function 5		0000	0000	0000	0000	0000
SP226	SFNC6	Spindle function 6		1000	1000	1000	1000	1000
SP227	SFNC7	Spindle function 7		0000	0000	0000	0000	0000
:				:	:	:	:	:
SP232		Voltage non-sensitive band compensation		0000	0000	0000	0000	0000
SP233	IVC	Voltage non-sensitive band compensation		0	0	0	0	0
SP234		Temperature compensation gain		0	0	0	0	0
SP235	R2H	Temperature compensation gain		0	0	0	0	0
SP236	WIH	Temperature compensation time constant		0	0	0	0	0
SP237	TCF	Torque command filter		500	500	500	500	500
SP238	SSCFEE D	Safely limited speed		0	0	0	0	0
SP239	SSCRPM	Safely limited motor speed		0	0	0	0	0
SP240				0	0	0	0	0
:				:	:	:	:	:
SP256				0	0	0	0	0

(8) 200V Standard motor SJ-V Series (Normal)

Motor				200V Standard motor SJ-V Series (Normal)	
Parameter				SJ-V15-09ZT	SJ-V18.5-01ZT
No.	Abbrev.	Details	Unit capacity	200	200
SP001	PGV	Position loop gain non-interpolation mode		15	15
SP002	PGN	Position loop gain interpolation mode		33	33
SP003	PGS	Position loop gain spindle synchronization		15	15
SP004		Not used		0	0
SP005	VGN1	Speed loop gain 1		150	150
SP006	VIA1	Speed loop lead compensation 1		1900	1900
SP007	VIL1	Speed loop delay compensation 1		0	0
SP008	VGN2	Speed loop gain 2		150	150
SP009	VIA2	Speed loop lead compensation 2		1900	1900
SP010	VIL2	Speed loop delay compensation 2		0	0
SP011		Not used		0	0
SP012		Not used		0	0
SP013		Not used		0	0
SP014	PY1	Minimum excitation rate 1		50	50
SP015	PY2	Minimum excitation rate 2		100	100
SP016	DDT	Phase alignment deceleration rate		20	20
SP017	SPEC1	Spindle specification 1		000C	000C
SP018	SPEC2	Spindle specification 2		0200	0200
SP019	RNG1	Sub side encoder resolution		-	-
SP020	RNG2	Main side encoder resolution		-	-
SP021	OLT	Overload detection time constant		60	60
SP022	OLL	Overload detection level		120	120
SP023	OD1	Excessive error detection width (interpolation mode - spindle synchronization)		120	120
SP024	INP	In-position width		875	875
SP025	INP2	2nd in-position width		875	875
SP026	TSP	Maximum motor speed		8000	8000
SP027	ZSP	Motor zero speed		25	30
SP028	SDTS	Speed detection set value		800	800
SP029	SDTR	Speed detection reset width		30	30
SP030	SDT2	2nd speed detection setting value		0	0
SP031	MTYP	Motor type		2200	2200
SP032	PTYP	Power supply type/ Regenerative resistor type		-	-
SP033	SFNC1	Spindle function 1		0000	0000
SP034	SFNC2	Spindle function 2		0000	0000
SP035	SFNC3	Spindle function 3		1600	1600
SP036	SFNC4	Spindle function 4		0000	0000
SP037	JL	Load inertia scale		100	100
SP038	FHz1	Notch filter frequency 1		0	0
:				:	:
SP046	FHz2	Notch filter frequency 2		0	0
SP047	EC	Inductive voltage compensation gain		100	100
SP048	LMC1	Lost motion compensation 1		0	0
:				:	:
SP052	DFBN	Dual feedback control non-sensitive band		0	0
SP053	ODS	Excessive error detection width (non-interpolation mode)		1600	1600
SP054	ORE	Overrun detection width in closed loop control		0	0
SP055	EMGx	Max. gate off delay time after emergency stop		5000	5000
SP056	EMGt	Deceleration time constant at emergency stop		300	300
SP057	GRA1	Spindle side gear ratio 1		1	1
SP058	GRA2	Spindle side gear ratio 2		1	1
SP059	GRA3	Spindle side gear ratio 3		1	1
SP060	GRA4	Spindle side gear ratio 4		1	1
SP061	GRB1	Motor side gear ratio 1		1	1
SP062	GRB2	Motor side gear ratio 2		1	1
SP063	GRB3	Motor side gear ratio 3		1	1
SP064	GRB4	Motor side gear ratio 4		1	1
SP065	TLM1	Torque limit 1		10	10
SP066	TLM2	Torque limit 2		10	10
SP067	TLM3	Torque limit 3		10	10
SP068	TLM4	Torque limit 4		10	10
SP069	PCMP	Phase alignment completion width		875	875
SP070	KDDT	Phase alignment deceleration rate scale		0	0
SP071	DIQM	Variable current limit during deceleration, lower limit value		60	45
SP072	DIQN	Variable current limit during deceleration, break point speed		5000	3700
SP073	VGVN	Variable speed gain target value		0	0
SP074	VGVS	Variable speed gain change start speed		0	0
SP075	DWSH	Slip compensation scale during regeneration high-speed coil		0	0
SP076	DWSL	Slip compensation scale during regeneration low- speed coil		0	0
SP077	IQA	Q axis current lead compensation		4096	4096

4 Setup

Parameter				Motor	
				200V Standard motor SJ-V Series (Normal)	
No.	Abbrev.	Details	Unit capacity	SJ-V15-09ZT 200	SJ-V18.5-01ZT 200
SP078	IDA	D axis current lead compensation		4096	4096
SP079	IQG	Q axis current gain		1024	1024
SP080	IDG	D axis current gain		1024	1024
SP081	IQAL	Q axis current lead compensation low-speed coil		0	0
:				:	:
SP088	FHz5	Notch filter frequency 5		0	0
SP089	TMKQ	Spindle output stabilizing gain Q axis		0	0
SP090	TMKD	Spindle output stabilizing gain D axis		0	0
:				:	:
SP113	OPLP	Current command value for open loop		0	0
SP114	MKT	Coil changeover gate cutoff timer		150	150
SP115	MKT2	Coil changeover current limit timer		250	250
SP116	MKIL	Coil changeover current limit value		120	120
SP117	SETM	Excessive speed deviation timer		12	12
SP118	MSFT	Magnetic pole shift amount		0	0
:				:	:
SP128	DA2MPY	D/A output ch2 output scale		0	0
SP129		Motor unique constants (H)		2	2
SP130		Motor unique constants (H)		58	58
SP131		Motor unique constants (H)		200	200
SP132		Motor unique constants (H)		0	0
SP133		Motor unique constants (H)		8000	8000
SP134		Motor unique constants (H)		1500	1500
SP135		Motor unique constants (H)		1800	1800
SP136		Motor unique constants (H)		1330	1514
SP137		Motor unique constants (H)		73	81
SP138		Motor unique constants (H)		3017	2847
SP139		Motor unique constants (H)		2601	2847
SP140		Motor unique constants (H)		1933	1905
SP141		Motor unique constants (H)		203	186
SP142		Motor unique constants (H)		0	0
SP143		Motor unique constants (H)		0	0
SP144		Motor unique constants (H)		0	0
SP145		Motor unique constants (H)		265	333
SP146		Motor unique constants (H)		360	434
SP147		Motor unique constants (H)		60	65
SP148		Motor unique constants (H)		473	538
SP149		Motor unique constants (H)		7177	7779
SP150		Motor unique constants (H)		3006	3267
SP151		Motor unique constants (H)		39	46
SP152		Motor unique constants (H)		90	90
SP153		Motor unique constants (H)		120	120
SP154		Motor unique constants (H)		150	150
SP155		Motor unique constants (H)		1036	1039
SP156		Motor unique constants (H)		0	0
SP157		Motor unique constants (H)		0	0
SP158		Motor unique constants (H)		0	0
SP159		Motor unique constants (H)		0	0
SP160		Motor unique constants (H)		0	0
:				:	:
SP224				0	0
SP225	SFNC5	Spindle function 5		0000	0000
SP226	SFNC6	Spindle function 6		0000	0000
SP227	SFNC7	Spindle function 7		0000	0000
:				:	:
SP232		Not used		0000	0000
SP233	IVC	Voltage non-sensitive band compensation		0	0
SP234				0	0
SP235	R2H	Temperature compensation gain		0	0
SP236	WIH	Temperature compensation time constant		0	0
SP237	TCF	Torque command filter		500	500
SP238	SSCFEED	Safely limited speed		0	0
SP239	SSCRPM	Safely limited motor speed		0	0
SP240		Not used		0	0
:				:	:
SP256				0	0

(9) 200V Standard motor SJ-V Series (Wide range constant output)

Motor				200V Standard motor SJ-V Series (Wide range constant output)		
Parameter				SJ-V11-01T	SJ-V11-09T	SJ-V15-03T
No.	Abbrev.	Details	Unit capacity	160	160	200
SP001	PGV	Position loop gain non-interpolation mode		15	15	15
SP002	PGN	Position loop gain interpolation mode		33	33	33
SP003	PGS	Position loop gain spindle synchronization		15	15	15
SP004				0	0	0
SP005	VGN1	Speed loop gain 1		150	150	150
SP006	VIA1	Speed loop lead compensation 1		1900	1900	1900
SP007	VIL1	Speed loop delay compensation 1		0	0	0
SP008	VGN2	Speed loop gain 2		150	150	150
SP009	VIA2	Speed loop lead compensation 2		1900	1900	1900
SP010	VIL2	Speed loop delay compensation 2		0	0	0
SP011		Not used		0	0	0
SP012		Not used		0	0	0
SP013		Not used		0	0	0
SP014	PY1	Minimum excitation rate 1		50	50	50
SP015	PY2	Minimum excitation rate 2		100	100	100
SP016	DDT	Phase alignment deceleration rate		20	20	20
SP017	SPEC1	Spindle specification 1		000C	000C	000C
SP018	SPEC2	Spindle specification 2		0200	0200	0200
SP019	RNG1	Sub side encoder resolution		-	-	-
SP020	RNG2	Main side encoder resolution		-	-	-
SP021	OLT	Overload detection time constant		60	60	60
SP022	OLL	Overload detection level		120	120	120
SP023	OD1	Excessive error detection width (interpolation mode - spindle synchronization)		120	120	120
SP024	INP	In-position width		875	875	875
SP025	INP2	2nd in-position width		875	875	875
SP026	TSP	Maximum motor speed		6000	6000	6000
SP027	ZSP	Motor zero speed		25	25	25
SP028	SDTS	Speed detection set value		600	600	600
SP029	SDTR	Speed detection reset width		30	30	30
SP030	SDT2	2nd speed detection setting value		0	0	0
SP031	MTYP	Motor type		2200	2200	2200
SP032	PTYP	Power supply type/ Regenerative resistor type		-	-	-
SP033	SFNC1	Spindle function 1		0000	0000	0000
SP034	SFNC2	Spindle function 2		0000	0000	0000
SP035	SFNC3	Spindle function 3		1600	1600	1600
SP036	SFNC4	Spindle function 4		0000	0000	0000
SP037	JL	Load inertia scale		100	100	100
SP038	FHz1	Notch filter frequency 1		0	0	0
:				:	:	:
SP046	FHz2	Notch filter frequency 2		0	0	0
SP047	EC	Inductive voltage compensation gain		100	100	100
SP048	LMC1	Lost motion compensation 1		0	0	0
:				:	:	:
SP052	DFBN	Dual feedback control non-sensitive band		0	0	0
SP053	ODS	Excessive error detection width (non-interpolation mode)		1200	1200	1200
SP054	ORE	Overrun detection width in closed loop control		0	0	0
SP055	EMGx	Max. gate off delay time after emergency stop		5000	5000	5000
SP056	EMGt	Deceleration time constant at emergency stop		300	300	300
SP057	GRA1	Spindle side gear ratio 1		1	1	1
SP058	GRA2	Spindle side gear ratio 2		1	1	1
SP059	GRA3	Spindle side gear ratio 3		1	1	1
SP060	GRA4	Spindle side gear ratio 4		1	1	1
SP061	GRB1	Motor side gear ratio 1		1	1	1
SP062	GRB2	Motor side gear ratio 2		1	1	1
SP063	GRB3	Motor side gear ratio 3		1	1	1
SP064	GRB4	Motor side gear ratio 4		1	1	1
SP065	TLM1	Torque limit 1		10	10	10
SP066	TLM2	Torque limit 2		10	10	10
SP067	TLM3	Torque limit 3		10	10	10
SP068	TLM4	Torque limit 4		10	10	10
SP069	PCMP	Phase alignment completion width		875	875	875
SP070	KDDT	Phase alignment deceleration rate scale		0	0	0
SP071	DIQM	Variable current limit during deceleration, lower limit value		60	100	50
SP072	DIQN	Variable current limit during deceleration, break point speed		3700	3000	3100
SP073	VGVN	Variable speed gain target value		0	0	0
SP074	VGVS	Variable speed gain change start speed		0	0	0
SP075	DWSH	Slip compensation scale during regeneration high-speed coil		0	0	0
SP076	DWSL	Slip compensation scale during regeneration low-speed coil		0	0	0
SP077	IQA	Q axis current lead compensation		4096	4096	4096

4 Setup

Parameter				200V Standard motor SJ-V Series (Wide range constant output)		
				Motor		SJ-V11-01T
No.	Abbrev.	Details	Unit capacity	160	160	200
SP078	IDA	D axis current lead compensation		4096	4096	4096
SP079	IQG	Q axis current gain		1024	1024	1024
SP080	IDG	D axis current gain		1024	1024	1024
SP081	IQAL	Q axis current lead compensation low-speed coil		0	0	0
:				:	:	:
SP088	FHz5	Notch filter frequency 5		0	0	0
SP089	TMKQ	Spindle output stabilizing gain Q axis		0	0	0
SP090	TMKD	Spindle output stabilizing gain D axis		0	0	0
:				:	:	:
SP112					0	0
SP113	OPLP	Current command value for open loop		0	0	0
SP114	MKT	Coil changeover gate cutoff timer		150	150	150
SP115	MKT2	Coil changeover current limit timer		250	25	250
SP116	MKIL	Coil changeover current limit value		120	120	120
SP117	SETM	Excessive speed deviation timer		12	12	12
SP118	MSFT	Magnetic pole shift amount		0	0	0
SP119		Not used		0	0	0
:				:	:	:
SP128	DA2MPY	D/A output ch2 output scale		0	0	0
SP129		Motor unique constants (H)		2	2	2
SP130		Motor unique constants (H)		30	58	58
SP131		Motor unique constants (H)		160	160	200
SP132				0	0	0
SP133		Motor unique constants (H)		6000	8000	8000
SP134		Motor unique constants (H)		1500	1100	1250
SP135		Motor unique constants (H)		1800	1320	1500
SP136		Motor unique constants (H)		1326	1893	1689
SP137		Motor unique constants (H)		68	68	73
SP138		Motor unique constants (H)		2854	3045	2886
SP139		Motor unique constants (H)		2744	2580	2775
SP140		Motor unique constants (H)		1922	1935	1913
SP141		Motor unique constants (H)		170	204	191
SP142		Motor unique constants (H)		0	0	0
SP143				0	0	0
SP144		Motor unique constants (H)		0	0	0
SP145		Motor unique constants (H)		266	396	322
SP146		Motor unique constants (H)		362	435	435
SP147		Motor unique constants (H)		64	60	64
SP148		Motor unique constants (H)		861	966	692
SP149		Motor unique constants (H)		5280	5044	6785
SP150		Motor unique constants (H)		1498	2083	2762
SP151		Motor unique constants (H)		64	82	58
SP152		Motor unique constants (H)		90	90	90
SP153		Motor unique constants (H)		120	120	120
SP154		Motor unique constants (H)		150	150	150
SP155		Motor unique constants (H)		1334	1048	1037
SP156		Motor unique constants (H)		0	0	0
SP157				0	0	0
SP158		Motor unique constants (H)		750	750	750
SP159		Motor unique constants (H)		750	750	750
SP160		Motor unique constants (H)		0	0	0
SP161				0	0	0
:				:	:	:
SP224				0	0	0
SP225	SFNC5	Spindle function 5		0000	0000	0000
SP226	SFNC6	Spindle function 6		0000	0000	0000
SP227	SFNC7	Spindle function 7		0000	0000	0000
:				:	:	:
SP232		Not used		0000	0000	0000
SP233	IVC	Voltage non-sensitive band compensation		0	0	0
SP234				0	0	0
SP235	R2H	Temperature compensation gain		0	0	0
SP236	WIH	Temperature compensation time constant		0	0	0
SP237	TCF	Torque command filter		500	500	500
SP238	SSCFEED	Safely limited speed		0	0	0
SP239	SSCRPM	Safely limited motor speed		0	0	0
SP240		Not used		0	0	0
:				:	:	:
SP256				0	0	0

(10) 200V Standard motor SJ-VL Series (Low-inertia)

Motor				200V Standard motor SJ-VL Series (Low-inertia)	
Parameter				SJ-VL11-02FZT	SJ-VL11-05FZT-S01
No.	Abbrev.	Details	Unit capacity	160	160
SP001	PGV	Position loop gain non-interpolation mode		15	15
SP002	PGN	Position loop gain interpolation mode		33	33
SP003	PGS	Position loop gain spindle synchronization		15	15
SP004				0	0
SP005	VGN1	Speed loop gain 1		150	150
SP006	VIA1	Speed loop lead compensation 1		1900	1900
SP007	VIL1	Speed loop delay compensation 1		0	0
SP008	VGN2	Speed loop gain 2		150	150
SP009	VIA2	Speed loop lead compensation 2		1900	1900
SP010	VIL2	Speed loop delay compensation 2		0	0
SP011		Not used		0	0
SP012		Not used		0	0
SP013		Not used		0	0
SP014	PY1	Minimum excitation rate 1		50	50
SP015	PY2	Minimum excitation rate 2		100	100
SP016	DDT	Phase alignment deceleration rate		20	20
SP017	SPEC1	Spindle specification 1		000C	000C
SP018	SPEC2	Spindle specification 2		0200	0200
SP019	RNG1	Sub side encoder resolution		-	-
SP020	RNG2	Main side encoder resolution		-	-
SP021	OLT	Overload detection time constant		60	60
SP022	OLL	Overload detection level		120	120
SP023	OD1	Excessive error detection width (interpolation mode - spindle synchronization)		120	120
SP024	INP	In-position width		875	875
SP025	INP2	2nd in-position width		875	875
SP026	TSP	Maximum motor speed		15000	15000
SP027	ZSP	Motor zero speed		25	25
SP028	SDTS	Speed detection set value		1500	1500
SP029	SDTR	Speed detection reset width		30	30
SP030	SDT2	2nd speed detection setting value		0	0
SP031	MTYP	Motor type		2200	2200
SP032	PTYP	Power supply type/ Regenerative resistor type		-	-
SP033	SFNC1	Spindle function 1		0000	0000
SP034	SFNC2	Spindle function 2		0000	0000
SP035	SFNC3	Spindle function 3		1600	1600
SP036	SFNC4	Spindle function 4		0000	0000
SP037	JL	Load inertia scale		100	100
SP038	FHz1	Notch filter frequency 1		0	0
:				:	:
SP046	FHz2	Notch filter frequency 2		0	0
SP047	EC	Inductive voltage compensation gain		100	100
SP048	LMC1	Lost motion compensation 1		0	0
:				:	:
SP052	DFBN	Dual feedback control non-sensitive band		0	0
SP053	ODS	Excessive error detection width (non-interpolation mode)		3000	3000
SP054	ORE	Overrun detection width in closed loop control		0	0
SP055	EMGx	Max. gate off delay time after emergency stop		5000	5000
SP056	EMGt	Deceleration time constant at emergency stop		300	300
SP057	GRA1	Spindle side gear ratio 1		1	1
SP058	GRA2	Spindle side gear ratio 2		1	1
SP059	GRA3	Spindle side gear ratio 3		1	1
SP060	GRA4	Spindle side gear ratio 4		1	1
SP061	GRB1	Motor side gear ratio 1		1	1
SP062	GRB2	Motor side gear ratio 2		1	1
SP063	GRB3	Motor side gear ratio 3		1	1
SP064	GRB4	Motor side gear ratio 4		1	1
SP065	TLM1	Torque limit 1		10	10
SP066	TLM2	Torque limit 2		10	10
SP067	TLM3	Torque limit 3		10	10
SP068	TLM4	Torque limit 4		10	10
SP069	PCMP	Phase alignment completion width		875	875
SP070	KDDT	Phase alignment deceleration rate scale		0	0
SP071	DIQM	Variable current limit during deceleration, lower limit value		55	75
SP072	DIQN	Variable current limit during deceleration, break point speed		8300	15000
SP073	VGVN	Variable speed gain target value		0	0
SP074	VGVS	Variable speed gain change start speed		0	0
SP075	DWSH	Slip compensation scale during regeneration high-speed coil		0	0
SP076	DWSL	Slip compensation scale during regeneration low- speed coil		0	0
SP077	IQA	Q axis current lead compensation		4096	4096

4 Setup

Parameter				Motor	
				200V Standard motor SJ-VL Series (Low-inertia)	
No.	Abbrev.	Details	Unit capacity	SJ-VL11-02FZT 160	SJ-VL11-05FZT-S01 160
SP078	IDA	D axis current lead compensation		4096	4096
SP079	IQG	Q axis current gain		1024	1024
SP080	IDG	D axis current gain		1024	1024
SP081	IQAL	Q axis current lead compensation low-speed coil		0	0
:				:	:
SP088	FHz5	Notch filter frequency 5		0	0
SP089	TMKQ	Spindle output stabilizing gain Q axis		0	0
SP090	TMKD	Spindle output stabilizing gain D axis		0	0
:				:	:
SP112				0	0
SP113	OPLP	Current command value for open loop		0	0
SP114	MKT	Coil changeover gate cutoff timer		150	150
SP115	MKT2	Coil changeover current limit timer		250	250
SP116	MKIL	Coil changeover current limit value		120	120
SP117	SETM	Excessive speed deviation timer		12	12
SP118	MSFT	Magnetic pole shift amount		0	0
SP119		Not used		0	0
:				:	:
SP128	DA2MPY	D/A output ch2 output scale		0	0
SP129		Motor unique constants (H)		1	1
SP130		Motor unique constants (H)		3	2
SP131		Motor unique constants (H)		160	160
SP132				0	0
SP133		Motor unique constants (H)		15000	20000
SP134		Motor unique constants (H)		4000	6000
SP135		Motor unique constants (H)		4800	7200
SP136		Motor unique constants (H)		538	341
SP137		Motor unique constants (H)		34	68
SP138		Motor unique constants (H)		2589	2897
SP139		Motor unique constants (H)		3082	3082
SP140		Motor unique constants (H)		1894	1855
SP141		Motor unique constants (H)		90	87
SP142		Motor unique constants (H)		0	0
SP143				0	0
SP144		Motor unique constants (H)		0	0
SP145		Motor unique constants (H)		197	172
SP146		Motor unique constants (H)		260	224
SP147		Motor unique constants (H)		44	42
SP148		Motor unique constants (H)		557	400
SP149		Motor unique constants (H)		4881	5131
SP150		Motor unique constants (H)		1474	1260
SP151		Motor unique constants (H)		98	130
SP152		Motor unique constants (H)		90	90
SP153		Motor unique constants (H)		120	120
SP154		Motor unique constants (H)		150	150
SP155		Motor unique constants (H)		1039	1068
SP156		Motor unique constants (H)		0	0
SP157				0	0
SP158		Motor unique constants (H)		0	0
SP159		Motor unique constants (H)		1500	5000
SP160		Motor unique constants (H)		0	0
SP161				0	0
:				:	:
SP224				0	0
SP225	SFNC5	Spindle function 5		0000	0000
SP226	SFNC6	Spindle function 6		0000	0000
SP227	SFNC7	Spindle function 7		0000	0000
:				:	:
SP232		Not used		0000	0000
SP233	IVC	Voltage non-sensitive band compensation		0	0
SP234				0	0
SP235	R2H	Temperature compensation gain		0	0
SP236	WIH	Temperature compensation time constant		0	0
SP237	TCF	Torque command filter		500	500
SP238	SSCFEED	Safely limited speed		0	0
SP239	SSCRPM	Safely limited motor speed		0	0
SP240		Not used		0	0
:				:	:
SP256				0	0

(11) 400V Standard motor SJ-4-V Series (Standard)

Motor				400V Standard motor SJ-4-V Series (Standard)			
				SJ-4-V7.5-13ZT	SJ-4-V11-18T	SJ-4-V18.5-14T	
Parameter	No.	Abbrev.	Details	Unit capacity	80	80	100
SP001	PGV		Position loop gain non-interpolation mode		15	15	15
SP002	PGN		Position loop gain interpolation mode		33	33	33
SP003	PGS		Position loop gain spindle synchronization		15	15	15
SP004					0	0	0
SP005	VGN1		Speed loop gain 1		150	150	150
SP006	VIA1		Speed loop lead compensation 1		1900	1900	1900
SP007	VIL1		Speed loop delay compensation 1		0	0	0
SP008	VGN2		Speed loop gain 2		150	150	150
SP009	VIA2		Speed loop lead compensation 2		1900	1900	1900
SP010	VIL2		Speed loop delay compensation 2		0	0	0
SP011					0	0	0
SP012					0	0	0
SP013					0	0	0
SP014	PY1		Minimum excitation rate 1		50	50	50
SP015	PY2		Minimum excitation rate 2		100	100	100
SP016	DDT		Phase alignment deceleration rate		20	20	20
SP017	SPEC1		Spindle specification 1		200C	200C	200C
SP018	SPEC2		Spindle specification 2		0200	0200	0200
SP019	RNG1		Sub side encoder resolution		-	-	-
SP020	RNG2		Main side encoder resolution		-	-	-
SP021	OLT		Overload detection time constant		60	60	60
SP022	OLL		Overload detection level		120	120	120
SP023	OD1		Excessive error detection width (interpolation mode - spindle synchronization)		120	120	120
SP024	INP		In-position width		875	875	875
SP025	INP2		2nd in-position width		875	875	875
SP026	TSP		Maximum motor speed		12000	8000	6000
SP027	ZSP		Motor zero speed		25	25	25
SP028	SDTS		Speed detection set value		1200	800	600
SP029	SDTR		Speed detection reset width		30	30	30
SP030	SDT2		2nd speed detection setting value		0	0	0
SP031	MTYP		Motor type		2200	2200	2200
SP032	PTYP		Power supply type/ Regenerative resistor type		-	-	-
SP033	SFNC1		Spindle function 1		0000	0000	0000
SP034	SFNC2		Spindle function 2		0000	0000	0000
SP035	SFNC3		Spindle function 3		1600	1600	1600
SP036	SFNC4		Spindle function 4		0000	0000	0000
SP037	JL		Load inertia scale		100	100	100
SP038	FHz1		Notch filter frequency 1		0	0	0
:					:	:	:
SP046	FHz2		Notch filter frequency 2		0	0	0
SP047	EC		Inductive voltage compensation gain		100	100	100
SP048	LMC1		Lost motion compensation 1		0	0	0
:					:	:	:
SP052	DFBN		Dual feedback control non-sensitive band		0	0	0
SP053	ODS		Excessive error detection width (non-interpolation mode)		2400	1600	1200
SP054	ORE		Overrun detection width in closed loop control		0	0	0
SP055	EMGx		Max. gate off delay time after emergency stop		5000	5000	5000
SP056	EMGt		Deceleration time constant at emergency stop		300	300	300
SP057	GRA1		Spindle side gear ratio 1		1	1	1
SP058	GRA2		Spindle side gear ratio 2		1	1	1
SP059	GRA3		Spindle side gear ratio 3		1	1	1
SP060	GRA4		Spindle side gear ratio 4		1	1	1
SP061	GRB1		Motor side gear ratio 1		1	1	1
SP062	GRB2		Motor side gear ratio 2		1	1	1
SP063	GRB3		Motor side gear ratio 3		1	1	1
SP064	GRB4		Motor side gear ratio 4		1	1	1
SP065	TLM1		Torque limit 1		10	10	10
SP066	TLM2		Torque limit 2		10	10	10
SP067	TLM3		Torque limit 3		10	10	10
SP068	TLM4		Torque limit 4		10	10	10
SP069	PCMP		Phase alignment completion width		875	875	875
SP070	KDDT		Phase alignment deceleration rate scale		0	0	0
SP071	DIQM		Variable current limit during deceleration, lower limit value		60	45	60
SP072	DIQN		Variable current limit during deceleration, break point speed		7600	3700	3700
SP073	VGVN		Variable speed gain target value		0	0	0
SP074	VGVS		Variable speed gain change start speed		0	0	0
SP075	DWSH		Slip compensation scale during regeneration high-speed coil		0	0	0
SP076	DWSL		Slip compensation scale during regeneration low-speed coil		0	0	0
SP077	IQA		Q axis current lead compensation		4096	4096	4096

4 Setup

Parameter				400V Standard motor SJ-4-V Series (Standard)		
				Motor		SJ-4-V7.5-13ZT
No.	Abbrev.	Details	Unit capacity	80	80	100
SP078	IDA	D axis current lead compensation		4096	4096	4096
SP079	IQG	Q axis current gain		1024	1024	1024
SP080	IDG	D axis current gain		1024	1024	1024
SP081	IQAL	Q axis current lead compensation low-speed coil		0	0	0
:				:	:	:
SP088	FHz5	Notch filter frequency 5		0	0	0
SP089	TMKQ	Spindle output stabilizing gain Q axis		0	0	0
SP090	TMKD	Spindle output stabilizing gain D axis		0	0	0
:				:	:	:
SP112				0	0	0
SP113	OPLP	Current command value for open loop		0	0	0
SP114	MKT	Coil changeover gate cutoff timer		150	150	150
SP115	MKT2	Coil changeover current limit timer		250	250	250
SP116	MKIL	Coil changeover current limit value		120	120	120
SP117	SETM	Excessive speed deviation timer		12	12	12
SP118	MSFT	Magnetic pole shift amount		0	0	0
SP119				0	0	0
:				:	:	:
SP128	DA2MPY	D/A output ch2 output scale		0	0	0
SP129		Motor unique constants (H)		2	2	2
SP130		Motor unique constants (H)		25	30	58
SP131		Motor unique constants (H)		80	80	100
SP132				0	0	0
SP133		Motor unique constants (H)		12000	8000	8000
SP134		Motor unique constants (H)		1500	1500	1500
SP135		Motor unique constants (H)		1950	1800	1800
SP136		Motor unique constants (H)		1926	2645	3019
SP137		Motor unique constants (H)		73	68	81
SP138		Motor unique constants (H)		3058	3062	2826
SP139		Motor unique constants (H)		2683	2734	2826
SP140		Motor unique constants (H)		1911	1899	1911
SP141		Motor unique constants (H)		170	171	186
SP142		Motor unique constants (H)		0	0	0
SP143				0	0	0
SP144		Motor unique constants (H)		0	0	0
SP145		Motor unique constants (H)		363	367	285
SP146		Motor unique constants (H)		440	436	390
SP147		Motor unique constants (H)		63	63	65
SP148		Motor unique constants (H)		2433	3443	2150
SP149		Motor unique constants (H)		2479	2648	3901
SP150		Motor unique constants (H)		886	863	1620
SP151		Motor unique constants (H)		204	267	185
SP152		Motor unique constants (H)		90	90	90
SP153		Motor unique constants (H)		120	120	120
SP154		Motor unique constants (H)		150	150	150
SP155		Motor unique constants (H)		1048	1045	1039
SP156		Motor unique constants (H)		0	0	0
SP157				0	0	0
SP158		Motor unique constants (H)		0	0	0
SP159		Motor unique constants (H)		0	0	0
SP160		Motor unique constants (H)		0	0	0
SP161				0	0	0
:				:	:	:
SP224				0	0	0
SP225	SFNC5	Spindle function 5		0000	0000	0000
SP226	SFNC6	Spindle function 6		0000	1000	0000
SP227	SFNC7	Spindle function 7		0000	0000	0000
:				:	:	:
SP232				0000	0000	0000
SP233	IVC	Voltage non-sensitive band compensation		0	0	0
SP234				0	0	0
SP235	R2H	Temperature compensation gain		0	0	0
SP236	WIH	Temperature compensation time constant		0	0	0
SP237	TCF	Torque command filter		500	500	500
SP238	SSCFEED	Safely limited speed		0	0	0
SP239	SSCRPM	Safely limited motor speed		0	0	0
SP240				0	0	0
:				:	:	:
SP256				0	0	0

(12) 400V Standard motor SJ-4-V Series (Wide range constant output)

Motor				400V Standard motor SJ-4-V Series (Wide range constant output)
Parameter				SJ-4-V15-20T
No.	Abbrev.	Details	Unit capacity	100
SP001	PGV	Position loop gain non-interpolation mode		15
SP002	PGN	Position loop gain interpolation mode		33
SP003	PGS	Position loop gain spindle synchronization		15
SP004				0
SP005	VGN1	Speed loop gain 1		150
SP006	VIA1	Speed loop lead compensation 1		1900
SP007	VIL1	Speed loop delay compensation 1		0
SP008	VGN2	Speed loop gain 2		150
SP009	VIA2	Speed loop lead compensation 2		1900
SP010	VIL2	Speed loop delay compensation 2		0
SP011				0
SP012				0
SP013				0
SP014	PY1	Minimum excitation rate 1		50
SP015	PY2	Minimum excitation rate 2		100
SP016	DDT	Phase alignment deceleration rate		20
SP017	SPEC1	Spindle specification 1		200C
SP018	SPEC2	Spindle specification 2		0200
SP019	RNG1	Sub side encoder resolution		-
SP020	RNG2	Main side encoder resolution		-
SP021	OLT	Overload detection time constant		60
SP022	OLL	Overload detection level		120
SP023	OD1	Excessive error detection width (interpolation mode - spindle synchronization)		120
SP024	INP	In-position width		875
SP025	INP2	2nd in-position width		875
SP026	TSP	Maximum motor speed		6000
SP027	ZSP	Motor zero speed		25
SP028	SDTS	Speed detection set value		600
SP029	SDTR	Speed detection reset width		30
SP030	SDT2	2nd speed detection setting value		0
SP031	MTYP	Motor type		2200
SP032	PTYP	Power supply type/ Regenerative resistor type		-
SP033	SFNC1	Spindle function 1		0000
SP034	SFNC2	Spindle function 2		0000
SP035	SFNC3	Spindle function 3		1600
SP036	SFNC4	Spindle function 4		0000
SP037	JL	Load inertia scale		100
SP038	FHz1	Notch filter frequency 1		0
:				:
SP046	FHz2	Notch filter frequency 2		0
SP047	EC	Inductive voltage compensation gain		100
SP048	LMC1	Lost motion compensation 1		0
:				:
SP052	DFBN	Dual feedback control non-sensitive band		0
SP053	ODS	Excessive error detection width (non-interpolation mode)		1200
SP054	ORE	Overrun detection width in closed loop control		0
SP055	EMGx	Max. gate off delay time after emergency stop		5000
SP056	EMGt	Deceleration time constant at emergency stop		300
SP057	GRA1	Spindle side gear ratio 1		1
SP058	GRA2	Spindle side gear ratio 2		1
SP059	GRA3	Spindle side gear ratio 3		1
SP060	GRA4	Spindle side gear ratio 4		1
SP061	GRB1	Motor side gear ratio 1		1
SP062	GRB2	Motor side gear ratio 2		1
SP063	GRB3	Motor side gear ratio 3		1
SP064	GRB4	Motor side gear ratio 4		1
SP065	TLM1	Torque limit 1		10
SP066	TLM2	Torque limit 2		10
SP067	TLM3	Torque limit 3		10
SP068	TLM4	Torque limit 4		10
SP069	PCMP	Phase alignment completion width		875
SP070	KDDT	Phase alignment deceleration rate scale		0
SP071	DIQM	Variable current limit during deceleration, lower limit value		60
SP072	DIQN	Variable current limit during deceleration, break point speed		3700
SP073	VGVN	Variable speed gain target value		0
SP074	VGVS	Variable speed gain change start speed		0
SP075	DWSH	Slip compensation scale during regeneration high-speed coil		0
SP076	DWSL	Slip compensation scale during regeneration low- speed coil		0
SP077	IQA	Q axis current lead compensation		4096

Motor			400V Standard motor SJ-4-V Series (Wide range constant output)
Parameter			SJ-4-V15-20T
No.	Abbrev.	Details	Unit capacity
SP078	IDA	D axis current lead compensation	100
SP079	IQG	Q axis current gain	4096
SP080	IDG	D axis current gain	1024
SP081	IQAL	Q axis current lead compensation low-speed coil	1024
:			0
SP088	FHz5	Notch filter frequency 5	0
SP089	TMKQ	Spindle output stabilizing gain Q axis	0
SP090	TMKD	Spindle output stabilizing gain D axis	0
:			0
SP112			0
SP113	OPLP	Current command value for open loop	0
SP114	MKT	Coil changeover gate cutoff timer	150
SP115	MKT2	Coil changeover current limit timer	250
SP116	MKIL	Coil changeover current limit value	120
SP117	SETM	Excessive speed deviation timer	12
SP118	MSFT	Magnetic pole shift amount	0
SP119			0
:			0
SP128	DA2MPY	D/A output ch2 output scale	0
SP129		Motor unique constants (H)	2
SP130		Motor unique constants (H)	58
SP131		Motor unique constants (H)	100
SP132		Motor unique constants (H)	0
SP133		Motor unique constants (H)	8000
SP134		Motor unique constants (H)	1250
SP135		Motor unique constants (H)	1250
SP136		Motor unique constants (H)	3365
SP137		Motor unique constants (H)	73
SP138		Motor unique constants (H)	2865
SP139		Motor unique constants (H)	2755
SP140		Motor unique constants (H)	1919
SP141		Motor unique constants (H)	191
SP142		Motor unique constants (H)	0
SP143		Motor unique constants (H)	0
SP144		Motor unique constants (H)	0
SP145		Motor unique constants (H)	382
SP146		Motor unique constants (H)	435
SP147		Motor unique constants (H)	63
SP148		Motor unique constants (H)	2771
SP149		Motor unique constants (H)	3406
SP150		Motor unique constants (H)	1367
SP151		Motor unique constants (H)	234
SP152		Motor unique constants (H)	90
SP153		Motor unique constants (H)	120
SP154		Motor unique constants (H)	150
SP155		Motor unique constants (H)	1038
SP156		Motor unique constants (H)	0
SP157		Motor unique constants (H)	0
SP158		Motor unique constants (H)	750
SP159		Motor unique constants (H)	750
SP160		Motor unique constants (H)	0
SP161		Motor unique constants (H)	0
:			0
SP224			0
SP225	SFNC5	Spindle function 5	0000
SP226	SFNC6	Spindle function 6	0000
SP227	SFNC7	Spindle function 7	0000
:			0
SP232			0000
SP233	IVC	Voltage non-sensitive band compensation	0
SP234			0
SP235	R2H	Temperature compensation gain	0
SP236	WIH	Temperature compensation time constant	0
SP237	TCF	Torque command filter	500
SP238	SSCFEED	Safely limited speed	0
SP239	SSCRPM	Safely limited motor speed	0
SP240			0
:			0
SP256			0

4.3.3 Spindle Parameters

These parameters are sent to the spindle drive unit when the NC power is turned ON. The standard parameters are designated with the "Spindle parameter setting list" enclosed when the spindle motor is delivered. There may be cases when the machine specifications are unclear, so the parameters determined by the machine specifications should be confirmed by the user.

The parameters with "(PR)" requires the CNC to be turned OFF after the settings. Turn the power OFF and ON to enable the parameter settings.

#13001	SP001 PGV	Position loop gain non-interpolation mode
<p>Set the position loop gain for "Non-interpolation" control mode. When the setting value increases, the command tracking ability will enhance and the positioning settling time can be shorter. However, the impact on the machine during acceleration/deceleration will increase. Use the selection command, the control mode "bit 2, 1, 0 = 000" in control input 4. (Note) The control mode is commanded by NC.</p> <p>---Setting range--- 1 to 200 (rad/s)</p>		
#13002	SP002 PGN	Position loop gain interpolation mode
<p>Set the position loop gain for "interpolation" control mode. When the setting value increases, the command tracking ability will enhance and the positioning settling time can be shorter. However, the impact on the machine during acceleration/deceleration will increase. Use the selection command, the control mode "bit 2, 1, 0 = 010 or 100" in control input 4. (Note) The control mode is commanded by NC. When carrying out the SHG control, set SP035/bitC to "1".</p> <p>---Setting range--- 1 to 200 (rad/s)</p>		
#13003	SP003 PGS	Position loop gain spindle synchronization
<p>Set the position loop gain for "spindle synchronization" control mode. When the setting value increases, the command tracking ability will enhance and the positioning settling time can be shorter. However, the impact on the machine during acceleration/deceleration will increase. Use the selection command, the control mode "bit 2, 1, 0 = 001" in control input 4. (Note 1) The control mode is commanded by NC. When carrying out the SHG control, set SP036/bit4 to "1". (Note 2) Set the same value for the basic and synchronous spindles in spindle synchronization.</p> <p>---Setting range--- 1 to 200 (rad/s)</p>		
#13004	SP004	
<p>Not used. Set to "0".</p>		
#13005	SP005 VGN1	Speed loop gain 1
<p>Set the speed loop gain. Set this according to the load inertia size. The higher setting value will increase the accuracy of control, however, vibration tends to occur. If vibration occurs, adjust by lowering by 20 to 30%. The final value should be 70 to 80% of the value at which the vibration stops.</p> <p>---Setting range--- 1 to 9999</p>		
#13006	SP006 VIA1	Speed loop lead compensation 1
<p>Set the speed loop integral control gain. The standard setting is "1900". Adjust the value by increasing/decreasing the value by about 100. Raise this value to improve the contour tracking accuracy in high-speed cutting. Lower this value when the position droop does not stabilize (when the vibration of 10 to 20Hz occurs).</p> <p>---Setting range--- 1 to 9999</p>		

#13007	SP007 VIL1	Speed loop delay compensation 1
<p>Set this parameter when the limit cycle occurs in the full-closed loop or overshooting occurs in positioning. When setting this parameter, make sure to set the torque offset "SP050(TOF)". When not using, set to "0".</p> <p>---Setting range--- 0 to 32767</p>		
#13008	SP008 VGN2	Speed loop gain 2
<p>Normally SP005(VGN1) is used. By setting "SP035/bit1, SP035/bit9 or SP036/bit1=1", gain 2 can be used according to the application. Gain 2 can also be used by setting "Speed gain set 2 changeover request (control input 5/ bitC) = 1". Refer to SP005(VGN1) for adjustment procedures.</p> <p>---Setting range--- 1 to 9999</p>		
#13009	SP009 VIA2	Speed loop lead compensation 2
<p>Normally SP006(VIA1) is used. By setting "SP035/bit1, SP035/bit9 or SP036/bit1=1", gain 2 can be used according to the application. Gain 2 can also be used by setting "Speed gain set 2 changeover request (control input 5/ bitC) = 1". Refer to SP006(VIA1) for adjustment procedures.</p> <p>---Setting range--- 1 to 9999</p>		
#13010	SP010 VIL2	Speed loop delay compensation 2
<p>Normally SP007(VIL1) is used. By setting "SP035/bit1, SP035/bit9 or SP036/bit1=1", gain 2 can be used according to the application. Gain 2 can also be used by setting "Speed gain set 2 changeover request (control input 5/ bitC) = 1". Refer to SP007(VIL1) for adjustment procedures.</p> <p>---Setting range--- 0 to 32767</p>		
#13011	SP011	
Not used. Set to "0".		
#13012	SP012	
Not used. Set to "0".		
#13013	SP013	
Not used. Set to "0".		
#13014	SP014 PY1	Minimum excitation rate 1
<p>Set the minimum value for the variable excitation rate. The standard setting is "50". Set to "0" when using an IPM spindle motor. If noise including gear noise is loud, select a small value. However, a larger setting value is more effective for impact response.</p> <p>(Note) When setting a value at "50 or more", check if there is no problem with gear noise, motor excitation noise, vibration during low-speed rotation or vibration when the servo is locked during orientation stop, etc. When setting a value at "less than 50", check if there is no problem with the impact load response or rigidity during servo lock.</p> <p>---Setting range--- 0 to 100 (%)</p>		

#13015	SP015 PY2	Minimum excitation rate 2
		<p>Normally, SP014(PY1) is used. By setting "SP035/bit2, SP035/bitA or SP036/bit2=1", the excitation rate 2 can be used according to the application. The excitation rate 2 can also be used by setting "the minimum excitation rate 2 changeover request (control input 5/ bitB) = 1". Refer to SP014(PY1) for adjustment procedures. Set to "0" when using an IPM spindle motor.</p> <p>---Setting range--- 0 to 100 (%)</p>

#13016	SP016 DDT	Phase alignment deceleration rate
		<p>Set the single-rotation position alignment deceleration rate for orientation stopping, phase alignment while rotating and switching from non-interpolation mode to spindle synchronization mode while rotating. When the load inertia is larger, the setting value should be smaller. When the setting value is larger, the orientation in-position and single-rotation position alignment complete faster, but the impact applied on the machine will increase. To change the deceleration rate only during rotation command (command F Δ T ≠ 0), set this parameter together with SP070 (KDDT).</p> <p>---Setting range--- 1 to 32767 (0.1(r/min)/ms)</p>

(PR)	#13017	SP017 SPEC1	Spindle specification 1																																		
			<p>Select the spindle specification. A function is allocated to each bit. Set this in hexadecimal format.</p> <div style="text-align: center;"> <table border="1"> <tr> <td>Bit-</td> <td>F</td> <td>E</td> <td>D</td> <td>C</td> <td>B</td> <td>A</td> <td>9</td> <td>8</td> <td>7</td> <td>6</td> <td>5</td> <td>4</td> <td>3</td> <td>2</td> <td>1</td> <td>0</td> </tr> <tr> <td></td> <td></td> <td></td> <td></td> <td></td> <td>0</td> <td>0</td> <td>0</td> <td>0</td> <td>0</td> <td>0</td> <td>0</td> <td></td> <td></td> <td></td> <td></td> <td></td> </tr> </table> </div>	Bit-	F	E	D	C	B	A	9	8	7	6	5	4	3	2	1	0						0	0	0	0	0	0	0					
Bit-	F	E	D	C	B	A	9	8	7	6	5	4	3	2	1	0																					
					0	0	0	0	0	0	0																										

bit F-C : msr Motor series selection

- 0: 200V specification IM spindle motor
- 1: 200V specification IPM spindle motor
- 2: 400V specification IM spindle motor
- 3: 400V specification IPM spindle motor
- 4: 200V specification Tool spindle motor

bit B-5 :

Not used. Set to "0".

bit 4 : fdir Position feedback

Set the machine side encoder's installation polarity.
 0: Forward polarity 1: Reverse polarity

bit 3 : vfb Speed feedback filter

0: Disable 1: Enable (4500Hz)

bit 2 : seqh READY ON sequence

0: Normal 1: High-speed

bit 1 : dfbx Dual feedback control

Control the position FB signal in full closed control by the combination of a motor side encoder and machine side encoder.
 0: Stop 1: Start

Related parameters: SP051, SP052

bit 0 : fdir2 Speed feedback polarity

Set the motor side encoder's installation polarity by a built-in motor.
 0: Forward polarity 1: Reverse polarity

(PR)	#13018	SP018 SPEC2	Spindle specification 2
-------------	---------------	--------------------	--------------------------------

Select the spindle specification.
 A function is allocated to each bit.
 Set this in hexadecimal format.

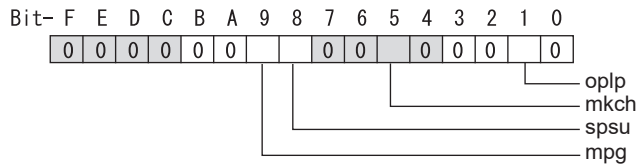

bit F-A :

Not used. Set to "0".

bit 9 : mpg Earth fault detection

0: Disable 1: Enable (standard)
 Set "0" and it is constantly "Enable" for MDS-EJ-SP Series.

bit 8 : spsu Command speed limit value

0: 33,750 r/min 1: 135,000 r/min

bit 7-6 :

Not used. Set to "0".

bit 5 : mkch Coil switch function

0: Disable 1: Enable

bit 4-2 :

Not used. Set to "0".

bit 1 : oplp Open loop control

This allows the operation in which no encoder feedback signals are used.
 It is used when adjusting the encoder, etc.
 0: Disable 1: Enable

bit 0 :

Not used. Set to "0".

(PR)	#13019	SP019 RNG1	Sub side encoder resolution
			<p>[For semi-closed loop] Set the same value as SP020 (RNG2). (Refer to the explanation of SP020.)</p> <p>[For full-closed loop] Set the number of pulses per revolution of the machine side encoder.</p> <p>When using the encoder interface unit MDS-EX-HR, use this with SP097(RNG1ex).</p> <p>Encoder OSE-1024 (ABZ pulse): SP019=4096, SP097=-1</p> <p>TS5690(64 teeth): SP019 = 2000, SP097=0 TS5690(90 teeth): SP019 = 2880, SP097=0 TS5690(128 teeth): SP019 = 4000, SP097=0 TS5690(192 teeth): SP019 = 6000, SP097=0 TS5690(256 teeth): SP019 = 8000, SP097=0 TS5690(384 teeth): SP019 = 12000, SP097=0</p> <p>ERM280(1200 teeth): SP019 = 4800, SP097=0 ERM280(2048 teeth): SP019 = 8000, SP097=0</p> <p>MPCI : SP019 = 7200, SP097=0 MBE205: SP019 = 2000, SP097=0 GEL2449M(524,288(p/rev)): SP019=0, SP097=8 MHS-04B Series(1,048,576(p/rev)): SP019=0, SP097=16</p> <p>---Setting range--- When SP097=0, the setting range is from 0 to 32767 (kp) When SP097≠0, the setting range is from 0 to 65535 (p)</p>
(PR)	#13020	SP020 RNG2	Main side encoder resolution
			<p>Set the number of pulses per revolution of the motor side encoder. Set the standard parameters for the motor with frame.</p> <p>---Setting range--- When SP098=0, the setting range is from 0 to 32767 (kp) When SP098≠0, the setting range is from 0 to 65535 (p)</p>
(PR)	#13021	SP021 OLT	Overload detection time constant
			<p>Set the detection time constant of Overload 1 (Alarm 50). (For Mitsubishi Electric adjustment) Normally, set to "60". Set to "300" when using an IPM spindle motor.</p> <p>---Setting range--- 1 to 15300 (s)</p>
#13022	SP022 OLL	Overload detection level	
		<p>Set the current detection level of "Overload 1" (Alarm 50) as a percentage against the motor short-time rated output current. (For Mitsubishi Electric adjustment) Normally, set to "120". Set to "100" when using an IPM spindle motor.</p> <p>---Setting range--- 1 to 200 (Short-time rated %)</p>	
#13023	SP023 OD1	Excessive error detection width (interpolation mode - spindle synchronization)	
		<p>Set the excessive error detection width for the interpolation mode and spindle synchronization. The standard setting is "120". When set to "0", the excessive error detection will be ignored, so do not set to "0".</p> <p>---Setting range--- 1 to 32767 (°)</p>	

	#13024	SP024 INP	In-position width
			Set the in-position detection width. Set the positioning accuracy required to the machine. Lower setting value increases the positioning accuracy, but makes the cycle time (settling time) longer. The standard setting is "875".
			---Setting range--- 0 to 32767 (1°/1000)
	#13025	SP025 INP2	2nd in-position width
			Use this when detecting an in-position different from normal in-position width such as advancing the in-position signal. The adjustment procedure is the same as SP024 (INP). The standard setting is "875".
			---Setting range--- 0 to 32767 (1°/1000)
(PR)	#13026	SP026 TSP	Maximum motor speed
			Set the maximum motor speed. If the motor speed exceeds the set maximum speed, an overspeed alarm will occur.
			---Setting range--- 1 to 32767 (r/min)
	#13027	SP027 ZSP	Motor zero speed
			Set the motor speed for detecting zero speed. If the motor speed drops below the set speed, the zero speed signal turns ON. The standard setting is "50".
			---Setting range--- 1 to 1000 (r/min)
	#13028	SP028 SDTS	Speed detection set value
			Set the motor speed for detecting the speed. If the motor speed drops below the set speed, the speed detection signal turns ON. The standard setting is 10% of the maximum motor speed.
			---Setting range--- 10 to 32767 (r/min)
	#13029	SP029 SDTR	Speed detection reset width
			Set the hysteresis width in which the speed detection changes from ON to OFF. If the setting value is small, the speed detection will chatter easily. The standard setting is "30".
			---Setting range--- 10 to 1000 (r/min)
	#13030	SP030 SDT2	2nd speed detection setting value
			Set the specified speed of the specified speed output. When carrying out digital output of the specified speed output, set SP229/bitC to "1". It is not available for MDS-EJ-SP Series.
			---Setting range--- 0 to 32767 (r/min)
(PR)	#13031	SP031 MTYP	Motor type
			Set the control system of the spindle drive unit. 2200: Semi closed loop control 4200: Full closed loop control by using spindle side ABZ pulse output encoder 6200: Full closed loop control by using spindle side serial output encoder

(PR)	#13032	SP032 PTYP	Power supply type/ Regenerative resistor type
------	--------	------------	---

MDS-E/EH Series: Power supply type

When connecting a power supply unit, set a code for each power supply unit.

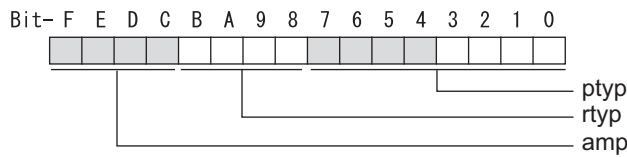

bit F-C : amp

Set the power backup function to be used.
 No function used : 0
 Deceleration and stop function at power failure : 8
 Retraction function at power failure: C

bit B-8 : rtyp

Not used. Set to "0".

bit 7-0 : ptyp External emergency stop setting

When the emergency stop input signal of the power supply unit is "disabled"

- Power supply unit is not connected : 00
- MDS-E-CV-37 / MDS-EH-CV-37 : 04
- MDS-E-CV-75 / MDS-EH-CV-75 : 08
- MDS-E-CV-110 / MDS-EH-CV-110 : 11
- MDS-E-CV-185 / MDS-EH-CV-185 : 19
- MDS-E-CV-300 / MDS-EH-CV-300 : 30
- MDS-E-CV-370 / MDS-EH-CV-370 : 37
- MDS-E-CV-450 / MDS-EH-CV-450 : 45
- MDS-E-CV-550 / MDS-EH-CV-550 : 55
- MDS-EH-CV-750 : 75

When the emergency stop input signal of the power supply unit is "enabled"

(Note) Set the power supply rotary switch to "4".

- Power supply unit is not connected : 00
- MDS-E-CV-37 / MDS-EH-CV-37 : 44
- MDS-E-CV-75 / MDS-EH-CV-75 : 48
- MDS-E-CV-110 / MDS-EH-CV-110 : 51
- MDS-E-CV-185 / MDS-EH-CV-185 : 59
- MDS-E-CV-300 / MDS-EH-CV-300 : 70
- MDS-E-CV-370 / MDS-EH-CV-370 : 77
- MDS-E-CV-450 / MDS-EH-CV-450 : 85
- MDS-E-CV-550 / MDS-EH-CV-550 : 95
- MDS-EH-CV-750 : B5

MDS-EM/EMH Series: Power supply type

Set as follows for the spindle drive section of the MDS-EM/EMH-SPV3.

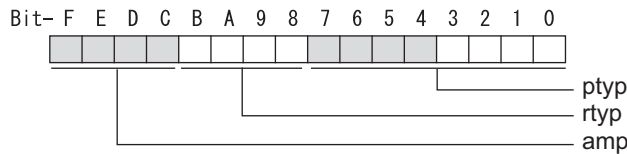

bit F-C : amp

Not used. Set to "0".

bit B-8 : rtp

Not used. Set to "0".

bit 7-0 : ptyp External emergency stop setting

Normal

MDS-EM: 20, MDS-EMH: 22, MDS-EM-SPV3-16040S: 16, MDS-EM-SPV3-320120: 37

External emergency stop function

MDS-EM: 60, MDS-EMH: 62, MDS-EM-SPV3-16040S: 56, MDS-EM-SPV3-320120: 77

MDS-EJ-SP Series: Regenerative resistor type

Set the regenerative resistor type.

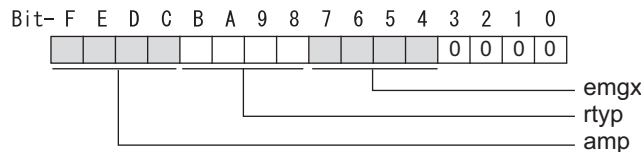

bit F-8 : amp(bit F-C) / rtp(bit B-8)

- Setting prohibited : 10-12
- MR-RB12 or GZG200W39OHMK : 13
- MR-RB32 or GZG200W120OHMK 3 units connected in parallel : 14
- MR-RB30 or GZG200W39OHMK 3 units connected in parallel : 15
- MR-RB50 or GZG300W39OHMK 3 units connected in parallel : 16
- Setting prohibited : 17-1F
- Setting prohibited : 20-23
- FCUA-RB22 : 24
- FCUA-RB37 : 25
- FCUA-RB55 : 26
- FCUA-RB75/2 1 unit : 27
- R-UNIT1 : 28
- R-UNIT2 : 29
- R-UNIT3 : 2A
- R-UNIT4 : 2B
- R-UNIT5 : 2C
- FCUA-RB75/2 2 units connected in parallel : 2D
- FCUA-RB55/2 2 units connected in parallel : 2E
- Setting prohibited : 2F

bit 7-4 : emgx External emergency stop function

Set the external emergency stop function.

0: Disable 4: Enable

bit 3-0 :

Not used. Set to "0".

#13033	SP033 SFNC1	Spindle function 1
---------------	--------------------	---------------------------

Select the spindle specification.
 A function is allocated to each bit.
 Set this in hexadecimal format.

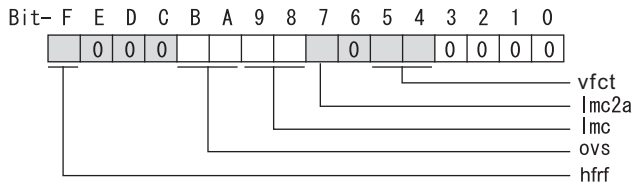

bit F : hfrf Higher harmonic suppression filter

- 0: Stop
- 1: Start

bit E-C :

Not used. Set to "0".

bit B-A : ovs Overshoot compensation

Set this parameter when overshooting occurs during positioning.
 bitB,A=
 00: Compensation stop
 01: Setting prohibited
 10: Setting prohibited
 11: Compensation type 3

Set the compensation amount in SP043(OVS1) and SP042(OVS2).

bit 9-8 : lmc Lost motion compensation type2

Set this parameter when the protrusion at quadrant change is too large.
 bit9,8=
 00: Compensation stop
 01: Setting prohibited
 10: Compensation type 2
 11: Setting prohibited

Set the compensation amount in SP048(LMC1) and SP041(LMC2).

bit 7 : lmc2a Lost motion compensation 2 timing

- 0: Normal
- 1: Change

bit 6 :

Not used. Set to "0".

bit 5-4 : vfc Jitter compensation pulse number

Suppress vibration by machine backlash when axis stops.
 bit5,4=
 00: Disable
 01: 1 pulse
 10: 2 pulse
 11: 3 pulses

bit 3-0 :

Not used. Set to "0".

#13034

SP034 SFNC2

Spindle function 2

Select the spindle function.
A function is allocated to each bit.
Set this in hexadecimal format.

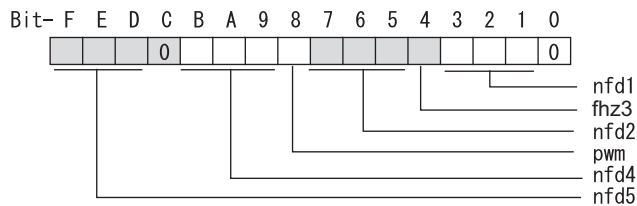
**bit F-D : nfd5 Depth of Notch filter 5**

Set the depth of Notch filter 5 (SP088).

bit F,E,D=

000: $-\infty$

001: -18.1[dB]

010: -12.0[dB]

011: -8.5[dB]

100: -6.0[dB]

101: -4.1[dB]

110: -2.5[dB]

111: -1.2[dB]

bit C :

Not used. Set to "0".

bit B-9 : nfd4 Depth of Notch filter 4

Set the depth of Notch filter 4 (SP087).

bit B,A,9=

000: $-\infty$

001: -18.1[dB]

010: -12.0[dB]

011: -8.5[dB]

100: -6.0[dB]

101: -4.1[dB]

110: -2.5[dB]

111: -1.2[dB]

bit 8 : pwm Current control

0: Standard current control 1: High frequency current control

bit 7-5 : nfd2 Depth of Notch filter 2

Set the depth of Notch filter 2 (SP046).

bit7,6,5=

000: $-\infty$

001: -18.1[dB]

010: -12.0[dB]

011: -8.5[dB]

100: -6.0[dB]

101: -4.1[dB]

110: -2.5[dB]

111: -1.2[dB]

bit 4 : fhz3 Notch filter 3

0: Stop 1: Start (1125Hz)

bit 3-1 : nfd1 Depth of Notch filter 1

Set the depth of Notch filter 1 (SP038).

bit3,2,1=

000: $-\infty$

001: -18.1[dB]

010: -12.0[dB]

011: -8.5[dB]

100: -6.0[dB]

101: -4.1[dB]

110: -2.5[dB]

111: -1.2[dB]

bit 0 :

Not used. Set to "0".

(PR)	#13035	SP035 SFNC3	Spindle function 3
------	--------	-------------	--------------------

Select the spindle function.
A function is allocated to each bit.
Set this in hexadecimal format.

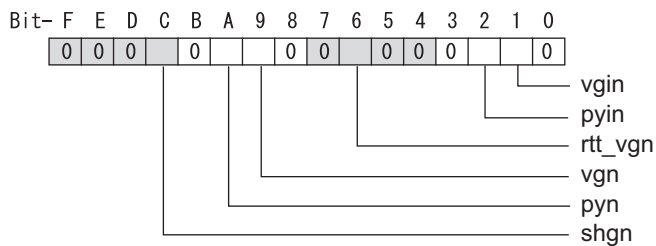
**bit F-D :**

Not used. Set to "0".

bit C : shgn SHG control in interpolation mode

0: Stop 1: Start
When using the OMR-FF control, set to "0".

bit B :

Not used. Set to "0".

bit A : pyn Excitation rate selection in interpolation mode

0: Select Excitation rate 1 1: Select Excitation rate 2

bit 9 : vgn Speed loop gain set selection in interpolation mode

0: Select Set 1 1: Select Set 2

bit 8-7 :

Not used. Set to "0".

bit 6 : rtt_vgn Real-time tuning I in non-interpolation mode / speed gain adaptation stop

0: Stop 1: Start

bit 5-3 :

Not used. Set to "0".

bit 2 : pyin Excitation rate selection in non-interpolation mode

The excitation rate after the in-position can be selected.
0: Select Excitation rate 1 1: Select Excitation rate 2

bit 1 : vgin Speed loop gain set selection in non-interpolation mode

The speed loop gain set after the in-position can be selected.
0: Select Set 1 1: Select Set 2

bit 0 :

Not used. Set to "0".

(PR)	#13036	SP036 SFNC4	Spindle function 4
-------------	---------------	--------------------	---------------------------

Select the spindle function.
 A function is allocated to each bit.
 Set this in hexadecimal format.

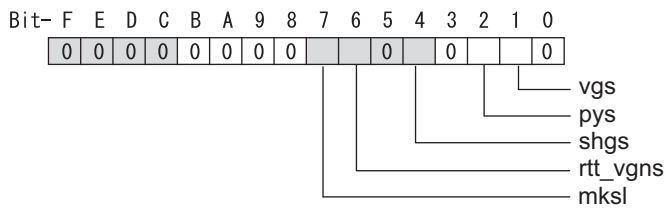

bit F-8 :

Not used. Set to "0".

bit 7 : mksl Coil selection in spindle synchronization mode

0: Select the coil commanded during synchronization 1: Select high-speed coil

bit 6 : rtt_vgns Real-time tuning I in spindle synchronization mode / speed gain adaptation stop

0: Stop 1: Start

bit 5 :

Not used. Set to "0".

bit 4 : shgs SHG control in spindle synchronization mode

0: Stop 1: Start
 When using the OMR-FF control, set to "0".

bit 3 :

Not used. Set to "0".

bit 2 : pys Excitation rate selection in spindle synchronization mode

0: Select Excitation rate 1 1: Select Excitation rate 2

bit 1 : vgs Speed loop gain set selection in spindle synchronization mode

0: Select Set 1 (SP005,SP006,SP007) 1: Select Set 2 (SP008,SP009,SP010)

bit 0 :

Not used. Set to "0".

#13037	SP037 JL	Load inertia scale
---------------	-----------------	---------------------------

Set the motor axis conversion total load inertia including motor itself in proportion to the motor inertia.
 $SV037(JL)=(Jm+JI)/Jm \times 100$
 Jm: Motor inertia
 JI: Motor axis conversion load inertia

---Setting range---

0 to 5000 (%)

#13038	SP038 FHZ1	Notch filter frequency 1
---------------	-------------------	---------------------------------

Set the vibration frequency to suppress when machine vibration occurs.
 (Enabled at 50 or more.)
 When not using, set to "0".

Related parameters: SP034/bit3-1

---Setting range---

0 to 5000 (Hz)

#13039	SP039 LMCD	Lost motion compensation timing
Set this parameter when the lost motion compensation type2 timing does not match. Adjust by increasing the value by 10 at a time.		
---Setting range---		
0 to 2000 (ms)		
#13040	SP040 LMCT	Lost motion compensation non-sensitive band
Set the non-sensitive band of the lost motion compensation in the feed forward control. When "0" is set, 2°/1000 is set. Adjust by increasing the value by 1°/1000 at a time.		
---Setting range---		
-32768 to 32767 (1°/1000)		
#13041	SP041 LMC2	Lost motion compensation 2
Set this parameter with SP048(LMC1) only to vary the lost motion compensation amount depending on the command directions. Normally, set to "0".		
---Setting range---		
-1 to 200 (Short-time rated %) Note that when SP227/bit2 is "1", the range will be -1 to 20000 (Short-time rated 0.01%).		
#13042	SP042 OVS2	Overshooting compensation 2
Set this parameter with SP043(OVS1) only to vary the lost motion compensation amount depending on the command directions. Normally, set to "0".		
---Setting range---		
-1 to 100 (Short-time rated %) Note that when SP227/bit2 is "1", the range will be -1 to 10000 (Short-time rated 0.01%).		
#13043	SP043 OVS1	Overshooting compensation 1
Set this parameter when overshooting occurs during positioning. This compensates the motor torque during positioning. This is valid only when the overshooting compensation SP033 (SFNC1/ovs) is selected.		
[Type 3 "When SP033/ bitB,A=11"] Use this when performing overshoot compensation in the feed forward control during arc cutting mode. Set the compensation amount based on the motor short-time rated current. Increase the value in increments of 1% to find the value where overshooting ceases.		
[To vary compensation amount depending on the direction] When SV042 (OVS2) is "0", change the SP043 (OVS1) value in both +/- directions to compensate. To change the compensation amount depending on the command direction, set this with SP042 (OVS2). (SP043: + direction, SP042: - direction, However, the directions may be opposite depending on other settings.) When "-1" is set, the compensation will not be performed in the command direction.		
---Setting range---		
-1 to 100 (Short-time rated %) Note that when SP227/bit2 is "1", the range will be -1 to 10000 (Short-time rated 0.01%).		
#13044	SP044 OBS2	Disturbance observer gain
Set the disturbance observer gain. The standard setting is "100". To use the disturbance observer, also set SP037(JL), SP045(OBS1) and SP226/ bitE. When not using, set to "0".		
---Setting range---		
0 to 500 (%)		

#13045	SP045 OBS1	Disturbance observer filter frequency
<p>Set the disturbance observer filter band. Normally, set to "100". To use the disturbance observer, also set SP037(JL), SP044(OBS2) and SP226/ bitE. When not using, set to "0".</p> <p>---Setting range--- 0 to 1000 (rad/s)</p>		
#13046	SP046 FHz2	Notch filter frequency 2
<p>Set the vibration frequency to suppress when machine vibration occurs. (Enabled at 50 or more.) When not using, set to "0".</p> <p>Related parameters: SP034/bit7-5</p> <p>---Setting range--- 0 to 5000 (Hz)</p>		
#13047	SP047 EC	Inductive voltage compensation gain
<p>Set the inductive voltage compensation gain. Normally, set to "100". Lower the gain when the current FB peak exceeds the current command peak.</p> <p>---Setting range--- 0 to 200 (%)</p>		
#13048	SP048 LMC1	Lost motion compensation 1
<p>Set this parameter when the protrusion (that occurs due to the non-sensitive band by friction, torsion, backlash, etc.) at quadrant change is too large. This sets the compensation torque at quadrant change (when an axis feed direction is reversed) by Short-time rated %. Whether to enable the lost motion compensation and the method can be set with other parameters.</p> <p>[Type 2 "When SP033/bit9,8=10"] Set the compensation amount based on the motor short-time rated current. The standard setting is double of the friction torque. The compensation amount will be 0 when "0" is set.</p> <p>Related parameters: SP033/bit9-8, SP039, SP040, SP041, SP227/bit2</p> <p>[To vary compensation amount depending on the direction] When SP041 (LMC2) is "0", change SP048 (LMC1) value in both of +/- directions to compensate. To vary the compensation amount depending on the command direction, set this with SP041 (LMC2). (SP048: + direction, SP041: - direction, However, the directions may be opposite depending on other settings.) When "-1" is set, the compensation will not be performed in the command direction.</p> <p>---Setting range--- -1 to 200 (Short-time rated %) Note that when SP227/bit2 is "1", the range will be -1 to 20000 (Short-time rated 0.01%).</p>		
#13049	SP049 FFC	Acceleration rate feed forward gain
<p>When a relative error in the synchronous control is too large, set this parameter to the axis that is delaying. The standard setting is "0". The standard setting in the SHG control is "50". Adjust relative errors in acceleration/deceleration by increasing the value by 50.</p> <p>---Setting range--- 0 to 999 (%)</p>		
#13050	SP050 TOF	Torque offset
<p>Set the imbalance torque.</p> <p>---Setting range--- -100 to 100 (Short-time rated %)</p>		

#13051	SP051 DFBT	Dual feed back control time constant
<p>Set the control time constant in dual feed back. When the function is valid, the standard setting is "100". When "0" is set, the value is 1 ms. When the time constant is increased, the operation will get closer to the semi-closed control and the limit of the position loop gain will be raised. However, this cannot be used when the spindle slip occurs in machine configuration such as V-belt drive.</p> <p>Related parameters: SP017/bit1, SP052</p> <p>---Setting range--- 0 to 9999 (ms)</p>		
#13052	SP052 DFBN	Dual feedback control non-sensitive band
<p>Set the non-sensitive band in the dual feedback control. Normally set to "0".</p> <p>Related parameters: SP017/bit1, SP051</p> <p>---Setting range--- 0 to 9999 (1/1000°)</p>		
#13053	SP053 ODS	Excessive error detection width (non-interpolation mode)
<p>Set the excessive error detection width in non-interpolation mode. Standard setting value: ODS = Maximum motor speed [r/min] × 6/PGV/2</p> <p>When set to "0", the excessive error detection will not be performed.</p> <p>---Setting range--- 0 to 32767 (°)</p>		
#13054	SP054 ORE	Overrun detection width in closed loop control
<p>Set the overrun detection width in the full-closed loop control. When the gap between the motor side encoder and the machine side encoder exceeds the set value, it is judged as an overrun and "Alarm 43" is detected. When "-1" is set, if the differential velocity between the motor side encoder and the machine side encoder exceeds the 30% of the maximum motor speed, it will be judged as overrun and "Alarm 43" will be detected. When "0" is set, overrun will be detected with 2°. In the full-closed loop control, normally set this parameter to "360". During V-belt drive, set to "-1".</p> <p>---Setting range--- -1 to 32767 (°)</p>		
#13055	SP055 EMGx	Max. gate off delay time after emergency stop
<p>Set the time required to forcibly execute READY OFF after the emergency stop is input. Normally set to "5000". When 5000ms or more is set for deceleration time constant at emergency stop(SP056), set the same value as SP056. When using the power backup system (MDS-D/DH-PFU) and setting the value of this parameter to 5000ms or more, a communication error between NC and drive unit may occur when power restarts after a instantaneous power interrupt. It is not a problem so turn the NC power ON again to start up. When "0" is set, 7000ms is the actual value to be set.</p> <p>Related parameters: SP056, SP230</p> <p>---Setting range--- 0 to 29900 (ms)</p>		
#13056	SP056 EMGt	Deceleration time constant at emergency stop
<p>Set the time constant used for the deceleration control at emergency stop. Set the time required to stop from the maximum motor speed (TSP). When "0" is set, the deceleration control is executed with "7000ms".</p> <p>Related parameters: SP055, SP230</p> <p>---Setting range--- 0 to 29900 (ms)</p>		

(PR)	#13057	SP057 GRA1	Spindle side gear ratio 1
			Set the number of gear teeth on the spindle side when "the gear selection command (control input 4/bit6, 5)" is set to "00".
			---Setting range---
			1 to 32767
(PR)	#13058	SP058 GRA2	Spindle side gear ratio 2
			Set the number of gear teeth on the spindle side when "the gear selection command (control input 4/bit6, 5)" is set to "01".
			---Setting range---
			1 to 32767
(PR)	#13059	SP059 GRA3	Spindle side gear ratio 3
			Set the number of gear teeth on the spindle side when "the gear selection command (control input 4/bit6, 5)" is set to "10".
			---Setting range---
			1 to 32767
(PR)	#13060	SP060 GRA4	Spindle side gear ratio 4
			Set the number of gear teeth on the spindle side when "the gear selection command (control input 4/bit6, 5)" is set to "11".
			---Setting range---
			1 to 32767
(PR)	#13061	SP061 GRB1	Motor side gear ratio 1
			Set the number of gear teeth on the motor side when "the gear selection command (control input 4/bit6, 5)" is set to "00".
			---Setting range---
			1 to 32767
(PR)	#13062	SP062 GRB2	Motor side gear ratio 2
			Set the number of gear teeth on the motor side when "the gear selection command (control input 4/bit6, 5)" is set to "01".
			---Setting range---
			1 to 32767
(PR)	#13063	SP063 GRB3	Motor side gear ratio 3
			Set the number of gear teeth on the motor side when "the gear selection command (control input 4/bit6, 5)" is set to "10".
			---Setting range---
			1 to 32767
(PR)	#13064	SP064 GRB4	Motor side gear ratio 4
			Set the number of gear teeth on the motor side when "the gear selection command (control input 4/bit6, 5)" is set to "11".
			---Setting range---
			1 to 32767
	#13065	SP065 TLM1	Torque limit 1
			Set the torque limit value when the torque limit (spindle control input 1/bitA, 9, 8) is set to "001" (TL3, TL2, TL1 = 001).
			---Setting range---
			0 to 999 (Short-time rated %)

#13066	SP066 TLM2	Torque limit 2
Set the torque limit value when the torque limit (spindle control input 1/bitA, 9, 8) is set to "010" (TL3, TL2, TL1 = 010).		
---Setting range---		
0 to 999 (Short-time rated %)		
#13067	SP067 TLM3	Torque limit 3
Set the torque limit value when the torque limit (spindle control input 1/bitA, 9, 8) is set to "011" (TL3, TL2, TL1 = 011).		
---Setting range---		
0 to 999 (Short-time rated %)		
#13068	SP068 TLM4	Torque limit 4
Set the torque limit value when the torque limit (spindle control input 1/bitA, 9, 8) is set to "100" (TL3, TL2, TL1 = 100).		
---Setting range---		
0 to 999 (Short-time rated %)		
#13069	SP069 PCMP	Phase alignment completion width
Set the single-rotation position alignment completion width for phase alignment and changing from non-interpolation to spindle synchronization mode during rotation. Set the rotation error that is required to the machine. When the setting value decreases, the rotation error will decrease, but the cycle time (settling time) will get longer. The standard setting is "875".		
---Setting range---		
0 to 32767 ($1^\circ/1000$)		
#13070	SP070 KDDT	Phase alignment deceleration rate scale
Set the scale for SP016 (DDT) to change the deceleration rate only during rotation command (command F $\Delta T \neq 0$). When the setting value increases, the single-rotation position alignment will be completed faster, but the impact to the machine will also increase. When not using, set to "0".		
---Setting range---		
0 to 255 (1/16-fold)		
#13071	SP071 DIQM	Variable current limit during deceleration, lower limit value
Set this parameter to adjust the deceleration time by changing the current limit value during deceleration depending on the motor speed. As shown below, set the lower limit rate of the current limit in SP071 (DIQM), and use with SP072 (DIQN). When DIQM is set to 100%, the standard current limit value in deceleration (SP152) is applied.		

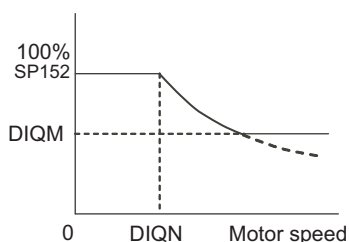
**---Setting range---**

0 to 999 (%)

#13072 SP072 DIQN Variable current limit during deceleration, break point speed

Set this parameter to adjust the deceleration time by changing the current limit value during deceleration depending on the motor speed.
 As shown below, set the lower limit rate of the current limit in SP071 (DIQM), and use with SP072 (DIQN).
 When DIQM is set to 100%, the standard current limit value in deceleration (SP152) is applied.

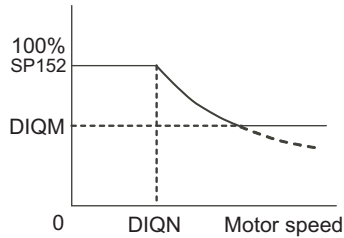

---Setting range---

1 to 32767 (r/min)

#13073 SP073 VGVN Variable speed gain target value

If noise is bothersome during high speed rotation, it may be reduced by lowering the speed loop gain at high speed.
 Set this value to ensure the adequate response by suppressing noise and vibration at low speeds and increasing the speed loop gain at high speeds for a high-speed spindle of machining center, etc.
 As shown below, set the speed loop gain rate for the overspeed detection speed in SP073 (VGVN), and use with SP074 (VGVS).
 When not using, set to "0".
 This function can be used when either Speed loop gain set 1 or Speed loop gain set 2 is selected.

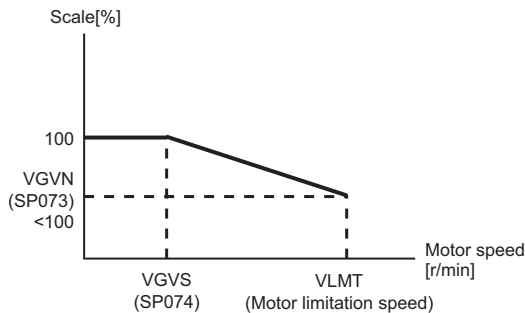

When lowering the speed loop gain at high speed

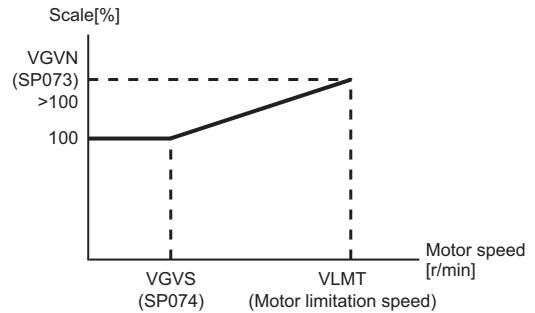

When increasing the speed loop gain at high speed

---Setting range---

0 to 999 (%)

#13074 SP074 VGVS Variable speed gain change start speed

If noise is bothersome during high speed rotation, it may be reduced by lowering the speed loop gain at high speed.

Set this value to ensure the adequate response by suppressing noise and vibration at low speeds and increasing the speed loop gain at high speeds for a high-speed spindle of machining center, etc.

As shown below, set the speed loop gain rate for the overspeed detection speed in SP073 (VGVN), and use with SP074 (VGVS).

When not using, set to "0".

This function can be used when either Speed loop gain set 1 or Speed loop gain set 2 is selected.

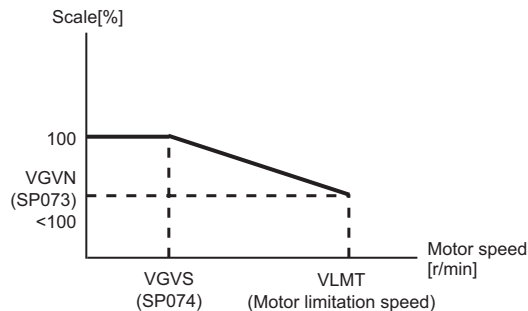

When lowering the speed loop gain at high speed

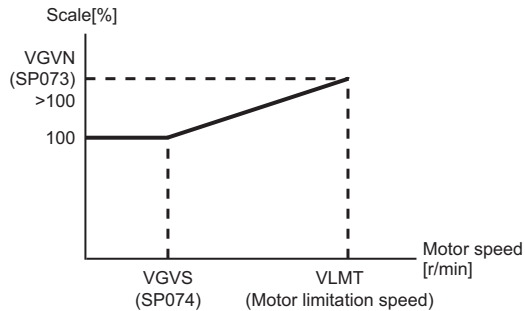

When increasing the speed loop gain at high speed

---Setting range---

0 to 32767 (r/min)

#13075 SP075 DWSH Slip compensation scale during regeneration high-speed coil

Set the slip frequency scale during deceleration. Normally, set to "0". (For Mitsubishi Electric adjustment)

---Setting range---

0 to 255 (1/16-fold)

#13076 SP076 DWSL Slip compensation scale during regeneration low-speed coil

Set the slip frequency scale at deceleration when using the low-speed coil. Normally, set to "0". (For Mitsubishi Electric adjustment)

---Setting range---

0 to 255 (1/16-fold)

#13077 SP077 IQA Q axis current lead compensation

Set the current loop gain.

To use the coil switch function, set the current loop gain for when the high-speed coil is selected.

The setting value is determined by the motor's electrical characteristics so that the value is fixed to each motor used.

Set the value given in the spindle parameter list. (For Mitsubishi Electric adjustment)

---Setting range---

1 to 20480

#13078 SP078 IDA D axis current lead compensation

Set the current loop gain.

To use the coil switch function, set the current loop gain for when the high-speed coil is selected.

The setting value is determined by the motor's electrical characteristics so that the value is fixed to each motor used.

Set the value given in the spindle parameter list. (For Mitsubishi Electric adjustment)

---Setting range---

1 to 20480

#13079	SP079 IQG	Q axis current gain
<p>Set the current loop gain. To use the coil switch function, set the current loop gain for when the high-speed coil is selected. The setting value is determined by the motor's electrical characteristics so that the value is fixed to each motor used. Set the value given in the spindle parameter list. (For Mitsubishi Electric adjustment)</p>		
---Setting range---		
1 to 8192		
#13080	SP080 IDG	D axis current gain
<p>Set the current loop gain. To use the coil switch function, set the current loop gain for when the high-speed coil is selected. The setting value is determined by the motor's electrical characteristics so that the value is fixed to each motor used. Set the value given in the spindle parameter list. (For Mitsubishi Electric adjustment)</p>		
---Setting range---		
1 to 8192		
#13081	SP081 IQAL	Q axis current lead compensation low-speed coil
<p>When using coil switch function, set the current loop gain for when the low-speed coil is selected. The setting value is determined by the motor's electrical characteristics so that the value is fixed to each motor used. Set the value given in the spindle parameter list. (For Mitsubishi Electric adjustment)</p>		
---Setting range---		
1 to 20480		
#13082	SP082 IDAL	D axis current lead compensation low-speed coil
<p>When using coil switch function, set the current loop gain for when the low-speed coil is selected. The setting value is determined by the motor's electrical characteristics so that the value is fixed to each motor used. Set the value given in the spindle parameter list. (For Mitsubishi Electric adjustment)</p>		
---Setting range---		
1 to 20480		
#13083	SP083 IQGL	Q axis current gain low-speed coil
<p>When using coil switch function, set the current loop gain for when the low-speed coil is selected. The setting value is determined by the motor's electrical characteristics so that the value is fixed to each motor used. Set the value given in the spindle parameter list. (For Mitsubishi Electric adjustment)</p>		
---Setting range---		
1 to 8192		
#13084	SP084 IDGL	D axis current gain low-speed coil
<p>When using coil switch function, set the current loop gain for when the low-speed coil is selected. The setting value is determined by the motor's electrical characteristics so that the value is fixed to each motor used. Set the value given in the spindle parameter list. (For Mitsubishi Electric adjustment)</p>		
---Setting range---		
1 to 8192		
#13085	SP085	
Not used. Set to "0".		
#13086	SP086	
Not used. Set to "0".		

#13087	SP087 FHz4	Notch filter frequency 4
Set the vibration frequency to suppress when machine vibration occurs. (Enabled at 50 or more.) When not using, set to "0".		
Related parameters: SP034/bitB-9		
---Setting range---		
0 to 5000 (Hz)		
#13088	SP088 FHz5	Notch filter frequency 5
Set the vibration frequency to suppress when machine vibration occurs. (Enabled at 50 or more.) When not using, set to "0".		
Related parameters: SP034/bitF-D		
---Setting range---		
0 to 5000 (Hz)		
#13089	SP089 TMKQ	Spindle output stabilizing gain Q axis
Set the magnification of the torque current stabilizing gain. (For Mitsubishi Electric adjustment) When set to "0", the torque current stabilization is disabled. When not using, set to "0".		
---Setting range---		
0 to 32767		
#13090	SP090 TMKD	Spindle output stabilizing gain D axis
Set the magnification of the excitation current stabilizing gain. (For Mitsubishi Electric adjustment) When set to "0", the excitation current stabilization is disabled. When not using, set to "0".		
---Setting range---		
0 to 32767		
#13091	SP091	
Not used. Set to "0".		
#13092	SP092	
Not used. Set to "0".		
#13093	SP093	
Not used. Set to "0".		
#13094	SP094 MPV	Magnetic pole error detection speed
In the magnetic pole position detection function, the command motor speed and motor speed during the position command stop are monitored. Set the command motor speed level and motor speed level during the position command stop in "r/min" unit. When the command motor speed level is set to "0", the magnetic pole position error is detected at 10r/min. Set to "10" as a standard setting when the magnetic pole position error detection function is enabled. This detects the magnetic pole position error when the motor speed is "100r/min".		
Ten-thousands digit, Thousands digit ----- Command motor speed level (10r/min) Hundreds digit, Tens digit, Ones digit ----- Motor speed level (10r/min)		
---Setting range---		
0 to 31999		

#13095	SP095 VIAX	Lead compensation scale during high-response acceleration/deceleration
<p>Set the magnification against delay/lead compensation (SP006) of the high-response acceleration/deceleration (valid when SP226/ bitD is set to "1"). Normally, set to "0". Set this parameter to suppress overshooting when the speed is reached.</p> <p>---Setting range--- 0 to 10000 (0.01%)</p>		
#13096	SP096 SDW	Speed slowdown allowable width
<p>When the spindle slows down due to multiple cutting, set the processable speed as percentage against the NC command speed. If the speed reduces below the tolerable range, the alarm 23 (Excessive speed error) will occur. (E.g.) When set to 90 [%] If S1000 is commanded, the speed reduced by 900r/min (=1000r/min × 90%) is the allowable lower limit. Thus if the spindle speed reduces to 100r/min or below, the alarm will occur. When "0" is set, the magnification is the same as when "85" is set. When set to "-1", the allowable width will be disabled.</p> <p>---Setting range--- -1,0 to 100 (%)</p>		
#13097	SP097 RNG1ex	Extension sub side encoder resolution
<p>When setting the machine side encoder resolution in pulse (p) unit, set the number of pulses to four bite data of SP097 (high-order) and SP019 (low-order) in pulse (p) unit.</p> <p>When SP097=0, the setting unit of SP019 is (kp). Refer to SP019 for details.</p> <p>Related parameters: SP019, SP020, SP098</p> <p>---Setting range--- -1 to 32767</p>		
#13098	SP098 RNG2ex	Extension main side encoder resolution
<p>When setting the motor side encoder resolution in pulse (p) unit, set the number of pulses to four bite data of SP098 (high-order) and SP020 (low-order) in pulse (p) unit.</p> <p>When SP098=0, the setting unit of SP020 is (kp). Refer to SP020 for details.</p> <p>Related parameters: SP019, SP020, SP097</p> <p>---Setting range--- -1 to 32767</p>		
#13099- 13105	SP099-SP105	
Not used. Set to "0".		
#13106	SP106 PGM	OMR-FF scale model gain
<p>Set the scale model gain (position response) in OMR-FF control. Set the same value as SV002(PGN). Increase the setting value to perform a high-speed machining such as a fine arc or to improve the path error. Lower the value when vibration occurs during acceleration/deceleration. Set to "0" when not using OMR-FF control.</p> <p>---Setting range--- 0 to 300 (rad/s)</p>		
#13107- 13111	SP107-SP111	
Not used. Set to "0".		

	#13112	SP112 IFF	OMR-FF current feed forward gain
	<p>Set the current feed forward rate in OMR-FF control. The standard setting is "10000". Setting value of 0 is equal to "10000(100%)" setting. Set to "0" when not using OMR-FF control.</p> <p>---Setting range---</p> <p>0 to 32767 (0.01%)</p>		
	#13113	SP113 OPLP	Current command value for open loop
	<p>Set the current command value for when the open loop control is enabled. When "0" is set, the state will be the same as when "50" is set. When not using, set to "0". The open loop control is enabled when "SP018/bit1" is set to "1".</p> <p>---Setting range---</p> <p>0 to 999 (Short-time rated %)</p>		
	#13114	SP114 MKT	Coil changeover gate cutoff timer
	<p>Set the time required to cut off the gate when turning OFF/ON the coil switch contactor. The value should be longer than the coil switch contactor's OFF/ON time. The standard setting is "150".</p> <p>---Setting range---</p> <p>0 to 3500 (ms)</p>		
	#13115	SP115 MKT2	Coil changeover current limit timer
	<p>Set the time required to limit the current immediately after the coil switch contactor ON/OFF is completed and the gate is turned ON. The standard setting is "250".</p> <p>---Setting range---</p> <p>0 to 3500 (ms)</p>		
	#13116	SP116 MKIL	Coil changeover current limit value
	<p>Set the time required to limit the current immediately after the coil switch contactor ON/OFF is completed and the gate is turned ON. The standard setting is "120".</p> <p>---Setting range---</p> <p>0 to 999 (Short-time rated %)</p>		
	#13117	SP117 SETM	Excessive speed deviation timer
	<p>Set the time to detect the speed excessive error alarm. Set the time required to the machine. The standard setting is "12".</p> <p>---Setting range---</p> <p>0 to 60 (s)</p>		
(PR)	#13118	SP118 MSFT	Magnetic pole shift amount
	<p>Set the magnetic pole shift amount of IPM spindle motor. During DC excitation of the initial setup: Set the same value displayed in the "AFLT gain" on the NC monitor screen in SP225/bit4=1. When not using, set to "0".</p> <p>---Setting range---</p> <p>-18000 to 18000 (electrical angle 0.01°)</p>		
	#13119	SP119	
	Not used. Set to "0".		

#13120	SP120	
Not used. Set to "0".		
#13121	SP121 MP Kpp	Magnetic pole detection position loop gain
Set the position loop gain in the magnetic polar detection loop. This is used in the initial magnetic polar detection when the IPM spindle motor is turned ON. Set to "0" when using an IM spindle motor.		
---Setting range---		
0 to 32767		
#13122	SP122 MP Kvp	Magnetic pole detection speed loop gain
Set the speed loop gain in the magnetic polar detection loop. This is used in the initial magnetic polar detection when the IPM spindle motor is turned ON. Set to "0" when using an IM spindle motor.		
---Setting range---		
0 to 32767		
#13123	SP123 MP Kvi	Magnetic pole detection speed loop lead compensation
Set the speed loop lead compensation in the magnetic polar detection loop. This is used in the initial magnetic polar detection when the IPM spindle motor is turned ON. Set to "0" when using an IM spindle motor.		
---Setting range---		
0 to 32767		
#13124	SP124 ILMTsp	Magnetic pole detection current limit value
Set the current limit value for the magnetic polar detection loop. This is used in the initial magnetic polar detection when the IPM spindle motor is turned ON. Set to "0" when using an IM spindle motor.		
---Setting range---		
0 to 999 (Short-time rated %)		
#13125	SP125 DA1NO	D/A output ch1 data No. / Initial DC excitation level
Input the desired data number to D/A output channel. When using the 2-axis drive unit, set "-1" to the axis that the data will not be output.		
When the DC excitation is running: Use in the DC excitation function. DC excitation: Set the initial excitation level when SP225/bit4=1. When "0" is set, the state will be the same as when "20" is set.		
---Setting range---		
-32768 to 32767		
#13126	SP126 DA2NO	D/A output ch2 data No. / Final DC excitation level
Input the desired data number to D/A output channel. When using the 2-axis drive unit, set "-1" to the axis that the data will not be output.		
When the DC excitation is running: Use in the DC excitation function. DC excitation: Set the final excitation level when SP225/bit4=1. When "0" is set, the state will be the same as when "50" is set.		
---Setting range---		
-32768 to 32767		

	#13127	SP127 DA1MPY	D/A output ch1 output scale / Initial DC excitation time
	<p>Set the output scale in increments of 1/100. When "0" is set, the scale is the same as when "100" is set.</p> <p>When the DC excitation is running: Use in the DC excitation function. DC excitation: Set the initial excitation time when SP225/bit4=1. When "0" is set, the state will be the same as when "10000" is set.</p> <p>---Setting range--- -32768 to 32767 (1/100-fold)</p>		
	#13128	SP128 DA2MPY	D/A output ch2 output scale
	<p>Set the output scale in increments of 1/100. When "0" is set, the scale is the same as when "100" is set.</p> <p>---Setting range--- -32768 to 32767 (1/100-fold)</p>		
(PR)	#13129- 13141	SP129-SP141	
	<p>Set the unique constants for the spindle motor. (High-speed coil) The setting value is determined by the motor's mechanical and electrical characteristics and specifications, so normally set the value given in the spindle parameter list.</p>		
(PR)	#13142	SP142	
	<p>Set the unique constants for the spindle motor. (High-speed coil) The setting value is determined by the motor's mechanical and electrical characteristics and specifications, so normally set the value given in the spindle parameter list. For IPM spindle motor This parameter is used in initial magnetic pole detection of IPM spindle motor. (1) Pulse application time: Set it in [μs] unit.(0 < application time < 350) (2) Pulse application coil: To select a low-speed coil, add 1000 to the pulse application time. (3) Polarity of estimated magnetic pole: When it is set to the reverse polarity, add "-" to the total of (1) and (2). E.g.: When performing 333μs pulse-applied magnetic pole estimation in a low-speed coil and selecting the reverse polarity for the estimated polarity SP142 = -(333+1000) = -1333</p>		
(PR)	#13143- 13160	SP143-SP160	
	<p>Set the unique constants for the spindle motor. (High-speed coil) The setting value is determined by the motor's mechanical and electrical characteristics and specifications, so normally set the value given in the spindle parameter list.</p>		
(PR)	#13161- 13192	SP161-SP192	
	<p>Set the unique constants for the spindle motor. (Low-speed coil) The setting value is determined by the motor's mechanical and electrical characteristics and specifications, so normally set the value given in the spindle parameter list.</p>		
	#13193	SP193 LMR	Change magnification for load meter standard output (High-speed coil)
	<p>Set the standard output to be displayed as 100% in load meter using the short-time rated output ratio. To display the continuous rated output as 100%, set as follows. Continuous rated output/Short-time rated output \times 100 When "0" is set, the standard output to be displayed as 100% in load meter will be the short-time rated output. (Note) When several output characteristics such as 15-minute rating and 30-minute rating are plotted on the characteristics figure, set the change magnification for the characteristic with the highest rated output.</p> <p>---Setting range--- 0 to 100 (%)</p>		

#13194 SP194 LMN Base speed for load meter standard output (High-speed coil)

Set the base speed of the standard output to be displayed as 100% in load meter.
 To display the continuous rated output as 100%, set the base speed of the continuous rated output as follows.

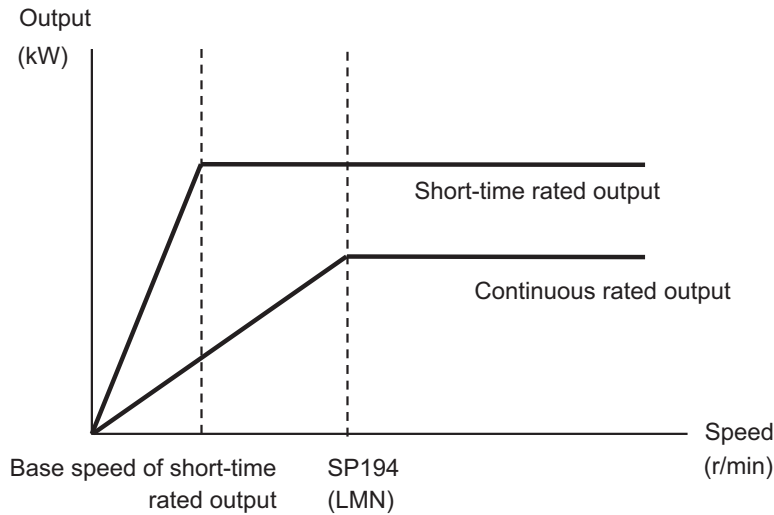

When "0" is set, the base speed of the short-time rated output will be applied.

(Note) When the speed is less than the base speed, the standard output to be displayed as 100% in load meter changes with the motor speed.

---Setting range---

0 to 32767 (r/min)

#13195 SP195 LMRL Change magnification for load meter standard output (Low-speed coil)

Set the standard output to be displayed as 100% in load meter using the short-time rated output ratio.

To display the continuous rated output as 100%, set as follows.

$\text{Continuous rated output} / \text{Short-time rated output} \times 100$

When "0" is set, the standard output to be displayed as 100% in load meter will be the short-time rated output.

(Note) When several output characteristics such as 15-minute rating and 30-minute rating are plotted on the characteristics figure, set the change magnification for the characteristic with the highest rated output.

---Setting range---

0 to 100 (%)

#13196	SP196 LMNL	Base speed for load meter standard output (Low-speed coil)
---------------	-------------------	---

Set the base speed of the standard output to be displayed as 100% in load meter.
 To display the continuous rated output as 100%, set the base speed of the continuous rated output as follows.

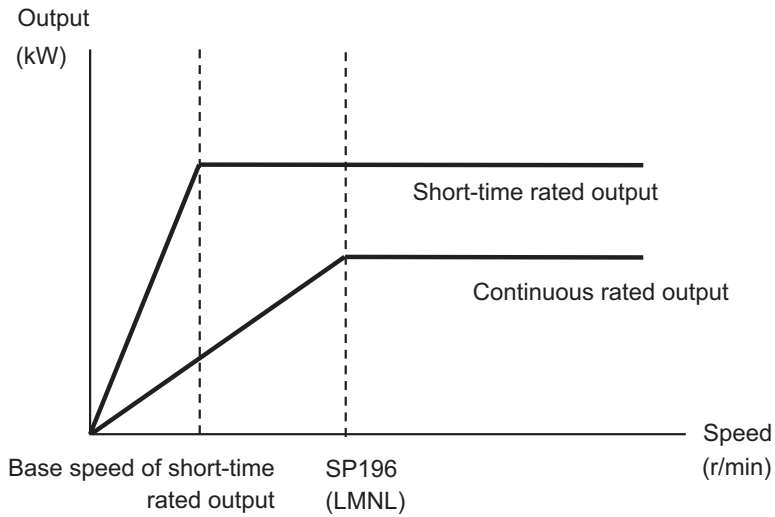

When "0" is set, the base speed of the short-time rated output will be applied.

(Note) When the speed is less than the base speed, the standard output to be displayed as 100% in load meter changes with the motor speed.

---Setting range---

0 to 32767 (r/min)

#13197-13198	SP197-SP198	
---------------------	--------------------	--

Not used. Set to "0".

#13199 SP199 RTGM Real-time tuning: maximum adaptive gain multiplier

In case that machine resonance is induced when mounting a workpiece, the speed loop gain is switched automatically in response to inertia by setting the speed loop gain and workpiece inertia multiplier in advance.

The speed loop gain SP199(RTGM) changes in response to the estimated inertia ratio SP200(RTJX) based on the speed loop gain SP005(VGN1) and the inertia multiplier SP037(JL) which were adjusted when no workpiece was mounted.

When SP199 is set to "0", the adaptation of the speed loop gain will be disabled.

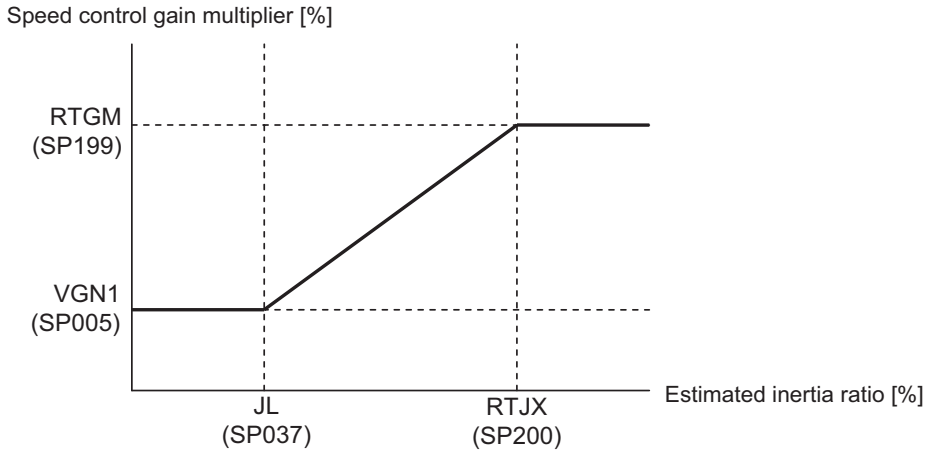

Related parameters: SP005, SP037, SP200

---Setting range---

0 to 5000 (%)

#13200 SP200 RTJX Real-time tuning: maximum adaptive inertia ratio

In case that machine resonance is induced when mounting a workpiece, the speed loop gain is switched automatically in response to inertia by setting the speed loop gain and workpiece inertia multiplier in advance.

The speed loop gain SP199(RTGM) changes in response to the estimated inertia ratio SP200(RTJX) based on the speed loop gain SP005(VGN1) and the inertia multiplier SP037(JL) which were adjusted when no workpiece was mounted.

When SP199 is set to "0", the adaptation of the speed loop gain will be disabled.

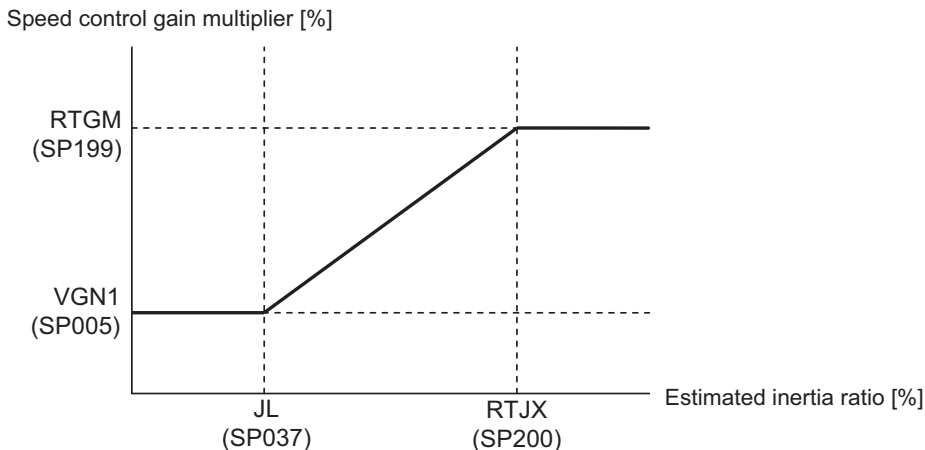

Related parameters: SP005, SP037, SP199

---Setting range---

0 to 32767 (%)

#13201- 13224	SP201-SP224
------------------	-------------

Not used. Set to "0".

#13225	SP225 SFNC5	Spindle function 5
--------	-------------	--------------------

Select the spindle functions.
Functions are allocated to each bit.
Set this in hexadecimal format.

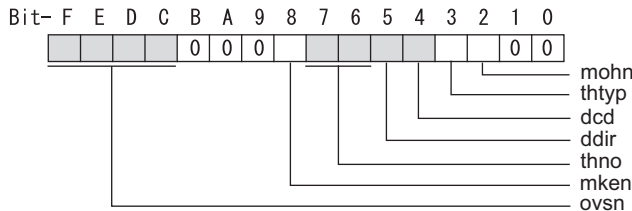

bit F-C: ovsn Overshooting compensation type 3 non-sensitive band

Set the non-sensitive band of the overshooting compensation type 3 in increments of 2°/1000. In the feed forward control, set the non-sensitive band for the model position droop and ignore the model overshooting. Set to "2°/1000" as a standard.

bit B-9:

Not used. Set to "0".

bit 8: mken Coil switch allowance in deceleration control

This enables a coil changeover while decelerating after an emergency stop for a spindle motor with coil changeover specification. A coil changeover may enable an excessive load inertia to stop within the maximum delay time.

0: Normal (Disable)

1: Enable

bit 7-6: thno

Select the thermistor characteristics.

When SP225/bit3=0 (N type) is selected

bit7,6=

00: For Mitsubishi Electric spindle motor

01: For Mitsubishi Electric spindle motor

10: PT3-51F

11: Setting prohibited

When SP225/bit3=1 (P type) is selected

bit7,6=

00: KTY84-130 (Manufactured by Philips)

01: Setting prohibited

10: Pt1000 (Platinum resistance temperature detector)

11: Setting prohibited

bit 5: ddir Proximity switch signal enable edge

0: Falling edge 1: Rising edge

bit 4: dcd DC excitation mode

0: Normal 1: Start

bit 3: thtyp

Select the thermistor type.

0: Type N thermistor (Mitsubishi Electric standard)

1: Type P thermistor or platinum resistance temperature detector

bit 2: mohn Thermistor temperature detection

0: Normal 1: Disable (Except for TS5690/5691)

bit 1-0:

Not used. Set to "0".

#13226

SP226 SFNC6

Spindle function 6

Select the spindle functions.
 Functions are allocated to each bit.
 Set this in hexadecimal format.

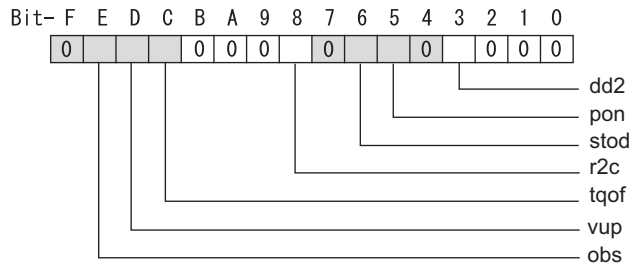

bit F :

Not used. Set to "0".

bit E : obs Disturbance observer

0: Normal 1: Enable

bit D : vup High response acceleration / deceleration

This suppresses a temporal delay which occurs when the target speed is attained from acceleration and when the spindle stops from deceleration.

0: Normal acceleration/deceleration 1: High response acceleration/deceleration Enable

bit C : tqof Spindle output stabilization during acceleration

0: Normal 1: Disable

bit B-9 :

Not used. Set to "0".

bit 8 : r2c Temperature compensation adjustment indicator

0: Normal 1: Display

bit 7 :

Not used. Set to "0".

bit 6 : stod 4D-2 detection disabled during deceleration and stop

0: Normal 1: Alarm 4D-2 detection disabled during deceleration and stop

bit 5 : pon IPM spindle pulse application magnetic pole estimation

0: Normal 1: Enable

bit 4 :

Not used. Set to "0".

bit 3 : dd2 High-speed synchronous tapping 2

0: Normal 1: Enable

bit 2-0 :

Not used. Set to "0".

#13227	SP227 SFNC7	Spindle function 7																
	<p>Select the spindle functions. Functions are allocated to each bit. Set this in hexadecimal format.</p>																	
	<p>Bit- F E D C B A 9 8 7 6 5 4 3 2 1 0</p> <table border="1" style="margin-left: 20px;"> <tr> <td style="width: 20px; height: 15px;"></td> <td style="width: 20px; height: 15px;"></td> <td style="width: 20px; height: 15px;"></td> <td style="width: 20px; height: 15px;"></td> <td style="width: 20px; height: 15px;"></td> <td style="width: 20px; height: 15px;"></td> <td style="width: 20px; height: 15px;">0</td> <td style="width: 20px; height: 15px;">0</td> <td style="width: 20px; height: 15px;">0</td> <td style="width: 20px; height: 15px;">0</td> <td style="width: 20px; height: 15px;">0</td> <td style="width: 20px; height: 15px;">0</td> <td style="width: 20px; height: 15px;">0</td> <td style="width: 20px; height: 15px;">0</td> <td style="width: 20px; height: 15px;">0</td> <td style="width: 20px; height: 15px;">0</td> </tr> </table> <div style="margin-left: 100px;"> <p>ccu</p> <p>dos3</p> <p>dis</p> </div>								0	0	0	0	0	0	0	0	0	0
						0	0	0	0	0	0	0	0	0	0			
	<p>bit F-C : dis Digital signal input selection</p> <p>0: No signal 4: Proximity switch signal detection Other settings: setting prohibited</p>																	
	<p>bit B-A : dos3 Digital signal output 3 selection (MDS-EJ-SP/SP2)</p> <p>bitB,A= 00: Disable 01: Setting prohibited 10: Contactor control signal output 11: Setting prohibited</p>																	
	<p>bit 9-3 :</p> <p>Not used. Set to "0".</p>																	
	<p>bit 2 : ccu Lost motion/overshoot compensation compensation amount setting unit</p> <p>0: Short-time rated % 1: Short-time rated 0.01%</p>																	
	<p>bit 1-0 :</p> <p>Not used. Set to "0".</p>																	
#13228	SP228 SFNC8	Spindle function 8																
	<p>Not used. Set to "0000".</p>																	

#13229

SP229 SFNC9

Spindle function 9

Select the spindle functions.
 Functions are allocated to each bit.
 Set this in hexadecimal format.

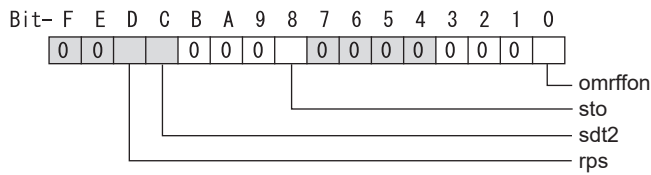

bit F-E :

Not used. Set to "0".

bit D : rps Safely limited speed setting unit

0: Normal 1: 100°/min

bit C : sdt2 Specified speed output digital signal 2 output

0: Normal 1: Enable

bit B-9 :

Not used. Set to "0".

bit 8 : sto Dedicated wiring STO function

Set this parameter to use dedicated wiring STO function.
 0: Dedicated wiring STO function unused 1: Dedicated wiring STO function used
 (Only for MDS-E/EH and MDS-EJ/EJH)

bit 7-1 :

Not used. Set to "0".

bit 0 : omrffon OMR-FF control enabled

0: Disable 1: Enable

#13230	SP230 SFNC10	Spindle function 10
	Select the spindle functions. Functions are allocated to each bit. Set this in hexadecimal format.	
	bit F-C : Not used. Set to "0".	
	bit B : pfdsr Set the spindle stop operation at a power failure when the deceleration and stop function at power failure is enabled. Normal (Coast to a stop at power failure) : 0 Deceleration and stop at power failure : 1	
	bit A-9 : Not used. Set to "0".	
	bit 8 : nohis History of communication error alarm between NC and DRV(34,36,38,39) 0: Enable 1: Disable	
	bit 7 : cse Spindle C axis command speed monitoring function 0: Normal setting (function disabled) 1: Function enabled	
	bit 6-0 : Not used. Set to "0". Related parameters: SP055, SP056	
#13231	SP231	
	bit 3-0 : Sensitivity of estimated resonance frequency Set the sensitivity of the estimated resonance frequency. Smaller setting value enables to detect smaller vibration component 0: Normal setting 1: Sensitivity high to F: Sensitivity low.	
#13232	SP232	
	Not used. Set to "0000".	
#13233	SP233 IVC	Voltage non-sensitive band compensation
	When 100% is set, the voltage equivalent to the logical non-energized time will be compensated. When "0" is set, 100% compensation will be performed. Adjust in increments of 10% from the default value 100%. If the value is too large, vibration or vibration noise may be generated.	
	---Setting range--- 0 to 255 (%)	
#13234	SP234	
	Not used. Set to "0".	
(PR) #13235	SP235 R2H	Temperature compensation gain
	Set the magnification in converting the thermistor temperature to the control compensation amount. When "0" is set, the temperature compensation function is disabled. When not using, or when using an IPM spindle motor, set to "0".	
	---Setting range--- 0 to 400 (%)	

(PR)	#13236	SP236 WIH	Temperature compensation time constant
			Set the delay time constant from the thermistor temperature to the control compensation amount. When "0" is set, the delay time constant is disabled. When not using, or when using an IPM spindle motor, set to "0".
			---Setting range--- 0 to 150 (min)
(PR)	#13237	SP237 TCF	Torque command filter
			Set the filter for the torque command. The standard value is "500".
			---Setting range--- 0 to 5000 (rad/s)
	#13238	SP238 SSCFEED	Safely limited speed
			Set the safely limited speed at the spindle end for the SLS (Safely Limited Speed) function. When not using, set to "0".
			---Setting range--- 0 to 18000 (°/min) However, when SP229/bitD is set to "1", the setting range is from -32768 to 32767 (100°/min).
	#13239	SP239 SSCRPM	Safely limited motor speed
			Set the motor's safely limited speed for the SLS (Safely Limited Speed) function. When not using, set to "0".
			---Setting range--- 0 to 32767 (r/min)
			(Note) The value of the safely limited speed and safely limited motor speed must satisfy the following relation. If this relation is not satisfied, the parameter error (37 or E4) will occur. (Error parameter No. is 239.) Checking this relation is executed when the drive unit is turned ON and parameter is changed and speed observation mode (states when a speed observation command is turned ON) is entered.
			$\frac{\text{SP238 :SSCFEED}}{360} \times \frac{\text{SP057 :GRA1}}{\text{SP061 :GRB1}} = \text{SP239 :SSCRPM}$
			Note that "1 (r/min)" is applied when the calculation result is "0 (r/min)"
(PR)	#13240	SP240	
			Not used. Set to "0".
(PR)	#13241- 13256	SP241-SP256	
			This is automatically set by the NC system.

5

Servo Adjustment

5.1 Servo Adjustment Procedure

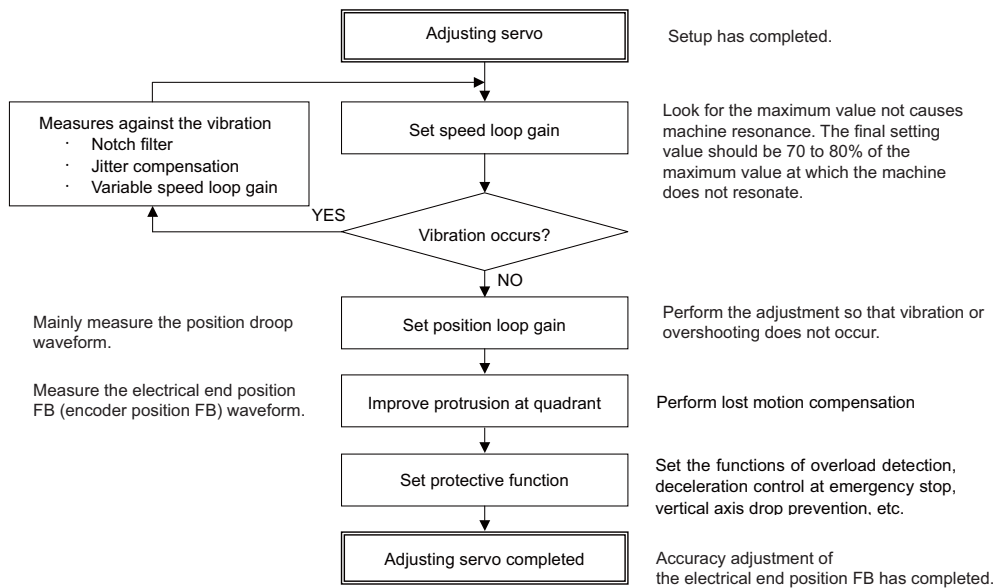

CAUTION

Perform adjusting the servo in the factory configuration of the machine. When the servo is adjusted without having an enough running-in or a cover, friction torque, machine resonance frequency or resonance gain may be different, resulting in an incorrect adjustment.

5.2 Gain Adjustment

5.2.1 Current Loop Gain

#2209 SV009 IQA Current loop q axis lead compensation

Set the fixed value of each motor.

Set the standard value for each motor described in the standard parameter list.

---Setting range---

1 to 20480

#2210 SV010 IDA Current loop d axis lead compensation

Set the fixed value of each motor.

Set the standard value for each motor described in the standard parameter list.

---Setting range---

1 to 20480

#2211 SV011 IQG Current loop q axis gain

Set the fixed value of each motor.

Set the standard value for each motor described in the standard parameter list.

---Setting range---

1 to 8192

#2212 SV012 IDG Current loop d axis gain

Set the fixed value of each motor.

Set the standard value for each motor described in the standard parameter list.

---Setting range---

1 to 8192

5.2.2 Speed Loop Gain

(1) Setting the speed loop gain

The speed loop gain 1 (SV005: VGN1) is an important parameter for determining the responsiveness of the servo control. During servo adjustment, the highest extent that this value can be set to becomes important. The setting value has a large influence on the machine cutting precision and cycle time.

- [1] Refer to the following standard VGN1 graphs and set the standard VGN1 according to the size of the entire load inertia (motor and machine load inertia).
- [2] If the standard VGN1 setting value is exceeded, the current command fluctuation will increase even if the speed feedback fluctuates by one pulse. This can cause the machine to vibrate easily, so set a lower value to increase the machine stability.

< When machine resonance does not occur at the standard VGN1 >

Set the standard VGN1. Use the standard value if no problem (such as machine resonance) occurs. If sufficient cutting precision cannot be obtained at the standard VGN1, VGN1 can be raised above the standard value as long as a 70 percent margin in respect to the machine resonance occurrence limit is maintained. The cutting accuracy can also be improved by adjusting with the disturbance observer.

< When machine resonance occurs at the standard VGN1 >

Machine resonance is occurring if the shaft makes abnormal sounds when operating or stopping, and a fine vibration can be felt when the machine is touched while stopped. Machine resonance occurs because the servo control responsiveness includes the machine resonance points. (Speed control resonance points occur, for example, at parts close to the motor such as ball screws.) Machine resonance can be suppressed by lowering VGN1 and the servo control responsiveness, but the cutting precision and cycle time are sacrificed. Thus, set a vibration suppression filter and suppress the machine resonance (Refer to section "Vibration Suppression Measures"), and set a value as close as possible to the standard VGN1. If the machine resonance cannot be sufficiently eliminated even by using a vibration suppression filter, then lower the VGN1.

#2205 SV005 VGN1 Speed loop gain 1

Set the speed loop gain.

The higher the setting value is, the more accurate the control will be, however, vibration tends to occur.

If vibration occurs, adjust by lowering by 20 to 30%.

The value should be determined to the 70 to 80% of the value at which the vibration stops.

The value differs depending on servo motors.

Aim at the standard value determined by the servo motor type and load inertia ratio to adjust.

---Setting range---

1 to 30000



POINT

Suppressing the resonance with the vibration suppression function and increasing the VGN1 setting is effective for adjusting the servo later.

Load inertia ratio display

Perform the measurement in the section "Measuring unbalance torque and frictional torque", and set a torque offset (SV032) and frictional torque (SV045).

When an acceleration/deceleration operation is executed with the setting of SV035/bitF=1, an estimated load inertia ratio will be displayed in "load inertia ratio" on the drive monitor screen.

Standard VGN1 graph (servo motor HG, HG-H Series)

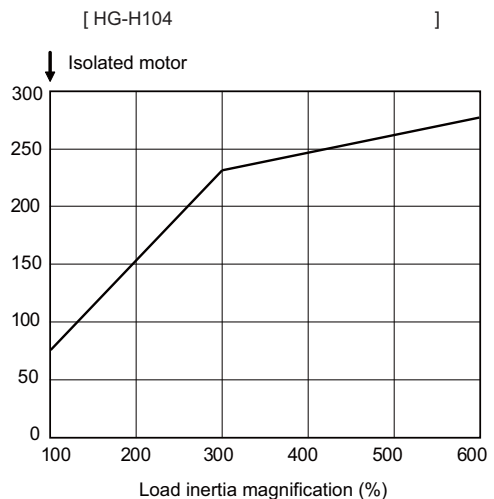
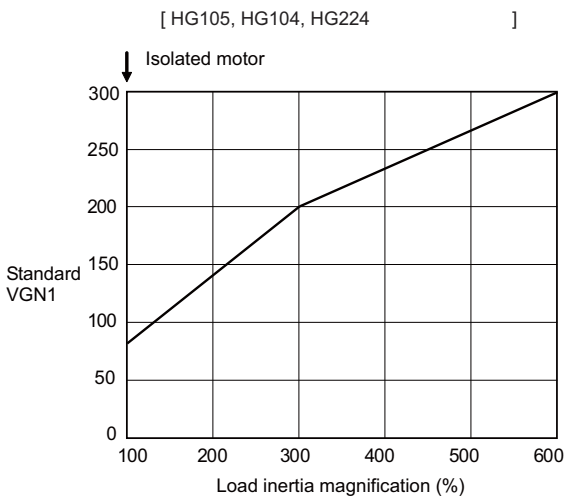
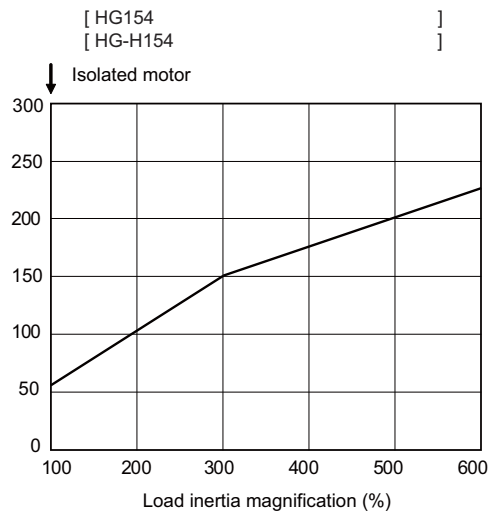
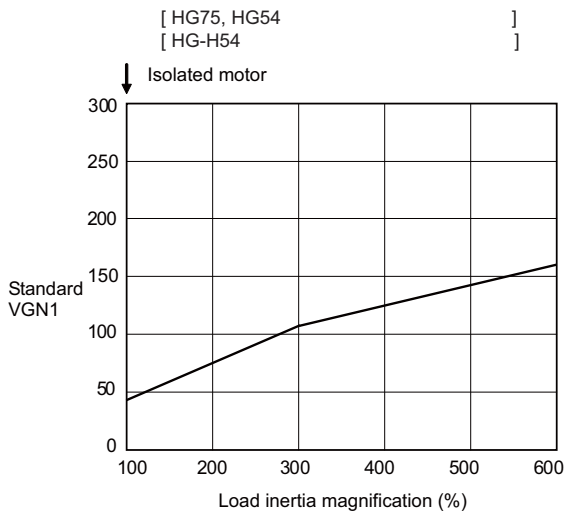
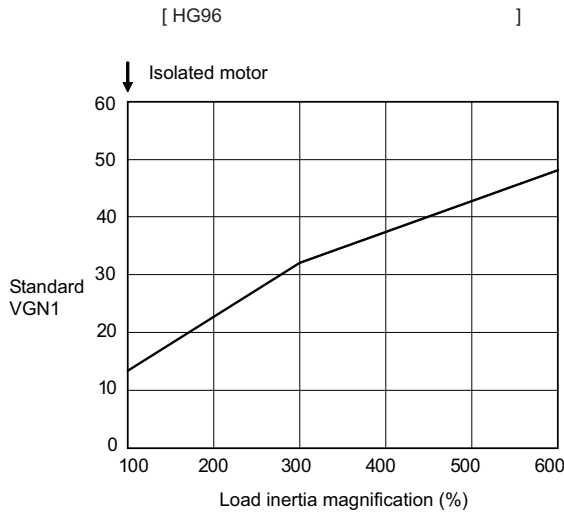

[HG204, HG354, HG123, HG142]
 [HG-H204]

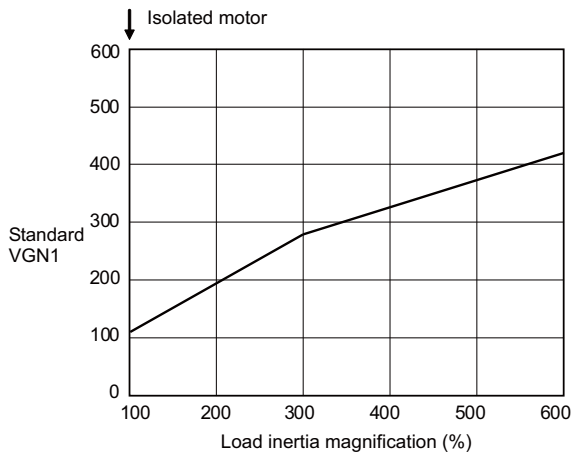

[HG223, HG453, HG702]
 [HG-H354, HG-H453]

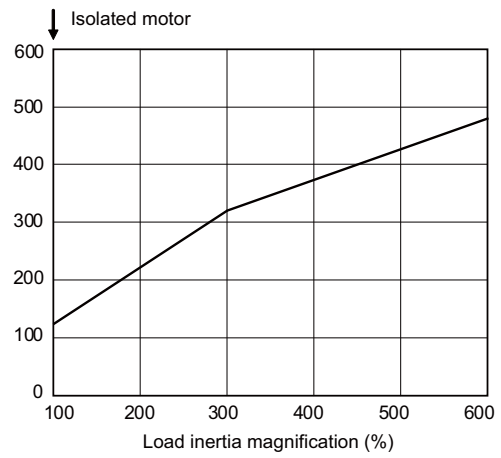

[HG303]

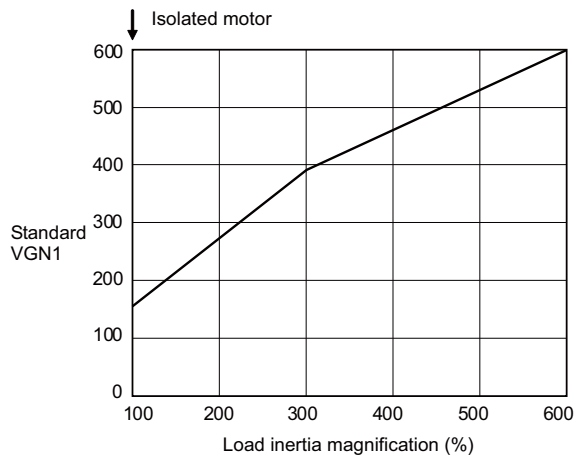

[HG302]

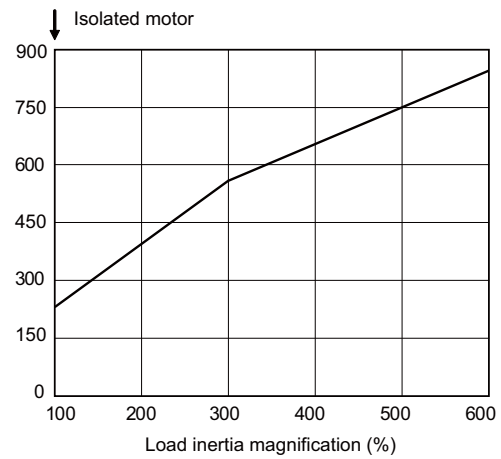

Standard VGN1 graph (servo motor HK, HK-H Series)

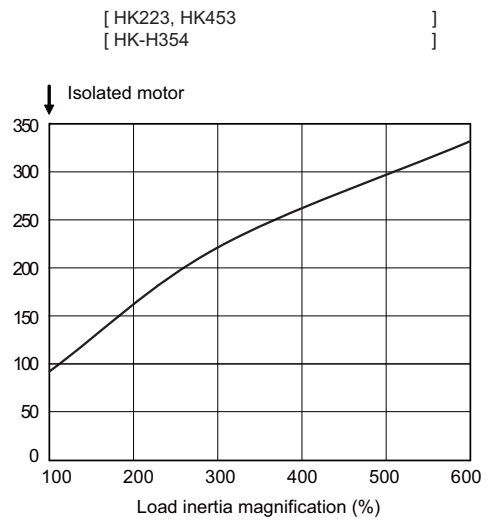
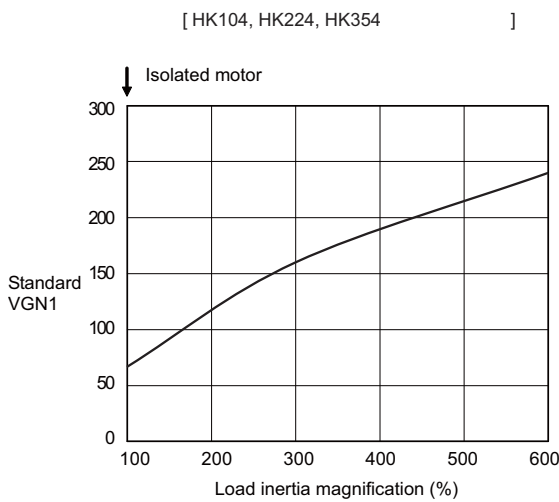
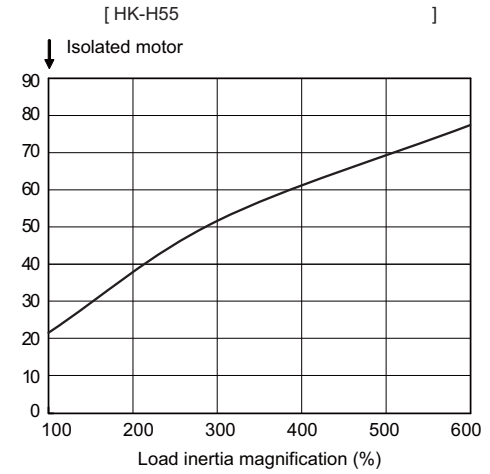
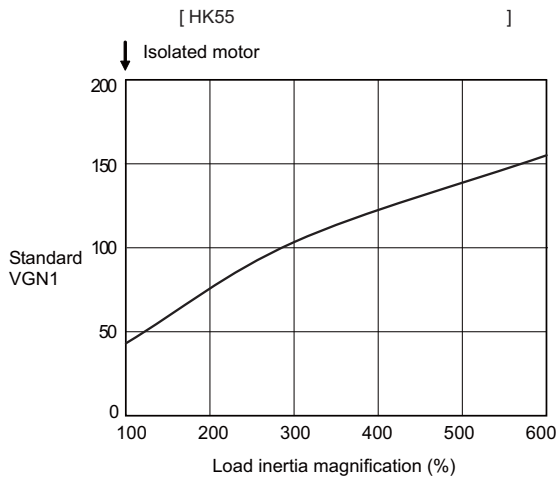
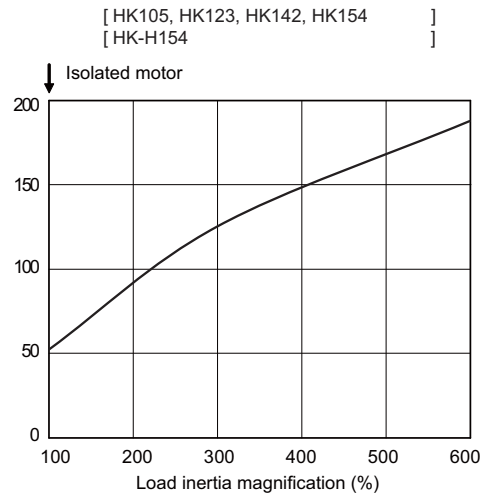
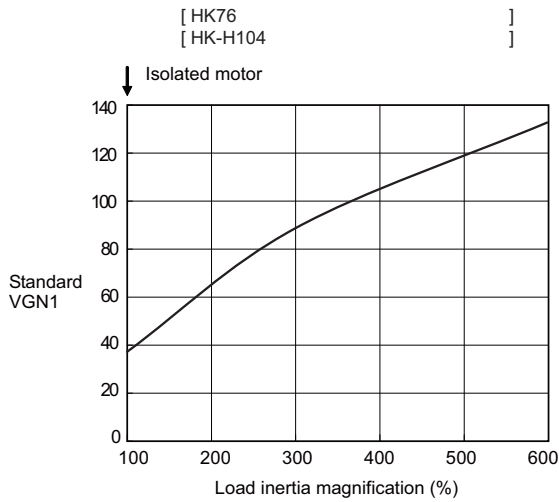

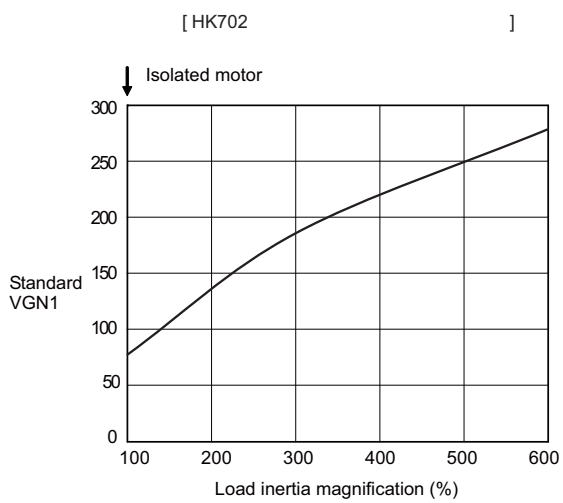
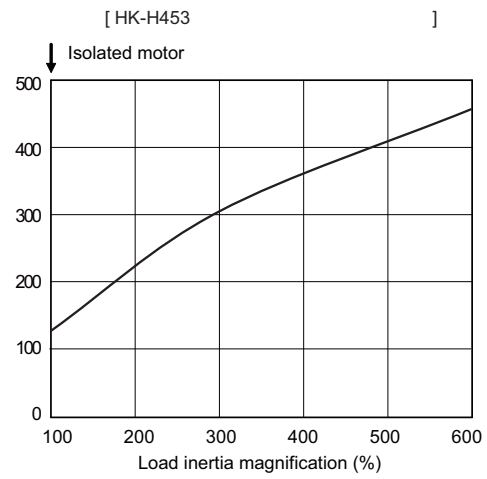
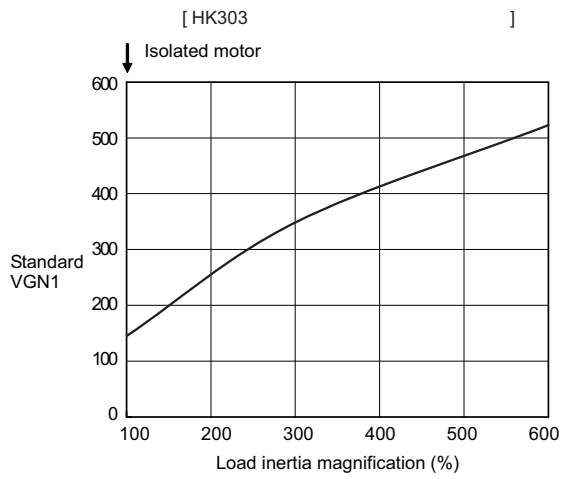
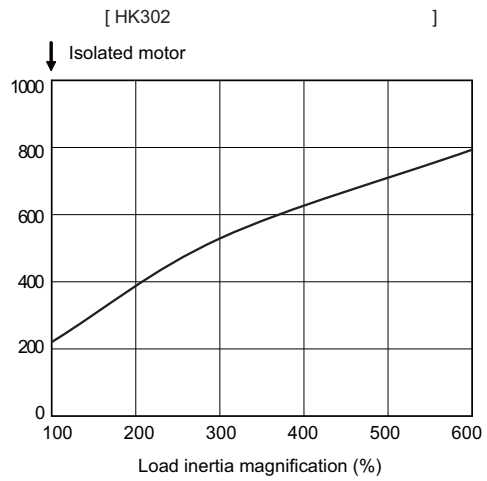
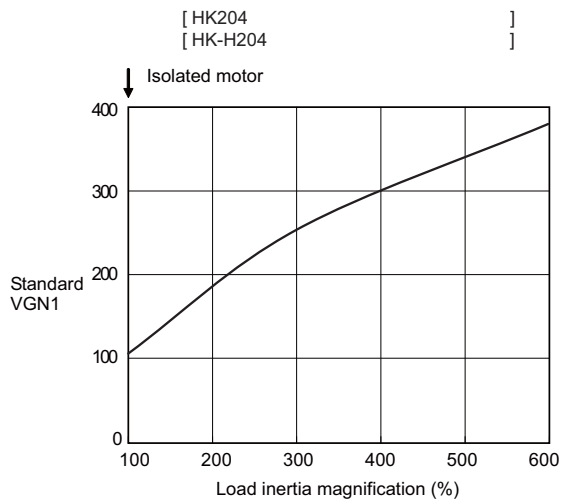

(2) Setting the speed loop lead compensation

The speed loop lead compensation (SV008: VIA) determines the characteristics of the speed loop mainly at low frequency regions. 1364 is set as a standard, and 1900 is set as a standard during SHG control. The standard value may drop in respect to loads with a large inertia.

When the VGN1 is set lower than the standard value because the load inertia is large or because machine resonance occurred, the speed loop control band is lowered. If the standard value is set in the leading compensation in this status, the leading compensation control itself will induce vibration. In concrete terms, a vibration of 10 to 20Hz could be caused during acceleration/ deceleration or stopping, and the position droop waveform could be disturbed when accelerating to a constant speed and when stopped. (Refer to lower left drawing)

This vibration cannot be suppressed by the vibration suppression functions. Lower the VIA in increments of 100 from the standard setting value. Set a value where vibration does not occur and the position droop waveform converges smoothly. Because lowering the VIA causes a drop in the position control's trackability, the vibration suppression is improved even when a disturbance observer is used without lowering the VIA. (Be careful of machine resonance occurrence at this time.)

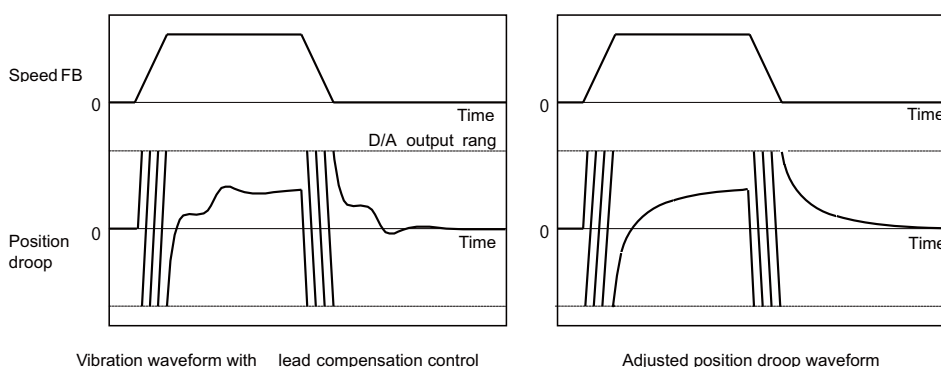

If VIA is lowered, the position droop waveform becomes smooth and overshooting does not occur.

However, because the trackability in respect to the position commands becomes worse, the positioning time and accuracy are sacrificed. VIA must be kept high (set the standard value) to guarantee precision, especially in high-speed contour cutting (generally $F = 1000$ or higher). In other words, in a machine aiming for high speed and high accuracy, a large enough value must be set in VGN1 so that VIA does not need to be lowered. When adjusting, the cutting precision will be better if adjustment is carried out to a degree where overshooting does not occur and a high VIA is maintained, without pursuing position droop smoothness.

If there are no vibration or overshooting problems, the high-speed contour cutting precision can be further improved by setting the VIA higher than the standard value. In this case, adjust by raising the VIA in increments of 100 from the standard value.

Setting a higher VIA improves the trackability regarding position commands in machines for which cycle time is important, and the time to when the position droop converges on the in-position width is shortened.

It is easier to adjust the VIA to improve precision and cycle time if a large value (a value near the standard value) can be set in VGN1, or if VGN1 can be raised equivalently using the disturbance observer.

#2208 SV008 VIA Speed loop lead compensation

Set the gain of the speed loop integral control.

Standard setting: 1364

Standard setting in the SHG control: 1900

Adjust the value by increasing/decreasing this by about 100 at a time.

Raise this value to improve contour tracking accuracy in high-speed cutting.

Lower this value when the position droop does not stabilize (when the vibration of 10 to 20Hz occurs).

---Setting range---

1 to 9999

**POINT**

Position droop vibration of 10Hz or less is not leading compensation control vibration. The position loop gain must be adjusted.

5.2.3 Position Loop Gain

(1) Setting the position loop gain

The position loop gain 1 (SV003: PGN1) is a parameter that determines the trackability to the command position. 33 is set as a standard. Set the same position loop gain value between interpolation axes.

When PGN1 is raised, the trackability will be raised and the settling time will be shortened, but a speed loop that has a responsiveness that can track the position loop gain with increased response will be required. If the speed loop responsiveness is insufficient, several Hz of vibration or overshooting will occur during acceleration/ deceleration. Vibration or overshooting will also occur when VGN1 is smaller than the standard value during VIA adjustment, but the vibration in the position loop occurs generally 10Hz or less. (The VIA vibration occurs from 10 to 20Hz.) When the position control includes machine resonance points (Position control machine resonance points occur at the tool end parts, etc.) because of insufficient machine rigidity, the machine will vibrate during positioning, etc. In either case, lower PGN1 and adjust so that vibration does not occur.

If the machine also vibrates due to machine backlash when the motor stops, the vibration can be suppressed by lowering the PGN1 and smoothly stopping.

If SHG control is used, an equivalently high position loop gain can be maintained while suppressing these vibrations. Adjust SHG control by raising the gain gradually after setting PGN1 as 1/2 a value of PGN1 at which a vibration does not occur under the normal control. If the PGN1 setting value is more than 1/2 of the normal control PGN1 when SHG control is used, there is an improvement effect in position control. (Note that for the settling time the improvement effect is at $1/\sqrt{2}$ or more.)

#2203 SV003 PGN1 Position loop gain 1

Set the position loop gain. The standard setting is "33".

The higher the setting value is, the more accurately the command can be followed, and the shorter the settling time in positioning gets, however, note that a bigger shock will be applied to the machine during acceleration/deceleration.

When using the SHG control, also set SV004 (PGN2) and SV057 (SHGC).

---Setting range---

1 to 200 (rad/s)

#2204 SV004 PGN2 Position loop gain 2

When performing the SHG control, set the value of "SV003 x 8/3" to "SV004".

When not using the SHG control, set to "0".

---Setting range---

0 to 999 (rad/s)

#2257 SV057 SHGC SHG control gain

When performing the SHG control, set to SV003(PGN1)*6.

When not using the SHG control, set to "0".

---Setting range---

0 to 1200 (rad/s)

CAUTION

Always set the same value for the position loop gain between the interpolation axes.

(2) Setting the position loop gain for spindle synchronous control

During spindle synchronous control (synchronous tapping control, etc.), there are three sets of position loop gain parameters besides the normal control.

#2249 SV049 PGN1sp Position loop gain 1 in spindle synchronous control

Set the position loop gain during spindle synchronization control (synchronous tapping and synchronization control with spindle C-axis).

Set the same value as that of the position loop gain for spindle synchronous tapping control.

When performing the SHG control, set this parameter with SV050 (PGN2sp) and SV058 (SHGCsp).

---Setting range---

1 to 200 (rad/s)

#2250 SV050 PGN2sp Position loop gain 2 in spindle synchronous control

When using SHG control during spindle synchronous control (synchronous tapping and synchronization control with spindle C-axis), set this parameter with SV049 (PGN1sp) and SV058 (SHGCsp).

Make sure to set the value 8/3 times that of SV049.

When not using the SHG control, set to "0".

---Setting range---

0 to 999 (rad/s)

#2258 SV058 SHGCsp SHG control gain in spindle synchronous control

When using SHG control during spindle synchronization control (synchronous tapping and synchronous control with spindle C-axis), set this parameter with SV049 (PGN1sp) and SV050 (PGN2sp).

Make sure to set the value 6 times that of SV049.

When not using the SHG control, set to "0".

---Setting range---

0 to 1200 (rad/s)

**CAUTION**

Always set the same value for the position loop gain between the spindle and servo synchronous axes.

(3) SHG control

If the position loop gain is increased or feed forward control (NC function) is used to shorten the settling time or increase the precision, the machine system may vibrate easily.

SHG control changes the position loop to a high-gain by stably compensating the servo system position loop through a delay. This allows the settling time to be reduced and a high precision to be achieved. (SHG: Smooth High-Gain)

(Feature 1) When the SHG control is set, even if PGN1 is set to the same value as the conventional gain, the position loop gain will be doubled.

(Feature 2) The SHG control response is smoother than conventional position control during acceleration/ deceleration, so the gain can be increased further with SHG control compared to the conventional position control.

(Feature 3) With SHG control, a high gain is achieved so a high precision can be obtained during contour control.

The following drawing shows an example of the improvement in roundness characteristics with SHG control.

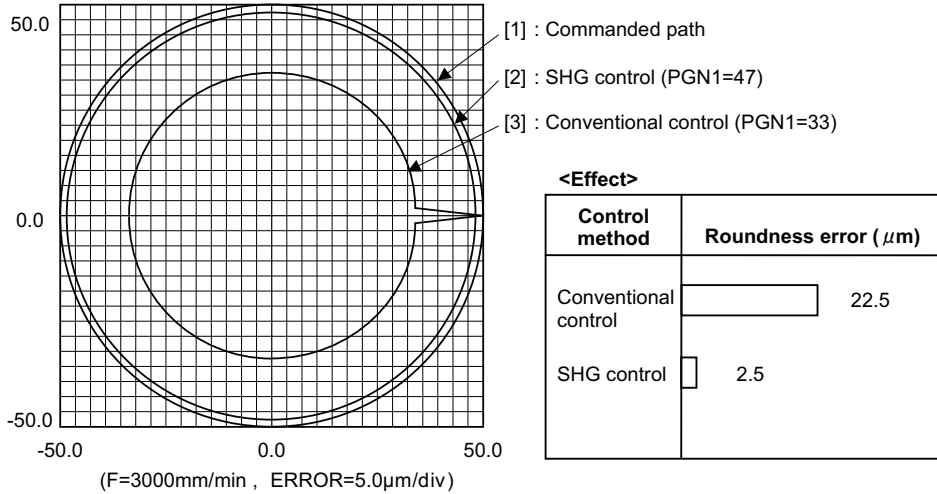

Shape error characteristics

During SHG control, PGN1, PGN2 and SHGC are set with the following ratio.

PGN1 : PGN2 : SHGC = 1 : 8/3 : 6

During SHG control even if the PGN1 setting value is the same, the actual position loop gain will be higher, so the speed loop must have a sufficient response. If the speed loop response is low, vibration or overshooting could occur during acceleration/deceleration in the same manner as conventional control. If the speed loop gain has been lowered because machine resonance occurs, lower the position loop gain and adjust.

No.	Abbrev.	Parameter name	Setting ratio	Setting example					Explanation	Setting range
SV003 (SV049)	PGN1 (PGN1sp)	Position loop gain 1	1	21	27	33	39	48	Always set with a combination of these three parameters.	1 to 200 (rad/s)
SV004 (SV050)	PGN2 (PGN2sp)	Position loop gain 2	8/3	56	72	88	104	128		0 to 999 (rad/s)
SV057 (SV058)	SHGC (SHGCsp)	SHG control gain	6	126	162	198	234	288		0 to 1200 (rad/s)

#2208 SV008 VIA Speed loop lead compensation

Set the gain of the speed loop integral control.
 Standard setting: 1364
 Standard setting in the SHG control: 1900
 Adjust the value by increasing/decreasing this by about 100 at a time.
 Raise this value to improve contour tracking accuracy in high-speed cutting.
 Lower this value when the position droop does not stabilize (when the vibration of 10 to 20Hz occurs).

---Setting range---
 1 to 9999

#2215 SV015 FFC Acceleration rate feed forward gain

When a relative error in synchronous control is too large, set this parameter to the axis that is delaying.
 The standard setting is "0". The standard setting in the SHG control is "100".
 To adjust a relative error in acceleration/deceleration, increase the value by 50 at a time.

---Setting range---
 0 to 999 (%)

5.2.4 OMR-FF Function

OMR-FF control improves the inner rounding amount of the arc, corner tracking error, or path vibration, etc. more comprehensively than conventional high-speed high-accuracy control by creating appropriate feed forward command for each of position, speed, and current depending on the vibration characteristics of the control target.

Feed forward is performed inside the drive unit according to the scale model and inertia setting in the OMR-FF generation part, and can independently set the command trackability with the scale model position loop gain (PGM) and the servo rigidity with the position control gain (PGN). This enables the higher and smoother trackability to the position command.

This function can be highly effective for linear servo, direct drive motors, or general motors in semi-closed loop control. OMR-FF control option for NC side is required when using this function.

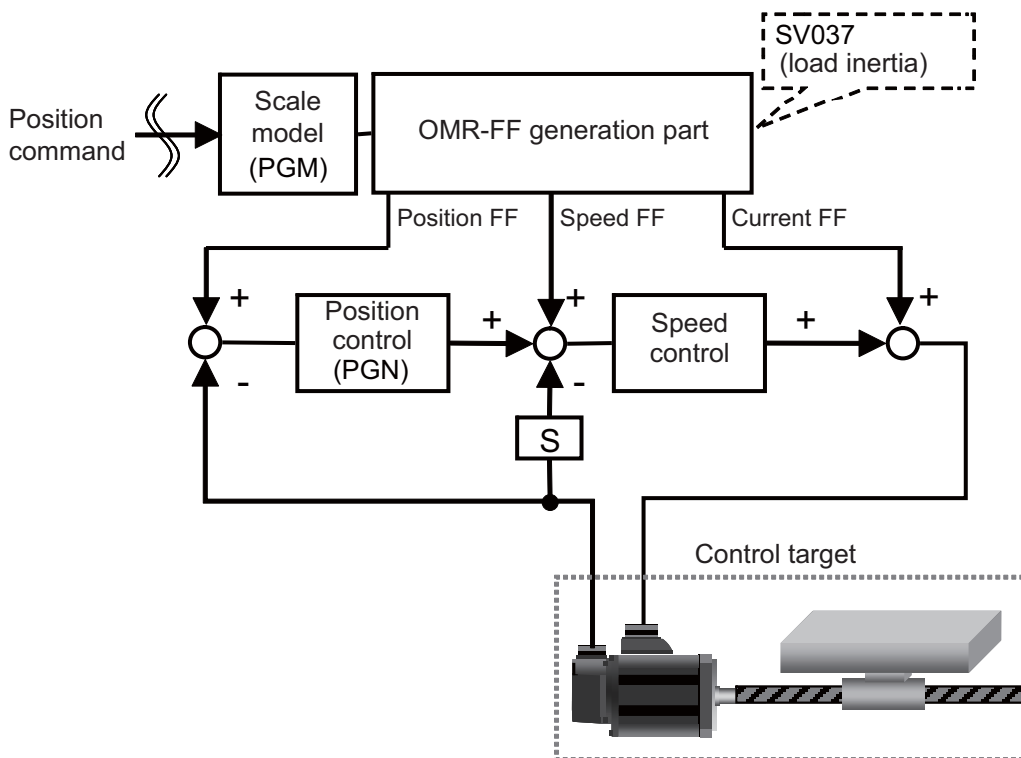

OMR-FF function adjustment parameters

No.	Abbrev.	Parameter name	Setting range (unit)
SV106	PGM	OMR-FF scale model gain	0 to 300 (rad/s)
SV112	IFF	OMR-FF current feed forward gain	0 to 32767 (0.01%)

CAUTION

1. Always set the load inertia scale when using this function because the parameter is crucial to this function.
If this function is enabled, the estimated inertia value is displayed as "0". If setting the load inertia scale, be sure to set it before the adjustment for OMR-FF function.
2. Disable SHG control when using this function.

< Initial implementation >

When using OMR-FF function, perform the following adjustment items beforehand. The adjustment for OMR-FF function does not operate correctly if the following items are not performed.

< Setting method >

- (1) Confirm that OMR-FF function is invalid.
 #2139 : omrff_off= "1"
 #2313 : SV113(SSF8)/bit0 = "0"
- (2) Set the standard parameters for the motor to be used.
- (3) Enable SHG control.
 Set #2203 : SV003(PGN1) to the standard setting, "33".
 Set #2204 : SV004(PGN2) to "88".
 Set #2257 : SV057(SHGC) to "198".
 Set #2208 : SV008(VIA) to "1900".
- (4) Adjust the speed loop gain. Adjust so that VGN1 is an appropriate value (the result of frequency response measurement on NC Analyzer is "Gain Margin > 8dB / Phase Margin > 30deg").
 -> For the adjustment method, refer to the section "6.1.2 (3) Adjusting the speed loop parameter".
- (5) Confirm that acceleration/deceleration operation can be executed with no alarm.
- (6) Set SV035(SSF4)/bitF(ctl) to "1" and repeat acceleration/deceleration several times. Check the estimated inertia value on the NC monitor screen and set the displayed value to SV037(JL).
- (7) Set SV003(PGN1) .
 Check "Cross Freq (Hz)" with frequency response measurement on NC Analyzer.

$$SV003(PGN1) = \text{"Cross Freq (Hz)} \times 2\pi / 4$$
 (Example 1) Measurement value Cross Freq : 100Hz
 Since $100(\text{Hz}) \times 2\pi / 4 \approx 157$, set SV003(PGN1) to 157.
 * The value of SV003(PGN1) must be set for each axis to be used.

#2139 omrff_off OMR-FF invalid

Select whether to enable or temporarily disable the OMR-FF control when OMR-FF is valid.

0 : OMR-FF function is applied if OMR-FF function is enabled.

1 : OMR-FF function is temporarily disabled and conventional feed forward control is applied if OMR-FF function is enabled.

#2203 SV003 PGN1 Position loop gain 1

Set the position loop gain. The standard setting is "33".

The higher the setting value is, the more accurately the command can be followed, and the shorter the settling time in positioning gets, however, note that a bigger shock will be applied to the machine during acceleration/deceleration.

When using the SHG control, also set SV004 (PGN2) and SV057 (SHGC).

When using the OMR-FF control, set the servo rigidity against quadrant projection or cutting load, etc. For the tracking ability to the command, set by SV106(PGM).

---Setting range---

1 to 200 (rad/s)

#2204 SV004 PGN2 Position loop gain 2

When performing the SHG control, set the value of "SV003 x 8/3" to "SV004".

When not using the SHG control, set to "0".

When using the OMR-FF control, set to "0".

Related parameters: SV003, SV057

---Setting range---

0 to 999 (rad/s)

#2257 SV057 SHGC SHG control gain

When performing the SHG control, set to SV003(PGN1)×6.

When not using the SHG control, set to "0".

When using the OMR-FF control, set to "0".

Related parameters: SV003, SV004

---Setting range---

0 to 1200 (rad/s)

#2237 SV037 JL Load inertia scale

Set the motor axis conversion total load inertia including motor itself in proportion to the motor inertia.

$$SV037(JL)=(Jm+JI)/Jm \times 100$$

Jm: Motor inertia

JI: Motor axis conversion load inertia

For linear motor, set the gross mass of the moving sections in kg unit.

<<Drive monitor load inertia ratio display>>

Set SV035/bitF=1 and imbalance torque and friction torque to both SV032 and SV045, and then repeat acceleration/deceleration for several times.

---Setting range---

For general motor: 0 to 5000 (%)

For linear motor 0 to 5000 (kg)

< OMR-FF function adjustment items >

Enable OMR-FF function after performing the adjustment items in < Initial implementation > and adjust the following parameters.

< Setting method >

- (1) Disable SHG control.
Set #2204 : SV004(PGN2) to "0"
Set #2257 : SV057(SHGC) to "0"
Set #2208 : SV008(VIA) to "1364"
- (2) Enable OMR-FF function.
#2139 : omrff_off = "0"
#2313 : SV113(SSF8)/bit0 = "1"
- (3) Set the OMR-FF function related parameters.
Set #2306 : SV106(PGM) to the same value as SV003.
Set #2312 : SV112(IFF) to "10000"
- (4) Set the following parameter with overshooting, machine vibration and current value in cutting feed and rapid traverse.
< Adjustment parameter >
#2306 : SV106(PGM)
- (5) Set the following parameters with the roundness measurement.
< Adjustment parameters >
#2306 : SV106(PGM)
- (6) Set the following parameters with the corner accuracy test.
< Adjustment parameters >
#2304 : SV104(FFR0)
#2305 : SV105(FFR1)
#2306 : SV106(PGM)

 **CAUTION**

1. After the above adjustment, set SV106 in the interpolation axes to the same value as the axis with the lowest SV106 value.
2. Perform the above confirmation of accuracy in G61.1(G8P1)(high-accuracy) mode; use the constant and filter for high-accuracy mode with OMR-FF function. Note that only #2010: fwd-g (Feed forward gain) will be disabled.
3. Feed forward gain (#2010 : fwd_g) on NC side will be disabled while this function is enabled (#2139:omrff_off = "0").
4. The following functions will be disabled when using this function.
 - Acceleration rate feed forward function
 - Overshoot compensation function

Adjustment method of OMR-FF function

Always perform < Initial implementation > before performing the following adjustment items.

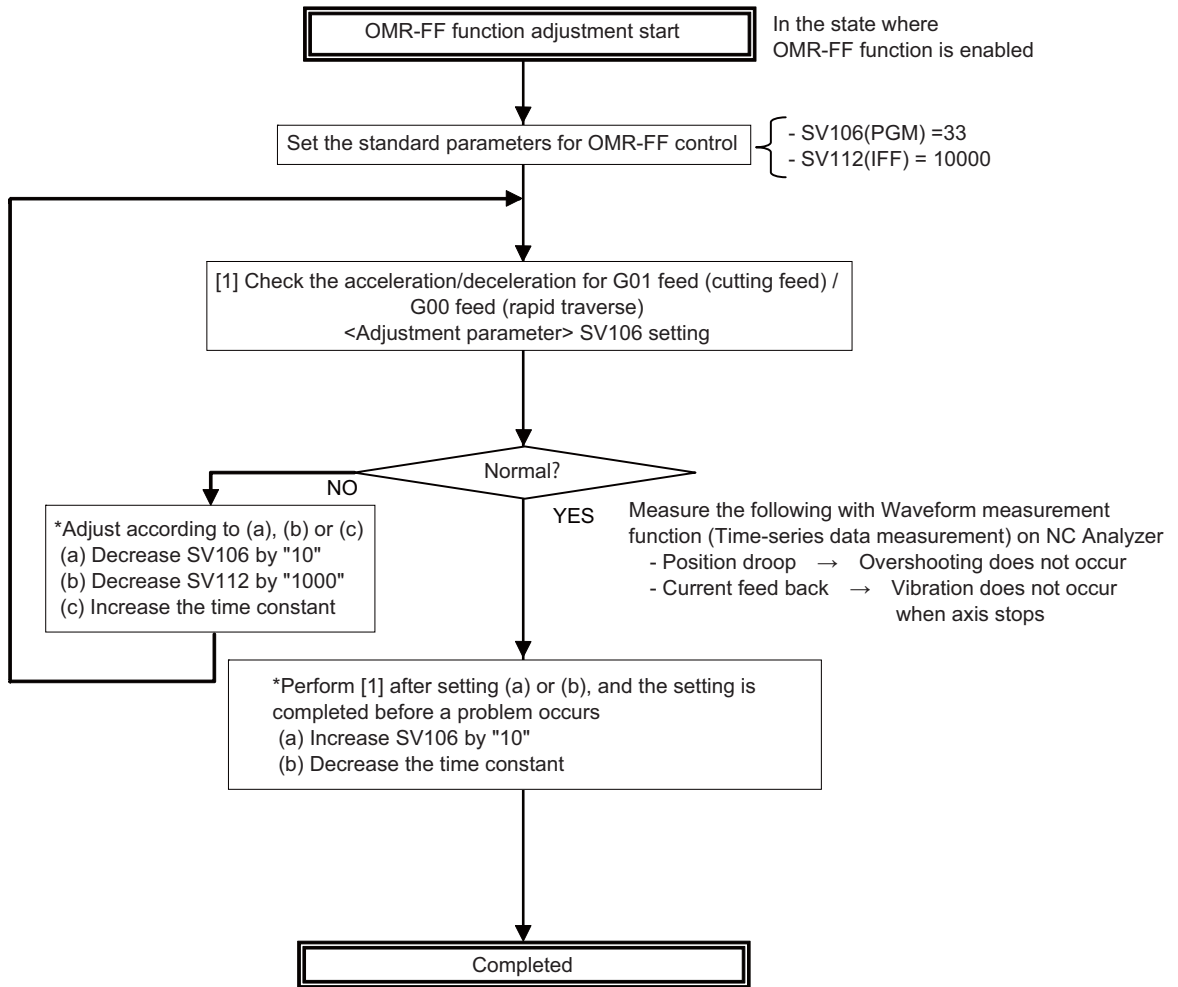

CAUTION

1. Always set the same value in the scale model gain of the interpolation axes when OMR-FF function is enabled.
2. Perform the above confirmation of accuracy in G61.1(G8P1)(high-accuracy) mode; use the constant and filter for high-accuracy mode with OMR-FF function.
Note that only #2010: fwd-g (Feed forward gain) will be disabled.

#2306 SV106 PGM OMR-FF scale model gain

Set the scale model gain (position response) in OMR-FF control.
Set the same value as SV003(PGN1).
Increase the setting value to perform a high-speed machining such as a fine arc or to improve the path error.
Lower the value when vibration occurs during acceleration/deceleration.
Set to "0" when not using OMR-FF control.

---Setting range---

0 to 300 (rad/s)

#2312 SV112 IFF OMR-FF current feed forward gain

Set the current feed forward rate in OMR-FF control.
The standard setting is "10000".
Setting value of "0" is equal to "10000(100%)" setting.
Set to "0" when not using OMR-FF control.

---Setting range---

0 to 32767 (0.01%)

#2313 SV113 SSF8 Servo function 8**bit 0 : omrffon OMR-FF control enabled**

0: Disable 1: Enable

5.3 Characteristics Improvement

5.3.1 Optimal Adjustment of Cycle Time

The following items must be adjusted to adjust the cycle time. Refer to the Instruction Manuals provided with each CNC for the acceleration/deceleration pattern.

- [1] Rapid traverse rate (rapid) : This will affect the maximum speed during positioning.
- [2] Clamp speed (clamp) : This will affect the maximum speed during cutting.
- [3] Acceleration/deceleration time constant (G0t*, G1t*) : Set the time to reach the feedrate.
- [4] In-position width (SV024) : This will affect each block's movement command end time.
- [5] Position loop gain (SV003) : This will affect each block's movement command settling time.

(1) Adjusting the rapid traverse

To adjust the rapid traverse, the CNC axis specification parameter rapid traverse rate (rapid) and acceleration/deceleration time constant (G0t*) are adjusted. The rapid traverse rate is set so that the motor speed matches the machine specifications in the range below the maximum speed in the motor specifications. For the acceleration/deceleration time constants, carry out rapid traverse reciprocation operation, and set so that the maximum current command value at acceleration/deceleration is within the range shown below. The output torque is limited at areas near the maximum speed, so monitor the current FB waveform during acceleration/deceleration and adjust so that the torque is within the specified range.

If the drive unit's input voltage is less than the rated voltage, the torque will easily become insufficient, and excessive errors will occur easily during acceleration/deceleration.

Maximum tolerable current command value when adjusting the rapid traverse acceleration/deceleration time constant

MDS-EM Series (200V series)		MDS-EMH Series (400V series)	
Motormodel	Max. current command value	Motormodel	Max. current command value
HG96	Within 260%	HG-H54	Within 460%
HG75	Within 380%	HG-H104	Within 370%
HG105	Within 270%	HG-H154	Within 410%
HG54	Within 460%	HG-H204	Within 310%
HG104	Within 350%	HG-H354	Within 330%
HG154	Within 410%	HG-H453	Within 320%
HG224	Within 320%	HK-H55	Within 400%
HG204	Within 340%	HK-H104	Within 250%
HG354	Within 280%	HK-H154	Within 360%
HG123	Within 190%	HK-H204	Within 310%
HG223	Within 230%	HK-H354	Within 310%
HG303	Within 260%	HK-H453	Within 280%
HG453	Within 220%		
HG702	Within 270%		
HG142	Within 190%		
HG302	Within 210%		
HK76	Within 270%		
HK105	Within 230%		
HK55	Within 390%		
HK104	Within 250%		
HK123	Within 220%		
HK142	Within 220%		
HK154	Within 360%		
HK223	Within 240%		
HK224	Within 310%		
HK204	Within 290%		
HK302	Within 220%		
HK303	Within 290%		
HK354	Within 260%		
HK453	Within 230%		
HK702	Within 230%		

(2) Adjusting the cutting feed

To adjust the cutting rate, the NC axis specification parameter clamp speed (clamp) and acceleration/deceleration time constant (G1t*) are adjusted. The in-position width at this time must be set to the same value as actual cutting.

- Determining the clamp rate and adjusting the acceleration/deceleration time constant

(Features)The maximum cutting rate (clamp speed) can be determined freely.

(Adjustment)Carry out cutting feed reciprocation operation with dwell at the maximum cutting rate and adjust the acceleration/deceleration time constant so that the maximum current command value during acceleration/deceleration is within the range shown below.

- Setting the step acceleration/deceleration and adjusting the clamp speed

(Features)The acceleration/deceleration time constant is determined with the position loop in the servo, so the acceleration/deceleration FΔT can be reduced.

(Adjustment)Set 1 (step) for the acceleration/deceleration time constant and carry out cutting feed reciprocation operation with dwell. Adjust the cutting feed rate so that the maximum current command value during acceleration/deceleration is within the range shown below, and then set the value in the clamp speed.

Maximum tolerable current command value when adjusting the cutting feed acceleration/deceleration time constant

MDS-EM Series (200V series)		MDS-EMH Series (400V series)	
Motormodel	Max. current command value	Motormodel	Max. current command value
HG96	Within 184%	HG-H54	Within 323%
HG75	Within 270%	HG-H104	Within 263%
HG105	Within 189%	HG-H154	Within 291%
HG54	Within 323%	HG-H204	Within 222%
HG104	Within 245%	HG-H354	Within 232%
HG154	Within 291%	HG-H453	Within 229%
HG224	Within 224%	HK-H55	Within 280%
HG204	Within 243%	HK-H104	Within 175%
HG354	Within 203%	HK-H154	Within 252%
HG123	Within 133%	HK-H204	Within 217%
HG223	Within 161%	HK-H354	Within 217%
HG303	Within 189%	HK-H453	Within 196%
HG453	Within 159%		
HG702	Within 189%		
HG142	Within 133%		
HG302	Within 147%		
HK76	Within 189%		
HK105	Within 161%		
HK55	Within 273%		
HK104	Within 175%		
HK123	Within 154%		
HK142	Within 154%		
HK154	Within 252%		
HK223	Within 168%		
HK224	Within 217%		
HK204	Within 203%		
HK302	Within 154%		
HK303	Within 203%		
HK354	Within 182%		
HK453	Within 161%		
HK702	Within 161%		

⚠ CAUTION

Always set the same value for the cutting feed time constant between the interpolation axes.

(3) Adjusting the in-position width

Because there is a response delay in the servo motor drive due to position loop control, a "settling time" is also required for the motor to actually stop after the command speed from the CNC reaches 0.

The movement command in the next block is generally started after it is confirmed that the machine has entered the "in-position width" range set for the machine.

Set the precision required for the machine as the in-position width. If a high precision is set needlessly, the cycle time will increase due to a delay in the settling time.

The in-position width is validated with the servo parameter settings, but there may be cases when it is validated with the NC parameters. Refer to each NC Instruction Manual.

#2224 SV024 INP In-position detection width

Set the in-position detection width.

Set the positioning accuracy required for the machine.

The lower the setting is, the higher the positioning accuracy will be. However the cycle time (settling time) becomes longer.

The standard setting value is "50".

---Setting range---

1 to 32767 (μm)

**POINT**

The in-position width setting and confirmation availability depend on the CNC parameters.

(4) Adjusting the settling time

The settling time is the time required for the position droop to enter the in-position width after the feed command (FΔT) from the CNC reaches 0.

The settling time can be shortened by raising the position loop gain or using SHG control. However, a sufficient response (sufficiently large VGN1 setting) for the speed loop is required to carry out stable control.

The settling time during normal control when the CNC is set to linear acceleration/ deceleration can be calculated using the following equation. During SHG control, estimate the settling time by multiplying PGN1 by $\sqrt{2}$.

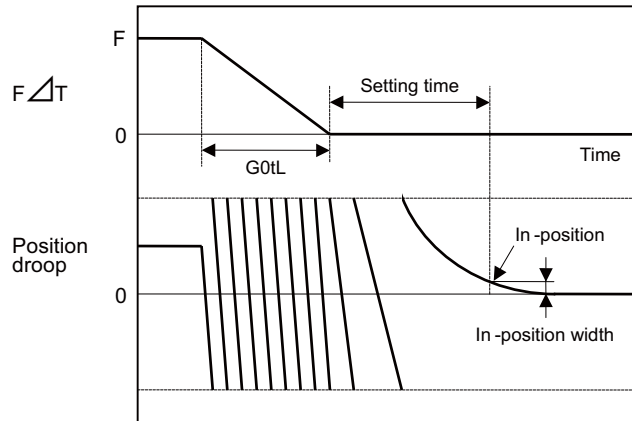

$$\text{Settling time (ms)} = \frac{10^3}{\text{PGN1}} \cdot \ln \left[\frac{\frac{F \times 10^6}{60 \times \text{G0tL} \times \text{PGN1}^2} \times \left[1 - \exp \left[-\frac{\text{PGN1} \times \text{G0tL}}{10^3} \right] \right]}{\text{INP}} \right]$$

- PGN1 : Position loop gain1 (SV003) (rad/s)
- F : Rapid traverse rate (mm/min)
- G0tL : Rapid traverse linear acceleration/ deceleration time constant (ms)
- INP : In-position width (SV024) (μm)

5.3.2 Vibration Suppression Measures

If vibration (machine resonance) occurs, it can be suppressed by lowering the speed loop gain 1 (VGN1). However, cutting precision and cycle time will be sacrificed. (Refer to "Speed Loop Gain".) Thus, try to maintain the VGN1 as high as possible, and suppress the vibration using the vibration suppression functions.

If the VGN1 is lowered and adjusted because vibration cannot be sufficiently suppressed with the vibration suppression functions, adjust the entire gain (including the position loop gain) again.

(Examples of vibration occurrence)

- A fine vibration is felt when the machine is touched, or a groaning sound is heard.
- Vibration or noise occurs during rapid traverse.

If machine resonance occurs, the resonance frequency can be confirmed at AFLT frequency on NC drive monitor screen. Based on this frequency, the notch filter frequency can be set. The display sensitivity can be adjusted in the "sensitivity of estimated resonance frequency" setting. When "0" is displayed, vibration at high frequency or vibration due to the machine system may be the reason.

POINT

Suppress the vibration using the vibration suppression functions, and maintain the speed loop gain (SV005) as high as possible.

< Notch filter >

This servo drive unit mounts 5 notch filters. Measure the resonance frequency with AFLT frequency display on NC drive monitor screen and the current feedback analog output function, and set that frequency in parameter. However, if the notch filter is set to a particularly low frequency, another resonance frequency that did not vibrate initially may occur. If the notch filter's depth compensation (SV033, nfd1, nfd2) is adjusted so that the filter does not operate unless necessary, the servo control will be stabilized. Notch filter 3 is a filter with frequency fixed to 1125Hz, and has no depth compensation.

< Setting method >

- [1] Set the resonance frequency in the notch filter frequency (1, 2, 4, 5).
- [2] If the machine starts to vibrate at another frequency, raise (make shallower) the notch filter depth compensation value, and adjust to the optimum value at which the resonance can be eliminated.
- [3] When the vibration cannot be completely eliminated, use also another notch filter for this frequency.

#2233 SV033 SSF2 Servo function 2**bit 7-5 : nfd2 Depth of Notch filter 2**

Set the depth of Notch filter 2 (SV046).

bit7,6,5=
 000: -∞
 001: -18.1[dB]
 010: -12.0[dB]
 011: -8.5[dB]
 100: -6.0[dB]
 101: -4.1[dB]
 110: -2.5[dB]
 111: -1.2[dB]

bit 4 : fhz3 Notch filter 3

0: Stop 1: Start (1125Hz)

bit 3-1 : nfd1 Depth of Notch filter 1

Set the depth of Notch filter 1 (SV038).

bit3,2,1=
 000: -∞
 001: -18.1[dB]
 010: -12.0[dB]
 011: -8.5[dB]
 100: -6.0[dB]
 101: -4.1[dB]
 110: -2.5[dB]
 111: -1.2[dB]

#2238 SV038 FHZ1 Notch filter frequency 1

Set the vibration frequency to suppress when machine vibration occurs.
 (Normally, do not set 80 or less.)
 Set to "0" when not using.

---Setting range---
 0 to 5000 (Hz)

#2246 SV046 FHZ2 Notch filter frequency 2

Set the vibration frequency to suppress when machine vibration occurs.
 (Normally, do not set 80 or less.)
 Set to "0" when not using.

---Setting range---
 0 to 5000 (Hz)

#2283 SV083 SSF6 Servo function 6**bit 7-5 : nfd5 Depth of Notch filter 5**

Set the depth of Notch filter 5 (SV088).

bit7,6,5=

000: -∞

001: -18.1[dB]

010: -12.0[dB]

011: -8.5[dB]

100: -6.0[dB]

101: -4.1[dB]

110: -2.5[dB]

111: -1.2[dB]

bit 3-1 : nfd4 Depth of Notch filter 4

Set the depth of Notch filter 4 (SV087).

bit3,2,1=

000: -∞

001: -18.1[dB]

010: -12.0[dB]

011: -8.5[dB]

100: -6.0[dB]

101: -4.1[dB]

110: -2.5[dB]

111: -1.2[dB]

#2287 SV087 FH4 Notch filter frequency 4

Set the vibration frequency to suppress when machine vibration occurs.

(Normally, do not set 80 or less.)

Set to "0" when not using.

---Setting range---

0 to 5000 (Hz)

#2288 SV088 FH5 Notch filter frequency 5

Set the vibration frequency to suppress when machine vibration occurs.

(Normally, do not set 80 or less.)

Set to "0" when not using.

---Setting range---

0 to 5000 (Hz)

< Notch filter frequency adaptive tracking function >

Machine system resonance can vary depending on secular changes or installation conditions of machine, resonance frequency may deviate from the notch filter frequency set at the initial adjustment. The adaptive tracking function estimates minor changes in resonance frequency from current command oscillating component, automatically adjusting notch filter effective frequency. The resonance frequency is estimated while G0 is moving and effective frequency is modified while the axis is stopped.

The adaptive tracking function can be applied to notch filter 1, 2, 4, 5 (SV038, SV046, SV087, SV088). When resonance frequency is detected within the adaptive ranges which centers in the frequency set by parameter, resonance frequency from which notch filter effective frequency with the closest setting value is detected, suppressing machine resonance.

< Other specifications >

- (a) Machine resonance is detected at frequency ranges of 150Hz to 90Hz.
- (b) The depth of notch filter is not automatically adjusted. Only the effective frequency will change while the filter depth remains fixed.
- (c) When the notch filter 5 is adaptive to all frequency and also, others are not available, the effective frequency of notch filter 5 is changed.
- (d) When parameter setting value is changed; if the effective frequency remains within the adaptive ranges, it will keep operating with the original frequency; if it doesn't, changed parameter value will be applied.

Notch filter application ranges when the adaptive tracking function is available

Notch filter	Estimated adaptive frequency range	Avail. Adaptive operation	Adaptive range
Notch filter 1	150 to 900 [Hz]	SV115/bit8	Setting value(SV038) \pm Adaptive range (SV115/bit4,5) [Hz]
Notch filter 2	150 to 900 [Hz]	SV115/bit9	Setting value (SV046) \pm Adaptive range (SV115/bit4,5) [Hz]
Notch filter 3	Not included	Not included	Not included
Notch filter 4	150 to 900 [Hz]	SV115/bitA	Setting value (SV087) \pm Adaptive range (SV115/bit4,5) [Hz]
Notch filter 5	150 to 900 [Hz]	SV115/bitB	Setting value (SV088) \pm Adaptive range (SV115/bit4,5) [Hz] (Note) When adaptive to all frequency (SV115/bitF) 150 to 900 [Hz]

 CAUTION

If adaptive ranges are set too wide, frequency may fluctuate so greatly that the control can become unstable.

When the notch filter 5 is set adaptive to all frequency, the depth of the filter shall be set shallowly to enable stable operation with low frequency.

#2315 SV115 SSF10 Servo function 10**bit F : are Notch filter5 all frequencies adopted**

When enabled, Notch filter5 all frequencies adoptive range is not limited regardless of SV115/bit4,5 setting.

0: Disable 1: Enable

bit E-C: dsl Notch filter frequency display

Switch the "AFLT frequency" display on drive monitor screen to check every notch filter frequency. When the selected notch filter is not used, "0" is displayed.

bitE,D,C=

000 : Estimated resonance frequency (Normal display)

001 : Notch filter 1 frequency

010 : Notch filter 2 frequency

011 : Notch filter 3 frequency (always displays 1125Hz)

100 : Notch filter 4 frequency

101 : Notch filter 5 frequency

Other settings: setting prohibited

bit B : ade5 Notch filter 5 / Adoptive follow-up function

0: Disable 1: Enable

bit A : ade4 Notch filter 4 / Adoptive follow-up function

0: Disable 1: Enable

bit 9 : ade2 Notch filter 2 / Adoptive follow-up function

0: Disable 1: Enable

bit 8 : ade1 Notch filter 1 / Adoptive follow-up function

0: Disable 1: Enable

bit 7-6 : dsn Estimated resonance frequency display holding time

Set the estimated resonance frequency display holding time to the "AFLT frequency" display on drive monitor screen.

bit7,6=

00: 4 [s]

01: 8 [s]

10: 12 [s]

11: 16 [s]

bit 5-4 : dfhz Notch filter frequency range

Set the adaptive range of the notch filter frequency. When the adaptive follow-up function is enabled and if the estimated resonance frequency exists in the set range, the notch filter will be adapted. Normally set this parameter to "00".

bit5,4=

00: -10 to 10 [%]

01: -20 to 20 [%]

10: -30 to 30 [%]

11: -40 to 40 [%]

bit 3-0 : esn Sensitivity of estimated resonance frequency

Set the sensitivity of the estimated resonance frequency. When the notch filter adaptive follow-up function is enabled, smaller setting value enables to detect smaller vibration component, however, adoptive movement will be repeated frequently. Normally set this parameter to "0".

0 : Normal setting (same sensitivity as A) 1 : Sensitivity high to F : Sensitivity low

< Jitter compensation (Vibration control when motor is stopped.) >

The load inertia becomes much smaller than usual if the motor position enters the machine backlash when the motor is stopped. Because this means that an extremely large VGN1 is set for the load inertia, vibration may occur. Jitter compensation can suppress the vibration that occurs at the motor stop by ignoring the backlash amount of speed feedback pulses when the speed feedback polarity changes.

Increase the number of ignored pulses by one pulse at a time, and set a value at which the vibration can be suppressed. (Because the position feedback is controlled normally, there is no worry of positional deviation.)

When jitter compensation is set to an axis that is not vibrating is set, vibration could be induced, so take care.

#2227 SV027 SSF1 Servo function 1**bit 5-4 : vfct Jitter compensation pulse number**

Suppress vibration by machine backlash when axis stops.

bit5,4=

00: Disable

01: 1 pulse

10: 2 pulse

11: 3 pulses

**POINT**

Jitter compensation vibration suppression is only effective when the motor is stopped.

< Variable speed loop gain control >

If vibration occurs when the motor is rotating at a high speed, such during rapid traverse, or if disturbing noise occurs, the state can be improved by lowering the speed loop gain during high-speed rotation. The low-speed region speed loop gain used for cutting feed (G1 feed), etc., is maintained at a high level, so the vibration can be improved without dropping the machining accuracy.

#2205 SV005 VGN1 Speed loop gain 1

Set the speed loop gain.

The higher the setting value is, the more accurate the control will be, however, vibration tends to occur.

If vibration occurs, adjust by lowering by 20 to 30%.

The value should be determined to the 70 to 80% of the value at which the vibration stops.

The value differs depending on servo motors.

Aim at the standard value determined by the servo motor type and load inertia ratio to adjust.

---Setting range---

1 to 30000

#2206 SV006 VGN2 Speed loop gain 2

Set the speed loop gain at the motor limitation speed VLMT with "VCS(SV029: Speed at the change of speed loop gain)".

Use this to suppress noise at high speed rotation during rapid traverse, etc. Then, the speed loop gain decreases at faster speed than the setting value of VCS.

When not using, set to "0".

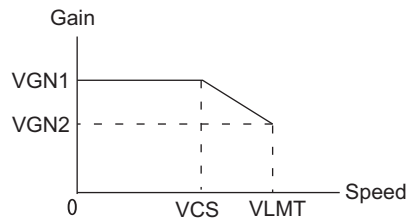
**---Setting range---**

-1000 to 30000

#2229 SV029 VCS Speed at the change of speed loop gain

Noise at high speed rotation including rapid traverse can be reduced by lowering the speed loop gain at high speeds.

Set the speed at which the speed loop gain changes. Use this with SV006 (VGN2).

When not using, set to "0".

---Setting range---

0 to 9999 (r/min)

5.3.3 Improving the Cutting Surface Precision

If the cutting surface precision or roundness is poor, these can be improved by increasing the speed loop gain (VGN1, VIA) or by using the disturbance observer function.

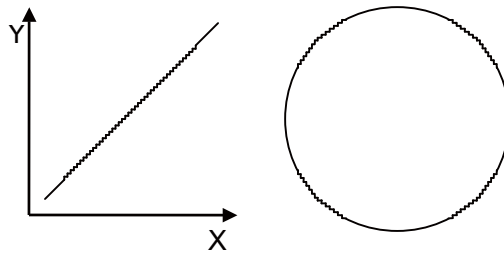

< Examples of faults >

- The surface precision in the 45° direction of a taper or arc is poor.
- The load fluctuation during cutting is large, causing vibration or surface precision defects to occur.



POINT

Adjust by raising the speed loop gain equivalently to improve cutting surface precision, even if the measures differ. In this case, it is important how much the machine resonance can be controlled, so adjust making sufficient use of vibration suppression functions.

(1) Adjusting the speed loop gain (VGN1)

If the speed loop gain is increased, the cutting surface precision will be improved but the machine will resonate easily.

The final VGN1 setting should be approx. 70 to 80% of the maximum value where resonance does not occur. (Refer to "Setting the speed loop gain")

(2) Adjusting the speed loop leading compensation (VIA)

The VIA has a large influence on the position trackability, particularly during high-speed cutting (generally F1000 or more). Raising the setting value improves the position trackability, and the contour precision during high-speed cutting can be improved. For high-speed high-precision cutting machines, adjust so that a value equal to or higher than the standard value can be set.

When VIA is set lower than the standard value and set to a value differing between interpolation axes, the roundness may worsen (the circle may distort). This is due to differences occurring in the position trackability between interpolation axes. The distortion can be improved by matching the VIA with the smaller of the values. Note that because the position trackability is not improved, the surface precision will not be improved.

(Refer to "Setting the speed loop lead compensation")

#2205 SV005 VGN1 Speed loop gain 1

Set the speed loop gain.

The higher the setting value is, the more accurate the control will be, however, vibration tends to occur.

If vibration occurs, adjust by lowering by 20 to 30%.

The value should be determined to the 70 to 80% of the value at which the vibration stops.

The value differs depending on servo motors.

Aim at the standard value determined by the servo motor type and load inertia ratio to adjust.

---Setting range---

1 to 30000

#2208 SV008 VIA Speed loop lead compensation

Set the gain of the speed loop integral control.

Standard setting: 1364

Standard setting in the SHG control: 1900

Adjust the value by increasing/decreasing this by about 100 at a time.

Raise this value to improve contour tracking accuracy in high-speed cutting.

Lower this value when the position droop does not stabilize (when the vibration of 10 to 20Hz occurs).

---Setting range---

1 to 9999

(3) Voltage non-sensitive zone (Td) compensation

With the PWM control of the inverter circuit, a dead time (non-energized time) is set to prevent short-circuits caused by simultaneous energizing of the P side and N side transistors having the same phase. The dead time has a non-sensitive zone for particularly low voltage commands. Thus, when feeding with a low speed and a low torque, the control may be unstable.

When an unbalanced axis is lowering, the frictional torque and unbalance torque, and the frictional torque and deceleration torque before the quadrant changes during circle cutting, are balanced. The motor output torque will be approximately zero, and the control accuracy may drop. In this case, the control accuracy can be improved by using the voltage non-sensitive band compensation. Note that this may cause vibration to be increased while the motor is running.

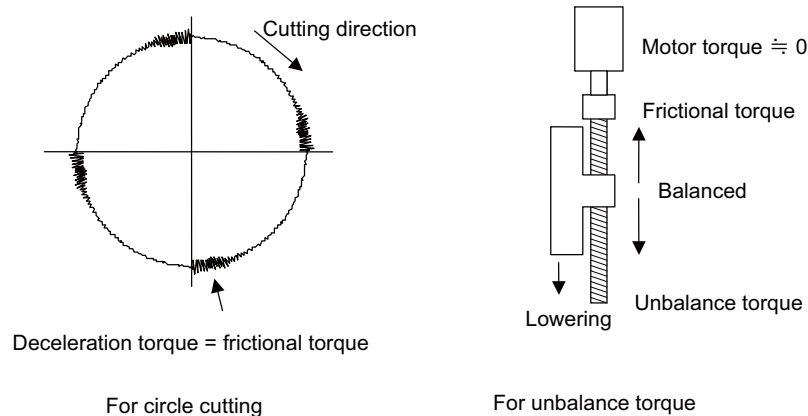
**#2230 SV030 IVC Voltage non-sensitive band compensation**

When 100% is set, the voltage reduction amount equivalent to the logical non-energization in the PWM control will be compensated.

When "0" is set, 100% compensation will be performed.

Adjust in increments of 10% from the default value of 100%.

If increased too much, vibration or vibration noise may be generated.

---Setting range---

0 to 255 (%)

(4) Disturbance observer

The disturbance observer can reduce the effect caused by disturbance, frictional resistance or torsion vibration during cutting by estimating the disturbance torque and compensating it. It also is effective in suppressing the vibration caused by speed leading compensation control.

< Setting method >

- [1] Adjust VGN1 to the value where vibration does not occur, and then lower it 10 to 20%.
- [2] Set the load inertia scale (SV037: JL) with a percentage in respect to the motor inertia of the total load inertia.
- [3] Set the observer filter band (observer pole) in the disturbance observer filter frequency (SV043: OBS1), and suppress the high frequency disturbance estimate to suppress the vibration. Set "100" as a standard.
- [4] Set the observer gain in disturbance observer gain (SV044: OBS2). The disturbance observer will function here for the first time. Set 100 first, and if vibration does not occur, increase the setting by 50 at a time to increase the observer effect.

#2237 SV037 JL Load inertia scale

Set the motor axis conversion total load inertia including motor itself in proportion to the motor inertia.

$$SV037(JL) = (J_m + J_l) / J_m \times 100$$

J_m: Motor inertia

J_l: Motor axis conversion load inertia

For linear motor, set the gross mass of the moving sections in kg unit.

<< Drive monitor load inertia ratio display >>

Set SV035/bitF=1 and imbalance torque and friction torque to both SV032 and SV045, and then repeat acceleration/deceleration for several times.

---Setting range---

For general motor: 0 to 5000 (%)

For linear motor 0 to 5000 (kg)

#2243 SV043 OBS1 Disturbance observer filter frequency

Set the disturbance observer filter band.

Normally, set to "100". Setting values of 49 or less is equal to "0" setting.

To use the disturbance observer, also set SV037 (JL) and SV044 (OBS2).

When disturbance observer related parameters are changed, lost motion compensation needs to be readjusted.

Set to "0" when not using.

---Setting range---

0 to 1000 (rad/s)

#2244 SV044 OBS2 Disturbance observer gain

Set the disturbance observer gain. The standard setting is "100 to 300".

To use the disturbance observer, also set SV037 (JL) and SV043 (OBS1).

When disturbance observer related parameters are changed, lost motion compensation needs to be readjusted.

Set to "0" when not using.

---Setting range---

0 to 500 (%)

**POINT**

The lost motion compensation must be readjusted when the disturbance observer is started.

5.3.4 Improvement of Characteristics during Acceleration/Deceleration

< SHG control >

Because SHG control has a smoother response during acceleration/deceleration than conventional position controls, the acceleration/deceleration torque (current FB) has more ideal output characteristics (A constant torque is output during acceleration/deceleration.) The peak torque is kept low by the same acceleration/deceleration time constant, enabling the time constant to be shortened.

Refer to item "(3) SHG control" in section "Position Loop Gain" for details on setting SHG control.

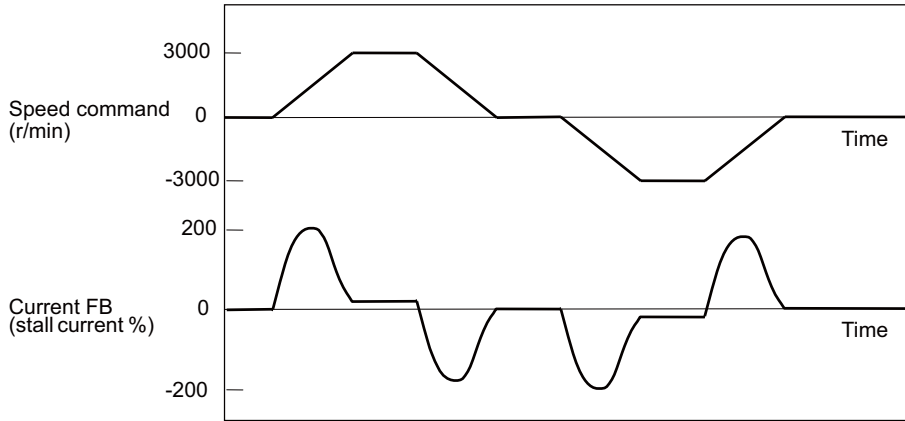

Acceleration/deceleration characteristics during conventional control

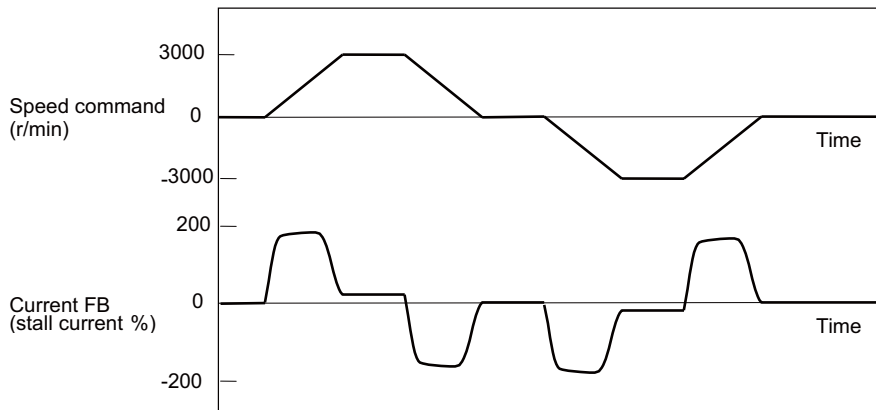

Acceleration/deceleration characteristics during SHG control

No.	Abbrev.	Parameter name	Setting ratio	Setting example					Explanation	Setting range
SV003 (SV049)	PGN1 (PGN1sp)	Position loop gain 1	1	21	27	33	39	48	Always set with a combination of these three parameters.	1 to 200 (rad/s)
SV004 (SV050)	PGN2 (PGN2sp)	Position loop gain 2	8/3	56	72	88	104	128		0 to 999 (rad/s)
SV057 (SV058)	SHGC (SHGCsp)	SHG control gain	6	126	162	198	234	288		0 to 1200 (rad/s)

< Acceleration feed forward >

Vibration may occur at 10 to 20 Hz during acceleration/deceleration when a short time constant of 30 ms or less is applied, and a position loop gain (PGN1) higher than the general standard value or SHG control is used. This is because the torque is insufficient when starting or when starting deceleration, and can be resolved by setting the acceleration rate feed forward gain (SV015: FFC). This is also effective in reducing the peak current (torque). While measuring the current command waveform, increase FFC by 50 to 100 at a time and set the value where vibration does not occur.

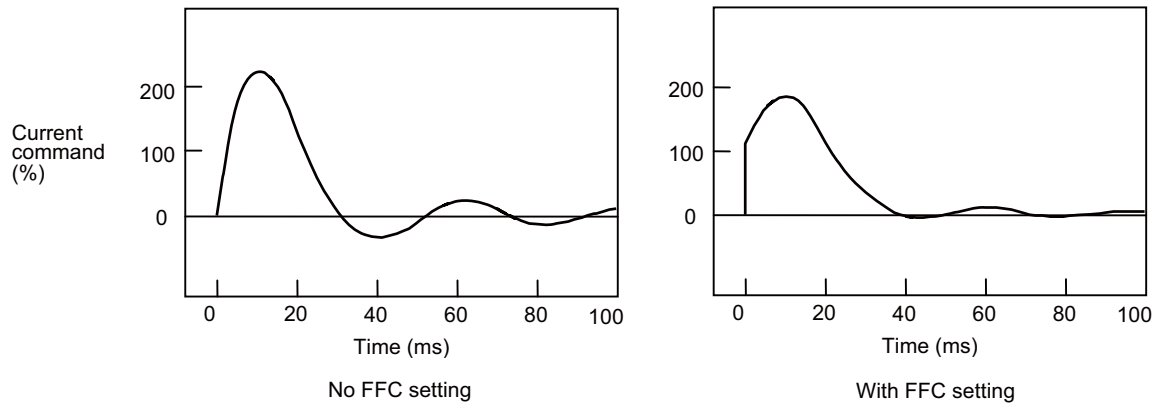

Acceleration rate feed forward gain means that the speed loop gain during acceleration/deceleration is raised equivalently. Thus, the torque (current command) required during acceleration/deceleration starts sooner. The synchronization precision will improve if the FFC of the delayed side axis is raised between axes for which high-precision synchronous control (such as synchronous tapping control and superimposition control).

#2215 SV015 FFC Acceleration rate feed forward gain

When a relative error in synchronous control is too large, set this parameter to the axis that is delaying.

The standard setting is "0". The standard setting in the SHG control is "100".

To adjust a relative error in acceleration/deceleration, increase the value by 50 at a time.

---Setting range---

0 to 999 (%)

**POINT**

Overshooting occurs easily when a value above the standard value is set during SHG control.

< Inductive voltage compensation >

The current loop response is improved by compensating the back electromotive force element induced by the motor rotation. This improved the current command efficiency, and allows the acceleration/deceleration time constant to be shortened.

< Adjustment method >

While accelerating/decelerating at rapid traverse, adjust the inductive voltage compensation gain (SV047: EC) so that the current FB peak (MAX current 3) is a few % smaller than the current command peak (MAX current 2).

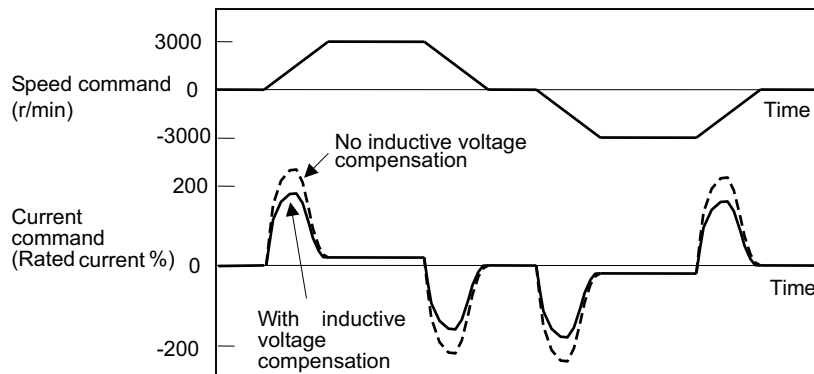

Inductive voltage compensation

#2247 SV047 EC Inductive voltage compensation gain

Set the inductive voltage compensation gain. Standard setting value is "100".
If the current FB peak exceeds the current command peak, lower the gain.

---Setting range---
0 to 200 (%)

**POINT**

If the current FB peak (MAX current 3) becomes larger than the current command peak (MAX current 2) (over compensation), an overcurrent (alarm 3A) will occur easily. Note that over compensation will occur easily if the load inertia is large.

< HAS control >

If an output torque during acceleration/deceleration is close to the servo motor's maximum torque, the motor cannot accelerate with a commanded time constant when the torque is saturated due to input voltage fluctuation, etc. Generally, if an acceleration command is switched to a constant speed command, speed FB overshoots to compensate a delay of position droop, making the machine operation unstable.

When the HAS control is enabled, a delay of position droop will be compensated by controlling the amount of speed FB overshoot within 1% or less than maximum speed of the motor.

The controllable amount of position droop delay with HAS control HAS can be set at 1/4 or 1/2 of the excessive error detection width.

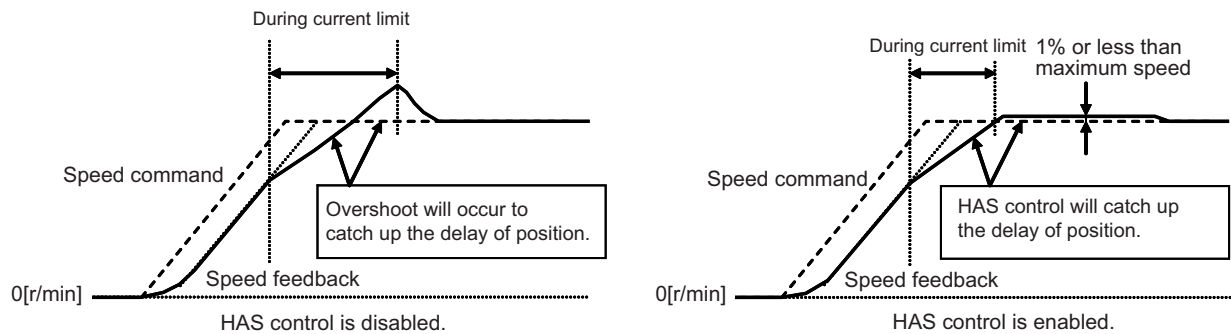
**#2234 SV034 SSF3 Servo function 3****bit 1 : has HAS control**

This stabilizes the speed overshooting by torque saturation phenomenon.

0: Normal setting 1: Enable

#2284 SV084 SSF7 Servo function 7**bit F : h2c HAS control cancel amount**

0: 1/4 (standard) 1: 1/2

**POINT**

1. During G1 drive, if HAS control is started, the compensation amount can not be compensated. Therefore, adjust the feed speed ramp value or acceleration/deceleration time constant so that the current limit does not occur.
2. HAS control can not be used for axes in synchronous control since machine torsion may be occur.
3. Even if HAS control is enabled, adjust the acceleration/deceleration time constant so that the current limit does not occur.
4. If setting half of error excessive encoder width to the droop compensation amount, error excessive alarm in acceleration may occur more easily than if 1/4.

5.3.5 Improvement of Protrusion at Quadrant Changeover

The response delay (caused by dead band from friction, torsion, expansion/contraction, backlash, etc.) caused when the machine advance direction reverses is compensated with the lost motion compensation (LMC compensation) function. With this, the protrusions that occur at the quadrant changeover in the DBB measurement method, or the streaks that occur when the quadrant changes during circular cutting can be improved.

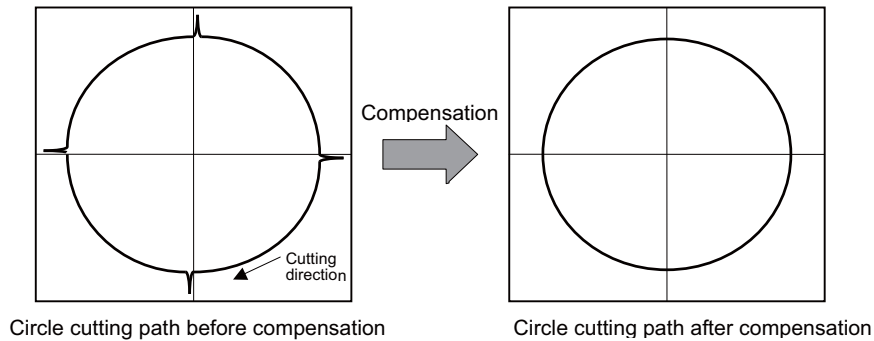

DBB: Double Ball Bar

[1] LMC compensation type 2

This is an obsolete compensation method. When performing new adjustment, use LMC compensation type 3.

[2] LMC compensation type 3

In addition to frictional torque influence, this type compensates torsion and expansion/contraction influences in the machine system in which compensation amount is changed by travel speed. A mechanical system viscosity coefficient setting further enhances the compensation accuracy even if the travel speed is changed. Adjustment requires a machine roundness measurement.

[3] LMC compensation type 4

This is used in combination with LMC compensation type 3. Compensation is performed by monitoring path tracking delay. Therefore, even if the machine friction amount has changed due to aged deterioration, the path tracking delay is controlled so that it will be minimum.



POINT

1. LMC compensation performs adjustment while measuring the electrical end roundness waveform (encoder position FB). Disable the NC side machine error compensation (pitch error compensation, relative position compensation, backlash compensation). All machine error compensation can be disabled at once by setting bit7 of SV113 to 1.
2. After the compensation adjustment is completed, adjust the machine error compensation while measuring the machine error compensation with DBB measurement method, etc.

(1) Measuring unbalance torque and frictional torque

Machine unbalance torque and frictional torque measurements are required before the LMC compensation can be set. However, the horizontal axis unbalance torque is necessarily "0".

Carry out the reciprocating operation (approx. F1000) with the measured axis, and the load current % value during constant-speed feed is measured at the NC servo monitor screen. The unbalance torque and frictional torque at that time are expressed by the following formulas.

$$\text{Unbalance torque (\%)} = \frac{(+ \text{ feed load current \%}) + (- \text{ feed load current \%})}{2}$$

$$\text{Frictional torque (\%)} = \frac{|(+ \text{ feed load current \%}) - (- \text{ feed load current \%})|}{2}$$

(Example)

Assume that the load current % was -55% in the + direction and -25% in the - direction when JOG feed was carried out at approx. F1000. The unbalance torque and frictional torque are as shown below.

$$\text{Unbalance torque (\%)} = \frac{(-55) + (-25)}{2} = -40\%$$

$$\text{Friction torque (\%)} = \frac{|(-55) - (-25)|}{2} = 15\%$$

The measurement values are not used for LMC compensation type 3. However, since they are used for other controls, set them to the following parameters.

#2232 SV032 TOF Torque offset

Set the unbalance torque on vertical axis and inclined axis.

When the vertical axis pull up function is enabled, the pull up compensation direction is determined by this parameter's sign. When set to "0", and the pull up function is enabled (SV033/bitE=1), the alarm "S02 2233 Initial parameter error" occurs.

This can be used for speed loop delay compensation and collision detection function.

To use load inertia estimation function (drive monitor display), set this parameter, friction torque (SV045) and load inertia display enabling flag (SV035/bitF).

Related parameters: SV007, SV033/bitE, SV059

---Setting range---

-100 to 100 (Stall current %)

#2245 SV045 TRUB Friction torque

Set the frictional torque when using the collision detection function.

To use load inertia estimation function (drive monitor display), set this parameter, imbalance torque (SV032) and load inertia display enabling flag (SV035/bitF).

---Setting range---

0 to 255 (Stall current %)

(2) Setting and adjusting LMC compensation type 3

LCM compensation type 3 can be used to accommodate quadrant projection changes that accompany feed rate and circular radius changes which could not be accommodated by LCM compensation type 2. In this case, on a machine model where the travel direction is reversed, the effect caused by torsion or expansion and contraction on the machine system are also considered in addition to the friction, with compensation occurring in accordance with the changes in the cutting conditions.

Adjust Compensation parameter (SV016, SV041), a basis of compensation, while measuring roundness at low speed. Then adjust viscous coefficient (SV086) while measuring roundness at high speed.

LMC compensation type 3 parameter adjustments should be made while measuring an electrical end position FB waveform by the NC sampling function.

< Adjustment method >

- [1] Turn the NC side machine error compensation (pitch error compensation, relative position compensation or backlash compensation) OFF.
- [2] Set servo function selection 5 SV082/ bit=1. (The LMC compensation type 3 will start).
- [3] Set a value double the friction torque to the lost motion compensation 1 (SV016). The SV016 setting value will be used for compensation in the positive and negative directions when the lost motion compensation 2 (SV041) is 0.
- [4] Set the initial value, SV016 x 200 to the lost motion compensation viscous coefficient (SV086).
- [5] Perform a roundness measurement at such speed as radius R=100mm and feedrate F=1000mm/min and adjust SV016 value.
- [6] Set SV041, when changing the compensation amount in the direction for compensation. The setting of the compensation direction is shown below with the setting of CW/CCW in the NC parameter. If compensating only one direction, set -1 to the side not to be compensated.

Compensation point	CW	CCW
A	X axis: SV041	X axis: SV016
B	Y axis: SV016	Y axis: SV041
C	X axis: SV016	X axis: SV041
D	Y axis: SV041	Y axis: SV016

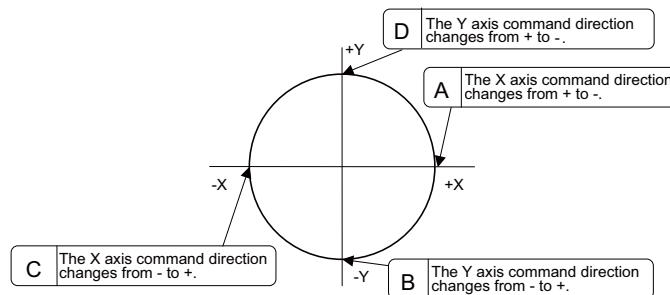

- [7] Perform a roundness measurement at such speed as radius, R=100mm and feedrate, F=5000mm/min. (Select a condition to be used for the actual cutting according to the machine's specification.) Adjust viscous coefficient (SV086) by increasing and reducing it approx. ± 500 gradually to have minimum quadrant protrusion.
- [8] After adjusting SV086, verify its accuracy by performing roundness measurement at low speed again.
- [9] At this time, if requiring to improve the accuracy further, adjust the spring constant (SV085) in increments of about 50 while performing the machine roundness measurement at low speed.

**POINT**

1. As the acceleration of circular feed increases, the quadrant protrusion tends to get larger. Therefore, the quadrant protrusion gets larger as the circular feedrate increases for the same radius and as radius gets smaller for the same feedrate.
2. Torque offset (SV032) does not work for LMC compensation type 3.
3. Always set 0 to the lost motion compensation timing (SV039:LMCD).

#2216 SV016 LMC1 Lost motion compensation 1

Set this parameter when the protrusion (that occurs due to the non-sensitive band by friction, torsion, backlash, etc.) at quadrant change is too large. This sets the compensation torque at quadrant change (when an axis feed direction is reversed) by the proportion (%) to the stall torque. Whether to enable the lost motion compensation and the method can be set with other parameters.

Type 2: When SV027/bit9, 8 =10 (Compatible with obsolete type)

Set the type 2 method compensation torque. The standard setting is double the friction torque.

Type 3: When SV082/bit1= 1

Set the compensation torque equivalent of dynamic friction amount of the type 3 method compensation amount. The standard setting is double the dynamic friction torque.

To vary compensation amount according to the direction.

When SV041 (LMC2) is "0", compensate with the value of SV016 (LMC1) in both +/-directions.

If you wish to change the compensation amount depending on the command direction, set this and SV041 (LMC2).

(SV016: + direction, SV041: - direction. However, the directions may be opposite depending on other settings.)

When "-1" is set, the compensation will not be performed in the direction of the command.

---Setting range---

-1 to 200 (Stall current %)

Note that when SV082/bit2 is "1", the setting range is between -1 and 20000 (Stall current 0.01%).

#2241 SV041 LMC2 Lost motion compensation 2

Set this with SV016 (LMC1) only when you wish to vary the lost motion compensation amount depending on the command directions.
Normally, set to "0".

---Setting range---

-1 to 200 (Stall current %)

Note that when SV082/bit2 is "1", the setting range is between -1 and 20000 (Stall current 0.01%).

#2282 SV082 SSF5 Servo function 5**bit 2 : ccu Lost motion overshoot compensation compensation amount setting increment**

0: Stall current % 1: Stall current 0.01%

bit 1 : lmc3 Lost motion compensation type 3

Set this when protrusion at a quadrant change is too big.

0: Stop 1: Start

#2285 SV085 LMCk Lost motion compensation 3 spring constant

Set the machine system's spring constant when selecting lost motion compensation type 3.
When not using, set to "0".

---Setting range---

0 to 32767 (0.01%/μm)

#2286 SV086 LMCc Lost motion compensation 3 viscous coefficient

Set the machine system's viscous coefficient when selecting lost motion compensation type 3.
When not using, set to "0".

---Setting range---

0 to 32767 (0.01%*s/mm)

(3) Setting and adjusting LMC compensation type 4

LMC compensation type 4 is enabled by being used with LMC compensation type 3. Make sure to adjust the LMC compensation type 3 before setting the LMC compensation type 4.

< Adjustment method >

- [1] Set about 5-fold SV016 setting value in SV091. (Set about 10% of machine friction.)
- [2] Increase SV0091 in increments of about 20%, and confirm the limit value where vibration does not occur. Note that the limit value is about 500.
- [3] Set 50% of the limit value.

#2291 SV091 LMC4G Lost motion compensation 4 gain

Use this with LMC compensation type 3. As the delay in path tracking is monitored and compensated, the delay in path tracking will be minimized even if machine friction amount changes by aging. Use the lost motion compensation amount (SV016) * 5 (10% of the dynamic friction torque) as the target. The higher the setting value is, the more accurate the quadrant change be; however, the more likely vibrations occur.

---Setting range---

0 to 20000 (Stall current 0.01%)

5.3.6 Improvement of Overshooting

The phenomenon when the machine position goes past or exceeds the command during feed stopping is called overshooting. Overshooting is compensated by overshooting compensation (OVS compensation). Overshooting occurs due to the following two causes.

- [1] Machine system torsion: Overshooting will occur mainly during rapid traverse settling.
- [2] Machine system friction: Overshooting will occur mainly during one pulse feed.

Either phenomenon can be confirmed by measuring the position droop.

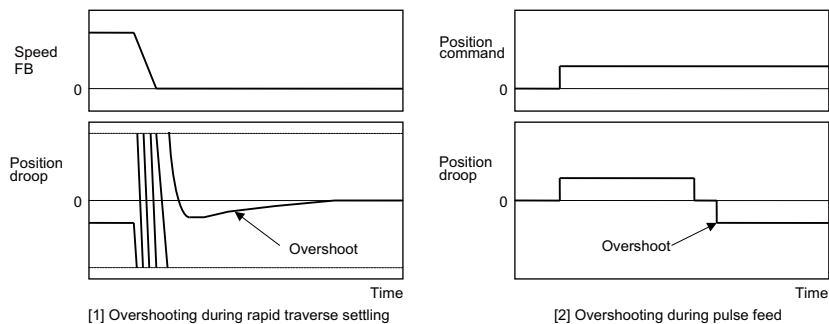

(1) Overshooting compensation (OVS compensation)

In OVS compensation, the overshooting is suppressed by subtracting the torque command set in the parameters when the motor stops.

OVS compensation type 3 has a compensation effect for the overshooting during either rapid traverse settling or pulse feed. To compensate overshooting during feed forward control, refer to the following section "(2) Adjusting for feed forward control".

< Setting and adjustment methods >

- [1] Set the servo function selection 1 (SV027: SSF1)/bit A, B. (OVS compensation type 3 will start.)
- [2] Observe the position droop waveform using the D/A output, and increase the overshooting compensation 1 (SV031: OVS1) value 1% at a time. Set the smallest value where the overshooting does not occur. If SV042 (OVS2) is 0, the overshooting will be compensated in both the forward/reverse directions with the OVS1 setting value.
- [3] If the compensation amount is to be changed in the direction to be compensated, set the + direction compensation value in OVS1 and the - direction compensation value in OVS2. If only one direction is to be compensated, set the side not to be compensated as -1. The compensation direction setting will be as reversed with the NC parameter CW/CCW setting.

**POINT**

1. When either parameter SV031: OVS1 or SV042: OVS2 is set to 0, the same amount of compensation is carried out in both the positive and negative direction, using the setting value of the other parameter (the parameter not set to 0).
2. To compensate in only one direction, set -1 in the parameter (OVS1 or OVS2) for the direction in which compensation is prohibited.
3. For contour cutting, the projection at the arc end point is compensated with OVS compensation. LMC compensation is carried out at the arc starting point.

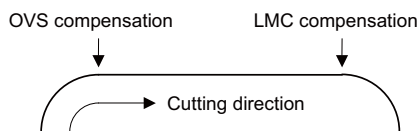
**(2) Adjusting for feed forward control**

When using feed forward control (high-speed high-accuracy control), the feed forward control must be stopped ($\text{fwd_g} = 0$) before adjusting the overshooting compensation. After adjusting the overshooting compensation with normal control, set the overshooting compensation non-sensitive zone (SV034 (SSF3)/bitC to F (ovsn) to 1 ($2\mu\text{m}$)) and start up feed forward control.

If overshooting compensation is used during feed forward control, the overshooting will increase, or protrusions could appear during arc cutting. This is because, when the NC is carrying out feed forward (fwd) control, overshooting equivalent to the operation fraction unit occurs in the position command, and the OVS compensation is recognized as a change in the command direction, resulting in compensation in the reverse direction. This can be improved by setting the overshooting compensation non-sensitive zone width.

If overshooting does not occur during normal control, and occurs only during feed forward control, adjust the feed forward gain (fwd_g).

#2231 SV031 OVS1 Overshooting compensation 1

This compensates the motor torque when overshooting occurs during positioning. This is valid only when the overshooting compensation (SV027/bitB,A) is selected.

Type 3 SV027/bitB,A = 11

Set the compensation amount based on the motor stall current. Observing positioning droop waveform, increase in increments of 1% and find the value where overshooting does not occur.

To vary compensation amount depending on the direction.

When SV042 (OVS2) is "0", change the SV031 (OVS1) value in both of the +/-directions to compensate.

To vary the compensation amount depending on the command direction, set this and SV042 (OVS2).

(SV031: + direction, SV042: - direction. However, the directions may be opposite depending on other settings.)

When "-1" is set, the compensation will not be performed in the direction of the command.

---Setting range---

-1 to 100 (Stall current %)

Note that the range will be "-1 - 10000" (Stall current 0.01%) when SV082/bit2 is "1".

#2242 SV042 OVS2 Overshooting compensation 2

Set this with SV031 (OVS1) only when you wish to vary the overshooting compensation amount depending on the command directions.

Normally, set to "0".

---Setting range---

-1 to 100 (Stall current %)

Note that when SV082/bit2 is "1", the setting range is between -1 and 10000 (Stall current 0.01%).

#2227 SV027 SSF1 Servo function 1**bit B-A : ovs Overshooting compensation**

Set this if overshooting occurs during positioning.

bitB,A=

00: Compensation stop

01: Setting prohibited

10: Setting prohibited

11: Type 3

Set the compensation amount in SV031(OVS1) and SV042(OVS2).

#2234 SV034 SSF3 Servo function 3**bit F-C: ovsn Overshooting compensation type 3 Non-sensitive band**

Set the non-sensitive band of the model position droop overshooting amount in increments of 2 μ m. In the feed forward control, set the non-sensitive band of the model position droop and ignore the overshooting of the model.

0 : 0 μ m, 1: 2 μ m, 2: 4 μ m,---, E : 28 μ m, F: 30 μ m

#2282 SV082 SSF5 Servo function 5**bit 2 : ccu Lost motion overshoot compensation compensation amount setting increment**

0: Stall current % 1: Stall current 0.01%

POINT

When using feed forward control (high-speed high-accuracy control), stop the feed forward control (fwd_g=0) before adjusting the overshooting compensation. If overshooting occurs during subsequent feed forward control, adjust the feed forward gain (fwd_g).

5.3.7 Improvement of the Interpolation Control Path

(1) Machine end compensation control

The machine end compensation control compensates the shape of the tool end during high-speed and high-speed acceleration/deceleration. The spring effect from the machine (spindle) end to the motor (scale) end is compensated. If the machine has a large spring effect, the shape may be fine during low-speed operation. However, at high speeds (specially when using a small radius), the section from the machine (spindle) end to the outer sides of the motor (scale) end could swell, and cause the shape to become elliptical during measurement of the roundness. The machine end compensation control compensates the motor end position according to the acceleration size, so the tool end position is always controlled to the commanded position.

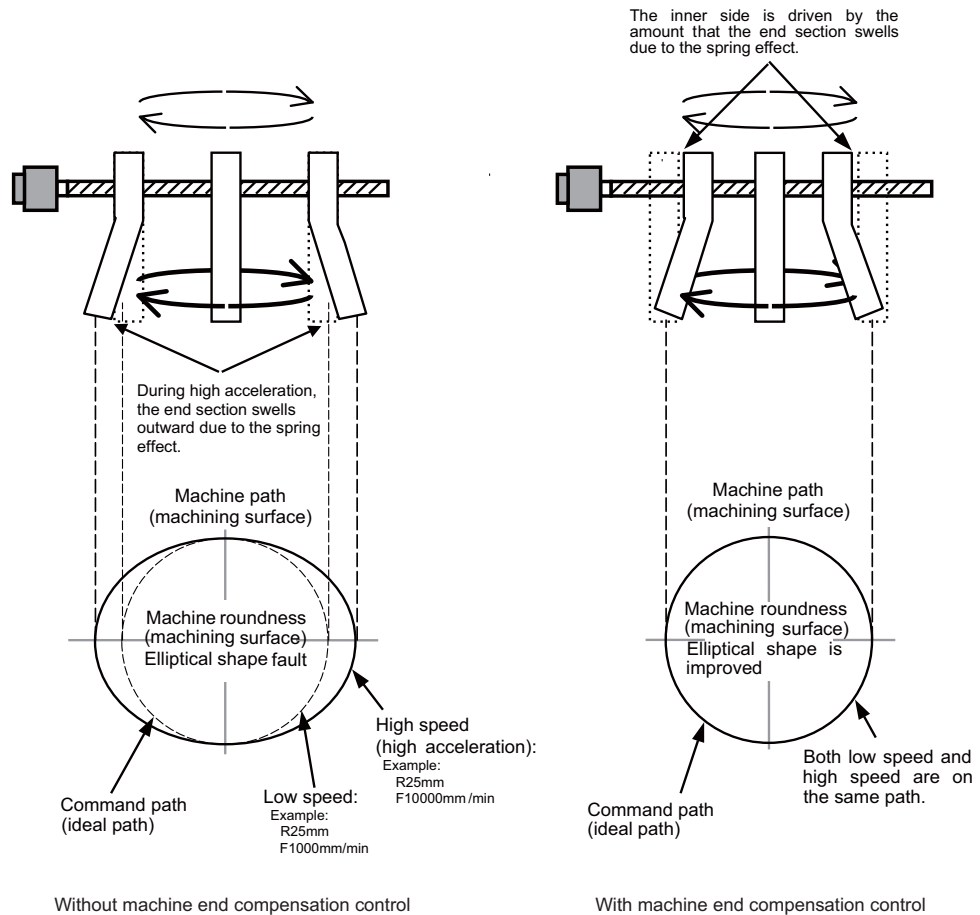

POINT

1. Always evaluate the roundness accuracy at the machine side.
2. Adjust the parameter after adjusting the electrical end roundness accuracy.

< Adjustment methods >

- [1] Confirm that the motor side circle accuracy measured with the NC sampling function is appropriate.
- [2] In this state, measure the machine side low-speed and high-speed circle path without machine end compensation control. The difference of the high-speed circle path and low-speed circle path is the amount that path has swelled due to the spring effect of the machine system. Calculate the SV065 setting value with the following expression using this amount as the compensation amount.

$$SV065 = \frac{\text{Compensation amount } [\mu\text{m}] \times \text{radius R } [\text{mm}] \times SV003 \times 16,200,000}{(\text{command speed F } [\text{mm/min}])^2}$$

- [3] Input the value calculated in step [2] into SV065. Measure the high-speed circle path. If the shape is still elliptical, adjust by increasing/decreasing the SV065 value in 1/10 units.
- [4] Confirm that there is no problem with the low-speed circle path.

Example of low-speed and high-speed roundness measurement for adjusting machine compensation

	When using grid encoder	When using DBB measurement	Acceleration
Low speed (reference circle)	R=25 [mm], F=500 [mm/min]	R=100 [mm], F=1000 [mm/min]	0.00028G
High-speed (when adjusting compensation amount)	R=25 [mm], F=10000 [mm/min]	R=100 [mm], F=20000 [mm/min]	0.11G

#2265 SV065 TLC Machine end compensation gain

The shape of the machine end is compensated by compensating the spring effect from the machine end to the motor end.

Set the machine end compensation gain. Measure the error amount by roundness measurement and estimate the setting value by the following formula.

$$\text{Compensation amount } (\mu\text{m}) = \text{Command speed F (mm/min)}^2 \times SV065 / (\text{Radius R (mm)} \times SV003 \times 16,200,000)$$

Set to "0" when not using.

---Setting range---

-30000 to 30000 (Acceleration ratio 0.1%)

**POINT**

1. To confirm the machine's spring element, adjust the electrical end roundness, and then machine roundness while changing the cutting speed. Confirm that the error increases with the speed.
2. The electrical roundness will have an error on the inner side when machine end compensation control is used.

**CAUTION**

If an excessive value is set in the machine end compensation gain (SV065), the machine could vibrate when stopping, resulting in a dangerous state.

5.4 Adjustment during Full Closed Loop Control

5.4.1 Outline

(1) Full closed loop control

The servo control is all closed loop control using the encoder's feedback. "Full closed loop control" is the system that directly detects the machine position using a linear scale, whereas the general "semi-closed loop" is the one that detects the motor position.

In a machine that drives a table with a ball screw, the following factors exist between the motor and table end:

- [1] Coupling or ball screw table bracket's backlash
- [2] Ball screw pitch error

These can adversely affect the accuracy. If the table position is directly detected with a linear scale, high-accuracy position control which is not affected by backlash or pitch error is possible. However, with the full closed loop system, the machine system is also directly included in the position loop control. Thus, if the machine's rigidity is not high, the gain cannot be increased, and the required high accuracy cannot be attained.

The procedures for adjusting the servo with the full closed loop system are the same as the semi-closed loop system. Vibration or overshooting will occur easily, so the position loop gain is generally lower than the semi-closed loop.

(2) Overrun detection

With the full closed system, the position feedback (FB) detected with the linear scale is used for the position control. However, the motor position FB is detected at the same time, and the error of both FB is observed. If this FB error exceeds the servo parameter SV054 setting value, alarm 43 will be detected and the system will stop to prevent overrunning due to a scale FB error from occurring.

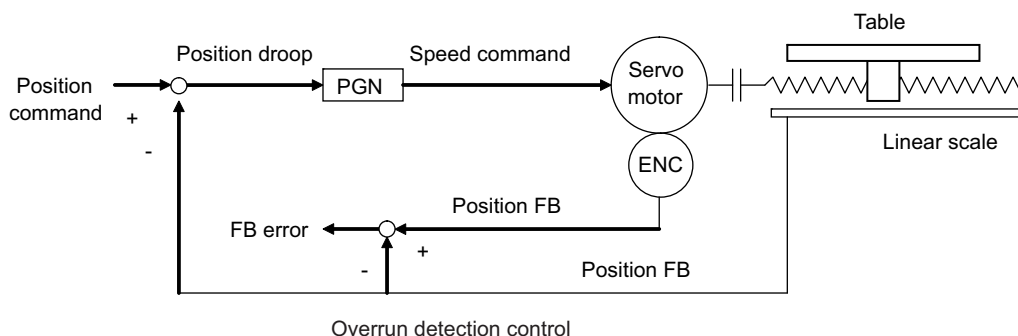

#2254 SV054 ORE Overrun detection width in closed loop control

Set the overrun detection width in the full-closed loop control.

When the gap between the motor side encoder and the linear scale (machine side encoder) exceeds the value set by this parameter, it will be judged as overrun and "Alarm 43" will be detected.

When "-1" is set, if the differential velocity between the motor side encoder and the machine side encoder exceeds the 30% of the maximum motor speed, it will be judged as overrun and "Alarm 43" will be detected.

When "0" is set, overrun will be detected with a 2mm width.

For linear servo/direct-drive motor system

Not used. Set to "0".

---Setting range---

-1 to 32767 (mm)

However, when SV084/bitD=1, the setting range is from -1 to 32767 (μm).

5.4.2 Speed Loop Delay Compensation

Generally, the machine position follows the operation later than the motor position. With full closed loop position loop control, the machine position is used for position feedback, so the motor position could advance too far and cause the machine position to overshoot easily. Speed loop delay compensation suppresses overshooting by weakening the speed loop PI control (weakening lead compensation = delaying). If the compensation is too large and PI control is weakened too far, the positioning time could increase, or the position droop will remain when the motor is stopped.

< Adjustment method >

- [1] Set the servo function selection 1 (SV027: SSF1)/bit1, bit0 to 10. (Select delay compensation changeover type 2)
- [2] Set the axis unbalance torque to the torque offset (SV032: TOF). (Refer to "Measuring unbalance torque and frictional torque" for details on measuring the unbalance torque.)
- [3] Observe the position droop waveform, and confirm the overshooting. Increase SV007 (VIL) in increments of 5, and adjust so that the overshooting is improved. If set too high, the position droop will remain when the axis is stopped.

#2207 SV007 VIL Speed loop delay compensation

Set this when the limit cycle occurs in the full-closed loop, or overshooting occurs in positioning. The speed loop delay compensation method can be selected with SV027/bit1,0. Normally, use "Changeover type 2". Changeover type 2 controls the occurrence of overshooting by lowering the speed loop lead compensation after the position droop gets 0. When setting this parameter, make sure to set the torque offset (SV032).

---Setting range---

0 to 32767

#2232 SV032 TOF Torque offset

Set the unbalance torque on vertical axis and inclined axis. When the vertical axis pull up function is enabled, the pull up compensation direction is determined by this parameter's sign. When set to "0", and the pull up function is enabled (SV033/bitE=1), the alarm "S02 2233 Initial parameter error" occurs. This can be used for speed loop delay compensation and collision detection function. To use load inertia estimation function (drive monitor display), set this parameter, friction torque (SV045) and load inertia display enabling flag(SV035/bitF).

---Setting range---

-100 to 100 (Stall current %)

#2227 SV027 SSF1 Servo function 1

bit 1-0 : vcnt Speed loop delay compensation changeover type selection

Normally, use "Changeover type 2".

bit1,0=

00: Disable

01: Changeover type 1

10: Changeover type 2

11: Setting prohibited

CAUTION

The position droop will remain if SV007 is set too high.

5.4.3 Dual Feedback Control

If the motor and machine coupling or machine system's rigidity is low (ex. large machine, etc.) when using a closed loop system, the response during acceleration/deceleration will vibrate and cause overshooting. This can cause the position loop gain from increasing. The dual feedback function is effective in this case.

To validate the dual feedback function, use position feedback with a motor side encoder in ranges with high acceleration to enable stable control. In ranges with low acceleration, use position feedback with the machine side encoder (scale).

This will make it possible to increase the position loop gain.

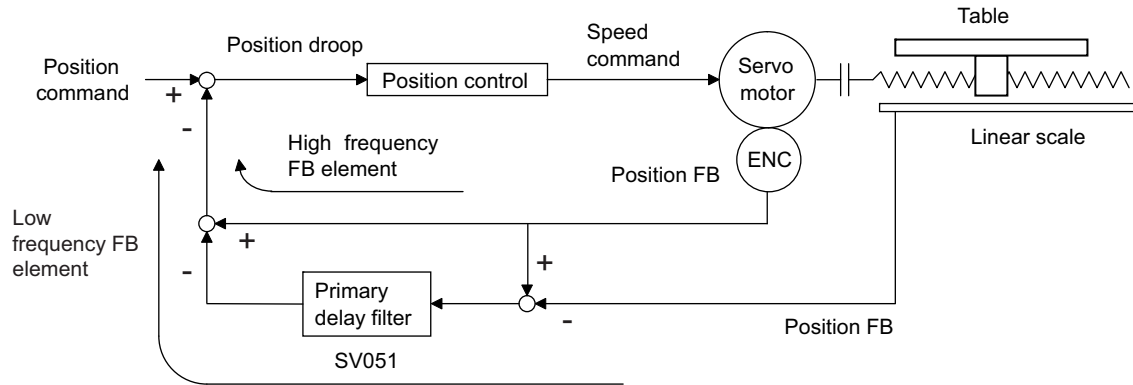

Dual feedback control

The state will approach the semi-closed loop system as the primary delay filter's time constant increases, so the position loop gain limit will increase. Note that the limit of the position loop gain increased with the dual feedback function is the same as the position loop gain limit for a semi-closed system that does not use a machine side encoder (scale, etc.). In addition, the positioning time will increase as the primary delay filter time constant increases.



POINT

1. Dual feedback control is a function that compensates symptoms resulting from insufficient machine rigidity. If there are items that can be improved on the machine (improvement of scale installation position, etc.) improve those first.
2. The position loop gain limit will not increase compared to the semi-closed loop system even when using dual feedback control.

< Adjustment method >

- [1] Set the servo specifications (SV017: SPEC)/bit1 to 1, and turn the NC power ON again.
- [2] Measure the position droop overshooting while increasing the dual feedback control time constant (SV051: DFBT) in increments of 5ms. Adjust to the time constant where overshooting does not occur.
- [3] For the final setting value, set a value 1.5 to 2-fold the value adjusted in 3.

#2217(PR) SV017 SPEC1 Servo specification 1**bit 1 : dfbx Dual feedback control**

Control the position FB signal in full closed control by the combination of a motor side encoder and machine side encoder.

0: Stop 1: Start

#2251 SV051 DFBT Dual feedback control time constant

Set the control time constant in dual feed back.

When "0" is set, it operates at 1ms.

The higher the time constant is, the closer it gets to the semi-closed control, so the limit of the position loop gain will be raised.

For linear servo/direct-drive motor system

Not used. Set to "0".

---Setting range---

0 to 9999 (ms)

#2252 SV052 DFBN Dual feedback control non-sensitive band

Set the non-sensitive band in the dual feedback control.

Normally, set to "0".

For linear servo/direct-drive motor system

Not used. Set to "0".

---Setting range---

0 to 9999 (μm)

5.4.4 Full-closed Torsion Compensation Function

This function performs compensation by setting the torsion compensation amount based on the distance between the motor-end position and the machine-end position when the direction is reversed. Setting the torsion compensation amount in addition to the conventional lost motion compensation enables to reduce the distance from the machine end and smooth the tracking to the position command. When "SV116/bit1" is set to "1", compensation is performed not only in the reverse direction but also in the forward direction. Compensation in the forward direction performs the starting torque compensation by restoring the torsion compensation amount based on the distance between the motor-end position and the machine-end position when stopped.

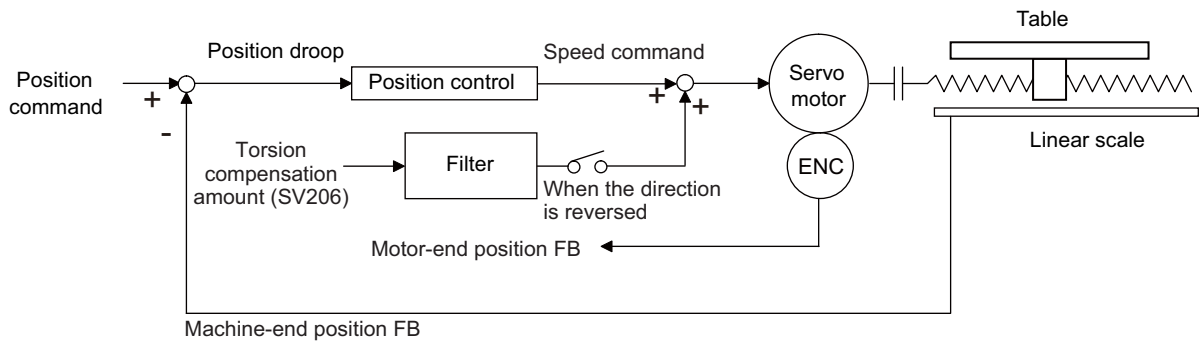

Full-closed torsion compensation

< Movement of machine end/motor end in the reverse direction >

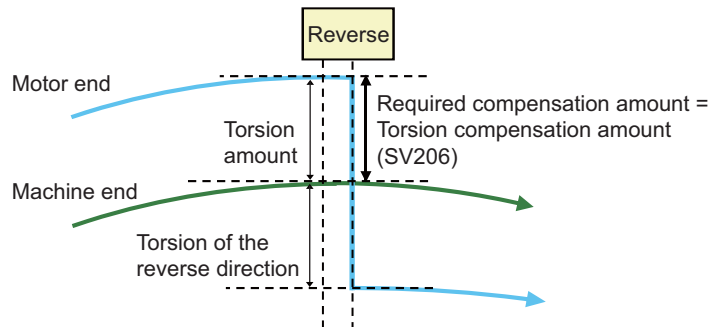

< Movement of machine end/motor end in the forward direction >

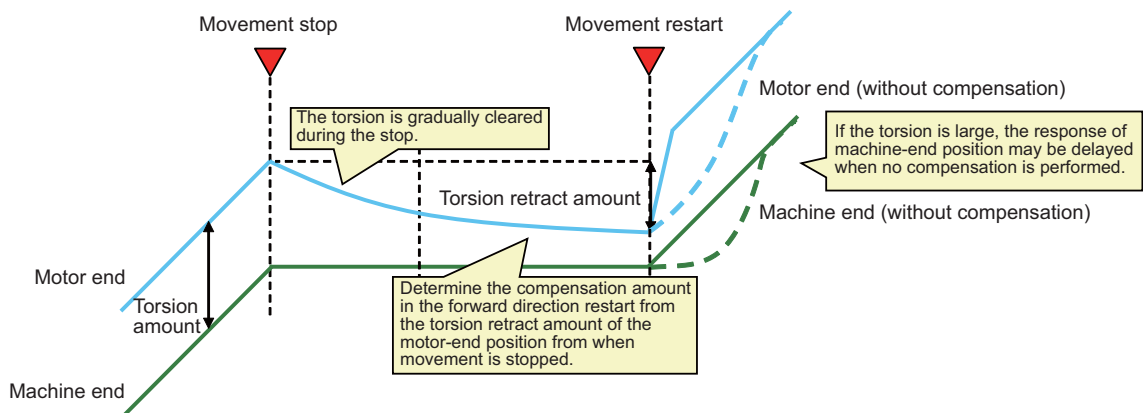

CAUTION

Always readjust the lost motion compensation when setting the torsion compensation amount (SV206).

< Setting method >

- (1) Disable all the input compensation parameters before checking the torsion amount with the motor-end feedback in the roundness measurement.
 - Set lost motion compensation 1 (LMC1) to "0".
 - Set lost motion compensation 2 (LMC2) to "0".
 - Set lost motion compensation 3 spring constant (LMCK) to "0".
 - Set lost motion compensation 3 viscous coefficient (LMCc) to "0".
 - Set lost motion compensation 4 gain (LMC4G) to "0".
 - Set full-closed torsion compensation control torsion amount (FCTC) to "0".

- (2) Perform "Roundness measurement" with NC Analyzer2 waveform measurement function.
 - Set radius R to about 100mm and feedrate F to about 3000mm/min.

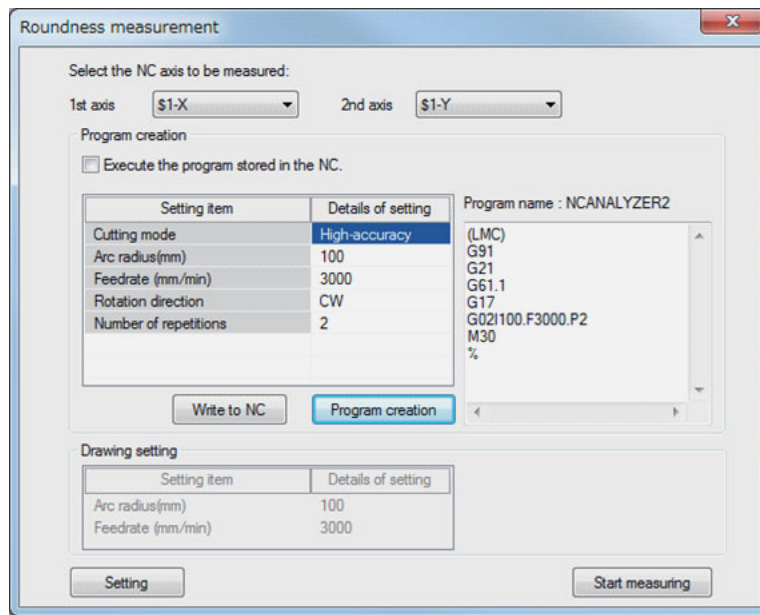

Select "Setting" from the measurement screen and change Waveform type, which is in Channel setting on "Sampling condition setting", from "Position FB" to "Motor end position".

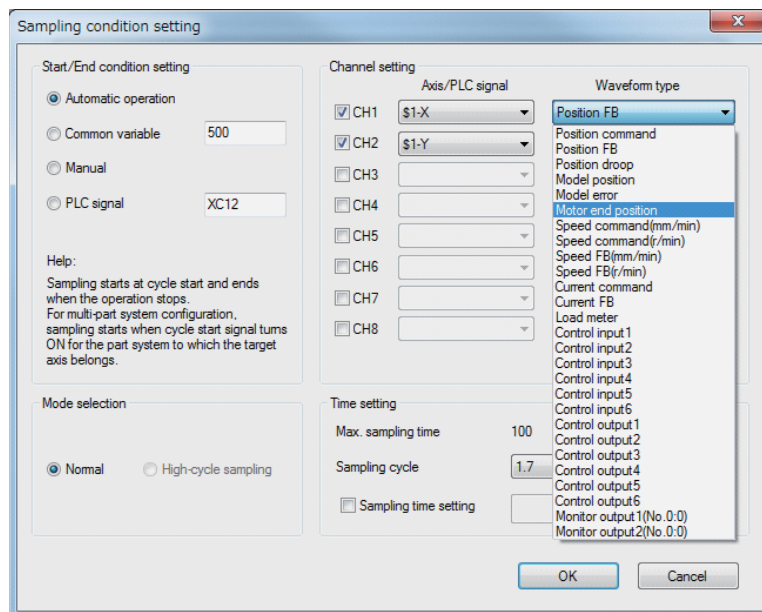

Measure the roundness and read the torsion amounts generated when the direction is reversed (linear parts in the following figure). Set the smaller value of the read values to the parameter: SV206 (unit: $0.01\mu\text{m}$) as the compensation amount.

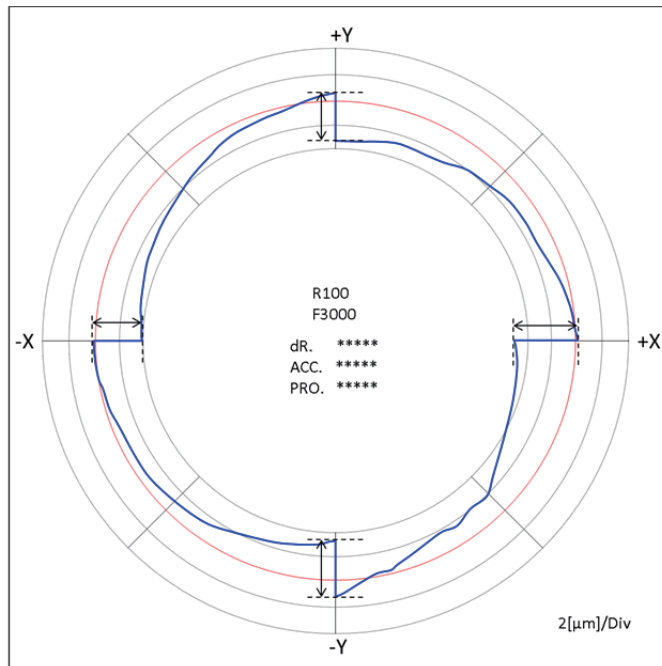

Motor-end roundness measurement

Example: When the values are $+X = 4.5\mu\text{m}$, $-X = 4.2\mu\text{m}$, $+Y = 3.9\mu\text{m}$, and $-Y = 4.2\mu\text{m}$, set SV206 for X axis to 420 and for Y axis to 390.

- (3) Perform lost motion adjustment.
 After setting the torsion amount (SV206), perform the lost motion adjustment (automatic) with NC Analyzer2 adjustment function.
 If requiring to improve the accuracy further than the adjustment result, adjust the lost motion compensation amount.
 Check the result in roundness measurement after adjusting the compensation amount.

#2406 SV206 FCTC Full-closed torsion compensation control torsion amount

Set the compensation amount of full-closed torsion compensation function.
 Set the torsion amount between the motor-end position and the machine-end position right after the stop as a standard setting value.
 When not using, set to "0".

---Setting range---
 0 to 32767 ($0.01\mu\text{m}$)

#2316 SV116 SSF11 Servo function 11

bit 1 : fctcfw Full-closed torsion compensation function forward direction compensation enabled

Compensate the torsion amount in the forward direction with the full-closed torsion compensation function. When compensating the torsion amount in the reverse direction only, set to "0".

0: Stop 1: Start

5.5 Settings for Emergency Stop

Emergency stop in this section refers to the following states.

- [1] Emergency stop was input (including other axis alarms)
- [2] NC power down was detected
- [3] A drive unit alarm was detected

5.5.1 Deceleration Control

With the servo drive unit, if the deceleration stop function is validated, the motor will decelerate following the set time constant while maintaining the READY ON state. READY will turn OFF and the dynamic brakes will function after stopping.

If an alarm, for which dynamic brakes are designated as the stopping method, occurs, the motor will stop with the dynamic brakes.

< Features >

When the load inertia is large, deceleration stop can be executed at a shorter time than the dynamic brakes. (The stop time for the normal acceleration/deceleration time constants will be achieved.)

(1) Setting the deceleration control time constant

Set the time for stopping from the rapid traverse rate (rapid: axis specification parameter) in the deceleration time constant for emergency stop (SV056: EMGt). The operation stops with the position loop step when 0 is set.

For the standard setting value of SV056, refer to the following table.

When applying this setting to the synchronous control axes, set the same value with negative symbol to the both axes. Even if the dynamic break stop is applied to either axis, it is also applied to the other axis.

Standard setting value of SV056

#2003: smgst Acceleration and deceleration modes bit 3-0: Rapid traverse acceleration/deceleration type (hexadecimal)			SV056: EMGt Deceleration time constant at emergency stop Standard setting value
1: Linear acceleration/deceleration			$EMGt \leq G0tL \times 0.9$
8: Exponential acceleration and linear deceleration			$EMGt \leq (2 \times G0t1) \times 0.9$
F: Soft acceleration/ deceleration	#1219:aux03/bit7=0	Accelerating/decelerating time is G0tL	$EMGt \leq (G0tL - G0t1) \times 0.9$
	#1219:aux03/bit7=1	Accelerating/decelerating time is obtained by G0tL+G0t1	$EMGt \leq G0tL \times 0.9$
A value other than the above			$EMGt \leq G0tL \times 0.9$

#2004: G0tL G0 time constant (linear)

#2005: G0t1 G0 time constant (primary delay) / Second-step time constant for soft acceleration/deceleration

CAUTION

If the deceleration control time constant at emergency stop (EMGt) is set to a value longer than the above value, the soft limit point (stroke end point) may be exceeded. Take care as the axis could collide the machine.

< Operation >

When an emergency stop occurs, the motor will decelerate at the same inclination from each speed.

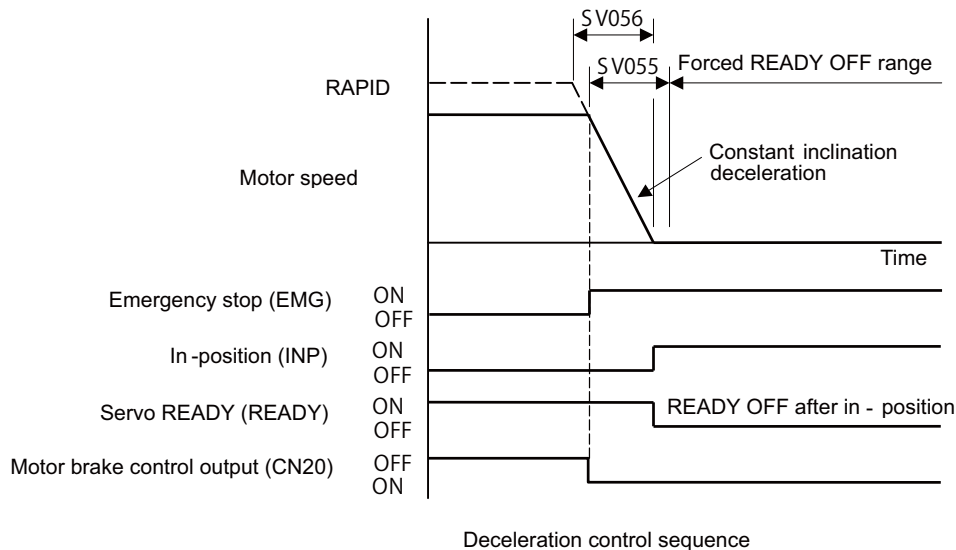

#2255 SV055 EMGx Max. gate off delay time after emergency stop

Set the time required between an emergency stop and forced READY OFF.
 Set the maximum value "+ 100ms" of the SV056 setting value of the servo drive unit electrified by the same power supply unit.
 When executing the vertical axis drop prevention, the gate off will be delayed for the length of time set at SV048 even when SV055's is smaller than that of SV048.

---Setting range---
 0 to 20000 (ms)

#2256 SV056 EMGt Deceleration time constant at emergency stop

Set the time constant used for the deceleration control at emergency stop.
 Set the time required to stop from rapid traverse rate (rapid).
 The standard setting value is $EMGt \leq G0tL \times 0.9$.
 However, note that the standard setting value differs from the above-mentioned value when the setting value of "#2003:smgst Acceleration and deceleration modes bit 3-0:Rapid traverse acceleration/deceleration type" is 8 or F. Refer to Instruction Manual of the drive unit (section "Deceleration Control") for details.

---Setting range---
 0 to 20000 (ms)

(2) Deceleration control stop distance

The stopping distance L_{emg} when the motor is stopped with deceleration control during an emergency stop can be approximated with the following expression. Note that the value will be higher than this if the current is limited during deceleration.

$$L_{emg} = \frac{F}{PGN1 \times 60} + \frac{1}{2} \times \frac{F}{60} \times \frac{F \times EMGt}{rapid \times 1000} \quad (\text{mm})$$

F : Feedrate during emergency stop (mm/min)

rapid : Rapid traverse rate (mm/min)

PGN1 : Position loop gain 1 (SV003) (rad/s)

EMGt : Deceleration time constant for emergency stop (SV056) (ms)

**POINT**

- Deceleration control will not take place when a servo alarm, for which the stopping method is dynamic, occurs.
The motor will stop with dynamic braking regardless of the parameter setting.
- If the power fails and the deceleration time constant is set to a relatively long time, the braking method may change from deceleration control to dynamic braking due to a drop in the bus voltage in the drive unit.

**CAUTION**

If the deceleration control time constant (EMGt) is set to a value longer than the acceleration/deceleration time constant, the soft limit point (stroke end point) may be exceeded.

Take care as the axis could collide the machine.

5.5.2 Vertical Axis Drop Prevention Control

The vertical axis drop prevention control is a function that prevents the vertical axis from dropping due to a delay in the brake operation when an emergency stop occurs. The no-control time until the brakes activate can be eliminated by delaying the servo READY OFF state by the time set in the parameters when an emergency stop occurs.

Always use this function together with deceleration control.

< Setting procedures >

- [1] Apply emergency stop while viewing the current position on the NC screen. Adjust the vertical axis drop prevention time (SV048), and set the 1.5-fold minimum delay time at which the axis does not drop. When using a motor with a break, confirm that the axis will not drop at the 150ms setting, and set 200ms.
- [2] Set the value of the normal acceleration/deceleration time constant plus 100ms for the max. gate off delay time at emergency stop (SV055), and set the standard setting value of the axis for the deceleration control time constant at emergency stop (SV056). Refer to "Deceleration Control" for details.
- [3] For the axis for which the vertical drop is to be controlled, set the same value as the acceleration/deceleration time constant for the deceleration control time constant at emergency stop (SV056).
- [4] If the vertical axis is MDS-EM/EMH Series (Multi axis unit), set the servo parameters for the other axis in the same unit.

SV048 = Same value as adjusted vertical axis SV048

SV055 = Same value as adjusted vertical axis SV055

SV056 = Standard setting value of SV055 for the axis (Refer to "Deceleration control" for details.)

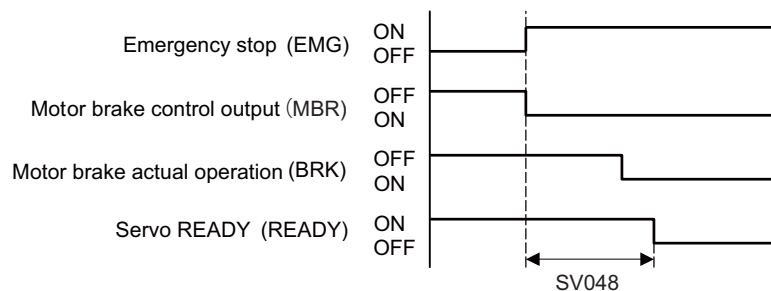

Vertical axis drop prevention control sequence

CAUTION

1. Always set deceleration control when using the vertical axis drop prevention control setting.
2. In the system with MDS-EM/EMH-SPV3 unit only, configure so that the contactor is controlled directly by the axis which controls the vertical axis drop prevention control.
3. If an alarm for which dynamic brake stopping is designated occurs, the function will not activate. To prevent axis dropping under all conditions, provide measures on the machine side by installing a balance unit, etc.
4. In consideration of the relay delay time for the break control, set the vertical axis drop prevention time.

#2248 SV048 EMGr Vertical axis drop prevention time

Input the time required to prevent the vertical axis from dropping by delaying READY OFF until the brake works at an emergency stop.

Increase in increments of 100ms at a time, find and set the value where the axis does not drop. When using a motor with a brake, set to "200ms" as a standard.

When the pull up function is enabled (SV033/bitE=1), the pull up is established during the drop prevention time.

(Note) When not using the spindle drive unit, use the servo axis that controls vertical axis drop prevention control to control the power supply (connect with CN4).

---Setting range---

0 to 20000 (ms)

#2255 SV055 EMGx Max. gate off delay time after emergency stop

Set the time required between an emergency stop and forced READY OFF.

Set the maximum value "+ 100ms" of the SV056 setting value of the servo drive unit electrified by the same power supply unit.

When executing the vertical axis drop prevention, the gate off will be delayed for the length of time set at SV048 even when SV055's is smaller than that of SV048.

---Setting range---

0 to 20000 (ms)

#2256 SV056 EMGt Deceleration time constant at emergency stop

Set the time constant used for the deceleration control at emergency stop.

Set the time required to stop from rapid traverse rate (rapid).

The standard setting value is $EMGt \leq G0tL \times 0.9$.

However, note that the standard setting value differs from the above-mentioned value when the setting value of "#2003:smgst Acceleration and deceleration modes bit 3-0:Rapid traverse acceleration/deceleration type" is 8 or F. Refer to Instruction Manual of the drive unit (section "Deceleration control") for details.

---Setting range---

0 to 20000 (ms)

**POINT**

1. SV048 and SV055 are set for each axis, but when using MDS-EM/EMH-SPV3 Series (Multi axis unit), the axes are controlled with the larger setting value.
2. If an alarm for which dynamic brake stopping is designated occurs, the function will not activate.
3. A drop amount of several μm to several $10\mu\text{m}$ may be generated due to brake play.

**CAUTION**

1. Do not set the vertical axis drop prevention time longer than required. The servo control and brakes could collide, resulting in an overload alarm or drive unit damage. There is no problem if the overlapping time is within 100ms.
2. Vertical axis drop prevention control (including deceleration control) longer than 100ms will not be guaranteed during a power failure. The operation will change to dynamic brakes.
3. If only SV048 and SV055 are set, and SV056 is set to 0, the deceleration stop will be a stepped stop and could result in collision with the machine.

< Outline of system configurations and corresponding parameter settings >

[1] Only one MDS-EM/EMH-SPV3 unit (vertical axis: Z axis)

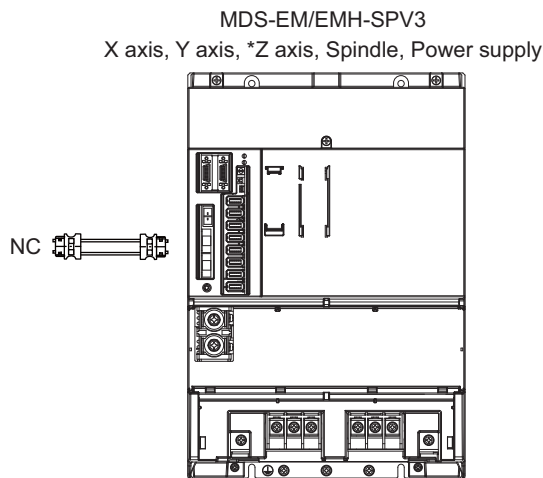

Parameter	Axis	X axis	Y axis	Z axis (Vertical axis)	Spindle
	MDS-EM/EMH-SPV3				
SV048		Same value as Z axis ->	Same value as Z axis ->	200ms as a standard (Set by adjustment)	Set as follows. SP055=5000 SP056=300
SV055		X, Y, Z axis Maximum value of SV056 setting value +100ms			
SV056		Standard setting value for each axis (Note)			

(Note) For the standard setting value of SV056, refer to "Deceleration control".

[2] MDS-EM/EMH-SPV3 unit (vertical axis: Z axis) + Spindle drive unit + Power supply unit

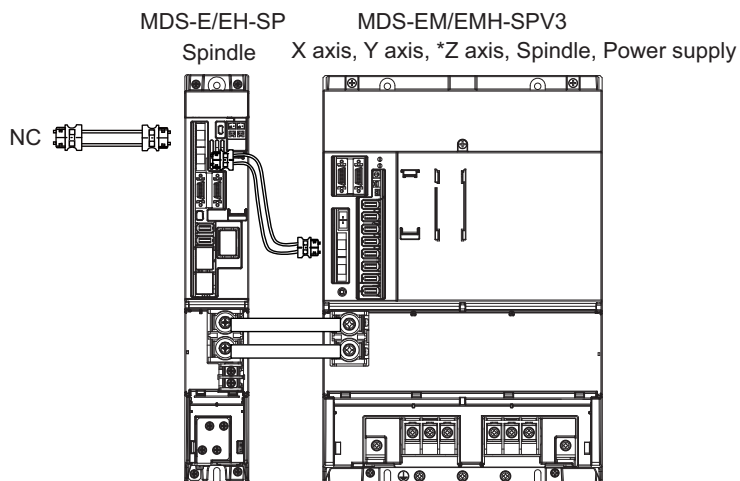

Parameter	Axis	X axis	Y axis	Z axis (Vertical axis)	Spindle
	MDS-EM/EMH-SPV3				MDS-E/EH-SP, MDS-EM/EMH-SPV3
SV048		Same value as Z axis ->	Same value as Z axis ->	200ms as a standard (Set by adjustment)	Set as follows. SP055=5000 SP056=300
SV055		X, Y, Z axis Maximum value of SV056 setting value +100ms			
SV056		Standard setting value for each axis (Note)			

(Note) For the standard setting value of SV056, refer to "Deceleration control".

[3] MDS-EM/EMH-SPV3 unit + Servo drive unit (vertical axis: Z axis) + Power supply unit

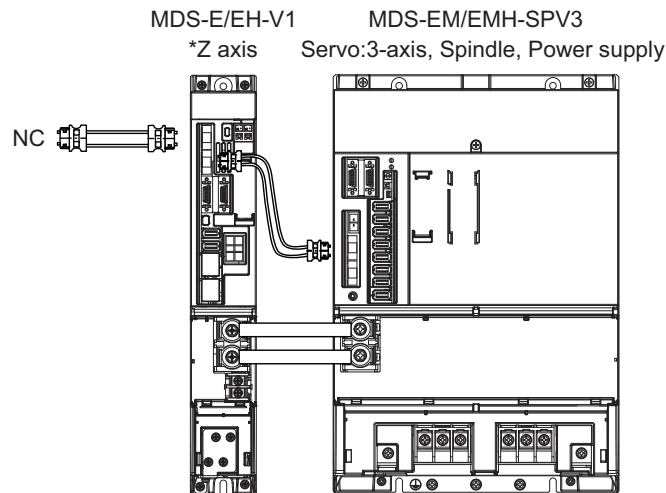

Parameter	Axis	Axis other than the right (3-axis)			Z axis (Vertical axis)	Spindle
		MDS-EM/EMH-SPV3			MDS-E/EH-V1	MDS-EM/EMH-SPV3
SV048		0	0	0	200ms as a standard (Set by adjustment)	Set as follows. SP055=5000 SP056=300
SV055		Each axis Maximum value of SV056 setting value +100ms				
SV056		Standard setting value for each axis (Note)				

(Note) For the standard setting value of SV056, refer to "Deceleration control".

5.5.3 Vertical Axis Pull-up Control

Even when the vertical axis drop prevention control is applied, the axis will drop several μm due to the mechanical play of the motor brakes. Work could be damaged especially when the power fails during machining. For the vertical machining center, etc., vertical axis pull-up control protect works from collision by slightly pulling the vertical axis when an emergency stop (including the power failure) occurs.

If the pull-up control itself has possibility to cause interference during synchronous tapping machining or soft limit's stop, vertical axis pull-up control suppression command (servo control input 4/bit2) is input from NC and stops the pull-up control.

< Adjustment procedure >

- [1] Set "Vertical Axis Drop Prevention Control".
- [2] Set servo function selection 2 SV033/bitE = 1 (Vertical axis drop prevention control will start).
- [3] Set the torque offset SV032. The pull-up directions is distinguished by this setting value's sign. Refer to "Measuring unbalance torque and frictional torque measurement" for details on the setting.
- [4] Input emergency stop when axes stop and confirm the subject axis to be retracted upward.
- [5] If the pull-up range is insufficient, adjust vertical axis pull-up distance SV095.

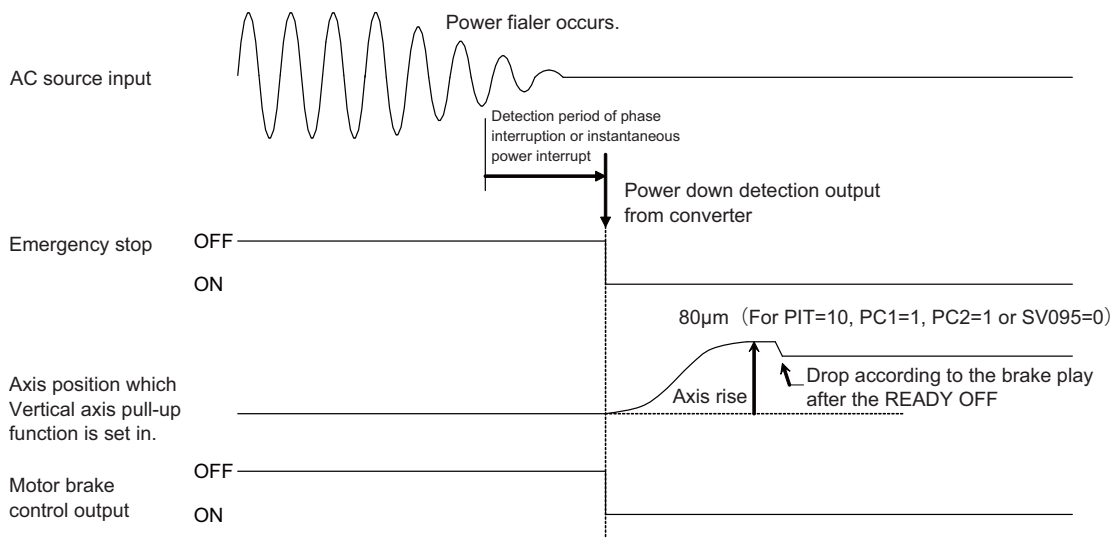

Vertical axis pull-up control operation sequences when the power fails

CAUTION

This function is valid for Z axis in the vertical machining center. Basically it cannot be used with the horizontal machining center's Y axis or the lathe's X axis as collisions could occur. Check the machine's working conditions carefully before using this function.

#2232 SV032 TOF Torque offset

Set the unbalance torque on vertical axis and inclined axis.

When the vertical axis pull up function is enabled, the pull up compensation direction is determined by this parameter's sign. When set to "0", and the pull up function is enabled (SV033/bitE=1), the alarm "S02 2233 Initial parameter error" occurs.

This can be used for speed loop delay compensation and collision detection function.

To use load inertia estimation function (drive monitor display), set this parameter, friction torque (SV045) and load inertia display enabling flag(SV035/bitF).

---Setting range---

-100 to 100 (Stall current %)

#2233 SV033 SSF2 Servo function 2**bit E : zup Vertical axis pull up function**

0: Stop 1: Enable

#2248 SV048 EMGrT Vertical axis drop prevention time

Input the time required to prevent the vertical axis from dropping by delaying READY OFF until the brake works at an emergency stop.
 Increase in increments of 100ms at a time, find and set the value where the axis does not drop.
 When using a motor with a break, set to "200ms" as a standard.
 When the pull up function is enabled (SV033/bitE=1), the pull up is established during the drop prevention time.

(Note) When not using the spindle drive unit, use the servo axis that controls vertical axis drop prevention control to control the power supply (connect with CN4).

---Setting range---

0 to 20000 (ms)

#2295 SV095 ZUPD Vertical axis pull up distance

Set this parameter to adjust the pull up distance when the vertical axis pull up function is enabled.
 When the pull up function is enabled and this parameter is set to "0", for a rotary motor, 8/1000 of a rotation at the motor end is internally set as the pull up distance, and for a linear motor, 80[μ m] is set.

---Setting range---0 to 2000 (μ m)

5.6 Protective Functions

5.6.1 Overload Detection

The servo drive unit is equipped with an electronic thermal that protects the servo motor and servo drive unit from overload conditions. The overload 1 alarm (alarm 50) is detected if an overload condition occurs, and the overload 2 alarm (alarm 51) is detected if 95% or more of the maximum current is commanded continuously for 1 second or longer due to a machine collision, etc. The parameters shown below are for Mitsubishi Electric adjustment purposes only, and should be kept at their standard settings (SV021=60, SV022=150).



For details concerning the overload protection characteristics, refer to the MDS-EM Series Specifications Manual (IB-1501238).

#2221 SV021 OLT Overload detection time constant

Normally, set to "60". (For Mitsubishi Electric adjustment.)

---Setting range---

1 to 999 (s)

#2222 SV022 OLL Overload detection level

Set the "Overload 1" (Alarm 50) current detection level as percentage to the stall current.
 Normally set this parameter to "150". (For Mitsubishi Electric adjustment.)

---Setting range---

110 to 500 (Stall current %)

5.6.2 Excessive Error Detection

An excessive error (alarms 52, 53, 54) is detected when the difference between the servo's commanded position and the FB position exceeds the value set by parameter. Separate excessive error detection width can be set for servo ON (SV023) and servo OFF (SV026) statuses. When a wider excessive error detection width than that used for standard control is required in stopper control, etc., the detection width setting can be changed to the SV053 setting value by NC command.

Follow-up control (NC commanded position tracks servo FB position) is used during emergency stop and during a servo OFF command, and so there is no excessive error detection at those times, although the follow-up control during a servo OFF status can be disabled by an NC system parameter setting.

#2223 SV023 OD1 Excessive error detection width during servo ON

Set the excessive error detection width in servo ON.

<Standard setting value>

$$OD1=OD2= (\text{Rapid traverse rate [mm/min]}) / (60 \times \text{PGN1}) / 2 \text{ [mm]}$$

When set to "0", the excessive error alarm detection will be ignored, so do not set to "0".

---Setting range---

0 to 32767 (mm)

However, when SV084/bitC=1, the setting range is from 0 to 32767 (μm).

#2226 SV026 OD2 Excessive error detection width during servo OFF

Set the excessive error detection width during servo OFF.

<Standard setting value>

$$OD1=OD2= (\text{Rapid traverse rate [mm/min]}) / (60 \times \text{PGN1}) / 2 \text{ [mm]}$$

When set to "0", the excessive error alarm detection will be ignored, so do not set to "0".

---Setting range---

0 to 32767 (mm)

However, when SV084/bitC=1, the setting range is from 0 to 32767 (μm).

#2253 SV053 OD3 Excessive error detection width in special control

Set the excessive error detection width when servo ON in a special control (initial absolute position setting, stopper control and etc.).

When "0" is set, excessive error detection will not be performed when servo ON during a special control.

---Setting range---

0 to 32767 (mm)

However, when SV084/bitC=1, the setting range is from 0 to 32767 (μm).

5.6.3 Collision Detection Function

Collision detection function quickly detects a collision of the motor shaft, and decelerates and stops the motor. This suppresses the generation of an excessive torque in the machine tool, and helps to prevent an abnormal state from occurring. Impact at a collision will not be prevented by using this collision detection function, so this function does not necessarily guarantee that the machine tool will not be damaged or that the machine accuracy will be maintained after a collision. The same caution as during regular operation is required to prevent the machine from colliding.

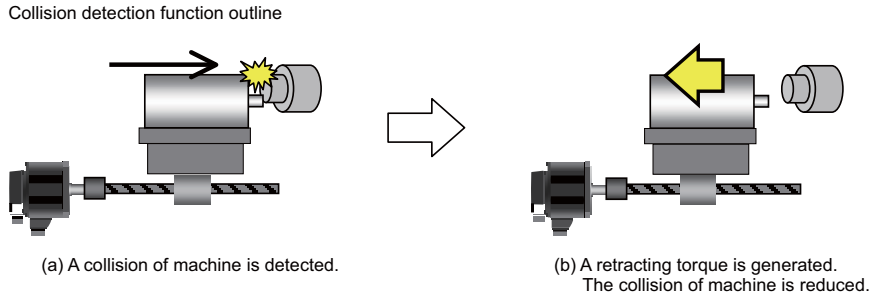

(1) Collision detection method 1

The required torque for the command is estimated from the position command issued from the NC, and the disturbance torque is obtained from the difference with the actual torque. When this disturbance torque exceeds the collision detection level set with the parameters, the motor will decelerate to a stop with a torque 80% (standard) value of the motor's maximum torque. After decelerating to a stop, alarm 58 or 59 will occur, and the system will stop.

The collision detection level for rapid traverse (G0) is set with SV060: TLMT. The collision detection level for cutting feed (G1) is set to 0 to 7-fold (SV35.cIG1) based on the collision detection level for rapid traverse. When cIG1 is set to 0, collision detection method 1 will not function during cutting feed. If SV060 is set to 0, all collision detection (including methods 1 and 2) will not function.

	Collision detection level setting parameter	Detected alarm
During rapid traverse (During G0 feed)	SV060	Alarm 58
During cutting feed (During G1 feed)	SV060 × cIG1 (SV035)	Alarm 59

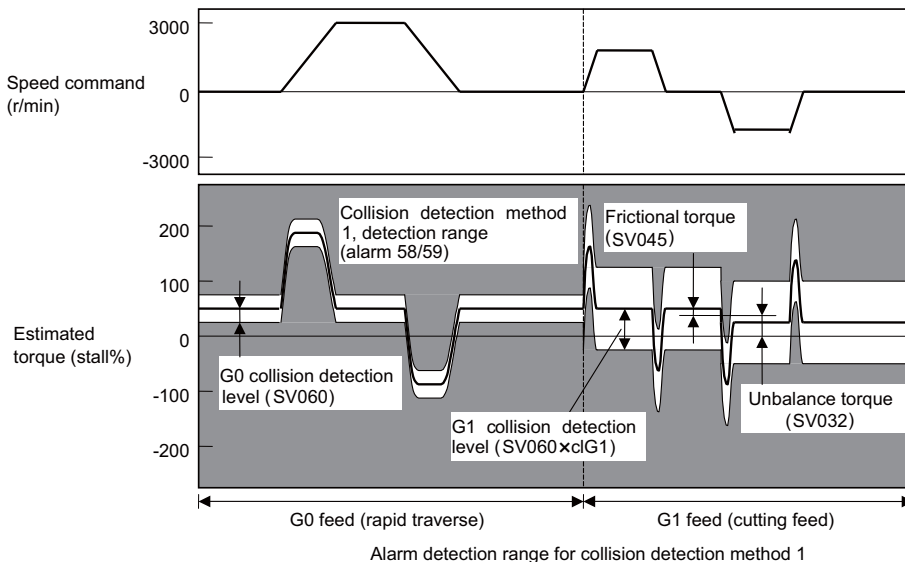

CAUTION

The collision detection function does not guarantee safety or machine accuracy when a collision occurs. Thus, the same caution as during regular operation is required to prevent the machine from colliding.

(2) Collision detection method 2

When the current command reaches the motor's maximum current, the motor will decelerate and stop at a torque 80% (standard value) of the motor's maximum torque. After decelerating to a stop, alarm 5A will occur, and the system will stop. If the acceleration/deceleration time constant is short and incorrect detections easily occur during normal operation, lengthen the acceleration/ deceleration time constant and adjust so that the current is not saturated (does not reach the maximum current) during acceleration.

If the acceleration/deceleration time constant cannot be lengthened, set parameter SV035/bitB (SSF4.c12n) to 1 to ignore collision detection method 2.

(3) Retracting torque

In each collision detection method, impact after a collision is reduced by generating the retracting torque after the collision is detected.

The retracting torque is a torque 70% to 100% which is set with SV035: SSF4/cltq (bit8, bit9) based on the current of the motor maximum ability.

**POINT**

1. Validate SHG control or OMR-FF function when using the collision detection function, or when carrying out SV059 setting value operation.
2. Provide an allowance in the detection level setting to prevent incorrect detections.
3. All collision detection functions will be disabled when SV60 is set to 0.
4. Collision detection method 2 will function if a value other than 0 is set in SV060. Note that the detection can be ignored by setting the parameter (SV035/bitB).
5. The torque estimated gain (SV059) must be readjusted when there are changes in the encoder replacement following maintenance, etc., in the encoder resolution, or in the position control system such as encoder loop gain (PGN), etc. (closed loop control and semi-closed loop has been changed).
6. The retracting torque generated when a collision is detected outputs the motor maximum torque. If the torque limitation is required in order to protect the machine, set "SV035 : SSF4/cltq (bit8, bit9)".
7. Due to the steady load during machining, and changes in frictional torque and unbalance torque, collision detection method 1 is sometimes unable to accurately detect collisions. Setting "SV035 : SSF4.clof (bit3)" to 1 can improve detection accuracy for such cases.

< Setting and adjustment methods >

- [1] Confirm that SHG control or OMR-FF function is enabled.
- [2] Set the axis unbalanced torque to the torque offset (SV032: TOF). (Refer to "Measuring unbalance torque and frictional torque" for details on measuring the unbalance torque.)
- [3] Measure the frictional torque and set in the frictional torque (SV045: TRUB). Carry out reciprocation operation (approx. F1000) with the axis to be adjusted, and measure the load current % when the axis is fed at the constant speed on the NC SERVO MONITOR screen. This frictional torque is expressed with the following expression.

$$\text{Frictional torque (\%)} = \left| \frac{(+ \text{ feed load current \%}) - (- \text{ feed load current \%})}{2} \right|$$

- [4] Set SV035: SSF4.clt (bitF) to 1 for the axis being adjusted, and move in both directions with JOG, etc., at the rapid traverse rate. When the load inertia ratio display on the NC SERVO MONITOR screen has stabilized, set that value for the torque estimated gain (SV059: TCNV). Return SV035: SSF4.clt (bitF) to 0.
- [5] To improve the detection accuracy of collision detection, set "SV035: SSF4.clof (bit3)" to 1, and enable the estimated disturbance torque offset.
- [6] If the acceleration/deceleration time is short, and the current is limited, set SV035: SSF4.c12n (bitB) to 1 to invalidate collision detection method 2.
- [7] Adjust the collision detection level (SV060: TLMT). First set 100. If operation at the rapid traverse rate results in an alarm, increase the setting value by approx. 20. If an alarm does not occur, lower the setting value by approx. 10. The estimated disturbance torque value on the servo monitor screen will indicate the estimated disturbance torque peak value for the latest two seconds. This value can be used as reference. Set the final setting value to a value approx. 1.5-fold the limit value at which an alarm does not occur.
- [8] Divide the maximum cutting load with the value set for the collision detection level (SV060: TLMT). (Round up the decimal) Set this value in SV035: SSF4.clG1 (bitC-E).
(Example) For maximum cutting load: 200%, SV060: TLMT setting value: 80%
200/80=2.5 -> The detection level is 3 (-fold), so set SV035:SSF4 to "3xxx".
- [9] Set the retracting torque when the a collision is detected to SV035: SSF4.cltq (bit8,9).
(Example) To set the retracting torque to 70% of the motor maximum torque:
Set SV035:SSF4 to "x3xx".

#2232 SV032 TOF Torque offset

Set the unbalance torque on vertical axis and inclined axis.

When the vertical axis pull up function is enabled, the pull up compensation direction is determined by this parameter's sign. When set to "0", and the pull up function is enabled (SV033/bitE=1), the alarm "S02 2233 Initial parameter error" occurs.

This can be used for speed loop delay compensation and collision detection function.

To use load inertia estimation function (drive monitor display), set this parameter, friction torque (SV045) and load inertia display enabling flag(SV035/bitF).

---Setting range---

-100 to 100 (Stall current %)

#2235 SV035 SSF4 Servo function 4**bit F : clt Inertia ratio display**

0: Setting for normal use

1: Display the total inertia ratio estimated at acceleration/deceleration at the inertia ratio on the servo monitor screen

To display it on the screen, set an imbalance torque and friction torque to both SV032 and SV045 and repeat acceleration/deceleration operations for several times.

bit E-C: clG1 G1 Collision detection level

Set the collision detection level in the collision detection method 1 during cutting feed (G1) in multiples of that of rapid traverse (G0). When set to "0", detection of collision detection method 1 during cutting feed will be ignored.

G1 Collision detection level = G0 collision detection level (SV060) × clG1

bit B : cl2n Collision detection method 2

0: Enable 1: Disable

bit 9-8 : cltq Retract torque in collision detection

Set the retract torque in collision detection using the ratio of motor's maximum torque.

bit9,8=

00: 100%

01: 90%

10: 80% (Standard)

11: 70%

bit 3 : cl0f Collision detection estimated disturbance torque offset

0: Disable 1: Enable

#2245 SV045 TRUB Friction torque

Set the frictional torque when using the collision detection function.

To use load inertia estimation function (drive monitor display), set this parameter, imbalance torque (SV032) and load inertia display enabling flag (SV035/bitF).

---Setting range---

0 to 255 (Stall current %)

#2259 SV059 TCNV Collision detection torque estimated gain

Set the torque estimated gain when using the collision detection function.

The standard setting value is the same as the load inertia ratio (SV037 setting value) including motor inertia.

Set to "0" when not using the collision detection function.

<<Drive monitor load inertia ratio display>>

Set SV035/bitF=1 and imbalance torque and friction torque to both SV032 and SV045, and then repeat acceleration/deceleration for several times.

---Setting range---

For general motor: 0 to 5000 (%)

For linear motor: 0 to 5000 (kg)

#2260 SV060 TLMT Collision detection level

When using the collision detection function, set the collision detection level at the G0 feeding.

When "0" is set, none of the collision detection function will work.

---Setting range---

0 to 999 (Stall current %)

5.7 Servo Control Signal

The sequence input/output signals exchanged between the NC and servo drive unit are explained in this section. The status of each signal is displayed on the NC SERVO MONITOR screen.

5.7.1 Servo Control Input (NC to Servo)

(1) Servo control input 1

Name	Details																																															
Servo control input 1	<table border="1"> <tr> <td>F</td><td>E</td><td>D</td><td>C</td><td>B</td><td>A</td><td>9</td><td>8</td><td>7</td><td>6</td><td>5</td><td>4</td><td>3</td><td>2</td><td>1</td><td>0</td> </tr> <tr> <td></td><td></td><td></td><td></td><td></td><td></td><td></td><td>IL1</td><td>ALMR</td><td>EOM</td><td>KPM</td><td></td><td></td><td></td><td>SRV</td><td>RDY</td> </tr> </table>																F	E	D	C	B	A	9	8	7	6	5	4	3	2	1	0								IL1	ALMR	EOM	KPM				SRV	RDY
	F	E	D	C	B	A	9	8	7	6	5	4	3	2	1	0																																
								IL1	ALMR	EOM	KPM				SRV	RDY																																
	bit	Details																																														
	0	RDY	READY ON command																																													
	1	SRV	Servo ON command																																													
	2	-	(For maintenance)																																													
	3	-	(For maintenance)																																													
	4	KPM	Position loop gain changeover command																																													
	5	-	(For maintenance)																																													
	6	EOM	Excessive error detection width changeover command																																													
	7	ALMR	Alarm reset command																																													
	8	IL1	Current limit selection command																																													
	9	-	(For maintenance)																																													
	A	-	(For maintenance)																																													
	B	-	(For maintenance)																																													
	C	-	(For maintenance)																																													
D	-	(For maintenance)																																														
E	-	(For maintenance)																																														
F	-	(For maintenance)																																														

bit0. READY ON command (RDY)
Status turns to ready ON at RDY=1.

bit1. Servo ON command (SRV)
[1] Drive unit turns ON at SRV=1 (servo ON status).
[2] Drive unit turns OFF at SRV=0 (servo OFF status).

bit4. Position loop gain changeover command (KPM)
[1] The position loop gain (SV049/SV050/SV058) for spindle synchronous (synchronoustapping, synchronous control with spindle C-axis, etc.) is selected at KPM=1.
[2] The normal position loop gain (SV003/SV004/SV057) is selected at KPM=0.

bit6. Excessive error detection width changeover command (EOM)
[1] The excessive error width (SV053) for the special control (initial absolute position setting, stopper control, etc.) is selected at EOM =1.
[2] The normal excessive error width (SV023) is selected at EOM =0.

bit7. Alarm reset command (ALMR)
NR alarm is reset at ALMR=1.

bit8. Current limit selection command (IL1)
[1] The current (torque) limit (SV014) for the special control (initial absolute position setting, stopper control, etc.) is selected at IL1 =1.
[2] The normal current (torque) limit (SV013) is selected at IL1 =0.

(Note) The bits other than those above are used for maintenance.

(2) Servo control input 2

Name	Details																
Servo control input 2	F	E	D	C	B	A	9	8	7	6	5	4	3	2	1	0	
					SRVDC	NCDC	SSW										
	bit	Details															
	0	-	(For maintenance)														
	1	-	(For maintenance)														
	2	-	(For maintenance)														
	3	-	(For maintenance)														
	4	-	(For maintenance)														
	5	-	(For maintenance)														
	6	-	(For maintenance)														
	7	-	(For maintenance)														
	8	-	(For maintenance)														
	9	SSW	Speed monitor command valid														
	A	NCDC	In door closed (controller)														
	B	SRVDC	In door closed (all drive units)														
	C	-	(For maintenance)														
D	-	(For maintenance)															
E	-	(For maintenance)															
F	-	(For maintenance)															

bit9. Speed monitor command valid (SSW)
When speed monitor command is valid, SSW=1 (valid) is set.

bitA. In door closed (controller) (NCDC)
When "In door closed" signal for controller is valid, NCDC =1 (valid) is set.

bitB. In door closed (all drive units) (SRVDC)
When the theoretical sum of "In door closed" signals for all drive units is valid, SRVDC =1 (valid) is set.

(Note) The bits other than those above are used for maintenance.

(3) Servo control input 3

Name	Details																
Servo control input 3	F	E	D	C	B	A	9	8	7	6	5	4	3	2	1	0	
																AXF	
	bit	Details															
	0	AXF	Control axis detachment command														
	1	-	(For maintenance)														
	2	-	(For maintenance)														
	3	-	(For maintenance)														
	4	-	(For maintenance)														
	5	-	(For maintenance)														
	6	-	(For maintenance)														
	7	-	(For maintenance)														
	8	-	(For maintenance)														
	9	-	(For maintenance)														
	A	-	(For maintenance)														
	B	-	(For maintenance)														
	C	-	(For maintenance)														
D	-	(For maintenance)															
E	-	(For maintenance)															
F	-	(For maintenance)															

bit0. Control axis detachment command (AXF)
The control axis is detached at AXF=1.

(Note) The bits other than those above are used for maintenance.

(4) Servo control input 4

This is used for maintenance.

(5) Servo control input 5

This is used for maintenance.

(6) Servo control input 6

Name	Details																
Servo control input 6	F	E	D	C	B	A	9	8	7	6	5	4	3	2	1	0	
								DD1									OMRFF
	bit	Details															
	0	OMRFF	OMR-FF control request														
	1	-	(For maintenance)														
	2	-	(For maintenance)														
	3	-	(For maintenance)														
	4	-	(For maintenance)														
	5	-	(For maintenance)														
	6	-	(For maintenance)														
	7	-	(For maintenance)														
	8	DD1	Drivers communication control request														
	9	-	(For maintenance)														
	A	-	(For maintenance)														
	B	-	(For maintenance)														
	C	-	(For maintenance)														
	D	-	(For maintenance)														
E	-	(For maintenance)															
F	-	(For maintenance)															

bit0. OMR-FF control request (OMRFF)

- [1] The OMR-FF control which determines the tracking ability to the position command by using scale model gain is selected with OMRFF=1.
- [2] The tracking ability to the position command is determined by using conventional position loop gain with OMRFF=0.

bit8. Drivers communication control request (DD1)

- [1] The high-speed synchronous tapping control which allows data communication between drive units is selected with DD1=1.
- [2] The normal synchronous tapping is selected with DD1=0.

(Note) The bits other than those above are used for maintenance.

5.7.2 Servo Control Output (Servo to NC)

(1) Servo control output 1

Name	Details																																
Servo control output 1	<table border="1"> <tr> <td>F</td><td>E</td><td>D</td><td>C</td><td>B</td><td>A</td><td>9</td><td>8</td><td>7</td><td>6</td><td>5</td><td>4</td><td>3</td><td>2</td><td>1</td><td>0</td> </tr> <tr> <td>WRN</td><td>AER</td><td>LMT</td><td>INP</td><td></td><td></td><td></td><td>IL1</td><td>ALMR</td><td>EOM</td><td>KPM</td><td></td><td></td><td>SRV</td><td>RDY</td><td></td> </tr> </table>	F	E	D	C	B	A	9	8	7	6	5	4	3	2	1	0	WRN	AER	LMT	INP				IL1	ALMR	EOM	KPM			SRV	RDY	
	F	E	D	C	B	A	9	8	7	6	5	4	3	2	1	0																	
	WRN	AER	LMT	INP				IL1	ALMR	EOM	KPM			SRV	RDY																		
	bit	Details																															
	0	RDY In READY ON																															
	1	SRV In servo ON																															
	2	- (For maintenance)																															
	3	- (For maintenance)																															
	4	KPM In position loop gain changeover																															
	5	- (For maintenance)																															
	6	EOM In excessive error detection width changeover																															
	7	ALMR In alarm																															
	8	IL1 In current limit selection																															
	9	- (For maintenance)																															
	A	- (For maintenance)																															
	B	- (For maintenance)																															
C	INP In in-position																																
D	LMT In current limit																																
E	AER In absolute position data loss																																
F	WRN In warning																																

- bit0. In ready ON (RDY)
It indicates that the status is in ready ON at RDN=1.
- bit1. In servo ON (SRV)
It indicates that the drive unit turns ON (servo ON) at SRV=1.
- bit4. In position loop gain changeover (KPM)
 - [1] The position loop gain (SV049/SV050/SV058) for spindle synchronous (synchronoustapping, synchronous control with spindle C-axis, etc.) is being selected at KPM=1.
 - [2] The normal position loop gain (SV003/SV004/SV057) is being selected at KPM=0.
- bit6. In excessive error detection width changeover (EOM)
 - [1] The excessive error width (SV053) for the special control (initial absolute position setting, stopper control, etc.) is being selected at EOM =1.
 - [2] The normal excessive error width (SV023) is being selected at EOM =0.
- bit7. In alarm (ALMR)
It indicates that drive unit is in some alarm state at ALM=1.
- bit8. In current limit selection (IL1)
 - [1] The current (torque) limit (SV014) for the special control (initial absolute position setting, stopper control, etc.) is being selected at IL1 =1.
 - [2] The normal current (torque) limit (SV013) is being selected at IL1 =0.
- bitC. In in-position (INP)
The status changes to INP=1 when position droop exists within the in-position area set by parameter SP024 (INP) regardless of serve ON or OFF.
- bitD. In current limit (LMT)
It indicates that the drive unit is in current limit at LMT=1.

bitE. In absolute position data loss (AER)
It indicates that the drive unit is in absolute position data loss at AER=1.

bitF. In warning (WRN)
It indicates that drive unit is in some warning state at WRN=1.

(Note) The bits other than those above are used for maintenance.

(2) Servo control output 2

Name	Details															
Servo control output 2	F	E	D	C	B	A	9	8	7	6	5	4	3	2	1	0
					SRVDC	NCDC	SSW		EXEMG				ZS			ZCN
	bit	Details														
	0	ZCN	Z phase passed													
	1	-	(For maintenance)													
	2	-	(For maintenance)													
	3	ZS	In zero speed													
	4	-	(For maintenance)													
	5	-	(For maintenance)													
	6	-	(For maintenance)													
	7	EXEMG	In external emergency stop													
	8	-	(For maintenance)													
	9	SSW	In speed monitor													
	A	NCDC	In door closed (controller)													
	B	SRVDC	In door closed (self drive unit)													
	C	-	(For maintenance)													
	D	-	(For maintenance)													
	E	-	(For maintenance)													
	F	-	(For maintenance)													

bit0. Z phase passed (ZCN)
ZCN is set to "1" after passing the Z phase at ZCN=0.

bit3. In zero speed (ZS)
It indicates that the servo motor is stopping at ZS=1.

bit7. In external emergency stop
It indicates that an external stop input to the power supply is being input.

bit9. In speed monitor
It indicates that a signal in speed monitor command is being received.

bitA. In door closed (controller)
It indicates that "In door closed" signal for controller is being received.

bitB. In door closed (self drive unit)
It indicates the status of "In door closed" signal for self drive unit.

(Note) The bits other than those above are used for maintenance.

(3) Servo control output 3

Name	Details															
Servo control output 3	F	E	D	C	B	A	9	8	7	6	5	4	3	2	1	0
																AXF
	bit	Details														
	0	AXF	In control axis detachment													
	1	-	(For maintenance)													
	2	-	(For maintenance)													
	3	-	(For maintenance)													
	4	-	(For maintenance)													
	5	-	(For maintenance)													
	6	-	(For maintenance)													
	7	-	(For maintenance)													
	8	-	(For maintenance)													
	9	-	(For maintenance)													
	A	-	(For maintenance)													
	B	-	(For maintenance)													
	C	-	(For maintenance)													
	D	-	(For maintenance)													
E	-	(For maintenance)														
F	-	(For maintenance)														

bit0. In control axis detachment (AXF)
 The control axis is being detached at AXF=1.

(Note) The bits other than those above are used for maintenance.

(4) Servo control output 4

This is used for maintenance.

(5) Servo control output 5

This is used for maintenance.

(6) Servo control output 6

Name	Details															
Servo control output 6	F	E	D	C	B	A	9	8	7	6	5	4	3	2	1	0
								DD1								OMRFF
	bit	Details														
	0	OMRFF	In OMR-FF control													
	1	-	(For maintenance)													
	2	-	(For maintenance)													
	3	-	(For maintenance)													
	4	-	(For maintenance)													
	5	-	(For maintenance)													
	6	-	(For maintenance)													
	7	-	(For maintenance)													
	8	DD1	In drivers communication control													
	9	-	(For maintenance)													
	A	-	(For maintenance)													
	B	-	(For maintenance)													
	C	-	(For maintenance)													
	D	-	(For maintenance)													
E	-	(For maintenance)														
F	-	(For maintenance)														

bit0. In OMR-FF control (OMRFF)
 OMRFF=1 (enabled) if OMR-FF control is enabled.

bit8. In drivers communication control (DD1)
 DD1=1 (enabled) if high-speed synchronous tapping control is enabled.

(Note) The bits other than those above are used for maintenance.

Spindle Adjustment

6.1 Adjustment Procedures for Each Control

CAUTION

1. Do not adjust when possible risks associated with adjustment procedures are not thoroughly taken into consideration.
2. Be careful when touching rotating section, or your hand may be caught in or cut.
3. Changing of parameters has to be done carefully.

6.1.1 Basic Adjustments

(1) Items to check during trial operation

- [1] When the power is ON for the first time, check the wiring. When the machine is operated for the first time, check the set parameters again.
- [2] Confirm that the values of the NC side parameters "slimt1 to 4", "smax1 to 4", and "smini" comply with the machine specification.
- [3] When the machine running-in has not been completed, gradually raise the rotation speed (in increments of 1000r/min) for the spindle. Raise the speed at the timing when the load meter value is stabilized during rotation.
If the load meter value is higher than the normal value, stop the operation and check the spindle section of the machine.
- [4] Confirm that the command (S command) speed and actual speed match during running-in. When gear ratio is set, the spindle end speed and motor speed differ.
- [5] Confirm that there is no abnormal noise, odor or motor overheat during running-in.

(2) Adjusting the spindle rotation speed

When the spindle motor and the spindle end are coupled using a gear or pulley, the rotation speeds of the spindle motor and the spindle end may not match. Adjust the command and the rotation speed of spindle end with the following method.

Apply the following adjustment methods [1] to [3] individually to each of the gears 00 to 11. Confirm that the machine's gear changes correctly before the adjustment.

- [1] Set the spindle specification parameters, "slimt1 to 4".
Calculation expression:
$$\text{slimt1 to 4} = \text{SP026} \times (\text{deceleration rate of the gears 00 to 11 between the motor and spindle end})$$
- [2] Set the S command to half of the maximum spindle rotation speed and confirm the rotation speed of the spindle end. Adjust slimt1 to 4 until the rotation speed matches.
- [3] Set the S command to the maximum spindle end rotation speed and confirm that the S command speed and the spindle end speed match.

6.1.2 Gain Adjustment

(1) Checking the current loop gain

Check to see if the settings of following parameters, SP077 to SP084, are the standard setting.

Basically, parameters for current loop gain do not need to be changed.

#13077 SP077 IQA Q axis current lead compensation

Set the current loop gain.

To use the coil switch function, set the current loop gain for when the high-speed coil is selected. The setting value is determined by the motor's electrical characteristics so that the value is fixed to each motor used.

Set the value given in the spindle parameter list. (For Mitsubishi Electric adjustment)

---Setting range---

1 to 20480

#13078 SP078 IDA D axis current lead compensation

Set the current loop gain.

To use the coil switch function, set the current loop gain for when the high-speed coil is selected. The setting value is determined by the motor's electrical characteristics so that the value is fixed to each motor used.

Set the value given in the spindle parameter list. (For Mitsubishi Electric adjustment)

---Setting range---

1 to 20480

#13079 SP079 IQG Q axis current gain

Set the current loop gain.

To use the coil switch function, set the current loop gain for when the high-speed coil is selected. The setting value is determined by the motor's electrical characteristics so that the value is fixed to each motor used.

Set the value given in the spindle parameter list. (For Mitsubishi Electric adjustment)

---Setting range---

1 to 8192

#13080 SP080 IDG D axis current gain

Set the current loop gain.

To use the coil switch function, set the current loop gain for when the high-speed coil is selected. The setting value is determined by the motor's electrical characteristics so that the value is fixed to each motor used.

Set the value given in the spindle parameter list. (For Mitsubishi Electric adjustment)

---Setting range---

1 to 8192

#13081 SP081 IQAL Q axis current lead compensation low-speed coil

When using coil switch function, set the current loop gain for when the low-speed coil is selected.

The setting value is determined by the motor's electrical characteristics so that the value is fixed to each motor used.

Set the value given in the spindle parameter list. (For Mitsubishi Electric adjustment)

---Setting range---

1 to 20480

#13082 SP082 IDAL D axis current lead compensation low-speed coil

When using coil switch function, set the current loop gain for when the low-speed coil is selected. The setting value is determined by the motor's electrical characteristics so that the value is fixed to each motor used.

Set the value given in the spindle parameter list. (For Mitsubishi Electric adjustment)

---Setting range---

1 to 20480

#13083 SP083 IQGL Q axis current gain low-speed coil

When using coil switch function, set the current loop gain for when the low-speed coil is selected. The setting value is determined by the motor's electrical characteristics so that the value is fixed to each motor used.

Set the value given in the spindle parameter list. (For Mitsubishi Electric adjustment)

---Setting range---

1 to 8192

#13084 SP084 IDGL D axis current gain low-speed coil

When using coil switch function, set the current loop gain for when the low-speed coil is selected. The setting value is determined by the motor's electrical characteristics so that the value is fixed to each motor used.

Set the value given in the spindle parameter list. (For Mitsubishi Electric adjustment)

---Setting range---

1 to 8192

(Note) Low-speed coil setting SP081, SP082, SP083 and SP084 are set to "0" when coil changeover specification is not available.

(2) Adjusting the gain parameter

Adjust the gain parameters as usual or by application in accordance with the chart below.

Control item	S command	Orientation		Synchronous tapping/ Spindle C axis		Spindle synchronization	
		#3106/bitE=0	#3106/bitE=1	-	-	-	-
Changeover setting	-	#3106/bitE=0	#3106/bitE=1	-	-	-	-
Position loop gain	SP001	SP002	SP001	SP002	SP003	SP003	SP003
SHG control start parameter	No setting	No setting	No setting	SP035/bitC=1	SP036/bit4=1	SP036/bit4=1	SP036/bit4=1
Application		Standard	Vibration suppression				

Control item	S command	Orientation				Synchronous tapping/ Spindle C axis		Spindle synchronization	
		SP035/ bit1=0	SP035/ bit1=1	SP035/ bit9=0	SP035/ bit9=1	SP036/ bit1=0	SP036/ bit1=1	SP036/ bit1=1	
Changeover setting	-	-	SP035/ bit1=1	SP035/ bit9=0	SP035/ bit9=1	SP036/ bit1=0	SP036/ bit1=1	SP036/ bit1=1	
Speed loop proportional gain	SP005	SP008	SP005	SP008	SP005	SP008	SP005	SP008	
Speed loop lead compensation	SP006	SP009	SP006	SP009	SP006	SP009	SP006	SP009	
Speed loop delay compensation	SP007	SP010	SP007	SP010	SP007	SP010	SP007	SP010	
Application		Standard				Standard	Double grasping control	Polygonal machining	

Control item	S command	Orientation				Synchronous tapping/ Spindle C axis		Spindle synchronization	
		SP035/ bit2=0	SP035/ bit2=1	SP035/ bitA=0	SP035/ bitA=1	SP036/ bit2=0	SP036/ bit2=1	SP036/ bit2=1	
Changeover setting	-	-	SP035/ bit2=1	SP035/ bitA=0	SP035/ bitA=1	SP036/ bit2=0	SP036/ bit2=1	SP036/ bit2=1	
Minimum excitation rate	SP014	SP015	SP014	SP015	SP014	SP015	SP014	SP015	
Application		Standard				Standard	Double grasping control	Polygonal machining	

(Note) Position and speed loop gain is switched depend on the control item, so set the parameter correctly.

(3) Adjusting the speed loop parameter

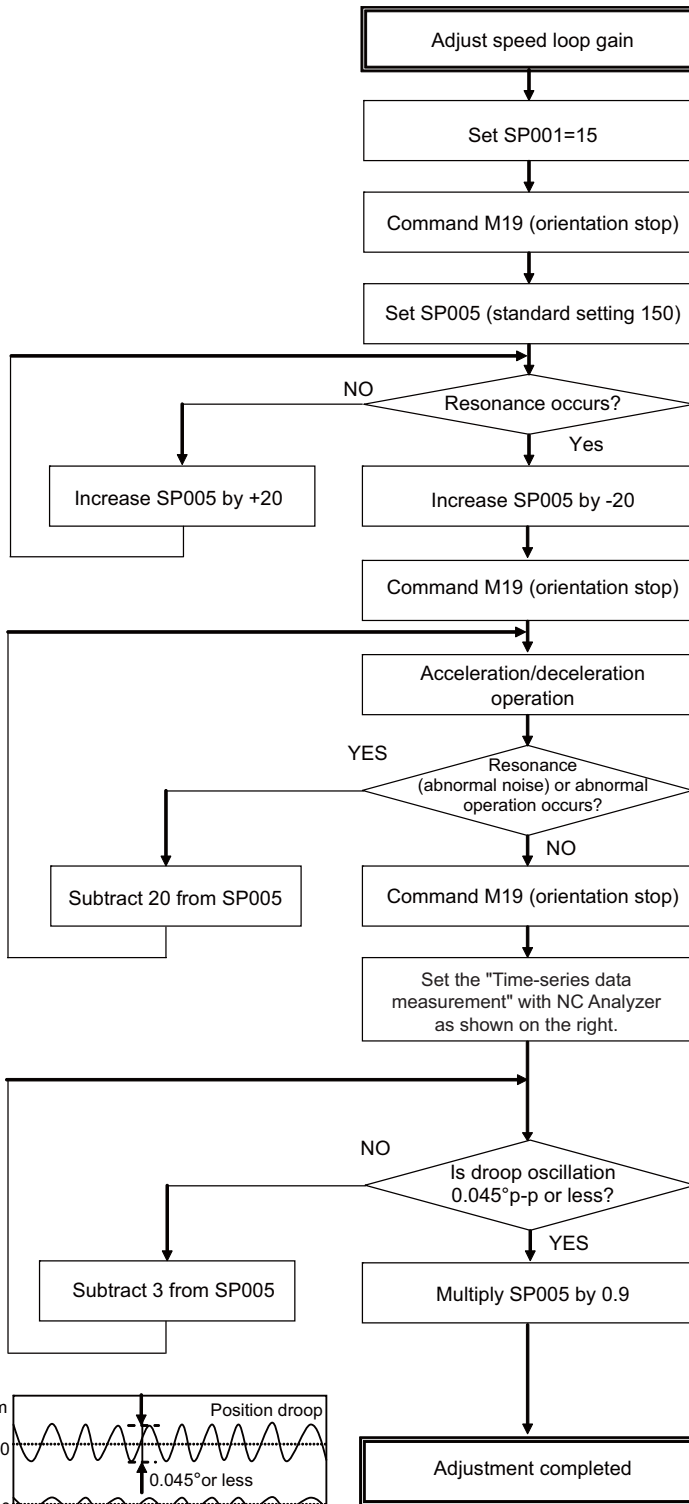

Stops at servo ON status

Increase the value up to where resonance occurs.

Executes acceleration/deceleration operation in phase up to maximum rotation speed from 0.

(Note)

When the maximum speed is 10000r/min, executes in approx. 1000r/min increments, divided by 10.

(Note)

NC analyzer cannot create a program when acquiring a spindle waveform. The program is created on the NC side.

< NC Analyzer setting (Time-series data measurement) >

Get	Waveform type
CH1	Position droop
CH2	Current feedback

Note that the maximum setting value is as follows:
 $SP005(max) \leq 150 \times \text{inertia ratio}$
 (Inertia ratio: total inertia/motor inertia)

(Example)

When inertia rate is double and the determined gain is 350, the setting value for SP005 is 315, which is 90% of the determined gain, however, the setting value for SP005 should be 300, because the maximum setting value is $150 \times 2 (\text{inertia rate}) = 300$.

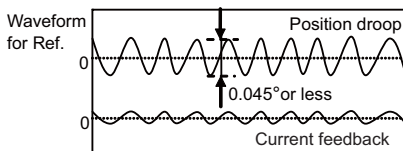

#13005 SP005 VGN1 Speed loop gain 1

Set the speed loop gain.
 Set this according to the load inertia size.
 The higher setting value will increase the accuracy of control, however, vibration tends to occur.
 If vibration occurs, adjust by lowering by 20 to 30%.
 The final value should be 70 to 80% of the value at which the vibration stops.

---Setting range---
 1 to 9999

(4) Adjusting the position loop gain (SP001: PGV non-interpolation mode position loop gain)

After setting the speed gain, in order to perform acceleration/deceleration operation, set the position loop gain (SP001) by increasing its setting value from 15. When overshooting occurs at the time of acceleration/deceleration completion, or when oscillation of the q axis current command gets bigger during a set rotation, the position loop gain is in limit state. Note that standard position loop gain below is set for the setting gain.

CAUTION
 Change "Excessive error detection width" (SP053) when "Position loop gain" (SP001) is changed.

Method for checking the limitation of position loop gain

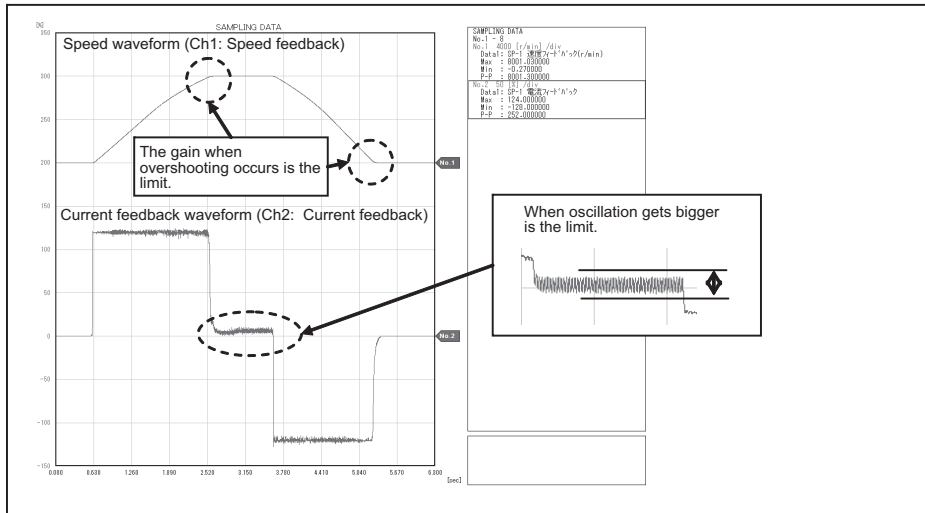

(Example)As the closest value should be selected from the standard setting range shown below, set 47 to SP001 when the limit gain is 55.

Standard position loop gain	15	18	21	23	26	33	38	47	60	70
-----------------------------	----	----	----	----	----	----	----	----	----	----

#13001 SP001 PGV Position loop gain non-interpolation mode

Set the position loop gain for "Non-interpolation" control mode.
 When the setting value increases, the command tracking ability will enhance and the positioning settling time can be shorter. However, the impact on the machine during acceleration/deceleration will increase.
 Use the selection command, the control mode "bit 2, 1, 0 = 000" in control input 4.
 (Note) The control mode is commanded by NC.

---Setting range---
 1 to 200 (rad/s)

6.1.3 Adjusting the Acceleration/Deceleration Operation

(1) Calculating the theoretical acceleration/deceleration time

The spindle motor output characteristics (shown on the right) have three ranges, which are constant torque, constant output, and deceleration ranges. Each range has different calculation method. The acceleration/deceleration time is calculated using the calculation expression which corresponds to each range of the rotation speed for calculation. Note that the load torque (friction torque) is not considered in the calculation expression, so the result may slightly differ from the actual acceleration/deceleration time.

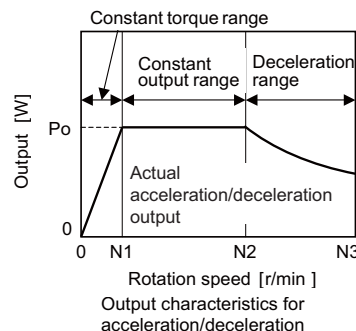

(a) Maximum motor output during acceleration/deceleration: P_o

The output during acceleration/deceleration (actual acceleration/deceleration output) P_o is 1.2-fold of "Standard output during acceleration/deceleration" or "Short time rated output".

The output P_o during acceleration/deceleration follows the expression below.

$$P_o = (\text{"Short time rated output" or "Standard output during acceleration/deceleration"}) \times 1.2$$

Substitute this value into P_o of the expression.

(b) Total load inertia: J_{all}

Total load inertia means the total inertia of the spindle motor and of the components which are rotated the motor (shaft, etc.).

$$J_{all} = (\text{Motor inertia}) + (\text{Spindle conversion inertia}) \quad [\text{kg}\cdot\text{m}^2]$$

The values obtained in (a) and (b) are substituted into the following calculation expressions.

To calculate the acceleration/deceleration time of the rotation speed N (r/min), use the expression (c), (d) or (e) which is selected depending on the range that corresponds to the speed N .

(c) Acceleration/deceleration time for constant torque range: $t_1 \cdots 0$ to N [r/min] ($0 \leq N \leq N_1$)

(For $N > N_1$, apply $N = N_1$ and also calculate t_2 or t_3 .)

$$t_1 = \frac{1.097 \times 10^{-2} \times J_{all} \times N_1 \times N}{P_o} \quad [\text{s}] \quad (\text{Caution 1})$$

(d) Acceleration/deceleration time for constant output range: $t_2 \cdots N_1$ to N [r/min] ($N_1 < N \leq N_2$)

(For $N > N_2$, apply $N = N_2$ and also calculate t_3 .)

$$t_2 = \frac{1.097 \times 10^{-2} \times J_{all} \times (N^2 - N_1^2)}{2 \times P_o} \quad [\text{s}] \quad (\text{Caution 1})$$

(e) Acceleration/deceleration time in deceleration output range: $t_3 \cdots N_2$ to N [r/min] ($N_2 < N \leq N_3$)

$$t_3 = \frac{1.097 \times 10^{-2} \times J_{all} \times (N^3 - N_2^3)}{3 \times P_o \times N_2} \quad [\text{s}] \quad (\text{Caution 1})$$

Based on the above expressions, the acceleration/deceleration time: t from 0 to N_3 [r/min] is:

$$t = t_1 + t_2 + t_3 \quad [\text{s}] \quad (\text{Caution 2})$$

⚠ CAUTION

1. Note that the inertia (J) is a quarter of "GD²".
Ex.) When "GD²" is 0.2 [kg•m²], the inertia is "0.2 / 4 = 0.05 [kg•m²]".
2. If the AC input power voltage to the power supply is low, or if the input power impedance is high, the acceleration/ deceleration time may be long. (Especially, the acceleration/deceleration time of the deceleration output range may be long.)
3. For the actual measurement in comparison with the theoretical value, perform under the same condition as the calculated load inertia of J_{all}.

The acceleration/deceleration time differs according to the inertia. When performing the measurement with a workpiece or tool installed to the spindle, confirm that the acceleration/deceleration time has been calculated when the total inertia is included in the installed workpiece and tool.

[Calculation example]

Calculate the acceleration/deceleration time from 0 to 10000[r/min] for an spindle motor having the output characteristics shown on the right when the motor inertia is 0.0148 [kg•m²], and when the motor shaft conversion load inertia is 0.05 [kg•m²].

$$P_o = (\text{Short-time rated output}) \times 1.2 = 5500 \times 1.2 = 6600 \text{ [W]}$$

$$J_{all} = (\text{Motor inertia}) + (\text{load inertia}) \\ = 0.0148 + 0.05 = 0.0648 \text{ [kg}\cdot\text{m}^2]$$

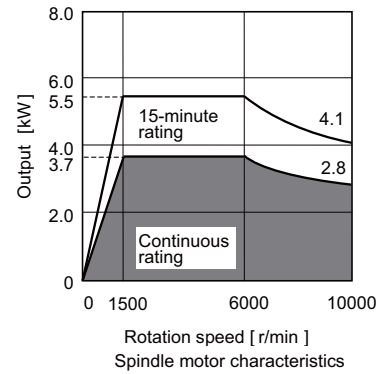

$$t_1 = \frac{1.097 \times 10^{-2} \times J_{all} \times N_1^2}{P_o} = \frac{1.097 \times 10^{-2} \times 0.0648 \times 1500^2}{6600} = 0.242 \text{ [s]}$$

$$t_2 = \frac{1.097 \times 10^{-2} \times J_{all} \times (N_2^2 - N_1^2)}{2 \times P_o} = \frac{1.097 \times 10^{-2} \times 0.0648 \times (6000^2 - 1500^2)}{2 \times 6600} = 1.818 \text{ [s]}$$

$$t_3 = \frac{1.097 \times 10^{-2} \times J_{all} \times (N_3^3 - N_2^3)}{3 \times P_o \times N_2} = \frac{1.097 \times 10^{-2} \times 0.0648 \times (10000^3 - 6000^3)}{3 \times 6600 \times 6000} = 4.691 \text{ [s]}$$

Thus,

$$t = t_1 + t_2 + t_3 = 0.242 + 1.818 + 4.691 = 6.751 \text{ [s]}$$

(2) Measuring the acceleration/deceleration waveforms

Measure the speed feedback and current feedback output by setting the monitor output data on "Time-series data measurement" with NC Analyzer, and check if theoretical acceleration/deceleration time is within $\pm 15\%$. Refer to "NC Analyzer Instruction Manual (IB-1501086)" for details on setting the monitor output data.

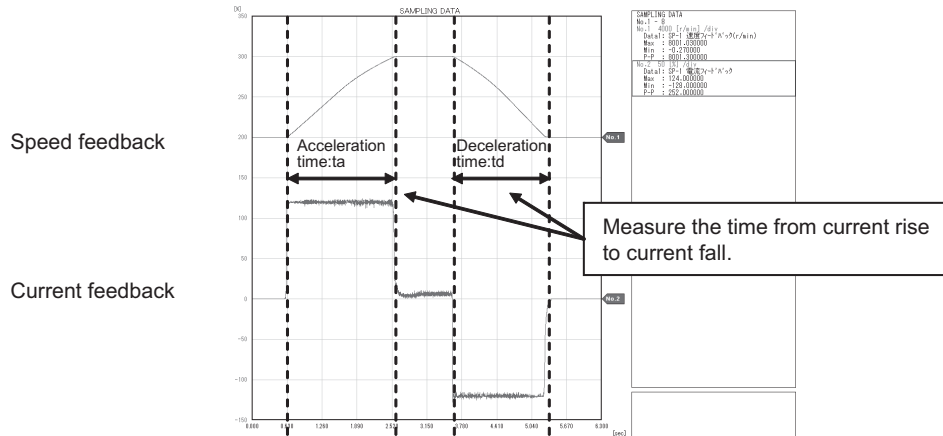

Acceleration/deceleration characteristics of spindle motor

When acceleration/deceleration time does not match the theoretical value (an error rate 15% or more), check the following items.

- [1] There may be an error in calculating load inertia for the motor axis conversion used when calculating the theoretical acceleration/deceleration time. Check the load inertia again.
- [2] When acceleration time is long and deceleration time is short, friction torque is thought to be large. Check load meter value at the maximum speed (spindle monitor screen). If the load is 10% or more, friction torque is thought to be relatively large. Mechanical friction, such as bearing friction or timing belt friction, is assumed to be large. Measure the acceleration/deceleration time again following trial run.
- [3] Even if the problems above are not found, when acceleration/deceleration time does not match, there may be a possibility of using spindle motor and spindle drive unit that are not specified, or using wrong parameters. Check the spindle motor type and spindle drive unit type again, as well as the spindle parameter settings.

**POINT**

There are cases where acceleration/deceleration waveforms change depending on the spindle temperature. Check the waveforms when the spindle temperature is high (after continuous operation) and when it is low.

**CAUTION**

Vibration or sudden acceleration/deceleration may occur during adjustment. When performing measurement with a workpiece or tool installed, pay careful attention for the safety during adjustment.

(3) Adjustment when the load inertia is large

When the load inertia is large and acceleration time is 10s or more, excessive speed deviation alarm (ALM23) may occur because the time in which deviation between speed command and speed FB, which is the actual spindle motor rotation speed, exists is prolonged. In this case, increase the time constant (3101 to 3104) during spindle rotation by S command. When the acceleration time is 10s or less, use the standard value 300 (300ms). Alarm can be avoided by adjusting excessive speed deviation timer (SP117). However, in this case, alarm detection will be delayed during constant speed operation.

#13117 SP117 SETM Excessive speed deviation timer

Set the time to detect the speed excessive error alarm.
Set the time required to the machine.
The standard setting is "12".

---Setting range---
0 to 60 (s)

#3101 sp_t 1 Acceleration/deceleration time constant with S command (Gear: 00)

Set the acceleration/deceleration time constant with S command (speed operation mode) when gear 00 is selected. Set the linear acceleration/deceleration time up to limit rotation speed (slimit1). Set the short time constant that the motor torque at acceleration is always saturated, however, when an abnormal noise or V-belt slip occurs, increase the time constant.

---Setting range---
0 to 30000 (ms)

(4) Acceleration/deceleration adjustment

Checks acceleration waveform and adjusts deceleration time.

(a) Checking acceleration waveform

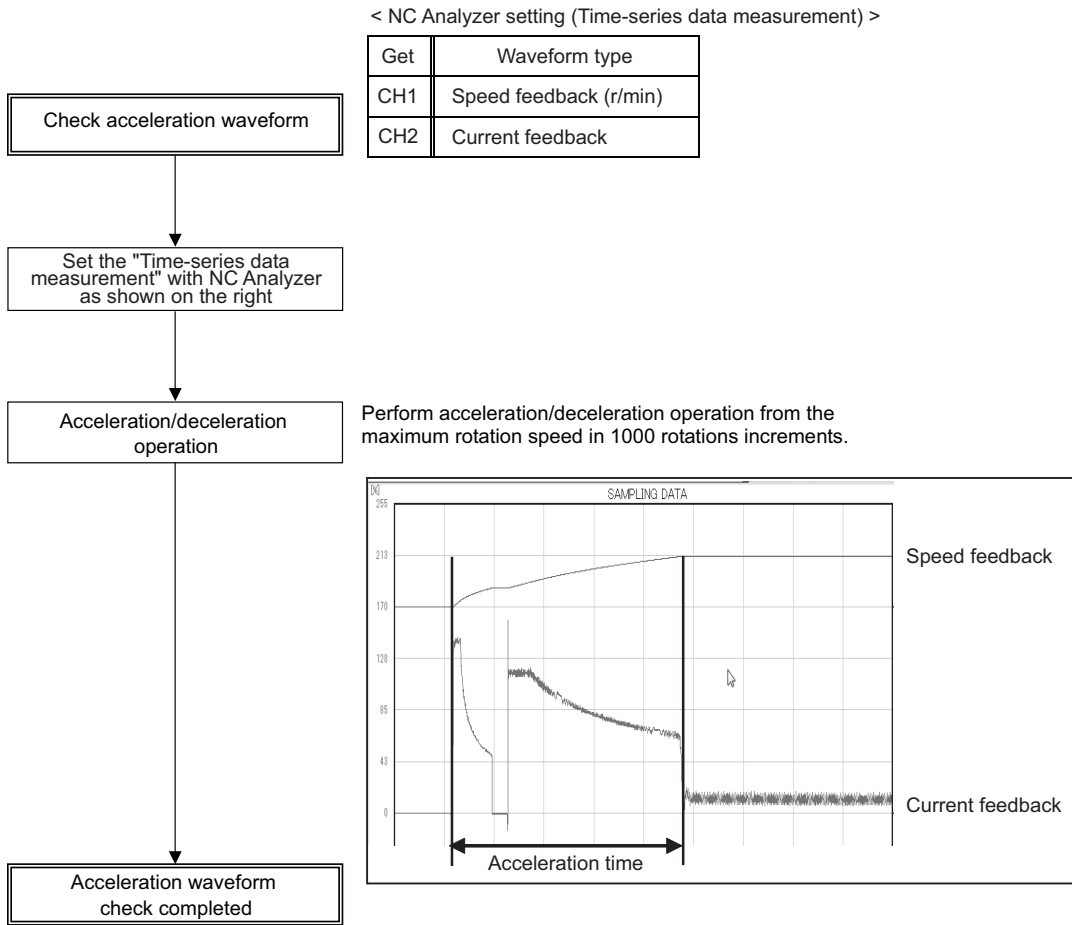

(b) Adjusting deceleration time

Adjusts deceleration time in the same manner as acceleration time by using SP071 (variable current limit during deceleration, lower limit value) and SP072 (variable current limit during deceleration, break point speed).

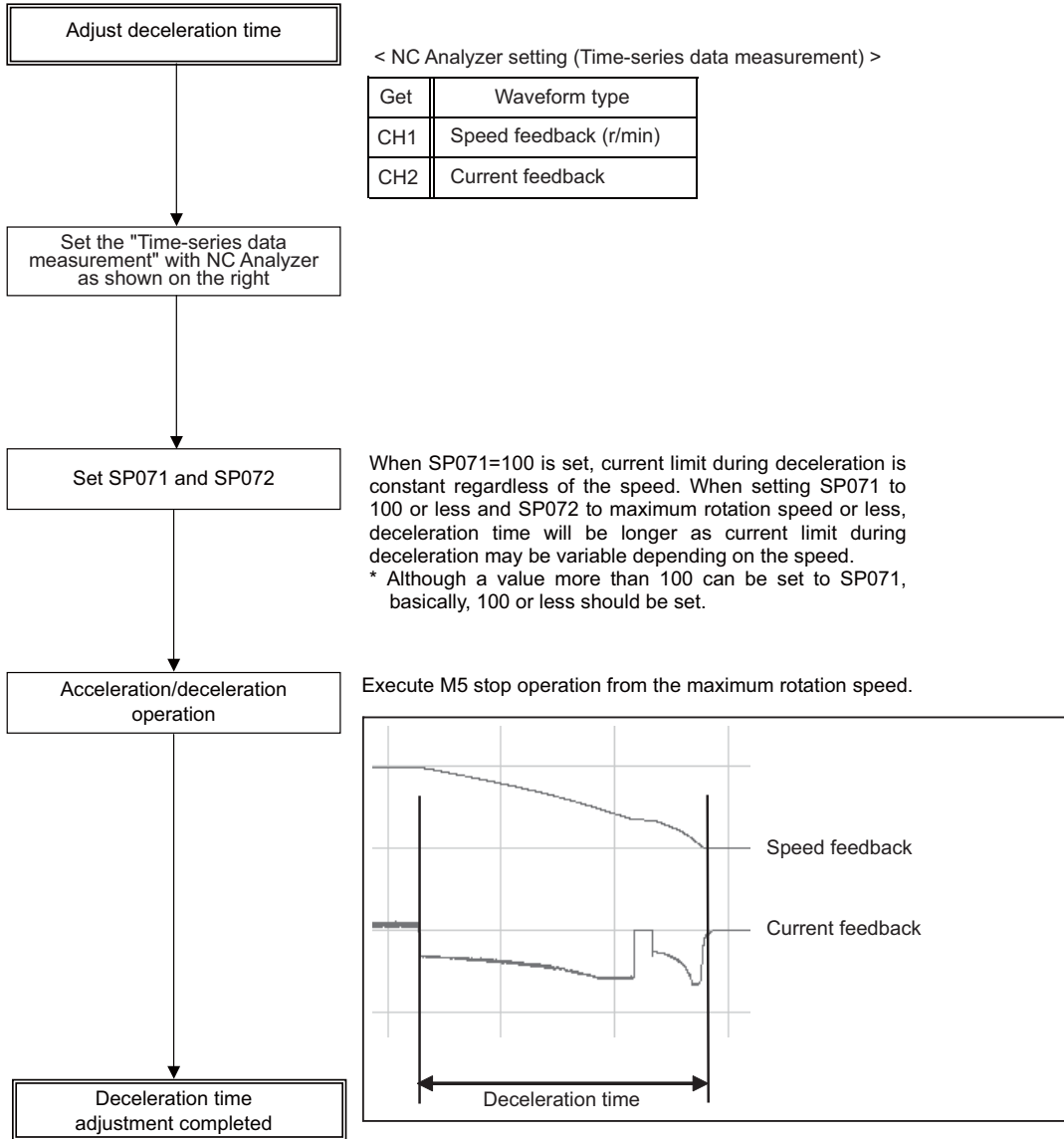

Relation between SP071 (variable current limit during deceleration, lower limit value) and SP072 (variable current limit during deceleration, break point speed)

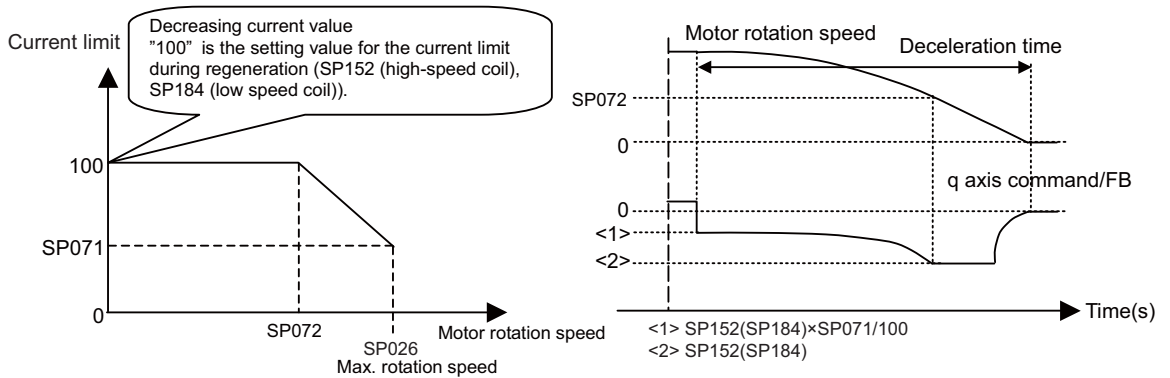

(1) Rotation speed – Decreasing current value curve

(2) Rotation speed/current command • FB waveform

#13071 SP071 DIQM Variable current limit during deceleration, lower limit value

Set this parameter to adjust the deceleration time by changing the current limit value during deceleration depending on the motor speed. As shown below, set the lower limit rate of the current limit in SP071 (DIQM), and use with SP072 (DIQN). When DIQM is set to 100%, the standard current limit value in deceleration (SP152) is applied.

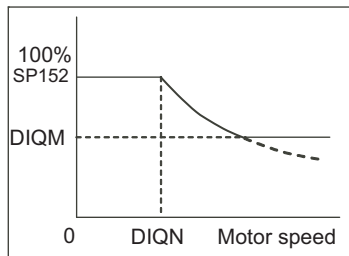

---Setting range---
0 to 999 (%)

#13072 SP072 DIQN Variable current limit during deceleration, break point speed

Set this parameter to adjust the deceleration time by changing the current limit value during deceleration depending on the motor speed. As shown below, set the lower limit rate of the current limit in SP071 (DIQM), and use with SP072 (DIQN). When DIQN is set to 100%, the standard current limit value in deceleration (SP152) is applied.

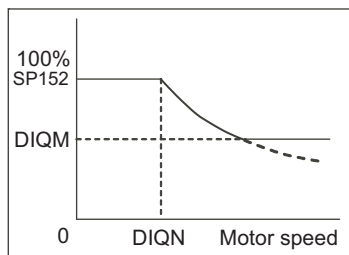

---Setting range---
1 to 32767 (r/min)

6.1.4 Orientation Adjustment

Adjusts orientation time by adjusting SP016.

(1) Orientation characteristics

When decelerating to stop is executed with orientation, the remaining distance to the orientation stop position is compensated within one rotation. Thus, as shown in Case 1 below, when the remaining distance in deceleration is about "0", orientation time would be the shortest (time required to decelerate and stop + 0s), and as shown in Case 2 below, when the remaining distance in deceleration is about as much as one rotation amount, orientation time would be the longest.

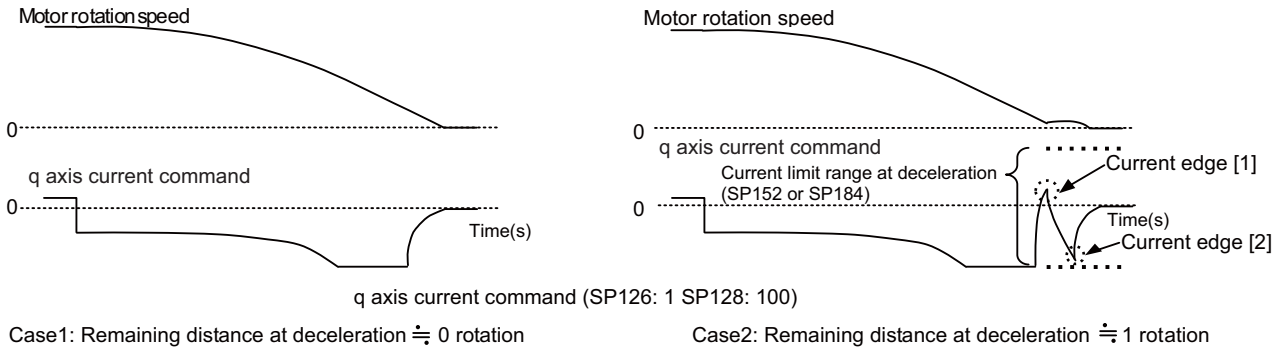

#13016 SP016 DDT Phase alignment deceleration rate

Set the single-rotation position alignment deceleration rate for orientation stopping, phase alignment while rotating and switching from non-interpolation mode to spindle synchronization mode while rotating.

When the load inertia is larger, the setting value should be smaller.

When the setting value is larger, the orientation in-position and single-rotation position alignment complete faster, but the impact applied on the machine will increase.

To change the deceleration rate only during rotation command (command $F \Delta T \neq 0$), set this parameter together with SP070 (KDDT).

---Setting range---

1 to 32767 (0.1(r/min)/ms)

#13035(PR) SP035 SFNC3 Spindle function 3

bit 2 : pyin Excitation rate selection in non-interpolation mode

The excitation rate after the in-position can be selected.

0: Select Excitation rate 1 1: Select Excitation rate 2

bit 1 : vgin Speed loop gain set selection in non-interpolation mode

The speed loop gain set after the in-position can be selected.

0: Select Set 1 1: Select Set 2

(2) Confirmation in orientation stop at deceleration ≈ 0 rotation according to spindle specification

If orientation stop is performed with the load inertia increased due to an excessive workpiece or tool installed to the spindle, the spindle may start vibrating by trying to reverse after overshooting the stop position and stop after converging the vibrations (refer to the waveform below).

In this case, the orientation completion time is extended by the time to converge the spindle vibrations. Thus, the adjustment to suppress the reversing and vibrations at stop is required.

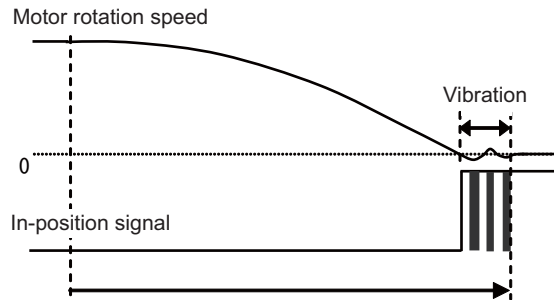
**< Adjustment method >**

- 1) Set SP016: Lower the setting value by 5. By lowering, the inclination of the speed becomes gradual. Set the optimum value while observing the speed waveform so that the speed will not vibrate.
- 2) Lower the position loop gain.
By lowering the position loop gain, a sway that exceeds the stop position is suppressed.
- 3) Adjust the speed gain (SP005, SP006).
The converging time becomes shorter if the rigidity during orientation stop is higher. However this affects the speed stability during constant feed, thus it is required to confirm the speed waveform at the constant speed and the machining surface during cutting.

(3) Orientation time adjustment method

(a) Orientation adjustment from maximum rotation speed

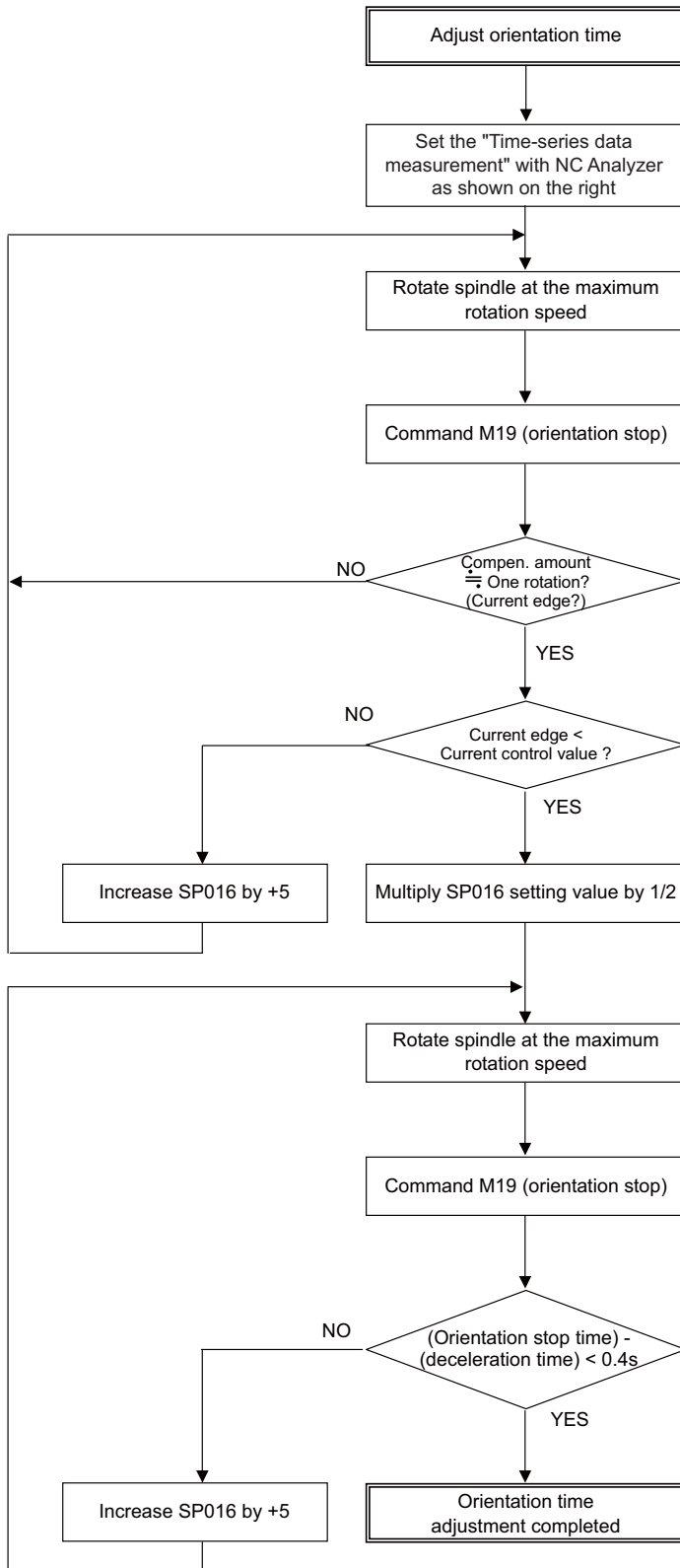

< NC Analyzer setting (Time-series data measurement) >

Get	Waveform type
CH1	Speed feedback (r/min)
CH2	Current feedback
CH3	Control output 1(bitC) *In-position signal

Orientation stop waveform example(≒ 1 rotation)

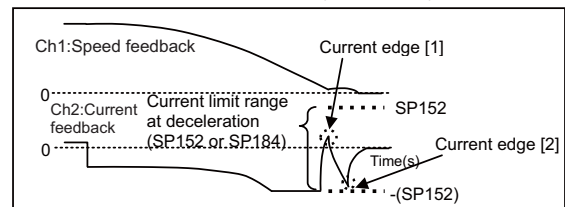

Set to SP016 as recovery time constant.

Orientation stop waveform example(≒ 1 rotation)

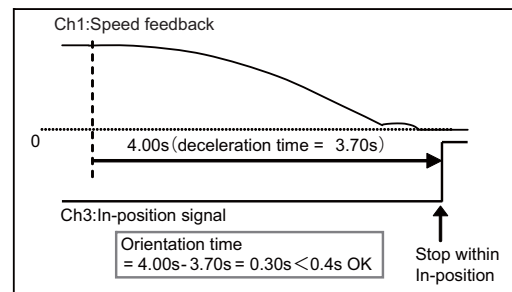

POINT

Check the orientation operation with the maximum inertia by installing a workpiece or tool to the spindle head. However, if it is dangerous to check the operation at the maximum speed, slow down to the safe speed to check.

(b) Orientation adjustment from stop mode

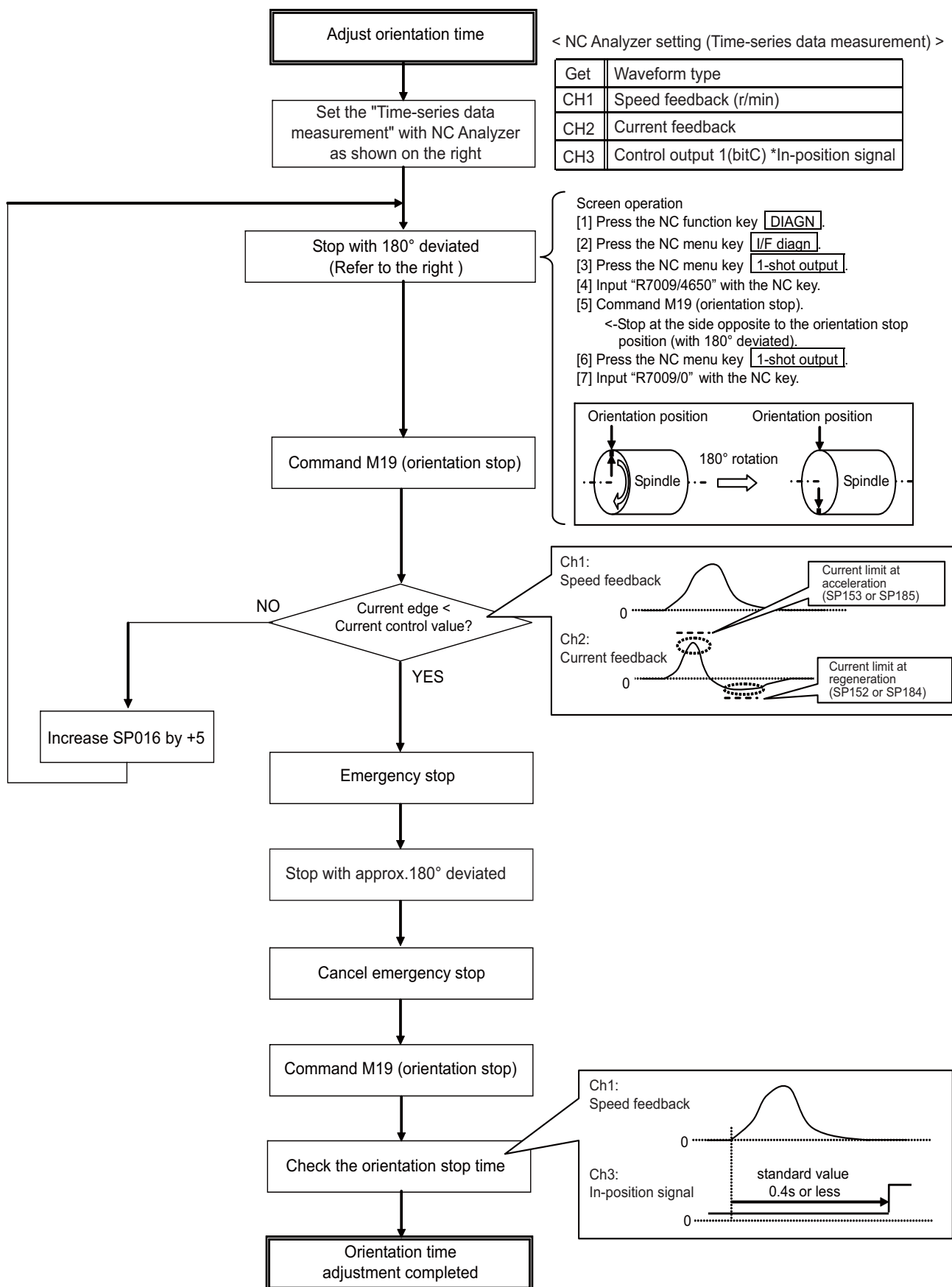

6.1.5 Synchronous Tapping Adjustment

(1) Gain setting and time constant determination

[1] For speed loop gain during synchronous tapping, speed loop gain set 2, which consists of SP008 (speed loop gain 2), SP009 (speed loop lead compensation 2), and SP010 (speed loop delay compensation 2), is used. Thus, SP035 has to be set as follows. For position loop gain, set standard 33 to SP002 (position loop gain interpolation mode).

< List of parameters used for adjustment >

Parameter	Setting value
SP002	33
SP008	Value in SP005 set at "Gain Adjustment" (Initial setting value: 150)
SP009	1900
SP010	0
SP035	0200: Speed loop gain set 2 selection (Validate bit9)

< Related servo parameters >

Set the spindle and interpolation axis by tapping.

Parameter	Setting value
SV049	Set the same value as spindle parameter "SP002"
SV050	Set it when using SHG control (when not using, set to "0")
SV058	Set it when using SHG control (when not using, set to "0")

[2] Create a NC program so that the synchronous tapping operation program has 3000r/min of spindle rotation speed, 1mm (equivalent of M6 screw) of screw pitch size, and depths at which the following two different operation patterns are generated.
(Note that the operation conditions, such as spindle rotation speed and screw pitch, may be specified by the machine tool builder.)

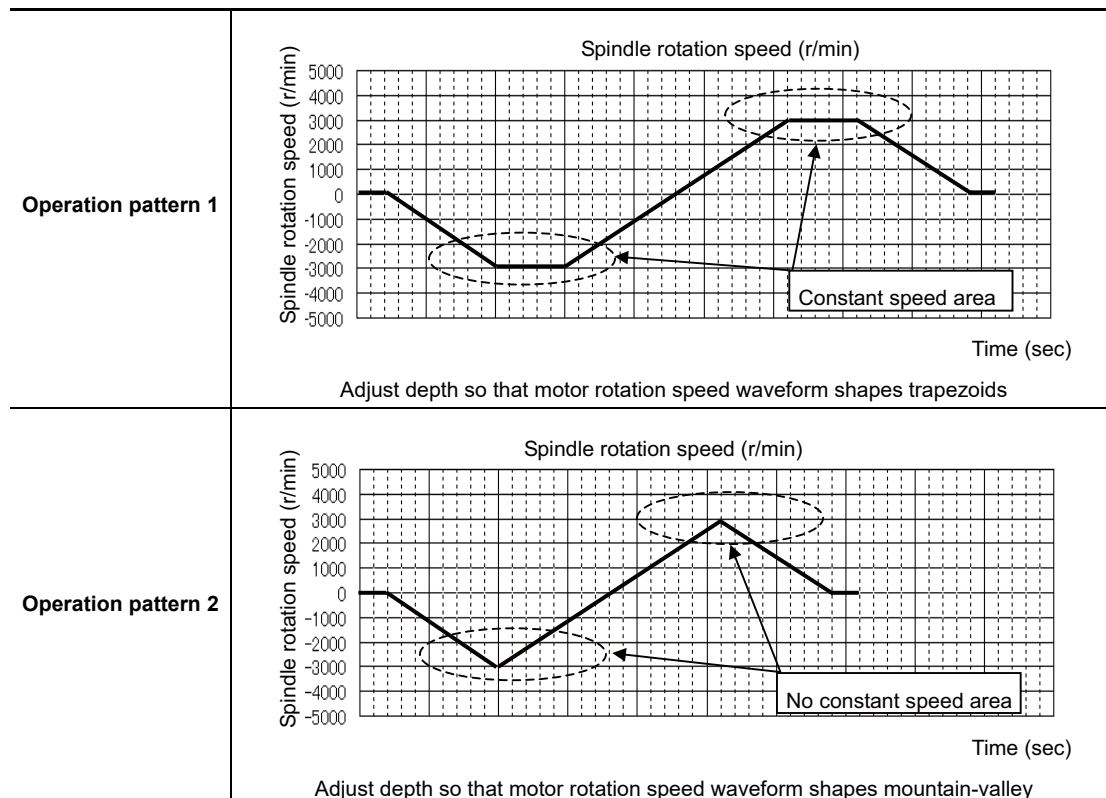

- [3] Select "Synchronous tapping error measurement" on NC Analyzer, and perform synchronous tapping operations with the operation pattern 2 above.
 *The following measurement data of servo and spindle are automatically set when "Synchronous tapping error measurement" is selected.

< NC Analyzer setting (Time-series data measurement) >

Get	Waveform type
CH1	Synchronous tapping error *Position error of spindle and servo axis
CH2	Speed feed back of servo
CH3	Speed feed back of spindle
CH4	Current feed back of servo
CH5	Current feed back of spindle

- [4] Check the waveform and adjust the synchronous tapping time constant so that the margin for current limit at acceleration/deceleration is 50% or more.

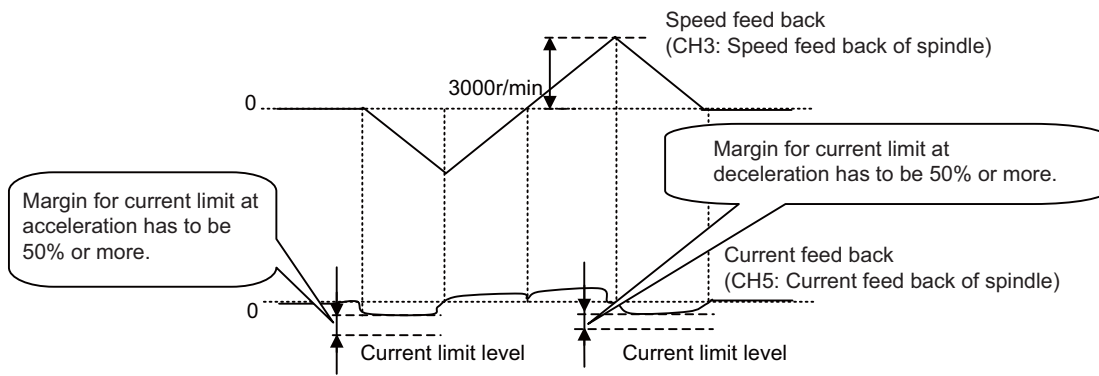

Output waveform example during synchronized tapping

(2) Accuracy test using NC Analyzer

- [1] Perform synchronous tapping operations using the time constant determined in (1) above.
- [2] Check the synchronous tapping accuracy (for both operation pattern 1 and 2) by using the synchronous tapping accuracy check tool.

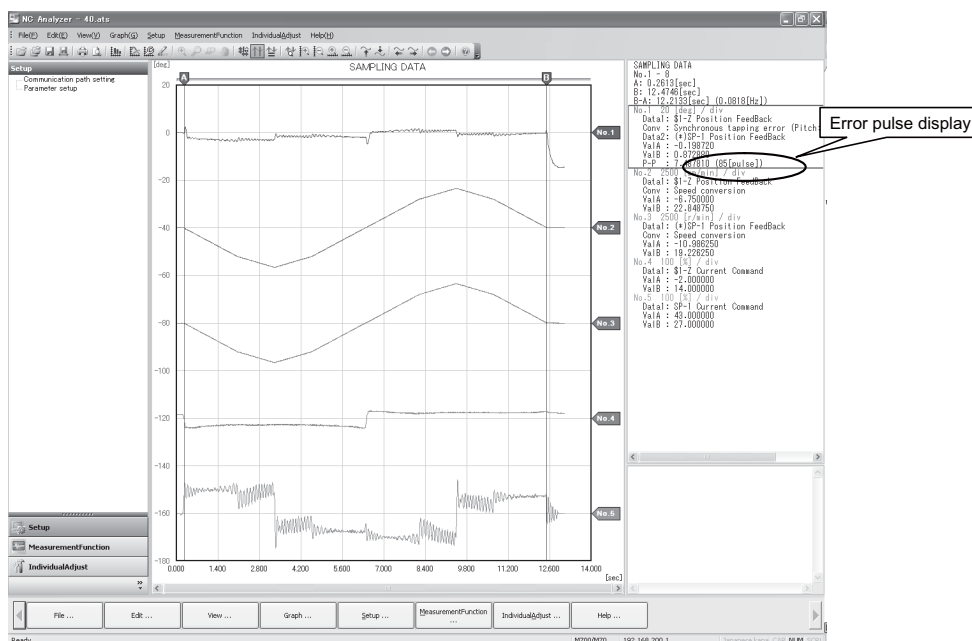

- [3] If the number of error pulse is 100 (p-p) or less, satisfactory accuracy is secured, and the check is completed.
- [4] If the number of error pulse exceeds 100, increase SP008 (VGN2) by 10 increments, and adjust so that the error pulse is 100 or less. Note that the maximum setting value is 150 × [inertia ratio].

#13002 SP002 PGN Position loop gain interpolation mode

Set the position loop gain for "interpolation" control mode.

When the setting value increases, the command tracking ability will enhance and the positioning settling time can be shorter. However, the impact on the machine during acceleration/deceleration will increase.

Use the selection command, the control mode "bit 2, 1, 0 = 010 or 100" in control input 4.

(Note) The control mode is commanded by NC.

When carrying out the SHG control, set SP035/bitC to "1".

---Setting range---

1 to 200 (rad/s)

#13008 SP008 VGN2 Speed loop gain 2

Normally SP005(VGN1) is used.

By setting "SP035/bit9=1", gain 2 can be used according to the application.

Gain 2 can also be used by setting "Speed gain set 2 changeover request (control input 5/ bitC) = 1".

Refer to SP005(VGN1) for adjustment procedures.

---Setting range---

1 to 9999

#13009 SP009 VIA2 Speed loop lead compensation 2

Normally SP006(VIA1) is used.

By setting "SP035/bit9=1", gain 2 can be used according to the application.

Gain 2 can also be used by setting "Speed gain set 2 changeover request (control input 5/ bitC) = 1".

Refer to SP006(VIA1) for adjustment procedures.

---Setting range---

1 to 9999

#13010 SP010 VIL2 Speed loop delay compensation 2

Normally SP007(VIL1) is used.

By setting "SP035/bit9=1", gain 2 can be used according to the application.

Gain 2 can also be used by setting "Speed gain set 2 changeover request (control input 5/ bitC) = 1".

Refer to SP007(VIL1) for adjustment procedures.

---Setting range---

0 to 32767

#13035(PR) SP035 SFNC3 Spindle function 3**bit C : shgn SHG control in interpolation mode**

0: Stop 1: Start

bit A : pyn Excitation rate selection in interpolation mode

0: Select Excitation rate 1 1: Select Excitation rate 2

bit 9 : vgn Speed loop gain set selection in interpolation mode

0: Select Set 1 1: Select Set 2

6.1.6 High-speed Synchronous Tapping

This function uses high-speed communication between drive units to send compensation data from a spindle to a servo system. The servo system uses the received data for compensation to follow the spindle position, and reduce synchronous errors. This function can also suppress speed overshoot in cases of acceleration/deceleration at time constants that may reach the spindle torque limit. As such, shorter time constants can be set compared to the conventional normal synchronous tapping, and cycle times can be reduced. However, high-speed synchronous tapping function does not guarantee higher machining accuracy than normal synchronous tapping.

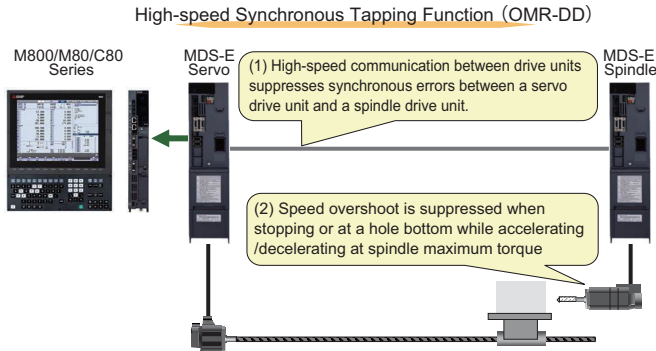

(1) System Configuration

As shown in the figure on the right, the high-speed synchronous tapping function uses the communication line between the drive units and NC for compensating between drive units. Also, the output and receiving of compensation data of each drive unit is commanded from the NC. Therefore, there are limitations in how drive units are connected and the order of connection. The following are cautions when using this function.

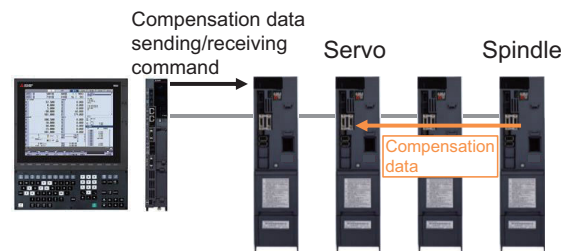

Configuration	Specification	Connection examples
Optical communication line Connection of multiple channels	Drive units that perform high-speed synchronous tapping are restricted to axes connected with the same optical communication line in the same channel.	
The connection order of drive units in the same channel	The maximum number of spindles that can be used in high-speed synchronous tapping is 4.	
Synchronous tapping in G68 (3-dimensional coordinate conversion)	When any one of three base axes cannot satisfy the above specifications, this function cannot be used in G68.	

(Note) When synchronous tapping is performed under conditions that high-speed synchronous tapping function cannot be used, operation continues without compensation. During synchronous tapping, the status can be confirmed with bit8 in spindle control command output 6. (0: Disabled, 1: Enabled)

(2) Related parameters

The following are the parameters related to high-speed synchronous tapping function.

[1] NC parameter

High-speed synchronous tapping function is an option. Check the machine specifications when adjusting the parameters.

#1281(PR) ext17**bit 5 : High-speed synchronous tapping valid**

Select whether to enable the high-speed synchronous tapping.

0: Disable

1: Enable

#3013-3016 stap1 - stap4 Synchronous tapping 1st step rotation speed

Set the speed which switches from 1st step to 2nd step in synchronous tapping multi-step acceleration/deceleration control when gears from 00 to 11 are selected.

---Setting range---

0 to 99999 (r/min)

#3017-3020 stapt1 - stapt4 Synchronous tapping 1st step acceleration/deceleration time constant

Set the time constant for synchronous tapping 1st step linear acceleration/deceleration control when gears from 00 to 11 are selected. (Linear acceleration/deceleration pattern)

---Setting range---

1 to 5000 (ms)

#3037-3040 taps21 - taps24 Synchronous tapping 2nd step rotation speed

Set the speed which switches from 2nd step to 3rd step in synchronous tapping multi-step acceleration/deceleration control when gears from 00 to 11 are selected.

---Setting range---

0 to 99999 (r/min)

#3041-3044 tapt21 - tapt24 Synchronous tapping 2nd step acceleration/deceleration time constant

Set the time constant for synchronous tapping 2nd step linear acceleration/deceleration control when gears from 00 to 11 are selected.

---Setting range---

1 to 5000 (ms)

#3001-3004 slimt1 - slimt4 Limit rotation speed

Set the spindle rotation speeds for maximum motor speed when gears from 00 to 11 are selected.
Set the spindle rotation speed for the S analog output=10V during analog spindle control.

---Setting range---

0 to 99999 (r/min)

#3045-3048 tapt31 - tapt34 Synchronous tapping 3rd step acceleration/deceleration time constant

Set the time constant for synchronous tapping 3rd step linear acceleration/deceleration control when gears from 00 to 11 are selected.

---Setting range---

1 to 5000 (ms)

#3120 staptr Time constant reduction rate in high-speed synchronous tapping

When performing high-speed synchronous tapping control(#1281/bit5), set the reduction rate of the time constant compared to the time constant in normal synchronous tapping.
(Setting "0" or "100" will be regarded as reduction rate zero, so the time constant won't be reduced.)
E.g.) When set to "10", time constant in high-speed synchronous tapping will be 90% of that in normal synchronous.

---Setting range---
0 to 100(%)

(Note) The inclination of linear acceleration/deceleration control for multi-step synchronous tapping is determined by the ratio of "rotation speed" to "acceleration/deceleration time constant". When using multi-step synchronous tapping, the inclination should be set so that the 1st step is higher than the second step, and the second step is higher than the third step. When the inclination of the latter step is higher, the multi-step setting is disabled and the inclination of the former step is applied.

[2] Drive unit parameter
[Servo]

#2232 SV032 TOF Torque offset

Set the unbalance torque on vertical axis and inclined axis.
When the vertical axis pull up function is enabled, the pull up compensation direction is determined by this parameter's sign.
When set to "0", and the pull up function is enabled (SV033/bitE=1), the alarm "S02 2233 Initial parameter error" occurs.
This can be used for speed loop delay compensation and collision detection function.
To use load inertia estimation function (drive monitor display), set this parameter, friction torque (SV045) and load inertia display enabling flag (SV035/bitF).

---Setting range---
-100 to 100 (Stall current %)

#2237 SV037 JL Load inertia scale

Set the motor axis conversion total load inertia including motor itself in proportion to the motor inertia.

$$SV037(JL)=(Jm+Jl)\div Jm\times 100$$

Jm: Motor inertia

Jl: Motor axis conversion load inertia

For linear motor, set the gross mass of the moving sections in kg unit.

<<Drive monitor load inertia ratio display>>

Set SV035/bitF=1 and imbalance torque and friction torque to both SV032 and SV045, and then repeat acceleration/deceleration for several times.

---Setting range---
For general motor: 0 to 5000 (%)
For linear motor: 0 to 5000 (kg)

#2313 SV113 SSF8 Servo function 8

Select the servo functions.

bit 7 : nmerc Machine error compensation amount

(Note) Do not turn ON the NC power supply with the setting as disable (set to "1"). The initial parameter error alarm is detected.

0:Enable (Normal setting)

1:Disable

#2329 SV129 Kwf Synchronous control feed forward filter frequency

Set the acceleration rate feed forward filter frequency in high-speed synchronous tapping control. The standard setting is "600".

---Setting range---

0 to 32767 (rad/s)

#2444(PR) SV244 DUNIT Communication interpolation unit for communication among drive units

Set the communication interpolation unit among drive units in high-speed synchronous tapping control. When set to "0", it will be regarded as 20 (0.05 μ m) is set.

(Note) This is enabled after turning ON the NC power supply again.

---Setting range---

0 to 2000 (1/ μ m)

[Spindle]

#13226 SP226 SFNC6 Spindle function 6

Select the spindle function.

bit 3 : dd2

0: Normal setting

1: High-speed synchronous tapping function valid

(Note) The bits that are not explained here must be set to "0".

#13228 SP228 SFNC8 Spindle function 8

Select the spindle function.

bit 0-2 : lmd

Select the load display

000: Normal

001: Load display effective motor current

010: Load display motor output effective value

011: Load display high cycle

100: Load display high-cycle motor output effective value

101: Setting prohibited

110: Torque current command

111: Torque current FB

(Note 1) The bits that are not explained here must be set to "0".

(Note 2) Do not turn ON the NC power supply with the setting of SP228 bit0-2=110,111.

The initial parameter error alarm 37 is detected.

#13244(PR) SP244 DUNIT Communication interpolation unit for communication among drive units

Set the communication interpolation unit among drive units in high-speed synchronous tapping control. When set to "0", it will be regarded as 20 (0.05 μ m) is set.

(Note) This is enabled after turning ON the NC power supply again.

---Setting range---

0 to 2000 (1/ μ m)

(Note 1) When adjusting high-speed synchronous tapping, SV032: Torque offset and SV037: Load inertia scale need to be set.

(Note 2) The following are the parameters for adjusting. When turning ON the NC power supply again with these parameters set, an initial parameter error alarm 37 occurs.

- Machine error compensation amount disable setting SV113 bit7 = 1

- Load display selection SP228 bit0-2 = 110, 111

[3] The checking of error waveforms

Check the error waveforms of the time constant to be set to confirm that the synchronous errors are less than or equal to the base value.

Disable machine end compensation such as backlash compensation before checking.

Base value

- The base value of synchronous errors is 8.8° or less during M6 and PIT1 machining.
(The conventional base value of 100 pulses or less is based on 4096 pulses per rotation, therefore $100 \text{ [pulse]}/4096 \text{ [pulse]} \times 360 \text{ [}^\circ\text{]} \approx 8.8 \text{ [}^\circ\text{]})$
- As shown in the figure below, a synchronous error may become larger due to lost motion of a servo axis etc. when starting tapping or during velocity reversal at the hole bottom. At the start, the work is not within cutting range so it will not be affected. When this error is large, adjust the servo axes with lost motion compensation etc.

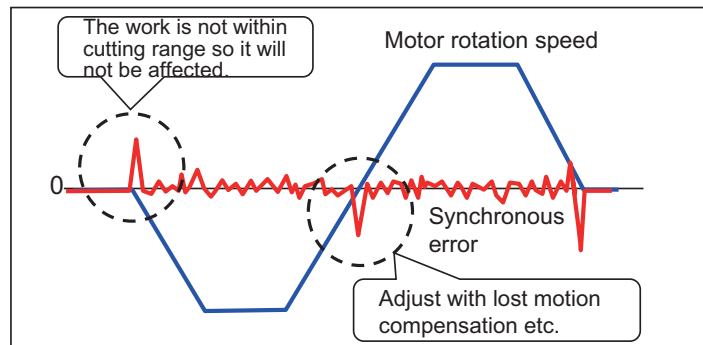

- When torque saturation is released, synchronous errors may become larger. There is no problem if the synchronous error is the same or smaller than the base value. If the error is large, it can be improved by increasing the time constant or lowering the synchronous tapping position gain of the spindle.

(4) Adjustment procedures

The adjustment procedures of high-speed synchronous tapping function are shown below.

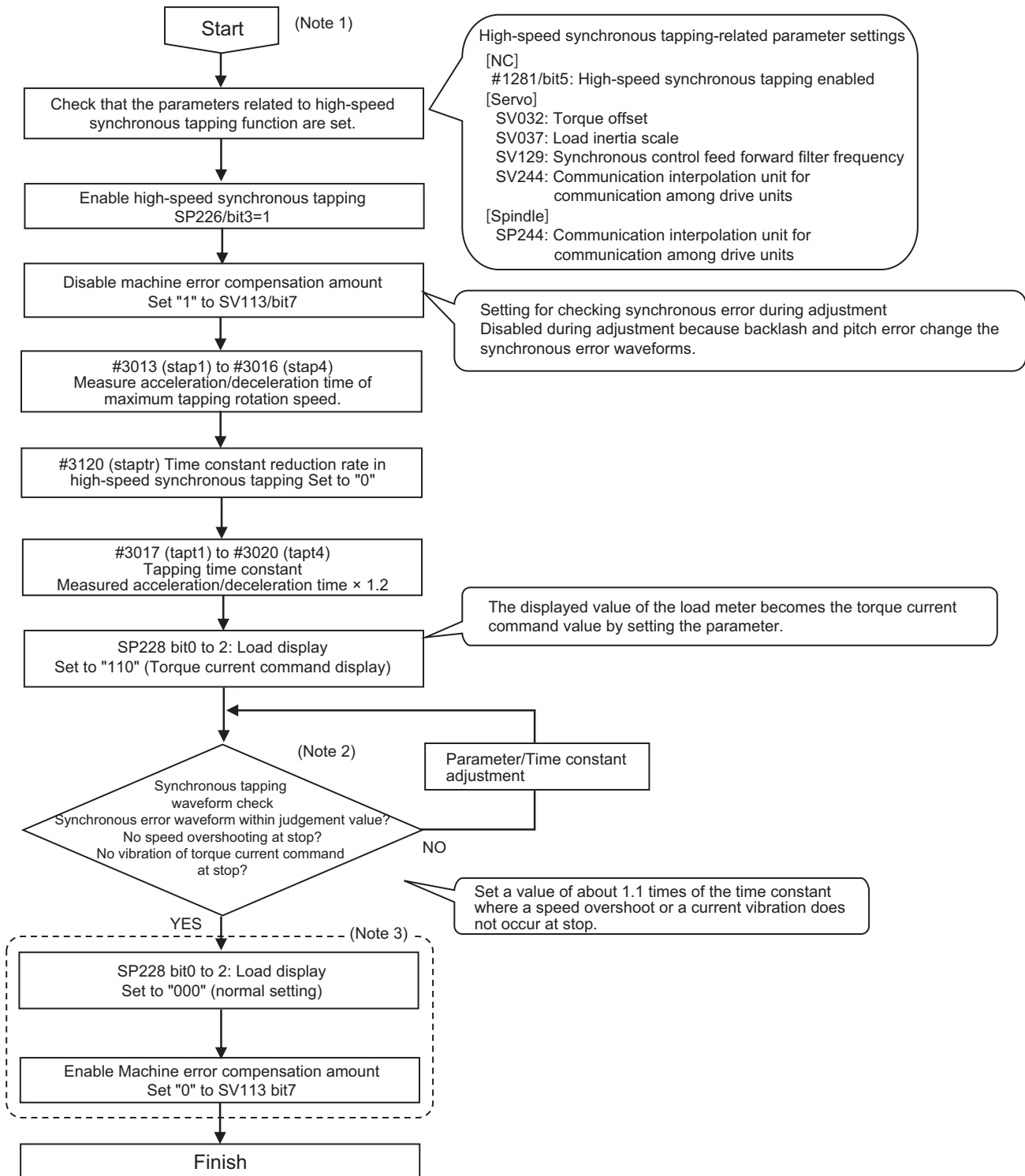

CAUTION

1. Perform the high-speed synchronous tapping function adjustment after servo adjustment.
2. Use NC Analyzer2 to check the synchronous tapping waveforms. The displayed value of the load meter is the torque current command.
3. Make sure to change the load display (SP228 bit0 to 2) back to the initial setting value and disable the machine error compensation amount (SV113 bit7=0) after high-speed synchronous tapping adjustment. Failure to observe this causes initial parameter error alarm 37 to occur after turning the NC power supply ON again.

6.1.7 Spindle C Axis Adjustment (For Lathe System)

(1) Setting the gain

For spindle C axis speed loop gain, SP008 (speed loop gain 2), speed loop gain set 2, which consists of SP009 (speed loop lead compensation 2), and SP010 (speed loop delay compensation 2), is used. Thus, SP035 has to be set as follows. For position loop gain, set standard 33 to SP002 (position loop gain, interpolation mode).

Parameter	Setting value
SP002	33
SP008	SP005 setting value set in "Basic Adjustments" (Initial setting value: 150)
SP009	1900
SP010	0
SP035	0200: Speed loop gain set 2 selection (validate bit9)

< Related servo parameters >

Set the spindle and interpolation axis.

Parameter	Setting value
SV003	Set the same value as spindle parameter "SP002"
SV004	Set it when using SHG control (when not using, set to "0")
SV057	Set it when using SHG control (when not using, set to "0")

(2) Gain adjustment and accuracy test during C axis operation

- [1] Set the "Time-series data measurement" with NC Analyzer as follows during stopped in C axis mode (servo ON status) or when executing cutting feed with G01 F20. Then check the droop fluctuation is within 10[°]/1000.

< NC Analyzer setting (Time-series data measurement) >

Get	Waveform type
CH1	Position droop
CH2	Current command

Offset is 2.5V.

* Waveform during stopped in C axis (Reference)

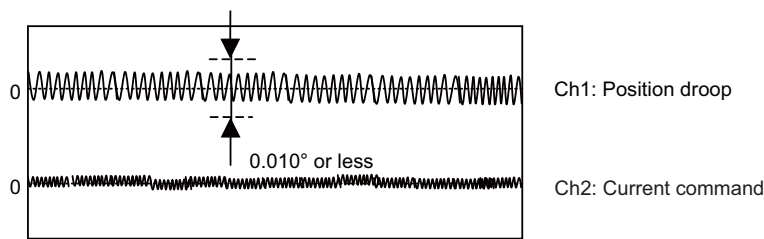

* Waveform when executing cutting feed with G01 F20 (Reference)

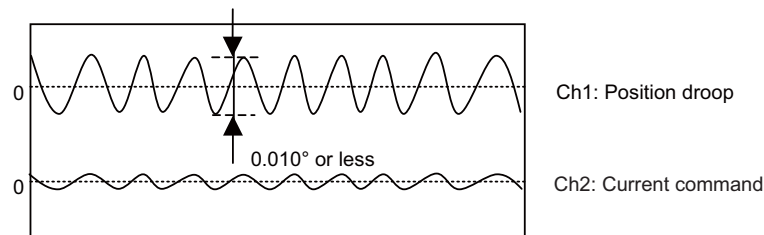

[2] When satisfactory accuracy is not secured, increase SP008 (VGN2) by 10 increments and adjust so that the accuracy level meets the standard. Note that the maximum setting value is 150 x [inertia ratio].

(3) Setting the notch filter

During spindle C axis operation, there are times where motor is rotated while brake is applied, resulting in resonance occurred. In this case, measure resonance frequency from q axis current command waveform and set the value to SP038 (notch filter 1). Also, depending on the set frequency, filter depth must be set to SP034. When notch filter is set, perform acceleration/deceleration operation at the maximum speed and confirm that no abnormal oscillation or noise is found.

Notch filter's set frequency and standard depth setting

SP034 Notch filter 1 Depth setting	bit3=0 bit2=0 bit1=0 Setting value: XXX0	bit3=0 bit2=1 bit1=0 Setting value: XXX4	bit3=1 bit2=0 bit1=0 Setting value: XXX8
SP038 Notch filter 1 Setting frequency	2000(Hz) to 400(Hz)	399(Hz) to 200(Hz)	190(Hz) or lower

Setting example: When there are 16 wavelengths within 0.02 sec.

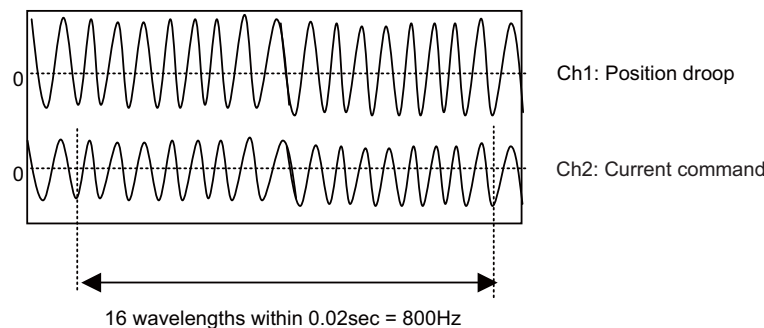

Set 800 to SP038 and XXX0 to SP034. Measure position droop and current command at this time, and adjust notch filter's frequency and depth so that the position droop is within standard range.

**POINT**

1. When incorrect frequency is set, suddenly resonance can occur and big abnormal noise can be generated. Input the appropriate value.
2. Do not set the value to low-frequency (50Hz).

#13002 SP002 PGN Position loop gain interpolation mode

Set the position loop gain for "interpolation" control mode.

When the setting value increases, the command tracking ability will enhance and the positioning settling time can be shorter. However, the impact on the machine during acceleration/deceleration will increase.

Use the selection command, the control mode "bit 2, 1, 0 = 010 or 100" in control input 4.

(Note) The control mode is commanded by NC.

When carrying out the SHG control, set SP035/bitC to "1".

---Setting range---

1 to 200 (rad/s)

#13008 SP008 VGN2 Speed loop gain 2

Normally SP005(VGN1) is used.

By setting "SP035/bit9=1", gain 2 can be used according to the application.

Gain 2 can also be used by setting "Speed gain set 2 changeover request (control input 5/ bitC) = 1".

Refer to SP005(VGN1) for adjustment procedures.

---Setting range---

1 to 9999

#13009 SP009 VIA2 Speed loop lead compensation 2

Normally SP006(VIA1) is used.

By setting "SP035/bit9=1", gain 2 can be used according to the application.

Gain 2 can also be used by setting "Speed gain set 2 changeover request (control input 5/ bitC) = 1".

Refer to SP006(VIA1) for adjustment procedures.

---Setting range---

1 to 9999

#13010 SP010 VIL2 Speed loop delay compensation 2

Normally SP007(VIL1) is used.

By setting "SP035/bit9=1", gain 2 can be used according to the application.

Gain 2 can also be used by setting "Speed gain set 2 changeover request (control input 5/ bitC) = 1".

Refer to SP007(VIL1) for adjustment procedures.

---Setting range---

0 to 32767

#13034 SP034 SFNC2 Spindle function 2**bit F-D : nfd5 Depth of Notch filter 5**

Set the depth of Notch filter 5 (SP088).

bit F,E,D=

000: -∞

001: -18.1[dB]

010: -12.0[dB]

011: -8.5[dB]

100: -6.0[dB]

101: -4.1[dB]

110: -2.5[dB]

111: -1.2[dB]

bit B-9 : nfd4 Depth of Notch filter 4

Set the depth of Notch filter 4 (SP087).

bit B,A,9=

000: -∞

001: -18.1[dB]

010: -12.0[dB]

011: -8.5[dB]

100: -6.0[dB]

101: -4.1[dB]

110: -2.5[dB]

111: -1.2[dB]

bit 7-5 : nfd2 Depth of Notch filter 2

Set the depth of Notch filter 2 (SP046).

bit7,6,5=

000: -∞

001: -18.1[dB]

010: -12.0[dB]

011: -8.5[dB]

100: -6.0[dB]

101: -4.1[dB]

110: -2.5[dB]

111: -1.2[dB]

bit 4 : fhz3 Notch filter 3

0: Stop 1: Start (1125Hz)

bit 3-1 : nfd1 Depth of Notch filter 1

Set the depth of Notch filter 1 (SP038).

bit3,2,1=

000: -∞

001: -18.1[dB]

010: -12.0[dB]

011: -8.5[dB]

100: -6.0[dB]

101: -4.1[dB]

110: -2.5[dB]

111: -1.2[dB]

#13035(PR) SP035 SFNC3 Spindle function 3**bit C : shgn SHG control in interpolation mode**

0: Stop 1: Start

bit A : pyn Excitation rate selection in interpolation mode

0: Select Excitation rate 1 1: Select Excitation rate 2

bit 9 : vgn Speed loop gain set selection in interpolation mode

0: Select Set 1 1: Select Set 2

#13038 SP038 FHz1 Notch filter frequency 1

Set the vibration frequency to suppress when machine vibration occurs.
(Enabled at 50 or more.)
When not using, set to "0".

---Setting range---
0 to 5000 (Hz)

#13046 SP046 FHz2 Notch filter frequency 2

Set the vibration frequency to suppress when machine vibration occurs.
(Enabled at 50 or more.)
When not using, set to "0".

---Setting range---
0 to 5000 (Hz)

#13087 SP087 FHz4 Notch filter frequency 4

Set the vibration frequency to suppress when machine vibration occurs.
(Enabled at 50 or more.)
When not using, set to "0".

---Setting range---
0 to 5000 (Hz)

#13088 SP088 FHz5 Notch filter frequency 5

Set the vibration frequency to suppress when machine vibration occurs.
(Enabled at 50 or more.)
When not using, set to "0".

---Setting range---
0 to 5000 (Hz)

6.1.8 Spindle Synchronization Adjustment (For Lathe System)

(1) Setting the gain, changeover rotation speed and time constant

[1] For speed loop gain during spindle synchronization, SP005 (speed loop gain 1), SP006 (speed loop lead compensation 1), and SP007 (speed loop delay compensation 2) are used. For position loop gain, set standard 15 to SP003 (position loop gain spindle synchronization).

Parameter	Setting value
SP003	15
SP036	0000

(Note1) To change the setting value of SP003, set the synchronous and basic spindles to the same value.
 (Note2) For the adjustment of SP005, SP006 and SP007, conduct "Adjusting the speed loop parameter" as a single unit beforehand.

- [2] Set rotation speed and time constant during acceleration/deceleration figured by theoretical calculations.
- [3] Set "Time-series data measurement" with NC Analyzer as follows and output speed feedback and current command.

< NC Analyzer setting (Time-series data measurement) >

Get	Waveform type
CH1	Speed feedback (r/min)
CH2	Current command

(2) Confirming the current margin

Perform acceleration/deceleration up to the maximum current speed in spindle synchronization mode. At this time, confirm that the current value for both acceleration side and deceleration side secure 30% or more of margin in respect to the current limit value. Also, confirm that no oscillation, etc. are found in the current waveforms.

(Note) If a margin is 30% or less, extend the acceleration/deceleration time constant so that the margin is adjusted to 30% or more.

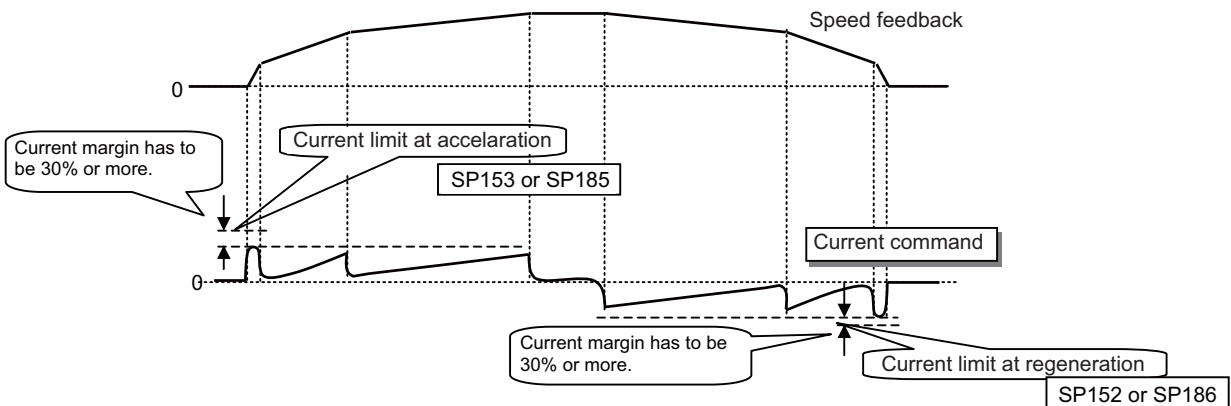

Output waveform example in spindle synchronous mode

#13003 SP003 PGS Position loop gain spindle synchronization

Set the position loop gain for "spindle synchronization" control mode.

When the setting value increases, the command tracking ability will enhance and the positioning settling time can be shorter. However, the impact on the machine during acceleration/deceleration will increase.

Use the selection command, the control mode "bit 2, 1, 0 = 001" in control input 4.

(Note 1) The control mode is commanded by NC.

When carrying out the SHG control, set SP036/bit4 to "1".

(Note 2) Set the same value for the basic and synchronous spindles in spindle synchronization.

---Setting range---

1 to 200 (rad/s)

#13036(PR) SP036 SFNC4 Spindle function 4**bit 4 : shgs SHG control in spindle synchronization mode**

0: Stop 1: Start

bit 2 : pys Excitation rate selection in spindle synchronization mode

0: Select Excitation rate 1 1: Select Excitation rate 2

bit 1 : vgs Speed loop gain set selection in spindle synchronization mode

0: Select Set 1 (SP005,SP006,SP007) 1: Select Set 2 (SP008,SP009,SP010)

6.1.9 Deceleration Coil Changeover Valid Function by Emergency Stop

If a large workpiece is mounted on a large workpiece chuck in lathe, the acceleration/deceleration time increases because of the increase of the total inertia. When the deceleration stop time at emergency stop exceeds the upper limit value (29900ms) of the gate shutoff delay time (SP055), the spindle motor will coast.

This function enables the coil changeover motor to change to low-speed coil during emergency stop and if the deceleration time is reduced to complete within the gate shutoff time, the spindle enters an emergency stop state.

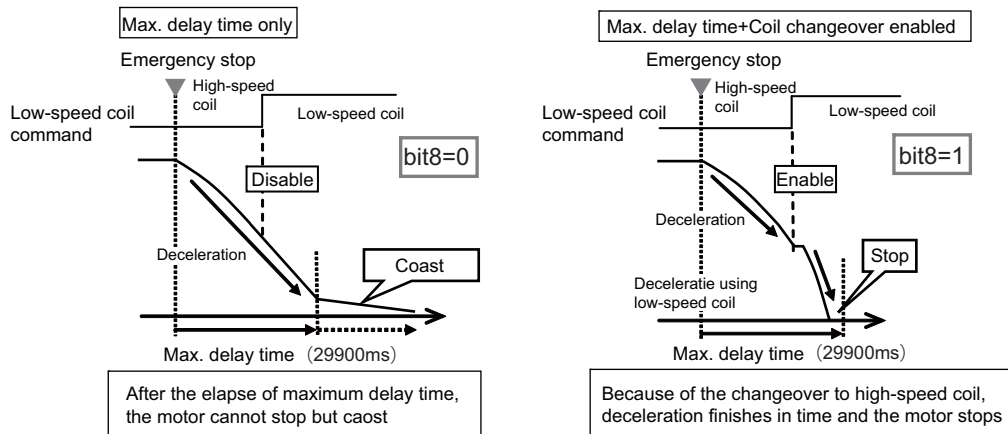

#13225 SP225 SFNC5 Spindle function 5

bit 8 : mken Coil switch allowance in deceleration control

This enables a coil changeover while decelerating after an emergency stop for a spindle motor with coil changeover specification. A coil changeover may enable an excessive load inertia to stop within the maximum delay time.

0: Normal (Disable) 1: Enable

#13055 SP055 EMGx Max. gate off delay time after emergency stop

Set the time required to forcibly execute READY OFF after the emergency stop is input. Normally set to "5000".

When 5000ms or more is set for deceleration time constant at emergency stop (SP056), set the same value as SP056.

When using the power backup system (MDS-D/DH-PFU) and setting the value of this parameter to 5000ms or more, a communication error between NC and drive unit may occur when power restarts after a instantaneous power interrupt.

It is not a problem so turn the NC power ON again to start up.

When "0" is set, 7000ms is the actual value to be set.

---Setting range---

0 to 29900 (ms)

#13056 SP056 EMGt Deceleration time constant at emergency stop

Set the time constant used for the deceleration control at emergency stop. Set the time required to stop from the maximum motor speed (TSP).

When "0" is set, the deceleration control is executed with "7000ms".

---Setting range---

0 to 29900 (ms)

6.1.10 High-response Acceleration/Deceleration Function

Under continuous position control method makes position droop is set with primary delay depending on the position control gain during the acceleration/deceleration by S command. If the position gain is set lower, the zero speed detection which indicates the spindle stop is more conspicuously delayed.

This function enables the position droop's primary delay to be shorter and the zero speed detection to be faster.

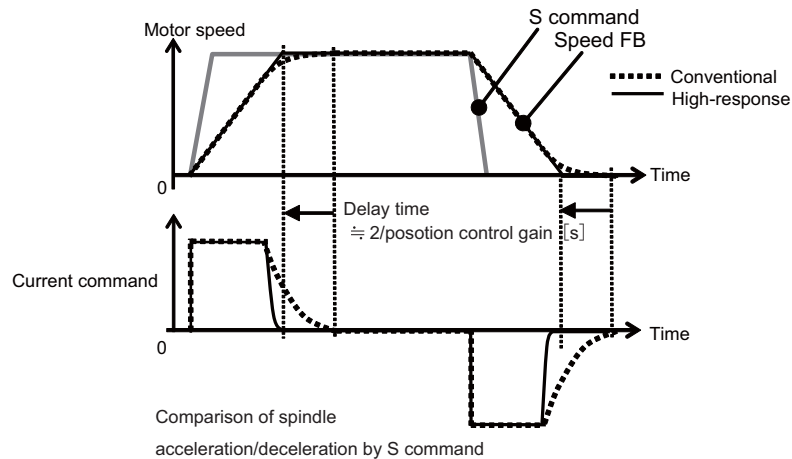

#13095 SP095 VIAX Lead compensation scale during high-response acceleration/deceleration

Set the magnification against delay/lead compensation (SP006) of the high-response acceleration/deceleration (valid when SP226/ bitD is set to "1"). Normally, set to "0". Set this parameter to suppress overshooting when the speed is reached.

---Setting range---

0 to 10000 (0.01%)

#13226 SP226 SFNC6 Spindle function 6

bit D : vup High response acceleration / deceleration

This suppresses a temporal delay which occurs when the target speed is attained from acceleration and when the spindle stops from deceleration.

0: Normal acceleration/deceleration 1: High response acceleration/deceleration Enable



POINT

This function is invalid during orientation and interpolation control (spindle synchronous/C axis/synchronous tapping control) even when it is set.

6.1.11 Spindle Cutting Withstand Level Improvement

Conventionally, the spindle rotation speed was slowed down due to heavy cutting that exceeds the spindle output characteristics, and this caused the alarm (Excessive error 52, Overload command 51) to stop the machining.

This function enables setting of the dropping speed allowable value by parameter. As long as the speed is the set value or higher, machining can be executed within the output characteristics without being stopped by the alarm.

Even when the parameter setting value is the normal value of 0, the standard value of 85 is applied. This can improve the efficiency of heavy cutting (feed per revolution).

If excessive speed dropping occurs and the speed exceeds the allowable range, the excessive speed deviation alarm 23 is output to reduce the damage to the machine.

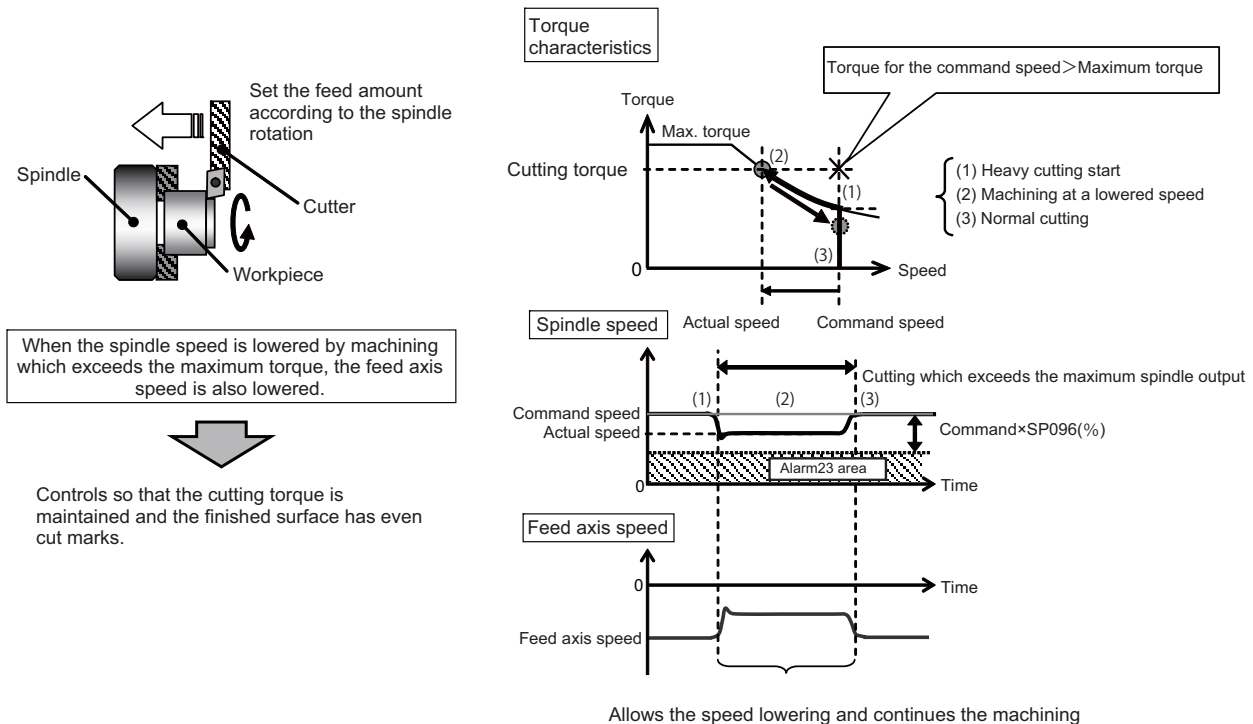

#13096 SP096 SDW Speed slowdown allowable width

When the spindle slows down due to multiple cutting, set the processable speed as percentage against the NC command speed.

If the speed reduces below the tolerable range, the alarm 23 (Excessive speed error) will occur. E.g.] When set to 90 [%]

If S1000 is commanded, the speed reduced by 900r/min (=1000r/min × 90%) is the allowable lower limit. Thus if the spindle speed reduces to 100r/min or below, the alarm will occur.

When "0" is set, the magnification is the same as when "85" is set. When set to "-1", the allowable width will be disabled.

---Setting range---

-1,0 to 100(%)

6.1.12 Spindle Motor Temperature Compensation Function

When an IM spindle motor is in a cooled state, its maximum output characteristics tend to degrade compared to when warmed up. Eventually the spindle acceleration deceleration time may extend or the cutting load on the display may increase immediately after the start of operation.

This function is designed to reduce the motor output degradation caused by the temperature fluctuation, by applying control compensation according to the temperature detected by the motor's built-in thermistor.

For an IPM spindle motor, changes in output characteristics induced by the temperature fluctuation can be ignored in principle, so no thermal compensation function is provided for this type of motor.

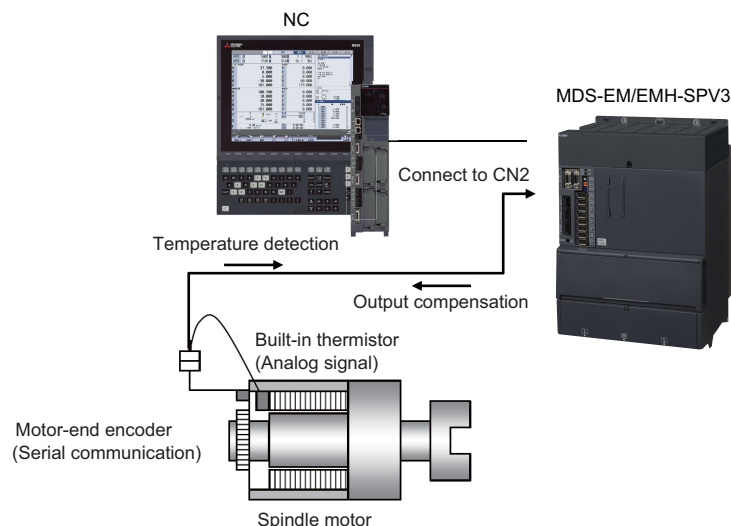

(1) Setting of the temperature compensation gain (SP235)

- [1] Set the parameters as SP235(R2H)=150 and SP236(WIH)=0.
* Change SP153 and SP185 to [original setting x 0.8] respectively and then turn the NC power OFF and ON.
- [2] Rotate the spindle at the command speed of 60r/min.
- [3] Make sure that [Cycle counter] on the spindle monitor screen is counting up or down.
- [4] Stop the spindle (M5 stop: servo OFF).
- [5] Create a program that repeats acceleration/deceleration up to the maximum rotation speed in constant output.
* If the machine's specified speed is lower than the motor's maximum speed in constant output, set the machine specification as the maximum rotation speed.
<Program example for a machining center with the maximum rotation speed in constant output of 7000r/min>
M3 S7000; (Accelerate to the maximum rotation speed)
G4 X2.0; (Dwell for 2.0 seconds)
M5; (Stop)
G4 X2.0; (Dwell for 2.0 seconds)
M99; (Repeat)
- [6] Set SP226 bit8 to 1. (Change SP226(SFNC6) from 0000 to 0100.)
- [7] Run the program (acceleration/deceleration) which you created in [5].
- [8] Make sure that [AFLT gain (dB)] on the spindle monitor is in the range of 90 to 110 during the acceleration/deceleration operation.
<If [AFLT gain (dB)] is out of the range of 90 to 110>
Adjust SP235(R2H) as follows and run the program created in [5] (acceleration/deceleration).
• When [AFLT gain (dB)] is smaller than 90:
Increment SP235(R2H) by 5 at a time until the gain reaches 90 or higher during the program execution.
• When [AFLT gain (dB)] is 111 or greater:
Decrement SP235(R2H) by 5 at a time until the gain reaches 110 or lower during the program execution.
- [9] Stop the spindle when [Temperature (°C)] on the spindle monitor reaches 100 (or the upper limit of temperature in practical use).
- [10] The value of SP235(R2H) you obtain at this time is the result of the final adjustment.

(2) Setting of the temperature compensation time constant (SP236)

- [1] Set SP236(WIH)=10. (Leave the setting of SP235 unchanged.)
- [2] Run the program (acceleration/deceleration) that you created in [5] of (1), and continue until [Temperature (°C)] on the spindle monitor screen reaches 100 (or the upper limit of temperature in practical use).
- [3] Stop the spindle when [Temperature (°C)] on the spindle monitor reaches 100 (or the upper limit of temperature in practical use). Then wait until [Temperature (°C)] drops to 80 (or the upper limit of temperature in practical use - 20°C).
- [4] When [Temperature (°C)] on the spindle monitor reaches 80 (or the upper limit of temperature in practical use - 20°C), run the program (acceleration/deceleration) you created in [5] of (1) by one cycle. Adjust SP236(WIH) as follows according to the value of [AFLT gain (dB)] on the spindle monitor screen during the operation.
 - When [AFLT gain (dB)] is smaller than 90:
Increment SP236(WIH) by 2 at a time and perform [2]
 - When [AFLT gain (dB)] is 111 or greater:
Decrement SP236(WIH) by 2 at a time and perform [2].
- [5] The SP236(WIH) value to be obtained while [AFLT gain (dB)] is in the range of 90 to 110 is the result of the final adjustment.
- [6] Set SP226 bit8 to 0. (Change SP226(SFNC6) from 0100 to 0000.)
*Change SP153 and SP185 back to the original settings and turn OFF and ON the NC power.

 **CAUTION**

Check the monitor screen to make sure that the motor has reached the maximum rotation speed in constant output during execution of the created program.

* "Maximum rotation speed in constant output" is the maximum speed at which the short-time rated output will not drop lower than the motor's specified output. (Refer to the motor output specifications.)

If the machine's specified speed is lower than the motor's maximum speed in constant output, the machine's specified speed serves as the maximum rotation speed.

< How to adjust the spindle motor temperature compensation function >

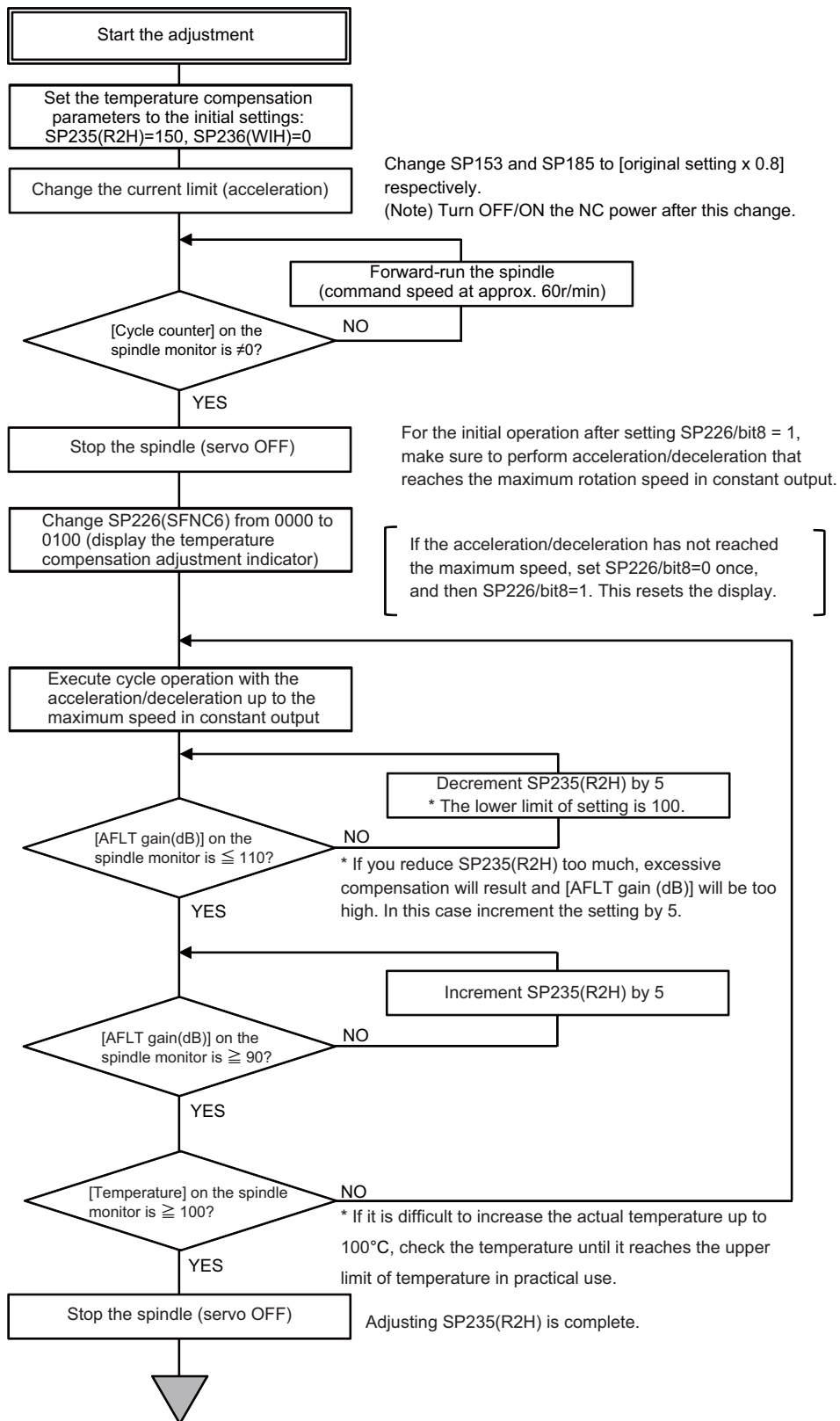

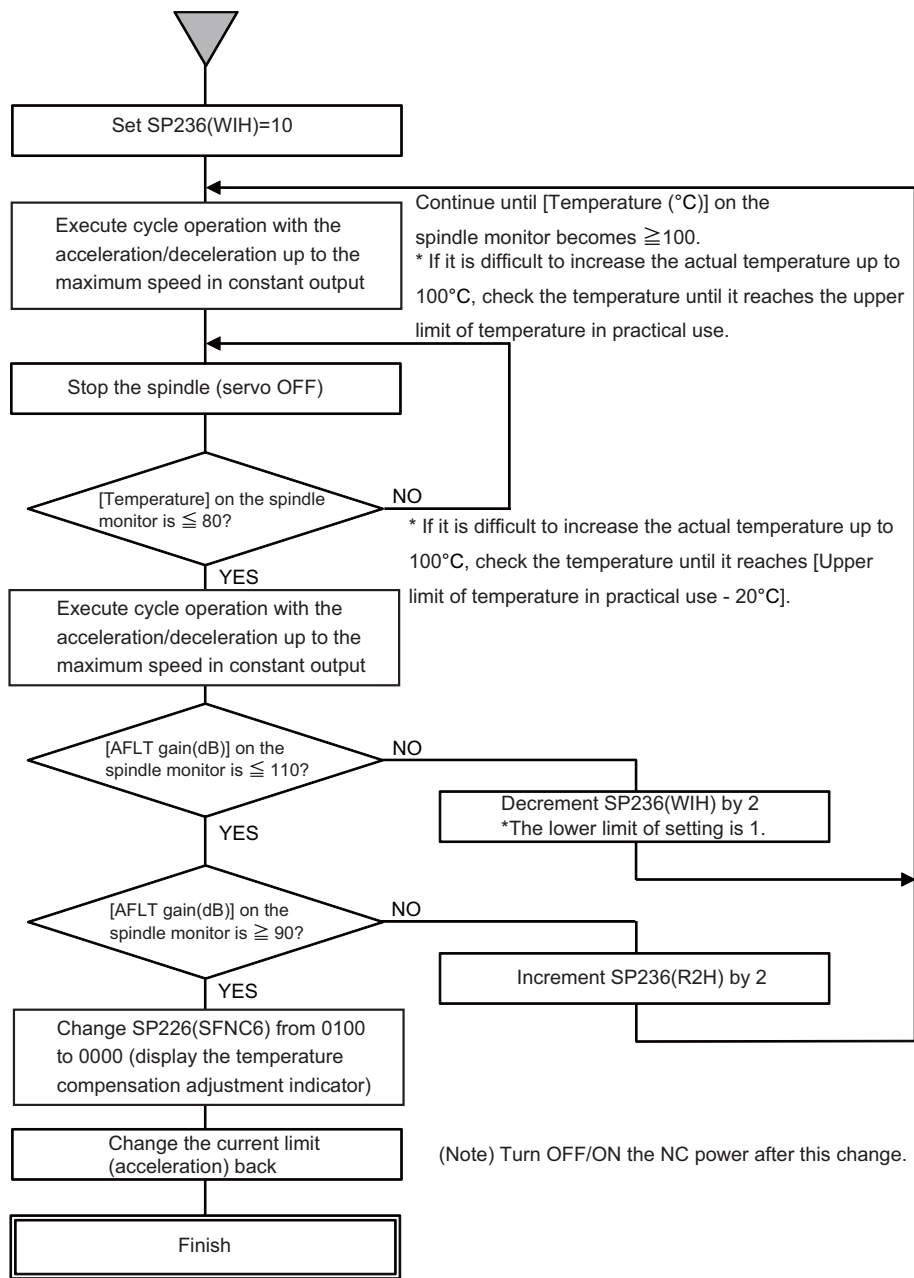

CAUTION

1. Carry out the adjustment within the motor's specified ambient temperature range (0 to +40°C).
2. This function is unavailable if the time taken to accelerate to the maximum speed in constant output is shorter than 0.1[s].
Make sure to perform such acceleration/deceleration that reaches the maximum rotation speed in constant output.
3. If you program a command for accelerating up to the maximum speed in constant output, insert a dwell time so that the spindle motor can reach the maximum speed.
4. Do not use this function for a spindle motor if it has a direct cooling system on the secondary side (rotor).
5. Before starting the adjustment, make sure that [Temperature (°C)] on the spindle monitor is close to the room temperature.
If [Temperature (°C)] is unchanged or any error is found during the adjustment, do not use this function.
6. Do not change the spindle motor cooling condition after the parameter adjustment for this function is complete.
Also make sure to change SP226(SFNC6)/bit8 back to 0.

#13226 SP226 SFNC6 Spindle function 6**bit 8 : r2c Temperature compensation adjustment indicator**

0: Normal 1: Display

#13235(PR) SP235 R2H Temperature compensation gain

Set the magnification in converting the thermistor temperature to the control compensation amount.
When "0" is set, the temperature compensation function is disabled.
When not using, or when using an IPM spindle motor, set to "0".

---Setting range---

0 to 400 (%)

#13236(PR) SP236 WIH Temperature compensation time constant

Set the delay time constant from the thermistor temperature to the control compensation amount.
When "0" is set, the delay time constant is disabled.
When not using, or when using an IPM spindle motor, set to "0".

---Setting range---

0 to 150 (min)

6.2 Settings for Emergency Stop

Emergency stop in this section refers to the following states.

- [1] Emergency stop was input (including other axis alarms)
- [2] NC power down was detected
- [3] A drive unit alarm was detected

6.2.1 Deceleration Control

(1) Setting the deceleration control time constant

Set the time for stopping from the maximum motor speed (TSP) in the deceleration time constant for emergency stop (SV056: EMGt). When "0" is set, the deceleration stop is executed with "7000ms".

<Operation>

When an emergency stop occurs, the motor will decelerate at the same inclination from each speed.

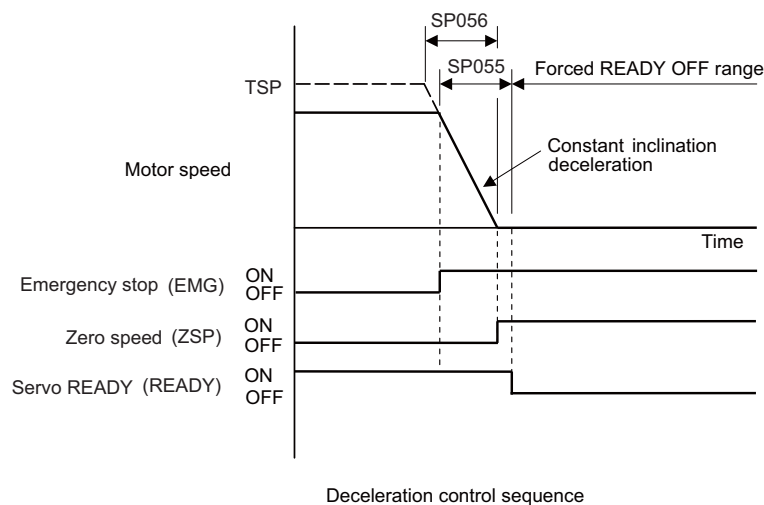

(Note) If the setting value of SP056 is longer than the value of SP055, the motor will coast.

#13055 SP055 EMGx Max. gate off delay time after emergency stop

Set the time required to forcibly execute READY OFF after the emergency stop is input.

Normally set to "5000".

When 5000ms or more is set for deceleration time constant at emergency stop (SP056), set the same value as SP056.

When using the power backup system (MDS-D/DH-PFU) and setting the value of this parameter to 5000ms or more, a communication error between NC and drive unit may occur when power restarts after a instantaneous power interrupt.

It is not a problem so turn the NC power ON again to start up.

When "0" is set, 7000ms is the actual value to be set.

---Setting range---

0 to 29900 (ms)

#13056 SP056 EMGt Deceleration time constant at emergency stop

Set the time constant used for the deceleration control at emergency stop. Set the time required to stop from the maximum motor speed (TSP).

When "0" is set, the deceleration control is executed with "7000ms".

---Setting range---

0 to 29900 (ms)

6.3 Spindle Control Signal

The sequence input/output signals exchanged between the NC and spindle drive unit are explained in this section. The status of each signal is displayed on the NC SPINDLE MONITOR screen.

6.3.1 Spindle Control Input (NC to Spindle)

(1) Spindle control input 1

Name	Details															
Spindle control input 1	F	E	D	C	B	A	9	8	7	6	5	4	3	2	1	0
							TL3	TL2	TL1	ALMR					SRV	RDY
	bit	Details														
	0	RDY	READY ON command													
	1	SRV	Servo ON command													
	2	-	(For maintenance)													
	3	-	(For maintenance)													
	4	-	(For maintenance)													
	5	-	(For maintenance)													
	6	-	(For maintenance)													
	7	ALMR	Alarm reset command													
	8	TL1	Torque limit 1 selection command													
	9	TL2	Torque limit 2 selection command													
	A	TL3	Torque limit 3 selection command													
	B	-	(For maintenance)													
	C	-	(For maintenance)													
D	-	(For maintenance)														
E	-	(For maintenance)														
F	-	(For maintenance)														

bit0. READY ON command (RDY)

Status turns to ready ON at RDY=1.

bit1. Servo ON command (SRV)

- [1] Drive unit turns ON at SRV=1 (gate ON status), and rotation control starts. Plus or minus of the rotation direction is determined depending on +/- of the NC command FΔT.
- [2] Servo immediately turns OFF (SON=0) at SRV=0 during rotation control. Drive unit also turns OFF (gate OFF status) at this time.

bit7. Alarm reset command (ALMR)

NR alarm is reset at ALMR=1.

bit8. Torque limit 1 selection command (TL1)

bit9. Torque limit 2 selection command (TL2)

bitA. Torque limit 3 selection command (TL3)

The following 4 types of torque limit are available depending on TL1, TL2 and TL3 bit combinations.

TL3	TL2	TL1	Torque limit value
0	0	1	Torque limit value (%) set with parameter SP065
0	1	0	Torque limit value (%) set with parameter SP066
0	1	1	Torque limit value (%) set with parameter SP067
1	0	0	Torque limit value (%) set with parameter SP068

(Note) The ratio to motor short time rated torque (load meter 100%) is indicated in %.

(Note) The bits other than those above are used for maintenance.

(2) Spindle control input 2

Name	Details																
Spindle control input 2	F	E	D	C	B	A	9	8	7	6	5	4	3	2	1	0	
					SRVDC	NCDC	SSW										
	bit	Details															
	0	-	(For maintenance)														
	1	-	(For maintenance)														
	2	-	(For maintenance)														
	3	-	(For maintenance)														
	4	-	(For maintenance)														
	5	-	(For maintenance)														
	6	-	(For maintenance)														
	7	-	(For maintenance)														
	8	-	(For maintenance)														
	9	SSW	Speed monitor command valid														
	A	NCDC	In door closed (controller)														
	B	SRVDC	In door closed (all drive units)														
	C	-	(For maintenance)														
	D	-	(For maintenance)														
E	-	(For maintenance)															
F	-	(For maintenance)															

bit9. Speed monitor command valid (SSW)

When speed monitor command is valid, SSW=1 (valid) is set.

bitA. In door closed (controller) (NCDC)

When "In door closed" signal for controller is valid, NCDC =1 (valid) is set.

bitB. In door closed (all drive units) (SRVDC)

When the theoretical sum of "In door closed" signals for all drive units is valid, SRVDC =1 (valid) is set.

(Note) The bits other than those above are used for maintenance.

(3) Spindle control input 3

This is used for maintenance.

(4) Spindle control input 4

Name	Details																
Spindle control input 4	F	E	D	C	B	A	9	8	7	6	5	4	3	2	1	0	
				LCS						GR2	GR1	GKC		SC3	SC2	SC1	
	bit	Details															
	0	SC1	Spindle control mode selection command 1														
	1	SC2	Spindle control mode selection command 2														
	2	SC3	Spindle control mode selection command 3														
	3	-	(For maintenance)														
	4	GKC	Gear changeover command														
	5	GR1	Gear selection command 1														
	6	GR2	Gear selection command 2														
	7	-	(For maintenance)														
	8	-	(For maintenance)														
	9	-	(For maintenance)														
	A	-	(For maintenance)														
	B	-	(For maintenance)														
	C	-	(For maintenance)														
	D	LCS	L coil selection command														
E	-	(For maintenance)															
F	-	(For maintenance)															

bit0. Spindle control mode selection command 1 (SC1)

bit1. Spindle control mode selection command 2 (SC2)

bit2. Spindle control mode selection command 3 (SC3)

- [1] Drive unit operation mode can be selected with the bit correspondences below.
- [2] Mode changeover is valid during in-position (INP=1) or other than during droop cancel / phase compensation (DCSL=PCMP=0).

SC3	SC2	SC1	Operation mode	
			Conventional method	New method
0	0	0	Speed/orientation control	Non interpolation control
0	0	1	Spindle synchronization	Spindle synchronization
0	1	0	C-axis control	Interpolation control
1	0	0	Synchronous tapping control	

(Note) When selecting bits other than above, control mode error (4E) occurs.

- [3] Continuity cannot be guaranteed for the value of position FB in non-interpolation mode. (Position may be skipped for multiple rotations due to droop cancel or phase compensation.)

bit4. In gear changeover command (GKC)

By inputting GKC=1, the gear ratio is changed to the gear ratio specified with the gear selection command (GR1, GR2). This command is invalid during the interpolation mode.

bit5. Gear selection command 1 (GR1)

bit6. Gear selection command 2 (GR2)

- [1] The following 4 types of gear ratio are available depending on GR1 and GR2 2-bit input combinations.
- [2] Gear specifications in semi-closed position control do not secure a position within one rotation of the spindle.

GR2	GR1	Parameters requiring gear ratio setting
0	0	SP057 (GRA1), SP061 (GRB1)
0	1	SP058 (GRA2), SP062 (GRB2)
1	0	SP059 (GRA3), SP063 (GRB3)
1	1	SP060 (GRA4), SP064 (GRB4)

bitD. L coil selection command (LCS)

- [1] L coil is selected at LCS=1 when coil changeover is valid.
- [2] Signal change is invalid during interpolation mode, but coil changeover is valid if control mode changeover is applied together.

(Note) The bits other than those above are used for maintenance.

(5) Spindle control input 5

Name	Details																																															
Spindle control input 5	<table border="1" style="width:100%; text-align:center;"> <tr> <td>F</td><td>E</td><td>D</td><td>C</td><td>B</td><td>A</td><td>9</td><td>8</td><td>7</td><td>6</td><td>5</td><td>4</td><td>3</td><td>2</td><td>1</td><td>0</td> </tr> <tr> <td>TLUP</td><td>ORC</td><td>VG2</td><td>PY2</td><td></td><td></td><td></td><td></td><td></td><td></td><td></td><td></td><td></td><td></td><td></td><td></td> </tr> </table>																F	E	D	C	B	A	9	8	7	6	5	4	3	2	1	0	TLUP	ORC	VG2	PY2												
	F	E	D	C	B	A	9	8	7	6	5	4	3	2	1	0																																
	TLUP	ORC	VG2	PY2																																												
	bit	Details																																														
	0	-																																														
	1	-																																														
	2	-																																														
	3	-																																														
	4	-																																														
	5	-																																														
	6	-																																														
	7	-																																														
	8	-																																														
	9	-																																														
	A	-																																														
	B	PY2	Minimum excitation rate 2 changeover request																																													
C	VG2	Speed gain set 2 changeover request																																														
D	ORC	Zero point re-detection request																																														
E	TLUP	Increase holding power of spindle																																														
F	-																																															

bitB. Minimum excitation rate 2 changeover request (PY2)

- [1] When PY2=1 is set, the minimum excitation rate 2 (SP015) is selected.
- [2] When PY2=0 is set, the minimum excitation rate 1 (SP014) is selected.

bitC. Speed gain set 2 changeover request (VG2)

- [1] When VG2=1 is set, the gain parameter (SP008/SP009/SP010) used in the speed loop is selected.
- [2] When VG2=0 is set, the gain parameter (SP005/SP006/SP007) used in the speed loop is selected.
- [3] The speed gain set changeover is valid during the in-position.

bitD. Zero point re-detection request (ORC)

When ORC is changed from 0 to 1, the Z phase passed will be 0 (control output2/bit0).

bitE. Increase holding power of spindle (TLUP)

Increase holding power of spindle (disturbance observer) starts at TLUP=1 and that state is retained during TLUP=1.

(Note) The bits other than those above are used for maintenance.

(6) Spindle control input 6

Name	Details																																															
Spindle control input 6	<table border="1" style="width: 100%; border-collapse: collapse; text-align: center;"> <tr> <td>F</td><td>E</td><td>D</td><td>C</td><td>B</td><td>A</td><td>9</td><td>8</td><td>7</td><td>6</td><td>5</td><td>4</td><td>3</td><td>2</td><td>1</td><td>0</td> </tr> <tr> <td></td><td></td><td></td><td></td><td></td><td></td><td></td><td>DD1</td><td></td><td></td><td></td><td></td><td></td><td></td><td></td><td>OMRFF</td> </tr> </table>																F	E	D	C	B	A	9	8	7	6	5	4	3	2	1	0								DD1								OMRFF
	F	E	D	C	B	A	9	8	7	6	5	4	3	2	1	0																																
								DD1								OMRFF																																
	bit	Details																																														
	0	OMRFF	OMR-FF control request																																													
	1	-	(For maintenance)																																													
	2	-	(For maintenance)																																													
	3	-	(For maintenance)																																													
	4	-	(For maintenance)																																													
	5	-	(For maintenance)																																													
	6	-	(For maintenance)																																													
	7	-	(For maintenance)																																													
	8	DD1	Drivers communication control request																																													
	9	-	(For maintenance)																																													
	A	-	(For maintenance)																																													
	B	-	(For maintenance)																																													
	C	-	(For maintenance)																																													
D	-	(For maintenance)																																														
E	-	(For maintenance)																																														
F	-	(For maintenance)																																														

bit0. OMR-FF control request (OMRFF)

- [1] The OMR-FF control which determines the tracking ability to the position command by using scale model gain is selected with OMRFF=1.
- [2] The tracking ability to the position command is determined by using conventional position loop gain with OMRFF=0.

bit8. Drivers communication control request (DD1)

- [1] The high-speed synchronous tapping control which allows data communication between drive units is selected with DD1=1.
- [2] The normal synchronous tapping is selected with DD1=0.

(Note) The bits other than those above are used for maintenance.

6.3.2 Spindle Control Output (Spindle to NC)

(1) Spindle control output 1

Name		Details																																																																		
Spindle control output 1		F	E	D	C	B	A	9	8	7	6	5	4	3	2	1	0																																																			
		WRN	LMT	INP			TL3	TL2	TL1	ALMR							SRV	RDY																																																		
		<table border="1"> <thead> <tr> <th>bit</th> <th colspan="2">Details</th> </tr> </thead> <tbody> <tr> <td>0</td> <td>RDY</td> <td>In ready ON</td> </tr> <tr> <td>1</td> <td>SRV</td> <td>In servo ON</td> </tr> <tr> <td>2</td> <td>-</td> <td>(For maintenance)</td> </tr> <tr> <td>3</td> <td>-</td> <td>(For maintenance)</td> </tr> <tr> <td>4</td> <td>-</td> <td>(For maintenance)</td> </tr> <tr> <td>5</td> <td>-</td> <td>(For maintenance)</td> </tr> <tr> <td>6</td> <td>-</td> <td>(For maintenance)</td> </tr> <tr> <td>7</td> <td>ALMR</td> <td>In alarm</td> </tr> <tr> <td>8</td> <td>TL1</td> <td>In torque limit 1 selection</td> </tr> <tr> <td>9</td> <td>TL2</td> <td>In torque limit 2 selection</td> </tr> <tr> <td>A</td> <td>TL3</td> <td>In torque limit 3 selection</td> </tr> <tr> <td>B</td> <td>-</td> <td>(For maintenance)</td> </tr> <tr> <td>C</td> <td>INP</td> <td>In in-position</td> </tr> <tr> <td>D</td> <td>LMT</td> <td>In torque limit</td> </tr> <tr> <td>E</td> <td>-</td> <td>(For maintenance)</td> </tr> <tr> <td>F</td> <td>WRN</td> <td>In warning</td> </tr> </tbody> </table>																bit	Details		0	RDY	In ready ON	1	SRV	In servo ON	2	-	(For maintenance)	3	-	(For maintenance)	4	-	(For maintenance)	5	-	(For maintenance)	6	-	(For maintenance)	7	ALMR	In alarm	8	TL1	In torque limit 1 selection	9	TL2	In torque limit 2 selection	A	TL3	In torque limit 3 selection	B	-	(For maintenance)	C	INP	In in-position	D	LMT	In torque limit	E	-	(For maintenance)	F	WRN	In warning
bit	Details																																																																			
0	RDY	In ready ON																																																																		
1	SRV	In servo ON																																																																		
2	-	(For maintenance)																																																																		
3	-	(For maintenance)																																																																		
4	-	(For maintenance)																																																																		
5	-	(For maintenance)																																																																		
6	-	(For maintenance)																																																																		
7	ALMR	In alarm																																																																		
8	TL1	In torque limit 1 selection																																																																		
9	TL2	In torque limit 2 selection																																																																		
A	TL3	In torque limit 3 selection																																																																		
B	-	(For maintenance)																																																																		
C	INP	In in-position																																																																		
D	LMT	In torque limit																																																																		
E	-	(For maintenance)																																																																		
F	WRN	In warning																																																																		

bit0. In ready ON (RDY)

It indicates that the status is in ready ON at RDY=1.

bit1. In servo ON (SRV)

- [1] It indicates that the status is in servo ON at SRV=1.
- [2] NC position command executes a followed up during SRV=0.

bit7. In alarm (ALMR)

It indicates that drive unit is in some alarm state at ALMR=1.

bit8. In torque limit 1 selection (TL1)

bit9. In torque limit 2 selection (TL2)

bitA. In torque limit 3 selection (TL3)

These are the answer outputs for torque limit 1, 2 and 3 (TL1, TL2 and TL3).

bitC. In in-position (INP)

The status changes to INP=1 when position droop exists within the in-position area set by parameter SP024 (INP) regardless of serve ON or OFF.

bitD. In torque limit (LMT)

It indicates that current command value is limited with motor maximum output current value or torque limit 1, 2 or 3 at LMT=1.

bitF. In warning (WRN)

It indicates that drive unit is in some warning state at WRN=1.

(Note) The bits other than those above are used for maintenance.

(2) Spindle control output 2

Name	Details															
Spindle control output 2	F	E	D	C	B	A	9	8	7	6	5	4	3	2	1	0
					SRVDC	NCDC	SSW		EXEMG				ZS			ZCN
	bit	Details														
	0	ZCN	Z phase passed													
	1	-	(For maintenance)													
	2	-	(For maintenance)													
	3	ZS	In zero speed													
	4	-	(For maintenance)													
	5	-	(For maintenance)													
	6	-	(For maintenance)													
	7	EXEMG	In external emergency stop													
	8	-	(For maintenance)													
	9	SSW	In speed monitor													
	A	NCDC	In door closed (controller)													
	B	SRVDC	In door closed (self drive unit)													
	C	-	(For maintenance)													
	D	-	(For maintenance)													
E	-	(For maintenance)														
F	-	(For maintenance)														

bit0. Z phase passed (ZCN)

- [1] When Z phase is passed, ZCN=0 is turned to ZCN=1.
- [2] Grid amount (within one rotation) is transmitted when ZCN =0 is changed to ZCN =1.

bit3. In zero speed (ZS)

- [1] Approximately 200ms after the motor speed reaches parameter SP027 (ZSP) + 15r/min, ZS=0 is set.
- [2] When the motor speed becomes slower than the speed set by parameter SP027 (ZSP), ZS=1 is set. ZS signal is detected by the motor speed absolute value regardless of the rotation direction.

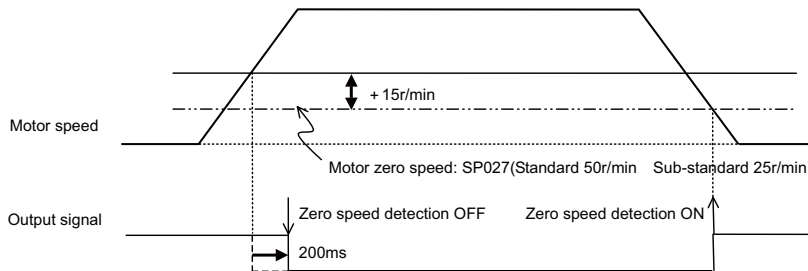

bit7. In external emergency stop

It indicates that an external stop input to the power supply is being input.

bit9. In speed monitor

It indicates that a signal in speed monitor command is being received.

bitA. In door closed (controller)

It indicates that "In door closed" signal for controller is being received.

bitB. In door closed (self drive unit)

It indicates the status of "In door closed" signal for self drive unit.

(Note) The bits other than those above are used for maintenance.

(3) Spindle control output 3

This is used for maintenance.

(4) Spindle control output 4

Name	Details															
Spindle control output 4	F	E	D	C	B	A	9	8	7	6	5	4	3	2	1	0
			LCS						MPN	GR2	GR1	GKC		SC3	SC2	SC1
	bit	Details														
	0	SC1	In spindle control mode selection 1													
	1	SC2	In spindle control mode selection 2													
	2	SC3	In spindle control mode selection 3													
	3	-	(For maintenance)													
	4	GKC	In gear changeover command													
	5	GR1	In gear selection 1													
	6	GR2	In gear selection 2													
	7	MPN	Magnetic pole position not set													
	8	-	(For maintenance)													
	9	-	(For maintenance)													
	A	-	(For maintenance)													
	B	-	(For maintenance)													
	C	-	(For maintenance)													
D	LCS	In L coil selection														
E	-	(For maintenance)														
F	-	(For maintenance)														

bit0. In spindle control mode selection 1 (SC1)

bit1. In spindle control mode selection 2 (SC2)

bit2. In spindle control mode selection 3 (SC3)

These are the answer outputs for control mode selection command 1, 2, 3 (SC1, SC2, SC3).

bit4. In gear changeover command (GKC)

[1] This is an answerer output for the gear changeover command.

[2] The position feedback is generated from the speed encoder at GKC=1.

bit5. In gear selection 1 (GR1)

bit6. In gear selection 2 (GR2)

These are the answer outputs for gear selection command 1 and 2 (GR1 and GR2).

bit7. Magnetic pole position not set (MPN)

It indicates that the magnetic pole position of the motor is not established at MPN=1.

bitD. In L coil selection (LCS)

It indicates that L coil is being selected at LCSA=1.

(Note) The bits other than those above are used for maintenance.

(5) Spindle control output 5

Name	Details																																		
Spindle control output 5	<table border="1"> <tr> <td>F</td><td>E</td><td>D</td><td>C</td><td>B</td><td>A</td><td>9</td><td>8</td><td>7</td><td>6</td><td>5</td><td>4</td><td>3</td><td>2</td><td>1</td><td>0</td> </tr> <tr> <td>INP2</td><td>ORF</td><td>VG2</td><td>PY2</td><td></td><td>SD2</td><td></td><td></td><td></td><td>MKC</td><td></td><td></td><td></td><td></td><td>MD</td><td></td> </tr> </table>	F	E	D	C	B	A	9	8	7	6	5	4	3	2	1	0	INP2	ORF	VG2	PY2		SD2				MKC					MD			
	F	E	D	C	B	A	9	8	7	6	5	4	3	2	1	0																			
INP2	ORF	VG2	PY2		SD2				MKC					MD																					
	<table border="1"> <thead> <tr> <th>bit</th> <th>Details</th> </tr> </thead> <tbody> <tr> <td>0</td> <td>- (For maintenance)</td> </tr> <tr> <td>1</td> <td>MD Speed detection</td> </tr> <tr> <td>2</td> <td>- (For maintenance)</td> </tr> <tr> <td>3</td> <td>- (For maintenance)</td> </tr> <tr> <td>4</td> <td>- (For maintenance)</td> </tr> <tr> <td>5</td> <td>- (For maintenance)</td> </tr> <tr> <td>6</td> <td>MKC In coil changeover</td> </tr> <tr> <td>7</td> <td>- (For maintenance)</td> </tr> <tr> <td>8</td> <td>- (For maintenance)</td> </tr> <tr> <td>9</td> <td>SD2 2nd speed detection</td> </tr> <tr> <td>A</td> <td>- (For maintenance)</td> </tr> <tr> <td>B</td> <td>PY2 In minimum excitation rate 2 selection</td> </tr> <tr> <td>C</td> <td>VG2 In speed gain set 2 selection</td> </tr> <tr> <td>D</td> <td>ORF Zero point re-detection request</td> </tr> <tr> <td>E</td> <td>- (For maintenance)</td> </tr> <tr> <td>F</td> <td>INP2 In 2nd in-position</td> </tr> </tbody> </table>	bit	Details	0	- (For maintenance)	1	MD Speed detection	2	- (For maintenance)	3	- (For maintenance)	4	- (For maintenance)	5	- (For maintenance)	6	MKC In coil changeover	7	- (For maintenance)	8	- (For maintenance)	9	SD2 2nd speed detection	A	- (For maintenance)	B	PY2 In minimum excitation rate 2 selection	C	VG2 In speed gain set 2 selection	D	ORF Zero point re-detection request	E	- (For maintenance)	F	INP2 In 2nd in-position
bit	Details																																		
0	- (For maintenance)																																		
1	MD Speed detection																																		
2	- (For maintenance)																																		
3	- (For maintenance)																																		
4	- (For maintenance)																																		
5	- (For maintenance)																																		
6	MKC In coil changeover																																		
7	- (For maintenance)																																		
8	- (For maintenance)																																		
9	SD2 2nd speed detection																																		
A	- (For maintenance)																																		
B	PY2 In minimum excitation rate 2 selection																																		
C	VG2 In speed gain set 2 selection																																		
D	ORF Zero point re-detection request																																		
E	- (For maintenance)																																		
F	INP2 In 2nd in-position																																		

bit1. Speed detection (MD)

- [1] When motor speed exceeds the speed set by parameter SP028 (SDTS) + SP029 (SDTR), SD=0 is set.
- [2] When motor speed becomes slower than the speed set by parameter SP028 (SDTS), SD=1 is set. SD signal is detected by the motor speed absolute value regardless of rotation direction.

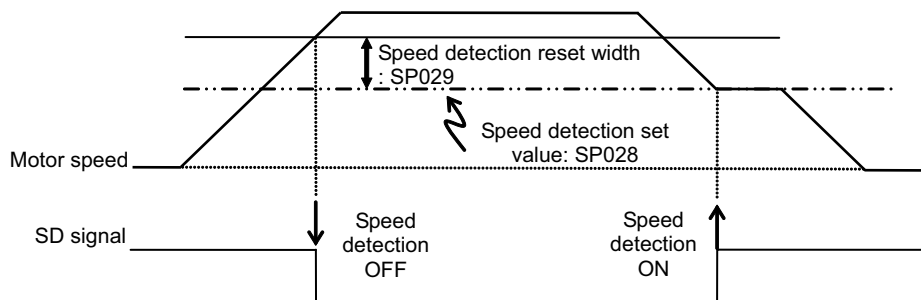

bit6. In coil changeover (MKC)

MKC=1 is set for the amount of time set by parameter SP114 (MKT) during coil changeover operation.

bit9. 2nd speed detection (SD2) (IPM spindle motor)

- [1] The status changes to SD2=0 when motor speed exceeds the speed set by parameter SP030 (SDT2) + SP029 (SDTR).
- [2] The status changes to SD2=1 when motor speed becomes slower than the speed set by parameter SP030 (SDT2).
- [3] It is used as M coil changeover speed. (IPM spindle motor only)

bitB. In minimum excitation rate 2 selection (PY2)

- [1] When PY2=1 is set, the minimum excitation rate 2 (SP015) is being selected.
- [2] When PY2=0 is set, the minimum excitation rate 1(SP014) is being selected.

bitC. In speed gain set 2 selection (VG2)

- [1] When VG2=1 is set, the gain parameter (SP008/SP009/SP010) used in the speed loop is being selected.
- [2] When VG2=0 is set, the gain parameter (SP005/SP006/SP007) used in the speed loop is being selected.

bitD. Zero point re-detection complete

If the zero point re-detection is completed after the zero point re-detection request (control input5/bitD) is set to 1, ORF=1 is set. If the zero point re-detection request is set to 0, ORF=0 is set.

bitF. In 2nd in-position (INP2)

The status changes to INP2=1 when position droop exists within the in-position area set by parameter SP025 (INP2) regardless of serve ON or OFF.

(Note) The bits other than those above are used for maintenance.

(6) Spindle control output 6

Name	Details																																																																		
Spindle control output 6	<table border="1" style="width: 100%; border-collapse: collapse;"> <tr> <td style="width: 10%;">F</td><td style="width: 10%;">E</td><td style="width: 10%;">D</td><td style="width: 10%;">C</td><td style="width: 10%;">B</td><td style="width: 10%;">A</td><td style="width: 10%;">9</td><td style="width: 10%;">8</td><td style="width: 10%;">7</td><td style="width: 10%;">6</td><td style="width: 10%;">5</td><td style="width: 10%;">4</td><td style="width: 10%;">3</td><td style="width: 10%;">2</td><td style="width: 10%;">1</td><td style="width: 10%;">0</td> </tr> <tr> <td></td><td></td><td></td><td></td><td></td><td></td><td></td><td style="text-align: center;">DD1</td><td></td><td></td><td></td><td></td><td></td><td></td><td></td><td style="text-align: center;">OMRFF</td> </tr> </table> <table border="1" style="width: 100%; border-collapse: collapse;"> <thead> <tr> <th style="text-align: left;">bit</th> <th style="text-align: left;">Details</th> </tr> </thead> <tbody> <tr> <td>0</td> <td>OMRFF In OMR-FF control</td> </tr> <tr> <td>1</td> <td>- (For maintenance)</td> </tr> <tr> <td>2</td> <td>- (For maintenance)</td> </tr> <tr> <td>3</td> <td>- (For maintenance)</td> </tr> <tr> <td>4</td> <td>- (For maintenance)</td> </tr> <tr> <td>5</td> <td>- (For maintenance)</td> </tr> <tr> <td>6</td> <td>- (For maintenance)</td> </tr> <tr> <td>7</td> <td>- (For maintenance)</td> </tr> <tr> <td>8</td> <td>DD1 In drivers communication control</td> </tr> <tr> <td>9</td> <td>- (For maintenance)</td> </tr> <tr> <td>A</td> <td>- (For maintenance)</td> </tr> <tr> <td>B</td> <td>- (For maintenance)</td> </tr> <tr> <td>C</td> <td>- (For maintenance)</td> </tr> <tr> <td>D</td> <td>- (For maintenance)</td> </tr> <tr> <td>E</td> <td>- (For maintenance)</td> </tr> <tr> <td>F</td> <td>- (For maintenance)</td> </tr> </tbody> </table>	F	E	D	C	B	A	9	8	7	6	5	4	3	2	1	0								DD1								OMRFF	bit	Details	0	OMRFF In OMR-FF control	1	- (For maintenance)	2	- (For maintenance)	3	- (For maintenance)	4	- (For maintenance)	5	- (For maintenance)	6	- (For maintenance)	7	- (For maintenance)	8	DD1 In drivers communication control	9	- (For maintenance)	A	- (For maintenance)	B	- (For maintenance)	C	- (For maintenance)	D	- (For maintenance)	E	- (For maintenance)	F	- (For maintenance)
F	E	D	C	B	A	9	8	7	6	5	4	3	2	1	0																																																				
							DD1								OMRFF																																																				
bit	Details																																																																		
0	OMRFF In OMR-FF control																																																																		
1	- (For maintenance)																																																																		
2	- (For maintenance)																																																																		
3	- (For maintenance)																																																																		
4	- (For maintenance)																																																																		
5	- (For maintenance)																																																																		
6	- (For maintenance)																																																																		
7	- (For maintenance)																																																																		
8	DD1 In drivers communication control																																																																		
9	- (For maintenance)																																																																		
A	- (For maintenance)																																																																		
B	- (For maintenance)																																																																		
C	- (For maintenance)																																																																		
D	- (For maintenance)																																																																		
E	- (For maintenance)																																																																		
F	- (For maintenance)																																																																		

bit0. In OMR-FF control (OMRFF)

OMRFF=1 (enabled) if OMR-FF control is enabled.

bit8. In drivers communication control (DD1)

DD1=1 (enabled) if high-speed synchronous tapping control is enabled.

(Note) The bits other than those above are used for maintenance.

7

Troubleshooting

7.1 Points of Caution and Confirmation

If an error occurs in the drive unit, the warning or alarm will occur. When a warning or alarm occurs, check the state while observing the following points, and inspect or remedy the unit according to the details given in this section.

< Points of confirmation >

- [1] What is the alarm code display?
- [2] Can the error or trouble be repeated? (Check alarm history)
- [3] Is the motor and servo drive unit temperature and ambient temperature normal?
- [4] Are the servo drive unit, control unit and motor grounded?
- [5] Was the unit accelerating, decelerating or running at a set speed? What was the speed?
- [6] Is there any difference during forward and backward run?
- [7] Was there a momentary power failure?
- [8] Did the trouble occur during a specific operation or command?
- [9] At what frequency does the trouble occur?
- [10] Is a load applied or removed?
- [11] Has the drive unit been replaced, parts replaced or emergency measures taken?
- [12] How many years has the unit been operating?
- [13] Is the power supply voltage normal? Does the state change greatly according to the time band?

CAUTION

1. This drive unit uses a large capacity electrolytic capacitor. When the CHARGE lamp on the front of the power supply unit is lit, voltage is still present. Do not touch the terminal block in this state.
2. Before replacing the unit, etc., always confirm that there is no voltage with a tester or wait at least 15 minutes after turning the main power OFF.
3. The conductivity in the unit cannot be checked.
4. Never carry out a megger test on the drive unit as the unit could be damaged.

7.1.1 LED Display When Alarm or Warning Occurs

(1) Servo and spindle drive unit

The axis No. and alarm/warning No. alternate on the display. The display flickers when an alarm occurs.

(Example) Spindle: an alarm occurs, Servo: Emergency stop

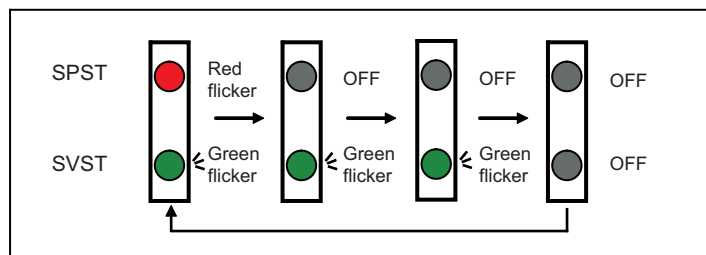

LED display during an alarm occurs (Servo 3 axes and Spindle)

(Note) MDS-EM/EMH-SPV3 Series has no segment, so confirm the alarm No. on the NC screen monitor.

7.2 Protective Functions List of Units

7.2.1 List of Alarms

When an alarm occurs, the servo drive unit will make the motor stop by the deceleration control or dynamic brake. The spindle drive unit will coast to a stop or will decelerate to a stop. At the same time, the alarm No. will appear on the NC monitor screen and with the LEDs on the front of the drive unit. Check the alarm No., and remove the cause of the alarm by following this list.

(1) Drive unit alarm

No.	Name	Details	Reset method	Servo stop method	Spindle stop method
10	Insufficient voltage	A drop of bus voltage was detected in main circuit.	PR	Dynamic stop	Coast to a stop
11	Axis selection error	The axis selection rotary switch has been incorrectly set.	AR	Initial error	Initial error
12	Memory error 1	A hardware error was detected during the power ON self-check.	AR	Initial error	Initial error
13	Software processing error 1	An error was detected for the software execution state.	PR	Dynamic stop	Coast to a stop
14	Software processing error2	The current processor is not operating correctly.	AR	Dynamic stop	Coast to a stop
16	Initial magnetic pole position detection error	In the built-in motor which uses the absolute position encoder, the servo ON has been set before the magnetic pole shift amount is set. The magnetic pole position, detected in the initial magnetic pole position detection control, is not correctly set.	PR	Dynamic stop	Coast to a stop
17	A/D converter error	A current feedback error was detected.	PR	Dynamic stop	Coast to a stop
18	Main side encoder: Initial communication error	An error was detected in the initial communication with the motor side encoder.	PR	Initial error	Initial error
19	Encoder communication error in synchronous control	An error of the shared encoder on the machine side was detected on the secondary axis of the speed command synchronization control.	PR	Dynamic stop	-
1A	Sub side encoder: Initial communication error	An error was detected in the initial communication with the machine side encoder.	PR	Initial error	Initial error
1B	Sub side encoder: Error 1	An error was detected by the encoder connected to the machine side. The error details are different according to the encoder type. Refer to "Encoder alarm" for details.		Dynamic stop	Coast to a stop
1C	Sub side encoder: Error 2				
1D	Sub side encoder: Error 3				
1E	Sub side encoder: Error 4				
1F	Sub side encoder: Communication error	An error was detected in the communication with the machine side encoder.	PR	Dynamic stop	Coast to a stop
21	Sub side encoder no signal 2	In the machine side encoder, ABZ-phase feedback cannot be returned even when the motor moves.	PR	Dynamic stop	Coast to a stop
22	Encoder data error	An error was detected in the feedback data from the position encoder.	AR	Dynamic stop	Coast to a stop
23	Excessive speed error	The state that there is a difference between the actual speed and command speed continued for longer than the excessive speed deviation timer setting.	NR	-	Coast to a stop
24	Grounding	The motor power cable is in contact with FG (Frame Ground).	PR	Dynamic stop	Coast to a stop
25	Absolute position data lost	The absolute position data was lost in the encoder.	AR	Initial error	-
26	Unused axis error	In the multiaxis drive unit, there is an axis set to free, and the other axis detected a power module error.	PR	Dynamic stop	Coast to a stop

(Note 1) Definitions of terms in the table are as follows.

Main side encoder: Encoder connected to CN2

Sub side encoder: Encoder connected to CN3

(Note 2) Resetting methods

NR: Reset with the NC RESET button. This alarm can also be reset with the PR and AR resetting conditions.

PR: Reset by turning the NC power ON again. This alarm can also be reset with the AR resetting conditions. When the control axis is removed, this alarm can be reset with the NC RESET button. (Excluding alarms 32 and 37.)

AR: Reset by turning the NC and servo drive unit power ON again.

7 Troubleshooting

No.	Name	Details	Reset method	Servo stop method	Spindle stop method
27	Sub side encoder: Error 5	An error was detected by the encoder connected to the machine side. The error details are different according to the encoder type. Refer to "Encoder alarm" for details.		Dynamic stop	Coast to a stop
28	Sub side encoder: Error 6				
29	Sub side encoder: Error 7				
2A	Sub side encoder: Error 8				
2B	Main side encoder: Error 1	An error was detected by the encoder connected to the motor side. The error details are different according to the encoder type. Refer to "Encoder alarm" for details.		Dynamic stop	Coast to a stop
2C	Main side encoder: Error 2				
2D	Main side encoder: Error 3				
2E	Main side encoder: Error 4				
2F	Main side encoder: Communication error	An error was detected in the communication with the motor side encoder.	PR	Dynamic stop	Coast to a stop
30	Over regeneration	Over-regeneration level exceeded 100%. The regenerative resistor is overloaded.	PR	Dynamic stop	Coast to a stop
31	Overspeed	The motor speed exceeded the allowable speed.	PR	Deceleration stop	Deceleration stop
32	Power module error (overcurrent)	The power module detected the overcurrent.	PR	Dynamic stop	Coast to a stop
33	Overvoltage	The bus voltage in main circuit exceeded the allowable value.	PR	Dynamic stop	Coast to a stop
34	NC communication: CRC error	The data received from the NC was outside the setting range.	PR	Deceleration stop	Deceleration stop
35	NC command error	The travel command data received from the NC was excessive.	PR	Deceleration stop	Deceleration stop
36	NC communication: Communication error	The communication with the NC was interrupted.	PR	Deceleration stop	Deceleration stop
37	Initial parameter error	An incorrect set value was detected among the parameters send from the NC at the power ON. In the SLS(Safely Limited Speed) function, an error was detected in the relation between the safety speed and safety rotation number in the speed observation mode.	PR	Initial error	Initial error
38	NC communication: Protocol error 1	An error was detected in the communication frames received from the NC. Or, removing an axis or changing an axis was performed in the synchronous control.	PR	Deceleration stop	Deceleration stop
39	NC communication: Protocol error 2	An error was detected in the axis data received from the NC. Or, in changing an axis, the parameter setting of the synchronous control was applied when the axis was installed.	PR	Deceleration stop	Deceleration stop
3A	Overcurrent	Excessive motor drive current was detected.	PR	Dynamic stop	Coast to a stop
3B	Power module error (overheat)	The power module detected an overheat.	PR	Dynamic stop	Coast to a stop
3C	Regeneration circuit error	An error was detected in the regenerative transistor or in the regenerative resistor.	PR	Dynamic stop	-
3D	Power supply voltage error at acceleration/deceleration	A motor control error during acceleration/deceleration, due to a power voltage failure, was detected.	PR	Dynamic stop	-
3E	Magnetic pole position detection error	The magnetic pole position, detected in the magnetic pole position detection control, is not correctly detected.	AR	Dynamic stop	Coast to a stop

(Note 1) Definitions of terms in the table are as follows.

Main side encoder: Encoder connected to CN2

Sub side encoder: Encoder connected to CN3

(Note 2) Resetting methods

NR: Reset with the NC RESET button. This alarm can also be reset with the PR and AR resetting conditions.

PR: Reset by turning the NC power ON again. This alarm can also be reset with the AR resetting conditions. When the control axis is removed, this alarm can be reset with the NC RESET button. (Excluding alarms 32 and 37.)

AR: Reset by turning the NC and servo drive unit power ON again.

7 Troubleshooting

No.	Name	Details	Reset method	Servo stop method	Spindle stop method
41	Feedback error 3	Either a missed feedback pulse in the motor side encoder or an error in the Z-phase was detected in the full closed loop system.	PR	Dynamic stop	Coast to a stop
42	Feedback error 1	Either a missed feedback pulse in the position detection or an error in the Z-phase was detected. Or the distance-coded reference check error exceeded the allowable value when the distance-coded reference scale was used.	PR	Dynamic stop	Coast to a stop
43	Feedback error 2	An excessive difference in feedback was detected between the machine side encoder and the motor side encoder.	PR	Dynamic stop	Coast to a stop
45	Fan stop	An overheat of the power module was detected during the cooling fan stopping.	PR	Dynamic stop	Coast to a stop
46	Motor overheat / Thermal error	Either the motor or the motor side encoder detected an overheat. Or, the thermistor signal receiving circuit of the linear motor or direct-drive motor was disconnected. Or, the thermistor signal receiving circuit was short-circuited.	NR	Deceleration stop	Deceleration stop
48	Main side encoder: Error 5	An error was detected by the encoder connected to the main side. The error details are different according to the connected encoder. Refer to "Encoder alarm".		Dynamic stop	Coast to a stop
49	Main side encoder: Error 6				
4A	Main side encoder: Error 7				
4B	Main side encoder: Error 8				
4C	Current error at initial magnetic pole estimate	Current detection failed at the initial magnetic pole estimation.	NR	Dynamic stop	Coast to a stop
4D	Dual signal error	An error was detected in the signal related to the dual signal. Refer to "Dual signal error (4D)" for details.			
4E	NC command mode error	An error was detected in the control mode send from the NC.	NR	Deceleration stop	Deceleration stop
4F	Instantaneous power interrupt	The control power supply has remained shut down.	NR	Deceleration stop	Deceleration stop
50	Overload 1	Overload detection level became 100% or more. The motor or the drive unit is overloaded.	NR	Deceleration stop	Deceleration stop
51	Overload 2	In a servo system, current command of 95% or more of the unit's max. current was given continuously for 1 second or longer. In a spindle system, current command of 95% or more of the motor's max. current was given continuously for 1 second or longer.	NR	Deceleration stop	Deceleration stop
52	Excessive error 1	A position tracking error during servo ON was excessive.	NR	Deceleration stop	Deceleration stop
53	Excessive error 2	A position tracking error during servo OFF was excessive.	NR	Dynamic stop	-
54	Excessive error 3	There was no motor current feedback when the alarm "Excessive error 1" was detected.	NR	Dynamic stop	Coast to a stop
56	Commanded speed error	The encoder has detected that the commanded speed exceeded 1.15 times of the rapid traverse rate (rapid), or the motor rotation speed exceeded the maximum speed.	NR	Deceleration stop	Deceleration stop
58	Collision detection 1: G0	A disturbance torque exceeded the allowable value in rapid traverse modal (G0).	NR	Max cap dec stop	-
59	Collision detection 1: G1	A disturbance torque exceeded the allowable value in the cutting feed modal (G1).	NR	Max cap dec stop	-
5A	Collision detection 2	A current command with the maximum drive unit current value was detected.	NR	Max cap dec stop	-

(Note 1) Definitions of terms in the table are as follows.

Main side encoder: Encoder connected to CN2

Sub side encoder: Encoder connected to CN3

(Note 2) Resetting methods

NR: Reset with the NC RESET button. This alarm can also be reset with the PR and AR resetting conditions.

PR: Reset by turning the NC power ON again. This alarm can also be reset with the AR resetting conditions. When the control axis is removed, this alarm can be reset with the NC RESET button. (Excluding alarms 32 and 37.)

AR: Reset by turning the NC and servo drive unit power ON again.

7 Troubleshooting

No.	Name	Details	Reset method	Servo stop method	Spindle stop method
5B	Safely limited: Commanded speed monitoring error	A commanded speed exceeding the safely limited speed was detected in the safely limited mode.	PR	Deceleration stop	Deceleration stop
5D	Safely limited: Door state error	The door state signal input in the NC does not coincide with the door state signal input in the drive unit in the safely limited mode. Otherwise, door open state was detected in normal mode.	PR	Deceleration stop	Deceleration stop
5E	Safely limited: Speed feedback monitoring error	A motor speed exceeding the safely limited speed was detected in the safely limited mode.	PR	Deceleration stop	Deceleration stop
5F	External contactor error	A contact of the external contactor is welding.	NR	Deceleration stop	Deceleration stop
60, 61, 63 to 77	Power supply alarm	The power supply unit detected an error. The error details are different according to the connected power supply unit. Refer to "Power supply alarm" for details.		Dynamic stop	Coast to a stop
62	Power supply: Frequency error			Deceleration stop	Deceleration stop
80	Main side encoder cable error	The cable type of the motor side encoder cable is for rectangular wave signal.	AR	Initial error	-
81	Sub side encoder cable error	The cable type of the machine side encoder cable does not coincide with the encoder type which is set by the parameter.	AR	Initial error	-
87	Drivers communication error	The communication frame between drive units was aborted.	PR	Dynamic stop	Coast to a stop
88	Watchdog	The drive unit does not operate correctly. LED display is fixed as "88".	AR	Dynamic stop	Coast to a stop
8A	Drivers communication data error 1	The communication data 1 between drivers exceeded the tolerable value in the communication between drive units.	PR	Dynamic stop	Coast to a stop
8B	Drivers communication data error 2	The communication data 2 between drivers exceeded the tolerable value in the communication between drive units.	PR	Dynamic stop	Coast to a stop

(Note 1) Definitions of terms in the table are as follows.

Main side encoder: Encoder connected to CN2

Sub side encoder: Encoder connected to CN3

(Note 2) Resetting methods

NR: Reset with the NC RESET button. This alarm can also be reset with the PR and AR resetting conditions.

PR: Reset by turning the NC power ON again. This alarm can also be reset with the AR resetting conditions. When the control axis is removed, this alarm can be reset with the NC RESET button. (Excluding alarms 32 and 37.)

AR: Reset by turning the NC and servo drive unit power ON again.

Encoder alarm (Servo drive unit)

Alarm number when the encoder is connected to CN2 side		2B	2C	2D	2E	48	49	4A	4B
Alarm number when the encoder is connected to CN3 side		1B	1C	1D	1E	27	28	29	2A
OSA405 OSA676 OSA24RS	Mitsubishi Electric	Memory alarm	LED alarm	Data alarm	Encoder thermal error	-	-	-	-
OSA405ET2AS OSA676ET2AS		Memory alarm	LED alarm	Data alarm	Encoder thermal error	-	-	-	-
MDS-EX-HR		Memory error	-	Data error	-	Scale not connected	-	-	-
CSW26KS		Memory alarm	LED alarm	Data alarm	Encoder thermal error	-	-	-	-
AT343 AT543 AT545 AT1143 ST748	Mitsutoyo	Initialization error (bit0)	EEPROM error (bit5)	Photoelectric type, static capacity type data mismatch (bit1)	ROM/RAM error (bit6)	CPU error (bit4)	Photoelectric type over-speed (bit7)	Static capacity type error (bit3)	Photoelectric type error (bit2)
LC195M, LC495M, LC291M, LIC2197M, LIC2199M MC15 RCN2590M, RCN5390M, RCN5590M, RCN8390M ROC425M, ROC2390M ECA4000Series EIB Series	HEIDENHAIN	Initialization error (bit0)	EEPROM error (bit5)	Relative/absolute position data mismatch (bit1)	ROM/RAM error (bit6)	CPU error (bit4)	Overspeed (bit7)	Absolute position data error (bit3)	Relative position data error (bit2)
MPRZ scale	NIDEC MACHINE TOOL	Installation accuracy fault (bit4)	-	Detection position deviance (bit1)	Scale breaking (bit0)	Absolute position detection fault (bit5)	-	Gain fault (bit3)	Phase fault (bit2)
SR67A, SR75, SR85 SR74, SR77 SR87, SR84 RU77 RS87	Magnescape	Laser diode error (bit0)	System memory error (bit5)	Encoder mismatch error (bit1)	-	-	Over speed (bit7)	Absolute position data error (bit3)	Relative position data error (bit2)
SAM/SVAM/ GAM/G2AM/ LAM/G3BM/ HAM/H2AM Series	FAGOR	-	-	Absolute value detection error (bit3)	H/W error (bit1)	CPU error (bit0)	-	-	-
RL40N/RA/FORTIS Series	Renishaw	Initialization error (bit0)	-	Absolute position data error (bit3)	-	-	Over speed (bit7)	-	-
WMFA/WMBA/ WMRA/LMFA/ LMBA Series (Note)	AMO	Initialization error (bit0)	-	Relative/absolute position data mismatch (bit2)	-	-	Over speed (bit5)	Absolute position data error (bit6)	-
AMS-ABS-3B Series	Schneeberger	- (bit0)	-	-	Absolute position data error (bit3)	-	-	-	-
MHS-04B Series	GUBOA	H/W error (bit0)	Waveform error (bit1)	-	Power voltage warning (bit3)	-	-	-	-

(Note 1) A drive unit processes all reset types of alarms as "PR". However, "AR" will be applied according to the encoder.

(Note 2) Bit No. in the table refers to a bit assignment for encoder side alarm management data.

Encoder alarm (Spindle drive unit)

Alarm number when the encoder is connected to CN2 side		2B	2C	2D	2E	48	49	4A	4B
Alarm number when the encoder is connected to CN3 side		1B	1C	1D	1E	27	28	29	2A
TS5690 TS5691	Mitsubishi Electric	Memory error	Waveform error	-	-	-	Overspeed	-	Relative position data error
MDS-EX-HR		Initialization error	-	Data error	-	Connection error	-	-	-
OSA24RS		CPU error	Waveform error	Data alarm	Encoder thermal error	-	-	-	-
EIB Series	HEIDENHAIN	Initialization error (bit0)	EEPROM error (bit5)	-	-	CPU error (bit4)	Overspeed (bit7)	-	Relative position data error (bit2)
ADB-K70M	NIDEC MACHINE TOOL	Installation accuracy fault (bit4)	-	Detection position deviation (bit1)	Scale breaking (bit0)	-	-	Gain fault (bit3)	Phase fault (bit2)
GEL2449M	LE-NORD+BAUER	Waveform error (bit0)	Analog signal warning (bit1)	EEPROM error (bit2)	Power voltage warning (bit3)	H/W error (bit4)	Overspeed warning (bit5)	Count error (bit6)	Overheat warning (bit7)
MHS-04B Series	GUBOA	H/W error (bit0)	Waveform error (bit1)	-	Power voltage warning (bit3)	-	-	-	-

(Note 1) A drive unit processes all reset types of alarms as "PR". However, "AR" will be applied according to the encoder.

(Note 2) Bit No. in the table refers to a bit assignment for encoder side alarm management data.

Dual signal error (4D)

No.	Name	Sub info	Details
004D.xxx	Dual signal error	-	An error was detected in the signal related to the dual signal. The name of the axis with an error is displayed. The number "xxx" in the decimal place indicates the sub-number.

(Note) Resetting method may be "PR" depending on the sub-number in the decimal place.

004D.xxx : Alarm number.Sub-number

Sub-No.	Name	Details	Reset method	Axis type	Servo stop method	Spindle stop method
1	Power shutoff error	Either of the STO signals entered an input state while the STO function is disabled.	NR	Each axis	Dynamic stop	Coast to a stop
2	Illegal power shutoff error	Either of the STO signals entered an input state during servo ON command or during deceleration and stop with the STO function enabled.	NR	Each axis	Dynamic stop	Coast to a stop
3	STO signal mismatch error	Input states of two STO signals were mismatched while the STO function is enabled.	NR	Each axis	Dynamic stop	Coast to a stop
15	Safety communication: Communication error 1	A receiving error was detected in the safety communication.	NR	Each axis	Dynamic stop	Coast to a stop
16	Safety communication: Initial communication error 1	A receiving error was detected in the initial communication for the safety communication.	PR	Each axis	Dynamic stop	Coast to a stop
17	Voltage diagnosis error	A power error was detected in the safety function.	NR	Each axis	Dynamic stop	Coast to a stop
19	DRAM diagnosis error	A DRAM error was detected in the safety function.	PR	Each axis	Dynamic stop	Coast to a stop
21	Control process error	An error was detected in the status of software execution for the safety function.	PR	Each axis	Dynamic stop	Coast to a stop
23	Safety encoder: Initial communication error 1	An error was detected in the initial communication with a safety encoder.	PR	Each axis	Initial error	Initial error
24	PCB error	A PCB error was detected in the safety function.	PR	Each axis	Initial error	Initial error
25	Synchronization error	A synchronization error was detected in the safety function.	PR	Each axis	Dynamic stop	Coast to a stop
26	Flash ROM diagnosis error	A Flash ROM error was detected in the safety function.	PR	Each axis	Initial error	Initial error
33	Safety encoder: Communication error 1	An error was detected in the communication with a safety encoder.	PR	Each axis	Dynamic stop	Coast to a stop
34	Safety encoder: Diagnosis error 1	A power supply voltage error was detected in the safety encoder.	PR	Each axis	Dynamic stop	Coast to a stop
35	Safety encoder: Diagnosis error 2	A H/W error was detected in the safety encoder.	PR	Each axis	Dynamic stop	Coast to a stop
36	Safety encoder: Diagnosis error 3	A process error was detected in the safety encoder.	PR	Each axis	Dynamic stop	Coast to a stop
37	Safety encoder: Diagnosis error 4	An A/D conversion error was detected in the safety encoder.	PR	Each axis	Dynamic stop	Coast to a stop
39	Non-safety encoder: Position feedback fixation diagnosis error	The position feedback from the non-safety encoder remains unchanged.	PR	Each axis	Dynamic stop	Coast to a stop
40	Safety encoder: Thermal error	The safety encoder detected a thermal error.	PR	Each axis	Dynamic stop	Coast to a stop
53	Safety communication: Transmission interval mismatch error	An error was detected in the transmission interval setting.	NR	Each axis	Initial error	Initial error
54	Safety communication: Initial communication error 2	A receiving error was detected in the initial communication for the safety communication.	NR	Each axis	Initial error	Initial error
55	Safety communication: Communication error 2	A receiving error was detected in the safety communication.	NR	Each axis	Dynamic stop	Coast to a stop
56	Safety parameter setting range error	A setting error was detected in the safety parameter.	PR	Each axis	Initial error	Initial error
57	Safety parameter combination error	A combination error was detected in the safety parameter.	PR	Each axis	Initial error	Initial error
65	Register diagnosis error	A register diagnosis error was detected in the safety function.	PR	Each axis	Initial error	Initial error

004D.xxx : Alarm number.Sub-number

Sub-No.	Name	Details	Reset method	Axis type	Servo stop method	Spindle stop method
66	Calculation device diagnosis error	An error was detected in the calculation device diagnosis for the safety function.	PR	Each axis	Initial error	Initial error
67	Sequence diagnosis error	An error was detected in the sequence diagnosis for the safety function.	PR	Each axis	Dynamic stop	Coast to a stop
68	Stack diagnosis error	An error was detected in the stack diagnosis for the safety function.	PR	Each axis	Dynamic stop	Coast to a stop
69	Temperature diagnosis error	Overheat was detected in the safety function.	NR	Each axis	Dynamic stop	Coast to a stop
71	Watchdog error	The safety function is not operating correctly.	PR	Each axis	Dynamic stop	Coast to a stop
72	Clock diagnosis error	An error was detected in the clock diagnosis for the safety function.	PR	Each axis	Dynamic stop	Coast to a stop
74	DO output compare error	An error was detected in the status of DO output for the safety function.	PR	Each axis	Dynamic stop	Coast to a stop
75	ISC communication error	An error was detected in the inter-system communication for the safety function.	PR	Each axis	Dynamic stop	Coast to a stop
78	Safety communication: Initial communication error 3	A receiving error was detected in the initial communication for the safety communication.	PR	Each axis	Dynamic stop	Coast to a stop
88	Safety circuit: STO error	An error was detected in the read-back diagnosis for STO.	PR	Each axis	Dynamic stop	Coast to a stop
91	Safety circuit: SBC error	An error was detected in the read-back diagnosis for SBC.	PR	Each axis	Dynamic stop	Coast to a stop
126	Safety communication: Communication error 3	A receiving error was detected in the safety communication.	PR	Each axis	Dynamic stop	Coast to a stop

(2) Power supply alarm

No.	Name	Details	Reset method
61	Power supply: Power module overcurrent	Overcurrent protection function in the power module has started its operation.	PR
62	Power supply: Frequency error	The input power supply frequency increased above the specification range.	PR
66	Power supply: Process error	An error occurred in the process cycle.	PR
67	Power supply: Phase interruption	An open-phase condition was detected in input power supply circuit.	PR
68	Power supply: Watchdog	The system does not operate correctly. LED display is fixed as "8".	AR
69	Power supply: Grounding	The motor power cable is in contact with FG (Frame Ground).	PR
6A	Power supply: External contactor welding	A contact of the external contactor is welding.	PR
6B	Power supply: Rush circuit error	An error was detected in the rush circuit.	PR
6C	Power supply: Main circuit error	An error was detected in charging operation of the main circuit capacitor.	PR
6D	Parameter setting error	An error was detected in the parameter sent from the drive unit.	PR
6E	Power supply: H/W error	An error was detected in the internal memory.	AR
	A/D error	An error was detected in the A/D converter.	
	Unit ID error	An error was detected in the unit identification.	
6F	Power supply error	No power supply is connected to the drive unit, or a communication error was detected.	AR (Note 4)
70	Power supply: External emergency stop error	A mismatch of the external emergency stop input and NC emergency stop input continued for 30 seconds.	PR
71	Power supply: Instantaneous power interruption	The power was momentarily interrupted.	NR
72	Power supply: Fan stop	A cooling fan built in the power supply unit stopped, and overheat occurred in the power module.	PR
73	Power supply: Over regeneration	Over-regeneration detection level became over 100%. The regenerative resistor is overloaded. This alarm cannot be reset for 15 min from the occurrence to protect the regeneration resistor. Leave the drive system energized for more than 15 min, then turn the power ON to reset the alarm.	NR
74	Power supply: Option unit error	An alarm was detected in the power backup unit (power supply option unit).	NR (Note 3)
75	Power supply: Overvoltage	L+ and L- bus voltage in main circuit exceeded the allowable value. As the voltage between L+ and L- is high immediately after this alarm, another alarm may occur if this alarm is reset in a short time. Wait more than 5 min before resetting so that the voltage drops.	NR
	Power supply: Function setting error	The rotary switch setting of external emergency stop is not correct, or a wrong external emergency stop signal is input.	
76	Power supply: Function selection error	Undefined area for the rotary switch is selected	AR
	Power supply: Power module overheat	Thermal protection function in the power module has started its operation.	
77	Power supply: Power module overheat	Thermal protection function in the power module has started its operation.	PR

(Note 1) If a power supply alarm (60 to 77) occurs, all servos will stop with the dynamic brakes, and all spindles will coast to a stop.

(Note 2) "b", "C" and "d" displayed on the power supply unit's LED as a solid light (not flickering) do not indicate an alarm.

(Note 3) Check the LED display of the power backup unit to identify what alarm is occurring to the power backup unit.

**Refer to MDS-E/EH Series Instruction Manual (IB-1501229) "List of Power Backup Function Alarms".

(Note 4) When the power supply alarm (6F) is detected in the 2nd part system, the reset method differs depending on the detected power supply alarm.

7.2.2 List of Warnings

When a warning occurs, a warning No. will appear on the NC monitor screen and with the LEDs on the front of the drive unit. Check the warning No., and remove the cause of the warning by following this list.

(1) Drive unit warning

No.	Name	Details	Reset method	Stop method
96	Scale feedback error	An excessive difference in feedback amount was detected between the main side encoder and the MPI scale in MPI scale absolute position detection system.	*	-
97	Scale offset error	An error was detected in the offset data that is read at the NC power-ON in MPI scale absolute position detection system.	PR	-
9B	Incremental encoder/ magnetic pole shift warning	The difference between the magnetic pole position after the phase Z has been passed (magnetic pole shift amount:SV028) and the initially detected position is excessive in the built-in motor's incremental control system. The magnetic pole is controlled by the initial detection value.	PR	-
9E	Absolute position encoder: Revolution counter error	An error was detected in the revolution counter data of the absolute position encoder. The accuracy of absolute position is not guaranteed.	*	-
9F	Battery voltage drop	The battery voltage to be supplied to the absolute position encoder is dropping.	NR	-
A3	In initial setup of ABS position	This warning is detected until the axis reaches the reference position during the initial setup of the distance-coded reference check function. This warning turns OFF after the axis has reached the position, thus set the value displayed on the drive monitor to the parameter.	PR	-
A4	Dual signal warning	An input was detected in the signal related to the dual signal. Refer to "Dual signal warning (A4)" for details.	*	-
A6	Fan stop warning	A cooling fan in the drive unit stopped.	*	-
E0	Overregeneration warning	Over-regeneration detection level exceeded 80%.	*	-
E1	Overload warning	A level of 80% of the Overload 1 alarm state was detected.	*	-
E4	Parameter warning	An incorrect set value was detected among the parameters send from the NC in the normal operation.	*	-
E6	Control axis detachment warning	A control axis is being detached. (State display)	*	-
E7	NC emergency stop	In NC emergency stop. (State display)	*	Dec stop enabled
E8 to EF	Power supply warning	The power supply unit detected a warning. The error details are different according to the connected power supply unit. Refer to "Power supply warning".	*	- *EA: Dec stop enabled

(Note1) Definitions of terms in the table are as follows.

Main side encoder: Encoder connected to CN2

Sub side encoder: Encoder connected to CN3

(Note 2) Resetting methods

* : Automatically reset once the cause of the warning is removed.

NR: Reset with the NC RESET button. This warning can also be reset with the PR and AR resetting conditions.

PR: Reset by turning the NC power ON again. This warning can also be reset with the AR resetting conditions. When the control axis is removed, this warning can be reset with the NC RESET button. (Excluding warning 93.)

AR: Reset by turning the NC and servo drive unit power ON again.

(Note 3) Servo and spindle motor do not stop when the warning occurs.

(Note 4) When an emergency stop is input, servo and spindle motor decelerate to a stop. (When SV048, SV055 or SV056 is set for servo and when SP055 or SP056 is set for spindle.)

Dual signal warning (A4)

No.	Name	Sub info	Details
00A4.00	Dual signal warning	Axis name	The system has been set in the STO state. The STO state is also entered at the time of emergency stop, but in this case, this warning will not appear because the emergency stop has priority.

(2) Power supply warning

No.	Name	Details	Reset method
E9	Instantaneous power interruption warning	The power was momentarily interrupted.	NR
EA	In external emergency stop state	External emergency stop signal was input.	*
EB	Power supply: Over regeneration warning	Over-regeneration detection level exceeded 80%.	*
EE	Power supply: Fan stop warning	A cooling fan built in the power supply unit stopped.	*
EF	Power supply: Option unit warning	A warning was detected in the power backup unit (power supply option unit).	*(Note 3)

(Note 1) Resetting methods

* : Automatically reset once the cause of the warning is removed.

NR: Reset with the NC RESET button. This warning can also be reset with the PR and AR resetting conditions.

PR: Reset by turning the NC power ON again. This warning can also be reset with the AR resetting conditions. When the control axis is removed, this warning can be reset with the NC RESET button. (Excluding warning 93.)

AR: Reset by turning the NC and servo drive unit power ON again.

(Note 2) Servo and spindle motor do not stop when the warning occurs.

(Note 3) Check the LED display of the power backup unit to identify what warning is occurring to the power backup unit.

**Refer to MDS-E/EH Series Instruction Manual (IB-1501229) "List of Power Backup Function Warnings".

7.3 Troubleshooting

Follow this section to troubleshoot the alarms that occur during start up or while the machine is operating. If the state is not improved with the following investigations, the drive unit may be faulty. Exchange the unit with another unit of the same capacity, and check whether the state is improved.

7.3.1 Troubleshooting at Power ON

If the NC system does not start up correctly and a system error occurs when the NC power is turned ON, the drive unit may not have been started up properly. Check the LED display on the drive unit, and take measures according to this section.

LED display	Symptom	Cause of occurrence	Investigation method	Remedy
AA	Initial communication with the CNC was not completed correctly.	The drive unit axis No. setting is incorrect.	Is there any other drive unit that has the same axis No. set?	Set correctly.
		The CNC setting is incorrect.	Is the No. of CNC controlled axes correct?	Set correctly.
		Communication with CNC is incorrect.	Is the connector (CN1A, CN1B) connected?	Connect correctly.
Is the cable broken?	Replace the cable.			
Ab	Initial communication with the CNC was not carried out.	The axis is not used, the setting is for use inhibiting.	Is the DIP switch set correctly?	Set correctly.
		Communication with CNC is incorrect.	Is the connector (CN1A, CN1B) connected?	Connect correctly.
			Is the cable broken?	Replace the cable.
12	An error was detected in the unit's memory and IC during the self-diagnosis at power ON.	The CPU peripheral circuit is abnormal.	Check the repeatability.	Replace the unit.
			Check whether there is any abnormality with the unit's surrounding environment, etc.	Improve the surrounding environment.

7.3.2 Troubleshooting for Each Alarm No.

Alarm No. 10		Insufficient voltage			
		Insufficient bus voltage was detected in main circuit.			
	Investigation details	Investigation results	Remedies	SV	SP
1	Check the timing when the alarm occurs.	The moment of READY ON	Check the investigation item No. 2.	○	○
		During operation	Increase the power supply capacity (KVA).		
2	Did the external contactor turn ON at the READY ON?	The external contactor did not turn ON.	Check the investigation item No. 3.	○	○
		The external contactor turned ON, but the alarm occurred immediately.	Check the investigation item No. 4.		
3	Check the wiring of contactor excitation circuit.	The wiring is correct.	Replace the contactor.	○	○
		The wiring is not correct.	Rewire.		
4	Check the input voltage of the drive unit by a tester. (Voltage between L1 and L2, L2 and L3, L1 and L3)	The input voltage is normal.	Replace the drive unit.	○	○
		The input voltage is abnormal.	Increase the power supply capacity (KVA).		
		The measured voltage fluctuates.	Replace the power supply.		

Alarm No. 11		Axis selection error			
		The axis selection rotary switch is incorrectly set.			
	Investigation details	Investigation results	Remedies	SV	SP
1	Check the setting of the axis selection switch (rotary switch) on the top of the unit.	The same axis No. is set for the L and M axes.	Correctly set the axis No. 0 = No. 1 axis, 1 = No. 2 axis, ...	○	○
		The value is duplicated with other axis.	Correctly set the axis No. 0 = No. 1 axis, 1 = No. 2 axis, ...		
		The axis No. is correctly set.	Replace the drive unit.		

Alarm No. 12		Memory error 1			
		Hardware error (a CPU or an internal memory error was detected during the power ON self-check).			
	Investigation details	Investigation results	Remedies	SV	SP
1	Check the repeatability.	The error is always repeated.	Replace the drive unit.	○	○
		The state returns to normal once, but occurs sometimes thereafter.	Check the investigation item No. 2.		
2	Check if there is any abnormality in the unit's ambient environment. (Ex. Ambient temperature, noise, grounding)	Take remedies according to the causes of the abnormality in the ambient environment.		○	○

Alarm No. 13		Software processing error 1			
		An error was detected in the software execution state. Software processing has not finished within the specified time.			
	Investigation details	Investigation results	Remedies	SV	SP
1	Check the repeatability.	The error is always repeated.	Replace the drive unit.	○	○
		The state returns to normal once, but occurs sometimes thereafter.	Check the investigation item No. 2.		
2	Check if there is any abnormality in the unit's ambient environment. (Ex. Ambient temperature, noise, grounding)	Take remedies according to the causes of the abnormality in the ambient environment. [1] Machine grounding check		○	○

Alarm No. 14		Software processing error 2			
		The current processor is not operating correctly.			
	Investigation details	Investigation results	Remedies	SV	SP
1	Check the repeatability.	The error is always repeated.	Replace the drive unit.	○	○
		The state returns to normal once, but occurs sometimes thereafter.	Check the investigation item No. 2.		
2	Check if there is any abnormality in the unit's ambient environment. (Ex. Ambient temperature, noise, grounding)	Take remedies according to the causes of the abnormality in the ambient environment.		○	○

7 Troubleshooting

Alarm No. 16		Initial magnetic pole position detection error			
		In linear motor or IPM spindle motor using absolute position encoder, the servo ON has been set before the magnetic pole shift amount(servo:SV028,spindle:SP118) is set. In the initial magnetic pole position detection control, the pole position was not correctly set.			
	Investigation details	Investigation results	Remedies	SV	SP
1	Check the parameters, SV028 (for the servo) and SP118(for the spindle).	The parameters have not been set.	Set the magnetic shift pole amount(SP118).	○	○
		The parameters have been set, but the alarm occurs.	Carry out the magnetic pole estimation again, as the setting value is wrong.		
		The setting parameter value is the same even when initial magnetic pole function was executed again.	Check the investigation item No. 2.		
2	Check the repeatability.	The error is always repeated.	Replace the drive unit.	○	○
		The state returns to normal once, but occurs sometimes thereafter.	Check the investigation item No. 3.		
3	Check if there is any abnormality in the unit's ambient environment. (Ex. Ambient temperature, noise, grounding)	Take remedies according to the causes of the abnormality in the ambient environment. [1] Machine grounding check [2] Shield connection of the cable		○	○

Alarm No. 17		A/D converter error			
		An error was detected in the current FB.			
	Investigation details	Investigation results	Remedies	SV	SP
1	Check the repeatability.	The error is always repeated.	Replace the drive unit.	○	○
		The state returns to normal, but occurs thereafter.	Check the investigation item No. 2.		
2	Check if there is any abnormality in the unit's ambient environment. (Ex. Ambient temperature, noise, grounding)	Take remedies according to the causes of the abnormality in the ambient environment.		○	○

Alarm No. 18		Main side encoder: Initial communication error			
		An error was detected in the initial communication with the motor side encoder.			
	Investigation details	Investigation results	Remedies	SV	SP
1	Check the encoder. Check if a pulse encoder is used for serial encoder specifications.	The pulse encoder is used.	Replace the encoder to the serial.	○	○
		The serial encoder is used.	Check the investigation item No. 2.		
2	Jiggle the encoder connectors (drive unit side and encoder side) and check if they are disconnected.	The connector is disconnected (or loose).	Correctly install.	○	○
		The connector is not disconnected.	Check the investigation item No. 3.		
3	Turn the power OFF, and check the encoder cable connection with a tester.	The connection is faulty.	Replace the encoder cable.	○	○
		The connection is normal.	Check the investigation item No. 4.		
4	Replace with another unit, and check whether the fault is on the unit side or encoder side.	The alarm is on the drive unit side.	Replace the drive unit.	○	○
		The alarm is on the encoder side.	Check the investigation item No. 5.		
5	Check if there is any abnormality in the encoder's ambient environment. (Ex. Ambient temperature, noise, grounding)	Take remedies according to the causes of the abnormality in the ambient environment. [1] Machine grounding check [2] Shield connection of the cable		○	○

Alarm No. 19		Encoder communication error in synchronous control:			
		An error was detected in the machine side encoder of the secondary axis at the speed command synchronization control.			
	Investigation details	Investigation results	Remedies	SV	SP
1	Check the servo parameter value of secondary axis (SV025.pen:position encoder).	The value is not set correctly.	Correctly set.	○	
		The value is set correctly.	Check the investigation item No. 2.		
2	Check if there are no problems in the connection between the encoder (linear scale) and MDS-EX-HR.	The screw connected to MDS-EX-HR is winded down.	Tighten up the screw.	○	
		No problems found in the connector connection.	Check the investigation item No. 3.		
3	Jiggle the encoder connectors (drive unit side and encoder side) and check if they are disconnected.	The connector is disconnected (or loose).	Correctly install.	○	
		The connector is not disconnected.	Check the investigation item No. 3.		
4	Turn the power OFF, and check the encoder cable connection with a tester.	The connection is faulty.	Replace the encoder cable.	○	
		The connection is normal.	Check the investigation item No. 4.		
5	Replace with another unit, and check whether the fault is on the unit side or encoder side.	The alarm is on the drive unit side.	Replace the drive unit.	○	
		The alarm is on the encoder side.	Check the investigation item No. 5.		
6	Check if there is any abnormality in the encoder's ambient environment. (Ex. Ambient temperature, noise, grounding)	Take remedies according to the causes of the abnormality in the ambient environment. [1] Machine grounding check [2] Shield connection of the cable		○	

7 Troubleshooting

Alarm No. 1A		Sub side encoder: Initial communication error			
		Initial communication with the machine side encoder failed.			
	Investigation details	Investigation results	Remedies	SV	SP
1	Check the servo parameter (SV025.pen:position encoder) setting value. Check the spindle parameter(SP019) setting value. Are the serial communication type encoder parameters set for the pulse type encoder?	The value is not set correctly.	Correctly set SV025.	○	○
		The value is set correctly.	Check the investigation item No. 2.		
2	Check the encoder. Check if the pulse encoder is used for the encoder specified to be serial.	The pulse encoder is used.	Replace the encoder.	○	○
		The serial encoder is used.	Check the investigation item No. 3.		
3	Jiggle the encoder connectors (drive unit side and encoder side) and check if they are disconnected.	The connector is disconnected (or loose).	Correctly install.	○	
		The connector is not disconnected.	Check the investigation item No. 4.		
4	Turn the power OFF, and check the encoder cable connection with a tester.	The connection is faulty.	Replace the encoder cable.	○	
		The connection is normal.	Check the investigation item No. 5.		
5	Replace with another unit, and check whether the fault is on the unit side or encoder side.	The alarm is on the drive unit side.	Replace the drive unit.	○	
		The alarm is on the encoder side.	Check the investigation item No. 6.		
6	Check if there is any abnormality in the encoder's ambient environment. (Ex. Ambient temperature, noise, grounding)	Take remedies according to the causes of the abnormality in the ambient environment.		○	

Alarm No. 1B		Sub side encoder: Error 1			
		The machine side encoder (CN3 side) detected an error. As details differ for each encoder, refer to section "Encoder alarm".			
	Investigation details	Investigation results	Remedies	SV	SP
1	Check whether the servo axis has moved and the spindle has rotated when an alarm occurred.	The axis has operated.	Check the investigation item No. 3.	○	○
		The axis has not operated.	Check the investigation item No. 2.		
2	Check whether the operation at low speed is normal.	The operation is normal.	Check the investigation item No. 3.	○	○
		The operation is not normal.	Check the cautions at power ON. [1] Wiring check [2] Parameter check		
3	Jiggle the encoder connectors (drive unit side and encoder side) and check if they are disconnected.	The connector is disconnected (or loose).	Correctly install.	○	○
		The connector is not disconnected.	Check the investigation item No. 4.		
4	Turn the power OFF, and check the encoder cable connection with a tester.	The connection is faulty.	Replace the encoder cable.	○	○
		The connection is normal.	Check the investigation item No. 5.		
5	Replace with another unit, and check whether the fault is on the unit side or encoder side.	The alarm is on the drive unit side.	Replace the drive unit.	○	○
		The alarm is on the encoder side.	Check the investigation item No. 6.		
6	Check if there is any abnormality in the encoder's ambient environment. (Ex. Ambient temperature, noise, grounding)	Take remedies according to the causes of the abnormality in the ambient environment.		○	○

Alarm No. 1C		Sub side encoder: Error 2			
		The machine side encoder (CN3 side) detected an error. As details differ for each encoder, refer to section "Encoder alarm".			
	Investigation details	Investigation results	Remedies	SV	SP
1	Check the alarm No. "1B" items.			○	

Alarm No. 1D		Sub side encoder: Error 3			
		The machine side encoder (CN3 side) detected an error. As details differ for each encoder, refer to section "Encoder alarm".			
	Investigation details	Investigation results	Remedies	SV	SP
1	Check the alarm No. "1B" items.			○	

Alarm No. 1E		Sub side encoder: Error 4			
		The machine side encoder (CN3 side) detected an error. As details differ for each encoder, refer to section "Encoder alarm".			
	Investigation details	Investigation results	Remedies	SV	SP
1	Check the alarm No. "1B" items.			○	

7 Troubleshooting

Alarm No. 1F		Sub side encoder: Communication error			
		An error was detected in communication data with the linear scale or the ball screw side encoder. Or the communication was interrupted.			
	Investigation details	Investigation results	Remedies	SV	SP
1	Jiggle the encoder connectors (drive unit side and encoder side) and check if they are disconnected.	The connector is disconnected (or loose). The connector is not disconnected.	Correctly install. Check the investigation item No. 2.	<input type="radio"/>	
2	Is the encoder cable wired in the same conduit as the motor's power cable, or are the two cables laid in parallel near each other?	The cables are wired near each other. (Noise is entering from the power cable.) The wires are sufficiently separated.	Wire the encoder cable away from the power cable. Shield the power cable. Check the investigation item No. 3.	<input type="radio"/>	
3	Is the motor FG wire connected only to the drive unit which drives it? (Is the motor grounded to one point?)	The motor FG wire is grounded on the motor side. The motor is grounded to one point.	Ground the motor to one point, connecting the wires together on the drive unit side. Check the investigation item No. 4.	<input type="radio"/>	
4	Turn the power OFF, and check the encoder cable connection with a tester. (Is the cable shielded?)	The connection is faulty. The connection is normal.	Replace the encoder cable. Check the investigation item No. 5.	<input type="radio"/>	
5	Replace with another unit, and check whether the fault is on the unit side or encoder side.	The alarm is on the drive unit side. The alarm is on the encoder side.	Replace the drive unit. Check the investigation item No. 6.	<input type="radio"/>	
6	Check if there is any abnormality in the encoder's ambient environment. (Ex. Ambient temperature, noise, grounding)	Take remedies according to the causes of the abnormality in the ambient environment.		<input type="radio"/>	

Alarm No. 21		Sub side encoder: No signal2			
		When an excessive error alarm occurred, no signal from the machine side encoder was detected. An error was detected in the ABZ-phase in the full closed loop control system.			
	Investigation details	Investigation results	Remedies	SV	SP
1	Check the servo parameter (SV025. pen: machine side encoder), and spindle parameter (SP019) setting value. Are the pulse type encoder parameters set for a serial communication type encoder?	The value is not set correctly. The value is set correctly.	Correctly set SV025.pen for the servo and SP019 for the spindle (including SP097 for pulse type). Check the investigation item No. 3.	<input type="radio"/>	<input type="radio"/>
2	Jiggle the encoder connectors (drive unit side and encoder side) and check if they are disconnected.	The connector is disconnected (or loose). The connector is not disconnected.	Correctly install. Check the investigation item No. 4.	<input type="radio"/>	<input type="radio"/>
3	Turn the power OFF, and check the encoder cable connection with a tester.	The connection is faulty. The connection is normal.	Replace the encoder cable. Check the investigation item No. 5.	<input type="radio"/>	<input type="radio"/>
4	Replace with another unit, and check whether the fault is on the unit side or encoder side.	The alarm is on the drive unit side. The alarm is on the encoder side.	Replace the drive unit. Replace the encoder.	<input type="radio"/>	<input type="radio"/>
5	Check if there is any abnormality in the encoder's ambient environment. (Ex. Ambient temperature, noise, grounding)	Take remedies according to the causes of the abnormality in the ambient environment.		<input type="radio"/>	<input type="radio"/>

Alarm No. 22		Encoder data error:			
		Drive unit received a wrong feedback data (scattered data) from the encoder and position deviation occurred.			
	Investigation details	Investigation results	Remedies	SV	SP
1	Check if the installation of the encoder is loosened.	It is loosened. It is not loosened.	Tightly install the encoder. Check the investigation item No. 2.	<input type="radio"/>	
2	Check if an excessive vibration is occurring during machining.	An excessive vibration is occurring. An excessive vibration is not occurring.	Check the installation of the machine. Check the investigation item No. 3.	<input type="radio"/>	
3	Check if there is any liquid ingress inside the encoder connector.	Liquid was entered into the connector. No liquid ingress.	Replace the motor encoder. Check the investigation item No. 4.	<input type="radio"/>	<input type="radio"/>
4	Check the investigation item No.2 or subsequent items in Alarm No.21.			<input type="radio"/>	

7 Troubleshooting

Alarm No. 23		Excessive speed error			
		A difference between the speed command and speed feedback was continuously exceeding 50 r/min for longer than the setting time.			
	Investigation details	Investigation results	Remedies	SV	SP
1	Check the U, V and W wiring connected to the spindle drive unit.	The wires are not correctly connected.	Correctly connect.		○
		The wires are correctly connected.	Check the investigation item No. 2.		
2	Check the spindle parameter SP020, SP026, SP027, from SP057 to SP064 and spindle specification parameters from slimit1 to slimit4 setting value.	The correct values are not set.	Correctly set.		○
		The correct values are set.	Check the investigation item No. 3.		
3	Measure the acceleration/ deceleration time from 0 to the point where the spindle speed reaches its maximum. If the alarm occurs when forward run is changed to reverse run, measure the acceleration/ deceleration time from the forward to reverse. Also measure it from the reverse to forward.	12sec or more. (SP117 setting value or more.)	Increase the spindle acceleration/ deceleration time constant setting value(sp_t1 to sp_t4). Reduce the load inertia.		○
		Less than 12sec.	Check the investigation item No. 4.		
4	Check the load amount when the alarm occurred during cutting.	The speed deterioration due to load amount has exceeded the tolerable range which is determined by the parameter SP096. -If SP096 is set to 0, it is regarded as 85%. Thus a speed of 85% of the machining speed or faster will be the tolerable speed.	Reduce the cutting load to mitigate the speed deterioration. Replace the tool.		○
		The load amount is within the SP096 setting value.	Check the investigation item No. 5.		
5	Check the fluctuation of the input voltage into the power supply unit with a tester.	Voltage drop during acceleration is 200V or less	Review the power supply capacity.		○
		Voltage drop during acceleration is 200V or more	Check the investigation item No.6.		
6	Check the capacity of the drive unit.	The capacity does not satisfy the motor output.	Change the capacity to the selected one.		○
		The capacity satisfies the motor output.	Replace the unit.		

Alarm No. 24		Grounding			
		The motor power cable is in contact with FG (Frame Ground).			
	Investigation details	Investigation results	Remedies	SV	SP
1	Measure the insulation across the power cables (U,V,W) for connected motors and the ground. (Carry out a megger test.) (Note) When the insulation is measured, disconnect wires from the drive unit.	Less than 1MΩ. (Grounding)	The motor or power cable may be ground faulted.	○	○
		1MΩ or more. (Normal)	Check the investigation item No. 2.		
2	Has oil adhered on the motor or power cable?	Oil has come adhered.	Take measures so that oil does not come in contact. Check the motor's cannon connector and the inside of the terminal box, and clean as necessary.	○	○
		Oil has not adhered.	Check the investigation item No. 3.		
3	Measure the insulation again.	Less than 1MΩ.	Replace the motor or cable.	○	○
		1MΩ or more.	Check the investigation item No. 4.		
4	Measure the resistance across the U, V, W phase terminals of the servo/spindle drive unit and the ground with a tester. (Note) Do not measure the insulation as the unit is damaged.	Less than 100kΩ.	Replace the drive unit.	○	○
		100kΩ or more.	Replace the power supply unit.		

Alarm No. 25		Absolute position data lost			
		The absolute position was lost, as the backup battery voltage dropped in the absolute position encoder.			
	Investigation details	Investigation results	Remedies	SV	SP
1	Is warning 9F occurring at the same time?	The warning is occurring.	Check the investigation item No. 2.	○	
		The warning is not occurring.	Check the investigation item No. 3.		
2	Measure the battery voltage with a tester at the DC range.	Less than 3V.	Replace the battery, and establish the zero point.	○	
		3V or more.	Check the NC bus cable connection.		
3	Did alarm No.18 occur when the power was turned ON the last time?	Alarm No.18 occurred.	Turn the drive unit control power ON again, and establish the zero point.	○	
		Alarm No.18 did not occur.	Check the investigation item No. 4.		
4	Was the encoder cable or battery cable left disconnected from the unit for a long time?	The unit was left disconnected for a long time. Guide at delivery: 20 hours or more After 5 years: 10 hours or more	Turn the drive unit control power ON again, and establish the zero point.	○	
		The cables were not left disconnected.	Check the investigation item No. 5.		
5	Check the encoder cable or battery cable connection with a tester.	The connection is faulty.	Replace the cable.	○	
		The connection is normal.	Replace the drive unit.		

7 Troubleshooting

Alarm No. 26		Unused axis error			
A power module error occurred in the axis whose axis No. selection switch was set to "F" (free axis).					
	Investigation details	Investigation results	Remedies	SV	SP
1	Check the repeatability.	The error is always repeated. The state returns to normal once, but occurs sometimes thereafter.	Replace the drive unit. Check the investigation item No. 2.	<input type="radio"/>	<input type="radio"/>
2	Check if there is any abnormality in the unit's ambient environment. (Ex. Ambient temperature, noise, grounding)	Take remedies according to the causes of the abnormality in the ambient environment.		<input type="radio"/>	<input type="radio"/>

Alarm No. 27		Sub side encoder: Error 5			
The machine side encoder (CN3 side) detected an error. As details differ for each encoder, refer to section "Encoder alarm".					
	Investigation details	Investigation results	Remedies	SV	SP
1	Check the alarm No. "1B" items.			<input type="radio"/>	

Alarm No. 28		Sub side encoder: Error 6			
The machine side encoder (CN3 side) detected an error. As details differ for each encoder, refer to section "Encoder alarm".					
	Investigation details	Investigation results	Remedies	SV	SP
1	Check the alarm No. "1B" items.			<input type="radio"/>	

Alarm No. 29		Sub side encoder: Error 7			
The machine side encoder (CN3 side) detected an error. As details differ for each encoder, refer to section "Encoder alarm".					
	Investigation details	Investigation results	Remedies	SV	SP
1	Check the alarm No. "1B" items.			<input type="radio"/>	

Alarm No. 2A		Sub side encoder: Error 8			
The machine side encoder (CN3 side) detected an error. As details differ for each encoder, refer to section "Encoder alarm".					
	Investigation details	Investigation results	Remedies	SV	SP
1	Check the alarm No. "1B" items.			<input type="radio"/>	

Alarm No. 2B		Main side encoder: Error 1			
The motor side encoder (CN2 side) detected an error. (Note) It includes the linear scale in the case of linear motor. As details differ for each encoder, refer to section "Encoder alarm".					
	Investigation details	Investigation results	Remedies	SV	SP
1	Check the alarm No. "1B" items.			<input type="radio"/>	<input type="radio"/>

Alarm No. 2C		Main side encoder: Error 2			
The motor side encoder (CN2 side) detected an error. (Note) It includes the linear scale in the case of linear motor. As details differ for each encoder, refer to section "Encoder alarm".					
	Investigation details	Investigation results	Remedies	SV	SP
1	Check the alarm No. "1B" items.			<input type="radio"/>	<input type="radio"/>

Alarm No. 2D		Main side encoder: Error 3			
The motor side encoder (CN2 side) detected an error. (Note) It includes the linear scale in the case of linear motor. As details differ for each encoder, refer to section "Encoder alarm".					
	Investigation details	Investigation results	Remedies	SV	SP
1	Check the alarm No. "1B" items.			<input type="radio"/>	<input type="radio"/>

7 Troubleshooting

Alarm No.	Main side encoder: Error 4				
	The motor side encoder (CN2 side) detected an error. (Note) It includes the linear scale in the case of linear motor. As details differ for each encoder, refer to section "Encoder alarm".				
	Investigation details	Investigation results	Remedies	SV	SP
1	Check the alarm No. "1B" items.			<input type="radio"/>	<input type="radio"/>

Alarm No.	Main side encoder: Communication error				
	An error was detected in communication data with the motor side encoder or with the linear scale of a linear servo system. Or the communication was interrupted.				
	Investigation details	Investigation results	Remedies	SV	SP
1	Jiggle the encoder connectors (drive unit side and encoder side) and check if they are disconnected.	The connector is disconnected (or loose). The connector is not disconnected.	Correctly install. Check the investigation item No. 2.	<input type="radio"/>	<input type="radio"/>
2	Is the encoder cable wired in the same conduit as the motor's power cable, or are the two cables laid in parallel near each other?	The cables are wired near each other. (Noise is entering from the power cable.) The wires are sufficiently separated.	Improve the cable wiring. Check the investigation item No. 3.	<input type="radio"/>	<input type="radio"/>
3	Is the motor FG wire connected only to the drive unit which drives it? (Is the motor grounded to one point?)	The motor FG wire is grounded on the motor side. The motor is grounded to one point.	Ground the motor to one point, connecting the wires together on the drive unit side. Check the investigation item No. 4.	<input type="radio"/>	<input type="radio"/>
4	Turn the power OFF, and check the encoder cable connection with a tester. (Is the cable shielded?)	The connection is faulty. The connection is normal.	Replace the encoder cable. Check the investigation item No. 5.	<input type="radio"/>	<input type="radio"/>
5	Replace with another unit, and check whether the fault is on the unit side or encoder side.	The alarm is on the drive unit side. The alarm is on the encoder side.	Replace the drive unit. Check the investigation item No. 6.	<input type="radio"/>	<input type="radio"/>
6	Check if there is any abnormality in the encoder's ambient environment. (Ex. Ambient temperature, noise, grounding)	Take remedies according to the causes of the abnormality in the ambient environment.		<input type="radio"/>	<input type="radio"/>

Alarm No.	Over regeneration:				
	Over-regeneration detection level became over 100%. The regenerative resistor is overloaded.				
	Investigation details	Investigation results	Remedies	SV	SP
1	Check if the regenerative capacity exceeds the regenerative resistor tolerable capacity.	The regenerative capacity exceeds the regenerative resistor tolerable capacity. The regenerative resistor selection is appropriate.	Add the option regenerative resistor or replace it. Check the investigation item No. 2.	<input type="radio"/>	<input type="radio"/>
2	Check if the parameter is set incorrectly, and check the values of sv036 and sp032.	The parameters are set incorrectly. The parameters are correct.	Change the parameters. Check the investigation item No. 3.	<input type="radio"/>	<input type="radio"/>
3	Is an external regenerative resistor used?	An external regenerative resistor is used. A built-in regenerative resistor is used.	Check the investigation item No. 5. Check the investigation item No. 4.	<input type="radio"/>	
4	Is the short wire connected between P and D terminal? Are there any problems with the connection condition?	The wire is not connected. The connector is disconnected. The connector has a contact fault.	Connect the wire. Reconnect the connector. Replace the connector.	<input type="radio"/>	
5	Is the connection of the regenerative resistor or regeneration resistor cable correct?	The connection is incorrect. The connection is correct.	Rewire. Check the investigation item No. 6.	<input type="radio"/>	<input type="radio"/>
6	Is the regeneration resistor or the regeneration resistor cable broken? Disconnect the regenerative resistor terminal and check the resistance value with a tester.	The regeneration resistor is broken. Or the resistance value is large. The regeneration resistor cable is broken. The resistance value is normal.	Replace the regenerative resistor. Replace the cable. Check the investigation item No. 7.	<input type="radio"/>	<input type="radio"/>
7	Check if the power supply voltage is too high.	The power supply voltage exceeded 253V. The power supply voltage is normal.	Review the power supply. Replace the drive unit.	<input type="radio"/>	<input type="radio"/>

7 Troubleshooting

Alarm No. 31		Overspeed			
		The motor was detected to rotate at a speed exceeding the allowable speed (In the case of linear motor, it was detected to move at a speed exceeding the allowable speed).			
	Investigation details	Investigation results	Remedies	SV	SP
1	Check if the unit in which the alarm was detected is servo or spindle.	The alarm was detected in servo.	Check the investigation item No. 2.	○	○
		The alarm was detected in spindle.	Check the investigation item No. 3.		
2	Check the servo parameters SV001 (PC1), SV002 (PC2), SV018 (PIT) and SV025 (MTYP) settings.	The settings are incorrect.	Correctly set.	○	
		Correctly set.	Check the investigation item No. 5.		
3	Check the spindle parameter SP026 (TSP) setting.	The setting is incorrect. The alarm is detected at the speed that exceeds the SP026 setting value.	Correctly set.		○
		Correctly set.	Check the investigation item No. 4.		
4	Check the PLG output waveform.	There is a problem.	Adjust the PLG output waveform.	○	○
		Normal.	Check the investigation item No. 5.		
5	Check whether the speed waveform is overshooting.	The waveform is overshooting.	Increase the acceleration/ deceleration time constant. Lower the load inertia.	○	○
		The waveform is not overshooting.	Check if there is any abnormality in the unit's ambient environment. (Ex.: Ambient temperature, noise, grounding) Check the investigation item No. 6.		
6	Check the repeatability.	[1] The alarm occurs when the motor is stopped. [2] The rotation speed displayed on the drive monitor varies when the motor is stopped.	Replace the encoder or encoder cable.	○	○
		The alarm occurs at all time.	Replace the drive unit.		

Alarm No. 32		Power module overcurrent			
		Overcurrent protection function in the power module has started its operation.			
	Investigation details	Investigation results	Remedies	SV	SP
1	Disconnect the power cable (U, V, W) from the unit's terminal block and motor, and check whether a short-circuit between the power cable or whether conduction at both end of wiring occurs with a tester.	[1] Before disconnecting the power cable, the cable connector or screw has been loosened.	[1] Tighten it. [2] Check the motor wiring. [3] Replace the power cable.	○	○
		[2] The short-circuit condition persists even after disconnecting the cable from the unit and motor.			
		There is no problem.	Check the investigation item No. 2.		
2	Check the motor insulation with a (megger) tester. -Between motor power and ground earth Check the unit capacity. [1] The same size but smaller than the selected capacity. [2] The combination of the motor and axis is alternated in a 2-axis unit.	Less than 1MΩ. (Grounding)	Replace the motor.	○	○
		1MΩ or more. (Normal)	Check the investigation item No. 3.		
		The capacity is small. The smaller capacity side was used in 2-axis unit.	Replace to the unit of the selected capacity or change the axis.		
3	Check the current loop gain parameters.	Different from the standard parameter settings.	Adjust the value to the standard setting.	○	○
		Equivalent to the standard parameter settings.	Check the investigation item No. 4.		
4	Jiggle the encoder connectors (drive unit side and encoder side) and check if they are disconnected.	The connector is disconnected (or loose).	Correctly install.	○	○
		The connector is not disconnected.	Check the investigation item No. 5.		
5	Turn the power OFF, and check the encoder cable connection with a tester.	Connection is faulty.	Replace the encoder cable.	○	○
		Connection is normal.	Check the investigation item No. 6.		
6	Check the repeatability.	The state returns to normal once, but occurs sometimes thereafter.	Check the investigation item No. 8.	○	○
		The error is always repeated.	Check the investigation item No. 7.		
7	Replace with another unit, and check whether the fault is on the drive unit side or encoder side.	The alarm is on the drive unit side.	Replace the drive unit.	○	○
		The alarm is on the encoder side.	Replace the encoder.		
8	Check for any abnormalities in the unit's ambient environment. (Ex.: Ambient temperature, noise, grounding)	Take remedies according to the causes of the abnormality in the ambient environment.		○	○

7 Troubleshooting

Alarm No. 33		Overvoltage:			
		The main circuit bus voltage exceeded the tolerable value.			
Investigation details		Investigation results	Remedies	SV	SP
1	Check the alarm No. "75" items.			<input type="radio"/>	<input type="radio"/>

Alarm No. 34		NC-DRV communication: CRC error			
		An error was detected in the data received from the CNC.			
Investigation details		Investigation results	Remedies	SV	SP
1	Gently shake the connectors of the optical cables by hand that link between NC and drive unit or between drive units to check for loosening and disconnection. Also check if an excessive force is not applied on them.	The connector is loose or nearly disconnected. The tab of the connector is damaged.	Correctly install. Replace the cable.	<input type="radio"/>	<input type="radio"/>
		The connector is not disconnected.	Check the investigation item No. 2.		
2	Check for damages at the ends of the optical communication cable. Replace the cable.	The damage is found at the end of the cable.	Replace the communication cable.	<input type="radio"/>	<input type="radio"/>
		The connection is normal.	Check the investigation item No. 3.		
3	Check whether the NC or drive unit software version was changed recently.	The version was changed.	Change software version back to the original.	<input type="radio"/>	<input type="radio"/>
		The version was not changed.	Check the investigation item No. 4.		
4	Replace with another drive unit, and check whether the fault is on the NC side or drive unit side.	The alarm is on the drive unit side.	Replace the drive unit.	<input type="radio"/>	<input type="radio"/>
		The alarm is on the unit connections.	Check the investigation item No. 5.		
5	Check if there is any abnormality in the unit's ambient environment. (Ex. Ambient temperature, noise, grounding)	Take remedies according to the causes of the abnormality in the ambient environment.		<input type="radio"/>	<input type="radio"/>

Alarm No. 35		NC command error			
		The travel command data that was received from the CNC was excessive.			
Investigation details		Investigation results	Remedies	SV	SP
1	Please contact the Service Center, Service Station, Sales Office or dealer.			<input type="radio"/>	<input type="radio"/>

Alarm No. 36		NC-DRV communication: Communication error			
		The communication with the CNC was interrupted.			
Investigation details		Investigation results	Remedies	SV	SP
1	Check the alarm No. "34" items.			<input type="radio"/>	<input type="radio"/>

7 Troubleshooting

Alarm No. 37		Initial parameter error			
		An incorrect parameter was detected among the parameters received from the CNC at the power ON.			
	Investigation details	Investigation results	Remedies	SV	SP
1	Check if the unit in which the alarm was detected is servo axis or spindle.	The alarm was detected in servo axis. The alarm was detected in spindle.	Check the investigation item No. 2. Check the investigation item No. 3.	○	○
2	Check the error parameters displayed on the NC diagnosis screen. Servo parameters: SV001 to SV065, SV082	Wrong parameters were set. The electronic gears are overflowing. The absolute position detection parameter is valid when OSE104 and OSE105 are connected. (Absolute position control cannot be used.) SV082/bitC to F are the same setting in one unit. SV082/bitC to F are not the same setting in one unit. Correct parameters were set.	Correct the parameter setting. Set the value within the designated setting range. Set SV001, SV002 and SV018 so that they meet the machine specifications. In order to use the absolute position control function, an absolute position option is required. Correct the setting of SV082/bit0 to B. Correct to the same setting. Check the investigation item No. 4.	○	
3	Check the error parameters displayed on the NC diagnosis screen. Spindle parameters: SP001 to SP240	The setting is wrong. The set parameters are correct. The set parameter value is different from that of the machine specified encoder.	Correct the parameter setting. Set the value within the designated setting range. Check the investigation item No. 4. Change the setting to meet the machine specifications.		○
4	Check the alarm No. "34" items.			○	○

Alarm No. 38		NC-DRV communication: Protocol error 1			
		An error was detected in the communication frames received from the CNC.			
	Investigation details	Investigation results	Remedies	SV	SP
1	Check the alarm No. "34" items.			○	○

Alarm No. 39		NC-DRV communication: Protocol error 2			
		An error was detected in the axis information data received from the CNC.			
	Investigation details	Investigation results	Remedies	SV	SP
1	Check the alarm No. "34" items.			○	○

Alarm No. 3A		Overcurrent			
		Excessive current was detected in the motor drive current.			
	Investigation details	Investigation results	Remedies	SV	SP
1	[1] Check whether vibration is occurring at the table or spindle. [2] Check if the vibration caused by the load fluctuation is occurring.	Vibration is occurring. There is no vibration.	[1] Set a filter. [2] Lower the speed loop gain (SV005/SP005). Check the investigation item No. 2.	○	○
2	Check the repeatability of the alarm at the rapid traverse feed for the servo and at acceleration/ deceleration for the spindle. (Note) Check the phenomenon caused by the load fluctuation.	The alarm occurs. The alarm does not occur.	Lower the speed loop gain (SV005/SP005) to the level at which the alarm does not occur. Check the investigation item No. 3.	○	○
3	For the servo, perform the rapid traverse feed repeatedly and check if the max. current value is within the tolerable value. For the spindle, check the load meter value at the unloaded max. rotation speed.	The displayed value is high. The displayed value is appropriate.	Increase the current loop gain. Servo: SV009 to 012 Spindle: SP077 to 080 and SP081 to 084 Check the investigation item No. 4.	○	○
4	Disconnect the power cable (U,V,W) from the terminal block and the cannon plug from the motor. Check the insulation of the cable and motor with a tester.	The resistance value of the power cable for each phase is not "∞". The resistance value of the motor terminal and unit (shaft) is 1MΩ or less. The values below are met when measured with a tester. Cable: ∞ Motor terminal - unit: 1MΩ or more	Replace the motor power cable. Replace the motor. (Note) For the motors equipped with the absolute position encoder, the zero point must be established. Check the investigation item No. 5.	○	○
5	Check the insulation between the motor power cable and FG.	There is a ground fault at the power cable. There is no problem.	Replace the motor power cable. Check the investigation item No. 6.	○	○
6	Check if there is any abnormality in the motor's ambient environment. (Ex. Ambient temperature, cutting water)	Take remedies according to the causes of the abnormality in the ambient environment.		○	○

7 Troubleshooting

Alarm No. 3B		Power module overheat			
		Thermal protection function in the power module has started its operation.			
	Investigation details	Investigation results	Remedies	SV	SP
1	Check that the fan of the drive unit is rotating correctly.	Large amounts of cutting oil or cutting chips, etc., are adhered to the fan, or the rotation is slow.	Clean or replace the fan.	○	○
		The fan is rotating properly.	Check the investigation item No. 2.		
2	Check whether the heat dissipating fins are dirty.	Cutting oil or cutting chips, etc., are adhered, and the fins are clogged.	Clean the fins.	○	○
		Cutting chips etc. are not adhered to the fins.	Check the investigation item No. 3.		
3	Measure the drive unit's ambient temperature.	55°C or more.	Improve the efficiency cooling for the power distribution panel.	○	○
		Less than 55°C.	Check the investigation item No. 4.		
4	Check if there is any abnormality in the unit's ambient environment. (Ex. Ambient temperature, noise, grounding)	Take remedies according to the causes of the abnormality in the ambient environment.		○	○

Alarm No. 3C		Regeneration circuit error:			
		An error was detected in the regenerative transistor or in the regenerative resistor.			
	Investigation details	Investigation results	Remedies	SV	SP
1	Check if an external regenerative resistor is used.	An external regenerative resistor is used.	Check the investigation item No. 3.	○	
		A built-in regenerative resistor is used.	Check the investigation item No. 2.		
2	Is the short wire connected between P and D terminal? Are there any problems with the connection condition? (looseness of the screw)	The wire is not connected.	Connect the wire.	○	
		The connector is disconnected.	Reconnect the connector.		
		The connector has a contact fault.	Replace the connector.		
3	Is the connection of the regenerative resistor or regeneration resistor cable correct?	The connection is correct.	Replace the drive unit.	○	○
		The wire is not connected.	Connect the wire.		
4	Is the regeneration resistor or the regeneration resistor cable broken? Disconnect the regenerative resistor terminal and check the resistance value with a tester.	The regeneration resistor is broken. Or the resistance value is different from the specified value.	Replace the regenerative resistor.	○	○
		The regeneration resistor cable is broken.	Replace the cable.		
		The resistance value is normal.	Replace the drive unit.		

Alarm No. 3D		Power supply voltage error at acceleration/deceleration:			
		A motor control error was detected at acceleration/deceleration due to an input voltage drop.			
	Investigation details	Investigation results	Remedies	SV	SP
1	Measure the input voltage during operations with a tester.	During operations, the voltage fluctuates widely.	Increase the power capacity (KVA).	○	-
		During operations, the voltage is stable.	Check the investigation item No. 2.		
2	Check the load inertia.	The load inertia (workpiece etc.) is excessive.	[1] Lower the load inertia. [2] Extend the rapid traverse time constant for G0/G1.	○	-
		The load inertia is normal.	Check the investigation item No. 3.		
3	Check the cooling fan of the drive unit.	The fan is stopped.	Replace the fan. If the state is not improved, replace the drive unit.	○	-
		The fan is rotating correctly.	Check the investigation item No. 4.		
4	Check the ambient temperature of the drive unit during operation.	The ambient temperature exceeds the specified value.	Correct the ambient temperature within the specified value.	○	-
		There is no problem in temperature.	Replace the drive unit.		

Alarm No. 3E		Magnetic pole position detection error:			
		The magnetic pole position is not reliable in the magnetic pole position detection control. This alarm occurs at the detection level which is set in SV094.			
	Investigation details	Investigation results	Remedies	SV	SP
1	Adjust the setting value of the servo parameter SV094 and detect the magnetic pole position.	Set SV094.	Set SV094. The standard value for a rotary motor is 10. The standard value for a linear motor is 10.	○	-
		SV094 is set.	Set the optimal value allowing for the coasting distance (Increase the value).		

7 Troubleshooting

Alarm No. 41	Feedback error 3			
	Either a missed feedback pulse in the main side incremental encoder or an error in the Z-phase was detected in the full closed loop system. In the servo, Z-phase was not detected by a rotary encoder within 2 rotations.			

	Investigation details	Investigation results	Remedies	SV	SP
1	Check the connection condition of the cable and encoder. - Check if the cable is disconnected.	The cable is disconnected.	Replace the cable.	○	○
		The cable is normal.	Check for dirt on the connector terminal and reconnect it.		
		The alarm occurs even after it is reconnected.	Replace the encoder.		

Alarm No. 42	Feedback error 1			
	An error was detected in the sub side encoder (feedback signals of the position encoder in a servo system, or PLG's feedback signals in a spindle system).			

	Investigation details	Investigation results	Remedies	SV	SP
1	Check SP019 and SP020.	Parameter is set incorrectly.	Correctly set.	○	○
		Parameter is set correctly.	Check the investigation item No. 2.		
2	Check the alarm No. "2C" items.			○	○

Alarm No. 43	Feedback error 2			
	Excessive difference was detected in position data between the motor side encoder and the machine side encoder.			

	Investigation details	Investigation results	Remedies	SV	SP
1	Check if the connecting pulley ratio of the spindle end to ABZ pulse encoder meets the machine specifications.	The pulley ratio of the spindle end to encoder is 1:1.	Check the parameter setting.	○	○
		The spindle end and encoder are not equal in the pulley ratio.	Check the parameter setting. When the encoder is smaller than the spindle end in the pulley ratio, replace the pulley.		
		No problem.	Check the investigation item No. 2.		
2	Check the setting value of the spindle parameter from SP057 to SP064.	The correct values are not set.	Correctly set.	○	○
		The correct values are set.	Check the investigation item No. 3.		
3	Check the spindle parameter SP054 setting value.	V-belt is used for the spindle end driving.	Set "-1" to the spindle parameter "SP054".	○	○
		Other than V-belt (gears or timing belt) is used for the spindle end driving.	Set "360" to the spindle parameter "SP054".		
		SP054 is set corresponding to the machine specifications.	Check the investigation item No. 4.		
4	Jiggle the encoder connectors (drive unit side and encoder side) and check if they are disconnected.	The connector is disconnected (or loose).	Correctly install.	○	○
		The connector is not disconnected.	Check the investigation item No. 5.		
5	Is the encoder cable wired in the same conduit as the motor's power cable, or are the two cables laid in parallel near each other?	The cables are wired near each other. Noise is entering from the power cable.	Improve the cable wiring. Divide it by a FG shield.	○	○
		The wires are sufficiently separated.	Check the investigation item No. 6.		
6	Is the motor FG wire connected only to the drive unit which drives it? (Is the motor grounded to one point?)	The motor FG wire is grounded on the motor side.	Ground the motor to one point, connecting the wires together on the drive unit side.	○	○
		The motor is grounded to one point.	Check the investigation item No. 7.		
7	Turn the power OFF, and check the encoder cable connection with a tester. (Is the cable shielded?)	The connection is faulty.	Replace the encoder cable.	○	○
		The connection is normal.	Check the investigation item No. 8.		
8	Replace with another unit, and check whether the fault is on the unit side or encoder side.	The alarm is on the drive unit side.	Replace the drive unit.	○	○
		The alarm is on the encoder side.	Check the investigation item No. 9.		
9	Check if there is any abnormality in the encoder's ambient environment. (Ex. Ambient temperature, noise, grounding)	Take remedies according to the causes of the abnormality in the ambient environment.		○	○
10	Check SP019, SP020, SV019, and SV020.	Parameter is set incorrectly.	Correctly set.	○	○
		Parameter is set correctly.	Check the investigation item No. 11.		
11	Check the alarm No. "1B" items.			○	○

7 Troubleshooting

Alarm No. 45		Fan stop			
		A cooling fan built in the drive unit stopped, and overheat occurred in the power module.			
	Investigation details	Investigation results	Remedies	SV	SP
1	Turn the unit power ON again, and confirm the rotation of the fan. Note) Assure more than 10 seconds for the time from when the power is turned OFF till when it is turned ON. For the fan used for the drive unit, assuring more than 10 seconds for the time from when the power is turned OFF till when it is turned ON is required.	The fan is rotating, and an alarm did not occur again.	Continue to use. The power may be turned ON without assuring more than 10 seconds for the time from when the power is turned OFF till when it is turned ON. Leave for more than 10 seconds, and turn the power ON again.	○	○
		The fan did not rotate. Or, an alarm occurred again.	Check the investigation item No. 2.		
2	Check if the connector connected to a fan is loosened or disconnected in the unit.	[1]The connector is loosened. [2]The connector is disconnected.	Correctly connect the connector. Replace the fan.	○	○
		[1]The connector is not loosened. [2]The connector is not disconnected.	Check the investigation item No. 3.		
3	Check if oil or cutting chips are adhered to the fan.	Oil or cutting chips are adhered.	Improve the use environment and replace the drive unit.	○	○
		Oil or cutting chips are not adhered. The cable may be broken.	Replace the fan. Replace the drive unit.		

Alarm No. 46		Motor overheat / Thermal error			
		Thermal protection function of the motor or in the encoder, has started its operation.			
	Investigation details	Investigation results	Remedies	SV	SP
1	Check the repeatability. (Note) For the spindle, check the "temperature" of the "spindle unit" displayed on the drive monitor screen.	[1] The alarm occurs before operation. [2] The "temperature" displayed on the drive monitor screen is different from ambient temperature.	Check the investigation item No. 2.	○	○
		[1] The alarm occurs after the operation continues for a while. [2] The "temperature" displayed on the drive monitor screen rises drastically during the spindle operation.	Check the investigation item No. 5.		
2	Jiggle the encoder connectors (drive unit side and encoder side) and check if they are disconnected.	The connector is disconnected (or loose). The connector is not disconnected.	Correctly install. Check the investigation item No. 3.	○	○
3	Turn the power OFF, and check the encoder cable connection with a tester.	The connection is faulty.	Replace the cable.	○	○
		The connection is normal.	Check the investigation item No. 4.		
4	When using MDS-EX-HR, check if the motor is validated even if a motor thermal is not provided?	SV034/bit2 = 0	Set SP034/bit2 to 1.	○	
		SV034/bit2 = 1	Check the investigation item No. 5.		
5	Check the overload % (servo) or load meter (spindle).	The load is large.	Servo: Check the investigation item No. 6. Spindle: Check the investigation item No. 8.	○	○
		The load is not large.	Check the investigation item No. 9.		
6	Is the unbalance torque high?	The constant load torque (friction + unbalance) is 60% or more.	Select the motor so that the constant load torque is 60% or less.	○	
		The constant load torque is less than 60%.	Check the investigation item No. 7.		
7	Was the overload alarm (50) forcibly reset by turning the drive unit power OFF?	The alarm was forcibly reset.	Do not turn the drive unit's power OFF when an overload alarm occurs. (The NC power can be turned OFF.)	○	○
		The alarm was not forcibly reset.	Check the investigation item No. 9.		
8	Check the parameter settings.	The parameter is not set correctly.	Correctly set.		○
		The parameter is set correctly.	Check the investigation item No. 9.		
9	Measure the motor temperature when the alarm occurs. (Note) For the spindle motor, check the "temperature" of the "spindle unit" shown on the drive monitor screen.	The motor unit is hot.	Check the investigation item No. 10.		
		The motor is not hot.	Check the investigation item No. 12.	○	○
10	When using a motor with fan, check whether the fan is stopped, or it is clogged with dust, etc.	The motor fan was stopped.	Check the investigation item No. 11.		
		The motor fan wind flow is poor.	Clean the fan and ventilation holes inside of the motor.	○	○
		The direction of the ventilation is opposite.	Change the connected phase sequence.		
11	Check the fan wiring.	There is no problem.	Check the investigation item No. 12.		
		The cable is broken.	Replace the cable.	○	○
		The cable is not broken.	Replace the fan.		
12	Replace the drive unit or motor with another drive unit or motor, and check whether the fault is on the drive unit side or motor side	The alarm is on the drive unit side.	Replace the drive unit.	○	○
		The alarm is on the motor side.	Replace the motor.		
13	Check if there is any abnormality in the unit's ambient environment. (Ex. Ambient temperature, noise, grounding)	Take remedies according to the causes of the abnormality in the ambient environment.		○	○

7 Troubleshooting

Alarm No. 48		Motor side encoder: Error 5			
		The motor side encoder (linear scale in the case of linear motor) detected an error. As details differ for each encoder, refer to section "Encoder alarm".			
Investigation details		Investigation results		Remedies	
1	Check the alarm No. "1B" items.			SV	SP
				<input type="radio"/>	<input type="radio"/>

Alarm No. 49		Motor side encoder: Error 6			
		The motor side encoder (linear scale in the case of linear motor) detected an error. As details differ for each encoder, refer to section "Encoder alarm".			
Investigation details		Investigation results		Remedies	
1	Check the alarm No. "1B" items.			SV	SP
				<input type="radio"/>	<input type="radio"/>

Alarm No. 4A		Motor side encoder: Error 7			
		The motor side encoder (linear scale in the case of linear motor) detected an error. As details differ for each encoder, refer to section "Encoder alarm".			
Investigation details		Investigation results		Remedies	
1	Check the alarm No. "1B" items.			SV	SP
				<input type="radio"/>	<input type="radio"/>

Alarm No. 4B		Motor side encoder: Error 8			
		The motor side encoder (linear scale in the case of linear motor) detected an error. As details differ for each encoder, refer to section "Encoder alarm".			
Investigation details		Investigation results		Remedies	
1	Check the alarm No. "1B" items.			SV	SP
				<input type="radio"/>	<input type="radio"/>

Alarm No. 4C		Current error at magnetic pole estimate			
		Current detection failed at the pulse-applied magnetic pole estimation by IPM spindle motor.			
Investigation details		Investigation results		Remedies	
1	Check the pulse-applied time.	The pulse-applied time can be short. The alarm also occurs after the pulse-applied time is set.	Set the pulse-applied time longer. Setting parameter:SP142 1) The pulse-applied time (0 to 350) 2) For low-speed coil:1)+1000 3) The polarity of magnetic pole estimate: Reverse polarity is "-" After the adjustment, perform the magnetic pole detection control again.	-	<input type="radio"/>
			Replace the unit.		

Alarm No. 4D		Dual signal error			
		An error was detected in the signal related to the dual signal.			
Investigation details		Investigation results		Remedies	
1	When not using dedicated wiring STO function	Is the connector to disable STO installed correctly?	Install the connector to disable STO correctly.	<input type="radio"/>	<input type="radio"/>
		Is the parameter setting (SV113,SP229/bit8) correct?	Set SV113,SP229/bit8. When using dedicated wiring STO function, set to "1".		
		The error is detected during the servo ON.	Input the STO signal after turning the servo OFF.		
2	When using dedicated wiring STO function	The error is detected during the servo OFF.	Remedy the wiring and signal for STO cable.		
3	Check "7.3.6 Details of Alarm 4D" items.				

Alarm No. 4E		NC command mode error			
		The mode outside the specification was input in spindle control mode selection.			
Investigation details		Investigation results		Remedies	
1	Check the wiring and setting environment. 1) Correctly grounded? 2) Any noise generating devices around the unit? 3) Are the speed/position encoder cables correctly shielded?	1) The grounding is incomplete.	Correctly ground.	-	<input type="radio"/>
		2) The alarm occurs easily when a specific device operates.	Use noise measures on the device described on the left.		
		3) The cable is not correctly shielded.	Correctly shield the cable.		
		No abnormality is found in particular.	Replace the drive unit.		

7 Troubleshooting

Alarm No. 4F		Instantaneous power interrupt			
		The control power supply has remained shut down.			
Investigation details		Investigation results		Remedies	
SV	SP				
1	Check the repeatability.	The alarm occurs occasionally.		Check the power facilities.	○ ○
				Check the wiring of the control power.	
Alarm No. 50		Overload 1			
		Overload detection level became over 100%. The motor or the drive unit is overloaded.			
Investigation details		Investigation results		Remedies	
SV	SP				
1	Check the overload parameters. Servo:SV021, SV022 Spindle:SP021,SP022	The standard values (below) are not set. Servo:SV021 = 60, SV022 = 150 Spindle:SP021=60,SP022=120 IPM:SP021=300,SP022=100		Set the standard values.	
		The standard values are set.		Investigate item 2.	
2	Check the items below displayed on the drive monitor screen during operation. <Servo> Max.current 3 (%) Overload(%) <Spindle> Load meter(%)	Perform the machining such as rapid traverse, where an alarm occurs. The examples are below. <Servo> [1] Max.current 3 constantly displays the maximum value. [2] Overload increases at a rapid speed. <Spindle> [1] The time to display 120% lasts long. [2] The value is higher than normal.		Servo [1] Mount a smaller workpiece. [2] Increase the time constant. [3] Check the investigation item No.6.	
		The value is within the supposed level and there is no problem.		Spindle [1] Lower the cutting amount. [2] Extend the cycle time.	
		Investigate item 3.			
3	Check whether machine resonance is occurring. Check for vibration and abnormal noise at the spindle and table.	Resonance is occurring when a tool or workpiece is mounted or during machining. (The load inertia changes)		Adjust the parameters. [1] Set the optimal notch filter. [2] Lower VGN1 (SV005,SP005).	
		Resonance is not occurring.		Investigate item 4.	
4	Check whether the shaft sways when the motor is stopped. "Hunting" of the spindle "Vibration" of the table	The motor is hunting.		Adjust the parameters. [1] Increase VGN1 (SV005, SP005). [2] Lower VIA (SV008, SP008).	
		The motor is not hunting.		Servo: Investigate item 5 Spindle: Investigate item 7	
5	Check the brake operation. [1] Check the brake relay. [2] Check the connector (CN20) connection.	The motor brakes are not released.		Correct the faulty section.	
		The motor brake operation is normal.		Investigate item 6.	
6	Check the load current with the NC Servo Monitor, and investigate the machine load.	The cutting load is large.		Lower the cutting load.	
		There is interference with the positioning pin.		When using the positioning pin, turn the servo OFF when stopped.	
		An excessive force is applied from the machine.		Check whether the ball screw is bent, or whether there is a fault in the guide.	
		The machine load is not large.		Investigate item 8.	
7	Check the PLG output waveform. TS5690 cannot be checked.	There is a problem.		Adjust the PLG output waveform. For TS5690, reinstall.	
		Normal		Investigate item 8.	
8	Confirm the motor capacity selection again.	The motor performance is insufficient.		Lower the acceleration/deceleration rate or cutting load.	
		The motor performance is sufficient.		Check the tool mounted on the spindle. - The service life is reached. Increase the number of teeth (chips) of the milling cutter, etc. Investigate item 9.	
9	Try replacing the drive unit.	Improved.		Use as it is.	
		Not improved.		Replace the motor.	

(Note) NR and PR resetting are not possible when the overload level is 50% or more. Do not forcibly reset (AR) by turning the unit power OFF. If AR resetting is used at 50% or higher, the level is set to 80% when the power is turned ON next. (Servo)

7 Troubleshooting

Alarm No. 51		Overload 2			
		Current command of more than 95% of the unit's max. current was being continuously given for longer than 1 second in a servo system. In a spindle system, current command of more than 95% of the motor's max. current was being continuously given for longer than 1 second.			
	Investigation details	Investigation results	Remedies	SV	SP
1	Did the alarm occur immediately after READY ON?	The alarm occurred after ready ON before operation starts.	Investigate item 2.	○	
		The alarm occurred after normal operation.	Investigate item 5.		
2	Check that the PN voltage is supplied to the drive unit. MDS-EJ/EJH Series is not connected to the power supply unit, so investigate item 3 for MDS-EJ/EJH. [1] Is the CHARGE lamp ON?	The CHARGE lamp becomes dark. L+ or L- screw was loosened.	Increase the capacity of power supply. Tighten the L+ and L- screws.	○	
		Approx. 300V is correctly supplied.	Investigate item 3.		
3	Check the motor power cable (U, V, W phases). [1] The power cable is not connected. [2] Is the cable connected to the motor for another axis?	The connections are incorrect. Connected to the incorrect axis.	Connect correctly.	○	
		The connections are correct.	Investigate item 4.		
4	Check the encoder cable connection. [1] Is the cable connected to the motor for another axis?	The connections are incorrect.	Connect correctly.	○	
		The connections are correct.	Investigate item 5.		
5	Check whether the machine has collided.	The machine has collided.	Check the machining program and soft limit settings.	○	
		The machine has not collided.	Investigate item 6.		
6	Check whether the current value on the NC Servo Monitor screen is saturated during acceleration/ deceleration.	The current is saturated during acceleration/ deceleration.	Increase the acceleration/ deceleration time constant.	○	
		The current value during acceleration/ deceleration is appropriate.	Investigate item 7.		
7	Check the encoder Feedback.	The Feedback signal is abnormal. - The droop does not stabilize.	Replace the encoder. (With the absolute position system, the zero point must be established.)	○	
		The Feedback signal is normal.	Replace the drive unit.		
8	Check the load meter value.	The value is large.	Lower the load.		○
		The value is normal.	Investigate item 9.		
9	Check the PLG output waveform. For TS5690, waveform cannot be checked.	There is a problem.	Adjust the PLG output waveform.		○
		Normal	Replace the drive unit.		

Alarm No. 52		Excessive error 1			
		A difference between the actual and theoretical motor positions during servo ON exceeded the setting value.			
	Investigation details	Investigation results	Remedies	SV	SP
1	The load inertia is large. The unbalance torque in the Z (gravity) direction is high. An excessive workpiece or tool is mounted on the spindle.	The load inertia is excessive.	[1] Lower the machine weight applied to the servo motors (by the unbalance torque). [2] Lower the weight of the workpiece.	○	○
		The load inertia is normal.	Investigate item 2.		
2	Check the excessive error detection width. Servo SV053 Spindle SP023 (Interpolation, spindle synchronization)SP053 (Non-interpolation)	The excessive error detection width is too small. Servo standard value: SV053 = {RAPID/(60*PGN1)}/2 Spindle standard value: No alarm is set at SP023 = 120:0 SP053 = motor max. speed*6/PGV/2	Set appropriate values.	○	○
		Appropriate values are set.	Investigate item 3.		
3	Check the position encoder polarity. SV017/bit4 (Servo) SP017/bit4 (Spindle: position FB) SP017/bit0 (Spindle: speed FB) #3106/bit7 (Synchronous tap control)	The polarity is reversed.	Correctly set the parameters.	○	○
		Normal.	Investigate item 4.		
4	Check the alarm No. "51" items.			○	○

7 Troubleshooting

Alarm No. 53		Excessive error 2			
		A difference between the actual and theoretical motor positions during servo OFF exceeded the setting value.			
	Investigation details	Investigation results	Remedies	SV	SP
1	Check the follow-up function while the NC is in the servo OFF state.	The axis detachment function (NC parameter) is invalid. (Note) For the axis detachment function, refer to the NC manual.	Check the investigation item No. 2.	○	
		The axis detachment function (NC parameter) is valid. (Note) For the axis detachment function, refer to the NC manual.	Check the investigation item No. 3.		
2	Check whether the axis has moved during servo OFF (either by visual inspection or monitor the position droop waveform). [1] Check if the motor brake is released in the middle. [2] Check if the axis moves because the servo OFF is applied during the C axis mode.	[1] The axis has moved. [2] The servo OFF is applied during the mode.	[1] Adjust the brakes, etc. so that the axis does not move. [2] Avoid the servo OFF from being applied during position control.	○	
		The axis has not moved.	Check the investigation item No. 3.		
3	Check the excessive error detection width. SV026 (Servo) (Note) Set the same value to SV023.	The excessive error detection width is too small. $SV026 = \{RAPID / (60 \times PGN1)\} / 2$	Set an appropriate value.	○	
		An appropriate value is set.	Check for problems on the NC side, such as the position FB follow-up control.		

Alarm No. 54		Excessive error 3			
		When an excessive error 1 occurred, detection of the motor current failed.			
	Investigation details	Investigation results	Remedies	SV	SP
1	Check that the PN voltage is supplied to the drive unit. [1] Is the CHARGE lamp ON?	The voltage is not supplied.	Correctly supply the PN voltage.	○	○
		It is correctly supplied (DC300V).	Investigate item 2.		
2	Check the motor power cable (U, V, W phases). [1] The power cable is not connected. [2] Is the cable connected to the motor for another axis?	The connections are incorrect.	Connect correctly.	○	○
		The connections are correct.	Replace the drive unit.		

Supplement (servo)

Depending on the ideal machine position in respect to the command position, the actual machine position could enter the actual shaded section shown below, which is separated more than the distance set in OD1.

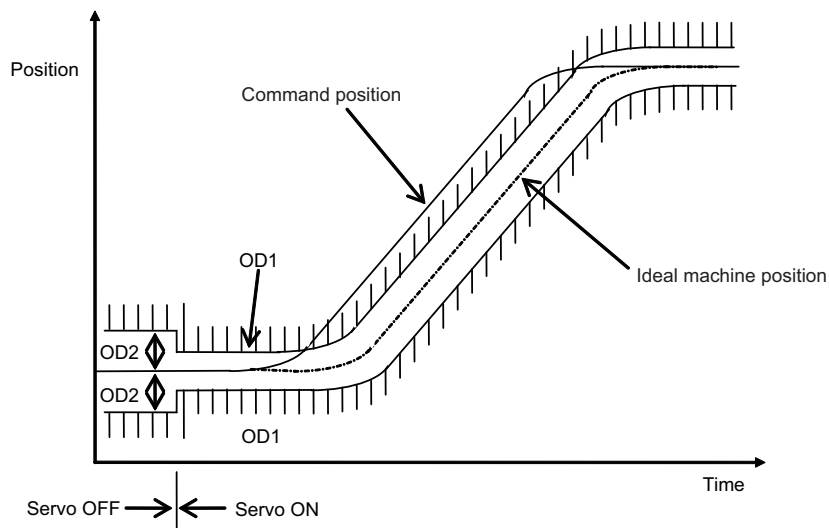

7 Troubleshooting

Alarm No. 56		Commanded speed error			
		The encoder has detected that the commanded speed exceeded 1.15 times of the rapid traverse rate (rapid), or the motor rotation speed exceeded the maximum speed.			
	Investigation details	Investigation results	Remedies	SV	SP
1	Check if the NC power is turned ON again when the rapid traverse rate (rapid) is changed.	NC power is turned OFF and ON.	Check the investigation item No. 2.	○	○ (Note)
		NC power is not turned OFF and ON	Turn the NC power OFF and ON.		
2	A value above the rapid traverse rate (rapid) is set to cutting feed clamp speed (clamp).	clamp > rapid	Review the clamp or rapid setting value.	○	○ (Note)
		clamp ≤ rapid	Check the commanded speed.		

(Note) For a spindle, the error is detected only during the spindle/C axis control.

Alarm No. 58		Collision detection 1: G0			
		When collision detection function (set to SV060) was valid, the disturbance torque in rapid traverse (G0) exceeded the collision detection level.			
	Investigation details	Investigation results	Remedies	SV	SP
1	Check whether the machine has collided during G0 operation.	A collision has occurred at the table, turret or spindle head in the machine during movement.	Check the machining program and soft limit settings.	○	
		There is no collision at the table, turret and spindle head in the machine during movement	Adjust the tolerable disturbance torque SV060. (Note) Set the detection level to be 1.5 times or more of the maximum torque.		

(Note) When the disturbance torque exceeds the collision detection level, the motor will decelerate to a stop with a torque 80% (standard) value of the motor's maximum torque. After decelerating to a stop, the alarm will occur.

Alarm No. 59		Collision detection 1: G1			
		When collision detection function was valid (SV035.c1G1 was set), the disturbance torque in cutting feed (G1) exceeded the collision detection level.			
	Investigation details	Investigation results	Remedies	SV	SP
1	Check whether the machine has collided during G0 operation.	The machine has collided during movement.	Check the machining program and soft limit settings.	○	
		The machine has not collided.	Increase the detection level (SV035. c1G1). G1 collision detection level =SV060*c1G1(001 to 111) (Note) Set the detection level larger than the maximum cutting load.		

(Note) When the disturbance torque exceeds the collision detection level, the motor will decelerate to a stop with a torque 80% (standard) value of the motor's maximum torque. After decelerating to a stop, the alarm will occur.

Alarm No. 5A		Collision detection 2			
		When collision detection function was valid, the command torque reached the max. motor torque.			
	Investigation details	Investigation results	Remedies	SV	SP
1	Check whether the machine has collided.	The machine has collided.	Check the machining program and soft limit settings.	○	
		The machine has not collided.	Check the investigation item No. 2.		
2	Check whether the current value on the NC Servo Monitor screen is saturated during acceleration/ deceleration.	The current is saturated during acceleration/ deceleration.	Check the investigation item No. 3.	○	
		The current value during acceleration/ deceleration is appropriate.	Investigate the cause of the load fluctuation.		
3	Can the acceleration/deceleration time constant be changed?	The constant can be changed.	Increase the acceleration/ deceleration time constant.	○	
		The constant cannot be changed.	Set to ignore collision detection method 2.		

(Note) When the command torque reaches the motor's maximum torque, the motor will decelerate to a stop with a torque 80% (standard) value of the motor's maximum torque. After decelerating to a stop, the alarm will occur.

Alarm No. 5B		Safely limited: Commanded speed error			
		In safely limited mode, the commanded speed was detected to exceed the safely limited speed.			
	Investigation details	Investigation results	Remedies	SV	SP
1	Check the commanded speed on the NC side.	The commanded speed and safely limited speed limit value are the same.	Reduce the commanded speed on the NC side or increase the safely limited speed limit value.	○	○
		The commanded speed is slower than the safely limited speed.	Replace the drive unit.		

7 Troubleshooting

Alarm No. 5D		Safely limited: Door state error			
		In safely limited mode, the door state signal from the NC and the same signal from the drive unit don't match. Otherwise, door open state was detected in normal mode.			
Investigation details		Investigation results		Remedies	
1	Check the DI input timing.	Both NC side and drive unit side input timings match one another within 500ms.	Review the DI input sequence. Check if the cable for the DI input signal is broken.	○	○
		NC side and drive unit side inputs do not match one another within 500ms.	Investigate the wiring and connection environment.		

Alarm No. 5E		Safely limited: Feedback speed error			
		In safely limited mode, the motor speed was detected to exceed the safely limited speed.			
Investigation details		Investigation results		Remedies	
1	Check the DI input timing.	The feedback speed and safely limited speed limit value are the same.	Reduce the commanded speed on the NC side or increase the safely limited speed limit value.	○	○
		The feedback speed is slower than the safely limited speed.	Replace the drive unit.		
2	Check the wiring and setting environment. 1) Correctly grounded? 2) Any noise generating devices around the unit? 3) Are the speed/position encoder cables correctly shielded?	1) The grounding is incomplete.	Correctly ground.	○	○
		2) The alarm occurs easily when a specific device operates.	Use noise measures on the device described on the left.		
		3) The cable is not correctly shielded.	Correctly shield the cable.		
		No abnormality is found in particular.	Replace the drive unit.		

Alarm No. 5F		External contactor error			
		A contact of the external contactor is welding.			
Investigation details		Investigation results		Remedies	
1	Check whether the contactor's contact has melted.	The contactor is melted.	Replace the contactor.	○	○
		The contactor is not melted.	Check the investigation item No. 2.		
2	Check whether the axis where an alarm occurred was a contactor control axis.	The alarm occurred at the axis where the contactor control is not executed.	Check the parameter. (EJ/EJH Series) With contactor control Servo:SV082, Spindle:SP227 0800h is added to the setting value. Without contactor control Change "Bit A,B" to "00" in the parameter above.	○	○
		The alarm occurred at the axis where the contactor control is executed.	Replace the drive unit.		
3	Check the connection with a regenerative resistor.	The short wire between the P and D terminals of the control circuit terminal block (CNP2) is disconnected.	Replace the control circuit terminal block (CNP2). Connect the short wire between the P and D terminals.	○	○
		The connection with an external option regenerative resistor unit is faulty.	Replace the cable.		

7 Troubleshooting

Alarm No. 61		Power supply: Power module overcurrent		
		Overcurrent protection function in the power module of power supply has started its operation.		
	Investigation details	Investigation results	Remedies	CV
1	Check the state of the operation when the alarm occurs, and check the repeatability.	The alarm occurs immediately after 200VAC is supplied or after READY is turned ON.	Replace the unit.	○
		The alarm occurs occasionally during READY ON.	Check the investigation item No. 3.	
		The alarm occurs after continuous operation for a long time. The unit is hot.	Check the investigation item No. 2.	
2	Check the load state of all motors (during stopped).	The total load of all motors exceeds the rated capacity of the power supply unit.	Lower the motor load and operation frequency.	○
		The total does not exceed the capacity.	Check the investigation item No. 3.	
3	Check the power capacity of the facility. Check the capacity of the step-down transformer (KVA).	The power capacity of the facility is insufficient.	Increase the power capacity of the facility.	○
		The specified power capacity is secured.	Check the investigation item No. 4.	
4	Measure the voltage across wires. Is the voltage 170V or more even when the motor is accelerating?	The voltage drops to 170V or less occasionally.	Increase the power capacity of the facility.	○
		The difference of the voltage across wires is 10V or more.	Improve the power phase balance.	
		The difference of the voltage across wires is less than 10V.	Check the investigation item No. 5.	
5	Check whether there is any device (machine) causing the power distortion.	Abnormal noise is heard from an AC reactor when stopping at the servo ON.	Improve the source of the distortion. For example, when abnormal noise is heard from another machine that is in operation, move the wiring to the power which is far from the machine's power supply.	○
		Abnormal noise is not heard.	Check the investigation item No. 6.	
6	Check if there is any abnormality in the unit's ambient environment. (Ex. Noise, grounding, etc.)	Take remedies according to the causes of the abnormality in the ambient environment.		○

Alarm No. 62		Power supply: Frequency error		
		The input power supply frequency increased above the specification range.		
	Investigation details	Investigation results	Remedies	CV
1	Check the state of the operation when the alarm occurs, and check the repeatability.	The alarm occurs each time immediately after the power is turned ON. Or, the alarm occurs occasionally regardless of the operation state.	Check the investigation item No. 2.	○
		The alarm occurs only while the motor is accelerating/decelerating.	Check the investigation item No. 3.	
2	Measure the power voltage waveform during normal operation.	The frequency is deviated from 50Hz±3% or 60Hz±3%.	Review the power facilities.	○
		The voltage waveform dips at some sections.	Improve the source of the distortion. Install an AC reactor.	
		There is no problem.	Check the investigation item No. 4.	
3	Measure the power voltage when the motor is accelerating/decelerating.	The frequency greatly fluctuates during acceleration/deceleration.	Review the power facilities.	○
		The voltage waveform during deceleration dips in some sections.	Improve the source of the distortion. Install an AC reactor.	
		There is no problem.	Check the investigation item No. 4.	
4	Check if there is any abnormality in the unit's ambient environment. (Ex. Noise, grounding, etc.)	Take remedies according to the causes of the abnormality in the ambient environment.		○

Alarm No. 66		Power supply: Process error		
		An error occurred in the process cycle.		
	Investigation details	Investigation results	Remedies	CV
1	Check the repeatability.	The alarm occurs each time after the power is turned ON.	Replace the unit.	○
		The alarm occurs occasionally.	Check the investigation item No. 2.	
2	Check if there is any abnormality in the unit's ambient environment. (Ex. Noise, grounding, etc.)	Take remedies according to the causes of the abnormality in the ambient environment.		○

Alarm No. 67		Power supply: Phase interruption		
		An open-phase condition was detected in input power supply circuit.		
	Investigation details	Investigation results	Remedies	CV
1	Check the voltage for each input phase.	There are phases with no voltage.	Correct the power supply.	○
		There is no problem.	Check the investigation item No. 2.	
2	Check the alarm No. "71" items.			○

7 Troubleshooting

Alarm No. 68		Power supply: Watchdog			
The system does not operate correctly. LED display is fixed as "8".					
Investigation details		Investigation results		Remedies	CV
1	Check the repeatability.	The alarm occurs each time READY is turned ON.	Replace the unit.		○
		The alarm occurs occasionally.	Check the investigation item No. 2.		
2	Check if there is any abnormality in the unit's ambient environment. (Ex. Noise, grounding, etc.)	Take remedies according to the causes of the abnormality in the ambient environment.			○

Alarm No. 69		Power supply: Grounding			
The motor power cable is in contact with FG (Frame Ground).					
Investigation details		Investigation results		SV	SP
1	Measure the insulation across the power cables (U,V,W) for all motors and the ground. (Carry out a megger test.)	Less than 1MΩ. (Grounding)	The motor or power cable may be ground faulted.	○	○
		1MΩ or more. (Normal)	Check the investigation item No. 2.		
2	Has oil adhered on the motor or power cable?	Oil has adhered.	Take measures so that oil does not come in contact. Check the motor's cannon connector and the inside of the terminal box, and clean as necessary.	○	○
		Oil has not adhered.	Check the investigation item No. 3.		
3	Measure the insulation again.	Less than 1MΩ. (Grounding)	Replace the motor or cable.	○	○
		1MΩ or more. (Normal)	Check the investigation item No. 2.		
4	Measure the resistance across the U, V, W phase terminals of the servo/spindle drive unit and the ground. (Note) Do not measure the insulation as the unit is damaged.	Less than 100kΩ.	Replace the drive unit.	○	○
		100kΩ or more.	Replace the power supply unit.		
5	Check whether there is any axis in which alarm 24 has occurred.	There is an axis in which alarm has occurred.	Check the alarm No. "24" items.	○	○
		There is no axis in which alarm has occurred.	Check the investigation item No. 2.		

Alarm No. 6A		Power supply: External contactor welding			
A contact of the external contactor is welding.					
Investigation details		Investigation results		Remedies	CV
1	Check whether any alarm has occurred on the drive unit side.	An alarm has occurred.	Remove the cause of the alarm on the drive side, and check the investigation item No. 2.		○
		An alarm has not occurred.	Check the investigation item No. 2.		
2	Check whether the contactor's contact has melted.	The contactor has melted.	Replace the contactor.		○
		The contactor has not melted.	Check the investigation item No. 3.		
3	Check that the contactor excitation wiring is correctly connected from the power supply unit's MC1 terminal.	The connection is correct.	Correctly connect.		○
		The connection is incorrect.	Replace the power supply unit.		

Alarm No. 6B		Power supply: Rush circuit error			
A thyristor for rush short circuit is ON when rushing.					
Investigation details		Investigation results		Remedies	CV
1	Check whether any alarm has occurred on the drive unit side.	An alarm has occurred.	Remove the cause of the alarm on the drive side, and then carry out the investigation details 2.		○
		An alarm has not occurred.	Check the investigation item No. 2.		
2	Check the repeatability.	The alarm occurs each time READY is turned ON.	Replace the unit.		○
		The alarm occurs occasionally.	Check the investigation item No. 3.		
3	Check if there is any ground fault in the motor.	Check the investigation item of Alarm No. 69.	Take remedies of Alarm No. 69.		○
		No ground fault.	Check the investigation item No. 4.		
4	Check if there is any abnormality in the unit's ambient environment. (Ex. Noise, grounding, etc.)	Take remedies according to the causes of the abnormality in the ambient environment.			○

7 Troubleshooting

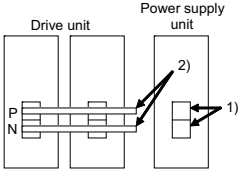
Alarm No. 6C		Power supply: Main circuit error																											
		An error was detected in charging operation of the main circuit capacitor.																											
Investigation details	Investigation results	Remedies	CV																										
1 Check the CHARGE lamp state when the alarm occurs.	[1] The light of the lamp becomes faint. [2] An alarm occurs when ready is turned ON again.	Replace the power supply unit.	○																										
	The lamp turns ON instantly, but when the alarm occurs and the contactor turns OFF, the lamp turns OFF immediately.	Check the investigation item No. 2.																											
	The lamp never turns ON.	Check the investigation item No. 2. Then replace the unit.																											
2 Disconnect the power supply unit's PN terminal block wiring, and measure the resistance value at 1) and 2) shown below.  <p>(Note) When disconnecting the PN wiring, turn OFF the power, make sure the CHARGE lamp has turned OFF at contactor OFF and then wait at least fifteen minutes before disconnecting. Do not disconnect immediately after the power OFF.</p>	1)The power supply unit side is abnormal. 2)The drive unit side is abnormal.	Replace the power supply unit. Disconnect the PN wiring, and then check the drive unit side.	○																										
	1) and 2) are both normal.	Replace the power supply unit.																											
		<table border="1"> <thead> <tr> <th rowspan="2">Tester measurement point</th> <th colspan="2">Polarity</th> <th rowspan="2">Normal</th> <th rowspan="2">Abnormal</th> </tr> <tr> <th>+</th> <th>-</th> </tr> </thead> <tbody> <tr> <td rowspan="2">1)</td> <td>P</td> <td>N</td> <td>Several 100Ω</td> <td>Short-circuit/∞Ω</td> </tr> <tr> <td>N</td> <td>P</td> <td>∞Ω</td> <td>Several 100Ω</td> </tr> <tr> <td rowspan="2">2)</td> <td>P</td> <td>N</td> <td>Several 100Ω</td> <td>Short-circuit/∞Ω</td> </tr> <tr> <td>N</td> <td>P</td> <td>∞Ω</td> <td>Several 100Ω</td> </tr> </tbody> </table>	Tester measurement point	Polarity		Normal	Abnormal	+	-	1)	P	N	Several 100Ω	Short-circuit/∞Ω	N	P	∞Ω	Several 100Ω	2)	P	N	Several 100Ω	Short-circuit/∞Ω	N	P	∞Ω	Several 100Ω		
Tester measurement point	Polarity			Normal	Abnormal																								
	+	-																											
1)	P	N	Several 100Ω	Short-circuit/∞Ω																									
	N	P	∞Ω	Several 100Ω																									
2)	P	N	Several 100Ω	Short-circuit/∞Ω																									
	N	P	∞Ω	Several 100Ω																									

Alarm No. 6D		Parameter setting error		
		An error was detected in the parameter sent from the drive unit.		
Investigation details	Investigation results	Remedies	CV	
1 Check the repeatability.	The alarm occurs each time after the power is turned ON.	Replace the unit.	○	
	The alarm occurs occasionally.	Check the investigation item No. 2.		
2 Check if there is any abnormality in the unit's ambient environment. (Ex. Noise, grounding, etc.)	Take remedies according to the causes of the abnormality in the ambient environment.		○	

Alarm No. 6E		Power supply: H/W error/A/D error		
		An error was detected in the internal memory or A/D converter.		
Investigation details	Investigation results	Remedies	CV	
1 Check the repeatability.	The alarm occurs each time READY is turned ON.	Replace the unit.	○	
	The alarm occurs occasionally.	Check the investigation item No. 2.		
2 Check if there is any abnormality in the unit's ambient environment. (Ex. Noise, grounding, etc.)	Take remedies according to the causes of the abnormality in the ambient environment.		○	

Alarm No. 6F		Power supply error		
		No power supply is connected to the drive unit, or a communication error was detected.		
Investigation details	Investigation results	Remedies	CV	
1 Check the time from when the unit power is turned OFF till when it is turned ON.	Within 3 seconds	Assure more than 3 seconds for the time from when the power is turned OFF till when it is turned ON.	○	
	More than 3 seconds	Check the investigation item No. 2.		
2 Check the LED display on the power supply unit.	"F" is flickering.	An A/D converter error has occurred. Check the alarm No. "6E" items.	○	
	Another alarm code is flickering.	Check items of each alarm No.		
	"0" is displayed.	Check the investigation item No. 3.		
	"F" is displayed.	Check the investigation item No. 3.		
	"8" is displayed.	Check the alarm No. "68" items.		
	"b", "C", "d" is displayed.	Check the investigation item No. 4.		
3 Check the rotary switch setting.	0 or 4 is set.	Check the investigation item No. 4.	○	
	A value other than the above is set.	Correctly set the rotary switch.		
4 Check the communication cable (CN4) connected with the drive unit.	There is a problem with the wiring or shield.	Replace the cable.	○	
	There is no problem.	Replace the unit.		

(Note) Alarm 6F is detected at the same time other power supply alarms occur.

7 Troubleshooting

Alarm No. 70		Power supply: External emergency stop error		
A mismatch of the external emergency stop input and CNC emergency stop input continued for 30 seconds.				
	Investigation details	Investigation results	Remedies	CV
1	Check the connection between external emergency stop and NC emergency stop.	Not wired.	Correctly wire the external emergency stop and NC emergency stop.	○
2	Check if there is any abnormality in the unit's ambient environment.	No abnormality is found in particular.	Replace the drive unit.	○
		The grounding is incomplete.	Take remedies according to the causes of the abnormality. Additionally ground and review.	

Alarm No. 71		Power supply: Instantaneous power interruption		
The power was momentarily interrupted.				
	Investigation details	Investigation results	Remedies	CV
1	Investigate the sequence to check whether the contactor has been turned OFF with an emergency stop button, etc.	The contactor has been turned OFF externally.	Review the machine sequence. When turning the contactor OFF with external means, such as an emergency stop button, this alarm can be avoided by inputting NC emergency stop at the same time.	○
		The contactor has not been turned OFF.	Check the investigation item No. 2.	
2	Check the repeatability.	The alarm occurs each time READY is turned ON.	Check the investigation item No. 3.	○
		The alarm occurs at a certain operation.	Check the investigation item No. 1. If there is no problem, check the investigation item No. 3.	
		The alarm occurs occasionally during operation.	Check the investigation item No. 4.	
3	Check whether the power input wire and contactor are correctly wired.	The wiring is incorrect.	Correctly connect.	○
		There is no problem.	Check the investigation item No. 4.	
4	Check the power voltage waveform with a synchroscope.	An instantaneous power failure or voltage drop occurs frequently.	Correct the power facility.	○
		There is no problem.	Replace the unit.	

Alarm No. 72		Power supply: Fan stop		
A cooling fan built in the power supply unit stopped, and overheat occurred in the power module.				
	Investigation details	Investigation results	Remedies	CV
1	Turn the unit power ON again, and confirm the rotation of the fan. Note) Assure more than 10 seconds for the time from when the power is turned OFF till when it is turned ON. For the fan used for the drive unit, assuring more than 10 seconds for the time from when the power is turned OFF till when it is turned ON is required.	The fan is rotating, and an alarm did not occur again.	Continue to use. The power may be turned ON without assuring more than 10 seconds for the time from when the power is turned OFF till when it is turned ON. Leave for more than 10 seconds, and turn the power ON again.	○
		The fan did not rotate. Or, an alarm occurred again.	Check the investigation item No. 2.	
2	Check if the connector connected to a fan is disconnected.	The connector is disconnected.	Correctly connect the connector.	○
		The connector is not disconnected.	Check the investigation item No. 3.	
3	Check if oil or cutting chips are adhered to the fan.	Oil or cutting chips are adhered.	Improve the use environment and replace the drive unit.	○
		Oil or cutting chips are not adhered. The cable may be broken.	Replace the drive unit.	

7 Troubleshooting

Alarm No. 73		Power supply: Over regeneration		
Over-regeneration detection level became over 100%. The regenerative resistor is overloaded. This alarm cannot be reset for 15 min from the occurrence. Leave the drive system energized for more than 15 min, then turn the power ON to reset the alarm.				
	Investigation details	Investigation results	Remedies	CV
1	Check the alarm occurrence state and regenerative load displayed on the NC Monitor screen while changing the operation mode.	<p>The regenerative load value increases when the power is turned ON and the motor is not rotated.</p> <p>The regenerative load value increases each time the motor decelerates, and the alarm occurs.</p> <p>The regenerative load value increases each time the motor decelerates, but the alarm does not occur when the operation mode is eased.</p>	<p>Check whether the state is affected by power fluctuation, grounding or noise. If there is no problem, replace the unit.</p> <p>A-CR: Check the investigation item No. 2. C1-CV: Check the investigation item No. 4.</p> <p>A-CR: Check the investigation item No. 2. C1-CV: Ease the operation mode.</p>	○
2	Check whether the parameter (regenerative resistor type) of the drive unit controlling the power supply unit is correct.	<p>The setting is incorrect.</p> <p>The setting is correct.</p>	<p>Correctly set. (Check the alarm No. "6D" items.)</p> <p>Check the investigation item No. 3.</p>	○
3	Check the regenerative resistor's state. [1] Is oil adhered? [2] Measure the resistance value.	<p>The regenerative resistor is abnormal.</p> <p>There is no problem.</p>	<p>Replace the regenerative resistor.</p> <p>Check the investigation item No. 4.</p>	○
4	Check the alarm No. "75" items.			○

Alarm No. 74		Power supply option unit error:			
An alarm was detected in the power backup unit (an option unit for the power supply).					
	Investigation details	Investigation results	Remedies	SV	SP
1	Check the LED display on the power backup unit.	Check the LED display on the power backup unit to identify what alarm is occurring to the unit.	<p>Fix the error occurring to the power backup unit and remove the alarm.</p> <p>Refer to MDS-E/EH Series Instruction Manual (IB-1501229(ENG)) "List of power backup function alarms".</p>	○	○

Alarm No. 75		Power supply: Overvoltage		
L+ and L- bus voltage in main circuit exceeded the allowable value. As the voltage between L+ and L- is high immediately after this alarm, another alarm may occur if this alarm is reset in a short time. Wait more than 5 min before resetting so that the voltage drops.				
	Investigation details	Investigation results	Remedies	CV
1	Check the repeatability.	<p>The alarm occurs each time the motor decelerates.</p> <p>The alarm occurs occasionally.</p>	<p>Check the investigation item No. 3.</p> <p>Check the investigation item No. 2.</p>	○
2	Check the power supply's alarm history.	<p>Auxiliary regeneration frequency over (E8) occurs just before the over-voltage occurs.</p> <p>Others.</p>	<p>Limit the occurrence of the excessive instantaneous regeneration by not decelerating multiple axes at the same time.</p> <p>Check the investigation item No. 3.</p>	○
3	Check the power capacity.	<p>The power capacity is insufficient.</p> <p>The specified power capacity is secured.</p>	<p>Increase the power capacity.</p> <p>Check the investigation item No. 4.</p>	○
4	Measure the voltage across wires. [1] Is the voltage 170V or more even when the motor is accelerating?	<p>The voltage drops to 170V or less occasionally.</p> <p>The difference of the voltage across wires is 10V or more.</p> <p>The difference of the voltage across wires is less than 10V.</p>	<p>Increase the power capacity.</p> <p>Improve the power phase balance.</p> <p>Check the investigation item No. 5.</p>	○
5	Measure the power voltage with a synchroscope, and check whether there is any distortion. [1] Are there any other devices causing the power distortion?	<p>The power voltage is distorted.</p> <p>The power voltage waveform is not abnormal.</p>	<p>Improve the source of the distortion. Install an AC reactor.</p> <p>Check the investigation item No. 6.</p>	○
6	Check if there is any abnormality in the unit's ambient environment. (Ex. Noise, grounding, etc.)	Take remedies according to the causes of the abnormality in the ambient environment.		○

Alarm No. 76		Power supply: Function setting error		
The rotary switch setting of external emergency stop is not correct, or a wrong external emergency stop signal is input.				
	Investigation details	Investigation results	Remedies	CV
1	Check the rotary switch setting.	When using external emergency stop, rotary switch is not set to "4".	Set the rotary switch to "4".	○
2	Check if there is any abnormality in the unit's ambient environment.	<p>No abnormality is found in particular.</p> <p>The grounding is incomplete.</p>	<p>Replace the drive unit.</p> <p>Take remedies according to the causes of the abnormality. Additionally ground and review.</p>	○

7 Troubleshooting

Alarm No. 77		Power supply: Power module overheat		
Thermal protection function in the power module has started its operation.				
	Investigation details	Investigation results	Remedies	CV
1	Confirm that the fan is properly rotating.	Large amounts of cutting oil or cutting chips, etc., are adhered, or the rotation is slow.	Clean or replace the fan.	○
		The fan is properly rotating.	Check the investigation item No. 2.	
2	Check whether the heat dissipating fins are dirty.	Cutting oil or cutting chips, etc., are adhered, and the fins are clogged.	Clean the fins.	○
		The fins are normal.	Check the investigation item No. 3.	
3	Measure the power supply unit's ambient temperature.	55°C or more	Improve the ventilation and cooling for the power distribution panel.	○
		Less than 55°C.	Check the investigation item No. 4.	
4	Check if there is any abnormality in the unit's ambient environment. (Ex. Ambient temperature, noise, grounding)	Take remedies according to the causes of the abnormality in the ambient environment.		○

Alarm No. 80		Main side encoder cable error			
A pulse type cable is used for the motor side encoder.					
	Investigation details	Investigation results	Remedies	SV	SP
1	Check the parameters. Servo:SV025 = "x200" Spindle:SP031 = "x200" And then, check the connected cable and the encoder.	The cable type is pulse.	Replace the cable to the serial type.	○	○
		There is no problem with the selection of the encoder and cable.	Replace the encoder or cable.		

7 Troubleshooting

Alarm No. 81		Sub side encoder cable error			
		The cable type of machine side encoder does not match the encoder specifications set by the parameter.			
	Investigation details	Investigation results	Remedies	SV	SP
1	Check if the below parameters match the connected encoder and cable. Servo: SV025 Spindle: SP031	The encoder does not match the specifications.	Replace the encoder.	○	○
		The parameter is not correct.	Set the parameters so that they meet the machine side encoder. <Servo:SV025> - Rotary Pulse 2xxx Serial 6xxx - Scale Pulse 8xxx Serial Axxx <Spindle:SP031> Pulse 4200 Serial 6200		
		There is no problem with the selection of the encoder and cable.	Replace the encoder or cable.		

Alarm No. 87		Drive unit communication error			
		The communication frame between drive units was aborted.			
	Investigation details	Investigation results	Remedies	SV	SP
1	Check the connection of the optical communication cable between drive units.	The cable and connector were loose.	Connect again so as not to be loosened.	○	○
		The cable and connector were not loose.	Replace the cable. Check the investigation item No. 2.		
2	Check the repeatability.	The error is always repeated (in high-speed synchronous tapping).	Replace the servo drive or spindle drive unit that is used for high-speed synchronous tapping.	○	○

Alarm No. 88		Watchdog			
		The system does not operate correctly. LED display is fixed as "88".			
	Investigation details	Investigation results	Remedies	SV	SP
1	Check whether the servo or spindle software version was changed recently.	The version was changed.	Change software version back to the original.	○	○
		The version was not changed.	Check the investigation item No. 2.		
2	Check the repeatability.	The error is always repeated.	Replace the drive unit.	○	○
		The state returns to normal once, but occurs sometimes thereafter.	Check the investigation item No. 3.		
3	Check if there is any abnormality in the unit's ambient environment. (Ex. Ambient temperature, noise, grounding)	Take remedies according to the causes of the abnormality in the ambient environment.		○	○

(Note) For MDS-EJ/EJH Series, "888" is displayed.

Alarm No. 8A		Drive unit communication data error 1			
		The communication data 1 between drive units exceeded the tolerable value in the communication between drive units.			
	Investigation details	Investigation results	Remedies	SV	SP
1	Check if the error has occurred during high-speed synchronous tapping.	The error occurs during the synchronous tapping.	[1]Check the tool. [2]Adjust the tapping.	○	○
		The error does not occur during the synchronous tapping.	Check the investigation item No. 2.		
2	Check the repeatability.	The error is always repeated.	Replace the drive unit.	○	○
		The state returns to normal once, but occurs sometimes thereafter.	Check the investigation item No. 3.		
3	Check if there is any abnormality in the unit's ambient environment. (Ex. Ambient temperature, noise, grounding)	Take remedies according to the causes of the abnormality in the ambient environment.		○	○

Alarm No. 8B		Drive unit communication data error 2			
		The communication data 2 between drive units exceeded the tolerable value in the communication between drive units.			
	Investigation details	Investigation results	Remedies	SV	SP
1	Check if the error was occurred during the synchronous tapping.	The error occurs during the synchronous tapping.	[1]Check the tool. [2]Adjust the tapping.	○	○
		Check if the error has occurred during high-speed synchronous tapping.	Check the investigation item No. 2.		
2	Check the repeatability.	The error is always repeated.	Replace the drive unit.	○	○
		The state returns to normal once, but occurs sometimes thereafter.	Check the investigation item No. 3.		
3	Check if there is any abnormality in the unit's ambient environment. (Ex. Ambient temperature, noise, grounding)	Take remedies according to the causes of the abnormality in the ambient environment.		○	○

7.3.3 Troubleshooting for Each Warning No.

Warning No.	Scale feedback error				
	An excessive difference in feedback amount was detected between the main side encoder and the MPI scale in MPI scale absolute position detection system.				
	Investigation details	Investigation results	Remedies	SV	SP
1	Check if there is any abnormality in the encoder's ambient environment. (Ex. Ambient temperature, noise, grounding)	Take remedies according to the causes of the abnormality in the ambient environment.		○	
2	Check the repeatability.	Occurs frequently.	Replace the encoder.	○	○
		Is not repeated.	Check the investigation item No. 1.		

Warning No.	Scale offset error				
	An error was detected in the offset data that is read at the NC power-ON in MPI scale absolute position detection system.				
	Investigation details	Investigation results	Remedies	SV	SP
1	Check if there is any abnormality in the encoder's ambient environment. (Ex. Ambient temperature, noise, grounding)	Take remedies according to the causes of the abnormality in the ambient environment.		○	
2	Check the repeatability.	Occurs frequently.	Replace the encoder.	○	○
		Is not repeated.	Check the investigation item No. 1.		

Warning No.	Incremental encoder/magnetic pole shift warning				
	For the incremental encoder, an error was detected in the magnetic pole shift amount set in the magnetic pole shift amount parameter "SV028".				
	Investigation details	Investigation results	Remedies	SV	SP
1	Check if there is any abnormality in the encoder's ambient environment. (Ex. Ambient temperature, noise, grounding)	Take remedies according to the causes of the abnormality in the ambient environment.		○	
2	Check the repeatability.	Occurs occasionally.	Execute magnetic pole detection control again and reset SV028.	○	
		Is not repeated.	Check the investigation item No. 1.		

Warning No.	Absolute position encoder: Revolution counter error				
	An error was detected in the revolution counter of the absolute position encoder. The absolute position data cannot be compensated.				
	Investigation details	Investigation results	Remedies	SV	SP
1	Check if there is any abnormality in the encoder's ambient environment. (Ex. Ambient temperature, noise, grounding)	Take remedies according to the causes of the abnormality in the ambient environment.		○	
2	Check if there is any liquid ingress inside the encoder connector.	Liquid was entered into the connector.	Replace the motor encoder.	○	○
		No liquid ingress.	Check the investigation item No. 1.		
3	Check the repeatability.	Occurs frequently.	Replace the encoder.	○	○
		Is not repeated.	Check the investigation item No. 1.		

7 Troubleshooting

Warning No.		Battery voltage drop				
9F		The battery voltage that is supplied to the absolute position encoder dropped. The absolute position data is retained.				
	Investigation details	Investigation results		Remedies	SV	SP
1	Change the used battery and check whether the warning does not occur. (Turning the power OFF and ON is required.)	The warning does not occur.		The battery has been drained.	○	
		The warning occurs.		Check the investigation item No. 2.		
2	Check whether the battery cable is disconnected, broken, or wired incorrectly.	The connection is faulty.		Correct the connection. Replace the cable.	○	
		The connection is normal.		Check the investigation item No. 3.		
3	Measure the new battery voltage.	Less than 4.8V.		Replace the battery.	○	
		4.8V or more.		Check the investigation item No. 6. When a battery box is used, check the investigation item No. 4.		
4	Check whether the cable connecting between the battery box and CN9 is short-circuited, broken, or wired incorrectly.	The connection is faulty.		Correct the connection. Replace the cable.	○	
		The connection is normal.		Check the investigation item No. 5.		
5	Disconnect the BT-LG cable of the battery box, and then measure the voltage between DO(ALM) and DOCOM terminals at power ON.	Low voltage.		Replace the battery box.	○	
		Equivalent of 24V.		Check the investigation item No. 6.		
6	Perform a conductivity check with the encoder cable between BT and LG of the drive unit in which the warning was detected. (Note) Make sure that the encoder side connector is disconnected.	Resistance value is low.		Replace the cable.	○	
		Resistance value is 100MΩ or more.		Replace the encoder. (With the absolute position system, the zero point must be established.)		

(Note 1) When warning 9F occurs, do not turn the drive unit power OFF to ensure that the absolute position data is held.
Replace the battery with the drive unit power ON.

Warning No.		In initial setup of ABS position				
A3		When the encoder with distance-coded reference marks is used, this warning is issued until the axis reaches the reference position during the initial setup of the distance-coded reference check function. This warning disappears after the axis has reached the position.				
	Investigation details	Investigation results		Remedies	SV	SP
1	Warning does not disappear.	Encoder with distance-coded reference marks	Stopped on the way to the reference position.	Setup again.	○	-

Warning No.		Dual signal warning				
A4		An input was detected in the signal related to the dual signal.				
	Investigation details	Investigation results		Remedies	SV	SP
1	Warning does not disappear.	In emergency stop state?		Cancel the emergency stop.	○	○

Warning No.		Fan stop warning				
A6		A cooling fan built in the drive unit stopped.				
	Investigation details	Investigation results		Remedies	SV	SP
1	Check the alarm No. "45" items.				○	○

Warning No.		Over regeneration warning				
E0		Over-regeneration detection level exceeded 80%.				
	Investigation details	Investigation results		Remedies	SV	SP
1	Check the alarm No. "30" items.				○	○

7 Troubleshooting

Warning No. E1		Overload warning			
		Overload detection level exceeded 80%.			
	Investigation details	Investigation results	Remedies	SV	SP
1	Check the alarm No. "50" items.			<input type="radio"/>	<input type="radio"/>

Warning No. E4		Set parameter warning			
		An incorrect parameter was detected among the parameters received from the CNC.			
	Investigation details	Investigation results	Remedies	SV	SP
1	Check the error parameter No.	SV001 to SV256 SP001 to SP256	Set the value within the designated setting range.	<input type="radio"/>	<input type="radio"/>
2	Check the spindle control input 4/bit 0 to 2.	Selected other than 000, 001, 010 and 100 when the alarm occurred.	Correctly select.		<input type="radio"/>

Warning No. E6		Control axis detachment warning			
		Control axis detachment was commanded.			
	Investigation details	Investigation results	Remedies	SV	SP
1	The status in which removal of the control axis was commanded from the NC is indicated.			<input type="radio"/>	

Warning No. E7		In NC emergency stop state			
		Emergency stop was input from the CNC.			
	Investigation details	Investigation results	Remedies	SV	SP
1	Check if the emergency stop is applied on the NC side.	The emergency stop is applied.	Check the investigation item No. 2.	<input type="radio"/>	<input type="radio"/>
		The emergency stop is cancelled.	Check the investigation item No. 3.		
2	Cancel the emergency stop.	Normally starts up.	Normal.	<input type="radio"/>	<input type="radio"/>
		"E7" remains displayed.	Check the investigation item No. 3.		
3	Check whether an alarm is occurring in another drive unit.	An alarm is occurring in another drive unit.	Reset the alarm in the other drive unit.	<input type="radio"/>	<input type="radio"/>
		An alarm is not occurring.	Check the investigation item No. 4.		
4	Turn the power of NC and 200VAC (400V) ON again			<input type="radio"/>	<input type="radio"/>

Warning No. E9		Instantaneous power interruption warning		
		The power was momentarily interrupted.		
	Investigation details	Investigation results	Remedies	CV
1	Check the alarm No. "4F" or "71" items.			<input type="radio"/>

Warning No. EA		In external emergency stop state		
		External emergency stop signal was input.		
	Investigation details	Investigation results	Remedies	CV
1	Check whether the specifications allow use of the external emergency stop.	Use is not allowed.	Invalidate the external emergency stop.	<input type="radio"/>
		Use is allowed.	Check the investigation item No. 2.	
2	Measure the input voltage of the external emergency stop connector of each unit.	24V is input.	Replace the power supply unit.	<input type="radio"/>
		24V is not input.	Check whether the external emergency stop cable is broken, or check the external contact operation.	

Warning No. EB		Power supply: Over regeneration warning		
		Over-regeneration detection level exceeded 80%.		
	Investigation details	Investigation results	Remedies	CV
1	Check the alarm No. "73" items.			<input type="radio"/>

Error parameter No.	Details	Related parameters
2236	For the MDS-E/EH Series: The power supply type (SV036) is set but a power supply unit is not connected. Always set the power supply type for the drive unit connected last on the NC optical communication cable.	SV036
	For the MDS-EM/EMH Series: Do not set the power supply type. It is set from the spindle side.	
	For the MDS-EJ/EJH Series: The selected regenerative resistor is not supported in the drive unit of this capacity.	
2261	When the DC excitation mode (SV034/bit4) is set, the initial DC excitation level (SV061) is set to a value outside the setting range.	SV034, SV061
2262	When the DC excitation mode (SV034/bit4) is set, the final DC excitation level (SV062) is set to a value outside the setting range.	SV034, SV062
2263	When the DC excitation mode (SV034/bit4) is set, the initial DC excitation time (SV063) is set to a value outside the setting range.	SV034, SV063
2281	-When the distance-coded reference scale (SV081/bit3) is set, the base reference mark interval (SV130) or the auxiliary reference mark interval (SV131) is not set. -When a HEIDENHAIN serial conversion interface unit is connected, the reference mark is set to be checked at 3 points (SV081/bit7=1).	SV025, SV081, SV130 SV131
2282	With a multiple-axis drive unit, the digital signal input selection (SV082/bitF-C) is set to a different value for each axis in the same unit.	SV082
2317	-The expansion sub side encoder resolution (SV117) is set to "0" for an encoder that requires the resolution expansion setting. If the upper 16 bits for the encoder resolution are 0, this should be set to "-1". -The expansion sub side encoder resolution (SV117) is set to a value other than "0" for an encoder that does not support the resolution expansion setting.	SV019,SV025,SV117
2318	-The expansion main side encoder resolution (SV118) is set to "0" for an encoder that requires the resolution expansion setting. If the upper 16 bits for the encoder resolution are 0, this should be set to "-1". -The expansion main side encoder resolution (SV118) is set to a value other than "0" for an encoder that does not support the resolution expansion setting.	SV020,SV025,SV118
2330	-The relation between the base reference mark interval (SV130) and the auxiliary reference mark interval (SV131) is invalid. -The base reference mark interval (SV130) is set to "0" when a distance-coded reference scale is connected. -The base reference mark interval (SV130) is set to a value other than "0" when a distance-coded reference scale is not connected. -The base reference mark interval (SV130) is set to a value other than "0" when the semi-closed loop is set .	SV018, SV025, SV130 SV131
2331	-The auxiliary reference mark interval (SV131) is not set when a distance-coded reference scale is connected. -The auxiliary reference mark interval (SV131) is set to a value other than "0" when a distance-coded reference scale is not connected.	SV130, SV131
2334	The distance-coded reference check / revolution counter (SV134) is set to a value other than "0" when the distance-coded reference scale is not set (SV081/bit3=0).	SV081, SV134
2335	- In the distance-coded reference scale system, the distance-coded reference check /position within one rotation High (SV135) is set to a value outside the motor side encoder's data range. - The distance-coded reference check /position within one rotation High (SV135) is set to a value other than "0" when the distance-coded reference scale is not set (SV081/bit3=0).	SV081, SV135, SV136
2336	The distance-coded reference check /position within one rotation Low (SV136) is set to a value other than "0" when the distance-coded reference scale is not set (SV081/bit3=0).	SV081, SV136
2337	The distance-coded reference check allowable width (SV137) is set to a value other than "0" when the distance-coded reference scale is not set (SV081/bit3=0).	SV081, SV137
2438	The safety observation safety speed (SV238) and the safety observation safety motor speed (SV239) dot not satisfy the following equation. (Round down the first decimal place. When the calculation results in "0", set SV239 to 1.) $\frac{SV238 : SSCFEED}{SV018 : PIT} \times \frac{SV002 : PC2}{SV001 : PC1} = SV239 : SSCRPM$	SV238,SV239
2439	The safety observation safety motor speed (SV239) is set to a value greater the overspeed detection motor speed.	SV239
2450	The base reference mark interval in the distance-coded reference scale is invalid.	SV019,SV117,SV130
2454	The absolute position detection is enabled when an incremental encoder is connected as an position encoder.	SV025, #2049
2455	The following settings are overflowing: -Electronic gear -Position loop gain -Conversion from the speed detection unit to position detection unit	SV001,SV002,SV003,SV018,SV019,SV020,SV049,SV117,SV118

(2) Spindle parameter error No.

Error parameter No.	Details	Related parameters
13017	The motor selected is of a motor series different from the drive unit's input voltage (200V/400V). Or a motor of an incompatible motor series is selected.	SP017
13032	For the MDS-E/EH Series: The power supply type (SP032) is set, but a power supply unit is not connected. Always set the power supply type for the drive unit connected last on the NC optical communication cable.	SP032
	For the MDS-EM/EMH Series: Set SP032 to 0019 (normal setting), or 0059 (external emergency stop function).	
	For the MDS-EJ/EJH Series: The selected regenerative resistor is not supported in the drive unit of this capacity.	
13097	-The expansion sub side encoder resolution (SP097) is set to "0" for an encoder that requires the resolution expansion setting. If the upper 16 bits for the encoder resolution are "0", this should be set to "-1". -The expansion sub side encoder resolution (SP097) is set to a value other than "0" for an encoder that does not support the resolution expansion setting.	SP019,SP031,SP097
13098	-The expansion main side encoder resolution (SP098) is set to "0" for an encoder that requires the resolution expansion setting. If the upper 16 bits for the encoder resolution are 0, this should be set to "-1". -The expansion main side encoder resolution (SP098) is set to a value other than "0" for an encoder that does not support the resolution expansion setting.	SP020,SP031,SP098
13125	When the DC excitation mode (SP225/bit4) is set, the initial DC excitation level (SP125) is set to a value outside the setting range.	SP225, SP125
13126	When the DC excitation mode (SP225/bit4) is set, the final DC excitation level (SP126) is set to a value outside the setting range.	SP225, SP126
13127	When the DC excitation mode (SP225/bit4) is set, the initial DC time (SP127) is set to a value outside the setting range.	SP225, SP127
13142	-The pulse application time for an IPM spindle motor is excessive. Set the pulse application time (SP142) to a value lower than 350μs. -The coil switch function is disabled and the pulse application coil for an IPM spindle motor is set to the low-speed coil. Set the pulse application coil to the high-speed coil, or enable the coil switch function.	SP017,SP018,SP142, SP226
13225	The DC excitation mode (SP225/bit4) has been set before the axis passes the Z phase. Set the DC excitation mode after the axis passes the Z phase.	SP225
13238	The safety observation safety speed (SP238) and the safety observation safety motor speed (SP239) do not satisfy the following equation: (Round down the first decimal place. When the calculation results in "0", set SP239 to 1.) $\frac{SP238 : SSCFEED}{360} \times \frac{SP057 : GRA1}{SP061 : GRB1} = SP239 : SSCRPM$	SP238,SP239
13239	The safety observation safety motor speed calculated from the actual gear ratio exceeds the overspeed detection motor speed. (Note) The safety observation safety motor speed calculated from the actual gear ratio = SP238:SSCFEED / 360 × PC2 / PC1 PC2: Spindle side gear ratio (SP057 to SP060) PC1: Motor side gear ratio (SP061 to SP064)	SP239
13255	The following settings are overflowing: -Electronic gear and motor side gear -Position loop gain -Conversion from the speed detection unit to position detection unit	SP057 to SP060 SP061 to SP064 SP001 to SP003 SP019, SP020

7.3.5 Troubleshooting the Spindle System When There Is No Alarm or Warning

If an abnormality is observed in the spindle system but no alarm or warning has occurred, refer to the following table and check the state.

[1] The rotation speed command and actual rotation speed do not match.

	Investigation item	Investigation results	Remedies
1	Check the commanded speed and the spindle rotation speed displayed on the drive monitor screen.	The speed command is not input correctly.	Input the correct speed command.
		The speed command is correct.	Check the investigation item No. 2.
2	Check whether there is slipping between the motor and spindle. (When connected with a belt or clutch.)	There is slipping.	Repair the machine side.
		No particular problems found.	Check the investigation item No. 3.
3	Check the spindle parameters (SP026, SP129 and following).	The correct values are not set.	Set the correct values.
		The correct values are set.	Replace the spindle drive unit.

[2] The acceleration/deceleration time is long or has increased in length.

	Investigation item	Investigation results	Remedies
1	Check whether the friction torque or load inertia has increased.	The friction torque has increased.	Repair the machine side.
		No particular problems found.	Check the investigation item No. 2.
2	Check if there is any abnormality in the motor's rotation during coasting.	The bearings do not rotate smoothly.	Replace the spindle motor.
		The bearings rotate smoothly.	Check the investigation item No. 3.
3	Check whether the torque limit signal has been input.	The signal has been input.	Release the input signal.
		The signal is not input.	Replace the drive unit.

[3] The motor stops during cutting.

	Investigation item	Investigation results	Remedies
1	Check the load rate (load meter value) during cutting.	The load meter sways over 120% during cutting.	Reduce the cutting amount.
		No particular problems found.	Check the investigation item No. 2.
2	Carry out the same investigations and remedies as section (4).		

[4] The vibration and noise (gear noise), etc., are large.

	Investigation item	Investigation results	Remedies
1	Check the machine's dynamic balance. (Coast from the maximum speed.)	The same noise is heard during coasting.	Repair the machine side.
		No particular problems found.	Check the investigation item No. 2.
2	Check whether there is a resonance point in the machine. (Coast from the maximum speed.)	Vibration and noise increase at a set rotation speed during coasting.	Repair the machine side.
		No particular problems found.	Check the investigation item No. 3.
3	Check the machine's backlash.	The backlash is great.	Repair the machine side.
		No particular problems found.	Check the investigation item No. 4.
4	Change the setting of the speed loop parameter (SP005:VGN1).	The vibration and noise are lost when the setting value is lowered by approx.100.	Change to the setting value. (Note) The impact response will drop.
		The symptoms do not change even if the above value is set.	Return the setting values to the original values. Check the investigation item No. 5.
5	Jiggle the encoder connectors (drive unit side and encoder side) and check if they are disconnected.	The connection is loosened.	Correctly connect the connector.
		The connector fixing is normal.	Check the investigation item No. 6.
6	Turn the power OFF, and check the connection of the speed encoder cable with a tester.	The connection is faulty or disconnected.	Replace the encoder cable. Correct the connection.
		The connection is normal.	Replace the drive unit.

[5] The spindle coasts during deceleration.

	Investigation item	Investigation results	Remedies
1	When connected with a belt or clutch, check whether there is slipping between the motor and spindle.	There is slipping.	Check the machine side and repair it.
		No particular problems found.	Replace the drive unit.

[6] The rotation does not stabilize.

	Investigation item	Investigation results	Remedies
1	Check the spindle parameter SP005 (SP008) settings.	The rotation stabilizes when the settings values are both set to approx. double.	Change the setting value. Note that the gear noise may increase.
		The symptoms do not change even when the above value is set.	Return the setting values to the original values. Check the investigation item No. 2.
2	Manually shake the speed encoder connectors (spindle drive unit side and speed encoder side) to check if they are disconnected.	The connector is disconnected (or loose).	Correctly connect the connector.
		The connector is not disconnected (or loose).	Check the investigation item No. 3.
3	Turn the power OFF, and check the connection of the speed encoder cable with a tester. (Especially check the shield wiring.)	The connection is faulty.	Replace the encoder cable. Correct the connection.
		The connection is normal.	Check the investigation item No. 4.
4	Investigate the wiring and installation environment. 1) Is the ground correctly connected? 2) Are there any noise-generating devices near the drive unit?	1) The grounding is incomplete.	Correctly ground.
		2) The alarm occurs easily when a specific device operates.	Use noise measures on the device described on the left.
		No particular problems found.	Replace the spindle drive unit.

[7] The speed does not rise above the command speed sometimes.

	Investigation item	Investigation results	Remedies
1	Check the speed command. Check whether the override input is input from the machine operation panel.	The speed command is not input correctly.	Input the correct speed command.
		The speed command is input correctly.	Check the investigation item No. 2.
2	Check whether the load has suddenly become heavier.	The load has become heavier.	Repair the machine side.
		No particular problems found.	Check the investigation item No. 3.
3	Manually rotate the motor bearings and check the movement.	The bearings do not rotate smoothly.	Replace the spindle motor.
		The bearings rotate smoothly.	Check the investigation item No. 4.
4	Manually shake the speed encoder connectors (spindle drive unit side and speed encoder side) to check if they are disconnected.	The connector is disconnected (or loose).	Correctly connect the connector.
		The connector is not disconnected (or loose).	Check the investigation item No. 5.
5	Turn the power OFF, and check the connection of the speed encoder cable with a tester. (Especially check the shield wiring.)	The connection is faulty.	Replace the encoder cable. Correct the connection.
		The waveform is normal.	Replace the spindle drive unit.

7.3.6 Details of Alarm 4D

If dual signal error (4D) occurs, the sub-number and the axis name will appear on the NC Diagnosis screen as shown below. Take measures for each sub-number referring to the following table.

S03 Servo error 004D.□□□ ○○

□□□ : Sub-number

○○ : Axis name

Sub-No.	Name	Alarm details	Investigation details	Remedies
1	Power shutoff error	Either of the STO signals entered an input state while the STO function is disabled.	Check if the connector to disable STO on the front of the drive unit is loosened.	Connect the connector to disable STO correctly.
			No abnormality is found in particular.	Replace the drive unit.
2	Illegal power shutoff error	Either of the STO signals entered an input state during servo ON command or during deceleration and stop with the STO function enabled.	Check if the STO sequence on the NC side (safety ladder side) issues the STO command before the servo OFF command.	Set correctly.
			No abnormality is found in particular.	Replace the drive unit.
3	STO signal mismatch error	Input states of two STO signals were mismatched while the STO function is enabled.	Check if the two STO output timings of the remote I/O unit are matched.	Set correctly.
			No abnormality is found in particular.	Replace the drive unit.
15	Safety communication: Communication error 1	A receiving error was detected in the safety communication.	Check if there is any abnormality in the unit's ambient environment. (Ex. Noise, grounding)	Take remedies according to the causes of the abnormality in the ambient environment.
			No abnormality is found in particular.	Replace the drive unit.
16	Safety communication: Initial communication error 1	A receiving error was detected in the initial communication for the safety communication.	Check if there is any abnormality in the unit's ambient environment. (Ex. Noise, grounding)	Take remedies according to the causes of the abnormality in the ambient environment.
			No abnormality is found in particular.	Replace the drive unit.
17	Voltage diagnosis error	A power error was detected in the safety function.	The alarm is on the drive unit side.	Replace the drive unit.
19	DRAM diagnosis error	A DRAM error was detected in the safety function.	The alarm is on the drive unit side.	Replace the drive unit.
21	Control process error	An error was detected in the status of software execution for the safety function.	The alarm is on the drive unit side.	Replace the drive unit.
23	Safety encoder: Initial communication error 1	An error was detected in the initial communication with a safety encoder.	Turn the power OFF, and check the encoder cable connection with a tester.	Replace the encoder cable.
			No abnormality is found in particular.	Replace the encoder.
24	PCB error	A PCB error was detected in the safety function.	The alarm is on the drive unit side.	Replace the drive unit.
25	Synchronization error	A synchronization error was detected in the safety function.	Check if there is any abnormality in the unit's ambient environment. (Ex. Noise, grounding)	Take remedies according to the causes of the abnormality in the ambient environment.
			No abnormality is found in particular.	Replace the drive unit.
26	Flash ROM diagnosis error	A Flash ROM error was detected in the safety function.	The alarm is on the drive unit side.	Replace the drive unit.
33	Safety encoder: Communication error 1	An error was detected in the communication with a safety encoder.	Turn the power OFF, and check the encoder cable connection with a tester.	Replace the encoder cable.
			No abnormality is found in particular.	Replace the encoder.
34	Safety encoder: Diagnosis error 1	An error was detected in the encoder.	The alarm is on the encoder side.	Replace the encoder.
35	Safety encoder: Diagnosis error 2	An error was detected in the encoder.	The alarm is on the encoder side.	Replace the encoder.
36	Safety encoder: Diagnosis error 3	An error was detected in the encoder.	The alarm is on the encoder side.	Replace the encoder.
37	Safety encoder: Diagnosis error 4	An error was detected in the encoder.	The alarm is on the encoder side.	Replace the encoder.
39	Non-safety encoder: Position feedback fixation diagnosis error	The position feedback from the non-safety encoder remains unchanged.	Check the safety parameters.	Set correctly.
			The alarm is on the encoder side.	Replace the encoder.
40	Safety encoder: Thermal error	The safety encoder detected a thermal error.	The alarm is on the encoder side.	Replace the encoder.
53	Safety communication: Transmission interval mismatch error	An error was detected in the transmission interval setting sent from the NC.	Check the safety parameters.	Set correctly.
			Check if there is any abnormality in the unit's ambient environment. (Ex. Noise, grounding)	Take remedies according to the causes of the abnormality in the ambient environment.
			No abnormality is found in particular.	Replace the drive unit.

7 Troubleshooting

Sub-No.	Name	Alarm details	Investigation details	Remedies
54	Safety communication: Initial communication error 2	A receiving error was detected in the initial communication for the safety communication.	Check the safety parameters.	Set correctly.
			Check if there is any abnormality in the unit's ambient environment. (Ex. Noise, grounding)	Take remedies according to the causes of the abnormality in the ambient environment.
			No abnormality is found in particular.	Replace the drive unit.
55	Safety communication: Communication error 2	A receiving error was detected in the safety communication.	Check the safety parameters.	Set correctly.
			Check if there is any abnormality in the unit's ambient environment. (Ex. Noise, grounding)	Take remedies according to the causes of the abnormality in the ambient environment.
			No abnormality is found in particular.	Replace the drive unit.
56	Safety parameter setting range error	A setting error was detected in the safety parameter.	Check the safety parameters.	Set correctly.
			No abnormality is found in particular.	Replace the drive unit.
57	Safety parameter combination error	A combination error was detected in the safety parameter.	Check the safety parameters.	Set correctly.
			No abnormality is found in particular.	Replace the drive unit.
65	Register diagnosis error	A register diagnosis error was detected in the safety function.	The alarm is on the drive unit side.	Replace the drive unit.
66	Calculation device diagnosis error	An error was detected in the calculation device diagnosis for the safety function.	The alarm is on the drive unit side.	Replace the drive unit.
67	Sequence diagnosis error	An error was detected in the sequence diagnosis for the safety function.	The alarm is on the drive unit side.	Replace the drive unit.
68	Stack diagnosis error	An error was detected in the stack diagnosis for the safety function.	The alarm is on the drive unit side.	Replace the drive unit.
69	Temperature diagnosis error	An error was detected in the temperature.	Check if there is any abnormality in the temperature environment.	Take remedies according to the causes of the abnormality in the ambient environment.
			No abnormality is found in particular.	Replace the drive unit.
71	Watchdog error	The safety function is not operating correctly.	The alarm is on the drive unit side.	Replace the drive unit.
72	Clock diagnosis error	An error was detected in the clock diagnosis for the safety function.	The alarm is on the drive unit side.	Replace the drive unit.
74	DO output compare error	An error was detected in the status of DO output for the safety function.	The alarm is on the drive unit side.	Replace the drive unit.
75	ISC communication error	An error was detected in the inter-system communication for the safety function.	Check if there is any abnormality in the unit's ambient environment. (Ex. Noise, grounding)	Take remedies according to the causes of the abnormality in the ambient environment.
			No abnormality is found in particular.	Replace the drive unit.
78	Safety communication: Initial communication error 3	A receiving error was detected in the initial communication for the safety communication.	Check if there is any abnormality in the unit's ambient environment. (Ex. Noise, grounding)	Take remedies according to the causes of the abnormality in the ambient environment.
			No abnormality is found in particular.	Replace the drive unit.
88	Safety circuit: STO error	An error was detected in the read-back diagnosis for STO.	Check if there is any abnormality in the unit's ambient environment. (Ex. Noise, grounding)	Take remedies according to the causes of the abnormality in the ambient environment.
			No abnormality is found in particular.	Replace the drive unit.
91	Safety circuit: SBC error	An error was detected in the read-back diagnosis for SBC.	Check the wiring for motor brakes.	Correctly connect according to the starting method of the motor brakes.
			No abnormality is found in particular.	Replace the drive unit.
126	Safety communication: Communication error 3	A receiving error was detected in the safety communication.	Check if there is any abnormality in the unit's ambient environment. (Ex. Noise, grounding)	Take remedies according to the causes of the abnormality in the ambient environment.
			No abnormality is found in particular.	Replace the drive unit.

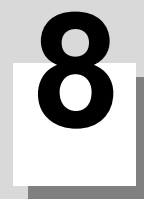

Maintenance

 **WARNING**

1. Before starting maintenance or inspections, turn the main circuit power and control power both OFF.
Wait at least fifteen minutes for the CHARGE lamp to turn OFF, and then using a tester, confirm that the input and output voltage are zero. Failure to observe this could lead to electric shocks.
2. Inspections must be carried out by a qualified technician. Failure to observe this could lead to electric shocks. Contact your nearest Mitsubishi branch or dealer for repairs and part replacement.

 **CAUTION**

1. Never perform a megger test (measure the insulation resistance) of the drive unit.
Failure to observe this could lead to faults.
2. The user must never disassemble or modify this product.

8.1 Periodic Inspections

8.1.1 Inspections

Periodic inspection of the following items is recommended.

- [1] Are any of the screws on the terminal block loose? If loose, tighten them.
- [2] Is any abnormal noise heard from the servo motor bearings or brake section?
- [3] Are any of the cables damaged or cracked? If the cables move with the machine, periodically inspect the cables according to the working conditions.
- [4] Is the core of the load coupling shaft deviated?

8.1.2 Cleaning of Spindle Motor

If you continue to use the spindle motor with dirt such as oil mist and dust adhered, its cooling performance degrades and the motor is unable to fully exercise its performance, which may cause the spindle motor overheat alarm. In some cases this may result in damage to the bearing or cooling fan. To ensure the cooling capability of the spindle motor's fan, carry out periodical cleaning of the spindle motor and its cooling fan according to the following cleaning procedure.

Note that the spindle motor SJ-D Series and the spindle motor SJ-VL Series is used as an example in this procedure. When cleaning the other spindle motors, carry it out based on this procedure.

 **CAUTION**

Do not touch the motor for some time after turning OFF the power, as the motor remains at a high temperature. This may lead to burns.

< For the spindle motor SJ-D Series >

- (1) Detaching the cooling fan unit
Remove the cooling fan unit from the spindle motor.

- [1] Remove fixing screws (hexagon socket screws at four locations) for the terminal box cover.

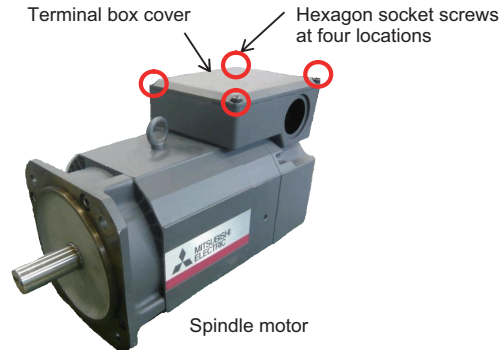

- [2] Remove the terminal box cover.

- [3] Remove the three lead wires (BU, BV, and BW) for the cooling fan from the one-touch terminal block.

[3-1] Applicable flat-blade screwdriver

Always use a flat-blade screwdriver whose blade edge size is 0.6×3.5mm for working.
(SZF1-0.6×3.5 manufactured by Phoenix Contact)

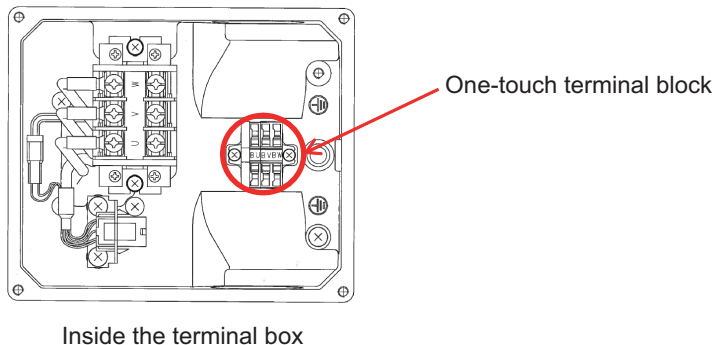

- [3-2] Insert the screwdriver into the insertion point (small square hole) of the one-touch terminal block in a diagonal direction. When the spring touches the blade edge, push the screwdriver down to the position that hits a conductive plate to the direction of arrow (a), tilting it in the inside direction of the terminal block. The screwdriver is held if it inserts appropriately.

- [3-3] After confirming that the spring is open, slowly unplug the lead wires for the cooling fan to the direction of arrow (b).

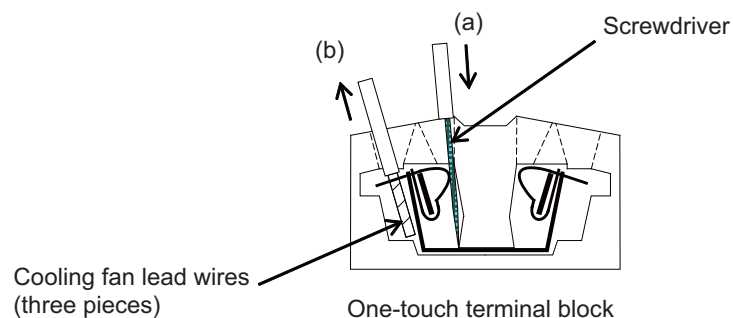

(Note 1) Do not let foreign objects enter the motor. In particular, if conductive objects such as screws or metal wires, etc., or combustible materials such as oil enter, the motor could be damaged.

- [4] Remove the fixing screws (hexagon socket screws at four locations) for the cooling fan unit.

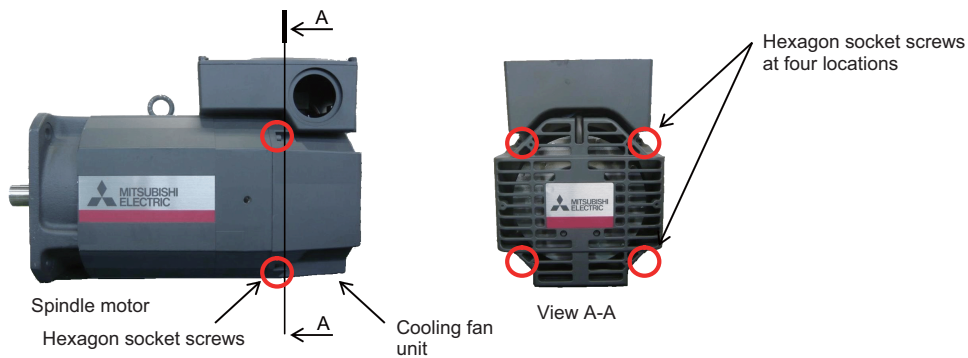

(Note 1) Some spindle motors have the fixing screws (hexagon socket screws) for the cooling fan unit at two locations.

- [5] Slowly unplug the lead wire of the cooling fan from the section where the lead wire for the cooling fan is led out. At this time, slowly unplug the protection tube which protects the lead wire for the cooling fan together. Slowly unplug the protection tube by pushing it out from inside the terminal box or pulling it from outside the terminal box not to overload the cooling fan side.

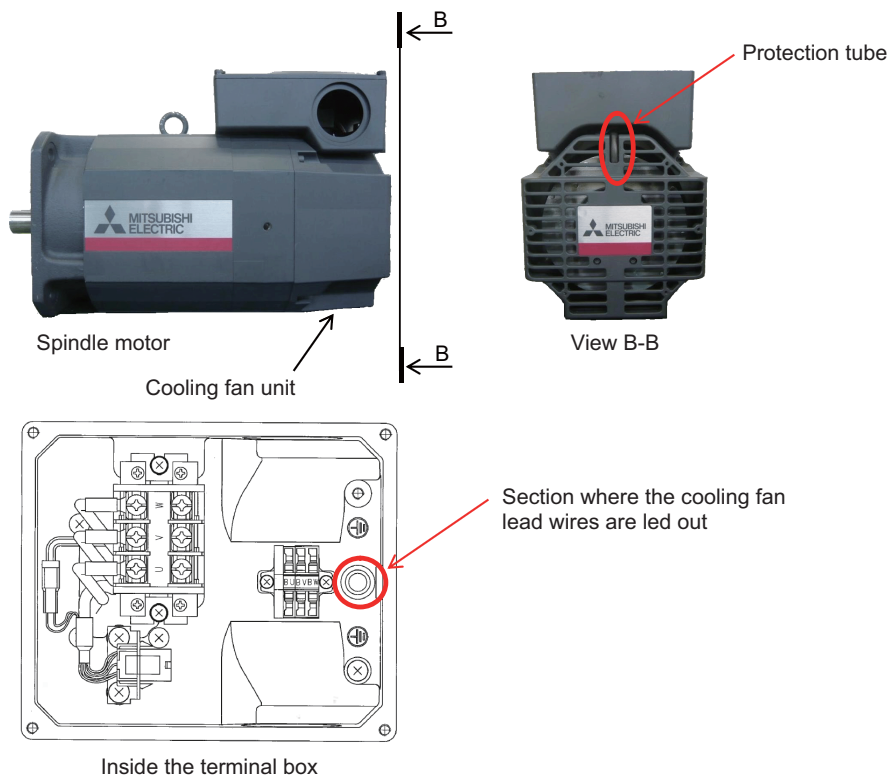

(Note 1) Take special care not to damage the lead wire for the cooling fan.

[6] Slowly remove the cooling fan unit in the direction of arrow (c).

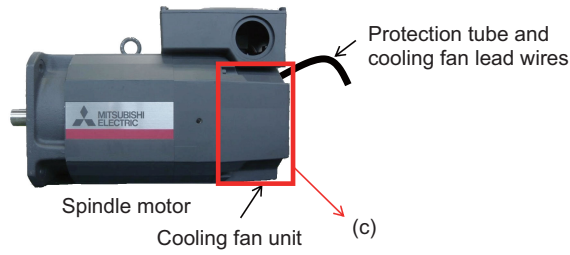

(Note 1) Do not strike the side face of the cooling fan unit. Failure to observe this may result in damages of the fan unit.

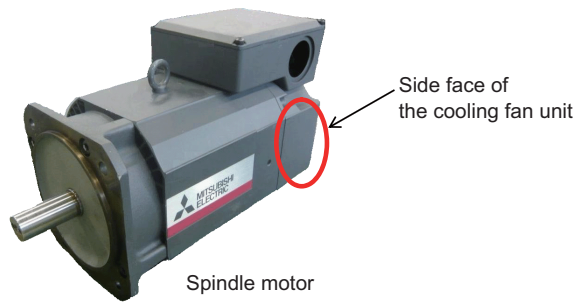

(Note 2) Perform it so as not to touch the edge part of the cooling fan unit. Failure to observe this may result in injury.

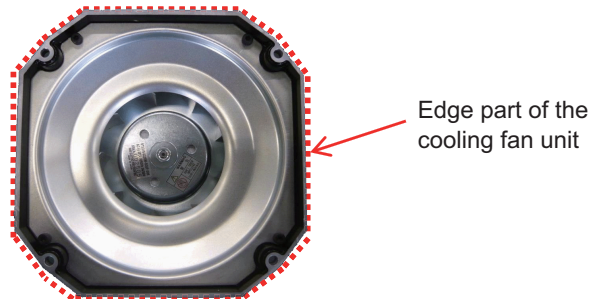

(Note 3) Do not grip the cooling fan lead wire (including the protection tube) when carrying the cooling fan unit. Carrying with gripping them may result in damages of the fan unit.

(2) Removal of the bellmouth inside the cooling fan unit

- [1] Remove the bellmouth fixing screws (hexagon socket screws at four locations).

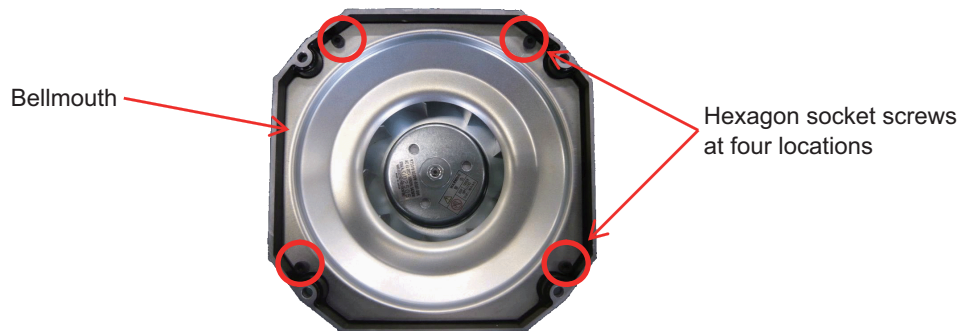

Cooling fan unit (before the bellmouth is removed)

(Note 1) Some spindle motors have the bellmouth fixing screws (hexagon socket screws) at two locations.

- [2] Remove the bellmouth.

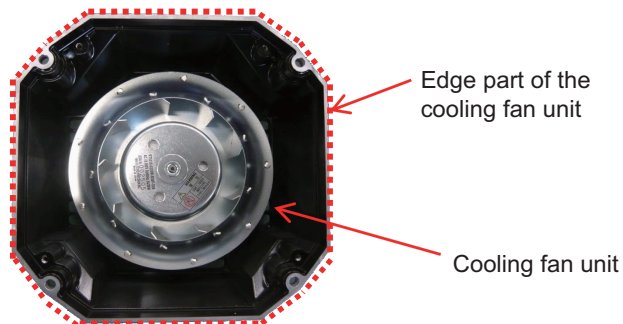

Cooling fan unit (after the bellmouth is removed)

(Note 1) Perform it so as not to touch the edge part of the cooling fan unit or the end part of the bellmouth. Failure to observe this may result in injury.

(Note 2) Do not let bellmouth fixing screws enter the cooling fan unit. Failure to observe this could lead to breakage or faults of the cooling fan.

(3) Cleaning

- [1] Check the situation of the cooling fan blade part and inside the case of the cooling fan unit by visual inspection.

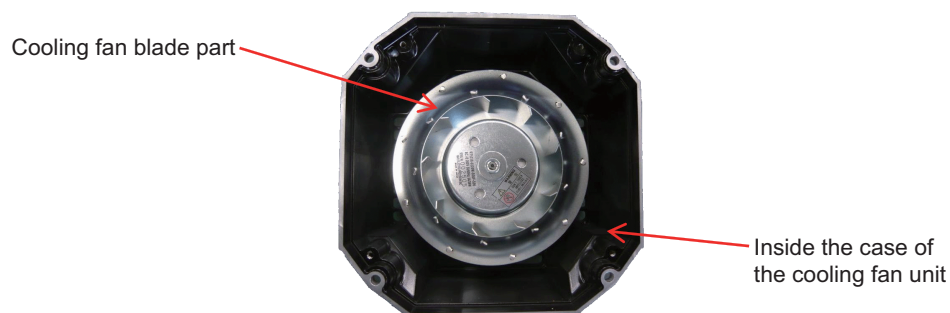

- [2] Clean up the inside of the cooling fan unit and the cooling air vent.
Wipe dirt off the inside of the cooling fan unit and the cooling air vent using wastes, etc.

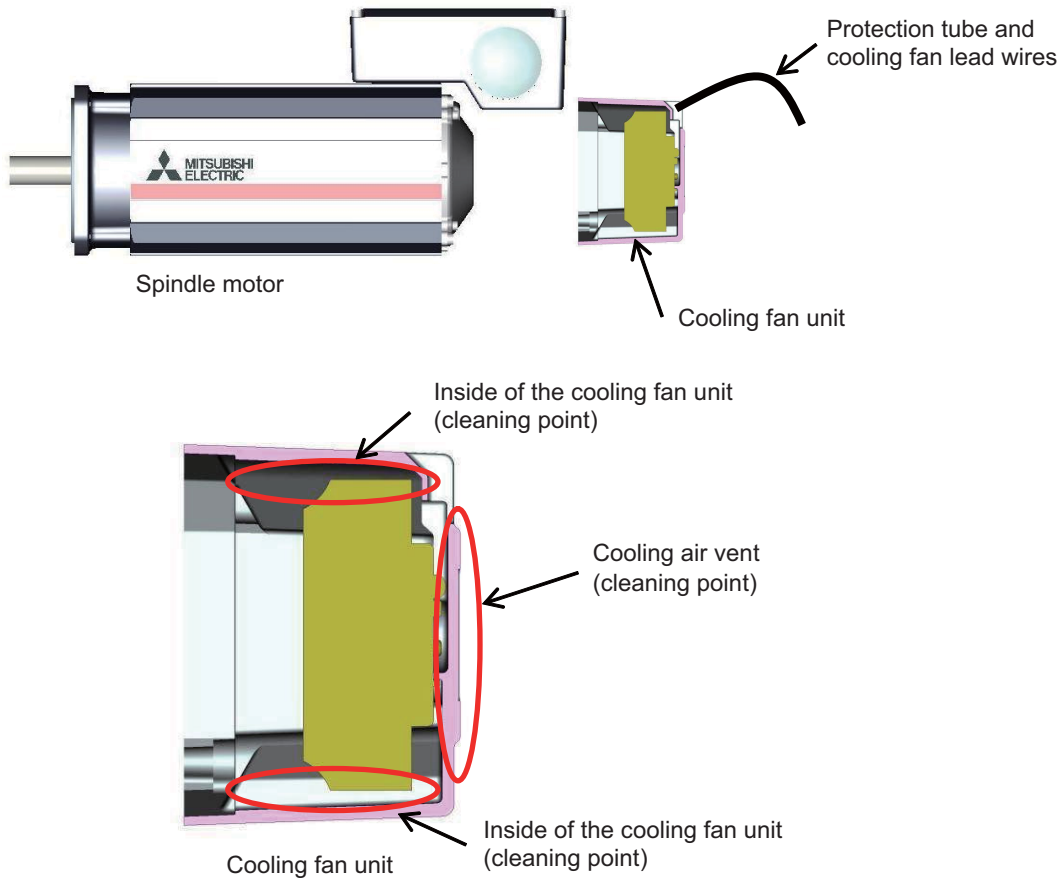

- (Note 1) Never disassemble or modify the cooling fan. Failure to observe this could lead to breakage or faults of the cooling fan.
- (Note 2) Do not drop the cooling fan or immerse it in water. Failure to observe this could lead to breakage or faults of the cooling fan.
- (Note 3) Do not use air blow as this may cause foreign matters to enter the inner part of the cooling fan motor.
- (Note 4) Do not wash with liquid detergent as the cooling fan motor is an electrical appliance.
- (Note 5) Take extra care not to damage the cooling fan during cleaning.

- [3] Clean up the air duct of the spindle motor frame
[3-1] Prepare the cleaning jigs (two types) as illustrated below.

The main body of the jigs A and B is a wire stick (approx. $\Phi 2\text{mm}$) with the length of approx. 500mm. A brush is attached at the top of the cleaning jig B. For the brush on the jig B, do not choose a hard brush such as the one made of wires.

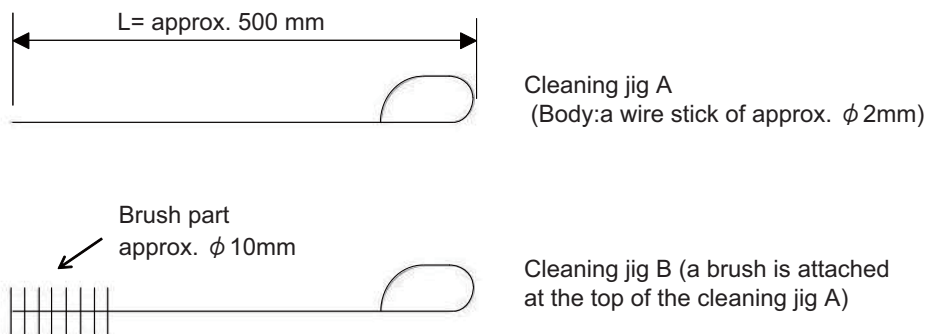

[3-2] Use the cleaning jigs to clean the air ducts of the spindle motor frame.

Insert the cleaning jigs A and B into the motor frame's air ducts from the counter-load side of the spindle motor, scrape out the dirt, and wipe it off with wastes, etc.

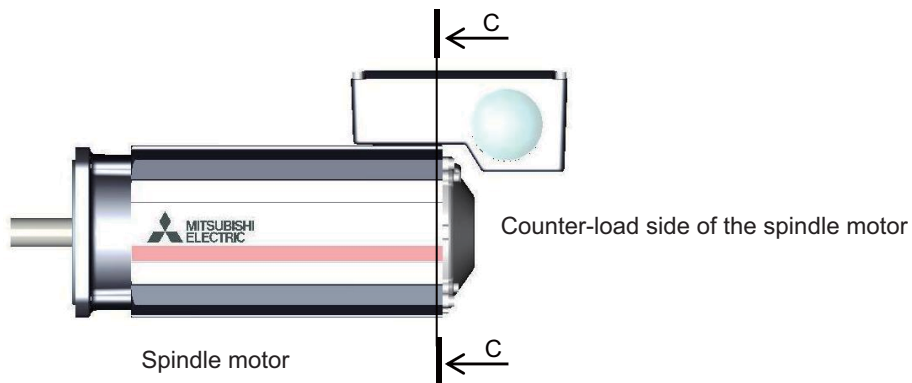

Counter-load side of the spindle motor

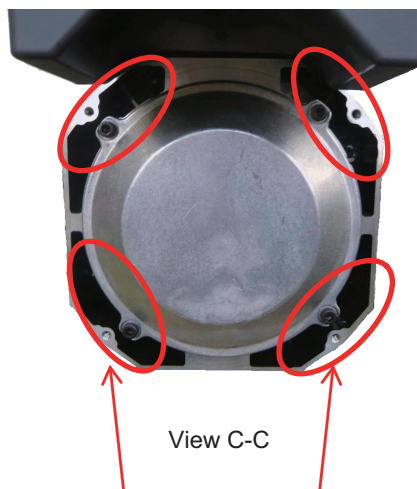

Motor frame's air ducts (cleaning points)

(4) Assembling

[1] After all the cleaning processes have been completed, attach the cooling fan unit to the motor in the order opposite to that of the detachment process.

[2] Precautions in installing cooling fan unit

(a) The section where the cooling fan lead wires are led out must be in the state without a space by inserting a protection tube for the cooling fan. A space could lead to faults of the motor by allowing foreign matters enter there.

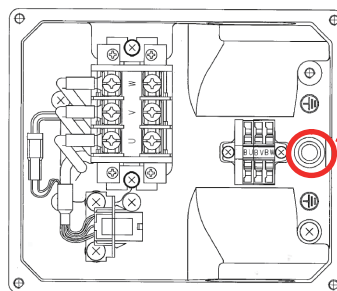

Section where the cooling fan lead wires are led out

Inside the terminal box

- (b) Draw the lead wires including the protection tube of the cooling fan unit into the terminal box not to project at the back side of the motor. Failure to observe this could lead to breakage of the lead wires.

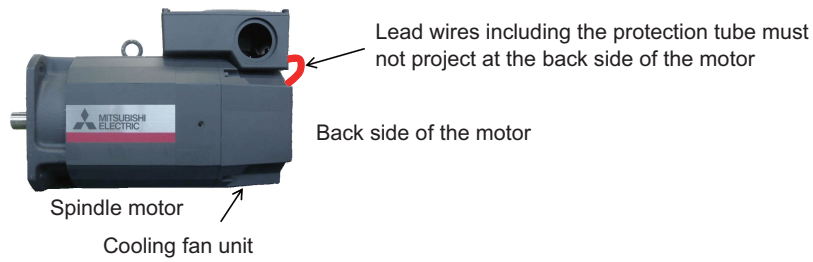

- (c) When installing the three lead wires (BU, BV, and BW) of the cooling fan to the one-touch terminal block, do not mistake the terminal connections. Improper connection could lead to breakage or malfunction.
- (d) Make sure not to pinch the cooling fan lead wire when installing the terminal box cover. Failure to observe this could lead to electric shocks.

[3] After attaching the unit, perform a test run to check the air blow direction of the fan, etc.

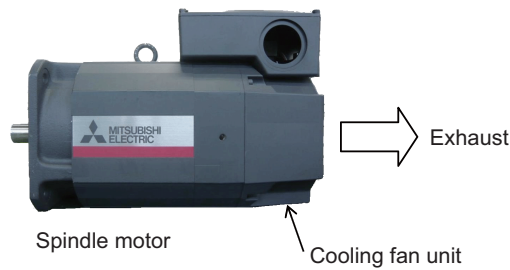

< For the spindle motor SJ-VL Series >

(1) Detaching the cooling fan unit

Remove the cooling fan unit from the spindle motor.

[1] Disconnect the cooling fan's terminals from the terminal block (See the diagram below).

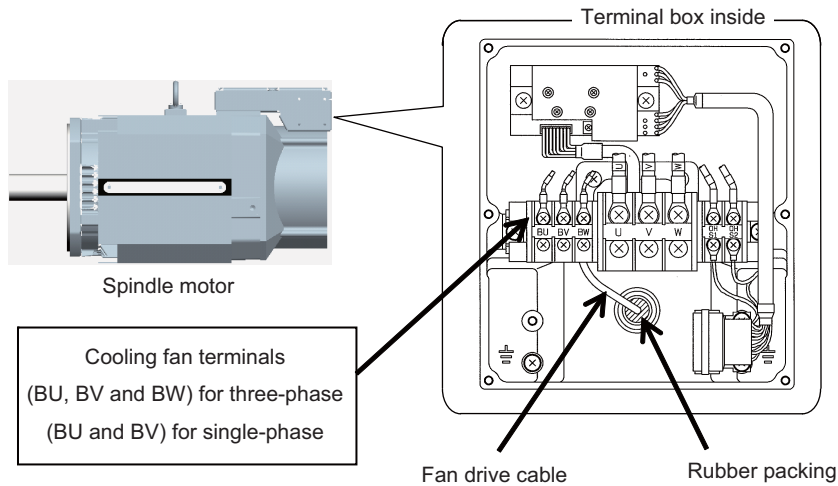

[2] Detach the cooling fan unit from the spindle motor.

Remove the four hexagon socket screws used to secure the cooling fan unit to the spindle motor.

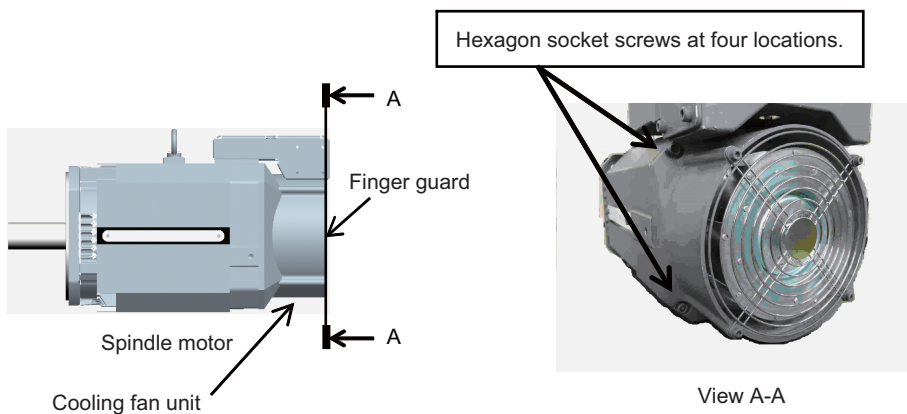

When slowly removing the cooling fan unit from the spindle motor, also unplug the fan drive cable slowly with the rubber packing left in the terminal box.

(Note 1) Pull out the solderless terminals one by one as the hole on the terminal box is small.

(Note 2) Take extra care not to damage the cable.

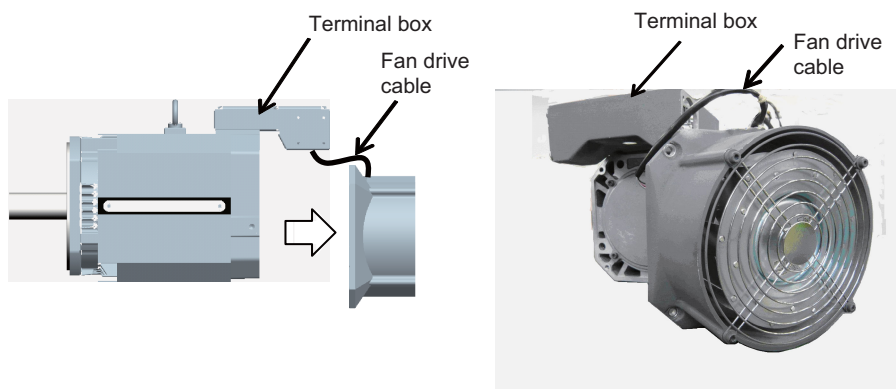

(2) Cleaning

(a) Clean up the backside of the cooling fan unit and the air duct in the counter-load side bracket of the spindle motor. Wipe dirt off the backside of the cooling fan unit and the air duct of the counter-load side bracket using wastes, etc.

(Note 1) Do not use air blow as this may cause foreign matters to enter the inner part of the cooling fan motor.

(Note 2) Do not wash with liquid detergent as the cooling fan motor is an electrical appliance.

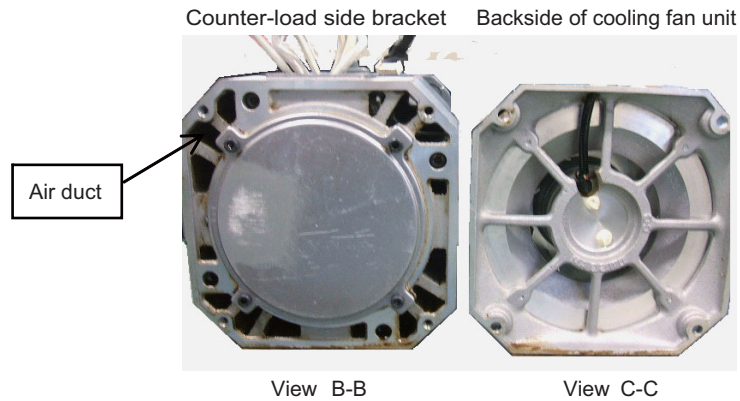
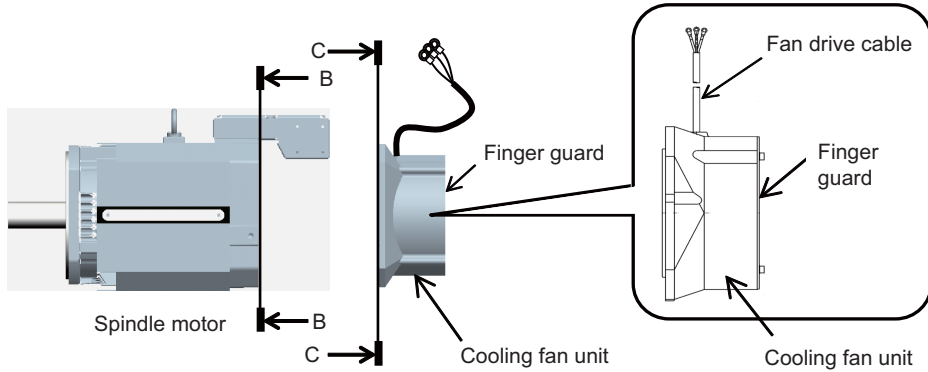

(b) Clean up the inner part of the fan case and the air duct of the spindle motor body

[1] Prepare the cleaning jigs (two types) as illustrated below.

The main body of the jigs A and B is a wire stick (approx. $\Phi 2\text{mm}$) with the length of approx. 500mm. A brush is attached at the top of the cleaning jig B. For the brush on the jig B, do not choose a hard brush such as the one made of wires.

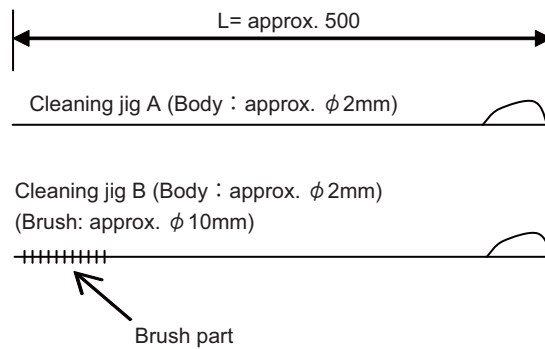

- [2] Detach the finger guard from the cooling fan unit.
Remove the four screws used for securing the finger guard.

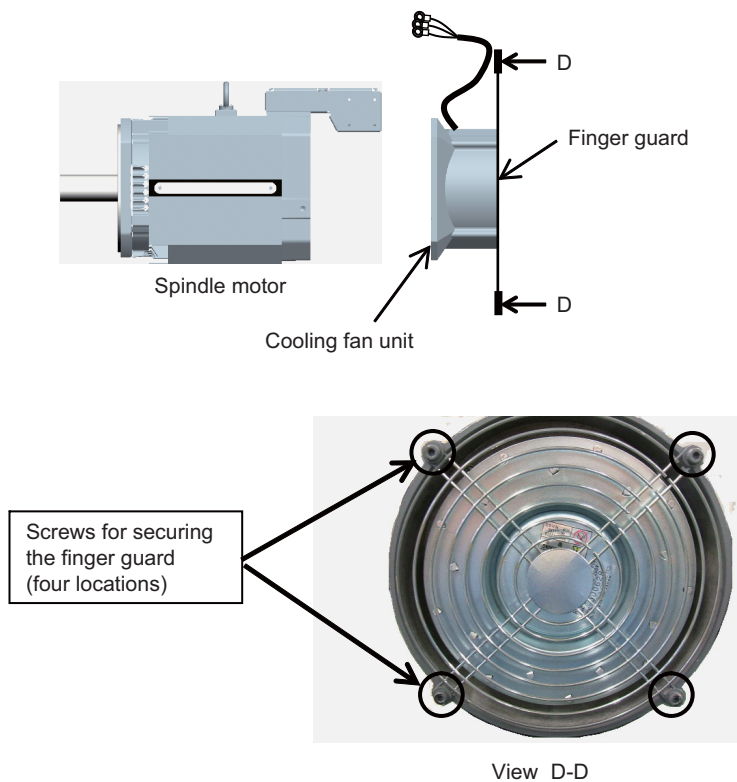

- [3] Wipe dirt off the finger guard using wastes, etc.
- [4] Use the cleaning jigs to clean the inner part of the cooling fan case.
Use the cleaning jigs A and B to scrape out dirt between the fan case and blades in the cooling fan unit, and wipe it off with wastes, etc.
- (Note 1) Do not use air blow as this may cause foreign matters to enter the inner part of the cooling fan motor.
- (Note 2) Do not wash with liquid detergent as the cooling fan motor is an electrical appliance.
- (Note 3) Take extra care not to damage the cooling fan during cleaning.

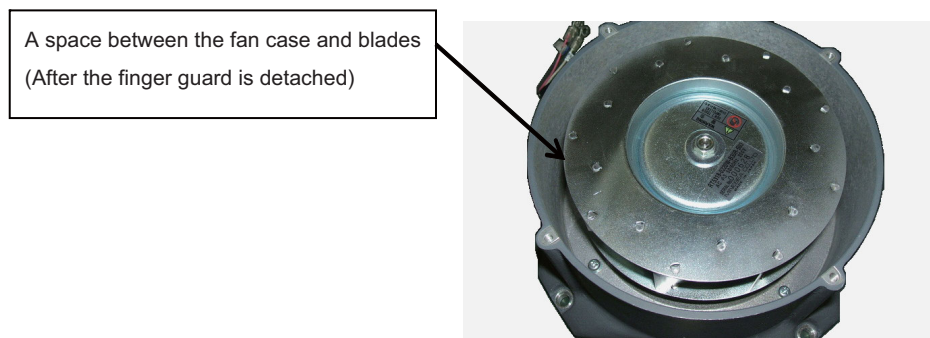

- [5] Use the cleaning jigs to clean the air ducts of the spindle motor body.
 Insert the cleaning jigs A and B into the motor's air ducts from the counter-load side bracket, scrape out the dirt, and wipe it off with wastes, etc.

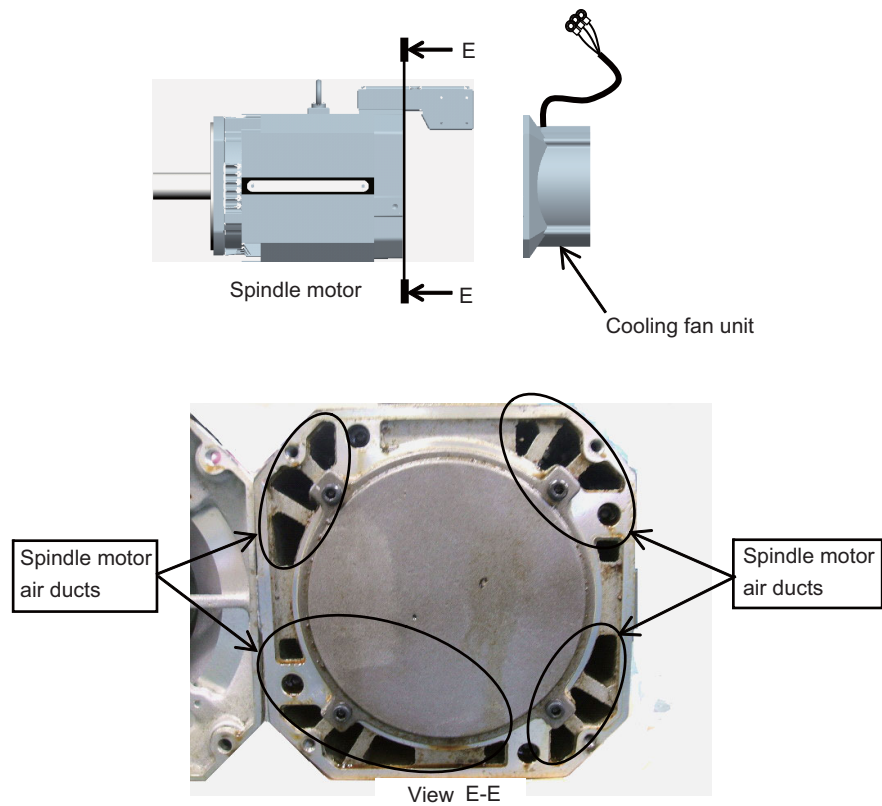

(3) Assembling

After all the cleaning processes have been completed, attach the cooling fan unit to the motor in the order opposite to that of the detachment process. After attaching the unit, perform a test run to check the air blow direction of the fan, etc. Be careful not to pinch the cable between the cooling fan unit and the terminal box.

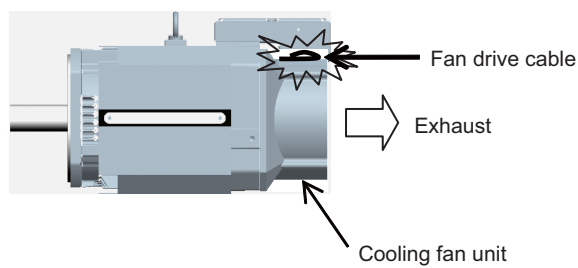

8.2 Service Parts

A guide to the part replacement cycle is shown below. Note that these will differ according to the working conditions or environmental conditions, so replace the parts if any abnormality is found. Contact Mitsubishi branch or your dealer for repairs or part replacements.

Part name		Standard replacement time	Remarks
Servo drive unit	Smoothing capacitor	10 years	The standard replacement time is a reference. Even if the standard replacement time is not reached, the part must be replaced if any abnormality is found.
	Cooling fan	10,000 to 30,000 hours (2 to 3 years)	
	Battery	10,000 hours (MDS-BAT6V1SET, MR-BAT6V1SET, MDSBTBOX-LR2060)	
Servo motor	Bearings	20,000 to 30,000 hours	
	Encoder	20,000 to 30,000 hours	
	Oil seal, V-ring	5,000 hours	

[1] Power smoothing capacitor:

The characteristics of the power smoothing capacitor will deteriorate due to the effect of ripple currents, etc. The capacitor life is greatly affected by the ambient temperature and working conditions. However, when used continuously in a normal air-conditioned environment (ambient temperature is an average of 40°C or less), the service life will be ten years.

[2] Relays:

Contact faults will occur due to contact wear caused by the switching current. The service life will be reached after 100,000 cumulative switches (switching life) although this will differ according to the power capacity.

[3] Servo motor bearings:

The motor bearings should be replaced after 20,000 to 30,000 hours of rated load operation at the rated speed. This will be affected by the operation state, but the bearings must be replaced when any abnormal noise or vibration is found in the inspections.

[4] Servo motor oil seal, V-ring:

These parts should be replaced after 5,000 hours of operation at the rated speed. This will be affected by the operation state, but these parts must be replaced if oil leaks, etc., are found in the inspections.

8.3 Adding and Replacing Units and Parts

CAUTION

1. Correctly transport the product according to its weight. Failure to do so could result in injury.
2. Do not stack the product above the indicated limit.
3. Installation directly on or near combustible materials could result in fires.
4. Install the unit as indicated at a place which can withstand the weight.
5. Do not get on or place heavy objects on the unit. Failure to observe this could result in injury.
6. Always use the unit within the designated environment condition range.
7. Do not allow conductive foreign matter such as screws or metal chips, or combustible foreign matter such as oil enter the servo drive or servo motor.
8. Do not block the intake or exhaust ports of the servo drive or servo motor. Failure to observe this could result in faults.
9. The servo drive and servo motor are precision devices. Do not drop them or apply strong impacts.
10. Do not install or operate a servo drive or servo motor which is damaged or missing parts.
11. When the unit has been stored for a long time, contact the Service Center.
12. Connect the encoder (CN2/CN3) immediately after the installation of the servo drive unit. In addition, when a battery box is used, immediately connect to the BTA/BTB connector. (prevention of absolute position data lost)

8.3.1 Replacing the Drive Unit

(1) Arrangement of replacing parts

Contact Mitsubishi branch or your dealer for an order or a replacement of the drive unit.
Place an order for the same type of a drive unit as the one to be replaced.

(2) Replacement procedure

Replace the drive unit with the following procedures.

Procedures

- [1] Turn the breaker for the input power OFF. Make sure the CHARGE lamp of the power supply unit is turned OFF.
- [2] Disconnect all the connectors and the wires connected to the drive unit.
- [3] Remove the two (four) screws fixing the drive unit onto the control panel. Remove the drive unit from the control panel.
- [4] Make a same setting for the rotary switch and the dip switch of the new drive unit as those of the uninstalled drive unit.
- [5] Install a new drive unit by following the removal procedure in reverse.

(3) Restoration

Data backup and restoration is not required before replacing drive units because drive units' data such as parameters are stored in the controller. However, carry out a backup of the whole system before replacement as a precautionary measure.

The power for keeping the encoder's position data of an absolute position system is supplied from the battery connected to the drive unit. Keep the power ON once for 30 minutes or more if possible, and make sure to complete the replacement within 60 minutes after charging the encoder's capacitor.

8.3.2 Replacing the Fan Unit

(1) Replacing parts

Drive unit type	Fan type
MDS-EM-SPV3-16040S	EM-FS-18
MDS-EM-SPV3-10040 to 200120 MDS-EMH-SPV3-8040 to 10060	EM-FS-26
MDS-EM-SPV3-320120	EM-FS-30

(2) Replacement procedure

Replace the fan unit with the following procedures.

[1] Remove the mounting screws from the fan unit cover on the top of the drive unit.

[2] Remove the fan unit cover.

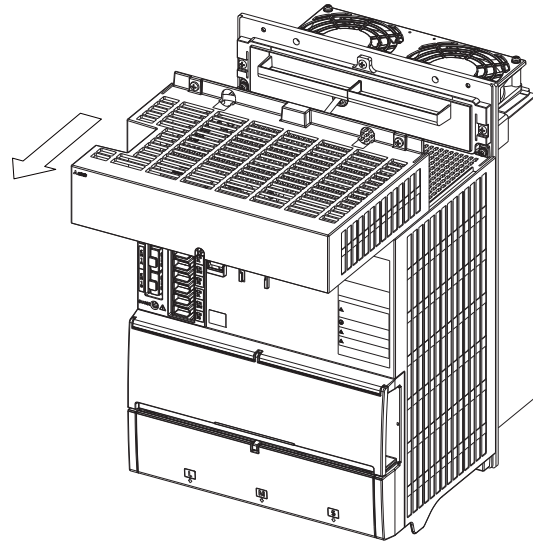
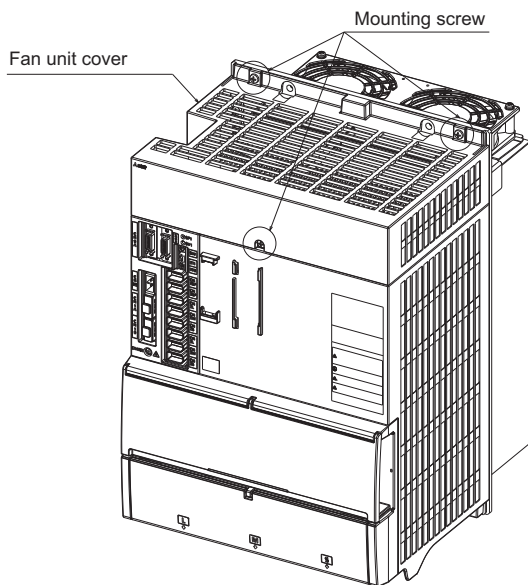

[3] Remove the fixing screws from the fan unit. Disconnect the connector on the top and pull out the fan unit.

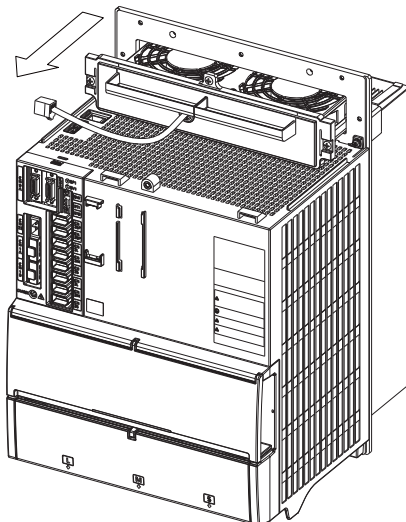
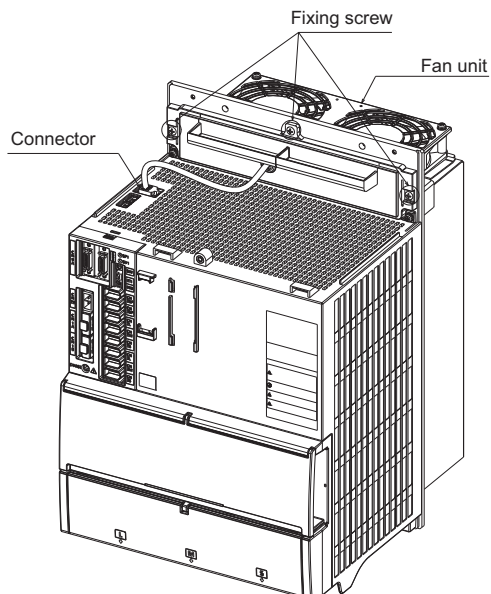

[4] When installing the fan unit, insert the sheet metal of the fan unit into the fin rails.

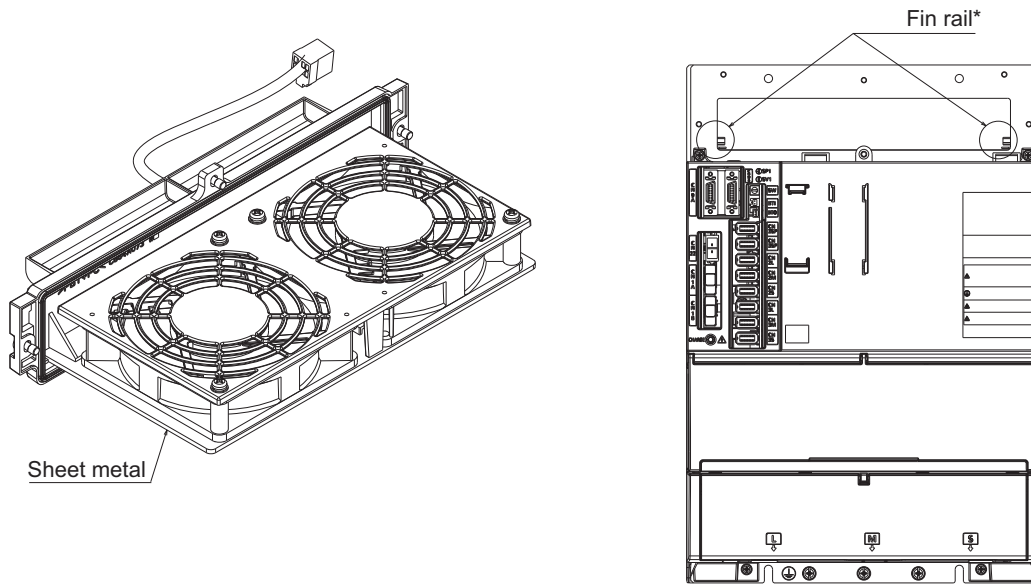

* Although MDS-EM-SPV3-16040S and 320120 do not have fin rails, the installation of fan units is not affected.

8.3.3 Replacing the Battery

(1) Replacing parts

<Replacing a battery equipped with the multi axis drive unit or the battery unit, MDSBTBOX-LR2060>

When the battery voltage is low (warning 9F), place an order for the same type of a battery as the one currently equipped with the unit.

Battery type LR20 is commercially available as a size-D alkaline battery. The battery may be purchased and replaced by the user.

Battery type

Type	Battery equipped unit
MDS-BAT6V1SET	Multi axis drive unit
MR-BAT6V1SET	Multi axis drive unit
LR20 (size-D alkaline battery)	Battery unit, MDSBTBOX-LR2060

(Note) Four LR20 size-D alkaline batteries are needed for per battery unit, MDSBTBOX-LR2060.

CAUTION

1. When the battery voltage is low (warning 9F), do not shut OFF the power of the drive unit until replacement of the battery to protect the data.
2. Replace the MDSBTBOX-LR2060 battery with new batteries (LR20) that is within the recommended service period.

(2) Replacement procedure

Replace the battery with the following procedures.

⚠ CAUTION

1. Replace the batteries with new ones immediately after the battery voltage drop alarm (9F) has been output.
2. Replace the batteries while applying the drive unit's control power.

< Replacement procedure for the cell battery MDS-BAT6V1SET >

- [1] Open the battery holder cover located at the front of the drive unit.
- [2] Pull out the battery connector connected with the drive unit. Remove the battery.
- [3] Install a new battery and connect a connector to the connector position where the old battery connector was pulled out from in step [2].
- [4] Cancel the warning 9F by executing an alarm reset (pushing the NC reset button).

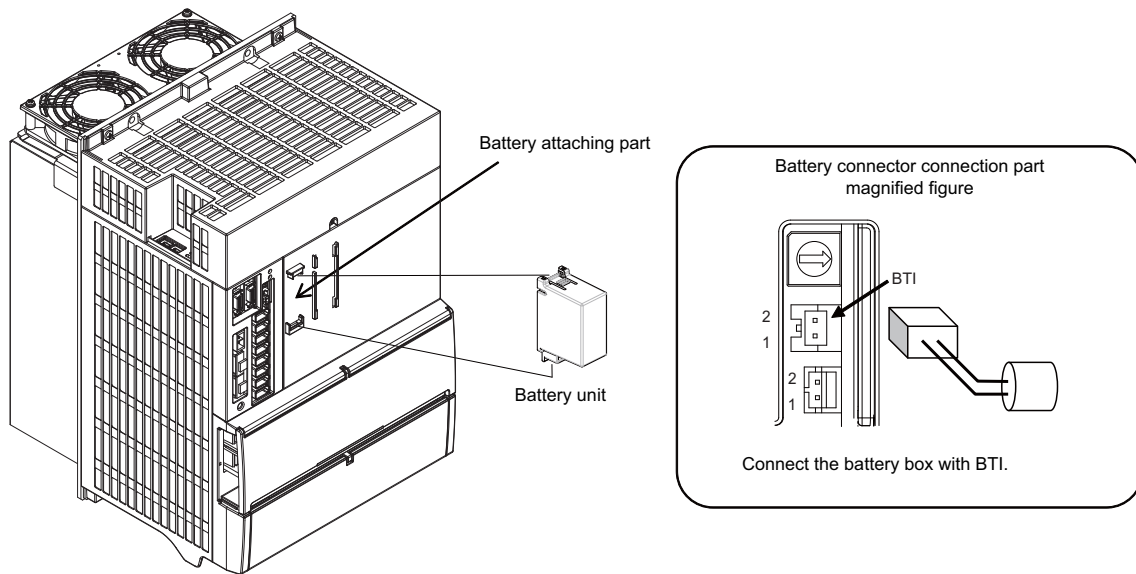

<Replacement procedure for the cell battery MR-BAT6V1SET>

- [1] Pull out the battery connector connected with the drive unit while pushing the unlocking lever.
- [2] Remove the battery unit by sliding upward while pushing the unlocking lever.
- [3] Install a new battery and connect a cable connector to the connector position where the old battery connector was pulled out from in step [2].
- [4] Cancel the warning 9F by executing an alarm reset (pushing the NC reset button).

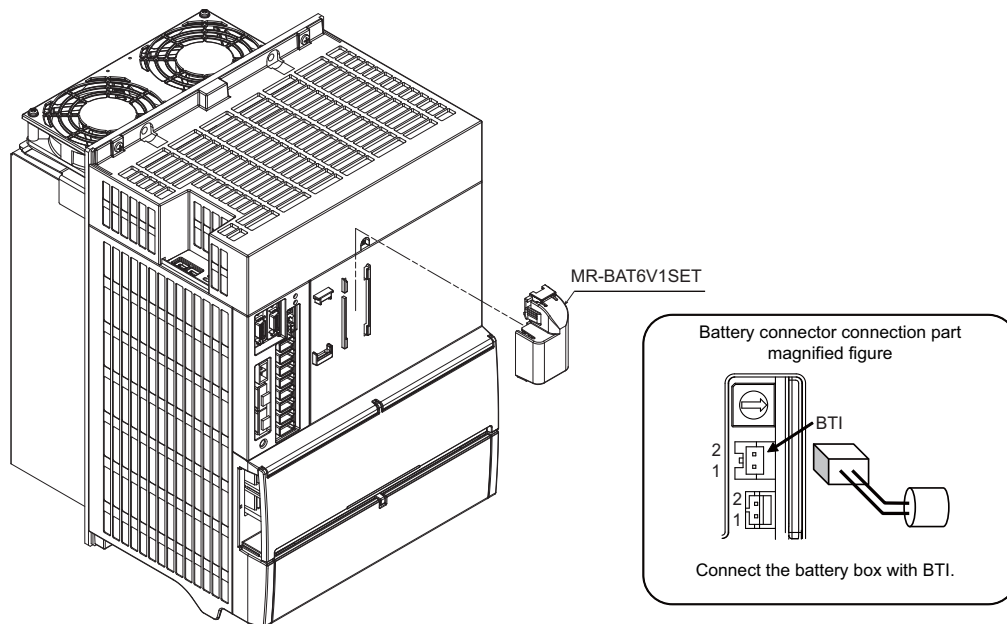

< Replacement procedure for the battery unit MDSBTBOX-LR2060 >**Possible backup period**

Possible backup period is at most one year. Thus, make sure to exchange the batteries in the one-year cycle.

How to replace the battery

[1] Remove the battery box cover (four screws).

[2] Replace the batteries with new ones. Be careful not to mistake the polarity.

[3] Attach the cover, and fix it with the four screws.

(Note 1) Replace the batteries while applying control power to the servo drive unit.

(Note 2) When replacing the battery, do not let foreign objects enter. If the terminal area gets dirty, clean there.

(Note 3) If the cover is ill-set, mist or foreign objects enter through the interstices and enter into the panel. Tighten the screws. (Tightening torque: 1N•m)

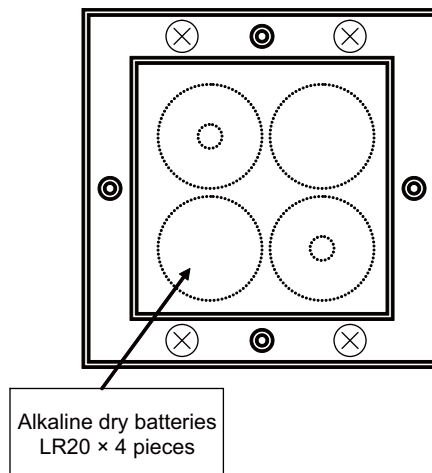
**⚠ CAUTION**

1. Use new batteries that are within the recommended service period. (Check the recommended service period written on the batteries before using them.)
2. Replace the batteries with new ones immediately after the battery voltage drop alarm (9F) has been output.
3. Replace the batteries while applying the servo drive unit's control power.
4. Wrong connection may cause liquid leakage, heat generation and/or explosion.
5. Do not mix new batteries with used ones or mix different type batteries.

Appx. 1: Cable and Connector Assembly

9.1 CMV1-xPxxS-xx Plug Connector

This section explains how to assemble the wire to CMV1 plug connector.

(1) Cutting a cable

Cut the cable to the following dimensions:

(Note) Not to change cable length.

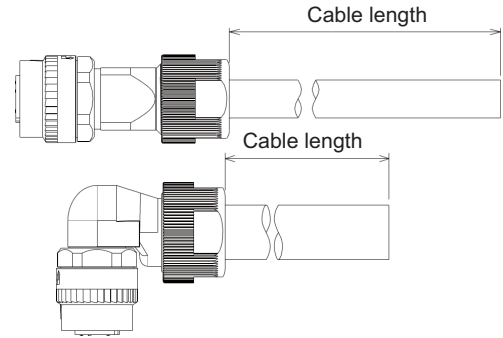

Cable length after cutting

connector name	Cable length after cutting [mm]
CMV1-SPxxS-xx	40±0.5 + Cable length
CMV1-APxxS-xx	47±0.5 + Cable length

(2) Inserting parts

Insert the clamp nut, the cable clamp, the bushing and the back shell, in that order, to the cable.

(Note) Pay attention to the direction each part is inserted.
 Make sure that every part is inserted.

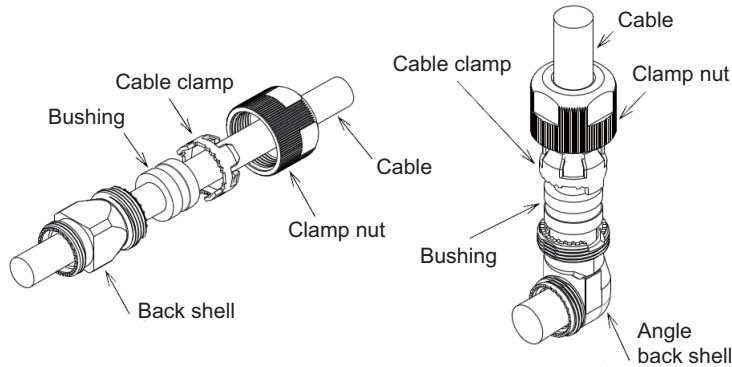

(3) Stripping a cable

Strip the cable's sheath to the A length, cut the wire set at its root and strip the core wire to the B length.

(Note) Make sure to strip the cable to the correct length.

Do not leave cutting or scratch to the cable core.

* When making CMV1-xP10S-xx, strip the cable for No. 10 terminal in a way that the A length becomes 1mm longer than that of other cores.

(This is to prevent excessive tension of the core when inserting the contact to the housing in the next process.)

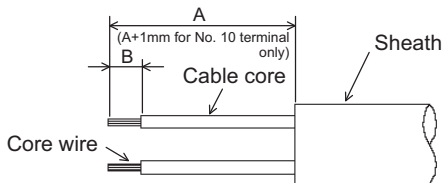

Cable length after stripping

Connector name	A [mm]	B [mm]
CMV1-SPxxS-xx	21.5 to 22.5	4.5 to 5.0
CMV1-APxxS-xx	28.5 to 29.5	

(4) Soldering a contact

Apply preliminary soldering to each contact and to the cable's core wire, then solder the core wire to the contacts.

Connector name	Applicable contact	Applicable wire
CMV1-xP2S-xx	CMV1-#22BSC-S2	AWG16 or below
CMV1-xP10S-xx	CMV1-#22ASC-S1	AWG20 or below

- (Note) Make sure that the core wire does not come out of the contact.
 When soldering, make sure that the solder does not stick to the circumference of the solder cup.
 When using a drain wire, attach a heat shrink tube to the drain cable after soldering.
- * When making CMV1-xP10S-xx, the cable for No. 10 terminal is 1mm longer than other cables. (To avoid the core tension when inserting a contact to the housing in a later process.)
 - * The difference in the total A length of the cables for other than No. 10 terminal must be 1mm or less.

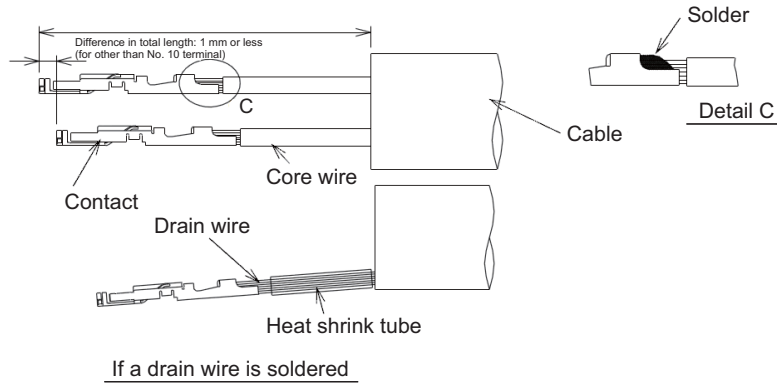

(5) Inserting the contact

Insert the contact into the specified terminal number point in the housing.

(Insert grounding wire or drain wire into terminal No. 10).

- * When the contact catches the housing, you will hear a snap.
- * Pulling the wire for confirming the correct position.

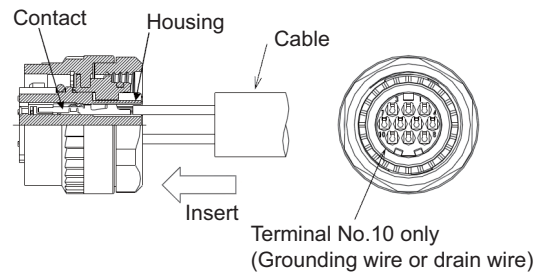

(Note) Before inserting the contact, check that the clamp nut, cable clamp, bushing and back shell is inserted. Take care not to insert the contact upside down as shown below.

- * Insert the contact so that the terminal number face the same direction.
- * Using a pull out tool for pulling up inserted contact.
 Tool No.: 357J-53184T
 Refer to the instruction manual in case of using pull up tool.
- * As Lance falls down easily after pulling up, set up to original position before re-insert.

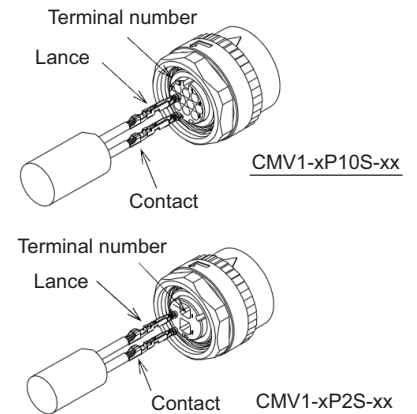

(6) Assembling a back shell

[1] To prevent the back shell from loosening, it is recommended to coat 2 threads of the circumference of the back shell with adhesive.

Recommended adhesive: 1401B (CV) (Three Bond Co., Ltd.)

[2] Rotate the back shell coupling of the connector and temporarily tighten the back shell.

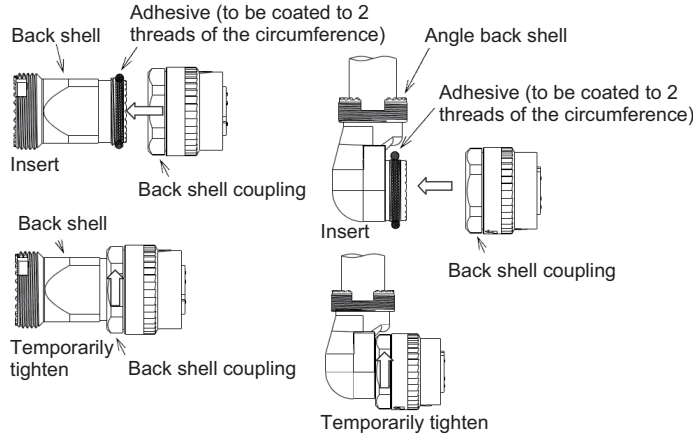

* When tightening temporarily, match the concavity and convexity of the plug shell with those of the back shell. (You can confirm the correct connection of concavity and convexity waving lightly back shell just before inserting to BS coupling.)

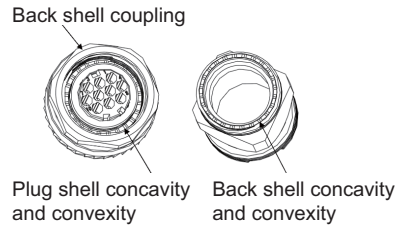

(7) Tightening a back shell

Straight back shell

- [1] Fix the 2 surface width of the straight back shell on the tightening guide.
 - [2] Set the tightening wrench adjusting to the back shell coupling.
 - [3] With the wrench, tighten the back shell coupling to the straight back shell.
- Recommended tightening torque: 4 to 5N•m
 (Note 1) When setting the work to the wrench, adjust it to the 2 surface width.
 To remove, take the reverse steps.
 (Note 2) Manufactured by DDK
 Contact: Fujikura Ltd. <http://www.fujikura.co.jp/eng/>

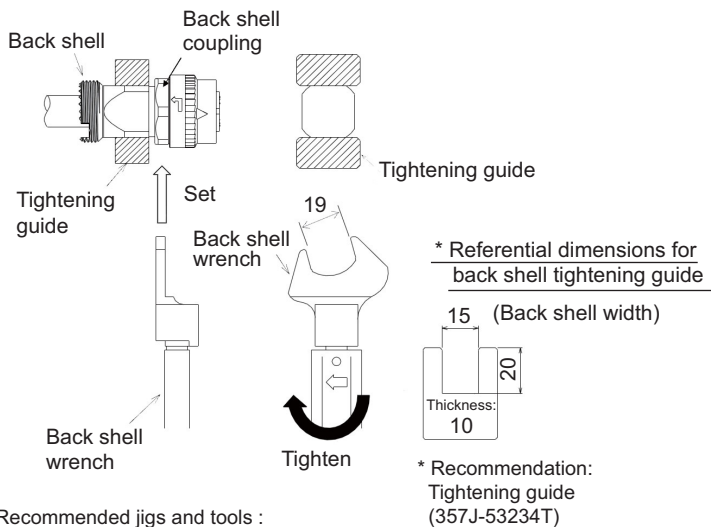

- Recommended jigs and tools :
 Back shell wrench (357J-51333T) (Note 2)
 { Bit (357J-51344T)
 Torque wrench (CL6N x 8D, Tonichi Mfg.) }
 * Recommended tightening guide: (357J-53234T) (Note 2)

Angle back shell

- [1] Fix the 2 surface width of the angle back shell on the tightening guide.
- [2] Set the back shell wrench adjusting to the 2 surface width of the back shell coupling.
- [3] With the wrench, tighten the back shell coupling to the angle back shell.

Recommended tightening torque: 4 to 5N.m

(Note 1) When setting the work to the wrench, adjust it to the 2 surface width.
To remove, take the reverse steps.

(Note 2) To change the back shell angle, adjust the tothing position of the plug shell and back shell.

(Note 3) Manufactured by DDK

Contact: Fujikura Ltd. <http://www.fujikura.co.jp/eng/>

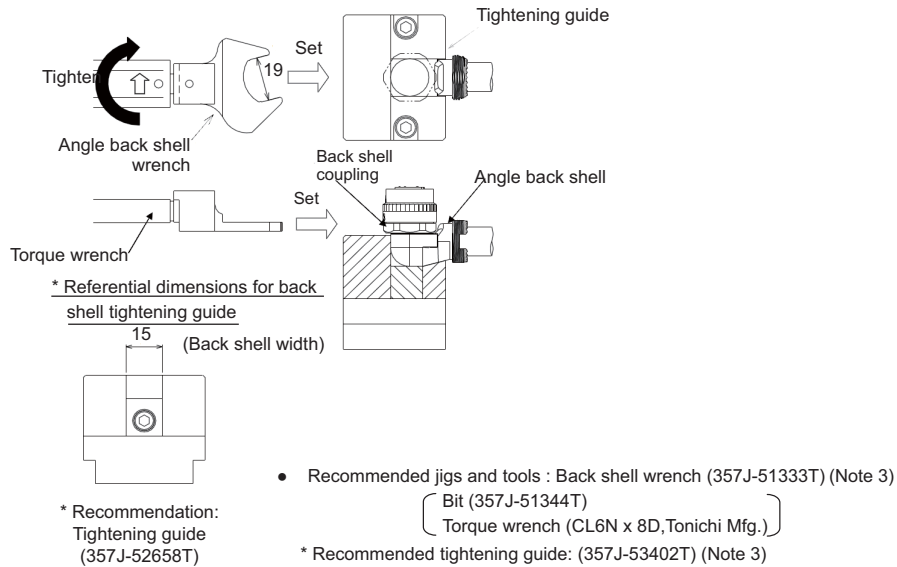

(8) Insert a bushing and a cable clamp

Insert the bushing and the cable clamp in the back shell.

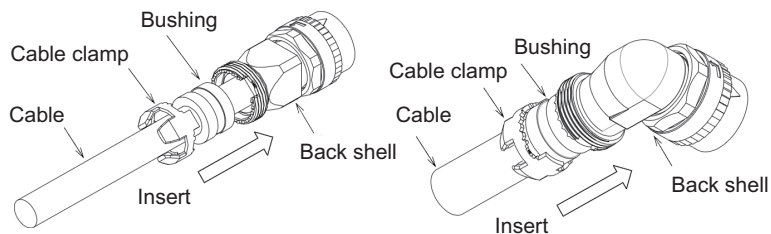

(Note) After the Bushing insert, confirm that cable position should be inside of Bushing.

(9) Tightening a clamp nut

Straight back shell

- [1] Temporarily tighten the clamp nut on the straight back shell.
*To prevent the loosening, it is recommended to coat the straight back shell with adhesive.

Recommended adhesive: 1401B (CV) (Three Bond Co., Ltd.)

- [2] Fix the 2 surface width of the straight back shell on the tightening guide.
- [3] With the wrench, tighten the clamp nut on the straight back shell.

Recommended tightening torque: 4 to 5N•m

(Note 1) When setting the work to the wrench, adjust the 2 surface width.
To remove, take the reverse steps.

(Note 2) Manufactured by DDK

Contact: Fujikura Ltd. <http://www.fujikura.co.jp/eng/>

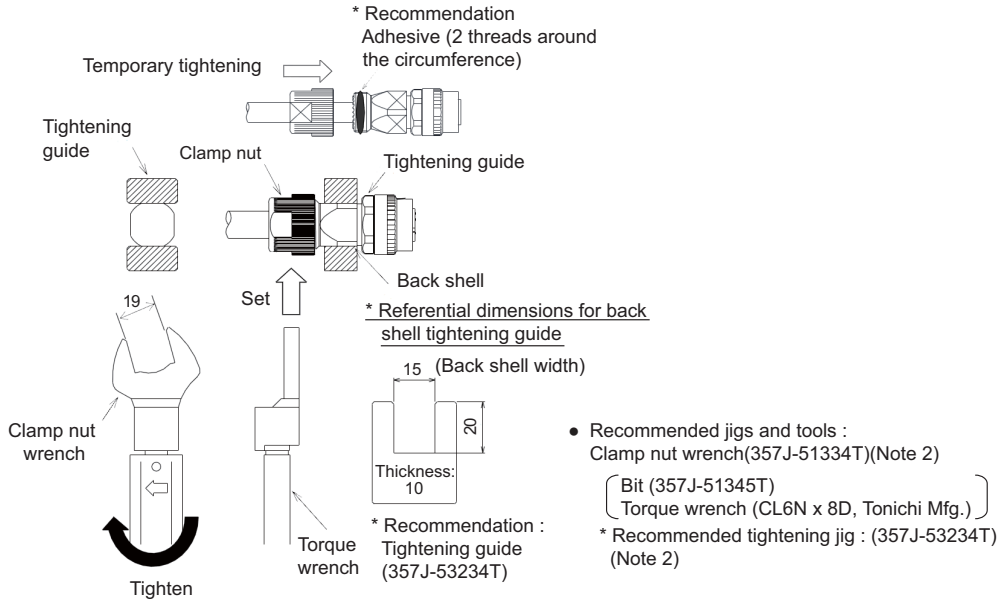

Angle back shell

- [1] Temporarily tighten the clamp nut on the angle back shell.
 * To prevent loosening, the adhesive should be applied to the angle back shell.

Recommended adhesive: 1401B (CV) (Three Bond Co., Ltd.)

- [2] Fix the 2 surface width of the angle back shell on the tightening guide.
- [3] Set the tightening wrench adjusting the 2 surface width of the clamp nut.
- [4] With the wrench, tighten the clamp nut on the angle back shell.

Recommended tightening torque: 5N•m

(Note 1) To set the work to the wrench, adjust the 2 surface width.

In case of squeezing the clamp nut with excess torque provided as above, the clamp nut may be broken. Please use the torque wrench.

To remove, take the reverse steps.

(Note 2) Manufactured by DDK

Contact: Fujikura Ltd. <http://www.fujikura.co.jp/eng/>

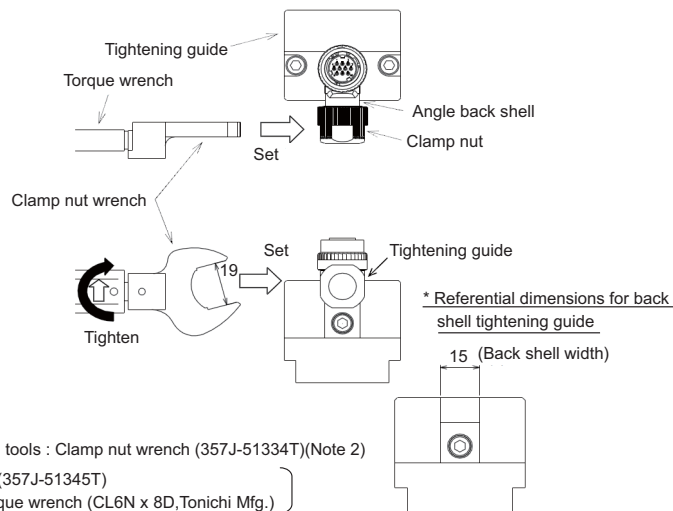
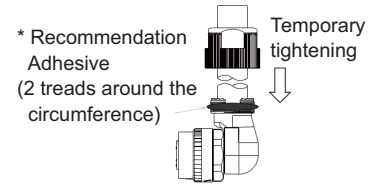

- Recommended jigs and tools : Clamp nut wrench (357J-51334T)(Note 2)
 (Bit (357J-51345T)
 Torque wrench (CL6N x 8D, Tonichi Mfg.))
 * Recommended tightening guide: (357J-52658T)(Note 2) * Recommendation:
 Tightening guide
 (357J-53402T)

<When connecting>

[1] Set the Δ mark of each other's connectors.

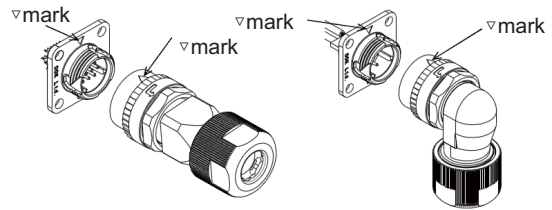

[2] Each other's key (concavity and convexity) are fit in. Push it straight, take care not to tilt.

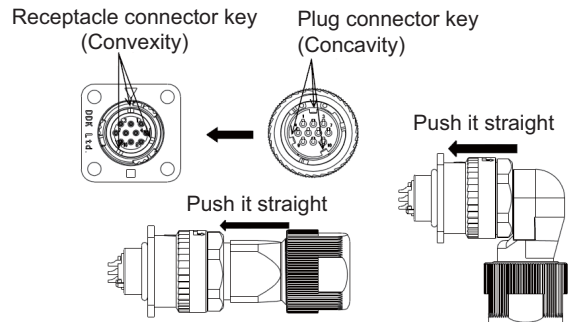

* To remove, rotate the coupling and pull out to straight.

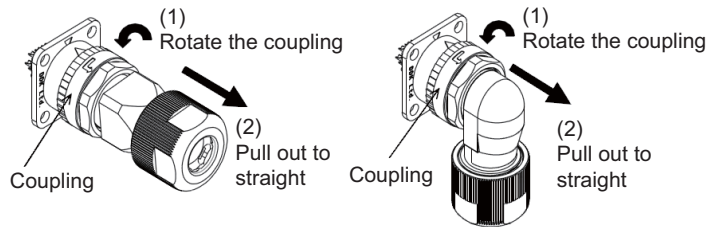

<When using a conduit>

- [1] Tighten the nipple of conduit connector on the plug connector (CMV1).
- [2] Set the conduit on the nipple of conduit connector.
- [3] Fix the conduit to the plug connector (CMV1). If the conduit is used in a moving part, fix the conduit with a saddle, etc. so that no load is applied to the plug connector (CMV1) and to the conduit connector. If the conduit is fixed with a saddle, etc., make sure that no load is applied to the fixing area. Set the protective cover (rubber etc.) on the conduit to avoid cable damage.

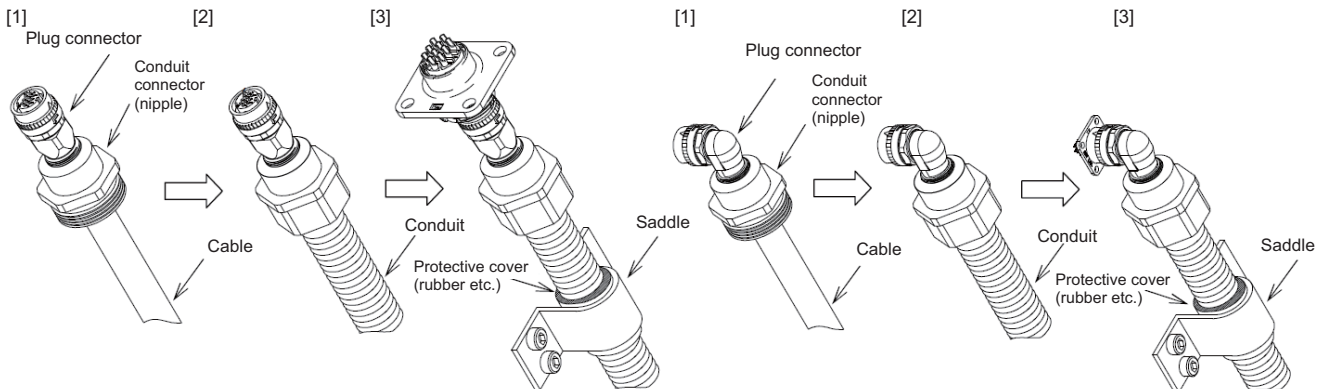

Recommended conduit

Type: VF Type: SR Type: FBN Type: EM Type: VFS Type: SRK etc. (Note)

Recommended connector

Type:RCM (Note)

(Note) Manufactured by NIPPON FLEX CO.,LTD.
 Contact: NIPPON FLEX CO.,LTD. <http://www.nipplex.co.jp/>

9.2 1747464-1 Plug Connector

9.2.1 Applicable Products

Part No.	Descriptions
1674320-1	Encoder cable I/O kit
1674320-2	
1674335-4	Receptacle contact

9.2.2 Applicable Cable

Wire conductor size	Cable jacket outside diameter
#26-22AWG	6.8 to 7.4 mm

Refer to Product Specification and Application Specification for details.

9.2.3 Related Documents

No.	Details
108-5864	Product Specification
114-5335	Rec, Contact Application Specification
114-5338	Ground Clip Application Specification

9.2.4 Assembly Procedure

Assemble the cable in the following procedure:

- (1) Insert accessories to the cable.

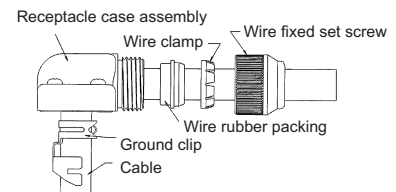

- (2) Remove the sheath of the cable jacket and core wires referring to the typical dimensions in the right figure.

Do not damage the core wires. Retry it if the core wires are partly cut off or damaged.

The length of mesh shield should be decided referring to the right figure and be turned up on the outside of a jacket.

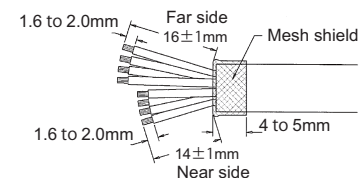

(Note) Even when the dimensions above is applied, product performance problem can occur depending on the wires which is used.

Be sure to contact with the sales department of the manufacturer below if you consider to adopt this connector.

Tyco Electronics Japan G.K. <http://www.te.com/en/home.html>

- (3) Twist a copper foil tape with conductive adhesive of width 5mm around the mesh shield.

Cable finish outside diameter: $\Phi 7.3$ to 7.7

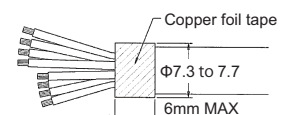

- (4) Refer to Application Specification (114-5335) and crimp the contacts. After crimping, check the state in accordance with the Specification.

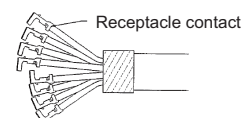

- (5) Verifying the direction, insert the crimped contact into the receptacle housing. After the insertion, pull each wire lightly to make sure that the contacts are fully inserted. (Lock feeling and sound can be confirmed when the contact is fully/ correctly inserted.)

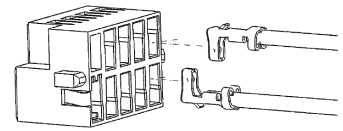

- (6) Crimp the ground clip.
As receptacle housing is settled inside a ground clip, it opts for direction according to the purpose, and positions as shown in the right figure.
(Note) Direction of receptacle housing is unchangeable after ground slip crimping.

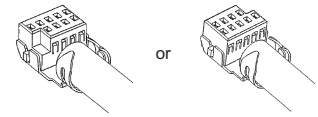

Positioning the cable jacket end as shown in the right figure. Refer to the Application Specification (114-5338) and crimp the ground clip.

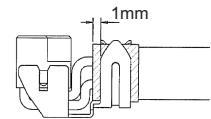

- (7) Store the receptacle housing and ground clip in the receptacle case.
Pull the cable side and draw the receptacle housing side as shown in the right figure, without pushing in it.

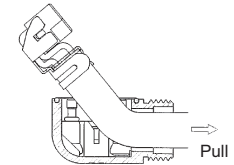

Work will become easy when the crimping part of the ground clip is pushed and the cable is bent as shown in the right figure.

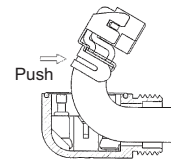

When the ground clip interferes with receptacle case at the position in the right figure and cause difficulty in continuing to draw in, push the ground clip to distort and drawing become easy.

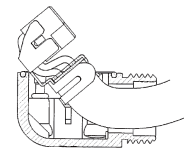

- (Note) To prevent a fracture, do not use the ground clip which is bend and unbend 3 times or more.

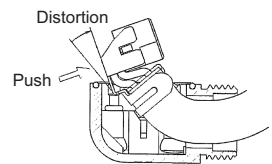

Turn the form of the ground clip back to normal and position it for the receptacle case as shown in the right figure.

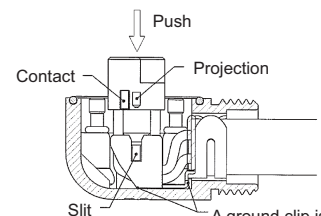

Adjust the projection of receptacle housing to the slit of the receptacle case and push in until it is fixed to the case.

- (Note) See that the contact of receptacle housing goes inside a ground clip.

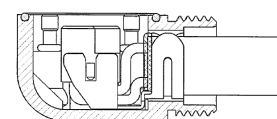

- (8) Shift the wire rubber packing and wire clamp to the position in the right figure, and tighten the wire fixed set screw to fix the cable to receptacle case.

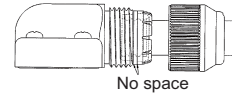

Tighten it not to create the space between the receptacle case and wire fixed set screw.

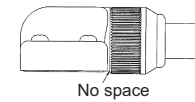

(Note) Confirm that the cable is fixed.

- (9) To ensure that there is no leaning on the receptacle housing in the receptacle case assembly, drop the POST BASE for inspection naturally as shown in the right figure.

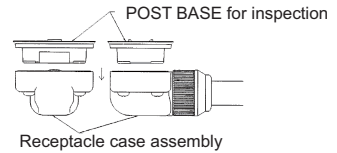

Confirm that the space between the receptacle case assembly and the POST BASE is within 1mm. Regarding POST BASE for inspection, contact with the sales department of the manufacturer below.

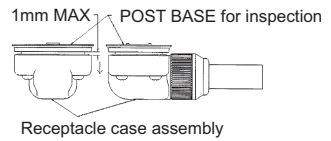

Tyco Electronics Japan G.K. <http://www.te.com/en/home.html>

- (10) Insert the assembled connector until it stick fast to the POST BASE and then, tighten the four bind screws to fix. The tightening torque of the bind screw is 5.0 to 10.0 N•cm.

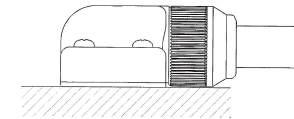

Appx. 2: D/A Output Specifications for Drive Unit

10.1 D/A Output Specifications

Drive unit has a function to D/A output the various control data. The servo and spindle adjustment data required for setting the servo and spindle parameters to match the machine can be D/A output. Measure using a high-speed waveform recorder, oscilloscope, etc.

Note that the output pins differ between MDS-EJ/EJH-V1, MDS-EJ-SP and MDS-EJ-V2/SP2.

D/A output specifications

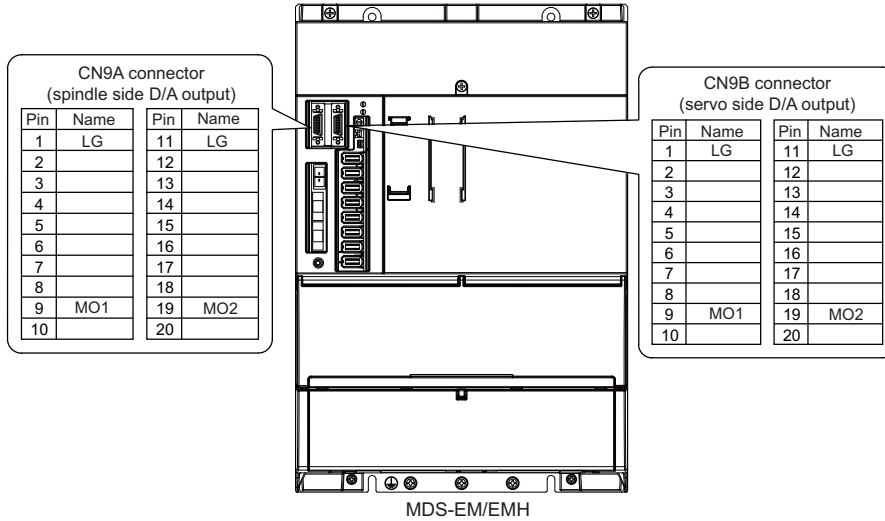

Item	Explanation
No. of channels	2ch
Output cycle	0.8ms (min. value)
Output precision	12bit
Output voltage range	0V to 2.5V (zero) to +5V
Output magnification setting	-32768 to 32767 (1/100-fold)
Output pin (servo side: CN9B connector)	MO1 = Pin 9, MO2 = Pin 19, LG = Pin 1, 11
Output pin (spindle side: CN9A connector)	MO1 = Pin 9, MO2 = Pin 19, LG = Pin 1, 11
Others	The D/A output for the 2nd axis or the 3rd axis is also 2ch. When using the 2nd axis or the 3rd axis, set "-1" for the output data (SV061, SV062) of the servo axis that is not to be measured.

When the output data is 0, the offset voltage is 2.5V. If there is an offset voltage, adjust the zero level position in the measuring instrument side.

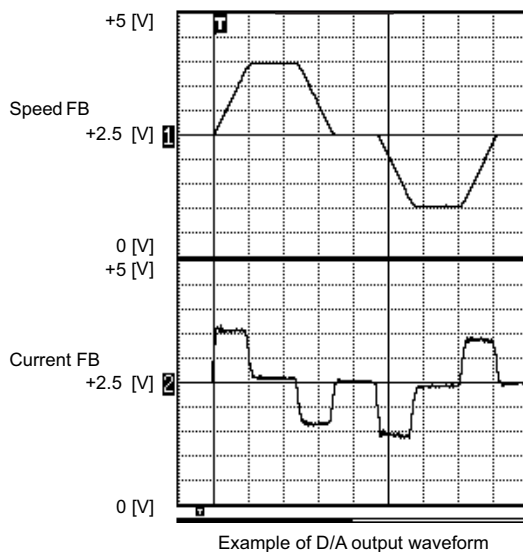

10.2 Output Data Settings

10.2.1 Servo Drive Unit Settings

<Standard output>

#2261 SV061 DA1NO D/A output ch1 data No.

Input the data number you wish to output to the D/A output channel 1.
When using the 2-axis drive unit, set "-1" to the axis that the data will not be output.

---Setting range---
-32768 to 32767

#2262 SV062 DA2NO D/A output ch2 data No.

Input the data number you wish to output to the D/A output channel 2.
When using the 2-axis drive unit, set "-1" to the axis that the data will not be output.

---Setting range---
-32768 to 32767

No.	Output data	Standard output unit		Output cycle
		Linear axis	Rotary axis	
-1	D/A output not selected	For 2nd axis or 3rd axis drive unit. Set the parameters to the other axes in the drive unit that is not D/A output.		
0	Commanded rotation speed	1000(r/min)/V		0.8ms
1	Motor rotation speed	1000(r/min)/V		0.8ms
2	Torque command	Motor stall rated ratio 100%/V		0.8ms
3	Torque feedback	Motor stall rated ratio 100%/V		0.8ms
6	Effective current command	100%/V		0.8ms
7	Effective current feedback	100%/V		0.8ms
8	Machine vibration frequency	500Hz/V		0.8ms
9	HAS control droop cancel amount	1mm/V	1°/V	0.8ms
30	Collision detection estimated torque	100%/V		0.8ms
31	Collision detection disturbance estimated torque	100%/V		0.8ms
32	Estimated load inertia ratio	100%/V		0.8ms
35	Disturbance observer estimated disturbance torque	100%/V		0.8ms
50	Position droop	1μm/V	1/1000°/V	0.8ms
51	Position command	1μm/V	1/1000°/V	0.8ms
52	Position feedback	1μm/V	1/1000°/V	0.8ms
53	Position FΔT	1μm/s/V	1/1000°/s/V	0.8ms
54	Deviation from ideal position (considering servo tracking delay)	1μm/V	1/1000°/V	0.8ms
60	Position droop	1mm/V	1°/V	0.8ms
61	Position command	1mm/V	1°/V	0.8ms
62	Position feedback	1mm/V	1°/V	0.8ms
63	Position FΔT	1mm/s/V	1°/s/V	0.8ms
64	Deviation from ideal position (considering servo tracking delay)	1mm/V	1°/V	0.8ms
70	Position droop	1m/V	1000°/V	0.8ms
71	Position command	1m/V	1000°/V	0.8ms
72	Position feedback	1m/V	1000°/V	0.8ms
73	Position FΔT	1m/s/V	1000°/s/V	0.8ms
74	Deviation from ideal position (considering servo tracking delay)	1m/V	1000°/V	0.8ms
126	Saw tooth wave	1.5V to 3.5V		0.8ms
127	2.5V test data	2.5V		0.8ms

(Servo control signal)

Servo control input (NC to Servo)			Servo control output (Servo to NC)		
No.	Details		No.	Details	
16384	Servo control input 1-0	READY ON command	16480	Servo control output 1-0	In READY ON
16385	Servo control input 1-1	Servo ON command	16481	Servo control output 1-1	In servo ON
16388	Servo control input 1-4	Position loop gain changeover command	16484	Servo control output 1-4	In position loop gain changeover
16390	Servo control input 1-6	Excessive error detection width changeover command	16486	Servo control output 1-6	In excessive error detection width changeover
16391	Servo control input 1-7	Alarm reset command	16487	Servo control output 1-7	In alarm
16392	Servo control input 1-8	Current limit selection command	16488	Servo control output 1-8	In current limit selection
			16492	Servo control output 1-C	In in-position
			16493	Servo control output 1-D	In current limit
			16494	Servo control output 1-E	In absolute position data loss
			16495	Servo control output 1-F	In warning
			16496	Servo control output 2-0	Z phase passed
			16499	Servo control output 2-3	In zero speed
			16503	Servo control output 2-7	In external emergency stop
16409	Servo control input 2-9	Speed monitor command valid	16505	Servo control output 2-9	In speed monitor
16410	Servo control input 2-A	In door closed (controller)	16506	Servo control output 2-A	In door closed (controller)
16411	Servo control input 2-B	In door closed (all drive units)	16507	Servo control output 2-B	In door closed (self drive unit)
16416	Servo control input 3-0	Control axis detachment command	16512	Servo control output 3-0	In control axis detachment
16472	Servo control input 6-8	Drivers communication control request	16568	Servo control output 6-8	In drivers communication control

(Note) For details on the servo signals, refer to the section "Servo control signal".

10.2.2 Spindle Drive Unit Settings

< Standard output >

#13125 SP125 DA1NO D/A output ch1 data No.

Input the desired data number to D/A output channel.

When using the 2-axis drive unit, set "-1" to the axis that the data will not be output.

---Setting range---

-32768 to 32767

#13126 SP126 DA2NO D/A output ch2 data No.

Input the desired data number to D/A output channel.

When using the 2-axis drive unit, set "-1" to the axis that the data will not be output.

---Setting range---

-32768 to 32767

No.	Output data	Output unit for standard setting	Output cycle
-1	D/A output stop	-	
0	Commanded motor rotation speed	1000(r/min)/V	0.8ms
1	Motor rotation speed	1000(r/min)/V	0.8ms
2	Torque current command	Short time rated ratio 100%/V	0.8ms
3	Torque current feedback	Short time rated ratio 100%/V	0.8ms
35	Disturbance observer estimated disturbance torque	Short time rated torque current value ratio 100%/V	0.8ms
50	Position droop	1/1000°/V	0.8ms
51	Position command	1/1000°/V	0.8ms
52	Position feedback	1/1000°/V	0.8ms
53	Position F&T	1/1000°/s/V	0.8ms
54	Deviation from ideal position (considering spindle tracking delay)	1/1000°/V	0.8ms
60	Position droop	1°/V	0.8ms
61	Position command	1°/V	0.8ms
62	Position feedback	1°/V	0.8ms
63	Position F&T	1°/s/V	0.8ms
64	Deviation from ideal position (considering spindle tracking delay)	1°/V	0.8ms
70	Position droop	1000°/V	0.8ms
71	Position command	1000°/V	0.8ms
72	Position feedback	1000°/V	0.8ms
73	Position F&T	1000°/s/V	0.8ms
74	Deviation from ideal position (considering spindle tracking delay)	1000°/V	0.8ms
110	3.0V output load meter (Note)	40%/V, 120%/3V	0.8ms
126	Saw tooth wave	1.5V to 3.5V	0.8ms
127	2.5V test data output	2.5V	0.8ms

(Note) Load meter displays "100%(=2.5V)" when the control power turns ON and the NC is starting. After the NC has been run, it displays "0%(=0V)".

< Special output >

The result of PLG(TS5690) installation accuracy diagnosis is output to D/A output. D/A output magnification:SP127(DA1MPY) and SP128(DA2MPY) is 0.

PLG installation diagnosis function can be enabled during the rotation, when open loop control is enabled:SP018(SPEC2)/bit1=1.

D/A output No.	Details	Description
120	Motor end PLG installation Gap diagnosis	Motor end PLG installation gap is diagnosed. When the gap is good, 2.5V is output. When the gap is excessive, 2.5V+1V is output. When the gap is too small, 2.5V-1V is output.
121	Motor end PLG installation All errors diagnosis	Motor end PLG installation error (including the gap) is diagnosed. When the installation is good, 2.5V is output. When the installation is incorrect, 2.5V+1V is output.
122	Spindle end PLG installation Gap diagnosis	Spindle end PLG installation gap is diagnosed. Diagnostic procedure is the same as that of motor end PLG.
123	Spindle end PLG installation All errors diagnosis	Spindle end PLG installation error (including the gap) is diagnosed. Diagnostic procedure is the same as that of motor end PLG.

< Spindle control signal >

Spindle control input (NC to Spindle)			Spindle control output (Spindle to NC)		
No.	Details		No.	Details	
16384	Spindle control input 1-0	READY ON command	16480	Spindle control output 1-0	In ready ON
16385	Spindle control input 1-1	Servo ON command	16481	Spindle control output 1-1	In servo ON
16391	Spindle control input 1-7	Alarm reset command	16487	Spindle control output 1-7	In alarm
16392	Spindle control input 1-8	Torque limit 1 selection command	16488	Spindle control output 1-8	In torque limit 1 selection
16393	Spindle control input 1-9	Torque limit 2 selection command	16489	Spindle control output 1-9	In torque limit 2 selection
16394	Spindle control input 1-A	Torque limit 3 selection command	16490	Spindle control output 1-A	In torque limit 3 selection
			16492	Spindle control output 1-C	In in-position
			16495	Spindle control output 1-F	In warning
			16496	Spindle control output 2-0	Z phase passed
			16499	Spindle control output 2-3	In zero speed
			16503	Spindle control output 2-7	In external emergency stop
16409	Spindle control input 2-9	Speed monitor command valid	16505	Spindle control output 2-9	In speed monitor
16410	Spindle control input 2-A	In door closed (controller)	16506	Spindle control output 2-A	In door closed (controller)
16411	Spindle control input 2-B	In door closed (all drive units)	16507	Spindle control output 2-B	In door closed (self drive unit)
16432	Spindle control input 4-0	Spindle control mode selection command 1	16528	Spindle control output 4-0	In spindle control mode selection 1
16433	Spindle control input 4-1	Spindle control mode selection command 2	16529	Spindle control output 4-1	In spindle control mode selection 2
16434	Spindle control input 4-2	Spindle control mode selection command 3	16530	Spindle control output 4-2	In spindle control mode selection 3
16436	Spindle control input 4-4	Gear changeover command	16532	Spindle control output 4-4	In gear changeover command
16437	Spindle control input 4-5	Gear selection command 1	16533	Spindle control output 4-5	In gear selection 1
16438	Spindle control input 4-6	Gear selection command 2	16534	Spindle control output 4-6	In gear selection 2
			16535	Spindle control output 4-7	Magnetic pole position not set
16445	Spindle control input 4-D	L coil selection command	16541	Spindle control output 4-D	In L coil selection
			16545	Spindle control output 5-1	Speed detection
			16550	Spindle control output 5-6	In coil changeover
16458	Spindle control input 5-A	Phase synchronization suppression command	16554	Spindle control output 5-A	In phase synchronization suppression
16459	Spindle control input 5-B	Minimum excitation rate 2 changeover request	16555	Spindle control output 5-B	In minimum excitation rate 2 selection
16460	Spindle control input 5-C	Speed gain set 2 changeover request	16556	Spindle control output 5-C	In speed gain set 2 selection
16461	Spindle control input 5-D	Zero point re-detection request	16557	Spindle control output 5-D	Zero point re-detection complete
16462	Spindle control input 5-E	Increase holding power of spindle	16558	Spindle control output 5-E	Increase holding power of spindle completed
			16559	Spindle control output 5-F	In 2nd in-position
16472	Spindle control input 6-8	Drivers communication control request	16568	Spindle control output 6-8	In drivers communication control

(Note 1) Control signal is bit output. Setting the No. of the table above to the data output (SP125, SP126), and when the scale (SP127, SP128) is set to "0", the output is "0V" for bit 0, and "2.5V" for bit 1.

(Note 2) Refer to "Spindle control signal" for details on the spindle control signal.

10.3 Setting the Output Magnification

10.3.1 Servo Drive Unit Settings

Set when outputting other than the standard output unit. When "0" is set, the magnification will be the same as "100".

(Example 1) When SV061=1 and SV063=50

The motor rotation speed is output at 2000(r/min)/V.

(Example 2) When SV062=3 and SV064=50

The torque feedback is output to D/A output channel 2 with 200%/V unit.

#2263 SV063 DA1MPY D/A output ch1 output scale

Set output scale of the D/A output channel 1 in increment of 1/100.
When "0" is set, the magnification is the same as when "100" is set.

---Setting range---

-32768 to 32767 (1/100-fold)

#2264 SV064 DA2MPY D/A output ch 2 output scale

Set output scale of the D/A output channel 2 in accruement of 1/100.
When "0" is set, the magnification is the same as when "100" is set.

---Setting range---

-32768 to 32767 (1/100-fold)

10.3.2 Spindle Drive Unit Settings

Set when outputting other than the standard output unit. When "0" is set, the magnification will be the same as "100".

(Example 1) When SP125=1, SP127=50

Commanded motor rotation speed is output to D/A output channel 1 in increments of 2000r/min/V.

(Example 2) When SP126=2, SP128=200

The torque axis current command is output to D/A output channel 2 in increments of 50%/V.

#13127 SP127 DA1MPY D/A output ch1 output scale

Set the output scale in increments of 1/100.
When "0" is set, the scale is the same as when "100" is set.

---Setting range---
-32768 to 32767 (1/100-fold)

#13128 SP128 DA2MPY D/A output ch2 output scale

Set the output scale in increments of 1/100.
When "0" is set, the scale is the same as when "100" is set.

---Setting range---
-32768 to 32767 (1/100-fold)

《Speed FB》

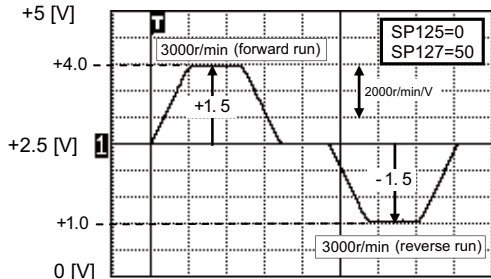

《Current FB》

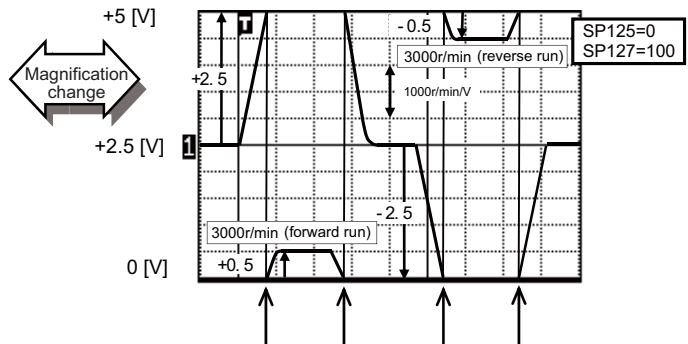
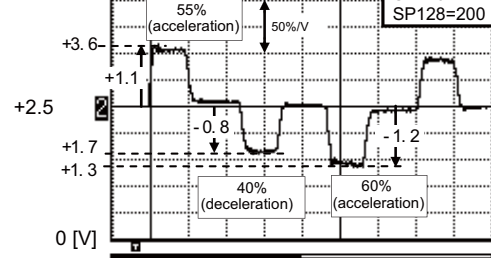

< When 3000r/min is displayed at the setting range of "1000r/min/V" >
When the speed waveform at 3000r/min is measured using a high-speed waveform recorder with SP127 set to "100", the data exceeds the D/A output range (+5.0V for forward run and 0V for reverse run) at 2500r/min, but it will be cleared immediately and then the remaining data will be output. Even if the data exceeds the D/A output range more than one time, it will be cleared and the remains will be output.

Example of D/A output waveform: 3000r/min during acceleration and deceleration

Appx. 3: Protection Function

11.1 Protection Function

The drive unit offers the protection function.

Configure the system with the safety function compliant control units when using the safety function which satisfies the international standards.

Refer to NC specifications manual "Smart safety observation (BNP-C3072-022)" for details.

11.1.1 Outline of Protection Function

Function	Details
Emergency stop observation	NC control unit (CNC CPU unit) and the drive unit separately observe the input of emergency stop. At the emergency stop, the motor power is shut off by controlling the contactor with each of the PLC CPU unit (only for C80), NC control unit (CNC CPU unit) and the drive unit (power supply unit).
SLS (Safely Limited Speed)	NC control unit (CNC CPU unit) and the drive unit (servo/spindle drive unit) separately observe the followings. The motor power is shut off when an error is detected during the observation. -The command speed does not exceed the speed set with the parameter. -The rotation speed of the motor does not exceed the rotation speed set with the parameter.

Protection function assumes the following configuration.

- A)The machine is equipped with at least one safety door.
- B)Safety is ensured when the safety door is closed.

When an operator requests to open the safety door, enable the safety function and release the lock on the safety door. Safety is ensured by enabling the safety function while the safety door is open. When canceling the safety door open request, the safety door enters the locked state and safety function will be released.

WARNING

The sequence of enabling or disabling the safety function by opening or closing the door is required to take necessary actions at the machine tool builders.

11.2 Emergency Stop Observation

The double-protection for the emergency stop signal is provided and observes whether any abnormality is found in the emergency stop signal. The whole system will be in the emergency stop state when one emergency stop signal is in open state.

(1) Input circuit of an external emergency stop

Besides the emergency stop input from the NC controller, double-protection when an emergency stop occurs can be provided by directly inputting an external emergency stop to the CN9B connector on the drive unit. Even if the emergency stop is not input from CNC for some reason, the contactors will be shut off by the external emergency stop input from CN9B connector on the drive unit.

(a) Connection

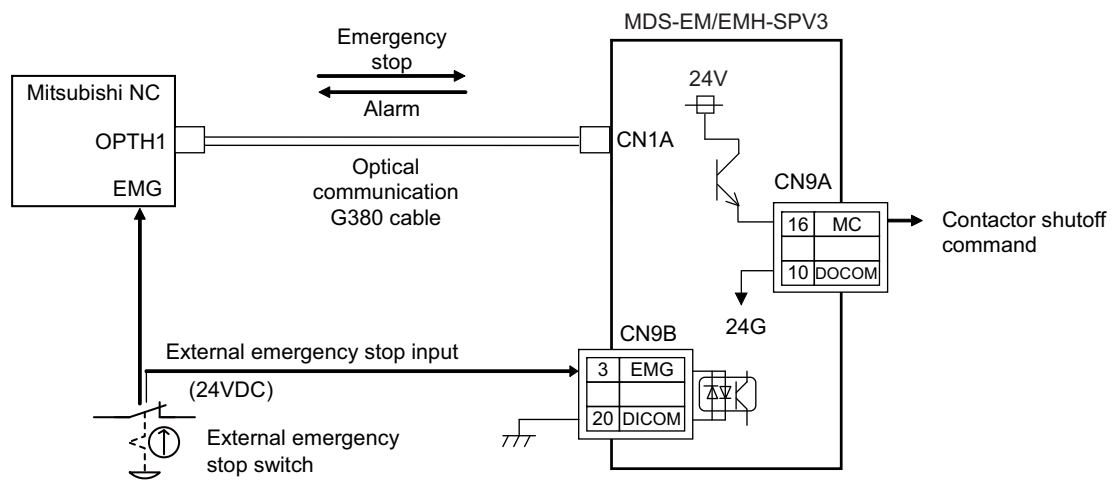

(b) Rotary switch setting

Setting the rotary switch is not required.

⚠ CAUTION

1. The emergency stop signal input to the CNC side cannot be used as a substitute for the external emergency stop function (CN9B).
2. To provide double-protection when an emergency stop occurs, the emergency stop input of NC and the external emergency stop input of drive unit are always wired from same emergency stop switch.
3. The external emergency stop function is a function which helps the NC emergency stop.

(2) Operation sequences of emergency stop

[1] Operation sequences of normal emergency stop

If the normal NC emergency stop and the external emergency stop are simultaneously input, the operation sequence will be the same as in the case of using only the NC emergency stop.

Immediately after the emergency stop is input, deceleration control is carried out in spindle control, and dynamic brake stop in servo control in a standard case, or deceleration control when the parameter is set. The ready signal is turned OFF after the NC confirms all axes stop, and the contactor control axis turns the contactor OFF.

Even when the NC emergency stop signal and the external emergency stop signal are not simultaneously input, the operation sequence will be the same as that of the normal emergency stop provided that both signals are input before all axes stop.

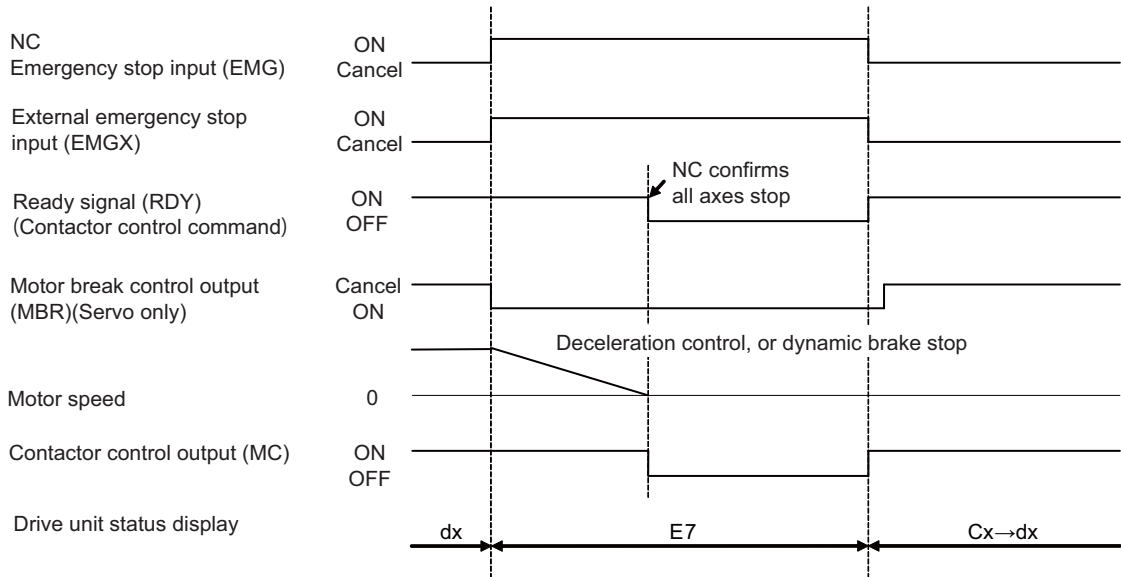

Operation sequences of normal emergency stop

[2] When only the external emergency stop is input

If only the external emergency stop is input, all the drive units that share one NC communication enter an emergency stop state and deceleration control (servo/spindle) or dynamic brake stop (servo) is executed. At this time, the axis to which the external emergency stop is input enters "in external emergency stop" (EA display). The contactor is turned OFF in accordance with the gate off delay time (SV055/SP055), as the NC emergency stop is not input and the ready signal is not turned OFF.

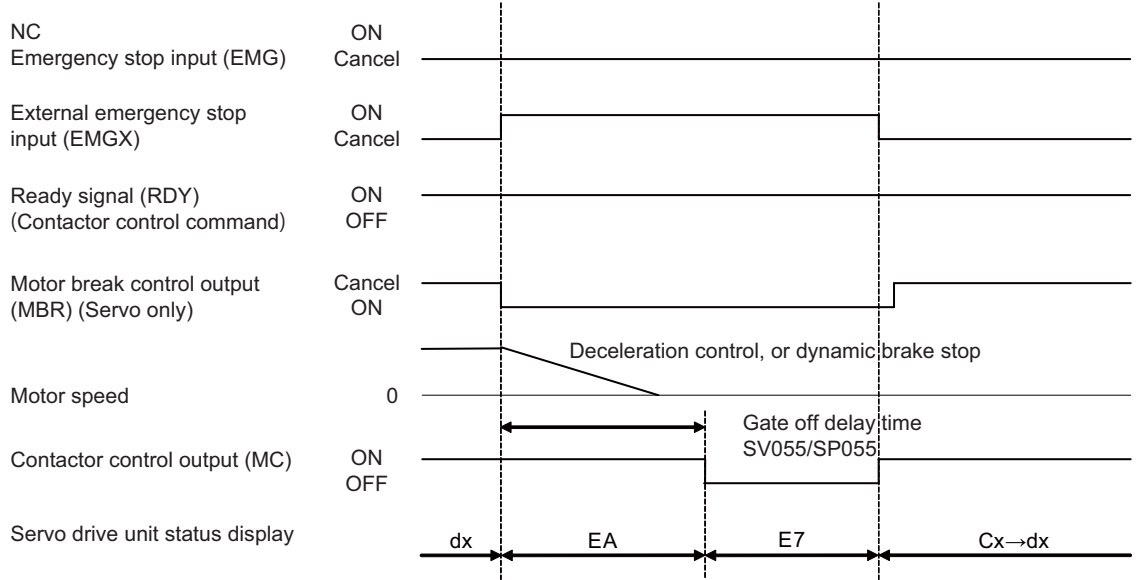

When only the external emergency stop is input

[3] When only the NC emergency stop is input

Motors of all axes enter deceleration stop in the same sequence as normal operation (when both NC and external emergency stop signals are input) and the contactor is shut off. In case that all axes stop is not confirmed and the ready signal is not turned OFF, the contactor is shut off in accordance with the max. gate off delay time (SV055/SP055) which is set to the contactor control axis.

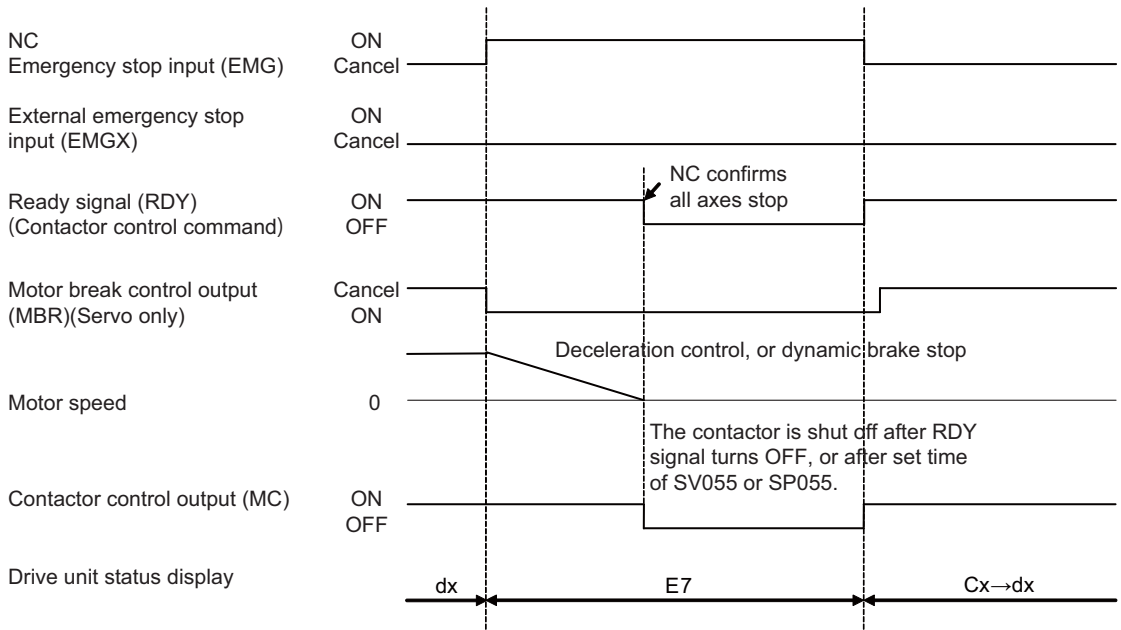

When only the emergency stop of NC is input

11.3 SLS (Safely Limited Speed) function

Safely Limited Speed function observes that the motors for servo and spindle do not exceed the specified speed when the safety door of the machine is open. The setup can be performed without shutting the machine power off and this contributes to reducing preparation time and improving operation. The speed is redundantly observed by the CPU of the drive unit and the NC control unit, and an alarm is issued when either one of the CPUs detect the speed command or speed feedback exceeds the specified speed, which lead to the deceleration control in the motor. The power is shut off by the STO (Safe Torque Off) function after the motor stops.

(1) Connection

The following three wirings are required for the SLS function.

- [1] The state signal for the safety door of the machine is wired to both the NC unit side (DI) and drive unit side (CN9B connector MPI1). The double-protection for the wiring must be provided by wiring the signal to each of the NC side and drive unit side as the following figure.
- [2] Add the wiring to control the contactor in the NC unit side in order to shut the power when an error occurs.
- [3] In addition to the emergency stop wiring for the NC unit, add the external emergency stop wiring for the CN9B connector of the drive unit.

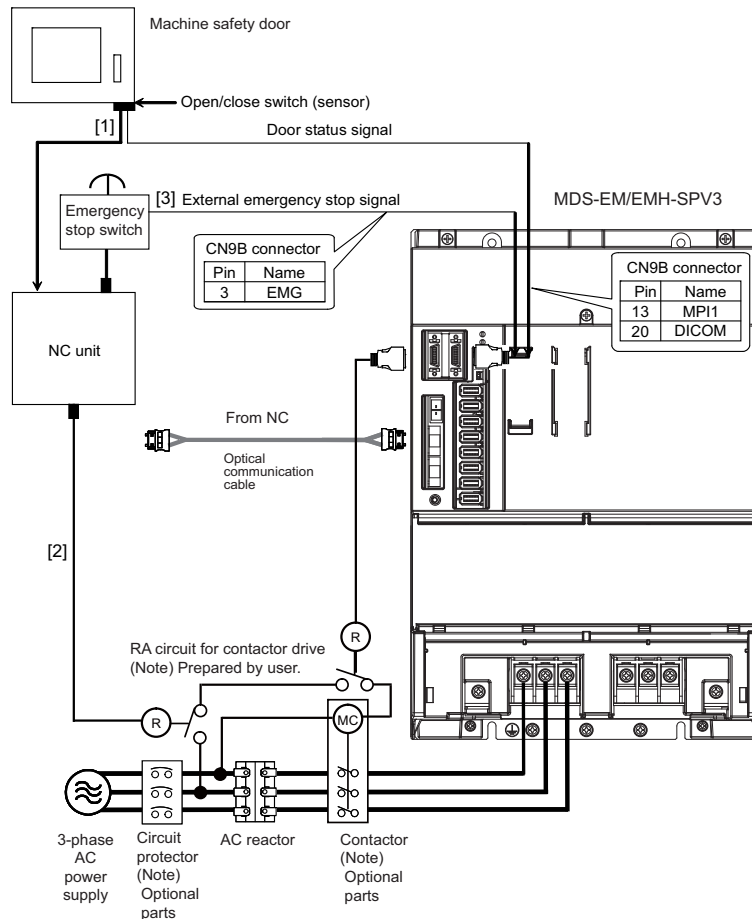

CAUTION

The door state signal is on both servo side (CN9B-13) and spindle side (CN9B-2). Since it is sufficient to input on either side, so select it according to other input signals.

The door state signal, battery box voltage drop signal and the proximity switch signal cannot be connected simultaneously. When using these signals at the same time, consider to wire the door state signal to other drive units connecting to the same NC communication line.

 **CAUTION**

1. Make sure to input one of the door status signal for each control system to CN9B connector of servo or spindle drive unit.
In the control system, it is conveyed to the axis which is not directly connected via the NC.
2. Using the SLS (Safely Limited Speed) function, it is required to set parameter in addition to the wiring mentioned above.
To prevent a certain axis from being involved in the SLS (Safely Limited Speed) function, set SV113/bitF or SP229/bitF to 0.

(2) Parameter setting for servo drive unit

Starts the SLS (Safely Limited Speed) function.

#2313 SV113 SSF8 Servo function 8**bit F : ssc SLS (Safely Limited Speed) function**

0: Stop 1: Start

The digital signal input selection is set to "1" for the drive unit connected with the door state signal. The digital signal input selection is set to "0" for the other drive unit not connected with the signal.

#2282 SV082 SSF5 Servo function 5**bit F-C: dis Digital signal input selection**

0: No signal
1: SLS (Safely Limited Speed) function door state signal
2 to F: Setting prohibited

Sets the safely limited speed of the machine and motor for which the SLS (Safely Limited Speed) function is executed.

#2233 SV033 SSF2 Servo function 2

bit D : rps Safely limited speed setting increment

Change the setting units of the specified speed signal output speed (SV073) and safely limited speed (SV238).

0: mm/min 1: 100mm/min

#2438 SV238 SSCFEED Safely limited speed

Set the machine's safely limited speed for the SLS (Safely Limited Speed) function. Set this parameter within the following setting ranges.

For linear axis: 2000mm/min or less

For rotary axis: 18000°/min (50r/min) or less

When not using, set to "0".

---Setting range---

0 to 18000 (mm/min) or (°/min)

However, when SV033/bitD=1, the setting range is from -32768 to 32767 (100 mm/min) or (100°/min).

#2439 SV239 SSCRPM Safely limited motor speed

Set the motor's safely limited speed for the SLS (Safely Limited Speed) function.

Set a value to hold the following relationship.

Be aware when setting the parameter as the setting units for general motors and linear motors are different.

<<For general motor>>

$$SV239 = (SV238/SV018) \times (SV002/SV001)$$

Only when the product is 0, set to "1".

<<For linear motor>>

$$SV239 = SV238/60$$

Only when the product is 0, set to "1".

When not using, set to "0".

---Setting range---

For general motor: 0 to 32767 (r/min)

For linear motor: 0 to 32767 (mm/s)

(Note) The value of the safely limited speed and safely limited motor speed must satisfy the above relation. If this relation is not satisfied, the parameter error (37or E4) will occur.(Error parameter No. is 239.) Checking this relation is executed when the drive unit is turned ON and parameter is changed and speed observation mode (states when a speed observation command is turned ON) is entered.

$$\frac{SV238 : SSCFEED}{SV018 : PIT} \times \frac{SV002 : PC2}{SV001 : PC1} = SV239 : SSCRPM$$

Note that "1 (r/min)" is applied when the calculation result is "0 (r/min)"

(3) Parameter setting for spindle drive unit

Starts the SLS (Safely Limited Speed) function.

#13229 SP229 SFNC9 Spindle function 9**bit F : ssc SLS (Safely Limited Speed) function**

0: Disable 1: Enable

The digital signal input selection is set to "1" for the drive unit connected with the door state signal.
The digital signal input selection is set to "0" for the other drive unit not connected with the signal.

bit D : rps Safely limited speed setting unit

0: Normal 1: 100°/min

Change the setting units of the specified speed signal output speed (SP030) and safely limited speed (SP238).

#13227 SP227 SFNC7 Spindle function 7**bit F-C : dis Digital signal input selection**

0: No signal
1: SLS (Safely Limited Speed) function door state signal
4: Proximity switch signal detection
Other settings: setting prohibited

Sets the safely limited speed of the machine and motor for which the SLS (Safely Limited Speed) function is executed.

#13238 SP238 SSCFEED Safely limited speed

Set the safely limited speed at the spindle end for the SLS (Safely Limited Speed) function.
When not using, set to "0".

---Setting range---

0 to 18000 (°/min)
However, when SP229/bitD is set to "1", the setting range is from -32768 to 32767 (100°/min).

#13239 SP239 SSCRPM Safely limited motor speed

Set the motor's safely limited speed for the SLS (Safely Limited Speed) function.
When not using, set to "0".

---Setting range---

0 to 32767 (r/min)

(Note) The value of the safely limited speed and safely limited motor speed must satisfy the following relation.
If this relation is not satisfied, the parameter error (37 or E4) will occur. (Error parameter No. is 239.)
Checking this relation is executed when the drive unit is turned ON and parameter is changed and speed observation mode (states when a speed observation command is turned ON) is entered.

$$\frac{\text{SP238 :SSCFEED}}{360} \times \frac{\text{SP057 :GRA1}}{\text{SP061 :GRB1}} = \text{SP239 :SSCRPM}$$

Note that "1 (r/min)" is applied when the calculation result is "0 (r/min)"

Appx. 4: Compliance to EC Directives

12.1 Compliance to EC Directives

12.1.1 European EC Directives

In the EU Community and UK, the attachment of a CE mark and a UKCA mark (European CE marking/UK UKCA Regulations) is mandatory to indicate that the basic safety conditions of the Machine Directives (issued Jan. 1995), EMC Directives (issued Jan. 1996), Electromagnetic Compatibility Regulations (issued Jan. 2021), the Low-voltage Directives (issued Jan. 1997), and the Electrical Equipment (Safety) Regulations (issued Jan. 2021) are satisfied. The machines and devices in which the servo and spindle drive are assembled are the targets for European CE marking and UK UKCA Regulations.

(1) Compliance to EMC Directives/Electromagnetic Compatibility Regulations

The servo and spindle drive are components designed to be used in combination with a machine or device. These are not directly targeted by the Directives, but a CE mark and a UKCA mark must be attached to machines and devices in which these components are assembled. The next section "EMC Installation Guidelines", which explains the unit installation and control panel manufacturing method, etc., has been prepared to make compliance to the EMC Directives/Electromagnetic Compatibility Regulations easier.

(2) Compliance to Low-voltage Directives/Electrical Equipment (Safety) Regulations

Each unit is targeted for the Low-voltage Directives/Electrical Equipment (Safety) Regulations. An excerpt of the precautions given in this specification is given below. Please read this section thoroughly before starting use.

For the EMC Directives/Electromagnetic Compatibility Regulations and Low-voltage Directives/Electrical Equipment (Safety) Regulations, Self-Declaration Documents has been prepared.

Contact Mitsubishi or your dealer when required.

12.1.2 Cautions for EC Directive Compliance

Use the Low-voltage Directive/Electrical Equipment (Safety) Regulations compatible parts for the servo/spindle drive and servo/spindle motor. In addition to the items described in this instruction manual, observe the items described below.

(1) Configuration

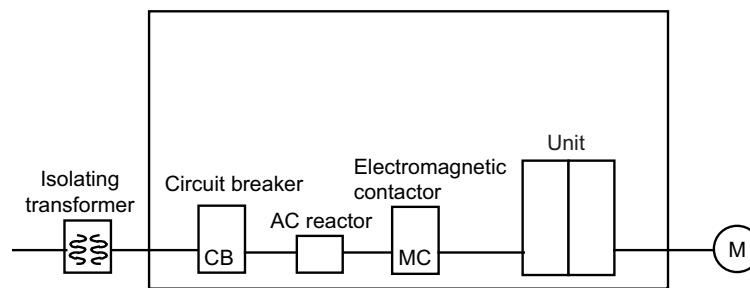

Insert a type B circuit breaker (RCD) in the power supply side of the unit.

(2) Environment

Use the units under an Overvoltage Category II (MDS-EM/EMH) and Pollution Class of 2 or less environment as stipulated in IEC60664.

- (a) To adjust the units to the Overvoltage Category II, insert an isolating transformer of the star connection complying with EN or IEC standard in the input of the power supply unit.
- (b) To adjust the units to the Pollution Class of 2, install the units in a control panel having a structure (IP54 or higher) in which water, oil, carbon or dust cannot enter.

Environment	Unit	Servo motor	Spindle motor
Ambient temperature	Operation: 0 to +55°C (with no freezing), Storage / Transportation: -15°C to +70°C (with no freezing)	Operation: 0 to +40°C (with no freezing), Storage: -15°C to +70°C (with no freezing)	Operation: 0 to +40°C (with no freezing), Storage: -20°C to +65°C (with no freezing)
Ambient humidity	Operation: 90%RH or less (with no dew condensation) Storage / Transportation: 90%RH or less (with no dew condensation)	Operation: 80%RH or less (with no dew condensation), HK(-H) Series: 10 to 90%RH or less (with no dew condensation) Storage: 90%RH or less (with no dew condensation) HK(-H) Series: 10 to 90%RH or less (with no dew condensation)	Operation: 90%RH or less (with no dew condensation) Storage: 90%RH or less (with no dew condensation)
Atmosphere	Indoors (no direct sunlight) With no corrosive gas, inflammable gas, oil mist, dust or conductive fine particles No object generating a strong magnetic field External magnetic field: 10 mT or less		
Altitude	Operation/Storage: 1000 meters or less above sea level, Transportation: 13000 meters or less above sea level	Operation/Storage: 1000 meters or less above sea level, Transportation: 10000 meters or less above sea level	
Vibration/impact	According to each unit or motor specification		

(Note) For details, confirm each unit or motor specifications in addition.

(3) Power supply

- [1] Use the power supply and servo/spindle drive unit under an Overvoltage Category II (MDS-EM/EMH) as stipulated in IEC60664.
- [2] Earth the PE terminal of the units to the neutral point of the star connection.
- [3] Do not omit the circuit breaker and electromagnetic contactor.

(4) Earthing

- [1] To prevent electric shocks, always connect the servo/spindle drive unit protective earth (PE) terminal (terminal with mark) to the protective earth (PE) on the control panel.
- [2] When connecting the earthing wire to the protective earth (PE) terminal, do not tighten the wire terminals together. Always connect one wire to one terminal.



(5) Wiring

- [1] Always use crimp terminals with insulation tubes so that the connected wire does not contact the neighboring terminals.

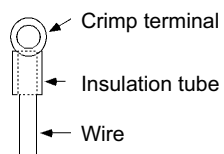

- [2] Do not connect the wires directly.

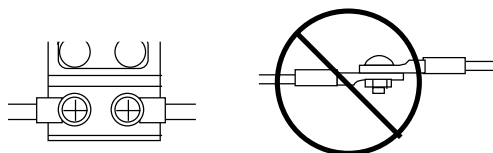

- [3] Always install the power supply unit and servo/spindle drive unit on the metal panel.

(6) Peripheral devices

- [1] Use EN/IEC Standards compliant parts for the circuit protector and contactor.
- [2] Select type B circuit protector manufactured by RCD.
 Apply Annex C of EN60204-1 for sizing of the circuit protector.

(7) Miscellaneous

- [1] Refer to the next section "EMC Installation Guidelines" for methods on complying with the EMC Directives/ Electromagnetic Compatibility Regulations.
- [2] Ground the facility according to each country's requirements.
- [3] The control circuit connector (○) is safely separated from the main circuit (⊙) and ground (●).
- [4] Inspect the appearance before installing the unit. Carry out a performance inspection of the final unit, and save the inspection records.

< When using MDS-EM/EMH together with MDS-E/EH >

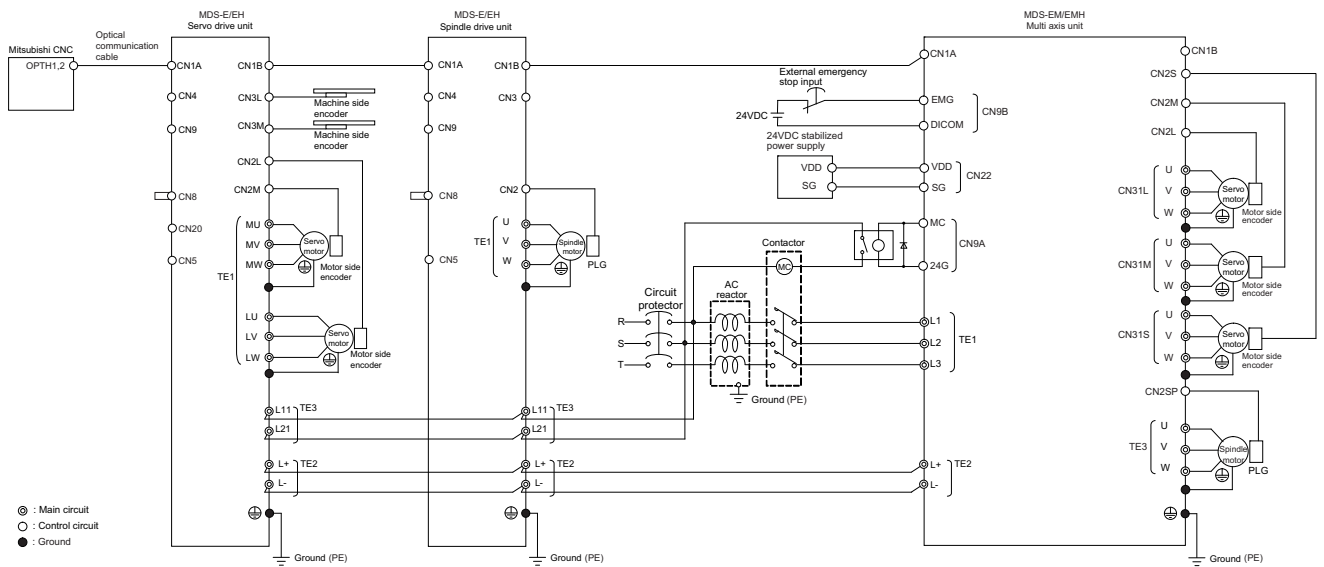

Appx. 5: EMC Installation Guidelines

13.1 Introduction

As the NC unit is a component designed to control machine tools, it is believed to be out of the direct EMC Directives/Electromagnetic Compatibility Regulations subject. However, we would like to introduce the following measure plans to backup EMC Directives/Electromagnetic Compatibility Regulations compliance of the machine tool as the NC unit is a major component of the machine tools.

- [1] Methods for installation in control/operation panel
- [2] Methods of wiring cable outside of panel
- [3] Introduction of countermeasure parts

Mitsubishi is carrying out tests to confirm the compliance to the EMC Directives/Electromagnetic Compatibility Regulations under the environment described in this manual. However, the level of the noise will differ according to the equipment type and layout, control panel structure and wiring lead-in, etc. Thus, we ask that the final noise level be confirmed by the machine tool builder.

For measures for CNC, refer to "EMC INSTALLATION GUIDELINES" of each NC Connection Manual.

13.2 EMC Directives/Electromagnetic Compatibility Regulations

The EMC Directives/Electromagnetic Compatibility Regulations regulate mainly the following two withstand levels.

Emission Capacity to prevent output of obstructive noise that adversely affects external sources.

Immunity Capacity not to malfunction due to obstructive noise from external sources.

The details of each level are classified in the table below. It is assumed that the Standards and test details required for a machine tool are about the same as these.

Class	Name	Details	Generic Standard	Standards for determining test and measurement
Emission	Radiated noise	Electromagnetic noise radiated through the air	EN61000-6-4 (General industrial machine) EN61800-3 (Motor control unit)	-----
	Conductive noise	Electromagnetic noise discharged from power line		
Immunity	Static electricity electrical discharge immunity test	(Example) Withstand level of discharge of electricity charged in a human body.	EN61000-6-2 (General industrial machine) EN61800-3 (Motor control unit)	EN61000-4-2
	Radiated radio-frequency magnetic field immunity test	(Example) Simulation of immunity from digital wireless transmitters		EN61000-4-3
	Electrical fast transient/burst immunity test	(Example) Withstand level of noise from relays or connecting/disconnecting live wires		EN61000-4-4
	Immunity to conducted disturbance induced by radio-frequency magnetic field	(Example) Withstand level of noise entering through power line, etc.		EN61000-4-6
	Power supply frequency field immunity test	(Example) 50/60Hz power frequency noise		EN61000-4-8
	Immunity test for voltage dip, short-time power failure and voltage fluctuation	(Example) Power voltage drop withstand level		EN61000-4-11
	Surge immunity test	(Example) Withstand level of noise caused by lightning		EN61000-4-5

13.3 EMC Measures

The main items relating to EMC measures include the following.

- [1] Store the device in an electrically sealed metal panel.
- [2] Earth all conductors that are floating electrically. (Lower the impedance.)
- [3] Wire the power line separated from the signal wire as far as possible.
- [4] Use shielded wires for the cables wired outside of the panel.
- [5] Install a noise filter.

Ensure the following items to suppress noise radiated outside of the panel.

- [1] Accurately ground the devices.
- [2] Clamp shielded wires in the control panel.
- [3] Increase the panel's electrical seal. Reduce the gap and hole size.

Note that the electromagnetic noise radiated in the air is greatly affected by the clearance of the panel and the quality of the cable shield.

13.4 Measures for Panel Structure

The design of the panel is a very important factor for the EMC measures, so take the following measures into consideration.

13.4.1 Measures for Control Panel Unit

- [1] Use metal for all materials configuring the panel.
- [2] For the joining of the top plate and side plates, etc., mask the contact surface with paint, and fix with welding or screws so that the impedance is reduced. In either case, keep the joining clearance to a max. of 20cm for a better effect.

Note that if the plate warps due to the screw fixing, etc., creating a clearance, noise could leak from that place.

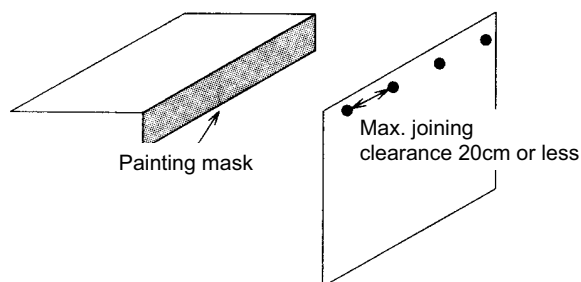

- [3] Plate the earth plate (with nickel, tin), and connect the connections with a low impedance.
- [4] If there is an opening on the panel surface, such as the ventilation holes, cover it with a metal plate or expanded metal.

Make sure not to connect using metal or a conductor without peeling off the surface, which results in an insufficient electrical connection. (ex. connection by putting painted surfaces together)

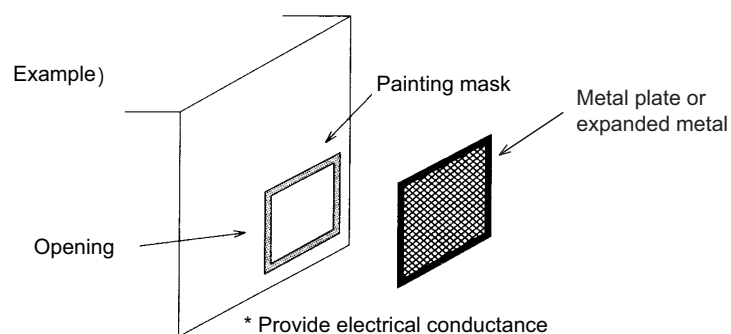

13.4.2 Measures for Door

- [1] Use metal for all materials configuring the door.
- [2] Use an EMI gasket or conductive packing for the contact between the door and control panel unit.
- [3] The EMI gasket or conductive packing must contact at a uniform and correct position of the metal surface of the control panel unit.
- [4] The surface of the control panel unit contacted with the EMI gasket or conductive packing must have conductance treatment.
(Example) Weld (or screw) a plate that is plated (with nickel, tin).

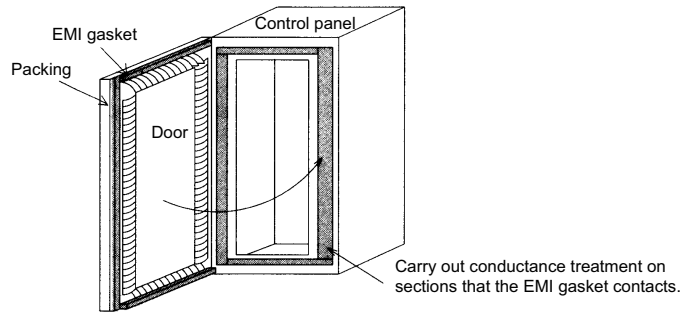

- [5] As a method other than the above, the control panel unit and door can be connected with a plain braided wire. In this case, the panel and door should be contacted at as many points as possible.

13.4.3 Measures for Operation Board Panel

- [1] Always connect the operation board and indicator with an earthing wire.
- [2] If the operation board panel has a door, use an EMI gasket or conductive packing between the door and panel to provide electrical conductance in the same manner as the control panel.
- [3] Connect the operation board panel and control panel with a sufficiently thick and short earthing wire.

13.4.4 Shielding of the Power Supply Input Section

- [1] Separate the input power supply section from other parts in the control panel so that the input power supply cable will not be contaminated by radiated noise.
- [2] Do not lead the power line through the panel without passing it through a filter.

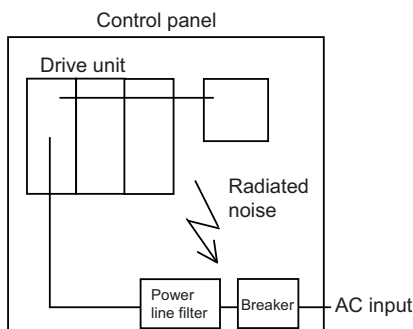

The power supply line noise is eliminated by the filter, but cable contains noise again because of the noise radiated in the control panel.

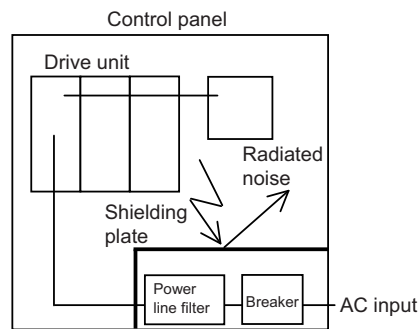

Use a metal plate, etc., for the shielding partition. Make sure not to create a clearance.

13.5 Measures for Various Cables

The various cables act as antennas for the noise and discharge the noise externally. Thus appropriate treatment is required to avoid the noise.

The wiring between the drive unit and motor act as an extremely powerful noise source, so apply the following measures.

13.5.1 Measures for Wiring in Panel

- [1] If the cables are led unnecessarily in the panel, they will easily pick up the radiated noise. Thus, keep the wiring length as short as possible.

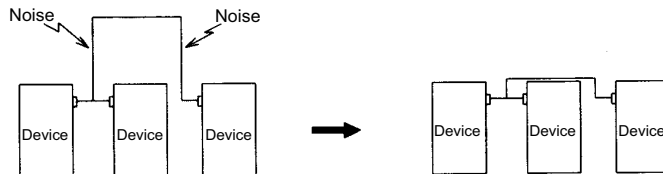

- [2] The noise from other devices will enter the cable and be discharged externally, so avoid internal wiring near the openings.

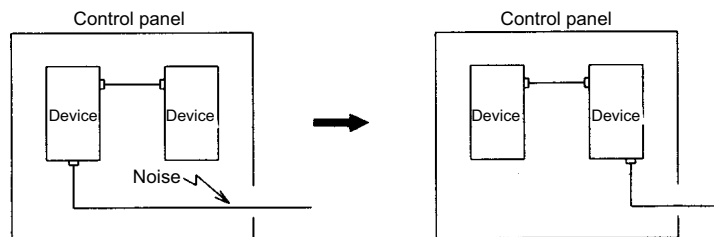

- [3] Connect the control device earthing terminal and earthing plate with a thick wire. Take care to the leading of the wire.

13.5.2 Measures for Shield Treatment

Common items

Use of shield clamp fittings is recommended for treating the shields. The fittings are available as options, so order as required. (Refer to the section "Shield Clamp Fitting" in this chapter.)

Clamp the shield at a position within 10cm from the panel lead out port.



POINT

1. When leading the cables, including the grounding wire (FG), outside of the panel, clamp the cables near the panel outlet (recommendation: within 10cm).
2. When using a metal duct or conduit, the cables do not need to be clamped near the panel outlet.
3. When leading cables not having shields outside the panel, follow the instructions given for each cable. (Installation of a ferrite core, etc., may be required.)

13.5.3 Servo/Spindle Motor Power Cable

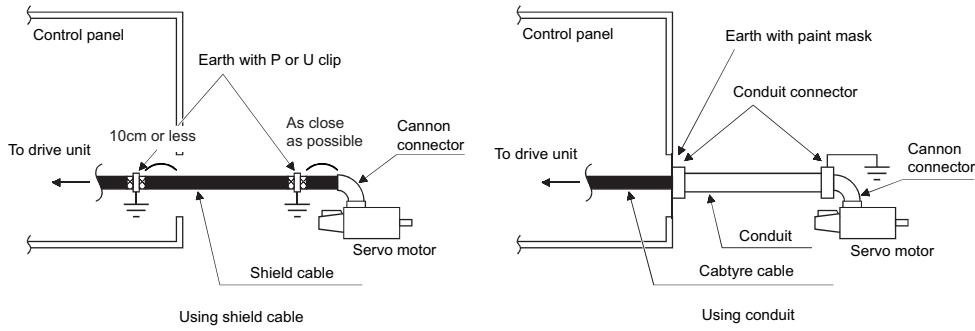

Power cable for servo motor

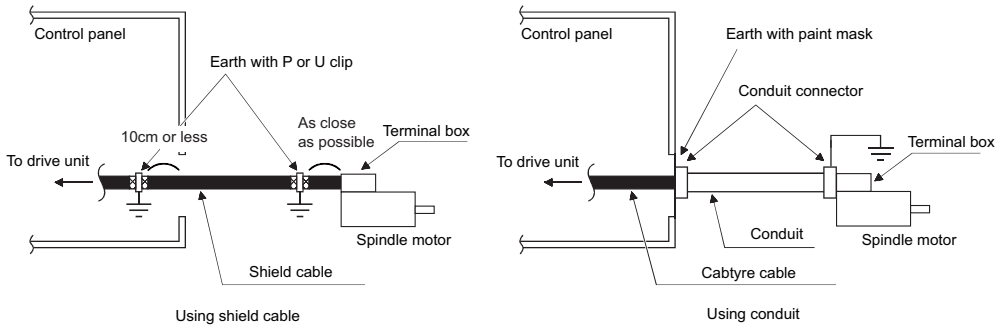

Power cable for spindle motor

- [1] Use four wires (3-phase + earthing) for the power cable that are completely shielded and free from breaks.
- [2] Earth the shield on both the control panel side and motor chassis side. The shield earth position on the drive unit side must be 10cm or less from the control panel.
- [3] Earth the shield with a metal P clip or U clip.
(A cable clamp fitting can be used depending on the wire size.)
- [4] Directly earth the shield. Do not solder the braided shield onto a wire and earth the end of the wire.

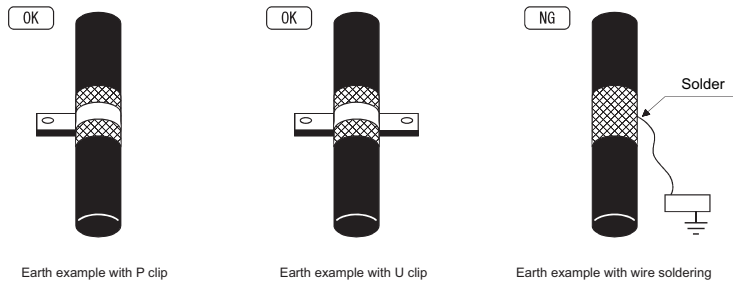

- [5] When not using a shield cable for the power cable, use a conventional cabtyre cable. Use a metal conduit outside the cable.
- [6] Earth the power cable on the control panel side at the contact surface of the conduit connector and control panel.
(Mask the side wall of the control panel with paint.)
- [7] Follow the treatment shown in the example for the conduit connector to earth the power cable on the motor side.
(Example: Use a clamp fitting, etc.)

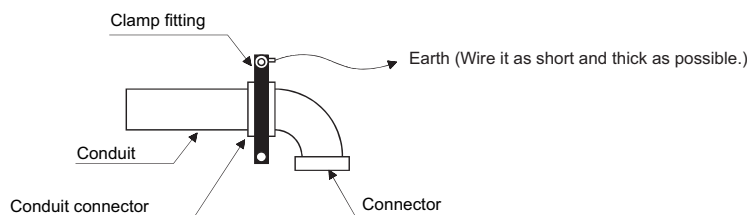

13.5.4 Servo/Spindle Motor Encoder Cable

Use a shield pair cable for encoder cable of the servo motor to earth on NC side (inside the control panel.) Mounting a ferrite core directly behind the unit connector is also effective in suppressing noise.

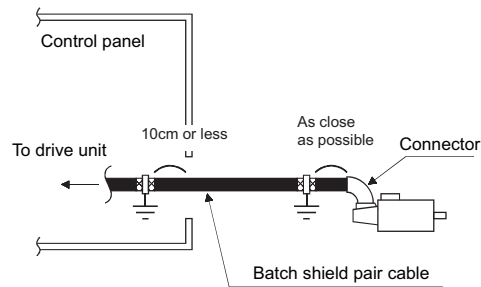

Encoder cable for servo motor

< Installation example >

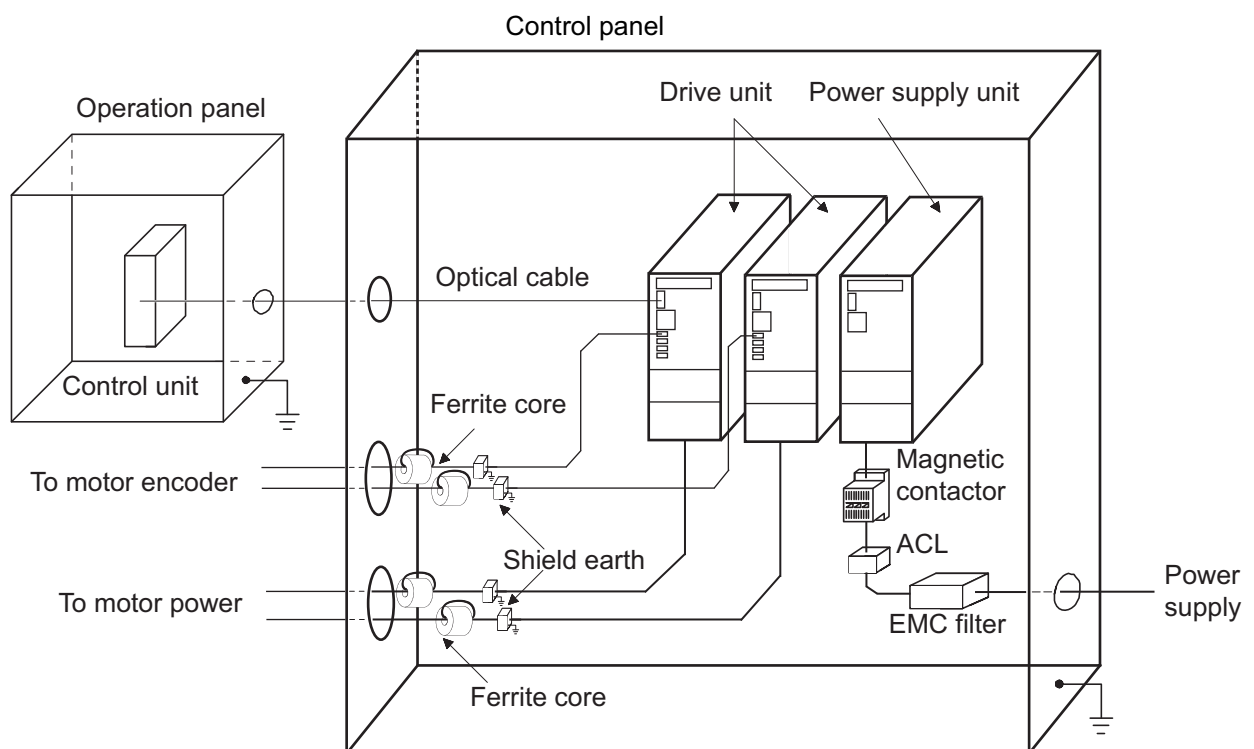

13.6 EMC Countermeasure Parts

13.6.1 Shield Clamp Fitting

The effect can be enhanced by connecting the cable directly to the earthing plate. Install an earthing plate near each panel's outlet (within 10cm), and press the cable against the earthing plate with the clamp fitting. If the cables are thin, several can be bundled and clamped together. Securely earth the earthing plate with the frame ground. Install directly on the cabinet or connect with an earthing wire.

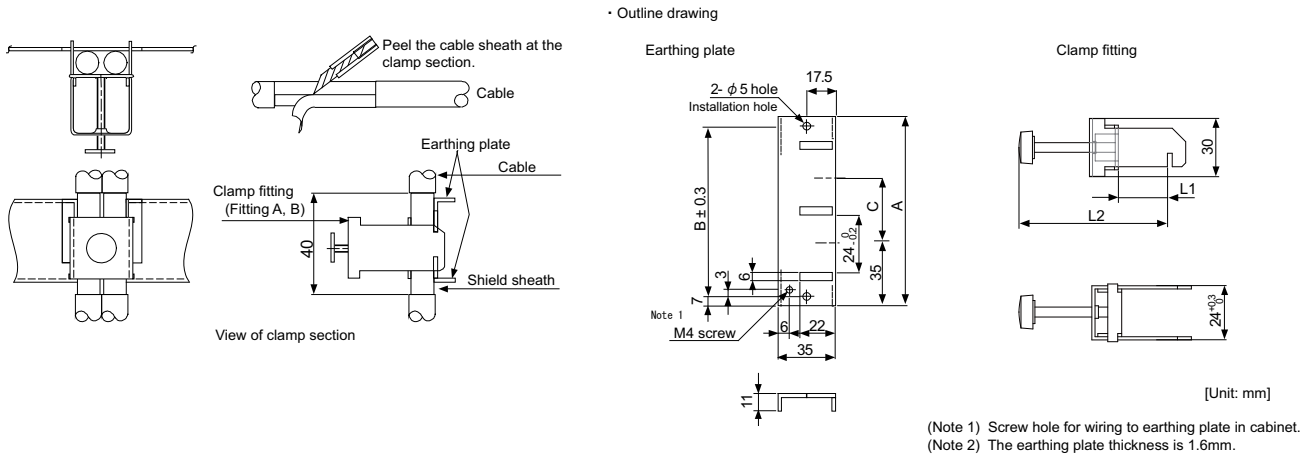

	A	B	C	Enclosed fittings
Ground Plate #D	100	86	30	Clamp fitting A x 2
Ground Plate #E	70	56	-	Clamp fitting B x 1

	L1 (maximum dimension when it is open)	L2 (reference dimension)
Clamp fitting A	25	(77)
Clamp fitting B	12	(54)

13.6.2 Ferrite Core

Noise can be suppressed by installing a ferrite core to the cable if the power cable and encoder cable, which are led from outside of the control panel, are the noise sources.

Specify the frequency of radiated noise and select the ferrite with high impedance corresponding to the frequency.

By wrapping the cable around the ferrite core according to the cable diameter as shown in the example, the impedance rises, obtaining a better effect.

< Example of use >

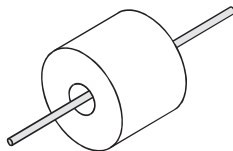

Lead through one time
(one turn)

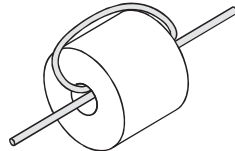

Lead through two times
(two turns)



Lead through three times
(three turns)

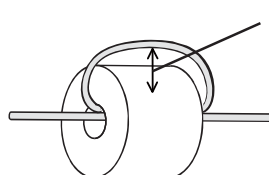

The clearance between the ferrite core and cable must be as narrow as possible when winding a cable.

< Recommended ferrite core >

A ferrite core is integrated and mounted on the plastic case. Quick installation is possible without cutting the interface cable or power cable. This ferrite core is effective against common mode noise, allowing measures against noise to be taken without affecting the signal quality.

TDK ZCAT Series

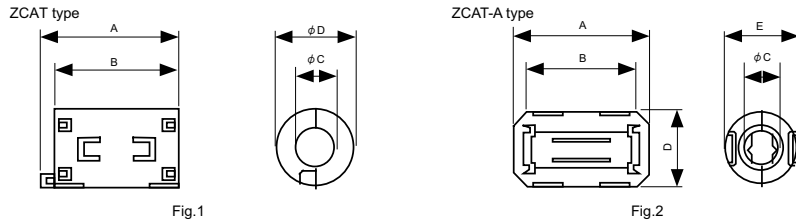

[Unit: mm]

Part name	Fig	A	B	C	D	E	Applicable cable outline	Mass
ZCAT3035-1330(-BK)*1	1	39±1	34±1	13	30	-	13max.	63
ZCAT2035-0930-M(-BK)	2	35±1	28±1	9±1	19.5±1	17.4±1	6 to 9	22

*1 A fixing band is enclosed when shipped.

Contact:

TDK Corporation
<http://www.global.tdk.com/>

Kitagawa Industries GRFC Series

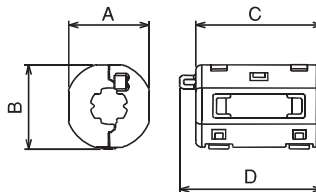

[Unit: mm]

Part number	A	B	C	D	Applicable bundle diameter	Impedance *Ω/100MHz (1 turn)
RFC-H13	31.7	29.4	41.0	-	Φ12.5 to 13.5	≥170
RFC-20	40.0	40.0	47.0	-	Max.Φ20	≥180

Contact:

KITAGAWA INDUSTRIES CO.,LTD.
<http://www.kitagawa-ind.com/eng/>

13.6.3 Power Line Filter

HF3000C-SZA Series for 200V/400V

■Features

- (a) 3-phase 3-wire type (500V series)
- (b) Compatible with 200V/400V
- (c) Compliant with EU Standards EN55011 (Group 1 Class A)
- (d) Downsized for the space-saving book type

■Application

- (a) Applications such as large machine tool, inverter, servo, etc.

■Specifications

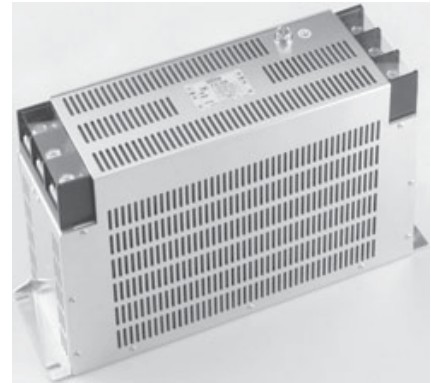

Part name	HF3000C-SZA Series											
	HF3010 C-SZA	HF3020 C-SZA	HF3030 C-SZA	HF3040 C-SZA	HF3050 C-SZA	HF3060 C-SZA	HF3080 C-SZA	HF3100 C-SZA	HF3150 C-SZA	HF3200 C-SZA	HF3250 C-SZA	HF3300 C-SZA
Rated voltage	3-phase 3-wire type 500VAC (530VAC max 50/60Hz)											
Rated current	10A	20A	30A	40A	50A	60A	80A	100A	150A	200A	250A	300A
Leakage current	7mA max 400VAC 50Hz(by UL1283)											
Ambient temp	-20 to 50°C											
Safety standards	CSA, UL1283/EN60939-2											
Vibration Resistance	Frequency: 10Hz to 55Hz Acceleration rate: 9.8m/s ²											

< Circuit diagram >

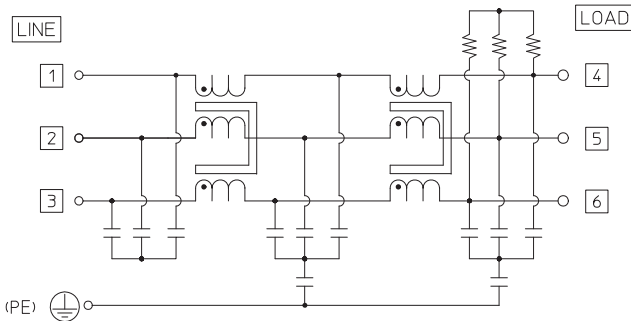

< Attenuation > Typical example: HF3150C-SZA

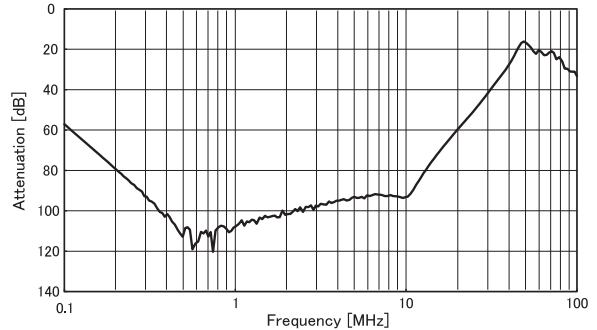

■Outline dimensions

Model	Rated current	Mass (typ.)	Dimension [Unit:mm]		
			W	D	H
HF3010C-SZA	10A	0.9kg	220	66	78
HF3020C-SZA	20A	1.3kg			
HF3030C-SZA	30A	1.3kg			
HF3040C-SZA	40A	2.0kg	270	80	84
HF3050C-SZA	50A	2.0kg			
HF3060C-SZA	60A	2.1kg			
HF3080C-SZA	80A	5.4kg	310	100	210
HF3100C-SZA	100A	5.8kg			
HF3150C-SZA	150A	9.0kg			
HF3200C-SZA	200A	11kg	400	120	260
HF3250C-SZA	250A	12kg			
HF3300C-SZA	300A	13kg			

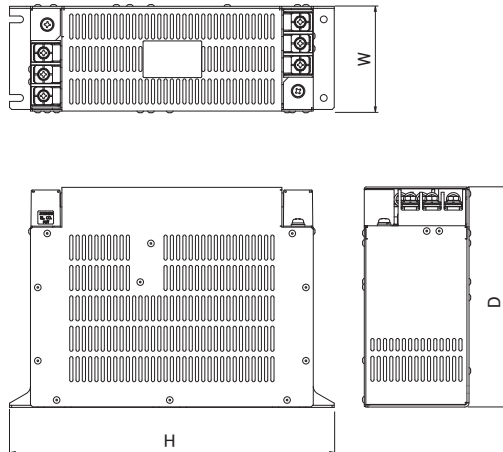

13.6.4 Surge Absorber

Insert a surge absorber in outside the AC reactor when viewed from the power supply unit and drive unit to prevent damage to the control panel or power supply unit, etc. caused by the surge (lightning or sparks, etc.) applied on the AC power line. Do not insert the surge absorber between the AC reactor, and the power supply unit and drive unit. Harmonic components occur due to the power regeneration control.

Use a surge absorber that satisfies the following electrical specifications.

< Surge absorber for 200V >

RSPD Series for 200V (for both between phases and between phase and earth)

Part name	Rated voltage 50/60Hz	Voltage protection level	Surge withstand level 8/20 μs	Service temperature
RSPD-250-U4	3AC 250V	1300V	2500A	-40 to 70°C

< Surge absorber for 400V >

RSPD Series for 400V (for both between phases and between phase and earth)

Part name	Rated voltage 50/60Hz	Voltage protection level	Surge withstand level 8/20μs	Service temperature
RSPD-500-U4	3AC 500V	2000V	2500A	-40 to 70°C

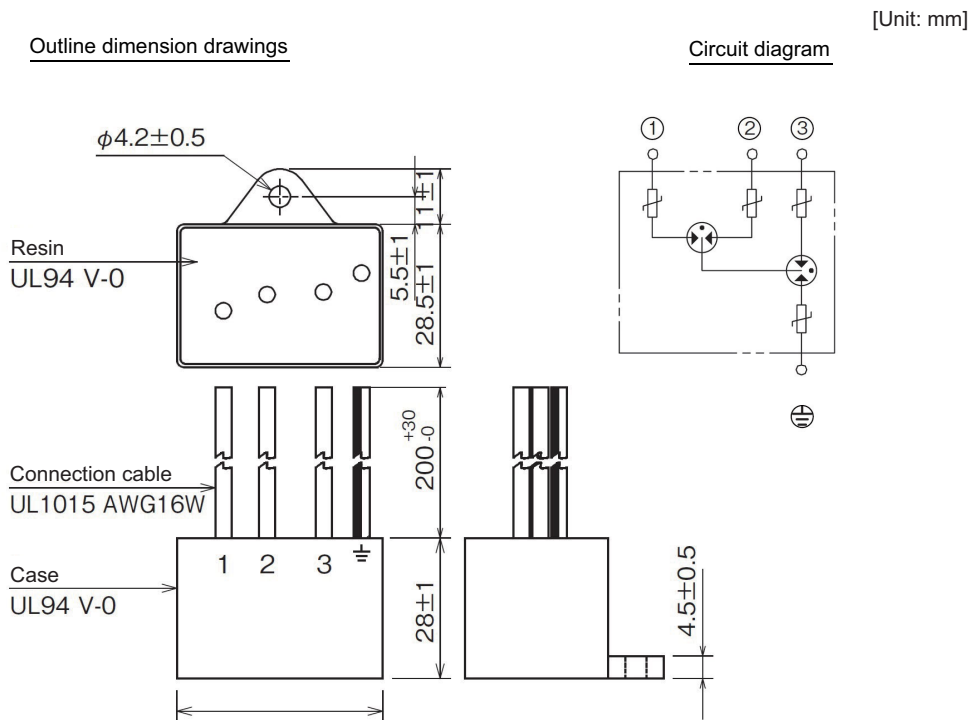

Contact: Okaya Electric Industries Co., Ltd. <http://www.okayaelec.co.jp/english/index.html>

< Example of surge absorber installation >

An example of installing the surge absorber in the machine control panel is shown below.

A short-circuit fault will occur in the surge absorber if a surge exceeding the tolerance is applied. Thus, install a circuit protector in the stage before the surge absorber. Note that almost no current flows to the surge absorber during normal use, so a circuit protector installed as the circuit protection for another device can be used for the surge absorber.

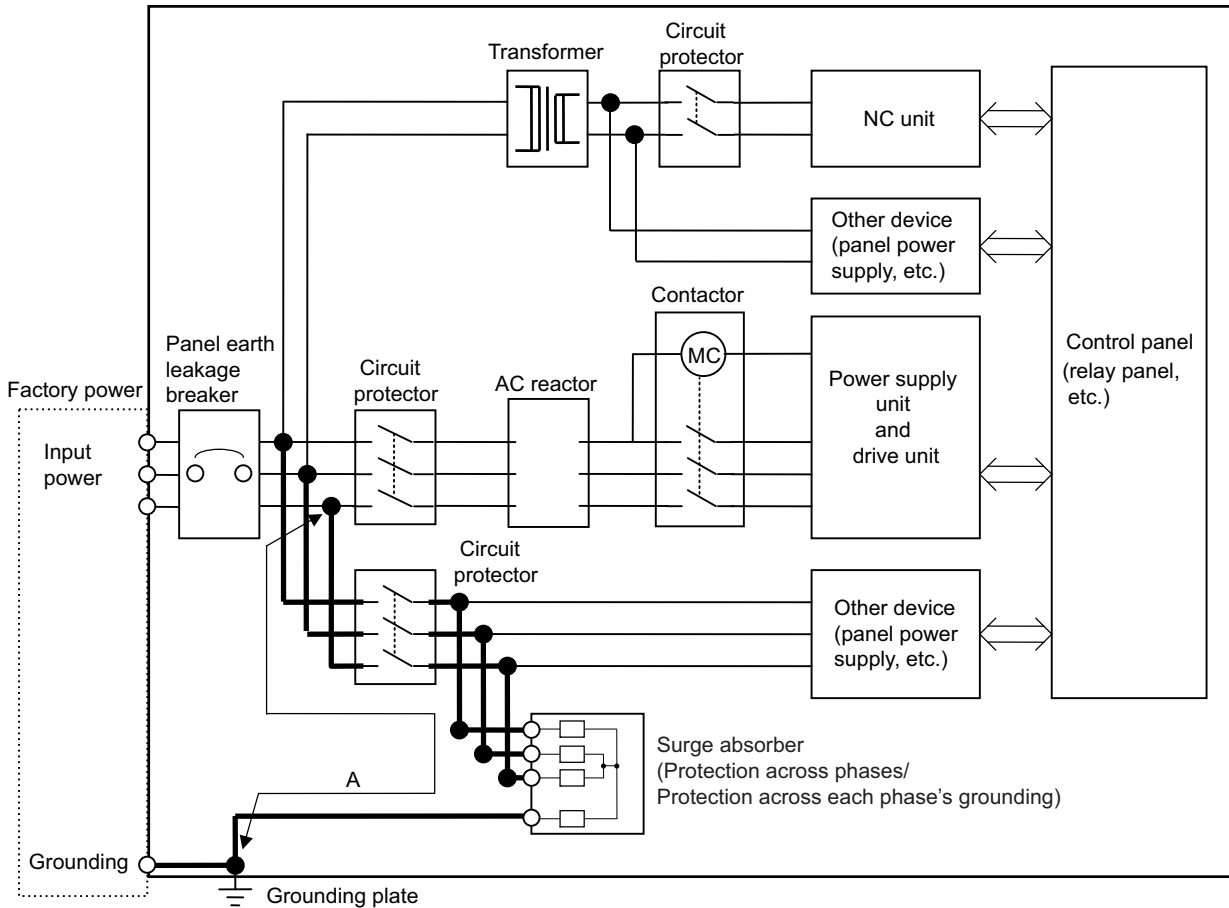

Installing the surge absorber

CAUTION

1. The wires from the surge absorber should be connected without extensions.
2. If the surge absorber cannot be installed just with the enclosed wires, keep the wiring length of A to 2m or less. If the wires are long, the surge absorber's performance may drop and inhibit protection of the devices in the panel.
3. Surge absorber to be selected varies depending on input power voltage.
4. Do not insert the surge absorber in the place with a lot of harmonic components.

Appx. 6: Higher Harmonic Suppression Measure Guidelines

14.1 Higher Harmonic Suppression Measure Guidelines

These guidelines apply to users for which the 6-pulse equivalent capacity total of the installed higher harmonic generator exceeds the reference in the following table. (Note that household appliances and general-purpose products having a rated current of 20A/phase or less connected to a 300V or less commercial power supply are excluded from the generators.)

Use the following flow chart to confirm whether the total exceeds the reference.

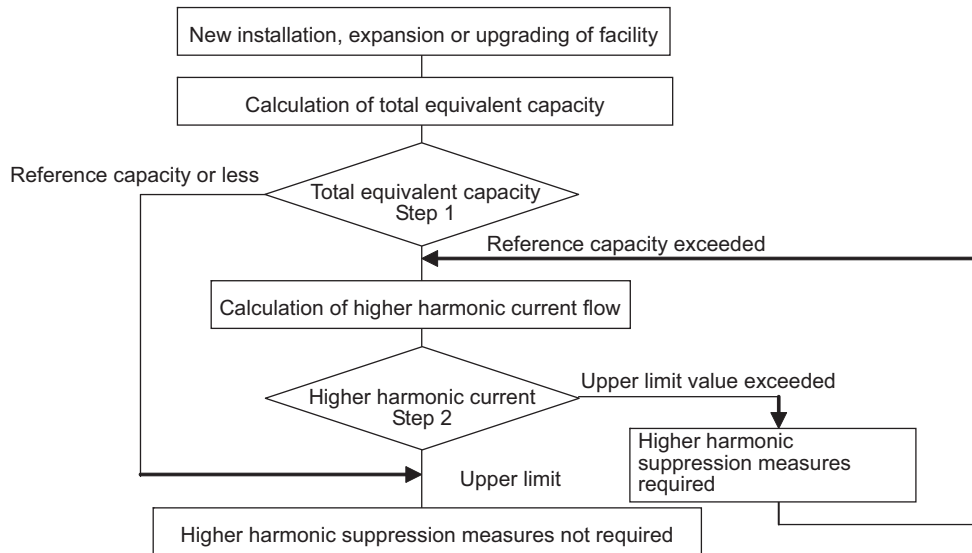

Higher Harmonic Suppression Guidelines were set in September 1994 by the Ministry of International Trade and Industry's Agency of Natural Resources and Energy.

- Higher Harmonic Suppression Measure Guidelines for Household Appliances and General-purpose Products
- Higher Harmonic Suppression Measure Guidelines for Consumers Receiving High Voltage or Special High Voltage Power

14.1.1 Calculating the Equivalent Capacity of the Higher Harmonic Generator

As a principle, the higher harmonic suppression measure guidelines must be followed by the customer.

- (1) Calculating the total equivalent capacity (Step 1)

Calculate the total equivalent capacity with the following expression.

Total equivalent circuit: $P_o = \Sigma \cdot K_i \cdot P_i$

K_i :Conversion coefficient (Refer to following table)

P_i :Rated input capacity of each device

(Table 1) Rated capacity of each unit

Unit type		Rated input capacity P_i [kVA]
MDS-EM-	MDS-EMH-	
SPV3-10040	-	24.12
SPV3-10080	-	26.47
SPV3-16040/16040S	-	26.8
SPV3-16080	SPV3-8040	27.2
SPV3-20080	SPV3-10040	35.9
SPV3-200120	SPV3-10060	44.7
SPV3-320120	-	57.6

(Note) The rated capacity P_i above, is the value used to calculate whether the product corresponds to the higher harmonic guidelines. Thus, the value will differ from the actual power facility's capacity.
(The power supply unit is not included.)

(Table 2) Circuit class and conversion coefficient for each unit

Name	Model	Circuit class	Circuit type	Conversion coefficient K_i
Servo drive unit	MDS-E/EH-V1/V2 Series	3	3-phase bridge (with smoothing capacitor) With AC reactor (Note 1)	$K_{32}=1.8$
Spindle drive unit	MDS-E/EH-SP/SP2 Series	3	3-phase bridge (with smoothing capacitor) With AC reactor (Note 1)	$K_{32}=1.8$

(Note) This applies when an AC reactor is installed on the power supply unit.

(Table 3) Limit values for total equivalent capacity

Incoming voltage	Total of 6-pulse equivalent capacity
6.6kV	50kVA
22/33kV	300kVA
66kV or more	2,000kVA

If the total equivalent capacity P_o exceeds the limit value given in (Table 3), proceed to "(2) Calculating the higher harmonic current flow".

Measures are not required if the value is not exceeded.

- (2) Calculating the higher harmonic current flow (Step 2)

To calculate the higher harmonic current flow, calculate the rated current for the incoming power voltage conversion.

$$\text{Rated current for incoming power voltage conversion (mA)} = a \cdot P_i$$

(Table 4) Incoming power voltage conversion coefficient a

Incoming power voltage	Coefficient a
6.6kV	87.5
22 kV	26.2
33 kV	17.5
66 kV	8.75
77 kV	7.5

(Table 5) Upper limit of higher harmonic current flow (mA/kW)

Conversion coefficient	5th- order	7th- order	11th- order	13th- order	17th- order	19th- order	23rd- order	25th- order
6.6kV	3.5	2.5	1.6	1.3	1.0	0.9	0.76	0.70
22kV	1.8	1.3	0.82	0.69	0.53	0.47	0.39	0.36
33kV	1.2	0.86	0.55	0.46	0.35	0.32	0.26	0.24
66kV	0.59	0.42	0.27	0.23	0.17	0.16	0.13	0.12
77kV	0.50	0.36	0.23	0.19	0.15	0.13	0.11	0.10

Obtain the upper limit of the higher harmonic current flow (judgment value) for each order.

(The contracted electricity must be known for this.)

$$\text{Upper limit of higher harmonic current flow (mA)} = \text{Contracted electricity, flow upper limit value}$$

Flow upper limit value :

Insert a value from Table 5 according to the higher harmonic order to be calculated.

Obtain the higher harmonic current flow for each order using the following expression.

$$\text{Higher harmonic current flow (mA)} = (a \cdot P_i), \text{ Device's maximum operation rate, target order}$$

Device's maximum operation rate : The user must set the operation rate.

Target order : Insert a value from Table 6 according to the higher harmonic order to be calculated.

(Table 6) Higher harmonic current generation rate %

Conversion coefficient	5th- order	7th- order	11th- order	13th- order	17th- order	19th- order	23rd- order	25th- order
K32 = 1.8	38.0	14.5	7.4	3.4	3.2	1.9	1.7	1.3
K31 = 3.4	65.0	41.0	8.5	7.7	4.3	3.1	2.6	1.8

Values when basic wave current is 100%.

Check whether the calculated results exceed the limit value.

If the limit value for the higher harmonic current flow is exceeded, consider the higher harmonic measures shown below.

Examples of higher harmonic measures

Item	Details
Power-factor improving capacitor	Higher harmonics are suppressed by adding a leading capacitor for improving the power factor.
Installation of AC line filter	A reactor and capacitor are combined to reduce the impedance for specific frequencies.

(3) Higher harmonic current flow calculation form

A higher harmonic current flow calculation form is shown below for reference.

<Form 1>

Higher harmonic generating device's higher harmonic current flow calculation form (Part 1)

Date of application
Application No.
Date of acceptance

User name	Industry	Incoming power voltage	kV	Contracted electricity	kV
-----------	----------	------------------------	----	------------------------	----

Step 1: Details of higher harmonic generating device										Step 2: Calculation of higher harmonic current flow rate										
No.	Higher harmonic generating device		Rated capacity (kVA)	Qty. of devices	Total capacity Pi (kVA)	Circuit type classification No.	6-pulse calculation coefficient Ki	6-pulse equivalent capacity [Ki x Pi] (kVA)	Rated current value for incoming power conversion [a x Pi] (mA)	Device's maximum operation rate (%)	Higher harmonic current flow per order									
	Device name	Maker									Type	5th-order	7th-order	11th-order	13th-order	17th-order	19th-order	23rd-order	25th-order	
1																				
2																				
3																				
4																				
5																				
6																				
7																				
8																				
9																				
10																				
11																				
12																				
13																				
14																				
15																				
<Instructions for completing form>										Total										
										Necessity of measures										

Step 1
 Indicate the details of the higher harmonic generating device. Refer to the reference and indicate the circuit type classification No., etc.
 If the device's circuit type classification No. is 10, complete the application shown in <Format 3>.
 If P_i > 50kVA (6kV incoming power), 300kVA (22, 33kV incoming power), 2000kVA (66kV or higher incoming power), proceed to Step 2. (Step 2 does not need to be completed in all other cases.)

Step 2
 If the current flow > current flow upper limit value at each order, then
 If there is a facility that lowers the higher harmonics in the factory, or when suppression measures are implemented, proceed to Calculation Form (Part 2)
 In all other cases, separate measures must be taken

Order	5th-order	7th-order	11th-order	13th-order	17th-order	19th-order	23rd-order	25th-order
Current upper limit value (mA)								

Revision History

Date of revision	Manual No.	Revision details
Jun. 2015	IB(NA)1501241-A	First edition created.
Dec. 2015	IB(NA)1501241-B	<ul style="list-style-type: none"> - Descriptions for MDS-EMH Series were added. - Servo motor HG75,105, HG-H54, 104, 154, 204, 354, 453 were added. - Function Specifications List was revised. - "Quakeproof Level", "Shaft Characteristics" and "Coupling with the Load" in "Installation of Servo Motor" were revised. - "Installation of Spindle Motor" was revised. - "Balancing the Spindle Motor (Unit)" was revised. - "Shaft Characteristics", "Coupling with the Fittings" and "Connection" in "Installation of Spindle Motor" were revised. - "Installation of the Terminal Box Cover" was added. - "Cable Stress" was revised. - "Installation Direction and Clearance" was revised. - "Heating Value" was revised. - "Spindle Side PLG Serial Output Encoder (TS5690, MU1606 Series)" was revised. - "Part System Connection Diagram" was revised. - "Main Circuit Terminal Block/Control Circuit Connector" was revised. - "NC and Drive Unit Connection" was revised. - "Motor and Encoder Connection" was revised. - "Connection of Power Supply" was revised. - "Wiring of the Motor Brake" was revised. - "Spindle Coil Changeover" and "Proximity Switch Orientation" were revised. - "STO (Safe Torque Off) Function" was revised. - "Initial Setup" was revised. - "Setting of Servo Specification Parameters" and "Setting of Machine Side Encoder" were revised. - "List of Standard Parameters for Each Servo Motor" was revised. - "Servo Parameters" was revised. - "List of Standard Parameters for Each Spindle Motor" was revised. - "Spindle Specification Parameters" was revised. - "Spindle Parameters" was revised. - "Spindle-type Servo Parameters" was added. - "Speed Loop Gain" and "OMR-FF Function" were revised. - "Optimal Adjustment of Cycle Time" was revised. - "Vertical Axis Drop Prevention Control" was revised. - "Spindle C Axis Adjustment (For Lathe System)" was revised. - "Spindle Motor Temperature Compensation Function" was revised. - "Points of Caution and Confirmation" was revised. - "Troubleshooting for Each Alarm No." was revised. - "Replacing the Fan unit" was added. - "Replacing the Battery" was revised. - "D/A Output Specifications for Drive Unit" was revised. - "Protection Function" was added. - "Compliance to EC Directives" was revised. - "Higher Harmonic Suppression Measure Guidelines" was revised. - Miswrite is corrected.

Date of revision	Manual No.	Revision details
Mar. 2016	IB(NA)1501241-C	<ul style="list-style-type: none"> - Descriptions for 400V specifications were deleted. - Servo motor HG96 was added. - MDS-EM-SPV3-16040 was added. - "Precautions for Safety" was revised. - Function Specifications List was revised. - "Quakeproof Level", "Shaft Characteristics", "Oil / Water Standards" and "Installation of Servo Motor" in "Installation of Servo Motor" were revised. - "Shaft Characteristics" in "Installation of Spindle Motor" was revised. - "Installation Direction and Clearance" was revised. - "Heating Value" was revised. - "Wiring and Connection" was revised. - "Initial Setup" was revised. - "OSA105ET2A" was replaced by "OSA405ET2AS". - "OSA166ET2NA" was replaced by "OSA676ET2AS". - "List of Standard Parameters for Each Servo Motor" and "Servo Parameters" were revised. - "List of Standard Parameters for Each Spindle Motor" and "Spindle Parameters" were revised. - "Speed Loop Gain" was revised. - "Optimal Adjustment of Cycle Time" was revised. - "Vertical Axis Drop Prevention Control" and "Vertical Axis Pull-up Control" were revised. - "Spindle Motor Temperature Compensation Function" was revised. - "LED Display When Alarm or Warning Occurs" was revised. - "Troubleshooting for Each Alarm No." was revised. - "Parameter Numbers during Initial Parameter Error" was revised. - "Replacing the Fan Unit" was revised. - "D/A Output Specifications" was revised. - "Emergency Stop Observation" and "SLS (Safely Limited Speed) function" were revised. - "Compliance to EC Directives" was revised. - "EMC Installation Guidelines" was revised. - "Higher Harmonic Suppression Measure Guidelines" was revised. - Miswrite is corrected.
Sep. 2016	IB(NA)1501241-D	<ul style="list-style-type: none"> - Descriptions for MDS-EMH Series were added. - "Multi axis integrated drive unit" was replaced by "Multi-hybrid drive unit". - Function Specifications List was revised. - "Quakeproof Level", "Shaft Characteristics", "Oil / Water Standards" and "Installation of Servo Motor" in "Installation of Servo Motor" were revised. - "Shaft Characteristics" in "Installation of Spindle Motor" was revised. - "Installation Direction and Clearance" and "Heating Value" were revised. - "Wiring and Connection" was revised. - "Initial Setup" was revised. - "Setting of Machine Side Encoder", "List of Standard Parameters for Each Servo Motor" and "Servo Parameters" were revised. - "Setting of Parameters Related to the Spindle", "List of Standard Parameters for Each Spindle Motor", "Spindle Specification Parameters" and "Spindle Parameters" were revised. - "Speed Loop Gain" was revised. - "OMR-FF Function" was revised.

Date of revision	Manual No.	Revision details
Sep. 2016	IB(NA)1501241-D	<ul style="list-style-type: none"> - "Optimal Adjustment of Cycle Time" and "Vibration Suppression Measures" were revised. - "Vertical Axis Drop Prevention Control" and "Vertical Axis Pull-up Control" were revised. - "Spindle C Axis Adjustment (For Lathe System)" was revised. - "Spindle Motor Temperature Compensation Function" was revised. - "LED Display When Alarm or Warning Occurs" was revised. - "List of Alarms" was revised. - "Troubleshooting for Each Alarm No." was revised. - "Replacing the Fan Unit" was revised. - "D/A Output Specifications" and "Servo Drive Unit Settings" were revised. - "Emergency Stop Observation" and "SLS (Safely Limited Speed) function" were revised. - "Compliance to EC Directives" was revised. - "EMC Installation Guidelines" was revised. - "Higher Harmonic Suppression Measure Guidelines" was revised. - Miswrite is corrected.
Nov. 2017	IB(NA)1501241-E	<ul style="list-style-type: none"> - "Multi-hybrid drive unit" was replaced by "Multi axis unit". - The words "machine manufacturers" were replaced by "machine tool builders". - The following spindle motors were added. SJ-D15/80-01, SJ-DG11/120-03T - The following spindle motors were deleted. SJ-V7.5-03ZT, SJ-V11-08ZT, SJ-V11-13ZT - "Precautions for Safety" was revised. - Function Specifications List was revised. - "Coupling with the Load" and "Oil / Water Standards" were revised. - "Environmental Conditions", "Shaft Characteristics", "Installation of Spindle Motor" and "Connection" in "Installation of Spindle Motor" were revised. - "Installation Direction and Clearance" and "Heating Value" were revised. - "Heat radiation countermeasures outside the control panel" was deleted from "Heat Radiation Countermeasures". - "Spindle Side PLG Serial Output Encoder (TS5690, MU1606 Series)" was revised. - "Twin-head Magnetic Encoder (MBA405W, MBE405W Series)" was deleted. - "Part System Connection Diagram", "Main Circuit Terminal Block/Control Circuit Connector", "NC and Drive Unit Connection" and "Motor and Encoder Connection" were revised. - "Power Supply Input Connection" was revised. - "Wiring of the Motor Brake" was revised. - "Proximity Switch Orientation" was revised. - "Harmonized Standard" was revised. - "STO (Safe Torque Off) Function" was revised. - "SBC (Safe Brake Control) Function" was revised. - "Initial Setup" was revised. - "Setting the Initial Parameters for the Servo Drive Unit" was revised. - "Setting of Servo Specification Parameters", "Setting of Machine Side Encoder", "List of Standard Parameters for Each Servo Motor", "Servo Parameters" were revised. - "Setting the Initial Parameters for the Spindle Drive Unit" was revised.

Date of revision	Manual No.	Revision details
Nov. 2017	IB(NA)1501241-E	<ul style="list-style-type: none"> - "Setting of Parameters Related to the Spindle", "List of Standard Parameters for Each Spindle Motor" and "Spindle Parameters" were revised. - "Spindle Specification Parameters" and "Spindle-type Servo Parameters" were deleted. - "Speed Loop Gain" and "OMR-FF Function" were revised. - "Optimal Adjustment of Cycle Time" and "Vibration Suppression Measures" were revised. - "Full-closed Torsion Compensation Function" was added. - "Vertical Axis Drop Prevention Control" was revised. - "Collision Detection Function" was revised. - "Adjusting the Acceleration/Deceleration Operation" was revised. - "High-speed Synchronous Tapping", "Spindle C Axis Adjustment (For Lathe System)" and "Spindle Synchronization Adjustment (For Lathe System)" were revised. - "Points of Caution and Confirmation" was revised. - "Protective Functions List of Units" was revised. - "Troubleshooting for Each Alarm No.", "Troubleshooting for Each Warning No." and "Parameter Numbers during Initial Parameter Error" were revised. - "Details of Alarm 4D" was added. - "Maintenance" was revised. - "Replacing the Battery" was revised. - "Compliance to EC Directives" was revised. - Miswrite is corrected.
Apr. 2018	IB(NA)1501241-F	<ul style="list-style-type: none"> - MDS-EM-SPV3-16040S and MDS-EM-SPV3-320120 were added. - The following spindle motors were added. SJ-D18.5/80-01, SJ-D22/80-01, SJ-D26/80-01 - Function Specifications List was revised. - "Shaft Characteristics" and "Connection" in "Installation of Spindle Motor" were revised. - "Installation Direction and Clearance", "Panel Installation Hole Work Drawings (Panel Cut Drawings)" and "Heating Value" were revised. - "Connector Pin Assignment" and "Servo Motor Power Supply Connector Wiring Method" were revised. - "NC and Drive Unit Connection" was revised. - "Setting of Distance-coded Reference Scale", "List of Standard Parameters for Each Servo Motor" and "Servo Parameters" were revised. - "Setting the Initial Parameters for the Spindle Drive Unit" was revised. - "OMR-FF Function" was revised. - "Full-closed Torsion Compensation Function" was revised. - "Gain Adjustment", "Synchronous Tapping Adjustment", "Spindle C Axis Adjustment (For Lathe System)" and "Spindle Synchronization Adjustment (For Lathe System)" were revised. - "Service Parts" was revised. - "Replacing the Fan Unit" was revised. - "Calculating the Equivalent Capacity of the Higher Harmonic Generator" was revised. - Miswrite is corrected.
Jun. 2020	IB(NA)1501241-G	<ul style="list-style-type: none"> - "Introduction" was revised. - "Connector Pin Assignment" was revised.
Nov. 2020	IB(NA)1501241-H	<ul style="list-style-type: none"> - Servo motor HG702 was added.

Date of revision	Manual No.	Revision details
Nov. 2020	IB(NA)1501241-H	<ul style="list-style-type: none"> - The following spindle motors were added. SJ-DG15/120-02T-K, SJ-DL5.5/240-05T, SJ-DN7.5/80-01, SJ-DN11/80-01, SJ-DN15/80-01, SJ-DN18.5/80-01 - Spindle motor SJ-V15-01ZT was deleted. - "Introduction" was revised. - "Precautions for Safety" was revised. - Function Specifications List was revised. - "Quakeproof Level", "Shaft Characteristics", and "Oil/Water Standards" in "Installation of Servo Motor" were revised. - "Installation of Spindle Motor" was revised. - "Installation of the Terminal Box Cover" was deleted. - "Heating Value" was revised. - "CAUTION", "Part System Connection Diagram", "NC and Drive Unit Connection", "Connection of the Servo Motor", and "Wiring of the Motor Brake" in "Wiring and Connection" were revised. - "Safety Function" was revised. - "STO (Safe Torque Off) Function" was revised. - "Transition of LED Display After Power Is Turned ON" was revised. - "Setting the Initial Parameters for the Servo Drive Unit" was revised. - "Setting the Initial Parameters for the Spindle Drive Unit" was revised. - "Speed Loop Gain" and "OMR-FF Function" were revised. - "Optimal Adjustment of Cycle Time", "Vibration Suppression Measures", "Improvement of Protrusion at Quadrant Changeover", and "Speed Loop Delay Compensation" were revised. - "Vertical Axis Drop Prevention Control", "Vertical Axis Pull-up Control", and "Collision Detection Function" were revised. - "Adjusting the Acceleration/Deceleration Operation", "High-speed Synchronous Tapping", "Deceleration Coil Changeover Valid Function by Emergency Stop", "Spindle Motor Temperature Compensation Function", "Settings for Emergency Stop", and "Spindle Control Signal" were revised. - "List of Alarms" was revised. - "Troubleshooting for Each Alarm No." and "Troubleshooting for Each Warning No." were revised. - "Adding and Replacing Units and Parts" was revised. - "Replacing the Battery" was revised. - "SLS (Safely Limited Speed) function" was revised. - "Cautions for EC Directive Compliance" was revised. - "EMC Installation Guidelines" was revised. - "Higher Harmonic Suppression Measure Guidelines" was revised. - Miswrite is corrected.
Sep. 2021	IB(NA)1501241-J	<ul style="list-style-type: none"> - Function Specifications List was revised. - "Specified Speed Output" was revised. - "Setting the Initial Parameters for the Servo Drive Unit" was revised. - "Setting of Machine Side Encoder" was revised. - "Servo Parameters" was revised. - "Spindle Parameters" was revised. - "Vibration Suppression Measures" was revised. - "List of Alarms" was revised. - "Troubleshooting for Each Warning No." was revised. - "CMV1-xPxxS-xx Plug Connector" was revised.

Date of revision	Manual No.	Revision details
Sep. 2021	IB(NA)1501241-J	<ul style="list-style-type: none"> - "Service Parts" was revised. - "Spindle Drive Unit Settings" was revised. - "Compliance to EC Directives" was revised. - "Introduction" and "EMC Directives/Electromagnetic Compatibility Regulations" in "EMC Installation Guidelines" were revised. - Miswrite is corrected.
Apr. 2022	IB(NA)1501241-K	<ul style="list-style-type: none"> - The following spindle motors were added. SJ-DG11/120-03T-S, SJ-DG11/120-12T-K, SJ-DG11/120-12T-KS, SJ-DG11/150-06T, SJ-DG11/150-06T-S, SJ-DG11/150-15T-K, SJ-DG11/150-15T-KS, SJ-DG15/120-02T-KS, SJ-DM11/120-01T - Function Specifications List was revised. - "Shaft Characteristics" and "Connection" in "Installation of Spindle Motor" were revised. - "Setting of Machine Side Encoder" was revised. - "Servo Parameters" was revised. - "List of Standard Parameters for Each Spindle Motor" was revised. - "Spindle Parameters" was revised. - "Vibration Suppression Measures" was revised. - "Vertical Axis Drop Prevention Control" was revised. - "List of Alarms" was revised. - "Troubleshooting for Each Alarm No." was revised. - Miswrite is corrected.
May 2023	IB(NA)1501241-L	<ul style="list-style-type: none"> - Descriptions for servo motor HK, HK-H Series were added. - "Precautions for Safety" was revised. - Function Specifications List was revised. - "Environmental Conditions", "Quakeproof Level", "Shaft Characteristics", "Oil/Water Standards", and "Installation of Servo Motor" of "Installation of Servo Motor" were revised. - "Connection of the Servo Motor" was revised. - "Wiring of the Motor Brake" was revised. - "Wiring of the Motor Magnetic Brake" was revised. - "SBC (Safe Brake Control) Function" was revised. - "Setting of Machine Side Encoder," "Setting of Distance-coded Reference Scale", "List of Standard Parameters for Each Servo Motor", and "Servo Parameters" of "Setting the Initial Parameters for the Servo Drive Unit" were revised. - "Setting of Parameters Related to the Spindle" and "Spindle Parameters" of "Setting the Initial Parameters for the Spindle Drive Unit" were revised. - "Speed Loop Gain" was revised. - "Optimal Adjustment of Cycle Time" was revised. - "List of Alarms" was revised. - "Parameter Numbers during Initial Parameter Error" was revised. - "Compliance to EC Directives" was revised. - Miswrite is corrected.

Global Service Network

AMERICA

MITSUBISHI ELECTRIC AUTOMATION INC. (AMERICA FA CENTER)

Central Region Service Center (Chicago)
500 CORPORATE WOODS PARKWAY, VERNON HILLS, ILLINOIS 60061, U.S.A.
TEL: +1-847-478-2500 / FAX: +1-847-478-2650
Minneapolis, MN Service Satellite
Detroit, MI Service Satellite
Grand Rapids, MI Service Satellite
Milwaukee, WI Service Satellite
Cleveland, OH Service Satellite
Indianapolis, IN Service Satellite
St. Louis, MO Service Satellite

South/East Region Service Center (Georgia)

1845 SATELLITE BOULEVARD STE. 450, DULUTH, GEORGIA 30097, U.S.A.
TEL: +1-678-258-4529 / FAX: +1-678-258-4519
Charleston, SC Service Satellite
Charlotte, NC Service Satellite
Raleigh, NC Service Satellite
Dallas, TX Service Satellite
Houston, TX Service Satellite
Hartford, CT Service Satellite
Knoxville, TN Service Satellite
Nashville, TN Service Satellite
Baltimore, MD Service Satellite
Pittsburg, PA Service Satellite
Tampa, FL Service Satellite
Syracuse, NY Service Satellite
Orlando, FL Service Satellite
Lafayette, LA Service Satellite
Philadelphia, PA Service Satellite

Western Region Service Center (California)

5900-B KATELLA AVE. - 5900-A KATELLA AVE. CYPRESS, CALIFORNIA 90630, U.S.A.
TEL: +1-714-699-2625 / FAX: +1-847-478-2650
San Jose, CA Service Satellite
Seattle, WA Service Satellite
Denver, CO Service Satellite

Canada Region Service Center (Toronto)

4299 14TH AVENUE MARKHAM, ONTARIO L3R 0J2, CANADA
TEL: +1-905-475-7728 / FAX: +1-905-475-7935
Edmonton, AB Service Satellite
Montreal, QC Service Satellite

Mexico Region Service Center (Querétaro)

Parque Tecnológico Innovación Querétaro, Lateral Carretera Estatal 431, Km 2+200, Lote 91 Modulos 1 y 2
Hacienda la Machorra, CP 76246, El Marqués, Querétaro, México
TEL: +52-442-153-6050
Monterrey, NL Service Satellite
Mexico City, DF Service Satellite

BRAZIL

MITSUBISHI ELECTRIC DO BRASIL COMÉRCIO E SERVIÇOS LTDA.

Votorantim Office
AV. GISELE CONSTANTINO,1578, PARQUE BELA VISTA, VOTORANTIM-SP, BRAZIL CEP:18.110-650
TEL: +55-15-3023-9000
Blumenau, Santa Catarina Office

EUROPE

MITSUBISHI ELECTRIC EUROPE B.V.

European Service Headquarters (Dusseldorf, GERMANY)
Mitsubishi-Electric-Platz 1 40882 RATINGEN, GERMANY
TEL: +49-2102-486-5000 / FAX: +49-2102-486-5910

South Germany Service Center (Stuttgart)

SCHELMENWASENSTRASSE 16-20, 70567 STUTTGART, GERMANY
TEL: +49-711-770598-0 / FAX: +49-711-770598-141

France Service Center (Paris)

2 RUE DE L'UNION, 92565 RUEIL-MALMAISON CEDEX, FRANCE
TEL: +33-1-41-02-83-13 / FAX: +33-1-49-01-07-25

France Service Satellite (Lyon)

240, ALLEE JACQUES MONOD 69800 SAINT PRIEST FRANCE
TEL: +33-1-41-02-83-13 / FAX: +33-1-49-01-07-25

Italy Service Center (Milan)

VIA ENERGY PARK 14, VIMERCATE 20871 (MB) ITALY
TEL: +39-039-6053-342 / FAX: +39-039-6053-206

Italy Service Satellite (Padova)

VIA G. SAVELLI, 24 - 35129 PADOVA, ITALY
TEL: +39-039-6053-342 / FAX: +39-039-6053-206

U.K. Service Center

TRAVELLERS LANE, HATFIELD, HERTFORDSHIRE, AL10 8XB, U.K.
TEL: +44-1707-288-780 / FAX: +44-1707-278-695

Spain Service Center

CTRA. RUBI, 76-80 8174 SAINT CUGAT DEL VALLES, BARCELONA, SPAIN
TEL: +34-935-65-2236 / FAX: +34-935-89-1579

Poland Service Center

UL.KRAKOWSKA 50, 32-083 BALICE, POLAND
TEL: +48-12-347-6500 / FAX: +48-12-630-4701

Hungary Service Center

BUDAÖRS OFFICE PARK, SZABADSÁG ÚT 117., 2040 BUDAÖRS, HUNGARY
TEL: +48-12-347-6500 / FAX: +48-12-630-4701

Turkey Service Center

MITSUBISHI ELECTRIC TURKEY ELEKTRİK ÜRÜNLERİ A.Ş
SERIFALI MAHALLESİ KALE SOKAK, NO.41 34775
UMRANIYE, ISTANBUL, TURKEY
TEL: +90-216-969-2500 / FAX: +90-216-661-44-47

Czech Republic Service Center

AutoCont Control Systems s.r.o (Service Partner)
KAFKOVA 1853/3, 702 00 OSTRAVA 2, CZECH REPUBLIC
TEL: +420-59-5691-185 / FAX: +420-59-5691-199

Russia Service Center

MITSUBISHI ELECTRIC RUSSIA LLC
LETNIKOVSKAYA STREET 2, BLD.1, 5TH 115114 MOSCOW, RUSSIA
TEL: +7-495-721-2070 / FAX: +7-495-721-2071

Sweden Service Center

HAMMARBACKEN 14, P.O.BOX 750 SE-19127, SOLLENTUNA, SWEDEN
TEL: +46-8-6251200 / FAX: +46-8-6251014

Bulgaria Service Center

AKHNATON Ltd. (Service Partner)
4 ANDREJ LJAPCHEV BLVD. POB 21, BG-1756 SOFIA, BULGARIA
TEL: +359-2-8176009 / FAX: +359-2-9744061

Ukraine Service Center (Kiev)

CSC Automation Ltd. (Service Partner)
4 B. YEVHENA SVERSTYUKA STR., 02002 KIEV, UKRAINE
TEL: +380-44-494-3344 / FAX: +380-44-494-3366

Belarus Service Center

TECHNIKON Ltd. (Service Partner)
NEZAVISIMOSTI PR.177, 220125 MINSK, BELARUS
TEL: +375-17-393-1177 / FAX: +375-17-393-0081

South Africa Service Center

Adroit Technologies (Service Partner)
20 WATERFORD OFFICE PARK, WATERFORD DRIVE, CNR OF WITKOPPEN ROAD,
FOURWAYS JOHANNESBURG SOUTH AFRICA
TEL: +27-11-658-6100 / FAX: +27-11-658-6101

ASEAN**MITSUBISHI ELECTRIC ASIA PTE. LTD. (ASEAN FA CENTER)**

Singapore Service Center
307 ALEXANDRA ROAD MITSUBISHI ELECTRIC BUILDING SINGAPORE 159943
TEL: +65-6473-2308 / FAX: +65-6476-7439

PHILIPPINES**MELCO FACTORY AUTOMATION PHILIPPINES INC.**

Head Office
128 LOPEZ RIZAL STREET, BRGY., HIGHWAY HILLS, MANDALUYONG CITY, MM PHILIPPINES 1550
TEL: +63-2-8256-8042 / FAX: +632-8637-2294

Philippines Service Center
KM.23 WEST SERVICE ROAD SSH, CUPANG, MUNTINLUPA CITY, PHILIPPINES
TEL: +63-2-8807-0420 / FAX: +63-2-8842-5202

VIETNAM**MITSUBISHI ELECTRIC VIETNAM CO., LTD.**

Vietnam Ho Chi Minh Service Center
11TH & 12TH FLOOR, VIETTEL TOWER B, 285 CACH MANG THANG 8 STREET, WARD 12, DISTRICT 10,
HO CHI MINH CITY, VIETNAM
TEL: +84-28-3910-5945 / FAX: +84-28-3910-5947

Vietnam Hanoi Service Center
14TH FLOOR, CAPITAL TOWER, 109 TRAN HUNG DAO STREET, CUA NAM WARD,
HOAN KIEM DISTRICT, HA NOI CITY, VIETNAM
TEL: +84-24-3937-8075 / FAX: +84-24-3937-8076

INDONESIA**PT. MITSUBISHI ELECTRIC INDONESIA**

Indonesia Service Center (Cikarang)
JL. KENARI RAYA BLOK G2-07A, DELTA SILICON 5, LIPPO CIKARANG - BEKASI 17550, INDONESIA
TEL: +62-21-2961-7797 / FAX: +62-21-2961-7794

MALAYSIA**MITSUBISHI ELECTRIC SALES MALAYSIA SDN. BHD.**

Malaysia Service Center (Kuala Lumpur Service Center)
LOT 11, JALAN 219, P.O BOX 1036, 46860 PETALING JAYA, SELANGOR DARUL EHSAN, MALAYSIA
TEL: +60-3-7626-5032
Johor Bahru Service Satellite
Pulau Pinang Service Satellite

THAILAND**MITSUBISHI ELECTRIC FACTORY AUTOMATION (THAILAND) CO., LTD.**

Thailand Service Center (Bangkok)
101, TRUE DIGITAL PARK OFFICE, 5TH FLOOR, SUKHUMVIT ROAD, BANGCHAK, PHRA KHANONG,
BANGKOK, 10260 THAILAND
TEL: +66-2-092-8600 / FAX: +66-2-043-1231-33

INDIA**MITSUBISHI ELECTRIC INDIA PVT., LTD.**

CNC Technical Center (Bangalore)
PLOT NO. 56, 4TH MAIN ROAD, PEENYA PHASE 3,
PEENYA INDUSTRIAL AREA, BANGALORE 560058, KARNATAKA, INDIA
TEL: +91-80-4655-2121
Chennai Service Satellite
Coimbatore Service Satellite
Hyderabad Service Satellite

North India Service Center (Gurgaon)
PLOT 517, GROUND FLOOR, UDYOG VIHAR PHASE-III, GURUGRAM 122008, HARYANA, INDIA
TEL: +91-124-463-0300
Ludhiana Service Satellite
Panthenagar Service Satellite
Delhi Service Satellite
Jamshedpur Service Satellite
Manesar Service Satellite

West India Service Center (Pune)
ICC-Devi GAURAV TECHNOLOGY PARK, UNIT NO.402, FOURTH FLOOR, NORTH WING,
SURVEY NUMBER 191-192 (P), NEXT to INDIAN CARD CLOTHING COMPANY Ltd,
OPP. VALLABH NAGAR, PIMPRI, PUNE- 411 018, MAHARASHTRA, INDIA
TEL: +91-20-6819-2274
Kolhapur Service Satellite
Aurangabad Service Satellite
Mumbai Service Satellite

West India Service Center (Ahmedabad)
204-209, 2ND FLOOR, 31FIVE, CORPORATE ROAD PRAHLADNAGAR,
AHMEDABAD -390015, GUJARAT, INDIA
TEL: + 91-79-6777-7888
Rajkot Service Satellite

CHINA**MITSUBISHI ELECTRIC AUTOMATION (CHINA) LTD. (CHINA FA CENTER)**

CNC Call Center
TEL: +86-400-921-5130

Shanghai Service Center
NO.1386 HONG QIAO ROAD, CHANG NING QU, SHANGHAI 200336, CHINA
TEL: +86-21-2322-3030 / FAX: +86-21-2322-3000*8422

Qingdao Service Center
Suzhou Service Center
Wuhan Service Center
Ningbo Service Center
Hefei Service Center
Beijing Service Center
Tianjin Service Center
Xian Service Center
Dalian Service Center
Chengdu Service Center

Shenzhen Service Center
LEVEL8, GALAXY WORLD TOWER B, 1 YABAO ROAD, LONGGANG DISTRICT,
SHENZHEN 518129, CHINA
TEL: +86-755-2399-8272 / FAX: +86-755-8229-3686

Dongguan Service Center
Xiamen Service Center

KOREA**MITSUBISHI ELECTRIC AUTOMATION KOREA CO., LTD. (KOREA FA CENTER)**

Korea Service Center
8F GANGSEO HANGANG XI-TOWER A, 401 YANGCHEON-RO, GANGSEO-GU,
SEOUL 07528 KOREA
TEL: +82-2-3660-9631 / FAX: +82-2-3664-8668
Korea Daegu Service Satellite

TAIWAN**MITSUBISHI ELECTRIC TAIWAN CO., LTD. (TAIWAN FA CENTER)**

Taiwan Taichung Service Center
NO. 8-1, GONGYEQU 16th RD., XITUN DIST., TAICHUNG CITY 40768, TAIWAN
TEL: +886-4-2359-0688 / FAX: +886-4-2359-0689

Taiwan Taipei Service Center
11F, NO.88, SEC.6, ZHONGSHAN N. RD., SHILIN DIST., TAIPEI CITY 11155, TAIWAN
TEL: +886-2-2833-5430 / FAX: +886-2-2833-5433

Taiwan Tainan Service Center
11F.-1, NO.30, ZHONGZHENG S. RD., YONGKANG DIST., TAINAN CITY 71067, TAIWAN
TEL: +886-6-252-5030 / FAX: +886-6-252-5031

OCEANIA**MITSUBISHI ELECTRIC AUSTRALIA PTY. LTD.**

Oceania Service Center
348 VICTORIA ROAD, RYDALMERE, N.S.W. 2116 AUSTRALIA
TEL: +61-2-9684-7269 / FAX: +61-2-9684-7245

Notice

Every effort has been made to keep up with software and hardware revisions in the contents described in this manual. However, please understand that in some unavoidable cases simultaneous revision is not possible.

Please contact your Mitsubishi Electric dealer with any questions or comments regarding the use of this product.

Duplication Prohibited

This manual may not be reproduced in any form, in part or in whole, without written permission from Mitsubishi Electric Corporation.

© 2015-2023 Mitsubishi Electric Corporation
ALL RIGHTS RESERVED

MITSUBISHI ELECTRIC CORPORATION

HEAD OFFICE : TOKYO BLDG.,2-7-3 MARUNOUCHI,CHIYODA-KU,TOKYO 100-8310,JAPAN

MODEL	MDS-EM/EMH Series
MODEL CODE	100-460
Manual No.	IB-1501241