

Low Voltage Air Circuit Breakers

World Super AE

V Series



For Safety : Please read the instruction manual carefully before using the products in this catalog. Wiring and connection must be done by the person who has a specialized knowledge of electric construction and wiring.

FA Global Site

<http://www.mitsubishielectric.com/fa/products/lvd/lvcb/index.html>



MITSUBISHI ELECTRIC CORPORATION

HEAD OFFICE: TOKYO BLDG., 2-7-3 MARUNOUCHI, CHIYODA-KU, TOKYO 100-8310, JAPAN

GLOBAL IMPACT OF MITSUBISHI ELECTRIC



Through Mitsubishi Electric's vision, "Changes for the Better" are possible for a brighter future.

Changes for the Better

"Changes for the Better" represents the Mitsubishi Electric Group's attitude to "always strive to achieve something better", as we continue to change and grow. Each one of us shares a strong will and passion to continuously aim for change, reinforcing our commitment to creating "an even better tomorrow".

Mitsubishi Electric is involved in many areas including the following:

Energy and Electric Systems

A wide range of power and electrical products from generators to large-scale displays.

Electronic Devices

A wide portfolio of cutting-edge semiconductor devices for systems and products.

Home Appliance

Dependable consumer products like air conditioners and home entertainment systems.

Information and Communication Systems

Commercial and consumer-centric equipment, products and systems.

Industrial Automation Systems

Maximizing productivity and efficiency with cutting-edge automation technology.

Our advances in AI and IoT are adding new value to society in diverse areas from automation to information systems. The creation of game-changing solutions is helping to transform the world, which is why we are honored to be recognized in the 2019 "Forbes Digital 100" as one of world's most influential digital corporations.



OVERVIEW

Warranty	4
Product Outline	6
Product Features	7
Product Specification	10
Closing method	11
Appearance and Product structure	12
Connections	14
Accessories	15
Electronic trip relay	22
Wiring diagram	30
Outline dimensions	32
Technical information	35
Ordering information	40
Service network	42

1
2
3
4
5
6
7
8
9
10
11
12
13

Warranty

Warranty period and warranty coverage

If any faults or defects (hereinafter “Failure”) found to be the responsibility of Mitsubishi Electric occurs during use of the product within the warranty period, the product shall be repaired at no cost via the sales representative or Mitsubishi Electric Sales office. However, if repairs are required on-site at domestic or overseas locations, expenses to send an engineer will be charged.

1. Warranty period

The free guarantee period of the product is one year from the day of purchase.

2. Warranty coverage

- (1) The primary failure diagnosis should be performed by users. However, if required by users, Mitsubishi Electric or Mitsubishi Electric Service Company may be able to perform the diagnosis. In that case, for damages caused by any cause found to be the responsibility of Mitsubishi Electric, the diagnosis will be performed at no cost. For details, contact a distributor.
- (2) The coverage shall be limited to ordinary use within the usage state, usage methods, usage environment, and other conditions which follow the instructions and precautions given in the instruction manual, user’s manual, and caution labels on the product.
- (3) Even within the warranty period, repair cost shall be charged for the following cases.
 - [1] Failure occurring from inappropriate storage or handling, carelessness or negligence by the user. Failure caused by selection of hardware or software design on the user side.
 - [2] Failure caused by modifications, etc. to the product by the user without any approvals from Mitsubishi Electric.
 - [3] In case Mitsubishi Electric product is assembled into a user’s device, failure that could have been avoided if functions or structures, judged as necessary in the legal safety measures the user’s device is subject to or as necessary by industry standards, had been provided.
 - [4] Failure that could have been avoided if the maintenance described in the user’s manual has been performed.
 - [5] Failure caused by external irresistible forces such as fires or abnormal voltages, and failure caused by natural disasters such as earthquakes, lightning, wind and water damages.
 - [6] Failure caused by reasons unpredictable based on scientific technology standards at the time of shipment from Mitsubishi Electric.
 - [7] Any other failure found not to be the responsibility of Mitsubishi Electric or that admitted not to be so by the user.

In addition, the warranty applies only to the product delivered. It does not apply to the damage that is caused by the failure of the product.

3. The period to supply the spare parts after discontinuation of production

Mitsubishi Electric shall supply spare parts for five years after discontinuation of production.

After five years, Mitsubishi Electric shall supply spare parts until the spare parts run out of stock.

Exclusion of loss in opportunity and secondary loss from warranty liability

Regardless of the warranty period, Mitsubishi Electric shall not be liable for compensation to:

- (1) Damages caused by any cause found not to be the responsibility of Mitsubishi Electric.
- (2) Loss in opportunity, lost profits incurred to the user by failures of Mitsubishi Electric product.
- (3) Damages whether foreseeable or not, secondary damages, compensation for accidents, and compensation for damages to products other than Mitsubishi Electric products, caused by exceptional situations.
- (4) Compensation for cost occurring secondarily from replacement work by the user, maintenance of on-site equipment and start-up test run and other operations.

Product applications

- (1) When using the products listed in this catalogue, the following conditions must be confirmed and obeyed. The product must be used so that a failure that occurs to the product does not lead to a serious accident. When a damage or failure occurs, the external backup function or fail-safe function must be executed systematically.

- (2) The products listed in this catalogue are designed and manufactured as general-purpose products for application to the general industry field. Therefore, the warranty does not apply to the following special uses.





- [1] The use that has a significant influence on the public facilities such as nuclear power plants and other power plants of power companies.
- [2] The use for railway companies, government offices, etc. that require to build the special quality assurance system.
- [3] The use for aerospace equipment, medical equipment, railway equipment, combustion and fuel equipment, passenger vehicles, manned transportation equipment, recreational equipment, safety equipment, and air conditioner for servers and the cooling facilities that are expected to have a significant influence on life, body, and property.

If the products listed in this catalogue are used for the above mentioned special uses, Mitsubishi Electric does not take any responsibility for the quality, performance, and safety of the product, which includes, but is not limited to, default liability, defect liability, quality assurance liability, tort liability, and product liability. However, in case the special quality (beyond general specifications) is not required and the use is a limited purpose and the backup/fail-safe functions are equipped with the facility, Mitsubishi Electric may determine that the products listed in this catalogue can be guaranteed. For details, consult a distributor or Mitsubishi Electric.

Safety precautions

- Before using this product, read “Safety precautions” and the user’s manual carefully and use it correctly.
- Important safety instructions are given below. Strictly observe the instructions.
- Be sure to instruct the end user with these safety precautions.

Meaning of indications

 DANGER	Incorrect handling of the product will result in a hazardous situation, such as death or serious injury.
 CAUTION	Incorrect handling of the product may result in a hazardous situation according to circumstances.
	This means prohibition. Never ignore this instruction.
	Warning for possible outbreak of a fire under certain conditions.

DANGER

- Do not use the product under the conditions with over-rated current. Otherwise, ground-fault or short circuit fault could occur due to dielectric breakdown, or explosion could occur due to a short circuit protection failure.
- Do not touch terminal area. There is a risk of electrical shock.

CAUTION

- The electrical work shall be performed by qualified personnel (electrical expert).
- Inspection and maintenance should be performed by qualified personnel (electrical expert). Before performing wiring works, turn off the upstream circuit breaker. Failure to do so may expose you to electrical shock.
- Tighten the terminal screw with the torque specified in the instruction manual. Failure to do so may cause a fire.
- Do not install or store in an abnormal environment with high temperature, high humidity, dust, corrosive gas, vibrations, or shocks, etc. To do so may cause a fire, malfunction of the circuit breaker or make it inoperative.
- Protect the circuit breaker so that foreign particles, such as dust, concrete powder and iron powder, and rain water will not enter the circuit breaker. Failure to do so may cause malfunction or fire.
- When the circuit breaker trips automatically, remove the cause before turning on the handle. Failure to do so may cause an electric shock or a fire.
- Retighten the terminals periodically. Failure to do so may cause a fire.
- Use the product in 50/60 Hz. Failure to do so may cause malfunction, inoperativeness or fire.
- Dispose of the product as industrial waste.

Changes in product specifications

The specifications of the product listed in this catalogue, manuals or technical documents are subject to change without prior notice.

Product Outline

World Super AE V Series C-class is All New Mitsubishi Air Circuit Breaker series.

The C-class has the solenoid mechanism inside its body. Developed to meet customers' expectation and needs.



World Super AE V Series AED1600-CV

- ①
- ②
- ③

- ① Mitsubishi ACB Direct Drive
- ② Rated Current (630, 1000, 1250, 1600 A)
- ③ AE V Series C-class

Line up (630 to 1600 A)

Rated current (A)	630	1000	1250	1600
AE V Series C-class	AED630-CV	AED1000-CV	AED1250-CV	AED1600-CV



Product Features

Mitsubishi Electric offers new air circuit breaker, AE V Series C-class. It has the breaking capacity of 50 kA at 500 V AC and can provide with the appropriate suggestion for the market with the breaking capacity of 50 kA or less.

Specifications of AE V Series C-class compared to AE-SW Series (Existing model)

Breaking capacity (Ics = 100% Icu at 500 V AC)			Short time withstand current (Icw 1 s)			Short time withstand current (Icw 3 s)		
Rated current	Mitsubishi AE-SW Series	Mitsubishi AE V Series C-class	Rated current	Mitsubishi AE-SW Series	Mitsubishi AE V Series C-class	Rated current	Mitsubishi AE-SW Series	Mitsubishi AE V Series C-class
630 A	65 kA	Added	630 A	65 kA	Added	630 A	50 kA	Added
1000 A		50 kA	1000 A		50 kA	36 kA		
1250 A			1250 A					
1600 A			1600 A					

Certificate

AE V Series C-class is certified by the following parties.

- China Compulsory Certificate system (CCC)
- Keuring van Elektrotechnische Materialen te Arnhem (KEMA)

Solenoid mechanism

The adoption of the solenoid mechanism brings positive effects on the circuit breakers.

- ACB (solenoid)
- Control voltage
- 110-125 V AC
- 220-250 V AC
- 110-125 V DC
- 220-250 V DC

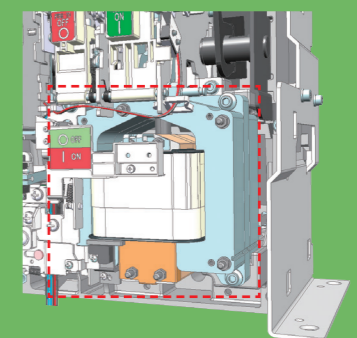

Remote operation

Solenoid mechanism is adopted to AE V Series C-class for ON operation. So you don't need to purchase "Closing coil (CC)" and "Motor charging device (MD)" additionally which are needed in case of existing model. Just purchase "Shunt trip device (SHT)" to utilize remote control function easily in case of AE V Series C-class. It can be used for switching a power supply as well.

Silent charging

No need to use motor charging device. Direct closing by Closing magnet. Charging noise is extremely low compared to our existing spring charge type ACB (AE-SW Series) and the impact inside panel can be reduced when charging operation.

New Features Flexibility of Neutral pole (N pole) (Only 4-poles model)

It is possible to choose the N pole position either left or right side as needed by customers. The default position of N pole is right side. Please inform us before placing an order in case the N pole on the left side is needed.

- Standard of N pole position is on the right side unless otherwise instructed.
- N pole on the left side is specially made in case of 4-pole model.



New Features Built-in drawout handle

AE V Series C-class is equipped with a built-in drawout handle as standard. Just insert a built-in drawout handle into the body after using it.



New Features UVT (INST) without controller



New UVT (INST) is only coil unit

UVT is newly designed. UVT controller is not needed for New ACB when operating time of UVT is instantaneous.

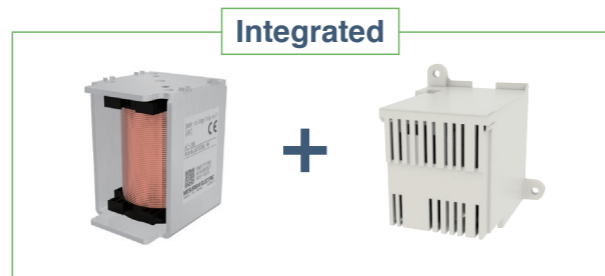

Adding "UVT delay unit" enable UVT operating time 0.5 s, 1.5 s, and 3 s. (New UVT has operating time 1.5 s.)

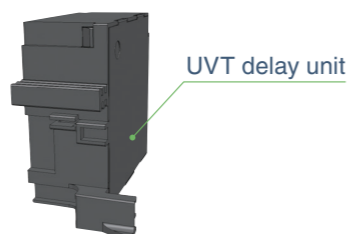

New Features Permanent Shunt trip device (Permanent SHT)

SHT (Shunt trip device) is improved to "Permanent SHT without controller" as standard. This makes OFF lock possible.

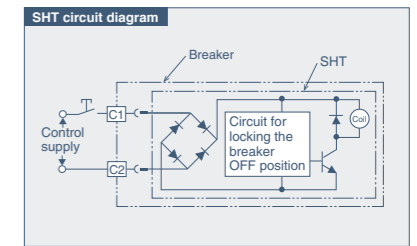

Electronic trip relay (ETR) for AE V Series C-class

The ETR has the following types; "Without DP" and "With DP".

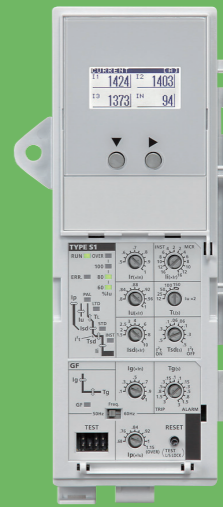
	Without DP	With DP
Type of ETR unit (Note 1)		
	Basic protection without display option	Basic protection with current display
Main protection (as standard)	Long-time Short-time Instantaneous (with MCR) Pre-alarm	
Optional protection (as option)	Ground fault (The control power supply is not required.)	
Power Supply (Note 2)	[P3] 100-240 V AC/100-125 V DC with output contacts [P4] 24-60 V DC with output contacts	[P3] 100-240 V AC/100-125 V DC with output contacts [P4] 24-60 V DC with output contacts
Display	-	Current display on ETR as standard
Communication	Not available	

Note 1) The above ETR units aren't modular structure.
Note 2) For details, refer to page 23.

Product Specification

Type		AED630-CV	AED1000-CV	AED1250-CV	AED1600-CV
Number of poles					3, 4
Rated insulation voltage (V)		Ui			1000
Impulse withstand voltage (kV)		Uimp			12
Rated operational voltage (V AC 50/60 Hz)		Ue			500
Suitability for isolation		IEC 60947-2			Yes
Pollution degree		IEC 60664-1			3
Environmental condition for EMC		IEC 60947-2			A
Circuit breaker as per IEC 60947-2					
Rating of neutral pole (A)		630	1000	1250	1600
Sensor ratings (A)		630	1000	1250	1600
Rated current setting I _r (A) at 40°C	General use (Rated current adjustable) 0.5 to 1.0 × I _n , 0.05 step	315-346.5-378-409.5-441-472.5-504-535.5-567-598.5-630	500-550-600-650-700-750-800-850-900-950-1000	625-687.5-750-812.5-875-937.5-1000-1062.5-1125-1187.5-1250	800-880-960-1040-1120-1200-1280-1360-1440-1520-1600
Utilization category					B
Ultimate breaking capacity (kA rms) 50/60 Hz (Note 1) (Note 7)	I _{cu}	240-500 V AC		50	
Rated service breaking capacity (kA rms)	I _{cs}	% I _{cu}		100%	
Rated short-time withstand current (kA rms) 50/60 Hz	I _{cw}	1 s		50	
		3 s		36	
Rated making capacity (kA peak) 50/60 Hz	I _{cm}	240-500 V AC		105	
Breaking time between tripping order and arc extinction (ms)					40 (Note 2)
Closing time (ms)					300
Switch-disconnector as per IEC 60947-3					
Operational current AC-23A		630	1000	1250	1600
Rated making capacity (kA peak) 50/60 Hz	I _{cm}	240-500 V AC		52.5	
Rated short-time withstand current (kA rms)	I _{cw}	1 s		50	
		3 s		36	
Maintenance/Connection/Installation					
Service life (Note 4)	Mechanical	with regular ordinary maintenance prescribed by the manufacturer		10000 (Note 3)	
	Electrical	with regular ordinary maintenance prescribed by the manufacturer	240-500 V AC	6000	
Connection (Note 5)	Horizontal		Available		
	Vertical		Available		
	Front		Available		
Dimensions (mm) (H × W × D)	Fixed	3-pole	410 × 340 × 294		
		4-pole	410 × 425 × 294		
	Drawout	3-pole	430 × 300 × 375		
		4-pole	430 × 385 × 375		
Weight (kg) (without accessories) (Note 6)	Fixed	3-pole	37		
		4-pole	43		
	Drawout	3-pole	57		
		4-pole	66		
Reverse connection					Possible

Note 1) The MCR is equipped as standard.
 Note 2) This value indicates the operating time for the O operation at the time of short circuit interruption. (For the CO operation, the value is 135 ms.) For the product with a UVT, refer to page 16.
 Note 3) The mechanical service life includes the electrical service life.
 Note 4) This is a guide of the service life when the regular maintenance specified by the manufacturer is performed. Regular maintenance means inspection, grease lubrication, as-needed replacement of prescribed component and so on.
 Note 5) For the details on the connection method of terminals, refer to Available connections (on page 14).
 Note 6) This weight indicates the weight of product with a electronic trip relay, which does not include other accessories. The values in the table are typical values and are not guaranteed values.
 Note 7) When the breaker without a trip relay (BARE) and the external OCR for general purpose are used, the breaking capacity is 25 kA.

Closing method

Solenoid mechanism

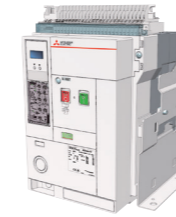

The breaker closes electrically.

The following describes the closing methods.

1. The breaker closes by pressing the ON button.
 2. The breaker closes electrically by remote operation and opens by pressing the OFF button.
- The indicator shows the ON or OFF state of the main contacts.
 - The breaker cannot be closed while the OFF button is being pressed. (Safety design)
 - OFF lock is enabled by padlock (Refer to page 12, 20) as standard.

Note) The voltage is required to apply to the control circuit terminal block. The rated value and circuit diagram are shown below.

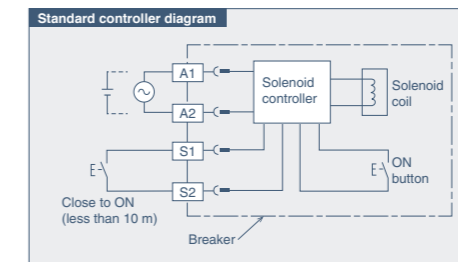

ACB (solenoid) control rating

Rated voltage (V)	Applicable voltage range (V)	Applied voltage (V)	Current (Peak value) (A)	Operating time (s)	Criterion for power requirement	
AC (50/60 Hz)	110-125	93.5-137.5	110	6.5	≤ 0.3	1000 VA
		125	7.7			
	220-250	187-275	220	3.3		
		250	3.9			
DC	110-125	93.5-137.5	110	7.1	≤ 0.3	1000 W
		125	8.4			
	220-250	187-275	220	3.5		
		250	4.2			

Note) In consideration of the voltage drop, set the power supply capacity for the solenoid not to be less than the operating voltage.

Appearance and Product structure

Fixed type



For the fixed type, lifting hooks (HP) are attached.

Drawout type

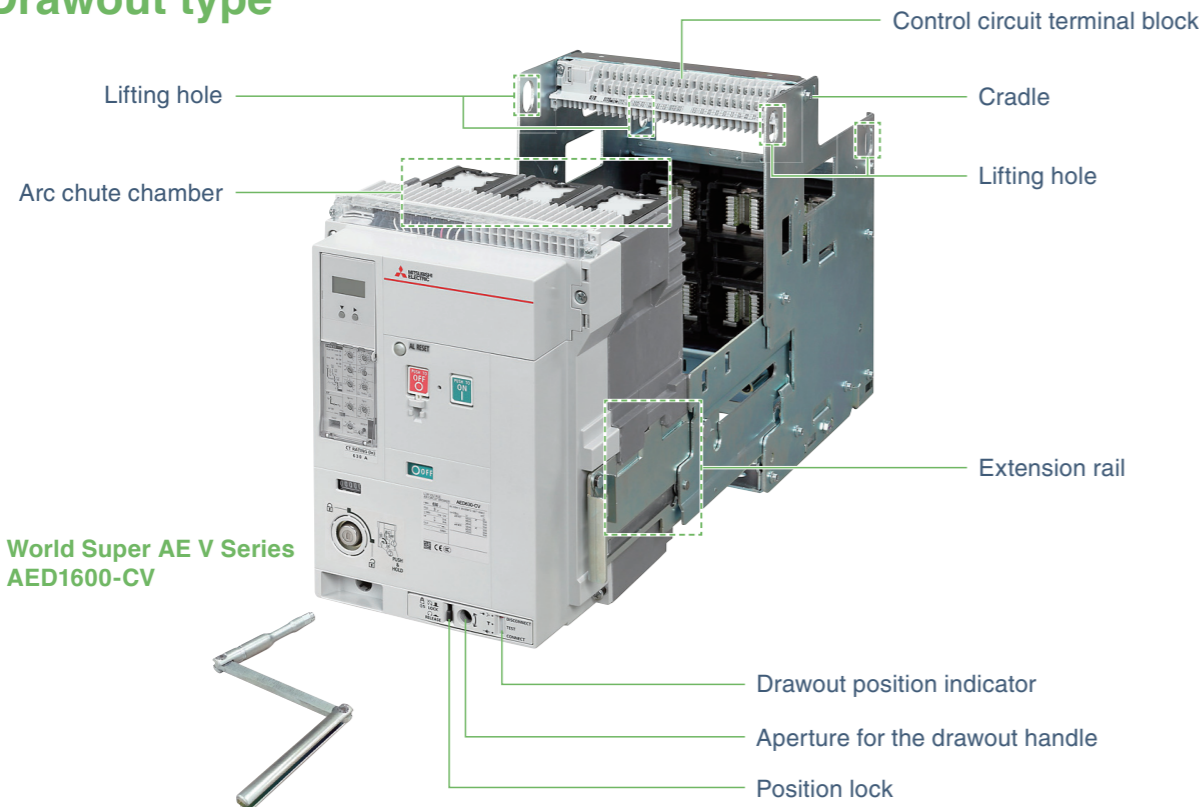

For the drawout type, a built-in drawout handle is attached.

Skeleton

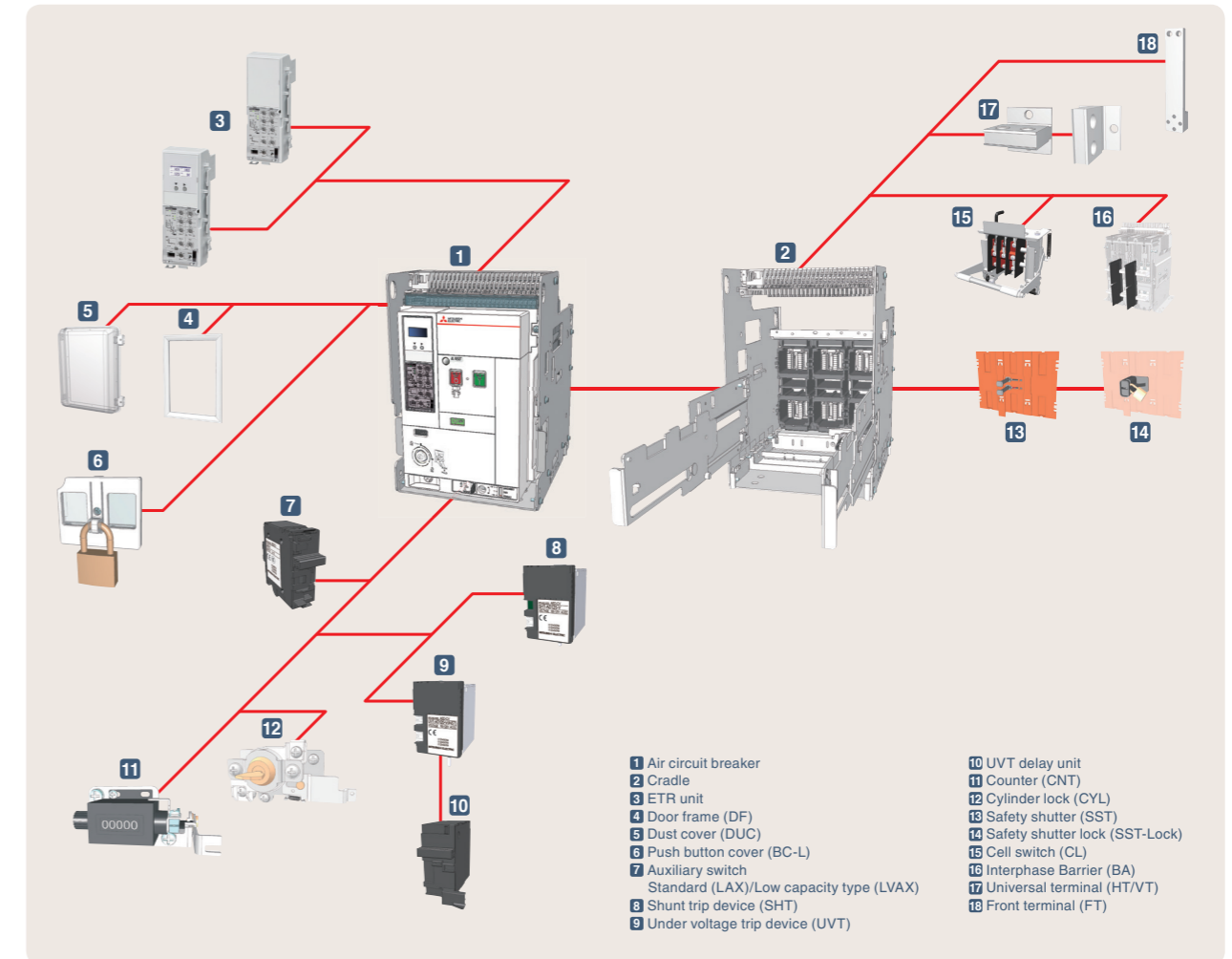

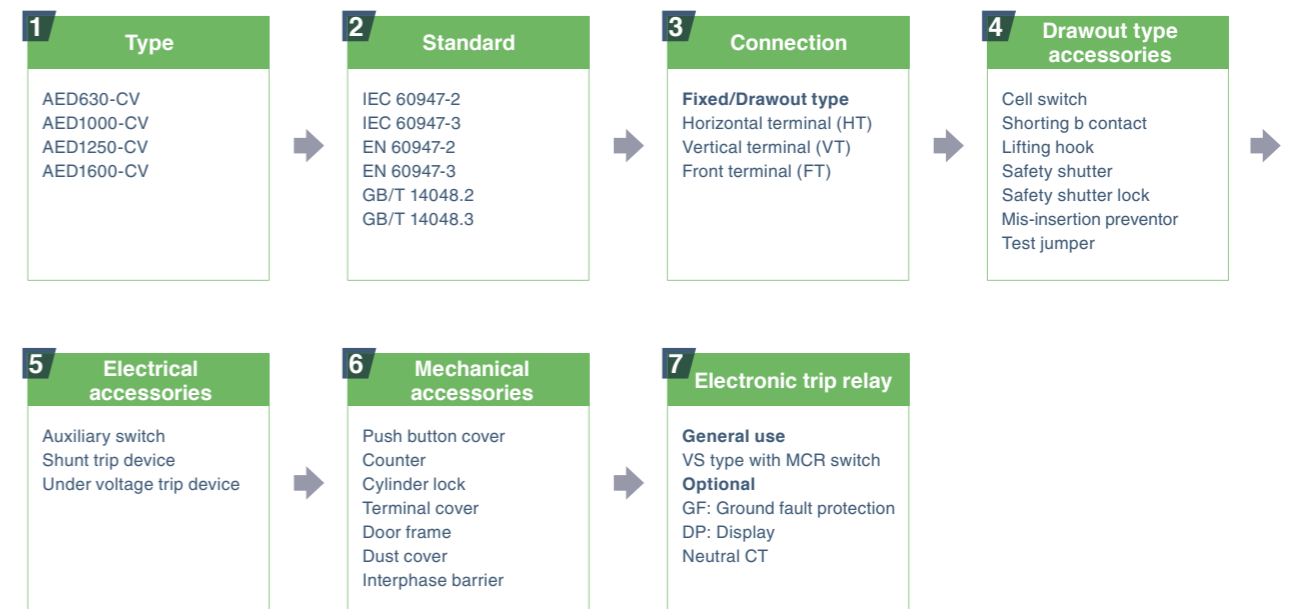

Product configuration

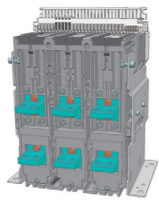
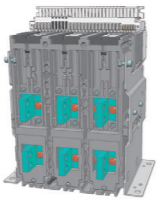
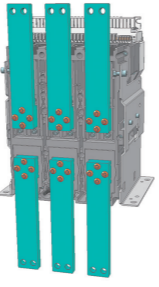

Connections

Overview (AED630-CV to AED1600-CV)

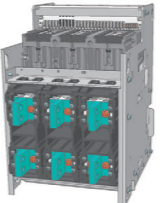
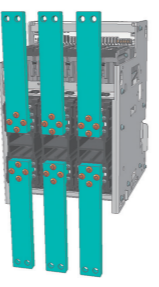
Type	Connections	Horizontal (HT)	Vertical (VT)	Front (FT)
Fixed type (FIX)				
		FIX-HT	FIX-VT	FIX-FT
				
Drawout type (DR)		DR-HT	DR-VT	DR-FT

* Connection image: AED630-CV to AED1600-CV, 3-pole type

Available connections

Type	LINE (upper) side/LOAD (lower) side	Abbreviation	AED630-CV/AED1000-CV/AED1250-CV/AED1600-CV
Fixed type (FIX)	Horizontal/Horizontal	FIX-HT	Available
	Vertical/Vertical	FIX-VT	
	Front/Front	FIX-FT	
	Horizontal/Vertical	FIX (HV)	
	Horizontal/Front	FIX (HF)	
	Vertical/Horizontal	FIX (VH)	
	Vertical/Front	FIX (VF)	
	Front/Horizontal	FIX (FH)	
Drawout type (DR)	Front/Vertical	FIX (FV)	Available
	Horizontal/Horizontal	DR-HT	
	Vertical/Vertical	DR-VT	
	Front/Front	DR-FT	
	Horizontal/Vertical	DR (HV)	
	Horizontal/Front	DR (HF)	
	Vertical/Horizontal	DR (VH)	
	Vertical/Front	DR (VF)	
Front/Horizontal	DR (FH)		
	Front/Vertical	DR (FV)	

Accessories

For breaker unit

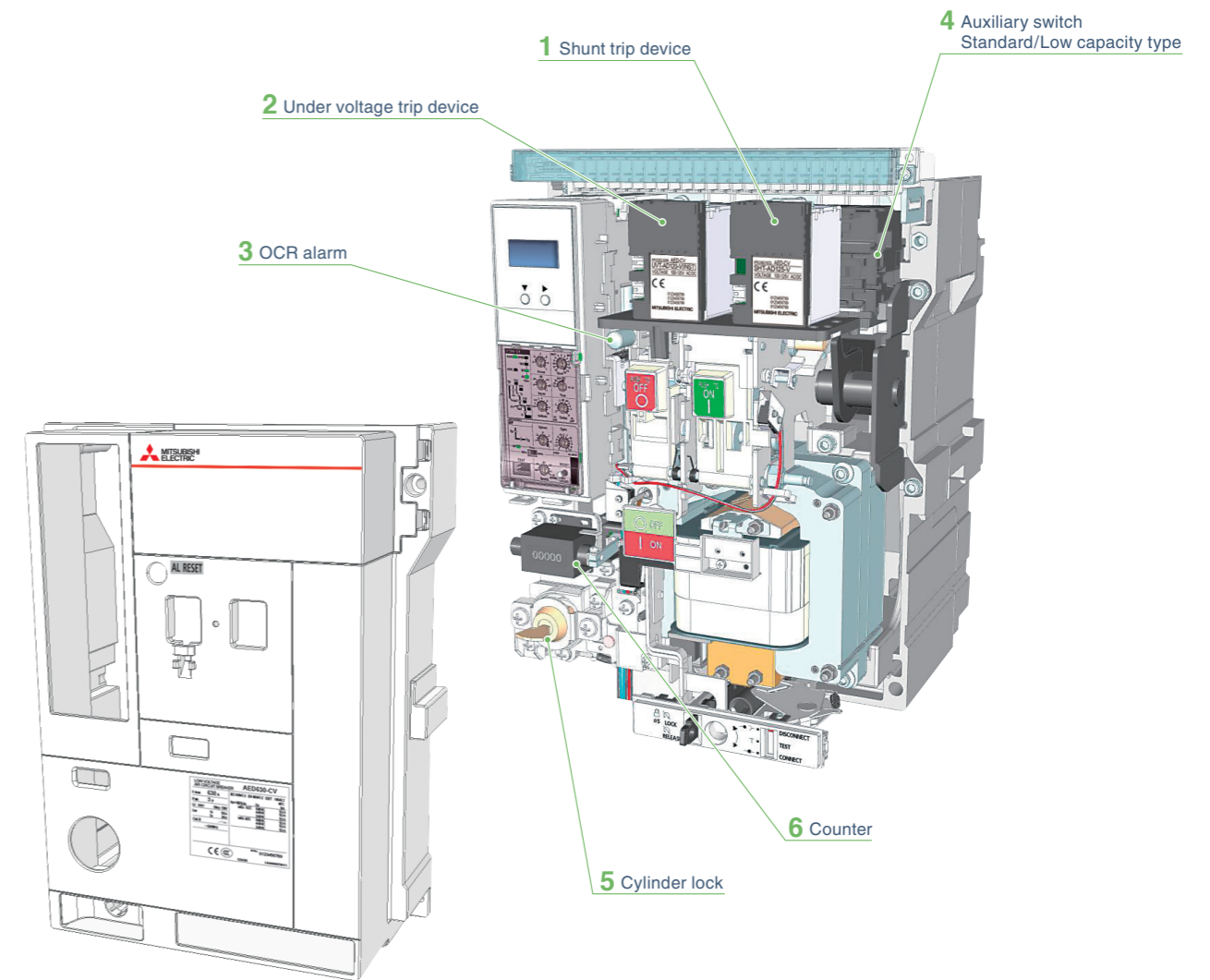

Shunt trip device (SHT)



The shunt trip device is a device to open the breaker by remote control.

Rated voltage (Applicable voltage)	Frequency (AC)	Operating voltage	Inrush current and power consumption	Steady power consumption (Note 1)	Operating time (Note 2)
24-30 V DC (16.8-33 V)	-	24 V	4 A 100 W	20 VA	0.05 s max.
		30 V	5 A 150 W		
		48 V	2.5 A 120 W		
48-60 V DC (33.6-66 V)	-	60 V	3 A 180 W	20 VA	0.05 s max.
		100 V	1 A 100 VA		
		125 V	1.2 A 150 VA		
100-125 V AC/DC (70-137.5 V)	50/60 Hz	200 V	1 A 200 VA	20 VA	0.05 s max.
		250 V	1.1 A 280 VA		
		250 V	1.1 A 280 VA		

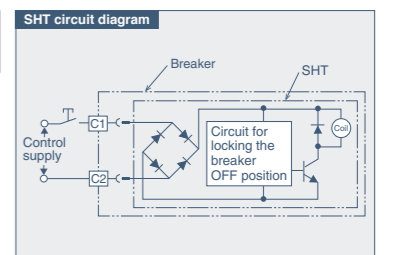

Diode rectifier is not used for control source 24-30 V DC and 48-60 V DC.

Note 1) While the voltage is applied to the input terminals (C1 and C2), the SHT keeps the breaker in the OFF position and the closing operation is cancelled. Therefore, the SHT can be used as a locking the breaker in the OFF position. (Breaker locking, in the OFF position, is released when the input voltage drops below 30% of the rated voltage. Release time is 1.0s or less.)

Note 2) In case of double rating of rated voltage, it is the value for the lower rating. (Example) In case of 24-30 V DC, it is operating time for 24 V DC.

Under voltage trip device (UVT)

2

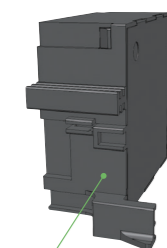

UVT delay unit (Note 1)

Option

This is the device that automatically trips the breaker when the circuit voltage drops below the nominal voltage. There are 4 kinds of tripping time, INST, 0.5 s, 1.5 s, and 3 s. A trip terminal for forced OFF function is included as standard equipment.

Rated voltage (Applicable voltage)	Frequency (AC)	Operating time (Time delay)	Pick-up voltage	Drop-out voltage	Inrush current and power consumption		Steady power consumption
					Operating voltage		
48 V DC (52.8 V max.)	—	□ INST (0.3 s max.) □ 0.5 s or more □ 1.5 s or more □ 3 s or more	31.2-40.8 V	21.6-33.6 V	48 V	3 A 150 W	20 VA
100-120 V AC/DC (132 V max.)	50/60 Hz	(Note 1) (Note 2) (Note 3)	65-85 V	45-70 V	100 V	2 A 200 VA	
					120 V	2.4 A 300 VA	
200-240 V AC/DC (264 V max.)	50/60 Hz	(Note 1) (Note 2) (Note 3)	130-170 V	90-140 V	200 V	1 A 200 VA	
					240 V	1.1 A 280 VA	

Note 1) The UVT delay unit is built in the products with the operating time 0.5 s, 1.5 s, or 3 s. (The UVT delay unit requires 30 seconds to charge. The operating time shortens if the voltage becomes insufficient within 30 seconds after the voltage is started applying to UVT.)

Note 2) The operating time is a guarantee value when it drops from 85% or more of rated voltage.

Note 3) Time delay should be allowed for 0.5 s between applying the voltage to the UVT and closing the breaker.

Note 4) If a remote trip function is required, remove the shorting bar (DT1, DT2) and connect a normally closed switch, rated 10 mA at 30 V DC (Min. applicable load 15 V DC 1 mA or less) across them.

Note 5) If a forced OFF function is used, the shorting (signal input to DT1 and DT2) should be held for 0.3 second or more.

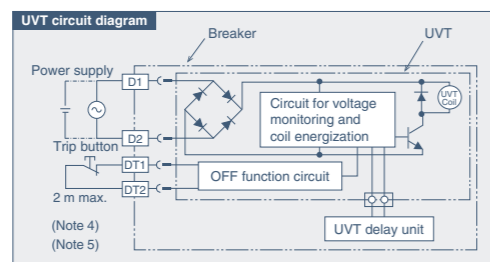

OCR alarm (AL) [MRE: Manual reset type]

3



AL in operation

Standard*

The gray manual reset button on the front side of the breaker will stick out continuously to the output OCR alarm (AL) if the breaker is tripped by the electronic trip relay. After tripping, the breaker cannot be turned ON unless the manual reset button is pressed for resetting.

*Standard if ETR is equipped.

Voltage (V)		Current (A)	
		Resistive load	Inductive load
AC (50/60 Hz)	240	3	2
	125	5	3
DC	240	0.2	0.2
	125	0.4	0.4
	30	4	3

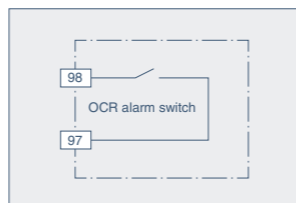

Note 1) This works when tripping occurs in LTD, STD, INST or GF.

Note 2) The alarm continues to output until the manual reset button is pressed.

Auxiliary switch Standard (LAX)/Low capacity type (LVAX)

4

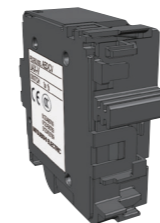

Option

This is the contact that remotely indicates the ON or OFF status of the breaker.

Switch rating

Voltage (V)	Current (A)			
	Standard (LAX)		Low capacity type (LVAX)	
	Resistive load	Inductive load	Resistive load	Inductive load
AC (50/60 Hz)	250	3	2	—
	125	5	3	0.1
DC	250	0.2	0.2	—
	125	0.4	0.4	—
30	4	3	0.1	—
Contacts max.	5a5b		5a5b	

Change-over sequence	Breaker state	a contact (NO)	b contact (NC)
	ON	ON	OFF
OFF	OFF	ON	

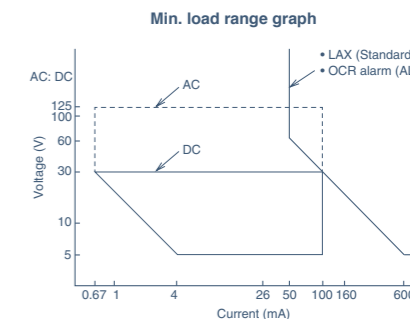

- The a and b contacts may simultaneously be turned ON instantaneously at the time of switching contact; Pay attention to the contact state when designing circuits.
- The chattering time at the time of contact ON-OFF is below 0.025 s.

Cylinder lock (CYL)

5



Option

The breaker is locked in the OFF state with the cylinder lock.

- Since it is an interlock which only allows the key to be removed when the breaker is locked off, it can be used for interlocking two or more breakers.
- Up to 5 types of cylinder locks can be manufactured.

Counter (CNT)

6

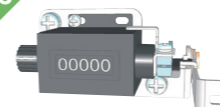

Option

The number of switching operations of the breaker are shown by a 5 digit counter.

Push button cover (BC-L)

7

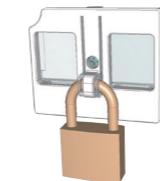

Option

The cover prevents from careless manual operation (ON, OFF) of the push buttons.

BC-L can be locked by a padlock. (The padlock should be supplied by the customer.) For the suitable size of a padlock, refer to page 20.

Door frame (DF)

8



Option

The door frame improves the appearance, after cutting out the panel door to install the breaker.

As for panel cut-out dimensions, refer to page 34.

Interphase barrier (BA)

Option

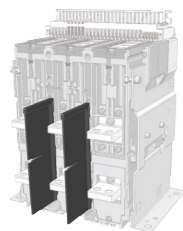

This enhances the interphase insulation between the terminals of the breaker, and prevents short-circuit due to conductive objects or dust. It can be attached and detached easily. The interphase insulation is available for all connection methods.

Terminal cover (TTC)

Option

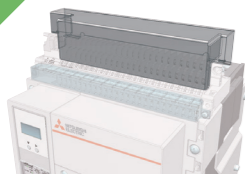

The transparent terminal cover prevents users from careless touching to the live control terminals. International Protection is IP20 (IEC 60947-1 Annex C). The terminal cover is available for both the fixed type breakers and the drawout type breakers.

Dust cover (DUC)

Option



The dust cover prevents the dust or water from entering into the panel board due to the breaker panel cut. Protection degree is IP54. DUC can be locked by the padlock. (The padlock should be supplied by the customer.) For the suitable size of the padlock, refer to page 20. Consult us for details.

For drawout type

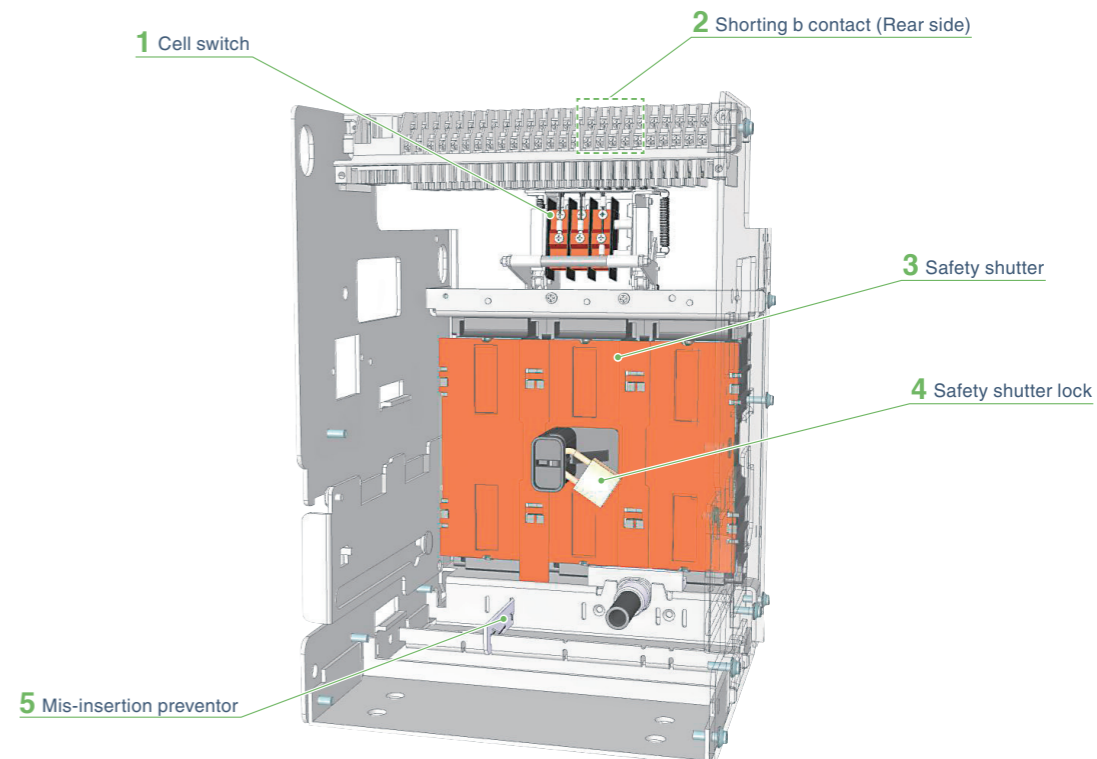

Cell switch (CL)

Option



This is the switch to show the drawout status (CONNECTED, TEST, and DISCONNECTED) of the breaker. An arbitrary combination up to 4 pieces is available.

Standard pattern

	CL-C	CL-T	CL-D
CL1	1	-	-
CL2	1	-	1
CL3	1	1	1
CL4	2	1	1

Operating sequence

Drawout position of breaker	Disconnected		Connected
	DISCONNECT	TEST	CONNECT
Display position of drawout operation			
Switch function			
CL-C (CONNECTED)	OFF		ON
CL-T (TEST)	OFF	ON	
CL-D (DISCONNECTED)	ON		OFF

Switch rating

Voltage (V)	Current (A)	
	Resistive load	Inductive load
AC (50/60 Hz)	250	10
	125	10
DC	250	1.5
	125	6
30	10	10
Contacts max.	Total 4c max.	

Note) The setting can be changed by customers later.
A preliminary setting of CL at factory shipment is as follows.
CL1: 1C, CL2: 1C1D, CL3: 1C1T1D, CL4: 2C1T1D

Shorting b contact (SBC)

Option

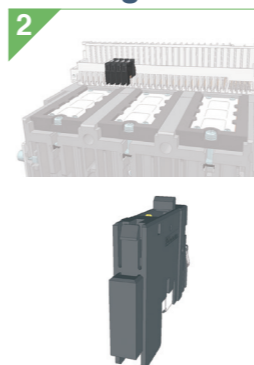

When moving the breaker from the connected position to the test positions, this contact is used to short-circuit the auxiliary switch (LAXb), thus maintaining the correct sequence of operation of the external control circuit. When ordering, SBC with the same number of contacts as auxiliary switches (LAXb) will be provided. Up to 5 SBCs can be mounted.

Operating sequence

Main circuit	Disconnected		Connected
	DISCONNECT	TEST	CONNECT
Display position of drawout operation			
Change-over sequence of SBC (b contact)	ON		OFF

Safety shutter (SST)



The safety shutters cover the conductors (cradle side) and prevent contact with them when the breaker is pulled out.

Option

Safety shutter lock (SST-Lock)

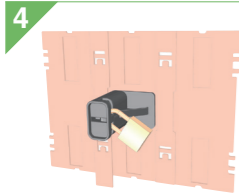

This kit is used to lock the safety shutter using a padlock (the padlock to be customer's supply). The safety shutter close when the breakers are drawn out to prevent accidental contact with the main contacts. This kit is used for the safety shutters both in the line side and load side. The safety shutter is locked while the breaker is open, and is unlocked automatically by inserting the breaker.

Option

Mis-insertion preventer (MIP)

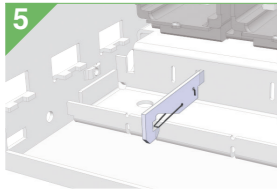

This prevents from other breakers unspecified from inserting into the cradle, and 5 patterns in maximum are available.

Option

Drawout interlock

This is the safety device that prevents insertion and drawout operation. When the breaker is ON, the drawout handle cannot be inserted, and insertion and drawout operation cannot be done unless the OFF button is pressed.

Standard*

*Standard equipment in case of Drawout type

Position lock



This is the device that locks automatically the drawout mechanism at "TEST" or "CONNECT" positions during insertion and drawout operation. When the lock plate is pushed in, lock is released and operation can be continued.

Standard*

*Standard equipment in case of Drawout type

Padlock

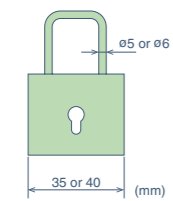

Outline dimensions (reference)

A padlock can be arranged at the lock plate. Thereby, it is possible to prevent the connection position from being changed unnecessarily. As for outline dimensions of the padlock, please refer to the left figure.

Note 1) For the breaker, only the padlock with ø 5 is available. For the BC-L, Position lock, and SST-Lock, DUC the padlock with ø 5 or ø 6 is available.
 Note 2) The padlock is available for the push button cover, safety shutter lock, and position lock.

Operating position of drawout type

CONNECTED position	TEST position	DISCONNECTED position	DRAWOUT position
<ul style="list-style-type: none"> Both the main and control circuits are connected. Normal in use condition. The lock plate is protruding. 	<ul style="list-style-type: none"> The main circuit is disconnected, but the control circuit is connected. The breaker operation can be tested with the door closed. The lock plate is protruding. 	<ul style="list-style-type: none"> Both the main and control circuits are disconnected. The door can be closed. 	<ul style="list-style-type: none"> This is the position for removing the breaker. The breaker is drawn out of the cradle on the extension rails.

Lifting hook (HP)

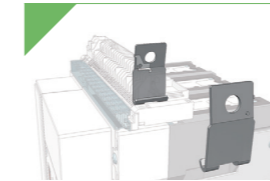

This is the metal fitting to suspend the main body when the breaker is removed from the drawout cradle. The fixed type breaker is equipped with HP as standard.

Option

Test jumper (TJ)

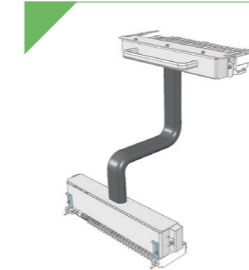

With the breaker taken out of its cradle, this device enables the breaker to be electrically opened and closed, and the operating sequence to be checked. A cable of 3 m is equipped as standard shipment. An extension cable (5 m) is providable.

Option

Electronic trip relay

Feature

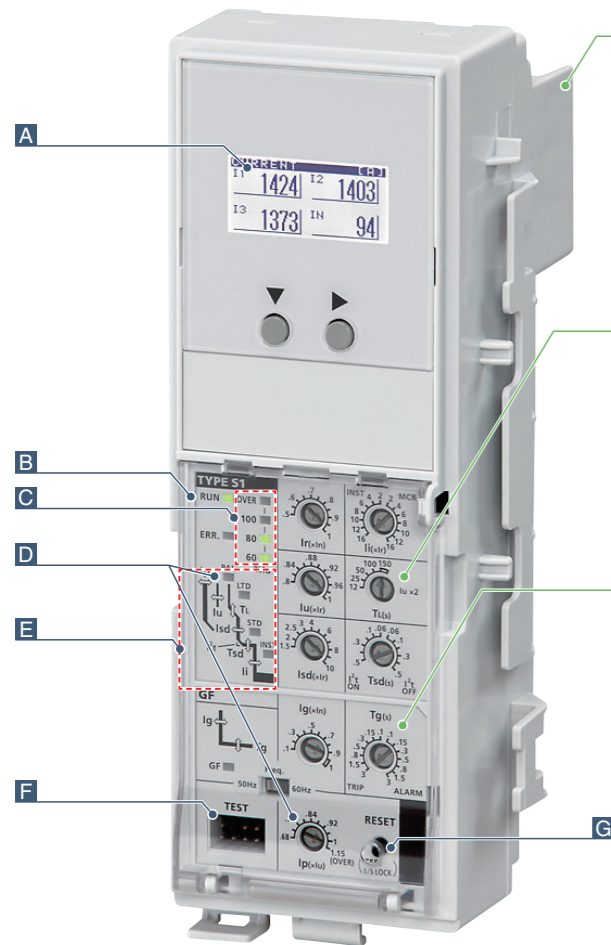

Power supply option
It provides the control power source for the trip indicator LED and DP. Please select a Power supply type from P3 or P4, which include Power supplies with output contact. (The overcurrent protection and ground fault protection (GF)* can work with power from the internal CT, even if the control power source is off.)

Main setting
The characteristic setting function of the overcurrent protection according to application can be set. ETR for general use (Type: S1) has the setting dials for LTD, STD, and INST operating characteristics. The 4-pole breaker provides the neutral 100% protection as standard.

Optional setting option
Ground fault protection (GF) can be added as needed.

Note *) For Ground fault protection, it works under the rated current (In) setting of 0.2-1.0 without Control power source.

- A Display option**
The measuring data (current) and alarms can be displayed with this module.
- B RUN and ERR. LED standard**
This indicator displays the ETR situation (Run and/or Error).
- C Load current LED standard**
This indicator shows the actual current-carrying level. The LED of 60, 80, 100, or OVER lights. When the load current exceeds 60% of I_n , the LED of 60 lights. When the load current exceeds the pickup current of LTD, the LED of OVER lights, and the breaker will be tripped after the predetermined time.
- D Pre-alarm (PAL LED and Current setting dial) standard**
This indicator displays the Pre-alarm situation when the setting current is exceeded.
- E Trip indicator LED standard**
This indicator displays the trip cause. (Self-holding type)
If the output contact for this trip indicator is required, The power supply module should be selected from Type P3 or P4.

- F TEST terminal standard**
This TEST terminal is used for the field testing of characteristics with Mitsubishi Tester "Y-2005" (refer to page 27).
- G RESET button standard**
With this RESET button, trip indicator, display data such as a fault cause and fault current and Pre-alarm are reseted. When the Type P3 or P4 is equipped, the resetting from the control circuit terminal becomes possible. Additionally, this RESET button provides a lock function of LTD and STD characteristics on the INST testing with Mitsubishi Tester "Y-2005".
- OCR alarm (AL) standard**
When the breaker is tripped by the overcurrent or ground fault protection (GF), this device continuously outputs the alarm signal until the alarm is reset. For details, refer to page 16.
- Neutral pole overcurrent protection (NP) standard**
When the humanics in load current become higher, the current on the neutral pole may exceed the rated current. This Neutral pole overcurrent protection prevents the troubles caused by higher Harmonics.

Power supply module

Type	Rated voltage (V)	Applicable voltage range (V)	Criterion for power requirement (VA)	Alarm output
P3	100-240 AC (50/60 Hz)/ 100-125 DC	85-264 AC 85-138 DC	15	5 output contacts
P4	24-60 DC	18-72 DC	10	5 output contacts

Contact capacity (Type P3 and P4)

Voltage (V)	Current (A)	
	Resistive load	Inductive load
	cosφ = 1.0	cosφ = 0.4 L/R = 0.7
AC (50/60 Hz)	240	1
	120	1
DC	125	0.1
	30	1

Note 1) The overcurrent protection and ground fault protection operates without control power source.
Note 2) Factory setting of 5 output contacts is as follows.

① LTD	② STD/INST	③ GF	④ PAL	⑤ ERR.
Self-holding	Self-holding	Refer to lower table	Automatic reset	Automatic reset

ETR dial set	GF
TRIP side	Self-holding
ALARM side	Automatic reset

Self-holding: The output is maintained until it resets.
Automatic reset: The output will be reset if it backs to normal condition.

Type of Electronic trip relay



Type: VS1

- Optional function**
NA: Without optional setting
GF: Ground fault protection
DP: Display
DPGF: Display & Ground fault protection
- Power supply**
P3: 100-240 V AC/100-125 V DC with output contact
P4: 24-60 V DC with output contact

Note) When using an ETR with DP, select the power supply type.

■ For general purpose: Type S1

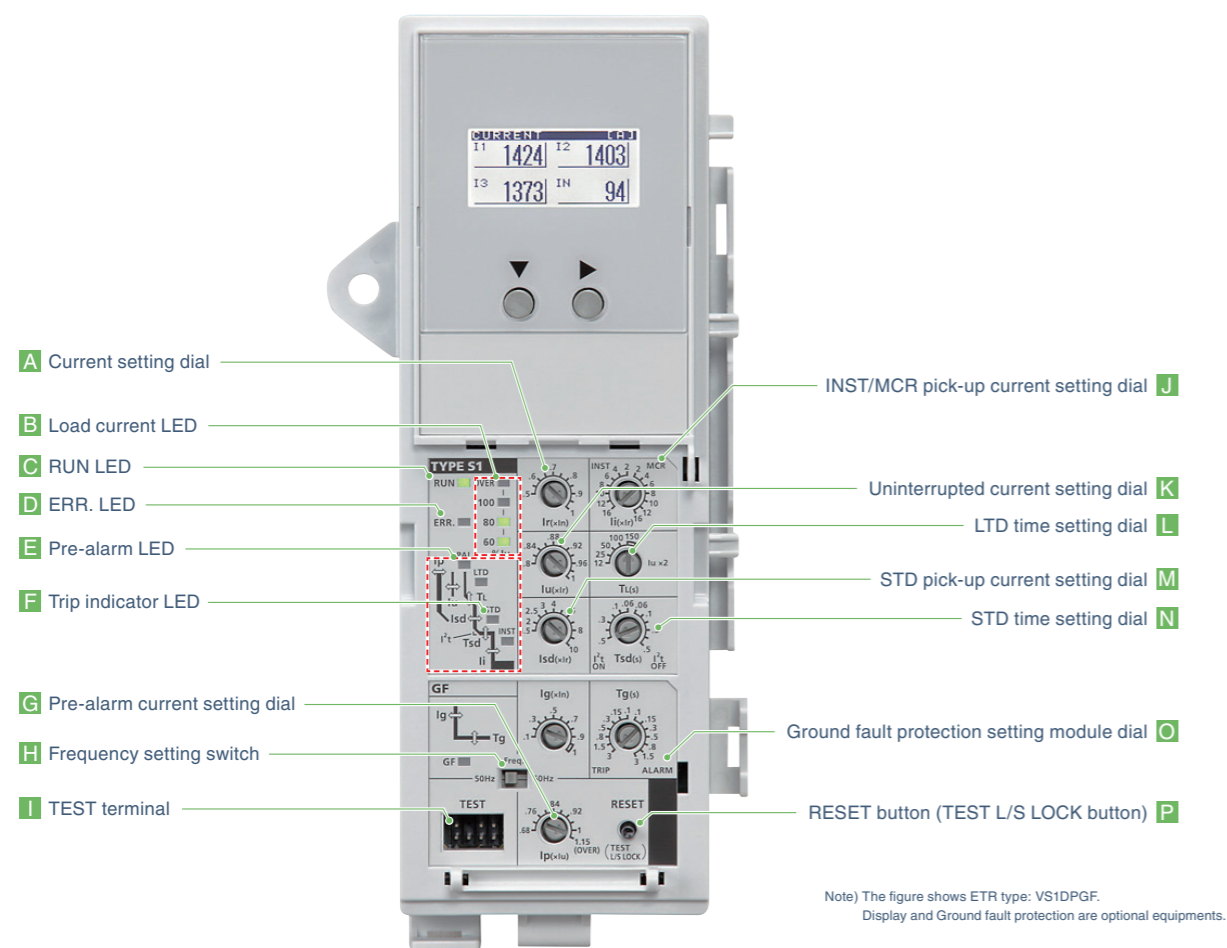

Note) The figure shows ETR type: VS1DPGF.
Display and Ground fault protection are optional equipments.

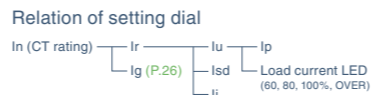

Adjustable setting range

No.	Setting item	Mark	Adjustable setting range	Accuracy	Factory default value
A	Current setting	Ir	0.5-1.0 (step 0.05) × In (CT rating)	-	1.0
K	Uninterrupted current	lu	0.8-1.0 × Ir (step 0.02), Pick-up current: 1.15 × lu	1.05 × lu...Non Pick-up 1.25 × lu...Pick-up	1.0
L	LTD time	TL	12-25-50-100-150 s at lu × 2	±20%	150
M	STD pick-up current	Isd	1.5-2-2.5-3-4-5-6-7-8-9-10 × Ir	±15%	10
N	STD time	Tsd	0.5-0.4-0.3-0.2-0.1-0.06-0.06-0.1-0.2-0.3-0.4-0.5 s (I ² t ON) (I ² t OFF) at Isd × 1.5	±20% (Note)	0.5 (I ² t ON)
J	INST/MCR pick-up current	li	16-12-10-8-6-4-2-2-4-6-8-10-12-16 × Ir (INST) (MCR)	±15%	16 (INST)
G	Pre-alarm current	Ip	lu × 0.68-1.0 (step 0.04) -OVER	±10%	OVER
-	Pre-alarm time	Tp	1/2 TL at lu × 2 (after 1/2 TL, PAL contact output turns on.)	±20%	-

The table and the figure include both optional display.
 Pre-alarm current "OVER" setting is lu × 1.15.
 Note) (O operation) When Tsd = "0.06" setting, operating time is 0.04-0.1 s.
 When Tsd = "0.1" setting, operating time is 0.1 s ±50%.
 (CO operation) When Tsd = "0.06, 0.1" setting, operating time is 0.04-0.15 s.

Operating characteristic curve (for general purpose: Type S1)

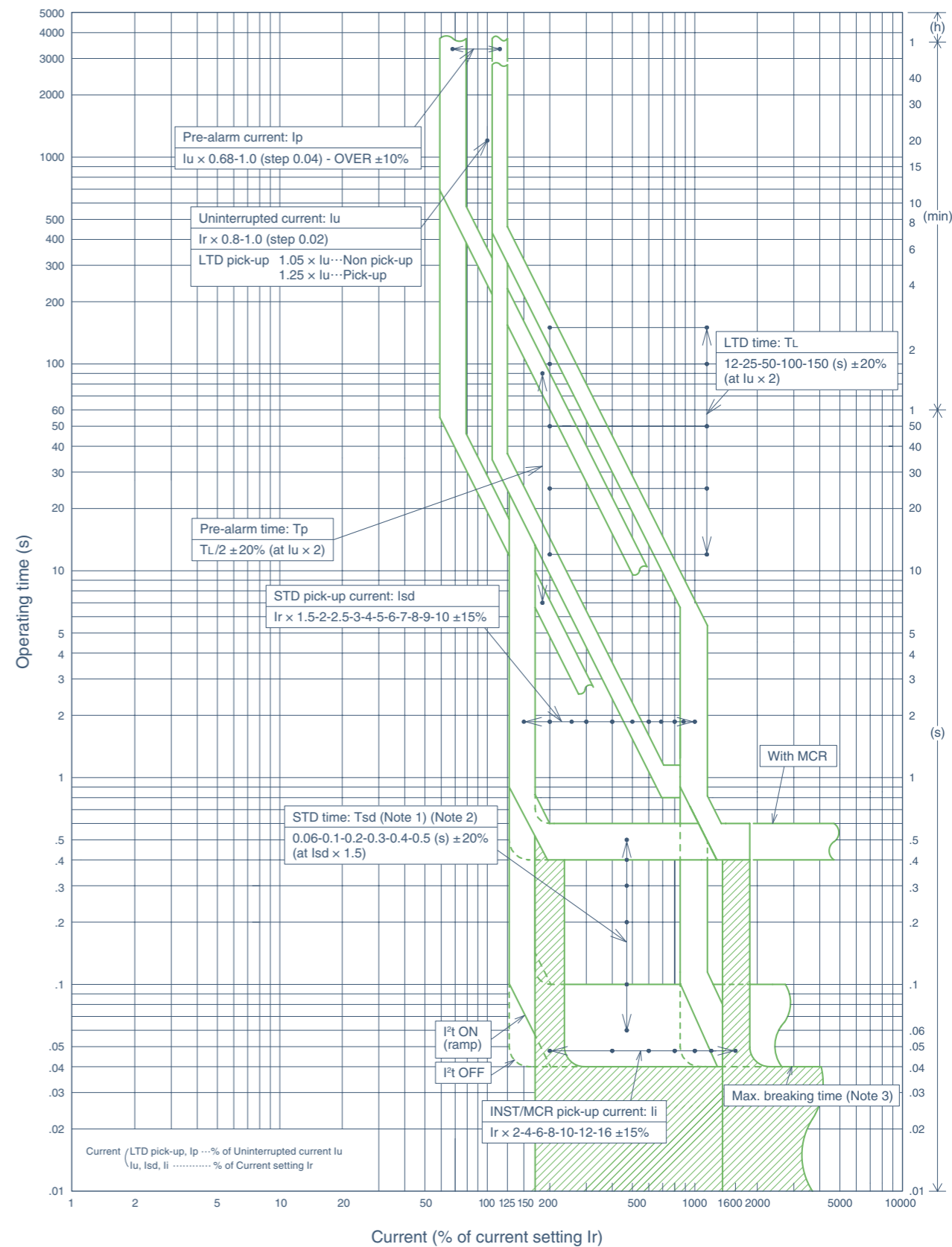

Note 1) (O operation) When Tsd = "0.06" setting, operating time is 0.04-0.1 s.
 When Tsd = "0.1" setting, operating time is 0.1 s ±50%.
 (CO operation) When Tsd = "0.06, 0.1" setting, operating time is 0.04-0.15 s.

Note 2) I²t is selectable: ON or OFF.
 Note 3) When CO operation, max. breaking time is 0.135 s.

Optional function for electronic trip relay

Ground fault protection (GF)

Option



The ground fault protection (GF) of several hundred amperes is available. This function can be selected for trip or alarm (no trip). Power supply is necessary for this function, even if there is not power supply, it can function at $0.2 \times I_n$ or higher.

Setting item	Mark	Adjustable setting range	Accuracy	Factory default value
GF pick-up current	I _g	0.1-0.2-0.3-0.4-0.5-0.6-0.7-0.8-0.9-1.0 × I _n	±20%	1.0
GF time	T _g	3-1.5-0.8-0.5-0.3-0.15-0.1 - <0.1-0.15-0.3-0.5-0.8-1.5-3 s TRIP ALARM (at 1.5 × I _g)	±20% (Note)	3 s (TRIP)
Alarm output	-	Setting for TRIP: Self-holding/Setting for ALARM: Automatic reset	-	Setting for TRIP (Self-holding)

Note) When T_g = "0.1" setting, operating time is 0.1 s ±50%.
When T_g = "0.15" setting, operating time is 0.15 s ±30%.

Neutral CT (NCT) *Only use for AE V Series

Option



The Neutral CT is used for ground fault protection when the 3-pole breaker is used on a 3-phase 4-wire system and for the overcurrent protection on N phase. Please use this CT in combination with ground fault protection (GF). As for the outline dimensions, refer to page 34. The length of the cable (attached) for NCT is 2 m.

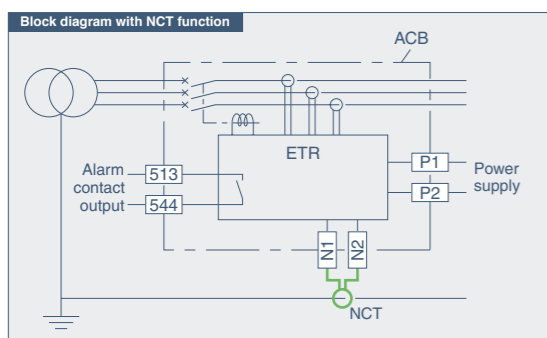
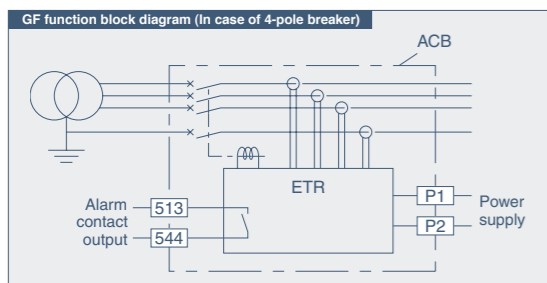

Neutral Current Transformer type name

Type name	ACB type	Rating ampere of current transformer (A)
NCT-06-V	AED630-CV	630
NCT-10-V	AED1000-CV	1000
NCT-12-V	AED1250-CV	1250
NCT-16-V	AED1600-CV	1600

For outline dimensions, please refer to page 34.

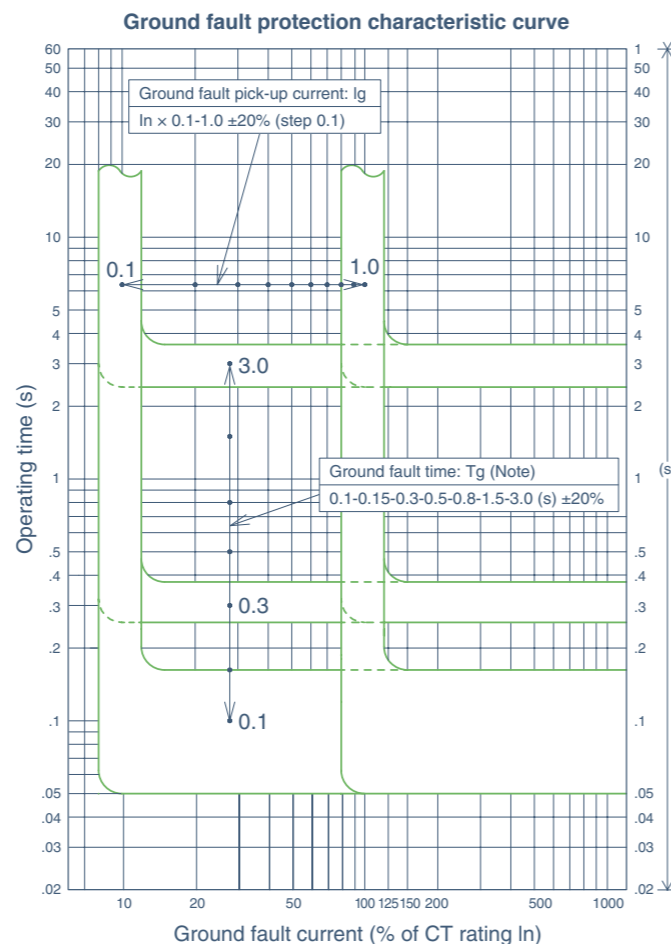

Note) When T_g = "0.1" setting, operating time is 0.1 s ±50%.
When T_g = "0.15" setting, operating time is 0.15 s ±30%.

Display (DP)

Option



The display shows the current and harmonics for real time monitoring. Moreover, the fault memory function is available so that it is possible to find out the reason of breaker trip.

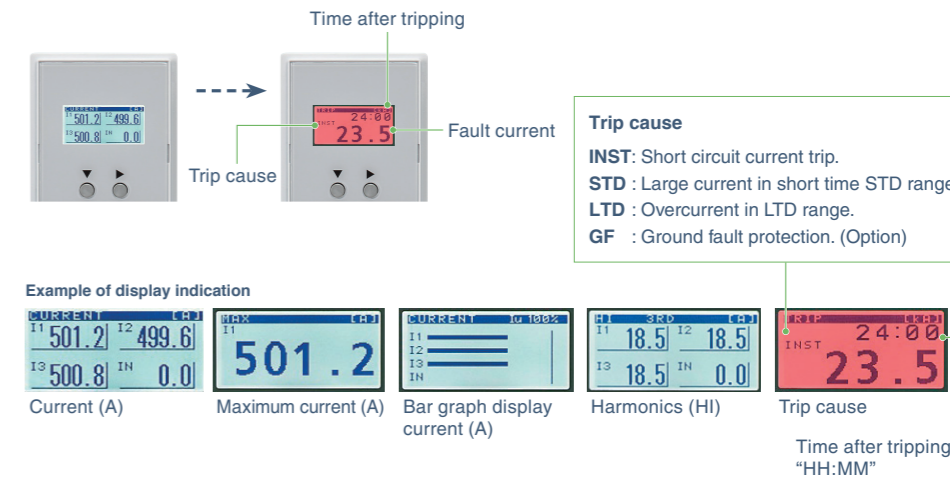

Specifications of display indication

Measuring items	Measuring range	Display indication	Remark
Current (A)	Current of each phase	0 to 200% I _n	***** A (I _n = 630 A to 1600 A)
	Maximum value		---
Harmonics (HI)	Fundamental harmonics of each phase		
	Harmonics of each phase/degree (3 rd , 5 th , 7 th , 9 th)		***** A (I _n = 630 A to 1600 A)
	Each phase total value	0 to 100% I _n	
	Each phase total distortion rate		****. %
Fault memory	Content rate of each phase/degree		
	Trip cause/Fault current	0 to 2000% I _n	LTD ***** A (0-19999 A) STD ***** kA (20000 A and more) INST ***** A
	Elapsed time since tripping	0 to 24:00	h: m

Field test device (Y-2005)

Option



The electronic trip relay can be checked by this field test device when the breaker is at the test position or the disconnect position. The breaker will be tripped when tested with this device in the "trip mode".

Y-2005 specification

Test items	LTD, STD, INST, GF, PAL
Range of signal output	Voltage signal equivalent to 1% to 2500% of Rated current I _n (CT rating)
Dimensions	220 mm (W) × 150 mm (H) × 340 mm (D)
Time counter	0.000 to 999.999 s
Input voltage	100-240 V AC 50/60 Hz
Weight	4.5 kg

MCR

Standard

With this MCR switch, at the time of breaker closing from OFF to ON the INST (Instantaneous) characteristic works, and then after breaker is in closed (ON) position the INST characteristic becomes ineffective. This controlling function of INST characteristic is useful for the protection on the short-circuit fault at the time of closing and also for expanding the selective combination with branch breakers after closed. MCR is equipped as standard.

Electronic trip relay circuit diagram for general use

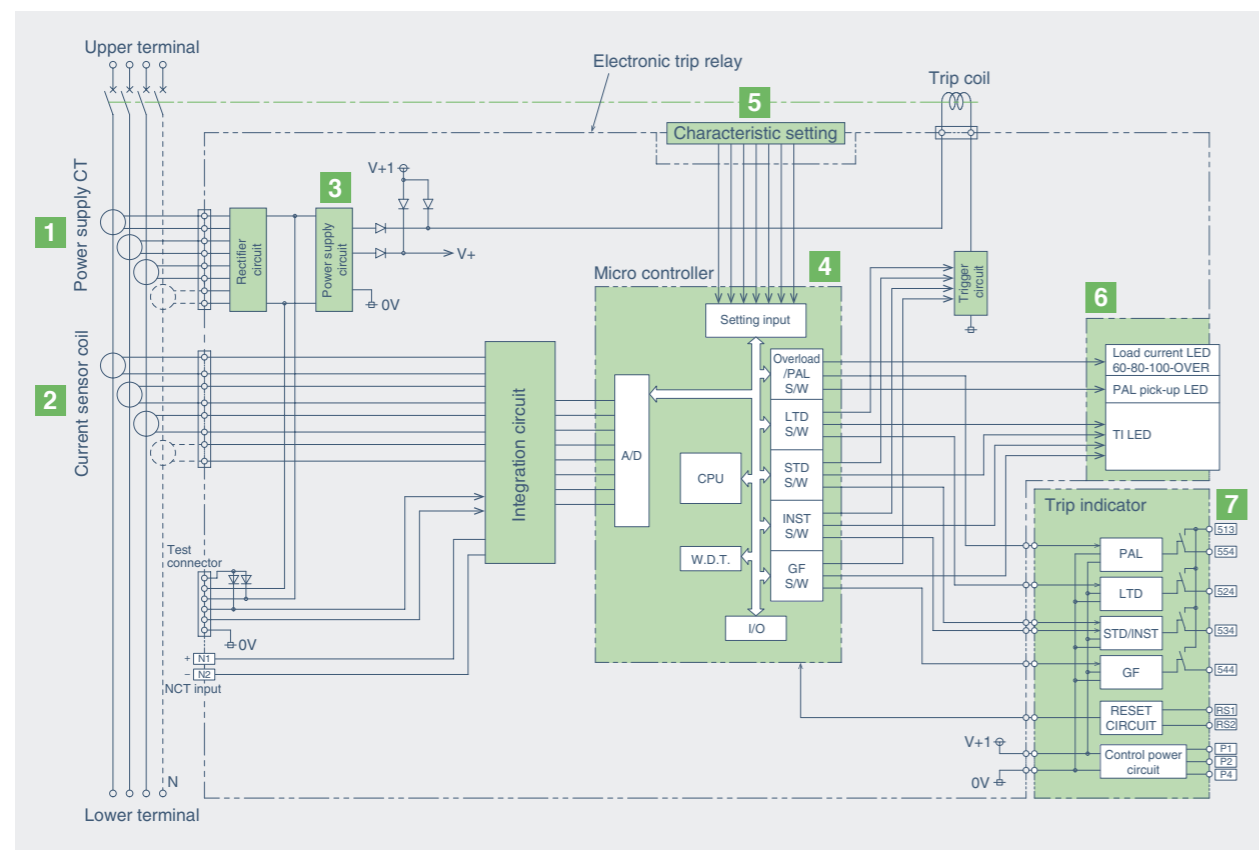

Note) For the N pole, the above diagram shows the (Standard) case that the accessories are equipped on the right side.

1 Power supply CT

Energy is supplied for the operation of the overcurrent tripping and ground fault tripping (GF) function of the electronic trip relay.

2 Current sensor coil

The current in each phase flowing through the breaker is detected. An air core coil which has good linearity is adopted.

3 Power supply circuit

This part converts power supply CT energy to constant voltage for respective circuits in the ETR.

4 Micro controller

The Micro controller integrates each phase current waveform from the Current sensor coil and performs processing for overcurrent protection and others.

5 Characteristic setting

This setting provides the characteristic setting of the ETR.

6 LEDs

The load current LED gives a figure of current in percent by CT energy. Trip indicator and pre-alarm are indicated by control power supply. RUN and ERR. LED indicate breaker's condition by control power supply or ten-odd percent of CT energy.

7 Trip indicator

This outputs contact signals of fault cause (including pre-alarm) and an other alarms. A control supply is necessary for this function.

Setting procedure

Push the screwdriver into the direction of the arrow to open the ETR cover

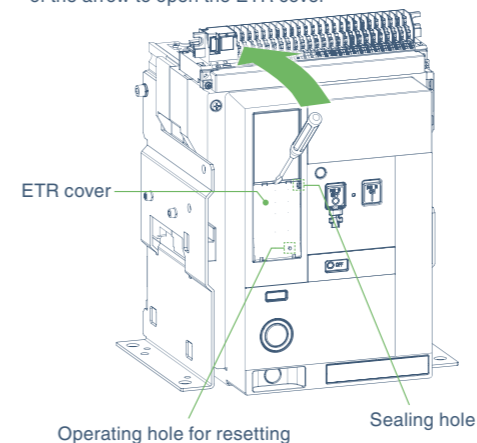

1. Prepare a small flat tipped screwdriver.

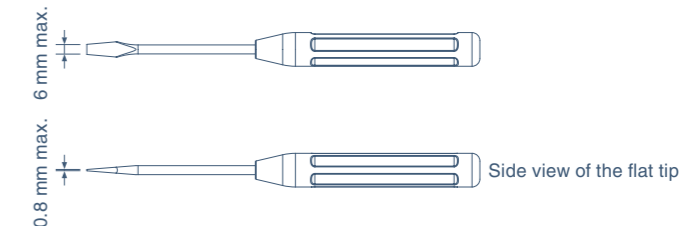

2. Insert the flat tipped screwdriver into the opening of the ETR cover. Then, lightly turn the screwdriver to the upside as shown in the left figure, and the ETR cover will open.

3. There are two kinds of switches for characteristics setting and for trip indicator reset. They should be used as follows.

① Adjustable in steps

Rotary code switch is used. Do not set the switch at points between steps. The setting value is the same when the switch is positioned at the thick line. (Set the switch with a torque of 0.02 N·m or below.)

Note) If the switch is set at points between steps, the characteristics setting value will be decided at either end of steps.

② Push button

This is for temporary operation, and press it with force of 3N or less.

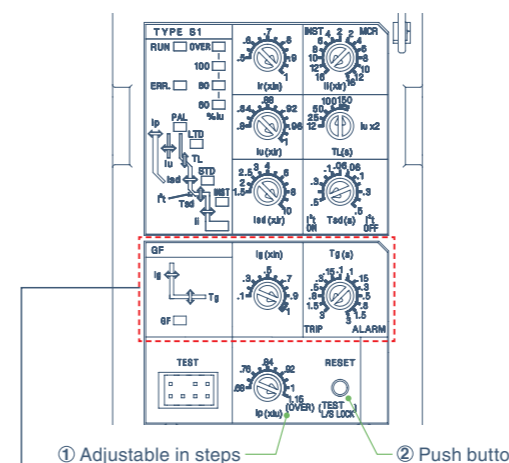

In the case of ETR with Display

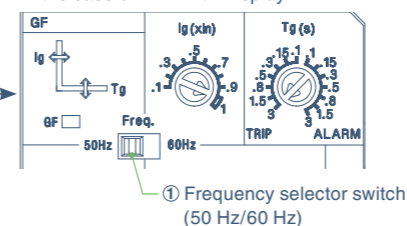

① Frequency selector switch

Do not set the switch at points between the slide. When operating the switch, use a flat tipped screwdriver of the following size.

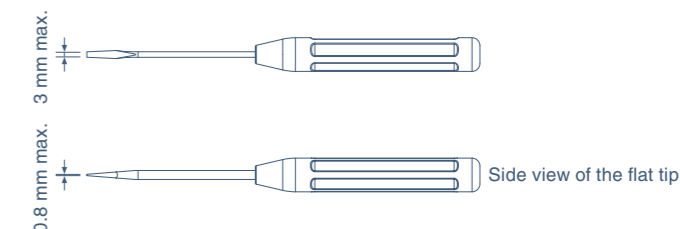

5. When the characteristic is set up, use a device like a field test device, etc to make sure that the required characteristic has been set.

6. When sealing, seal the ETR cover by using the sealing hole at the top of the ETR cover.

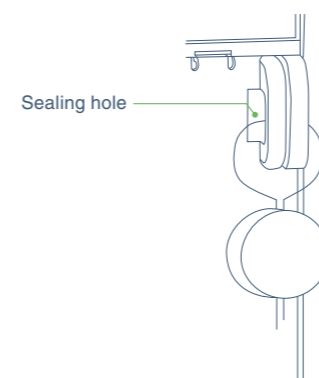

Wiring diagram

The following diagram shows the case that accessories are fully equipped. For the N pole, the following diagram shows the (Standard) case that the accessories are equipped on the right side.

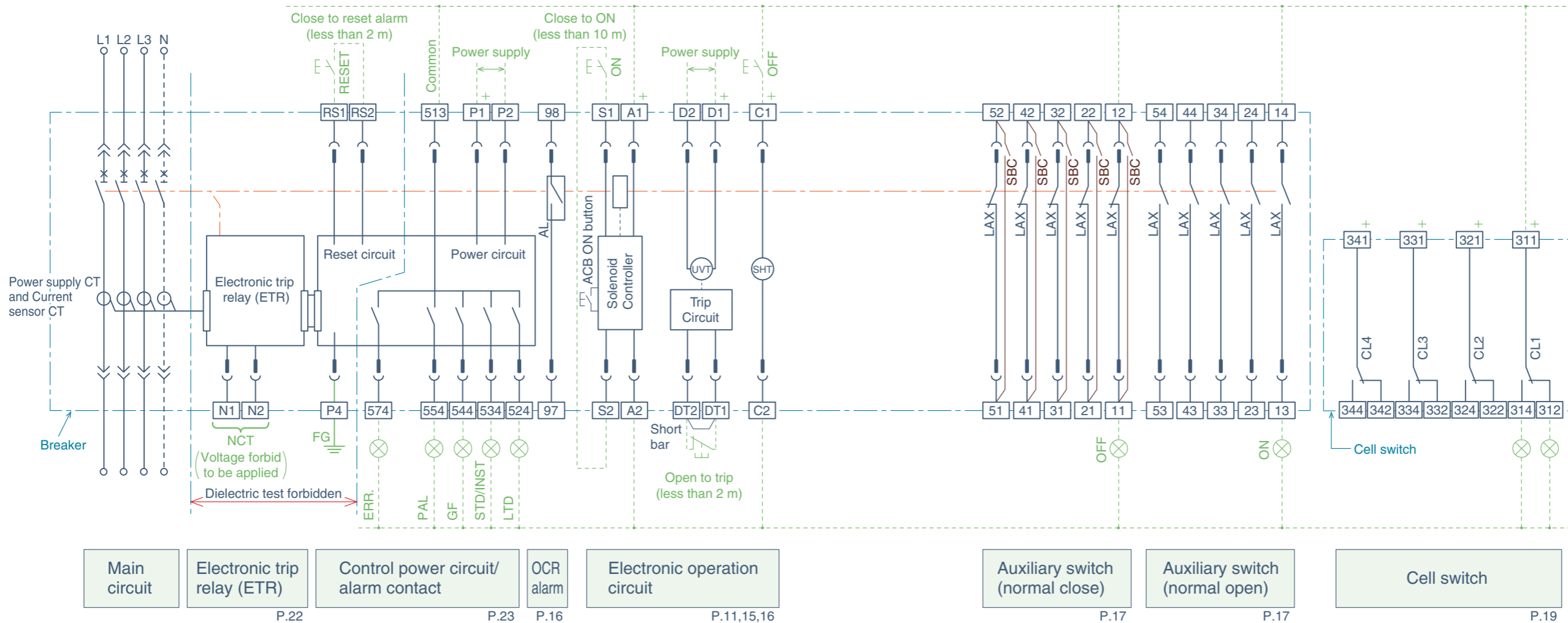

Terminal description

13 14 53 54	Auxiliary switch "a contacts"
11 12 51 52	Auxiliary switch "b contacts"
D1 D2	Voltage Input terminal of UVT
DT1 DT2	Trip terminal of UVT (Remote trip)
A1 A2	Power supply for Solenoid Controller
S1 S2	External ON (Close by remote control)
C1 C2	Shunt trip
97 98	OCR alarm
P1 P2	Power supply for ETR
P4	FG of power supply (FG: Frame Ground)
RS1 RS2	Alarm reset (Trip cause, alarm contact)
513 524 534 544 554 574	Trip cause, alarm contact
N1 N2	For Neutral CT (NCT)

Accessory Symbols

(SHT)	Shunt tripping device
(UVT)	UVT coil
LAX	Auxiliary switch Standard
AL	OCR alarm switch
SBC	Shorting b contact
CL	Cell switch

— Internal wiring
 - - - External wiring (user's wiring)
 ⊕ Control circuit connector (drawout type)

⚡ Applying power to the terminals [A1] and [A2] changes the terminals [S1] and [S2] to the live part. Applying power to the terminals [D1] and [D2] changes a terminals [DT1] and [DT2] to the live part. Do not touch the terminals.

- On the drawout type, the cables should have the length which allow the control circuit terminal block to be moved to the left or right by 5 mm.
- When a coil load is connected in the same control circuit as the ETR, surge absorbers are required to absorb the surge voltage.
- Since some terminals are polarized, the wiring should be done correctly as the polarity shown in the wiring diagram when the control voltage is DC.
- To close the circuit breaker remotely, connect a switch between terminals [S1] and [S2]. The switch used for remote close should be rated 30 V DC 10 mA or more (minimum applicable load 15 V DC 1 mA or less).
- For the power supply type P3 or P4, the high sensitive relay used in contact output may cause the chattering noise (wrong output of 1 ms level) during ON and OFF operation, depending on the panel placing condition. When it used in the quick responsive sequence, the filter circuit of a few milli-second (ms) should be provided or the double reading sampling should be implemented.
- Alarm reset (Terminal: [RS1] and [RS2]) and Alarm contacts (Terminal: [513], [524], [534], [544], [554], [574]) are available only for power supply type P3, P4. The switch used for remote reset should be rated at 15 V DC 10 mA or more. Alarms will be reset if terminals [RS1] and [RS2] are short-circuited for 0.5 seconds or longer.
- Under voltage trip device (UVT)
 The switch used for remote trip should be rated 30 V DC 10 mA or more (minimum applicable load 15 V DC 1 mA or less). Remote trip terminal has short bar at shipment, so remove it before using this function. Disconnect the voltage input wires during dielectric testing of main circuit.

Outline dimensions

Drawout type AED630-CV, AED1000-CV, AED1250-CV, AED1600-CV

Fixed type AED630-CV, AED1000-CV, AED1250-CV, AED1600-CV

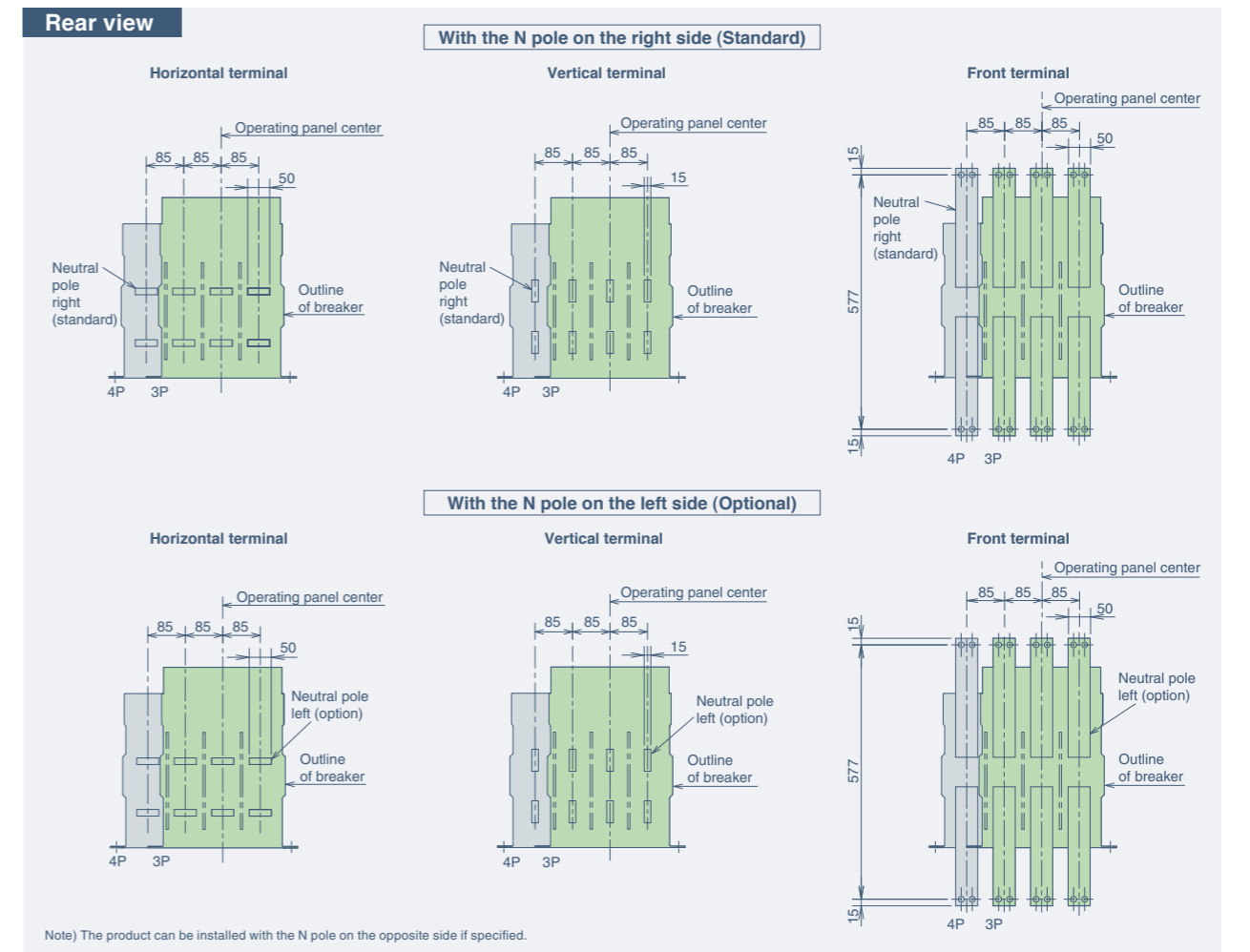
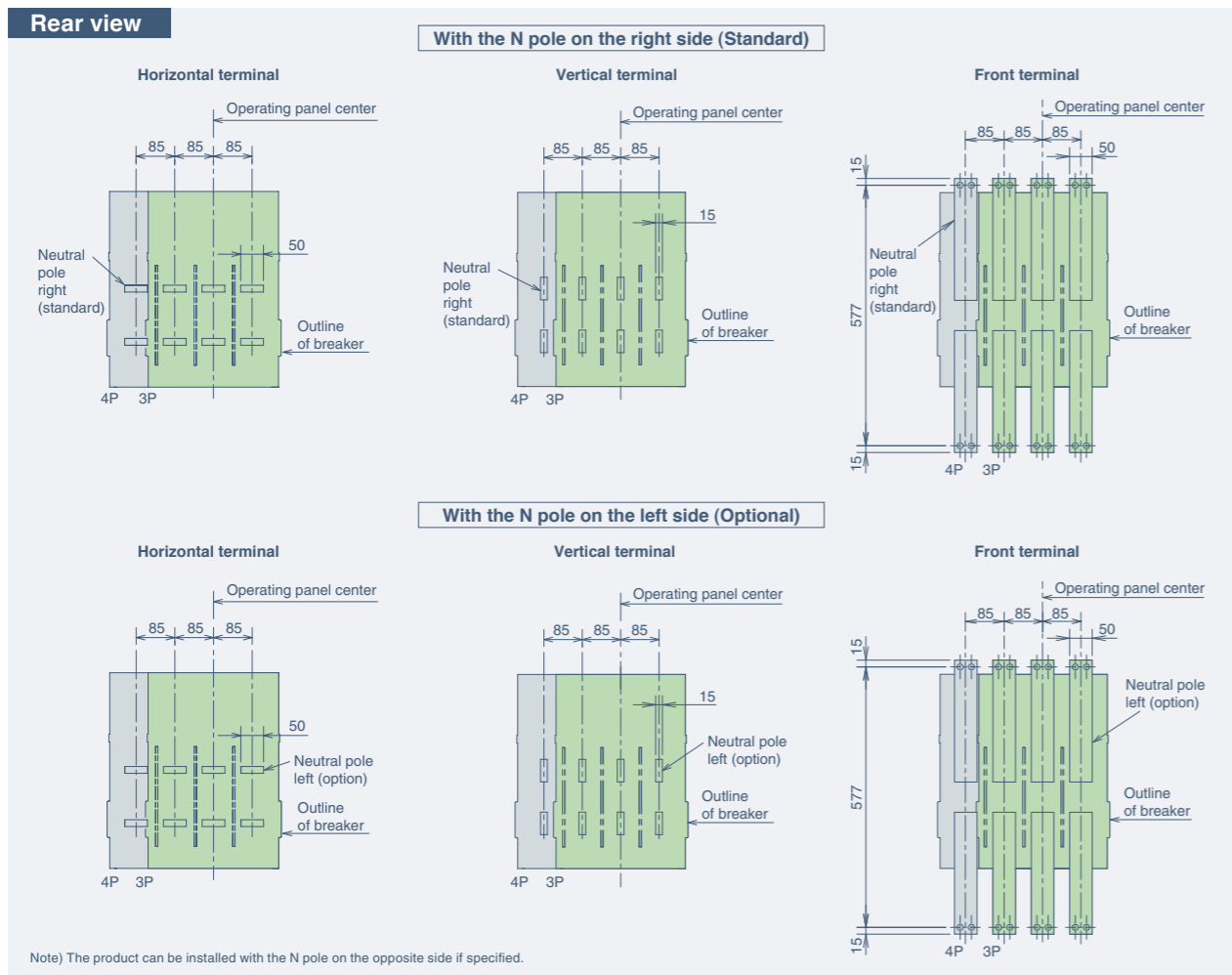
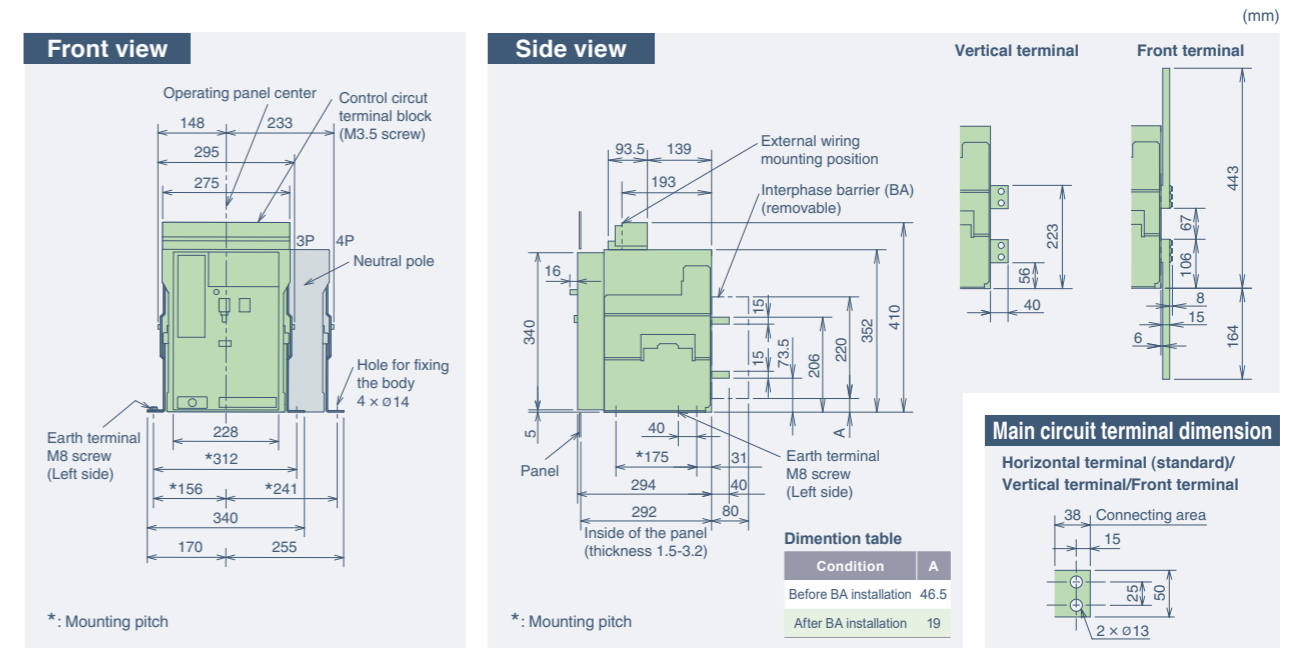
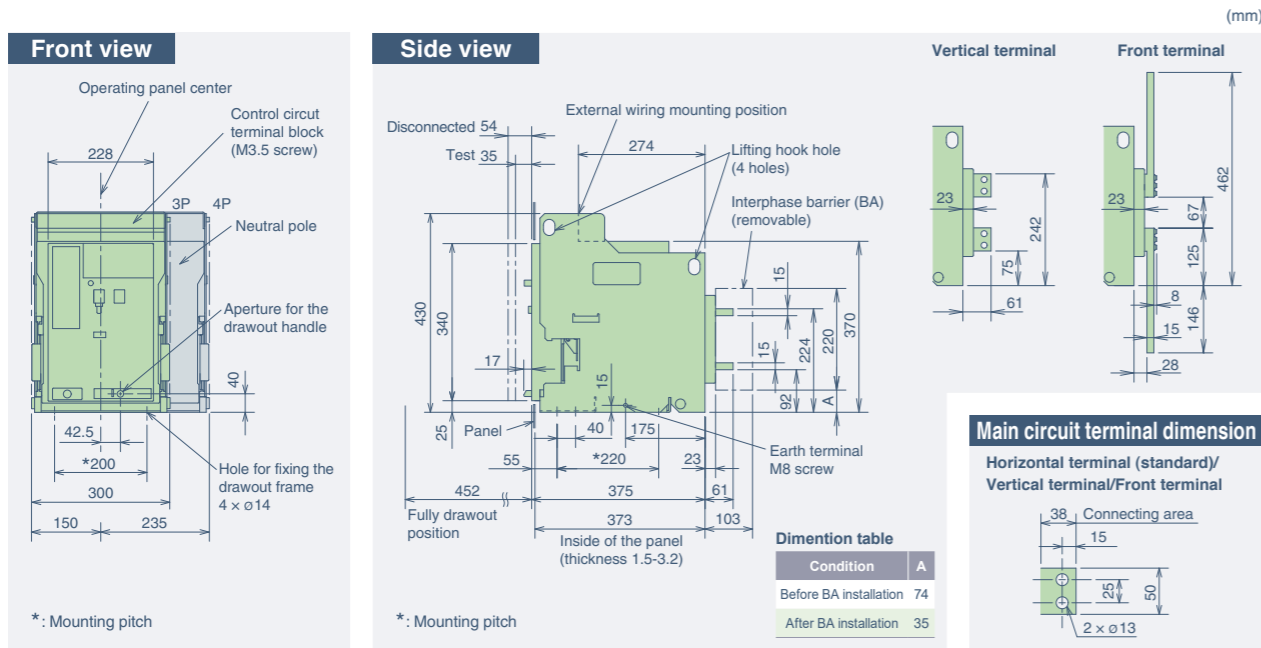

■ Panel cut-out, Front terminal adapter, Drawout handle, Lifting hook (HP)

(mm)

Panel cut-out dimensions

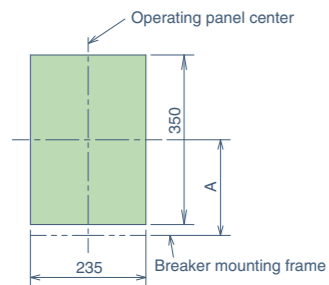

Door frame panel cut-out dimensions

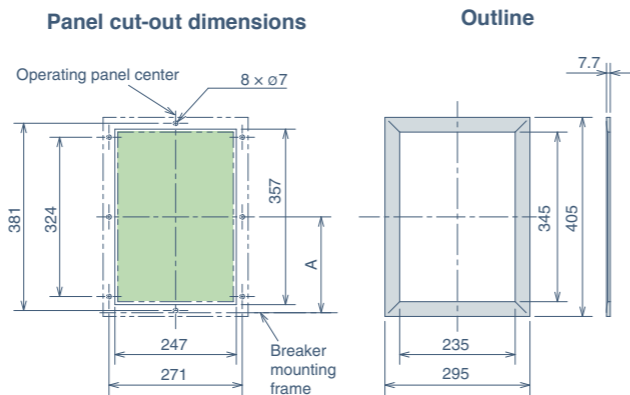

* Door frame use (option).

Dimensions		
Type	A	
AED630-CV to AED1600-CV	Fixed type	175
	Drawout type	195

Front terminal adapter

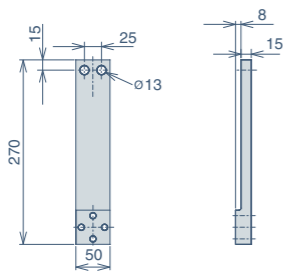

Lifting hook (HP)

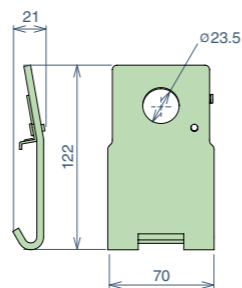

HP is standard equipment for Fixed for Fixed type.

■ Neutral CT (NCT)

Neutral CT (NCT)

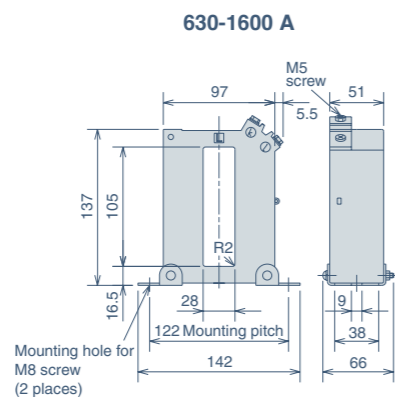

Technical information

Precautions for connecting

Use M12 bolts, plain washers, and spring washers to connect the conductor. Clean the surface of conductor to be connected to the (silver plating) ACB terminal of circuit breaker and securely tighten the bolts with a correct torque (M12: 45 ±5 N·m).

The ACB terminal which is applicable to connect the conductor is different depending on the shape of the terminal. Refer to the outline dimensions on page 32, 33.

Standard tightening torque

Screw size	Tightening torque (N·m)
M12	45 ±5

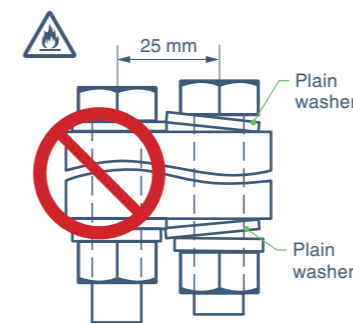

Use small washers to connect so that the washers do not overlap with each other.

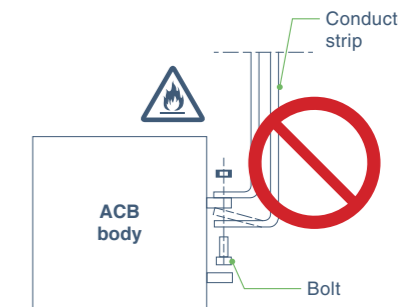
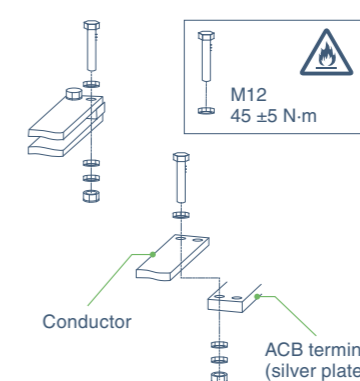

Arrange the conductor strip to contact the terminal of the circuit breaker securely. And fix the conductor strip with a bolt so that no force is applied to any direction of the terminal.

Since the fault current flowing through the conductors causes large electromagnetic forces, the conductors should be secured firmly, using the values in the below table as a reference. Max. distance between the fixing support and ACB conductor strip should be less than 200 mm.

Electromagnetic force in N per 1 m conductor (three phase short circuit) (N)		
Type	AED630-CV to AED1600-CV	
Conductor distance (mm)	85	
Prospective fault current kA (pf)		
30 (0.2)	7700	
42 (0.2)	15100	
50 (0.2)	21400	

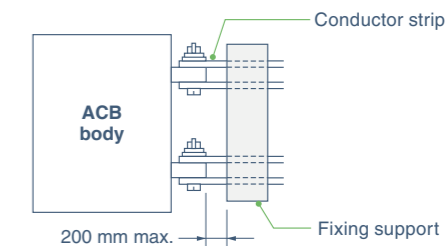

When selecting conductors to be connected to AE V breakers, ensure that they have a sufficient current capacity. Refer to the following table.

Conductor size (Ambient temperature: 40°C at open air) (Compliance with IEC 60947-1)

Rated current connecting Max. (A)	Conductors (Copper bus bar)		
	Arrangement	Quantity (Note)	Conductor size (mm)
630	With long surface vertical	2	40 × 5
1000		2	60 × 5
1250		2	80 × 5
1600		2	100 × 5

Note) The values indicate the quantity per pole and terminal.

The above table shows the suitable connecting conductor size based on IEC 60947-1, which is assured from the test under Ambient temp. 40°C, Open air and testing configuration as shown in the right figure.

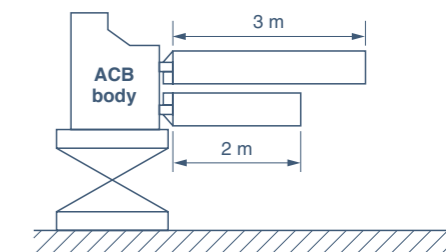

Arc space

When a short-circuit current is interrupted, discharged hot gas blows out from the exhaust port of the arc chute chamber, so provide a clearance as shown in the following table.

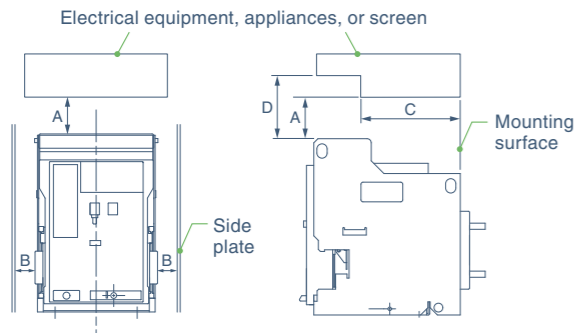

Dimensions		(mm)	
Type	AED630-CV to AED1600-CV		
Applicable voltage	500 V AC or less		
Fixed type	A	0 (Note 1)	
	B	50	
	C	162	
	D	50 (Note 2)	
Drawout type	A	0	
	B	50	
	C	240	
	D	50 (Note 2)	

Note 1) 300 mm or more clearance is necessary to inspect the arc chute chamber and contacts.
Note 2) The wiring space required for the control terminal block.

Service conditions

1. Normal service condition

Under ordinary conditions that the following normal working conditions are all satisfied, the AE V Series air circuit breaker may be used unless otherwise specified.

1. Ambient temperature

A range of +40°C max. to -5°C min. is recommended.
And the average over 24 hours must not exceed +35°C.

2. Altitude

2000 m (6600 feet) or less

3. Environmental conditions

The air must be clean, and the relative humidity must be 85% or less at +40°C max. Do not use and store the product in atmospheres with sulfide gas and ammonia gas etc. (H₂S ≤ 0.01 ppm, SO₂ ≤ 0.1 ppm, NH₃ ≤ 0.25 ppm.)

4. Installation conditions

When installing the AE V Series air circuit breaker, refer to the installation instructions in the catalogue and instruction manual.

5. Storage temperature

A range of max. +60°C to min. -20°C is recommended to be stored.
And the average over 24 hours must not exceed +35°C.

6. Guideline for replacement

Within approx. 15 years. Please refer to the instruction manual.

2. Special service conditions

In case of special service condition, the service life may become shorter in some cases.

1. Special environmental conditions

High temperature and/or high humidity
Corrosive gas

2. High ambient temperature

If the ambient temperature exceeds +40°C, the uninterrupted current rating will be reduced. Since the derating value is different depending on the applicable standard, refer to page 37.

3. High altitude

Since the heat radiation rate is reduced for use at the 2000 m or higher, accordingly the operating voltage, continuous current capacity, and breaking capacity are derated. Moreover, the insulation durability is also decreased owing to the atmospheric pressure. Please inquire us for further details.

Precautions on installation

Installation direction

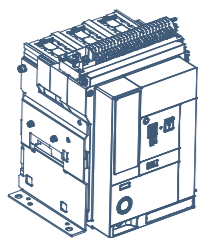

Possible position

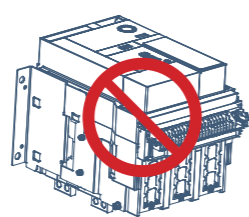
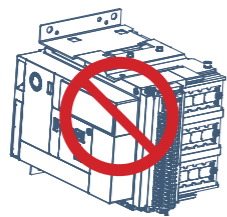

Tightening torque

Screw size	Tightening torque (N·m)
M12	45 ±5

Grounding terminal

Unless otherwise specified, ground a grounding terminal for safety.

Internal resistance, reactance and power consumption (per pole)

Type	Connections	Internal resistance (mΩ)	Reactance (mΩ)	Power consumption (W)
AED630-CV	Fixed type	0.017	0.11	7
	Drawout type	0.037	0.15	15
AED1000-CV	Fixed type	0.017	0.11	17
	Drawout type	0.037	0.15	37
AED1250-CV	Fixed type	0.017	0.11	27
	Drawout type	0.037	0.15	58
AED1600-CV	Fixed type	0.017	0.11	44
	Drawout type	0.037	0.15	95

The values are typical values per pole (in unused condition). Please regard it as a reference.

Deratings by ambient temperature

Table 1 Deratings of Max. rated current by ambient temperature (Vertical connection) ^(A)

Standard	Ambient temperature	AED630-CV	AED1000-CV	AED1250-CV	AED1600-CV
IEC 60947-2 (Standard 40°C)	40°C	630	1000	1250	1600
	45°C	560	1000	1250	1600
	50°C	500	1000	1250	1600
	55°C	500	1000	1250	1590
	60°C	440	1000	1250	1540

Table 2 Deratings of Max. rated current by ambient temperature (Horizontal connection) ^(A)

Standard	Ambient temperature	AED630-CV	AED1000-CV	AED1250-CV	AED1600-CV
IEC 60947-2 (Standard 40°C)	40°C	630	1000	1250	1600
	45°C	560	1000	1250	1600
	50°C	500	1000	1250	1560
	55°C	500	1000	1250	1500
	60°C	440	1000	1200	1430

Table 3 Deratings of Max. rated current by ambient temperature with Display ^(A)

In case extension, display (DP1) are attached, the following derating values shown in this table are applied.

Standard	Ambient temperature	AED630-CV	AED1000-CV	AED1250-CV	AED1600-CV
IEC 60947-2 (Standard 40°C)	40°C	630	1000	1250	1600
	45°C	560	1000	1250	1600
	50°C	500	1000	1250	1440
	55°C	-	-	-	-
	60°C	-	-	-	-

(1) The above table shows the maximum rated current per each ambient temperature for drawout type breaker with vertical connection (at brand new product), when breaker and bus bar are installed in open air.
(2) Connection bus bar is according to IEC 60947-1. As for ambient temperature exceeding 60°C, please inquire us.
(3) The above table shows the maximum rated current at the ambient temperature.
(4) The above table shows the values calculated by the values measured under the test conditions specified in the IEC 60947-2, which are not actual values. With the circuit breaker mounted to the panel, verify the values under the test conditions specified in the IEC 61439-1 and others.
Note) Set the proper values using the assembly verification in consideration of the influence of the heat of other devices in the panel, heat capacity of the connecting conductor, supply and exhaust, and air convection in the panel.

Discrimination table

AE V Series air circuit breakers provide easy selective coordination with branch circuit breakers.
For the selective coordinations, refer to the following table.

230 V AC sym kA

Unit breaking capacity	Main circuit breaker	AED-CV			
		AED630-CV	AED1000-CV	AED1250-CV	AED1600-CV
Branch circuit breaker		50	50	50	50
NF-S/NV-S/NFL/NF-H/NV-H	NF32-SV	7.5	7.5	7.5	7.5
	NV32-SV	10	10	10	10
	NF63-SV	15	15	15	15
	NV63-SV	15	15	15	15
	NF63-HV	25	25	25	25
	NV63-HV	25	25	25	25
	NF125-SV	50	27 (50)	50	50
	NV125-SV	50	27 (50)	50	50
	NF125-SEV	85	16 (50)	29 (50)	38 (50)
	NV125-SEV	85	16 (50)	29 (50)	38 (50)
	NF125-SGV	85	16 (50)	31 (50)	42 (50)
	NF125-LGV	90	9.5 (50)	37 (50)	50
	NF125-HV	100	27 (50)	50	50
	NV125-HV	100	27 (50)	50	50
	NF125-HEV	100	9.5 (50)	33 (50)	50
	NV125-HEV	100	9.5 (50)	33 (50)	50
	NF125-HGV	100	9.5 (50)	37 (50)	50
	NF160-SGV	85	16 (50)	30 (50)	40 (50)
	NF160-LGV	90	9.5 (50)	35 (50)	50
	NF160-HGV	100	9.5 (50)	35 (50)	50
	NF250-SV	85	16 (50)	29 (50)	38 (50)
	NV250-SV	85	16 (50)	29 (50)	38 (50)
	NF250-SEV	85	16 (50)	29 (50)	38 (50)
	NV250-SEV	85	16 (50)	29 (50)	38 (50)
	NF250-SGV	85	16 (50)	29 (50)	38 (50)
	NF250-LGV	90	9.5 (50)	33 (50)	50
	NF250-HV	100	9.5 (50)	33 (50)	50
	NV250-HV	100	9.5 (50)	33 (50)	50
	NF250-HEV	100	9.5 (50)	33 (50)	50
	NV250-HEV	100	9.5 (50)	33 (50)	50
	NF250-HGV	100	9.5 (50)	33 (50)	50
	NF400-SW	85	-	16 (50)	23 (50)
	NV400-SW	85	-	16 (50)	23 (50)
	NF400-SEW	85	9.5 (50)	16 (50)	23 (50)
	NV400-SEW	85	9.5 (50)	16 (50)	23 (50)
	NF400-HEW	100	9.5 (50)	16 (50)	23 (50)
	NV400-HEW	100	9.5 (50)	16 (50)	23 (50)
	NF400-REW	150	9.5 (50)	16 (50)	23 (50)
	NV400-REW	150	9.5 (50)	16 (50)	23 (50)
	NF630-SW	85	-	-	19 (50)
NV630-SW	85	-	-	19 (50)	
NF630-SEW	85	-	14 (50)	19 (50)	
NV630-SEW	85	-	14 (50)	19 (50)	
NF630-HEW	100	-	14 (50)	19 (50)	
NV630-HEW	100	-	14 (50)	19 (50)	
NF630-REW	150	-	14 (50)	19 (50)	
NF800-SEW	85	-	-	19 (50)	
NV800-SEW	85	-	-	19 (50)	
NF800-HEW	100	-	-	19 (50)	
NV800-HEW	100	-	-	19 (50)	
NF800-REW	150	-	-	19 (50)	
NF-C/NV-C	NF63-CV	7.5	7.5	7.5	7.5
	NV63-CV	7.5	7.5	7.5	7.5
	NF125-CV	30	15 (30)	30	30
	NV125-CV	30	15 (30)	30	30
	NF250-CV	36	9.5 (36)	21 (36)	36
	NV250-CV	36	9.5 (36)	21 (36)	36
	NF400-CW	50	-	16 (50)	23 (50)
	NV400-CW	50	-	16 (50)	23 (50)
	NF630-CW	50	-	-	19 (50)
	NV630-CW	50	-	-	19 (50)
NF-U	NF800-CEW	50	-	-	19 (50)
	NF125-RGV	150	27 (50)	50	50
	NF125-UV	200	39 (50)	50	50
	NF250-RGV	150	14 (50)	40 (50)	50
	NF250-UV	200	16 (50)	50	50
	NF400-UEW	200	9.5 (50)	14 (50)	19 (50)
	NF800-UEW	200	-	-	19 (50)
	NF800-UEW	200	-	-	24 (50)

- The values in the table represent the max. rated current for both Series AE V air circuit breakers and branch breakers, and the selective coordination applies when the AE V series air circuit breakers instantaneous pick up is set to maximum.
- The numerals shown in parentheses are for AE V with MCR. (When set MCR.)

440 V AC sym kA

Unit breaking capacity	Main circuit breaker	AED-CV			
		AED630-CV	AED1000-CV	AED1250-CV	AED1600-CV
Branch circuit breaker		50	50	50	50
NF-S/NV-S/NFL/NF-H/NV-H	NF32-SV	2.5	2.5	2.5	2.5
	NV32-SV	5	5	5	5
	NF63-SV	7.5	7.5	7.5	7.5
	NV63-SV	7.5	7.5	7.5	7.5
	NF63-HV	10	10	10	10
	NV63-HV	10	10	10	10
	NF125-SV	25	14 (25)	25	25
	NV125-SV	25	14 (25)	25	25
	NF125-SEV	36	9.5 (36)	17 (36)	27 (36)
	NV125-SEV	36	9.5 (36)	17 (36)	27 (36)
	NF125-SGV	36	9.5 (36)	20 (36)	31 (36)
	NF125-LGV	50	9.5 (50)	25 (50)	40 (50)
	NF125-HV	50	14 (50)	37 (50)	50
	NV125-HV	50	14 (50)	37 (50)	50
	NF125-HEV	65	9.5 (50)	22 (50)	33 (50)
	NV125-HEV	65	9.5 (50)	22 (50)	33 (50)
	NF125-HGV	65	9.5 (50)	25 (50)	40 (50)
	NF160-SGV	36	9.5 (36)	18 (36)	28 (36)
	NF160-LGV	50	9.5 (50)	23 (50)	36 (50)
	NF160-HGV	65	9.5 (50)	23 (50)	36 (50)
	NF250-SV	36	9.5 (36)	17 (36)	27 (36)
	NV250-SV	36	9.5 (36)	17 (36)	27 (36)
	NF250-SEV	36	9.5 (36)	17 (36)	27 (36)
	NV250-SEV	36	9.5 (36)	17 (36)	27 (36)
	NF250-SGV	36	9.5 (36)	17 (36)	26 (36)
	NF250-LGV	50	9.5 (50)	22 (50)	33 (50)
	NF250-HV	65	9.5 (50)	22 (50)	33 (50)
	NV250-HV	65	9.5 (50)	22 (50)	33 (50)
	NF250-HEV	65	9.5 (50)	22 (50)	33 (50)
	NV250-HEV	65	9.5 (50)	22 (50)	33 (50)
	NF250-HGV	65	9.5 (50)	22 (50)	33 (50)
	NF400-SW	42	-	15 (42)	19 (42)
	NV400-SW	42	-	15 (42)	19 (42)
	NF400-SEW	42	9.5 (42)	15 (42)	19 (42)
	NV400-SEW	42	9.5 (42)	15 (42)	19 (42)
	NF400-HEW	65	9.5 (50)	15 (50)	19 (50)
	NV400-HEW	65	9.5 (50)	15 (50)	19 (50)
	NF400-REW	125	9.5 (50)	15 (50)	19 (50)
	NV400-REW	125	9.5 (50)	15 (50)	19 (50)
	NF630-SW	42	-	-	19 (42)
NV630-SW	42	-	-	19 (42)	
NF630-SEW	42	-	15 (42)	19 (42)	
NV630-SEW	42	-	15 (42)	19 (42)	
NF630-HEW	65	-	15 (50)	19 (50)	
NV630-HEW	65	-	15 (50)	19 (50)	
NF630-REW	125	-	15 (50)	19 (50)	
NF800-SEW	42	-	-	19 (42)	
NV800-SEW	42	-	-	19 (42)	
NF800-HEW	65	-	-	19 (50)	
NV800-HEW	65	-	-	19 (50)	
NF800-REW	125	-	-	19 (50)	
NF-C/NV-C	NF63-CV	2.5	2.5	2.5	2.5
	NV63-CV	2.5	2.5	2.5	2.5
	NF125-CV	10	10	10	10
	NV125-CV	10	10	10	10
	NF250-CV	15	9.3 (15)	15	15
	NV250-CV	15	9.3 (15)	15	15
	NF400-CW	25	-	15 (25)	19 (25)
	NV400-CW	25	-	15 (25)	19 (25)
	NF630-CW	36	-	-	19 (36)
	NV630-CW	36	-	-	19 (36)
NF-U	NF800-CEW	36	-	-	19 (36)
	NF125-RGV	125	27 (50)	50	50
	NF125-UV	200	39 (50)	50	50
	NF250-RGV	125	14 (50)	40 (50)	50
	NF250-UV	200	16 (50)	50	50
	NF400-UEW	200	9.5 (50)	14 (50)	19 (50)
	NF800-UEW	200	-	-	19 (50)
	NF800-UEW	200	-	-	24 (50)

- The values in the table represent the max. rated current for both Series AE V air circuit breakers and branch breakers, and the selective coordination applies when the AE V series air circuit breakers instantaneous pick up is set to maximum.
- The numerals shown in parentheses are for AE V with MCR. (When set MCR.)

Ordering information

World Super AE V series (C-class) Air Circuit Breaker and Switch Disconnecter

Customer name: _____ Order ref no: _____ Quantity: _____

To indicate customer's choices, please check the applicable square boxes
And input the appropriate information in the rectangles

Type P.6 AED -CV
 Number of poles 3P 4P (Standard: Neutral pole on right side) 4P (Neutral pole on left side)
 Current setting I_r A
 Control voltage 110-125 V DC 220-250 V DC 110-125 V AC 220-250 V AC
 Equipment type FIXED DRAW OUT
 Ambient temperature 40°C (Standard) Others

Main circuit terminal P.14
 Horizontal/Horizontal (HT) Horizontal/Vertical (HV) Horizontal/Front (HF)
 Vertical/Vertical (VT) Vertical/Horizontal (VH) Vertical/Front (VF)
 Front/Front (FT) Front/Horizontal (FH) Front/Vertical (FV)

Electronic trip relay (ETR)
 With ETR Type VS1 Neutral CT (NCT)
 • Optional function
 NA: Without optional setting
 DP: Display
 GF: Ground fault protection
 DPGF: Display & Ground fault protection
 • Power supply
 P3: 100-240 V AC/100-125 V DC with output contact
 P4: 24-60 V DC with output contact
 P0: No power supply
 Connection
 3 φ 3 W
 3 φ 4 W
 BARE (without ETR) (Note 3)

Electrical accessories for breaker unit P.15-17
 Auxiliary switch (AX) Standard (LAX) Low capacity type (LVAX)
 Shunt trip device (SHT) 24-30 V DC 48-60 V DC 100-125 V AC/DC 200-250 V AC/DC
 Under voltage trip device (UVT) 48 V DC 100-120 V AC/DC 200-240 V AC/DC
 Time delay
 Instantaneous (INST)
 0.5 s
 1.5 s
 3.0 s
 2 (1a1b)
 4 (2a2b)
 6 (3a3b)
 8 (4a4b)
 10 (5a5b)

Mechanical accessories P.17-21
 Cylinder lock (CYL)
 R0220 (Standard)
 R501
 R502
 R503
 R504
 Counter (CNT)
 Terminal cover (TTC)
 Door frame (DF)
 Dust cover (DUC)
 Push button cover (BC-L)
 Interphase barrier (BA)
 *Drawout type accessories
 Lifting hook (HP)
 Mis-insertion preventor (MIP)
 Test jumper (TJ)
 Safety shutter (SST)
 Safety shutter lock (SST-Lock)
 Cell switch (CL)
 (1 or 2 or 3 or 4)
 Shorting b-contact (SBC)
 (1 or 2 or 3 or 4 or 5)

Remark

Order issuer

World Super AE V series (C-class) Air Circuit Breaker and Switch Disconnecter

Customer name: _____ Order ref no: _____ Quantity: _____

To indicate customer's choices, please check the applicable square boxes
And input the appropriate information in the rectangles

Type P.6 AED -CV
 Number of poles 3P 4P (Standard: Neutral pole on right side) 4P (Neutral pole on left side)
 Current setting I_r A
 Control voltage 110-125 V DC 220-250 V DC 110-125 V AC 220-250 V AC
 Equipment type FIXED DRAW OUT
 Ambient temperature 40°C (Standard) Others

Main circuit terminal P.14
 Horizontal/Horizontal (HT) Horizontal/Vertical (HV) Horizontal/Front (HF)
 Vertical/Vertical (VT) Vertical/Horizontal (VH) Vertical/Front (VF)
 Front/Front (FT) Front/Horizontal (FH) Front/Vertical (FV)

Electronic trip relay (ETR)
 With ETR Type VS1 Neutral CT (NCT)
 • Optional function
 NA: Without optional setting
 DP: Display
 GF: Ground fault protection
 DPGF: Display & Ground fault protection
 • Power supply
 P3: 100-240 V AC/100-125 V DC with output contact
 P4: 24-60 V DC with output contact
 P0: No power supply
 Connection
 3 φ 3 W
 3 φ 4 W
 BARE (without ETR) (Note 3)

Electrical accessories for breaker unit P.15-17
 Auxiliary switch (AX) Standard (LAX) Low capacity type (LVAX)
 Shunt trip device (SHT) 24-30 V DC 48-60 V DC 100-125 V AC/DC 200-250 V AC/DC
 Under voltage trip device (UVT) 48 V DC 100-120 V AC/DC 200-240 V AC/DC
 Time delay
 Instantaneous (INST)
 0.5 s
 1.5 s
 3.0 s
 2 (1a1b)
 4 (2a2b)
 6 (3a3b)
 8 (4a4b)
 10 (5a5b)

Mechanical accessories P.17-21
 Cylinder lock (CYL)
 R0220 (Standard)
 R501
 R502
 R503
 R504
 Counter (CNT)
 Terminal cover (TTC)
 Door frame (DF)
 Dust cover (DUC)
 Push button cover (BC-L)
 Interphase barrier (BA)
 *Drawout type accessories
 Lifting hook (HP)
 Mis-insertion preventor (MIP)
 Test jumper (TJ)
 Safety shutter (SST)
 Safety shutter lock (SST-Lock)
 Cell switch (CL)
 (1 or 2 or 3 or 4)
 Shorting b-contact (SBC)
 (1 or 2 or 3 or 4 or 5)

Remark

Order issuer

Service network

Country/Region	Corporation Name	Address	Telephone
Australia	Mitsubishi Electric Australia Pty. Ltd.	348 Victoria Road, Rydalmere, N.S.W. 2116, Australia	+61-2-9684-7777
Algeria	Mec Casa	Rue I N 125 Hay-Es-Salem, 02000, W-Chief, Algeria	+213-27798069
Bangladesh	PROGRESSIVE TRADING CORPORATION	HAQUE TOWER, 2ND FLOOR, 610/11, JUBILEE ROAD, CHITTAGONG, BANGLADESH	+880-31-624307
	ELECTRO MECH AUTOMATION & ENGINEERING LTD.	SHATABDI CENTER, 12TH FLOOR, SUITES:12-B, 292, INNER CIRCULAR ROAD, FAKIRA POOL, MOTIJHEEL, DHAKA-1000, BANGLADESH	+88-02-7192826
Belarus	Tehnikon	Otkyabrskaya 19, Off. 705, BY-220030 Minsk, Belarus	+375 (0) 17210 46 26
Belgium	Koning & Hartman B.V.	Woluweaan 31, BE-1800 Vilvoorde, Belgium	+32 (0) 2 / 2570240
Brasil	Mitsubishi Electric do Brasil Comércio e Serviços Ltda.	Avenida Adelino Cardana, 293 21 andar Bethaville, Barueri SP, Brasil	+55-11-4689-3000
Cambodia	DHINIMEX CO.,LTD.	#245, St. Tep Phan, Phnom Penh, Cambodia	+855-23-997-725
Central America	Automation International LLC	7050 W. Palmetto Park Road Suite #15 PMB #555, Boca Raton, FL 33433	+1-561-237-5228
Chile	Rhona S.A. (Main office)	Vte. Agua Santa 4211 Casilla 30-D (P.O. Box) Vina del Mar, Chile	+56-32-2-320-600
	Mitsubishi Electric Automation (China) Ltd.	Mitsubishi Electric Automation Building, No.1386 Hongqiao Road, Shanghai, China 200336	+86-21-2322-3030
	Mitsubishi Electric Automation (China) Ltd. Beijing Branch	5/F, ONE INDIGO, 20 Juxianqiao Road Chaoyang District, Beijing, China 100016	+86-10-6518-8830
	Mitsubishi Electric Automation (China) Ltd. ShenZhen Branch	Level 8, Galaxy World Tower B, 1 Yabao Road, Longgang District, Shenzhen, China 518129	+86-755-2399-8272
	Mitsubishi Electric Automation (China) Ltd. GuangZhou Branch	Rm.1006, A1 Times E-Park, No.276-282, Hanxi Road East, Zhongcun Street, Panyu Distric, Guangzhou, China 510030	+86-20-8923-6730
	Mitsubishi Electric Automation (China) Ltd. ChengDu Branch	1501-1503, 15F, Guang-hua Centre Building-C, No.98 North Guang Hua 3th Rd Chengdu, China 610000	+86-28-8446-8030
	Mitsubishi Electric Automation (Hong Kong) Ltd.	20/F, Cityplaza One, 1111 King's Road, Taikoo shing, Hong Kong	+852-2510-0555
Colombia	Proelectrico Representaciones S.A.	Carrera 42 N° 75-367 Bodega 109, Itagüí, Medellín, Antioquia, Colombia	+57-4-444284
	Maviconrol Ltda	Calle 78 No. 70 A-03 BRR BONANZA, Bogotá-Colombia	+57-1-4303803
Czech Republic	AUTOCONT CONTROL SYSTEMS S.R.O	Technologická 374/6, CZ-708 00 Ostrava-Pustkovec	+420 595 691 150
Denmark	BEJER ELECTRONICS A/S	LYKKEGARDSVEJ 17, DK-4000 ROSKILDE, Denmark	+45 (0) 46/75 76 66
Egypt	Cairo Electrical Group	9, Rostoum St. Garden City P.O. Box 165-11516 Maglis El-Shaab, Cairo-Egypt	+20-2-27961337
France	Mitsubishi Electric Europe B.V. French Branch	FR-92741 Nanterre Cedex	+33 (0) 1 55 68 57 01
Germany	Mitsubishi Electric Europe B.V.	Mitsubishi-Elctric-Platz 1, 40882 Ratingen, Germany	+49 (0) 2102 4860
Greece	KALAMARAKIS-SAPOUNAS S.A.	IONIAS & NEROMILOU STR., CHAMOMILOU ACHARNES, ATHENS, 13678 Greece	+30-2102 406000
	UTEKO	5, MAVROGENOUS STR., 18542 PIRAEUS, Greece	+30-211-1206-900
Hungary	Meltrade Ltd.	Fertő utca 14, HU-1107 Budapest, Hungary	+36 (0) 1-431-9726
India	Mitsubishi Electric India Private Limited	3rd Floor, Tower A, Global Gateway, MG Road, Gurugram -122002, Haryana, India	+91(124) 673-9300
	Mitsubishi Electric India Private Limited Pune Sales Office	ICC-Devi Gaurav Technology Park, Unit no. 402, Fourth Floor, Survey no. 191-192 (P), Opp. Vallabh Nagar Bus Depot, Pune-411018, Maharashtra, India	+91-20-68192100
Indonesia	P.T. Sahabat Indonesia	P.O.Box 5045 Kawasan Industri Pergudangan, Jakarta, Indonesia	+62-(0) 21-6610651-9
Ireland	Mitsubishi Electric Europe B.V.	Westgate Business Park, Ballymount, IRL-Dublin 24, Ireland	+353 (0) 1-4198800
Israel	Gino Industries Ltd.	26, Ophir Street IL-32235 Haifa, Israel	+972 (0) 4-867-0656
Italy	Mitsubishi Electric Europe B.V.	Viale Colleoni 7, I-20041 Agrate Brianza (MI), Italy	+39 039-60531
Kazakhstan	Kazpromavtomatika	Ul. Zhambylia 28, KAZ-100017 Karaganda	+7-7212-501000
Korea	Mitsubishi Electric Automation Korea Co., Ltd.	9F Gangseo Hangang xi-tower, 401 Yangcheon-ro, Gangseo-gu, Seoul 07528 Korea	+82-2-3660-9572
Laos	AROUNKIT CORPORATION IMPORT-EXPORT SOLE CO.LTD.	SAPHANMO VILLAGE, SAYSETHA DISTRICT, VIENTIANE CAPITAL, LAOS	+856-20-415899
Lebanon	Comptoir d'Electricite Generale-Liban	Cebaco Center-Block A Autostrade Dora, P.O. Box 11-2597 Beirut-Lebanon	+961-1-240445
Lithuania	Rifas UAB	Tinklu 29A, LT-5300 Panevezys, Lithuania	+370 (0) 45-582-728
Malaysia	Mitric Sdn Bhd	No. 5 Jalan Pemberia U1/49, Temasya Industrial Park, Glenmarie 40150 Shah Alam, Selangor, Malaysia	+603-5569-3748
Malta	ALFATRADE LTD.	99 PAOLA HILL, PAOLA PLA 1702, Malta	+356 (0) 21-697-816
Marocco	SCHIELE MAROC	KM 7, 2 NOUVELLE ROUTE DE RABAT AIN SEBAA, 20600 Casablanca, Marocco	+212 661 45 15 96
Myanmar	Peace Myanmar Electric Co.,Ltd.	NO137/139 Botahtaung Pagoda Road, Botahtaung Town Ship 11161, Yangon, Myanmar	+95-(0) 1-202589
Nepal	Watt & Volt House	KHA 2-65, Volt House Dillibazar Post Box:2108, Kathmandu, Nepal	+977-1-4411330
Netherlands	Imtech Marine & Offshore B.V.	Suijsjesdijk 155, NL-3087 AG Rotterdam n, Netherlands	+31 (0) 10-487-19 11
North America	Mitsubishi Electric Automation, Inc.	500 Corporate Woods Parkway, Vernon Hills, IL 60061 USA	+847-478-2100
Norway	Scanelec AS	Leirvikasen 43B, NO-5179 Godvik, Norway	+47 (0) 55-506000
Mexico	Mitsubishi Electric Automation, Inc. Mexico Branch	Bld. Miguel de Cervantes Saavedra 301, Torre Norte Piso 5, Col. Ampliación Granada, Miguel Hidalgo, Ciudad de México, CP 11520, México	+52-55-3067-7511
Middle East Arab Countries & Cyprus	Comptoir d'Electricite Generale-International-S.A.L.	Cebaco Center-Block A Autostrade Dora P.O. Box 11-1314 Beirut-Lebanon	+961-1-240430
Pakistan	Prince Electric Co.	2-P GULBERG II, LAHORE, 54600, PAKISTAN	+92-42-575232, 5753373
Peru	Rhona S.A. (Branch office)	Avenida Argentina 2201, Cercado de Lima	+51-1-464-4459
Philippines	Edison Electric Integrated, Inc.	24th Fl. Galleria Corporate Center, Edsa Cr. Ortigas Ave., Quezon City Metro Manila, Philippines	+63-(0) 2-634-8691
Poland	Mitsubishi Electric Europe B.V. Polish Branch	Krakowska 48, 32-083 Balice, Poland	+48 12 347 65 00
Republic of Moldova	Intehsis SRL	bld. Traian 23/1, MD-2060 Kishinev, Moldova	+373 (0) 22-66-4242
Romania	Sirius Trading & Services SRL	RO-060841 Bucuresti, Sector 6 Aleea Lacul Morii Nr. 3	+40-(0) 21-430-40-06
	Mitsubishi Electric (Russia) LLC	2 bld.1, Letnikovskaya street, Moscow, 115114, Russia	+7 495 721-2070
Russia	Center of Electrical Goods	Al-Shuwayer St. Side way of Salahuddin Al-Ayoubi St. P.O. Box 15955 Riyadh 11454-Saudi Arabia	+966-1-4770149
Saudi Arabia	Mitsubishi Electric Asia Pte. Ltd.	307 Alexandra Road, Mitsubishi Electric Building, Singapore 159943	+65-6473-2308
Singapore	PROCONT, Presov	Kupelna 1/, SK-08001 Presov, Slovakia	+421 (0) 51-7580 611
Slovakia	SIMAP	Jana Derku 1671, SK-91101 Trenčin, Slovakia	+421 (0) 32 743 04 72
Slovenia	Inea RBT d.o.o.	Stegne 11, SI-1000 Ljubljana, Slovenia	+386 (0) 1-513-8116
South Africa	CBI-electric: low voltage	Private Bag 2016, ZA-1600 Isando Gauteng, South Africa	+27-(0) 11-9282000
Spain	Mitsubishi Electric Europe B.V. Spanish Branch	Carretera de Rubi 76-80, E-08190 Sant Cugat del Vallés (Barcelona), Spain	+34 (0) 93-565-3131
	Mitsubishi Electric Europe B.V. (Scandinavia)	Hedvig Möllers gata 6, 223 55 Lund, Sweden	+46 (0) 8-625-10-00
Sweden	Euro Energy Components AB	Järnvägsgatan 36, S-434 24 Kungsbacka, Sweden	+46 (0) 300-690040
Switzerland	TriElec AG	Muehentalstrasse 136, CH-8201 Schaffhausen, Switzerland	+41-(0) 52-6258425
Taiwan	Setsuyo Enterprise Co., Ltd.	5th Fl., No.105, Wu Kung 3rd, Wu-Ku Hsiang, Taipei, Taiwan, R.O.C.	+886-(0) 2-2298-8889
Thailand	United Trading & Import Co., Ltd.	77/12 Bamrungruang Road, Klong Mahanak Pomprab Bangkok Thailand	+66-223-4220-3
Tunisia	MOTRA Electric	3, Résidence Imen, Avenue des Martyrs Mourouj III, 2074-EI Mourouj III Ben Arous, Tunisia	+216-71 474 599
Turkey	Mitsubishi Electric Turkey A.Ş.	Şerifali Mahallesi Kale Sokak No: 41, 34775 Ümraniye, İstanbul, Turkey	+90-216-969-2666
United Kingdom	Mitsubishi Electric Europe B.V.	Travellers Lane, UK-Hatfield, Herts. AL10 8XB, United Kingdom	+44 (0) 1707-276100
Uruguay	Fierro Vignoli S.A.	Avda. Uruguay 1274 Montevideo Uruguay	+598-2-902-0808
Vietnam	Mitsubishi Electric Vietnam Co.,Ltd. Head Office	12 floor, Viettel Tower B, 285 Cach Mang Thang 8 street, Ward 12, District 10, Ho Chi Minh City, Vietnam	+84-28-3910-5945
	Mitsubishi Electric Vietnam Co.,Ltd. Hanoi Branch	24th Floor, Handico Tower, Pham Hung Road, khu do thi moi Me Tri Ha, Nam Tu Liem District, Hanoi City, Vietnam	+84-24-3937-8075

YOUR SOLUTION PARTNER

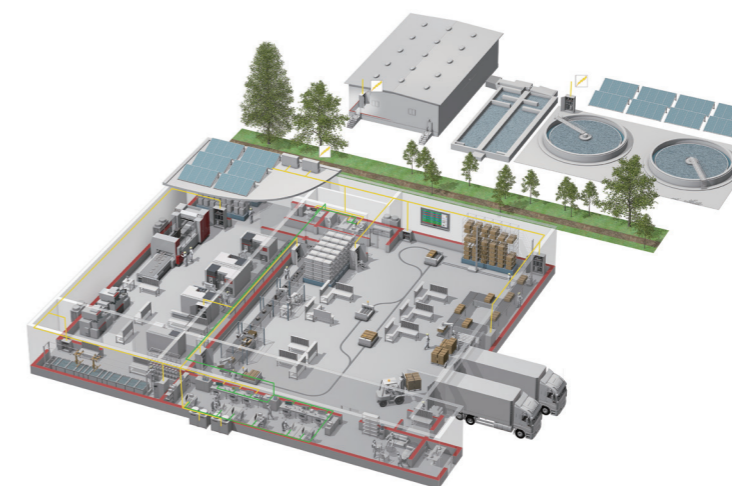

Mitsubishi Electric offers a wide range of automation equipment from PLCs and HMIs to CNC and EDM machines.

A NAME TO TRUST

Since its beginnings in 1870, some 45 companies use the Mitsubishi name, covering a spectrum of finance, commerce and industry.

The Mitsubishi brand name is recognized around the world as a symbol of premium quality.

Mitsubishi Electric Corporation, established in 1921, is active in space development, transportation, semi-conductors, energy systems, communications and information processing, audio visual equipment and home electronics, building and energy management and automation systems, and has 183 factories, laboratories and offices worldwide in over 140 countries.

This is why you can rely on Mitsubishi Electric automation solution - because we know first hand about the need for reliable, efficient, easy-to-use automation and control in our own factories.

As one of the world's leading companies with a global turnover of over 4 trillion Yen (over \$40 billion), employing over 146,000 people, Mitsubishi Electric has the resource and the commitment to deliver the ultimate in service and support as well as the best products.



Low voltage: MCCB, MCB, ACB



Medium voltage: VCB, VCC



Power monitoring, energy management



Compact and Modular Controllers



Inverters, Servos and Motors



Visualization: HMIs



Numerical Control (NC)



Industrial / Collaborative Robots

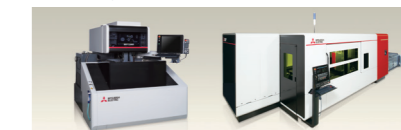

Processing machines: EDM, Lasers, IDS



Transformers, Air conditioning, Photovoltaic systems

* Not all products are available in all countries.