



Mitsubishi Electric AC Servo System

MITSUBISHI ELECTRIC SERVO SYSTEM
MELSERVO-J5

MR-J5 User's Manual (Function)



-MR-J5- _G_
-MR-J5W _ _G_
-MR-J5D _ _G_
-MR-J5- _G_ - _N1
-MR-J5W _ _G_ - _N1
-MR-J5D _ _G_ - _N1
-MR-J5- _B_
-MR-J5W _ _B_
-MR-J5- _A_

SAFETY INSTRUCTIONS

Please read the instructions carefully before using the equipment.

To use the equipment correctly, do not attempt to install, operate, maintain, or inspect the equipment until you have read through this manual, installation guide, and appended documents carefully. Do not use the equipment until you have a full knowledge of the equipment, safety information and instructions.





In this manual, the safety instruction levels are classified into "WARNING" and "CAUTION".

 WARNING	Indicates that incorrect handling may cause hazardous conditions, resulting in death or severe injury.
 CAUTION	Indicates that incorrect handling may cause hazardous conditions, resulting in medium or slight injury.

Note that the CAUTION level may lead to a serious consequence depending on conditions.

Please follow the instructions of both levels because they are important to personnel safety.

Forbidden actions and required actions are indicated by the following diagrammatic symbols.

	Indicates a forbidden action. For example, "No Fire" is indicated by  .
	Indicates a required action. For example, grounding is indicated by  .

In this manual, precautions for hazards that can lead to property damage, instructions for other functions, and other information are shown separately in the "Point" area.

After reading this manual, keep it accessible to the operator.

[Installation/wiring]

WARNING

- To prevent an electric shock, turn off the power and wait for 15 minutes or more (20 minutes or more for a converter unit/drive unit) before starting wiring and/or inspection.
 - To prevent an electric shock, ground the servo amplifier.
 - To prevent an electric shock, any person who is involved in wiring should be fully competent to do the work.
 - To prevent an electric shock, mount the servo amplifier before wiring.
 - To prevent an electric shock, connect the protective earth (PE) terminal of the servo amplifier to the protective earth (PE) of the cabinet, then connect the grounding lead wire to the ground.
 - To prevent an electric shock, do not touch the conductive parts.
-

[Setting/adjustment]

WARNING

- To prevent an electric shock, do not operate the switches with wet hands.
-

[Operation]

WARNING

- To prevent an electric shock, do not operate the switches with wet hands.
-

[Maintenance]

WARNING

- To prevent an electric shock, any person who is involved in inspection should be fully competent to do the work.
 - To prevent an electric shock, do not operate the switches with wet hands.
-

ABOUT THE MANUAL

Point

e-Manuals are Mitsubishi Electric FA electronic book manuals that can be browsed with a dedicated tool.

e-Manuals enable the following:

- Searching for desired information in multiple manuals at the same time (manual cross searching)
- Jumping from a link in a manual to another manual for reference
- Browsing for hardware specifications by scrolling over the components shown in product illustrations
- Bookmarking frequently referenced information
- Copying sample programs to engineering tools

If using the servo for the first time, prepare and use the following related manuals to ensure that the servo is used safely. For the related manuals, refer to the User's Manual (Introduction).

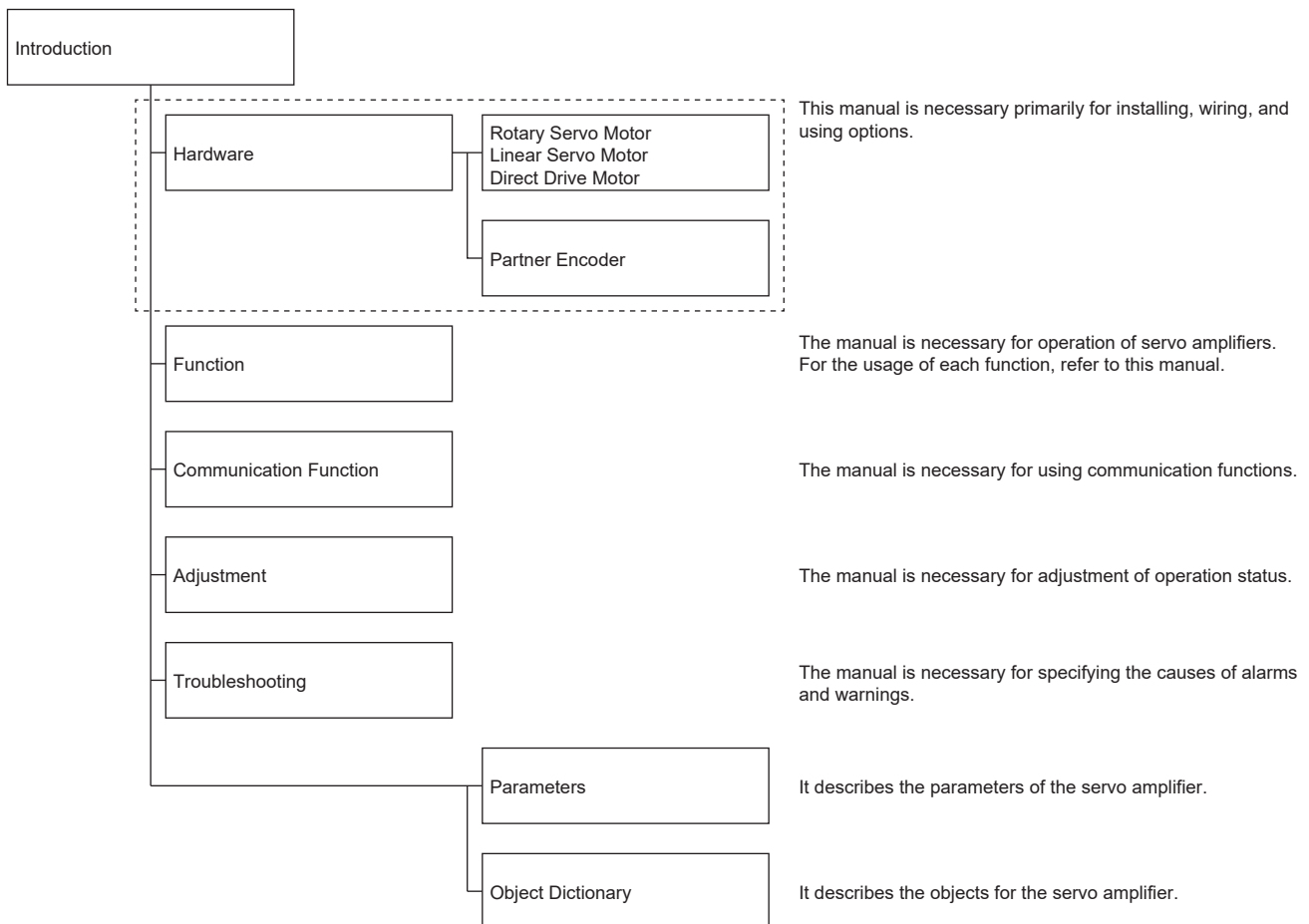

This manual covers the following servo amplifiers.

- MR-J5-G /MR-J5W--G /MR-J5D--G /MR-J5-B /MR-J5W--B /MR-J5-A

In this manual, the servo amplifier names are abbreviated as shown below.

Symbol	Servo amplifier
[G]	MR-J5- <u>G</u> /MR-J5W- <u>-G</u> /MR-J5D- <u>-G</u>
[B]	MR-J5- <u>B</u> /MR-J5W- <u>-B</u>
[A]	MR-J5- <u>A</u>

When reading this manual to use a drive unit, substitute "drive unit" for "servo amplifier".

Global standards and regulations

Compliance with the indicated global standards and regulations is current as of the release date of this manual. Some standards and regulations may have been modified or withdrawn.

OBJECT UNITS

This section explains the pos units, vel units, and acc units used in this manual.

The degree unit is available on servo amplifiers with firmware version B6 or later.

The mm unit and inch unit are available on servo amplifiers with firmware version B8 or later in the positioning mode (point table method).

pos units

The standard unit can be changed using [Pr. PT01.2 Unit for position data] as shown in the following table.

Setting value	Standard unit
0	mm
1	inch
2	degree
3	pulse

vel units

The speed unit can be changed using [Pr. PT01.1 Speed/acceleration/deceleration unit selection] as shown in the following table. The command unit can be changed to "0.001 mm", "0.0001 inch", "0.001 degree", or "pulse" using [Pr. PT01.2].

Setting value	Unit
0	0.01 r/min, 0.01 mm/s *1
1	Command unit/s

*1 "0.01 mm/s" is used in the linear servo motor control mode.

acc units

The acceleration unit can be changed using [Pr. PT01.1] as shown in the following table. The command unit can be changed to "0.001 mm", "0.0001 inch", "0.001 degree", or "pulse" using [Pr. PT01.2].

Setting value	Unit
0	ms
1	Command unit/s ²

U.S. CUSTOMARY UNITS

U.S. customary units are not shown in this manual. Convert the values if necessary according to the following table.

Quantity	SI (metric) unit	U.S. customary unit
Mass	1 [kg]	2.2046 [lb]
Length	1 [mm]	0.03937 [inch]
Torque	1 [N•m]	141.6 [oz•inch]
Moment of inertia	1 [(× 10 ⁻⁴ kg•m ²)]	5.4675 [oz•inch ²]
Load (thrust load/axial load)	1 [N]	0.2248 [lbf]
Temperature	N [°C] × 9/5 + 32	N [°F]

CONTENTS

SAFETY INSTRUCTIONS	1
ABOUT THE MANUAL	3
OBJECT UNITS.	4
U.S. CUSTOMARY UNITS	4
CHAPTER 1 FUNCTION	12
1.1 Function explanation	12
CHAPTER 2 CONTROL MODE	22
2.1 Control mode [G].	22
Control switching	23
Cyclic synchronous position mode (csp)	24
Cyclic synchronous velocity mode (csv)	26
Cyclic synchronous torque mode (cst)	28
Profile position mode (pp)	30
Profile velocity mode (pv)	34
Profile torque mode (tq).	38
Point table mode (pt)	41
JOG operation mode (jg)	45
Continuous operation to torque control mode (ct)	49
Homing mode (hm)	54
2.2 Control mode [B].	90
Continuous operation to torque control mode (ct)	91
2.3 Control mode [A].	92
Control switching	92
Position control mode (P)	92
Speed control mode (S).	96
Torque control mode (T)	98
Position/speed control switching mode (P/S)	101
Speed/torque control switching mode (S/T)	103
Torque/position control switch mode (T/P)	105
CHAPTER 3 BASIC FUNCTION	106
3.1 Outline of servo parameter and object dictionary	106
Servo parameter	106
Object dictionary [G]	108
3.2 Rotation/travel direction selection [G]	109
Setting methods of functions	110
3.3 Rotation/travel direction selection [B].	113
Setting methods of functions	114
3.4 Rotation/travel direction selection [A].	115
Setting methods of functions	116
3.5 Stroke limit function [G]	117
Explanation of the stroke limit signal names	117
Setting methods of functions	118
Stop method at stroke limit detection	121
Servo parameter list	122
Limit switch release position assessment function	124

3.6	Stroke limit function [B]	125
	Servo parameter list	125
3.7	Stroke limit function [A]	126
	Setting methods of functions	126
	Stop method at stroke limit detection	127
	Servo parameter list	127
3.8	Command unit select function [G]	128
	Position command unit selection function	128
	Speed command unit selection function	131
3.9	Command unit select function [A]	132
	Torque command unit selection function	132
3.10	Electronic gear function [G]	133
	Setting method	133
	Setting example	134
3.11	Electronic gear function [B]	140
	Setting method	140
3.12	Electronic gear function [A]	141
	Setting method	141
	Setting example	142
	Electronic gear selection function	144
3.13	In-position range setting	145
	Setting method [G]	146
	Setting method [B]	146
	Setting method [A]	146
3.14	Assigning I/O devices	147
	Setting method [G]	148
	Setting method [B]	151
	Setting method [A]	152
3.15	Regenerative option selection	153
	Regenerative option	153
3.16	Alarm function	154
	Operation status at alarm occurrence [G] [B]	154
	Operation status at alarm occurrence [A]	154
	Operation status at warning occurrence [G] [B]	155
	Operation status at warning occurrence [A]	155
	Returning from an alarm [G] [B]	156
	Returning from an alarm [A]	156
	Returning from a warning	156
	Alarm history [G]	156
	Alarm History [B]	159
	Alarm history [A]	159
	Stop method at occurrence of alarms/warnings	160
	Timing chart at alarm occurrence (MR-J5-_G_/MR-J5W_-_G_/MR-J5-_B_/MR-J5W_-_B_/MR-J5-_A_)	161
	Timing chart at alarm occurrence (MR-J5D_-_G_)	164
3.17	Forced stop deceleration function	173
	Setting method [G] [B]	173
	Setting method [A]	174
	Timing chart [G] [B]	174
	Timing chart [A]	175
3.18	Electromagnetic brake interlock function	176
	Base circuit shut-off delay time function	176

	Setting method [G] [B]	176
	Setting method [A]	177
	Timing chart	178
3.19	Vertical axis freefall prevention function	189
	Setting method [G] [B]	189
	Setting method [A]	189
	Timing chart [G] [B]	190
	Timing chart [A]	190
3.20	Acceleration/deceleration function [G] [A]	191
	Acceleration/deceleration time constant	191
	S-pattern acceleration/deceleration time constant [G]	193
	S-pattern acceleration/deceleration time constant [A]	194
	Acceleration/deceleration [G]	195
3.21	Quick stop [G]	197
	Setting method	198
	Timing chart	200
3.22	Halt [G]	202
	Objects for setting	202
	Timing chart	203
3.23	Command pulse train monitoring function [A]	204
	Setting a command frequency error threshold	204
	Setting PEN (Command input permission signal)	204
CHAPTER 4 APPLICABLE FUNCTIONS		205
4.1	Tough drive function	207
	Vibration tough drive	207
	Instantaneous power failure tough drive	207
4.2	Compliance with SEMI-F47 standard	212
	Setting method	212
	Behavior	212
	Requirements of the SEMI-F47 standard	213
	Calculation method of tolerance against instantaneous power failure	213
4.3	Scale measurement function [G] [B]	214
	Outline	214
	Function block diagram [G]	216
	Function block diagram [B]	216
	System configuration	217
	Scale measurement encoders	219
	Setting method	222
	Procedure for replacing the scale measurement encoder (Mitsubishi Electric servo motor equipped with a battery-less absolute position encoder)	224
	Procedure of replacing a servo amplifier without losing the absolute position data [B]	225
	Related objects [G]	226
4.4	Touch probe [G]	227
	Outline	227
	Setting method	228
4.5	Machine diagnosis	242
	Friction vibration estimation function	243
	Friction failure prediction function	249
	Vibration failure prediction function	258

	Total travel distance failure prediction function	264
	Gear failure diagnosis function	271
	Belt diagnosis function.....	285
4.6	Drive recorder	304
	Specification outline.....	306
	How to use the function [G].....	306
	How to use the function [B]	309
	How to use the function [A]	311
	Servo parameter/object dictionary.....	313
	Standard acquisition waveform list [G] [B].....	333
	Standard acquisition waveform list [A].....	336
	Waveform recording inapplicable alarm list.....	338
	List of auxiliary recording data.....	339
4.7	Software reset	340
	Software reset in MR Configurator2	340
	Software reset via network communication [G].....	340
	Software reset with an object [G].....	340
4.8	Software position limit [G]	341
	Setting method	341
4.9	Torque limit [G]	344
	Setting method	344
	Checking "Limiting torque" status	345
4.10	Torque limit [B]	346
	Setting method	346
	Checking "Limiting torque" status	346
4.11	Torque limit [A]	347
	Setting method	348
	Checking "Limiting torque" status	349
4.12	Speed limit [G].....	350
	Setting method	350
	Checking "Limiting speed" status	350
4.13	Speed limit [B].....	351
	Setting method	351
	Checking "Limiting speed" status	351
4.14	Speed limit [A].....	352
	Setting method	352
	Checking "Limiting speed" status	353
4.15	A/B/Z-phase pulse output function	354
	Setting method [G] [B].....	354
	Setting method [A].....	357
	Z-phase pulse output.....	359
4.16	Degree unit [G].....	360
	Summary	360
	Position-related data when the unit is set to "degree".....	360
	Setting method	362
	Sequence	363
4.17	Infinite feed function [G].....	367
	Outline	367
	Setting method	367
	When the servo motor rotates 32768 rev or more.....	367
	When using the infinite feed function with a controller	367

4.18	Servo amplifier life diagnosis function	368
	Cumulative energization time function	368
	Relay usage count display function	369
4.19	Encoder communication diagnosis function	370
	Usage [G] [B]	370
	Usage [A]	371
	Diagnostic procedure	371
4.20	Disconnection/incorrect wiring detection function	372
	Input open-phase detection function	372
	Output open-phase detection function	375
	Servo motor incorrect wiring detection function [G]	377
4.21	Overload protection (electronic thermal) function	379
4.22	Command offset [G]	380
4.23	Excessive error alarm detection function	382
	Outline	382
	Setting method [G] [B]	382
	Setting method [A]	382
	Excessive error alarm trigger level adjustment method [G] [B]	383
	Excessive error alarm trigger level adjustment method [A]	384
4.24	Override function [G]	385
 CHAPTER 5 MONITORING		 388
5.1	Explanation of monitor signals	388
	Name and description of the monitor signals	388
	Signal block diagram	406
5.2	Checking with MR Configurator2	409
	"Display All" function	409
	Graph function	409
	I/O monitor display	410
	System configuration display	411
5.3	Analog monitor [G]	412
	Setting method	412
	Setting details	413
5.4	Analog monitor [B]	417
	Setting method	417
	Setting details	418
5.5	Analog monitor [A]	422
	Setting method	422
	Setting details	423
5.6	Optional data monitor function [B]	427
	Registered monitor	427
	Transient command	429
 CHAPTER 6 FUNCTIONAL SAFETY		 432
6.1	Functions and configuration	432
	Outline	432
	Outline of safety sub-functions	432
	Risk assessments	434
6.2	Signal	435
	Explanation of signals	435

	Power-on sequence	437
6.3	Setting method	438
	Setting functional safety parameters	438
	Functional safety parameters that must be set	439
	Test operation	440
6.4	Safety sub-function	441
	Achievable safety level	441
	I/O function	444
	STO function	483
	SS1 function	486
	SS2/SOS function	494
	SLS function	500
	SSM function	504
	SBC function	505
	SDI function	506
	SLI function	509
	SLT function	511
	Status monitor (SM) function	515
	Multiple operation commands for safety sub-functions	515
	Simultaneous operation of STO and SS1 functions	516
	At alarm occurrence	517
6.5	Troubleshooting	519
	Parameter combinations that trigger [AL. 537.2 Parameter combination error A (safety sub-function)]	519

CHAPTER 7 NETWORK FUNCTION (ETHERNET) [G] [A] 521

7.1	IP address setting	521
	Setting an IP address [G]	521
	Setting an IP address [A]	521
7.2	Managing accounts	522
	Setting an account	522
	Precautions	523
7.3	FTP server function	524
	Restrictions	524
	Precautions	524
	Directory structure	525
	Steps of accessing the FTP server	525
7.4	Firmware update	525

CHAPTER 8 NETWORK FUNCTION (SSCNET III/H) [B] 526

8.1	Functions and configuration	526
	Communication specifications	526
	System configuration	526
8.2	Application function	527
	Master-slave operation function	527

CHAPTER 9 COMMUNICATION FUNCTION (MITSUBISHI ELECTRIC AC SERVO PROTOCOL) [A] 531

9.1	Structure	531
	System architecture	531
	Precautions for using the RS-422/USB communication function	533

9.2	Communication specifications	534
	Outline of communication specifications	534
	Setting servo parameters	534
9.3	Protocol	535
	Transmission data configuration	535
	Character codes	537
	Error codes	538
	Checksum	538
	Time-out processing	539
	Retry processing	539
	Initialization	539
	Communication procedure example	540
9.4	Command and data No. list	541
	Reading command	541
	Writing commands	548
9.5	Detailed explanations of commands	550
	Data processing	550
	Status display	552
	Servo parameter	553
	External I/O signal status (DIO diagnosis)	556
	Input device on/off	558
	Disabling/enabling I/O devices (DIO)	559
	Input device on/off (test operation)	559
	Test operation mode	560
	Output signal pin on/off (output signal (DO) forced output)	564
	Alarm history	565
	Current alarm	567
	Version	568
	Absolute position monitoring	568
CHAPTER 10 POSITIONING MODE (POINT TABLE METHOD) (CP) [G]		570
10.1	Operation mode and selection method	571
	Operation mode	571
	Operation mode selection method	571
10.2	Point table mode (pt)	572
	Point table mode (pt)	572
	Point table operation (absolute value command method)	573
	Timing chart of the point table operation	578
	Positioning function to the home position	595
10.3	JOG operation mode (jg)	596
	JOG operation	596
10.4	How to Set Point Table	600
	Setting method using MR Configurator2	600
	Setting method using objects	602
	REVISIONS	604
	WARRANTY	605
	TRADEMARKS	606

1 FUNCTION

1.1 Function explanation

This section lists the functions mentioned in this manual. For details of the functions, refer to each section indicated in the detailed explanation column.



For the functions which are not listed here, refer to "FUNCTION" in the User's Manual (Introduction).

In this section, the models of servo amplifiers are abbreviated as follows.

J5: MR-J5-G /MR-J5-G-RJ/MR-J5W-G

J5D: MR-J5D-G

Control mode

FUNCTION	Detailed functions	Description	Ver. *1				Detailed explanation
			[G]		[B]	[A]	
			J5	J5D			
CiA 402 control mode	Cyclic synchronous position mode (csp)	This function operates the servo motor in the cyclic synchronous position mode.	A0	C0	—	—	☞ Page 24 Cyclic synchronous position mode (csp)
	Cyclic synchronous velocity mode (csv)	This function operates the servo motor in the cyclic synchronous velocity mode.	A0	C0	—	—	☞ Page 26 Cyclic synchronous velocity mode (csv)
	Cyclic synchronous torque mode (cst)	This function operates the servo motor in the cyclic synchronous torque mode.	A0	C0	—	—	☞ Page 28 Cyclic synchronous torque mode (cst)
	Profile position mode (pp)	This function operates the servo motor in the profile position mode.	A5	C0	—	—	☞ Page 30 Profile position mode (pp)
	Profile velocity mode (pv) *2	This function operates the servo motor in the profile velocity mode.	A5	C0	—	—	☞ Page 34 Profile velocity mode (pv)
	Profile torque mode (tq) *2	This function operates the servo motor in the profile torque mode.	A5	C0	—	—	☞ Page 38 Profile torque mode (tq)
	Homing mode (hm)/homing	This function either operates the servo motor in the homing mode or performs homing.	A0	C0	—	—	☞ Page 54 Homing mode (hm)
Point table method	Point table mode (pt)	This function operates the servo motor according to the setting values by selecting the point table with preset 255 points.	B8	C0	—	—	☞ Page 41 Point table mode (pt)
	JOG operation mode (jg)	This control mode enables desired positioning for machine adjustment and home positioning.	B8	C0	—	—	☞ Page 45 JOG operation mode (jg)
Thrust/torque control	Continuous operation to torque control mode (ct)	This function enables smooth switching to torque control from the position control mode or speed control mode without stopping the servo motor. This eliminates rapid change of speed and torque, contributing to reduction in load to the machine and high-quality product molding.	B0	C0	C4	—	☞ Page 49 Continuous operation to torque control mode (ct)
Control mode	Position control mode (P_SSC)	This function operates the servo motor in the position control mode.	—	—	C4	—	☞ Page 90 Control mode [B]
	Speed control mode (S_SSC)	This function operates the servo motor in the speed control mode.	—	—	C4	—	
	Torque control mode (T_SSC)	This function operates the servo motor in the torque control mode.	—	—	C4	—	

FUNCTION	Detailed functions	Description	Ver. *1				Detailed explanation
			[G]		[B]	[A]	
			J5	J5D			
Pulse/analog/DI command	Position control mode (P) (pulse train input)	This function operates the servo motor in the position control mode by the pulse train input.	—	—	—	A0	☞ Page 92 Position control mode (P)
	Speed control mode (S) (Internal speed command/ analog speed command)	This function operates the servo motor in the speed control mode by the internal speed command or analog speed command.	—	—	—	A0	☞ Page 96 Speed control mode (S)
	Torque control mode (T) (Analog torque command)	This function operates the servo motor in the torque control mode by the analog torque command.	—	—	—	A0	☞ Page 98 Torque control mode (T)

*1 "Ver." indicates the supported firmware version of the servo amplifier. The functions are available on servo amplifiers with the indicated firmware version or later.

*2 This control mode is not available for multi-axis servo amplifiers.

Network

Functions	Detailed functions	Description	Ver. *1				Detailed explanation
			[G]		[B]	[A]	
			J5	J5D			
Remote maintenance	Firmware update	This function updates the firmware of the servo amplifier.	A0	C0	—	A0	☞ Page 525 Firmware update
SSCNET system	SSCNET III/H	This function connects the servo amplifier to equipment such as a controller through SSCNET III/H.	—	—	C4	—	☞ Page 526 NETWORK FUNCTION (SSCNET III/H) [B]

*1 "Ver." indicates the supported firmware version of the servo amplifier. The functions are available on servo amplifiers with the indicated firmware version or later.

Position detection

Functions	Detailed functions	Description	Ver. *1				Detailed explanation
			[G]		[B]	[A]	
			J5	J5D			
Control method	Scale measurement function	This function connects the scale measurement encoder in the state of the semi closed loop control to transmit the position information of the scale measurement encoder to the controller.	A5	C0	C4	—	☞ Page 214 Scale measurement function [G] [B]

*1 "Ver." indicates the supported firmware version of the servo amplifier. The functions are available on servo amplifiers with the indicated firmware version or later.

Operation function

Functions	Detailed functions	Description	Ver. *1				Detailed explanation
			[G]		[B]	[A]	
			J5	J5D			
Stop function	Quick Stop	This function stops the servo motor with a specified method and switches to the servo-off status.	A0	C0	—	—	☞ Page 197 Quick stop [G]
	Halt	This function stops the servo motor while the servo-on status is maintained.	A0	C0	—	—	☞ Page 202 Halt [G]
	Stroke limit function	This function uses LSP (Forward rotation stroke end) and LSN (Reverse rotation stroke end) to limit the travel interval of the servo motor.	A0	C0	—	A0	☞ Page 117 Stroke limit function [G] ☞ Page 126 Stroke limit function [A]
		This function limits the travel interval of the servo motor using FLS (Upper stroke limit) and RLS (Lower stroke limit) via a controller.	A0	C0	C4	—	☞ Page 117 Stroke limit function [G] ☞ Page 125 Stroke limit function [B]
	Software position limit	This function uses servo parameters to limit the travel intervals by address. A function equivalent to the stroke limit function can be set with the servo parameter.	A0	C0	—	—	☞ Page 341 Software position limit [G]
Command generation	Command pulse selection	The command pulse train form can be selected from among three different types.	—	—	—	A0	☞ Page 92 Position control mode (P)
	Rotation/travel direction selection	This function sets the rotation direction of the servo motor without changing the command polarity.	A0	C0	C4	A0	☞ Page 109 Rotation/travel direction selection [G] ☞ Page 113 Rotation/travel direction selection [B] ☞ Page 115 Rotation/travel direction selection [A]
	Electronic gear	This function performs positioning control with the value obtained by multiplying the position command from the upper controller by a set electronic gear ratio.	A0	C0	C4	A0	☞ Page 133 Electronic gear function [G] ☞ Page 140 Electronic gear function [B] ☞ Page 141 Electronic gear function [A]
	Acceleration/deceleration function	This function enables smooth acceleration/deceleration.	A0	C0	—	A0	☞ Page 191 Acceleration/deceleration function [G] [A]
	S-pattern acceleration/deceleration time constant	This function performs smooth acceleration and deceleration.	A5	C0	—	A0	☞ Page 193 S-pattern acceleration/deceleration time constant [G] ☞ Page 194 S-pattern acceleration/deceleration time constant [A]
	Torque limit	This function limits the servo motor torque.	A0	C0	C4	A0	☞ Page 344 Torque limit [G] ☞ Page 346 Torque limit [B] ☞ Page 347 Torque limit [A]
	Speed limit	This function limits the servo motor speed in the torque control mode.	A0	C0	C4	A0	☞ Page 350 Speed limit [G] ☞ Page 351 Speed limit [B] ☞ Page 352 Speed limit [A]
	Command offset	This function compensates the position/speed/torque commands by adding a desired amount of offset to the commands.	A5	C0	—	—	☞ Page 380 Command offset [G]

Functions	Detailed functions	Description	Ver. *1				Detailed explanation
			[G]		[B]	[A]	
			J5	J5D			
Synchronization function	Master-slave operation function *2*3*4	This function transmits the torque of the master axis to a slave axis in driver communication, and the slave axis performs the torque control operation using the torque as a command.	D0	D0	—	—	For master-slave operation using CC-Link IE TSN, refer to "Master-slave operation function" in the User's Manual (Communication Function).
			—	—	C4	—	☞ Page 527 Master-slave operation function

*1 "Ver." indicates the supported firmware version of the servo amplifier. The functions are available on servo amplifiers with the indicated firmware version or later.

*2 Not available for CC-Link IE Field Network Basic.

*3 This function is not available for CC-Link IE TSN Class A.

*4 When the safety sub-function by a network is used (when [Pr. PSA01.1 Input mode selection] is set to "1"), this function is not available.

Positioning function

Functions	Detailed functions	Description	Ver. *1				Detailed explanation
			[G]		[B]	[A]	
			J5	J5D			
Override function	Override function	This function can change the servo motor speed via communication. The value can be changed to 0% to 360% of the set speed.	D4	D4	—	—	☞ Page 385 APPLICABLE FUNCTIONS
Absolute position	Infinite feed function	In an absolute position detection system, even if the servo motor rotates 32768 rev or more in the same direction, [AL. 0E3.1 Multi-revolution counter travel distance exceeded warning] will not occur and the home position will not be erased. Therefore, the current position will be restored after the power is cycled. When this function is not used, if the servo motor rotates 32768 rev or more in the same direction, [AL. 0E3.1] will occur and the home position will be erased.	B6	C0	—	—	☞ Page 367 Infinite feed function [G]

*1 "Ver." indicates the supported firmware version of the servo amplifier. The functions are available on servo amplifiers with the indicated firmware version or later.

I/O, monitor

Functions	Detailed functions	Description	Ver. *1				Detailed explanation
			[G]		[B]	[A]	
			J5	J5D			
DI/DO	Input signal selection (device selection)	This function assigns input devices such as LSP (Forward rotation stroke end) to certain pins of the connector.	A0	C0	—	A0	☞ Page 147 Assigning I/O devices
	Output signal selection (device setting)	This function assigns output devices such as MBR (Electromagnetic brake interlock) to certain pins of the connector.	A0	C0	C4	A0	☞ Page 147 Assigning I/O devices
	A/B/Z-phase output	This function outputs the positions of the encoder and linear encoder in the A/B/Z-phase signal.	A0	C0	C4	A0	☞ Page 354 A/B/Z-phase pulse output function
Analog input/output	Analog monitor	This function outputs the servo status in voltage in real time.	A0	C0	C4	A0	☞ Page 388 MONITORING
Monitor	Power monitoring function	This function calculates the running power and the regenerative power from the data in the servo amplifier such as speed and current. The power consumption and other values are displayed on MR Configurator2.	A0	C0	C4	A0	
Touch probe	Current position latch function	This function latches the current position when TPR1 (Touch probe 1), TPR2 (Touch probe 2), or TPR3 (Touch probe 3) is turned on.	A5	C0	—	—	☞ Page 227 Touch probe [G]

*1 "Ver." indicates the supported firmware version of the servo amplifier. The functions are available on servo amplifiers with the indicated firmware version or later.

Option

Functions	Detailed functions	Description	Ver. *1				Detailed explanation
			[G]		[B]	[A]	
			J5	J5D			
Regenerative capacity enhancement	Regenerative option	Use this function if the built-in regenerative resistor of the servo amplifier does not have sufficient regenerative capacity for the generated regenerative power.	A0	—	C4	A0	☞ Page 153 Regenerative option selection













*1 "Ver." indicates the supported firmware version of the servo amplifier. The function is available on servo amplifiers with the indicated firmware version or later.

Protective functions

Functions	Detailed functions	Description	Ver. *1				Detailed explanation
			[G]		[B]	[A]	
			J5	J5D			
Alarm	Alarm function	This function displays an alarm or warning when an error occurs during operation. When an alarm occurs, ALM (Malfunction) turns off and stops the servo motor. When a warning occurs, WNG (Warning) will turn on. The servo motor may stop or continue operation depending on the warning.	A0	C0	C4	A0	☞ Page 154 Alarm function
Power error detection	Disconnection detection function	This function detects a disconnection in the main circuit power supply input and the servo motor power supply output.	A0	C0	C4	A0	For MR-J5D_ - _G_ , the input open-phase detection function and servo motor incorrect wiring detection function cannot be used. ☞ Page 372 Disconnection/incorrect wiring detection function
Coasting distance reduction	Forced stop deceleration function	This function decelerates the servo motor to a stop at EM2 (Forced stop 2) off or when there is an alarm.	A0	C0	C4	A0	☞ Page 173 Forced stop deceleration function
Drop protection	Electromagnetic brake interlock function	This function operates the electromagnetic brake at servo off and error occurrence, and prevents the vertical axis from dropping.	A0	C0	C4	A0	☞ Page 176 Electromagnetic brake interlock function
	Vertical axis freefall prevention function	This function moves the axis up by the mechanical backlash amount of the electromagnetic brake to prevent damage to machines.	A0	C0	C4	A0	☞ Page 189 Vertical axis freefall prevention function

*1 "Ver." indicates the supported firmware version of the servo amplifier. The functions are available on servo amplifiers with the indicated firmware version or later.

Functional safety

Functions	Detailed functions	Description	Ver. *1				Detailed explanation
			[G]		[B]	[A]	
			J5	J5D			
Safety sub-function	STO (Safe torque off) (When functional safety parameters are not used)	This servo amplifier supports the STO function for functional safety as per IEC/EN 61800-5-2. This allows a safety system to be easily configured for the equipment.	A0	C0	C4	A0	Refer to "USING STO FUNCTION" in the following manuals.  IMR-J5 User's Manual (Hardware)  IMR-J5D User's Manual (Hardware)
	STO (Safe torque off) (When functional safety parameters are used)	This function electrically shuts off the servo motor driving energy with input signals from external devices (shut-off by the secondary-side output). This is equivalent to the stop category 0 of IEC/EN 60204-1.	B2	C0	—	—	 Page 483 STO function
	SS1 (Safe stop 1)	This function starts deceleration with input signals from external devices. After the specified time to confirm the motor stop, the STO function is executed (SS1). This is equivalent to the stop category 1 of IEC/EN 60204-1.	B2	C0	—	—	 Page 486 SS1 function
	SS2 (Safe stop 2)	This function starts deceleration with input signals from external devices. After the specified time to confirm the motor stop, the SOS function is executed (SS2). This is equivalent to the stop category 2 of IEC/EN 60204-1.	B2	C0	—	—	 Page 494 SS2/SOS function
	SOS (Safe operating stop)	This function monitors whether the servo motor stops within the prescribed range. Energy is supplied to the servo motor.	B2	C0	—	—	
	SLS (Safely-limited speed)	This function monitors whether the speed is within the prescribed speed limit. If the speed exceeds the specified speed limit, the STO will shut off energy.	B2	C0	—	—	 Page 500 SLS function
	SSM (Safe speed monitor)	This function outputs signals when the servo motor speed is below the prescribed speed.	B2	C0	—	—	 Page 504 SSM function
	SBC (Safe brake control)	This function outputs signals for controlling the external brake.	B2	C0	—	—	 Page 505 SBC function
	SDI (Safe direction)	This function monitors whether the servo motor travels in the specified direction. If the servo motor travels in a direction different from the specified direction, the STO will shut off energy.	B2	C0	—	—	 Page 506 SDI function
	SLI (Safely-limited increment)	This function monitors whether the travel distance of the servo motor is within the specified range. If the travel distance of the servo motor exceeds the specified range, the STO will shut off energy.	B2	C0	—	—	 Page 509 SLI function
	SLT (Safely-limited torque)	This function monitors whether the torque is below the specified torque. If the torque exceeds the specified torque, the STO will shut off energy.	B2	C0	—	—	 Page 511 SLT function
	Status monitor (SM: Status monitor)	This function outputs the statuses of the safety sub-functions as signals. This is a function designed specifically for the safety sub-functions and differs from the function defined in IEC/EN 61800-5-2.	B2	C0	—	—	 Page 515 Status monitor (SM) function

*1 "Ver." indicates the supported firmware version of the servo amplifier. The functions are available on servo amplifiers with the indicated firmware version or later.

Instantaneous power failure measures

Functions	Detailed functions	Description	Ver. *1				Detailed explanation
			[G]		[B]	[A]	
			J5	J5D			
Tough drive	SEMI-F47 function	This function uses the electrical energy charged in the capacitor to avoid triggering [AL.010 Undervoltage] in case that an instantaneous power failure occurs during operation. Use a 3-phase power supply for the input power supply of the servo amplifier. Using a 1-phase 200 V AC for the input power supply will not comply with SEMI-F47 standard.	A0	—	C4	A0	☞ Page 212 Compliance with SEMI-F47 standard
	Tough drive function	This function makes the equipment continue operating even under conditions where an alarm would normally occur. There are two types of tough drive function: the vibration tough drive and the instantaneous power failure tough drive.	A0	C0	C4	A0	For MR-J5D_-_G_, the instantaneous power failure tough drive cannot be used. ☞ Page 207 Tough drive function

*1 "Ver." indicates the supported firmware version of the servo amplifier. The functions are available on servo amplifiers with the indicated firmware version or later.

Diagnostics

Functions	Detailed functions	Description	Ver. *1				Detailed explanation
			[G]		[B]	[A]	
			J5	J5D			
Drive data diagnosis	Drive recorder	This function continuously monitors the servo status and records the state transition before and after an alarm for a fixed period of time. The recorded data can be checked by the Waveform-Display button on the drive recorder window of MR Configurator2 being clicked.	A0	C0	C4	A0	☞ Page 304 Drive recorder
	Graph function	This function obtains the servo status in the graph.	A0	C0	C4	A0	☞ Page 409 Graph function
Failure diagnosis	Encoder communication diagnosis function	This function diagnoses with MR Configurator2 whether the encoder communication error is caused by the circuit malfunction of the servo amplifier or by the malfunction of the cables/ encoder.	A0	C0	C4	A0	☞ Page 370 Encoder communication diagnosis function
Service life diagnosis	Servo amplifier life diagnosis function	This function enables checking of the cumulative energization time, the number of the inrush relay on/off times, and the number of dynamic brake usage times. It gives an indication of the replacement time for parts on the servo amplifier with a service life (such as the capacitor and the relay) before they malfunction. MR Configurator2 is required for this function.	A0	C0	C4	A0	☞ Page 368 Servo amplifier life diagnosis function
	Motor life diagnosis function	This function predicts failures of the equipment and the servo motor based on the machine total travel distance. It gives an indication of the replacement time for the servo motor.	A0	C0	C4	A0	☞ Page 242 Machine diagnosis
	Machine diagnosis function	This function uses the data in the servo amplifier to estimate the friction and vibrational component of the drive system in the equipment and to recognize an error in machine parts such as ball screws and bearings.	A0	C0	C4	A0	
		This function automatically sets the threshold used for detecting the error of machine parts such as ball screws and bearings. It outputs the warning when the friction, vibrational component, and total revolution of the servo motor are out of the set threshold. The error in the machine parts such as ball screws and bearings can be detected automatically.	A0	C0	C4	A0	
		This function estimates the friction of gears and loosening of belts (decrease in the belt tension), and detects errors in the gears and belts.	A0	C0	C4	A0	
System diagnosis	System configuration information	This function uses MR Configurator2 to monitor the servo amplifier model, connected servo motor, encoder, and other information.	A0	C0	C4	A0	☞ Page 411 System configuration display

*1 "Ver." indicates the supported firmware version of the servo amplifier. The functions are available on servo amplifiers with the indicated firmware version or later.

History

Functions	Detailed functions	Description	Ver. *1				Detailed explanation
			[G]		[B]	[A]	
			J5	J5D			
—	Alarm history	This function saves information of the alarm that occurred in the servo amplifier. The information is saved in chronological order and used for occasions such as analyzing the cause of the alarm.	A0	C0	C4	A0	<ul style="list-style-type: none"> ☞ Page 156 Alarm history [G] ☞ Page 159 Alarm History [B] ☞ Page 159 Alarm history [A]

*1 "Ver." indicates the supported firmware version of the servo amplifier. The functions are available on servo amplifiers with the indicated firmware version or later.

2 CONTROL MODE

2.1 Control mode [G]

The method for driving a servo motor varies depending on each control mode. The characteristics of each control mode are shown in the following.

Category	Control mode	Symbol	Description
CiA 402 control mode	Cyclic synchronous position mode	csp	This is a control mode to drive servo motors by receiving a position command at a constant period in the synchronous communication with a controller. Use an absolute position address for the command.
	Cyclic synchronous velocity mode	csv	This is a control mode to drive servo motors by receiving a speed command at a constant period in the synchronous communication with a controller.
	Cyclic synchronous torque mode	cst	This is a control mode to drive servo motors by receiving a torque command at a constant period in the synchronous communication with a controller.
	Profile position mode ^{*1}	pp	This is a positioning mode to drive servo motors by receiving an end position command via either synchronous or asynchronous communication with a controller. Use an absolute position address or a relative position address for the command.
	Profile velocity mode ^{*1}	pv	This is a control mode to drive servo motors by receiving a target speed command via either synchronous or asynchronous communication with a controller.
	Profile torque mode ^{*1}	tq	This is a control mode to drive servo motors by receiving a target torque command via either synchronous or asynchronous communication with a controller.
	Homing mode	hm	This is a control mode to perform homing with the method specified by the controller.
Positioning mode (Point table method) (CP) ^{*3}	Point table mode	pt	This is a control mode to drive the servo motor in accordance with the setting value by selecting the point table with the preset 255 points.
	JOG operation mode	jpg	This is a control mode that enables desired positioning for machine adjustment and home positioning.
Thrust/torque control	Continuous operation to torque control mode ^{*2}	ct	This function enables smooth switching to torque control from the position control mode or speed control mode without stopping the servo motor. This eliminates rapid change of speed and torque, contributing to reduction in load to the machine and high-quality product molding.
Slave axis control	Slave axis torque mode ^{*4}	slt	This control mode drives servo motors by receiving a torque command from the master axis. For master-slave operation using CC-Link IE TSN, refer to "Master-slave operation function" in the User's Manual (Communication Function).

*1 Available on servo amplifiers with firmware version A5 or later.

*2 Available on servo amplifiers with firmware version B0 or later.

*3 Available on servo amplifiers with firmware version B8 or later.

*4 Available on servo amplifiers with firmware version D0 or later.

Control switching

Point

- The control mode is set to the cyclic synchronous position mode as a default. When using the cyclic synchronous position mode, perform position follow-up with the controller at servo-on.
- To use the profile mode, switch to the mode in the servo-off state. After the control mode is switched, turn on the servo-on.
- If the control mode is switched without performing position follow-up, unexpected movements such as sudden acceleration of the servo motor may occur.

The control mode can be switched with [Modes of operation (Obj. 6060h)]. Switching the control modes with [Modes of operation (Obj. 6060h)] applies to the cyclic modes (csp, csv, and cst), profile modes (pp, pv, and tq), homing mode (hm), and continuous operation to torque control mode (ct).

For details of the control switching, refer to the User's Manual (Communication Function).

The positioning mode (point table method), can be switched to point table mode (pt), JOG operation mode (jg), home position mode (hm).

Control switching in positioning mode

The control mode is switched (pt, jg, and hm) only if the condition for control switching is met, following which [Modes of operation display (Obj. 6061h)] is changed. If the condition for control switching is not met, the control mode will not be switched and the value in [Modes of operation display (Obj. 6061h)] will not be changed. The condition for control switching is "Motor being stopped".

"Motor being stopped" means that bit 3 of [Status DO 2 (Obj. 2D12h: 00h)] (S_ZSP) is on, and bit 6 of [Status DO 5 (Obj. 2D15h: 00h)] (S_MEND) is on.

In the servo off-state, control switching can be performed if S_ZSP is on.

Precautions

- Changes to the OMS Bit of [Controlword (Obj. 6040h)] are not accepted until control switching finishes. Before inputting commands, check that the control mode has been switched by referring to [Modes of operation display (Obj. 6061h)].
- Switch the control modes when the start command is turned off. (For example, when "Homing operation start" is turned off in homing mode (hm).)

The following shows a timing chart of control switching from the point table mode (pt) to JOG operation mode (jg).

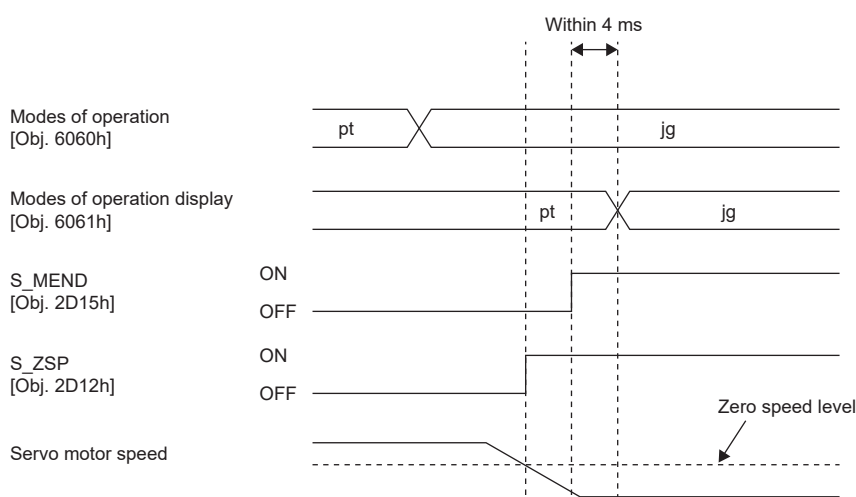

Cyclic synchronous position mode (csp)

The functions and related objects of the cyclic synchronous position mode (csp) are shown in the following.

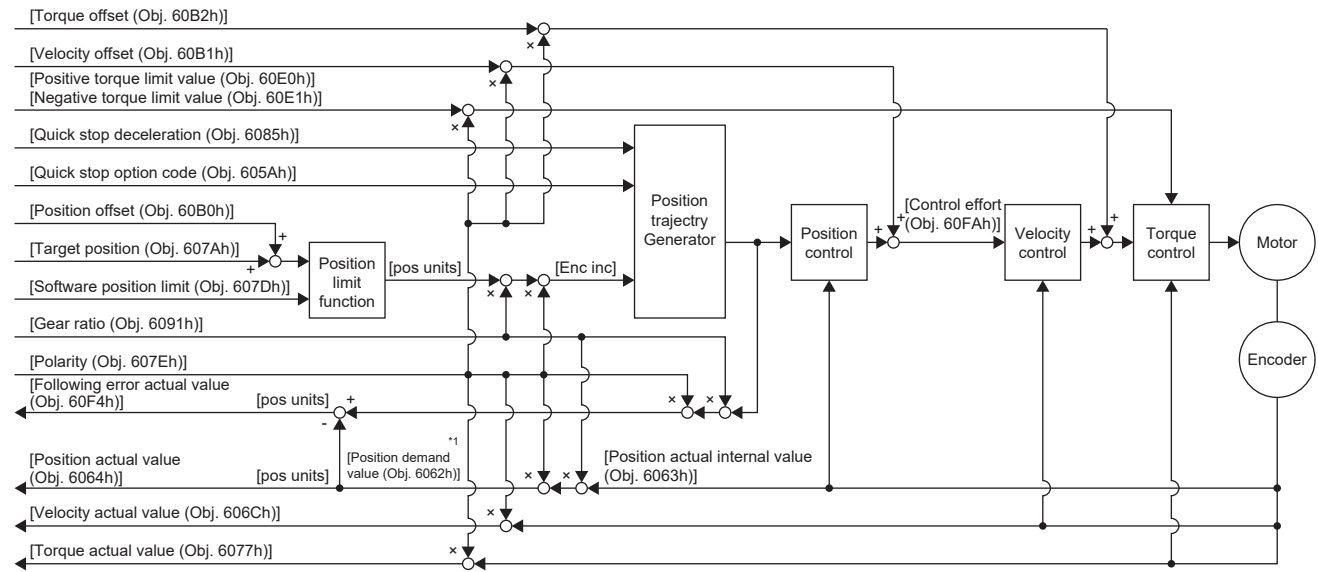

*1 This object may not be used depending on the network being used. For details, refer to the User's Manual (Object Dictionary).

Related objects

For details on the objects, refer to the User's Manual (Object Dictionary).

Index	Sub	Object	Name	Description
607Ah	—	VAR	Target position	Command position Unit: pos units
607Bh	0	ARRAY	Position range limit	Number of entries
	1		Min position range limit	Minimum value of the position range limit Unit: pos units
	2		Max position range limit	Maximum value of the position range limit Unit: pos units
607Dh	0	ARRAY	Software position limit	Number of entries
	1		Min position limit	Minimum position address Unit: pos units
	2		Max position limit	Maximum position address Unit: pos units
6085h	—	VAR	Quick stop deceleration	Deceleration at deceleration to a stop with Quick stop Unit: acc units
605Ah	—	VAR	Quick stop option code	Operation setting for Quick stop Page 197 Quick stop [G]
6080h	—	VAR	Max motor speed	Servo motor maximum speed Unit: r/min, mm/s
6063h	—	VAR	Position actual internal value	Current position Unit: Enc inc
6064h	—	VAR	Position actual value	Current position Unit: pos units
606Ch	—	VAR	Velocity actual value	Current speed Unit: vel units
6077h	—	VAR	Torque actual value	Current torque Unit: 0.1 % (with rated torque being 100 %)
6092h	0	ARRAY	Feed constant	Travel distance per revolution of an output shaft
	1		Feed	Travel distance setting
	2		Shaft revolutions	Number of servo motor shaft revolutions Unit: rev
60F4h	—	VAR	Following error actual value	Droop pulses Unit: pos units

Index	Sub	Object	Name	Description
60FAh	—	VAR	Control effort	Position control loop output (speed command) Unit: vel units
60E0h	—	VAR	Positive torque limit value	Torque limit value (forward) Unit: 0.1 % (with rated torque being 100 %)
60E1h	—	VAR	Negative torque limit value	Torque limit value (reverse) Unit: 0.1 % (with rated torque being 100 %)
6091h	0	ARRAY	Gear ratio	Gear ratio
	1		Motor revolutions	Number of revolutions of the servo motor shaft (numerator) ☞ Page 133 Electronic gear function [G]
	2		Shaft revolutions	Number of revolutions of the drive shaft (denominator) ☞ Page 133 Electronic gear function [G]
607Eh	—	VAR	Polarity	Polarity selection Bit 7: Position POL Bit 6: Velocity POL Bit 5: Torque POL ☞ Page 109 Rotation/travel direction selection [G]
60A8h	—	VAR	SI unit position	SI unit position It is automatically set in [Pr. PT01.2 Unit for position data].
60A9h	—	VAR	SI unit velocity	SI unit velocity The SI unit velocity is returned. It is automatically set in [Pr. PT01.2 Unit for position data].
60B0h	—	VAR	Position offset	Position offset Unit: pos units
60B1h	—	VAR	Velocity offset	Velocity offset Unit: vel units
60B2h	—	VAR	Torque offset	Torque offset Unit: 0.1 % (with rated torque being 100 %)
6062h *1	—	VAR	Position demand value	Command position (absolute position) The command position inside the servo amplifier is returned. Unit: pos units

*1 This object may not be used depending on the network being used. For details, refer to the User's Manual (Object Dictionary).

Controlword/Statusword

By changing [Controlword (Obj. 6040h)], control commands can be given to the servo amplifier. The control status can also be checked with [Statusword (Obj. 6041h)].

Some bits of [Controlword (Obj. 6040h)] and [Statusword (Obj. 6041h)] vary depending on the control mode. The bits that vary depending on the control mode are listed in the following tables.

■ Controlword OMS Bit (csp)

Bit	Symbol	Description
4	(reserved)	The value at reading is undefined. Set "0" when writing.
5	(reserved)	
6	(reserved)	
8	(reserved)	
9	(reserved)	

■ Statusword OMS Bit (csp)

Bit	Symbol	Description
10	(reserved)	The value at reading is undefined.
12	Drive follows the command value (Target position ignored)	0: [Target position (Obj. 607Ah)] is being discarded. 1: [Target position (Obj. 607Ah)] is being used as a position control loop input.
13	Following error	0: No following error 1: Following error When the time set in [Following error time out (Obj. 6066h)] elapses in a state where the value of [Following error actual value (Obj. 60F4h)] exceeds the value set in [Following error window (Obj. 6065h)], this bit changes to "1".

Cyclic synchronous velocity mode (csv)

The functions and related objects of the cyclic synchronous velocity mode (csv) are shown in the following.

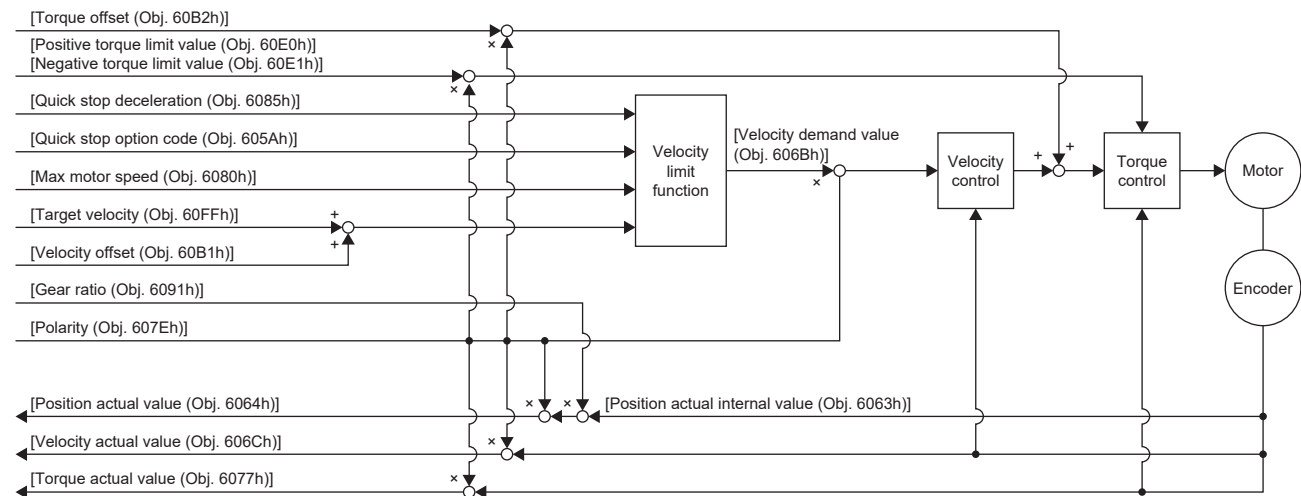

Related objects

For details on the objects, refer to the User's Manual (Object Dictionary).

Index	Sub	Object	Name	Description
60FFh	—	VAR	Target velocity	Command speed Unit: vel units
6085h	—	VAR	Quick stop deceleration	Deceleration at deceleration to a stop with Quick stop Unit: acc units
605Ah	—	VAR	Quick stop option code	Operation setting for Quick stop ☞ Page 197 Quick stop [G]
6080h	—	VAR	Max motor speed	Servo motor maximum speed Unit: r/min, mm/s
606Bh	—	VAR	Velocity demand value	Command speed (after limit) Unit: vel units
6063h	—	VAR	Position actual internal value	Current position Unit: Enc inc
6064h	—	VAR	Position actual value	Current position Unit: pos units
606Ch	—	VAR	Velocity actual value	Current speed Unit: vel units
6077h	—	VAR	Torque actual value	Current torque Unit: 0.1 % (with rated torque being 100 %)
6092h	0	ARRAY	Feed constant	Travel distance per revolution of an output shaft
	1		Feed	Travel distance setting
	2		Shaft revolutions	Number of servo motor shaft revolutions Unit: rev
60E0h	—	VAR	Positive torque limit value	Torque limit value (forward) Unit: 0.1 % (with rated torque being 100 %)
60E1h	—	VAR	Negative torque limit value	Torque limit value (reverse) Unit: 0.1 % (with rated torque being 100 %)
6091h	0	ARRAY	Gear ratio	Gear ratio
	1		Motor revolutions	Number of revolutions of the servo motor shaft (numerator) ☞ Page 133 Electronic gear function [G]
	2		Shaft revolutions	Number of revolutions of the drive shaft (denominator) ☞ Page 133 Electronic gear function [G]
607Eh	—	VAR	Polarity	Polarity selection Bit 7: Position POL Bit 6: Velocity POL Bit 5: Torque POL ☞ Page 109 Rotation/travel direction selection [G]

Index	Sub	Object	Name	Description
60A8h	—	VAR	SI unit position	SI unit position It is automatically set in [Pr. PT01.2 Unit for position data].
60A9h	—	VAR	SI unit velocity	SI unit velocity The SI unit velocity is returned. It is automatically set in [Pr. PT01.2 Unit for position data].
60B1h	—	VAR	Velocity offset	Velocity offset Unit: vel units
60B2h	—	VAR	Torque offset	Torque offset Unit: 0.1 % (with rated torque being 100 %)

Controlword/Statusword

By changing [Controlword (Obj. 6040h)], control commands can be given to the servo amplifier. The control status can also be checked with [Statusword (Obj. 6041h)].

Some bits of [Controlword (Obj. 6040h)] and [Statusword (Obj. 6041h)] vary depending on the control mode. The bits that vary depending on the control mode are listed in the following tables.

■ Controlword OMS Bit (csv)

Bit	Symbol	Description
4	(reserved)	The value at reading is undefined. Set "0" when writing.
5	(reserved)	
6	(reserved)	
8	(reserved)	
9	(reserved)	

■ Statusword OMS Bit (csv)

Bit	Symbol	Description
10	(reserved)	The value at reading is undefined.
12	Drive follows the command value (Target position ignored)	0: [Target velocity (Obj. 60FFh)] is being discarded. 1: [Target velocity (Obj. 60FFh)] is being used as a speed control loop input.
13	(reserved)	The value at reading is undefined.

Cyclic synchronous torque mode (cst)

The functions and related objects of the cyclic synchronous torque mode (cst) are shown in the following.

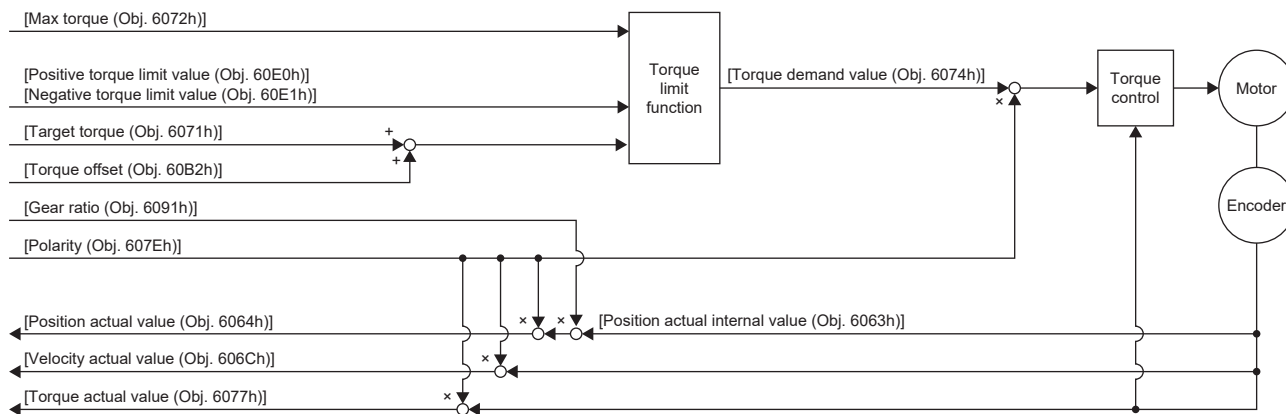

Related objects

For details on the objects, refer to the User's Manual (Object Dictionary).

Index	Sub	Object	Name	Description
6071h	—	VAR	Target torque	Command torque Unit: 0.1 % (with rated torque being 100 %)
6072h	—	VAR	Max torque	Maximum torque Unit: 0.1 % (with rated torque being 100 %)
6074h	—	VAR	Torque demand value	Command torque (after limit) Unit: 0.1 % (with rated torque being 100 %)
6063h	—	VAR	Position actual internal value	Current position Unit: Enc inc
6064h	—	VAR	Position actual value	Current position Unit: pos units
606Ch	—	VAR	Velocity actual value	Current speed Unit: vel units
6077h	—	VAR	Torque actual value	Current torque Unit: 0.1 % (with rated torque being 100 %)
6092h	0	ARRAY	Feed constant	Travel distance per revolution of an output shaft
	1		Feed	Travel distance setting
	2		Shaft revolutions	Number of servo motor shaft revolutions Unit: rev
60E0h	—	VAR	Positive torque limit value	Torque limit value (forward) Unit: 0.1 % (with rated torque being 100 %)
60E1h	—	VAR	Negative torque limit value	Torque limit value (reverse) Unit: 0.1 % (with rated torque being 100 %)
6091h	0	ARRAY	Gear ratio	Gear ratio
	1		Motor revolutions	Number of revolutions of the servo motor shaft (numerator) Page 133 Electronic gear function [G]
	2		Shaft revolutions	Number of revolutions of the drive shaft (denominator) Page 133 Electronic gear function [G]
607Eh	—	VAR	Polarity	Polarity selection Bit 7: Position POL Bit 6: Velocity POL Bit 5: Torque POL Page 109 Rotation/travel direction selection [G]
2D20h	—	VAR	Velocity limit value	Speed limit value Unit: vel units
60A8h	—	VAR	SI unit position	SI unit position It is automatically set in [Pr. PT01.2 Unit for position data].
60A9h	—	VAR	SI unit velocity	SI unit velocity The SI unit velocity is returned. It is automatically set in [Pr. PT01.2 Unit for position data].

Index	Sub	Object	Name	Description
60B2h	—	VAR	Torque offset	Torque offset Unit: 0.1 % (with rated torque being 100 %)

Controlword/Statusword

By changing [Controlword (Obj. 6040h)], control commands can be given to the servo amplifier. The control status can also be checked with [Statusword (Obj. 6041h)].

Some bits of [Controlword (Obj. 6040h)] and [Statusword (Obj. 6041h)] vary depending on the control mode. The bits that vary depending on the control mode are listed in the following tables.

■ Controlword OMS Bit (cst)

Bit	Symbol	Description
4	(reserved)	The value at reading is undefined. Set "0" when writing.
5	(reserved)	
6	(reserved)	
8	(reserved)	
9	(reserved)	

■ Statusword OMS Bit (cst)

Bit	Symbol	Description
10	(reserved)	The value at reading is undefined.
12	Drive follows the command value (Target position ignored)	0: [Target torque (Obj. 6071h)] is being discarded. 1: [Target torque (Obj. 6071h)] is being used as a torque control loop input.
13	(reserved)	The value at reading is undefined.

Profile position mode (pp)

This mode is available on servo amplifiers with firmware version A5 or later.

The following shows the functions and related objects of the profile position mode (pp).

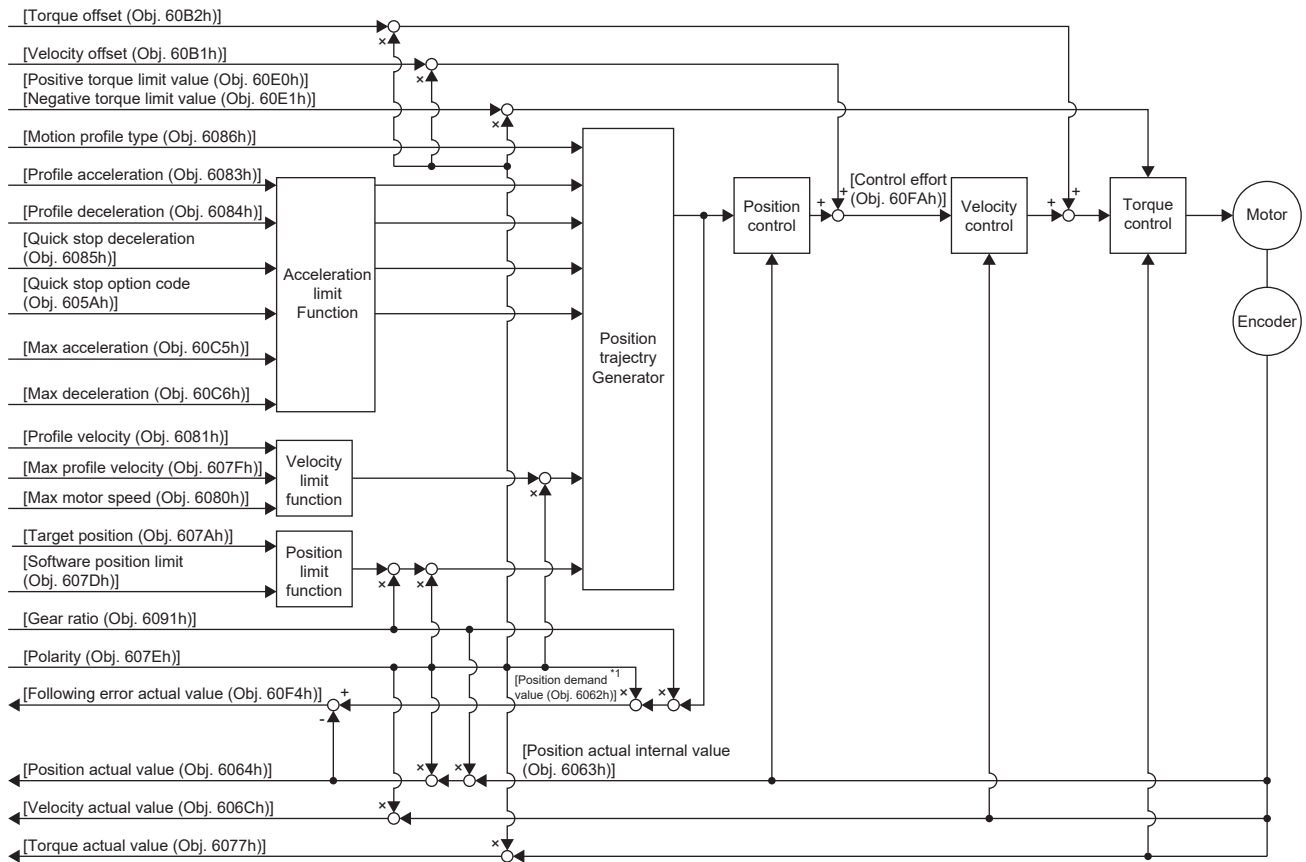

*1 This object may not be used depending on the network being used. For details, refer to the User's Manual (Object Dictionary).

Related objects

For details on the objects, refer to the User's Manual (Object Dictionary).

Index	Sub	Object	Name	Description
607Ah	—	VAR	Target position	Command position Unit: pos units
607Bh	0	ARRAY	Position range limit	Number of entries
	1		Min position range limit	Minimum value of the position range limit Unit: pos units
	2		Max position range limit	Maximum value of the position range limit Unit: pos units
607Dh	0	ARRAY	Software position limit	Number of entries
	1		Min position limit	Minimum position address Unit: pos units
	2		Max position limit	Maximum position address Unit: pos units
607Fh	—	VAR	Max profile velocity	Maximum speed Unit: vel units
6080h	—	VAR	Max motor speed	Servo motor maximum speed Unit: r/min, mm/s
6081h	—	VAR	Profile velocity	Speed after acceleration finished Unit: vel units
6083h	—	VAR	Profile acceleration	Acceleration at start of movement to target position Unit: acc units
6084h	—	VAR	Profile deceleration	Deceleration at arrival to target position Unit: acc units

Index	Sub	Object	Name	Description
6085h	—	VAR	Quick stop deceleration	Deceleration at deceleration to a stop with Quick stop Unit: acc units
6086h	—	VAR	Motion profile type	Acceleration/deceleration type selection -1: S-pattern 0: Linear ramp (not supported) 1: Sin ² ramp (not supported) 2: Jerk-free ramp (not supported) 3: Jerk-limited ramp (not supported)
605Ah	—	VAR	Quick stop option code	Operation setting for Quick stop ☞ Page 197 Quick stop [G]
60C5h *2	—	VAR	Max acceleration	Acceleration limit value Unit: Command unit/s ²
60C6h *2	—	VAR	Max deceleration	Deceleration limit value Unit: Command unit/s ²
6063h	—	VAR	Position actual internal value	Current position Unit: Enc inc
6064h	—	VAR	Position actual value	Current position Unit: pos units
606Ch	—	VAR	Velocity actual value	Current speed Unit: vel units
6077h	—	VAR	Torque actual value	Current torque Unit: 0.1 % (with rated torque being 100 %)
6092h	0	ARRAY	Feed constant	Travel distance per revolution of an output shaft
	1		Feed	Travel distance setting Unit: pos units
	2		Shaft revolutions	Number of servo motor shaft revolutions Unit: rev
60F4h	—	VAR	Following error actual value	Droop pulses Unit: pos units
60FAh	—	VAR	Control effort	Position control loop output (speed command) Unit: vel units
60E0h	—	VAR	Positive torque limit value	Torque limit value (forward) Unit: 0.1 % (with rated torque being 100 %)
60E1h	—	VAR	Negative torque limit value	Torque limit value (reverse) Unit: 0.1 % (with rated torque being 100 %)
6091h	0	ARRAY	Gear ratio	Gear ratio
	1		Motor revolutions	Number of revolutions of the servo motor shaft (numerator) ☞ Page 133 Electronic gear function [G]
	2		Shaft revolutions	Number of revolutions of the drive shaft (denominator) ☞ Page 133 Electronic gear function [G]
607Eh	—	VAR	Polarity	Polarity selection Bit 7: Position POL Bit 6: Velocity POL Bit 5: Torque POL ☞ Page 109 Rotation/travel direction selection [G]
60A8h	—	VAR	SI unit position	SI unit position It is automatically set in [Pr. PT01.2 Unit for position data].
60A9h	—	VAR	SI unit velocity	SI unit velocity The SI unit velocity is returned. It is automatically set in [Pr. PT01.2 Unit for position data].
60B1h	—	VAR	Velocity offset	Velocity offset Unit: vel units
60B2h	—	VAR	Torque offset	Torque offset Unit: 0.1 % (with rated torque being 100 %)
6062h *1	—	VAR	Position demand value	Command position (absolute position) The command position inside the servo amplifier is returned. Unit: pos units

*1 This object may not be used depending on the network being used. For details, refer to the User's Manual (Object Dictionary).

*2 Available on servo amplifiers with firmware version C0 or later.

Controlword/Statusword

By changing [Controlword (Obj. 6040h)], control commands can be given to the servo amplifier. The control status can also be checked with [Statusword (Obj. 6041h)].

Some bits of [Controlword (Obj. 6040h)] and [Statusword (Obj. 6041h)] vary or are common depending on the control mode. The bits that vary depending on the control mode are listed in the following tables.

■ Controlword OMS Bit (pp)

Bit	Symbol	Description
4	New set-point	Obtains a new positioning servo parameter at bit rising.
5	Change set immediately	0: Set of set-points 1: Single set-point (The positioning servo parameter update is immediately accepted.)
6	abs/rel	0: Absolute position command 1: Relative position command
8	HALT	0: Drives the servo motor. 1: Stops the servo motor according to [Halt option code (Obj. 605Dh)].
9	Change on set-point	Enabled only in Set of set-points (when the bit 5 of [Obj. 6040h: 00h] is "0"). 0: Shifts to the next positioning after completing the current positioning. 1: Shifts to the next positioning after performing positioning up to the current set-point with the setting of [profile velocity (Obj. 6081h)].  Page 33 Set of set-points

■ Statusword OMS Bit (pp)

Bit	Symbol	Description
10	Target reached	0: Halt (Bit 8) = 0: Target position not reached. 0: Halt (Bit 8) = 1: Axis decelerates. 1: Halt (Bit 8) = 0: Target position reached. 1: Halt (Bit 8) = 1: Velocity of axis is 0. Judgment condition of Target position reached: When the time set in [Position window time (Obj. 6068h)] elapses in a state where the difference between the values in [Position actual value (Obj. 6064h)] and [Target position (Obj. 607Ah)] is equal to or below the value set in [Position window (Obj. 6067h)], the state changes to "Target position reached".
12	Set-point acknowledge	0: Positioning completed (waiting for next command) 1: Positioning in progress (When Single set-point (When bit 5 of [Obj. 6040h: 00h] is "1"), setpoint can be overwritten.)
13	Following error	0: No following error 1: Following error

Single Set-point

Update of positioning servo parameters during a positioning operation is immediately accepted. (The current positioning operation is canceled and the next positioning operation is started.)

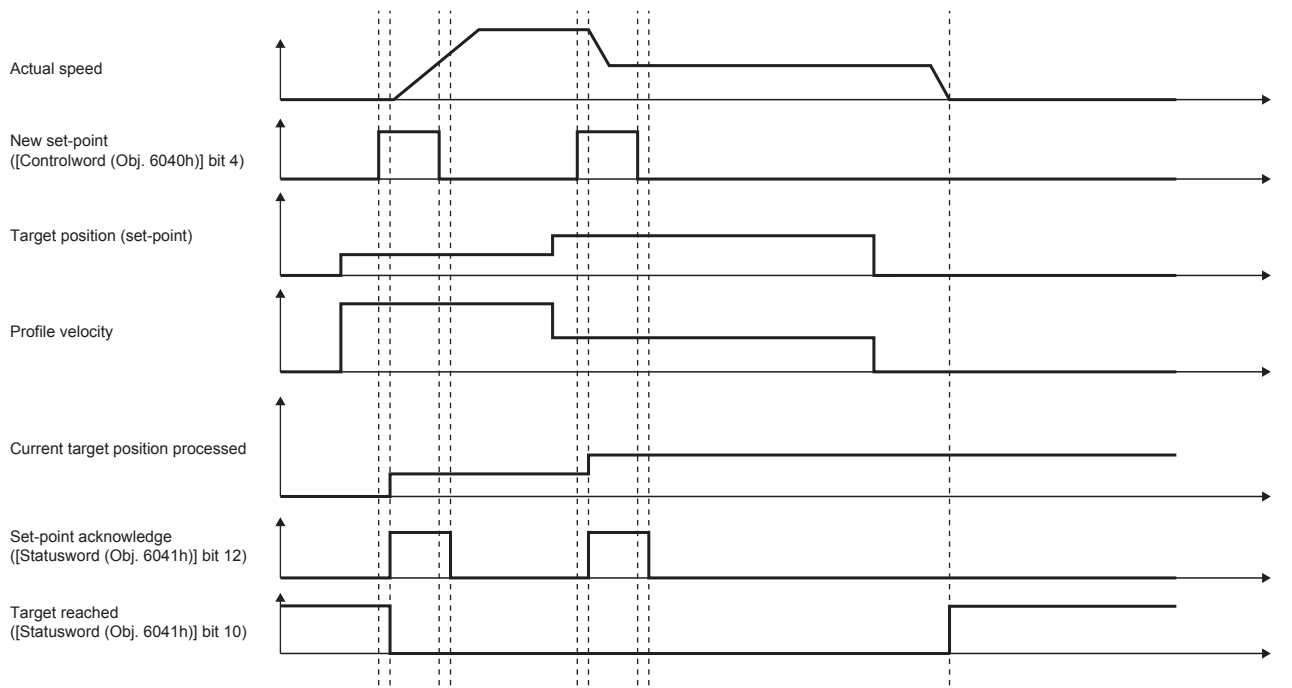

Set of set-points

After the current positioning operation finishes, the next positioning starts. Use the setting value of Change on set-point (Controlword Bit 9) to switch whether the positioning operation is to be stopped at the first positioning point when the positioning servo parameter is updated before completion of the positioning operation.

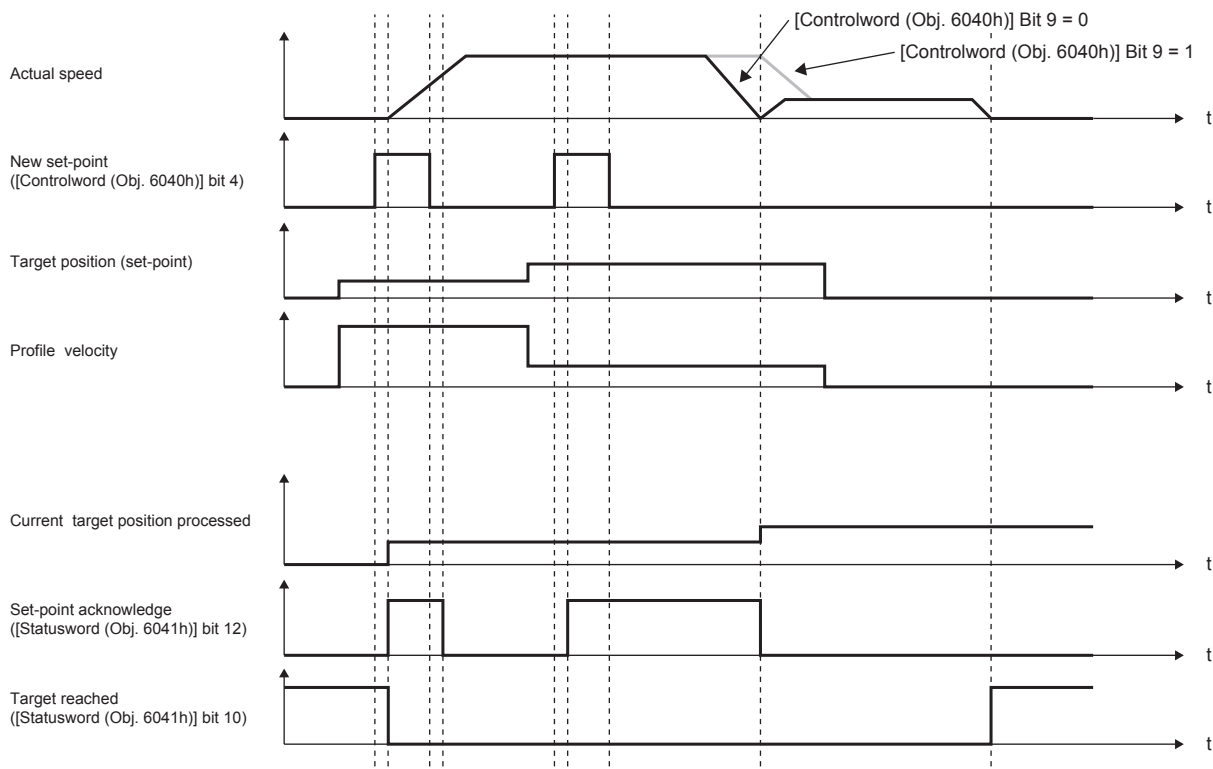

Profile velocity mode (pv)

This mode is available on servo amplifiers with firmware version A5 or later.

The following shows the functions and related objects of the profile velocity mode (pv).

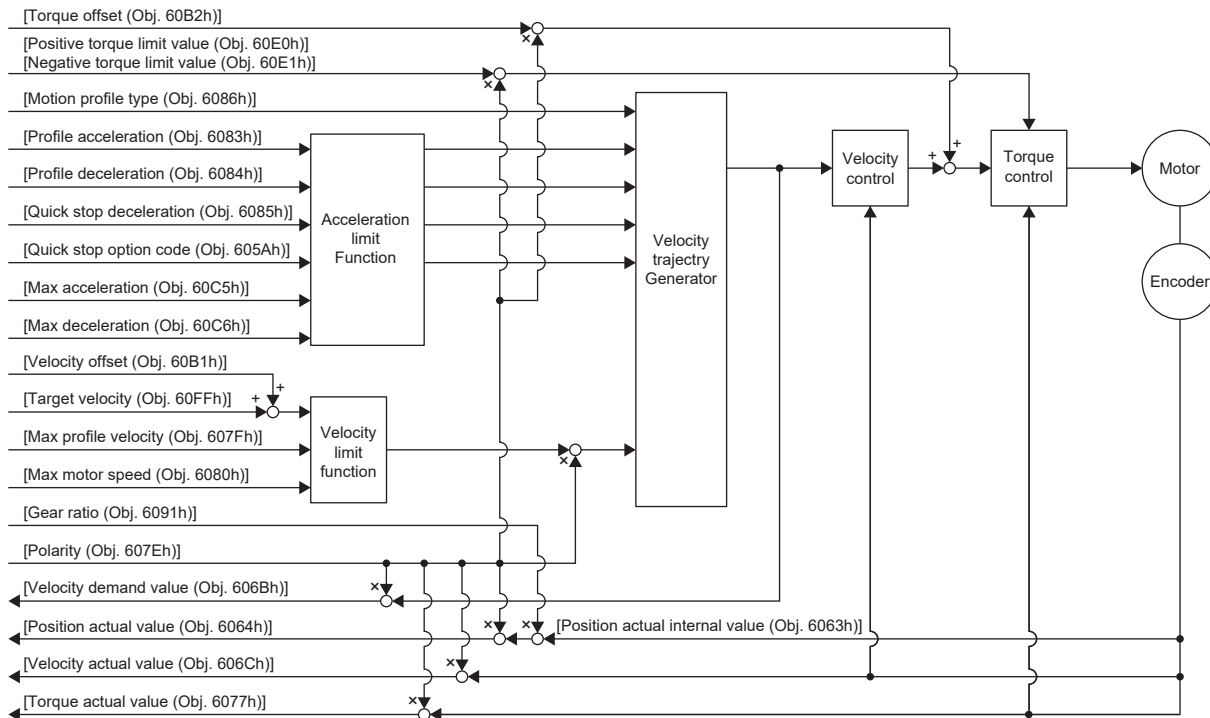

Related objects

For details on the objects, refer to the User's Manual (Object Dictionary).

Index	Sub	Object	Name	Description
60FFh	—	VAR	Target velocity	Command speed Unit: vel units
607Fh	—	VAR	Max profile velocity	Maximum speed Unit: vel units
6080h	—	VAR	Max motor speed	Servo motor maximum speed Unit: r/min, mm/s
6083h	—	VAR	Profile acceleration	Acceleration at start of movement to target position Unit: acc units
6084h	—	VAR	Profile deceleration	Deceleration at arrival to target position Unit: acc units
6085h	—	VAR	Quick stop deceleration	Deceleration at deceleration to a stop with Quick stop Unit: acc units
6086h	—	VAR	Motion profile type	Acceleration/deceleration type selection -1: S-pattern 0: Linear ramp (not supported) 1: Sin ² ramp (not supported) 2: Jerk-free ramp (not supported) 3: Jerk-limited ramp (not supported)
605Ah	—	VAR	Quick stop option code	Operation setting for Quick stop Page 197 Quick stop [G]
6063h	—	VAR	Position actual internal value	Current position Unit: Enc inc
6064h	—	VAR	Position actual value	Current position Unit: pos units
606Bh	—	VAR	Velocity demand value	Speed command (after trajectory generation) Unit: vel units
606Ch	—	VAR	Velocity actual value	Current speed Unit: vel units

Index	Sub	Object	Name	Description
6077h	—	VAR	Torque actual value	Current torque Unit: 0.1 % (with rated torque being 100 %)
6092h	0	ARRAY	Feed constant	Travel distance per revolution of an output shaft
	1		Feed	Travel distance setting
	2		Shaft revolutions	Number of servo motor shaft revolutions Unit: rev
60C5h *1	—	VAR	Max acceleration	Acceleration limit value Unit: Command unit/s ²
60C6h *1	—	VAR	Max deceleration	Deceleration limit value Unit: Command unit/s ²
60E0h	—	VAR	Positive torque limit value	Torque limit value (forward) Unit: 0.1 % (with rated torque being 100 %)
60E1h	—	VAR	Negative torque limit value	Torque limit value (reverse) Unit: 0.1 % (with rated torque being 100 %)
6091h	0	ARRAY	Gear ratio	Gear ratio
	1		Motor revolutions	Number of revolutions of the servo motor shaft (numerator) ☞ Page 133 Electronic gear function [G]
	2		Shaft revolutions	Number of revolutions of the drive shaft (denominator) ☞ Page 133 Electronic gear function [G]
607Eh	—	VAR	Polarity	Polarity selection Bit 7: Position POL Bit 6: Velocity POL Bit 5: Torque POL ☞ Page 109 Rotation/travel direction selection [G]
606Dh	—	VAR	Velocity window	Speed error threshold for judging Target reached Unit: vel units
606Eh	—	VAR	Velocity window time	Target reached judgment time Unit: ms
606Fh	—	VAR	Velocity threshold	Zero speed threshold for judging Speed Unit: vel units
6070h	—	VAR	Velocity threshold time	Speed judgment time Unit: ms
60A8h	—	VAR	SI unit position	SI unit position It is automatically set in [Pr. PT01.2 Unit for position data].
60A9h	—	VAR	SI unit velocity	SI unit velocity The SI unit velocity is returned. It is automatically set in [Pr. PT01.2 Unit for position data].
60B1h	—	VAR	Velocity offset	Velocity offset Unit: vel units
60B2h	—	VAR	Torque offset	Torque offset Unit: 0.1 % (with rated torque being 100 %)

*1 Available on servo amplifiers with firmware version C0 or later.

Controlword/Statusword

By changing [Controlword (Obj. 6040h)], control commands can be given to the servo amplifier. The control status can also be checked with [Statusword (Obj. 6041h)].

Some bits of [Controlword (Obj. 6040h)] and [Statusword (Obj. 6041h)] vary or are common depending on the control mode. The bits that vary depending on the control mode are listed in the following tables.

■ Controlword OMS Bit (pv)

Bit	Symbol	Description
4	(reserved)	The value at reading is undefined. Set "0" when writing.
5	(reserved)	
6	(reserved)	
8	HALT	0: Drives the servo motor. 1: Stops the servo motor according to [Halt option code (Obj. 605Dh)].
9	(reserved)	The value at reading is undefined. Set "0" when writing.

■ Statusword OMS Bit (pv)

Bit	Symbol	Description
10	Target reached	0: Halt (Bit 8) = 0: Target velocity not reached. 0: Halt (Bit 8) = 1: Axis decelerates. 1: Halt (Bit 8) = 0: Target velocity reached. 1: Halt (Bit 8) = 1: Velocity of axis is 0. Judgment condition of Target velocity reached: When the time set in [Velocity window time (Obj. 606Eh)] elapses in a state where the difference between the values in [Velocity actual value (Obj. 606Ch)] and [Target velocity (Obj. 60FFh)] is equal to or below the value set in [Velocity window (Obj. 606Dh)], the state changes to "Target velocity reached".
12	Speed	0: Speed is not equal 0 1: Speed is equal 0 Judgment condition of Speed is not equal 0: When the time set in [Velocity threshold time (Obj. 6070h)] elapses in a state where the absolute value of [Velocity actual value (Obj. 606Ch)] is equal to or above the setting value of [Velocity threshold (Obj. 606Fh)], the bit changes to "Speed is not equal 0".
13	Max slippage error	0: Maximum slippage not reached 1: Maximum slippage reached (not supported) Max slippage is the maximum slippage of the asynchronous servo motor.

Operation sequence

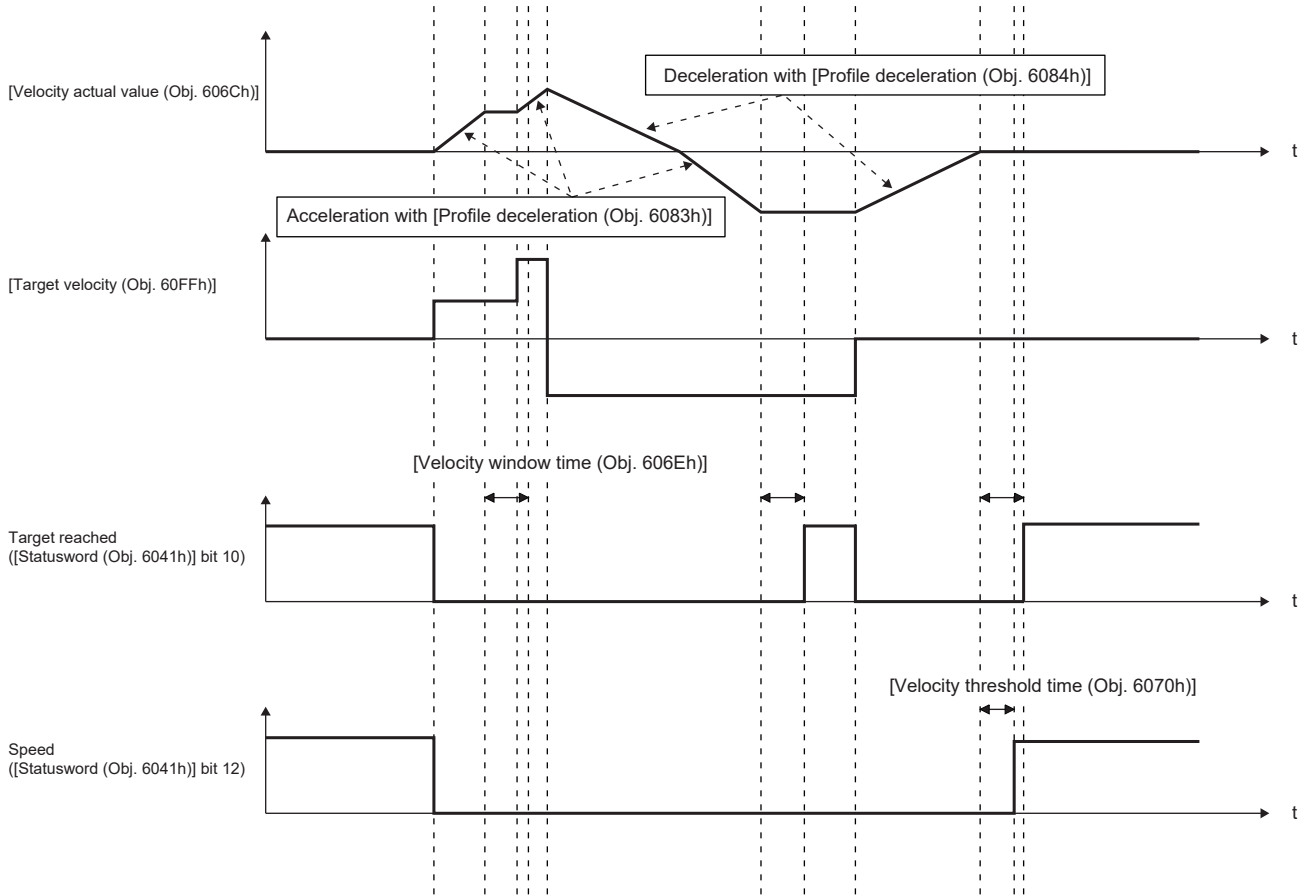

Profile torque mode (tq)

This mode is available on servo amplifiers with firmware version A5 or later.

The following shows the functions and related objects of the profile torque mode (tq).

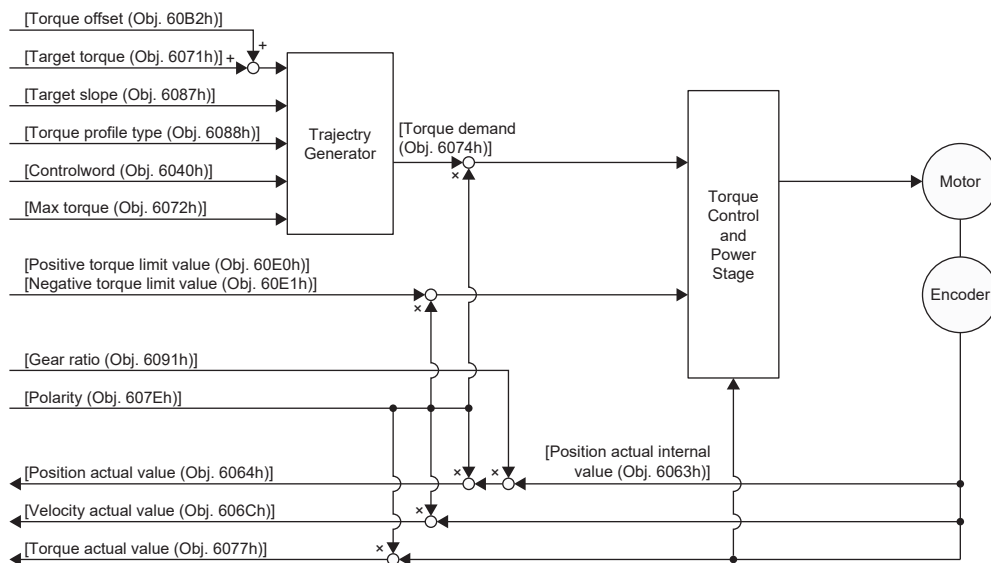

Related objects

For details on the objects, refer to the User's Manual (Object Dictionary).

Index	Sub	Object	Name	Description
6040h	—	VAR	Controlword	Common control command
6071h	—	VAR	Target torque	Command torque Unit: 0.1 % (with rated torque being 100 %)
6072h	—	VAR	Max torque	Maximum torque Unit: 0.1 % (with rated torque being 100 %)
6074h	—	VAR	Torque demand value	Command torque (after limit) Unit: 0.1 % (with rated torque being 100 %)
6087h	—	VAR	Torque slope	Torque variation Unit: 0.1 %/s (with rated torque being 100 %)
6088h	—	VAR	Torque profile type	Torque variation pattern 0: Linear ramp 1: sin ² ramp (not supported)
6063h	—	VAR	Position actual internal value	Current position Unit: Enc inc
6064h	—	VAR	Position actual value	Current position Unit: pos units
606Ch	—	VAR	Velocity actual value	Current speed Unit: vel units
6077h	—	VAR	Torque actual value	Current torque Unit: 0.1 % (with rated torque being 100 %)
6092h	0	ARRAY	Feed constant	Travel distance per revolution of an output shaft
	1		Feed	Travel distance setting
	2		Shaft revolutions	Number of servo motor shaft revolutions Unit: rev
60E0h	—	VAR	Positive torque limit value	Torque limit value (forward) Unit: 0.1 % (with rated torque being 100 %)
60E1h	—	VAR	Negative torque limit value	Torque limit value (reverse) Unit: 0.1 % (with rated torque being 100 %)

Index	Sub	Object	Name	Description
6091h	0	ARRAY	Gear ratio	Gear ratio
	1		Motor revolutions	Number of revolutions of the servo motor shaft (numerator) ☞ Page 133 Electronic gear function [G]
	2		Shaft revolutions	Number of revolutions of the drive shaft (denominator) ☞ Page 133 Electronic gear function [G]
607Eh	—	VAR	Polarity	Polarity selection Bit 7: Position POL Bit 6: Velocity POL Bit 5: Torque POL ☞ Page 109 Rotation/travel direction selection [G]
2D20h	—	VAR	Velocity limit value	Speed limit value Unit: vel units
60A8h	—	VAR	SI unit position	SI unit position It is automatically set in [Pr. PT01.2 Unit for position data].
60A9h	—	VAR	SI unit velocity	SI unit velocity The SI unit velocity is returned. It is automatically set in [Pr. PT01.2 Unit for position data].
60B2h	—	VAR	Torque offset	Torque offset Unit: 0.1 % (with rated torque being 100 %)

Controlword/Statusword

By changing [Controlword (Obj. 6040h)], control commands can be given to the servo amplifier. The control status can also be checked with [Statusword (Obj. 6041h)].

Some bits of [Controlword (Obj. 6040h)] and [Statusword (Obj. 6041h)] vary or are common depending on the control mode. The bits that vary depending on the control mode are listed in the following tables.

■ Controlword OMS Bit (tq)

Bit	Symbol	Description
4	(reserved)	The value at reading is undefined. Set "0" when writing.
5	(reserved)	
6	(reserved)	
8	HALT	0: Drives the servo motor. 1: Stops the servo motor according to [Halt option code (Obj. 605Dh)].
9	(reserved)	The value at reading is undefined. Set "0" when writing.

■ Statusword OMS Bit (tq)

Bit	Symbol	Description
10	Target reached (not supported)	0: Halt (Bit 8) = 0: Target torque not reached. 0: Halt (Bit 8) = 1: Axis decelerates. 1: Halt (Bit 8) = 0: Target torque reached. 1: Halt (Bit 8) = 1: Velocity of axis is 0. Judgment condition of Target torque reached: When the time set in [Torque window time] elapses in a state where the difference between the values in [Torque actual value (Obj. 6077h)] and [Target torque (Obj. 6071h)] is equal to or below the value set in [Torque window], the state changes to "Target torque reached".
12	(reserved)	The value at reading is undefined.
13	(reserved)	

Operation sequence

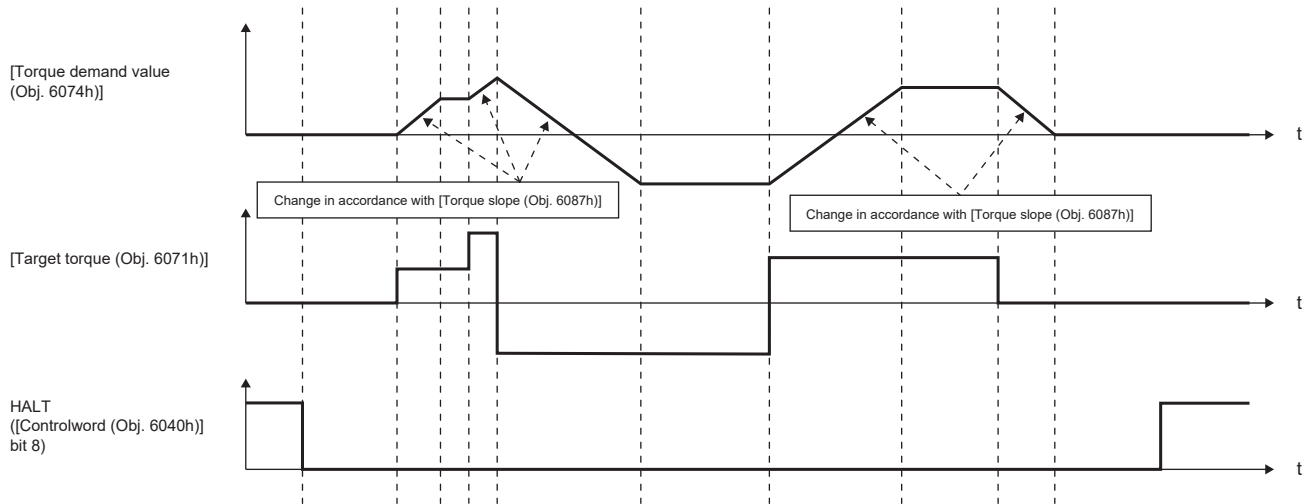

Point table mode (pt)

This mode is available on servo amplifiers with firmware version B8 or later.

The following shows the functions and related objects of the point table mode (pt).

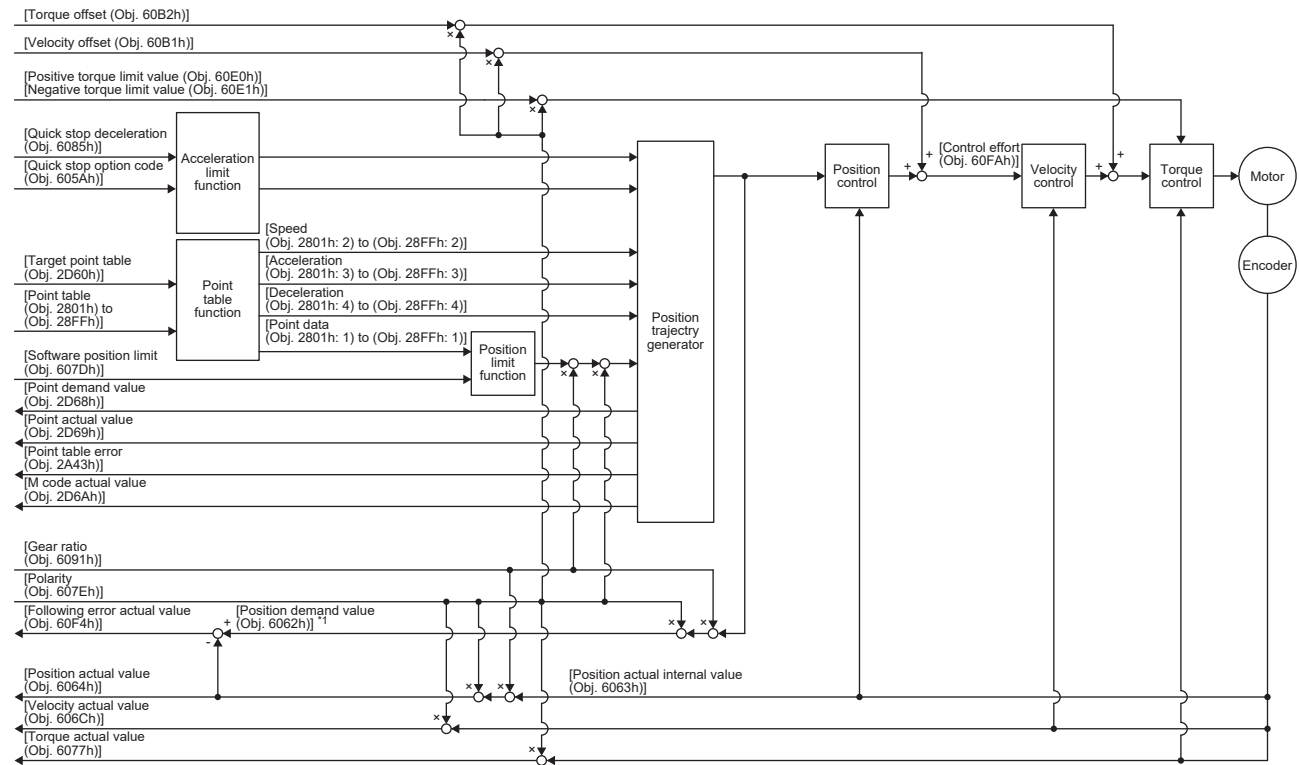

*1 This object may not be used depending on the network being used. For details, refer to the User's Manual (Object Dictionary).

Related objects

For details on the objects, refer to the User's Manual (Object Dictionary).

Index	Sub	Object	Name	Description
607Bh	0	ARRAY	Position range limit	Number of entries
	1		Min position range limit	Minimum value of the position range limit Unit: pos units
	2		Max position range limit	Maximum value of the position range limit Unit: pos units
607Dh	0	ARRAY	Software position limit	Number of entries
	1		Min position limit	Minimum position address Unit: pos units
	2		Max position limit	Maximum position address Unit: pos units
6085h	—	VAR	Quick stop deceleration	Deceleration at deceleration to a stop with Quick stop Unit: acc units
605Ah	—	VAR	Quick stop option code	Operation setting for Quick stop Page 197 Quick stop [G]
6080h	—	VAR	Max motor speed	Servo motor maximum speed Unit: r/min, mm/s
6063h	—	VAR	Position actual internal value	Current position Unit: Enc inc
6064h	—	VAR	Position actual value	Current position Unit: pos units
606Ch	—	VAR	Velocity actual value	Current speed Unit: vel units
6077h	—	VAR	Torque actual value	Current torque Unit: 0.1 % (with rated torque being 100 %)

Index	Sub	Object	Name	Description
6092h	0	ARRAY	Feed constant	Travel distance per revolution of an output shaft
	1		Feed	Travel distance setting
	2		Shaft revolutions	Number of servo motor shaft revolutions Unit: rev
60F4h	—	VAR	Following error actual value	Droop pulses Unit: pos units
60FAh	—	VAR	Control effort	Position control loop output (speed command) Unit: vel units
60E0h	—	VAR	Positive torque limit value	Torque limit value (forward) Unit: 0.1 % (with rated torque being 100 %)
60E1h	—	VAR	Negative torque limit value	Torque limit value (reverse) Unit: 0.1 % (with rated torque being 100 %)
6091h	0	ARRAY	Gear ratio	Gear ratio
	1		Motor revolutions	Number of revolutions of the servo motor shaft (numerator) ☞ Page 133 Electronic gear function [G]
	2		Shaft revolutions	Number of revolutions of the drive shaft (denominator) ☞ Page 133 Electronic gear function [G]
607Eh	—	VAR	Polarity	Polarity selection Bit 7: Position POL Bit 6: Velocity POL Bit 5: Torque POL ☞ Page 109 Rotation/travel direction selection [G]
60A8h	—	VAR	SI unit position	SI unit position It is automatically set in [Pr. PT01.2 Unit for position data].
60A9h	—	VAR	SI unit velocity	SI unit velocity The SI unit velocity is returned. It is automatically set in [Pr. PT01.2 Unit for position data].
60AAh	—	VAR	SI unit acceleration	SI unit acceleration The SI unit acceleration is returned. It is automatically set in [Pr. PT01.2 Unit for position data] or [Pr. PT01.1 Speed/acceleration/deceleration unit selection].
6086h	—	VAR	Motion profile type	Acceleration/deceleration type selection -1: S-pattern 0: Linear ramp (not supported) 1: Sin ² ramp (not supported) 2: Jerk-free ramp (not supported) 3: Jerk-limited ramp (not supported)
2D60h	—	VAR	Target point table	Point table command 0: Does not operate. 1 to 255: Executes the specified point table. -1: Positioning to the home
2D68h	—	VAR	Point demand value	Point table request The point table number which is currently being commanded is returned. When the servo motor is stopped, the setting value of [Target point Table (Obj. 2D60h)] is returned.
2D69h	—	VAR	Point actual value	Current point table The point table number at which execution has completed is returned.
2801h to 28FFh	0	ARRAY	Point table 001 to 255	Number of entries (point table data)
	1		Point data	Position data Unit: pos units
	2		Speed	Speed data Unit: vel units
	3		Acceleration	Acceleration time constant Unit: acc units
	4		Deceleration	Deceleration time constant Unit: acc units
	5		Dwell	Dwell Unit: ms
	6		Auxiliary	Auxiliary function
	7		M code	M code

Index	Sub	Object	Name	Description
2A43h	0	ARRAY	Point table error	Number of entries (point table data)
	1		Point table error No.	Point table error number During [AL. 037.3 Point table setting error] occurrence, the point table number that triggers the alarm is returned.
	2		Point table error factor	Point table error element During [AL. 037.3] occurrence, the element of the point table that triggers the alarm is returned. The bit is turned on to indicate the error status.
2D6Ah	—	VAR	M code actual value	Current M code The M code of the point table at which execution has completed is returned.
60B1h	—	VAR	Velocity offset	Velocity offset Unit: vel units
60B2h	—	VAR	Torque offset	Torque offset Unit: 0.1 % (with rated torque being 100 %)
6062h *1	—	VAR	Position demand value	Command position (absolute position) The command position inside the servo amplifier is returned. Unit: pos units

*1 This object may not be used depending on the network being used. For details, refer to the User's Manual (Object Dictionary).

Controlword/Statusword

By changing [Controlword (Obj. 6040h)], control commands can be given to the servo amplifier. The control status can also be checked with [Statusword (Obj. 6041h)].

Some bits of [Controlword (Obj. 6040h)] and [Statusword (Obj. 6041h)] vary depending on the control mode. The bits that vary depending on the control mode are listed in the following tables.

■ Controlword OMS Bit (pt)

Bit	Symbol	Description
4	New set-point	Operation is started from the point table specified with [Target point table (Obj. 2D60h)] at bit rising.
5	(reserved)	The value at reading is undefined. Set "0" when writing.
6	(reserved)	
8	HALT	0: Performs positioning. 1: Stops the servo motor according to [Halt option code (Obj. 605Dh)].
9	(reserved)	The value at reading is undefined. Set "0" when writing.

■ Statusword OMS Bit (pt)

Bit	Symbol	Description
10	Target reached	<p>0 (Halt (Bit 8) = 0) : Target position not reached. 0 (Halt (Bit 8) = 1) : Axis decelerates 1 (Halt (Bit 8) = 0) : Target position reached. 1 (Halt (Bit 8) = 1) : Velocity of axis is 0 Judgment condition of Target position reached When the difference between the current position and point table command position has stayed within [Position window (Obj. 6067h)] for [Position window time (Obj. 6068h)] or longer, the state changes to "Target position reached".</p>
12	Set-point acknowledge	<p>0: Positioning completed (waiting for next command) 1: Positioning in progress</p>
13	Following error	<p>0: No following error 1: Following error Judgment condition of Following error: When the time set in [Following error time out (Obj. 6066h)] elapses in a state where [Following error actual value (Obj. 60F4h)] exceeds the value set in [Following error window (Obj. 6065h)], this bit changes to "1".</p>

JOG operation mode (jg)

This mode is available on servo amplifiers with firmware version B8 or later.

The following shows the functions of the JOG operation mode (jg) as well as related objects.

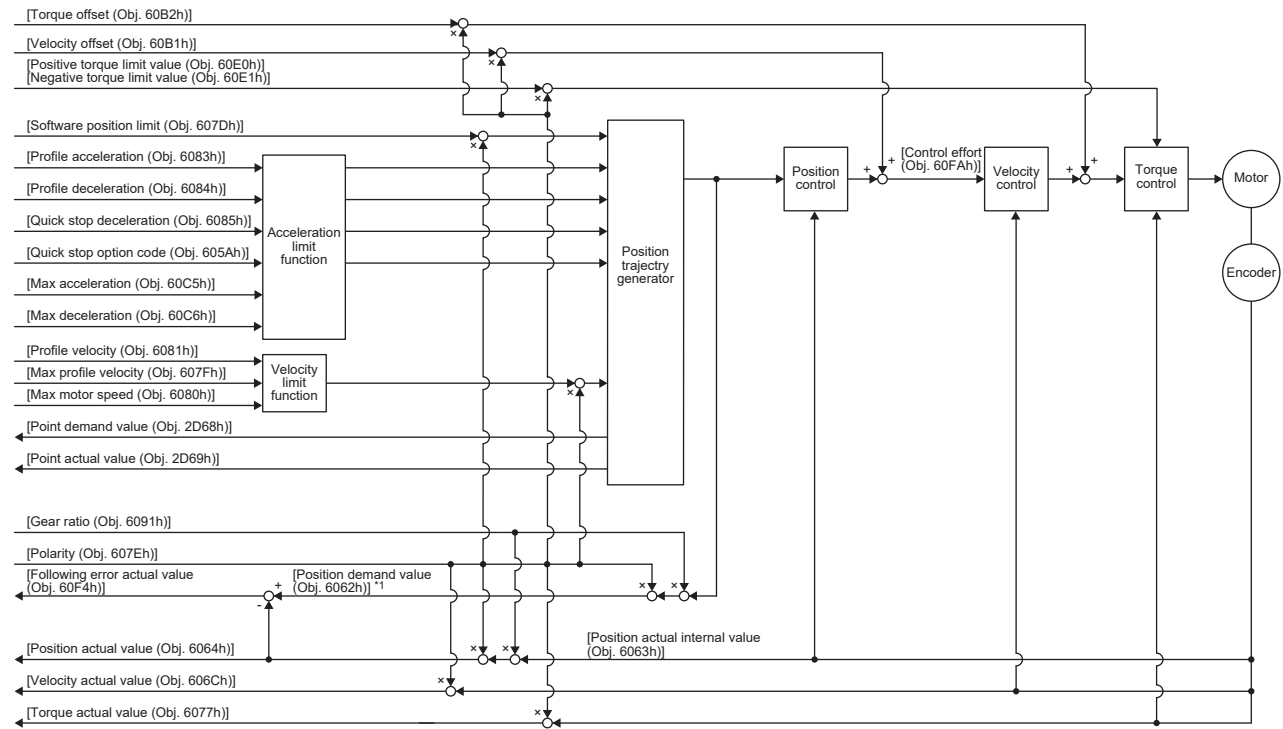

*1 This object may not be used depending on the network being used. For details, refer to the User's Manual (Object Dictionary).

Related objects

For details on the objects, refer to the User's Manual (Object Dictionary).

Index	Sub	Object	Name	Description
607Bh	0	ARRAY	Position range limit	Number of entries
	1		Min position range limit	Minimum value of the position range limit Unit: pos units
	2		Max position range limit	Maximum value of the position range limit Unit: pos units
607Dh	0	ARRAY	Software position limit	Number of entries
	1		Min position limit	Minimum position address Unit: pos units
	2		Max position limit	Maximum position address Unit: pos units
607Fh	—	VAR	Max profile velocity	Maximum speed Unit: vel units
6080h	—	VAR	Max motor speed	Servo motor maximum speed Unit: r/min, mm/s
6081h	—	VAR	Profile velocity	Speed after acceleration finished Unit: vel units
6083h	—	VAR	Profile acceleration	Acceleration at start of movement to target position Unit: acc units
6084h	—	VAR	Profile deceleration	Deceleration at arrival to target position Unit: acc units
6085h	—	VAR	Quick stop deceleration	Deceleration at deceleration to a stop with Quick stop Unit: acc units
605Ah	—	VAR	Quick stop option code	Operation setting for Quick stop ☞ Page 197 Quick stop [G]
6063h	—	VAR	Position actual internal value	Current position Unit: Enc inc
6064h	—	VAR	Position actual value	Current position Unit: pos units
606Ch	—	VAR	Velocity actual value	Current speed Unit: vel units
6077h	—	VAR	Torque actual value	Current torque Unit: 0.1 % (with rated torque being 100 %)
6092h	0	ARRAY	Feed constant	Travel distance per revolution of an output shaft
	1		Feed	Travel distance setting Unit: pos units
	2		Shaft revolutions	Number of servo motor shaft revolutions Unit: rev
60C5h *2	—	VAR	Max acceleration	Acceleration limit value Unit: Command unit/s ²
60C6h *2	—	VAR	Max deceleration	Deceleration limit value Unit: Command unit/s ²
60F4h	—	VAR	Following error actual value	Droop pulses Unit: pos units
60FAh	—	VAR	Control effort	Position control loop output (speed command) Unit: vel units
60E0h	—	VAR	Positive torque limit value	Torque limit value (forward) Unit: 0.1 % (with rated torque being 100 %)
60E1h	—	VAR	Negative torque limit value	Torque limit value (reverse) Unit: 0.1 % (with rated torque being 100 %)
6091h	0	ARRAY	Gear ratio	Gear ratio
	1		Motor revolutions	Number of revolutions of the servo motor shaft (numerator) ☞ Page 133 Electronic gear function [G]
	2		Shaft revolutions	Number of revolutions of the drive shaft (denominator) ☞ Page 133 Electronic gear function [G]

Index	Sub	Object	Name	Description
607Eh	—	VAR	Polarity	Polarity selection Bit 7: Position POL Bit 6: Velocity POL Bit 5: Torque POL  Page 109 Rotation/travel direction selection [G]
60A8h	—	VAR	SI unit position	SI unit position It is automatically set in [Pr. PT01.2 Unit for position data].
60A9h	—	VAR	SI unit velocity	SI unit velocity The SI unit velocity is returned. It is automatically set in [Pr. PT01.2 Unit for position data].
60AAh	—	VAR	SI unit acceleration	SI unit acceleration The SI unit acceleration is returned. It is automatically set in [Pr. PT01.2 Unit for position data] or [Pr. PT01.1 Speed/acceleration/deceleration unit selection].
6086h	—	VAR	Motion profile type	Acceleration/deceleration type selection -1: S-pattern 0: Linear ramp (not supported) 1: Sin ² ramp (not supported) 2: Jerk-free ramp (not supported) 3: Jerk-limited ramp (not supported)
2D68h	—	VAR	Point demand value	Point table request Always "0".
2D69h	—	VAR	Point actual value	Current point table The previous value is retained.
60B1h	—	VAR	Velocity offset	Velocity offset Unit: vel units
60B2h	—	VAR	Torque offset	Torque offset Unit: 0.1 % (with rated torque being 100 %)
6062h *1	—	VAR	Position demand value	Command position (absolute position) The command position inside the servo amplifier is returned. Unit: pos units

*1 This object may not be used depending on the network being used. For details, refer to the User's Manual (Object Dictionary).

*2 Available on servo amplifiers with firmware version C0 or later.

Controlword/Statusword

By changing [Controlword (Obj. 6040h)], control commands can be given to the servo amplifier. The control status can also be checked with [Statusword (Obj. 6041h)].

Some bits of [Controlword (Obj. 6040h)] and [Statusword (Obj. 6041h)] vary or are common depending on the control mode. The bits that vary depending on the control mode are listed in the following tables.

■ Controlword OMS Bit (jg)

Bit	Symbol	Description
4	Rotation start	0: Servo motor stop 1: Servo motor start
5	Direction	0: Forward rotation (Address increasing) 1: Reverse rotation (Address decreasing)
6	(reserved)	The value at reading is undefined. Set "0" when writing.
8	HALT	0: Performs positioning. 1: Stops the servo motor according to [Halt option code (Obj. 605Dh)].
9	(reserved)	The value at reading is undefined. Set "0" when writing.

■ Statusword OMS Bit (jg)

Bit	Symbol	Description
10	Target reached	0 (Halt (Bit 8) = 0) : Target position not reached. 0 (Halt (Bit 8) = 1) : Axis decelerates 1 (Halt (Bit 8) = 0) : Target position reached. 1 (Halt (Bit 8) = 1) : Velocity of axis is 0 Judgment condition of Target position reached When the difference between the current position and command position has stayed within [Position window (Obj. 6067h)] for [Position window time (Obj. 6068h)] or longer, the state becomes "Target position reached".
12	(reserved)	The value at reading is undefined.
13	Following error	0: No following error 1: Following error Judgment condition of Following error: When the time set in [Following error time out (Obj. 6066h)] elapses in a state where [Following error actual value (Obj. 60F4h)] exceeds the value set in [Following error window (Obj. 6065h)], this bit changes to "1".

Continuous operation to torque control mode (ct)

This mode is available on servo amplifiers with firmware version B0 or later.

Restrictions

The following functions are not available in the continuous operation to torque control mode. Therefore, if an alarm occurs, the servo motor will stop using the method DB or EDB, or coast.

- Base circuit shut-off delay time function
- Forced stop deceleration function
- Vertical axis freefall prevention function
- Stroke limit function
- Software position limit
- Auto tuning function
- Vibration suppression control 1, 2
- Slight vibration suppression control
- One-touch tuning
- Quick tuning function

Precautions

The relation between the setting value of the command torque and the servo motor torque generation direction can be changed with the setting values of [Pr. PA14 Travel direction selection] and [Pr. PC29.3 Torque POL reflection selection]. The servo motor outputs the torque calculated by adding up the command torque and the values set in [Pr. PE47 Unbalanced torque offset] and [Torque offset (Obj. 60B2h)].

Switching from the csv mode to the continuous operation to torque control mode while a large value is set in [Velocity offset (Obj. 60B1h)] may cause a shock.

In the continuous operation to torque control mode, the response to the torque command is affected. Do not set servo parameters as shown below.

- [Pr. PB12 Overshoot amount compensation] is set to a value other than "0".
- [Pr. PB24.1 PI-PID switching control selection] is set to "3".

Functions and the related objects

The following shows the functions of the continuous operation to torque control mode (ct) and the related objects.

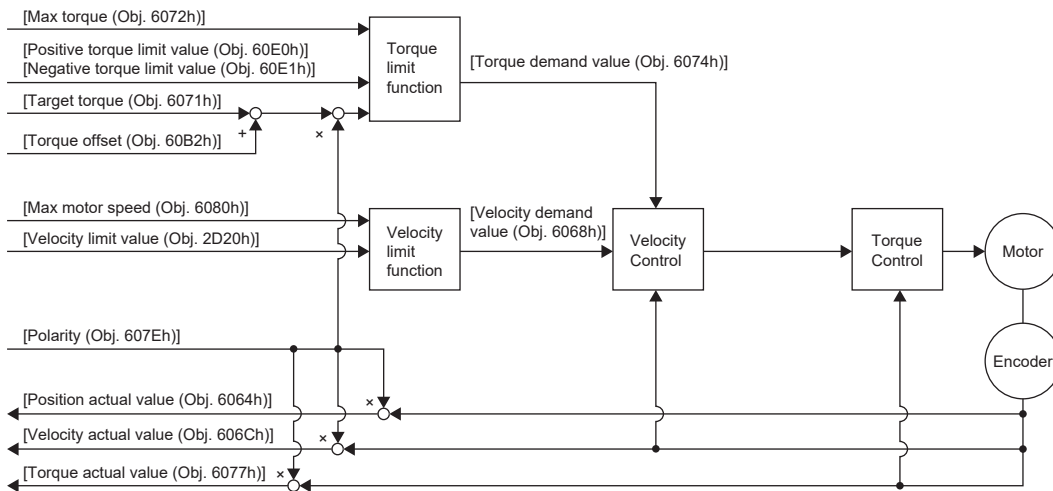

■ Related objects

For details on the objects, refer to the User's Manual (Object Dictionary).

Index	Sub	Object	Name	Description
6080h	—	VAR	Max motor speed	Servo motor maximum speed Unit: r/min
606Bh	—	VAR	Velocity demand value	Command speed (after limit) Unit: vel units
6071h	—	VAR	Target torque	Command torque Unit: 0.1 % (with rated torque being 100 %)
6072h	—	VAR	Max torque	Maximum torque Unit: 0.1 % (with rated torque being 100 %)
6074h	—	VAR	Torque demand value	Command torque (after limit) Unit: 0.1 % (with rated torque being 100 %)
6063h	—	VAR	Position actual internal value	Current position Unit: Enc inc
6064h	—	VAR	Position actual value	Current position Unit: Pos units
606Ch	—	VAR	Velocity actual value	Current speed Unit: vel units
6077h	—	VAR	Torque actual value	Current torque Unit: 0.1 % (with rated torque being 100 %)
6092h	0	ARRAY	Feed constant	Travel distance per revolution of an output shaft
	1		Feed	Travel distance setting
	2		Shaft revolutions	Number of servo motor shaft revolutions Unit: rev
60E0h	—	VAR	Positive torque limit value	Torque limit value (forward) Unit: 0.1 % (with rated torque being 100 %)
60E1h	—	VAR	Negative torque limit value	Torque limit value (reverse) Unit: 0.1 % (with rated torque being 100 %)
6091h	0	ARRAY	Gear ratio	Gear ratio
	1		Motor revolutions	Number of revolutions of the servo motor shaft (numerator) ☞ Page 133 Electronic gear function [G]
	2		Shaft revolutions	Number of revolutions of the drive shaft (denominator) ☞ Page 133 Electronic gear function [G]
607Eh	—	VAR	Polarity	Polarity selection Bit 7: Position POL Bit 6: Velocity POL Bit 5: Torque POL ☞ Page 109 Rotation/travel direction selection [G]
2D20h	—	VAR	Velocity limit value	Speed limit value Unit: vel units

Index	Sub	Object	Name	Description
60A8h	—	VAR	SI unit position	SI unit position It is automatically set in [Pr. PT01.2 Unit for position data].
60A9h	—	VAR	SI unit velocity	SI unit velocity The SI unit velocity is returned. It is automatically set in [Pr. PT01.2 Unit for position data].
60B2h	—	VAR	Torque offset	Torque offset Unit: 0.1 % (with rated torque being 100 %)

■ Controlword/Statusword

By changing [Controlword (Obj. 6040h)], control commands can be given to the servo amplifier. The control status can also be checked with [Statusword (Obj. 6041h)].

Some bits of [Controlword (Obj. 6040h)] and [Statusword (Obj. 6041h)] vary depending on the control mode. The bits that vary depending on the control mode are listed in the following tables.

- Controlword OMS Bit (ct)

Bit	Symbol	Description
4	(reserved)	The value at reading is undefined. Set "0" when writing.
5	(reserved)	
6	(reserved)	
8	(reserved)	
9	(reserved)	

- Statusword OMS Bit (ct)

Bit	Symbol	Description
10	(reserved)	The value at reading is undefined.
12	Target torque ignored	0: [Target torque (Obj. 6071h)] is being discarded. 1: [Target torque (Obj. 6071h)] is being used as a continuous operation to torque control loop input.
13	(reserved)	The value at reading is undefined.

■ Control mode switching

For information on the control switching, refer to "Control switching for continuous operation to torque control mode (ct)" in the User's Manual (Communication Function).

■ Setting the torque feedback control gain

In the continuous operation to torque control mode, use the initial value of [Pr. PB03 Torque feedback loop gain] for the torque feedback gain. If the response is not satisfactory, adjust the torque feedback gain.

 Page 53 Parameter adjustment method

Behavior

■ Behavior of the continuous operation to torque control mode

If a workpiece comes into contact with a target object in the continuous operation to torque control mode, the torque control is performed assuming that the command torque is the sum of the values set in [Target torque (Obj. 6071h)], [Pr. PE47 Unbalanced torque offset], and [Torque offset (Obj. 60B2h)]. If a workpiece does not come into contact with a target object, the mode attempts to move the servo motor using the speed limit value set in [Velocity limit value (Obj. 2D20h)]. The command torque and speed limit value can be changed in the continuous operation to torque control mode.

■ Current value in the continuous operation to torque control mode

[Position actual internal value (Obj. 6063h)] and [Position actual value (Obj. 6064h)] are continuously updated even in the continuous operation to torque control mode. However, since the software position limit is disabled, [AL. 098 Software position limit warning] will not occur even if [Position actual value (Obj. 6064h)] exceeds the software position limit value.

■ Switching between csp and continuous operation to torque control mode

The following shows a timing chart when the mode is switched between the csp mode and continuous operation to torque control mode.

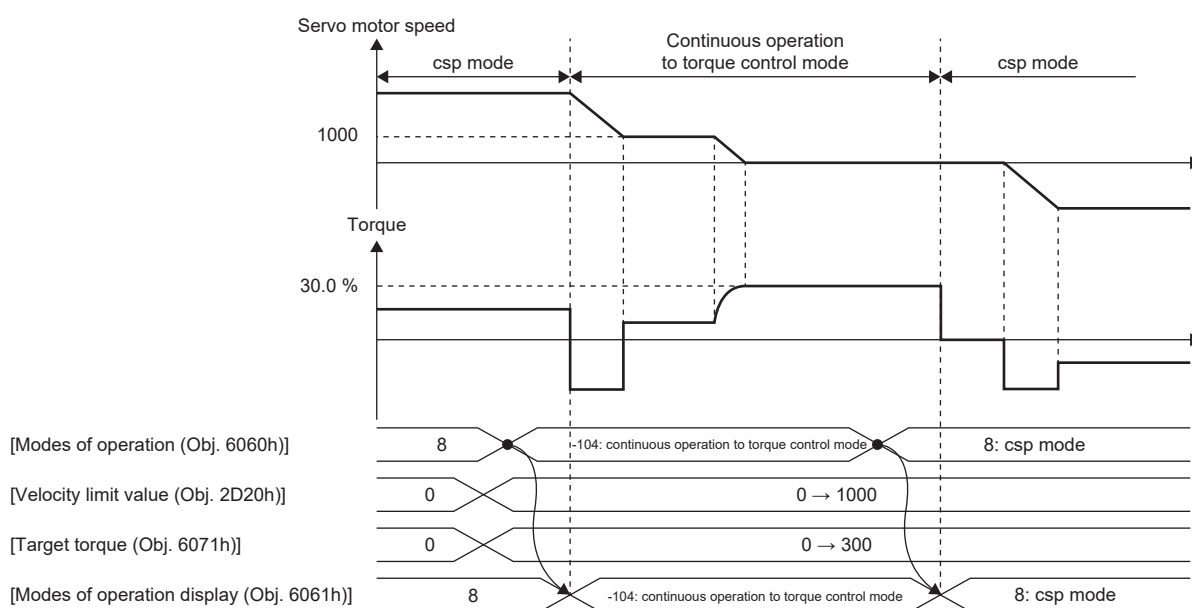

■ Switching between csv and continuous operation to torque control mode

The following shows a timing chart when the mode is switched between the csv mode and continuous operation to torque control mode.

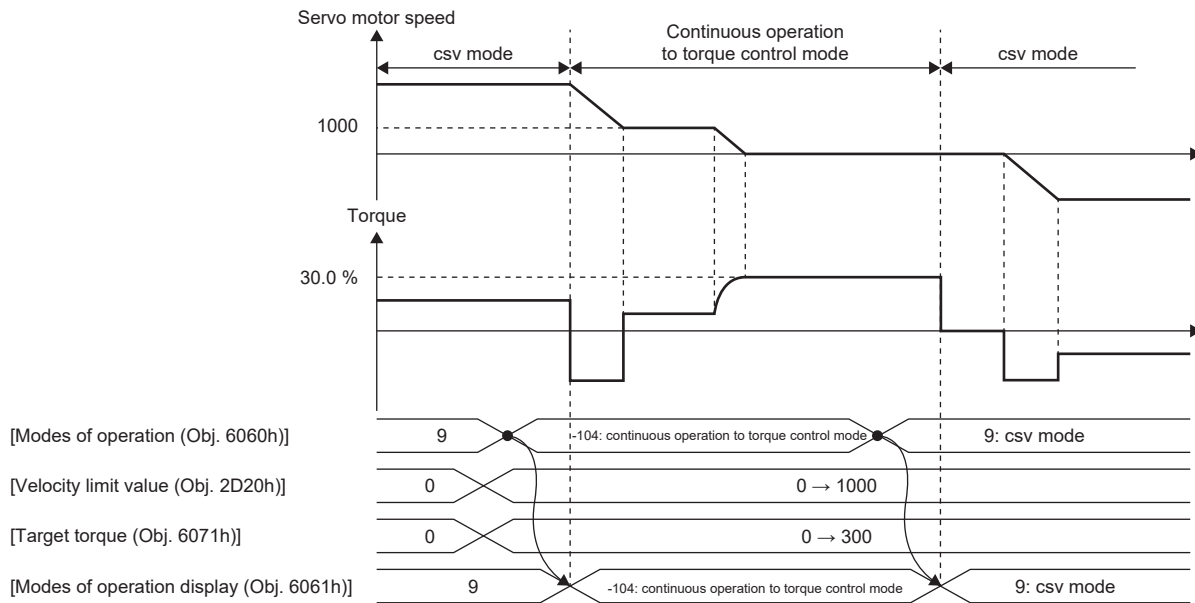

■ Parameter adjustment method

When using the continuous operation to torque control mode, adjust parameters using the following steps.

1. Adjusting servo stability

Adjust servo stability so that the operation is performed normally without vibration in the position mode or speed mode.

2. Setting the torque feedback gain

Restore the value of [Pr. PB03 Torque feedback loop gain] to the initial value.

3. Adjusting the torque feedback gain

If the servo motor speed or torque fluctuates when a workpiece comes into contact with a target object, decrease the value of [Pr. PB03]. Decreasing the value of [Pr. PB03] will help suppress fluctuation in servo motor speed or torque when a workpiece comes into contact with a target object. However, doing so will decrease trackability to the command torque.

Homing mode (hm)

The following shows the functions of the homing mode (hm) as well as related objects.

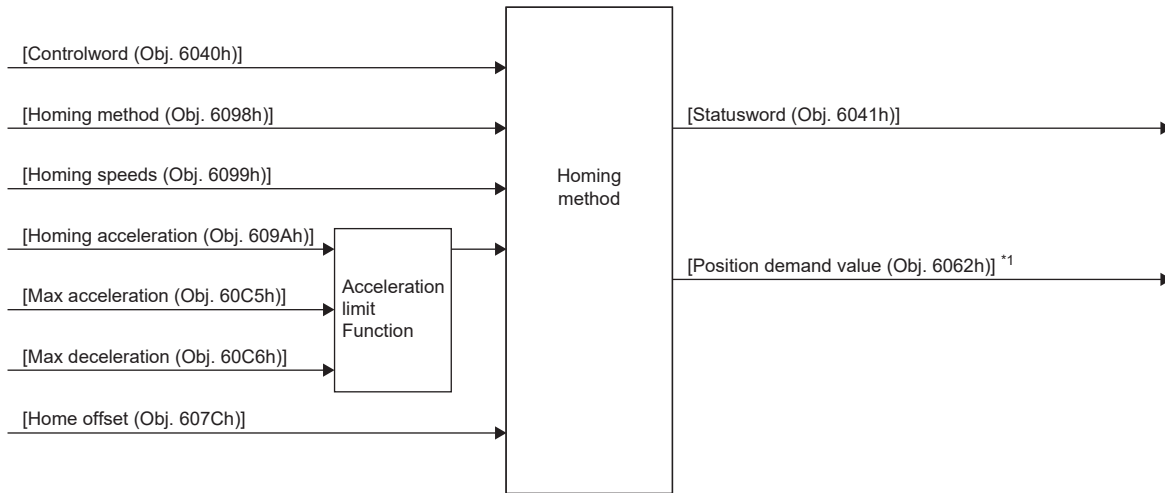

*1 This object may not be used depending on the network being used. For details, refer to the User's Manual (Object Dictionary).

Related objects

For details on the objects, refer to the User's Manual (Object Dictionary).

Index	Sub	Object	Name	Description
607Ch	0	VAR	Home offset	Set the difference between zero position of the machine coordinate system and homing position. After homing finishes, the value set to this object is subtracted from the homing position, and at the same time, [Position demand value (Obj. 6062h)] and [Position actual value (Obj. 6064h)] are changed. The setting made by this object is reflected upon completion of the homing operation or when the servo amplifier connects to the network. The setting is not reflected when homing is incomplete.
6098h	0	VAR	Homing Method	Specify a homing method. Refer to the following for the supported homing methods. ☞ Page 57 Homing method list
6099h	0	ARRAY	Homing Speeds	Number of entries of the homing speed
	1		Speed during search for switch	Specify the travel speed until dog detection. *2 (vel units) Range: 0 to servo motor maximum speed
	2		Speed during search for zero	Specify the travel speed to the home position after dog detection. *1 *2 (vel units) Range: 0 to servo motor maximum speed
609Ah	0	VAR	Homing acceleration	Acceleration/deceleration time constant at homing Unit: acc units
60C5h *4	—	VAR	Max acceleration	Acceleration limit value Unit: Command unit/s ²
60C6h *4	—	VAR	Max deceleration	Deceleration limit value Unit: Command unit/s ²
60E3h	0	ARRAY	Supported Homing Method	Number of entries of the supported homing method
	1		1st supported homing method	—
	to		—	—
	41		41st supported homing method	—
6062h *3	—	VAR	Position demand value	Command position (absolute position) The command position inside the servo amplifier is returned. Unit: pos units

*1 In the homing mode (hm), the servo motor is brought to a quick stop according to the deceleration time constant when the stroke end is detected. Set the homing speed carefully.

*2 If the set speed exceeds 8000 r/min (mm/s), the speed is clamped at 8000 r/min (mm/s).

*3 This object may not be used depending on the network being used. For details, refer to the User's Manual (Object Dictionary).

*4 Available on servo amplifiers with firmware version C0 or later.

Controlword/Statusword

By changing [Controlword (Obj. 6040h)], control commands can be given to the servo amplifier. The control status can also be checked with [Statusword (Obj. 6041h)].

Some bits of [Controlword (Obj. 6040h)] and [Statusword (Obj. 6041h)] vary depending on the control mode. The bits that vary depending on the control mode are listed in the following tables.

■ Controlword OMS Bit (hm)

Bit	Symbol	Description
4	HOS	Homing operation start 0: Do not start homing procedure 1: Start or continue homing procedure
5	(reserved)	The value at reading is undefined. Set "0" when writing.
6	(reserved)	
8	HALT	Halt 0: Drives the servo motor. 1: Stops the servo motor according to [Halt option code (Obj. 605Dh)].
9	(reserved)	The value at reading is undefined. Set "0" when writing.

■ Statusword OMS Bit (hm)



- Before updating the position after homing finishes, check that both Bit 12 and Bit 10 of Statusword have been changed to "1".

Bit	Symbol	Description
10	Target reached	Refer to the following table for the description.
12	Homing attained	
13	Homing error	

The following shows the definition of Bit 10, Bit 12, and Bit 13 of Statusword in the hm mode.

Bit 13	Bit 12	Bit 10	Definition
0	0	0	Homing procedure is in progress.
0	0	1	Homing procedure is interrupted or not started.
0	1	0	Homing is attained, but target is not reached.
0	1	1	Homing procedure is completed successfully.
1	0	0	Homing error occurred, velocity is not 0.
1	0	1	Homing error occurred, velocity is 0.
1	1	—	reserved

Homing method list

In the following cases, make sure that the Z-phase has been passed once before performing homing. If the Z-phase has not been passed, [AL. 090.5 Homing incomplete warning] will occur.

- When using an incremental linear encoder in the linear servo motor control mode
- When using an incremental external encoder in the fully closed loop control mode
- When using a direct drive motor manufactured by Mitsubishi Electric in the direct drive motor control mode

To execute homing securely, move the linear servo motor to the opposite stroke end with csv or other operation modes from the controller, then start homing. [Digital inputs (Obj. 60FDh)] can be used to check whether the linear servo motor has reached the stroke end.

When changing the mode after homing finishes, set [Target position (Obj. 607Ah)] to "0", then change the control mode.

If using an A/B/Z-phase differential output rotary encoder without a Z-phase, do not perform dog type homing or homing using a Z-phase. Doing so may cause the servo motor to keep driving without homing being completed. Perform data set type homing or homing without using a Z-phase.

If an A/B/Z-phase differential output type encoder is used, the accuracy of homing using the Z-phase depends on the Z-phase width in relation to the A and B-phases.

For servo amplifiers with firmware version D4 or later, the setting of [Pr. PA14 Travel direction selection (*POL)] can be reflected to the homing direction depending on the setting value of [Pr. PT55.1 Homing POL reflection selection].

To specify the homing method in the homing mode (hm), use [Homing Method (Obj. 6098h)]. The homing methods in the following table are supported.

Method No.	Homing methods	Homing direction *3		Description	Home position shift function
		[Pr. PA14] = 0	[Pr. PA14] = 1		
-1	Dog type homing (Rear end detection - Z-phase reference)	Forward rotation (CCW) or positive direction	Reverse rotation (CW) or negative direction	Performs homing using the Z-phase pulse after a moving part has moved past the proximity dog. Deceleration starts from the front end of the proximity dog. After the rear end is passed, the position specified by the first Z-phase signal or the position of the first Z-phase signal shifted by the specified home position shift distance is used as the home position.	Available
-33		Reverse rotation (CW) or negative direction	Forward rotation (CCW) or positive direction		Available
-2	Count type homing (Front end detection - Z-phase reference)	Forward rotation (CCW) or positive direction	Reverse rotation (CW) or negative direction	Performs homing using the encoder pulse count after a moving part came into contact with the proximity dog. Deceleration starts from the front end of the proximity dog. After the front end is passed, the position specified by the first Z-phase signal after the set distance or the position of the Z-phase signal shifted by the set home position shift distance is set as the home position.	Available
-34		Reverse rotation (CW) or negative direction	Forward rotation (CCW) or positive direction		Available
-3	Data set type homing	—	—	Performs homing without a dog. The current position is set as the home position. Homing can be executed in the Operational enabled state. Homing cannot be executed in the servo-off status.	Not available
-4	Stopper type homing (Stopper position reference)	Forward rotation (CCW) or positive direction	Reverse rotation (CW) or negative direction	Performs homing with a workpiece pressed against a mechanical stopper. A workpiece is pressed against a mechanical stopper, and the stop position is set as the home position.	Not available
-36		Reverse rotation (CW) or negative direction	Forward rotation (CCW) or positive direction		Not available
-6	Dog type homing (Rear end detection - rear end reference)	Forward rotation (CCW) or positive direction	Reverse rotation (CW) or negative direction	Performs homing with reference to the rear end of the proximity dog. Deceleration starts from the front end of the proximity dog. After the rear end is passed, the position is shifted by the travel distance after proximity dog and the home position shift distance. The position after the shifts is set as the home position.	Available
-38		Reverse rotation (CW) or negative direction	Forward rotation (CCW) or positive direction		Available

Method No.	Homing methods	Homing direction *3		Description	Home position shift function
		[Pr. PA14] = 0	[Pr. PA14] = 1		
-7	Count type homing (Front end detection - front end reference)	Forward rotation (CCW) or positive direction	Reverse rotation (CW) or negative direction	Performs homing with reference to the front end of the proximity dog. Deceleration starts from the front end of the proximity dog. The position is shifted by the travel distance after the proximity dog and the home position shift distance. The position after the shifts is set as the home position.	Available
-39		Reverse rotation (CW) or negative direction	Forward rotation (CCW) or positive direction		Available
-8	Dog cradle type homing	Forward rotation (CCW) or positive direction	Reverse rotation (CW) or negative direction	Performs homing using the first Z-phase pulse with reference to the front end of the proximity dog. The position specified by either the first Z-phase signal after the front end of the proximity dog is detected or the position of the first Z-phase signal shifted by the home position shift distance can be set as the home position.	Available
-40		Reverse rotation (CW) or negative direction	Forward rotation (CCW) or positive direction		Available
-9	Dog type last Z-phase reference homing	Forward rotation (CCW) or positive direction	Reverse rotation (CW) or negative direction	Performs homing using the last Z-phase pulse with reference to the front end of the proximity dog. After the front end of the proximity dog is detected, the position is shifted away from the proximity dog in the reverse direction. Then, the position specified by the first Z-phase signal or the position of the first Z-phase signal shifted by the home position shift distance is used as the home position.	Available
-41		Reverse rotation (CW) or negative direction	Forward rotation (CCW) or positive direction		Available
-10	Dog type front end reference homing	Forward rotation (CCW) or positive direction	Reverse rotation (CW) or negative direction	Performs homing with reference to the front end of the proximity dog in the direction of the front end. Starting from the front end of the proximity dog, the position is shifted by the travel distance after the proximity dog and the home position shift distance. The position after the shifts is set as the home position.	Available
-42		Reverse rotation (CW) or negative direction	Forward rotation (CCW) or positive direction		Available
-11	Dogless Z-phase reference homing	Forward rotation (CCW) or positive direction	Reverse rotation (CW) or negative direction	Performs homing with reference to the first Z-phase in the direction of the dog front end. The position specified by the first Z-phase signal or the position of the first Z-phase signal shifted by the home position shift distance is used as the home position.	Available
-43		Reverse rotation (CW) or negative direction	Forward rotation (CCW) or positive direction		Available
1 **	Homing on negative limit switch and index pulse	Reverse rotation (CW) or negative direction	Forward rotation (CCW) or positive direction	After the reverse rotation stroke end is detected, the position moves in the opposite direction. Then, the position specified by either the first Z-phase signal after leaving the stroke end or the position of the first Z-phase signal shifted by the home position shift distance can be set as the home position. If the position is shifted in the forward rotation direction, and the forward rotation stroke end is detected before the Z-phase signal is detected, [AL. 090 Homing incomplete warning] will occur. When FLS/RLS is used, this homing method is available on servo amplifiers with firmware version C0 or later.	Available

Method No.	Homing methods	Homing direction ^{*3}		Description	Home position shift function
		[Pr. PA14] = 0	[Pr. PA14] = 1		
2 ^{*1}	Homing on positive limit switch and index pulse	Forward rotation (CCW) or positive direction	Reverse rotation (CW) or negative direction	After the forward rotation stroke end is detected, the position moves in the opposite direction. Then, the position specified by either the first Z-phase signal after leaving the stroke end or the position of the first Z-phase signal shifted by the home position shift distance can be set as the home position. If the position is shifted in the reverse rotation direction, and the reverse rotation stroke end is detected before the Z-phase signal is detected, [AL. 090 Homing incomplete warning] will occur. When FLS/RLS is used, this homing method is available on servo amplifiers with firmware version C0 or later.	Available
3	Homing on positive home switch and index pulse	Forward rotation (CCW) or positive direction	Reverse rotation (CW) or negative direction	This is the same as the dog type last Z-phase reference homing. If the stroke end is detected during homing, [AL. 090 Homing incomplete warning] will occur.	Available
4	Homing on positive home switch and index pulse	Forward rotation (CCW) or positive direction	Reverse rotation (CW) or negative direction	This is the same as the dog cradle type homing. If the stroke end is detected during homing, [AL. 090 Homing incomplete warning] will occur.	Available
5	Homing on negative home switch and index pulse	Reverse rotation (CW) or negative direction	Forward rotation (CCW) or positive direction	This is the same as the dog type last Z-phase reference homing. If the stroke end is detected during homing, [AL. 090 Homing incomplete warning] will occur.	Available
6	Homing on negative home switch and index pulse	Reverse rotation (CW) or negative direction	Forward rotation (CCW) or positive direction	This is the same as the dog cradle type homing. If the stroke end is detected during homing, [AL. 090 Homing incomplete warning] will occur.	Available
7	Homing on home switch and index pulse	Forward rotation (CCW) or positive direction	Reverse rotation (CW) or negative direction	This is the same as the dog type last Z-phase reference homing.	Available
8	Homing on home switch and index pulse	Forward rotation (CCW) or positive direction	Reverse rotation (CW) or negative direction	This is the same as the dog cradle type homing.	Available
9 ^{*2}	Homing on home switch and index pulse	Forward rotation (CCW) or positive direction	Reverse rotation (CW) or negative direction	With reference to the rear end of the proximity dog, the home position is the Z-phase pulse immediately before the rear end of the dog. With this homing method, the position shifted by the home position shift distance is used as the home position.	Available
10 ^{*2}	Homing on home switch and index pulse	Forward rotation (CCW) or positive direction	Reverse rotation (CW) or negative direction	With reference to the rear end of the proximity dog, the home position is the Z-phase pulse immediately before the rear end of the dog. With this homing method, the position shifted by the home position shift distance is used as the home position.	Available
11	Homing on home switch and index pulse	Reverse rotation (CW) or negative direction	Forward rotation (CCW) or positive direction	This is the same as the dog type last Z-phase reference homing.	Available
12	Homing on home switch and index pulse	Reverse rotation (CW) or negative direction	Forward rotation (CCW) or positive direction	This is the same as the dog cradle type homing.	Available
13 ^{*2}	Homing on home switch and index pulse	Reverse rotation (CW) or negative direction	Forward rotation (CCW) or positive direction	This is the same as Homing method 9.	Available
14 ^{*2}	Homing on home switch and index pulse	Reverse rotation (CW) or negative direction	Forward rotation (CCW) or positive direction	This is the same as Homing method 10.	Available

Method No.	Homing methods	Homing direction *3		Description	Home position shift function
		[Pr. PA14] = 0	[Pr. PA14] = 1		
17 *2	Homing without index pulse	Reverse rotation (CW) or negative direction	Forward rotation (CCW) or positive direction	After the reverse rotation stroke end is detected, the position is shifted away from the stroke end in the forward direction, where the home position is set. With this homing method, the position shifted by the home position shift distance is used as the home position. If the position is shifted in the forward rotation direction, and the forward rotation stroke end is detected, [AL. 090 Homing incomplete warning] will occur.	Available
18 *2	Homing without index pulse	Forward rotation (CCW) or positive direction	Reverse rotation (CW) or negative direction	After the forward rotation stroke end is detected, the position is shifted away from the stroke end in the reverse direction, where the home position is set. With this homing method, the position shifted by the home position shift distance is used as the home position. If the position is shifted in the reverse rotation direction, and the reverse rotation stroke end is detected, [AL. 090 Homing incomplete warning] will occur.	Available
19	Homing without index pulse	Forward rotation (CCW) or positive direction	Reverse rotation (CW) or negative direction	This is the same as the dog type front end reference homing. If the stroke end is detected during homing, [AL. 090 Homing incomplete warning] will occur.	Available
20	Homing without index pulse	Forward rotation (CCW) or positive direction	Reverse rotation (CW) or negative direction	Although this type is the same as the dog cradle type homing, the stop position is not on the Z-phase. Starting from the front end of the dog, the position is shifted by the travel distance after proximity dog and the home position shift distance. The position after the shifts is set as the home position. If the stroke end is detected during homing, [AL. 090 Homing incomplete warning] will occur.	Available
21	Homing without index pulse	Reverse rotation (CW) or negative direction	Forward rotation (CCW) or positive direction	This is the same as the dog type front end reference homing. If the stroke end is detected during homing, [AL. 090 Homing incomplete warning] will occur.	Available
22	Homing without index pulse	Reverse rotation (CW) or negative direction	Forward rotation (CCW) or positive direction	Although this type is the same as the dog cradle type homing, the stop position is not on the Z-phase. Starting from the front end of the dog, the position is shifted by the travel distance after proximity dog and the home position shift distance. The position after the shifts is set as the home position. If the stroke end is detected during homing, [AL. 090 Homing incomplete warning] will occur.	Available
23	Homing without index pulse	Forward rotation (CCW) or positive direction	Reverse rotation (CW) or negative direction	This is the same as the dog type front end reference homing.	Available
24	Homing without index pulse	Forward rotation (CCW) or positive direction	Reverse rotation (CW) or negative direction	Although this type is the same as the dog cradle type homing, the stop position is not on the Z-phase. Starting from the front end of the dog, the position is shifted by the travel distance after proximity dog and the home position shift distance. The position after the shifts is set as the home position.	Available
27	Homing without index pulse	Reverse rotation (CW) or negative direction	Forward rotation (CCW) or positive direction	This is the same as the dog type front end reference homing.	Available

Method No.	Homing methods	Homing direction ^{*3}		Description	Home position shift function
		[Pr. PA14] = 0	[Pr. PA14] = 1		
28	Homing without index pulse	Reverse rotation (CW) or negative direction	Forward rotation (CCW) or positive direction	Although this type is the same as the dog cradle type homing, the stop position is not on the Z-phase. Starting from the front end of the dog, the position is shifted by the travel distance after proximity dog and the home position shift distance. The position after the shifts is set as the home position.	Available
33	Homing on index pulse	Reverse rotation (CW) or negative direction	Forward rotation (CCW) or positive direction	Although this type is the same as the dogless Z-phase reference homing, the creep speed is applied as the movement start speed.	Available
34	Homing on index pulse	Forward rotation (CCW) or positive direction	Reverse rotation (CW) or negative direction	Although this type is the same as the dogless Z-phase reference homing, the creep speed is applied as the movement start speed.	Available
35	Homing on current position	—	—	The current position is set as the home position. Homing can be executed even when the servo amplifier is not in the Operational enabled state. Homing can be executed in the servo-off status as well.	Not available
37	Homing on current position	—	—	The current position is set as the home position. Homing can be executed even when the servo amplifier is not in the Operational enabled state. Homing can be executed in the servo-off status as well.	Not available

*1 Available on servo amplifiers with firmware version B2 or later.

*2 Available on servo amplifiers with firmware version C0 or later.

*3 When [Pr. PT55.1 Homing POL reflection selection] is set to "1" for servo amplifiers with firmware version D4 or later, the setting value of [Pr. PA14_Travel direction selection] is reflected at homing.

Home position shift function

The home position shift function can set the position shifted by the value set in [Pr. PT07] from the reference home position in each homing method as the home position.

Restriction

For the homing methods available in the home position shift function, refer to the following list.

☞ Page 57 Homing method list

Precautions

- The timing charts of the homing method operation examples are described assuming the home position shift distance is a positive value. Setting the home position shift distance to a negative value will move the position in the opposite direction.
- If the home position shift distance is a positive value, the servo motor will not stop even if it reaches the reference position in accordance with the homing method. The servo motor will stop after it moves by the shift distance. If the home position shift distance is a negative value, the servo motor will move to the reference position once in the set homing method. After that, the servo motor will move by the set shift distance.
- The creep speed is applied when the servo motor moves by the home position shift distance.

Setting method

Set the home position shift distance in [Pr. PT07 Home position shift distance].

Ex.

Dog type homing is shown in the timing charts.

- When the home position shift distance is a positive value

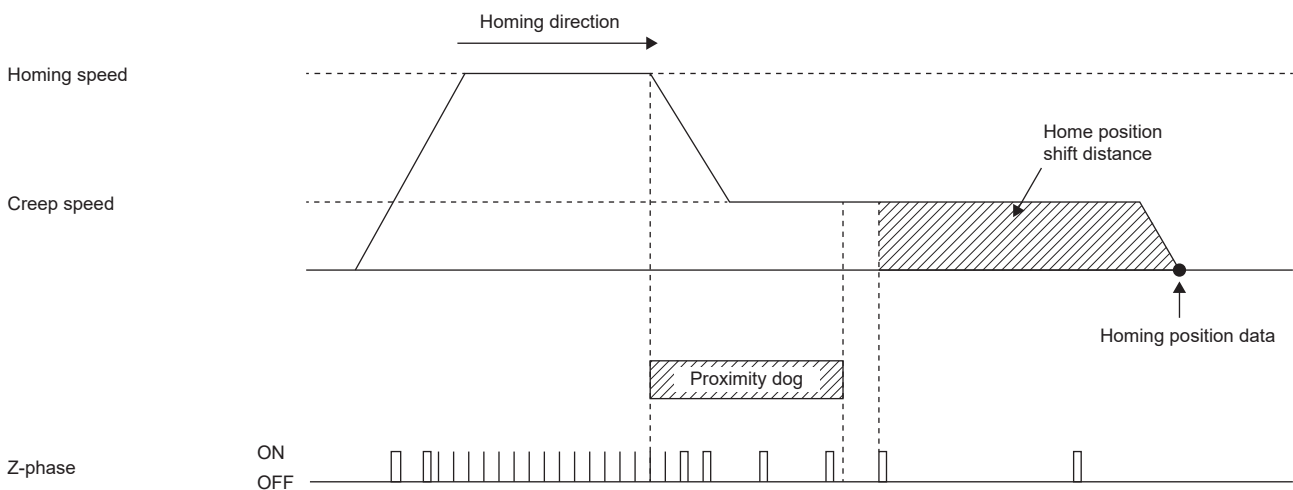

- When the home position shift distance is a negative value

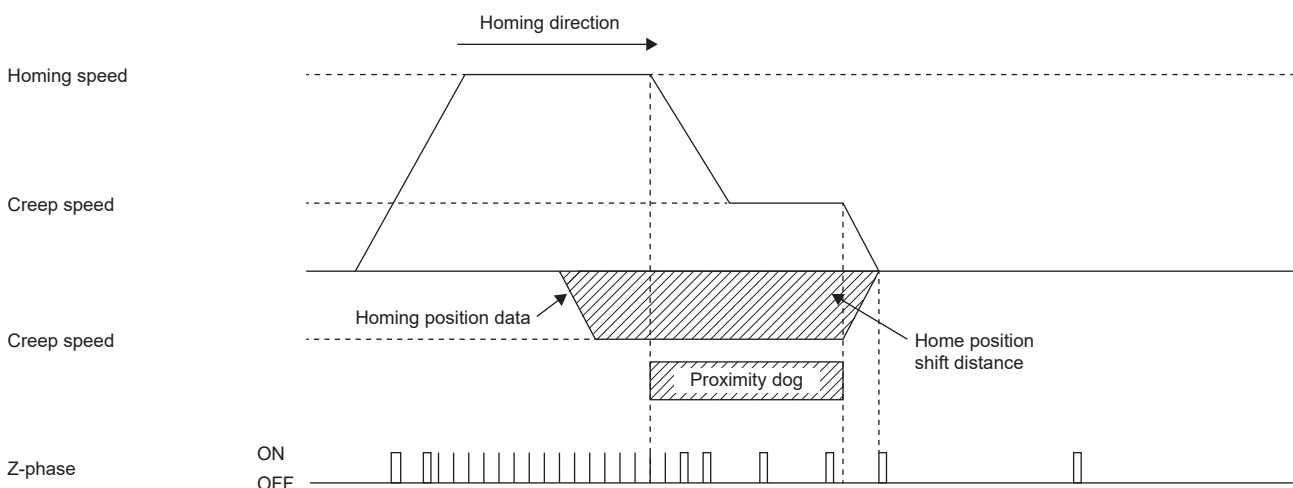

Conditions for erasing absolute position data

For an incremental system, the absolute position data is erased in the following situations:

- If homing is not being executed.
- If homing is in progress.
- If [AL. 069 Command error] occurs.

For an absolute position detection system, the absolute position data is erased in the following situations:

- If homing is not being executed.
- If homing is in progress.
- If [AL. 069 Command error] occurs.
- If [AL. 025 Absolute position erased] or [AL. 0E3 Absolute position counter warning] occurs.
- If the electronic gear ([Pr. PA06] or [Pr. PA07]) is changed.
- If the setting of [Pr. PA03.0 Absolute position detection system selection] is changed.
- If [Pr. PA14 Travel direction selection] is changed.
- If [Pr. PA01.1 Operation mode] is changed.

CiA 402-type Homing method

Point

- For details on signal polarity and other I/O device assignments, refer to the following.
☞ Page 147 Assigning I/O devices

The following shows the CiA 402-type homing.

■ Method 1: Homing on negative limit switch and index pulse

This homing method uses the stroke end as reference and sets the Z-phase right after the stroke end as a home position. After the reverse rotation stroke end is detected, the position is shifted away from the stroke end at creep speed in the forward rotation direction. Then, the position specified by the first Z-phase signal or the position of the first Z-phase signal shifted by the home position shift distance is used as the home position.

Note that if the position is shifted in the forward rotation direction, and the forward rotation stroke end is detected before the Z-phase signal is detected, [AL. 090 Homing incomplete warning] will occur.

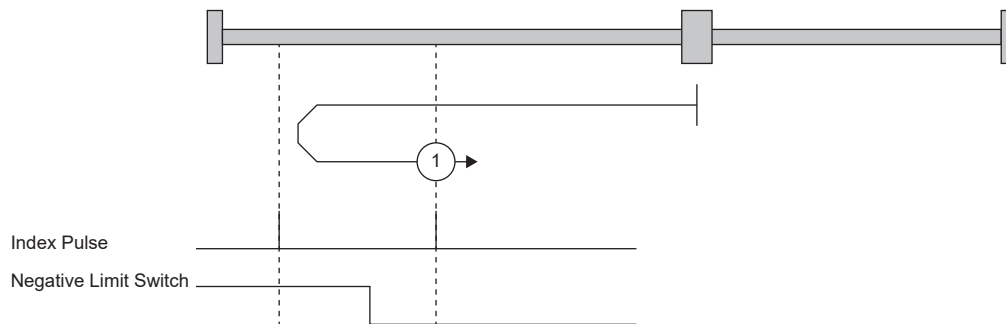

■ Method 2: Homing on positive limit switch and index pulse

This homing method uses the stroke end as reference and sets the Z-phase right after the stroke end as a home position. After the forward rotation stroke end is detected, the position is shifted away from the stroke end at creep speed in the reverse rotation direction. Then, the position specified by the first Z-phase signal or the position of the first Z-phase signal shifted by the home position shift distance is used as the home position.

Note that if the position is shifted in the reverse rotation direction, and the reverse rotation stroke end is detected before the Z-phase signal is detected, [AL. 090 Homing incomplete warning] will occur.

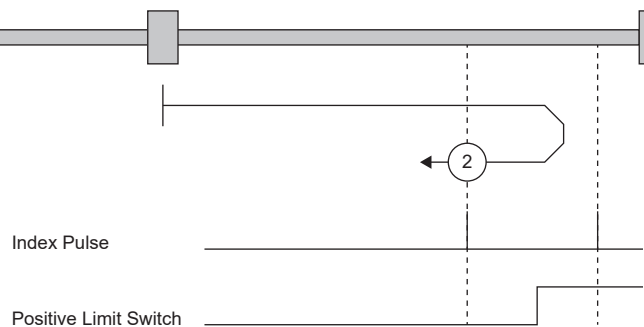

Method 3 and Method 4: Homing on positive home switch and index pulse

These homing methods use the front end of the proximity dog as reference and set the Z-phase right before and right after the dog as a home position.

Method 3 has the same operation as the dog type last Z-phase reference homing, and Method 4 has the same operation as the dog cradle type homing at a forward rotation start. However, if the stroke end is detected during homing, [AL. 090] occurs.

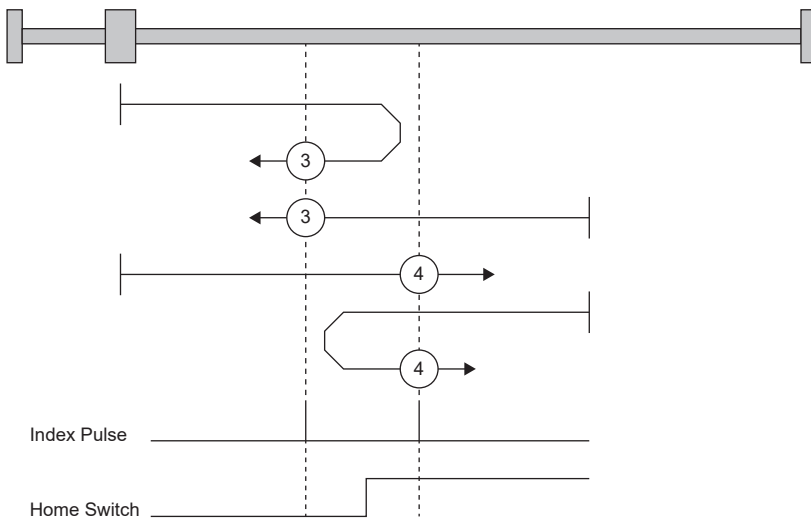

Method 5 and Method 6: Homing on negative home switch and index pulse

These homing methods use the front end of the proximity dog as reference and set the Z-phase right before and right after the dog as a home position. Method 5 and 6 are the same as Method 3 and 4 except that the starting direction is forward in Method 3 and 4, and reverse in Method 5 and 6.

Method 7, Method 8, Method 11, and Method 12: Homing on home switch and index pulse

These methods include the operation at stroke end detection in addition to the operation of Method 3 to Method 6. Thus, the home position is the same as that of Method 3 to Method 6. Method 7 has the same operation as dog type last Z-phase reference homing. Method 8 has the same operation as dog cradle type homing at a forward rotation start. Method 11 and 12 are the same as Method 7 and 8 except that the starting direction is forward in Method 7 and 8, and reverse in Method 11 and 12.

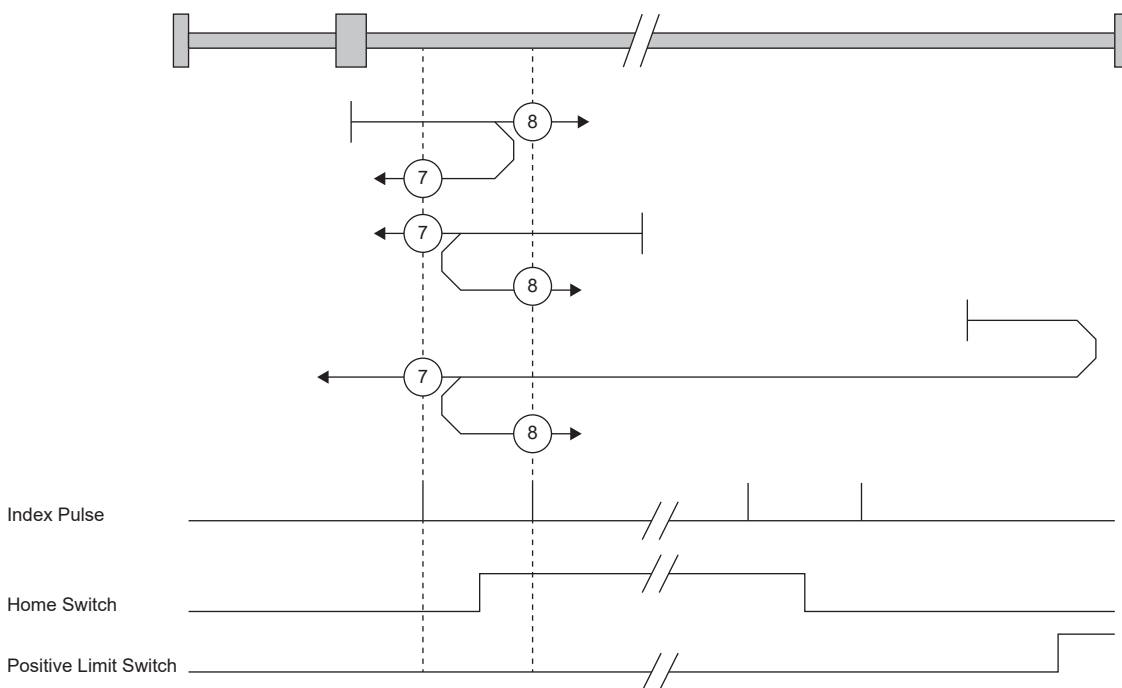

■ Method 9, Method 10, Method 13, and Method 14: Homing on home switch and index pulse

These homing methods use the Home switch (dog) and Index pulse (Z-phase). The homing direction is forward rotation (CCW) or positive direction.

In Method 9, the home position is the Z-phase immediately before the rear end of the dog, and in Method 10, the home position is the Z-phase immediately after the rear end of the dog. When the forward rotation stroke end is detected, the moving direction is reverse rotation (CW) or reverse direction.

Method 13 and Method 14 are similar to Method 9 and Method 10, except that the homing direction is reverse rotation (CW) or reverse direction.

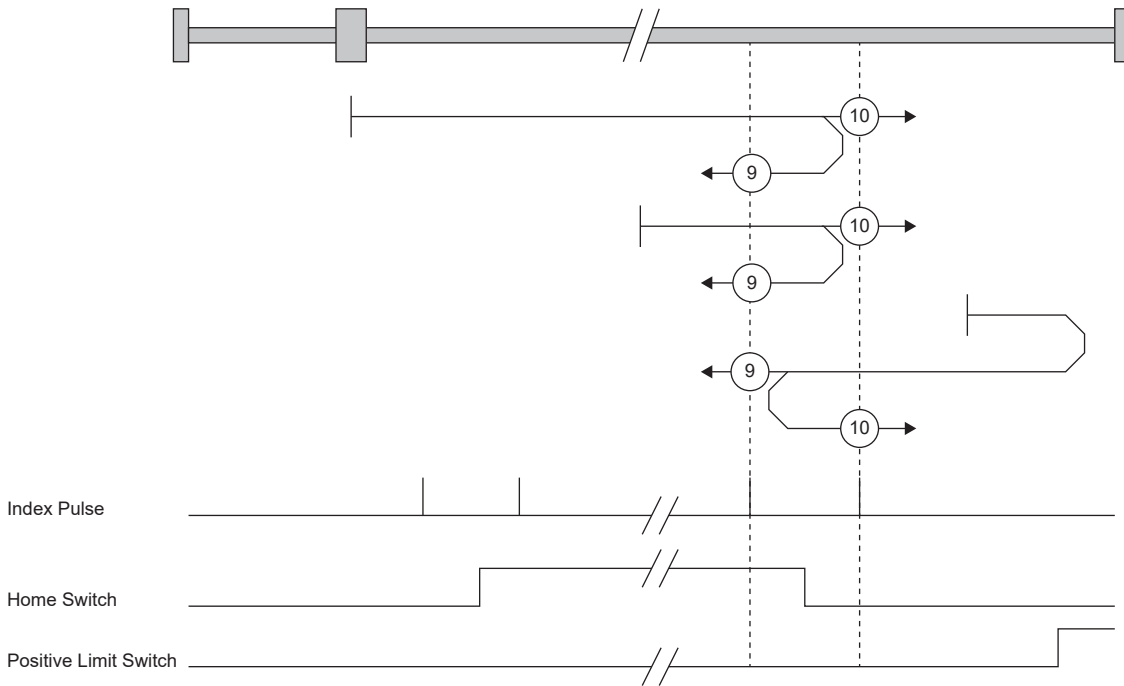

■ Method 17 to Method 30: Homing without index pulse

Method 17 to Method 30 have the same movement as Method 1 to Method 14, but these methods set the home position on the dog or stroke end, but not on the Z-phase. The following figure shows the operation of the homing methods of Method 19 and Method 20. Method 19 and Method 20 have the same operation as Method 3 and Method 4; however, these types set the home position on the dog but not on the Z-phase. Also, Method 19 has the same operation as the dog type front end reference homing. Method 20 has the same operation as the dog cradle type homing; however, the stop position is on the dog but not on the Z-phase.

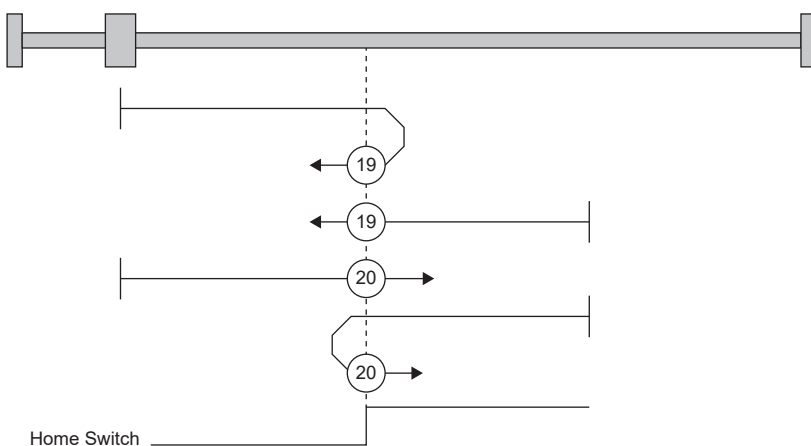

Method 33 and Method 34: Homing on index pulse

These homing methods set the Z-phase detected first as a home position. The operation is the same as that of the dogless Z-phase reference homing except that the creep speed is applied at the start.

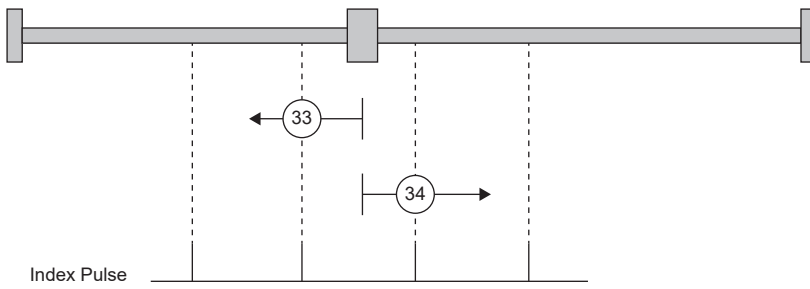

Method 35 and Method 37: Homing on current position

These homing methods set the current position as a home position. The operation is the same as that of the data set type homing, however, homing can be executed even in the servo-off status.

Homing cannot be executed in the servo-off status when Motion modules manufactured by Mitsubishi Electric (RD78G(H)/FX5-SSC-G) are used. For details, refer to each controller manual.

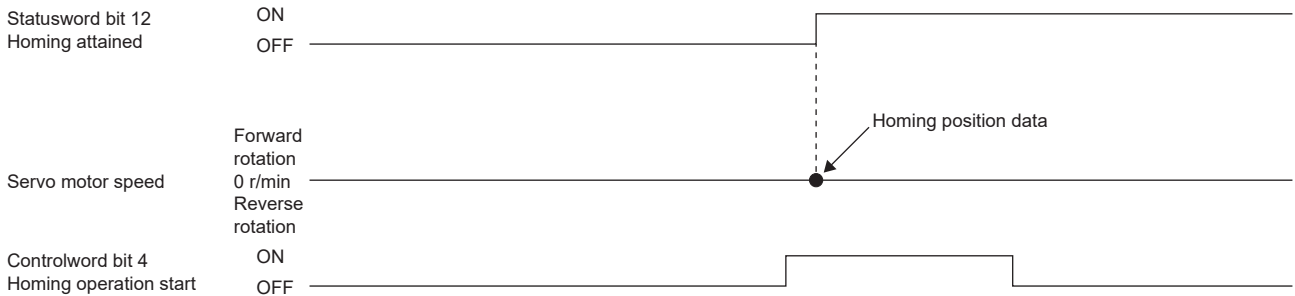

Operation example of the CiA 402-type Homing method

The following shows an operation example of the homing in the CiA 402-type Homing method when [Pr. PA14_Travel direction selection] is set to "0".

The homing direction when [Pr. PA14] is "1" is opposite to the figure.

When [Pr. PT55.1 Homing POL reflection selection] is set to "1" for servo amplifiers with firmware version D4 or later, the setting value of [Pr. PA14] is reflected at homing.

■ Method 1 (Homing on negative limit switch and index pulse) and Method 2 (Homing on positive limit switch and index pulse)

The following figure shows the operation of Homing method 2 when the home position shift distance is a positive value. The homing direction of Homing method 1 is opposite to that of Homing method 2.



- If there is a stroke end near the Z-phase, the homing completion position varies. The recommended detection position for the stroke end can be found by rotating the servo motor about a half-turn away.

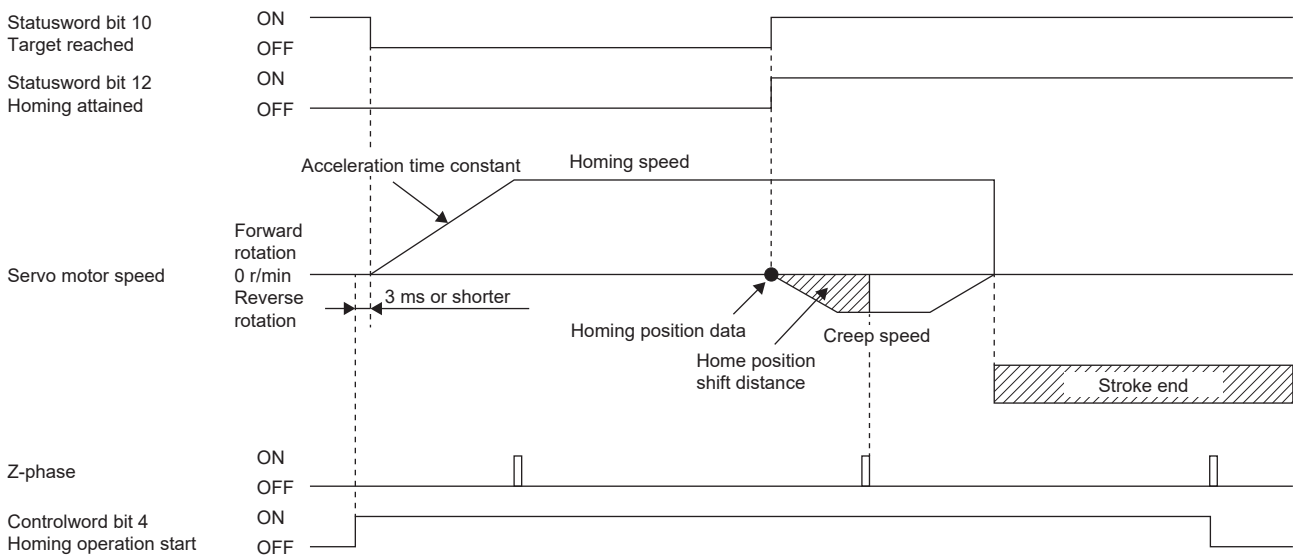

- When homing is started from the stroke end

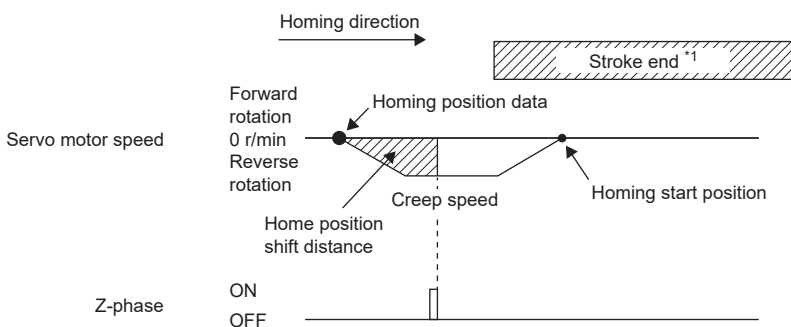

*1 This cannot be used with the software limit.

■ Method 3 (Homing on positive home switch and index pulse) and Method 5 (Homing on negative home switch and index pulse)

The following figure shows the operation of Homing method 3 when the home position shift distance is a positive value. The homing direction of Homing method 5 is opposite to that of Homing method 3.

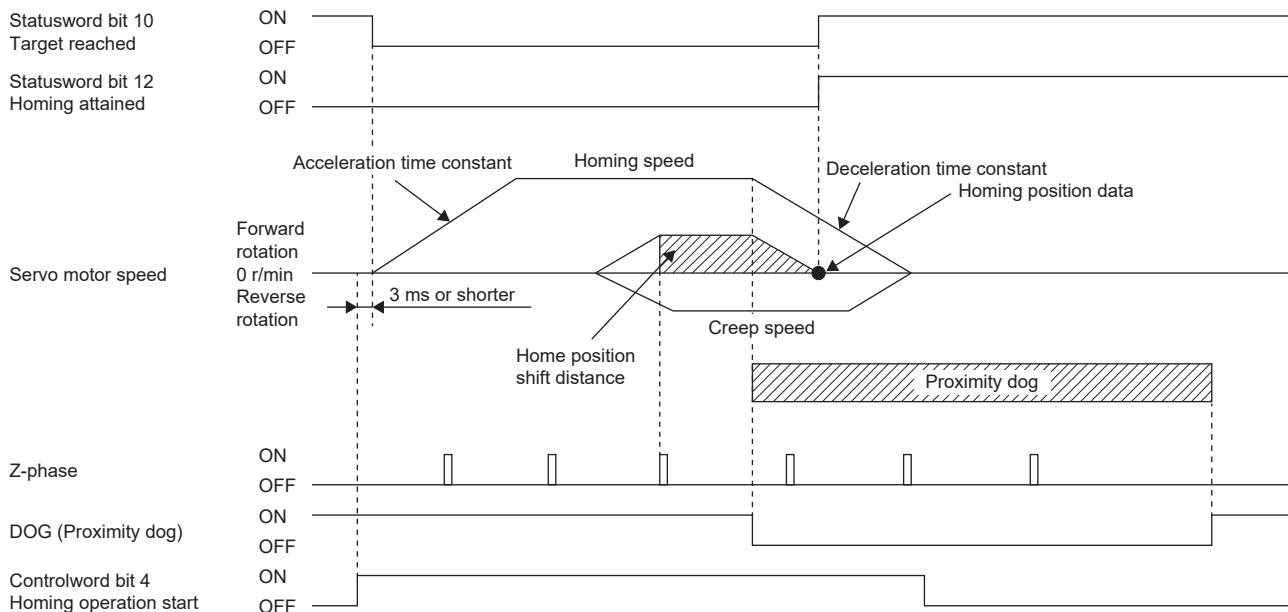

- When homing is started from the proximity dog

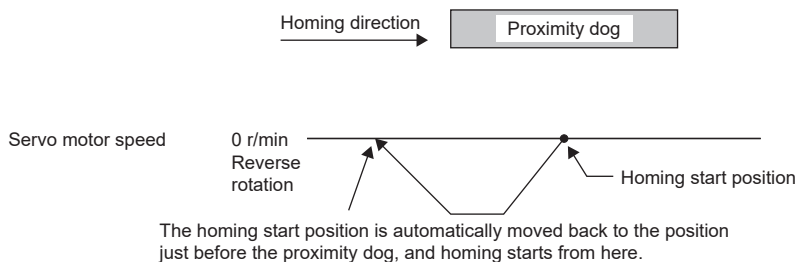

- When the stroke end is detected

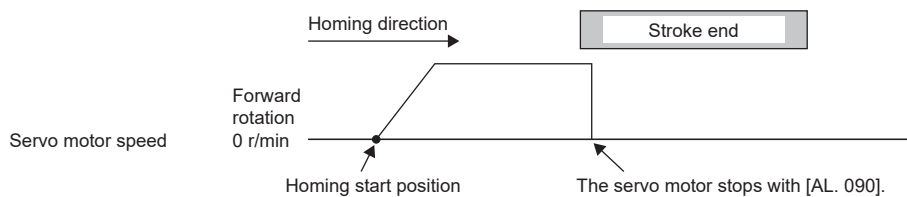

■ Method 4 (Homing on positive home switch and index pulse) and Method 6 (Homing on negative home switch and index pulse)

The following figure shows the operation of Homing method 4 when the home position shift distance is a positive value. The homing direction of Homing method 6 is opposite to that of Homing method 4.

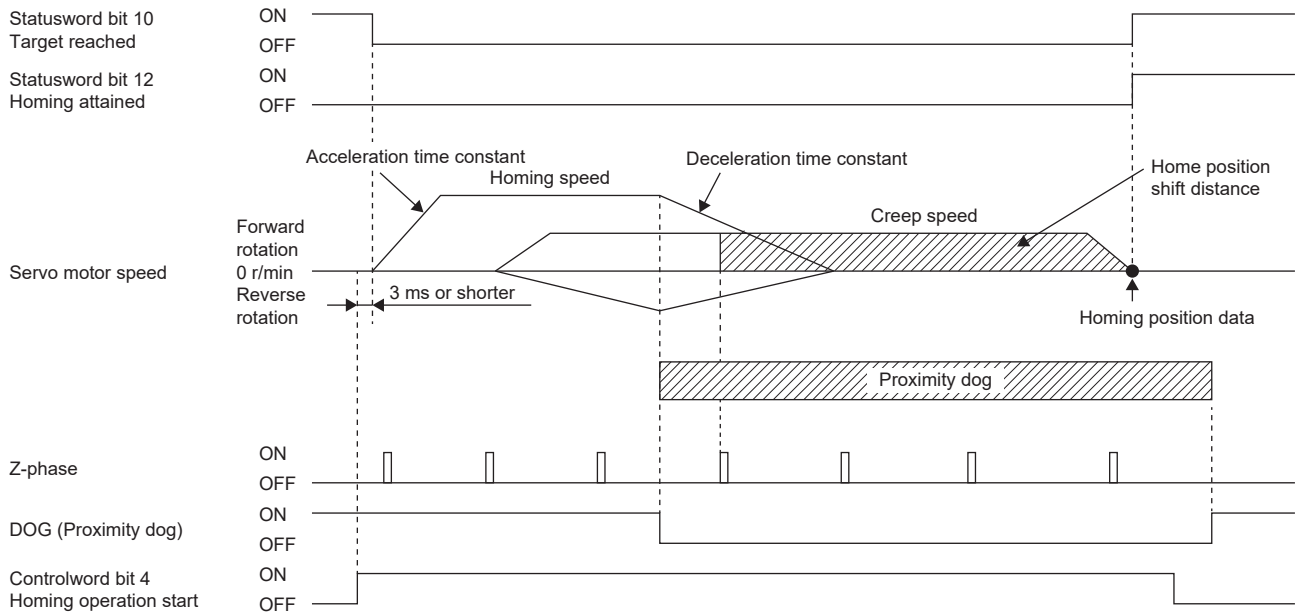

- When homing is started from the proximity dog

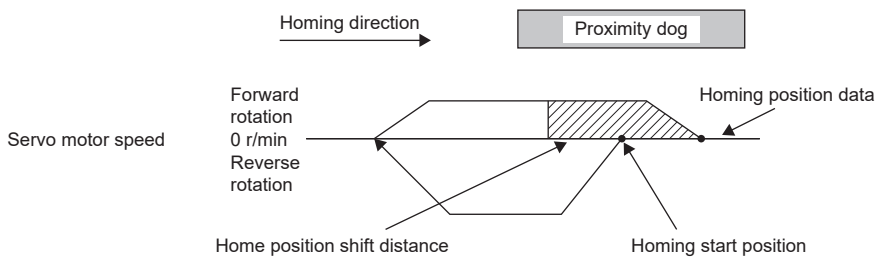

- When the stroke end is detected

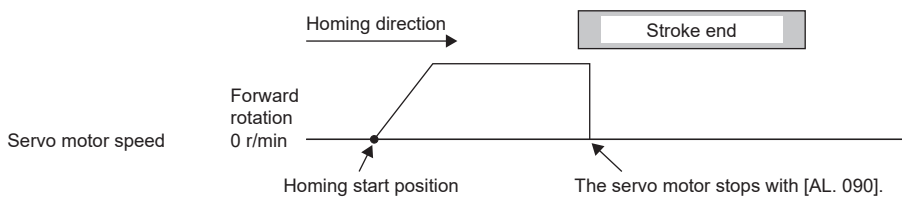

Method 7 and Method 11 (Homing on home switch and index pulse)

The following figure shows the operation of Homing method 7 when the home position shift distance is a positive value. The homing direction of Homing method 11 is opposite to that of Homing method 7.

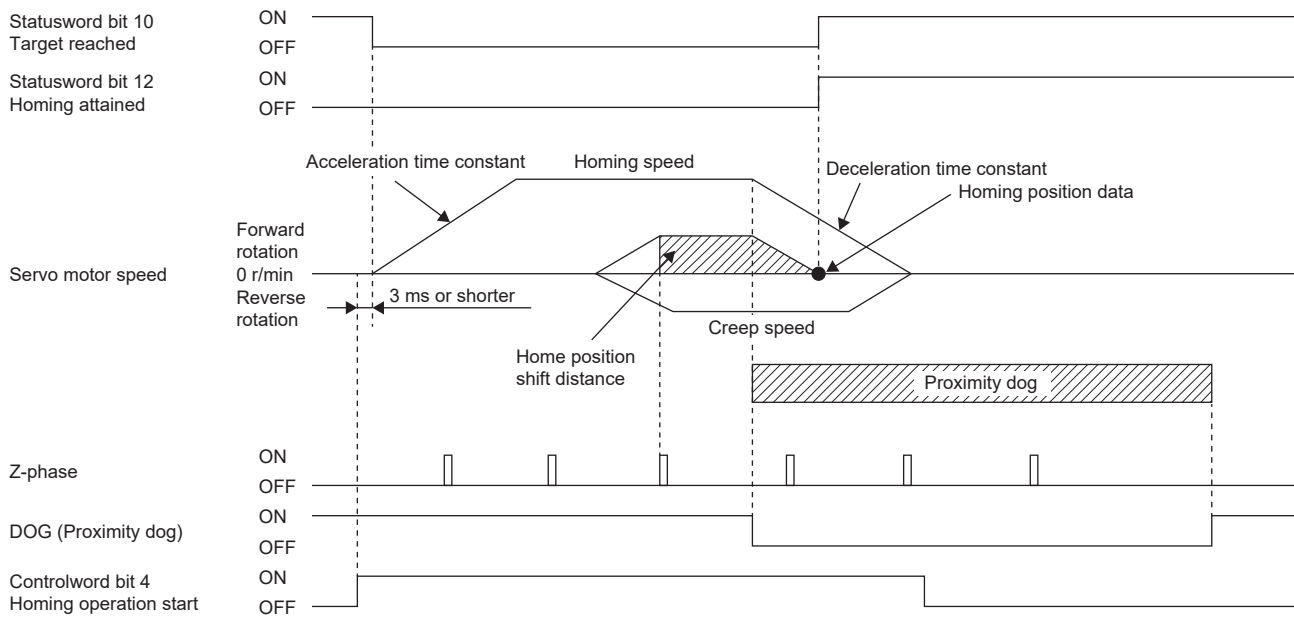

- When homing is started from the proximity dog

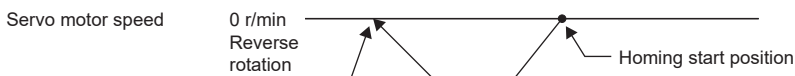

The homing start position is automatically moved back to the position just before the proximity dog, and homing starts from here.

- When the servo motor returns at the stroke end

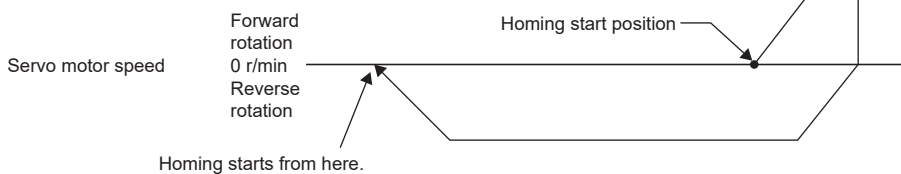

Homing starts from here.

*1 This cannot be used with the software limit.

■ Method 8 and Method 12 (Homing on home switch and index pulse)

The following figure shows the operation of Homing method 8 when the home position shift distance is a positive value. The homing direction of Homing method 12 is opposite to that of Homing method 8.

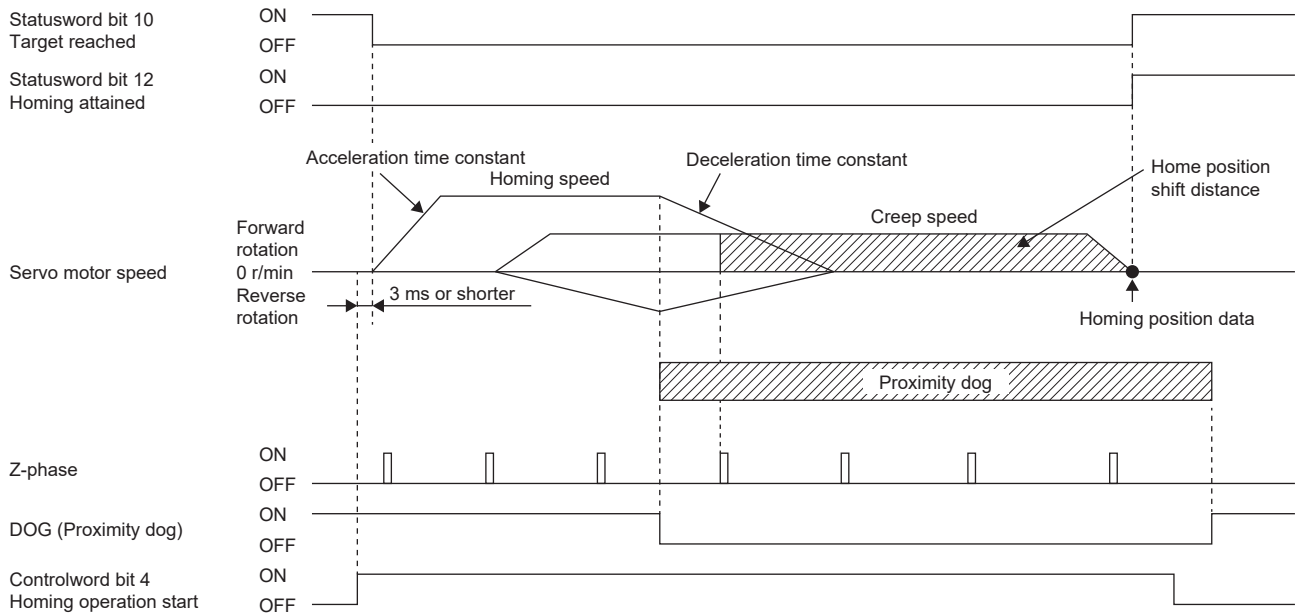

- When homing is started from the proximity dog

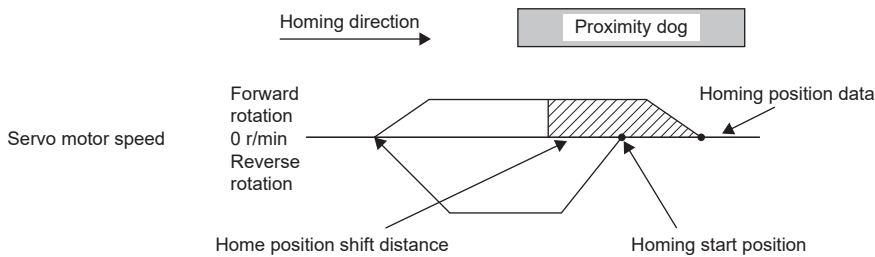

- When the servo motor returns at the stroke end

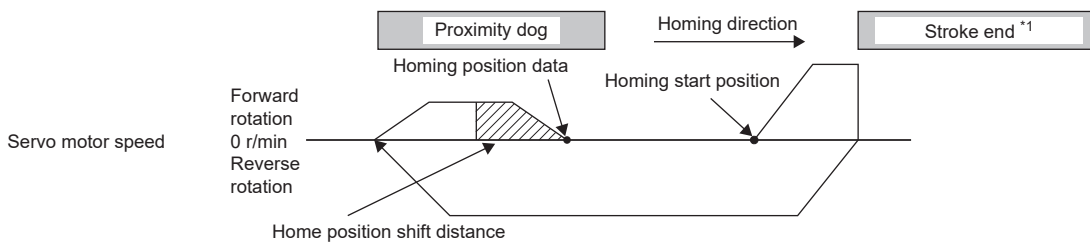

*1 This cannot be used with the software limit.

Method 9 and Method 13 (Homing on home switch and index pulse)

The following figure shows the operation of Homing method 9 when the home position shift distance is a positive value. The homing direction of Homing method 13 is opposite to that of Homing method 9.

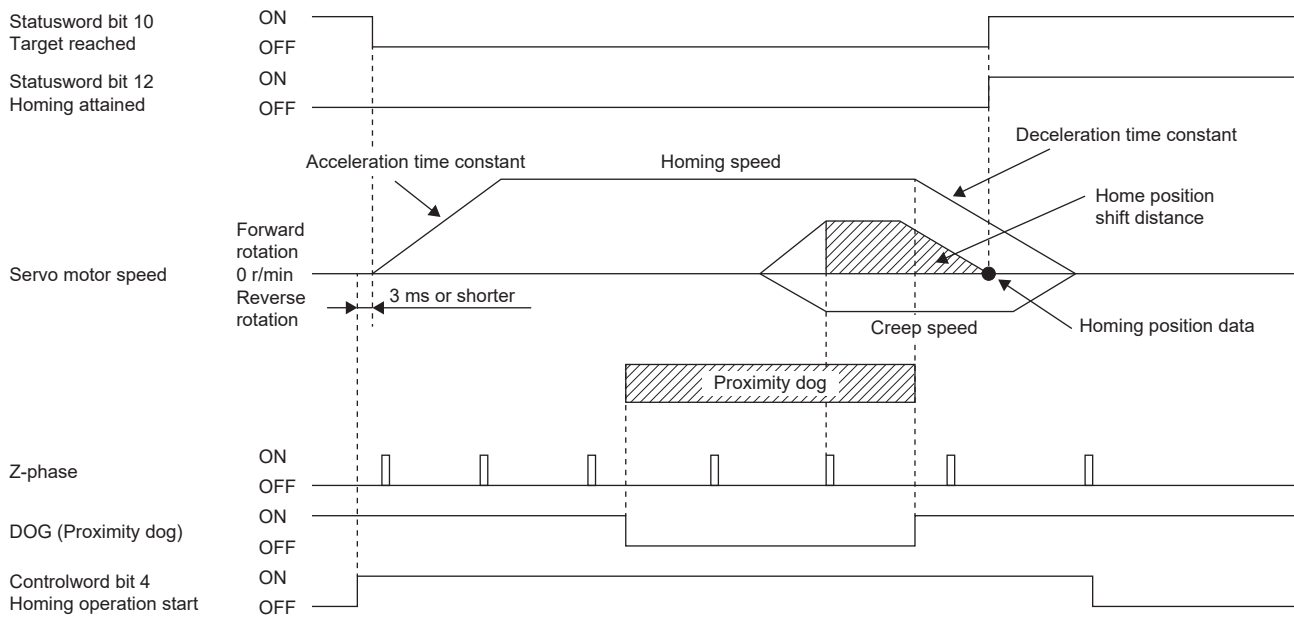

- When the servo motor returns at the stroke end

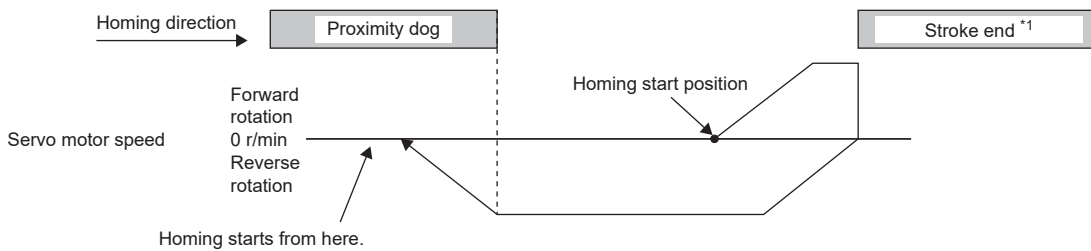

*1 This cannot be used with the software limit.

■ Method 10 and Method 14 (Homing on home switch and index pulse)

The following figure shows the operation of Homing method 10 when the home position shift distance is a positive value. The homing direction of Homing method 14 is opposite to that of Homing method 10.

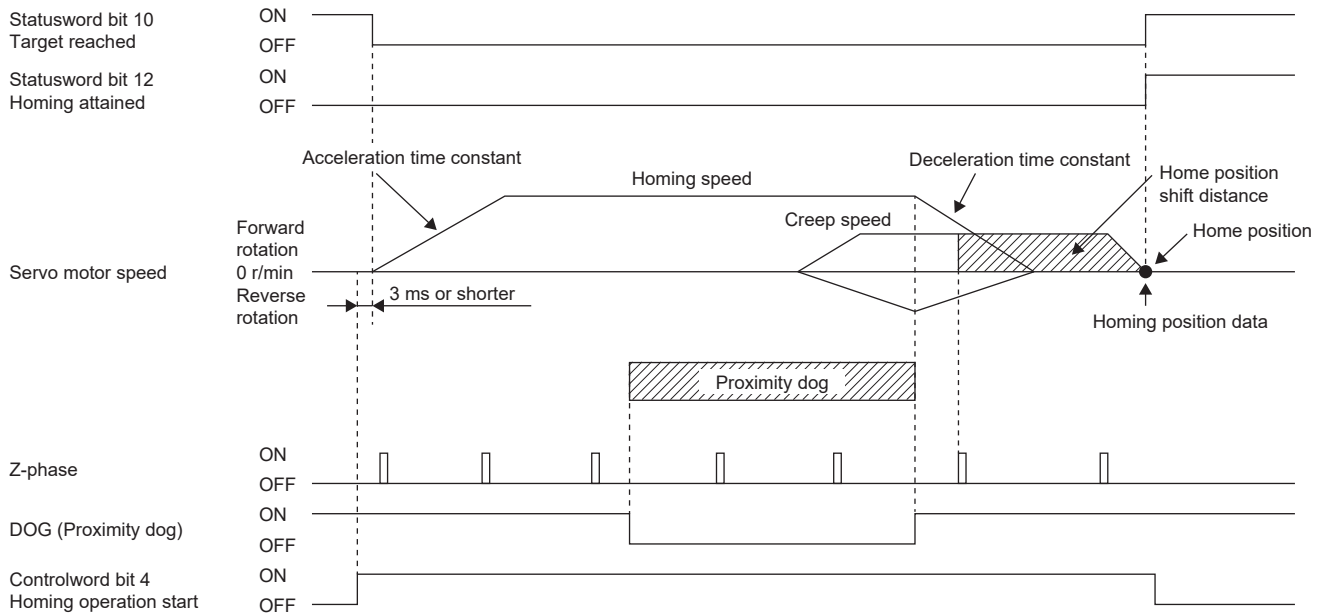

- When the servo motor returns at the stroke end

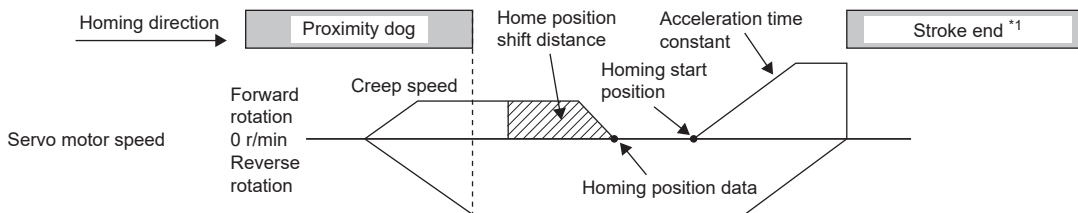

*1 This cannot be used with the software limit.

Method 17 (Homing on negative limit switch) and Method 18 (Homing on positive limit switch)

The following figure shows the operation of Homing method 18 when the home position shift distance is a positive value. The homing direction of Homing method 17 is opposite to that of Homing method 18.

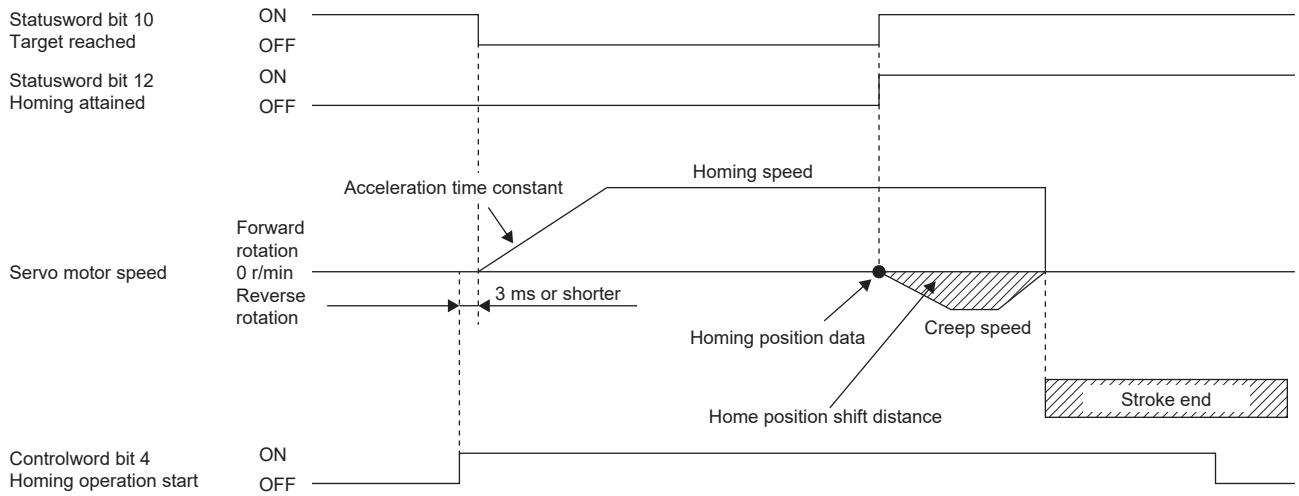

- When the servo motor returns at the stroke end

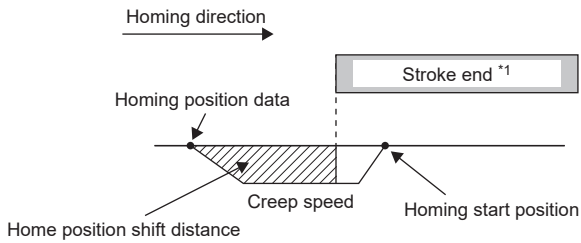

*1 This cannot be used with the software limit.

■ Method 19 and Method 21 (Homing without index pulse)

The following figure shows the operation of Homing method 19 when the home position shift distance is a positive value. The homing direction of Homing method 21 is opposite to that of Homing method 19.

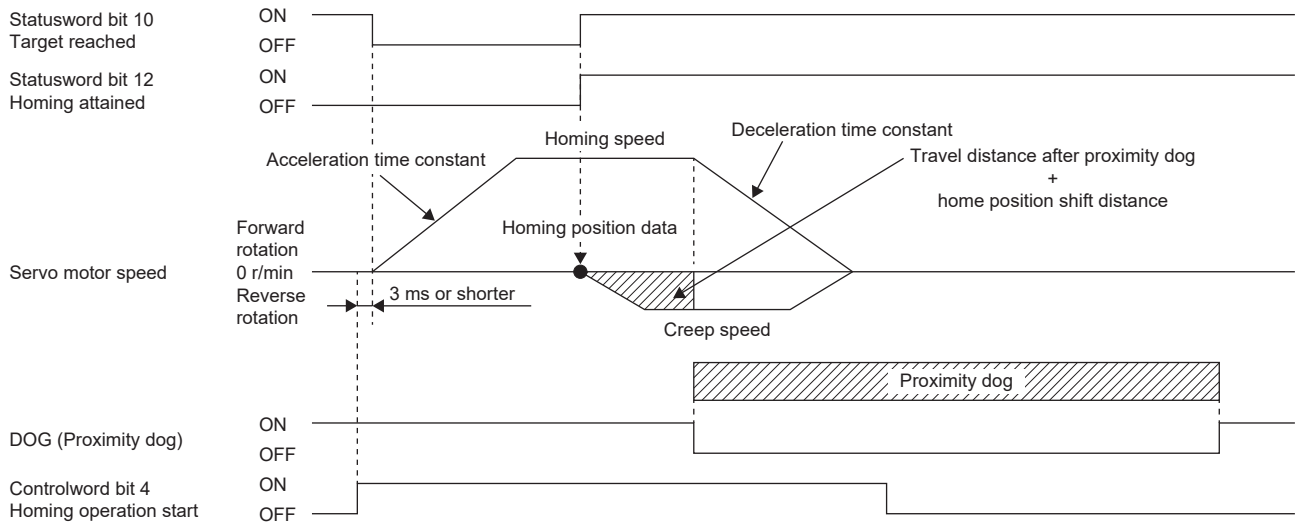

- When homing is started from the proximity dog

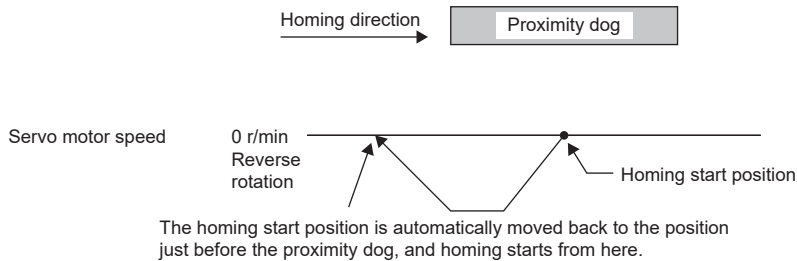

- When the stroke end is detected

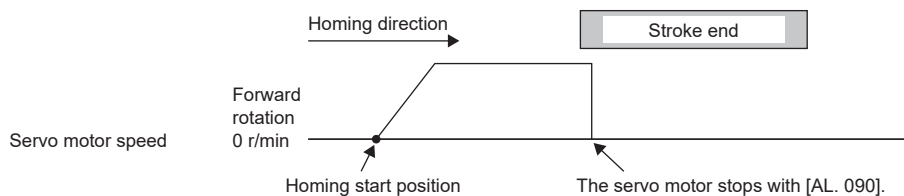

Method 20 and Method 22 (Homing without index pulse)

The following figure shows the operation of Homing method 20 when the home position shift distance is a positive value. The homing direction of Homing method 22 is opposite to that of Homing method 20.

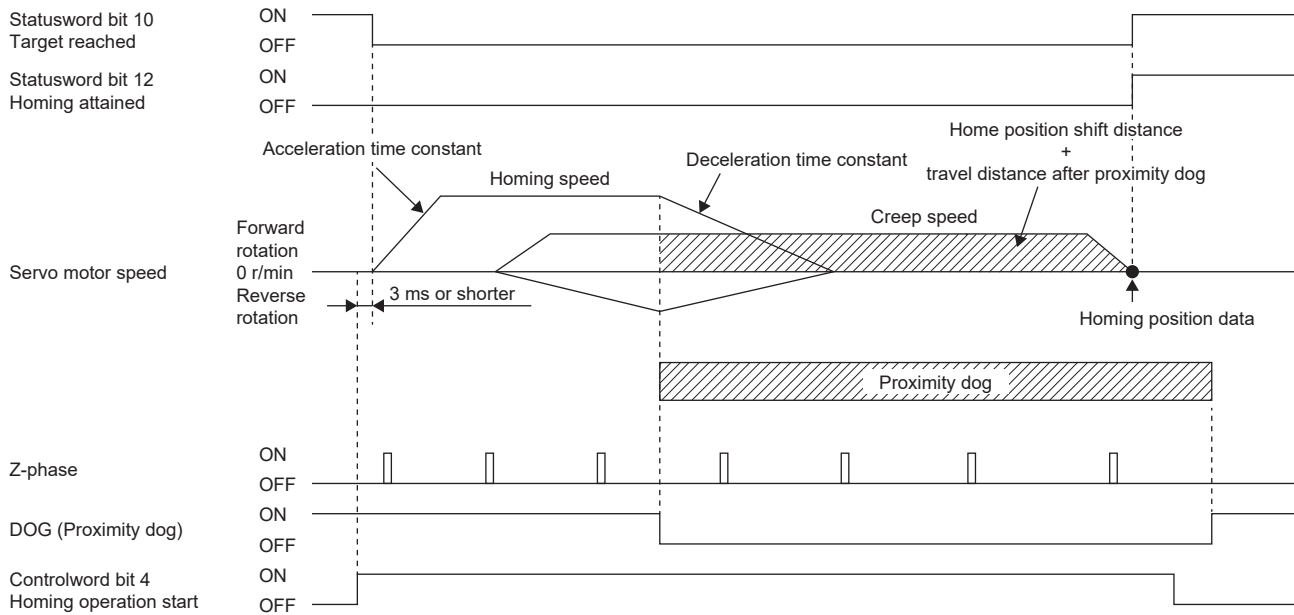

- When homing is started from the proximity dog

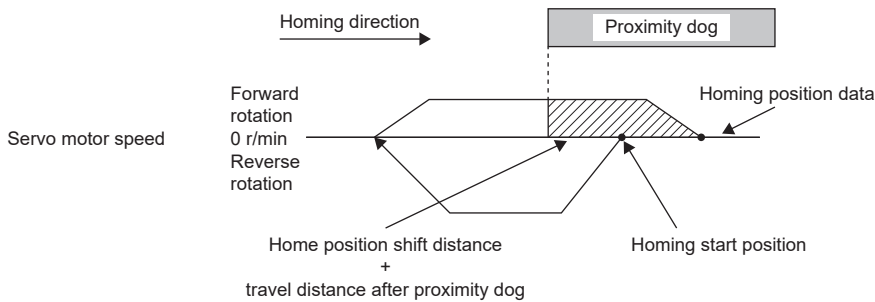

- When the stroke end is detected

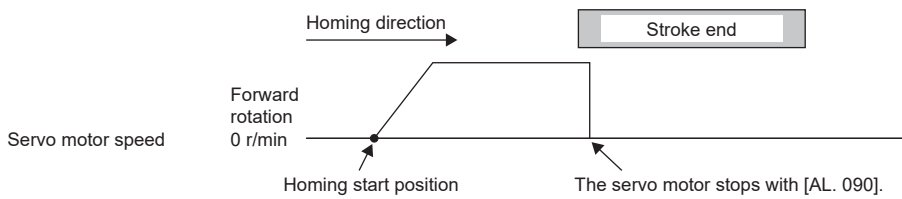

■ Method 23 and Method 27 (Homing without index pulse)

The following figure shows the operation of Homing method 23 when the home position shift distance is a positive value. The homing direction of Homing method 27 is opposite to that of Homing method 23.

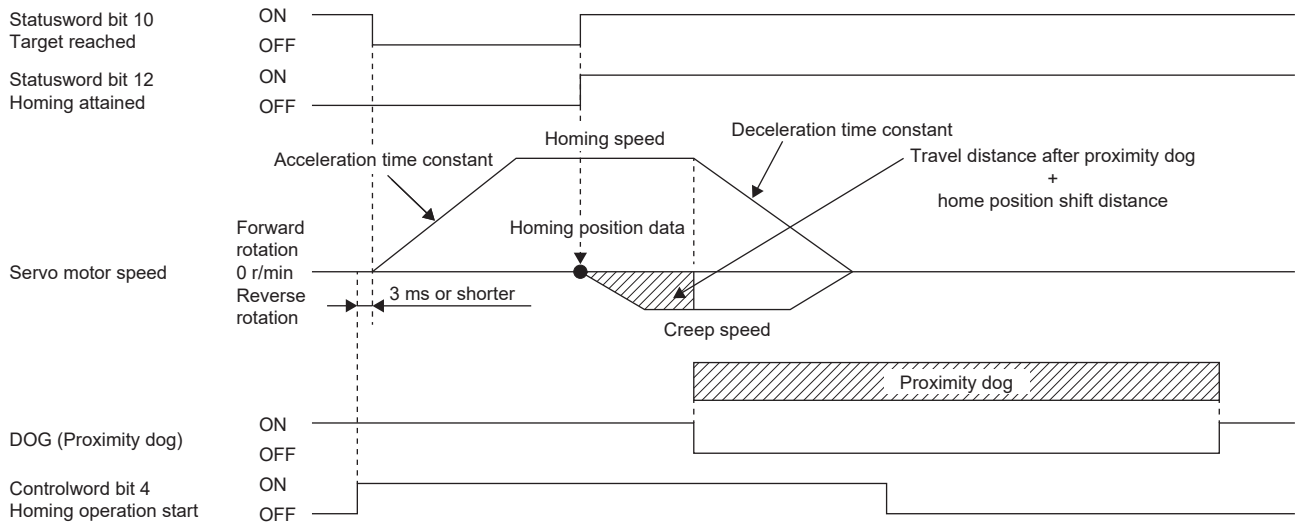

- When homing is started from the proximity dog

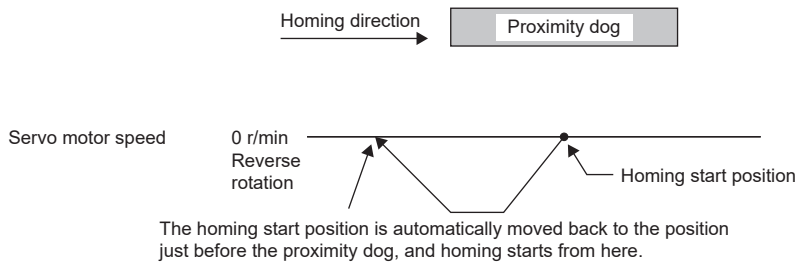

- When the servo motor returns at the stroke end

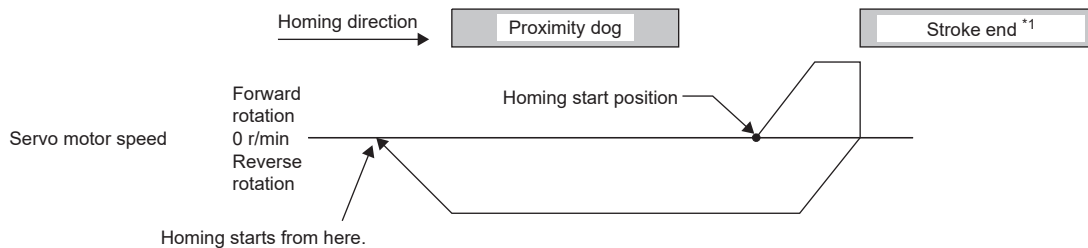

*1 This cannot be used with the software limit.

Method 24 and Method 28 (Homing without index pulse)

The following figure shows the operation of Homing method 24 when the home position shift distance is a positive value. The homing direction of Homing method 28 is opposite to that of Homing method 24.

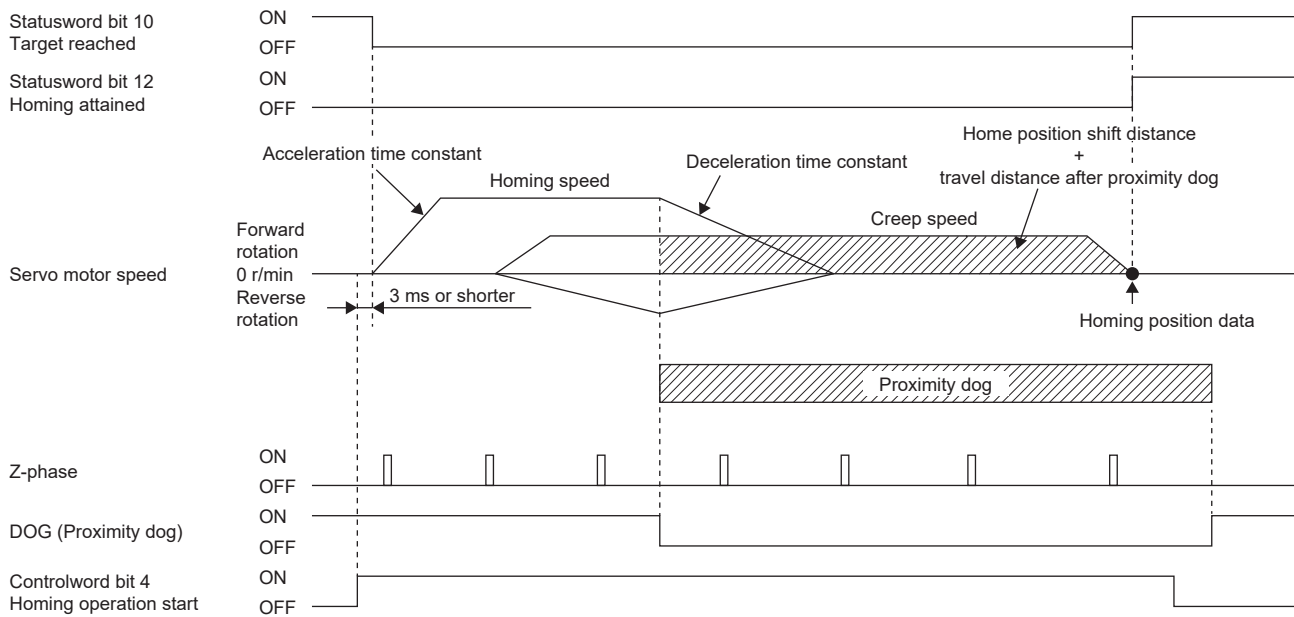

- When homing is started from the proximity dog

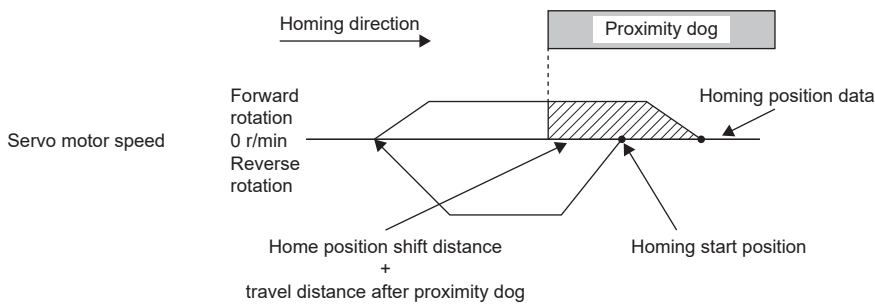

- When the servo motor returns at the stroke end

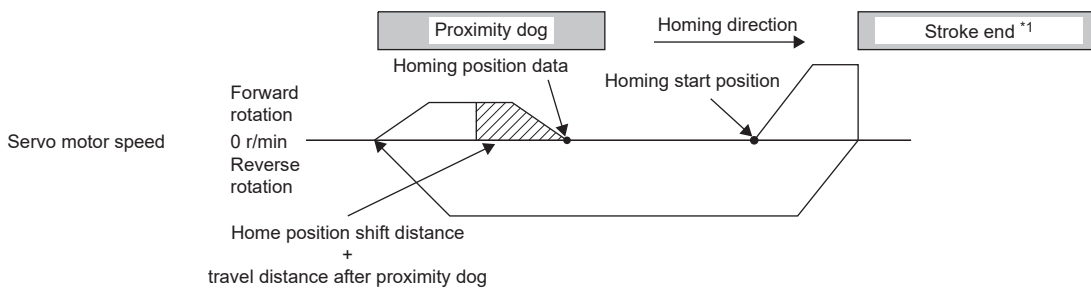

*1 This cannot be used with the software limit.

Method 33 and Method 34 (Homing on index pulse)

The following figure shows the operation of Homing method 34 when the home position shift distance is a positive value. The homing direction of Homing method 33 is opposite to that of Homing method 34.

Point

- When homing is performed from near the Z-phase, the homing completion position varies. The recommended start position for homing can be found by rotating the servo motor about a half-turn away from the homing direction.

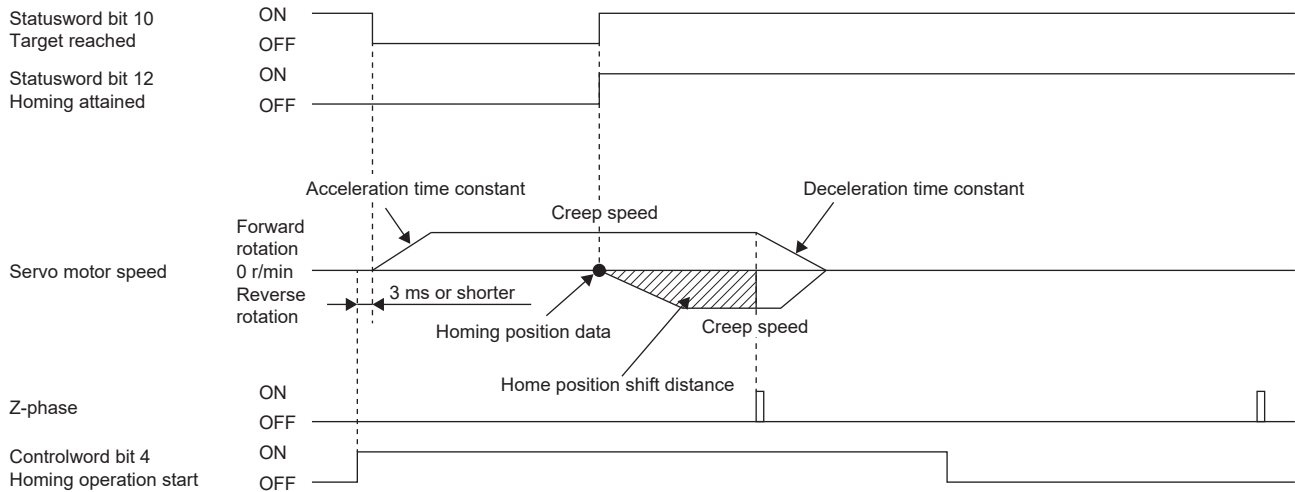

- When the stroke end is detected

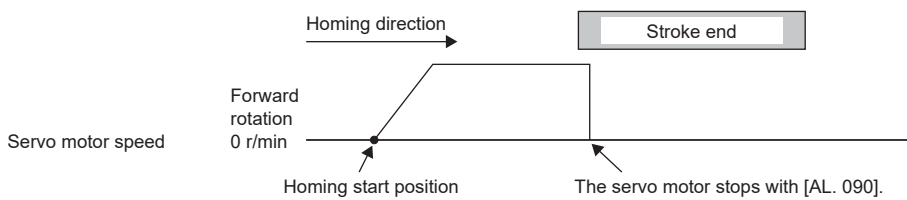

Method 35 and Method 37 (Homing on current position)

The following figure shows the operation of Homing method 35 and Homing method 37. Homing can be executed even in the servo-off status.

Homing cannot be executed in the servo-off status when Motion modules manufactured by Mitsubishi Electric (RD78G(H)/FX5-SSC-G) are used. For details, refer to each controller manual.

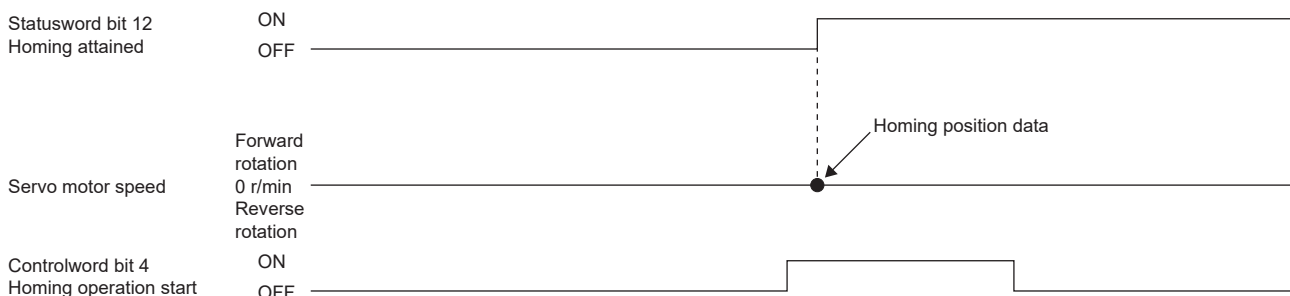

Operation example of Manufacturer-specific Homing method

Point

- For details on signal polarity and other I/O device assignments, refer to the following.
 Page 147 Assigning I/O devices

The following shows an operation example of the Manufacturer-specific homing when [Pr. PA14_Travel direction selection] is set to "0".

The homing direction when [Pr. PA14] is "1" is opposite to the figure.

When [Pr. PT55.1 Homing POL reflection selection] is set to "1" for servo amplifiers with firmware version D4 or later, the setting value of [Pr. PA14] is reflected at homing.

Method -1 and Method -33 (Dog type homing)

The following figure shows the operation of Homing method -1 when the home position shift distance is a positive value. The homing direction of Homing method -33 is opposite to that of Homing method -1.

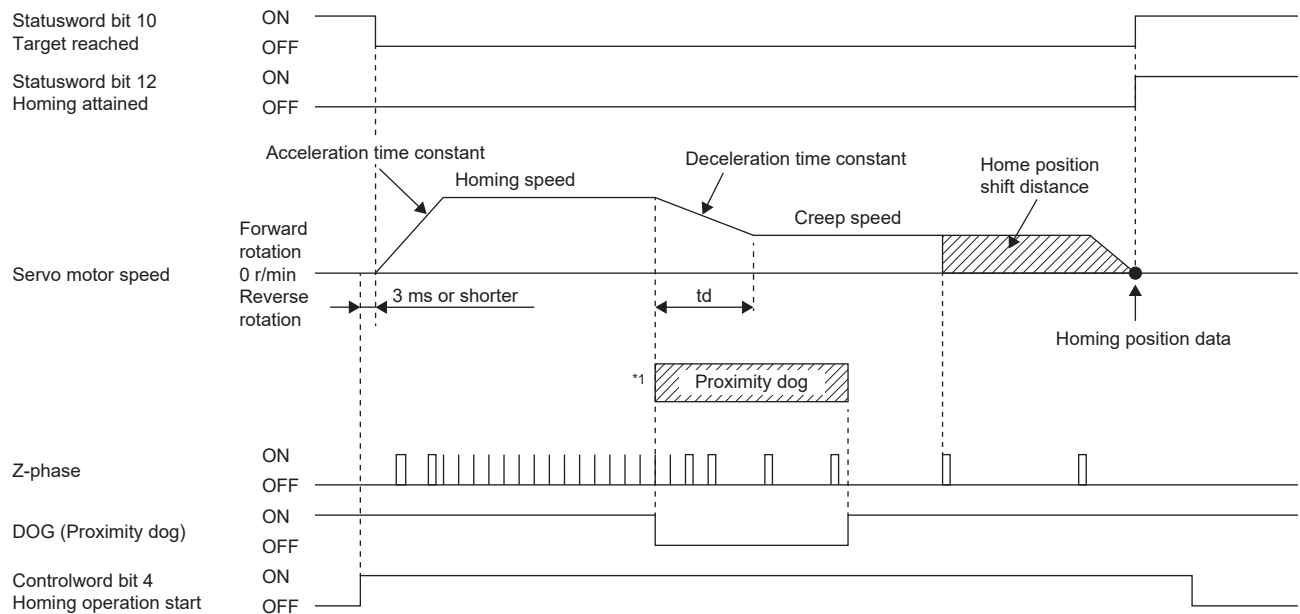

*1 After the front end of the proximity dog is detected, if the distance after proximity dog is traveled without reaching the creep speed, [AL. 090] occurs. Set the travel distance after proximity dog enough for the servo motor to decelerate from the homing speed to the creep speed.

- When homing is started from the proximity dog

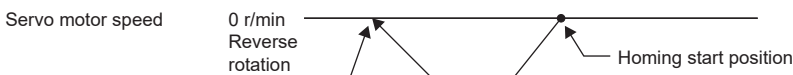

The homing start position is automatically moved back to the position just before the proximity dog, and homing starts from here.

- When the servo motor returns at the stroke end

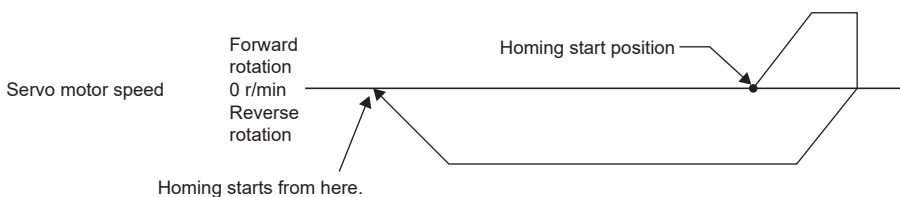

Homing starts from here.

*1 This cannot be used with the software limit.

Method -2 and Method -34 (Count type homing)

Point

For the count type homing, after the front end of the proximity dog is detected, the position is shifted by the distance set in the travel distance after proximity dog. Then, the first Z-phase is set as the home position. Therefore, when the on-time of the proximity dog is 10 ms or more, the length of the proximity dog has no restrictions. Use this homing when the dog type homing cannot be used because the length of the proximity dog cannot be reserved or other cases.

The following figure shows the operation of Homing method -2 when the home position shift distance is a positive value. The homing direction of Homing method -34 is opposite to that of Homing method -2.

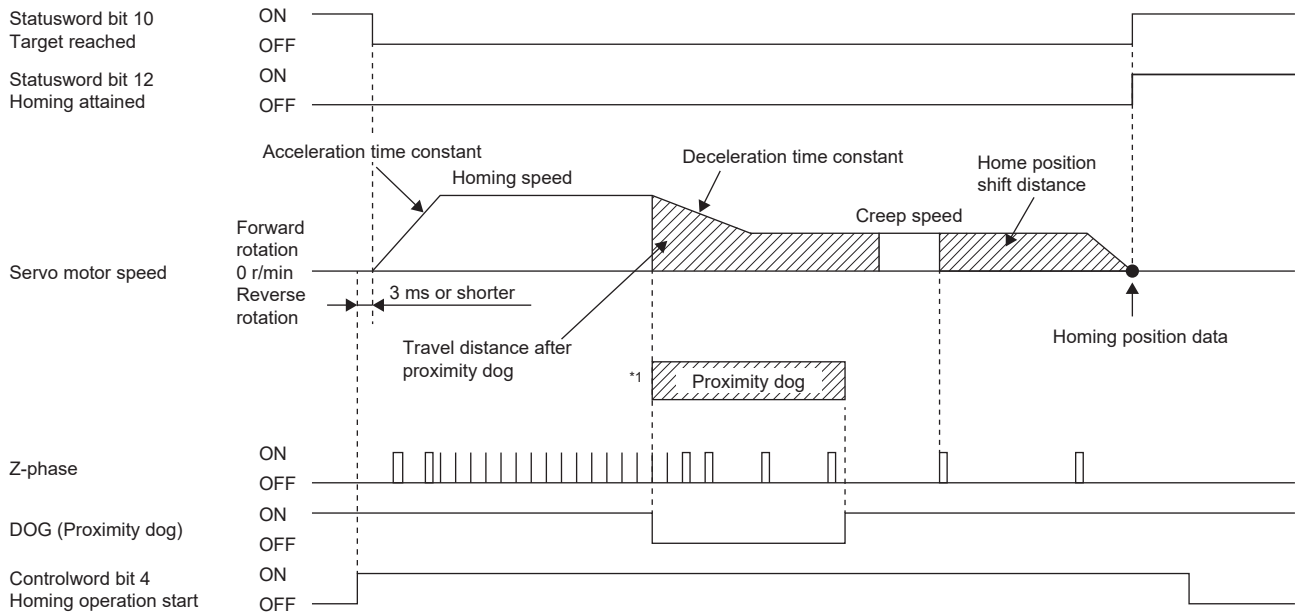

*1 After the front end of the proximity dog is detected, if the distance after proximity dog is traveled without reaching the creep speed, [AL. 090] occurs. Set the travel distance after proximity dog enough for the servo motor to decelerate from the homing speed to the creep speed.

- When homing is started from the proximity dog



The homing start position is automatically moved back to the position just before the proximity dog, and homing starts from here.

- When the servo motor returns at the stroke end



Homing starts from here.

*1 This cannot be used with the software limit.

Method -3 (Data set type homing)

The following figure shows the operation of Homing method -3. Data set type homing cannot be executed in the servo-off status.

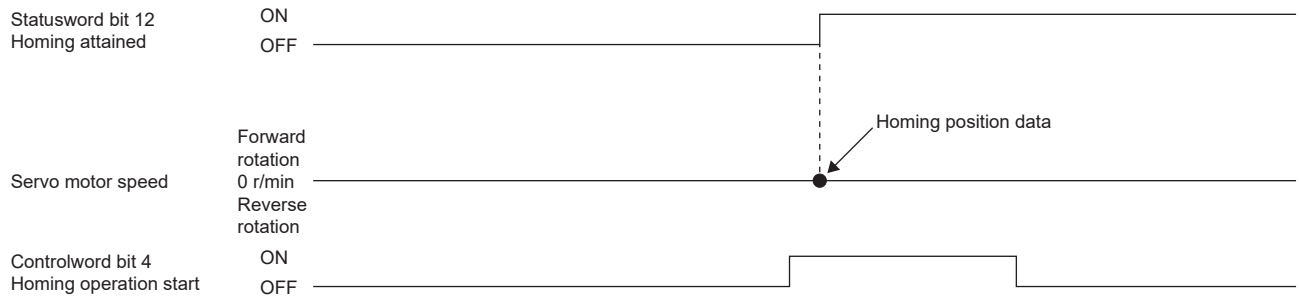

Method -4 and Method -36 (Stopper type homing)



Since the workpiece collides with the mechanical stopper, the homing speed must be low enough.

The following figure shows the operation of Homing method -4. The homing direction of Homing method -36 is opposite to that of Homing method -4.

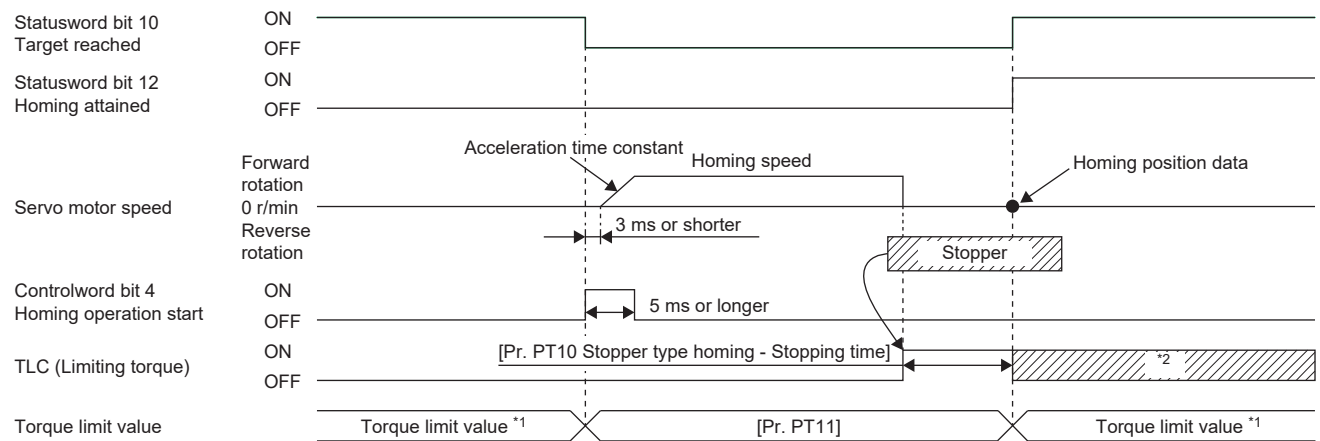

*1 When Method -4 is set, the torque limit value of [Positive torque limit value (Obj. 60E0h)] is applied. When Method -36 is set, the torque limit value of [Negative torque limit value (Obj. 60E1h)] is applied.

*2 If the torque limit value has been reached, TLC remains on even after homing finishes.

- When the stroke end is detected

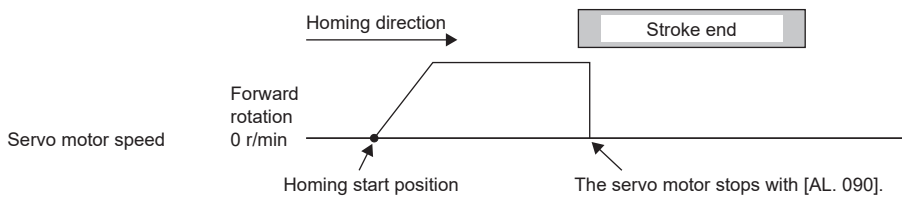

Method -6 and Method -38 (Dog type rear end reference homing)

Point

This homing method depends on the timing of reading DOG (Proximity dog) that has detected the rear end of the proximity dog. Therefore, when the creep speed is set to 100 r/min and homing is performed, the home position has the following error.

$$\pm (\text{Encoder resolution}) \times 100/65536 [\text{pulse}]$$

The error in the home position becomes larger as the creep speed increases.

The following figure shows the operation of Homing method -6 when the home position shift distance is a positive value. The homing direction of Homing method -38 is opposite to that of Homing method -6.

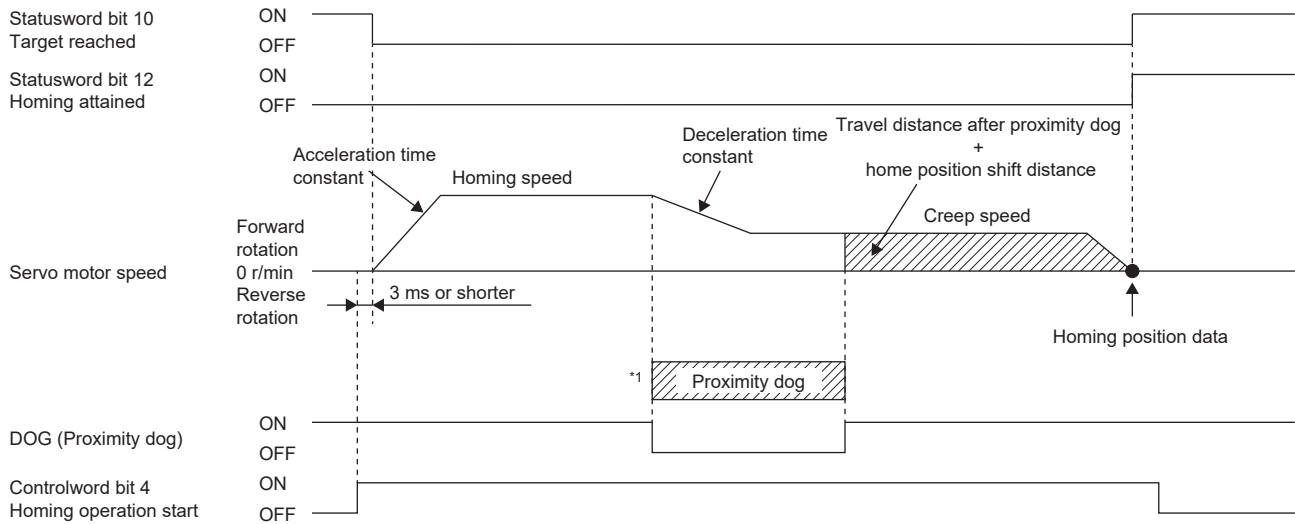

*1 After the front end of the proximity dog is detected, if the rear end of the proximity dog is detected without reaching the creep speed, [AL. 090] occurs. Revise the length of the proximity dog, or revise both the homing speed and creep speed.

- When homing is started from the proximity dog

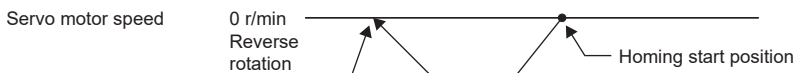

The homing start position is automatically moved back to the position just before the proximity dog, and homing starts from here.

- When the servo motor returns at the stroke end

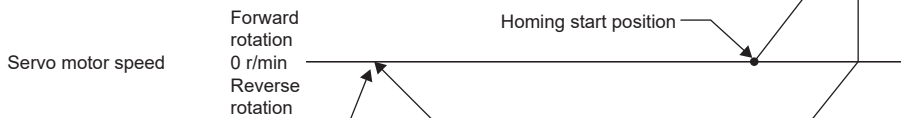

Homing starts from here.

*1 This cannot be used with the software limit.

Method -7 and Method -39 (Count type front end reference homing)



This homing method depends on the timing of reading DOG (Proximity dog) that has detected the front end of the proximity dog. Therefore, when the creep speed is set to 100 r/min and homing is performed, the home position has the following error.

$$\pm (\text{Encoder resolution}) \times 100/65536 [\text{pulse}]$$

The error in the home position becomes larger as the homing speed increases.

The following figure shows the operation of Homing method -7 when the home position shift distance is a positive value. The homing direction of Homing method -39 is opposite to that of Homing method -7.

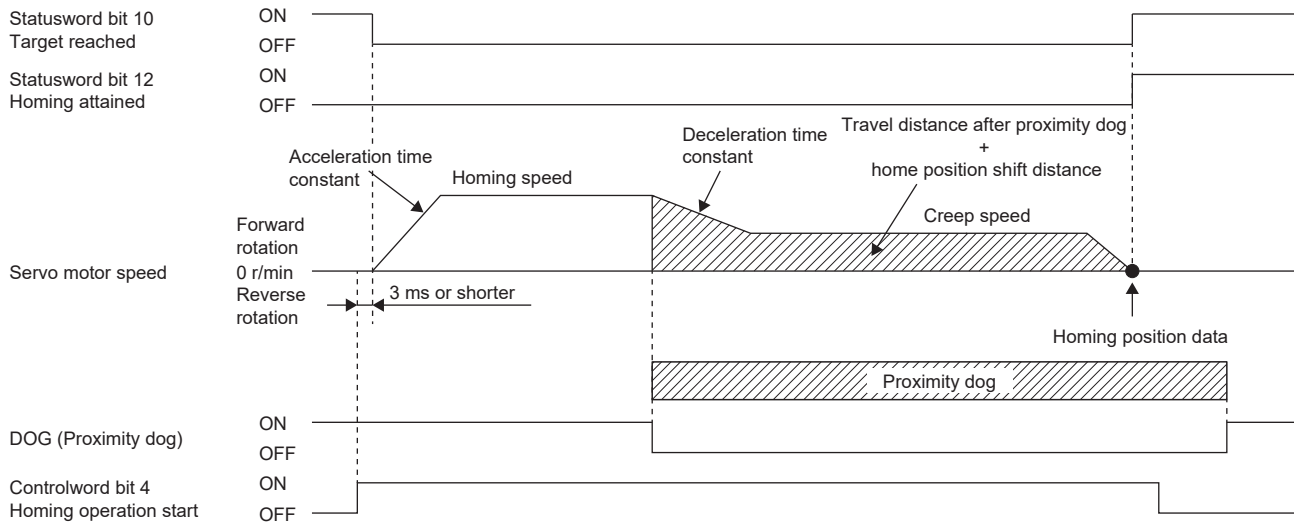

- When homing is started from the proximity dog

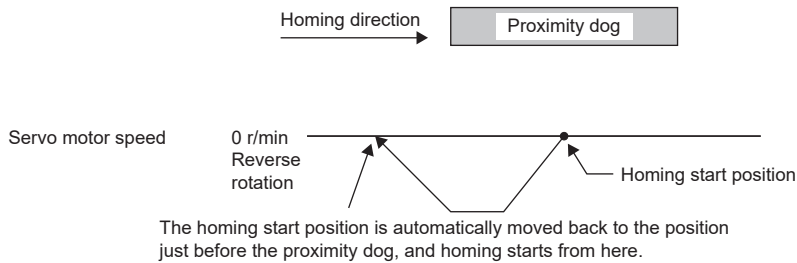

- When the servo motor returns at the stroke end

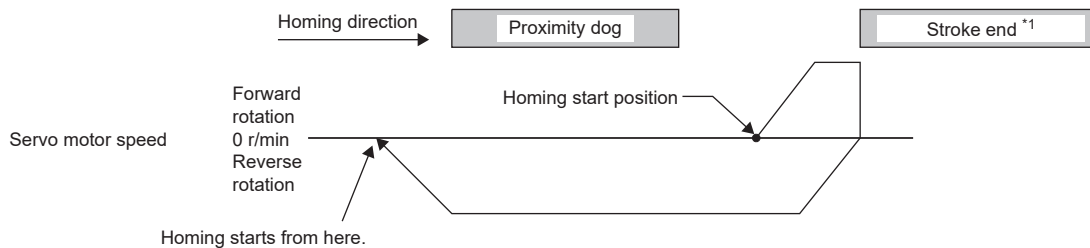

*1 This cannot be used with the software limit.

■ Method -8 and Method -40 (Dog cradle type homing)

The following figure shows the operation of Homing method -8 when the home position shift distance is a positive value. The homing direction of Homing method -40 is opposite to that of Homing method -8.

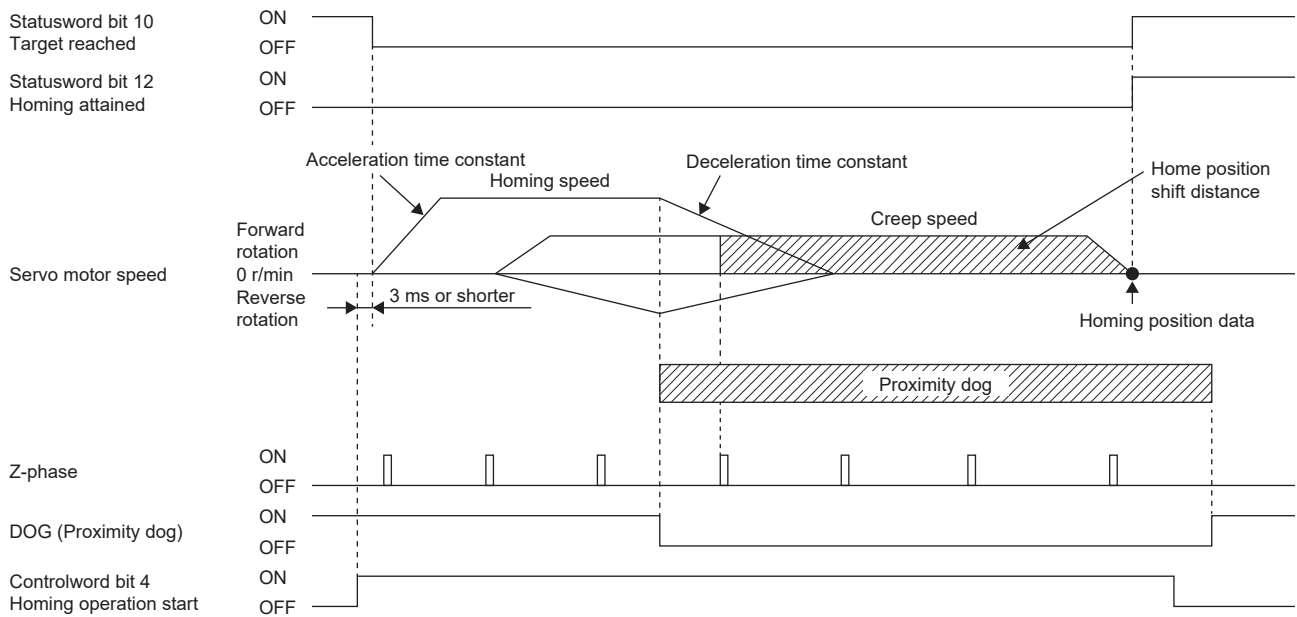

- When homing is started from the proximity dog

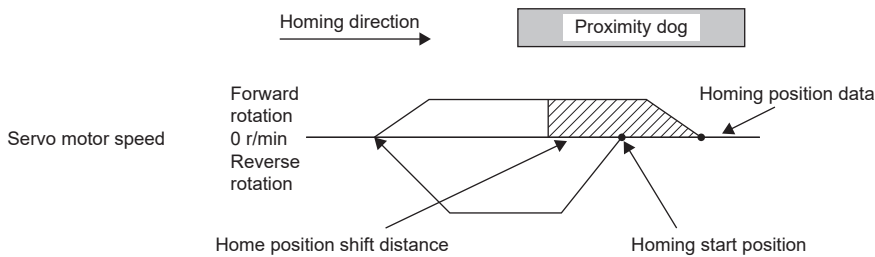

- When the servo motor returns at the stroke end

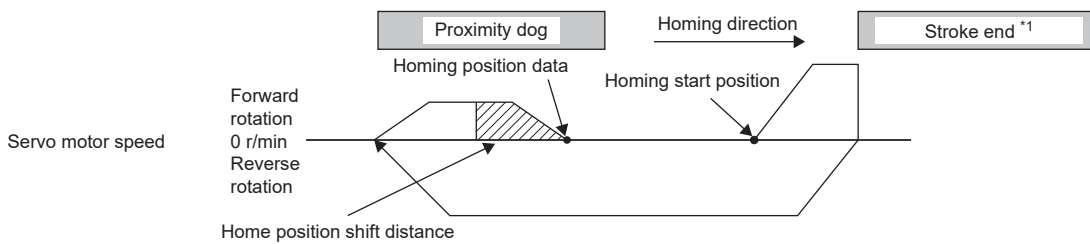

*1 This cannot be used with the software limit.

Method -9 and Method -41 (Dog type last Z-phase reference homing)

The following figure shows the operation of Homing method -9 when the home position shift distance is a positive value. The homing direction of Homing method -41 is opposite to that of Homing method -9.

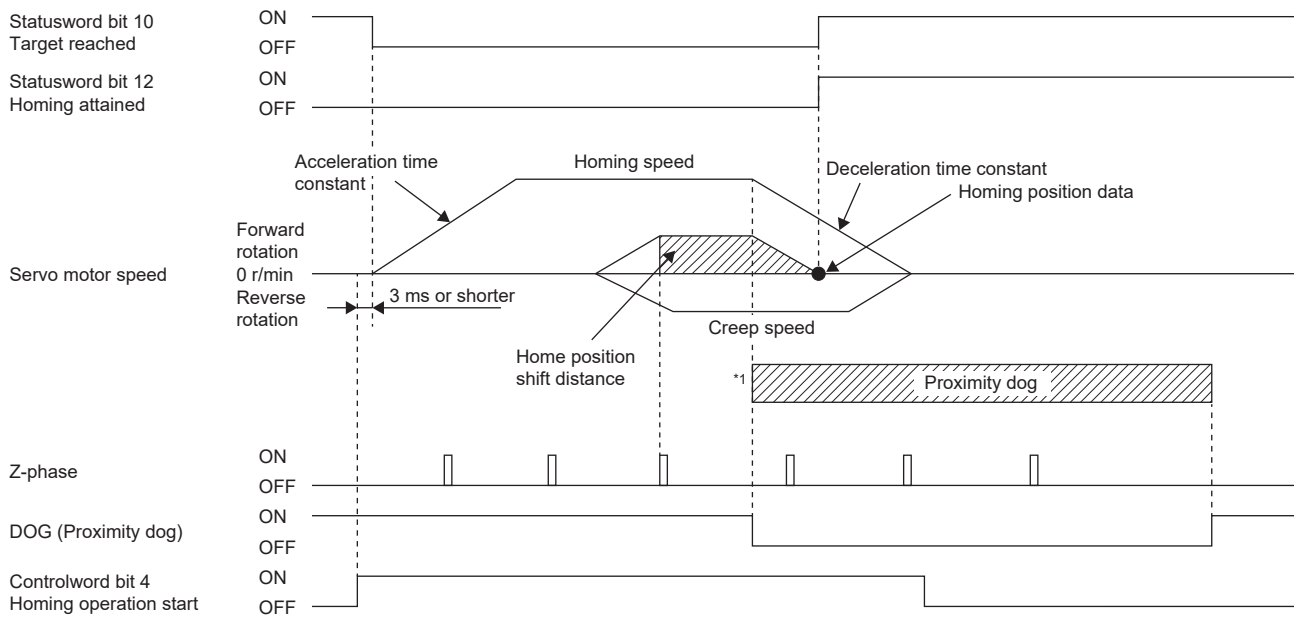

*1 After the front end of the proximity dog is detected, if the rear end of the proximity dog is detected without stop, [AL. 090] occurs. Revise the length of the proximity dog, or revise both the homing speed and creep speed.

- When homing is started from the proximity dog

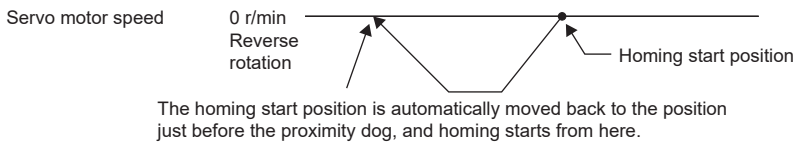

- When the servo motor returns at the stroke end

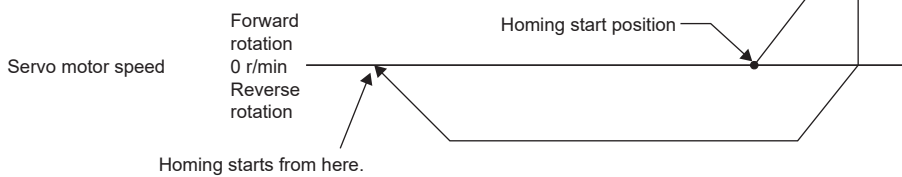

*1 This cannot be used with the software limit.

■ Method -10 and Method -42 (Dog type front end reference homing)

The following figure shows the operation of Homing method -10 when the home position shift distance is a positive value. The homing direction of Homing method -42 is opposite to that of Homing method -10.

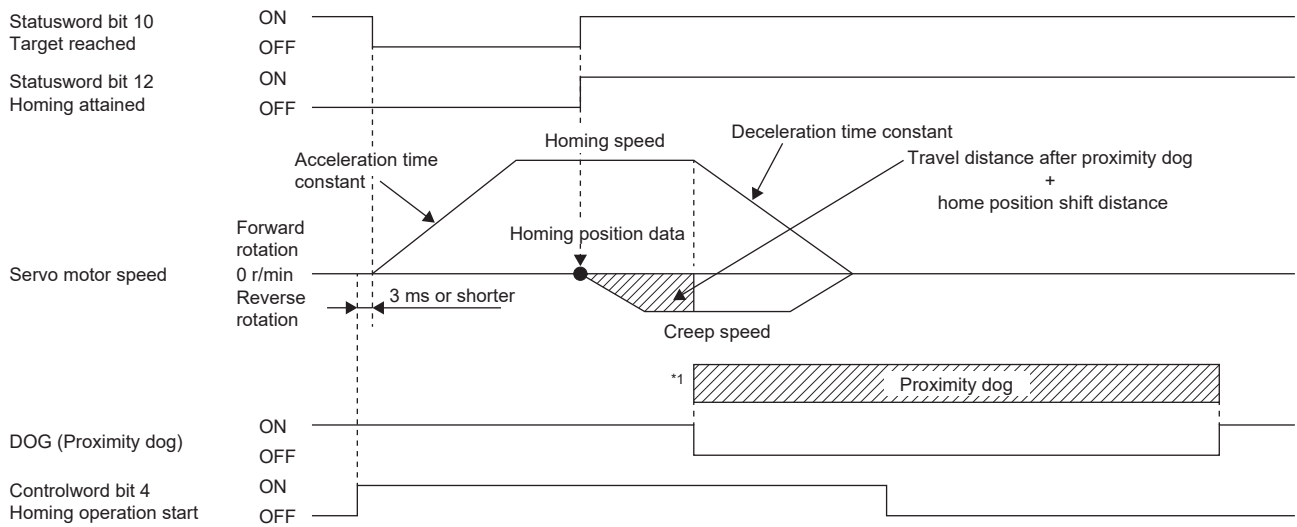

*1 After the front end of the proximity dog is detected, if the rear end of the proximity dog is detected without reaching the creep speed, [AL. 090] occurs. Revise the length of the proximity dog, or revise both the homing speed and creep speed.

- When homing is started from the proximity dog

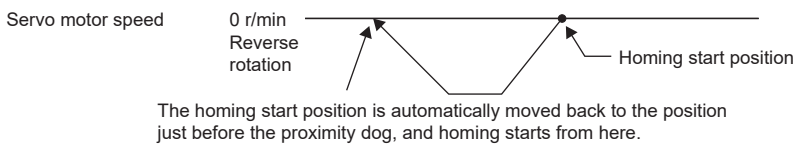

- When the servo motor returns at the stroke end

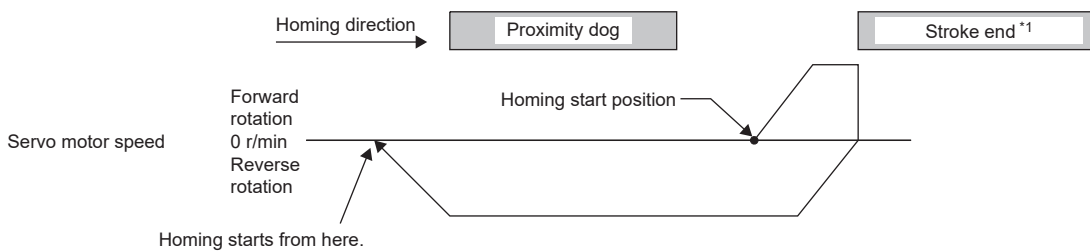

*1 This cannot be used with the software limit.

Method -11 and Method -43 (Dogless Z-phase reference homing)

The following figure shows the operation of Homing method -11 when the home position shift distance is a positive value. The homing direction of Homing method -43 is opposite to that of Homing method -11.

Point

- When homing is performed from near the Z-phase, the homing completion position varies. The recommended start position for homing can be found by rotating the servo motor about a half-turn away from the homing direction.

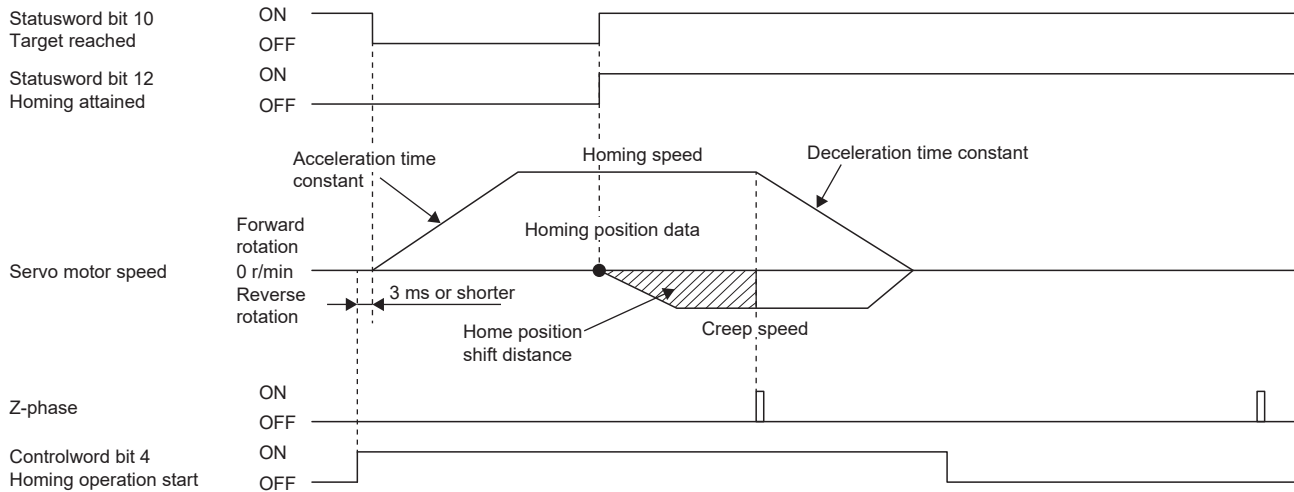

- When the stroke end is detected

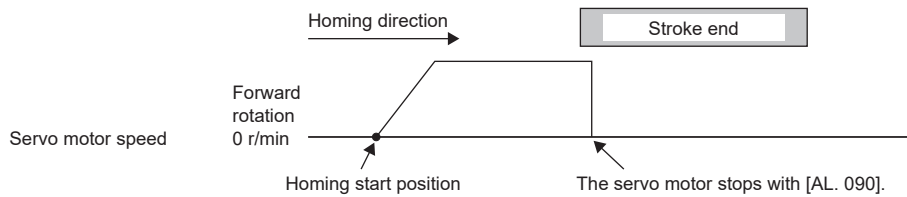

2.2 Control mode [B]

The method for driving a servo motor varies depending on each control mode. The characteristics of each control mode are shown in the following.

Category	Control mode	Symbol	Description
SSCNET III/H control mode	Position control mode	P_SSC	This is a control mode to drive servo motors by receiving a position command at a constant period in the synchronous communication with a controller.
	Speed control mode	S_SSC	This is a control mode to drive servo motors by receiving a speed command at a constant period in the synchronous communication with a controller.
	Torque control mode	T_SSC	This is a control mode to drive servo motors by receiving a torque command at a constant period in the synchronous communication with a controller.
Thrust/torque control	Continuous operation to torque control mode	ct	This function enables smooth switching to torque control from the position control mode or speed control mode without stopping the servo motor. This eliminates rapid change of speed and torque, contributing to reduction in load to the machine and high-quality product molding.

For the usage, refer to each controller manual.

Continuous operation to torque control mode (ct)

Restrictions

The following functions are not available in the continuous operation to torque control mode. Therefore, if an alarm occurs, the servo motor will stop using the method DB or EDB, or coast.

- Base circuit shut-off delay time function
- Forced stop deceleration function
- Vertical axis freefall prevention function
- Auto tuning function
- Vibration suppression control 1, 2
- Slight vibration suppression control
- One-touch tuning
- Quick tuning function

Precautions

The relation between the setting value of the command torque and the servo motor torque generation direction can be changed with the setting values of [Pr. PA14 Travel direction selection] and [Pr. PC29.3 Torque POL reflection selection]. The servo motor outputs the torque calculated by adding up the command torque and the value set in [Pr. PE47 Unbalanced torque offset].

In the continuous operation to torque control mode, the response to the torque command is affected. Do not set servo parameters as shown below.

- [Pr. PB12 Overshoot amount compensation] is set to a value other than "0".
- [Pr. PB24.1 PI-PID switching control selection] is set to "3".

Behavior

For details, refer to each controller manual.

■ Parameter adjustment method

When using the continuous operation to torque control mode, adjust parameters using the following steps.

1. Adjusting servo stability

Adjust servo stability so that the operation is performed normally without vibration in the position mode or speed mode.

2. Setting the torque feedback gain

Restore the value of [Pr. PB03 Torque feedback loop gain] to the initial value.

3. Adjusting the torque feedback gain

If the servo motor speed or torque fluctuates when a workpiece comes into contact with a target object, decrease the value of [Pr. PB03]. Decreasing the value of [Pr. PB03] will help suppress fluctuation in servo motor speed or torque when a workpiece comes into contact with a target object. However, doing so will decrease trackability to the command torque.

2.3 Control mode [A]

The method for driving a servo motor varies depending on each control mode. The characteristics of each control mode are shown in the following.

Category	Control mode	Symbol	Description
Pulse/analog/DI command	Position control mode	P	This is a control mode which operates the servo motor with the input of the pulse train.
	Speed control mode	S	This is a control mode which operates the servo motor with the internal speed or with the analog speed command.
	Torque control mode	T	This is a control mode which operates the servo motor with the analog torque command.
	Position/speed control switching mode	P/S	This is a control mode which performs switching between the position control and speed control with the input device.
	Speed/torque control switching mode	S/T	This is a control mode which performs switching between the speed control and torque control with the input device.
	Torque/position control switching mode	T/P	This is a control mode which performs switching between the torque control and position control with the input device.

Control switching

The control mode can be switched with LOP (Control switching).

Control mode switching by using LOP (Control switching)

LOP (Control switching) enables two control modes to be mutually switched. When switching the position control mode to a different mode, or when switching any control mode to the position control mode, perform switching at a zero speed state.

■ Switching the position control and speed control

☞ Page 101 Position/speed control switching mode (P/S)

■ Switching the speed control and torque control

☞ Page 103 Speed/torque control switching mode (S/T)

■ Switching the torque control and position control

☞ Page 105 Torque/position control switch mode (T/P)

Position control mode (P)

The speed can be controlled with the pulses that are input to the servo amplifier. [Pr. PA01.0 Control mode selection] can be operated when set to the initial value "0" (Position control mode).

Set the logic of the positioning module and the command pulse of the servo amplifier as follows.

- Q series/L series/R series positioning module

Signal type	Command pulse logic setting	
	Setting of Pr. 23 in Q series/L series/R series positioning module	The setting value in [Pr. PA13.1 Pulse train logic selection]
Open-collector type	Positive logic	Positive logic (0)
	Negative logic	Negative logic (1)
Differential line driver type	Positive logic ^{*1}	Negative logic (1)
	Negative logic ^{*1}	Positive logic (0)

^{*1} For Q, L, and R series, the logic means the N-side waveform. Therefore, reverse the input pulse logic of the servo amplifier.

- F series positioning module

Signal type	Command pulse logic setting	
	F series positioning module (fixed)	The setting value in [Pr. PA13.1 Pulse train logic selection]
Open-collector type Differential line driver type	Negative logic	Negative logic (1)

Pulse train input

Input pulse waveform selection

The command pulses can be input in three different forms, and either positive or negative logic can be selected. Set the command pulse train form in [Pr. PA13 Command pulse input form].

Connection and waveform

- Open-collector type

The following section explains about the case where the input waveform is set to negative logic and forward/reverse rotation pulse train, [Pr. PA13.0 Command input pulse train - Form selection] is set to "0" (Forward/reverse rotation pulse trains), and [Pr. PA13.1 Pulse train logic selection] is set to "1" (negative logic).

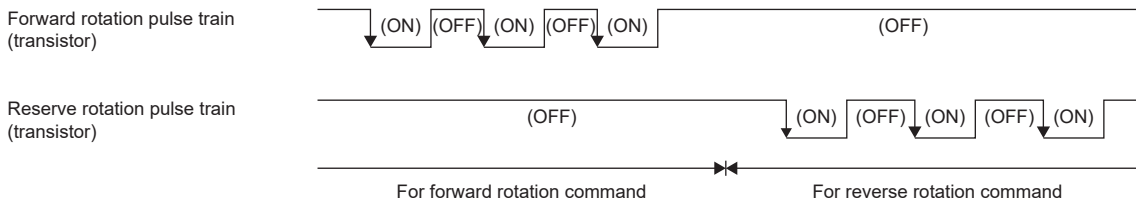

- Differential line driver type

The following explains about the case where [Pr. PA13.0 Command input pulse train - Form selection] is set to "0" (Forward/reverse rotation pulse trains) and [Pr. PA13.1 Pulse train logic selection] is set to "1" (negative logic). The waveforms of PP, PG, NP, and NG are based on LG.

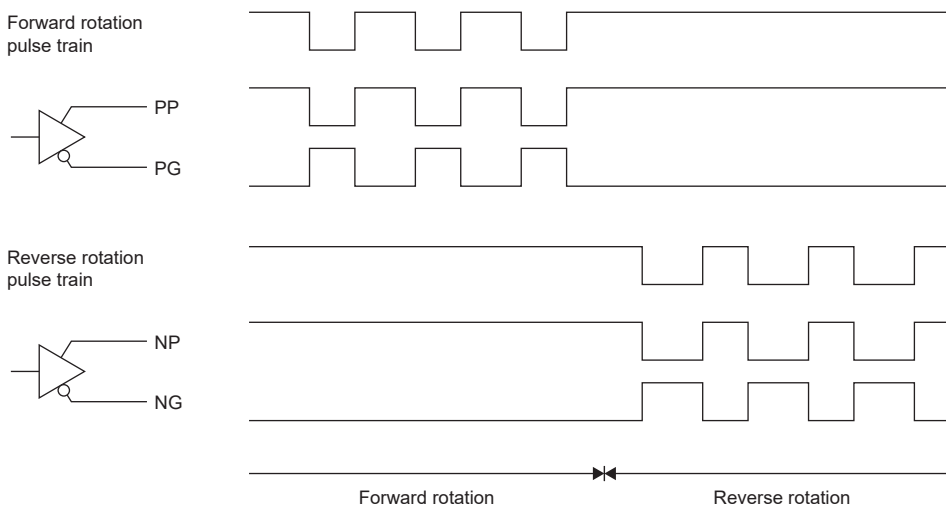

INP (In-position)

When the number of droop pulses falls within the preset in-position range ([Pr. PA10 In-position range]), INP turns on. INP may be on continuously during a low-speed operation with a large value set as the in-position range.

Refer to the following.

📖 Page 145 In-position range setting

RD (Ready)

When the servo-on state is made by turning on SON (servo-on), RD turns on.

When SON (servo-on) is turned off or at alarm occurrence, RD is off.

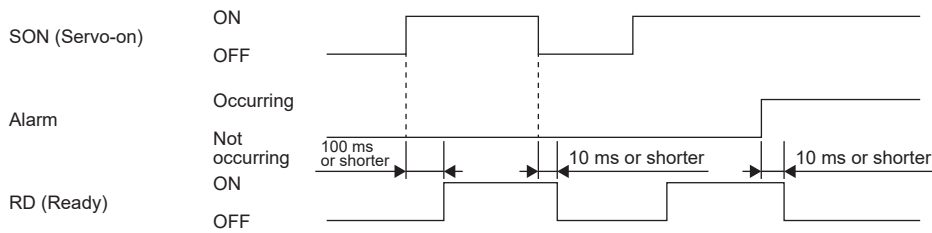

Electronic gear switching

Select the four different electronic gear numerators set in the servo parameters with the combination of CM1 and CM2.

Refer to the following.

☞ Page 141 Electronic gear function [A]

Torque limit

Precautions

- If the torque limit is canceled during servo-lock, the servo motor may suddenly rotate, depending on the amount of the position deviation from the command position.

■ Torque limit and torque

The maximum torque is always limited by the values of [Pr. PA11 Forward rotation torque limit] and [Pr. PA12 Reverse rotation torque limit] during operation.

Refer to the following.

☞ Page 347 Torque limit [A]

■ Torque limit value selection

By using TL (External torque limit selection), select the torque limit from [Pr. PA11 Forward rotation torque limit] or [Pr. PA12 Reverse rotation torque limit] and TLA (Analog torque limit).

Refer to the following.

☞ Page 347 Torque limit [A]

■ TLC (Limiting torque)

TLC turns on when the servo motor torque reaches the torque that was limited by any of the forward rotation torque limit, reverse rotation torque limit, or analog torque limit.

Position command speed adjustment time constant (position smoothing)

With [Pr. PB03 Position command speed adjustment time constant (position smoothing)], set the constant of a primary delay filter to the position command.

Also, the control methods in "Primary delay" or "Linear acceleration/deceleration" can be selected with [Pr. PB25.1 Position acceleration/deceleration filter method selection]. The setting range of "Linear acceleration/deceleration" is 0 ms to 10 ms. When a value of 10 ms or larger is set, the value is recognized as 10 ms.

When the linear acceleration/deceleration is selected, do not change [Pr. PA01.0 Control mode selection] to any setting other than the initial value "0" (Position control mode). Doing so brings the servo motor or linear servo motor to a quick stop at the time of position control mode switching.

(Usage example)

When a command is given from a synchronous encoder, a synchronous operation will start smoothly even during line operation.

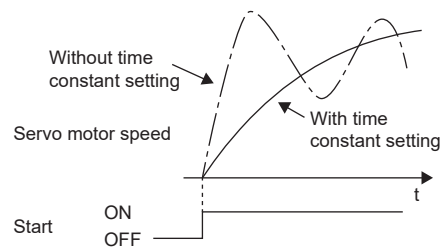
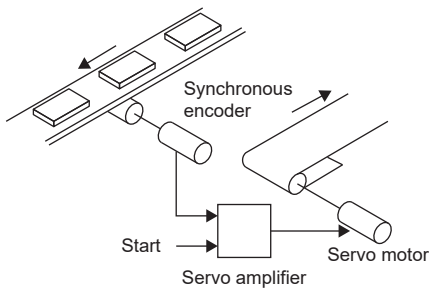

Speed control mode (S)



Set [Pr. PA01.0] to "2" (Speed control mode).

The speed can be controlled with the servo parameter setting or with the applied voltage of VC (Analog speed command).

Speed setting

Speed command and speed

The servo motor is operated at the speed set in the servo parameter or at the speed set in the applied voltage of VC (Analog speed command). The relation between the applied voltage in VC (Analog speed command) and the servo motor speed is shown below.

The rated speed is achieved at ± 10 V in the initial setting. The servo motor speed at ± 10 V can be changed with [Pr. PC12 Analog speed command - Maximum speed].

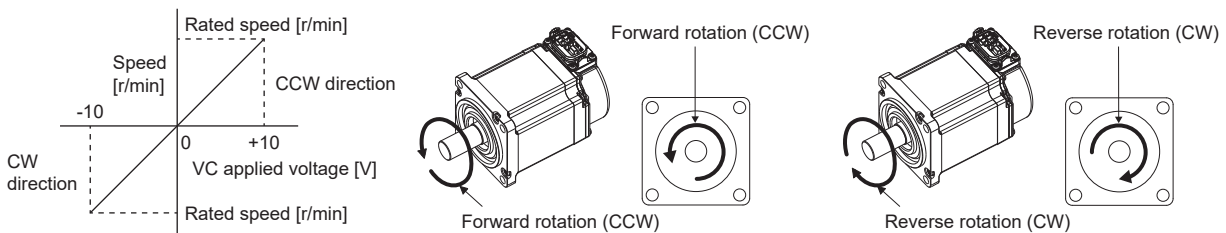

The rotation direction can be selected by using ST1 (Forward rotation start), ST2 (Reverse rotation start), or VC (Analog speed command).

Input device ^{*1}		Rotation direction ^{*2}			
ST2	ST1	VC (Analog speed command)			Internal speed
		Polarity: +	0 V	Polarity: -	
0	0	Stop (servo-lock)	Stop (servo-lock)	Stop (servo-lock)	Stop (servo-lock)
0	1	CCW	Stop (no servo-lock)	CW	CCW
1	0	CW		CCW	CW
1	1	Stop (servo-lock)	Stop (servo-lock)	Stop (servo-lock)	Stop (servo-lock)

*1 0: Off
1: On

*2 If the torque limit is canceled during servo-lock, the servo motor may suddenly rotate, depending on the amount of the position deviation from the command position.

For linear servo motors, CCW is the positive direction and CW is the negative direction.

■ SP1 (Speed selection 1)/SP2 (Speed selection 2) and speed command value

The speed command can be selected with SP1 (Speed selection 1) and SP2 (Speed selection 2).

Input device *1		Speed command value
SP2	SP1	
0	0	VC (Analog speed command)
0	1	[Pr. PC05 Internal speed 1]
1	0	[Pr. PC06 Internal speed 2]
1	1	[Pr. PC07 Internal speed 3]

*1 0: Off
1: On

When SP3 (Speed selection 3) is enabled with the settings of [Pr. PD03 Input device selection 1] to [Pr. PD22 Input device selection 10], internal speed 4 to 7 can be selected.

Input device *1			Speed command value
SP3	SP2	SP1	
0	0	0	VC (Analog speed command)
0	0	1	[Pr. PC05 Internal speed 1]
0	1	0	[Pr. PC06 Internal speed 2]
0	1	1	[Pr. PC07 Internal speed 3]
1	0	0	[Pr. PC08 Internal speed 4]
1	0	1	[Pr. PC09 Internal speed 5]
1	1	0	[Pr. PC10 Internal speed 6]
1	1	1	[Pr. PC11 Internal speed 7]

*1 0: Off
1: On

The speed can also be switched during operation. Acceleration/deceleration is performed with the time constant setting in [Pr. PC01 Speed acceleration time constant] and [Pr. PC02 Speed deceleration time constant].

When the internal speed is used to command a speed, the speed does not vary with the ambient temperature.

SA (Speed reached)

SA turns on when the servo motor speed has nearly reached the speed set to the internal speed or analog speed command.

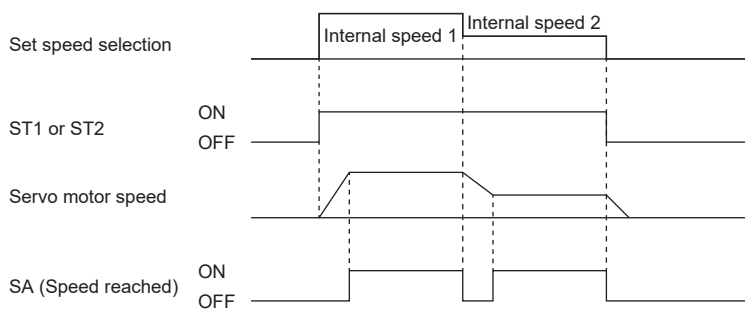

Torque limit

Same as when in position control mode.

☞ Page 94 Torque limit

Torque control mode (T)

Point

Set [Pr. PA01.0] to "4" (Torque control mode).

The torque can be controlled with the combination of the applied voltage of TC (Analog torque command) and either of RS1 (Forward rotation selection) or RS2 (Reverse rotation selection).

Torque control

Torque command and torque

The following shows a relation between the applied voltage of TC (Analog torque command) and the torque by the servo motor.

In the initial setting, 100.0% of the output torque is set to the maximum torque at ± 8 V. The output torque at ± 8 V can be changed [Pr. PC13 Analog torque command maximum output].

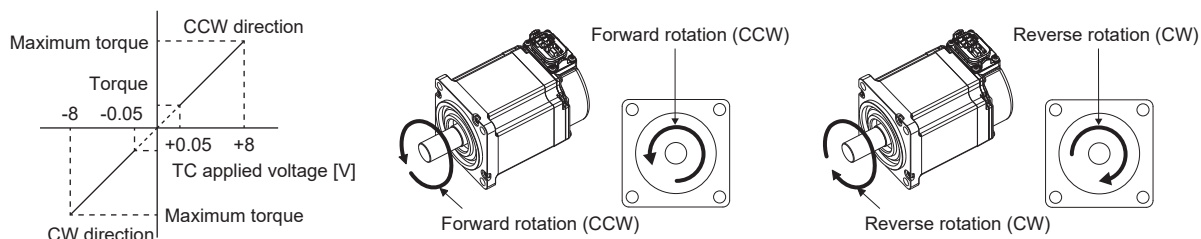

The command value for output torque relative to the voltage varies by approximately 5 % between motors. The torque may vary if the voltage is low (-0.05 V to 0.05 V) and the actual speed is close to the limit value. In such a case, increase the speed limit value.

The direction of torque generation can be selected with RS1 (Forward rotation selection), RS2 (Reverse rotation selection), and TC (Analog torque command).

Input device *1		Rotation direction *2		
RS2	RS1	TC (Analog torque command)		
		Polarity: +	0 V	Polarity: -
0	0	Torque is not generated.	Torque is not generated.	Torque is not generated.
0	1	CCW (Forward rotation in power running mode/reverse rotation in regenerative mode)		CW (Reverse rotation in power running mode/forward rotation in regenerative mode)
1	0	CW (Reverse rotation in power running mode/forward rotation in regenerative mode)	Torque is not generated.	CCW (Forward rotation in power running mode/reverse rotation in regenerative mode)
1	1	Torque is not generated.		Torque is not generated.

*1 0: Off
1: On

*2 For linear servo motors, CCW is the positive direction and CW is the negative direction.

Analog torque command offset

Using [Pr. PC38 Analog command input 2 offset], the offset voltage of -9999 mV to 9999 mV can be added to the TC applied voltage as follows.

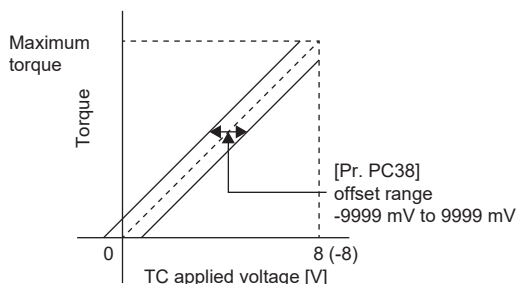

Torque limit

The maximum torque is always limited by the values of [Pr. PA11 Forward rotation torque limit] and [Pr. PA12 Reverse rotation torque limit] during operation.

A relation between limit value and servo motor torque is the same as in the description of the position control mode.

Note that TLA (Analog torque limit) is unavailable.

☞ Page 94 Torque limit

Speed limit

■ Speed limit value and speed

The speed is limited to the values set with [Pr. PC05 Internal speed 1] to [Pr. PC11 Internal speed 7] or the value set in the applied voltage of VLA (Analog speed limit). The relation between the applied voltage in VLA (Analog speed limit) and the servo motor speed is shown below.

When the servo motor speed reaches the speed limit value, torque control may become unstable. Make the set value more than 100 r/min greater than the desired speed limit value.

In the initial setting, the rated speed is set to the speed limit value at ± 10 V. The speed limit value at ± 10 V can be changed with [Pr. PC12 Analog speed command - Maximum speed].

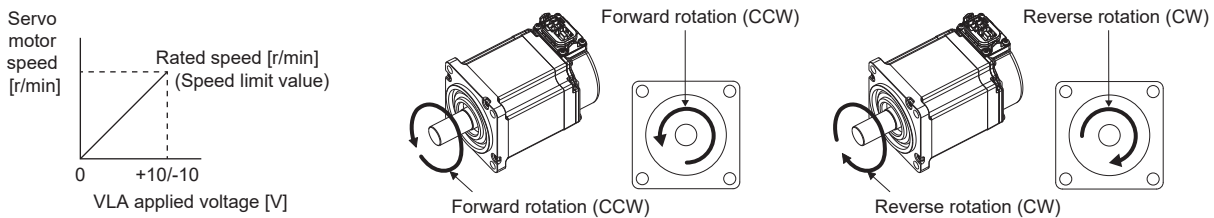

The following table indicates the limit direction according to the combination of RS1 (Forward rotation selection) and RS2 (Reverse rotation selection).

Input device ^{*1}		TC (Analog torque command)		Speed limit direction ^{*2}		
RS1	RS2	Voltage polarity	Torque command direction	VLA (Analog speed limit)		Internal speed limit
				Polarity: +	Polarity: -	
1	0	Polarity: +	CCW	CCW	CCW	CCW
		Polarity: -	CW	CW	CW	CW
0	1	Polarity: +	CW	CW	CW	CW
		Polarity: -	CCW	CCW	CCW	CCW

*1 0: Off
1: On

*2 For linear servo motors, CCW is the positive direction and CW is the negative direction.

■ Speed limit value selection

The speed limit can be selected with SP1 (Speed selection 1), SP2 (Speed selection 2), and SP3 (Speed selection 3).

Input device *1			Speed limit
SP3	SP2	SP1	
0	0	0	VLA (Analog speed limit)
0	0	1	[Pr. PC05 Internal speed 1]
0	1	0	[Pr. PC06 Internal speed 2]
0	1	1	[Pr. PC07 Internal speed 3]
1	0	0	[Pr. PC08 Internal speed 4]
1	0	1	[Pr. PC09 Internal speed 5]
1	1	0	[Pr. PC10 Internal speed 6]
1	1	1	[Pr. PC11 Internal speed 7]

*1 0: Off

1: On

When internal speed 1 to 7 are used to limit a speed, the speed does not vary with the ambient temperature.

■ VLC (Limiting speed)

VLC turns on when the servo motor speed reaches a speed limited with internal speed 1 to 7 or the analog speed limit.

Position/speed control switching mode (P/S)

Point

Set [Pr. PA01.0] to "1" (Position/Speed control switching mode).

Switching between the position control and speed control is enabled at a zero speed status. Refer to the following.

☞ Page 92 Control mode switching by using LOP (Control switching)

Use LOP (Control switching) to switch between the position control mode and the speed control mode with an external contact. This function is not available in the absolute position detection system.

LOP (Control switching)

Use LOP (Control switching) to switch between the position control mode and the speed control mode with an external contact. The following shows the relation between LOP and control modes.

LOP *1	Control mode
0	Position control mode
1	Speed control mode

*1 0: Off
1: On

Switching the control mode is enabled at a zero speed status. To ensure safety, switch modes after the servo motor has stopped. When position control mode is switched to speed control mode, droop pulses are cleared.

After LOP is switched at a speed higher than the zero speed, the control mode cannot be switched even at a speed lower than the zero speed.

The following shows a switching timing chart.

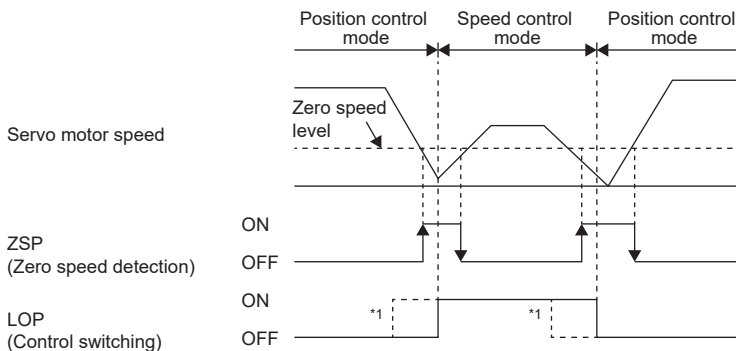

*1 When ZSP is not turned on, the control mode cannot be switched even if LOP is turned on/off. After LOP is turned on/off, even if ZSP is turned on, the control mode cannot be switched.

Torque limit in position control mode

The specifications are the same as those described in the section for the position control mode.

☞ Page 94 Torque limit

Speed setting in speed control mode

■ Speed command and speed

The servo motor is operated at the speed set in the servo parameter or at the speed set in the applied voltage of VC (Analog speed command). The relation between an applied voltage of VC (Analog speed command) and servo motor speed, and the rotation direction with turning on ST1/ST2 are the same as in the section of the speed control mode.

☞ Page 96 Speed command and speed

■ Speed command value selection

The speed command can be selected with SP1 (Speed selection 1) and SP2 (Speed selection 2).

Input device *1		Speed command value
SP2	SP1	
0	0	VC (Analog speed command)
0	1	[Pr. PC05 Internal speed 1]
1	0	[Pr. PC06 Internal speed 2]
1	1	[Pr. PC07 Internal speed 3]

*1 0: Off
1: On

When SP3 (Speed selection 3) is enabled with the settings of [Pr. PD03 Input device selection 1] to [Pr. PD22 Input device selection 10], internal speed 4 to 7 can be selected.

Input device *1			Speed command value
SP3	SP2	SP1	
0	0	0	VC (Analog speed command)
0	0	1	[Pr. PC05 Internal speed 1]
0	1	0	[Pr. PC06 Internal speed 2]
0	1	1	[Pr. PC07 Internal speed 3]
1	0	0	[Pr. PC08 Internal speed 4]
1	0	1	[Pr. PC09 Internal speed 5]
1	1	0	[Pr. PC10 Internal speed 6]
1	1	1	[Pr. PC11 Internal speed 7]

*1 0: Off
1: On

The speed can also be switched during operation. Acceleration/deceleration is performed with the time constant setting in [Pr. PC01 Speed acceleration time constant] and [Pr. PC02 Speed deceleration time constant].

When the internal speed 1 to 7 are used to command a speed, the speed does not vary with the ambient temperature.

■ SA (Speed reached)

The specifications are the same as those described in the section of the speed control mode.

☞ Page 97 SA (Speed reached)

Speed/torque control switching mode (S/T)



Set [Pr. PA01.0] to "3" (Speed control mode and torque control mode).

Use LOP (Control switching) to switch between the speed control mode and the torque control mode with an external contact. The control mode may be switched at any time.

LOP (Control switching)

Use LOP (Control switching) to switch between the speed control mode and the torque control mode with an external contact. The following shows the relation between LOP and control modes.

LOP *1	Control mode
0	Speed control mode
1	Torque control mode

*1 0: Off
1: On

The control mode may be switched at any time. The following shows a switching timing chart.

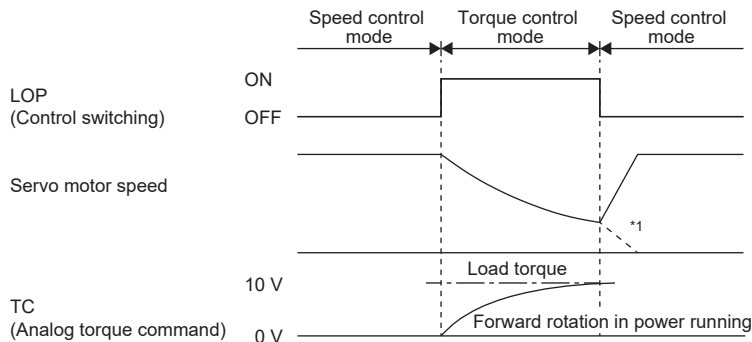

*1 When ST1 (Forward rotation start) and ST2 (Reverse rotation start) are switched off as soon as the mode is switched to the speed control, the servo motor comes to a stop according to the deceleration time constant. A shock may occur at switching control modes.

Speed setting and torque limit in speed control mode

The specifications are the same as those described in the section for the speed control mode.

☞ Page 96 Speed setting

☞ Page 94 Torque limit

Speed limit in torque control mode

■ Speed limit value and speed

The speed is limited to the limit value of the servo parameter or the value set in the applied voltage of VLA (Analog speed limit).

A relation between the VLA (Analog speed limit) applied voltage and the limit value is the same as the specification in the section of the torque control mode.

☞ Page 99 Speed limit value and speed

■ Speed limit value selection

The speed limit can be selected with SP1 (Speed selection 1).

Input device ^{*1}	Speed limit value
SP1	
0	VLA (Analog speed limit)
1	[Pr. PC05 Internal speed 1]

*1 0: Off
1: On

The speed can also be switched during operation. Acceleration/deceleration is performed with the time constant setting in [Pr. PC01 Speed acceleration time constant] and [Pr. PC02 Speed deceleration time constant].

When the internal speed 1 is used to command a speed, the speed does not vary with the ambient temperature.

■ VLC (Limiting speed)

The specifications are the same as those described in the section for the torque control mode.

☞ Page 100 VLC (Limiting speed)

Torque control and torque limit in torque control mode

The specifications are the same as those described in the section for the torque control mode.

☞ Page 98 Torque control

☞ Page 99 Torque limit

Torque/position control switch mode (T/P)

Point

Set [Pr. PA01.0] to "5" (Torque/position control switching mode).

Switching between the torque control and position control is enabled at a zero speed status. Refer to the following.

☞ Page 92 Control mode switching by using LOP (Control switching)

Use LOP (Control switching) to switch between the torque control mode and the position control mode with an external contact. When position control mode is switched to torque control mode, droop pulses are cleared.

LOP (Control switching)

Use LOP (Control switching) to switch between the torque control mode and the position control mode with an external contact. The following shows the relation between LOP and control modes.

LOP *1	Control mode
0	Torque control mode
1	Position control mode

*1 0: Off
1: On

Switching the control mode is enabled at a zero speed status. To ensure safety, switch modes after the servo motor has stopped. When position control mode is switched to torque control mode, droop pulses are cleared.

After LOP is switched at a speed higher than the zero speed, the control mode cannot be switched even at a speed lower than the zero speed.

The following shows a switching timing chart.

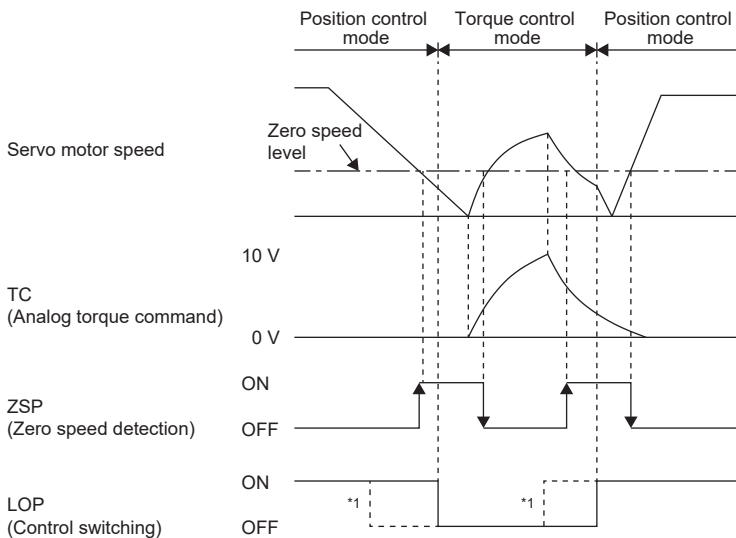

*1 When ZSP is turned off, the control mode cannot be switched even if LOP is turned on/off. After LOP is turned on/off, even if ZSP is turned on, the control mode cannot be switched.

Speed limit, torque control, and torque limit in torque control mode

The specifications are the same as those described in the section for the torque control mode.

☞ Page 99 Speed limit

☞ Page 98 Torque control

☞ Page 99 Torque limit

Torque limit in position control mode

The specifications are the same as those described in the section of the position control mode.

☞ Page 94 Torque limit

3 BASIC FUNCTION

This chapter explains each function that is used for basic operation of the servo amplifier. Set each function as required. For advanced operation of the servo amplifier, refer to the following.

☞ Page 205 APPLICABLE FUNCTIONS

Precautions

- To prevent a malfunction and machine damage, on the first operation after setting, check the operating condition with a low speed command.

3.1 Outline of servo parameter and object dictionary

On MR-J5 servo amplifiers, the functions of the servo amplifiers are set with servo parameters, and objects enable communication of data such as command values and feedback values with controllers.

Servo parameter



For the servo parameters that updates data periodically in the cyclic communication, do not write a value with an engineering tool or other tools, as the values will be overwritten from the controller.

Each function of the servo amplifiers can be set with the servo parameters. The servo parameters are stored in the non-volatile memory in the servo amplifier. Initial values are set for the servo parameters in the factory setting. Change the setting with engineering tools or other methods as necessary.

The servo parameters related to the basic functions explained in this manual are shown in the following example.

If the servo parameter name is "Travel direction selection" and the number is "PA14"

[Pr. PA14 Travel direction selection]

Servo parameter	Symbol	Name	Outline
PA14	*POL	Travel direction selection	The rotation direction of the servo motor or the travel direction of the linear servo motor can be set. Initial value: 0 (CCW or positive direction)

In addition, the servo parameters in which the symbols are preceded by * are enabled by the following conditions.

- *: After setting, cycle the power, or reset either the controller or the software.
- **: After setting, cycle the power or reset the software.

For a servo parameter which uses one particular digit to select a function, the position of its digit indicates the detail number of the servo parameter, and the value in hexadecimal which is set to the digit indicates the selected function.

For example, the detail number of the servo parameter in the last digit is expressed as [Pr. PA01.0]. In addition, a servo parameter which uses a combination of several digits to select a function, is expressed using "-" as seen in [Pr. PA01.0-1].

The following is an example of the servo parameter number PA01 with the setting values of "FEDCBA98" in hexadecimal.

- When setting a servo parameter with one particular digit

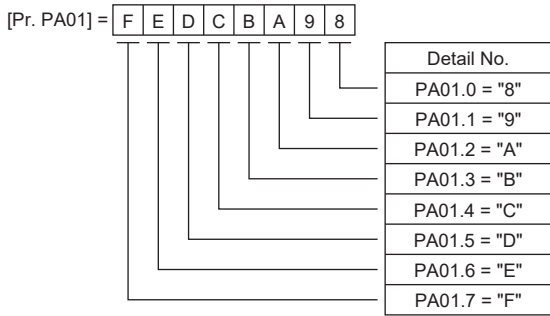

- When setting a servo parameter using a combination of several digits

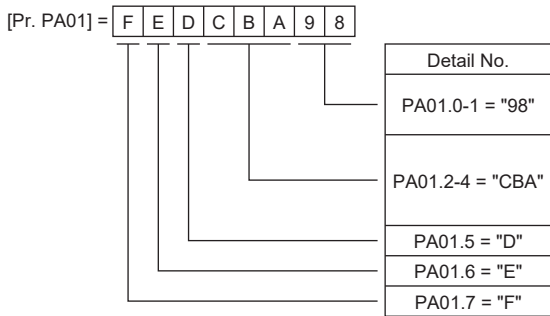

For example, if the servo parameter name is "Function selection A-1", the setting digit name is "Forced stop deceleration function selection", and the setting digit is the fourth last digit in PA04, the servo parameter is expressed as shown below.

[Pr. PA04.3 Forced stop deceleration function selection]

Servo parameter	Symbol	Name	Outline
PA04.3	*AOP1	Forced stop deceleration function selection	Set "Forced stop deceleration function" to enabled/disabled. Initial value: 1h (enabled)

Object dictionary [G]

MR-J5 servo amplifiers communicate information such as position commands and position feedback via a network. For identification, each information is assigned to a unique number from 0000h to FFFFh called Index, and the assigned information is called an object.

For example, the command position is the object that is assigned to the Index of 607Ah. A servo amplifier has a huge number of objects, which are called an object dictionary in the aggregate.

The basic functions described in this manual also describe the method of use of the objects, as there are operations that give commands to the servo amplifier through objects, as well as operations that notify status to the controller through objects.

When using a controller manufactured by Mitsubishi Electric, any concern regarding the Objects is alleviated as the controller itself has the functions to set and obtain the Object values necessary to implement each function. When the respective object values are needed to be obtained and set specifically, use the servo cyclic transmission function or the servo transient transmission function. For details, refer to each controller manual.

The objects related to the basic functions explained in this manual are shown in the following example.

Ex.

[Target position (Obj. 607Ah)]

Index	Sub	Object	Name	Description
607Ah	—	VAR	Target position	Command position Unit: pos units

For details on how to save the content set in the object, refer to "Saving object dictionary data" in the User's Manual (Communication Function).

3.2 Rotation/travel direction selection [G]

The rotation direction of a servo motor or the travel direction of a linear servo motor can be changed according to position commands, speed commands, and torque commands. Set the directions with servo parameters or objects in accordance with the system configurations.

The servo motor rotation direction is as follows.

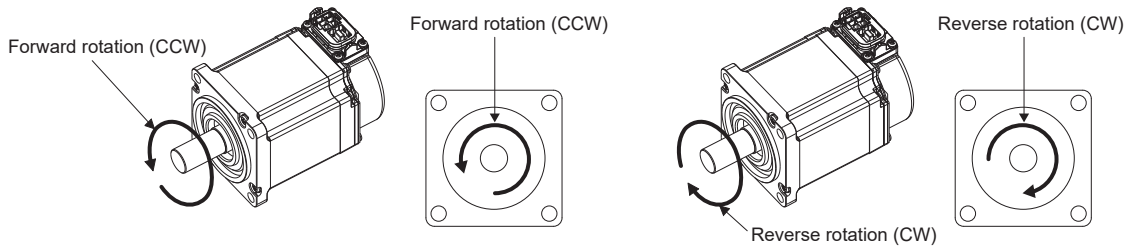

The positive and negative directions of the linear servo motor are as follows.

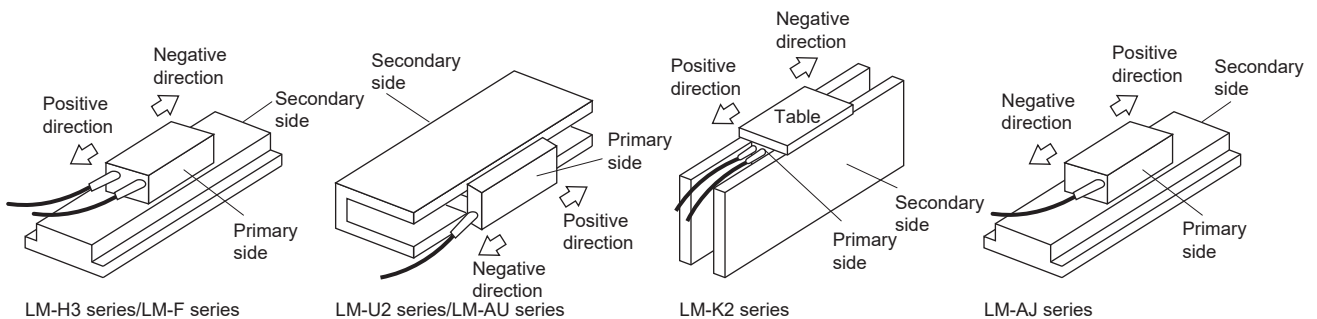

Restriction

- When the setting of the servo motor rotation direction is changed, the status changes to "Homing incomplete". Execute homing again.

Precautions

- The setting of the rotation/travel direction selection does not change the "Display All" function and "Graph" function in MR Configurator2.
- Some objects can be changed with the setting of the rotation/travel direction selection, and some cannot. Refer to the following for details.

☞ Page 112 Target object

Setting methods of functions

Setting with servo parameters

The rotation/travel direction can be changed without changing the polarity of the command from the controller. With regards to the commands from the controller, and in the feedback information to be transmitted to the controller, the position/speed information is changed with the setting of [Pr. PA14 Travel direction selection].

The torque information is changed with the combination of [Pr. PA14 Travel direction selection] and [Pr. PC29.3 Torque POL reflection selection].

The rotation/travel direction setting is common for all the control modes. For example, when the torque polarity is changed with [Pr. PA14] and [Pr. PC29.3], the torque information polarity will also change in the position mode.

The servo parameters related to the setting of the rotation/travel direction selection are as follows:

Servo parameter	Symbol	Name	Outline
PA14	*POL	Travel direction selection	The rotation direction of the servo motor and the travel direction of the linear servo motor can be set. Initial value: 0 (CCW or positive direction)
PC29.3	*COPB	Torque POL reflection selection	Torque POL reflection selection can be set. The torque polarity can be changed with the combination of this servo parameter and [Pr. PA14]. Initial value: 1h (disabled)

The following tables show the rotation/travel direction of the position information, speed information, and torque information that is changed in servo parameter settings.

■ Position information

[Pr. PA14] Setting value	Servo motor rotation direction/linear servo motor travel direction	
	Positioning address increasing direction	Positioning address decreasing direction
0	CCW or positive direction	CW or negative direction
1	CW or negative direction	CCW or positive direction

■ Speed information

[Pr. PA14] Setting value	Servo motor rotation direction/linear servo motor travel direction	
	Speed handled by the controller: positive	Speed handled by the controller: negative
0	CCW or positive direction	CW or negative direction
1	CW or negative direction	CCW or positive direction

■ Torque information

Setting value		Servo motor rotation direction/linear servo motor travel direction	
[Pr. PA14]	[Pr. PC29.3]	Torque handled by the controller: positive	Torque handled by the controller: negative
0	0: Enabled	CCW or positive direction	CW or negative direction
	1: Disabled		
1	0: Enabled	CW or negative direction	CCW or positive direction
	1: Disabled	CCW or positive direction	CW or negative direction

Setting with object dictionary

[Polarity (Obj. 607Eh)] enables the rotation/travel direction to be changed without changing the polarity of the command from the controller. The setting of [Polarity (Obj. 607Eh)] for the position information and speed information corresponds to [Pr. PA14 Travel direction selection]. The setting of [Polarity (Obj. 607Eh)] for the torque information corresponds to [Pr. PA14 Travel direction selection] and "Torque POL reflection selection" in [Pr. PC29].

A change in the setting of [Polarity (Obj. 607Eh)] is not applied immediately.

The table below shows the relations between the object definition, object setting values, and the servo parameters. Settings can only be made with the combinations indicated here.

Bit	Description
0	(reserved) The value at reading is undefined. Set "0" when writing.
1	
2	
3	
4	
5	0: Servo motor CCW rotation at positive torque 1: Servo motor CW rotation at positive torque
6	0: Servo motor CCW rotation at positive speed 1: Servo motor CW rotation at positive speed
7	0: Servo motor CCW rotation in the positioning address increasing direction 1: Servo motor CW rotation in the positioning address increasing direction

The below table shows the relations between the object setting value of [Polarity (Obj. 607Eh)] and the servo parameters.

Object			Servo parameter		Description
[Polarity (Obj. 607Eh)]			[Pr. PA14]	[Pr. PC29.3]	
Bit7	Bit6	Bit5			
0	0	0	0	1	The polarity does not change.
1	1	0	1	1	The polarity of the position and speed is reversed.
1	1	1	1	0	The polarity of the position, speed, and torque is reversed.

Target object

The following shows the objects in which the polarity is reversed by the setting of [Polarity (Obj. 607Eh)] and by the settings of [Pr. PA14] and [Pr. PC29.3].

- [Target position (Obj. 607Ah)]
- [Target velocity (Obj. 60FFh)]
- [Target torque (Obj. 6071h)]
- [Position demand value (Obj. 6062h)]

Available on servo amplifiers with firmware version B6 or later.

- [Position actual value (Obj. 6064h)]
- [Velocity demand value (Obj. 606Bh)]

Whether to reverse the polarity with [Polarity (Obj. 607Eh)] can be set by setting one of the following values in [Pr. PC76.2 Internal command speed POL reflection selection].

Available on servo amplifiers with firmware version A5 or later.

"0": Automatic setting (POL setting enabled)

"1" (POL setting enabled): The polarity is reversed with [Polarity (Obj. 607Eh)].

"2" (POL setting disabled): The polarity is not reversed with [Polarity (Obj. 607Eh)].

- [Velocity actual value (Obj. 606Ch)]
- [Torque demand value (Obj. 6074h)]
- [Torque actual value (Obj. 6077h)]
- [Current actual value (Obj. 6078h)]

Available on servo amplifiers with firmware version B6 or later.

- [Position offset (Obj. 60B0h)]

Available on servo amplifiers with firmware version A5 or later.

- [Velocity offset (Obj. 60B1h)]

Available on servo amplifiers with firmware version A5 or later.

- [Torque offset (Obj. 60B2h)]

Available on servo amplifiers with firmware version A5 or later.

- [Positive torque limit value (Obj. 60E0h)]

With the settings of [Pr. PA14] and [Pr. PC29.3], the corresponding servo parameters are changed as follows:

[Pr. PA14]	[Pr. PC29.3]	Supported servo parameter
0	1 (disabled)	[Pr. PA11 Forward rotation torque limit]
	0 (enabled)	
1	1 (disabled)	[Pr. PA12 Reverse rotation torque limit]
	0 (enabled)	

- [Negative torque limit value (Obj. 60E1h)]

With the settings of [Pr. PA14] and [Pr. PC29.3], the corresponding servo parameters are changed as follows:

[Pr. PA14]	[Pr. PC29.3]	Supported servo parameter
0	1 (disabled)	[Pr. PA12 Reverse rotation torque limit]
	0 (enabled)	
1	1 (disabled)	[Pr. PA11 Forward rotation torque limit]
	0 (enabled)	

- [Digital inputs (Obj. 60FDh)]

The corresponding status is changed in accordance with the setting of [Pr. PA14] as follows:

[Pr. PA14]	Negative limit switch (bit 0)	Positive limit switch (bit 1)
0	LSN (Reverse rotation stroke end)	LSP (Forward rotation stroke end)
1	LSP (Forward rotation stroke end)	LSN (Reverse rotation stroke end)

3.3 Rotation/travel direction selection [B]

The rotation direction of a servo motor or the travel direction of a linear servo motor can be changed according to position commands, speed commands, and torque commands. Set the directions with servo parameters in accordance with the system configurations.

The servo motor rotation direction is as follows.

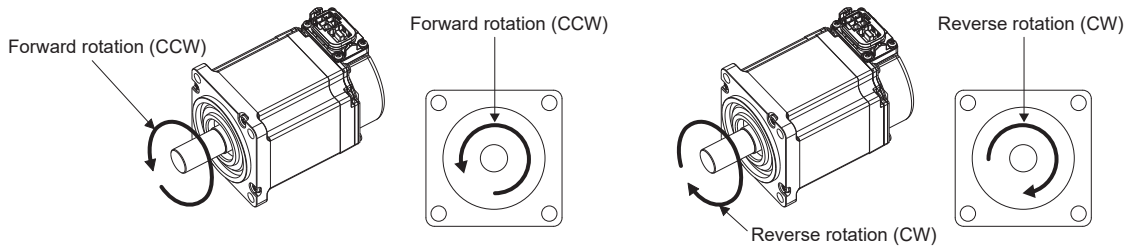

The positive and negative directions of the linear servo motor are as follows.

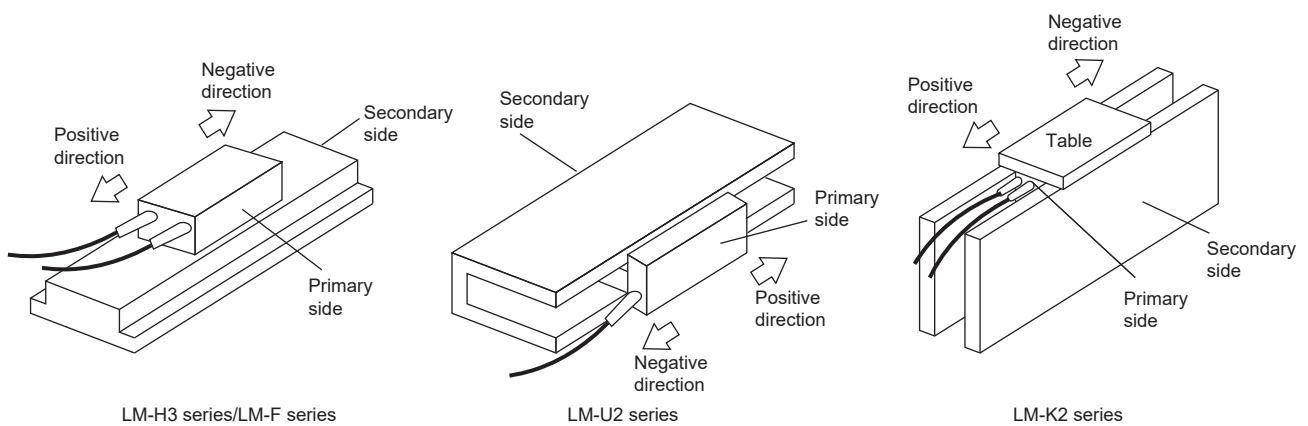

Restriction

- When the setting of the servo motor rotation direction is changed, the homing request turns on on the controller. Execute homing again. For details, refer to each controller manual.

Precautions

- The setting of the rotation/travel direction selection does not change the "Display All" function and "Graph" function in MR Configurator2.

Setting methods of functions

Setting with servo parameters

The rotation/travel direction can be changed without changing the polarity of the command from the controller. With regards to the commands from the controller, and in the feedback information to be transmitted to the controller, the position/speed information is changed with the setting of [Pr. PA14 Travel direction selection].

The torque information is changed with the combination of [Pr. PA14 Travel direction selection] and [Pr. PC29.3 Torque POL reflection selection].

The rotation/travel direction setting is common for all the control modes. For example, when the torque polarity is changed with [Pr. PA14] and [Pr. PC29.3], the torque information polarity will also change in the position mode.

The servo parameters related to the setting of the rotation/travel direction selection are as follows:

Servo parameter	Symbol	Name	Outline
PA14	*POL	Travel direction selection	The rotation direction of the servo motor and the travel direction of the linear servo motor can be set. Initial value: 0 (CCW or positive direction)
PC29.3	*COPB	Torque POL reflection selection	Torque POL reflection selection can be set. The torque polarity can be changed with the combination of this servo parameter and [Pr. PA14]. Initial value: 0h (enabled)

The following tables show the rotation/travel direction of the position information, speed information, and torque information that is changed in servo parameter settings.

■ Position information

[Pr. PA14] Setting value	Servo motor rotation direction/linear servo motor travel direction	
	Positioning address increasing direction	Positioning address decreasing direction
0	CCW or positive direction	CW or negative direction
1	CW or negative direction	CCW or positive direction

■ Speed information

[Pr. PA14] Setting value	Servo motor rotation direction/linear servo motor travel direction	
	Speed handled by the controller: positive	Speed handled by the controller: negative
0	CCW or positive direction	CW or negative direction
1	CW or negative direction	CCW or positive direction

■ Torque information

- Other than the continuous operation to torque control mode

Setting value		Servo motor rotation direction/linear servo motor travel direction	
[Pr. PA14]	[Pr. PC29.3]	Torque handled by the controller: positive	Torque handled by the controller: negative
0	0: Enabled	CCW or positive direction	CW or negative direction
	1: Disabled		
1	0: Enabled	CW or negative direction	CCW or positive direction
	1: Disabled	CCW or positive direction	CW or negative direction

- Continuous operation to torque control mode

Setting value		Servo motor rotation direction/linear servo motor travel direction	
[Pr. PA14]	[Pr. PC29.3]	Torque handled by the controller: positive	Torque handled by the controller: negative
0	0: Enabled	CCW or positive direction	CW or negative direction
	1: Disabled		
1	0: Enabled	CCW or positive direction	CW or negative direction
	1: Disabled		

3.4 Rotation/travel direction selection [A]

The rotation direction of a servo motor or the travel direction of a linear servo motor can be changed according to position commands, speed commands, and torque commands. Set the directions with servo parameters in accordance with the system configurations.

The servo motor rotation direction is as follows.

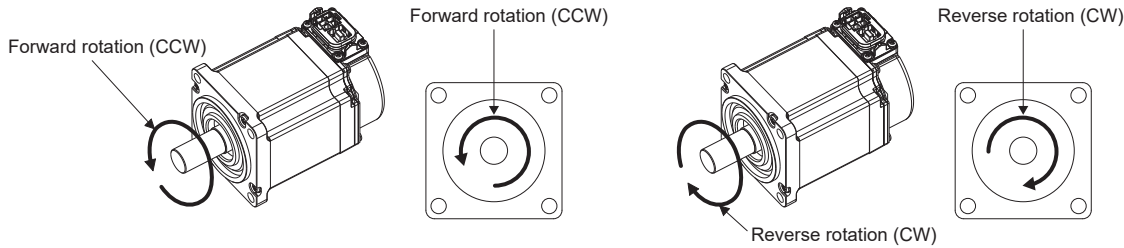

The positive and negative directions of the linear servo motor are as follows.

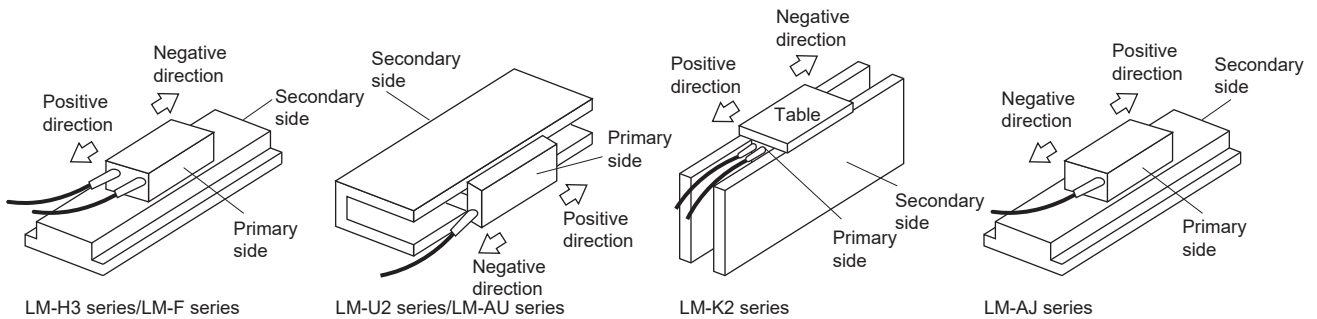

Restriction

- When the setting of the servo motor rotation direction is changed, the status changes to "Homing incomplete". Execute homing again.
- In the speed control mode (S) and torque control mode (T), the rotation direction setting cannot be changed with the servo parameters. Change the rotation direction with the combination of ST1 (Forward rotation start) and ST2 (Reverse rotation start).

Precautions

- The setting of the rotation/travel direction selection does not change the "Display All" function and "Graph" function in MR Configurator2.

Setting methods of functions

Setting with servo parameters

The rotation/travel direction in each control mode is as follows:

■ For position control mode

With the setting of [Pr. PA14 Travel direction selection], the rotation/travel direction can be changed without changing the forward/reverse rotation pulse inputs of the input pulse train.

Servo parameter	Symbol	Name	Outline
PA14	*POL	Travel direction selection	The rotation direction of the servo motor and the travel direction of the linear servo motor can be set. Initial value: 0 (CCW or positive direction)

The following table shows the rotation/travel direction of the position information to be changed by the servo parameter settings.

- Position information

[Pr. PA14] Setting value	Servo motor rotation direction/linear servo motor travel direction	
	Positioning address increasing direction	Positioning address decreasing direction
0	CCW or positive direction	CW or negative direction
1	CW or negative direction	CCW or positive direction

■ For speed and torque control modes

The rotation and travel direction cannot be changed with the servo parameter.

3.5 Stroke limit function [G]

The stroke limit function is a function that limits the travel distance of servo motors. On a system configuration where the movable range is limited, wire the stroke limit signal and use this function to prevent machine damage due to a collision. When the stroke limit signal is detected, a warning regarding the detected signal occurs, and the servo motor stops based on the stop method described in this section.

When a system configuration without the limited movable range is used and therefore the stroke limit function is not necessary, set the stroke limit signal to always on.

Restriction

- The stroke limit signal cannot be used in the torque mode. In the torque mode of the linear servo motor and the direct drive motor, the stroke limit signal can be used only at the time of magnetic pole detection.
- In the continuous operation to torque control mode, the stroke limit signal is available only when the magnetic pole is detected using a linear servo motor or direct drive motor. The stroke limit signal will be unavailable after the magnetic pole detection is completed.

Precautions

- The stroke limit signal is the signal for a normally closed contact. The limit is released when the contact is on (shorted), and the limit is in progress when the contact is off (open).
- Depending on the stop method setting of the stroke limit and the commands from the controller, the home position may be erased when the servo motor is stopped by the stroke limit signal being detected during operation. If the home position is erased, perform homing again.

Explanation of the stroke limit signal names

There are two sets of stroke limit signals: FLS (Upper stroke limit)/RLS (Lower stroke limit) and LSP (Forward rotation stroke end)/LSN (Reverse rotation stroke end). The characteristics of both signals are shown in the following table. The signal names differ depending on whether the stroke limit signal is used on the controller or on the servo amplifier. Use the signal that is appropriate for the system configuration being used.

To wire limit switches to the servo amplifier, wire the limit switch installed in CCW direction to LSP (Forward rotation stroke end), and wire the limit switch installed in CW direction to LSN (Reverse rotation stroke end).

To wire limit switches to the controller, wire the limit switch installed in the increasing direction of the positioning address to FLS (Upper stroke limit), and wire the limit switch installed in the decreasing direction to RLS (Lower stroke limit). Then, input the signals from the controller.

Name	Symbol	Purpose of the signal
Upper stroke limit	FLS	The limit signal which suppresses the operation in the positioning address increasing direction with regard to the command from the controller
Lower stroke limit	RLS	The limit signal which suppresses the operation in the positioning address decreasing direction with regard to the command from the controller
Forward rotation stroke end	LSP	The limit signal which suppresses the operation in the servo motor CCW direction or in the linear servo motor positive direction
Reverse rotation stroke end	LSN	The limit signal which suppresses the operation in the servo motor CW direction or in the linear servo motor negative direction

Setting methods of functions

Refer to the following table, and make the appropriate settings for the system configuration.

Item	Reference
When wiring the limit switch to the servo amplifier	☞ Page 118 When wiring the limit switch to the servo amplifier
When wiring the limit switch to equipment other than the servo amplifier	☞ Page 120 When wiring the limit switch to equipment other than the servo amplifier
When setting the movable range with the position data	☞ Page 120 When setting the movable range with the position data
When the movable range is not limited	☞ Page 120 When the movable range is not limited

When wiring the limit switch to the servo amplifier

Refer to the system configuration example shown in this section, and input the signal of the limit switch to the servo amplifier. Set [Pr. PD41.3 Sensor input method selection] to "0" to use the initial setting (Input from the servo amplifier (LSP/LSN/DOG)). Set the limit switch installed in CCW or the positive direction to LSP, and set the limit switch installed in CW or the negative direction to LSN. In the initial setting, LSP is assigned to the CN3-2 pin, and LSN is assigned to the CN3-12 pin. The information from the stroke end that is transmitted to the controller changes depending on the setting in [Pr. PA14 Travel direction selection].

When [Pr. PA14 Travel direction selection] is set to "0" (rotating in CCW or traveling in the positive direction) with an increasing positioning address.

Signal names of the stroke end		Signal names of the corresponding stroke limits	
Symbol	Signal name	Symbol	Signal name
LSP	Forward rotation stroke end	FLS	Upper stroke limit
LSN	Reverse rotation stroke end	RLS	Lower stroke limit

When [Pr. PA14 Travel direction selection] is set to "1" (rotating in CW or traveling in the negative direction) with an increasing positioning address.

Signal names of the stroke end		Signal names of the corresponding stroke limits	
Symbol	Signal name	Symbol	Signal name
LSP	Forward rotation stroke end	RLS	Lower stroke limit
LSN	Reverse rotation stroke end	FLS	Upper stroke limit

System configuration example

- [Pr. PA14 Travel direction selection] = "0" (CCW or the positive direction)

Set LSP (Upper stroke end) for the limit signal that suppresses the operation in CCW or the positive direction. The on/off status of LSP (Forward rotation stroke end) is output as FLS (Upper stroke limit) to the controller, and the on/off status of LSN (Reverse rotation stroke end) is output as RLS (Lower stroke limit).

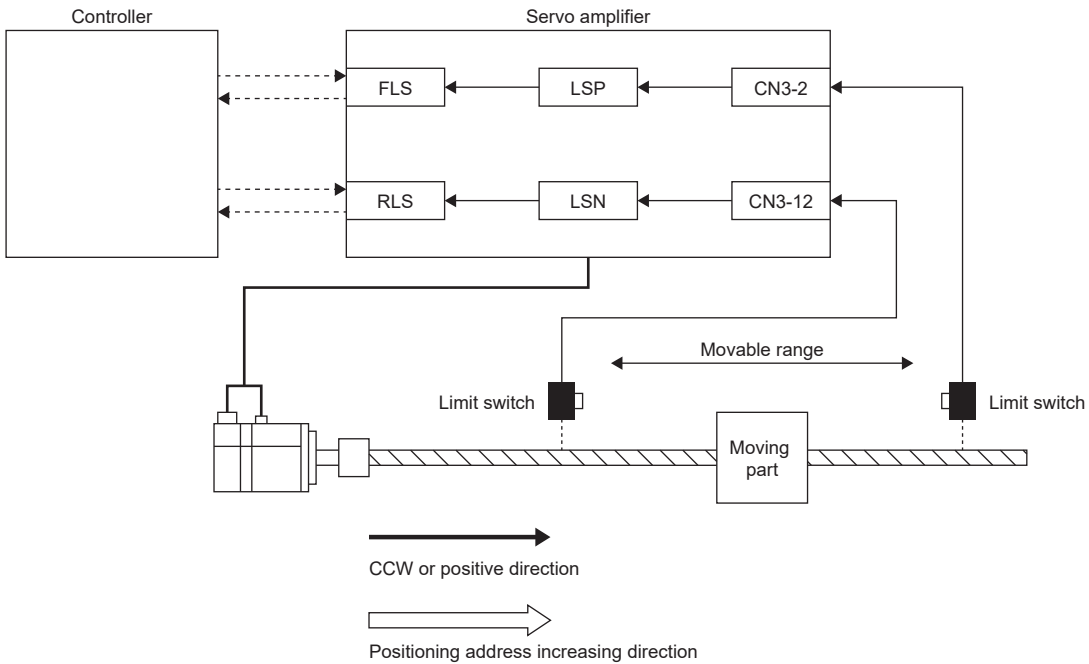

- [Pr. PA14 Travel direction selection] = "1" (CW or the negative direction)

This example shows a case where CCW or the positive direction of the servo amplifier is different from the positioning address increasing direction of the controller. The on/off status of LSN (Reverse rotation stroke end) is output as FLS (Upper stroke limit) to the controller, and the on/off status of LSP (Forward rotation stroke end) is output as RLS (Lower stroke limit).

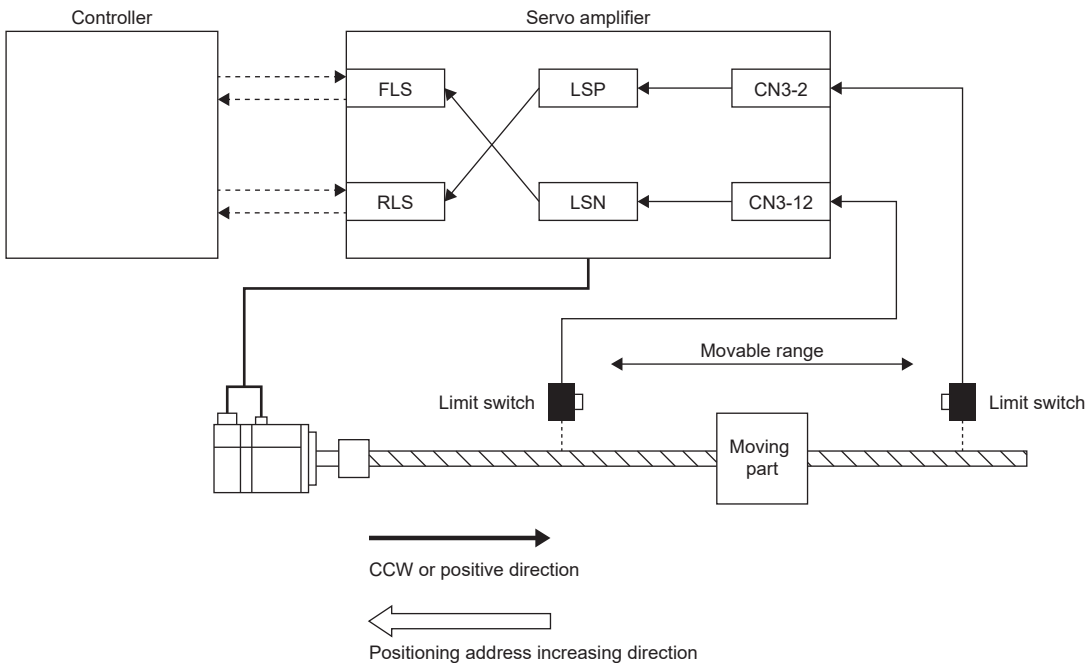

When wiring the limit switch to equipment other than the servo amplifier

By wiring the limit switch to equipment other than the servo amplifier, such as a controller, the stroke limit function is enabled to be used with input signals from the controller. Refer to the system configuration example shown in this section when installing the limit switch.

Set [Pr. PD41.3 Sensor input method selection] to "1" (input from controller (C_FLS/C_RLS/C_DOG)). From the controller to the servo amplifier, input the limit switch installed in the positioning address increasing direction as FLS (Upper stroke limit), and the limit switch installed in the decreasing direction as RLS (Lower stroke limit).

For details of the controller settings, refer to controller manuals.

■ System configuration example

The following shows an example where the limit switch is wired to the controller. To FLS (Upper stroke limit), input the limit signal which suppresses the operation in the positioning address increasing direction against the command from the controller. The limit switch does not need to be wired to the servo amplifier.

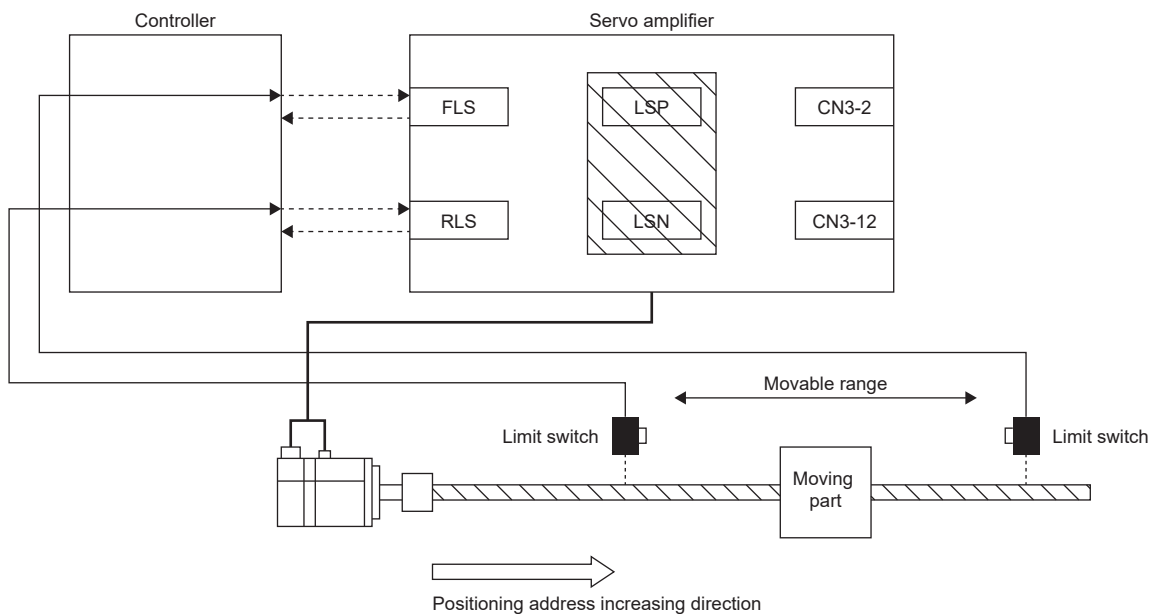

When setting the movable range with the position data

Use software position limit to specify the upper and lower limits in order to limit the movable range.

☞ Page 341 Software position limit [G]

When the movable range is not limited

On a system configuration without the limited movable range, such as a conveyor, set LSP/LSN to be automatically turned on. As the signal is set to be always turned on, the servo motor does not stop with the stroke limit. This can be set from the "Basic Setting" of "Digital I/O" on MR Configurator2.

Stop method at stroke limit detection

When LSP (Forward rotation stroke end)/LSN (Reverse rotation stroke end) or FLS (Upper stroke limit)/RLS (Lower stroke limit) is turned off, the servo motor stops with the stop method shown in this section.

In the cyclic synchronous position mode (csp), stop the command when the stroke end is detected. When the command position exceeds the position where the stroke end is detected by 30 bits, [AL. 069 Command error] occurs. If [AL. 069 Command error] occurs, the home position is erased. Perform homing again.

☞ Page 54 Homing mode (hm)



Operation status		Remark
During rotation at constant speed	During deceleration to a stop	The servo motor stops after having traveled for the droop pulses. Perform homing again.
<p>— No S-pattern acceleration/deceleration - - - With S-pattern acceleration/deceleration</p> <p>Servo motor speed</p> <p>0 r/min (0 mm/s)</p> <p>LSP or LSN ON OFF</p>	<p>— No S-pattern acceleration/deceleration - - - With S-pattern acceleration/deceleration</p> <p>Servo motor speed</p> <p>0 r/min (0 mm/s)</p> <p>LSP or LSN ON OFF</p>	

When the stroke limit signal is detected, perform the following return methods.

Control mode	Return method
Cyclic synchronous position mode	After following up [Target position (Obj. 607Ah)] with [Position actual value (Obj. 6061h)], input the position command of the direction opposite to the limit. Make sure that Bit 12 of [Statusword (Obj. 6041h)] is 0 before inputting the position command.
Cyclic synchronous velocity mode	Input the speed command of the direction opposite to the limit to [Target velocity (Obj. 60FFh)]. Make sure that Bit 12 of [Statusword (Obj. 6041h)] is 0 before inputting the speed command.
Profile position mode	Input the position command of the direction opposite to the limit to [Target position (Obj. 607Ah)].
Profile velocity mode	Input the speed command of the direction opposite to the limit to [Target velocity (Obj. 60FFh)].
Point table mode	Perform positioning operation by the point table in the opposite direction to the limit.
JOG operation mode	Perform JOG operation in the opposite direction to the limit.

Servo parameter list

The settings related to the stroke limit function can be performed directly with the servo parameters. Perform the settings as required.

Servo parameter	Symbol	Name	Outline
PC19.0	*COP6	[AL. 099 Stroke limit warning] selection	Enable or disable [AL. 099 Stroke limit warning]. When "Disabled" is selected, [AL. 099 Stroke limit warning] does not occur when LSP (Forward rotation stroke end) or LSN (Reverse rotation stroke end) is off, but the stroke limit does still stop the operation. 0: Enabled (initial value) 1: Disabled
PD01.2	*DIA1	Input signal automatic ON selection	Set LSP (Forward rotation stroke end) and LSN (Reverse rotation stroke end) to "Disabled" (use for an external input signal) or "Enabled" (Automatic on). Initial value: 0h (disabled (use for an external input signal.))
PD03.0-1	*DI1	Device selection	Assign any input devices to the connector pins. For the connector pin numbers to be assigned, refer to the following.  Page 123 Connector pin numbers assigned in [Pr. PD03.0-1] Initial value: 0Ah (LSP (Forward rotation stroke end))
PD04.0-1	*DI2	Device selection	Assign any input devices to the connector pins. For the connector pin numbers to be assigned, refer to the following.  Page 123 Connector pin numbers assigned in [Pr. PD04.0-1] Initial value: 0Bh (LSN (Reverse rotation stroke end))
PD05.0-1	*DI3	Device selection	Assign any input devices to the connector pins. For the connector pin numbers to be assigned, refer to the following.  Page 123 Connector pin numbers assigned in [Pr. PD05.0-1] Initial value: 22h (DOG (Proximity dog))
PD41.2	*DOP4	Limit switch enabled status selection	0: Limit switch always enabled (initial value) 1: Enabled only for homing mode
PD41.3	*DOP4	Sensor input method selection	0: Input from servo amplifier (LSP/LSN/DOG) (initial value) 1: Input from controller (C_FLS/C_RLS/C_DOG)
PL08.2	*LIT3	Magnetic pole detection - Stroke limit enabled/disabled selection	Select whether to enable or disable the stroke limit function during magnetic pole detection. 0: Enabled (initial value) 1: Disabled

Connector pin numbers assigned in [Pr. PD03.0-1]

Model	Axis	Connector pin No.	Initially assigned device
MR-J5-_G_	—	CN3-2	LSP
MR-J5W2-_G_	A-axis	CN3-7	LSP-A
	B-axis	CN3-20	LSP-B
MR-J5W3-_G_	A-axis	CN3-7	LSP-A
	B-axis	CN3-20	LSP-B
	C-axis	CN3-1	LSP-C
MR-J5D1-_G_	—	CN3-12	LSP
MR-J5D2-_G_	A-axis	CN3-12	LSP-A
	B-axis	CN3-26	LSP-B
MR-J5D3-_G_	A-axis	CN3-12	LSP-A
	B-axis	CN3-26	LSP-B
	C-axis	CN3-10	LSP-C

Connector pin numbers assigned in [Pr. PD04.0-1]

Model	Axis	Connector pin No.	Initially assigned device
MR-J5-_G_	—	CN3-12	LSN
MR-J5W2-_G_	A-axis	CN3-8	LSN-A
	B-axis	CN3-21	LSN-B
MR-J5W3-_G_	A-axis	CN3-8	LSN-A
	B-axis	CN3-21	LSN-B
	C-axis	CN3-2	LSN-C
MR-J5D1-_G_	—	CN3-28	LSN
MR-J5D2-_G_	A-axis	CN3-28	LSN-A
	B-axis	CN3-25	LSN-B
MR-J5D3-_G_	A-axis	CN3-28	LSN-A
	B-axis	CN3-25	LSN-B
	C-axis	CN3-9	LSN-C

Connector pin numbers assigned in [Pr. PD05.0-1]

Model	Axis	Connector pin No.	Initially assigned device
MR-J5-_G_	—	CN3-19	DOG
MR-J5W2-_G_	A-axis	CN3-9	DOG-A
	B-axis	CN3-22	DOG-B
MR-J5W3-_G_	A-axis	CN3-9	DOG-A
	B-axis	CN3-22	DOG-B
	C-axis	CN3-15	DOG-C
MR-J5D1-_G_	—	CN3-29	DOG
MR-J5D2-_G_	A-axis	CN3-29	DOG-A
	B-axis	CN3-27	DOG-B
MR-J5D3-_G_	A-axis	CN3-29	DOG-A
	B-axis	CN3-27	DOG-B
	C-axis	CN3-11	DOG-C

Limit switch release position assessment function

Outline

The limit switch release position assessment function is available on servo amplifiers with firmware version B2 or later. This function can be used in the cyclic synchronous position mode (csp) or cyclic synchronous velocity mode (csv). Use this function in the following cases: After the limit switch has been detected, the moving part passes through the limit switch detection position and stops. If the moving part passes through the limit switch detection position and stops, commands in the direction where the moving part has moved cannot be accepted until the warning release conditions are met.

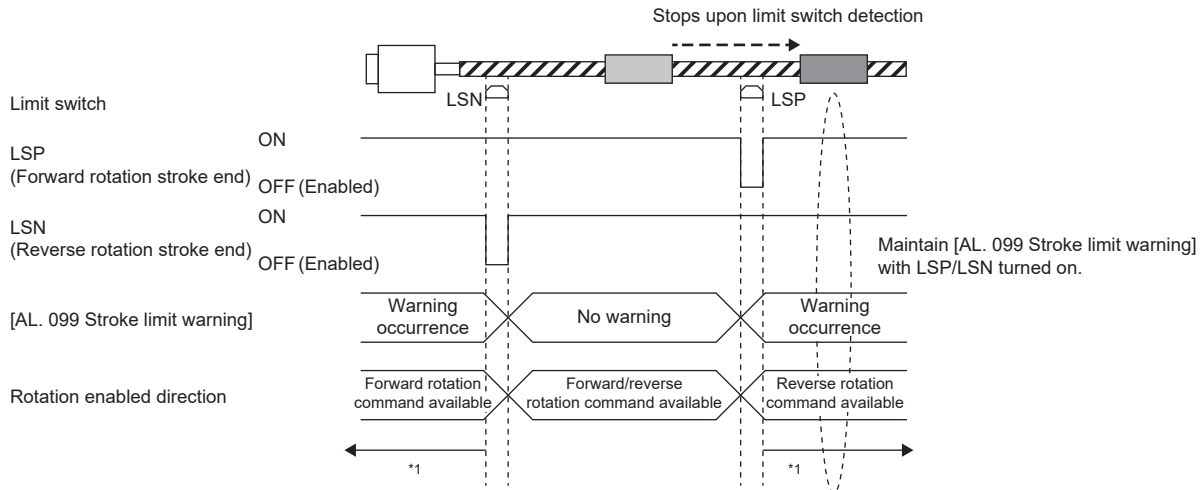

*1 Page 124 Precautions

Precautions

Check that the moving part is currently located in the area between the limit switches before operation. This function cannot work properly in the following situations:

- Turning on the power while the moving part is outside the area between the limit switches.
- Resetting the controller while the moving part is outside the area between the limit switches.
- Performing homing while the moving part is outside the area between the limit switches.
- Switching the control mode while the moving part is outside the area between the limit switches.
- The limit switches are on for less than 10 ms.

Setting methods of functions

[Pr. PT38.4 Limit switch release position assessment function selection] can be used to select whether [AL. 099 Stroke limit warning] is released without or after a limit position assessment. The stroke limit warning will be released after all the release conditions have been met.

[Pr. PT38.4]	Limit switch release position assessment function
0	Disabled
1	Enabled

■ Limit position assessment

When the moving part returns to the position where the stroke end was detected, the warning release conditions will be met.

3.6 Stroke limit function [B]

The stroke limit function is a function that limits the travel distance of servo motors using the controller. On a system configuration where the movable range is limited, wire the stroke limit signal and use this function to prevent machine damage due to a collision.

Stroke limit signals can be assigned to devices with the controller setting.

For the setting method, refer to each controller manual.

Restriction

- Assign stroke limit signals to servo amplifiers during the magnetic pole detection of the linear servo motor and direct drive motor.

Servo parameter list

The settings related to the stroke limit function can be performed directly with the servo parameters. Perform the settings as required.

Servo parameter	Symbol	Name	Outline
PD02.0	*DIA2	Input signal automatic ON selection 1	Set FLS (Upper stroke limit) and RLS (Lower stroke limit) to "Disabled" (use for an external input signal) or "Enabled" (Automatic on). Initial value: 0h (disabled (use for an external input signal.))
PL08.2	*LIT3	Magnetic pole detection - Stroke limit enabled/disabled selection	Select whether to enable or disable the stroke limit function during magnetic pole detection. 0: Enabled (initial value) 1: Disabled

3.7 Stroke limit function [A]

The stroke limit function is a function that limits the travel distance of servo motors. On a system configuration where the movable range is limited, wire the stroke limit signal and use this function to prevent machine damage due to a collision. When the stroke limit signal is detected, a warning regarding the detected signal occurs, and the servo motor stops based on the stop method described in this section.

When a system configuration without the limited movable range is used and therefore the stroke limit function is not necessary, set the stroke limit signal to always on.

Restriction

- The stroke limit signal cannot be used in the torque mode. In the torque mode of the linear servo motor and the direct drive motor, the stroke limit signal can be used only at the time of magnetic pole detection.

Precautions

- The stroke limit signal is the signal for a normally closed contact. The limit is released when the contact is on (shorted), and the limit is in progress when the contact is off (open).
- Depending on the stop method setting of the stroke limit and the commands from the controller, the home position may be erased when the servo motor is stopped by the stroke limit signal being detected during operation. If the home position is erased, perform homing again.

Setting methods of functions

Refer to the following table, and make the appropriate settings for the system configuration.

Item	Reference for this section
When wiring the limit switch to the servo amplifier	☞ Page 126 When wiring the limit switch to the servo amplifier
When the movable range is not limited	☞ Page 127 When the movable range is not limited

When wiring the limit switch to the servo amplifier

Input the output signal of the limit switch (LSP and LSN) to the servo amplifier.

Wire the limit switch installed in CCW or the positive direction to LSP, and wire the limit switch installed in CW or the negative direction to LSN.

In the initial setting, LSP (Forward rotation stroke end) is assigned to the CN3-43 pin, and LSN (Reverse rotation stroke end) is assigned to the CN3-44 pin.

System configuration example

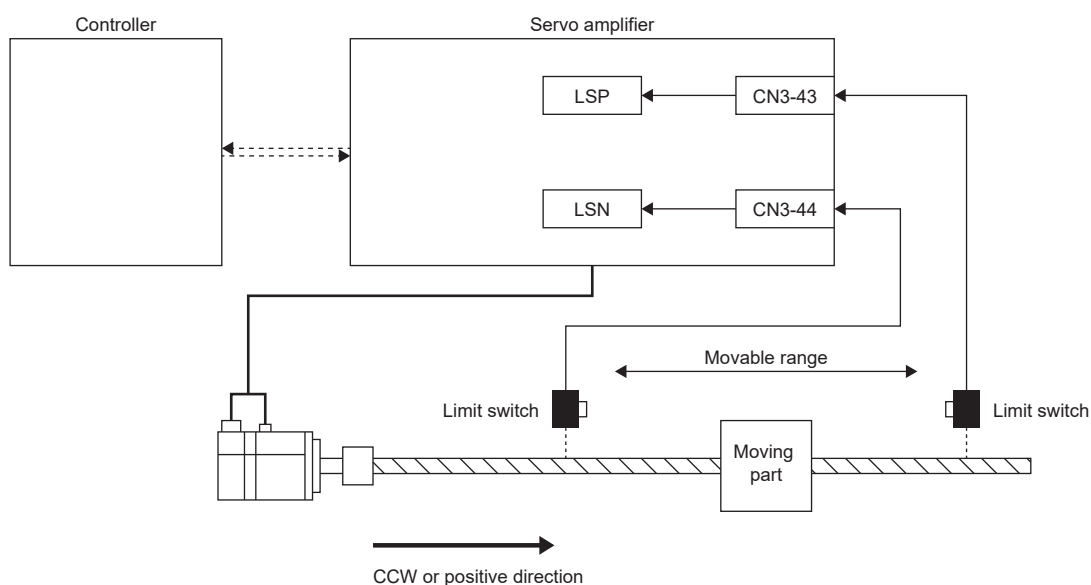

When the movable range is not limited

On a system configuration without the limited movable range, such as a conveyor, set LSP/LSN to be automatically turned on. As the signal is set to be always turned on, the servo motor does not stop with the stroke limit. This can be set from the "Basic Setting" of "Digital I/O" on MR Configurator2.

Stop method at stroke limit detection

When LSP (Forward rotation stroke end)/LSN (Reverse rotation stroke end) is turned off, the servo motor stops in accordance with the setting of [Pr. PD30.0 Stop processing selection at LSP/LSN signal off].

In MR Configurator2, a stop method can be selected in "I/O Setting".

Setting value of [Pr. PD30.0]

"0"

Quick stop (initial value)

"1"

Slow stop

When the stroke end is detected, perform the following return methods. If the home position is erased, perform homing.

Control mode	Return method
Position control mode	Input the position command of the direction opposite to the limit.
Speed control mode	Input the speed command of the direction opposite to the limit.

Servo parameter list

The settings related to the stroke limit function can be performed directly with the servo parameters. Perform the settings as required. For pin number of the input device pins and the corresponding servo parameters, refer to the following.

Servo parameter	Symbol	Name	Outline
PC26.0	*COP5	[AL. 099 Stroke limit warning] selection	Enable or disable [AL. 099 Stroke limit warning]. When "Disabled" is selected, [AL. 099 Stroke limit warning] does not occur when LSP (Forward rotation stroke end) or LSN (Reverse rotation stroke end) is off, but the stroke limit does still stop the operation. 0: Enabled (initial value) 1: Disabled
PD01.2	*DIA1	Input signal automatic ON selection	Set LSP (Forward rotation stroke end) and LSN (Reverse rotation stroke end) to "Disabled" (use for an external input signal) or "Enabled" (Automatic on). Initial value: 0h (disabled (use for an external input signal.))
PD03 to PD14, PD17 to PD22, PD43 to PD46	—	—	Assign LSN or LSP to the specified pin in CN3. In the initial setting, LSP is assigned to the CN3-43 pin, and LSN is assigned to the CN3-44 pin.
PD30.0	*DOP1	At Stop processing selection at LSP/LSN signal off	Select the stop method at the stroke limit signal detection. 0: Quick stop (initial value) 1: Slow stop
PL08.2	*LIT3	Magnetic pole detection - Stroke limit enabled/disabled selection	Select whether to enable or disable the stroke limit function during magnetic pole detection. 0: Enabled (initial value) 1: Disabled

3.8 Command unit select function [G]

Position command unit selection function

The position command unit selection function and degree unit are available on servo amplifiers with firmware version B6 or later.

The mm unit and inch unit are available on servo amplifiers with firmware version B8 or later in the positioning mode (point table method).

The position command unit selection function can be used to select the position data command unit (mm/inch/pulse/degree) according to the system being used.

For information on which control mode can be used with the unit "degree", refer to "Selecting control mode (Modes of operation)" in the User's Manual (Communication Function).

Command unit	Explanation
mm inch pulse	This unit is suitable for line coordinate systems. (For example, X-Y tables)
degree	This unit is suitable for rotating coordinate systems. (For example, index tables)

Restriction

- In the cyclic synchronous mode, "degree" cannot be used as the unit of position data. Setting "degree" will not allow switching to the cyclic synchronous mode.

Precautions

- To adjust the rotation amount/travel distance of the servo motor relative to the position data in the command unit, use the electronic gear function.

 Page 133 Electronic gear function [G]

- The setting units of servo parameters vary depending on the command unit. For details, refer to the units of servo parameters.

Function block diagram

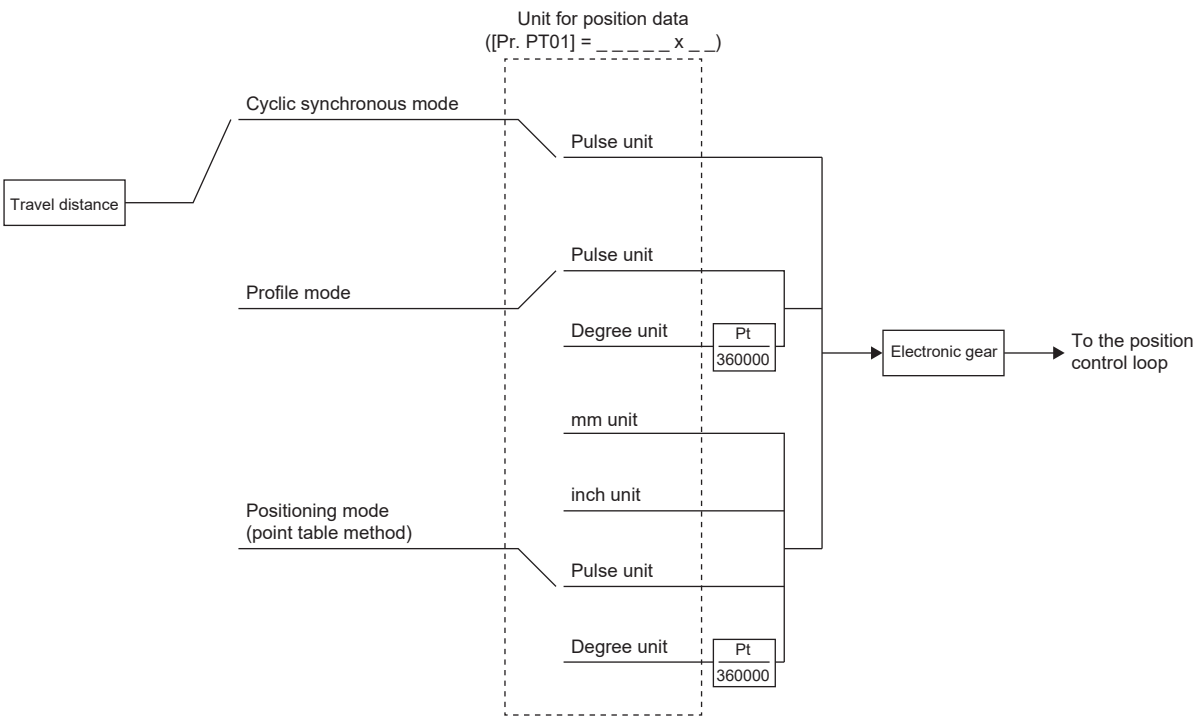

The following shows the setting units for travel distance in each command unit.

Command unit	Setting unit of the travel distance
mm	0.001 [mm]
inch	0.0001 [inch]
pulse	1 [pulse]
degree	0.001 [degree]

Setting method

■ Setting with servo parameters

Use [Pr. PT01.2 Unit for position data] to set the command unit of position data.

Servo parameter	Symbol	Name	Outline
PT01.2	**CTY	Unit for position data	Set the unit for position data. 0: mm 1: inch 2: degree 3: pulse (initial value)

■ Setting with object dictionary

For details on the objects, refer to the User's Manual (Object Dictionary).

Index	Sub	Object	Name	Description
6092	0	ARRAY	Feed constant	Travel distance per revolution of an output shaft
	1		Feed	Travel distance setting
	2		Shaft revolutions	Number of servo motor shaft revolutions
60A8h	—	VAR	SI unit position	SI unit position A value is automatically set in accordance with "Unit for position data" of [Pr. PT01.2 Unit for position data].

[Feed (Obj. 6092h: 01h)] is automatically set in accordance with [Pr. PT01.2 Unit for position data]. Do not write a value to [Feed (Obj. 6092h: 01h)]. Doing so will cause an error.

[Shaft revolutions (Obj. 6092h: 02h)] is automatically set. Do not write a value to [Shaft revolutions (Obj. 6092h: 02h)]. Doing so will cause an error.

The values of [Feed constant (Obj. 6092h)] are as follows.

[Pr. PT01.2 Unit for position data]	Feed	Shaft revolutions
0: mm	Servo motor encoder resolution	1
1: inch		1
2: degree	360000	1
3: pulse	Servo motor encoder resolution	1

[Position actual value (Obj. 6064h)] is calculated from [Gear ratio (Obj. 6091h)] and [Feed constant (Obj. 6092h)] as follows.

$$[\text{Position actual value (Obj. 6064h)}] = \frac{[\text{Position actual internal value (Obj. 6063h)}] \times [\text{Feed constant (Obj. 6092h)}]}{[\text{Position encoder resolution (Obj. 608Fh)}] \times [\text{Gear ratio (Obj. 6091h)}]}$$

If the unit is set to "degree", the result can be any value from 0 to 359999.

A value is automatically set in [SI unit position (Obj. 60A8h)] in accordance with the setting of [Pr. PT01.2 Unit for position data].

The values of [SI unit position] are as follows.

[Pr. PT01.2]	Value
0: mm	FA010000 (0.001 mm)
1: inch	FCC00000 (0.0001 inch)
2: degree	FD410000 (0.001 degree)
3: pulse	00000000 (pulse)

Speed command unit selection function

This function is available on servo amplifiers with firmware version A5 or later.

This is a function to select setting units for speed data. Either r/min (mm/s) or command unit/s can be selected.

Setting unit	Explanation
r/min, mm/s	Use this when setting the speed data as servo motor speed (encoder unit).
Command unit/s	Use this when setting the speed data in command units. [Pr. PT01.2 Unit for position data] can be used to change the command unit to "mm, inch, pulse" or "degree".

Precautions

- The servo parameter for setting the speed data varies depending on the unit selected in [Pr. PT01.1 Speed/acceleration/deceleration unit selection]. However, the same object is used for setting the acceleration/deceleration data regardless of the unit selected.
- Depending on the unit selected in [Pr. PT01.1], both the speed data and the unit of acceleration/deceleration data are changed.

Setting method

Select the speed data setting unit in [Pr. PT01.1 Speed/acceleration/deceleration unit selection].

Servo parameter	Symbol	Name	Outline
PT01.1	**CTY	Speed/acceleration/deceleration unit selection	Select a speed unit. 0: r/min, mm/s 1: Command unit/s

Relevant speed data and acceleration/deceleration data

[Pr. PT01.1 Speed/acceleration/deceleration unit selection]		Object interlocked with servo parameter
0	1	
[Pr. PT65 Profile speed command]	[Pr. PV01 Profile speed command extension setting]	[Profile velocity (Obj. 6081h)]
[Pr. PT66 Maximum profile speed]	[Pr. PV03 Maximum profile speed extension setting]	[Max profile velocity (Obj. 607Fh)]
[Pr. PT49 Speed acceleration time constant]	[Pr. PV05 Profile acceleration]	[Profile acceleration (Obj. 6083h)]
[Pr. PT50 Speed deceleration time constant]	[Pr. PV07 Profile deceleration]	[Profile deceleration (Obj. 6084h)]
[Pr. PC24 Deceleration time constant at forced stop]	[Pr. PV09 Deceleration at forced stop]	[Quick stop deceleration (Obj. 6085h)]
[Pr. PT05 Homing speed]	[Pr. PV11 Homing speed extension setting]	[Speed during search for switch (Obj. 6099h: 01h)]
[Pr. PT06 Creep speed]	[Pr. PV13 Creep speed extension setting]	[Speed during search for zero (Obj. 6099h: 02h)]
[Pr. PT56 Homing acceleration time constant]	[Pr. PV15 Homing acceleration]	[Homing acceleration (Obj. 609Ah)]
[Pr. PT57 Homing deceleration time constant]	[Pr. PV17 Homing deceleration]	—
[Pr. PC72 Speed reached 2 - Output range]	[Pr. PV19 Speed reached 2 - Output range - Extension setting]	[Velocity window (Obj. 606Dh)]
[Pr. PC65 Zero speed 2 level]	[Pr. PV20 Zero speed 2 level extension setting]	[Velocity threshold (Obj. 606Fh)]
[Pr. PT67 Speed limit]	[Pr. PV21 Speed limit extension setting]	[Velocity limit value (Obj. 2D20h)]

3.9 Command unit select function [A]

The unit of torque command can be selected.

Torque command unit selection function

This is a function to select setting units of torque data. The setting units of analog torque command and torque limit can be selected.

Item	Explanation
Analog torque command	The setting unit can be selected from the maximum torque unit or the rated torque unit.
Torque limit	

Precautions

- When changing the value of [Pr. PC50.0 Torque limit unit change] from the initial value "1" (rated torque unit) to "0" (maximum torque unit), check if an appropriate value is set for the torque limit value.

Setting method

Servo parameter	Symbol	Name	Outline
PC50.0	**COPB	Torque limit unit change	Select the setting unit of the torque limit. 0: Maximum torque unit 1: Rated torque unit (initial value)
PC50.1	**COPB	Analog torque command unit change	Select the setting unit of the analog torque command. 0: Maximum torque unit (initial value) 1: Rated torque unit

3.10 Electronic gear function [G]

Electronic gear function is a function that multiplies the electronic gear ratio to the position command, and sets the ratio of the rotation amount/travel distance of the servo motor to the rotation amount/travel distance of the command unit as desired. For the position feedback, the inverse number of the electronic gear ratio is multiplied.

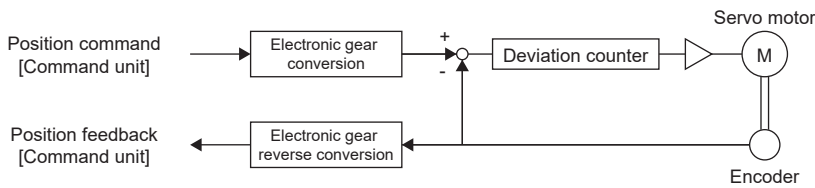

Restriction

- Set the electronic gear within the range of conditions. If a value out of the range is set, [AL. 037 Parameter error] occurs.

Precautions

- To prevent unexpected operation, set the electronic gear correctly.
- If an excessive command pulse frequency is input from the controller in the cyclic synchronous position mode, [AL. 031 Overspeed] or [AL. 035 Command frequency error] may occur, depending on the value of the electronic gear ratio.

Setting method

Setting with servo parameters

Servo parameter	Symbol	Name	Outline
PA06	CMX	Electronic gear numerator	Set the electronic gear numerator. Initial value: 1
PA07	CDV	Electronic gear denominator	Set the electronic gear denominator. Initial value: 1

Setting with object dictionary

Set the electronic gear numerator for [Motor revolutions (Obj. 6091h: 01h)], and electronic gear denominator for [Shaft revolutions (Obj. 6091h: 02h)].

For details on the objects, refer to the User's Manual (Object Dictionary).

Index	Sub	Object	Name	Description
6091h	0	ARRAY	Gear ratio	Gear ratio
	1		Motor revolutions	Number of revolutions of the servo motor shaft (numerator) This corresponds to [Pr. PA06].
	2		Shaft revolutions	Number of revolutions of the drive shaft (denominator) This corresponds to [Pr. PA07].

Setting example

Point

The electronic gears on the position command side are illustrated in the function block diagrams. The inverse number of the electronic gear ratio is multiplied to the position feedback side.

In the cyclic synchronous position mode

Adjust [Pr. PA06 Electronic gear numerator] and [Pr. PA07 Electronic gear denominator] so that the travel distance set in the controller matches the travel distance on the machine. [Motor revolutions (Obj. 6091h: 01h)] and [Shaft revolutions (Obj. 6091h: 02h)] can also be used for the setting.

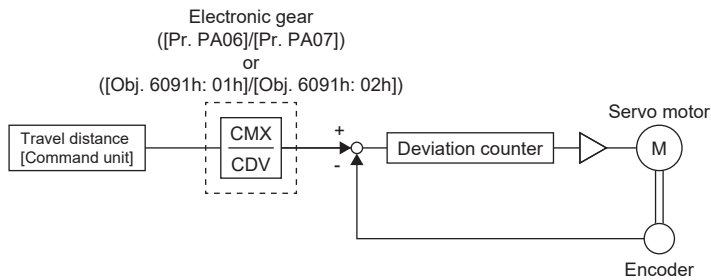

P_t : Servo motor encoder resolution [pulse/rev]

ΔS : Travel distance per servo motor revolution [command unit/rev]

CMX: Electronic gear numerator

CDV: Electronic gear denominator

$$CMX/CDV = P_t/\Delta S$$

The following setting example shows how to calculate the electronic gear.

Point

The following specification symbols are necessary for calculation of the electronic gear.

Pb: Ball screw lead [mm]

1/n: Reduction ratio

P_t : Servo motor encoder resolution [pulse/rev]

ΔL_0 : Travel distance per command pulse [mm/pulse]

ΔS : Travel distance per servo motor revolution [mm/rev]

$\Delta \theta^\circ$: Angle per pulse [$^\circ$ /pulse]

$\Delta \theta$: Angle per revolution [$^\circ$ /rev]

Ex.

Setting example for a ball screw

The following shows an example where the ball screw is moved at 10 μm per pulse.

Machine specifications

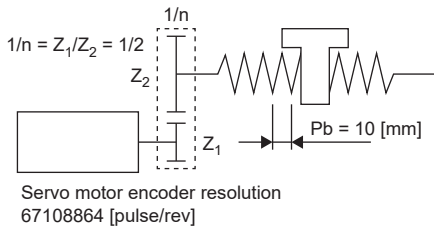

Ball screw lead $P_b = 10$ [mm]

Reduction ratio: $1/n = Z_1/Z_2 = 1/2$

Z_1 : Number of gear teeth on servo motor side

Z_2 : Number of gear teeth on load gear

Servo motor encoder resolution: $P_t = 67108864$ [pulse/rev]

$$\frac{CMX}{CDV} = \Delta L_0 \cdot \frac{P_t}{\Delta S} = \Delta L_0 \cdot \frac{P_t}{1/n \cdot P_b} = 10 \times 10^{-3} \cdot \frac{67108864}{1/2 \cdot 10} = \frac{67108864}{500} = \frac{16777216}{125}$$

Therefore, set $CMX = 16777216$ and $CDV = 125$.

Ex.

Setting example for conveyors

The following shows the example of when the conveyor is rotated at 0.01° per pulse.

Machine specifications

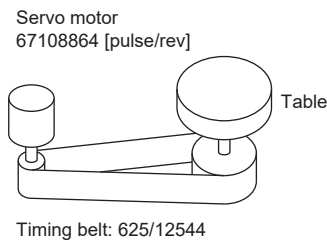

Table: 360°/rev

Reduction ratio: $1/n = 625/12544$

Servo motor encoder resolution: $P_t = 67108864$ [pulse/rev]

$$\frac{CMX}{CDV} = \Delta \theta \cdot \frac{P_t}{\Delta \theta} = 0.01 \cdot \frac{67108864}{625/12544 \cdot 360} = \frac{841813590016}{22500000} = \frac{26306674688}{703125}$$

At this point, as CMX is outside of the setting range (2147483647 or less), the value needs to be reduced. After reducing CMX to the setting range or less, round off the value to the nearest whole number.

$$\frac{CMX}{CDV} = \frac{26306674688}{703125} = \frac{1753778312.53}{46875} \approx \frac{1753778313}{46875}$$

Therefore, set $CMX = 1753778313$ and $CDV = 46875$.

Point

If the servo motor rotates in one direction endlessly on systems such as an index table, the error in rounding off accumulates, resulting in the index position mismatch.

For example, even if 36000 pulses are input for the command in the previous example, the following result is obtained for the table. Therefore, a positioning to the same position cannot be performed on the table.

$$36000 \cdot \frac{1753778313}{46875} \cdot \frac{1}{67108864} \cdot \frac{625}{12544} \cdot 360^\circ = 360.0000001^\circ$$

Reduce the value so that the calculated values before and after reduction are as close as possible.

For profile position mode

■ When setting "3" (pulse) in [Pr. PT01.2 Unit for position data]

Adjust [Pr. PA06 Electronic gear numerator] and [Pr. PA07 Electronic gear denominator] so that the travel distance set in the servo amplifier matches the travel distance on the machine. [Motor revolutions (Obj. 6091h: 01h)] and [Shaft revolutions (Obj. 6091h: 02h)] can also be used for the setting.

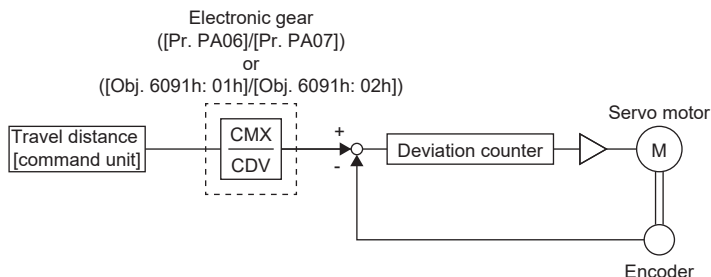

P_t : Servo motor encoder resolution [pulse/rev]

ΔS : Travel distance per servo motor revolution [command unit/rev]

CMX: Electronic gear numerator

CDV: Electronic gear denominator

$$CMX/CDV = P_t/\Delta S$$

The following setting example shows how to calculate the electronic gear.

Point

To calculate the electronic gear, the following specification symbols are required.

Pb: Ball screw lead [mm]

1/n: Reduction ratio

P_t : Servo motor encoder resolution [pulse/rev]

ΔS : Travel distance per servo motor revolution [mm/rev]

Ex.

Setting example for a ball screw

Machine specifications

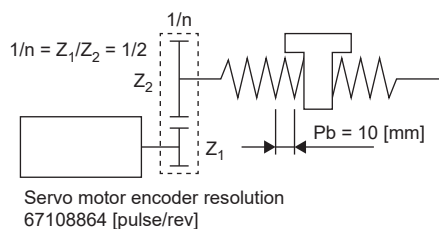

Ball screw lead $P_b = 10$ [mm]

Reduction ratio: $1/n = Z_1/Z_2 = 1/2$

Z_1 : Number of gear teeth on servo motor side

Z_2 : Number of gear teeth on load gear

Servo motor encoder resolution: $P_t = 67108864$ [pulse/rev]

$$\frac{CMX}{CDV} = \frac{P_t}{\Delta S} = \frac{P_t}{1/n \cdot P_b \cdot \alpha^{*1}} = \frac{67108864}{1/2 \cdot 10 \cdot 1000} = \frac{67108864}{5000} = \frac{8388608}{625}$$

Therefore, set $CMX = 8388608$ and $CDV = 625$.

*1 When the command unit is "pulse", convert as $\alpha = 1$.

Ex.

Setting example for conveyors

Machine specifications

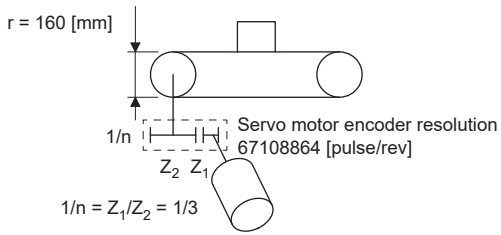

Pulley diameter: $r = 160$ [mm]

Reduction ratio: $1/n = Z_1/Z_2 = 1/3$

Z_1 : Number of gear teeth on servo motor side

Z_2 : Number of gear teeth on load gear

Servo motor encoder resolution: $P_t = 67108864$ [pulse/rev]

$$\frac{CMX}{CDV} = \frac{P_t}{\Delta S} = \frac{P_t}{1/n \cdot r \cdot \pi \cdot \alpha^{*1}} = \frac{67108864}{1/3 \cdot 160 \cdot \pi \cdot 1000} = \frac{67108864}{167551.61} \approx \frac{524288}{1309}$$

Reduce CMX and CDV to the setting range or less and round off each value to the nearest whole number.

Therefore, set $CMX = 524288$ and $CDV = 1309$.

*1 When the command unit is "pulse", convert as $\alpha = 1$.

■ When setting "2" (degree) in [Pr. PT01.2 Unit for position data]

Set the number of gear teeth on machine side with [Pr. PA06 Electronic gear numerator] and the number of gear teeth on servo motor side with [Pr. PA07 Electronic gear denominator]. [Motor revolutions (Obj. 6091h: 01h)] and [Shaft revolutions (Obj. 6091h: 02h)] can also be used for the setting.

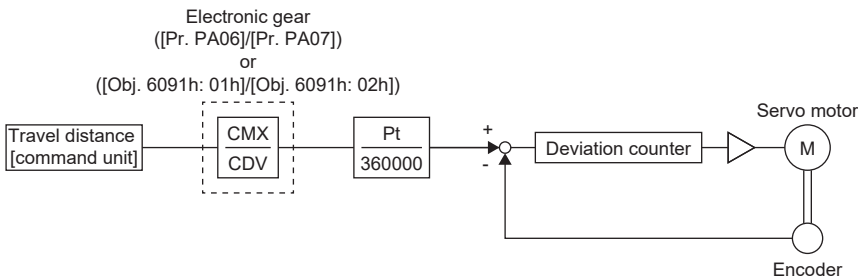

P_t : Servo motor encoder resolution [pulse/rev]

CMX: Number of gear teeth on machine side

CDV: Number of gear teeth on servo motor side

Ex.

If the number of gear teeth on machine side is 25 and the number of gear teeth on servo motor side is 11, set [Pr. PA06] to 25 and [Pr. PA07] to 11.

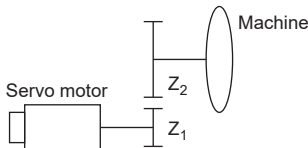

P_t (servo motor resolution): 67108864 pulses/rev

Z_1 : Number of gear teeth on servo motor side

Z_2 : Number of gear teeth on machine side

$Z_1: Z_2 = 11: 25$

For positioning mode (point table method)

■ When setting "3" (pulse) in [Pr. PT01.2 Unit for position data]

Adjust [Pr. PA06 Electronic gear numerator] and [Pr. PA07 Electronic gear denominator] so that the travel distance set in the servo amplifier matches the travel distance on the machine. [Motor revolutions (Obj. 6091h: 01h)] and [Shaft revolutions (Obj. 6091h: 02h)] can also be used for the setting.

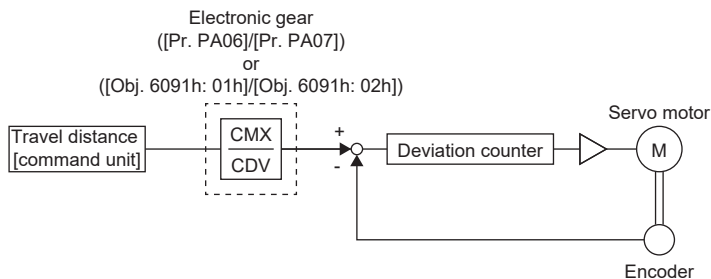

P_t : Servo motor encoder resolution [pulse/rev]

ΔS : Travel distance per servo motor revolution [command unit/rev]

CMX: Electronic gear numerator

CDV: Electronic gear denominator

$$CMX/CDV = P_t/\Delta S$$

The following setting example shows how to calculate the electronic gear.

Point

To calculate the electronic gear, the following specification symbols are required.

Pb: Ball screw lead [mm]

1/n: Reduction ratio

P_t : Servo motor encoder resolution [pulse/rev]

ΔS : Travel distance per servo motor revolution [mm/rev]

Ex.

Setting example for a ball screw

Machine specifications

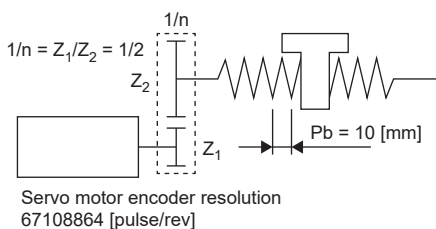

Ball screw lead $P_b = 10$ [mm]

Reduction ratio: $1/n = Z_1/Z_2 = 1/2$

Z_1 : Number of gear teeth on servo motor side

Z_2 : Number of gear teeth on load gear

Servo motor encoder resolution: $P_t = 67108864$ [pulse/rev]

$$\frac{CMX}{CDV} = \frac{P_t}{\Delta S} = \frac{P_t}{1/n \cdot P_b \cdot \alpha^{*1}} = \frac{67108864}{1/2 \cdot 10 \cdot 1000} = \frac{67108864}{5000} = \frac{8388608}{625}$$

Therefore, set $CMX = 8388608$ and $CDV = 625$.

*1 When the command unit is "mm", convert as $\alpha = 1000$. When the command unit is "inch", convert as $\alpha = 10000$. When the command unit is "pulse", convert as $\alpha = 1$.

Ex.

Setting example for conveyors

Machine specifications

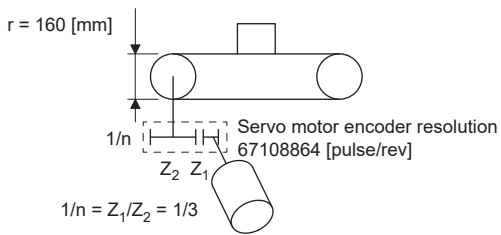
Pulley diameter: $r = 160$ [mm]Reduction ratio: $1/n = Z_1/Z_2 = 1/3$ Z_1 : Number of gear teeth on servo motor side Z_2 : Number of gear teeth on load gearServo motor encoder resolution: $P_t = 67108864$ [pulse/rev]

$$\frac{CMX}{CDV} = \frac{P_t}{\Delta S} = \frac{P_t}{1/n \cdot r \cdot \pi \cdot \alpha^{*1}} = \frac{67108864}{1/3 \cdot 160 \cdot \pi \cdot 1000} = \frac{67108864}{167551.61} \approx \frac{524288}{1309}$$

Reduce CMX and CDV to the setting range or less and round off each value to the nearest whole number.

Therefore, set CMX = 524288 and CDV = 1309.

*1 When the command unit is "mm", convert as $\alpha = 1000$. When the command unit is "inch", convert as $\alpha = 10000$. When the command unit is "pulse", convert as $\alpha = 1$.

■ **When setting "2" (degree) in [Pr. PT01.2 Unit for position data]**

Same as the profile positioning mode.

☞ Page 137 When setting "2" (degree) in [Pr. PT01.2 Unit for position data]

3.11 Electronic gear function [B]

Electronic gear function is a function that multiplies the electronic gear ratio to the position command, and sets the ratio of the rotation amount/travel distance of the servo motor to the rotation amount/travel distance of the command unit as desired. For the position feedback, the inverse number of the electronic gear ratio is multiplied.

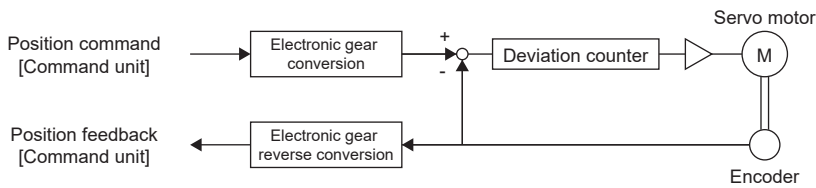

Restriction

- Set the electronic gear within the range of conditions. If a value out of the range is set, [AL. 037 Parameter error] occurs.

Precautions

- To prevent unexpected operation, set the electronic gear correctly.
- If an excessive command pulse frequency is input from the controller in the position mode, [AL. 031 Overspeed] or [AL. 035 Command frequency error] may occur, depending on the value of the electronic gear ratio.

Setting method

Adjust [Pr. PA06 Electronic gear numerator] and [Pr. PA07 Electronic gear denominator] so that the travel distance set in the controller matches the travel distance on the machine. For details, refer to each controller manual.

Setting with servo parameters

Servo parameter	Symbol	Name	Outline
PA06	CMX	Electronic gear numerator	Set the electronic gear numerator. Initial value: 1
PA07	CDV	Electronic gear denominator	Set the electronic gear denominator. Initial value: 1

3.12 Electronic gear function [A]

Electronic gear function is a function that multiplies the electronic gear ratio to the position command, and sets the ratio of the rotation amount/travel distance of the servo motor to the rotation amount/travel distance of the command unit as desired. For the position feedback, the inverse number of the electronic gear ratio is multiplied.

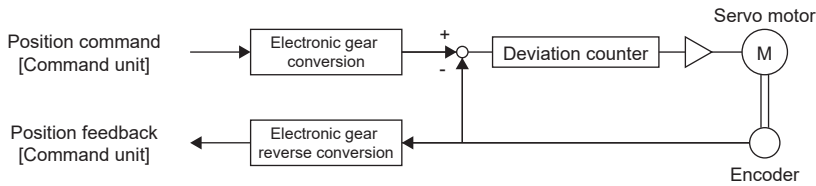

Restriction

- Set the electronic gear within the range of conditions. If a value out of the range is set, [AL. 037 Parameter error] occurs.

Precautions

- To prevent unexpected operation, set the electronic gear correctly.
- In the position control mode, ensure that the electronic gear is in servo-off status before setting the gear so as to prevent unexpected operation due to incorrect setting.
- If an excessive command pulse frequency is input from the controller in the position control mode, [AL. 031 Overspeed] may occur, depending on the value of the electronic gear ratio.

Setting method

Setting with servo parameters

Set the electronic gear numerator in [Pr. PA06 Electronic gear numerator], and electronic gear denominator in [Pr. PA07 Electronic gear denominator]. When using the electronic gear in the command input pulses per revolution, set [Pr. PA05 Number of command input pulses per revolution]. Set the servo parameter of the electronic gear and the electronic gear setting compatibility mode to be used in "Electronic gear compatibility selection" of [Pr. PA21].

Servo parameter	Symbol	Name	Outline
PA05	*FBP	Number of command input pulses per revolution	Set the number of command input pulses per revolution. Initial value: 10000 [pulse]
PA06	CMX	Electronic gear numerator	Set the electronic gear numerator. Initial value: 1
PA07	CDV	Electronic gear denominator	Set the electronic gear denominator. Initial value: 1
PA21.3	*AOP3	Electronic gear compatibility selection	Select the electronic gear, and set the electronic gear setting compatibility mode. 0: Electronic gear (initial value) 1: Number of command input pulses per revolution 2: J3 electronic gear setting value compatibility mode 3: J2S electronic gear setting value compatibility mode 4: J4 electronic gear setting value compatibility mode
PC32	CMX2	Command input pulse multiplication numerator 2	Set the electronic gear numerator at switching with CM1 (Electronic gear selection 1) and CM2 (Electronic gear selection 2) of the input device. Initial value: 1
PC33	CMX3	Command input pulse multiplication numerator 3	
PC34	CMX4	Command input pulse multiplication numerator 4	

Setting example

Point

The electronic gears on the position command side are illustrated in the function block diagrams. The inverse number of the electronic gear ratio is multiplied to the position feedback side.

For position control mode

Adjust [Pr. PA06 Electronic gear numerator] and [Pr. PA07 Electronic gear denominator] so that the travel distance set in the controller matches the travel distance on the machine. When the value is converted with [Pr. PA05 Number of command input pulses per revolution], the numerator of the electronic gear ratio is the encoder resolution, and the denominator is the setting value in [Pr. PA05].

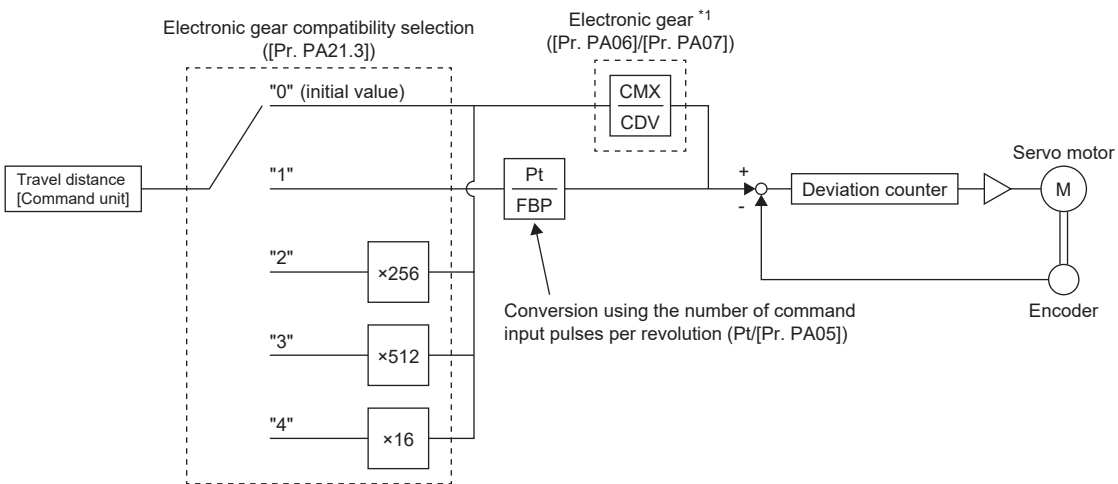

*1 With CM1 (Electronic gear selection 1) and CM2 (Electronic gear selection 2) of the input device, the setting value of CMX can be selected from [Pr. PA06], [Pr. PC32], [Pr. PC33], or [Pr. PC34].

P_t : Servo motor encoder resolution [pulse/rev]

ΔS : Travel distance per servo motor revolution [command unit/rev]

CMX: Electronic gear numerator

CDV: Electronic gear denominator

$$CMX/CDV = P_t/\Delta S$$

The following setting example shows how to calculate the electronic gear.

Point

The following specification symbols are necessary for calculation of the electronic gear.

Pb: Ball screw lead [mm]

1/n: Reduction ratio

P_t : Servo motor encoder resolution [pulse/rev]

ΔL_0 : Travel distance per command pulse [mm/pulse]

ΔS : Travel distance per servo motor revolution [mm/rev]

$\Delta \theta^\circ$: Angle per pulse [$^\circ$ /pulse]

$\Delta \theta$: Angle per revolution [$^\circ$ /rev]

■ Setting example for a ball screw

The following shows an example where the ball screw is moved at 10 μm per pulse.

Machine specifications

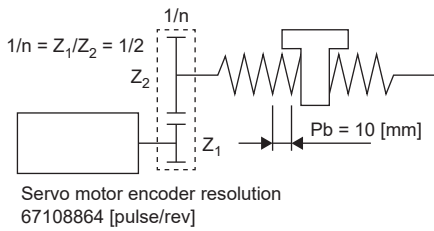

Ball screw lead $P_b = 10$ [mm]

Reduction ratio: $1/n = Z_1/Z_2 = 1/2$

Z_1 : Number of gear teeth on servo motor side

Z_2 : Number of gear teeth on load gear

Servo motor encoder resolution: $P_t = 67108864$ [pulse/rev]

$$\frac{CMX}{CDV} = \Delta L_0 \cdot \frac{P_t}{\Delta S} = \Delta L_0 \cdot \frac{P_t}{1/n \cdot P_b} = 10 \times 10^{-3} \cdot \frac{67108864}{1/2 \cdot 10} = \frac{67108864}{500} = \frac{16777216}{125}$$

Therefore, set $CMX = 16777216$ and $CDV = 125$.

■ Setting example for conveyors

The following shows the example of when the conveyor is rotated at 0.01° per pulse.

Machine specifications

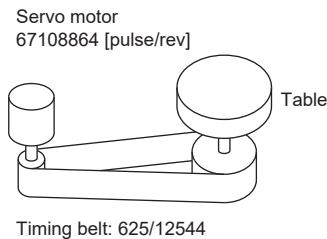

Table: 360°/rev

Reduction ratio: $1/n = 625/12544$

Servo motor encoder resolution: $P_t = 67108864$ [pulse/rev]

$$\frac{CMX}{CDV} = \Delta \theta \cdot \frac{P_t}{\Delta \theta} = 0.01 \cdot \frac{67108864}{625/12544 \cdot 360} = \frac{841813590016}{22500000} = \frac{26306674688}{703125}$$

At this point, as CMX is outside of the setting range (2147483647 or less), the value needs to be reduced. After reducing CMX to the setting range or less, round off the value to the nearest whole number.

$$\frac{CMX}{CDV} = \frac{26306674688}{703125} = \frac{1753778312.53}{46875} \approx \frac{1753778313}{46875}$$

Therefore, set $CMX = 1753778313$ and $CDV = 46875$.

Point

If the servo motor rotates in one direction endlessly on systems such as an index table, the error in rounding off accumulates, resulting in the index position mismatch.

For example, even if 36000 pulses are input for the command in the previous example, the following result is obtained for the table. Therefore, a positioning to the same position cannot be performed on the table.

$$36000 \cdot \frac{1753778313}{46875} \cdot \frac{1}{67108864} \cdot \frac{625}{12544} \cdot 360^\circ = 360.0000001^\circ$$

Reduce the value so that the calculated values before and after reduction are as close as possible.

Electronic gear selection function

With the input devices CM1 (Electronic gear selection 1) and CM2 (Electronic gear selection 2), the numerator of the electronic gear (CMX) can be selected. The electronic gear numerator (CMX) switches at the same time as CM1 and CM2 are turned on or off. If a shock occurs at switching, use the position smoothing ([Pr. PB03 Position command speed adjustment time constant (position smoothing)]) to relieve the shock.

Input device ^{*1}		Electronic gear numerator
CM2	CM1	
0	0	[Pr. PA06]
0	1	[Pr. PC32]
1	0	[Pr. PC33]
1	1	[Pr. PC34]

*1 0: Off
1: On

3.13 In-position range setting

The positioning completion status can be checked with INP (in-position). When the number of droop pulses falls within or less than the range set in servo parameters, INP (in-position) turns on. In addition, the range unit for the in-position and the conditions to turn on the in-position can be changed with servo parameters.

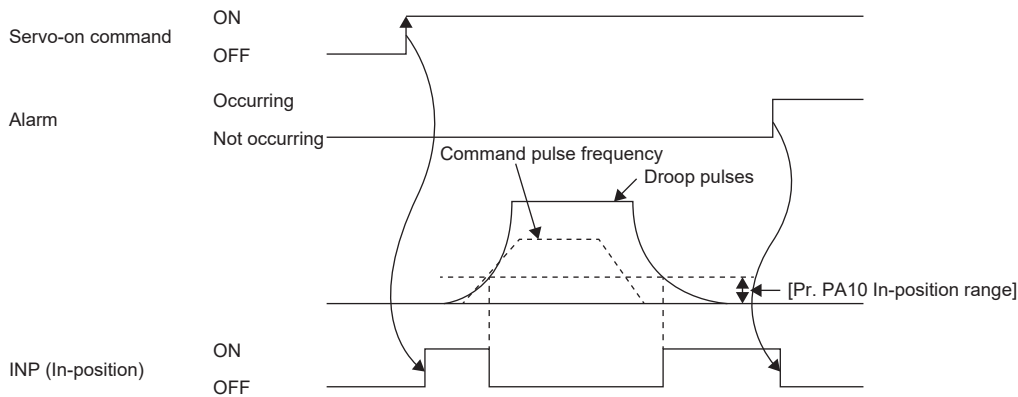

Restriction

- INP is always off in the velocity mode, torque mode, and continuous operation to torque control mode.

Precautions

- If the value of [Pr. PA10 In-position range] is set too large and the servo motor is operated at a low speed, INP may always be turned on. In this case, lower the setting value until the in-position signal stops being output.
- After the in-position has fallen to within or below the range, the in-position may turn on and off repeatedly if the droop pulses exceed the in-position range due to overshoot, vibration, or oscillation. In that case, take actions such as adjusting the gain and reviewing the operation pattern.

In the super trace control, droop pulses are near 0 during the servo motor control. Thus, the INP (In-position) signal may remain on. To prevent the INP (In-position) signal from remaining on, set the servo parameters as follows.

[G] [B]: [Pr. PD13.2 INP output signal ON condition selection] = "1" (Within the in-position range and at the completion of command output)

[A]: [Pr. PD31.2 INP output signal ON condition selection] = "1" (Within the in-position range and at the completion of command output)

Setting method [G]

The servo parameters related to the in-position setting are as follows.

Servo parameter	Symbol	Name	Outline
PA10	INP	In-position range	Set the in-position range. Initial value: 25600 [pulse]
PC06.0	*COP3	In-position range unit selection	Select a unit of the in-position range. 0: Command input pulse unit (initial value) 1: Servo motor encoder pulse unit
PD13.2	*DOP2	INP output signal ON condition selection	Select the in-position on condition. 0: Within the in-position range (initial value) 1: Within the in-position range and at the completion of command output 2: Within the in-position range, at the completion of command output, and at start signal off

Setting method [B]

The servo parameters related to the in-position setting are as follows.

Servo parameter	Symbol	Name	Outline
PA10	INP	In-position range	Set the in-position range. Initial value: 25600 [pulse]
PD13.2	*DOP2	INP output signal ON condition selection	Select the in-position on condition. 0: Within the in-position range (initial value) 1: Within the in-position range and at the completion of command output

Setting method [A]

The servo parameters related to the in-position setting are as follows.

Servo parameter	Symbol	Name	Outline
PA10	INP	In-position range	Set the in-position range. Initial value: 400 [pulse]
PC24.0	*COP3	In-position range unit selection	Select a unit of the in-position range. 0: Command input pulse unit (initial value) 1: Servo motor encoder pulse unit
PD31.2	*DOP2	INP output signal ON condition selection	Select the in-position on condition. 0: Within the in-position range (initial value) 1: Within the in-position range and at the completion of command output

3.14 Assigning I/O devices

External I/O signals for the servo amplifier can be assigned to I/O devices. Also, some signals can be assigned to the I/O devices without wiring (Automatic ON). In addition, if the external input signal causes chattering due to noise or other factors, the input filter can be used to suppress the effect of noise. For the MR-J5-_A_ and MR-J5_-_G_, the polarity of the DI pin can be set. Configure settings in accordance with the system configuration.

Restrictions [G]

- "Automatic ON" can be set to some input devices, but not to other input devices. For the input devices to which "Automatic ON" can be set, refer to [Pr. PD01 Input signal automatic ON selection 1].

Restrictions [B]

- "Automatic ON" can be set to some input devices, but not to other input devices. For the input devices to which "Automatic ON" can be set, refer to [Pr. PD02 Input signal automatic ON selection 2].

Restrictions [A]

- "Automatic ON" can be set to some input devices, but not to other input devices. For the input devices to which "Automatic ON" can be set, refer to [Pr. PD01 Input signal automatic ON selection 1], [Pr. PD41 Input signal automatic ON selection 3], and [Pr. PD42 Input signal automatic ON selection 4].
- Particular devices such as ABS transfer mode (ABSM) or ABS request (ABSR), and particular connector pin numbers such as CN3-22 may be changed in functions other than the device setting. In addition, each control mode has restrictions on its usable devices.

Precautions [G] [A]

- If signals for machine protection such as the LSP (forward rotation stroke end) and LSN (reverse rotation stroke end) are set to "Automatic ON", protection by the servo amplifier is disabled. Therefore, ensure the safety for the entire system.
- If the polarity of the DI pin is set to "ON with 0 V input", the DI pin may turn on when the input circuit malfunctions. For this reason, it is not recommended to set the polarity of DI pins to which signals related to machine protection such as LSP (forward rotation stroke end) or LSN (reverse rotation stroke end) are assigned to "ON with 0 V input". If doing this setting, ensure the safety in the entire system.

Precautions [B]

- If signals for machine protection such as the FLS (upper stroke limit) and RLS (lower stroke limit) are set to "Automatic ON", protection by the servo amplifier is disabled. Therefore, ensure the safety for the entire system.

Setting method [G]

Servo parameter list

Input/output device selection, input signal automatic ON selection, input signal filter selection, and DI pin polarity selection settings can be performed directly with servo parameters.

■ MR-J5-_G_

Servo parameter	Symbol	Name	Outline
PD01.2	*DIA1	Input signal automatic ON selection	Set LSP (Forward rotation stroke end) and LSN (Reverse rotation stroke end) to "Disabled" (use for an external input signal) or "Enabled" (Automatic on). Initial value: 0h (use for an external input signal)
PD03.0-1	*DI1	Device selection	Assign any input device to the CN3-2 pin. Initial value: 0Ah (LSP (Forward rotation stroke end))
PD04.0-1	*DI2	Device selection	Assign any input device to the CN3-12 pin. Initial value: 0Bh (LSN (Reverse rotation stroke end))
PD05.0-1	*DI3	Device selection	Assign any input device to the CN3-19 pin. Initial value: 22h (DOG (Proximity dog))
PD07.0-1	*DO1	Device selection	Assign any output device to the CN3-13 pin. Initial value: 05h (MBR (Electromagnetic brake interlock))
PD08.0-1	*DO2	Device selection	Assign any output device to the CN3-9 pin. Initial value: 04h (INP (In-position))
PD09.0-1	*DO3	Device selection	Assign any output device to the CN3-15 pin. Initial value: 03h (ALM (Malfunction))
PD11.0	*DIF	Input signal filter selection	Select an input signal filter. Initial value: 7h (3.500 [ms])
PD60.0-1 ^{*1}	*DIP	DI pin polarity selection	Select the DI pin polarity. Initial value: 00h (ON with 24 V input)
PT29.0	*TOP3	Device input polarity 1	Select the proximity dog input polarity. Initial value: 0h (Dog detection with off)

*1 Available on servo amplifiers with firmware version A5 or later.

■ MR-J5W_-G_

Servo parameter	Symbol	Name	Outline
PD01.2	*DIA1	Input signal automatic ON selection	Set LSP (Forward rotation stroke end) and LSN (Reverse rotation stroke end) to "Disabled" (use for an external input signal) or "Enabled" (Automatic on). Initial value: 0h (disabled (use for an external input signal.))
PD03.0-1	*DI1	Device selection	Assign any input device to the CN3-7 pin (A-axis), CN3-20 pin (B-axis), and CN3-1 pin (C-axis). Initial value: 0Ah (LSP (Forward rotation stroke end))
PD04.0-1	*DI2	Device selection	Assign any input device to the CN3-8 pin (A-axis), CN3-21 pin (B-axis), and CN3-2 pin (C-axis). Initial value: 0Bh (LSN (Reverse rotation stroke end))
PD05.0-1	*DI3	Device selection	Assign any input device to the CN3-9 pin (A-axis), CN3-22 pin (B-axis), and CN3-15 pin (C-axis). Initial value: 22h (DOG (Proximity dog))
PD07.0-1	*DO1	Device selection	Assign any output device to the CN3-12 pin (A-axis), CN3-25 pin (B-axis), and CN3-13 pin (C-axis). Initial value: 05h (MBR (Electromagnetic brake interlock))
PD08.0-1	*DO2	Device selection	Assign any output device to the CN3-24 pin (common). Initial value: 04h (INP (In-position))
PD09.0-1	*DO3	Device selection	Assign any output device to the CN3-11 pin (common). Initial value: 03h (ALM (Malfunction))
PD11.0	*DIF	Input signal filter selection	Select an input signal filter. Initial value: 7h (3.500 [ms])
PD60.0 *1	*DIP	DI pin polarity selection	Select the DI pin polarity. Initial value: 0h (ON with 24 V input)
PT29.0	*TOP3	Device input polarity 1	Select the proximity dog input polarity. Initial value: 0h (Dog detection with off)

*1 Available on servo amplifiers with firmware version A5 or later.

■ MR-J5D1_-G_

Servo parameter	Symbol	Name	Outline
PD01.2	*DIA1	Input signal automatic ON selection	Set LSP (Forward rotation stroke end) and LSN (Reverse rotation stroke end) to "Disabled" (use for an external input signal) or "Enabled" (Automatic on). Initial value: 0h (use for an external input signal)
PD03.0-1	*DI1	Device selection	Assign any input device to the CN3-12 pin. Initial value: 0Ah (LSP (Forward rotation stroke end))
PD04.0-1	*DI2	Device selection	Assign any input device to the CN3-28 pin. Initial value: 0Bh (LSN (Reverse rotation stroke end))
PD05.0-1	*DI3	Device selection	Assign any input device to the CN3-29 pin. Initial value: 22h (DOG (Proximity dog))
PD07.0-1	*DO1	Device selection	Assign any output device to the CN3-32 pin. Initial value: 05h (MBR (Electromagnetic brake interlock))
PD08.0-1	*DO2	Device selection	Assign any output device to the CN3-16 pin. Initial value: 04h (INP (In-position))
PD09.0-1	*DO3	Device selection	Assign any output device to the CN3-15 pin. Initial value: 03h (ALM (Malfunction))
PD11.0	*DIF	Input signal filter selection	Select an input signal filter. Initial value: 7h (3.500 [ms])
PD60.0-1	*DIP	DI pin polarity selection	Select the DI pin polarity. Initial value: 00h (ON with 24 V input)
PT29.0	*TOP3	Device input polarity 1	Select the proximity dog input polarity. Initial value: 0h (Dog detection with off)

■ MR-J5D2-_G_/MR-J5D3-_G_

Servo parameter	Symbol	Name	Outline
PD01.2	*DIA1	Input signal automatic ON selection	Set LSP (Forward rotation stroke end) and LSN (Reverse rotation stroke end) to "Disabled" (use for an external input signal) or "Enabled" (Automatic on). Initial value: 0h (disabled (use for an external input signal.))
PD03.0-1	*DI1	Device selection	Assign any input device to the CN3-12 pin (A-axis), CN3-26 pin (B-axis), and CN3-10 pin (C-axis). Initial value: 0Ah (LSP (Forward rotation stroke end))
PD04.0-1	*DI2	Device selection	Assign any input device to the CN3-28 pin (A-axis), CN3-25 pin (B-axis), and CN3-10 pin (C-axis). Initial value: 0Bh (LSN (Reverse rotation stroke end))
PD05.0-1	*DI3	Device selection	Assign any input device to the CN3-29 pin (A-axis), CN3-27 pin (B-axis), and CN3-11 pin (C-axis). Initial value: 22h (DOG (Proximity dog))
PD07.0-1	*DO1	Device selection	Assign any output device to the CN3-32 pin (A-axis), CN3-31 pin (B-axis), and CN3-30 pin (C-axis). Initial value: 05h (MBR (Electromagnetic brake interlock))
PD08.0-1	*DO2	Device selection	Assign any output device to the CN3-16 pin (common). Initial value: 04h (INP (In-position))
PD09.0-1	*DO3	Device selection	Assign any output device to the CN3-15 pin (common). Initial value: 03h (ALM (Malfunction))
PD11.0	*DIF	Input signal filter selection	Select an input signal filter. Initial value: 7h (3.500 [ms])
PD60.0	*DIP	DI pin polarity selection	Select the DI pin polarity. Initial value: 0h (ON with 24 V input)
PT29.0	*TOP3	Device input polarity 1	Select the proximity dog input polarity. Initial value: 0h (Dog detection with off)

Setting method [B]

Servo parameter list

Input/output device selection, input signal automatic ON selection, and input signal filter selection settings can be performed directly with servo parameters.

■ MR-J5-_B_

Servo parameter	Symbol	Name	Outline
PD02.0	*DIA2	Input signal automatic ON selection 1	Set FLS (Upper stroke limit) and RLS (Lower stroke limit) to "Disabled" (use for an external input signal) or "Enabled" (Automatic on). Initial value: 0h (disabled (use for an external input signal.))
PD07.0-1	*DO1	Device selection	Assign any output device to the CN3-13 pin. Initial value: 05h (MBR (Electromagnetic brake interlock))
PD08.0-1	*DO2	Device selection	Assign any output device to the CN3-9 pin. Initial value: 04h (INP (In-position))
PD09.0-1	*DO3	Device selection	Assign any output device to the CN3-15 pin. Initial value: 03h (ALM (Malfunction))
PD11.0	*DIF	Input signal filter selection	Select an input signal filter. Initial value: 7h (3.500 [ms])

■ MR-J5W_-_B_

Servo parameter	Symbol	Name	Outline
PD02.0	*DIA2	Input signal automatic ON selection 1	Set LSP (Forward rotation stroke end) and LSN (Reverse rotation stroke end) to "Disabled" (use for an external input signal) or "Enabled" (Automatic on). Initial value: 0h (disabled (use for an external input signal.))
PD07.0-1	*DO1	Device selection	Assign any output device to the CN3-12 pin (A-axis), CN3-25 pin (B-axis), and CN3-13 pin (C-axis). Initial value: 05h (MBR (Electromagnetic brake interlock))
PD08.0-1	*DO2	Device selection	Assign any output device to the CN3-24 pin (common). Initial value: 04h (INP (In-position))
PD09.0-1	*DO3	Device selection	Assign any output device to the CN3-11 pin (common). Initial value: 03h (ALM (Malfunction))
PD11.0	*DIF	Input signal filter selection	Select an input signal filter. Initial value: 7h (3.500 [ms])

Setting method [A]

Servo parameter list

Input/output device selection, input signal automatic ON selection, input signal filter selection, and DI pin polarity selection settings can be performed directly with servo parameters.

Servo parameter	Symbol	Name	Outline
PD01.0-3	*DIA1	Input signal automatic ON selection 1	Select input devices that turn on automatically. For the initial value, refer to each servo parameter.
PD03 to PD14, PD17 to PD22, PD43 to PD46	—	—	Assign any input device to the specified pin of the CN3. For the initial value, refer to each servo parameter.
PD23 to PD26, PD28, PD47	—	—	Assign any output device to the specified pin of the CN3. For the initial value, refer to each servo parameter.
PD29.0	*DIF	Input signal filter selection	Select an input signal filter. Initial value: 7h (3.500 [ms])
PD29.1	*DIF	RES signal dedicated filter selection	Select an RES (Reset) signal dedicated filter. Initial value: 0h (disabled)
PD29.2	*DIF	CR signal dedicated filter selection	Select a CR (Clear) signal dedicated filter. Initial value: 0h (disabled)
PD60.0-2 *1	*DIP	DI pin polarity selection	Select the DI pin polarity. Initial value: 000h (ON with 24 V input)

*1 Available on servo amplifiers with firmware version A5 or later.

3.15 Regenerative option selection

If the generated regenerative power is too large and the regenerative capacity of the built-in regenerative resistor of the servo amplifier is insufficient, use the regenerative option to improve the regenerative capacity and consume the generated regenerative power. Set [Pr. PA02.0-1 Regenerative option selection] in accordance with the regenerative resistor in use. Refer to "Regenerative option" in the following manual for the details of the regenerative options.

MR-J5 User's Manual (Hardware)

Regenerative option

For the regenerative options, select the Mitsubishi Electric-specified regenerative resistor (MR-RB series).

Restriction

- The regenerative option cannot be used with the MR-J5D _ _ G _ .

Precautions

- To prevent a fire from occurring, use servo amplifiers with regenerative options in the specified combinations.

Setting method

Servo parameter	Symbol	Name	Outline
PA02.0-1	**REG	Regenerative option selection	<p>Select a regenerative option to be used. Incorrect setting may cause the regenerative option to burn. If a selected regenerative option is not for use with the servo amplifier, [AL. 037 Parameter error] occurs. Other regenerative options cannot be used together with the FR-XC-(H). The setting value of this servo parameter is disabled for the MR-J5D _ _ G _ .</p> <p>00: Regenerative option is not used.</p> <ul style="list-style-type: none"> No regenerative resistors are used on servo amplifiers with a capacity of 100 W. Built-in regenerative resistors are used on servo amplifiers with a capacity of 0.2 kW to 7 kW. <p>01: FR-XC-(H) 02: MR-RB032 03: MR-RB12 05: MR-RB30 06: MR-RB50 (A cooling fan is required.) 08: MR-RB31 09: MR-RB51 (A cooling fan is required.) 0B: MR-RB3N 0C: MR-RB5N (A cooling fan is required.) 0D: MR-RB14 0E: MR-RB34 1C: MR-RB3Z 1D: MR-RB5Z (A cooling fan is required.) 80: MR-RB1H-4 81: MR-RB3M-4 (A cooling fan is required.) 82: MR-RB3G-4 (A cooling fan is required.) 83: MR-RB5G-4 (A cooling fan is required.) 93: MR-RB3Y-4 (A cooling fan is required.) 94: MR-RB5Y-4 (A cooling fan is required.) "1C" and "1D" are available on servo amplifiers with firmware version B6 or later.</p>

3.16 Alarm function

This function displays an alarm or warning when an error occurs during operation. When an alarm occurs, ALM (Malfunction) turns off and the servo motor stops. When a warning occurs, the servo motor may not stop for each warning number.

The stop method changes depending on whether the forced stop deceleration function is enabled or disabled. However, even if the forced stop deceleration function is enabled, the forced stop deceleration may not be effective and the servo motor may stop with the dynamic brake or other methods, depending on the alarm that has occurred.







After releasing the alarm or warning, resume the operation.

Refer to the following manual for the details of alarms and warnings.

 MR-J5 User's Manual (Troubleshooting)





Operation status at alarm occurrence [G] [B]

The following shows the status of servo amplifiers at alarm occurrence.

Status	Reference
The No. of the alarm that has occurred is shown on the 7-segment LED.	Refer to "Switch setting and display of the servo amplifier" or "Switch setting and display of the drive unit" in the User's Manual (Introduction).
When an alarm is detected during operation, the servo motor stops safely with the methods specified in accordance with the alarm No.	 Page 160 Stop method at occurrence of alarms/warnings
The occurred alarm is recorded as the alarm history. In the alarm history, the latest 16 alarms are recorded so that the types of alarms that have occurred in the past can be checked.	 Page 156 Alarm history [G]  Page 159 Alarm History [B]
The conditions of the servo amplifier (such as the servo motor speed and droop pulses) before/after alarm occurrence are recorded with the drive recorder. This is useful for analyzing the cause of alarm occurrence.	 Page 304 Drive recorder
The ALM (Malfunction) of the output device signal is turned off.	—
The occurrence status of alarms and warnings can be monitored with MR Configurator2 or via a network.	 Page 156 Alarm history [G]  Page 159 Alarm History [B]

Operation status at alarm occurrence [A]

The following shows the status of servo amplifiers at alarm occurrence.

Status	Reference
The No. of the alarm that has occurred is shown on the 7-segment LED.	Refer to "Switch setting and display of the servo amplifier" in the User's Manual (Introduction).
When an alarm is detected during operation, the servo motor stops safely with the methods specified in accordance with the alarm No.	 Page 160 Stop method at occurrence of alarms/warnings
The occurred alarm is recorded as the alarm history. In the alarm history, the latest 16 alarms are recorded so that the types of alarms that have occurred in the past can be checked.	 Page 159 Alarm history [A]
The conditions of the servo amplifier (such as the servo motor speed and droop pulses) before/after alarm occurrence are recorded with the drive recorder. This is useful for analyzing the cause of alarm occurrence.	 Page 304 Drive recorder
The ALM (Malfunction) and ALMWNG (Malfunction/Warning) of the output device signal are turned off.	—
The occurrence status of alarms and warnings can be monitored with MR Configurator2.	 Page 159 Alarm history [A]

Operation status at warning occurrence [G] [B]

The following shows the status of servo amplifiers at a warning occurrence.

Status	Reference
The No. of the warning that has occurred is shown on the 7-segment LED.	Refer to "Switch setting and display of the servo amplifier" or "Switch setting and display of the drive unit" in the User's Manual (Introduction).
The operation is continued. However, when a warning that stops the servo motor occurs, the servo motor is stopped using the method determined by the warning.	☞ Page 160 Stop method at occurrence of alarms/warnings
Output device signals such as WNG (Warning) are turned off. In addition, at an occurrence of a warning to stop the servo motor, WNGSTOP (Motor stop warning) is turned off.	—
The occurrence status of alarms and warnings can be monitored with MR Configurator2 or via a network.	☞ Page 156 Alarm history [G] ☞ Page 159 Alarm History [B]

Operation status at warning occurrence [A]

The following shows the status of servo amplifiers at a warning occurrence.

Status	Reference
The No. of the warning that has occurred is shown on the 7-segment LED.	—
The operation is continued. However, when a warning that stops the servo motor occurs, the servo motor is stopped using the method determined by the warning.	☞ Page 160 Stop method at occurrence of alarms/warnings
Output device signals such as WNG (Warning), ALMWNG (Malfunction/Warning) are turned off. In addition, at an occurrence of a warning to stop the servo motor, WNGSTOP (Motor stop warning) is turned off.	—
The occurrence status of alarms and warnings can be monitored with MR Configurator2.	☞ Page 159 Alarm history [A]

Returning from an alarm [G] [B]

Point

When an alarm occurs, remove its cause, check that the operation signal is not being input, ensure safety, and reset the alarm before restarting the operation.

Remove the cause of the alarm in accordance with the following manual.

 MR-J5 User's Manual (Troubleshooting)

The following table shows how to deactivate the alarm.

Alarm deactivation	Explanation
Alarm reset	<ul style="list-style-type: none">• Error reset command from the controller• Click "Occurred Alarm Reset" in the "Alarm Display" window of MR Configurator2.
Communication reset	<ul style="list-style-type: none">• Disconnect/reconnect network.• Reset the controller.
Power cycling	<ul style="list-style-type: none">• Cycle the power.• Perform the software reset with commands from the controller and MR Configurator2.

Returning from an alarm [A]

Point

When an alarm occurs, remove its cause, check that the operation signal is not being input, ensure safety, and reset the alarm before restarting the operation.

Remove the cause of the alarm in accordance with the following manual.

 MR-J5 User's Manual (Troubleshooting)

The following table shows how to deactivate the alarm.

Alarm deactivation	Explanation
Alarm reset	<ul style="list-style-type: none">• Error reset command from the controller• Click "Occurred Alarm Reset" in the "Alarm Display" window of MR Configurator2.• Turn on RES (Reset) with an input device• Push the "SET" button while the display of the servo amplifier is in the current alarm display mode
Power cycling	<ul style="list-style-type: none">• Cycle the power.• Perform the software reset with commands from the controller and MR Configurator2.

Returning from a warning

Some warnings are automatically canceled after the cause is removed, and other warnings are canceled after the cause is removed and the alarm is reset.

Remove the cause of the warning in accordance with the following manual.

 MR-J5 User's Manual (Troubleshooting)

Alarm history [G]

The No. of the alarm that has occurred and the time at which it occurred can be recorded in the history. In the alarm history, the latest 16 alarms are recorded so that the types of alarms that have occurred in the past can be checked.

The alarm history can be cleared with [Pr. PC21.0 Alarm clear history selection] or on the alarm display of MR Configurator2.

Method for checking with MR Configurator2

1. Connect the servo amplifier and a personal computer and select "Alarm Display" from "Diagnosis" in MR Configurator2.
2. The alarm display shows the alarm No., detail number, accumulated time after power-on, and actual time.

Related objects

By using the objects, the alarm occurrence status and alarm history can be checked.

For details on the objects, refer to the User's Manual (Object Dictionary).

Index	Sub	Object	Name	Description	
2A00h	0	RECORD	Alarm history newest	The number of sub objects (7) is returned.	
	1	RECORD	Alarm No.	The Alarm No. and detail number of the alarm that has occurred are returned. (32 bits)	
	2	RECORD	Alarm time (Hour)	The accumulated power-on time from time of factory shipment until an alarm occurrence is returned.	
	3	RECORD	Alarm2 No.	The value "0000h" is returned. (16 bits)	
	4	RECORD	Alarm time (second)	The alarm occurrence time is returned as a 32-bit integer (time passed from January 1, 1970, 0:00:00).	
	5	RECORD	Alarm time (nanosecond)	The digits after the ones indicating seconds in the alarm occurrence time are returned as a 32-bit integer.	
	6	RECORD	Alarm time (time zone)	The time zone at an alarm occurrence time is returned as a 32-bit integer.	
2A01h	7	RECORD	Alarm time (summer time)	The daylight saving time at an alarm occurrence time is returned as a 32-bit integer.	
	0	RECORD	Alarm history 1	The number of sub objects (7) is returned.	
	1	RECORD	Alarm No.	The Alarm No. and detail number of the second alarm are returned. (32 bits)	
	2	RECORD	Alarm time (Hour)	The occurrence time of the second alarm is returned.	
	3	RECORD	Alarm2 No.	The value "0000h" is returned. (16 bits)	
	4	RECORD	Alarm time (second)	The occurrence time of the second alarm is returned as a 32-bit integer (time passed from January 1, 1970, 0:00:00).	
	5	RECORD	Alarm time (nanosecond)	In the second alarm occurrence time, the digits after the ones indicating seconds are returned as a 32-bit integer.	
2A0Fh	6	RECORD	Alarm time (time zone)	The time zone at the second alarm occurrence time is returned as a 32-bit integer.	
	7	RECORD	Alarm time (summer time)	The daylight saving time at the second alarm occurrence time is returned as a 32-bit integer.	
	:	:	:	:	
	0	RECORD	Alarm history 15	The number of sub objects (7) is returned.	
	1	RECORD	Alarm No.	The Alarm No. and detail number of the 16th alarm are returned. (32 bits)	
	2	RECORD	Alarm time (Hour)	The occurrence time of the 16th alarm is returned.	
	3	RECORD	Alarm2 No.	The value "0000h" is returned. (16 bits)	
2A40h	4	RECORD	Alarm time (second)	The occurrence time of the 16th alarm is returned as a 32-bit integer (time passed from January 1, 1970, 0:00:00).	
	5	RECORD	Alarm time (nanosecond)	In the 16th alarm occurrence time, the digits after the ones indicating seconds are returned as a 32-bit integer.	
	6	RECORD	Alarm time (time zone)	The time zone at the 16th alarm occurrence time is returned as a 32-bit integer.	
	7	RECORD	Alarm time (summer time)	The daylight saving time at the 16th alarm occurrence time is returned as a 32-bit integer.	
	—	VAR	Clear alarm history	Writing "1EA5h" enables the alarm history to be cleared.	
	2A41h	—	VAR	Current alarm	The number of the current alarm is returned. (32 bits)
	2A42h	—	VAR	Current alarm2	The number of the current alarm is returned. (16 bits)
2A43h	0	ARRAY	Point table error	The number of sub objects (2) is returned.	
	1	ARRAY	Point table error No.	The point table error number is returned.	
	2	ARRAY	Point table error factor	The point table error element is returned.	
2A44h	—	VAR	Parameter error number	The number of the servo parameter errors are returned.	
2A45h	0	ARRAY	Parameter error list	The number of sub objects (254) is returned.	
	1	ARRAY	Parameter error list 1	When [AL. 037 Parameter error] occurs, the first servo parameter number that caused the alarm is returned.	
	:	:	:	:	
2A46h	254	ARRAY	Parameter error list 254	When [AL. 037 Parameter error] occurs, the 254th servo parameter number that caused the alarm is returned.	
	—	VAR	Reset alarm	Writing the value "1EA5h" resets the alarm.	

Index	Sub	Object	Name	Description
2A47h	—	VAR	Converter Alarm No.	The number of the alarm that has occurred on the converter unit side is returned.

Alarm History [B]

The No. of the alarm that has occurred and the time at which it occurred can be recorded in the history. In the alarm history, the latest 16 alarms are recorded so that the types of alarms that have occurred in the past can be checked.

The alarm history can be cleared with [Pr. PC21.0 Alarm clear history selection], on the alarm display of MR Configurator2, or by using the transient command of the optional data monitor function.

Method for checking with MR Configurator2

1. Connect the servo amplifier and a personal computer and select "Alarm Display" from "Diagnosis" in MR Configurator2.
2. The alarm display shows the alarm No., detail number, accumulated time after power-on, and actual time.

Method for checking with the optional data monitor function

Refer to the following.

 Page 429 Transient command

Alarm history [A]

The No. of the alarm that has occurred and the cumulative power-on time can be recorded in the history. In the alarm history, the latest 16 alarms are recorded so that the types of alarms that have occurred in the past can be checked.

The alarm history can be cleared with [Pr. PC18.0 Alarm clear history selection] or on the alarm display of MR Configurator2.

Method for checking with MR Configurator2

1. Connect the servo amplifier and a personal computer and select "Alarm Display" from "Diagnosis" in MR Configurator2.
2. The alarm display shows the alarm No., detail number, accumulated time after power-on, and actual time.

Method for checking on the servo amplifier display

Refer to "Display sequence" in the following manual.

 MR-J5-A User's Manual (Introduction)

Stop method at occurrence of alarms/warnings

The servo motor stop methods at alarm occurrence are as follows: forced stop deceleration, stop with dynamic brake, and stop with electronic dynamic brake. For the servo motor stop method of each alarm number, refer to the following manual.

 MR-J5 User's Manual (Troubleshooting)

Forced stop deceleration

The servo motor stops with the dynamic brake after forced stop deceleration.

Stop with dynamic brake

The servo motor stops with the dynamic brake without forced stop deceleration. For a servo amplifier without the dynamic brake, the servo motor coasts.

Stop with electronic dynamic brake

When a specific servo motor is used, the servo motor stops with the electronic dynamic brake without forced stop deceleration. When other than the specific servo motor is used, the servo motor stops with dynamic brake.

For the specific servo motors, refer to "Precautions relating to the dynamic brake characteristics" in the following manuals.

 MR-J5 User's Manual (Hardware)

 MR-J5D User's Manual (Hardware)

Timing chart at alarm occurrence (MR-J5-_G_/MR-J5W_-_G_/MR-J5-_B_/MR-J5W_-_B_/MR-J5-_A_)

• MR-J5-_G_/MR-J5W_-_G_

Point

- In the torque mode and continuous operation to torque control mode, the forced stop deceleration function cannot be used.
- When the servo motor is at a stop due to an alarm or other factors, commands from the controller are not accepted. When restarting the operation in the cyclic synchronous position mode, confirm the position command.

• MR-J5-_B_/MR-J5W_-_B_

Point

In the torque mode and continuous operation to torque control mode, the forced stop deceleration function cannot be used.

• MR-J5-_A_

Point

In the torque mode, the forced stop deceleration function cannot be used.

When using the forced stop deceleration function

Point

- When [Pr. PA04.3 Forced stop deceleration function selection] is set to "2" (Forced stop deceleration function enabled).
- For a machine in which multiple axes are connected to each other, such as a tandem configuration, set [Pr. PA04.3] to "0" (Forced stop deceleration function disabled). If an alarm occurs with the forced stop deceleration function disabled, the servo motor will stop with dynamic brake.

■ Stopping with forced stop deceleration function

When an alarm is detected, the servo motor stops using forced stop deceleration and MBR and ALM are turned off.

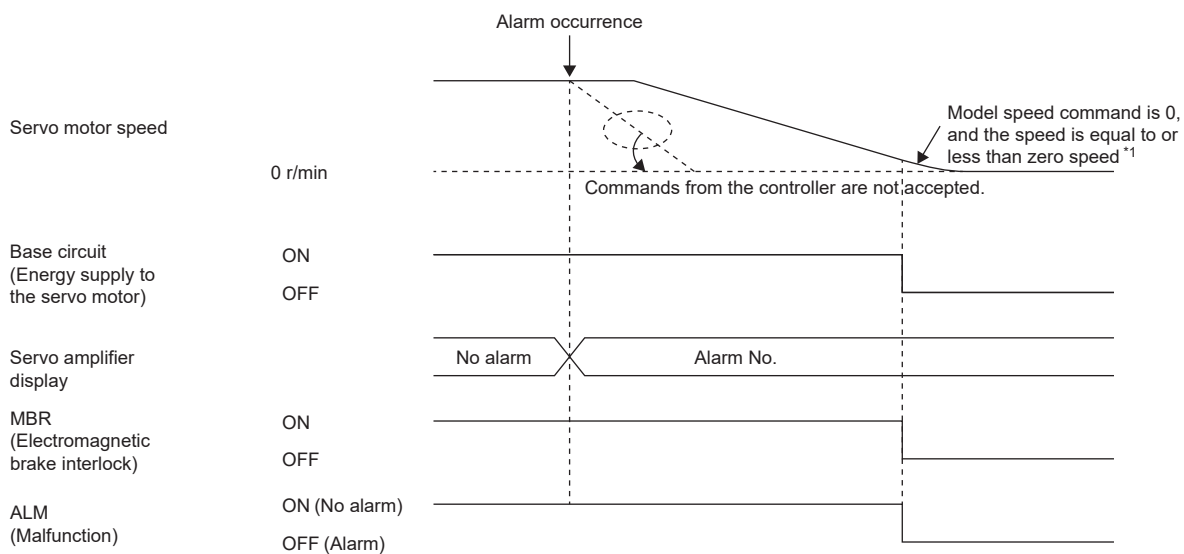

*1 The model speed command is a speed command generated in the servo amplifier for forced stop deceleration of the servo motor.

■ Stopping with dynamic brake

When an alarm is detected, MRB and ALM are turned off, and the servo motor stops using the dynamic brake and electromagnetic brake.

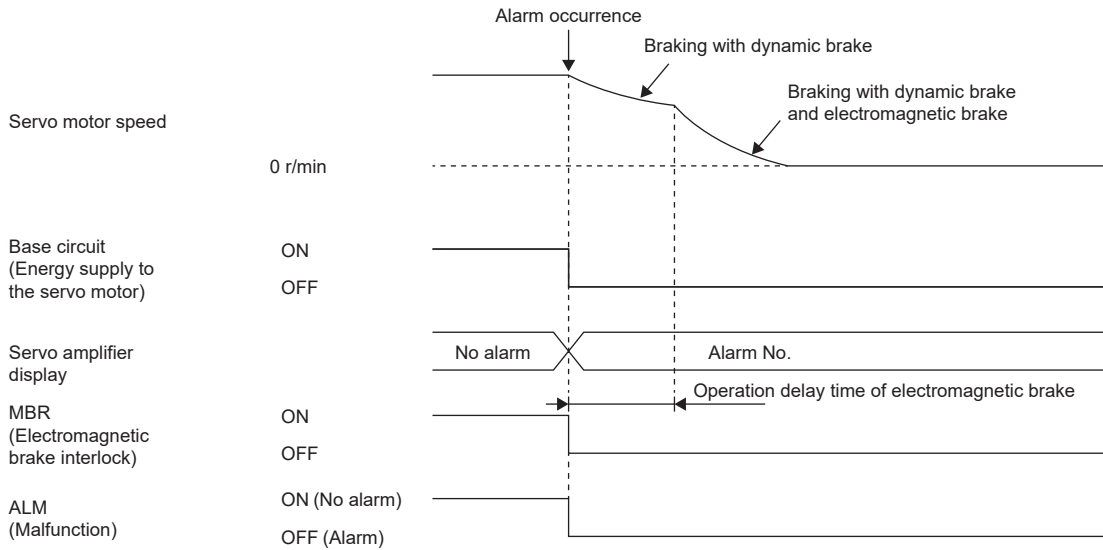

■ When network communication shut-off or communication time-out has occurred [G]

The dynamic brake may operate depending on the communication shut-off status.

Communication shut-off or communication time-out may not be detected, depending on the network. For details, refer to the User's Manual (Communication Function).

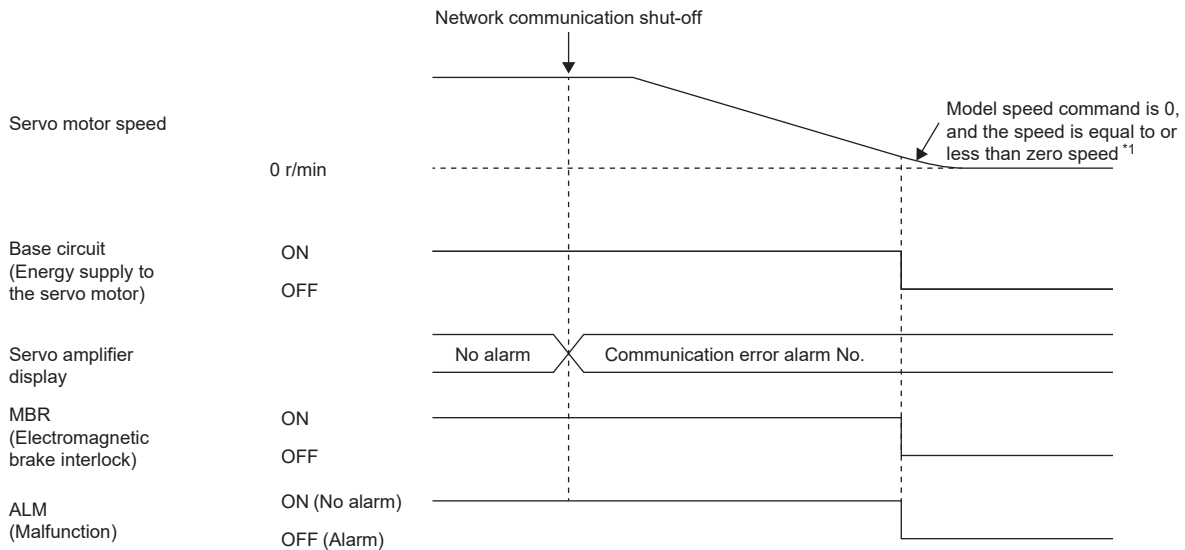

*1 The model speed command is a speed command generated in the servo amplifier for forced stop deceleration of the servo motor.

■ When network communication shut-off has occurred [B]

The dynamic brake may operate depending on the communication shut-off status.

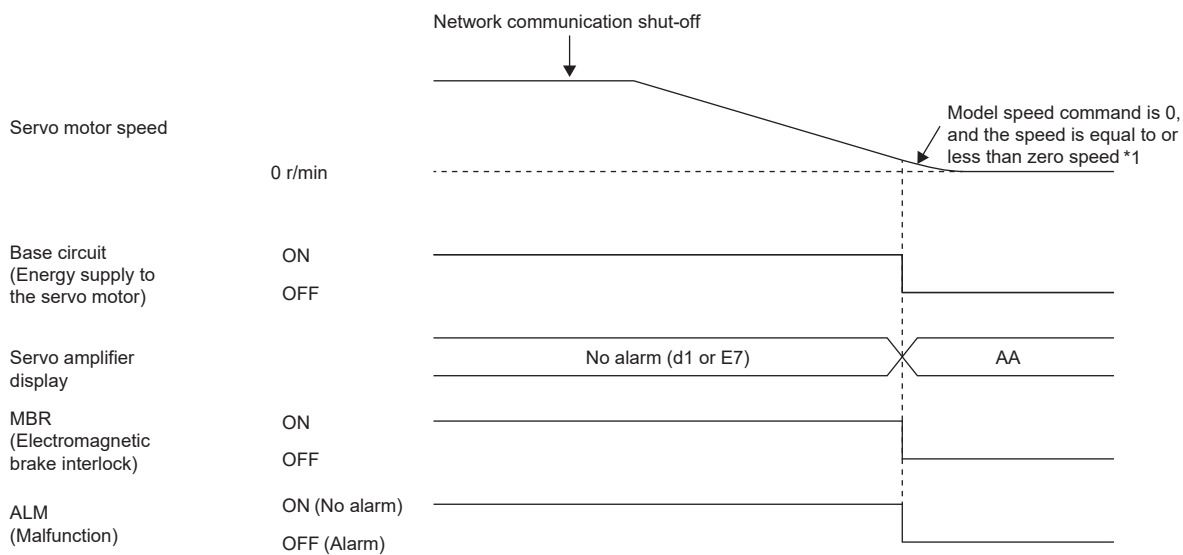

*1 The model speed command is a speed command generated in the servo amplifier for forced stop deceleration of the servo motor.

When the forced stop deceleration function is not used

Point

When [Pr. PA04.3 Forced stop deceleration function selection] is set to "0" (Forced stop deceleration function disabled).

The operation status during an alarm occurrence or network communication shut-off is the same as in the stop method with dynamic brake shown in this section.

Page 162 Stopping with dynamic brake

Timing chart at alarm occurrence (MR-J5D_-_G_)

Point

In the torque mode and continuous operation to torque control mode, the forced stop deceleration function cannot be used.

When the servo motor is at a stop due to an alarm or other factors, commands from the controller are not accepted. When restarting the operation in the cyclic synchronous position mode, confirm the position command.

When connecting multiple MR-J5D_-_G_ to one MR-CV, set [Pr. PC46.2 Protection coordination multiple connections selection] to "1".

When using the forced stop deceleration function (when MR-CV and MR-J5D_-_G_ are connected one-to-one)

Point

- When [Pr. PA04.3 Forced stop deceleration function selection] is set to "2" (Forced stop deceleration function enabled).
- For a machine in which multiple axes are connected to each other, such as a tandem configuration, set [Pr. PA04.3] to "0" (Forced stop deceleration function disabled). If an alarm occurs with the forced stop deceleration function disabled, the servo motor will stop with dynamic brake.

■ Stopping with forced stop deceleration function

When an alarm is detected, the servo motor stops using forced stop deceleration and MBR and ALM are turned off.

When the corresponding axis stop alarm occurs in the MR-J5D2_-_G_ or the MR-J5D3_-_G_, only the axis on which the alarm occurred will be in the operation status explained in this section. Operation of the axes where no alarms are occurring can continue.

When the all-axis stop alarm occurs in the MR-J5D2_-_G_ or the MR-J5D3_-_G_, all axes will be in the operation status explained in this section.

For details on the corresponding axis stop alarm and the all-axis stop alarm, refer to "List of alarm No./warning No." in the following manual.

MR-J5 User's Manual (Troubleshooting)

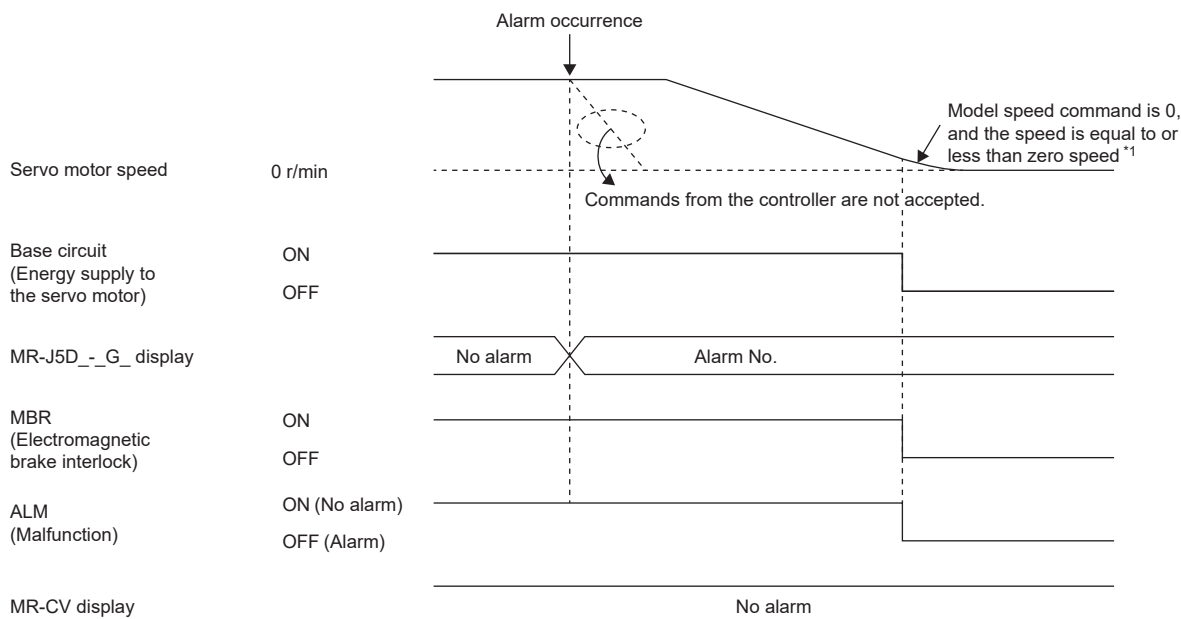

*1 The model speed command is a speed command generated in the servo amplifier for forced stop deceleration of the servo motor.

■ Stopping with dynamic brake

When an alarm is detected, MRB and ALM are turned off, and the servo motor stops using the dynamic brake and electromagnetic brake.

When the corresponding axis stop alarm occurs in the MR-J5D2-_G_ or the MR-J5D3-_G_, only the axis on which the alarm occurred will be in the operation status explained in this section. Operation of the axes where no alarms are occurring can continue.

When the all-axis stop alarm occurs in the MR-J5D2-_G_ or the MR-J5D3-_G_, all axes will be in the operation status explained in this section.

For details on the corresponding axis stop alarm and the all-axis stop alarm, refer to "List of alarm No./warning No." in the following manual.

📖 MR-J5 User's Manual (Troubleshooting)

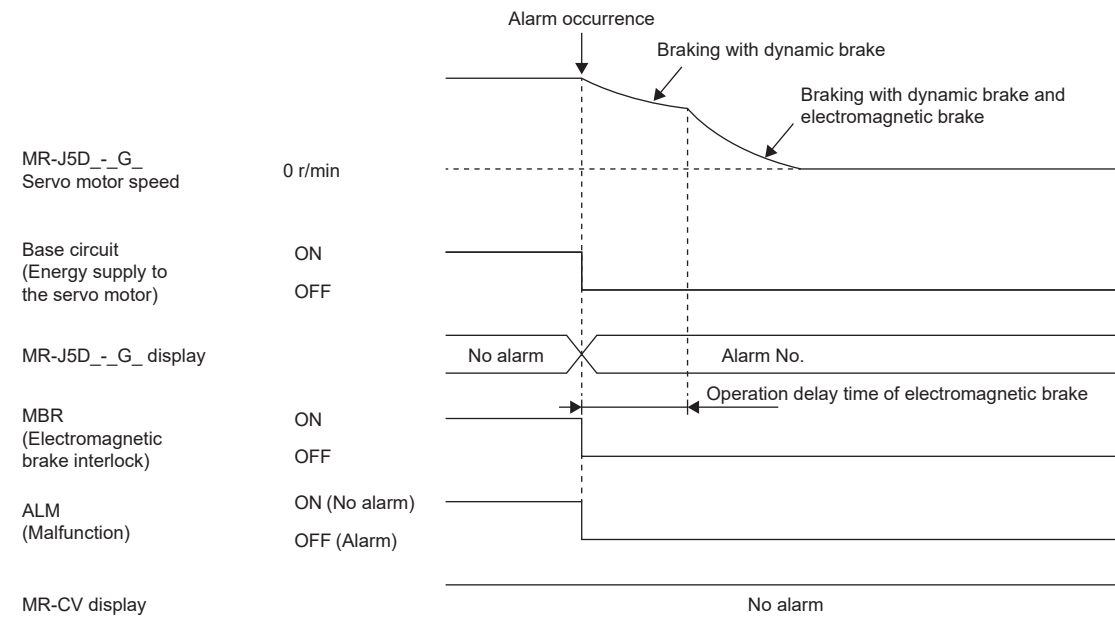

■ When network communication shut-off or communication time-out has occurred

The dynamic brake may operate depending on the communication shut-off status.

Communication shut-off or communication time-out may not be detected depending on the network. For details, refer to the User's Manual (Communication Function).

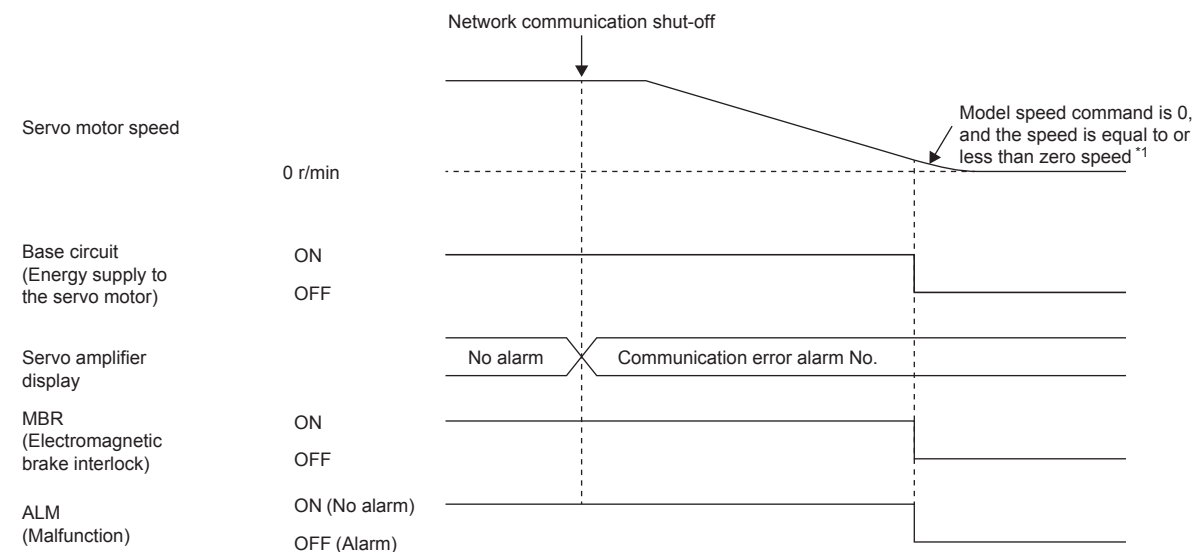

*1 The model speed command is a speed command generated in the servo amplifier for forced stop deceleration of the servo motor.

When using the forced stop deceleration function (when multiple MR-J5D_-_G_ are connected to the MR-CV)

Point

- When [Pr. PA04.3 Forced stop deceleration function selection] is set to "2" (Forced stop deceleration function enabled).
- For a machine in which multiple axes are connected to each other, such as a tandem configuration, set [Pr. PA04.3] to "0" (Forced stop deceleration function disabled). If an alarm occurs with the forced stop deceleration function disabled, the servo motor will stop with dynamic brake.

■ Stopping with forced stop deceleration function

Point

When connecting multiple MR-J5D_-_G_ to one MR-CV, set [Pr. PC46.2 Protection coordination multiple connections selection] to "1".

When an alarm is detected, the servo motor stops using forced stop deceleration, and MBR is turned off.

When an alarm that is not subject to the converter main circuit stop occurs in the MR-J5D2_-_G_ and MR-J5D3_-_G_, the servo motor stops due to forced stop deceleration only for the axis where the alarm occurred. Axes where no alarm has occurred and other MR-J5D_-_G_ connected with the protection coordination cable can continue to operate.

When an alarm that is not subject to the converter main circuit stop occurs in the all axes of the MR-J5D_-_G_, the other MR-J5D_-_G_ connected with the protection coordination cable also stops the servo motor after the servo motor stops due to forced stop deceleration for the axes where the alarm occurred.

For the alarms that are subject to the converter main circuit stop, refer to "List of alarm No./warning No." in the following manual.

 MR-J5 User's Manual (Troubleshooting)

The following example uses the MR-J5D2-_G_ as the first unit and MR-J5D1-_G_ as the second unit.

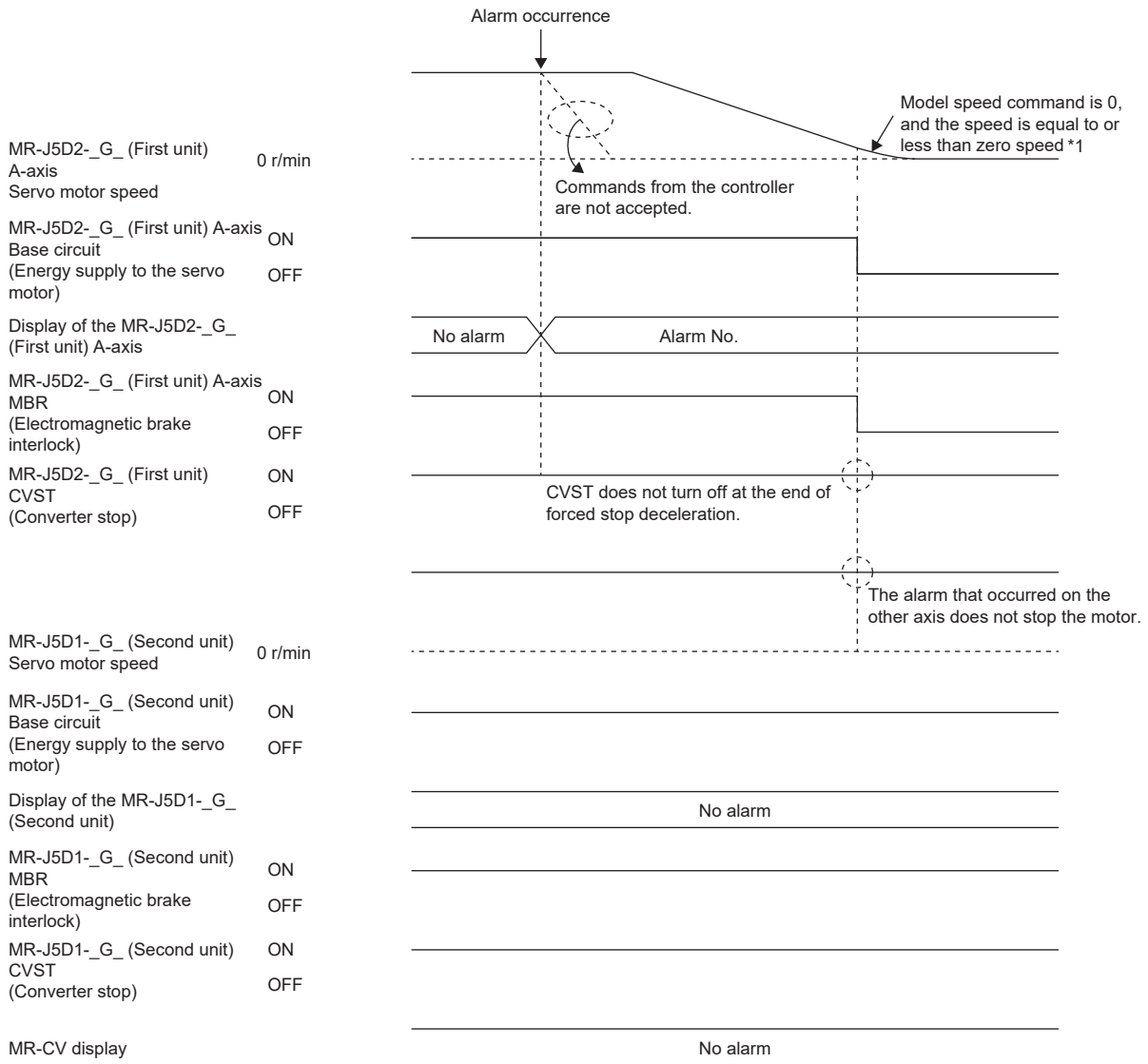
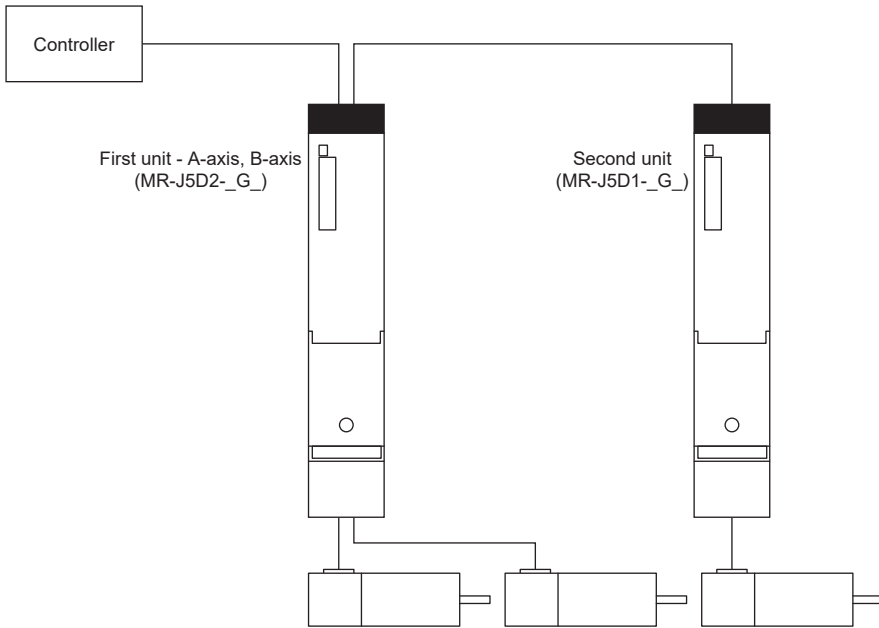

*1 The model speed command is a speed command generated in the servo amplifier for forced stop deceleration of the servo motor.

■ Stopping with dynamic brake

Point

When connecting multiple MR-J5D_-G_ to one MR-CV, set [Pr. PC46.2 Protection coordination multiple connections selection] to "1".

- When an alarm that is subject to the converter main circuit stop occurs

When an alarm is detected, MBR and CVST are turned off, and the servo motor is stopped using the dynamic brake and electromagnetic brake.

When an alarm that is subject to the converter main circuit stop occurs in an MR-J5D_-G_, the other MR-J5D_-G_ connected with the protection coordination cable also stops the servo motor.

For the alarms that are subject to the converter main circuit stop, refer to "List of alarm No./warning No." in the following manual.

📖 MR-J5 User's Manual (Troubleshooting)

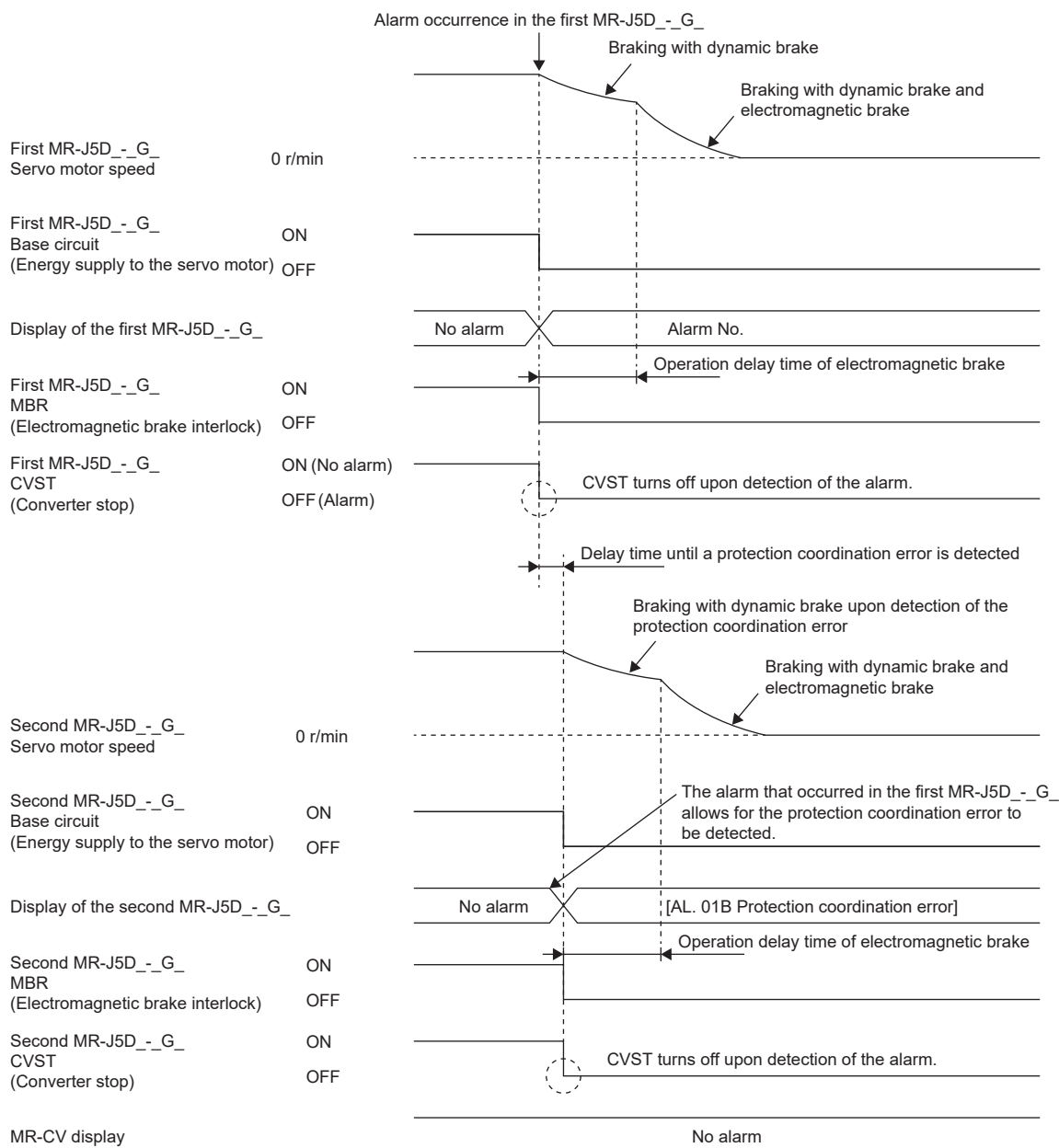

- When an alarm that is not subject to the converter main circuit stop occurs

Point 

When connecting multiple MR-J5D-_G_ to one MR-CV, set [Pr. PC46.2 Protection coordination multiple connections selection] to "1".

When an alarm is detected, MBR is turned off, and the servo motor is stopped using the dynamic brake and electromagnetic brake.

When an alarm that is not subject to the converter main circuit stop occurs in the MR-J5D2-_G_ and MR-J5D3-_G_, the servo motor stops only for the axes where the alarm occurred. Axes where no alarm has occurred and other MR-J5D_-_G_ connected with the protection coordination cable can continue to operate.

When an alarm that is not subject to the converter main circuit stop occurs in the all axes of the MR-J5D_-_G_, the other MR-J5D_-_G_ connected with the protection coordination cable also stops the servo motor after the servo motor stops due to forced stop deceleration for the axes where the alarm occurred.

For the alarms that are subject to the converter main circuit stop and the corresponding axis stop alarms, refer to "List of alarm No./warning No." in the following manual.

 MR-J5 User's Manual (Troubleshooting)

The following example uses the MR-J5D2-_G_ as the first unit and MR-J5D1-_G_ as the second unit.

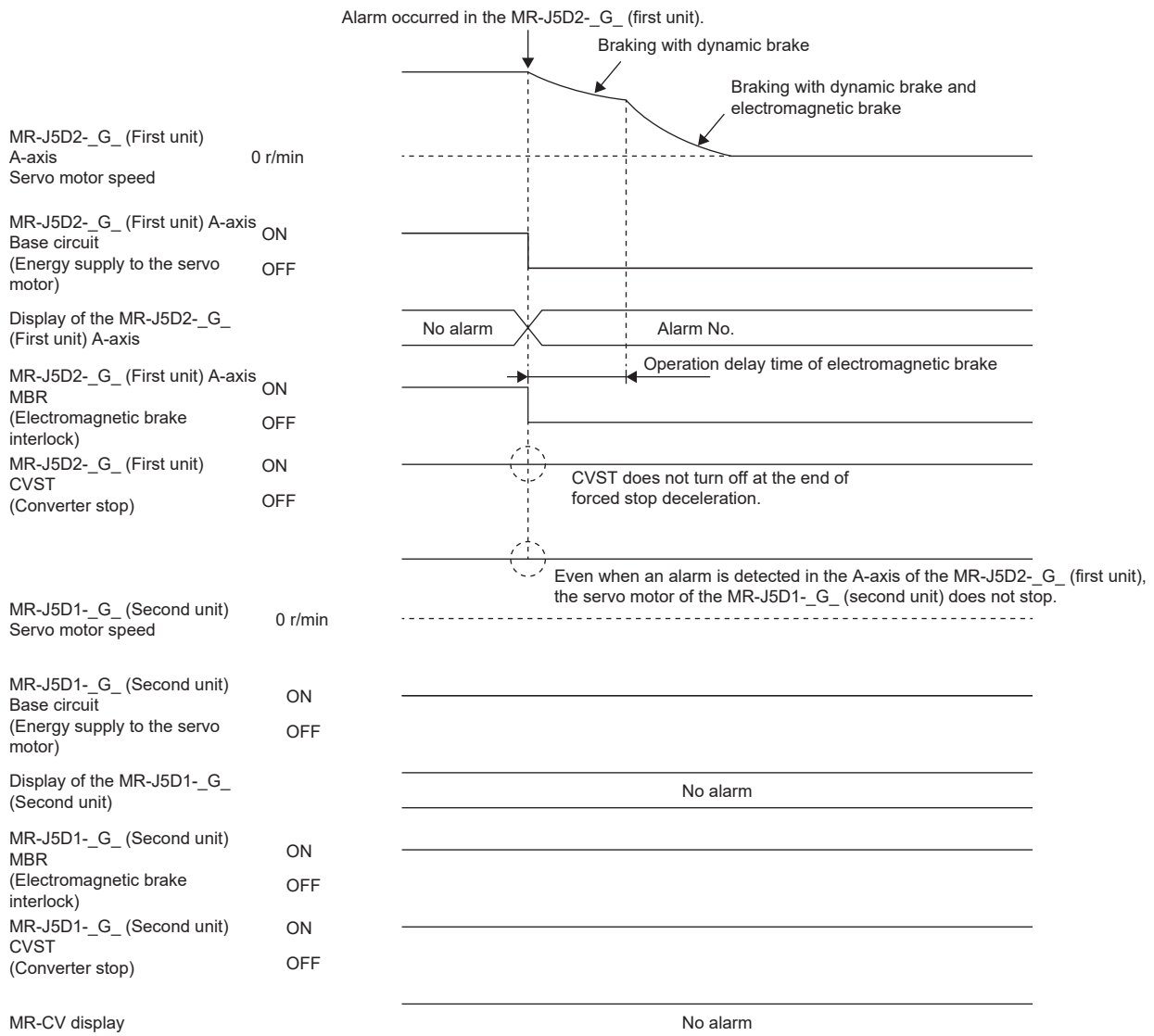
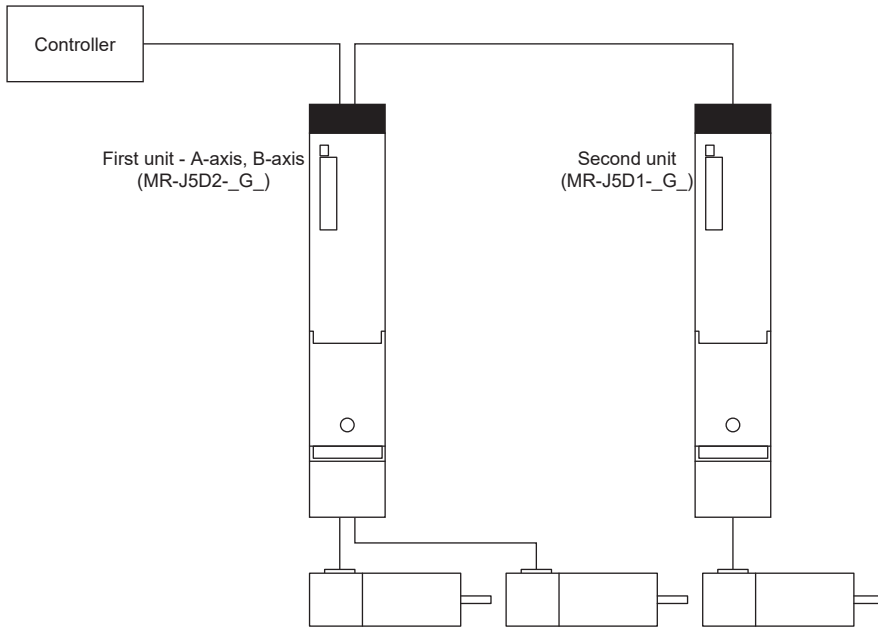

- When an alarm occurs in the MR-CV

When the MR-J5D_-_G_ detects that an alarm has occurred in the MR-CV_, MBR, ALM and CVST are turned off, and the servo motors are stopped using the dynamic brake and electromagnetic brake for all axes in the servo-on status.

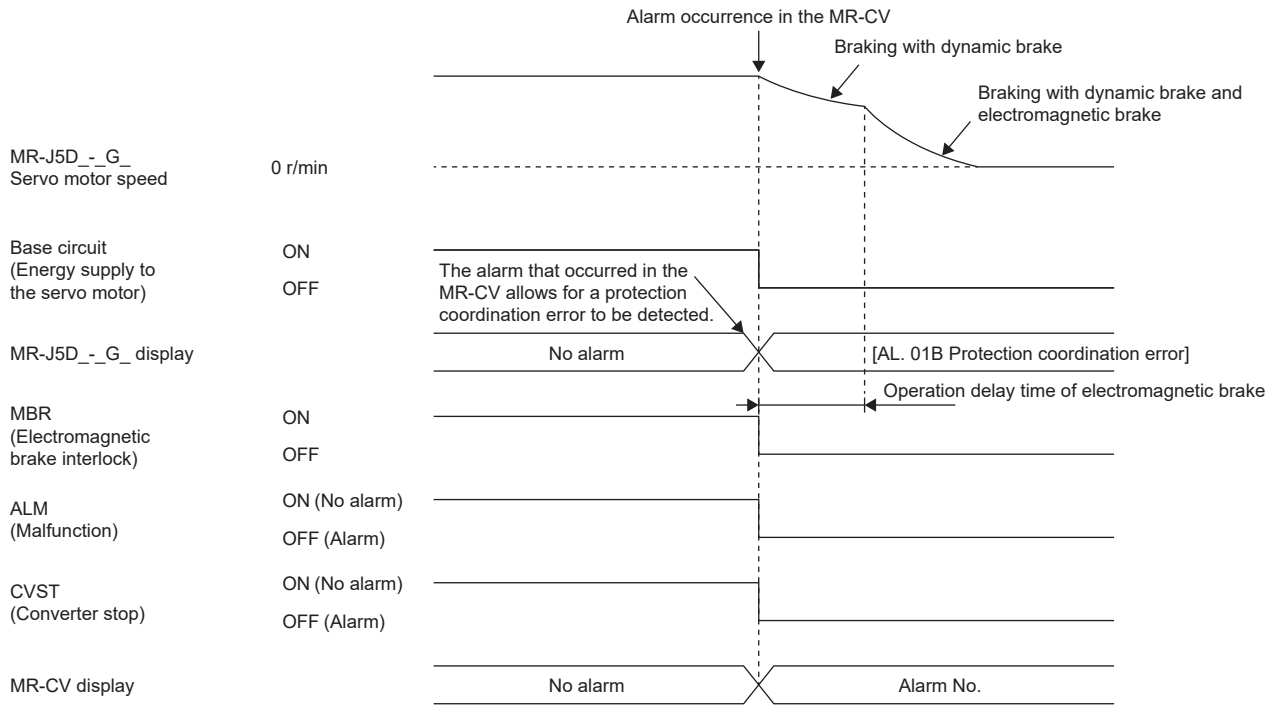

■ When network communication shut-off or communication time-out has occurred

The dynamic brake may operate depending on the communication shut-off status.

Communication shut-off or communication time-out may not be detected, depending on the network. For details, refer to the User's Manual (Communication Function).

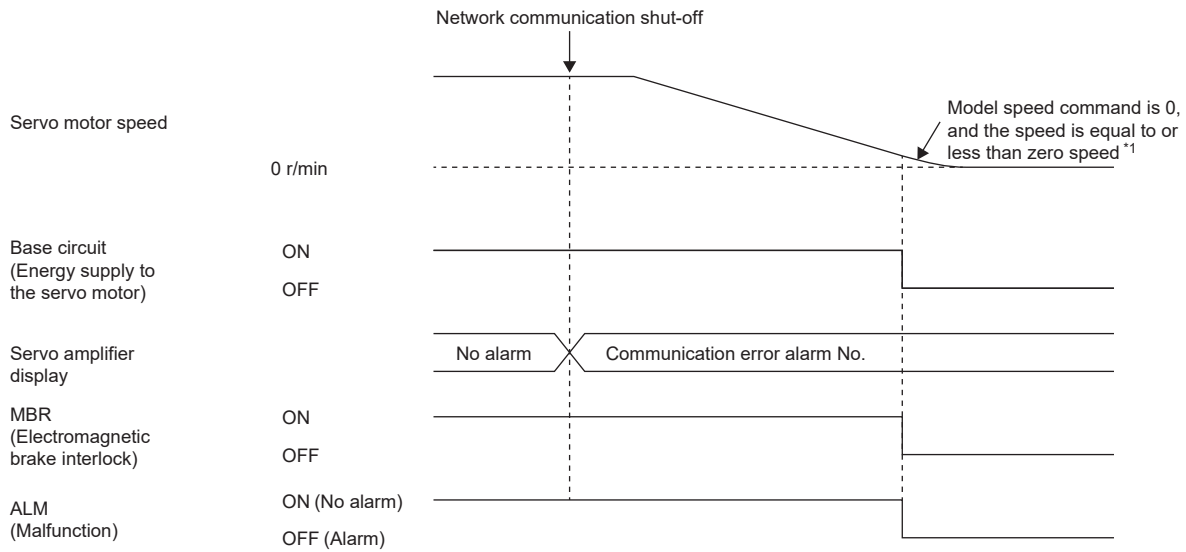

*1 The model speed command is a speed command generated in the servo amplifier for forced stop deceleration of the servo motor.

When the forced stop deceleration function is not used

Point

This is the case when [Pr. PA04.3 Forced stop deceleration function selection] is set to "0" (Forced stop deceleration function disabled).

The operation status during an alarm occurrence or network communication shut-off is the same as in the stop method with dynamic brake shown in this section.

☞ Page 165 Stopping with dynamic brake

☞ Page 168 Stopping with dynamic brake

3.17 Forced stop deceleration function

Forced stop deceleration function is a function that decelerates the servo motor with commands when EM2 (Forced stop 2) is turned off, and stops the servo motor with the dynamic brake when the servo motor rotates at the zero speed or less. This enables the servo motor to stop with shorter coasting distance than stopping only with dynamic brake. When the forced stop deceleration function is activated, [AL. 0E6 Servo forced stop warning] is shown in the display. The amount of time to reach 0 [r/min] or [mm/s] from the rated speed and the zero speed detection range can be set with the servo parameters.

[G]: The forced stop deceleration function can even be operated through commands from the network by using Quick stop.

☞ Page 197 Quick stop [G]

[B]: The forced stop deceleration function can even be operated through the emergency stop command from the controller. For details, refer to each controller manual.

Restriction

- In the torque mode and continuous operation to torque control mode, the forced stop deceleration function cannot be used.
- When connecting multiple MR-J5D_-_G_ to one MR-CV, set [Pr. PC46.2 Protection coordination multiple connections selection] to "1".

Precautions

- The forced stop deceleration does not operate on alarms that are not subject to the forced stop deceleration function.
 - When the network communication is shut off, forced stop deceleration operates.
- ☞ Page 162 When network communication shut-off or communication time-out has occurred [G]
- ☞ Page 163 When network communication shut-off has occurred [B]
- Disable the forced stop deceleration function for a machine in which multiple axes are connected to each other, such as a tandem configuration. If an alarm occurs with the forced stop deceleration function disabled, the servo motor will stop with dynamic brake.
 - Turn off EM2 (Forced stop 2), then turn off the servo-on command (from controller) and ready-on command (from controller). If the ready-on command (from controller) is turned off before EM2 is turned off, the base circuit shut-off delay and vertical axis freefall prevention do not function.
 - During normal operation, do not use EM2 (Forced stop 2) to alternate between stop and drive. Doing so may shorten the service life of the servo amplifier.
 - If an alarm that operates the dynamic brake occurs during forced stop deceleration, the braking distance until the servo motor stops will be longer than the braking distance when the forced stop deceleration is properly operated.
 - If STO is turned off during forced stop deceleration, the dynamic brake stops the servo motor, which may shorten the service life of the dynamic brake relay.
 - To prevent a malfunction in the dynamic brake or fire, do not drive the servo motor with an external force when the power is shut off or an alarm or other factors trigger to activate the dynamic brake.

Setting method [G] [B]

Set [Pr. PA04.3 Forced stop deceleration function selection] to enable/disable the forced stop deceleration function. Setting [Pr. PA04.3 Forced stop deceleration function selection] to "2" (Forced stop deceleration function enabled) operates the forced stop deceleration function when EM2 (Forced stop 2) is turned off. In addition, set the level of ZSP (Zero speed detection) and the amount of time to reach 0 [r/min] or [mm/s] from the rated speed by using [Pr. PC07 Zero speed] and [Pr. PC24 Deceleration time constant at forced stop].

Servo parameter	Symbol	Name	Outline
PA04.3	*AOP1	Forced stop deceleration function selection	Set "Forced stop deceleration function" to enabled/disabled. 0: Forced stop deceleration function disabled (EM1 is used) 2: Forced stop deceleration function enabled (EM2 is used) (initial value)
PC07	ZSP	Zero speed	Set the level of ZSP (Zero speed detection). Initial value: 50 [r/min], [mm/s]
PC24	RSBR	Deceleration time constant at forced stop	Set the deceleration time constant at forced stop. Initial value: 100 [ms]

Setting method [A]

Set [Pr. PA04.3 Forced stop deceleration function selection] to enable/disable the forced stop deceleration function. Setting [Pr. PA04.3 Forced stop deceleration function selection] to "2" (Forced stop deceleration function enabled) operates the forced stop deceleration function when EM2 (Forced stop 2) is turned off. In addition, set the level of ZSP (Zero speed detection) and the amount of time to reach 0 [r/min] or [mm/s] from the rated speed by using [Pr. PC17 Zero speed] and [Pr. PC51 Deceleration time constant at forced stop].

Servo parameter	Symbol	Name	Outline
PA04.3	*AOP1	Forced stop deceleration function selection	Set "Forced stop deceleration function" to enabled/disabled. 0: Forced stop deceleration function disabled (EM1 is used) 2: Forced stop deceleration function enabled (EM2 is used) (initial value)
PC17	ZSP	Zero speed	Set the level of ZSP (Zero speed detection). Initial value: 50 [r/min], [mm/s]
PC51	RSBR	Deceleration time constant at forced stop	Set the deceleration time constant at forced stop. Initial value: 100 [ms]

Timing chart [G] [B]

When EM2 (Forced stop 2) is turned off, the servo motor decelerates in accordance with the value of [Pr. PC24 Deceleration time constant at forced stop]. Once the servo motor speed becomes below [Pr. PC07 Zero speed] after completion of the deceleration command, the base circuit will be shut off and the dynamic brake will activate.

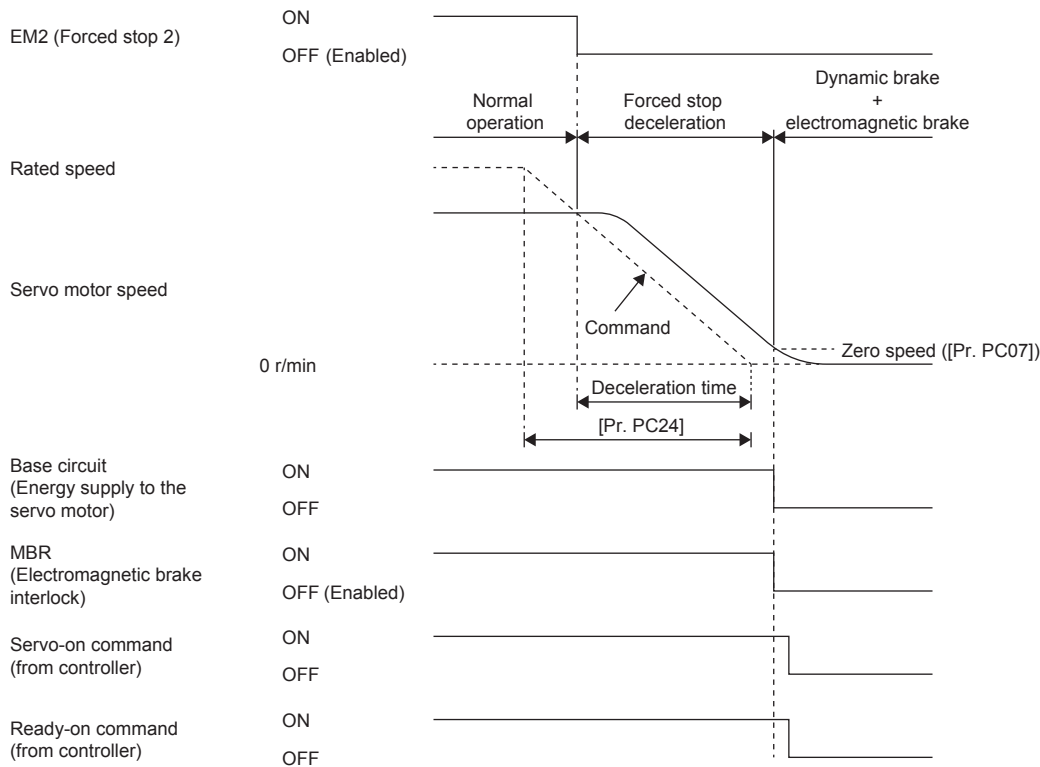

Timing chart [A]

When EM2 (Forced stop 2) is turned off, the servo motor decelerates in accordance with the value of [Pr. PC51 Deceleration time constant at forced stop]. Once the servo motor speed becomes below [Pr. PC17 Zero speed] after completion of the deceleration command, the base circuit will be shut off and the dynamic brake will activate.

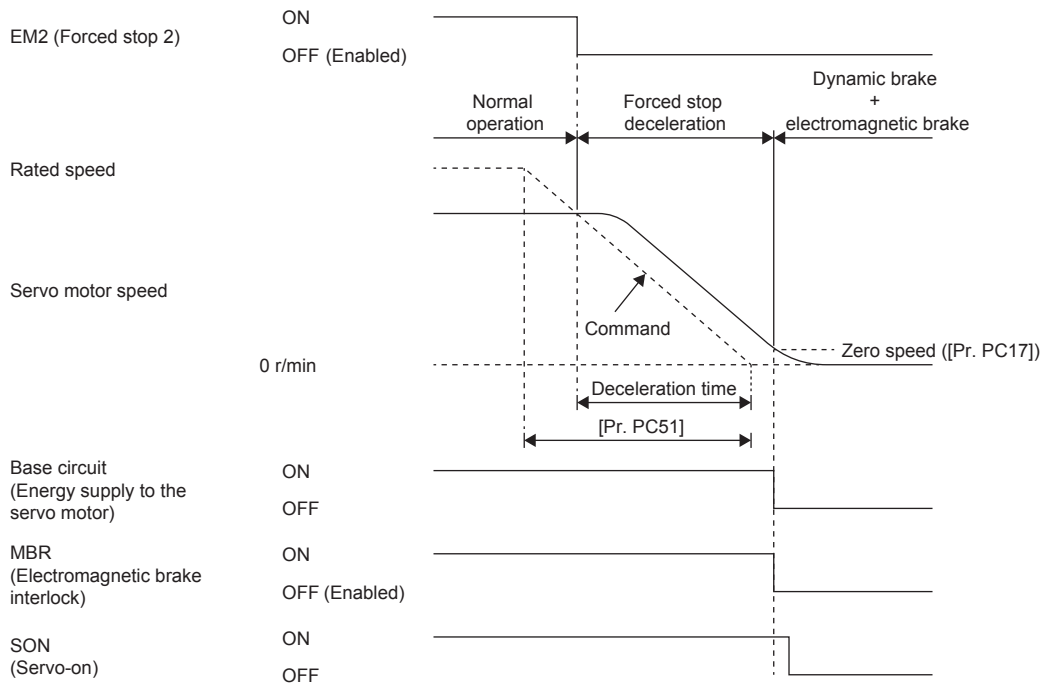

3.18 Electromagnetic brake interlock function

For servo motors with an electromagnetic brake, this function activates the electromagnetic brake at servo-off, upon an error occurrence, and at other necessary times. By using the electromagnetic brake, the position can be maintained so that the servo motor will not move due to external force. When this function is used on a system with a vertical axis, a drop in vertical lift applications can be prevented.

Base circuit shut-off delay time function

The base circuit shut-off delay time function is used in the following cases to prevent the vertical axis from dropping due to delayed electromagnetic brake operations:

- Under servo-off command
- At forced stop (EM2 is turned off)
- At alarm occurrence
- At network communication shut-off occurrence

The delay time used between the MBR (Electromagnetic brake interlock) shut-off and the base circuit shut-off can be set in servo parameters.

Restriction

- This function does not operate on alarms that are not subject to the forced stop deceleration function.
- When the forced stop deceleration function is disabled, this function does not operate at forced stop (EM2 is turned off) or upon an alarm occurrence or network communication shut-off.

Precautions

- [G]: This function does not operate when the ready-off command is input. To use this function, set [Pr. PC41.3 Electromagnetic brake sequence output function selection] to "1" (Switched On/Ready to switch on/Switch on disabled).

Setting method [G] [B]

Point

For specifications such as the power supply capacity and operation delay time of the electromagnetic brake, refer to "Characteristics of electromagnetic brake" in the following manual.

 Rotary Servo Motor User's Manual (For MR-J5)

For a selection example of a surge absorber for the electromagnetic brake, refer to "Characteristics of electromagnetic brake" in the following manual.

 Rotary Servo Motor User's Manual (For MR-J5)

Set MBR (Electromagnetic brake interlock) to available with [Pr. PD07 Output device selection 1] to [Pr. PD09 Output device selection 3].

When the electromagnetic brake is placed in servo-off status, MBR and the base circuit both shut off following a short delay. Set this delay time (Tb) in [Pr. PC02 Electromagnetic brake sequence output].

 Page 178 When using the forced stop deceleration function

Servo parameter	Symbol	Name	Outline
PC02	MBR	Electromagnetic brake sequence output	Set the delay time used between the MBR (Electromagnetic brake interlock) shut-off and the base circuit shut-off. Initial value: 0 [ms]
PD07.0-1	*DO1	Device selection	Select a function of the output device pin.
PD08.0-1	*DO2	Device selection	
PD09.0-1	*DO3	Device selection	

Setting method [A]

Point

For specifications such as the power supply capacity and operation delay time of the electromagnetic brake, refer to "Characteristics of electromagnetic brake" in the following manual.

 Rotary Servo Motor User's Manual (For MR-J5)

For a selection example of a surge absorber for the electromagnetic brake, refer to "Characteristics of electromagnetic brake" in the following manual.

 Rotary Servo Motor User's Manual (For MR-J5)

Set MBR (Electromagnetic brake interlock) to available with the following servo parameters: [Pr. PD23 Output device selection 1] to [Pr. PD26 Output device selection 4], [Pr. PD28 Output device selection 6], and [Pr. PD47 Output device selection 7]. In addition, when the electromagnetic brake is placed in servo-off status, MBR and the base circuit both shut off following a short delay. Set this delay time (Tb) in [Pr. PC16 Electromagnetic brake sequence output].

 Page 178 When using the forced stop deceleration function

Servo parameter	Symbol	Name	Outline
PC16	MBR	Electromagnetic brake sequence output	Set the delay time used between the MBR (Electromagnetic brake interlock) shut-off and the base circuit shut-off. Initial value: 0 [ms]
PD23.0-1	*DO1	Device selection	Select a function of the CN3-22 pin.
PD24.0-1	*DO2	Device selection	Select a function of the CN3-23 pin.
PD25.0-1	*DO3	Device selection	Select a function of the CN3-24 pin.
PD26.0-1	*DO4	Device selection	Select a function of the CN3-25 pin.
PD28.0-1	*DO6	Device selection	Select a function of the CN3-49 pin.
PD47.0-1	*DO7	Device selection	Select a function of the CN3-13 pin.
PD47.2-3	*DO7	Device selection	Select a function of the CN3-14 pin.

Timing chart

When using the forced stop deceleration function

Point

When [Pr. PA04.3 Forced stop deceleration function selection] is set to "2" (Forced stop deceleration function enabled).

Turning the servo-on command on/off [G] [B]

When the servo-on command is turned off, the servo lock is released after T_b [ms], following which the servo motor coasts. If the electromagnetic brake is enabled during servo-lock, its service life may be shortened. Therefore, when using this function with the vertical axis, set T_b to about 1.5 times of the minimum delay time where the moving part will not drop down.

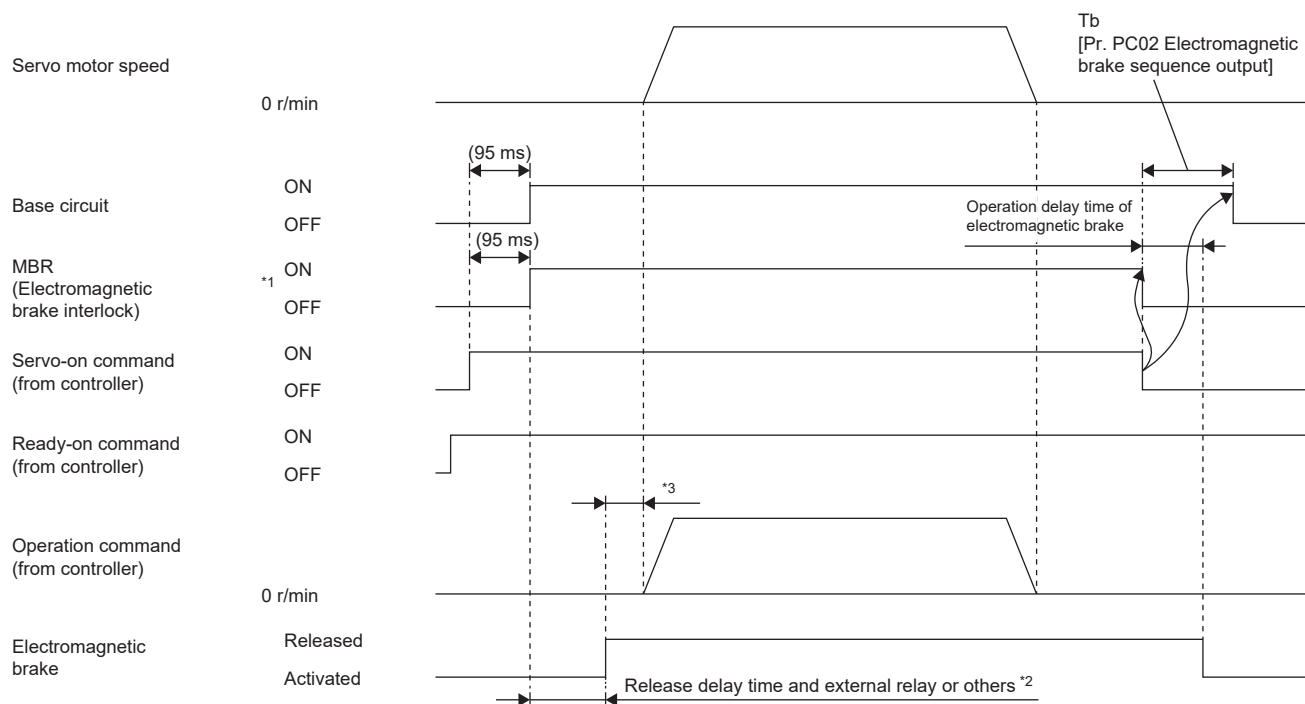

*1 ON: Electromagnetic brake is not activated
OFF: Electromagnetic brake is activated

*2 The electromagnetic brake is released after the release delay time of the electromagnetic brake and the operation time of external circuit relay or other operations. For the release delay time of electromagnetic brake, refer to "Characteristics of electromagnetic brake" in the following manual.

Rotary Servo Motor User's Manual (For MR-J5)

*3 Give an operation command from the controller after the electromagnetic brake is released.

■ Turning the servo-on command on/off [A]

When the servo-on command is turned off, the servo lock is released after T_b [ms], following which the servo motor coasts. If the electromagnetic brake is enabled during servo-lock, its service life may be shortened. Therefore, when using this function with the vertical axis, set T_b to about 1.5 times of the minimum delay time where the moving part will not drop down.

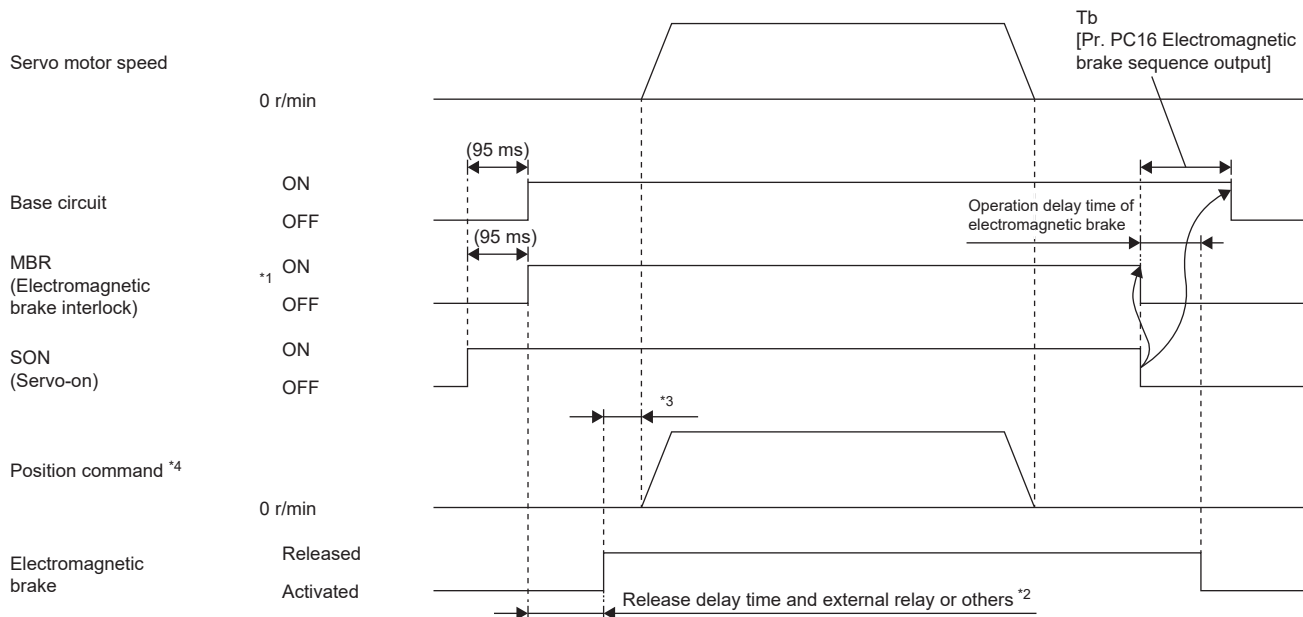

*1 ON: Electromagnetic brake is not activated
 OFF: Electromagnetic brake is activated

*2 The electromagnetic brake is released after the release delay time of the electromagnetic brake and the operation time of external circuit relay or other operations. For the release delay time of electromagnetic brake, refer to "Characteristics of electromagnetic brake" in the following manual.

Rotary Servo Motor User's Manual (For MR-J5)

*3 Give a position command after the electromagnetic brake is released.

*4 When in the position control mode.

■ Turning the quick stop command (from controller) or EM2 (Forced stop 2) on/off [G] [B]

Point

In the torque mode and continuous operation to torque control mode, the forced stop deceleration function cannot be used.

Turn off the quick stop command (from controller) or EM2 (Forced stop 2), then turn off the servo-on command (from controller) and ready-on command (from controller). If the ready-on command (from controller) is turned off before the quick stop command (from controller) or EM2 is turned off, Tb [Pr. PC02 Electromagnetic brake sequence output] does not function.

MBR is turned off after the servo motor stops through forced stop deceleration, then the base circuit is turned off after the base circuit shut-off delay time.

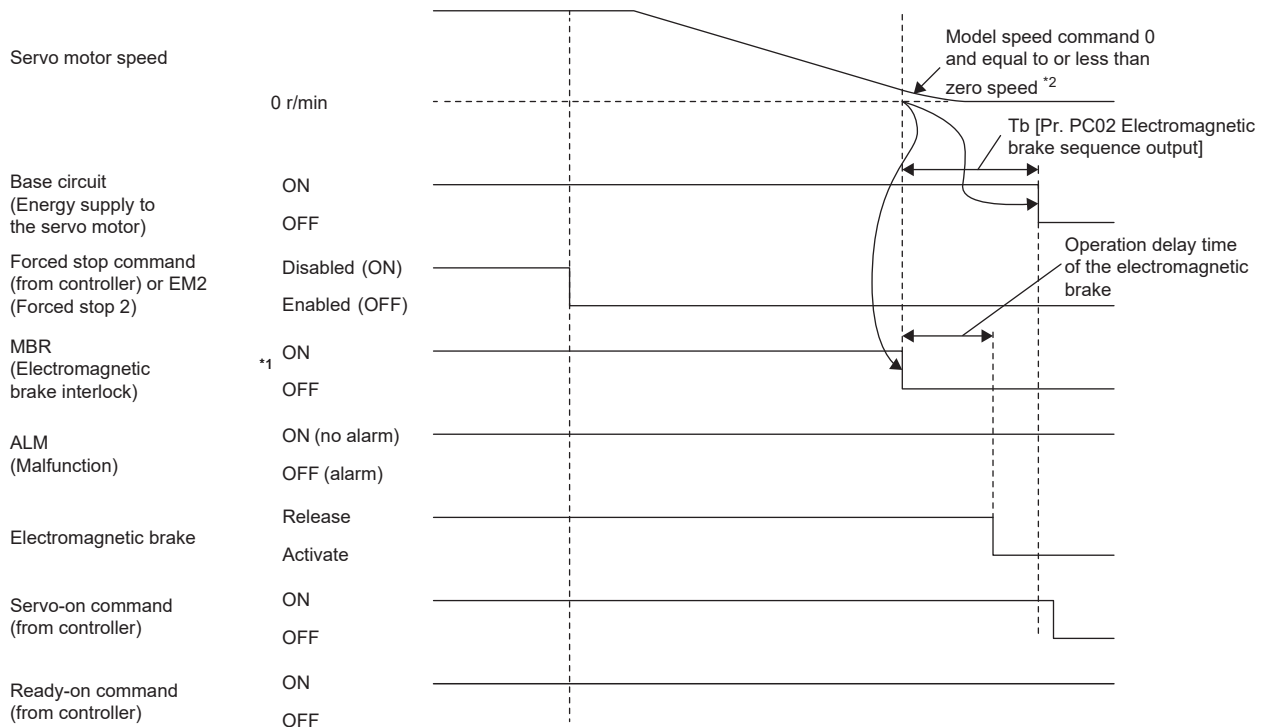

*1 ON: Electromagnetic brake is not activated
OFF: Electromagnetic brake is activated

*2 The model speed command is a speed command generated in the servo amplifier for forced stop deceleration of the servo motor.

■ Turning EM2 (Forced stop 2) off/on [A]

Point

In the torque mode, the forced stop deceleration function cannot be used.

Turn off EM2 (Forced stop 2), then turn off SON (Servo-on). When SON is turned off before EM2 is turned off, the operation state of the servo amplifier is the same as the following.

☞ Page 179 Turning the servo-on command on/off [A]

MBR is turned off after the servo motor stops through forced stop deceleration, then the base circuit is turned off after the base circuit shut-off delay time.

3

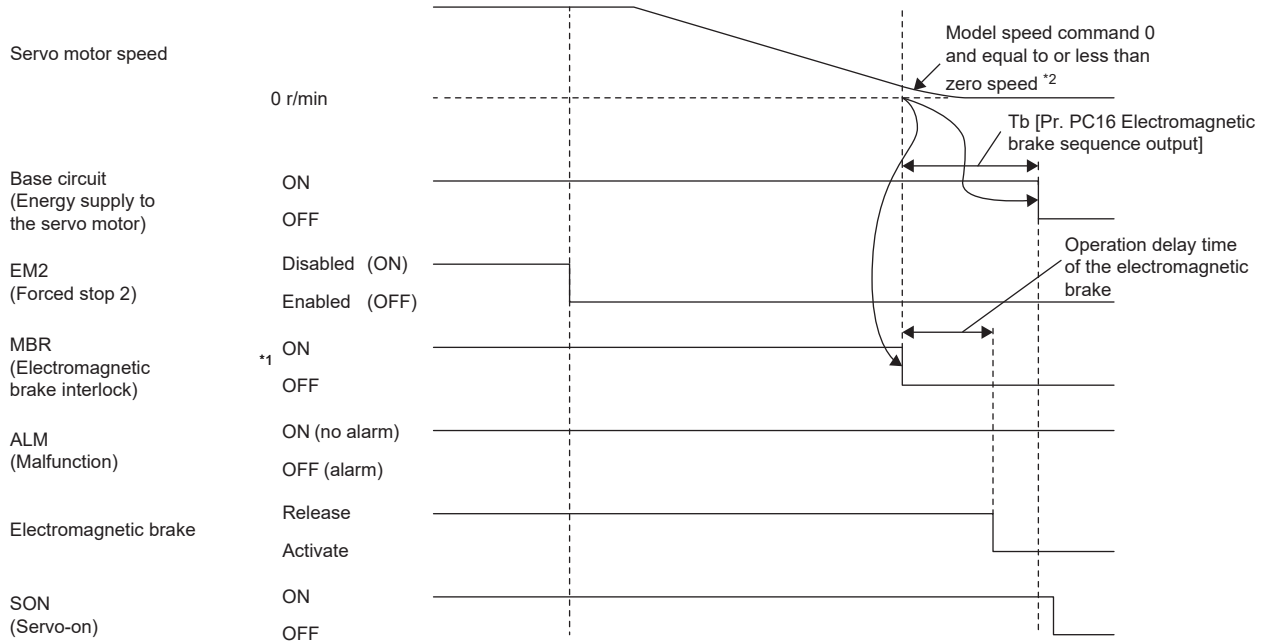

*1 ON: Electromagnetic brake is not activated
OFF: Electromagnetic brake is activated

*2 The model speed command is a speed command generated in the servo amplifier for forced stop deceleration of the servo motor.

■ Alarm occurrence [G] [B]

- When forced stop deceleration is enabled

MBR is turned off after the servo motor stops through forced stop deceleration, then the base circuit and ALM are turned off after the base circuit shut-off delay time.

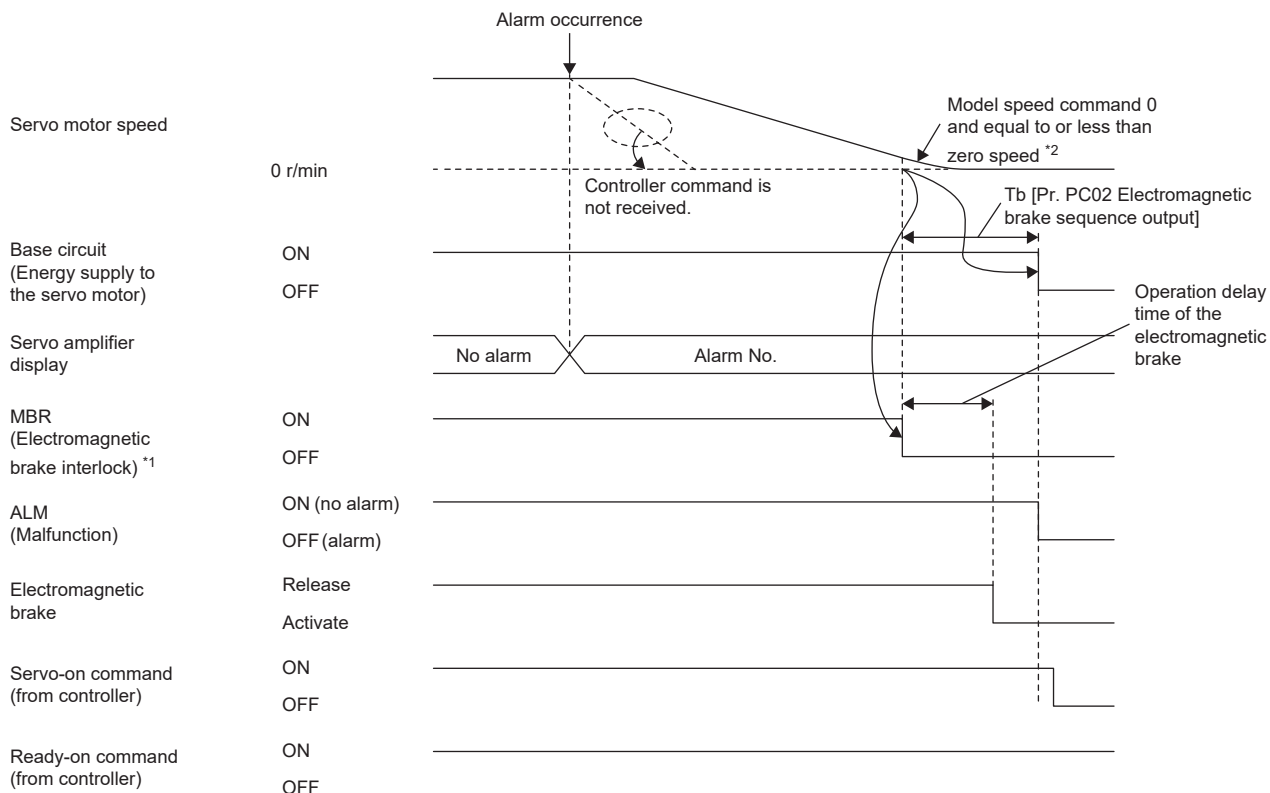

*1 ON: Electromagnetic brake is not activated

OFF: Electromagnetic brake is activated

*2 The model speed command is a speed command generated in the servo amplifier for forced stop deceleration of the servo motor.

- When forced stop deceleration becomes disabled

The servo motor stops using the same method as with the dynamic brake.

☞ Page 165 Stopping with dynamic brake

- When network communication shut-off has occurred [G]

MBR is turned off after the servo motor stops through forced stop deceleration, then the base circuit and ALM are turned off after the base circuit shut-off delay time. The dynamic brake may operate depending on the communication shut-off status.

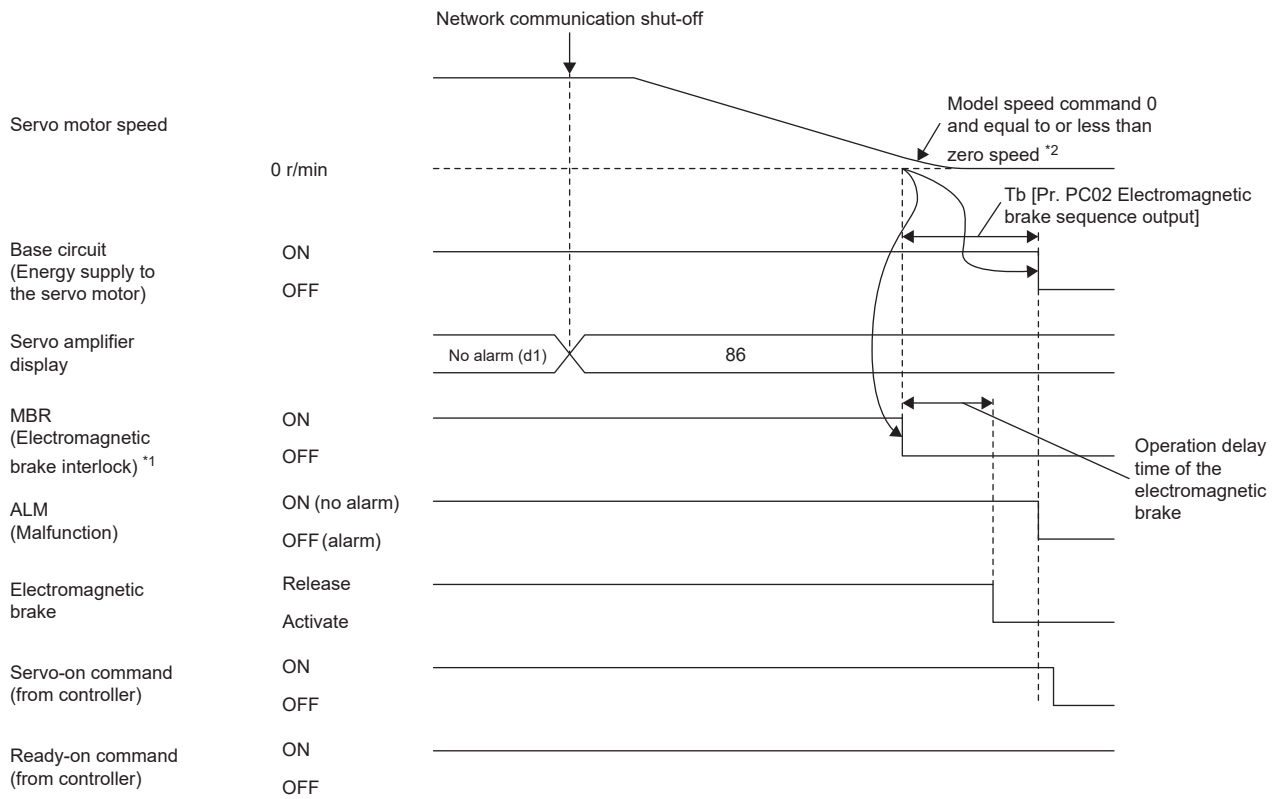

*1 ON: Electromagnetic brake is not activated
 OFF: Electromagnetic brake is activated

*2 The model speed command is a speed command generated in the servo amplifier for forced stop deceleration of the servo motor.

- When network communication shut-off has occurred [B]

MBR is turned off after the servo motor stops through forced stop deceleration, then the base circuit and ALM are turned off after the base circuit shut-off delay time. The dynamic brake may operate depending on the communication shut-off status.

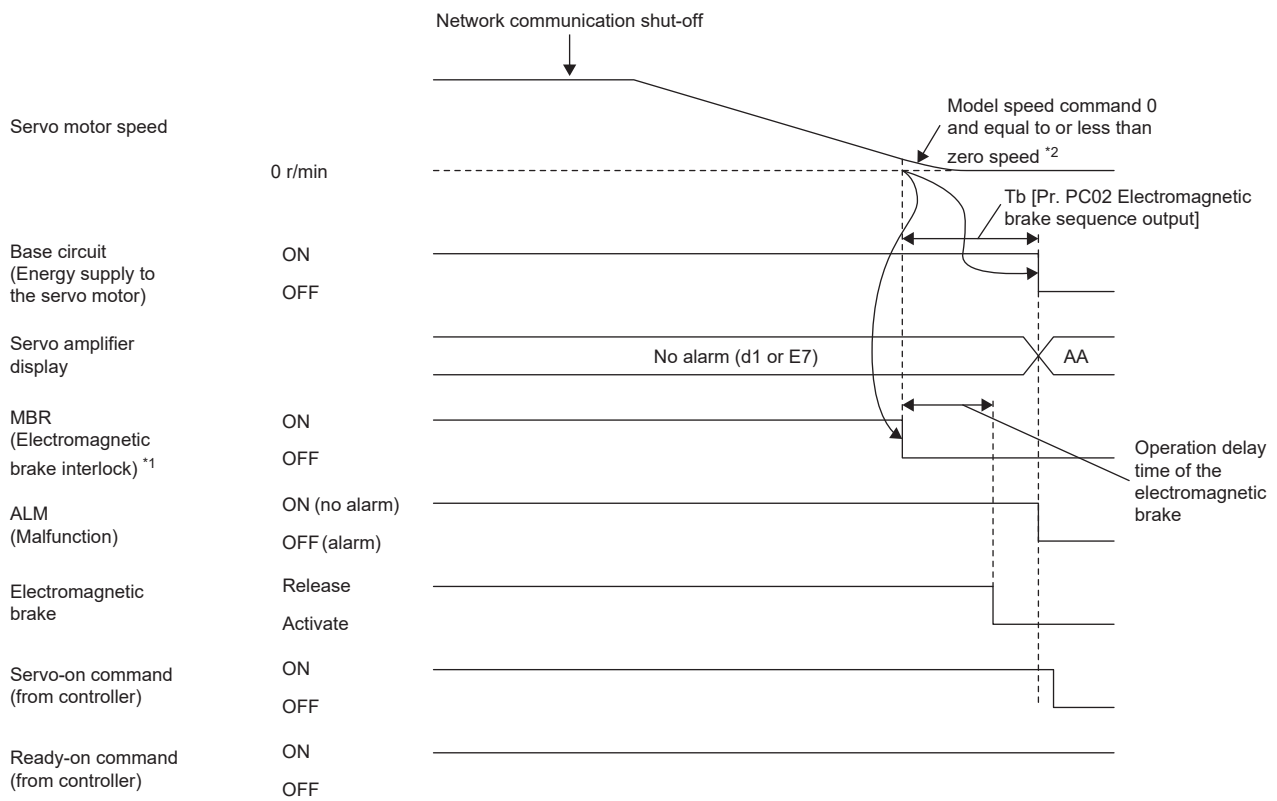

*1 ON: Electromagnetic brake is not activated
 OFF: Electromagnetic brake is activated

*2 The model speed command is a speed command generated in the servo amplifier for forced stop deceleration of the servo motor.

■ Alarm occurrence [A]

- When forced stop deceleration is enabled

MBR is turned off after the servo motor stops through forced stop deceleration, then the base circuit and ALM are turned off after the base circuit shut-off delay time.

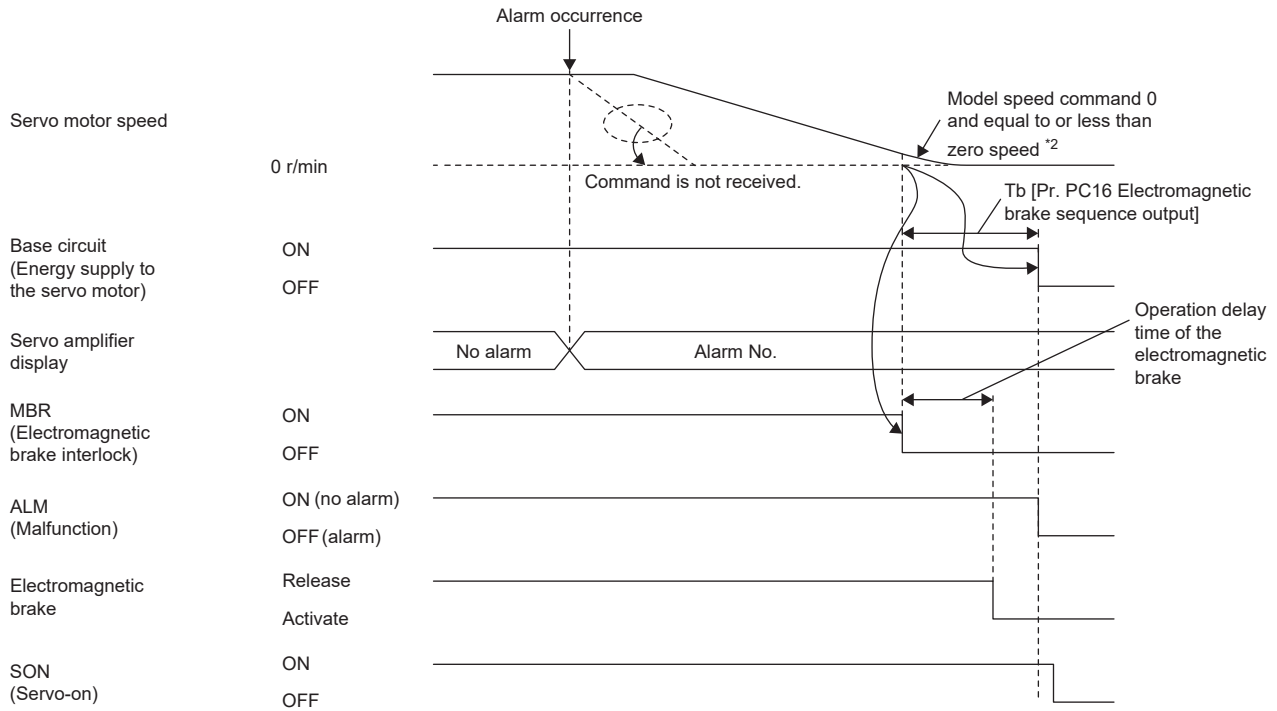

*1 ON: Electromagnetic brake is not activated

OFF: Electromagnetic brake is activated

*2 The model speed command is a speed command generated in the servo amplifier for forced stop deceleration of the servo motor.

- When forced stop deceleration becomes disabled

The servo motor stops using the same method as with the dynamic brake.

☞ Page 165 Stopping with dynamic brake

■ When both the main circuit power supply and the control circuit power supply are turned off

When the base circuit is turned off, the servo motor is stopped with the dynamic brake and electromagnetic brake.

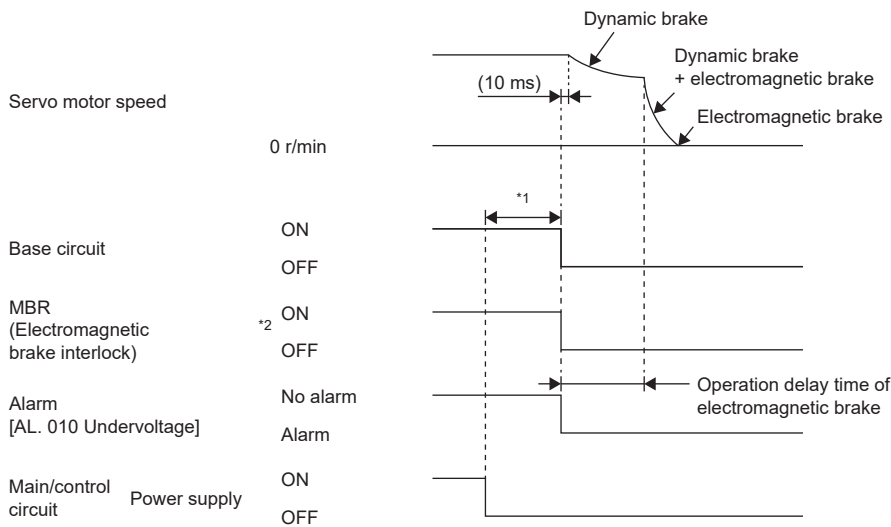

*1 The length of time varies depending on the operation status.

*2 ON: Electromagnetic brake is not activated
OFF: Electromagnetic brake is activated

■ When the main circuit power supply is turned off and the control circuit power supply is on



In the torque mode and continuous operation to torque control mode, the forced stop deceleration function cannot be used.

Forced stop deceleration starts when a voltage drop is detected, and after the base circuit is turned off the servo motor is stopped with the dynamic brake and the electromagnetic brake.

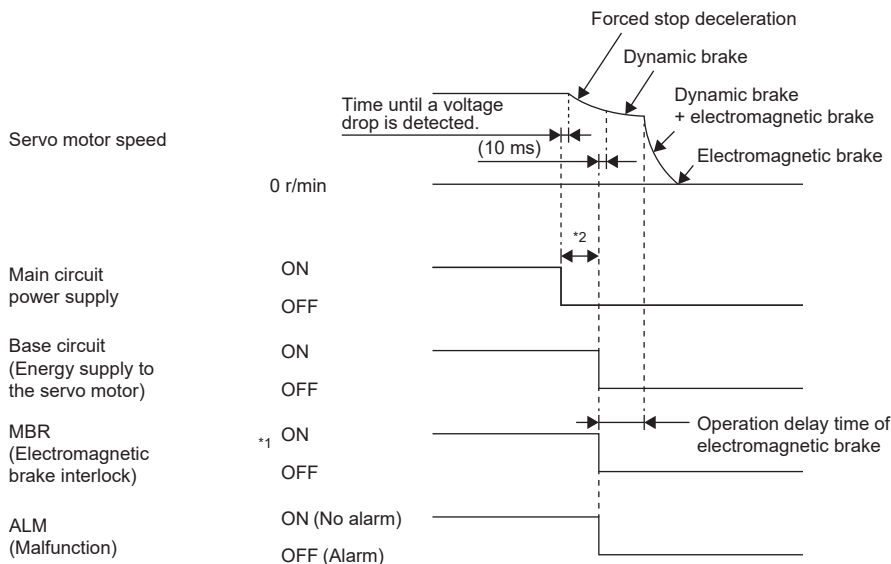

*1 ON: Electromagnetic brake is not activated
OFF: Electromagnetic brake is activated

*2 The length of time varies depending on the operation status.

■ Ready-off command from controller [G]

After the base circuit is turned off with the ready-off command, the servo motor is stopped with the dynamic brake and electromagnetic brake.

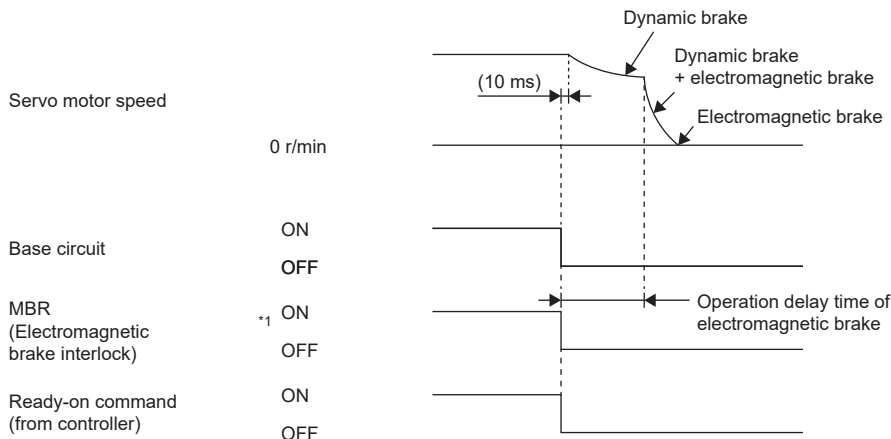

*1 ON: Electromagnetic brake is not activated
 OFF: Electromagnetic brake is activated

When the forced stop deceleration function is not used



When [Pr. PA04.3 Forced stop deceleration function selection] is set to "0" (Forced stop deceleration function disabled).

■ Turning the servo-on command on/off [G] [B]

☞ Page 178 Turning the servo-on command on/off [G] [B]

■ Turning the servo-on command on/off [A]

☞ Page 179 Turning the servo-on command on/off [A]

■ Turning the quick stop command (from controller) or EM1 (Forced stop 1) on/off

When the off command is input, the servo motor is stopped with the dynamic brake and electromagnetic brake.

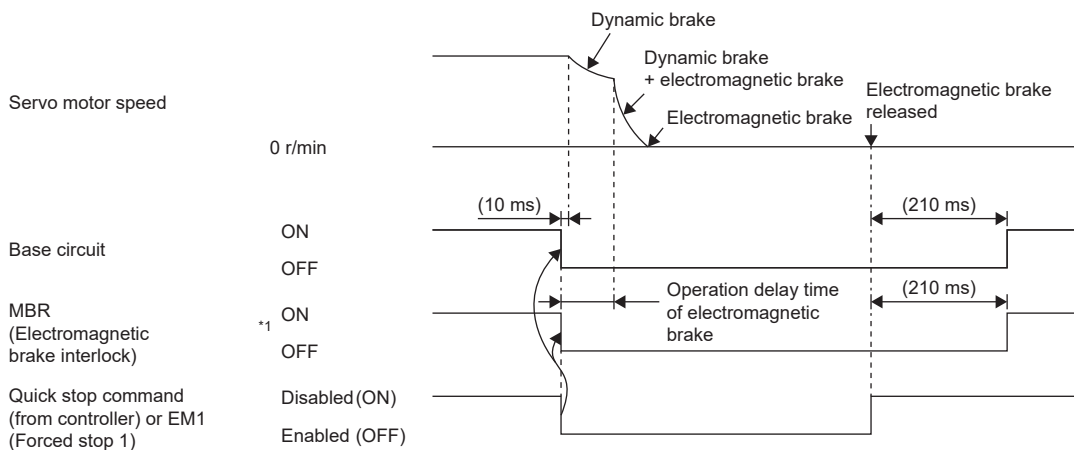

*1 ON: Electromagnetic brake is not activated
 OFF: Electromagnetic brake is activated

■ Alarm occurrence

When an alarm occurs, the servo motor stops using the same method as with the dynamic brake.

☞ Page 162 Stopping with dynamic brake

■ When both the main circuit power supply and the control circuit power supply are turned off

☞ Page 186 When both the main circuit power supply and the control circuit power supply are turned off

■ When the main circuit power supply is turned off and the control circuit power supply is on

When a voltage drop is detected, the servo motor is stopped with the dynamic brake and electromagnetic brake.

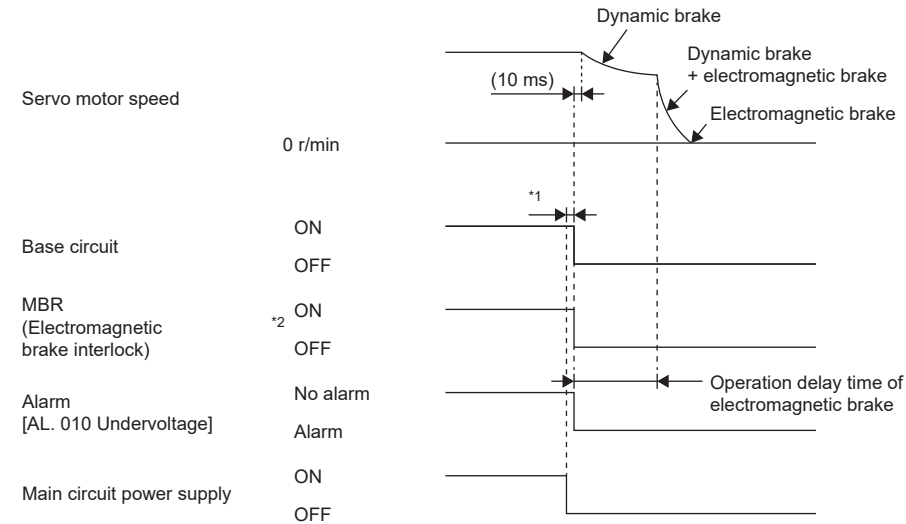

*1 The length of time varies depending on the operation status.

*2 ON: Electromagnetic brake is not activated

OFF: Electromagnetic brake is activated

■ Ready-off command from controller [G]

☞ Page 187 Ready-off command from controller [G]

3.19 Vertical axis freefall prevention function

When the servo motor is used to operate a vertical axis, the servo motor electromagnetic brake and the base circuit shut-off delay time function can be used to prevent the vertical axis from dropping at forced stop; however, the axis may fall by several μm due to mechanical clearance of the servo motor electromagnetic brake. The vertical axis freefall prevention function is a function that is used to prevent fall-based damage to the machine by pulling up the shaft slightly when such a risk exists.

Point

- Once each of the servo parameters is set, this function operates when the servo motor speed is at or below the zero speed, the EM2 (forced stop 2) is off, an alarm occurs, or the network communication shuts off.

Restriction

- This function does not operate on alarms that are not subject to the forced stop deceleration function.
- This function can be used in the position mode, point table mode, homing mode, and JOG operation mode.

Precautions

- Refer to the setting method shown in this section, and check if each servo parameter has been set. If not set, this function does not operate.
- Check that the forced stop deceleration function is enabled. If disabled, this function does not operate.

Setting method [G] [B]

Set the freefall prevention compensation amount with [Pr. PC31 Vertical axis freefall prevention compensation amount]. After that, turn off the EM2 (Forced stop 2) during a servo motor stop, then adjust the base circuit shut-off delay time in [Pr. PC02 Electromagnetic brake sequence output] in accordance with the travel distance ([Pr. PC31]). Adjust the time considering the freefall prevention compensation amount by checking the servo motor speed, torque ripple, and other areas.

Servo parameter	Symbol	Name	Outline
PC02	MBR	Electromagnetic brake sequence output	Set the base circuit shut-off delay time. Initial value: 0 [ms]
PC31	RSUP1	Vertical axis freefall prevention compensation amount	Set the freefall prevention compensation amount. Initial value: 0 [0.0001 rev], [0.01 mm]

Setting method [A]

Set the freefall prevention compensation amount with [Pr. PC54 Vertical axis freefall prevention compensation amount]. After that, turn off the EM2 (Forced stop 2) during a servo motor stop, then adjust the base circuit shut-off delay time in [Pr. PC16 Electromagnetic brake sequence output] in accordance with the travel distance ([Pr. PC54]). Adjust the time considering the freefall prevention compensation amount by checking the servo motor speed, torque ripple, and other areas.

Servo parameter	Symbol	Name	Outline
PC16	MBR	Electromagnetic brake sequence output	Set the base circuit shut-off delay time. Initial value: 0 [ms]
PC54	RSUP1	Vertical axis freefall prevention compensation amount	Set the freefall prevention compensation amount. Initial value: 0 [0.0001 rev], [0.01 mm]

Timing chart [G] [B]

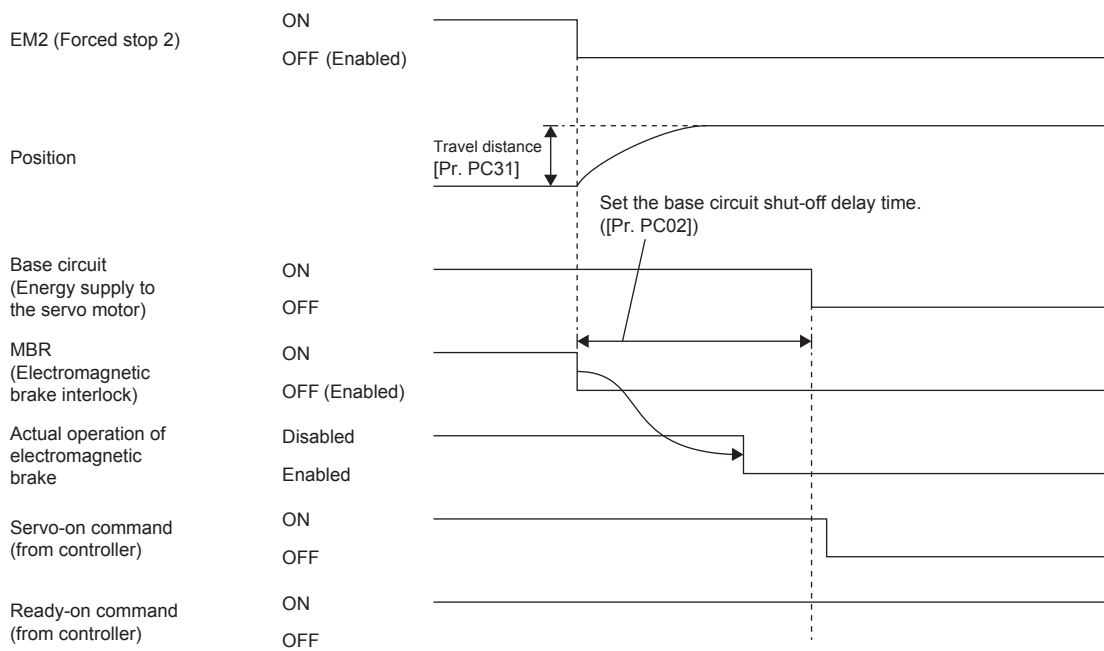

Timing chart [A]

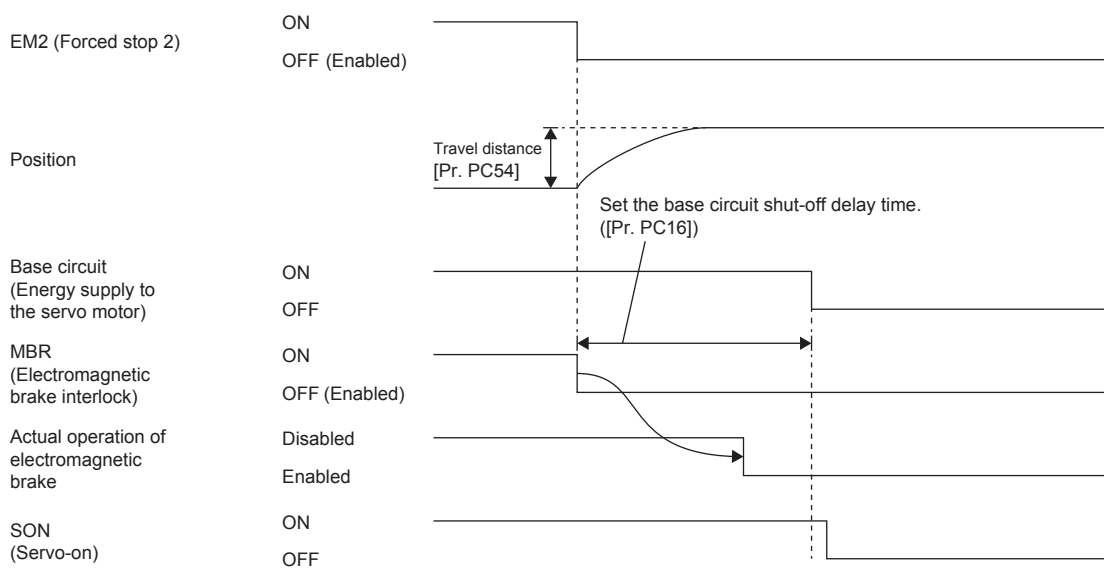

3.20 Acceleration/deceleration function [G] [A]

This function enables smooth acceleration/deceleration. The following methods are available for the acceleration/deceleration function.

MR-J5- _G_/MR-J5W- _G_

Item	Explanation	Reference
Acceleration/deceleration time constant method	This is a method for performing acceleration/deceleration in accordance with the specified acceleration/deceleration time constants [ms]. Set [Pr. PT01.1 Speed/acceleration/deceleration unit selection] to "0" to enable this method.	Page 191 Acceleration/deceleration time constant Page 193 S-pattern acceleration/deceleration time constant [G]
Acceleration/deceleration method *1	This is a method for performing acceleration/deceleration in accordance with the specified acceleration/deceleration [command unit/s ²]. Using this method together with S-pattern acceleration/deceleration time constant enables smoother acceleration/deceleration. Set [Pr. PT01.1 Speed/acceleration/deceleration unit selection] to "1" to enable this method.	Page 193 S-pattern acceleration/deceleration time constant [G] Page 195 Acceleration/deceleration [G]

*1 Available on servo amplifiers with firmware version A5 or later.

MR-J5- _A_

Item	Explanation	Reference
Acceleration/deceleration time constant method	This is a method for performing acceleration/deceleration in accordance with the specified acceleration/deceleration time constants [ms]. Using this method together with S-pattern acceleration/deceleration time constant [ms] enables smoother acceleration/deceleration.	Page 191 Acceleration/deceleration time constant Page 194 S-pattern acceleration/deceleration time constant [A]

Acceleration/deceleration time constant

The acceleration/deceleration time constant is the period of time taken to reach the rated speed from 0 [r/min] (0 [mm/s]) or to reach 0 [r/min] (0 [mm/s]) from the rated speed for the commands or limits. The control mode influences whether the acceleration/deceleration time constant is set in each control mode.

Ex.

For a servo motor with a rated speed of 3000 [r/min], set 3 [s] to accelerate from 0 [r/min] to 1000 [r/min] in 1 [s].

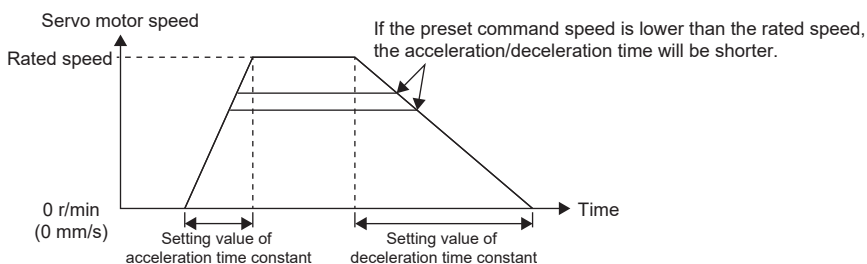

Precautions

- Refer to the different servo parameters, point tables, and objects in each control mode.

Setting method [G]

The setting method varies for each control mode. Refer to the following table. In addition, the deceleration time constant of the forced stop deceleration function can be set with [Pr. PC24 Deceleration time constant at forced stop].

Page 173 Forced stop deceleration function

Control mode	Symbol	Description
Cyclic synchronous position mode	csp	Determined by the commands from the controller.
Cyclic synchronous velocity mode	csv	Set according to the manual of the controller to be used.
Cyclic synchronous torque mode	cst	
Profile position mode *1	pp	Can be set with [Profile acceleration (Obj. 6083h)] and [Profile deceleration (Obj. 6084h)]. Can also be set with [Pr. PT49 Speed acceleration time constant] and [Pr. PT50 Speed deceleration time constant].
Profile velocity mode *1	pv	Can be set with [Profile acceleration (Obj. 6083h)] and [Profile deceleration (Obj. 6084h)]. Can also be set with [Pr. PT49 Speed acceleration time constant] and [Pr. PT50 Speed deceleration time constant].
Profile torque mode *1	tq	The amount of torque change can be set with [Torque slope (Obj. 6087h)].
Homing mode	hm	This mode can be set with [Homing acceleration (Obj. 609Ah)]. Page 54 Homing mode (hm)
Point table mode *2	pt	Page 600 How to Set Point Table
JOG operation mode *2	jp	Page 596 JOG operation mode (jp)

*1 Available on servo amplifiers with firmware version A5 or later.

*2 Available on servo amplifiers with firmware version B8 or later.

Setting method [A]

The setting method varies for each control mode. Refer to the following table. In addition, the deceleration time constant of the forced stop deceleration function can be set with [Pr. PC51 Deceleration time constant at forced stop].

Page 173 Forced stop deceleration function

Control mode	Symbol	Setting method
Position control mode	P	Determined by the command pulse frequency from the controller. Set according to the manual of the controller to be used.
Speed control mode	S	This mode can be set with [Pr. PC01 Speed acceleration time constant] and [Pr. PC02 Speed deceleration time constant]. By turning on the STAB2 (Speed acceleration/deceleration selection), the speed control mode will be changed to the value set in [Pr. PC30 Speed acceleration time constant 2] and [Pr. PC31 Speed deceleration time constant 2]. Page 96 Speed control mode (S)
Torque control mode	T	This mode can be set with [Pr. PC01 Speed acceleration time constant] and [Pr. PC02 Speed deceleration time constant]. By turning on the STAB2 (Speed acceleration/deceleration selection), the speed control mode will be changed to the value set in [Pr. PC30 Speed acceleration time constant 2] and [Pr. PC31 Speed deceleration time constant 2]. Page 98 Torque control mode (T) For the torque limit and the speed limit, refer to the following. Page 347 Torque limit [A] Page 352 Speed limit [A]

Servo parameter	Symbol	Name	Outline
PC01	STA	Speed acceleration time constant	Set the speed acceleration time constant. Initial value: 0 [ms]
PC02	STB	Speed deceleration time constant	Set the speed deceleration time constant. Initial value: 0 [ms]
PC30	STA2	Speed acceleration time constant 2	Set the speed acceleration time constant for when STAB2 (Speed acceleration/deceleration selection) is turned on. Initial value: 0 [ms]
PC31	STB2	Speed deceleration time constant 2	Set the speed deceleration time constant for when STAB2 (Speed acceleration/deceleration selection) is turned on. Initial value: 0 [ms]

S-pattern acceleration/deceleration time constant [G]

This function is available on servo amplifiers with firmware version A5 or later.

Setting S-pattern acceleration/deceleration time constant enables smooth start/stop of the servo motor.

This function operates when [Pr. PT51 S-pattern acceleration/deceleration time constants] is set.

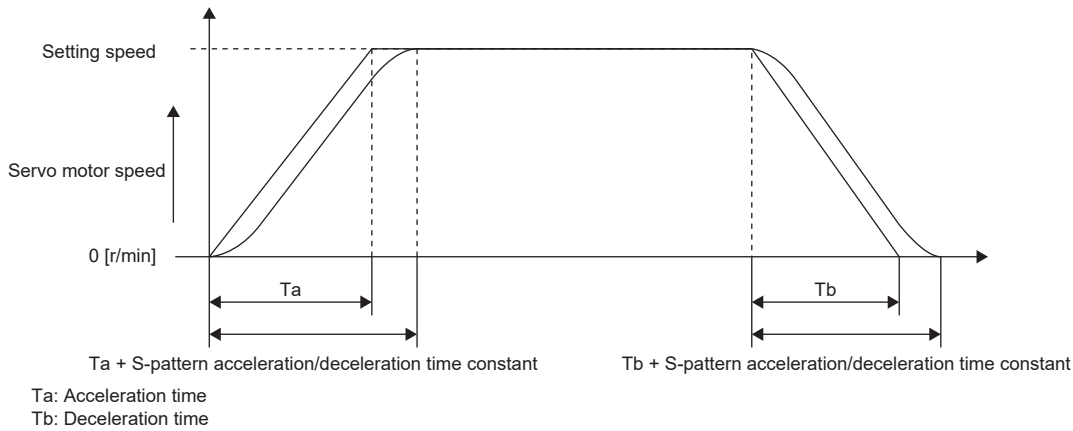

Restriction

- This function is enabled in the profile position mode, profile velocity mode, point table mode, and JOG operation mode.
- This function is disabled when [Pr. PT51] is set to "0".
- In the point table mode and JOG operation mode, the time from start to output of MEND (traveling completion) becomes longer by the set amount of S-pattern acceleration/deceleration time constant.
- This function is disabled in the homing mode.
- If the S-pattern acceleration/deceleration time constants are set to values of 1000 ms or more in the profile position mode, point table mode, and JOG operation mode, the value is clamped to 1000 ms.

Precautions

- If the setting of acceleration or deceleration time is too long, the timing error may occur on the arc part against the setting of the S-pattern acceleration/deceleration time constant.
- If the S-pattern acceleration/deceleration time constant is set longer than the constant speed time, the speed may not reach the command speed.
- The upper time limit on the arc part of the S-pattern acceleration/deceleration is limited by the acceleration time and deceleration time. Refer to [Pr. PT51] for details.

Setting method

Servo parameter	Symbol	Name	Outline
PT51	STC	S-pattern acceleration/deceleration time constant	Set the S-pattern acceleration/deceleration time constant. Initial value: 0 [ms]

S-pattern acceleration/deceleration time constant [A]

Setting S-pattern acceleration/deceleration time constant enables smooth start/stop of the servo motor. This function is enabled when [Pr. PC03 S-pattern acceleration/deceleration time constants] is set.

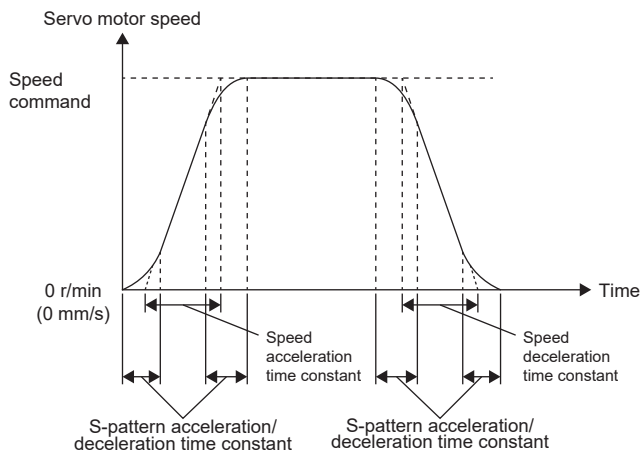

Restriction

- This function can be used in the speed control mode and torque control mode.
- This function is disabled when [Pr. PC03 S-pattern acceleration/deceleration time constants] is set to "0".

Precautions

- If the acceleration/deceleration time constant is set too long, the timing error may occur on the arc part against the setting of the S-pattern acceleration deceleration time constant.
- If the S-pattern acceleration/deceleration time constant is set longer than the constant speed time, the speed may not reach the command speed.
- The upper time limit on the arc part of the S-pattern acceleration/deceleration is limited by the setting value of the speed acceleration/deceleration time constants. For details, refer to [Pr. PC03 S-pattern acceleration/deceleration time constants].

Setting method

Servo parameter	Symbol	Name	Outline
PC03	STC	S-pattern acceleration/deceleration time constant	Set the S-pattern acceleration/deceleration time constant. Initial value: 0 [ms]

Acceleration/deceleration [G]

Acceleration/deceleration are available on servo amplifiers with firmware version A5 or later.

Acceleration/deceleration is performed in accordance with the specified acceleration/deceleration [command unit/s²]. Unlike the acceleration/deceleration time constants, acceleration/deceleration can be performed independent of the rated speed of the servo motor.

The control mode influences whether the acceleration/deceleration is set in the control mode.

Setting example

To accelerate at 0.5 [s] from 0 [command unit/s] to 1500 [command unit/s], set 3000 [command unit/s²] for the acceleration.
To decelerate at 2 [s] from 1500 [command unit/s] to 0 [command unit/s], set 750 [command unit/s²] for the deceleration.

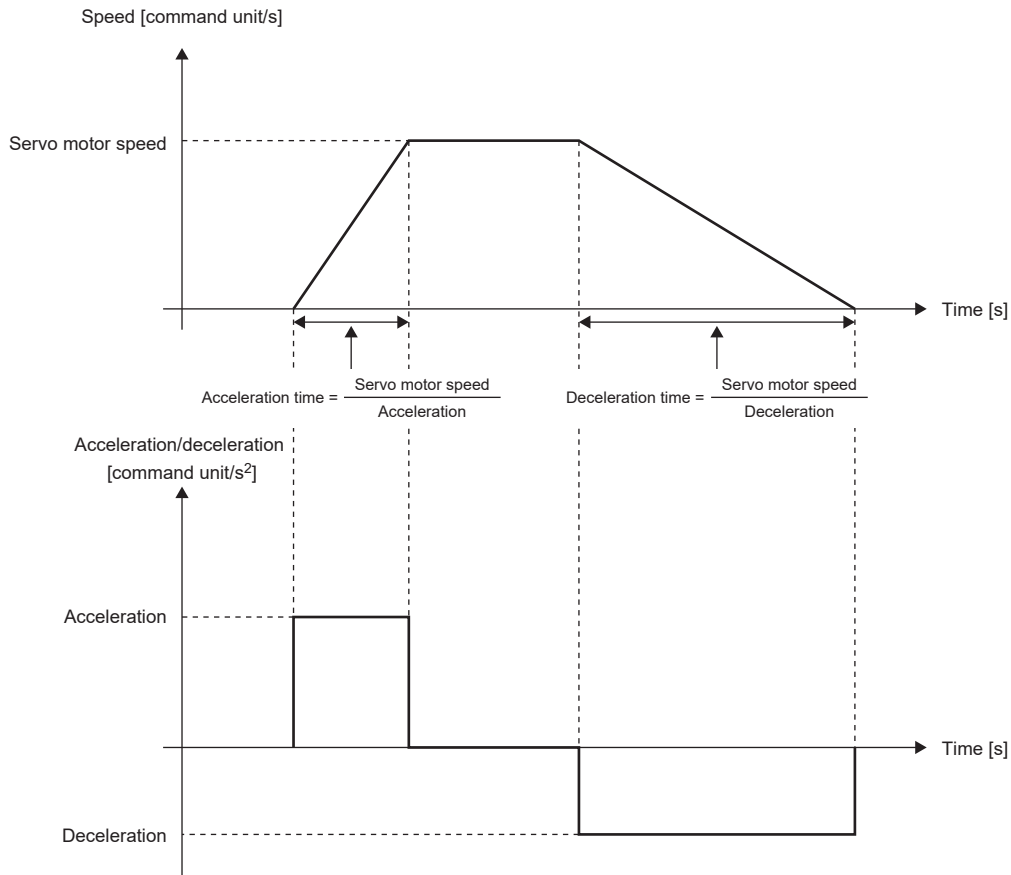

Precautions

- The servo parameter for setting the acceleration/deceleration data varies depending on the unit selected in [Pr. PT01.1 Speed/acceleration/deceleration unit selection]. However, the same object is used for setting the acceleration/deceleration data regardless of the unit selected. Refer to [Pr. PT01.1] for details. For the precautions for each acceleration/deceleration data, refer to the setting servo parameters, point table, and objects.

Setting method

Select an acceleration/deceleration unit in [Pr. PT01.1 Speed/acceleration/deceleration unit selection]. When [Pr. PT01.1] is set to "1" (command unit/s²), select the command unit with [Pr. PT01.2 Unit for position data].

Servo parameter	Symbol	Name	Outline
PT01.1	**CTY	Speed/acceleration/deceleration unit selection	Select an acceleration/deceleration unit. 0: ms 1: Command unit/s ²
PT01.2		Unit for position data	Select the unit for position data. 0: mm 1: inch 2: degree 3: pulse

Relevant acceleration/deceleration data

 Page 131 Relevant speed data and acceleration/deceleration data

3.21 Quick stop [G]

With Quick stop defined in CiA 402, the servo motor can be stopped by the forced stop deceleration. For details of the forced stop deceleration, refer to the following.

 Page 173 Forced stop deceleration function

When the Quick stop command in [Controlword (Obj. 6040h)] is turned off, the servo motor decelerates to a stop in accordance with the setting of [Quick stop option code (Obj. 605Ah)], following which the status changes to "Switch On Disabled" (servo-off) or "Quick Stop Active" (servo-on maintained).

3

Point

- When canceling Quick stop in the cyclic synchronous position mode (csp), update [Target position (Obj. 607Ah)] and [Position offset (Obj. 60B0h)] to [Position actual value (Obj. 6064h)]. If Quick stop is canceled without performing position follow-up, unexpected movements such as sudden acceleration of the servo motor may occur.
- When [Pr. PA04.3 Forced stop deceleration function selection] is set to "0" (forced stop deceleration function disabled), the servo motor stops with the dynamic brake regardless of the setting value of [Quick stop option code (Obj. 605Ah)].
- The Quick stop command is accepted only when the PDS state transition is in the "Operation Enabled" state.

Restriction

- This function can be used in the cyclic synchronous mode (csp/csv/cst), profile mode (pp/pv/tq), point table mode (pt), JOG operation mode (jg), and homing mode (hm).
- In the torque mode or continuous operation to torque control mode (ct), the servo motor stops with the dynamic brake without deceleration to a stop.
- If an alarm that causes forced stop deceleration has occurred during the deceleration stop operation with Quick stop, the PDS state transition will shift to "Fault reaction active". After the servo motor stops at the deceleration time constant of Quick stop, the servo-off state will be established.
- If a warning that causes forced stop deceleration has occurred during the deceleration stop operation with Quick stop, the PDS state transition maintains "Quick stop active". After the servo motor stops at the deceleration time constant of Quick stop, the servo-off state will be established.
- If a warning causes deceleration stop with Quick stop during the deceleration stop operation, the PDS state transition will shift to "Quick stop active". After the servo motor stops at the deceleration time constant of the deceleration stop caused by the warning, the servo-off state will be established.
- When the Quick stop command is turned off at the command stop of the controller, the command stop takes precedence and the servo motor stops with the dynamic brake without deceleration to a stop.

Setting method

Setting with servo parameters

[Pr. PT68.0 Quick stop method selection] can be used to specify the deceleration stop operation method. [Pr. PT68.0] corresponds to [Quick stop option code (Obj. 605Ah)].

Servo parameter	Name	Outline
PC24	Deceleration time constant at forced stop	Set the deceleration time constant at forced stop.* ¹ Initial value: 100 [ms]
PV09	Deceleration at forced stop	Set the deceleration to be used for the forced stop deceleration function.* ¹ Initial value: 0 [command unit/s ²]
PT68.0	Quick stop method selection	Select the quick stop method. In the slave axis torque mode (slt), the servo motor ignores the Quick Stop input and decelerates to a stop in accordance with the stop command from the master axis regardless of the setting value of this servo parameter. For details, refer to "Master-slave operation simultaneous stop function" in the User's Manual (Communication Function). Forced stop deceleration by turning off EM2 (Forced stop 2) is the same as "2" (servo-off after deceleration to a stop with [Quick stop deceleration (Obj. 6085h)]) regardless of the setting value of this servo parameter. When [Pr. PA04.3 Forced stop deceleration function selection] is set to "0" (forced stop deceleration function disabled), the servo motor stops with the dynamic brake regardless of the setting value of this servo parameter. 0: Stop with dynamic brake * ² 1: Servo-off after deceleration to a stop at the deceleration time constant of any of the control modes * ² * ⁴ 2: Servo-off after deceleration to a stop with [Quick stop option code (Obj. 605Ah)] 5: Maintain servo-on after deceleration to a stop at the deceleration time constant of any of the control modes * ² * ³ * ⁴ * ⁵ 6: Maintain servo-on after deceleration to a stop with [Quick stop option code (Obj. 605Ah)] * ² * ³ * ⁵ * ⁶ Initial value: 2

*¹ The servo parameter to be set varies depending on the unit selected in [Pr. PT01.1 Speed/acceleration/deceleration unit selection]. However, the same object is used for setting the acceleration/deceleration data regardless of the unit selected. For details, refer to "[Pr. PT01.1 Speed/acceleration/deceleration unit selection]" in the User's Manual (Parameters).

*² Available on servo amplifiers with firmware version D0 or later.

*³ Not available for CC-Link IE Field Network Basic.

*⁴ For the deceleration time constants of the control modes, refer to "[Quick stop option code (Obj. 605Ah)]" in the User's Manual (Object Dictionary).

*⁵ When the controller being used cannot perform follow-up in the "Quick stop active" state (during servo-on), do not use this setting value in the cyclic synchronous position mode (csp). For information on whether the controller being used can perform follow-up in the "Quick stop active" state, refer to the manual for the controller.

*⁶ When canceling Quick stop in the cyclic synchronous position mode (csp), cancel it after servo-off or perform position follow-up with the controller. If Quick stop is canceled without performing position follow-up, the servo motor may suddenly accelerate.

Settings with objects

For details on the objects, refer to the User's Manual (Object Dictionary).

Index	Sub	Object	Name	Description
6085h	—	VAR	Quick stop deceleration	Deceleration at deceleration to a stop with Quick stop Unit: acc units
605Ah	—	VAR	Quick stop option code	Refer to the following table for the description.

The methods and operations supported in [Quick stop option code (Obj. 605Ah)] are shown in the following table.

Setting value	Description
0 *1	Stop with dynamic brake The state shifts immediately to "Switch On Disabled" (ready-off/servo-off), and the servo motor stops with the dynamic brake.
1 *1	Servo-off after deceleration to a stop at the deceleration time constant of any of the control modes In the cyclic synchronous positioning/velocity mode (csp/csv), the servo motor decelerates to a stop with [Quick stop deceleration (Obj. 6085h)] and the state shifts to "Switch On Disabled" (ready-off/servo-off). In the cyclic synchronous torque mode (cst), the profile torque mode (tq), and the continuous operation to torque control mode (ct), the state immediately shifts to "Switch On Disabled" (ready-off/servo-off) and the servo motor stops with the dynamic brake. In the profile positioning/velocity mode (pp/pv) and JOG operation mode (jg), the servo motor decelerates to a stop with [Profile deceleration (Obj. 6084h)] and the state shifts to "Switch On Disabled" (ready-off/servo-off). In the homing mode (hm), the servo motor decelerates to a stop with [Homing acceleration (Obj. 609Ah)] and the state shifts to "Switch On Disabled" (ready-off/servo-off). In the point table mode (pt), the servo motor decelerates to a stop at the deceleration time constant of the point table number during positioning operation, and the state shifts to "Switch On Disabled" (ready-off/servo-off).
2	Servo-off after deceleration to a stop with [Quick stop deceleration (Obj. 6085h)] In the cyclic synchronous positioning/velocity mode (csp/csv), profile positioning/velocity mode (pp/pv), point table mode (pt), JOG operation mode (jg), and homing mode (hm), the servo motor decelerates to a stop with [Quick stop deceleration (Obj. 6085h)] and the state shifts to "Switch On Disabled" (ready-off/servo-off). In the cyclic synchronous torque mode (cst), the profile torque mode (tq), and the continuous operation to torque control mode (ct), the state immediately shifts to "Switch On Disabled" (ready-off/servo-off) and the servo motor stops with the dynamic brake.
3 (not supported)	—
4 (not supported)	—
5 *1*2*3*4	Maintain servo-on after deceleration to a stop at the deceleration time constant of any of the control modes In the cyclic synchronous positioning/velocity mode (csp/csv), the servo motor decelerates to a stop with [Quick stop deceleration (Obj. 6085h)] and the state remains as "Quick Stop Active". (Servo-on is maintained.) In the cyclic synchronous torque mode (cst), the profile torque mode (tq), and the continuous operation to torque control mode (ct), the state immediately shifts to "Switch On Disabled" (ready-off/servo-off) and the servo motor stops with the dynamic brake. In the profile positioning/velocity mode (pp/pv) and JOG operation mode (jg), the servo motor decelerates to a stop with [Profile deceleration (Obj. 6084h)] and the state remains as "Quick Stop Active". (Servo-on is maintained.) In the homing mode (hm), the servo motor decelerates to a stop with [Homing acceleration (Obj. 609Ah)] and the state remains as "Quick Stop Active". (Servo-on is maintained.) In the point table mode (pt), the servo motor decelerates to a stop at the deceleration time constant of the point table number during positioning operation, and the state remains as "Quick Stop Active". (Servo-on is maintained.)
6 *1*2*3*4	Maintain servo-on after deceleration to a stop with [Quick stop deceleration (Obj. 6085h)] In the cyclic synchronous positioning/velocity mode (csp/csv), profile positioning/velocity mode (pp/pv), point table mode (pt), JOG operation mode (jg), and homing mode (hm), the servo motor decelerates to a stop with [Quick stop deceleration (Obj. 6085h)] and the state remains as "Quick Stop Active". (Servo-on is maintained.) In the cyclic synchronous torque mode (cst), the profile torque mode (tq), and the continuous operation to torque control mode (ct), the state immediately shifts to "Switch On Disabled" (ready-off/servo-off) and the servo motor stops with the dynamic brake.
7 (not supported)	—
8 (not supported)	—

*1 Available on servo amplifiers with firmware version D0 or later.

*2 When canceling Quick stop in the cyclic synchronous position mode (csp), cancel it after servo-off or perform position follow-up with the controller. If Quick stop is canceled without performing position follow-up, the servo motor may suddenly accelerate.

*3 Not available for CC-Link IE Field Network Basic.

*4 When the controller being used cannot perform follow-up in the "Quick stop active" state (during servo-on), do not use this setting value in the cyclic synchronous position mode (csp). For information on whether the controller being used can perform follow-up in the "Quick stop active" state, refer to the manual for the controller.

Timing chart

When [Quick stop option code (Obj. 605Ah)] is set to "1"

The servo motor decelerates to a stop at the deceleration time constant of any of the control modes, then the state shifts to "Switch On Disabled". For the deceleration time constant, refer to the User's Manual (Object Dictionary).

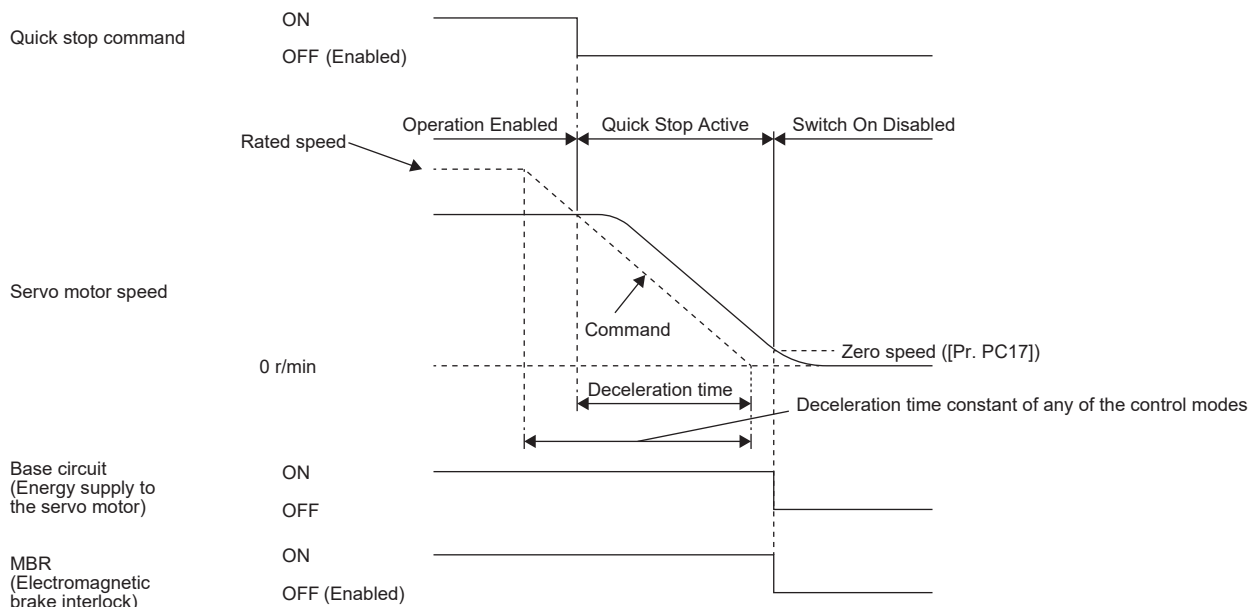

When [Quick stop option code (Obj. 605Ah)] is set to "2"

The servo motor decelerates to a stop with [Quick stop deceleration (Obj. 6085h)], and the state shifts to "Switch On Disabled".

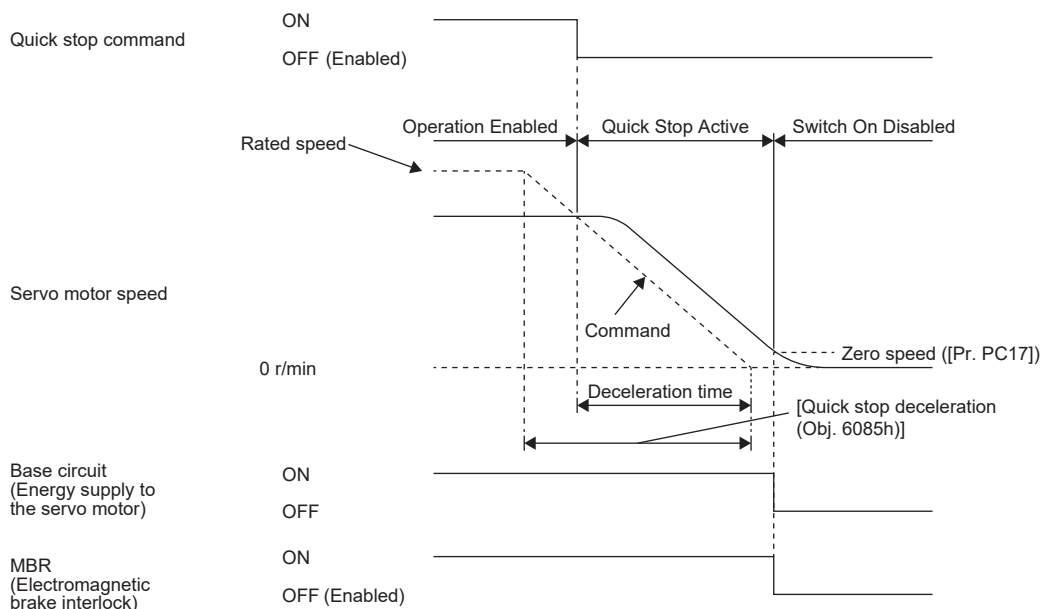

When [Quick stop option code (Obj. 605Ah)] is set to "5"

The servo motor decelerates to a stop at the deceleration time constant of any of the control modes, then the state remains as "Quick Stop Active" (servo-on). For the deceleration time constant, refer to the User's Manual (Object Dictionary).

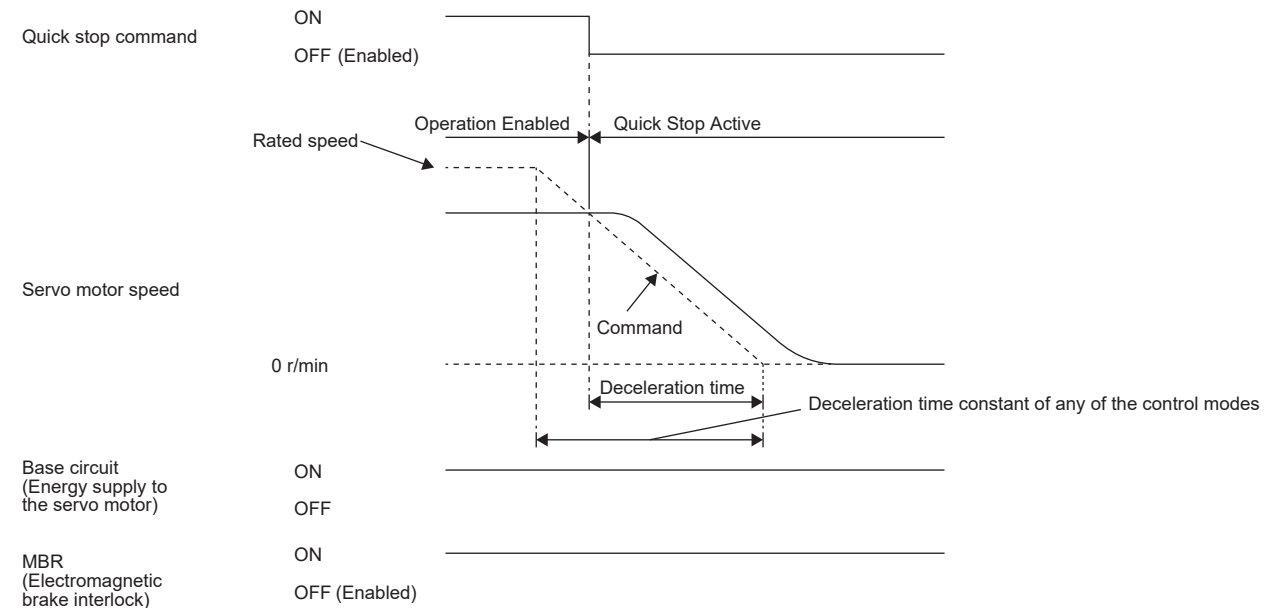

When [Quick stop option code (Obj. 605Ah)] is set to "6"

After deceleration to a stop with [Quick stop deceleration (Obj. 6085h)], the state remains as "Quick Stop Active" (servo-on).

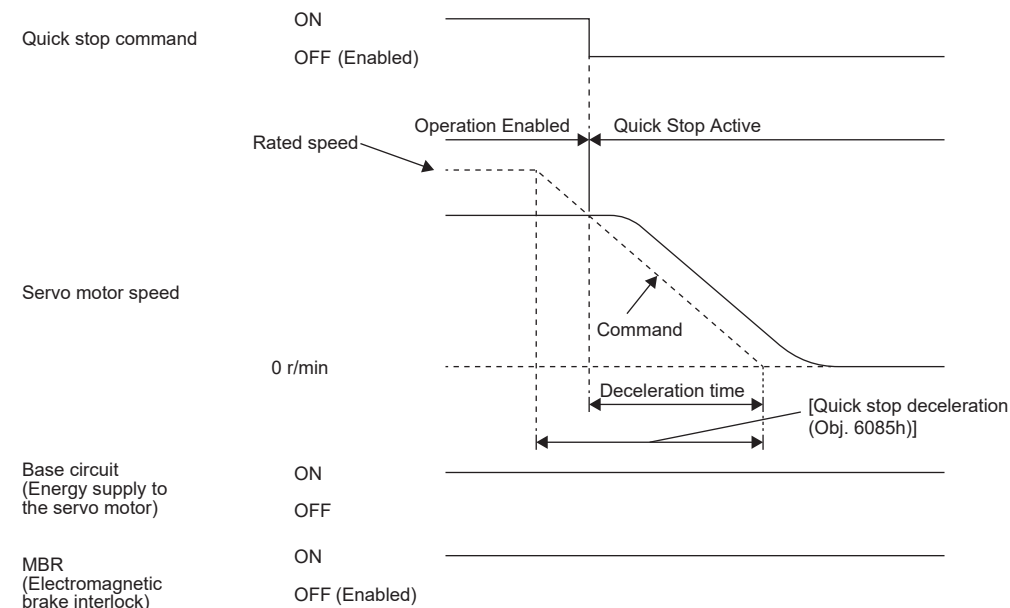

3.22 Halt [G]

Halt defined in CiA 402 enables temporary stop of the servo motor.

When 1 is set in Bit 8 (HALT) of [Controlword (Obj. 6040h)], the servo motor decelerates to a stop with the deceleration time constant of [Profile deceleration (Obj. 6084h)] or [Homing acceleration (Obj. 609Ah)], and then the state remains as "Operation Enable" (Servo-on), in accordance with the setting of [Halt option code (Obj. 605Dh)]. When Halt Bit is set to 0 during the deceleration stop operation, the servo motor decelerates to a stop and returns to the operable state.

Restriction

- This function can be used in the profile mode (pp/pv/tq), point table mode (pt), JOG operation mode (jg), and homing mode (hm). The other control modes can be operated regardless of the Halt Bit status.
- In the profile torque mode (tq), [Torque demand value (Obj. 6074h)] is set to 0 regardless of [Halt option code (Obj. 605Dh)]. The amount of torque change at this time can be set using [Torque slope (Obj. 6087h)].

Objects for setting

For details on the objects, refer to the User's Manual (Object Dictionary).

Index	Sub	Object	Name	Description
605Dh	—	VAR	Halt option code	Setting for executing the Halt function Refer to the following table for the description.
6084h	—	VAR	Profile deceleration	Deceleration at arrival to target position Unit: acc units
609Ah	—	VAR	Homing acceleration	Deceleration at arrival to target position Unit: acc units
6074h	—	VAR	Torque demand value	Command torque (after limit) Unit: 0.1 % (with rated torque being 100 %)
6087h	—	VAR	Torque slope	Torque variation Unit: 0.1 %/s (with rated torque being 100 %)
2801h to 28FFh *1	4	VAR	Deceleration	Deceleration time constant of point table Unit: acc units

*1 Available on servo amplifiers with firmware version B8 or later.

The following table shows descriptions of [Halt option code (Obj. 605Dh)].

Setting value	Description
1	The servo motor decelerates to a stop in accordance with [Profile deceleration (Obj. 6084h)] during the profile positioning/velocity mode (pp/pv) and JOG operation mode (jg), in accordance with the point table deceleration time constant/point table deceleration during the point table mode (pt), and in accordance with [Homing acceleration (Obj. 609Ah)] during the homing mode (hm), and the servo motor remains "Operation Enabled". During the profile torque mode (tq), [Torque demand value (Obj. 6074h)] becomes "0" stopping the servo motor in accordance with the amount of torque change set in [Torque slope (Obj. 6087h)], and the state remains "Operation Enabled".
2 (not currently supported)	After deceleration to a stop in accordance with [Quick stop deceleration (Obj. 6085h)], the state remains as "Operation Enabled". (Servo-on is maintained.)
3 (not supported)	After deceleration to a stop by limiting the current, the state remains as "Operation Enabled". (Servo-on is maintained.)
4 (not supported)	After deceleration to a stop by limiting the voltage, the state remains as "Operation Enabled". (Servo-on is maintained.)

Timing chart

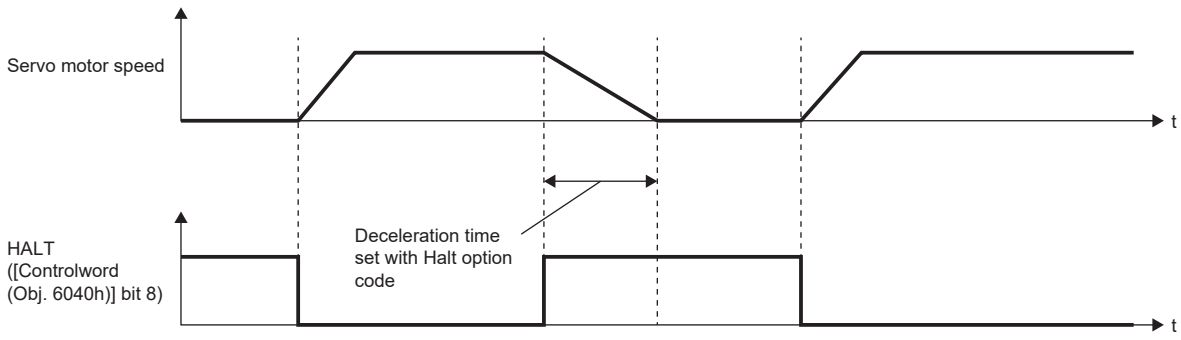

3.23 Command pulse train monitoring function [A]

Available on servo amplifiers with firmware version A5 or later.

It is recommended to use this function for safety aspect.

Use this function so that a command pulse train will not be input incorrectly due to such a factor as noise, which results in unexpected operation.

Setting a command frequency error threshold

Set [Pr. PC90 Command frequency error threshold].

If the frequency of a command pulse train input is detected to be larger than the setting value, [AL. 035 Command frequency error] occurs.

Setting PEN (Command input permission signal)

Assign PEN (Command input permission signal) to an input device.

☞ Page 147 Assigning I/O devices

A command pulse train input is not accepted while PEN is turned off.

A command pulse train input is accepted by turning on PEN.

If PEN has not been assigned to the input device, a command pulse train input is always accepted.

If PENS (Command pulse train input permitted) has been assigned to an output device, PENS is turned on when a command pulse train input can be acceptable.

There is a delay from the time PEN is turned on until PENS is turned on, or from the time PEN is turned off until PENS is turned off.

The following shows a timing chart of command pulse train input acceptance.

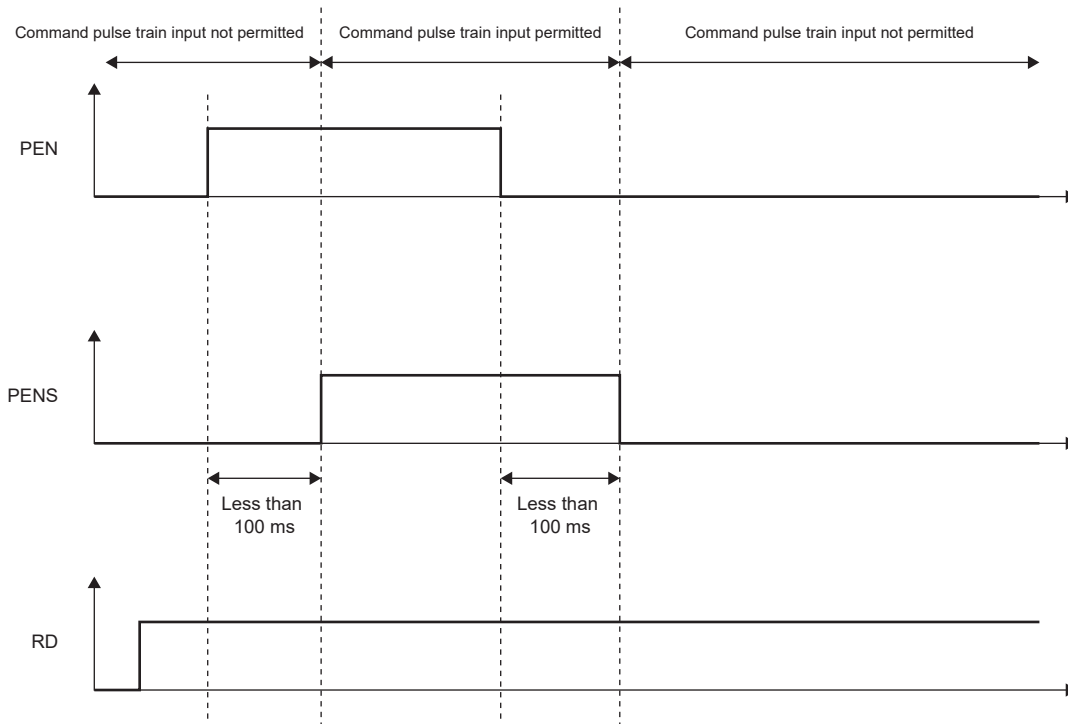

4 APPLICABLE FUNCTIONS

This chapter explains the applicable functions. Please select the applicable function to be used from the following table.

Function to operate safely

APPLICABLE FUNCTIONS	Outline	Reference
Software position limit	Prevents a moving part from colliding with the equipment.	☞ Page 341 Software position limit [G]
Torque limit	Prevents the servo motor from outputting a higher torque than the specified value.	☞ Page 344 Torque limit [G] ☞ Page 347 Torque limit [A]
Speed limit	Prevents the servo motor from operating faster than the specified speed.	☞ Page 350 Speed limit [G] ☞ Page 352 Speed limit [A]
Excessive error alarm detection function	Prevents the motor feedback position from deviating from the position command by more than a predetermined value.	☞ Page 382 Excessive error alarm detection function

4

Functions to enhance the failure detection capability of the servo amplifier

Applicable function	Outline	Reference
Machine diagnosis	Diagnoses mechanical parts failure of the drive system.	☞ Page 242 Machine diagnosis
Servo amplifier life diagnosis	Use this function to check the service life of the servo amplifier.	☞ Page 368 Servo amplifier life diagnosis function
Encoder communication diagnosis function	Diagnoses encoder communication circuit failure.	☞ Page 370 Encoder communication diagnosis function
Disconnection detection function	Detects disconnection of the main circuit and the servo motor power supply wires.	☞ Page 372 Disconnection/incorrect wiring detection function

Functions to prevent the drive of servo motor from stopping

Applicable function	Outline	Reference
Tough drive function	Prevents the equipment from being stopped by an instantaneous power failure or a vibration.	☞ Page 207 Tough drive function
Compliance with SEMI-F47 standard	Use this function to comply with SEMI-F47 standard.	☞ Page 212 Compliance with SEMI-F47 standard

Functions to perform advanced control in specific applications

Applicable function	Outline	Reference
Degree unit ^{*1}	Enables control in modulo coordinates (axes of rotation) such as a tool changer in the positioning mode.	☞ Page 360 Degree unit [G]
Infinite feed length ^{*1}	Generates 32767 or more revolutions from the home position in the absolute position detection system.	☞ Page 367 Infinite feed function [G]
Override function ^{*2}	Changes the servo motor speed in the point table mode or profile position mode.	☞ Page 385 Override function [G]

*1 Available on servo amplifiers with firmware version B6 or later.

*2 Available on servo amplifiers with firmware version D4 or later.

Functions to store data sampled at high speed from the servo amplifier, then communicate/output it to the controller

Applicable function	Outline	Reference
Drive recorder	Stores data at alarm occurrence. The stored data can be used for a cause analysis.	☞ Page 304 Drive recorder
Scale measurement function ^{*1}	Sends linear encoder data to the servo system controller via the servo amplifier.	☞ Page 214 Scale measurement function [G] [B]
Touch probe ^{*1}	Accurately latches the positions at the rising and falling edges of TPR1 (Touch probe 1), TPR2 (Touch probe 2), and TPR3 (Touch probe 3), and detects them with precision of 1 μs. To latch the current position, turn the touch probe signal on.	☞ Page 227 Touch probe [G]

Applicable function	Outline	Reference
A/B/Z-phase pulse output function	Outputs the position information of the servo motor or the load-side encoder as A/B/Z-phase pulses. Use this function to execute synchronous control or other operations.	☞ Page 354 A/B/Z-phase pulse output function

*1 Available on servo amplifiers with firmware version A5 or later.

Function to shorten operating time

Applicable function	Outline	Reference
Parameter automatic setting	Transmits servo parameter data from the controller with SLMP communication via CC-Link IE TSN.	Refer to "Parameter automatic setting" in the User's Manual (Communication Function).
Software reset	The same processing performed at power cycle of the servo amplifier is performed without the need for actual cycling. Resets the status of the servo amplifier.	☞ Page 340 Software reset

Performance-improving function

Applicable function	Outline	Reference
Command offset *1	This function adds an arbitrary offset amount for the position/speed/torque commands. Use this function to correct the target command or to improve the response to the target command.	☞ Page 380 Command offset [G]

*1 Available on servo amplifiers with firmware version A5 or later.

4.1 Tough drive function

Tough drive function is a function that allows the operation to continue without stopping the device, even when an alarm would occur normally. This function also features the vibration tough drive and the instantaneous power failure tough drive.

Vibration tough drive

Vibration tough drive function is a function to: 1) prevent vibration, as the mechanical resonance frequency changes due to aging of the machine; and 2) instantaneously reset the filter when machine resonance occurs. For details, refer to "Vibration tough drive" in the following manual.

📖MR-J5 User's Manual (Adjustment)

Instantaneous power failure tough drive

The instantaneous power failure tough drive function avoids the occurrence of [AL. 010 Undervoltage], even when an instantaneous power failure occurs during operation. Operating continuously without stopping the system is feasible. When the instantaneous power failure tough drive activates, the function will increase the tolerance against instantaneous power failure using the electrical energy charged in the capacitor in the servo amplifier and will change an alarm level of [AL. 010 Undervoltage] simultaneously. The [AL. 010.1 Voltage drop in the control circuit power] detection time for the control circuit power supply can be changed with [Pr. PF25 SEMI-F47 function - Instantaneous power failure detection time (Instantaneous power failure tough drive detection time)]. In addition, [AL. 010.2 Voltage drop in the main circuit power] detection level for the bus voltage is changed automatically.

Precautions

- For MR-J5D_-_G_, this function cannot be used.
- MBR (Electromagnetic brake interlock) is on during the instantaneous power failure tough drive.
- When the load of instantaneous power failure is large, [AL. 010.2] caused by the bus voltage drop may occur regardless of the set value of [Pr. PF25 SEMI-F47 function - Instantaneous power failure detection time (Instantaneous power failure tough drive detection time)].
- The external dynamic brake cannot be used when complying with the SEMI-F47 standard. Do not assign DB (Dynamic brake interlock) to the output device. If DB is assigned, the servo amplifier switches to servo-off status when an instantaneous power failure occurs.
- When complying with the SEMI-F47 standard, [Pr. PF25] does not need to be changed from the initial value (200 [ms]). When the instantaneous power failure time exceeds 200 ms, and if the instantaneous power failure voltage is less than 70 % of the rated input voltage, the normal power off may occur even if a value larger than 200 ms is set in the servo parameter.

Setting method

Set [Pr. PA20.2 SEMI-F47 function selection] to "1" (enabled).

To set the time until the occurrence of [AL. 010.1 Voltage drop in the control circuit power], use [Pr. PF25 SEMI-F47 function - Instantaneous power failure detection time (Instantaneous power failure tough drive detection time)].

To extend the time until the occurrence of [AL. 010.2 Voltage drop in the main circuit power], set [Pr. PA26.0 Torque limit function selection at instantaneous power failure] to "1" (enabled).

Servo parameter	Symbol	Name	Outline
PA20.2	*TDS	SEMI-F47 function selection	Enable or disable the SEMI-F47 function. 0: Disabled (initial value) 1: Enabled
PA26.0	*AOP5	Torque limit function selection at instantaneous power failure	Enable or disable the torque limit function at instantaneous power failure. 0: Disabled (initial value) 1: Enabled

Servo parameter	Symbol	Name	Outline
PF25	CVAT	SEMI-F47 function - Instantaneous power failure detection time (instantaneous power failure tough drive detection time)	Set the time until the occurrence of [AL. 010.1 Voltage drop in the control circuit power]. Initial setting: 200 [ms]

Timing chart

■ When the instantaneous power failure time of the control circuit power supply > [Pr. PF25 SEMI-F47 function - Instantaneous power failure detection time (Instantaneous power failure tough drive detection time)]

The alarm occurs when the instantaneous power failure time of the control circuit power supply exceeds [Pr. PF25 SEMI-F47 function - Instantaneous power failure detection time (Instantaneous power failure tough drive detection time)]. MTTR turns on after the instantaneous power failure is detected.

MBR (Electromagnetic brake interlock) turns off when the alarm occurs.

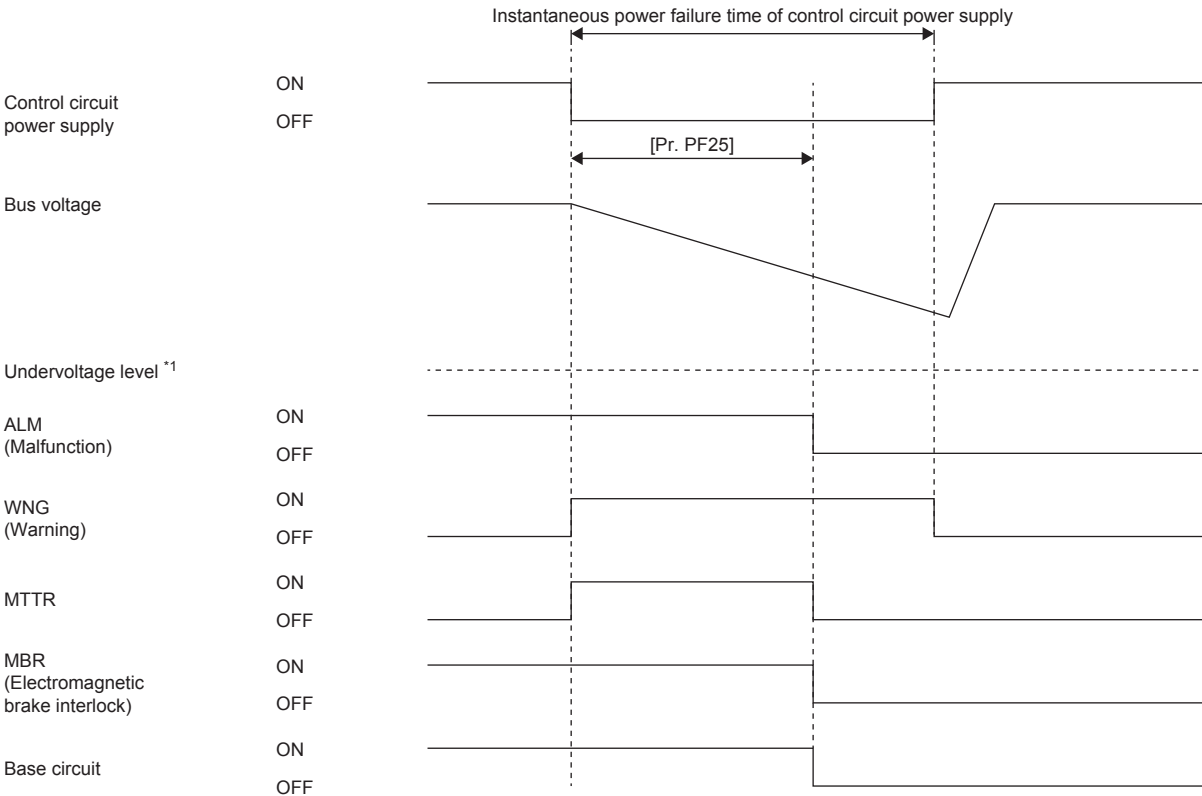

*1 For the undervoltage level, refer to the following table.

☞ Page 212 Behavior

■ When the instantaneous power failure time of the control circuit power supply < [Pr. PF25 SEMI-F47 function - Instantaneous power failure detection time (Instantaneous power failure tough drive detection time)]

The operation status differs depending on how much the bus voltage decreases.

- When the bus voltage does not decrease to the undervoltage level or lower within instantaneous power failure time of control circuit power supply

The operation continues without generating an alarm.

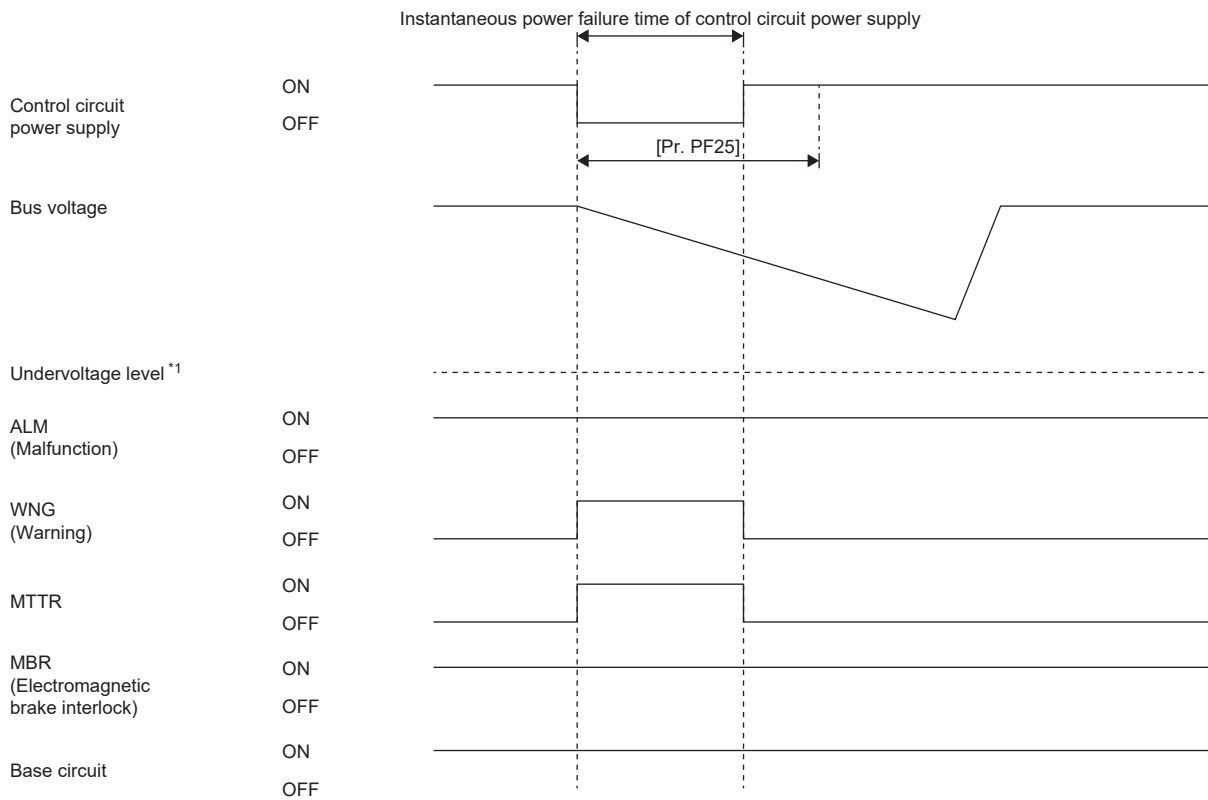

*1 For the undervoltage level, refer to the following table.

- When the bus voltage decreases to the undervoltage level or lower within instantaneous power failure time of control circuit power supply

[AL. 010 Undervoltage] occurs when the bus voltage decreases to the undervoltage level or lower even if the instantaneous power failure tough drive is enabled.

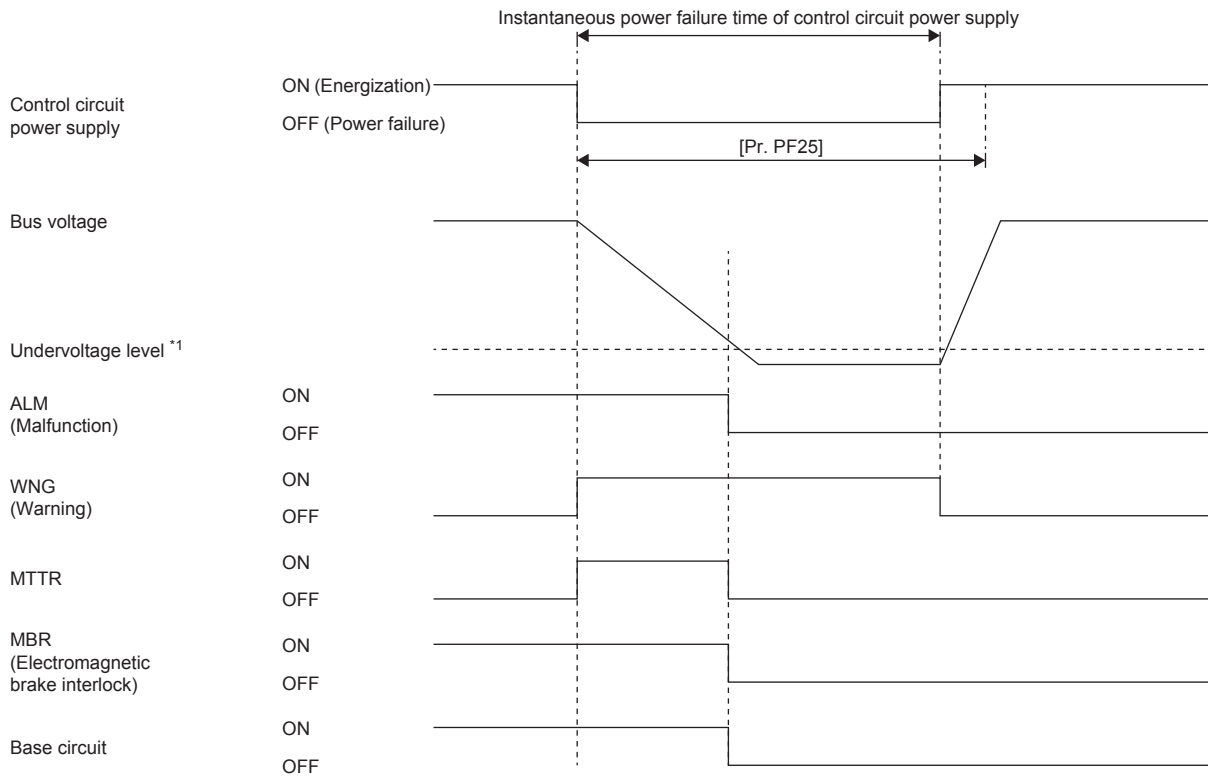

*1 For the undervoltage level, refer to the following table.

☞ Page 212 Behavior

4.2 Compliance with SEMI-F47 standard

This function complies with "SEMI-F47 semiconductor process equipment voltage sag immunity test". With this function, even when an instantaneous power failure occurs during operation, the occurrence of [AL. 010 Undervoltage] can be avoided by using the electrical energy charged in the capacitor.

Restriction

- Use a 3-phase power supply for the input power supply of the servo amplifier. Using a 1-phase 200 V AC for the input power supply will not comply with SEMI-F47 standard.

Precautions

- For MR-J5D_-_G_, this function cannot be used.
- Although the control circuit power supply of the servo amplifier can comply with SEMI-F47 standard, depending on the power supply impedance and operating situation, a back-up capacitor may be required for instantaneous power failure in the main circuit power supply.
- The external dynamic brake cannot be used when complying with the SEMI-F47 standard. Do not assign DB (Dynamic brake interlock) to the output device. If DB is assigned, the servo amplifier switches to servo-off status when an instantaneous power failure occurs.
- Perform an actual machine test and a detailed check of the equipment for the SEMI-F47 power instantaneous power failure standard.

Setting method

Setting [Pr. PA20.2 SEMI-F47 function selection] to "1" (enabled), and [Pr. PF25 SEMI-F47 function - Instantaneous power failure detection time (Instantaneous power failure tough drive detection time)] to "200" [ms] enables the SEMI-F47 standard compliant function.

Servo parameter	Symbol	Name	Outline
PA20.2	*TDS	SEMI-F47 function selection	Enable or disable the SEMI-F47 function. 0: Disabled (initial value) 1: Enabled
PF25	CVAT	SEMI-F47 function - Instantaneous power failure detection time (instantaneous power failure tough drive detection time)	Set the time until the occurrence of [AL. 010.1 Voltage drop in the control circuit power]. Initial setting: 200 [ms]

Behavior

When the SEMI-F47 standard compliant function is enabled, the operation will be as follows:

- When the control circuit power supply voltage continues for 200 ms at the rated voltage × 50 % or less, [AL. 010.1 Control circuit supply voltage drop] occurs.
- [AL. 010.2 Voltage drop in the main circuit power] will occur when bus voltage is as follows.

Servo amplifier	Bus voltage which triggers alarm
MR-J5-10_ to MR-J5-700_ MR-J5W_-_	DC 158 V
MR-J5-60_4_ to MR-J5-350_4_	DC 380 V

- MBR (Electromagnetic brake interlock) turns off when [AL. 010.1 Voltage drop in the control circuit power] occurs.

Requirements of the SEMI-F47 standard

The following table shows the permissible instantaneous power failure time for the instantaneous power failure voltage.

Instantaneous power failure voltage	Permissible time for instantaneous power failure [s]
Rated voltage × 80 %	1
Rated voltage × 70 %	0.5
Rated voltage × 50 %	0.2

Calculation method of tolerance against instantaneous power failure

The following table shows the tolerance against instantaneous power failure when the instantaneous power failure voltage is the rated voltage × 50 %, and the instantaneous power failure time is 200 ms.

Instantaneous maximum output means the power which the servo amplifier can output using maximum torque at the rated speed. The margin can be examined by comparing the value of each condition with the instantaneous maximum output. Even when the maximum torque is generated in actual operation, if the speed is low, the servo motor does not generate the maximum output and the generated torque will instead be treated as a margin.

The following shows the conditions of tolerance against instantaneous power failure.

Delta connection

When the three phases (L1/L2/L3) are connected by delta connection, apply an instantaneous power failure to one of the three pairs of line voltages (e.g. between L1 and L2).

Star connection

When the three phases (L1/L2/L3) are connected by star connection, from a total of six pairs of voltages, being (1) 3 pairs of line voltages (between L1 and L2, L2 and L3, L3 and L1) and (2) 3 pairs of phases and a neutral point (between L1 and N, L2 and N, L3 and N), apply an instantaneous power failure to one pair of line voltages (e.g. between L1 and N).

Servo amplifier model	Instantaneous maximum output [W]	Tolerance against instantaneous power failure [W] (voltage drop between lines)
MR-J5-10_	350	250
MR-J5-20_	700	420
MR-J5-40_	1400	630
MR-J5-60_	1800	410
MR-J5-70_	3375	1150
MR-J5-100_	4000	1190
MR-J5-200_	6000	2040
MR-J5-350_	10500	2600
MR-J5-500_	15000	4100
MR-J5-700_	21000	5900
MR-J5W2-22_	1400 (700 × 2)	790
MR-J5W2-44_	2800 (1400 × 2)	1190
MR-J5W2-77_	6750 (3375 × 2)	2300
MR-J5W2-1010_	8000 (4000 × 2)	2400
MR-J5W3-222_	2100 (700 × 3)	970
MR-J5W3-444_	4200 (1400 × 3)	1700
MR-J5-60_4_	1800	190
MR-J5-100_4_	3500	200
MR-J5-200_4_	6000	350
MR-J5-350_4_	10500	730

4.3 Scale measurement function [G] [B]

This function is available on servo amplifiers with firmware version A5 or later.

If a linear encoder is used as a scale measurement encoder for this servo amplifier, refer to the following manual.

 MR-J5 Partner's Encoder User's Manual

Point

To replace a servo motor with a batteryless absolute position encoder using the absolute position detection system, set [Pr. PA03.2 Scale measurement encoder replacement preparation]. By setting [Pr. PF63.1 [AL. 01A.6 Servo motor combination error 4] selection] to "1" (disabled) while the absolute position detection system is enabled at startup, an in-use batteryless absolute position scale measurement encoder can be replaced without changing the setting value of [Pr. PA03.2].

Outline

The scale measurement function transmits the position information of a scale measurement encoder by connecting the encoder to the servo amplifier in the state of the semi closed loop control.

Restriction

If the scale measurement function is used for the MR-J5-_G_, MR-J5W2-_G_, MR-J5D2-_G_, MR-J5-_B_, and MR-J5W2-_B_, the following restrictions apply. However, these restrictions do not apply to the MR-J5-_G_-RJ, MR-J5D1-_G_, or MR-J5-_B_-RJ. Note that this function cannot be used on the MR-J5W3-_G_, MR-J5D3-_G_, or MR-J5W3-_B_. Enabling the scale measurement function on the MR-J5W3-_G_, MR-J5D3-_G_, or MR-J5W3-_B_ triggers [AL. 037 Parameter error].

- A/B/Z-phase differential output type encoders cannot be used as a scale measurement encoder.
- Only the scale measurement encoders with the two-wire type communication method can be used for this function. The scale measurement encoders and servo motor encoders with the four-wire type communication method cannot be used.

The scale measurement function cannot be used in the fully closed loop control mode. Enabling the scale measurement function in the fully closed loop control mode triggers [AL. 037].

For the MR-J5-_B_, set "0" (standard control mode) for [Pr. PA01.1 Operation mode selection]. Setting any other operation mode triggers [AL. 037].

The scale measurement encoders can be used as HK-KT servo motor encoders, HK-MT servo motor encoders, linear encoders, or A/B/Z-phase differential output type encoders. For scale measurement encoders that can be used with this servo amplifier, contact your local sales office.

If the network communication cycle is less than 125 μ s when the scale measurement function is enabled, [AL. 09E Network warning] occurs.

If the network communication cycle is less than 125 μ s when the scale measurement function is enabled on the MR-J5-_G_ or MR-J5D1-_G_, [AL. 09E] occurs.

If the network communication cycle is less than 250 μ s when the scale measurement function is enabled on the MR-J5W2-_G_ or the MR-J5D2-_G_, [AL. 09E] occurs.

Precautions

- When the Mitsubishi Electric servo motor equipped with a batteryless absolute position encoder is used, the absolute position data is erased under the following conditions.

The servo motor or servo amplifier is replaced.

[Pr. PA22.3 Scale measurement function selection] is set to "0" (disabled) or "2" (use with incremental system).

- In the case of using the Mitsubishi Electric servo motor equipped with a batteryless absolute position encoder, connecting a servo motor that had not been connected at the startup of the absolute position detection system will cause [AL. 01A Servo motor combination error].

In such cases, reconnect the servo motor that was connected at the startup of the absolute position detection system to operate without losing the absolute position data.

However, when [Pr. PF63.1 AL. 01A.6 Servo motor combination error 4 selection] is "1" (disabled), connecting a servo motor that had not been connected at the startup of the absolute position detection system will cause [AL. 025.2 Scale measurement encoder - Absolute position erased], erasing absolute position data.

Therefore, check if a correct servo motor is connected.

When replacing a servo motor, refer to the following.

 Page 224 Procedure for replacing the scale measurement encoder (Mitsubishi Electric servo motor equipped with a batteryless absolute position encoder)

Function block diagram [G]

The following shows a block diagram of the scale measurement function. In the scale measurement function, the control is performed in the units of the servo motor encoder.

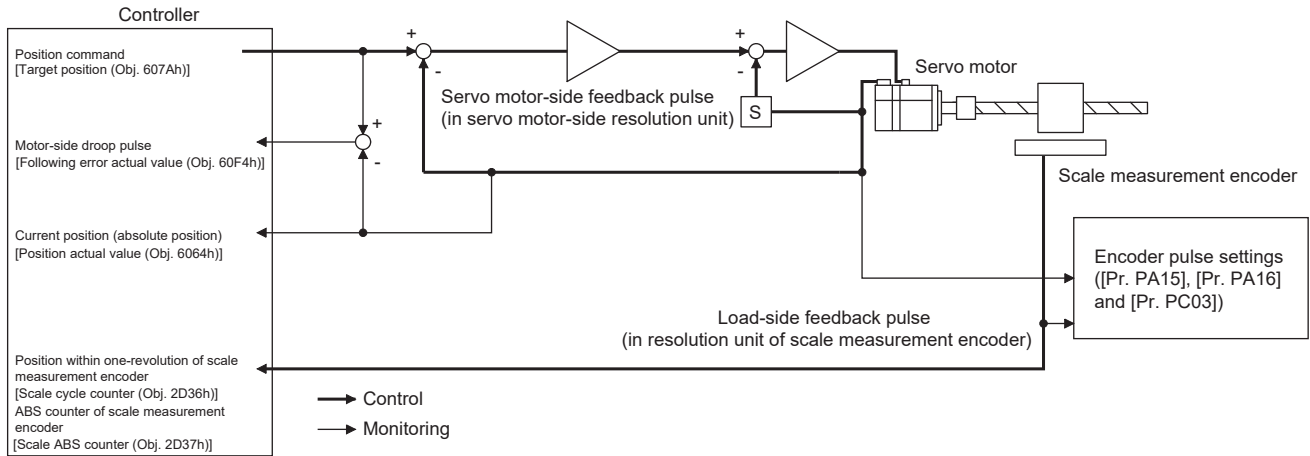

Function block diagram [B]

The following shows a block diagram of the scale measurement function. In the scale measurement function, the control is performed in the units of the servo motor encoder.

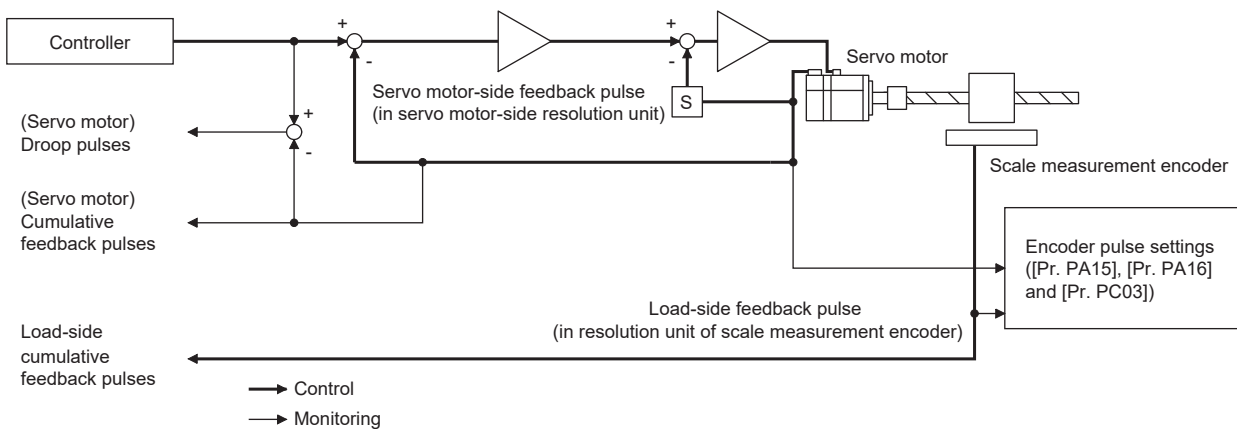

System configuration

For linear encoders

■ Servo amplifier without CN2L or CN2AL

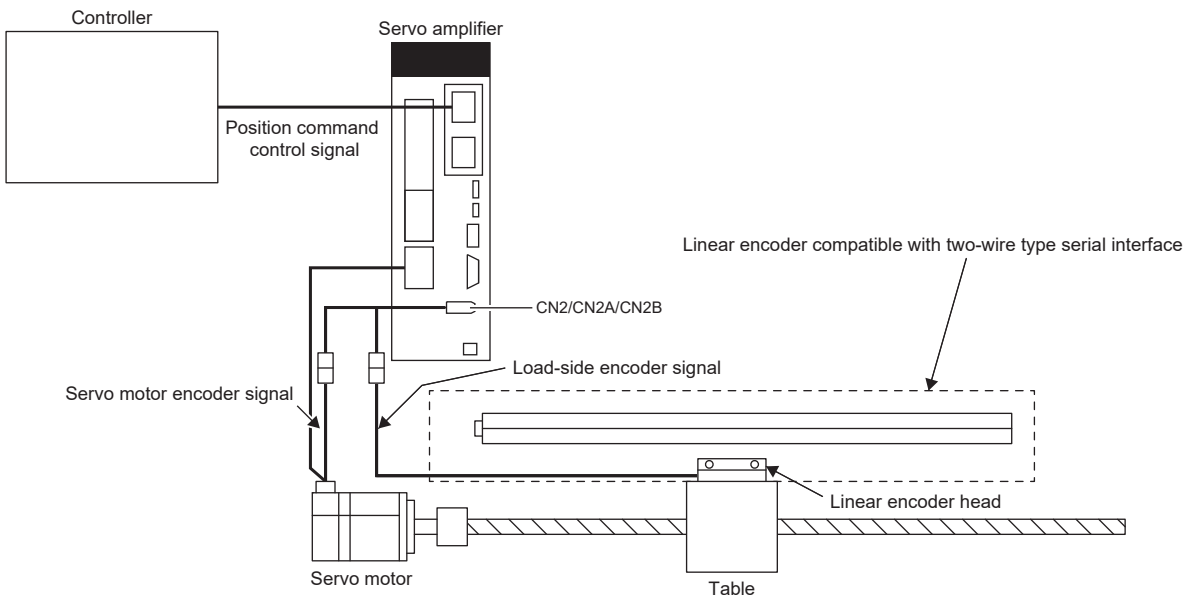

■ Servo amplifier with CN2L or CN2AL

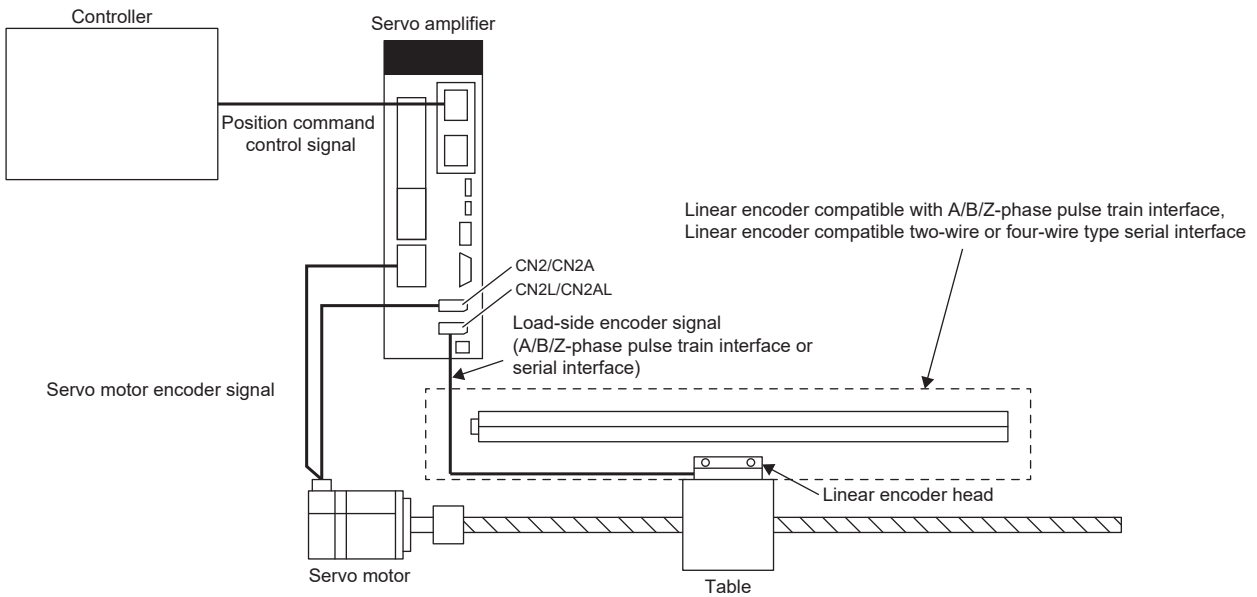

For rotary encoders

■ Servo amplifier without CN2L or CN2AL

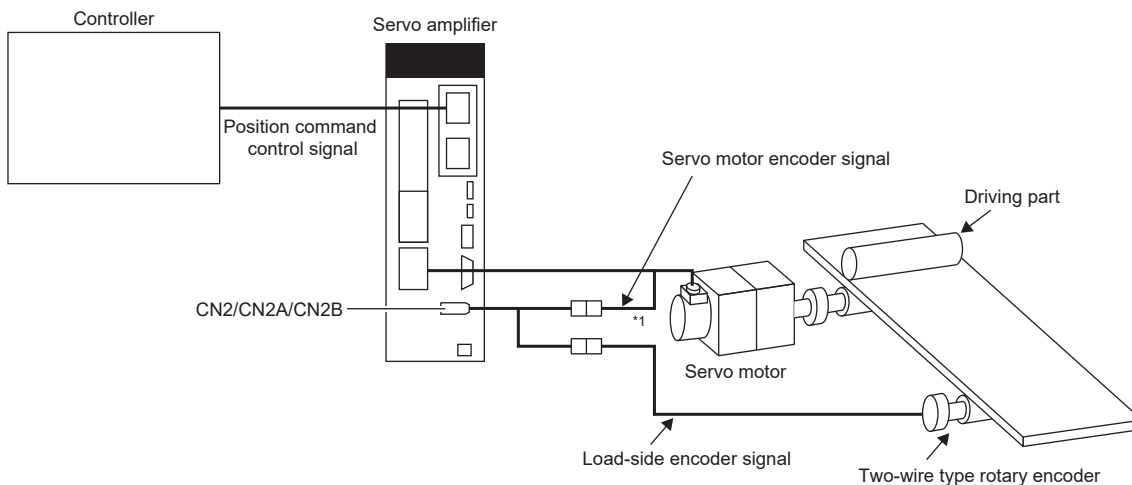

*1 Use a two-wire type encoder cable. A four-wire type encoder cable cannot be used.

■ Servo amplifier with CN2L or CN2AL

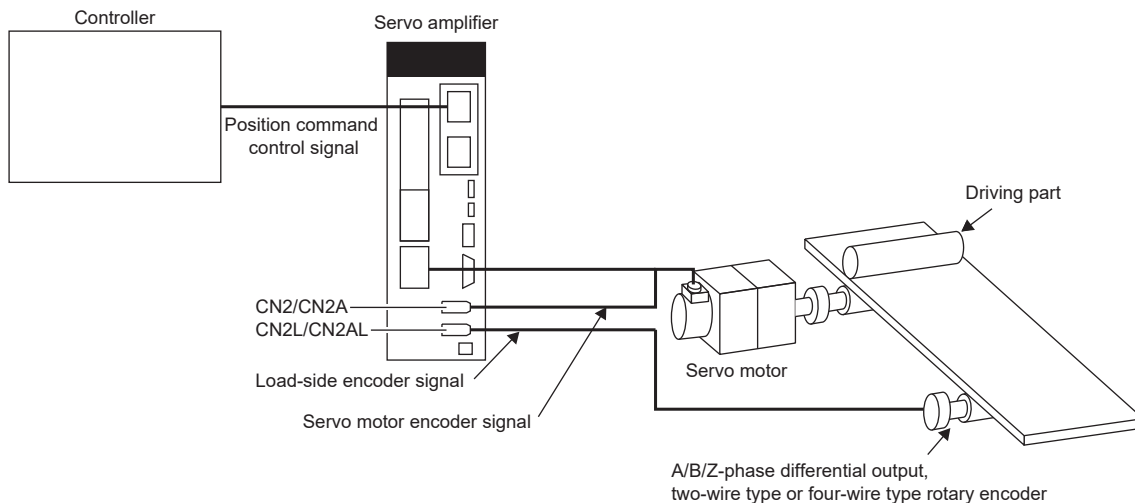

Scale measurement encoders

Precautions

Contact the manufacturer of the scale measurement encoder being used for information on specifications, performance and guarantees.

Linear encoders

Refer to the following manual for linear encoders that can be used as a scale measurement encoder.

 MR-J5 Partner's Encoder User's Manual

To use [Pr. PA22.3 Scale measurement function selection] by setting it to "1" (use with absolute position detection system), an absolute position type linear encoder is required. In this case, the encoder battery need not be mounted to the servo amplifier to hold the load-side absolute position data.

Rotary encoders

If using a rotary encoder as a scale measurement encoder, use the following motor as the encoder.

Servo amplifier	HK-KT
	HK-MT
MR-J5-_G_/MR-J5-_B_	<input type="radio"/>
MR-J5-_G_-RJ_/MR-J5D1-_G_/MR-J5-_B_-RJ	<input type="radio"/>
MR-J5W2-_G_/MR-J5D2-_G_/MR-J5W2-_B_	<input type="radio"/>

For the MR-J5-_G_, MR-J5W2-_G_, MR-J5D1-_G_, MR-J5D2-_G_, MR-J5-_B_, and MR-J5W2-_B_, use two-wire type encoder cables.

If using [Pr. PA22.3 Scale measurement function selection] by setting it to "1" (use with absolute position detection system) and connecting a battery backup type rotary encoder to the servo amplifier, an encoder battery must be mounted to the servo amplifier to hold the load-side absolute position data. In this case, the battery life will be shorten because the current consumption is increased as the power from the battery is supplied to both the servo motor-side and the load-side encoder. If connecting a batteryless rotary encoder to the servo amplifier, the encoder battery need not be mounted to the servo amplifier. For A/B/Z-phase differential output type rotary encoders, refer to "A/B/Z-phase differential output type encoder" in the following manual.

 MR-J5 Partner's Encoder User's Manual

Encoder cable configuration diagram for linear encoders

Cables to be used vary depending on each scale measurement encoder.

Refer to the following manual for the linear encoder cables.

MR-J5 Partner's Encoder User's Manual

■ Servo amplifier without CN2L or CN2AL

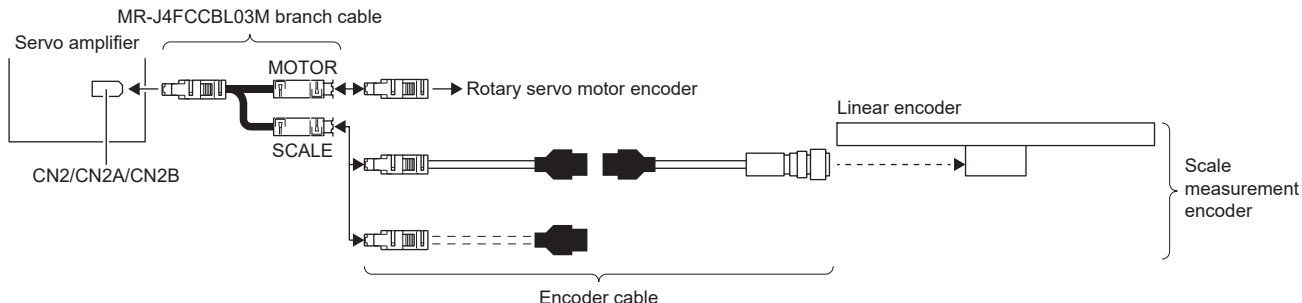

■ Servo amplifier with CN2L or CN2AL

The linear encoder can be connected without using an MR-J4FCCBL03M branch cable. In addition, a four-wire type linear encoder can also be used.

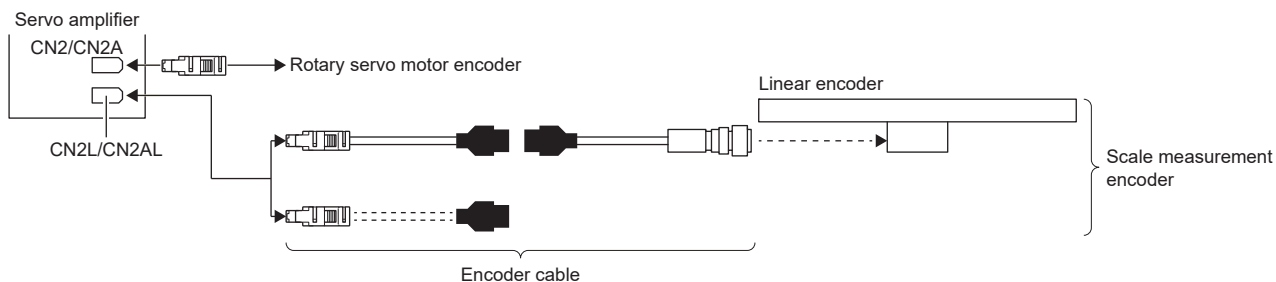

Encoder cable configuration diagram for rotary encoders

Point

- If using a rotary encoder as a scale measurement encoder, use an HK-KT servo motor or HK-MT servo motor encoder for as the encoder.
- Use a two-wire type encoder cable.

For cables for rotary encoders, refer to "Motor cables/connector sets" and "Encoder cable" in the following manual.

📖 Rotary Servo Motor User's Manual (For MR-J5)

■ Servo amplifier without CN2L or CN2AL

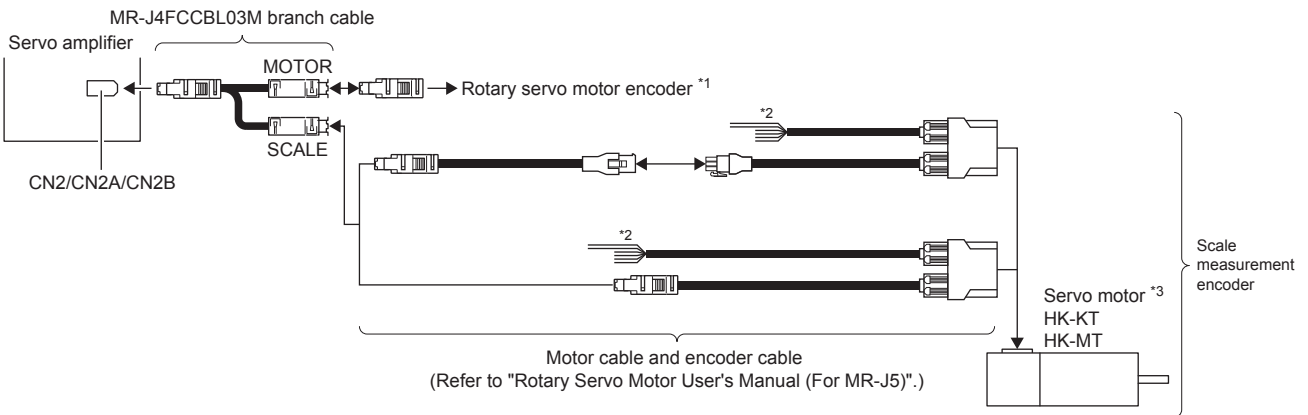

*1 Use a two-wire type encoder cable. A four-wire type encoder cable cannot be used.

*2 When the motor type of the servo motor is "HK-KT_W" or "HK-MT_W", a maximum of 240 V is output from the power cable, and when the motor type is "HK-KT_4_W", a maximum of 480 V is output. Insulation is therefore required. Apply insulation protection according to the maximum voltage to U, V, W, and each grounding wire. Do not disconnect the power cable during the insulation protection.

*3 Use the servo motor in the range not exceeding the maximum servo motor speed described in "Standard specifications list" in the following manual.

📖 Rotary Servo Motor User's Manual (For MR-J5)

■ Servo amplifier with CN2L or CN2AL

The rotary encoder can be connected without using an MR-J4FCCBL03M branch cable.

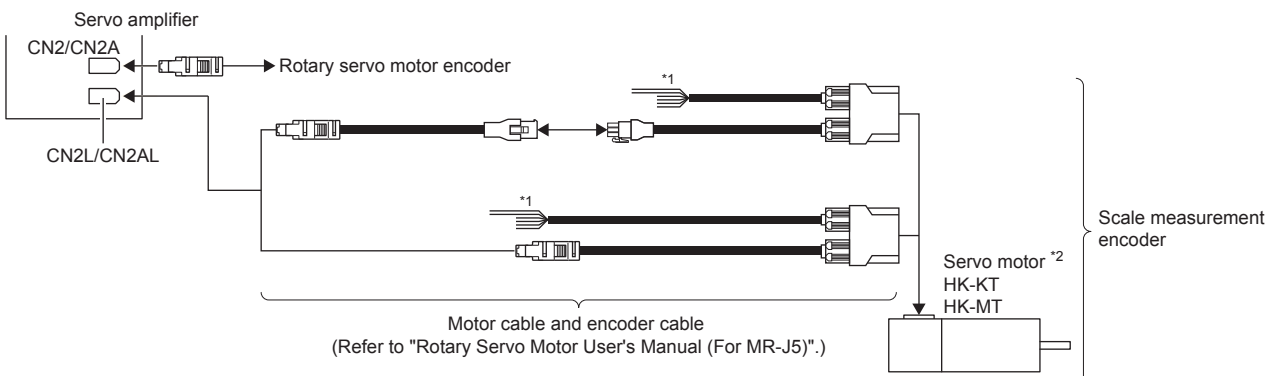

*1 When the motor type of the servo motor is "HK-KT_W" or "HK-MT_W", a maximum of 240 V is output from the power cable, and when the motor type is "HK-KT_4_W", a maximum of 480 V is output. Insulation is therefore required. Apply insulation protection according to the maximum voltage to U, V, W, and each grounding wire. Do not disconnect the power cable during the insulation protection.

*2 Use the servo motor in the range not exceeding the maximum servo motor speed described in "Standard specifications list" in the following manual.

📖 Rotary Servo Motor User's Manual (For MR-J5)

Setting method

Precautions

After mounting the scale measurement encoder and setting the servo parameters, operate the device (scale measurement encoder) to check that the data of the scale measurement encoder has been updated properly. If not properly updated, check the mounting, wiring, and servo parameter settings of the scale measurement encoder. Change the polarity of the scale measurement encoder as necessary.

Selecting the scale measurement function

Set the scale measurement function with a combination of [Pr. PA01] and [Pr. PA22].

■ Selecting the semi closed loop control mode

The scale measurement function can be used only when the semi closed loop control mode is selected. Set [Pr. PA01.4 Fully closed loop operation mode selection] to "0" (disabled: semi closed loop control mode).

No.	Symbol	Name	Outline
PA01.4	**STY	Fully closed loop operation mode selection	Select the semi closed loop control mode. Initial setting: 0 (Disabled (semi closed loop control mode))

■ Scale measurement function selection

Select the scale measurement function. Select "1" (use with absolute position detection system) or "2" (use with incremental system) in [Pr. PA22.3 Scale measurement function selection] according to the encoder to be used.

No.	Symbol	Name	Outline
PA22.3	**PCS	Scale measurement function selection	Select the scale measurement function. Initial setting: 0 (disabled)

■ Canceling [AL. 025.2 Scale measurement encoder - Absolute position erased]

When using the device in an absolute position detection system, [AL. 025.2] occurs at initial power-on after the encoder cable is connected. After allowing the alarm to occur for 5 s, cycle the power to cancel the alarm.

Selecting a communication method for the scale measurement encoder

The communication method varies depending on the scale measurement encoder type. For the communication method when using a linear encoder as a scale measurement encoder, refer to "Compatible encoder list" in the following manual.

📖MR-J5 Partner's Encoder User's Manual

Select a cable to be connected to CN2L or CN2AL with [Pr. PC26.3 Load-side encoder cable communication method selection]. Select "0" (two-wire type) or "1" (four-wire type) in [Pr. PC26.3] according to the cable to be used.

No.	Symbol	Name	Outline
PC26.3	**COP8	Load-side encoder cable communication method selection	Select the communication method of load side encoder cables. Initial setting: 0 (two-wire type)

Selecting a polarity of the scale measurement encoder

Select the polarity of the scale measurement encoder in [Pr. PC27.0 Encoder pulse count polarity selection] and set [Pr. PC27.2 ABZ phase input interface encoder ABZ phase connection assessment function selection] shown below as required.

Precautions

[Pr. PC27.0 Encoder pulse count polarity selection] is not related to [Pr. PA14 Travel direction selection]. Set the parameter according to the relationships between the servo motor, linear encoder, and rotary encoder.

■ Selection of the encoder pulse count polarity

This servo parameter is used to set the polarity of the load-side encoder to be connected to CN2L or CN2AL to match the CCW direction of the servo motor and the increasing direction of the load-side encoder feedback. For [Pr. PC27.0 Encoder pulse count polarity selection], select "0" (Encoder pulse increasing direction in the servo motor CCW or positive direction) or "1" (Encoder pulse decreasing direction in the servo motor CCW or positive direction).

No.	Symbol	Name	Outline
PC27.0	**COP9	Encoder pulse count polarity selection	Select a polarity of the load-side encoder. Initial setting: 0 (Encoder pulse increasing direction in the servo motor CCW or positive direction)

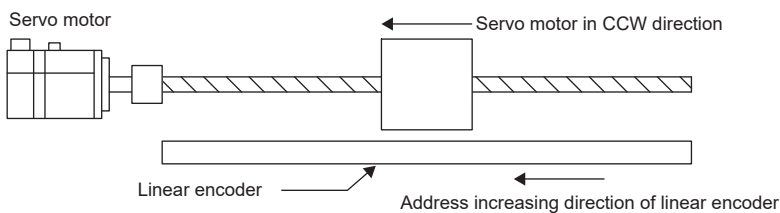

■ A/B/Z-phase input interface encoder Z-phase connection assessment function

This function triggers an alarm by detecting non-signal for Z phase.

The Z-phase connection assessment function is enabled in the initial state. The Z-phase connection assessment function can be disabled with [Pr. PC27.2 ABZ phase input interface encoder ABZ phase connection assessment function selection].

Select "0" (enabled) or "1" (disabled) for [Pr. PC27.2] as needed.

No.	Symbol	Name	Outline
PC27.2	**COP9	ABZ phase input interface encoder ABZ phase connection assessment function selection	Select the non-signal detection status for the pulse train signal from the A/B/Z-phase input interface encoder. Initial setting: 0 (enabled)

■ Resolution setting of scale measurement encoder

When using an A/B/Z-phase differential output rotary encoder as a scale measurement encoder, set the resolution in [Pr. PE51 Load-side encoder resolution setting].

No.	Symbol	Name	Outline
PE51	**EDV2	Load-side encoder resolution setting	Set the resolution of the load-side encoder. Initial value: 0 [pulse]

■ Selection of use of A/B/Z-phase differential output type encoder as scale measurement encoder [G]

If a serial encoder is connected to CN2 and an A/B/Z-phase differential output type encoder is connected to CN2L or CN2AL, determine which encoder is to be used as a scale measurement encoder. Use [Pr. PC27.5 Scale measurement encoder selection] to select whether the A/B/Z-phase differential output type encoder is to be used as a servo motor encoder or scale measurement encoder as required.

No.	Symbol	Name	Outline
PC27.5	**COP9	Scale measurement encoder selection	Select a scale measurement encoder when using an A/B/Z-phase differential output type encoder. 0: Use an A/B/Z-phase differential output type encoder as a scale measurement encoder (Initial value) 1: Use a serial encoder as a scale measurement encoder

Procedure for replacing the scale measurement encoder (Mitsubishi Electric servo motor equipped with a batteryless absolute position encoder)

To replace the Mitsubishi Electric servo motor equipped with a batteryless absolute position encoder being used as a scale measurement encoder, use the following procedure.

Servo motor replacement procedure

Point

For servo amplifiers with firmware version D8 or later, step 3 is not required.

1. Replacing the servo motor

Turn off the power supply of the servo amplifier and replace the servo motor.

2. Canceling [AL. 01A Servo motor combination error]

When the power supply of the servo amplifier is turned on, [AL. 01A.6 Servo motor combination error 4] occurs.

After setting [Pr. PA03.2 Scale measurement encoder replacement preparation] to "1" (enabled), cycle the power of the servo amplifier or perform the software reset and then deactivate [AL. 01A.6].

3. Cycling the power

After checking that [AL. 01A.6] does not occur, cycle the power of the servo amplifier or perform the software reset.

4. Homing

The absolute position data is erased by servo motor replacement. Before starting operation, perform homing.

Procedure of replacing the servo motor without changing the servo parameter setting

By setting [Pr. PF63.1 [AL. 01A.6 Servo motor combination error 4] selection] to "1" (disabled) while the absolute position detection system is enabled, an in-use batteryless absolute position scale measurement encoder can be replaced without changing the setting value of [Pr. PA03.2 Scale measurement encoder replacement preparation].

Connecting a scale measurement encoder that had not been connected at the startup of the absolute position detection system will cause [AL. 025.2 Scale measurement encoder - Absolute position erased], erasing absolute position data. Therefore, check if a correct servo motor is connected.

To replace the servo motor without changing the servo parameter setting, refer to the following procedure. Set [Pr. PF63.1] to "1" (disabled) in advance, and reset the controller or cycle the power.

1. Replacing the servo motor

Turn off the power supply of the servo amplifier and replace the servo motor.

2. Canceling [AL. 025.2 Scale measurement encoder - Absolute position erased]

When the power supply of the servo amplifier is turned on, [AL. 025.2] occurs.

Cycle the power of the servo amplifier to deactivate [AL. 025.2].

3. Homing

When [AL. 025] occurs, the absolute position data is erased. Before starting operation, perform homing.

Procedure of replacing a servo amplifier without losing the absolute position data [B]

Point

When using existing parameter settings for a servo amplifier with factory settings, check that the settings of [Pr. PC92 Servo amplifier replacement data 9] to [Pr. PC95 Servo amplifier replacement data 12] are "0" before connecting the servo amplifier to the controller. Otherwise, [AL. 01A.6 Servo motor combination error 4] may occur. When [AL. 01A.6] occurs, after changing the setting value of [Pr. PA03.2 Scale measurement encoder replacement preparation] to "1" (enabled), cycle the power and then deactivate [AL. 01A Servo motor combination error]. Perform homing again. After connecting the servo amplifier to the controller, servo parameters will be set automatically.

To replace a servo amplifier that uses a servo motor with a batteryless absolute position encoder for scale measurement due to a servo amplifier malfunction, use the following procedure.

1. Servo parameter setting

After the communication between the controller and the servo amplifier is established, set [Pr. PF63.2 Servo amplifier replacement data save selection] to "1" (enabled). After setting, cycle the power, or reset either the controller or the software to reflect the setting.

2. Checking the setting values of the controller

After the communication between the controller and the servo amplifier is established, check that the value is reflected to [Pr. PC92 Servo amplifier replacement data 9] to [Pr. PC95 Servo amplifier replacement data 12] with the controller.

3. Replacing the servo amplifier

Turn off the power supply of the servo amplifier and replace it. The absolute position will not be erased. This enables positioning operation without performing homing again.

Related objects [G]

Scale measurement function objects

Check that bit 1 of [Encoder status 2 (Obj. 2D35h: 02h)] is on before reading the object.

If the object is read while bit 1 is off, the value of each object will be 0.

For details on the objects, refer to the User's Manual (Object Dictionary).

Index	Sub	Object	Name	Description
2D36h	0	VAR	Scale cycle counter	Position within one-revolution of scale measurement encoder Rotary encoder: Cycle counter Linear encoder absolute position type: ABS counter Linear encoder incremental type: Scale free-run counter *1 Linear encoder A/B/Z-phase differential output type (incremental type): Scale free-run counter *1 Rotary encoder A/B/Z-phase differential output type (incremental type): Cycle counter
2D37h	0	VAR	Scale ABS counter	Scale ABS counter Rotary encoder: Multi-revolution ABS counter Linear encoder absolute position type: Fixed to 0 Linear encoder incremental type: Fixed to 0 Linear encoder A/B/Z-phase differential output type (incremental type): Fixed to 0 Rotary encoder A/B/Z-phase differential output type (incremental type): Fixed to 0
2D3Ch	0	VAR	Scale measurement encoder reception status	Scale encoder alarm data 0: Normal. Correct data is stored in each object. Other than 0: Abnormal. The previous value is stored in each object.
2D38h	0	VAR	Scale measurement encoder resolution	Scale encoder resolution For example, when a rotary encoder with a resolution of 67108864 pulses/rev is connected as a scale encoder, the object value is 67108864. The value is always "0" except for the rotary encoder.
2D35h	0	ARRAY	Encoder status	Encoder status display
	1	ARRAY	Encoder status 1	Encoder status display 1 The encoder status is returned. In a fully closed loop system, the external encoder status is returned. Bit 0: The encoder status is returned by the servo amplifier and confirms whether it is an absolute position detection system. (OFF = Incremental system, ON = Absolute position detection system)
	2	ARRAY	Encoder status 2	Encoder status display 2 The status of the scale measurement encoder is returned. Bit 0: The encoder status is returned by the servo amplifier and confirms whether it is an absolute position detection system. (OFF = Incremental system, ON = Absolute position detection system) Bit 1: The encoder status is returned by the servo amplifier and confirms whether the scale measurement function is enabled or disabled. (OFF = Disabled, ON = Enabled) Bit 2: The encoder status is returned by the servo amplifier and confirms whether the currently connected scale measurement encoder is an absolute position type. (OFF = Incremental type, ON = Absolute position type)

*1 The counter indicates the cumulative amount of travel distance from 0 (the position at power-on) to the travel direction.
The range is -2147483648 to 2147483647.

Calculating a scale measurement encoder position

The scale measurement encoder position is calculated as follows.

Scale position = ([Scale ABS counter (Obj. 2D37h)] × [Scale measurement encoder resolution (Obj. 2D38h)]) + [Scale cycle counter (Obj. 2D36h)]



4.4 Touch probe [G]

Outline

This function is available on servo amplifiers with firmware version A5 or later.

The touch probe function latches the current position by inputting a signal from a sensor or the like. Position feedback at the rising edge and falling edge of an input device can be detected with precision of 1 μ s and stored into an object according to specified conditions.

Restriction

- For the MR-J5-_G, this function is available on servo amplifiers with firmware version C0 or later and manufactured in June 2021 or later.
- For input device assignment, the touch probe function has restrictions on pins that can be set.
 Page 228 Setting method
- For the multi-axis servo amplifier, when input devices TPR1 (Touch probe 1), TPR2 (Touch probe 2), and TPR3 (Touch probe 3) are set and the network communication cycle is less than 250 [μ s], [AL. 09E Network warning] occurs.
- For the 3-axis servo amplifiers, when input devices TPR1, TPR2, and TPR3 are set and CC-Link IE TSN communication is used, the A/B/Z-phase pulse output function cannot be used.
 Page 354 A/B/Z-phase pulse output function
- If semi-closed loop control/fully closed loop control switching is performed while this function operates, the position may not be detected correctly.
- When multiple linear encoder home positions exist during the full stroke of the linear encoder, the trigger cannot be set to the zero point of the encoder.

Precautions

If the external input signal causes chattering due to noise or other factors, the position may not be detected correctly. Review the surrounding environment.

Setting method

The touch probe function memorizes position feedback and stores it in each object according to the conditions specified with [Touch probe function (Obj. 60B8h)] or [Touch probe function 2 (Obj. 2DE8h)].

Refer to the following table for the settings of input/output devices.

☞ Page 147 Assigning I/O devices

☞ Page 229 Input device settings

Refer to the following for the timing chart.

☞ Page 240 Timing chart

The following table shows the objects and input devices to use touch probes.

Touch probe	Target object			Input device	
	Index	Name	Bit range	Name	Symbol
Touch probe1	60B8h	Touch probe function	Bit 0 to 7	Touch probe 1	TPR1
	60B9h	Touch probe status	Bit 0 to 7		
	60BAh	Touch probe 1 positive edge	—		
	60BBh	Touch probe 1 negative edge	—		
	60D1h	Touch probe time stamp 1 positive value	—		
	60D2h	Touch probe time stamp 1 negative value	—		
Touch probe2	60B8h	Touch probe function	Bit 8 to 15	Touch probe 2	TPR2
	60B9h	Touch probe status	Bit 8 to 15		
	60BCh	Touch probe 2 positive edge	—		
	60BDh	Touch probe 2 negative edge	—		
	60D3h	Touch probe time stamp 2 positive value	—		
	60D4h	Touch probe time stamp 2 negative value	—		
Touch probe3	2DE8h	Touch probe function 2	Bit 0 to 7	Touch probe 3	TPR3
	2DE9h	Touch probe status 2	Bit 0 to 7		
	2DEAh	Touch probe 3 positive edge	—		
	2DEBh	Touch probe 3 negative edge	—		
	2DF8h	Touch probe time stamp 3 positive value	—		
	2DF9h	Touch probe time stamp 3 negative value	—		

Input device settings

■ For MR-J5-_G_

The following table shows the connector pin numbers to which input devices TPR1, TPR2, and TPR3 can be assigned and the servo parameters used for the assignment.

Connector pin No.	Servo parameter	Initially assigned device
CN3-10 *1	[Pr. PD38 Input device selection 4]	TPR1
CN3-1 *1	[Pr. PD39 Input device selection 5]	TPR2

*1 Available on servo amplifiers with firmware version C0 or later and manufactured in June 2021 or later.

■ For MR-J5-_G_-RJ_

The following table shows the connector pin numbers to which input devices TPR1, TPR2, and TPR3 can be assigned and the servo parameters used for the assignment.

Connector pin No.	Servo parameter	Initially assigned device
CN3-10	[Pr. PD38 Input device selection 4]	TPR1
CN3-1	[Pr. PD39 Input device selection 5]	TPR2
CN3-19	[Pr. PD05 Input device selection 3]	DOG

■ For MR-J5W_-_G_

Assign input devices (TPR1, TPR2, and TPR3) and also select on which axis an input signal is used. The touch probe function can be set such as the following: one channel for A-axis, B-axis, and C-axis respectively, three channels on B-axis, and latching current positions of A-axis, B-axis, and C-axis simultaneously with one input signal.

However, if the zero point of the encoder is set for the trigger with bit 2 of [Touch probe function (Obj. 60B8h)] instead of an input device, the position of the set axis is latched only and the position of any other axes cannot be latched.

The following table shows the connector pin numbers to which input devices TPR1, TPR2, and TPR3 can be assigned and the servo parameters used for the assignment.

Connector pin No.	MR-J5W2-_G_		MR-J5W3-_G_	
	Servo parameter	Initially assigned device	Servo parameter	Initially assigned device
CN3-9	[Pr. PD05 Input device selection 3] (A-axis)	DOG-A	[Pr. PD05 Input device selection 3] (A-axis)	DOG-A
CN3-22	[Pr. PD05 Input device selection 3] (B-axis)	DOG-B	[Pr. PD05 Input device selection 3] (B-axis)	DOG-B
CN3-15	[Pr. PD51 Input device selection 3-2] (Common)	Not assigned	[Pr. PD05 Input device selection 3] (C-axis)	DOG-C

■ For MR-J5D1-_G_

The following table shows the connector pin numbers to which input devices TPR1, TPR2, and TPR3 can be assigned and the servo parameters used for the assignment.

Connector pin No.	Servo parameter	Initially assigned device
CN3-11	[Pr. PD38 Input device selection 4]	TPR1
CN3-27	[Pr. PD39 Input device selection 5]	TPR2
CN3-29	[Pr. PD05 Input device selection 3]	DOG

■ For MR-J5D2-_G_/MR-J5D3-_G_

Assign input devices (TPR1, TPR2, and TPR3) and also select on which axis an input signal is used. The touch probe function can be set such as the following: one channel for A-axis, B-axis, and C-axis respectively, three channels on B-axis, and latching current positions of A-axis, B-axis, and C-axis simultaneously with one input signal.

However, if the zero point of the encoder is set for the trigger with bit 2 of [Touch probe function (Obj. 60B8h)] instead of an input device, the position of the set axis is latched only and the position of any other axes cannot be latched.

The following table shows the connector pin numbers to which input devices TPR1, TPR2, and TPR3 can be assigned and the servo parameters used for the assignment.

Connector pin No.	MR-J5D2-_G_		MR-J5D3-_G_	
	Servo parameter	Initially assigned device	Servo parameter	Initially assigned device
CN3-29	[Pr. PD05 Input device selection 3] (A-axis)	DOG-A	[Pr. PD05 Input device selection 3] (A-axis)	DOG-A
CN3-27	[Pr. PD05 Input device selection 3] (B-axis)	DOG-B	[Pr. PD05 Input device selection 3] (B-axis)	DOG-B
CN3-11	[Pr. PD51 Input device selection 3-2] (Common)	Not assigned	[Pr. PD05 Input device selection 3] (C-axis)	DOG-C

Ex.

The following shows a setting example of the MR-J5W3-_G_. Assign input devices (TPR1, TPR2, TPR3) with [Pr. PD05.0-1 Input device selection 3], and select an axis for using an input signal with [Pr. PD05.4 Input axis selection 3].

When storing latched positions of A-axis, B-axis, and C-axis to each corresponding touch probe 1

Axis to be latched	Object		
	Touch probe 1	Touch probe 2	Touch probe 3
A-axis	CN3-9	—	—
B-axis	CN3-22	—	—
C-axis	CN3-15	—	—

Set as shown in the following table.

Connector pin No.	Servo parameter setting			Device name	Setting details
	Axis to set	[Pr. PD05.0-1]	[Pr. PD05.4]		
CN3-9	A-axis	"2Ch" (TPR1)	"0h" (automatic selection: A-axis)	TPR1-A	Assign TPR1 to the A-axis input pin.
CN3-22	B-axis	"2Ch" (TPR1)	"0h" (automatic selection: B-axis)	TPR1-B	Assign TPR1 to the B-axis input pin.
CN3-15	C-axis	"2Ch" (TPR1)	"0h" (automatic selection: C-axis)	TPR1-C	Assign TPR1 to the C-axis input pin.

When using three channels of the touch probe function on B-axis

Axis to be latched	Object		
	Touch probe 1	Touch probe 2	Touch probe 3
A-axis	—	—	—
B-axis	CN3-9	CN3-22	CN3-15
C-axis	—	—	—

Set as shown in the following table.

Connector pin No.	Servo parameter setting			Device name	Setting details
	Axis to set	[Pr. PD05.0-1]	[Pr. PD05.4]		
CN3-9	A-axis	"2Ch" (TPR1)	"2h" (B-axis enabled)	TPR1-B	Enable B-axis to be used on the A-axis input pin and assign TPR1.
CN3-22	B-axis	"2Dh" (TPR2)	"0h" (automatic selection: B-axis)	TPR2-B	Assign TPR2 to the B-axis input pin.
CN3-15	C-axis	"63h" (TPR3)	"2h" (B-axis enabled)	TPR3-B	Enable B-axis to be used on the C-axis input pin and assign TPR3.

When associating input signal pins, axes to be latched, and objects for storage

Axis to be latched	Object		
	Touch probe 1	Touch probe 2	Touch probe 3
A-axis	CN3-9	CN3-15	—
B-axis	CN3-22		—
C-axis	—		—

Set as shown in the following table.

Connector pin No.	Servo parameter setting			Device name	Setting details
	Axis to set	[Pr. PD05.0-1]	[Pr. PD05.4]		
CN3-9	A-axis	"2Ch" (TPR1)	"0h" (automatic setting: A-axis)	TPR1-A	Assign TPR1 to the A-axis input pin.
CN3-22	B-axis	"2Ch" (TPR1)	"6h" (B and C-axes enabled)	TPR1-B TPR1-C	Enable B-axis and C-axis at the B-axis input pin and assign TPR1.
CN3-15	C-axis	"2Dh" (TPR2)	"7h" (A, B, and C-axes enabled)	TPR2-A TPR2-B TPR2-C	Enable A-axis, B-axis, and C-axis at the C-axis input pin and assign TPR2.

Servo parameter

The filter settings of [Pr. PD11.0 Input signal filter selection] are disabled for pins to which TPR1, TPR2, or TPR3 is assigned.

■ MR-J5-_G_

Servo parameter	Symbol	Name	Outline
PD38.0-1 *1	*DI4	Input device selection 4	Assign any input device to the CN3-10 pin. Initial value: 2Ch (TPR1)
PD39.0-1 *1	*DI5	Input device selection 5	Assign any input device to the CN3-1 pin. Initial value: 2Dh (TPR2)
PT26.4 *2	*TOP2	Touch probe latch position selection	Select a touch probe latch position. Initial value: 0

*1 Available on servo amplifiers with firmware version C0 or later and manufactured in June 2021 or later.

*2 Available on servo amplifiers with firmware version C4 or later.

■ MR-J5-_G_-RJ_

Servo parameter	Symbol	Name	Outline
PD05.0-1	*DI3	Input device selection 3	Assign any input device to the CN3-19 pin. Initial value: 22h (DOG)
PD38.0-1	*DI4	Input device selection 4	Assign any input device to the CN3-10 pin. Initial value: 2Ch (TPR1)
PD39.0-1	*DI5	Input device selection 5	Assign any input device to the CN3-1 pin. Initial value: 2Dh (TPR2)
PT26.4 *1	*TOP2	Touch probe latch position selection	Select a touch probe latch position. Initial value: 0

*1 Available on servo amplifiers with firmware version C4 or later.

■ MR-J5W2-_G_

Servo parameter	Symbol	Name	Outline
PD05.0-1 (A-axis)	*DI3	Input device selection 3	Assign any input device to the CN3-9 pin. Initial value: 22h (DOG)
PD05.4 (A-axis)		Input axis selection 3	Set which axis is used for the input signal of the CN3-9 pin. Initial value: 0h (automatic setting: A-axis)
PD05.0-1 (B-axis)	*DI3	Input device selection 3	Assign any input device to the CN3-22 pin. Initial value: 22h (DOG)
PD05.4 (B-axis)		Input axis selection 3	Set which axis is used for the input signal of the CN3-22 pin. Initial value: 0h (automatic setting: B-axis)
PD51.0-1	*DI3W2	Input device selection 3-2	For the MR-J5W2-_G_, assign any input device to the CN3-15 pin. Initial value: 62h (No assigned function)
PD51.4		Input axis selection 3-2	For the MR-J5W2-_G_, set which axis is used for the input signal of the CN3-15 pin. Initial value: 0h (automatic setting: A-axis)
PT26.4 *1	*TOP2	Touch probe latch position selection	Select a touch probe latch position. Initial value: 0

*1 Available on servo amplifiers with firmware version C4 or later.

■ MR-J5W3-_G_

Servo parameter	Symbol	Name	Outline
PD05.0-1 (A-axis)	*DI3	Input device selection 3	Assign any input device to the CN3-9 pin. Initial value: 22h (DOG-A)
PD05.4 (A-axis)		Input axis selection 3	Set which axis is used for the input signal of the CN3-9 pin. Initial value: 0h (automatic setting: A-axis)
PD05.0-1 (B-axis)	*DI3	Input device selection 3	Assign any input device to the CN3-22 pin. Initial value: 22h (DOG-B)
PD05.4 (B-axis)		Input axis selection 3	Set which axis is used for the input signal of the CN3-22 pin. Initial value: 0h (automatic setting: B-axis)
PD05.0-1 (C-axis)	*DI3	Input device selection 3	Assign any input device to the CN3-15 pin. Initial value: 22h (DOG-C)
PD05.4 (C-axis)		Input axis selection 3	Set which axis is used for the input signal of the CN3-15 pin. Initial value: 0h (automatic setting: C-axis)
PT26.4 *1	*TOP2	Touch probe latch position selection	Select a touch probe latch position. Initial value: 0

*1 Available on servo amplifiers with firmware version C4 or later.

■ MR-J5D1-_G_

Servo parameter	Symbol	Name	Outline
PD05.0-1	*DI3	Input device selection 3	Assign any input device to the CN3-29 pin. Initial value: 22h (DOG)
PD38.0-1	*DI4	Input device selection 4	Assign any input device to the CN3-11 pin. Initial value: 2Ch (TPR1)
PD39.0-1	*DI5	Input device selection 5	Assign any input device to the CN3-27 pin. Initial value: 2Dh (TPR2)
PT26.4 *1	*TOP2	Touch probe latch position selection	Select a touch probe latch position. Initial value: 0

*1 Available on drive units with firmware version C4 or later.

■ MR-J5D2-_G_

Servo parameter	Symbol	Name	Outline
PD05.0-1 (A-axis)	*DI3	Input device selection 3	Assign any input device to the CN3-29 pin. Initial value: 22h (DOG)
PD05.4 (A-axis)		Input axis selection 3	Set which axis is used for the input signal of the CN3-29 pin. Initial value: 0h (automatic setting: A-axis)
PD05.0-1 (B-axis)	*DI3	Input device selection 3	Assign any input device to the CN3-27 pin. Initial value: 22h (DOG)
PD05.4 (B-axis)		Input axis selection 3	Set which axis is used for the input signal of the CN3-27 pin. Initial value: 0h (automatic setting: B-axis)
PD51.0-1	*DI3W2	Input device selection 3-2	For the MR-J5D2-_G_, assign any input device to the CN3-11 pin. Initial value: 62h (No assigned function)
PD51.4		Input axis selection 3-2	For the MR-J5D2-_G_, set which axis is used for the input signal of the CN3-11 pin. Initial value: 0h (automatic setting: A-axis)
PT26.4 *1	*TOP2	Touch probe latch position selection	Select a touch probe latch position. Initial value: 0

*1 Available on drive units with firmware version C4 or later.

■ MR-J5D3-_G_

Servo parameter	Symbol	Name	Outline
PD05.0-1 (A-axis)	*DI3	Input device selection 3	Assign any input device to the CN3-29 pin. Initial value: 22h (DOG-A)
PD05.4 (A-axis)		Input axis selection 3	Set which axis is used for the input signal of the CN3-29 pin. Initial value: 0h (automatic setting: A-axis)
PD05.0-1 (B-axis)	*DI3	Input device selection 3	Assign any input device to the CN3-27 pin. Initial value: 22h (DOG-B)
PD05.4 (B-axis)		Input axis selection 3	Set which axis is used for the input signal of the CN3-27 pin. Initial value: 0h (automatic setting: B-axis)
PD05.0-1 (C-axis)	*DI3	Input device selection 3	Assign any input device to the CN3-11 pin. Initial value: 22h (DOG-C)
PD05.4 (C-axis)		Input axis selection 3	Set which axis is used for the input signal of the CN3-11 pin. Initial value: 0h (automatic setting: C-axis)
PT26.4 *1	*TOP2	Touch probe latch position selection	Select a touch probe latch position. Initial value: 0

*1 Available on drive units with firmware version C4 or later.

Object dictionary

For details on the objects, refer to the User's Manual (Object Dictionary).

Index	Sub	Object	Name	Description
60B8h	—	VAR	Touch probe function	☞ Page 236 Details on [Touch probe function (Obj. 60B8h)]
60B9h	—	VAR	Touch probe status	☞ Page 238 Details on [Touch probe status (Obj. 60B9h)]
60BAh	—	VAR	Touch probe 1 positive edge	The rising edge position of TPR1 (Touch probe 1) is stored. (pos units)
60BBh	—	VAR	Touch probe 1 negative edge	The falling edge position of TPR1 (Touch probe 1) is stored. (pos units)
60D1h	—	VAR	Touch probe time stamp 1 positive value	The time stamp at the rising edge of TPR1 (Touch probe 1) is stored. (ns)
60D2h	—	VAR	Touch probe time stamp 1 negative value	The time stamp at the falling edge of TPR1 (Touch probe 1) is stored. (ns)
60BCh	—	VAR	Touch probe 2 positive edge	The rising edge position of TPR2 (Touch probe 2) is stored. (pos units)
60BDh	—	VAR	Touch probe 2 negative edge	The falling edge position of TPR2 (Touch probe 2) is stored. (pos units)
60D3h	—	VAR	Touch probe time stamp 2 positive value	The time stamp at the rising edge of TPR2 (Touch probe 2) is stored. (ns)
60D4h	—	VAR	Touch probe time stamp 2 negative value	The time stamp at the falling edge of TPR2 (Touch probe 2) is stored. (ns)
2DE8h	—	VAR	Touch probe function 2	☞ Page 237 Details on [Touch probe function 2 (Obj. 2DE8h)]
2DE9h	—	VAR	Touch probe status 2	☞ Page 239 Details on [Touch probe status 2 (Obj. 2DE9h)]
2DEAh	—	VAR	Touch probe 3 positive edge	The rising edge position of TPR3 (Touch probe 3) is stored. (pos units)
2DEBh	—	VAR	Touch probe 3 negative edge	The falling edge position of TPR3 (Touch probe 3) is stored. (pos units)
2DF8h	—	VAR	Touch probe time stamp 3 positive value	The time stamp at the rising edge of TPR3 (Touch probe 3) is stored. (ns)
2DF9h	—	VAR	Touch probe time stamp 3 negative value	The time stamp at the falling edge of TPR3 (Touch probe 3) is stored. (ns)

■ Details on [Touch probe function (Obj. 60B8h)]

Bit	Description
0	0: Touch probe 1 disabled 1: Touch probe 1 enabled
1	0: Single trigger mode 1: Continuous trigger mode
2	0: Triggered by inputting touch probe 1 1: Triggered at the zero point of the encoder
3	(reserved) The value at reading is undefined. Set "0" when writing.
4	0: Stop sampling the rising edge of touch probe 1 1: Start sampling the rising edge of touch probe 1 If input of touch probe 1 is set as a trigger (bit 2 = 0), the position feedback latched at the rising edge of touch probe 1 is stored in [Touch probe 1 positive edge (Obj. 60BAh)], and the time stamp in [Touch probe time stamp 1 positive value (Obj. 60D1h)]. If the zero point of the encoder is set as a trigger (bit 2 = 1), the position feedback at passing the zero point of the encoder *1 is stored in [Touch probe 1 positive edge (Obj. 60BAh)].
5	0: Stop sampling the falling edge of touch probe 1 1: Start sampling the falling edge of touch probe 1 If input of touch probe 1 is set as a trigger (bit 2 = 0), the position feedback latched at the falling edge of touch probe 1 is stored in [Touch probe 1 negative edge (Obj. 60BBh)], and the time stamp in [Touch probe time stamp 1 negative value (Obj. 60D2h)]. If the zero point of the encoder is set as a trigger (bit 2 = 1), the position feedback at passing the zero point of the encoder *1 is stored in [Touch probe 1 negative edge (Obj. 60BBh)].
6	(reserved) The value at reading is undefined. Set "0" when writing.
7	
8	0: Touch probe 2 disabled 1: Touch probe 2 enabled
9	0: Single trigger mode 1: Continuous trigger mode
10	0: Triggered by inputting touch probe 2 1: Triggered at the zero point of the encoder
11	(reserved) The value at reading is undefined. Set "0" when writing.
12	0: Stop sampling the rising edge of touch probe 2 1: Start sampling the rising edge of touch probe 2 If input of touch probe 2 is set as a trigger (bit 10 = 0), the position feedback latched at the rising edge of touch probe 2 is stored in [Touch probe 2 positive edge (Obj. 60BCh)], and the time stamp in [Touch probe time stamp 2 positive value (Obj. 60D3h)]. If the zero point of the encoder is set as a trigger (bit 10 = 1), the position feedback at passing the zero point of the encoder *1 is stored in [Touch probe 2 positive edge (Obj. 60BCh)].
13	0: Stop sampling the falling edge of touch probe 2 1: Start sampling the falling edge of touch probe 2 If input of touch probe 2 is set as a trigger (bit 10 = 0), the position feedback latched at the falling edge of touch probe 2 is stored in [Touch probe 2 negative edge (Obj. 60BDh)], and the time stamp in [Touch probe time stamp 2 negative value (Obj. 60D4h)]. If the zero point of the encoder is set as a trigger (bit 10 = 1), the position feedback at passing the zero point of the encoder *1 is stored in [Touch probe 2 negative edge (Obj. 60BDh)].
14	(reserved) The value at reading is undefined. Set "0" when writing.
15	

*1 For linear servo motors, the zero point of the encoder is a position between homing stop intervals [pulse] (changeable with [Pr. PL01.2 Homing stop interval setting]) based on the linear encoder home position.

■ Details on [Touch probe function 2 (Obj. 2DE8h)]

Bit	Description
0	0: Touch probe 3 disabled 1: Touch probe 3 enabled
1	0: Single trigger mode 1: Continuous trigger mode
2	0: Triggered by inputting touch probe 3 1: Triggered at the zero point of the encoder
3	(reserved) The value at reading is undefined. Set "0" when writing.
4	0: Stop sampling the rising edge of touch probe 3 1: Start sampling the rising edge of touch probe 3 If input of touch probe 3 is set as a trigger (bit 2 = 0), the position feedback latched at the rising edge of touch probe 3 is stored in [Touch probe 3 positive edge (Obj. 2DEAh)], and the time stamp in [Touch probe time stamp 3 positive value (Obj. 2DF8h)]. If the zero point of the encoder is set as a trigger (bit 2 = 1), the position feedback at passing the zero point of the encoder *1 is stored in [Touch probe 3 positive edge (Obj. 2DEAh)].
5	0: Stop sampling the falling edge of touch probe 3 1: Start sampling the falling edge of touch probe 3 If input of touch probe 3 is set as a trigger (bit 2 = 0), the position feedback latched at the falling edge of touch probe 3 is stored in [Touch probe 3 negative edge (Obj. 2DEBh)], and the time stamp in [Touch probe time stamp 3 negative value (Obj. 2DF9h)]. If the zero point of the encoder is set as a trigger (bit 2 = 1), the position feedback at passing the zero point of the encoder *1 is stored in [Touch probe 3 negative edge (Obj. 2DEBh)].
6	(reserved) The value at reading is undefined. Set "0" when writing.
7	
8 to 15	

*1 For linear servo motors, the zero point of the encoder is a position between homing stop intervals [pulse] (changeable with [Pr. PL01.2 Homing stop interval setting]) based on the linear encoder home position.

■ Details on [Touch probe status (Obj. 60B9h)]

Bit	Description
0	0: Touch probe 1 disabled 1: Touch probe 1 enabled
1	0: The data at the rising edge of touch probe 1 has not been stored. 1: The data at the rising edge of touch probe 1 has been stored. When the position feedback is stored in [Touch probe 1 positive edge (Obj. 60BAh)] and the time stamp is stored in [Touch probe time stamp 1 positive value (Obj. 60D1h)], "1" is set. This bit is cleared to "0" when bit 4 of [Touch probe function (Obj. 60B8h)] is set to "0".
2	0: The data at the falling edge of touch probe 1 has not been stored. 1: The data at the falling edge of touch probe 1 has been stored. When the position feedback is stored in [Touch probe 1 negative edge (Obj. 60BBh)] and the time stamp is stored in [Touch probe time stamp 1 negative value (Obj. 60D2h)], "1" is set. This bit is cleared to "0" when bit 5 of [Touch probe function (Obj. 60B8h)] is set to "0".
3 to 5	(reserved) The value at reading is undefined. Set "0" when writing.
6	Toggle status for latch completion at the rising edge of touch probe 1 0 or 1: When bit 1 of [Touch probe function (Obj. 60B8h)] is set to "1" (continuous trigger mode), the status toggles between "0" and "1" every time the position feedback is stored in [Touch probe 1 positive edge (Obj. 60BAh)] and the time stamp is stored in [Touch probe time stamp 1 positive value (Obj. 60D1h)].
7	Toggle status for latch completion at the falling edge of touch probe 1 0 or 1: When bit 1 of [Touch probe function (Obj. 60B8h)] is set to "1" (continuous trigger mode), the status toggles between "0" and "1" every time the position feedback is stored in [Touch probe 1 negative edge (Obj. 60BBh)] and the time stamp is stored in [Touch probe time stamp 1 negative value (Obj. 60D2h)].
8	0: Touch probe 2 disabled 1: Touch probe 2 enabled
9	0: The data at the rising edge of touch probe 2 has not been stored. 1: The data at the rising edge of touch probe 2 has been stored. When the position feedback is stored in [Touch probe 2 positive edge (Obj. 60BCh)] and the time stamp is stored in [Touch probe time stamp 2 positive value (Obj. 60D3h)], "1" is set. This bit is cleared to "0" when bit 9 of [Touch probe function (Obj. 60B8h)] is set to "0".
10	0: The data at the falling edge of touch probe 2 has not been stored. 1: The data at the falling edge of touch probe 2 has been stored. When the position feedback is stored in [Touch probe 2 negative edge (Obj. 60BDh)] and the time stamp is stored in [Touch probe time stamp 2 negative value (Obj. 60D4h)], "1" is set. This bit is cleared to "0" when bit 10 of [Touch probe function (Obj. 60B8h)] is set to "0".
11 to 13	(reserved) The value at reading is undefined. Set "0" when writing.
14	Toggle status for latch completion at the rising edge of touch probe 2 0 or 1: When bit 9 of [Touch probe function (Obj. 60B8h)] is set to "1" (continuous trigger mode), the status toggles between "0" and "1" every time the position feedback is stored in [Touch probe 2 positive edge (Obj. 60BCh)] and the time stamp is stored in [Touch probe time stamp 2 positive value (Obj. 60D3h)].
15	Toggle status for latch completion at the falling edge of touch probe 2 0 or 1: When bit 9 of [Touch probe function (Obj. 60B8h)] is set to "1" (continuous trigger mode), the status toggles between "0" and "1" every time the position feedback is stored in [Touch probe 2 negative edge (Obj. 60BDh)] and the time stamp is stored in [Touch probe time stamp 2 negative value (Obj. 60D4h)].

■ Details on [Touch probe status 2 (Obj. 2DE9h)]

Bit	Description
0	0: Touch probe 3 disabled 1: Touch probe 3 enabled
1	0: The position at the rising edge of touch probe 3 has not been stored. 1: The position at the rising edge of touch probe 3 has been stored. When the position feedback is stored in [Touch probe 3 positive edge (Obj. 2DEAh)] and the time stamp is stored in [Touch probe time stamp 3 positive value (Obj. 2DF8h)], "1" is set. This bit is cleared to "0" when bit 4 of [Touch probe function 2 (Obj. 2DE8h)] is set to "0".
2	0: The position at the falling edge of touch probe 3 has not been stored. 1: The position at the falling edge of touch probe 3 has been stored. When the position feedback is stored in [Touch probe 3 negative edge (Obj. 2DEBh)] and the time stamp is stored in [Touch probe time stamp 3 negative value (Obj. 2DF9h)], "1" is set. This bit is cleared to "0" when bit 5 of [Touch probe function 2 (Obj. 2DE8h)] is set to "0".
3 to 5	(reserved) The value at reading is undefined.
6	Toggle status for latch completion at the rising edge of touch probe 3 0 or 1: When bit 1 of [Touch probe function 2 (Obj. 2DE8h)] is set to "1" (continuous trigger mode), the status toggles between "0" and "1" every time the position feedback is stored in [Touch probe 3 positive edge (Obj. 2DEAh)] and the time stamp is stored in [Touch probe time stamp 3 positive value (Obj. 2DF8h)].
7	Toggle status for latch completion at the falling edge of touch probe 3 0 or 1: When bit 1 of [Touch probe function 2 (Obj. 2DE8h)] is set to "1" (continuous trigger mode), the status toggles between "0" and "1" every time the position feedback is stored in [Touch probe 3 negative edge (Obj. 2DEBh)] and the time stamp is stored in [Touch probe time stamp 3 negative value (Obj. 2DF9h)].
8 to 15	(reserved) The value at reading is undefined.

Timing chart

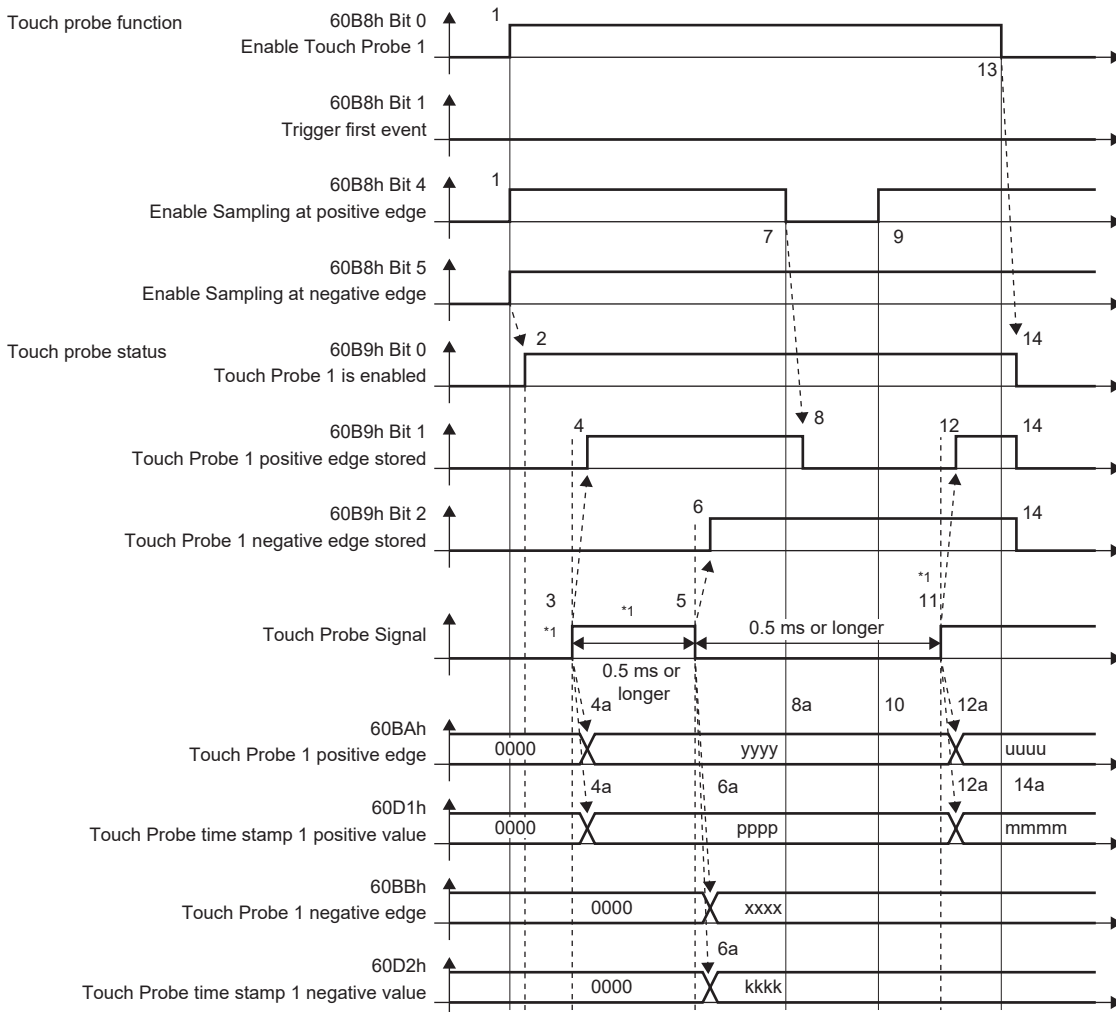

*1 Change "Touch Probe Signal" so that both the on-time and off-time are 0.5 ms or longer.

Transition No.	Object	Description
1	60B8h Bit 0, 4, 5 = 1	Enables Touch Probe1. The rising edge and falling edge are enabled.
2	→ 60B9h Bit 0 = 1	Turns on the Touch Probe1 enable status.
3	—	Turns on Touch Probe Signal (TPR1).
4	→ 60B9h Bit 1 = 1	Turns on the Touch Probe1 positive edge stored status.
4a	→ 60BAh, 60D1h	Sets the latched position feedback for Touch probe 1 positive edge and the latched time stamp for Touch probe time stamp 1 positive value.
5	—	Turns off Touch Probe Signal (TPR1).
6	→ 60B9h Bit 2 = 1	Turns on the Touch Probe1 negative edge stored status.
6a	→ 60BBh, 60D2h	Sets the latched position feedback for Touch probe 1 negative edge and the latched time stamp for Touch probe time stamp 1 negative value.
7	60B8h Bit 4 = 0	Turns off Sample positive edge. Rising edge detection is disabled.
8	→ 60B9h Bit 1 = 0	Turns off the Touch Probe1 positive edge stored status.
8a	→ 60BAh, 60D1h	Touch probe 1 positive edge and Touch probe time stamp 1 positive value do not change.
9	60B8h Bit 4 = 1	Turns on Sample positive edge. Rising edge detection is enabled.
10	→ 60BAh, 60D1h	Touch probe 1 positive edge and Touch probe time stamp 1 positive value do not change.
11	—	Turns on Touch Probe Signal (TPR1).
12	→ 60B9h Bit 1 = 1	Turns on the Touch Probe1 positive edge stored status.
12a	→ 60BAh, 60D1h	Sets the latched position feedback for Touch probe 1 positive edge and the latched time stamp for Touch probe time stamp 1 positive value.
13	60B8h Bit 0 = 0	Disables Touch Probe1.





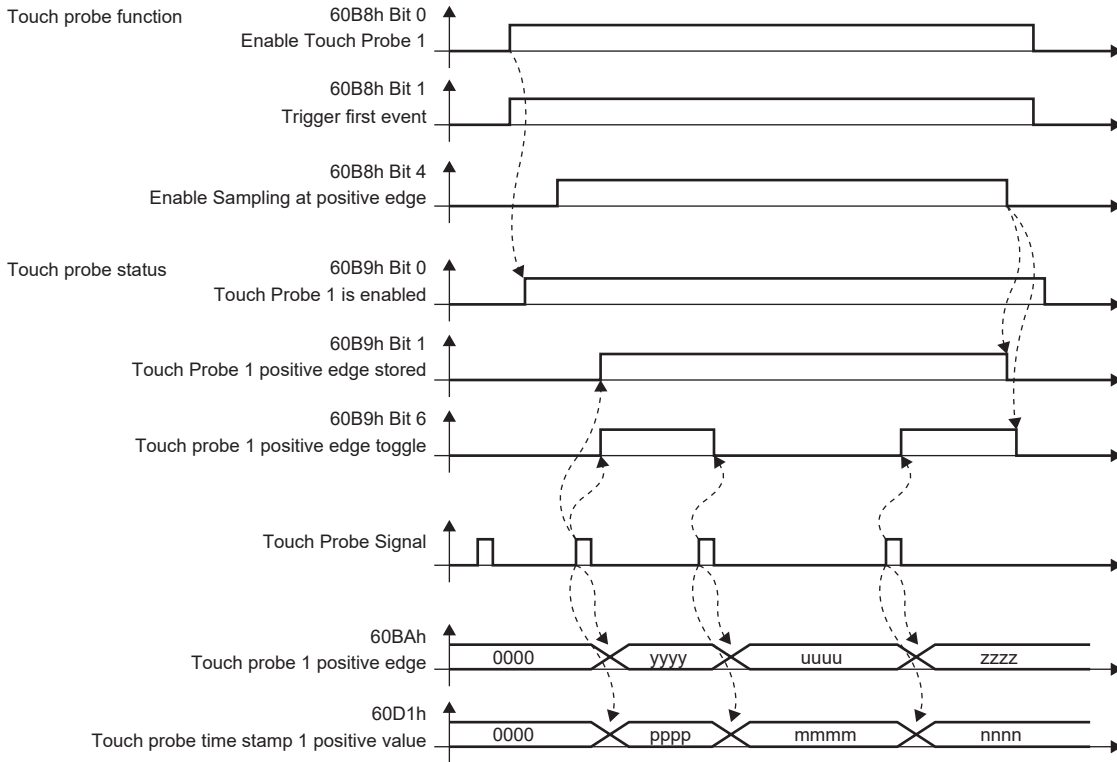



Transition No.	Object	Description
14	→ 60B9h Bit 0, 1, 2 = 0	Clears all the status bits.
14a	→ 60BAh, 60BBh, 60D1h, 60D2h	Touch probe 1 positive/negative edge and Touch probe time stamp 1 positive/negative value do not change.

The following shows a timing chart of Bit 6 of [Touch probe status (Obj. 60B9h)]. Bit 7 of [Touch probe status (Obj. 60B9h)] changes when latching completes at the falling edge.



4.5 Machine diagnosis

The machine diagnosis function estimates the friction and vibrational component of the drive system in the equipment based on the data in the servo amplifier and detects errors in machine parts such as ball screws and bearings. The machine diagnosis function features the following functions:

Diagnosis target	Diagnosis item	Diagnosis function	Outline	Detailed explanation
Linear guide Ball screw	Static friction/dynamic friction	Friction estimation function	The friction estimation function estimates and detects the static friction (including gravity) and the dynamic friction of guides and ball screws after operation is performed in any operation pattern.	 Page 243 Friction vibration estimation function
		Friction failure prediction function	The friction failure prediction function predicts device failure based on the friction estimated by the friction vibration estimation function.	 Page 249 Friction failure prediction function
	Servo motor vibration torque	Vibration estimation function	The vibration estimation function estimates and detects the vibration level both during servo motor operation and at a servo motor stop, and vibration frequency both during servo motor operation and at a servo motor stop, after operation is performed in any operation pattern.	 Page 243 Friction vibration estimation function
		Vibration failure prediction function	The vibration failure prediction function predicts device failure based on the vibration level that has been estimated with the vibration estimation function during servo motor operation.	 Page 258 Vibration failure prediction function
Servo motor Equipment parts	Motor total travel distance	Total travel distance failure prediction function	The total travel distance failure prediction function predicts failures of the equipment and the servo motor, based on the servo motor total travel distance.	 Page 264 Total travel distance failure prediction function
Gear	Backlash value	Backlash estimation function	The backlash amount of the gear connected to the servo motor is estimated from the servo motor drive status.	 Page 271 Gear failure diagnosis function
		Gear failure diagnosis function	Gear failure is predicted based on the estimated backlash amount.	 Page 271 Gear failure diagnosis function
Belt	Belt tension	Friction failure prediction function	For the static friction failure prediction function, the deterioration in belt tension is predicted by the increase/decrease of the static friction estimated by the friction estimation function.	 Page 285 Belt diagnosis function
		Belt tension deterioration prediction function	The belt tension deterioration prediction function estimates the belt tension from the servo amplifier internal data and predicts when the belt tension is below the set threshold using the belt tension servo parameter.	 Page 285 Belt diagnosis function

Friction vibration estimation function

In the friction vibration estimation function, the friction estimation function estimates the friction of the drive system in the equipment, and the vibration estimation function estimates the minute vibration level and vibration frequency based on the data in the servo amplifier. The friction estimation function estimates and detects the static friction (including gravity) and the dynamic friction of guides and ball screws after operation is performed in any operation pattern. The vibration estimation function estimates and detects the vibration level both during servo motor operation and at a servo motor stop, and vibration frequency both during servo motor operation and at a servo motor stop, after operation is performed in any operation pattern.

Restriction

- If the vibration frequency is extremely low or high, vibration estimation cannot be performed. For example, low frequency vibrations of several 10 Hz cannot be detected on a low rigidity machine.
 - When there is vibration with multiple frequencies at the same time, such as multiple mechanical resonances, the vibration frequency may not be estimated properly.
 - Vibration frequency may not be estimated properly if the torque reaches the limit value. To prevent the excessive torque vibrations, set a longer acceleration/deceleration time for the command, or slightly decrease the gains.
 - The friction failure prediction function and the static friction failure estimation function cannot be used together at the same time. [AL. 037 Parameter error] occurs if both the friction failure prediction function and the static friction failure prediction function are enabled at the same time.
-

Precautions

- It is recommended that the values estimated by the friction vibration estimation function be saved at the start of operation. By comparing the value estimated by the friction vibration estimation function after the start of operation and with the value at the start of operation, how much the machine is aged after operation can be learned, which is useful for preventive maintenance.

Setting method [G] [B]

■ Friction estimation function

1. Startup the system.
2. When the maximum operation speed is under the rated speed, set [Pr. PF31] to half of the maximum speed during operation. Alternatively, set [Pr. PF34.6] to "1" (automatic setting) to automatically calculate [Pr. PF31].
3. Drive the servo motor.
4. The static friction and the dynamic friction (at rated speed) are estimated.
5. Save the data of the estimated static friction and dynamic friction.

Servo parameter	Symbol	Name	Description
PF31	FRIC	Machine diagnosis function - Friction estimate area judgment speed at low speed	Set the servo motor speed to divide the friction estimation area between low-speed and high-speed in the friction estimation process of machine diagnosis. When the maximum operation speed is under the rated speed, it is recommended to set half the value of the maximum operation speed. *1*2 Setting [Pr. PF34.6 Friction estimate area judgment speed setting] to "1" (automatic setting) will automatically calculate the servo parameter value from the operation pattern during servo motor driving. When this servo parameter value is calculated automatically, this servo parameter value is automatically rewritten to the calculation result. Initial value: 0 [r/min], [mm/s]
PF34.6	*MFP	Friction estimate area judgment speed setting	Set the setting method for Machine diagnosis function - Friction estimate area judgment speed at low speed. 0: Manual setting (Initial value) 1: Automatic setting When "1" (automatic setting) is set, [Pr. PF31] will be calculated according to the servo motor operation pattern. After the calculation, [Pr. PF31] is rewritten to the calculation result, and the servo parameter will change to "0" (manual setting). When "1" (automatic setting) is set, friction estimation stops.

*1 When "0" is set, the value is set to half the rated speed.

*2 The setting value will be clamped at the maximum speed. When changing the speed to the permissible speed, set the speed in [Pr. PA28.4 Speed range limit selection].

■ Vibration estimation function

Setting is not required. The servo amplifier constantly estimates the vibration in the operation pattern.

1. Startup the system.
2. Drive the servo motor.
3. The vibration level and vibration frequency are estimated.
4. Save the estimated vibration level and vibration frequency.

Setting method [A]

■ Friction estimation function

1. Startup the system.
2. When the maximum operation speed is under the rated speed, set [Pr. PF31] to half of the maximum speed during operation. Alternatively, set [Pr. PF34.6] to "1" (automatic setting) to automatically calculate [Pr. PF31].
3. Drive the servo motor.
4. The static friction and the dynamic friction (at rated speed) are estimated.
5. Save the data of the estimated static friction and dynamic friction.

Servo parameter	Symbol	Name	Description
PF31	FRIC	Machine diagnosis function - Friction estimate area judgment speed at low speed	Set the servo motor speed to divide the friction estimation area between low-speed and high-speed in the friction estimation process of machine diagnosis. When the maximum operation speed is under the rated speed, it is recommended to set half the value of the maximum operation speed. *1*2 Setting [Pr. PF51.6 Friction estimate area judgment speed setting] to "1" (automatic setting) will automatically calculate the servo parameter value from the operation pattern during servo motor driving. When this servo parameter value is calculated automatically, this servo parameter value is automatically rewritten to the calculation result. Initial value: 0 [r/min], [mm/s]
PF51.6	*MFP	Friction estimate area judgment speed setting	Set the setting method for Machine diagnosis function - Friction estimate area judgment speed at low speed. 0: Manual setting (Initial value) 1: Automatic setting When "1" (automatic setting) is set, [Pr. PF31] will be calculated according to the servo motor operation pattern. After the calculation, [Pr. PF31] is rewritten to the calculation result, and the servo parameter will change to "0" (manual setting). When "1" (automatic setting) is set, friction estimation stops.

*1 When "0" is set, the value is set to half the rated speed.

*2 The setting value will be clamped at the maximum speed. When changing the speed to the permissible speed, set the speed in [Pr. PA28.4 Speed range limit selection].

■ Vibration estimation function

Setting is not required. The servo amplifier constantly estimates the vibration in the operation pattern.

1. Startup the system.
2. Drive the servo motor.
3. The vibration level and vibration frequency are estimated.
4. Save the estimated vibration level and vibration frequency.

Friction estimation function

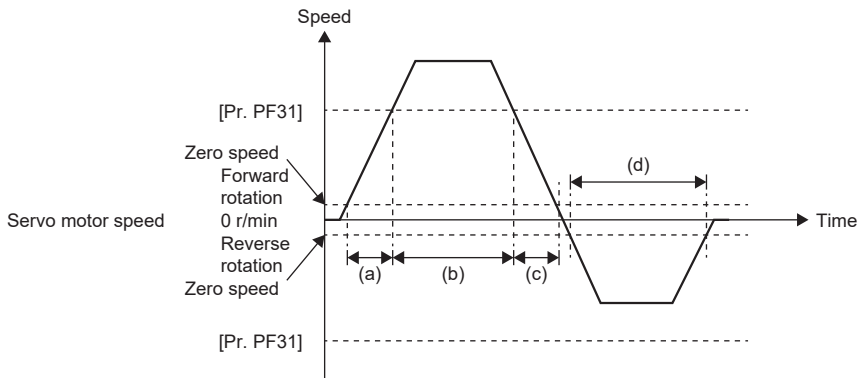

To perform friction estimation, the servo motor must be rotated at zero speed or higher, and operated for 150 s both in the high and low-speed sections. The high speed indicates the section where the absolute value of the servo motor speed is equal to or higher than [Pr. PF31 Machine diagnosis function - Friction estimate area judgment speed at low speed], whereas the low speed indicates the section where the absolute value of the servo motor speed is less than [Pr. PF31]. For the above operation pattern, when (a) + (c) is 150 s or more and (b) is 150 s or more, the friction in the forward rotation direction is estimated. The friction in the reverse rotation direction is estimated even if time (d) is 150 s or more because the servo motor is not operated in the high-speed section. In this case, decrease the setting value of [Pr. PF31] to perform friction estimation. When [Pr. PF31] is set to "0", the threshold is 1/2 of the rated speed.

For the following operation pattern, it takes approximately 20 min. to finish friction estimation.

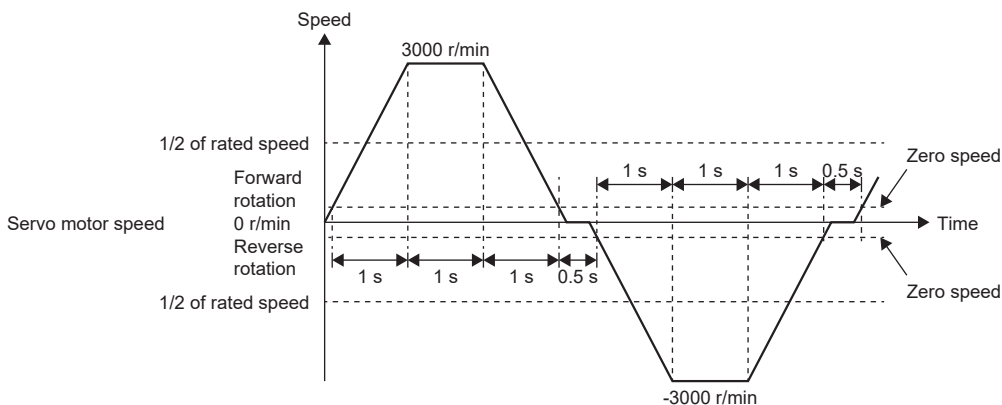

The friction estimation function estimates the static friction both at forward rotation and reverse rotation, and the dynamic friction (at rated speed) both at forward rotation and reverse rotation. To estimate these values, it is unnecessary to perform to-and-fro positioning operation. When the servo motor is operated in acceleration/deceleration for forward rotation, only the static friction and dynamic friction (at rated speed) at forward rotation can be estimated. When the servo motor is operated in acceleration/deceleration for reverse rotation, only the static friction and dynamic friction (at rated speed) at reverse rotation can be estimated.

The progress of the friction estimation can be checked by using MR Configurator2 or a controller. When using MR Configurator2 to check the progress, open the machine diagnosis screen. The progress can also be checked by the controller by using [Friction estimate status (Obj. 2C31h)].

Vibration estimation function

The vibration estimation function monitors torque vibrations to estimate high-frequency, minute vibration levels and vibration frequencies. An increase in the vibration level and a change in the vibration frequency due to excess play or deterioration in guides, ball screws, and belts can be observed.

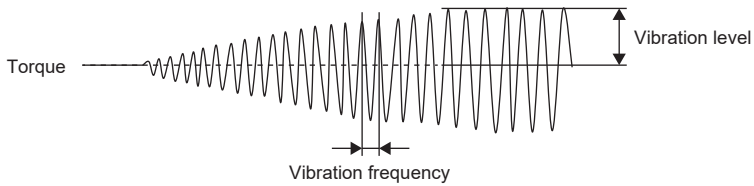

The vibration estimation function estimates the vibration level and vibration frequency respectively during servo motor operation and at a servo motor stop. Vibration levels and frequencies during servo motor operation and during servo motor stop are estimated separately.

Related objects [G]

For details on the objects, refer to the User's Manual (Object Dictionary).

index	Sub	Object	Name	Description
2C20h	0	VAR	Machine diagnostic status	The machine diagnostic status is returned. [Bit 0 to 3: Friction estimation status at forward rotation] **1*2 0: Estimation in progress. (normal) 1: Estimation has finished. (normal) 2: The motor may have rotated/traveled more frequently in one direction than the other. (warning) 3: The servo motor speed may be too slow for friction estimation. (warning) 4: The change in the servo motor speed may be too small for friction estimation. (warning) 5: The acceleration/deceleration time constants may be too short for friction estimation. (warning) 6: The operation time may be insufficient. (warning) [Bit 4 to 7: Friction estimation status at reverse rotation] **1*2 0: Estimation in progress. (normal) 1: Estimation has finished. (normal) 2: The motor may have rotated/traveled more frequently in one direction than the other. (warning) 3: The servo motor speed may be too slow for friction estimation. (warning) 4: The change in the servo motor speed may be too small for friction estimation. (warning) 5: The acceleration/deceleration time constants may be too short for friction estimation. (warning) 6: The operation time may be insufficient. (warning) [Bit 8 to 11: Vibration estimation status] 0: Estimation in progress. 1: Estimation has finished. [Bit 12 to 15: reserved]
2C21h	0	VAR	Static friction torque at forward rotation	The static friction at forward rotation torque is returned. Unit: 0.1 % (with rated torque being 100 %)
2C22h	0	VAR	Dynamic friction torque at forward rotation (at rated speed)	The dynamic friction at forward rotation torque at the rated speed is returned. Unit: 0.1 % (with rated torque being 100 %)
2C23h	0	VAR	Static friction torque at reverse rotation	The static friction at reverse rotation torque is returned. Unit: 0.1 % (with rated torque being 100 %)
2C24h	0	VAR	Dynamic friction torque at reverse rotation (at rated speed)	The dynamic friction at reverse rotation torque at the rated speed is returned. Unit: 0.1 % (with rated torque being 100 %)
2C25h	0	VAR	Oscillation frequency during motor stop	The vibration frequency during stop/servo-lock is returned. Unit: [Hz]
2C26h	0	VAR	Vibration level during motor stop	The vibration level during stop/servo-lock is returned. Unit: 0.1 % (with rated torque being 100 %)
2C27h	0	VAR	Oscillation frequency during motor operating	The vibration frequency during operation is returned. Unit: [Hz]
2C28h	0	VAR	Vibration level during motor operating	The vibration level during operation is returned. Unit: 0.1 % (with rated torque being 100 %)
2C31h	0	VAR	Friction estimate status	The progress of friction estimation is returned. Unit: [%]

*1 When warning conditions for 2 to 6 are established at the same time, the smallest number is returned.

*2 Once an estimation finishes even after a warning has occurred, the status will change to "Estimation has finished".

Friction failure prediction function

The friction failure prediction function predicts device failure based on the dynamic friction (at rated speed) estimated by the friction vibration estimation function.



- In the torque mode, the friction failure prediction function cannot be used.

Precautions [G] [B]

- To create a dynamic friction threshold with the automatic threshold setting in the friction failure prediction function, the equipment must be operated for 3 consecutive hours or more, and operated in the position or velocity mode for a cumulative time of 90 hours or more after the machine total travel distance exceeds 1/2 of [Pr. PF41 Failure prediction - Servo motor total travel distance].
- The threshold value when using the friction failure prediction function and the vibration failure prediction function can be checked with MR Configurator2 or controller.

Precautions [A]

- To create a dynamic friction threshold with the automatic threshold setting in the friction failure prediction function, the equipment must be operated for 3 consecutive hours or more, and operated in the position or velocity mode for a cumulative time of 90 hours or more after the machine total travel distance exceeds 1/2 of [Pr. PF53 Failure prediction - Servo motor total travel distance].
- The threshold value when using the friction failure prediction function and the vibration failure prediction function can be checked with MR Configurator2.

Setting method [G] [B]

The friction failure prediction function predicts a failure of the equipment from the increase and decrease in the dynamic friction (at rated speed) estimated by the friction estimation function. If a failure of the equipment is predicted, [AL. 0F7.2 Friction failure prediction warning] will occur. Set the friction failure prediction function in accordance with the following course:

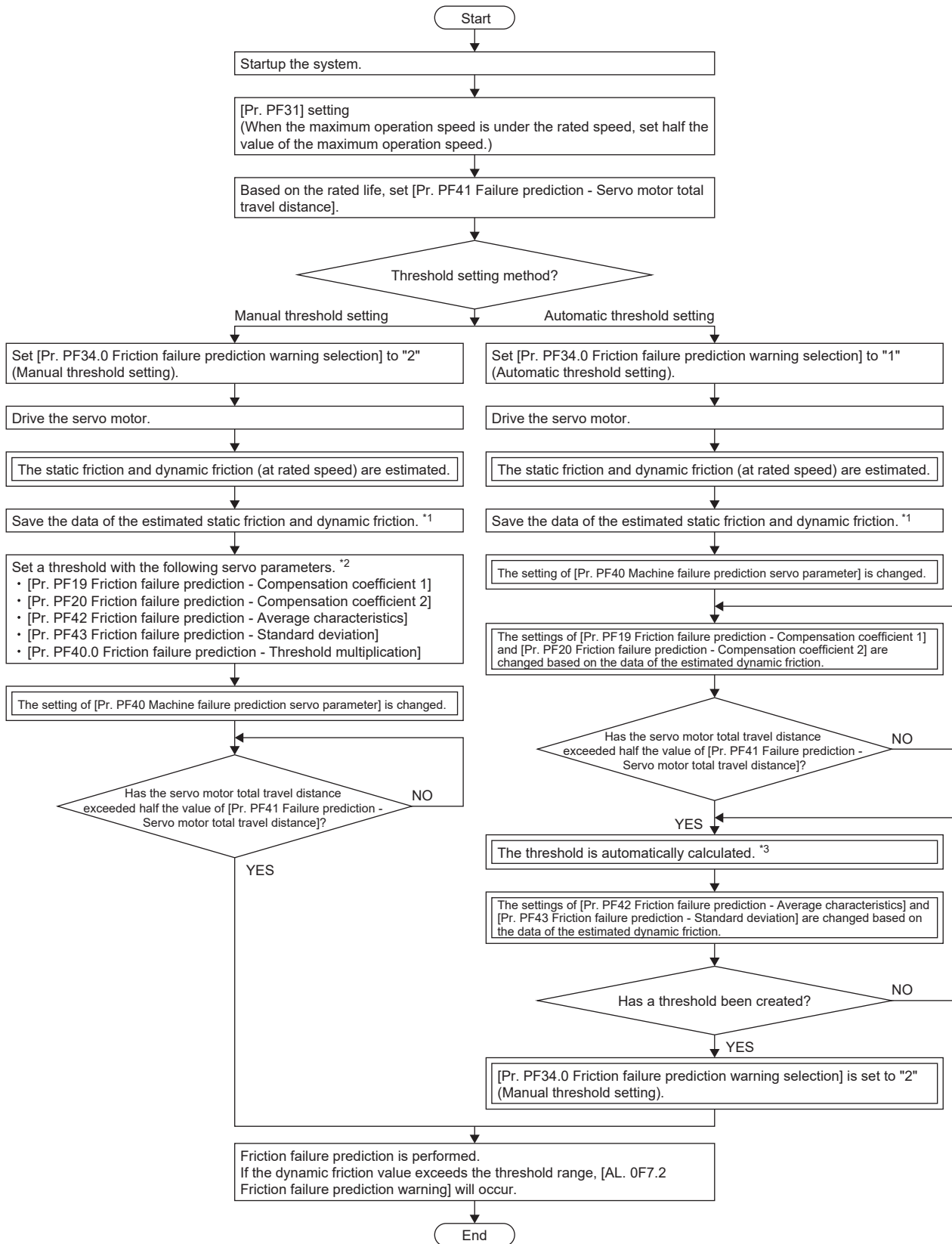

- *1 The data of the estimated static friction and dynamic friction can be saved on the machine diagnosis screen of MR Configurator2.
- *2 Setting the value estimated by the automatic threshold setting in [Pr. PF19] and [Pr. PF20] reduces the possibility of an erroneous detection for failure prediction although the function operates properly with the initial value of [Pr. PF19] and [Pr. PF20].
- *3 If the equipment has been operated for less than continuous three hours, or the friction estimation has not finished for the travel direction set in [Pr. PF40], the threshold is not calculated automatically.

For the friction failure prediction function, the threshold that triggers [AL. 0F7.2 Friction failure prediction warning] can be set using the following two methods.

■ Automatic threshold setting

This is a method to automatically calculate the threshold for triggering [AL. 0F7.2 Friction failure prediction warning] using the dynamic friction (at rated speed) estimated by the friction estimation function. With this setting, the friction failure prediction function can be used without setting a threshold. However, after the machine total travel distance exceeds 1/2 of [Pr. PF41 Failure prediction - Servo motor total travel distance], a threshold is not automatically set until the equipment is operated continuously for 3 hours or more, and operated in the position mode or velocity mode for a cumulative time of 90 hours or more. [AL. 0F7.2 Friction failure prediction warning] does not occur until the calculation of the threshold value in the servo amplifier is complete.

■ Manual threshold setting

This is a method of setting a threshold that triggers [AL. 0F7.2 Friction failure prediction warning] with [Pr. PF40.0 Friction failure prediction - Threshold multiplication], [Pr. PF42 Friction failure prediction - Average characteristics], or [Pr. PF43 Friction failure prediction - Standard deviation]. For the manual threshold setting, friction failure prediction starts when the machine total travel distance exceeds 1/2 of [Pr. PF41 Failure prediction - Servo motor total travel distance]. Thus, if the dynamic friction threshold is known, or the equipment is configured the same as another piece of equipment used for calculating the threshold with the automatic threshold setting, an initial failure and other types of failures can also be detected with the manual threshold setting.

When performing manual threshold setting on the equipment for which automatic threshold setting has been made once, set the value, which is obtained by the automatic threshold setting, in [Pr. PF19 Friction failure prediction - Compensation coefficient 1] and [Pr. PF20 Friction failure prediction - Compensation coefficient 2]. Setting [Pr. PF19 Friction failure prediction - Compensation coefficient 1] and [Pr. PF20 Friction failure prediction - Compensation coefficient 2] reduces the possibility of erroneous detection of failure prediction.

■ Setting "Friction failure prediction warning"

Set [Pr. PF34.0 Friction failure prediction warning selection] to "1" (automatic threshold setting) or "2" (manual threshold setting) to enable the friction failure prediction warning.

Servo parameter	Symbol	Name	Outline
PF34.0	*MFP	Friction failure prediction warning selection	Use this servo parameter to enable the friction failure prediction warning. 0: Disabled (initial value) 1: Enabled (automatic threshold setting) 2: Enabled (manual threshold setting) 3: Threshold reset

■ Setting "Failure prediction - Servo motor total travel distance"

Set the "Failure prediction - Servo motor total travel distance" when using the automatic threshold setting. It is recommended that the servo motor total travel distance for failure prediction be set to about the same as the rated life suggested by the manufacturers of the guides and ball screws being used. For example, for a rated life of 8×10^5 rev, set [Pr. PF41 Failure prediction - Servo motor total travel distance] to "80000" [10 rev].

■ Threshold setting method

When the automatic threshold setting is used, [Pr. PF42 Friction failure prediction - Average characteristic] and [Pr. PF43 Friction failure prediction - Standard deviation] for determining the threshold value are automatically rewritten according to the dynamic friction (at rated speed) estimated inside the servo amplifier. At this time, the threshold can be changed with [Pr. PF40.0 Friction failure prediction - Threshold multiplication]. If [AL. 0F7.2 Friction failure prediction warning] is generated with the value calculated by the automatic threshold setting, set [Pr. PF40.0 Friction failure prediction - Threshold multiplication] to "6" or more. After the threshold is calculated in the servo amplifier, [Pr. PF34.0 Friction failure prediction warning selection] changes to "2" (manual threshold setting).

For the manual threshold setting, the upper and lower limit thresholds can be calculated with the equations below. When [Pr. PF40.0 Friction failure prediction - Threshold multiplication] is "0", the upper and lower limit thresholds are calculated as "5".

Upper limit threshold [0.1 %] = [Pr. PF42] + [Pr. PF43] × [Pr. PF40.0]

Lower limit threshold [0.1 %] = [Pr. PF42] - [Pr. PF43] × [Pr. PF40.0]

■ Threshold reset method

To automatically reset thresholds after the upper and lower limit thresholds are set automatically, set [Pr. PF34.0 Friction failure prediction warning selection] to "3" (threshold reset), then cycle the power. After cycling the power, the threshold value is reset, and [Pr. PF34.0 Friction failure prediction warning selection] changes to "1" (threshold value automatic setting). If the equipment parts are replaced after starting the friction failure prediction function, reset the friction thresholds and servo motor total travel distance.

Setting method [A]

The friction failure prediction function predicts a failure of the equipment from the increase and decrease in the dynamic friction (at rated speed) estimated by the friction estimation function. If a failure of the equipment is predicted, [AL. 0F7.2 Friction failure prediction warning] will occur. Set the friction failure prediction function in accordance with the following course:

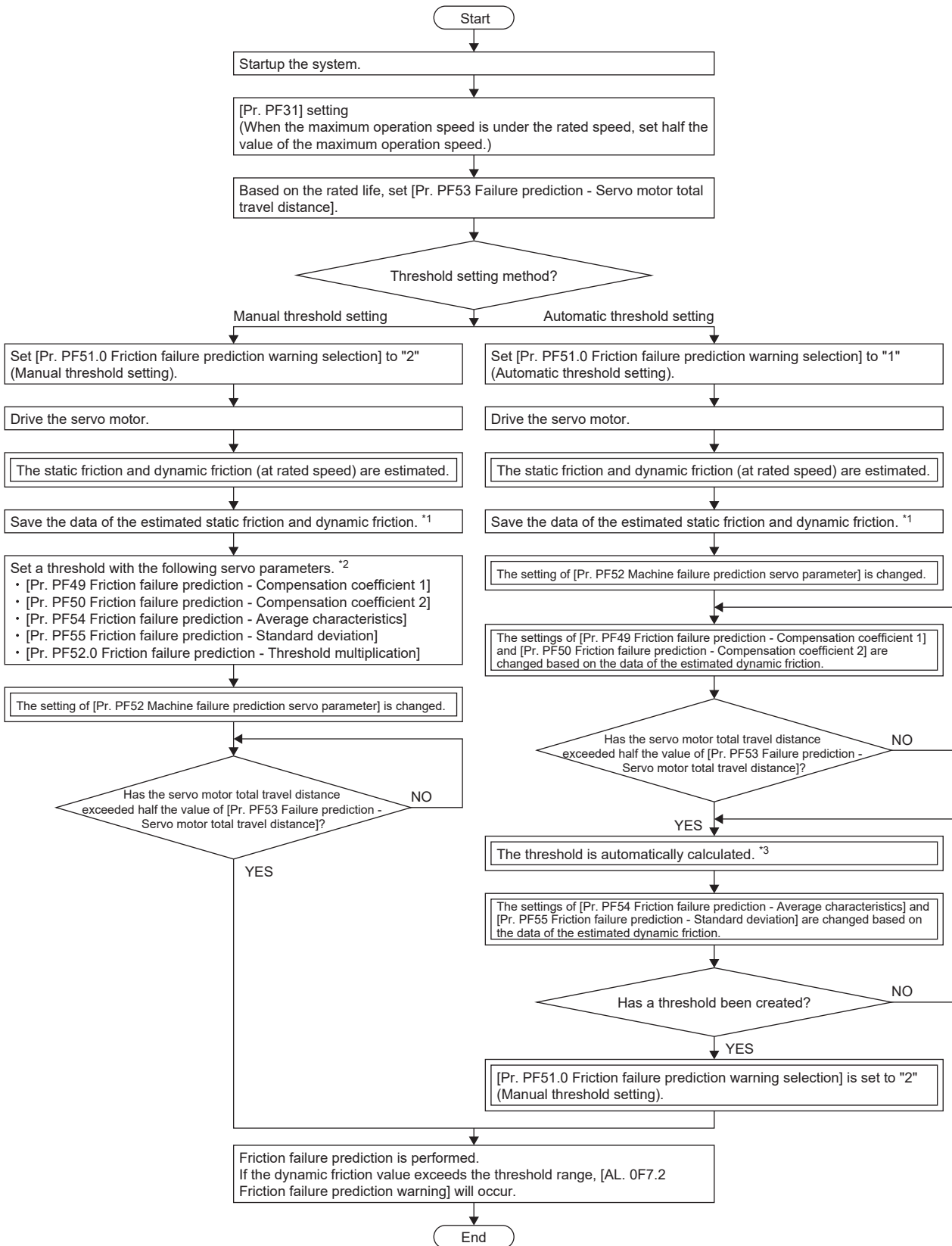

- *1 The data of the estimated static friction and dynamic friction can be saved on the machine diagnosis screen of MR Configurator2.
- *2 Setting the value estimated by the automatic threshold setting in [Pr. PF19] and [Pr. PF20] reduces the possibility of an erroneous detection for failure prediction although the function operates properly with the initial value of [Pr. PF19] and [Pr. PF20].
- *3 If the equipment has been operated for less than continuous three hours, or the friction estimation has not finished for the travel direction set in [Pr. PF40], the threshold is not calculated automatically.

For the friction failure prediction function, the threshold that triggers [AL. 0F7.2 Friction failure prediction warning] can be set using the following two methods.

■ Automatic threshold setting

This is a method to automatically calculate the threshold for triggering [AL. 0F7.2 Friction failure prediction warning] using the dynamic friction (at rated speed) estimated by the friction estimation function. With this setting, the friction failure prediction function can be used without setting a threshold. However, after the machine total travel distance exceeds 1/2 of [Pr. PF53 Failure prediction - Servo motor total travel distance], a threshold is not automatically set until the equipment is operated continuously for 3 hours or more, and operated in the position mode or velocity mode for a cumulative time of 90 hours or more. [AL. 0F7.2 Friction failure prediction warning] does not occur until the calculation of the threshold value in the servo amplifier is complete.

■ Manual threshold setting

This is a method of setting a threshold that triggers [AL. 0F7.2 Friction failure prediction warning] with [Pr. PF52.0 Friction failure prediction - Threshold multiplication], [Pr. PF54 Friction failure prediction - Average characteristics], or [Pr. PF55 Friction failure prediction - Standard deviation]. In manual threshold setting, friction failure prediction starts when the servo motor total travel distance exceeds 1/2 of [Pr. PF53 Failure prediction - Servo motor total travel distance]. Thus, if the dynamic friction threshold is known, or the equipment is configured the same as another piece of equipment used for calculating the threshold with the automatic threshold setting, an initial failure and other types of failures can also be detected with the manual threshold setting.

When performing manual threshold setting on the equipment for which automatic threshold setting has been made once, set the value, which is obtained by the automatic threshold setting, in [Pr. PF49 Friction failure prediction - Compensation coefficient 1] and [Pr. PF50 Friction failure prediction - Compensation coefficient 2]. Setting [Pr. PF49 Friction failure prediction - Compensation coefficient 1] and [Pr. PF50 Friction failure prediction - Compensation coefficient 2] reduces the possibility of erroneous detection of failure prediction.

■ Setting "Friction failure prediction warning"

Set [Pr. PF51.0 Friction failure prediction warning selection] to "1" (automatic threshold setting) or "2" (manual threshold setting) to enable the friction failure prediction warning.

Servo parameter	Symbol	Name	Outline
PF51.0	*MFP	Friction failure prediction warning selection	Use this servo parameter to enable the friction failure prediction warning. 0: Disabled (initial value) 1: Enabled (automatic threshold setting) 2: Enabled (manual threshold setting) 3: Threshold reset

■ Setting "Failure prediction - Servo motor total travel distance"

Set the "Failure prediction - Servo motor total travel distance" when using the automatic threshold setting. It is recommended that the servo motor total travel distance for failure prediction be set to about the same as the rated life suggested by the manufacturers of the guides and ball screws being used. For example, for a rated life of 8×10^5 rev, set [Pr. PF53 Failure prediction - Servo motor total travel distance] to "80000" [10 rev].

■ Threshold setting method

When the automatic threshold setting is used, [Pr. PF54 Friction failure prediction - Average characteristic] and [Pr. PF55 Friction failure prediction - Standard deviation] for determining the threshold value are automatically rewritten according to the dynamic friction (at rated speed) estimated inside the servo amplifier. At this time, the threshold can be changed with [Pr. PF52.0 Friction failure prediction - Threshold multiplication]. If [AL. 0F7.2 Friction failure prediction warning] is generated with the value calculated by the automatic threshold setting, set [Pr. PF52.0 Friction failure prediction - Threshold multiplication] to "6" or more. After the threshold is calculated in the servo amplifier, [Pr. PF51.0 Friction failure prediction warning selection] changes to "2" (manual threshold setting).

For the manual threshold setting, the upper and lower limit thresholds can be calculated with the equations below. When [Pr. PF52.0 Friction failure prediction - Threshold multiplication] is "0", the upper and lower limit thresholds are calculated as "5".

Upper limit threshold [0.1 %] = [Pr. PF54] + [Pr. PF55] × [Pr. PF52.0]

Lower limit threshold [0.1 %] = [Pr. PF54] - [Pr. PF55] × [Pr. PF52.0]

■ Threshold reset method

To automatically reset thresholds after the upper and lower limit thresholds are set automatically, set [Pr. PF51.0 Friction failure prediction warning selection] to "3" (threshold reset), then cycle the power. After cycling the power, the threshold value is reset, and [Pr. PF51.0 Friction failure prediction warning selection] changes to "1" (threshold value automatic setting). If the equipment parts are replaced after starting the friction failure prediction function, reset the friction thresholds and servo motor total travel distance.

Friction failure prediction [G] [B]

When upper and lower limit thresholds are input to the servo amplifier, the servo amplifier starts friction failure prediction. If the dynamic friction (at rated speed) estimated by the friction estimation function exceeds the upper or lower limit threshold during the friction failure prediction, [AL. 0F7.2 Friction failure prediction warning] occurs. After the occurrence of [AL. 0F7.2 Friction failure prediction warning], if the dynamic friction (at rated speed) falls within the upper and lower limit threshold, [AL. 0F7.2 Friction failure prediction warning] will be canceled.

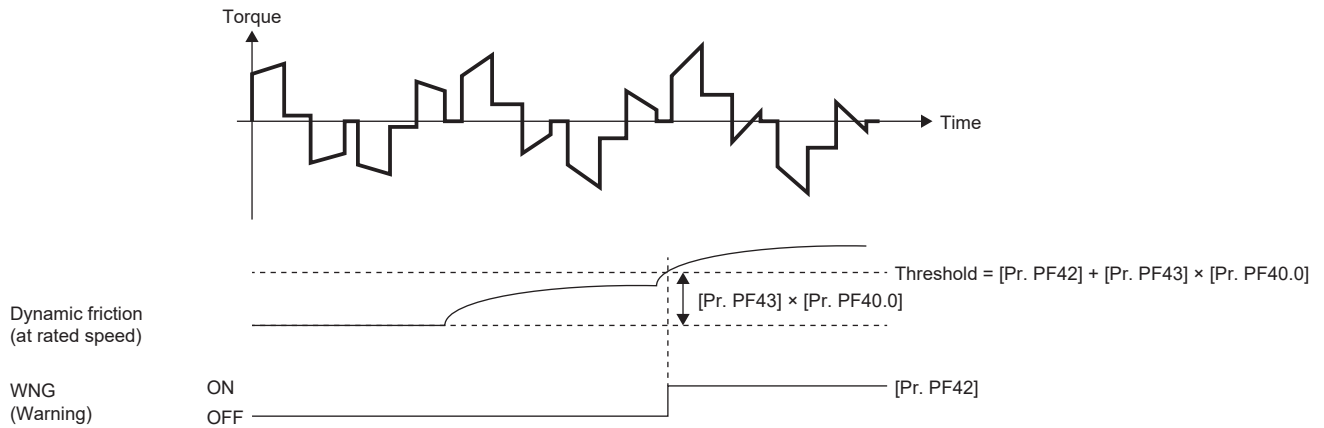

Friction failure prediction [A]

When upper and lower limit thresholds are input to the servo amplifier, the servo amplifier starts friction failure prediction. If the dynamic friction (at rated speed) estimated by the friction estimation function exceeds the upper or lower limit threshold during the friction failure prediction, [AL. 0F7.2 Friction failure prediction warning] occurs. After the occurrence of [AL. 0F7.2 Friction failure prediction warning], if the dynamic friction (at rated speed) falls within the upper and lower limit threshold, [AL. 0F7.2 Friction failure prediction warning] will be canceled.

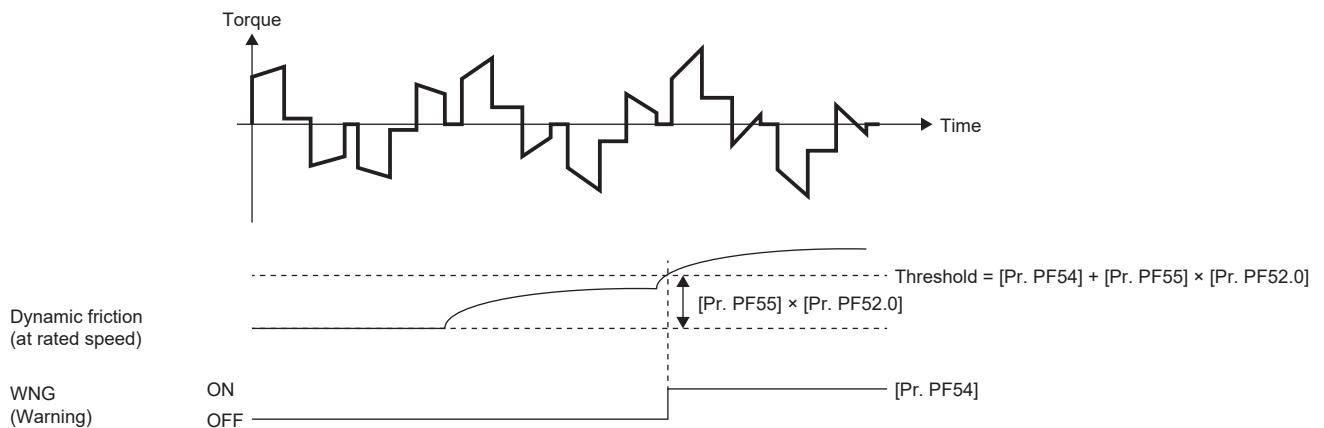

Related objects [G]

For details on the objects, refer to the User's Manual (Object Dictionary).

index	Sub	Object	Name	Description
2C29h	0	VAR	Fault prediction status	<p>[Bit 0 to 3: Friction failure prediction status]</p> <p>0: Friction failure prediction disabled</p> <p>1: During preparation for friction failure prediction</p> <p>2: During execution of friction failure prediction</p> <p>3: During friction failure prediction warning</p> <p>[Bit 4 to 7: Vibration failure prediction status]</p> <p>0: Vibration failure prediction disabled</p> <p>1: During preparation for vibration failure prediction</p> <p>2: During execution of vibration failure prediction</p> <p>3: During vibration failure prediction warning</p> <p>[Bit 8 to 11: Total travel distance failure prediction status]</p> <p>0: Motor total travel distance failure prediction disabled</p> <p>1: Motor total travel distance failure prediction being executed</p> <p>2: Motor total travel distance failure prediction at warning</p> <p>[Bit 12 to 15: Motor total travel distance calculation status]</p> <p>0: During stop of motor total travel distance calculation</p> <p>1: During calculation of motor total travel distance</p> <p>[Bit 16 to 19: reserved]</p> <p>[Bit 20 to 23: Static friction failure prediction status]</p> <p>0: Static friction failure prediction disabled</p> <p>1: During preparation for static friction failure prediction</p> <p>2: During execution of static friction failure prediction</p> <p>3: During static friction failure prediction warning</p> <p>[Bit 24 to 27: Belt tension deterioration prediction status]</p> <p>0: Belt tension deterioration prediction disabled</p> <p>1: Belt tension deterioration prediction in progress</p> <p>2: During belt tension deterioration warning</p> <p>[Bit 28 to 31: Belt tension estimation status]</p> <p>0: Belt tension estimation in progress</p> <p>1: Belt tension estimation has finished</p> <p>7: Belt tension estimation is not set</p>
2C2Ah	0	VAR	Friction based fault prediction upper threshold	<p>Friction failure prediction - Upper limit threshold</p> <p>The upper limit threshold used for friction failure prediction is displayed in increments of 0.1 % in relation to the rated torque as 100 %.</p>
2C2Bh	0	VAR	Friction based fault prediction lower threshold	<p>Friction failure prediction - Lower limit threshold</p> <p>The lower limit threshold used for friction failure prediction is displayed in increments of 0.1 % in relation to the rated torque as 100 %.</p>
2C2Ch	0	VAR	Friction based fault prediction prepare status	<p>Friction failure prediction - Preparation progress</p> <p>The threshold creation progress used for friction failure prediction is displayed as a percentage. Creation of friction failure prediction for the upper and lower limit threshold finishes at 100 %.</p>

Vibration failure prediction function

The vibration failure prediction function predicts device failure based on the vibration level that has been estimated with the friction vibration estimation function during servo motor operation.

Precautions

- When the vibration failure prediction function is enabled, a vibration failure warning may occur if the gains of the servo amplifier are changed. Enable the vibration failure prediction function after the gains of the servo amplifier are adjusted.
- To create a vibration level threshold with the automatic threshold setting in the vibration failure prediction function, the equipment must be operated for three consecutive hours or longer, and be in the position or velocity mode for a cumulative time of 90 hours or longer.

Setting method [G] [B]

The vibration prediction function predicts a failure of the equipment with the increase of the vibration level, which is estimated by the vibration estimation function. If a failure of the equipment is predicted from the vibration, [AL. 0F7.1 Vibration failure prediction warning] occurs. Set the vibration failure prediction function in the following order:

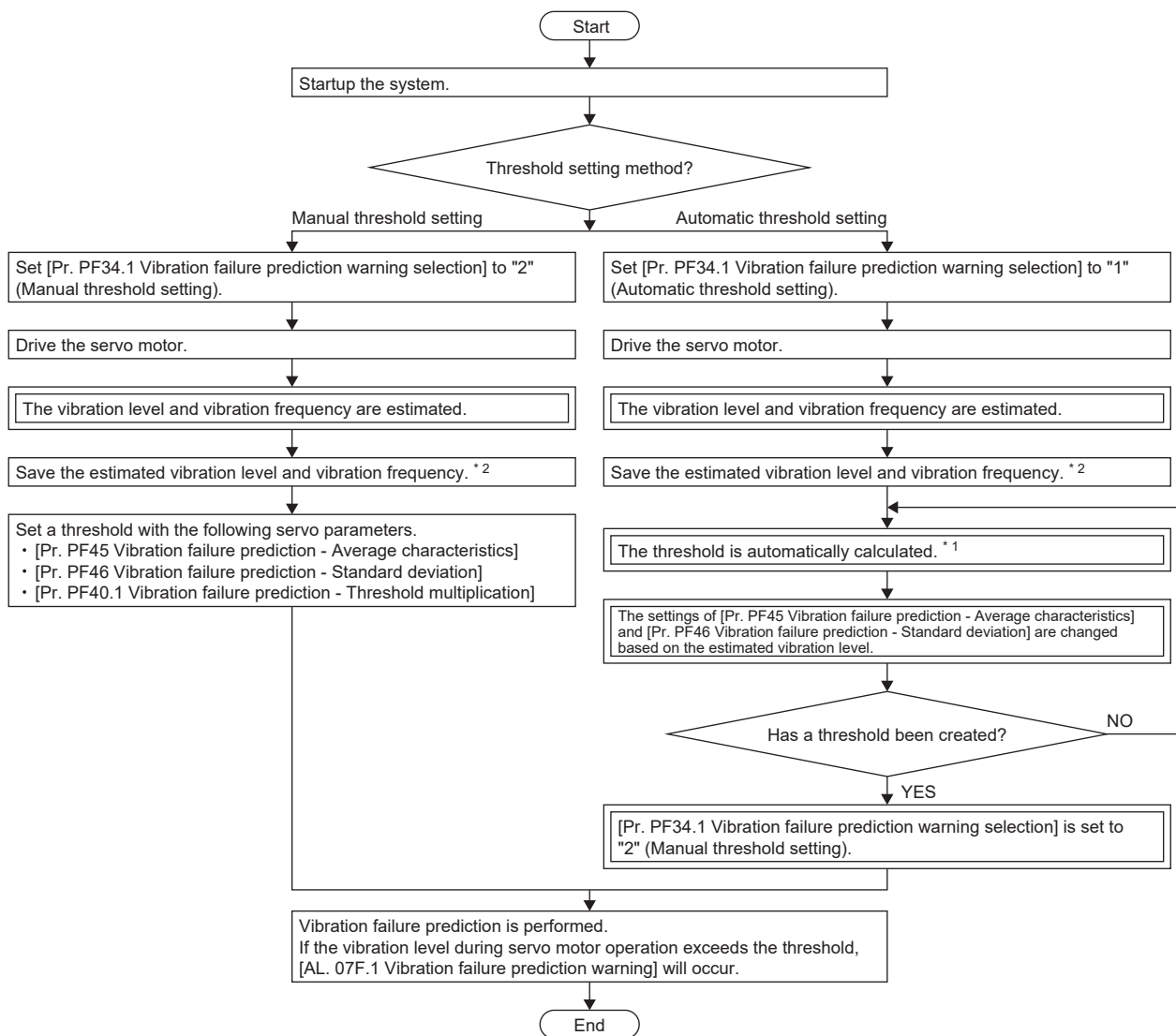

*1 If the equipment is operated continuously for less than 3 hours, and operated in the position mode or velocity mode for a cumulative time of less than 90 hours, a threshold is not calculated automatically.

*2 The data of the estimated vibration level and vibration frequency can be saved on the machine diagnosis screen of MR Configurator2.

For the vibration failure prediction function, the threshold that triggers [AL. 0F7.1 Friction failure prediction warning] can be set using the following two methods.

■ Automatic threshold setting

From the vibration level estimated by the vibration estimation function, a threshold that triggers [AL. 0F7.1 Vibration failure prediction warning] is automatically calculated in the servo amplifier. With this setting, the vibration failure prediction function can be used without setting a threshold. However, after the vibration failure prediction function operates, the equipment must be operated for about 90 hours before vibration failure prediction is actually performed. [AL. 0F7.1] does not occur until the calculation of the threshold value in the servo amplifier is complete.

■ Manual threshold setting

This is a method of setting a threshold that triggers [AL. 0F7.1 Vibration failure prediction warning] with [Pr. PF40.1 Vibration failure prediction - Threshold multiplication], [Pr. PF45 Vibration failure prediction - Average characteristics], or [Pr. PF46 Vibration failure prediction - Standard deviation]. For the manual threshold setting, vibration failure prediction will start immediately after the vibration failure prediction function begins operation. Thus, if the vibration amplitude threshold is known, or the equipment to be used is configured the same as another piece of equipment that had been used for calculating the threshold with the automatic threshold setting, an initial failure and other types of failures can also be detected by the manual threshold setting.

■ Vibration failure prediction warning setting

Set [Pr. PF34.1 Vibration failure prediction warning selection] to "1" (automatic threshold setting) or "2" (manual threshold setting) to enable vibration failure prediction warning.

Servo parameter	Symbol	Name	Outline
PF34.1	*MFP	Vibration failure prediction warning selection	Set when the vibration failure prediction warning is enabled. 0: Disabled (initial value) 1: Enabled (automatic threshold setting) 2: Enabled (manual threshold setting) 3: Threshold reset

■ Threshold setting method

When the automatic threshold setting is used, [Pr. PF45 Vibration failure prediction - Average characteristic] and [Pr. PF46 Vibration failure prediction - Standard deviation] for determining the threshold value are automatically rewritten according to the vibration level estimated in the servo amplifier. At this time, the threshold can be changed with [Pr. PF40.1 Vibration failure prediction - Threshold multiplication]. If [AL. 0F7.1 Vibration failure prediction warning] is generated with the value calculated by the automatic threshold setting, set [Pr. PF40.1 Vibration failure prediction - Threshold multiplication] to "6" or more. Once the calculation of the threshold inside the servo amplifier completes, [Pr. PF34.1 Vibration failure prediction warning selection] will change to "2" (manual threshold setting).

For the manual threshold setting, the upper and lower limit thresholds can be calculated with the equations below. When [Pr. PF40.1 Vibration failure prediction - Threshold multiplication] is "0", the threshold is calculated as "5".

Threshold [0.1 %] = [Pr. PF45 Vibration failure prediction - Average characteristic] + [Pr. PF46 Vibration failure prediction - Standard deviation] × [Pr. PF40.1 Vibration failure prediction - Threshold multiplication]

The values of [Pr. PF45 Vibration failure prediction - Average characteristic] and [Pr. PF46 Vibration failure prediction - Standard deviation] can also be determined by measuring the torque ripple with the graph function of MR Configurator2. The threshold for the vibration failure prediction can also be set by setting the measurement values for the average and the standard deviation of the torque ripple from the graph function in [Pr. PF45 Vibration failure prediction - Average characteristics] and [Pr. PF46 Vibration failure prediction - Standard deviation].

■ Threshold reset method

To automatically reset a threshold after the threshold is set automatically, set [Pr. PF34.1 Vibration failure prediction warning selection] to "3" (threshold reset), then cycle the power. After the power is cycled, the threshold is reset and [Pr. PF34.1 Vibration failure prediction warning selection] changes to "1" (automatic threshold setting). If servo parameters such as gains and machine resonance suppression filters are changed, or any part of the equipment is replaced after the vibration failure prediction function is started, reset the threshold.

Setting method [A]

The vibration prediction function predicts a failure of the equipment with the increase of the vibration level, which is estimated by the vibration estimation function. If a failure of the equipment is predicted from the vibration, [AL. 0F7.1 Vibration failure prediction warning] occurs. Use the following flowchart to set the vibration failure prediction function.

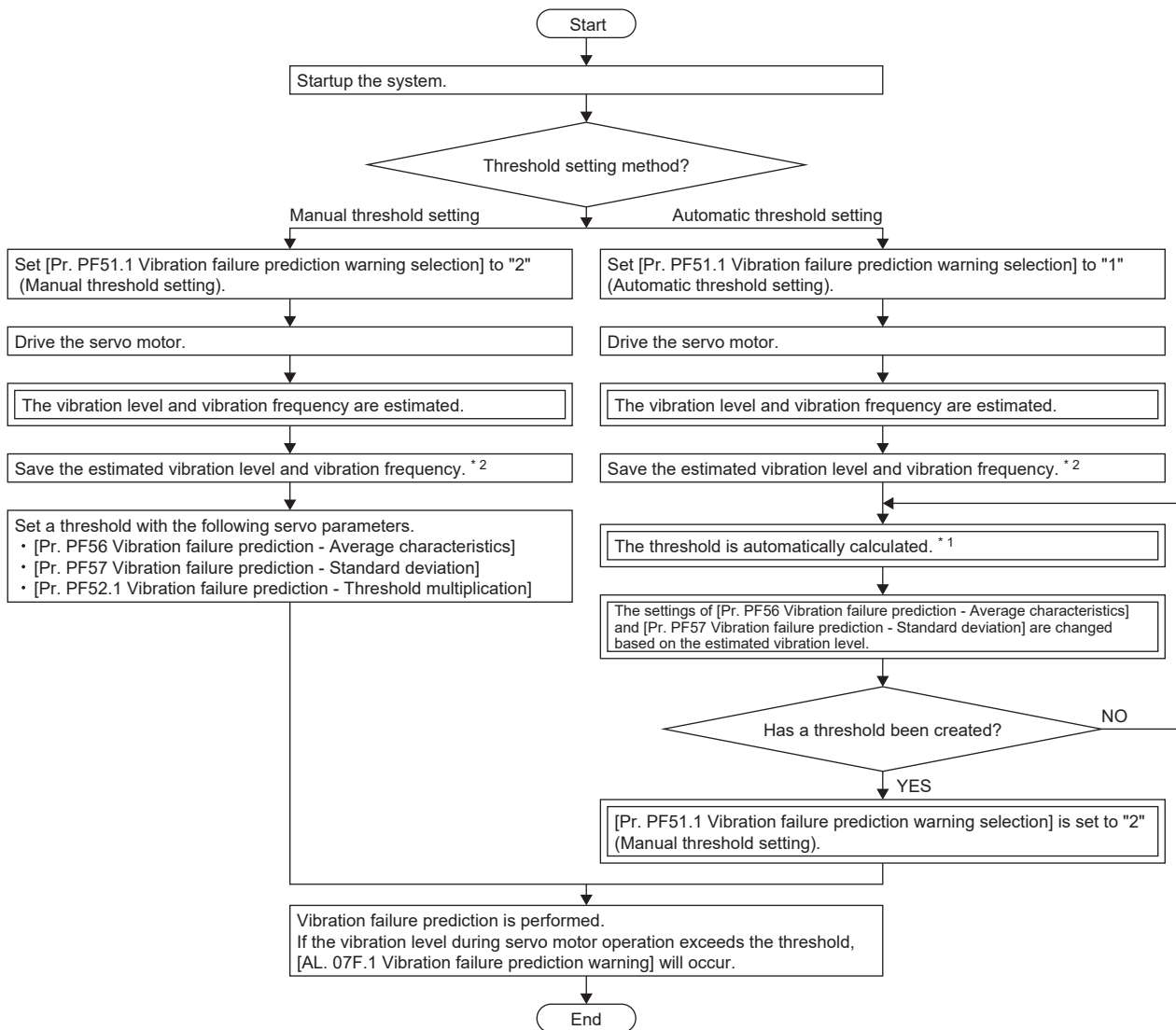

*1 If the equipment is operated continuously for less than 3 hours, and operated in the position mode or velocity mode for a cumulative time of less than 90 hours, a threshold is not calculated automatically.

*2 The data of the estimated vibration level and vibration frequency can be saved on the machine diagnosis screen of MR Configurator2. For the vibration failure prediction function, the threshold that triggers [AL. 0F7.1 Friction failure prediction warning] can be set using the following two methods.

■ Automatic threshold setting

From the vibration level estimated by the vibration estimation function, a threshold that triggers [AL. 0F7.1 Vibration failure prediction warning] is automatically calculated in the servo amplifier. With this setting, the vibration failure prediction function can be used without setting a threshold. However, after the vibration failure prediction function operates, the equipment must be operated for about 90 hours before vibration failure prediction is actually performed. [AL. 0F7.1] does not occur until the calculation of the threshold value in the servo amplifier is complete.

■ Manual threshold setting

This is a method of setting a threshold that triggers [AL. 0F7.1 Vibration failure prediction warning] with [Pr. PF52.1 Vibration failure prediction - Threshold multiplication], [Pr. PF56 Vibration failure prediction - Average characteristics], or [Pr. PF57 Vibration failure prediction - Standard deviation]. For the manual threshold setting, vibration failure prediction will start immediately after the vibration failure prediction function begins operation. Thus, if the vibration amplitude threshold is known, or the equipment to be used is configured the same as another piece of equipment that had been used for calculating the threshold with the automatic threshold setting, an initial failure and other types of failures can also be detected by the manual threshold setting.

■ Vibration failure prediction warning setting

Set [Pr. PF51.1 Vibration failure prediction warning selection] to "1" (automatic threshold setting) or "2" (manual threshold setting) to enable vibration failure prediction warning.

Servo parameter	Symbol	Name	Outline
PF51.1	*MFP	Vibration failure prediction warning selection	Set when the vibration failure prediction warning is enabled. 0: Disabled (initial value) 1: Enabled (automatic threshold setting) 2: Enabled (manual threshold setting) 3: Threshold reset

■ Threshold setting method

When the automatic threshold setting is used, [Pr. PF56 Vibration failure prediction - Average characteristic] and [Pr. PF57 Vibration failure prediction - Standard deviation] for determining the threshold value are automatically rewritten according to the vibration level estimated in the servo amplifier. At this time, the threshold can be changed with [Pr. PF52.1 Vibration failure prediction - Threshold multiplication]. If [AL. 0F7.1 Vibration failure prediction warning] is generated with the value calculated by the automatic threshold setting, set [Pr. PF52.1 Vibration failure prediction - Threshold multiplication] to "6" or more. Once the calculation of the threshold inside the servo amplifier completes, [Pr. PF51.1 Vibration failure prediction warning selection] will change to "2" (manual threshold setting).

For the manual threshold setting, the upper and lower limit thresholds can be calculated with the equations below. When [Pr. PF52.1 Vibration failure prediction - Threshold multiplication] is "0", the threshold is calculated as "5".

Threshold [0.1 %] = [Pr. PF56 Vibration failure prediction - Average characteristic] + [Pr. PF57 Vibration failure prediction - Standard deviation] × [Pr. PF52.1 Vibration failure prediction - Threshold multiplication]

The values of [Pr. PF56 Vibration failure prediction - Average characteristic] and [Pr. PF57 Vibration failure prediction - Standard deviation] can also be determined by measuring the torque ripple with the graph function of MR Configurator2. The threshold for the vibration failure prediction can also be set by setting the measurement values for the average and the standard deviation of the torque ripple from the graph function in [Pr. PF56 Vibration failure prediction - Average characteristics] and [Pr. PF57 Vibration failure prediction - Standard deviation].

■ Threshold reset method

To automatically reset a threshold after the threshold is set automatically, set [Pr. PF51.1 Vibration failure prediction warning selection] to "3" (threshold reset), then cycle the power. After the power is cycled, the threshold is reset and [Pr. PF51.1 Vibration failure prediction warning selection] changes to "1" (automatic threshold setting). If servo parameters such as gains and machine resonance suppression filters are changed, or any part of the equipment is replaced after the vibration failure prediction function is started, reset the threshold.

Vibration failure prediction [G] [B]

When a threshold is input to the servo amplifier, the servo amplifier starts vibration failure prediction. During vibration failure prediction, if the vibration level estimated by the vibration estimation function while the servo motor is in operation exceeds the threshold, [AL. 0F7.1 Vibration failure prediction warning] occurs. After the occurrence of [AL. 0F7.1 Vibration failure prediction warning], if the vibration level during servo motor operation is lower than the threshold, [AL. 0F7.1 Vibration failure prediction warning] is canceled.

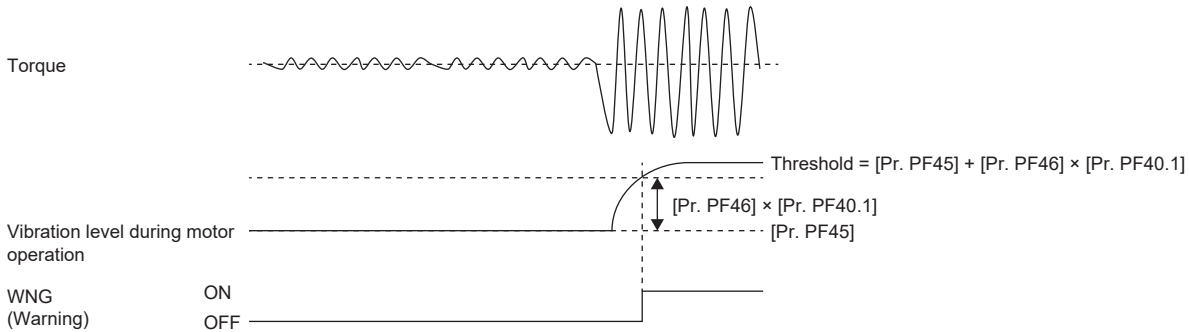

Vibration failure prediction [A]

When a threshold is input to the servo amplifier, the servo amplifier starts vibration failure prediction. During vibration failure prediction, if the vibration level estimated by the vibration estimation function while the servo motor is in operation exceeds the threshold, [AL. 0F7.1 Vibration failure prediction warning] occurs. After the occurrence of [AL. 0F7.1 Vibration failure prediction warning], if the vibration level during servo motor operation is lower than the threshold, [AL. 0F7.1 Vibration failure prediction warning] is canceled.

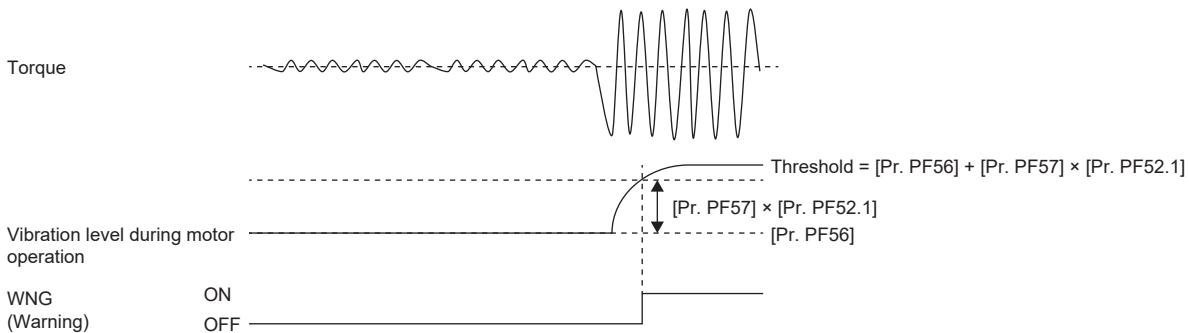

Related objects [G]

For details on the objects, refer to the User's Manual (Object Dictionary).

index	Sub	Object	Name	Description
2C29h	0	VAR	Fault prediction status	<p>[Bit 0 to 3: Friction failure prediction status]</p> <p>0: Friction failure prediction disabled</p> <p>1: During preparation for friction failure prediction</p> <p>2: During execution of friction failure prediction</p> <p>3: During friction failure prediction warning</p> <p>[Bit 4 to 7: Vibration failure prediction status]</p> <p>0: Vibration failure prediction disabled</p> <p>1: During preparation for vibration failure prediction</p> <p>2: During execution of vibration failure prediction</p> <p>3: During vibration failure prediction warning</p> <p>[Bit 8 to 11: Total travel distance failure prediction status]</p> <p>0: Motor total travel distance failure prediction disabled</p> <p>1: Motor total travel distance failure prediction being executed</p> <p>2: Motor total travel distance failure prediction at warning</p> <p>[Bit 12 to 15: Motor total travel distance calculation status]</p> <p>0: During stop of motor total travel distance calculation</p> <p>1: During calculation of motor total travel distance</p> <p>[Bit 16 to 19: reserved]</p> <p>[Bit 20 to 23: Static friction failure prediction status]</p> <p>0: Static friction failure prediction disabled</p> <p>1: During preparation for static friction failure prediction</p> <p>2: During execution of static friction failure prediction</p> <p>3: During static friction failure prediction warning</p> <p>[Bit 24 to 27: Belt tension deterioration prediction status]</p> <p>0: Belt tension deterioration prediction disabled</p> <p>1: Belt tension deterioration prediction in progress</p> <p>2: During belt tension deterioration warning</p> <p>[Bit 28 to 31: Belt tension estimation status]</p> <p>0: Belt tension estimation in progress</p> <p>1: Belt tension estimation has finished</p> <p>7: Belt tension estimation is not set</p>
2C2Dh	0	VAR	Vibration based fault prediction threshold	<p>Vibration failure prediction - Threshold</p> <p>The threshold used for vibration failure prediction is displayed in increments of 0.1 % in relation to the rated torque as 100 %.</p>
2C2Eh	0	VAR	Vibration based fault prediction prepare status	<p>Vibration failure prediction - Preparation progress</p> <p>The threshold creation progress used for vibration failure prediction is displayed as a percentage. The creation of a threshold for vibration failure prediction finishes at 100 %.</p>

Total travel distance failure prediction function

Outline [G] [B]

The total travel distance failure prediction function can check the total travel distance of devices and that of the servo motor after the shipment.

The servo motor total travel distance indicates the cumulative number of rotations or total travel distance of the servo motor. The servo motor total travel distance is intended to be used as a guide for the timing of replacement and maintenance of the servo motor and mechanical parts in the equipment.

The servo amplifier has the data of the servo motor total travel distance. Therefore, perform settings on the servo amplifier such as offsetting and resetting after replacing the equipment parts.

By setting [Pr. PF34.2 Servo motor total travel distance failure prediction warning selection], when the servo motor total travel distance exceeds the threshold, a warning is output by the servo amplifier and the servo motor and mechanical parts failure can be predicted in advance.

Outline [A]

The total travel distance failure prediction function can check the total travel distance of devices and that of the servo motor after the shipment.

The servo motor total travel distance indicates the cumulative number of rotations or total travel distance of the servo motor. The servo motor total travel distance is intended to be used as a guide for the timing of replacement and maintenance of the servo motor and mechanical parts in the equipment.

The servo amplifier has the data of the servo motor total travel distance. Therefore, perform settings on the servo amplifier such as offsetting and resetting after replacing the equipment parts.

By setting [Pr. PF51.2 Servo motor total travel distance failure prediction warning selection], when the servo motor total travel distance exceeds the threshold, a warning is output by the servo amplifier and the servo motor and mechanical parts failure can be predicted in advance.

Precautions [G] [B]

- In the total travel distance failure prediction function, the servo motor total travel distance will be calculated when [Pr. PF34.0] is set to a value other than "0" (disabled), or [Pr. PF34.2] is set to "1" (enabled).

Precautions [A]

- In the total travel distance failure prediction function, the servo motor total travel distance will be calculated when [Pr. PF51.0] is set to a value other than "0" (disabled), or [Pr. PF51.2] is set to "1" (enabled).

Total travel distance reading method [G] [B]

The servo motor total travel distance can be read with the engineering tool (MR Configurator2) via network or USB connection. The value set in [Pr. PF47 Servo motor total travel distance offset] is added to the read servo motor total travel distance.

■ When reading the total travel distance via the network [G]

Specify and read the target object. Refer to the following for details of the objects.

 Page 270 Related objects [G]

■ When reading the total travel distance with an engineering tool (MR Configurator2)

Select the servo motor total travel distance on the machine diagnosis screen and click "Read". The servo motor total travel distance at the time of clicking "Read" is displayed, and can be checked and compared with the threshold of the servo motor total travel distance. In addition, the read servo motor total travel distance can be saved on the machine diagnosis screen. The displayed range is from 0 to 42949672950. If it exceeds this range, it is clamped at the maximum value.

Total travel distance reading method [A]

The servo motor total travel distance can be read with the engineering tool (MR Configurator2) via USB connection. The value set in [Pr. PF58 Servo motor total travel distance offset] is added to the read servo motor total travel distance.

■ When reading the total travel distance with an engineering tool (MR Configurator2)

Select the servo motor total travel distance on the machine diagnosis screen and click "Read". The servo motor total travel distance at the time of clicking "Read" is displayed, and can be checked and compared with the threshold of the servo motor total travel distance. In addition, the read servo motor total travel distance can be saved on the machine diagnosis screen. The displayed range is from 0 to 42949672950. If it exceeds this range, it is clamped at the maximum value.

Setting method of total travel distance failure prediction function [G] [B]

Using the servo motor total travel distance, the total travel distance failure prediction function can be performed in the following procedure.

■ Failure prediction function setting with servo motor total travel distance

To enable servo motor total travel distance failure prediction warning, set [Pr. PF34.2 Servo motor total travel distance failure prediction warning selection] to "1" (enabled). Set "Failure prediction - Servo motor total travel distance". It is recommended that the servo motor total travel distance for failure prediction be set to about the same as the rated life suggested by the manufacturers of the guides and ball screws being used. For example, for a rated life of 8×10^5 rev, set [Pr. PF41] to "80000" [10 rev]. When "0" is set in [Pr. PF41], servo motor total travel distance failure prediction does not start. To carry over the servo motor total travel distance when replacing equipment, set [Pr. PF47 Servo motor total travel distance offset]. For the setting method of [Pr. PF47], refer to the following:

☞ Page 269 When replacing equipment [G] [B]

1. Startup the system.
2. Set [Pr. PF34.2 Servo motor total travel distance failure prediction warning selection] to "1" (enabled).
3. Based on the rated life, set [Pr. PF41 Failure prediction - Servo motor total travel distance].
4. When replacing the equipment, set [Pr. PF47 Servo motor total travel distance offset].

☞ Page 269 When replacing equipment [G] [B]

5. Drive the servo motor.
6. Machine total travel distance failure prediction is performed.

[AL. 0F7.3 Failure prediction warning based on servo motor total travel distance] occurs when the machine total travel distance exceeds [Pr. PF41 Failure prediction - Servo motor total travel distance].

Servo parameter	Symbol	Name	Outline
PF34.2	*MFP	Servo motor total travel distance failure prediction warning selection	Enable/disable the warning output for servo motor total travel distance. 0: Disabled (initial value) 1: Enabled 2: Servo motor total travel distance reset
PF41	FPMT	Failure prediction - Servo motor total travel distance	Set the threshold of the warning output for servo motor total travel distance. If the value is "0", the warning output for servo motor total travel distance is not performed. Initial value: 0 [10 rev], [m]
PF47	TMO	Servo motor total travel distance offset	Set an offset value for servo motor total travel distance. ☞ Page 269 When replacing equipment [G] [B] Initial value: 0 [10 rev], [m]

Setting method of total travel distance failure prediction function [A]

Using the servo motor total travel distance, the total travel distance failure prediction function can be performed in the following procedure.

■ Failure prediction function setting with servo motor total travel distance

To enable servo motor total travel distance failure prediction warning, set [Pr. PF51.2 Servo motor total travel distance failure prediction warning selection] to "1" (enabled). Set "Failure prediction - Servo motor total travel distance". It is recommended that the servo motor total travel distance for failure prediction be set to about the same as the rated life suggested by the manufacturers of the guides and ball screws being used. For example, for a rated life of 8×10^5 rev, set [Pr. PF53] to "80000" [10 rev]. When "0" is set in [Pr. PF53], servo motor total travel distance failure prediction does not start. To carry over the servo motor total travel distance when replacing equipment, set [Pr. PF58 Servo motor total travel distance offset]. For the setting of [Pr. PF58], refer to the following:

 Page 269 When replacing equipment [A]

1. Startup the system.
2. Set [Pr. PF51.2 Servo motor total travel distance failure prediction warning selection] to "1" (enabled).
3. Based on the rated life, set [Pr. PF53 Failure prediction - Servo motor total travel distance].
4. When replacing the equipment, set [Pr. PF58 Servo motor total travel distance offset].

 Page 269 When replacing equipment [A]

5. Drive the servo motor.
6. Machine total travel distance failure prediction is performed.

[AL. 0F7.3 Failure prediction warning based on servo motor total travel distance] occurs when the machine total travel distance exceeds [Pr. PF53 Failure prediction - Servo motor total travel distance].

Servo parameter	Symbol	Name	Outline
PF51.2	*MFP	Servo motor total travel distance failure prediction warning selection	Enable/disable the warning output for servo motor total travel distance. 0: Disabled (initial value) 1: Enabled 2: Servo motor total travel distance reset
PF53	FPMT	Failure prediction - Servo motor total travel distance	Set the threshold of the warning output for servo motor total travel distance. If the value is "0", the warning output for servo motor total travel distance is not performed. Initial value: 0 [10 rev], [m]
PF58	TMO	Servo motor total travel distance offset	Set an offset value for servo motor total travel distance.  Page 269 When replacing equipment [A] Initial value: 0 [10 rev], [m]

Execution of total travel distance failure prediction function [G] [B]

Using the servo motor total travel distance, the total travel distance failure prediction function operates as follows.

■ Total travel distance failure prediction with servo motor total travel distance

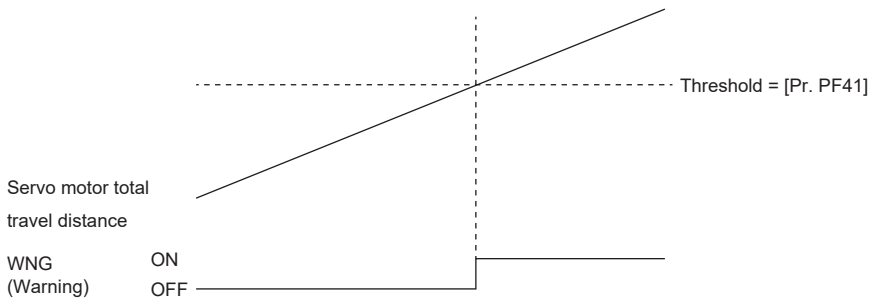

When [Pr. PF34.2 Servo motor total travel distance failure prediction warning selection] is set to "1" (enabled), the servo amplifier starts total travel distance failure prediction using the servo motor total travel distance. [AL. 0F7.3 Failure prediction warning based on servo motor total travel distance] occurs when the servo motor total travel distance exceeds the threshold. The procedure to follow when this alarm occurs and the canceling method are as follows:

When [AL. 0F7.3 Failure prediction warning based on servo motor total travel distance] occurs, take one of the following actions:

- Check that the threshold has been set correctly. If the threshold is set incorrectly, reset it, and restart the equipment.
- Check the equipment. When replacing the equipment, refer to the following.

☞ Page 269 When replacing equipment [G] [B]

[AL. 0F7.3 Failure prediction warning based on servo motor total travel distance] can be deactivated by using one of the following methods:

- Set a value larger than the servo motor total travel distance in [Pr. PF41 Failure prediction - Servo motor total travel distance].
- Set [Pr. PF34.2] to "0" (disabled).
- Set "2" (servo motor total travel distance reset) in [Pr. PF34.2] to reset the servo motor total travel distance.

For the resetting method, refer to the following.

☞ Page 268 Reset method of servo motor total travel distance [G] [B]

Execution of total travel distance failure prediction function [A]

Using the servo motor total travel distance, the total travel distance failure prediction function operates as follows.

■ Total travel distance failure prediction with servo motor total travel distance

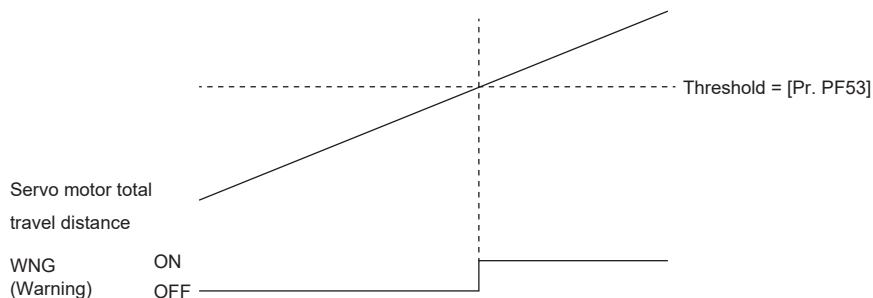

When [Pr. PF51.2 Servo motor total travel distance failure prediction warning selection] is set to "1" (enabled), the servo amplifier starts total travel distance failure prediction using the servo motor total travel distance. [AL. 0F7.3 Failure prediction warning based on servo motor total travel distance] occurs when the servo motor total travel distance exceeds the threshold. The procedure to follow when this alarm occurs and the canceling method are as follows:

When [AL. 0F7.3 Failure prediction warning based on servo motor total travel distance] occurs, take one of the following actions:

- Check that the threshold has been set correctly. If the threshold is set incorrectly, reset it, and restart the equipment.
- Check the equipment. When replacing the equipment, refer to the following.

☞ Page 269 When replacing equipment [A]

[AL. 0F7.3 Failure prediction warning based on servo motor total travel distance] can be deactivated by using one of the following methods:

- Set a value larger than the servo motor total travel distance in [Pr. PF53 Failure prediction - Servo motor total travel distance].
- Set [Pr. PF51.2] to "0" (disabled).
- Set "2" (servo motor total travel distance reset) in [Pr. PF51.2] to reset the servo motor total travel distance.

For the resetting method, refer to the following.

☞ Page 268 Reset method of servo motor total travel distance [A]

Reset method of servo motor total travel distance [G] [B]

If any part of the equipment is replaced, reset the servo motor total travel distance. To reset the servo motor total travel distance, set [Pr. PF34.2] to "2" (servo motor total travel distance reset), and then cycle the power or perform either the software reset or the controller reset. When the servo motor total travel distance is reset, [Pr. PF34.2] is changed to "1" (enabled).

Reset method of servo motor total travel distance [A]

If any part of the equipment is replaced, reset the servo motor total travel distance. To reset the servo motor total travel distance, set [Pr. PF51.2] to "2" (servo motor total travel distance reset), and then cycle the power or perform either the software reset or the controller reset. When the servo motor total travel distance is reset, [Pr. PF51.2] is changed to "1" (enabled).

When replacing equipment [G] [B]

When replacing the equipment, set the servo motor total travel distance offset to obtain the accurate total travel distance for the device and have the servo motor total travel distance continue from the previous distance value. Perform the actions shown in the following table when replacing the equipment.

Equipment being replaced	Action
Servo motor (the servo amplifier and the equipment are not replaced)	None
Servo amplifier (the servo motor and the equipment are not replaced)	Step 1. Check the servo motor total travel distance before replacement.* ¹ Step 2. After replacement, set the servo motor total travel distance before the replacement in [Pr. PF47 Servo motor total travel distance offset].
Servo amplifier and servo motor (the equipment is not replaced)	Step 1. Check the servo motor total travel distance before replacement.* ¹ Step 2. After replacement, set the servo motor total travel distance before the replacement in [Pr. PF47 Servo motor total travel distance offset].
Encoder (the servo motor, the servo amplifier, and the equipment are not replaced)	None
Equipment such as ball screws and guidelines (the servo motors and the servo amplifiers are not replaced)	After replacement, reset the servo motor total travel distance by setting "2" (servo motor total travel distance reset) in [Pr. PF34.2] followed by cycling the power or performing either of the software reset or controller reset.

*1 When the servo motor total travel distance cannot be checked due to a servo amplifier malfunction, set "0" in [Pr. PF47 Servo motor total travel distance offset], or set the value of the servo motor total travel distance at the last check before the malfunction.

When replacing equipment [A]

When replacing the equipment, set the servo motor total travel distance offset to obtain the accurate total travel distance for the device and have the servo motor total travel distance continue from the previous distance value. Perform the actions shown in the following table when replacing the equipment.

Equipment being replaced	Action
Servo motor (the servo amplifier and the equipment are not replaced)	None
Servo amplifier (the servo motor and the equipment are not replaced)	Step 1. Check the servo motor total travel distance before replacement.* ¹ Step 2. After replacement, set the servo motor total travel distance before the replacement in [Pr. PF58 Servo motor total travel distance offset].
Servo amplifier and servo motor (the equipment is not replaced)	Step 1. Check the servo motor total travel distance before replacement.* ¹ Step 2. After replacement, set the servo motor total travel distance before the replacement in [Pr. PF58 Servo motor total travel distance offset].
Encoder (the servo motor, the servo amplifier, and the equipment are not replaced)	None
Equipment such as ball screws and guidelines (the servo motors and the servo amplifiers are not replaced)	After replacement, reset the servo motor total travel distance by setting "2" (servo motor total travel distance reset) in [Pr. PF51.2] followed by cycling the power or performing either of the software reset or controller reset.

*1 When the servo motor total travel distance cannot be checked due to a servo amplifier malfunction, set "0" in [Pr. PF58 Servo motor total travel distance offset], or set the value of the servo motor total travel distance at the last check before the malfunction.

Related objects [G]

For details on the objects, refer to the User's Manual (Object Dictionary).

index	Sub	Object	Name	Description
2C29h	0	VAR	Fault prediction status	[Bit 0 to 3: Friction failure prediction status] 0: Friction failure prediction disabled 1: During preparation for friction failure prediction 2: During execution of friction failure prediction 3: During friction failure prediction warning [Bit 4 to 7: Vibration failure prediction status] 0: Vibration failure prediction disabled 1: During preparation for vibration failure prediction 2: During execution of vibration failure prediction 3: During vibration failure prediction warning [Bit 8 to 11: Total travel distance failure prediction status] 0: Motor total travel distance failure prediction disabled 1: Motor total travel distance failure prediction being executed 2: Motor total travel distance failure prediction at warning [Bit 12 to 15: Motor total travel distance calculation status] 0: During stop of motor total travel distance calculation 1: During calculation of motor total travel distance [Bit 16 to 19: reserved] [Bit 20 to 23: Static friction failure prediction status] 0: Static friction failure prediction disabled 1: During preparation for static friction failure prediction 2: During execution of static friction failure prediction 3: During static friction failure prediction warning [Bit 24 to 27: Belt tension deterioration prediction status] 0: Belt tension deterioration prediction disabled 1: Belt tension deterioration prediction in progress 2: During belt tension deterioration warning [Bit 28 to 31: Belt tension estimation status] 0: Belt tension estimation in progress 1: Belt tension estimation has finished 7: Belt tension estimation is not set
2C2Fh	0	VAR	Motor total distance	Servo motor total travel distance Servo motor total travel distance is displayed in the units of rev or m.

Gear failure diagnosis function

The gear failure diagnosis function uses the servo motor driving status to predict a gear malfunction by estimating the backlash amount of the gear connected to the servo motor. The gear failure diagnosis function includes the backlash estimation function and the gear failure prediction function.

- Backlash estimation function

For the backlash estimation function, the backlash amount of the gear connected to the servo motor is estimated from the servo amplifier internal data during the to-and-fro positioning operation. When the servo motor is at a stop, click the estimation start button of MR Configurator2 to start. If the servo motor speed is 20 r/min or faster, pressing the estimation start button of MR Configurator2 will not start the backlash estimation and an error will be displayed.

- Gear failure prediction function

The gear failure prediction function predicts the gear failure by comparing the backlash amount estimated by the backlash estimation function with the backlash threshold set by the servo parameter. After inputting the backlash threshold with [Pr. PF67 Backlash nominal value] and [Pr. PF68 Backlash threshold multiplication] and executing backlash estimation, gear failure prediction is performed.

Restriction

- When using a linear servo motor, the gear failure diagnosis function cannot be used. When the linear servo motor is used, backlash estimation does not start as errors will occur.
- Perform backlash estimation when all the servo motors connected to the servo amplifier have been stopped. If any of the servo motors connected to the servo amplifier are being operated, backlash estimation is not performed as errors will occur.

Precautions

- During gear diagnosis, the servo amplifier automatically generates a command to drive the servo motor. Even if the servo motor moves by the travel distance + 1 rotation during gear diagnosis, ensure that the movable part does not collide with the equipment, then execute backlash estimation. Use the stroke limit or EM2 (Forced stop 2) during the gear diagnosis.
- The gear failure diagnosis function can be used for the gears with backlash amount of 0.1 degree in the servo motor shaft conversion. If the backlash estimation is performed on the gears with the backlash amount of less than 0.1 degree, the error between the estimated value and true value becomes too large, causing an incorrect detection of [AL. 0F7 Machine diagnosis warning]. Also, [AL. 0F7 Machine diagnosis warning] may not be detected during a gear malfunction.
- The gear failure diagnosis function can be used only when the load to motor inertia ratio is two times or more. If backlash estimation is performed when no load is applied or when the load to inertia ratio of the connected load is less than two times, the error between the estimated value and the true value becomes too large, causing an incorrect detection of [AL. 0F7 Machine diagnosis warning]. [AL. 0F7 Machine diagnosis warning] may not be detected during a gear malfunction.
- Once backlash estimation is performed, the servo amplifier will enter the test operation mode and control commands from the controller will not be available. After executing the backlash estimation, reset the communication or cycle the power of the servo amplifier.
- If the overspeed alarm level and the torque limit value are too small, the backlash estimation may fail.
- If the gear diagnosis is executed simultaneously on two or more axes in the equipment with mechanical interference, the equipment may malfunction. Execute the gear diagnosis on one axis at a time.
- Adjust the gain before executing the backlash estimation so that the equipment does not oscillate or vibrate. The backlash estimation estimates the backlash from the servo motor drive status during the to-and-fro operation. If the equipment oscillates/vibrates, the error between the backlash estimate and the actual value may be too large.
- If the gear ratio on the load side is too large, the backlash estimate accuracy may deteriorate.
- When executing the backlash estimation on the MR-J5_ _B_, assign both FLS (Upper stroke limit) and RLS (Lower stroke limit) to the servo amplifier. When backlash estimation is executed with them assigned to the controller, "C007" is displayed in the error code status.

Setting method

Use the gear failure diagnosis function with the following procedure:

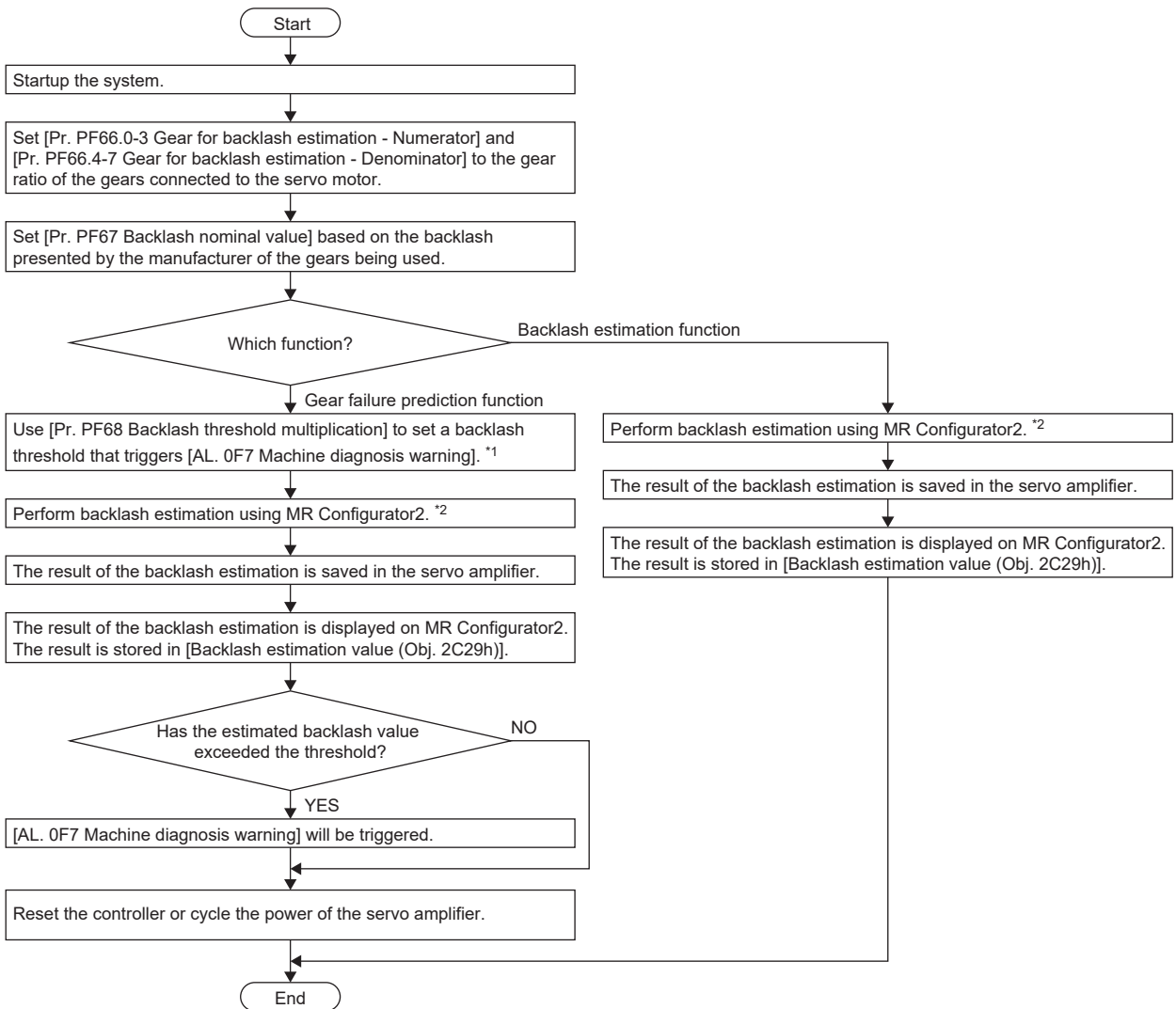

*1 The threshold for outputting [AL. 0F7 Machine diagnostic warning] is backlash threshold = [Pr. PF67 Backlash nominal value] × [Pr. PF68 Backlash threshold multiplication].

*2 Once backlash estimation is performed, the servo amplifier will enter the test operation mode and control commands from the controller will not be available.

■ Backlash estimation servo parameter input

- Setting of gear ratio for backlash estimation

Input the numerator and denominator of the gear ratio on the gear connected to the servo motor. Inputting the numerator and denominator of the gear ratio limits the travel distance during the backlash estimation to the minimum. When either the numerator or the denominator of the gear ratio is set to "0", the travel distance during the backlash estimation is two rotations each in the forward and reverse rotation side from the starting position of the backlash estimation.

Servo parameter	Symbol	Name	Outline
PF66.0-3	BLG	Gear for backlash estimation - Numerator	Set the gear ratio numerator of the gear connected to the servo motor in hexadecimal. If multiple gears are connected to the servo motor, set the gear ratio up to where the load is applied. If the gear ratio numerator and the denominator cannot be expressed by numbers up to "2 ¹⁶ -1", round up the gear ratio and set a value equal to or less than "2 ¹⁶ -1" for both the numerator and the denominator. [Pr. PF66.0-3 Gear for backlash estimation - Numerator] and [Pr. PF66.4-7 Gear for backlash estimation - Denominator] do not affect the accuracy of the backlash estimation even if they are shifted by a fraction. Initial value: 0000h
PF66.4-7	BLG	Gear for backlash estimation - Denominator	Set the gear ratio denominator of the gear connected to the servo motor in hexadecimal. If multiple gears are connected to the servo motor, set the gear ratio up to where the load is applied. If the gear ratio numerator and the denominator cannot be expressed by numbers up to "2 ¹⁶ -1", round up the gear ratio and set a value equal to or less than "2 ¹⁶ -1" for both the numerator and the denominator. Initial value: 0000h

■ Gear diagnosis threshold setting method

The backlash threshold used in the gear failure prediction function can be set with [Pr. PF67 Backlash nominal value] and [Pr. PF68 Backlash threshold multiplication], and is calculated by the following equation. When [Pr. PF68 Backlash threshold multiplication] is set to "0", a value twice the value of [Pr. PF67 Backlash nominal value]/100 is set as the threshold. Changing [Pr. PF68 Backlash threshold multiplication] from the initial value is not required. To change the backlash threshold used for the gear failure prediction function, change [Pr. PF68 Backlash threshold multiplication].

$$\text{Backlash threshold} = [\text{Pr. PF67 Backlash nominal value}] / 100 \times [\text{Pr. PF68 Backlash threshold multiplication}] / 10$$

Servo parameter	Symbol	Name	Outline
PF67	BLN	Backlash nominal value	To set the threshold for gear failure prediction, a backlash nominal value must be set. Input a backlash value presented by the manufacturer of the gear connected to the servo motor. When [Pr. PF66.0-3 Gear for backlash estimation - Numerator] or [Pr. PF66.4-7 Gear for backlash estimation - Denominator] is set to "0", input the backlash nominal value after converting the value into the rotation angle on the servo motor side. When a value other than "0" is set in [Pr. PF66.0-3 Gear for backlash estimation - Numerator] and [Pr. PF66.4-7 Gear for backlash estimation - Denominator], input a value considering the gear ratio for backlash estimation. When "0" is set, even if backlash estimation is performed, [AL. 0F7 Machine diagnosis warning] does not generate. Initial setting: 0 [0.01 degree]
PF68	BLTT	Backlash threshold multiplication	Set the threshold multiplication that will be used for setting the threshold for gear failure prediction. The threshold used for gear failure prediction is as follows. Backlash threshold = [Pr. PF67 Backlash nominal value]/100 × [Pr. PF68 Backlash threshold multiplication]/10 When "0" is set, a value twice the value of [Pr. PF67 Backlash nominal value]/100 is set as the backlash threshold. When the backlash threshold is "0", even when the backlash estimation is performed, [AL. 0F7 Machine diagnosis warning] will not be output. Initial setting: 0

■ Backlash estimation unit selection [G] [A]

Select the unit for the travel distance which is to be automatically set in the backlash estimation function.

Servo parameter	Symbol	Name	Outline
PF62.0	FOP14	Backlash estimation unit selection	<p>Select the unit for "travel distance at backlash estimation" which is to be automatically set in the backlash estimation function.</p> <p>0: Command pulse unit 1: Servo motor encoder pulse unit</p> <p>A time-out will occur at execution of the backlash estimation function depending on the setting values for the electronic gear ([Pr. PA06 Electronic gear numerator]/[Pr. PA07 Electronic gear denominator]). When a time-out occurs, set this servo parameter to "1".</p> <p>When this servo parameter is "0", the servo motor rotation amount is as follows. Servo motor rotation amount = travel distance at backlash estimation × ([Pr. PA06]/[Pr. PA07]) [rev]</p> <p>For "travel distance at backlash estimation", refer to the following setting examples.  Page 278 Setting example [G] [A]</p> <p>Initial value: 0</p>

Backlash estimation function [G]

Start the backlash estimation by clicking the estimation start button of MR Configurator2 during a servo motor stop. When the start button for the backlash estimation is clicked during servo-off, the status automatically shifts to servo-on, and the backlash estimation will be started. In addition, if the backlash estimation is started in the servo-off status, the servo motor automatically switches to servo-off after the completion/cancellation of the backlash estimation.

In the backlash estimation, the servo motor performs reciprocating positioning four times by the calculated travel distance either from the forward rotation to the reverse rotation or from the reverse rotation to the forward rotation. From the servo amplifier internal data on the four times of to-and-fro positioning operation, the backlash is estimated. During backlash estimation execution, the movement direction, the maximum velocity at the to-and-fro positioning operation, and the acceleration/deceleration time are calculated inside the servo amplifier.

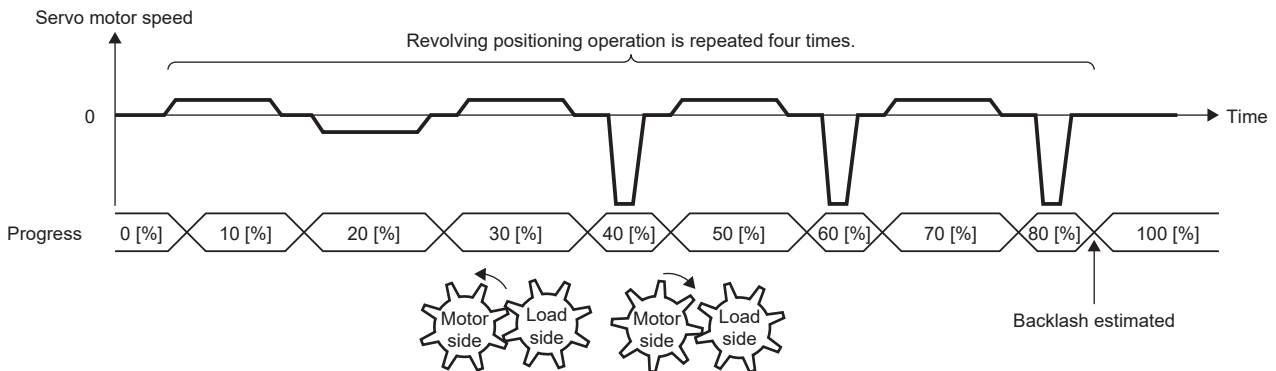

Item	Description
Travel distance	The backlash threshold is automatically set with the following equation using [Pr. PF67 Backlash nominal value] and [Pr. PF68 Backlash threshold multiplication]. If the result is less than one rotation, the travel distance is 1. $\text{Backlash threshold [degree]} = [\text{Pr. PF67}] / 100 \times [\text{Pr. PF68}] / 10$ When [Pr. PF67] is set to "0", the travel distance is two rotations in the forward direction and two rotations in the reverse direction. $\text{Travel distance [rev]} = 4 \times \text{Backlash threshold}$ [Pr. PF62.0 Backlash estimation unit selection] can be used to select the servo motor rotation amount.
Servo motor speed	A speed not exceeding 1/2 of the rated speed and the overspeed alarm detection level ([Pr. PC08]) is automatically set.
Acceleration time constant Deceleration time constant	Acceleration and deceleration time constant are determined in order for the acceleration/deceleration torque to become the input torque. However, when the input torque is larger than the torque limit value that has been set in backlash estimation, the acceleration time constant and deceleration time constant are automatically set below the torque limit value. In the initial value, the acceleration time constant and the deceleration time constant are automatically set below the rated torque of 120 % and also below the torque limit value that is set at the start of the backlash estimation.
Dwell time	This is automatically set by calculating the time from the command completion to the servo motor tracking completion in the servo amplifier. The actual calculated dwell time is Max (200 ms, 9800/[Pr. PB07 Model control gain]).

The progress status is displayed during backlash estimation. The backlash estimation completes when the progress reaches 100 %.

After backlash estimation, "0000" is displayed in the error code status, and the backlash estimate is displayed in the "estimation result".

When [Pr. PF66.0-3 Gear for backlash estimation - Numerator] or [Pr. PF66.4-7 Gear for backlash estimation - Denominator] is set to "0", the backlash estimation value is output as the rotation angle on the servo motor side. In a mechanism in which multiple gears are connected like a planetary gear, the backlash estimation amount is calculated by enlarging the actual backlash by the reduction ratio only.

When a value other than "0" is set in [Pr. PF66.0-3 Gear for backlash estimation - Numerator] and [Pr. PF66.4-7 Gear for backlash estimation - Denominator], a backlash estimated amount is output in consideration of the gear ratio for backlash estimation.

After the backlash estimation is executed, control by the command from the controller is disabled. To perform control again using commands from the controller, reset the communication, cycle the power, or execute the software reset.

Backlash estimation function [B]

Start the backlash estimation by clicking the estimation start button of MR Configurator2 during a servo motor stop. When the start button for the backlash estimation is clicked during servo-off, the status automatically shifts to servo-on, and the backlash estimation will be started. In addition, if the backlash estimation is started in the servo-off status, the servo motor automatically switches to servo-off after the completion/cancellation of the backlash estimation.

In the backlash estimation, the servo motor performs reciprocating positioning four times by the calculated travel distance either from the forward rotation to the reverse rotation or from the reverse rotation to the forward rotation. From the servo amplifier internal data on the four times of to-and-fro positioning operation, the backlash is estimated. During backlash estimation execution, the movement direction, the maximum velocity at the to-and-fro positioning operation, and the acceleration/deceleration time are calculated inside the servo amplifier.

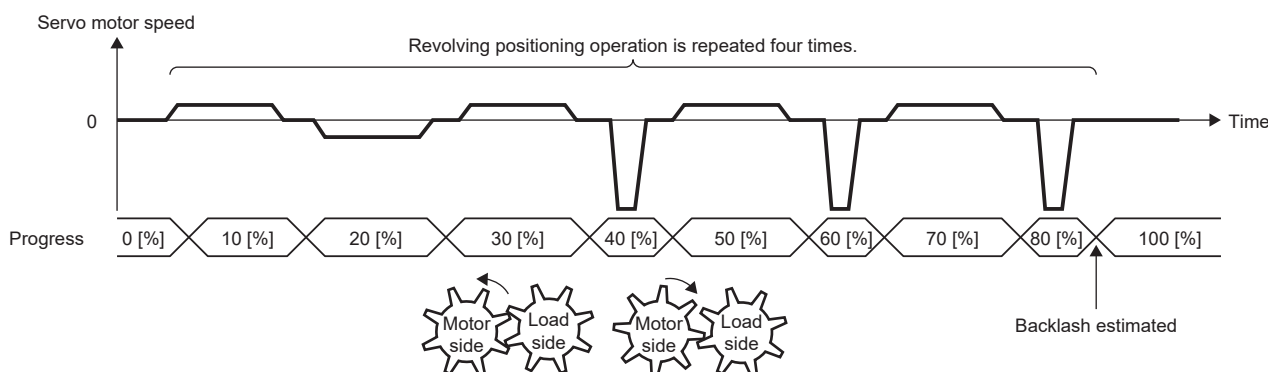

Item	Description
Travel distance	The backlash threshold is automatically set with the following equation using [Pr. PF67 Backlash nominal value] and [Pr. PF68 Backlash threshold multiplication]. If the result is less than one rotation, the travel distance is 1. $\text{Backlash threshold [degree]} = [\text{Pr. PF67 Backlash nominal value}] / 100 \times [\text{Pr. PF68 Backlash threshold multiplication}] / 10$ When [Pr. PF67 Backlash nominal value] is set to "0", the travel distance is two rotations in the forward direction and two rotations in the reverse direction. $\text{Travel distance [rev]} = 4 \times \text{Backlash threshold}$
Servo motor speed	A speed not exceeding 1/2 of the rated speed and the overspeed alarm detection level ([Pr. PC08]) is automatically set.
Acceleration time constant Deceleration time constant	Acceleration and deceleration time constant are determined in order for the acceleration/deceleration torque to become the input torque. However, when the input torque is larger than the torque limit value that has been set in backlash estimation, the acceleration time constant and deceleration time constant are automatically set below the torque limit value. In the initial value, the acceleration time constant and the deceleration time constant are automatically set below the rated torque of 120 % and also below the torque limit value that is set at the start of the backlash estimation.
Dwell time	This is automatically set by calculating the time from the command completion to the servo motor tracking completion in the servo amplifier. The actual calculated dwell time is Max (200 ms, 9800/[Pr. PB07 Model control gain]).

The progress status is displayed during backlash estimation. The backlash estimation completes when the progress reaches 100 %.

After backlash estimation, "0000" is displayed in the error code status, and the backlash estimate is displayed in the "estimation result".

When [Pr. PF66.0-3 Gear for backlash estimation - Numerator] or [Pr. PF66.4-7 Gear for backlash estimation - Denominator] is set to "0", the backlash estimation value is output as the rotation angle on the servo motor side. In a mechanism in which multiple gears are connected like a planetary gear, the backlash estimation amount is calculated by enlarging the actual backlash by the reduction ratio only.

When a value other than "0" is set in [Pr. PF66.0-3 Gear for backlash estimation - Numerator] and [Pr. PF66.4-7 Gear for backlash estimation - Denominator], a backlash estimated amount is output in consideration of the gear ratio for backlash estimation.

After the backlash estimation is executed, control by the command from the controller is disabled. To perform control again using commands from the controller, reset the communication, cycle the power, or execute the software reset.

Backlash estimation function [A]

Start the backlash estimation by clicking the estimation start button of MR Configurator2 during a servo motor stop. When the start button for the backlash estimation is clicked during servo-off, the status automatically shifts to servo-on, and the backlash estimation will be started. In addition, if the backlash estimation is started in the servo-off status, the servo motor automatically switches to servo-off after the completion/cancellation of the backlash estimation.

In the backlash estimation, the servo motor performs reciprocating positioning four times by the calculated travel distance either from the forward rotation to the reverse rotation or from the reverse rotation to the forward rotation. From the servo amplifier internal data on the four times of to-and-fro positioning operation, the backlash is estimated. During backlash estimation execution, the movement direction, the maximum velocity at the to-and-fro positioning operation, and the acceleration/deceleration time are calculated inside the servo amplifier.

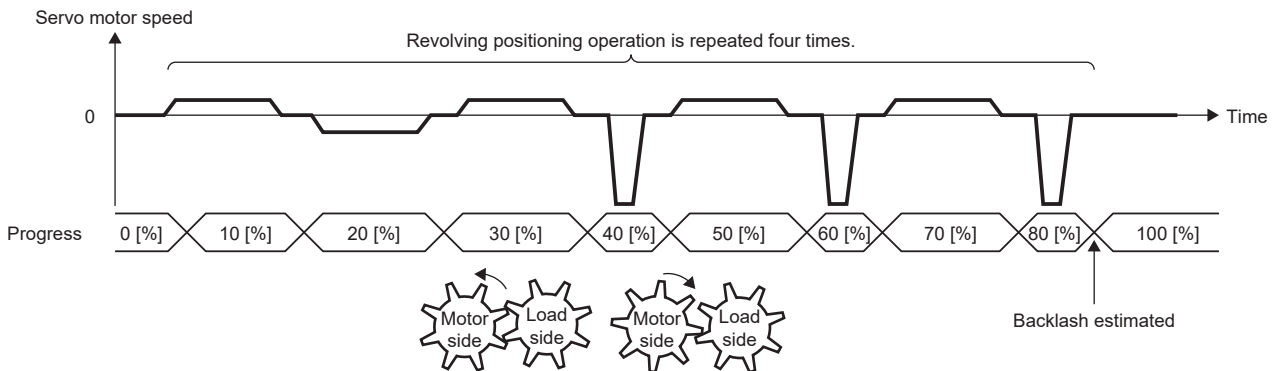

Item	Description
Travel distance	The backlash threshold is automatically set with the following equation using [Pr. PF67 Backlash nominal value] and [Pr. PF68 Backlash threshold multiplication]. If the result is less than one rotation, the travel distance is 1. $\text{Backlash threshold [degree]} = [\text{Pr. PF67}] / 100 \times [\text{Pr. PF68}] / 10$ When [Pr. PF67] is set to "0", the travel distance is two rotations in the forward direction and two rotations in the reverse direction. $\text{Travel distance [rev]} = 4 \times \text{Backlash threshold}$ [Pr. PF62.0 Backlash estimation unit selection] can be used to select the servo motor rotation amount.
Servo motor speed	A speed not exceeding 1/2 of the rated speed and the overspeed alarm detection level is automatically set.
Acceleration time constant Deceleration time constant	Acceleration and deceleration time constant are determined in order for the acceleration/deceleration torque to become the input torque. However, when the input torque is larger than the torque limit value that has been set in backlash estimation, the acceleration time constant and deceleration time constant are automatically set below the torque limit value. In the initial value, the acceleration time constant and the deceleration time constant are automatically set below the rated torque of 120 % and also below the torque limit value that is set at the start of the backlash estimation.
Dwell time	This is automatically set by calculating the time from the command completion to the servo motor tracking completion in the servo amplifier.

The progress status is displayed during backlash estimation. The backlash estimation completes when the progress reaches 100 %.

After backlash estimation, "0000" is displayed in the error code status, and the backlash estimate is displayed in the "estimation result".

When [Pr. PF66.0-3 Gear for backlash estimation - Numerator] or [Pr. PF66.4-7 Gear for backlash estimation - Denominator] is set to "0", the backlash estimation value is output as the rotation angle on the servo motor side. In a mechanism in which multiple gears are connected like a planetary gear, the backlash estimation amount is calculated by enlarging the actual backlash by the reduction ratio only.

When a value other than "0" is set in [Pr. PF66.0-3 Gear for backlash estimation - Numerator] and [Pr. PF66.4-7 Gear for backlash estimation - Denominator], a backlash estimated amount is output in consideration of the gear ratio for backlash estimation.

After the backlash estimation is executed, control by the command from the controller is disabled. To perform control again using commands from the controller, reset the communication, cycle the power, or execute the software reset.

Setting example [G] [A]

The following setting example shows how to use the backlash estimation function.

Ex.

Machine specifications

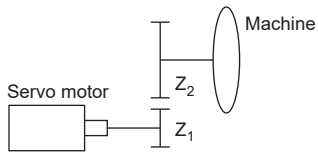

Pt (servo motor resolution): 67108864 pulses/rev

Z₁ Number of gear teeth on servo motor side: 11

Z₂ Number of gear teeth on machine side: 25

Z₁: Z₂ = 11: 25

Bn Backlash nominal value presented by the manufacturer: 10 [degree]

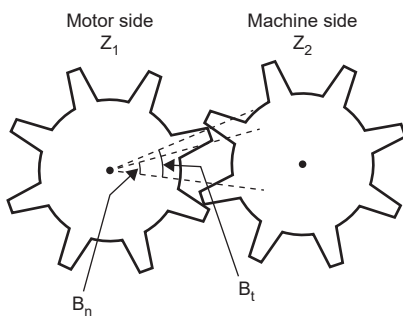

■ When the gear ratio of the gear connected to the servo motor is identified

Setting [Pr. PF66.0-3 Gear for backlash estimation - Numerator] and [Pr. PF66.4-7 Gear for backlash estimation - Denominator] limits the travel distance during the backlash estimation to the minimum. The backlash estimation value of the gear connected to the servo motor is the value in the load-side unit.

1. Set the gear ratio of the gear connected to the servo motor in hexadecimal.

If the number of gear teeth on servo motor side is 11 and the number of gear teeth on machine side is 25, set [Pr. PF66.0-3] to "000B" and [Pr. PF66.4-7] to "0019".

If multiple gears are connected to the servo motor, set the gear ratio up to where the load is applied.

2. Set the backlash nominal value presented by the manufacturer of the gear connected to the servo motor.

Set the backlash nominal value in [Pr. PF67 Backlash nominal value] taking the gear ratio for backlash estimation into account.

If the backlash nominal value is 10 [degree], the following equation is used for the calculation.

Backlash nominal value presented by the manufacturer $\times 100 \times ([Pr. PF66.0-3] / [Pr. PF66.4-7]) = 10 \times 100 \times (11/25) = 440.0$

Therefore, set [Pr. PF67] to 440 [0.01 degree]. Round up the calculated value.

If the backlash nominal value is in the load-side unit, there is no need to consider the gear ratio for backlash estimation.

If the backlash nominal value is 10 [degree] in load-side unit, set the following calculation result in [Pr. PF67].

Backlash nominal value presented by the manufacturer $\times 100 = 10 \times 100 = 1000$ [0.01 degree]

3. Select the unit for the travel distance which is to be automatically set in the backlash estimation function.

A time-out will occur at execution of the backlash estimation function depending on the setting values for the electronic gear ([Pr. PA06 Electronic gear numerator]/[Pr. PA07 Electronic gear denominator]). In this case, set [Pr. PF62.0 Backlash estimation unit selection] to "1".

4. Adjust the settings of the gear failure prediction function.

To change the backlash threshold used for the gear failure prediction function, change [Pr. PF68 Backlash threshold multiplication]. When "0" (initial value) is set, a value twice the value of [Pr. PF67] / 100 is set as the backlash threshold.

The threshold used for gear failure prediction is calculated with the following equation.

Backlash threshold = [Pr. PF67] / 100 \times [Pr. PF68] / 10

When setting the backlash threshold to 1000 [0.01 degree] while the backlash nominal value is 440 [0.01 degree], use the following equation for the calculation.

[Pr. PF68] = Backlash threshold [0.01 degree] / [Pr. PF67] $\times 10 = 1000 / 440 \times 10 = 22.72\dots$

Therefore, set [Pr. PF68] to 23 [0.1 times]. Round up the calculated value.

■ When the gear ratio of the gear connected to the servo motor is not identified

When either [Pr. PF66.0-3 Gear for backlash estimation - Numerator] or [Pr. PF66.4-7 Gear for backlash estimation - Denominator] is set to "0", the travel distance during the backlash estimation is two rotations each in the forward and reverse rotation side from the starting position of the backlash estimation. The backlash estimation value of the gear connected to the servo motor is the value in the servo motor-side unit.

1. Set the backlash nominal value presented by the manufacturer of the gear connected to the servo motor.

Set the backlash nominal value in [Pr. PF67 Backlash nominal value] after converting the value into the rotation angle on the servo motor side.

If the backlash nominal value is 10 [degree], the following equation is used for the calculation.

Backlash nominal value presented by the manufacturer $\times 100 = 1000$

Therefore, set [Pr. PF67] to 1000 [0.01 degree].

2. Select the unit for the travel distance which is to be automatically set in the backlash estimation function.

A time-out will occur at execution of the backlash estimation function depending on the setting values for the electronic gear ([Pr. PA06 Electronic gear numerator]/[Pr. PA07 Electronic gear denominator]). In this case, set [Pr. PF62.0 Backlash estimation unit selection] to "1".

3. Adjust the settings of the gear failure prediction function.

To change the backlash threshold used for the gear failure prediction function, change [Pr. PF68 Backlash threshold multiplication]. When "0" (initial value) is set, a value twice the value of [Pr. PF67] / 100 is set as the backlash threshold.

The threshold used for gear failure prediction is calculated with the following equation.

$$\text{Backlash threshold} = [\text{Pr. PF67}] / 100 \times [\text{Pr. PF68}] / 10$$

When setting the backlash threshold to 2000 [0.01 degree] while the backlash nominal value is 1000 [0.01 degree], set [Pr. PF68] to 20 [0.1 times].

Setting example [B]

The following setting example shows how to use the backlash estimation function.

Ex.

Machine specifications

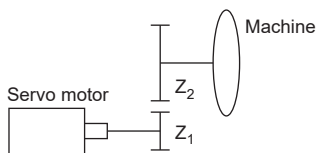

P_t (servo motor resolution): 67108864 pulses/rev

Z_1 Number of gear teeth on servo motor side: 11

Z_2 Number of gear teeth on machine side: 25

$Z_1: Z_2 = 11: 25$

B_n Backlash nominal value presented by the manufacturer: 10 [degree]

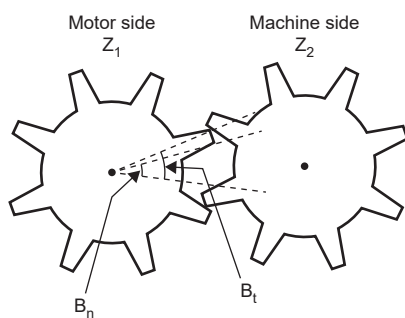

■ When the gear ratio of the gear connected to the servo motor is identified

Setting [Pr. PF66.0-3 Gear for backlash estimation - Numerator] and [Pr. PF66.4-7 Gear for backlash estimation - Denominator] limits the travel distance during the backlash estimation to the minimum. The backlash estimation value of the gear connected to the servo motor is the value in the load-side unit.

1. Set the gear ratio of the gear connected to the servo motor in hexadecimal.

If the number of gear teeth on servo motor side is 11 and the number of gear teeth on machine side is 25, set [Pr. PF66.0-3] to "000B" and [Pr. PF66.4-7] to "0019".

If multiple gears are connected to the servo motor, set the gear ratio up to where the load is applied.

2. Set the backlash nominal value presented by the manufacturer of the gear connected to the servo motor.

Set the backlash nominal value in [Pr. PF67 Backlash nominal value] taking the gear ratio for backlash estimation into account.

If the backlash nominal value is 10 [degree], the following equation is used for the calculation.

Backlash nominal value presented by the manufacturer $\times 100 \times ([Pr. PF66.0-3] / [Pr. PF66.4-7]) = 10 \times 100 \times (11/25) = 440.0$

Therefore, set [Pr. PF67] to 440 [0.01 degree]. Round up the calculated value.

If the backlash nominal value is in the load-side unit, there is no need to consider the gear ratio for backlash estimation.

If the backlash nominal value is 10 [degree] in load-side unit, set the following calculation result in [Pr. PF67].

Backlash nominal value presented by the manufacturer $\times 100 = 10 \times 100 = 1000$ [0.01 degree]

3. Adjust the settings of the gear failure prediction function.

To change the backlash threshold used for the gear failure prediction function, change [Pr. PF68 Backlash threshold multiplication]. When "0" (initial value) is set, a value twice the value of [Pr. PF67] / 100 is set as the backlash threshold.

The threshold used for gear failure prediction is calculated with the following equation.

Backlash threshold = [Pr. PF67] / 100 \times [Pr. PF68] / 10

When setting the backlash threshold to 1000 [0.01 degree] while the backlash nominal value is 440 [0.01 degree], use the following equation for the calculation.

[Pr. PF68] = Backlash threshold [0.01 degree] / [Pr. PF67] $\times 10 = 1000 / 440 \times 10 = 22.72\dots$

Therefore, set [Pr. PF68] to 23 [0.1 times]. Round up the calculated value.

■ When the gear ratio of the gear connected to the servo motor is not identified

When either [Pr. PF66.0-3 Gear for backlash estimation - Numerator] or [Pr. PF66.4-7 Gear for backlash estimation - Denominator] is set to "0", the travel distance during the backlash estimation is two rotations each in the forward and reverse rotation side from the starting position of the backlash estimation. The backlash estimation value of the gear connected to the servo motor is the value in the servo motor-side unit.

1. Set the backlash nominal value presented by the manufacturer of the gear connected to the servo motor.

Set the backlash nominal value in [Pr. PF67 Backlash nominal value] after converting the value into the rotation angle on the servo motor side.

If the backlash nominal value is 10 [degree], the following equation is used for the calculation.

Backlash nominal value presented by the manufacturer $\times 100 = 1000$

Therefore, set [Pr. PF67] to 1000 [0.01 degree].

2. Adjust the settings of the gear failure prediction function.

To change the backlash threshold used for the gear failure prediction function, change [Pr. PF68 Backlash threshold multiplication]. When "0" (initial value) is set, a value twice the value of [Pr. PF67] / 100 is set as the backlash threshold.

The threshold used for gear failure prediction is calculated with the following equation.

Backlash threshold = [Pr. PF67] / 100 \times [Pr. PF68] / 10

When setting the backlash threshold to 2000 [0.01 degree] while the backlash nominal value is 1000 [0.01 degree], set [Pr. PF68] to 20 [0.1 times].

Cancellation of backlash estimation function

Click the stop button during backlash estimation to cancel the backlash estimation. When backlash estimation is canceled, "C000" is displayed in the error code status. When resuming backlash estimation, stop the servo motor once. In addition, return the movable part to the estimated starting position.

When backlash estimation error occurs

If an estimation error occurs during the backlash estimation, the estimation will be canceled. At this time, as the error code is displayed in the error code status, check the cause of the estimation error. To perform backlash estimation again, stop the servo motor once. In addition, return the movable part to the estimated starting position.

Display	Name	Error description	Handling example
0000	Successfully completed	—	—
C000	Tuning canceled	"Stop button" was clicked during the backlash estimation.	—
C001	Servo-off during estimation	Switched to servo-off during the backlash estimation.	Prevent the servo amplifier from switching to servo-off during backlash estimation.
C002	Backlash misestimation	The backlash estimation amount could not be calculated.	Drive the servo motor under the following conditions: <ul style="list-style-type: none"> • The overspeed alarm level is 100 [r/min] or higher. • The acceleration/deceleration torque is 30 % or more of the rated torque.
		The to-and-fro positioning operation cannot be performed because of the effect of oscillation.	After adjusting the gain so that oscillation does not occur, perform the backlash estimation.
		The backlash estimation is performed without the gear.	Execute the backlash estimation while the gear is connected to the servo motor.
C003	Backlash estimation start error during servo motor driving	Starting backlash estimation is attempted when the servo motor speed is 20 r/min or faster.	Perform backlash estimation while the servo motor is stopped.
C004	Backlash estimation start error	The backlash estimation start button was pushed during the backlash estimation.	Press the backlash estimation start button when the backlash estimation is not performed.
		The backlash estimation start button was pushed during the amplifier command method one-touch tuning.	Push the backlash estimation start button when the amplifier command method one-touch tuning is not performed.
C005	Backlash estimation control mode error	Backlash estimation started in the linear servo motor control mode.	Backlash estimation cannot be used in the linear servo motor control mode.
C006	Backlash estimation command generation error	The torque limit value has been set to "0".	Set the torque limit value to exceed the rated torque by 30 %.
C007	Stop signal error	[G] [A]: LSP and LSN were turned off during the backlash estimation. EM2 was turned off during the backlash estimation. FLS and RLS were turned off during the backlash estimation.	Review the starting position of the backlash estimation. After ensuring safety, turn EM2 on.
		[B]: EM2 was turned off during the backlash estimation. FLS and RLS were turned off during the backlash estimation. The emergency stop command from the controller was turned off during the backlash estimation via the controller.	Review the starting position of the backlash estimation. After ensuring safety, turn on EM2 or the emergency stop command from the controller.
C008	Servo parameter	Only one gear ratio is set to "0".	Set a value other than "0" for both the gear ratio numerator and denominator.
		Servo parameter for manufacturer setting has been changed.	Restore the servo parameters for manufacturer setting to the initial values.
		The overspeed alarm level is too low.	Increase the overspeed alarm level.
		Only one gear ratio is set to "0".	Set both the gear ratio numerator and denominator.
C009	Alarm	A backlash estimation was attempted to start during occurrence of an alarm or warning. An alarm/warning occurred during backlash estimation.	Start the backlash estimation when no alarm/warning occurs. Prevent alarm/warning from occurring during backlash estimation.
C00A	Time-out	Two minutes or more passed during backlash estimation.	Start backlash estimation after the torque limit value and the overspeed alarm detection level have been increased.
		Communication with MR Configurator2 was disconnected during backlash estimation.	Prevent communication with MR Configurator2 from being disconnected during backlash estimation.
FFFF	Backlash estimation not implemented	The backlash estimation is not implemented.	Perform backlash estimation.

Gear failure prediction function

The gear failure prediction function predicts the gear failure by comparing the backlash amount estimated by the backlash estimation function with the backlash value set in the servo parameter.

After inputting the threshold to the servo amplifier with the gear diagnosis threshold setting method, performing backlash estimation executes the gear failure prediction. Refer to the following for the gear diagnosis threshold setting method.

 Page 273 Gear diagnosis threshold setting method

When executing the gear failure prediction, [AL. 0F7 Machine diagnostic warning] is output if the backlash estimate value is larger than the threshold. When [AL. 0F7 Machine diagnostic warning] is output, this warning can be canceled by setting [Pr. PF67 Backlash nominal value] to 0, resetting the communication, cycling the servo amplifier power, or executing software reset.

[AL. 0F7 Machine diagnostic warning] is output after the backlash estimation is complete. [AL. 0F7 Machine diagnostic warning] will not be output even if the backlash estimation result stored inside the servo amplifier is larger than the backlash threshold.

Related objects [G]

Outline of objects related to the gear failure diagnosis function.

For details on the objects, refer to the User's Manual (Object Dictionary).

Index	Sub	Object	Name	Description
2C32h	0	VAR	Backlash estimation value	The result of backlash estimation is displayed. When the gear numerator for backlash estimation or the gear denominator for backlash estimation is set to "0", the backlash estimation amount is output as the rotation angle on the servo motor side. When a value other than "0" is set for the gear ratio of backlash estimation, a backlash estimated value is output in consideration of the gear ratio for backlash estimation. Unit: 0 [0.01 degree]

Belt diagnosis function



- [AL. 037 Parameter error] occurs when the friction failure prediction function and static friction failure prediction function are enabled at the same time.

Precautions

- The static friction failure prediction function uses the static friction estimated by the friction estimation function to predict failures. Therefore, in order to estimate the static friction with the friction estimation function, set [Pr. PF31 Machine diagnostic function low speed friction estimated region judgment speed].

Outline [G] [B]

The belt diagnosis function estimates the tension deterioration of the belt connected to the servo motor by using the friction value of the servo amplifier internal data. A belt failure can be predicted based on the tension deterioration of the belt. Also, the timing of belt re-tensioning can be determined. Note that belt breakage cannot be predicted with the belt diagnosis function.

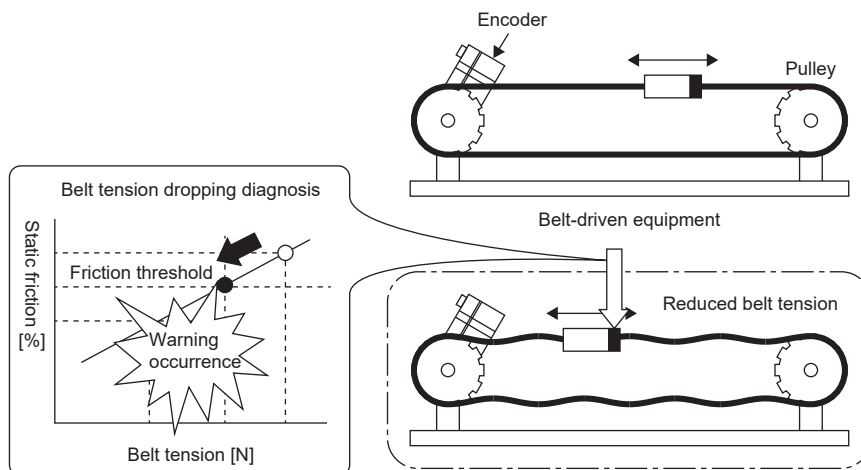

The belt diagnosis function includes the following two functions:

■ Friction failure prediction function

The friction failure prediction function predicts a failure of the equipment from the increase/decrease in the static friction estimated by the friction estimation function. If a failure of the equipment is predicted, [AL. 0F7 Machine diagnosis warning] occurs. The threshold of [AL. 0F7 Machine diagnosis warning] can be set automatically, and therefore this function is easier to use than the belt tension deterioration prediction function. In order for the static friction failure prediction function to detect the increase/decrease of the static friction, the accuracy of belt tension deterioration is low, and the initial stretch of the belt may trigger [AL. 0F7 Machine diagnosis warning].

■ Belt tension deterioration prediction function

For the belt tension deterioration prediction function, [AL. 0F7 Machine diagnostic warning] occurs when the belt tension that is estimated from the servo amplifier internal data is equal to or lower than the input threshold of the belt tension servo parameter. Although the relationship between the belt tension and the static friction needs to be input with servo parameters, this function can improve the accuracy in detection of the belt tension deterioration by estimating the belt tension and outputting [AL. 0F7 Machine diagnosis warning].

Differences between the static friction failure prediction function and the belt tension deterioration function are shown on the following table.

Item	Friction failure prediction function	Belt tension deterioration prediction function
Determination criteria	Static friction	Belt tension
Threshold setting	Automatic setting possible	Manual setting
Input required servo parameter	[Pr. PF34.5 Static friction failure prediction warning selection] [Pr. PF41 Failure prediction - Servo motor total travel distance]	[Pr. PF71.0 Belt tension deterioration prediction function selection] [Pr. PF72 Belt tension on installation] [Pr. PF73 Belt tension when extended] [Pr. PF74 Static friction during installation] [Pr. PF75 Static friction when extended] [Pr. PF76 Belt tension irregular threshold]
Belt tension deterioration detection accuracy	Low	High

Outline [A]

The belt diagnosis function estimates the tension deterioration of the belt connected to the servo motor by using the friction value of the servo amplifier internal data. A belt failure can be predicted based on the tension deterioration of the belt. Also, the timing of belt re-tensioning can be determined. Note that belt breakage cannot be predicted with the belt diagnosis function.

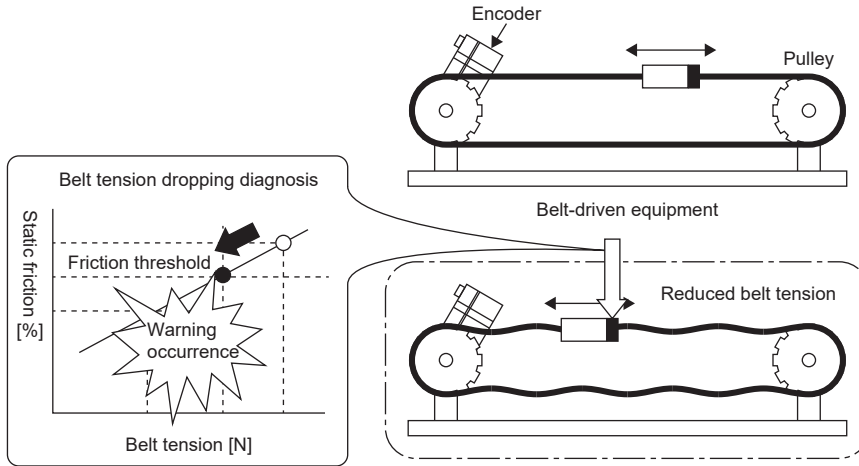

The belt diagnosis function includes the following two functions:

■ Friction failure prediction function

The friction failure prediction function predicts a failure of the equipment from the increase/decrease in the static friction estimated by the friction estimation function. If a failure of the equipment is predicted, [AL. 0F7 Machine diagnosis warning] occurs. The threshold of [AL. 0F7 Machine diagnosis warning] can be set automatically, and therefore this function is easier to use than the belt tension deterioration prediction function. In order for the static friction failure prediction function to detect the increase/decrease of the static friction, the accuracy of belt tension deterioration is low, and the initial stretch of the belt may trigger [AL. 0F7 Machine diagnosis warning].

■ Belt tension deterioration prediction function

For the belt tension deterioration prediction function, [AL. 0F7 Machine diagnostic warning] occurs when the belt tension that is estimated from the servo amplifier internal data is equal to or lower than the input threshold of the belt tension servo parameter. Although the relationship between the belt tension and the static friction needs to be input with servo parameters, this function can improve the accuracy in detection of the belt tension deterioration by estimating the belt tension and outputting [AL. 0F7 Machine diagnosis warning].

Differences between the static friction failure prediction function and the belt tension deterioration function are shown on the following table.

Item	Friction failure prediction function	Belt tension deterioration prediction function
Determination criteria	Static friction	Belt tension
Threshold setting	Automatic setting possible	Manual setting
Input required servo parameter	[Pr. PF51.5 Static friction failure prediction warning selection] [Pr. PF53 Failure prediction - Servo motor total travel distance]	[Pr. PF71.0 Belt tension deterioration prediction function selection] [Pr. PF72 Belt tension on installation] [Pr. PF73 Belt tension when extended] [Pr. PF74 Static friction during installation] [Pr. PF75 Static friction when extended] [Pr. PF76 Belt tension irregular threshold]
Belt tension deterioration detection accuracy	Low	High

Static friction failure prediction function [G] [B]

Friction failure prediction function method of use

Follow these procedures when using the static friction failure prediction function. For the static friction failure prediction function, threshold that outputs a warning can be calculated automatically inside the servo amplifier using the automatic threshold setting or set with servo parameters using the manual threshold setting. With the manual threshold setting, the threshold that outputs a warning can be set to any value.

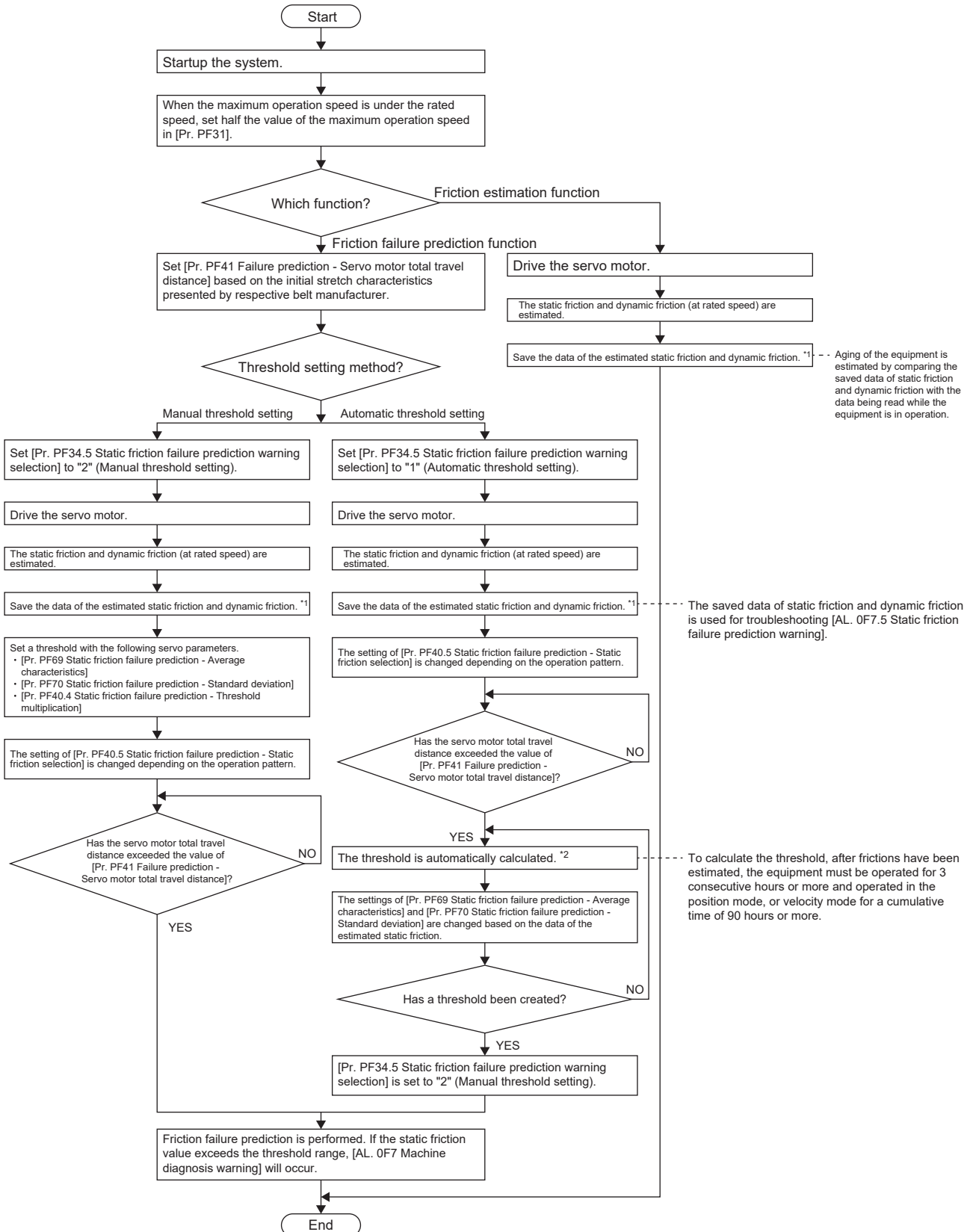

- *1 Estimated static friction and dynamic friction can be saved by opening the machine diagnostic screen of MR Configurator2.
- *2 If the equipment has been operated for less than continuous three hours, or the friction estimation has not finished for the rotation direction set in [Pr. PF40.5 Static friction failure prediction - Static friction selection], the threshold is not calculated automatically.

■ Static friction failure prediction warning setting

Set [Pr. PF34.5 Static friction failure prediction warning selection], and enable the static friction failure prediction warning. When "1" (static friction threshold automatic setting) is set, the threshold is automatically calculated inside the servo amplifier. When "2" (static friction threshold manual setting) is set, set the threshold with servo parameter.

Servo parameter	Symbol	Name	Description
PF34.5	*MFP	Static friction failure prediction warning selection	0: Disabled (initial value) 1: Automatic threshold setting 2: Manual threshold setting 3: Threshold reset

■ Setting "Failure prediction - Servo motor total travel distance"

When using the automatic threshold setting, set the Failure prediction - Servo motor total travel distance in [Pr. PF41 Failure prediction - Servo motor total travel distance].

If the machine total travel distance is smaller than the Failure prediction - Servo motor total travel distance, the threshold will not be automatically set from the estimated static friction, assuming that the belt has been initially stretched. Set a machine total travel distance at which the initial stretch completes in consideration of the Failure prediction - Servo motor total travel distance by referring to the initial stretch characteristic presented by respective belt manufacturers and the typical drive pattern of the device. For example, if the Failure prediction - Servo motor total travel distance is to be 8×10^5 rev, set "80000" [10 rev] in [Pr. PF41 Failure prediction - Servo motor total travel distance].

■ Threshold setting method

When [Pr. PF34.5 Static friction failure prediction warning selection] is set to "1" (automatic threshold setting), [Pr. PF69 Static friction failure prediction - Average characteristics] and [Pr. PF70 Static friction failure prediction - Standard deviation] for determining a threshold are automatically rewritten according to the static friction estimated in the servo amplifier.

The threshold can be changed with [Pr. PF40.4 Static friction failure prediction - Threshold multiplication]. If [AL. 0F7 Machine diagnosis warning] is incorrectly detected with the value calculated by the automatic threshold setting, increase the value of [Pr. PF40.4 Static friction failure prediction - Threshold multiplication].

After the threshold is calculated in the servo amplifier, [Pr. PF34.5 Static friction failure prediction warning selection] changes to "2" (manual threshold setting).

Set [Pr. PF34.5 Static friction failure prediction warning selection] to "2" (manual threshold setting) to set the threshold manually. The upper and lower thresholds can be set by [Pr. PF40.4 Static friction failure prediction - Threshold multiplication], [Pr. PF69 Static friction failure prediction - Average characteristic], and [Pr. PF70 Static friction failure prediction - Standard deviation], and are calculated with the following formula. When [Pr. PF40.4 Static friction failure prediction - Threshold multiplication] is "0" in the following formula, calculate the upper and lower thresholds with the static friction failure prediction threshold multiplication as 5.

Upper limit threshold [0.1 %] = [Pr. PF69] + [Pr. PF70] × [Pr. PF40.4]

Lower limit threshold [0.1 %] = [Pr. PF69] - [Pr. PF70] × [Pr. PF40.4]

Servo parameter	Symbol	Name	Description
PF40.4	MFPP	Static friction failure prediction - Threshold multiplication	Set a multiplying factor for calculating the threshold used in the static friction failure prediction function. Setting a small threshold multiplication for static friction failure prediction will decrease the threshold used for static friction failure prediction. Thus, this will enable the prediction of a failure at an early stage, but will increase the possibility of erroneously detecting a failure. *1 Initial value: 0h
PF69	SPAV	Static friction failure prediction - Average characteristics	Set a static friction torque average. *2 Initial value: 0 [0.1 %]
PF70	SPSD	Static friction failure prediction - Standard deviation	Set a standard deviation of static friction torque. *2 Initial value: 0 [0.1 %]

*1 When "0" is set, the threshold is 5 times.

*2 Enabled when [Pr. PF34.5 Static friction failure prediction warning selection] is set to "2" (manual threshold setting).

When [Pr. PF34.5 Static friction failure prediction warning selection] is set to "1" (automatic threshold setting), the value will be calculated automatically from the estimated static friction torque.

■ Threshold reset method

When the automatic threshold setting is performed again after being used to set the upper and lower threshold, set [Pr. PF34.5 Static friction failure prediction warning selection] to "3" (threshold reset), then cycle the power or reset the software afterwards. After cycling the power or resetting the software, the threshold is reset and [Pr. PF34.5 Static friction failure prediction warning selection] changes to "1" (automatic threshold setting).

If a part on the equipment is replaced after the static friction failure prediction function has started, reset the static friction threshold and machine total travel distance.

■ Friction failure prediction function

When the upper and lower thresholds are input to the servo amplifier with the threshold setting method, the servo amplifier starts the static friction failure prediction. For the threshold setting method, refer to the following.

☞ Page 290 Threshold setting method

During the static friction failure prediction, [AL. 0F7 Machine diagnostic warning] is output when the static friction estimated by the friction estimation function exceeds the upper limit threshold. Also, [AL. 0F7 Machine diagnostic warning] is output even when the static friction falls below the lower limit threshold.

After [AL. 0F7 Machine diagnosis warning] is output, if the static friction falls within the range of the upper and lower threshold, [AL. 0F7 Machine diagnostic warning] will be canceled.

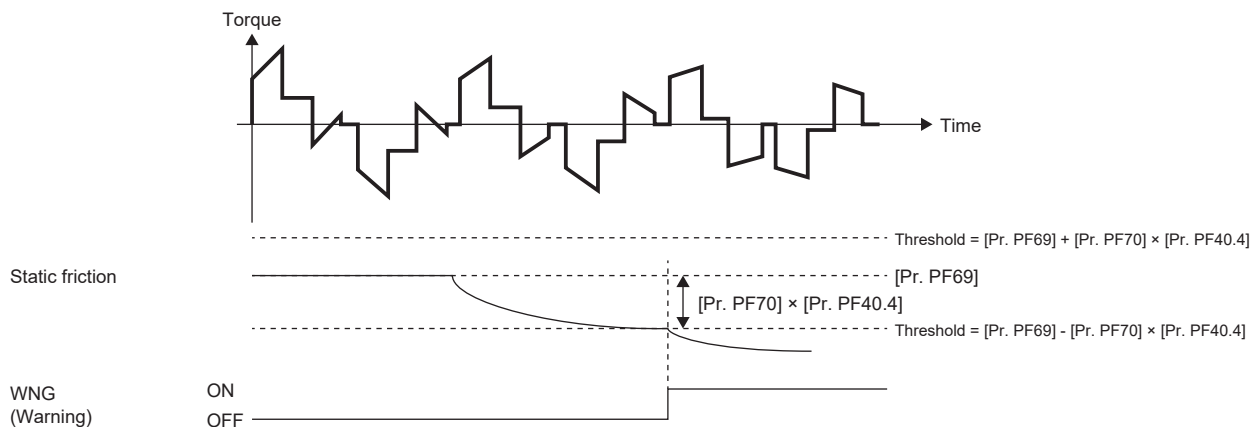

■ Related objects [G]

The following is a description of objects related to the static friction failure prediction function.

For details on the objects, refer to the User's Manual (Object Dictionary).

Index	Sub	Object	Name	Description
2C29h	0	VAR	Fault prediction status	<p>[Bit 0 to 3: Friction failure prediction status]</p> <p>0: Friction failure prediction disabled</p> <p>1: During preparation for friction failure prediction</p> <p>2: During execution of friction failure prediction</p> <p>3: During friction failure prediction warning</p> <p>[Bit 4 to 7: Vibration failure prediction status]</p> <p>0: Vibration failure prediction disabled</p> <p>1: During preparation for vibration failure prediction</p> <p>2: During execution of vibration failure prediction</p> <p>3: During vibration failure prediction warning</p> <p>[Bit 8 to 11: Total travel distance failure prediction status]</p> <p>0: Motor total travel distance failure prediction disabled</p> <p>1: Motor total travel distance failure prediction being executed</p> <p>2: Motor total travel distance failure prediction at warning</p> <p>[Bit 12 to 15: Motor total travel distance calculation status]</p> <p>0: During stop of motor total travel distance calculation</p> <p>1: During calculation of motor total travel distance</p> <p>[Bit 16 to 19: reserved]</p> <p>[Bit 20 to 23: Static friction failure prediction status]</p> <p>0: Static friction failure prediction disabled</p> <p>1: During preparation for static friction failure prediction</p> <p>2: During execution of static friction failure prediction</p> <p>3: During static friction failure prediction warning</p> <p>[Bit 24 to 27: Belt tension deterioration prediction status]</p> <p>0: Belt tension deterioration prediction disabled</p> <p>1: Belt tension deterioration prediction in progress</p> <p>2: During belt tension deterioration warning</p> <p>[Bit 28 to 31: Belt tension estimation status]</p> <p>0: Belt tension estimation in progress</p> <p>1: Belt tension estimation has finished</p> <p>7: Belt tension estimation is not set</p>
2C33h	0	VAR	Static friction based fault prediction upper threshold	The upper limit threshold used for static friction failure prediction is displayed in increments of 0.1 % in relation to the rated torque as 100 %.
2C34h	0	VAR	Static friction based fault prediction lower threshold	The lower limit threshold used for static friction failure prediction is displayed in increments of 0.1 % in relation to the rated torque as 100 %.
2C35h	0	VAR	Static friction based fault prediction prepare status	The creation progress of the thresholds used in static friction failure prediction is displayed as a percentage. Creation of friction failure prediction for the upper and lower limit threshold finishes at 100 %.

Static friction failure prediction function [A]

Friction failure prediction function method of use

Follow these procedures when using the static friction failure prediction function. For the static friction failure prediction function, threshold that outputs a warning can be calculated automatically inside the servo amplifier using the automatic threshold setting or set with servo parameters using the manual threshold setting. With the manual threshold setting, the threshold that outputs a warning can be set to any value.

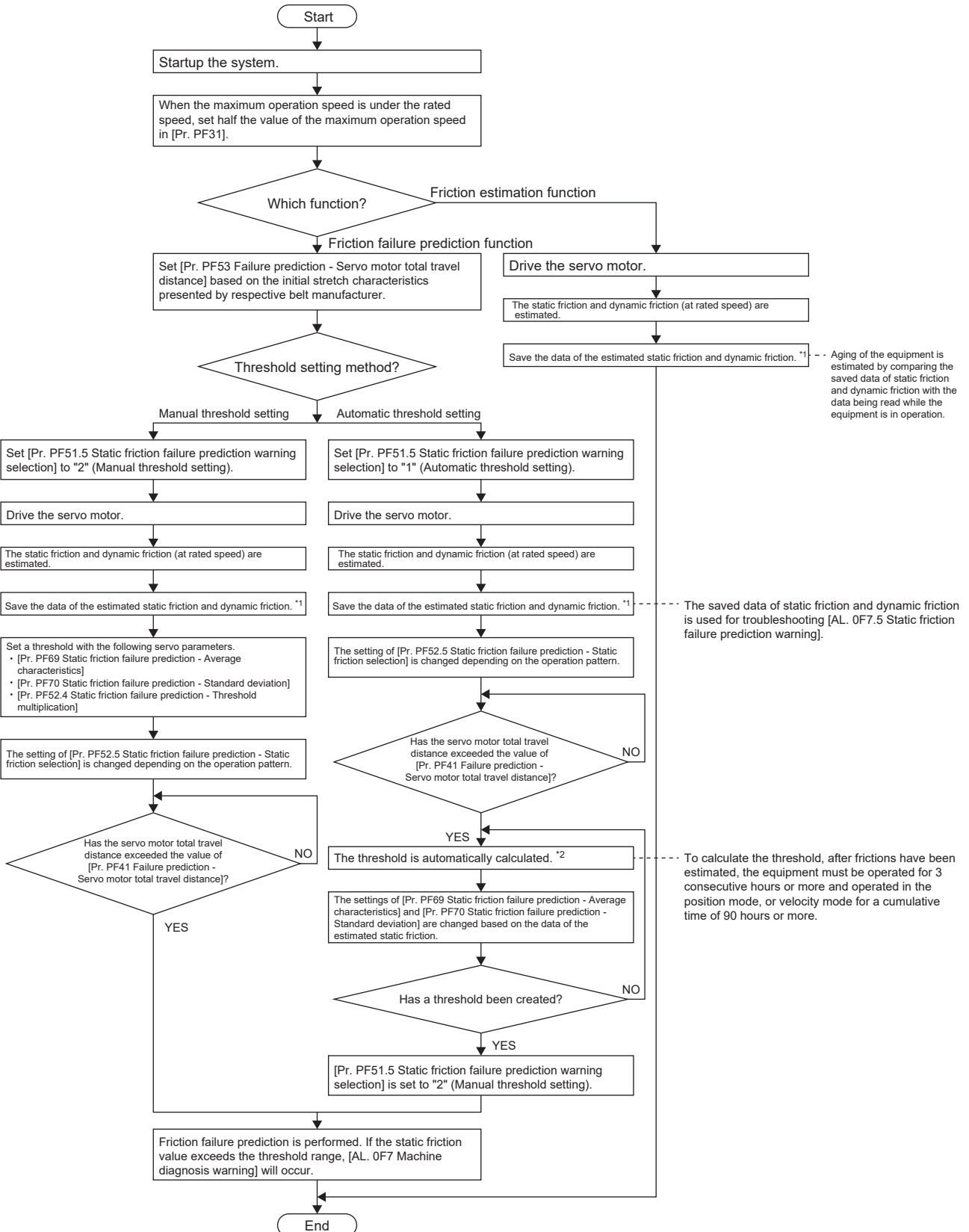

- *1 Estimated static friction and dynamic friction can be saved by opening the machine diagnostic screen of MR Configurator2.
- *2 If the equipment has been operated for less than continuous three hours, or the friction estimation has not finished for the rotation direction set in [Pr. PF52.5 Static friction failure prediction - Static friction selection], the threshold is not calculated automatically.

■ Static friction failure prediction warning setting

Set [Pr. PF51.5 Static friction failure prediction warning selection], and enable the static friction failure prediction warning. When "1" (static friction threshold automatic setting) is set, the threshold is automatically calculated inside the servo amplifier. When "2" (static friction threshold manual setting) is set, set the threshold with servo parameter.

Servo parameter	Symbol	Name	Description
PF51.5	*MFP	Static friction failure prediction warning selection	0: Disabled (initial value) 1: Automatic threshold setting 2: Manual threshold setting 3: Threshold reset

■ Setting "Failure prediction - Servo motor total travel distance"

When using the automatic threshold setting, set the Failure prediction - Servo motor total travel distance in [Pr. PF53 Failure prediction - Servo motor total travel distance].

If the machine total travel distance is smaller than the Failure prediction - Servo motor total travel distance, the threshold will not be automatically set from the estimated static friction, assuming that the belt has been initially stretched. Set a servo motor travel distance at which the initial stretch completes in consideration of the Failure prediction - Servo motor total travel distance by referring to the initial stretch characteristic presented by respective belt manufacturers and the typical drive pattern of the device. For example, if the Failure prediction - Servo motor total travel distance is to be 8×10^5 rev, set "80000" [10 rev] in [Pr. PF53 Failure prediction - Servo motor total travel distance].

■ Threshold setting method

When [Pr. PF51.5 Static friction failure prediction warning selection] is set to "1" (automatic threshold setting), [Pr. PF69 Static friction failure prediction - Average characteristics] and [Pr. PF70 Static friction failure prediction - Standard deviation] for determining a threshold are automatically rewritten according to the static friction estimated in the servo amplifier.

The threshold can be changed with [Pr. PF52.4 Static friction failure prediction - Threshold multiplication]. If [AL. 0F7 Machine diagnosis warning] is incorrectly detected with the value calculated by the automatic threshold setting, increase the value of [Pr. PF52.4 Static friction failure prediction - Threshold multiplication].

After the threshold is calculated in the servo amplifier, [Pr. PF51.5 Static friction failure prediction warning selection] changes to "2" (manual threshold setting).

Set [Pr. PF51.5 Static friction failure prediction warning selection] to "2" (manual threshold setting) to set the threshold manually. The upper and lower thresholds can be set by [Pr. PF52.4 Static friction failure prediction - Threshold multiplication], [Pr. PF69 Static friction failure prediction - Average characteristic], and [Pr. PF70 Static friction failure prediction - Standard deviation], and are calculated with the following formula. When [Pr. PF52.4 Static friction failure prediction - Threshold multiplication] is "0" in the following formula, calculate the upper and lower thresholds with the static friction failure prediction threshold multiplication as 5.

Upper limit threshold [0.1 %] = [Pr. PF69] + [Pr. PF70] × [Pr. PF52.4]

Lower limit threshold [0.1 %] = [Pr. PF69] - [Pr. PF70] × [Pr. PF52.4]

Servo parameter	Symbol	Name	Description
PF52.4	MFPP	Static friction failure prediction - Threshold multiplication	Set a multiplying factor for calculating the threshold used in the static friction failure prediction function. Setting a small threshold multiplication for static friction failure prediction will decrease the threshold used for static friction failure prediction. Thus, this will enable the prediction of a failure at an early stage, but will increase the possibility of erroneously detecting a failure. *1 Initial value: 0h
PF69	SPAV	Static friction failure prediction - Average characteristics	Set a static friction torque average. *2 Initial value: 0 [0.1 %]
PF70	SPSD	Static friction failure prediction - Standard deviation	Set a standard deviation of static friction torque. *2 Initial value: 0 [0.1 %]

*1 When "0" is set, the threshold is 5 times.

*2 Enabled when [Pr. PF51.5 Static friction failure prediction warning selection] is set to "2" (manual threshold setting).

When [Pr. PF51.5 Static friction failure prediction warning selection] is set to "1" (automatic threshold setting), the value will be calculated automatically from the estimated static friction torque.

■ Threshold reset method

When the automatic threshold setting is performed again after being used to set the upper and lower threshold, set [Pr. PF51.5 Static friction failure prediction warning selection] to "3" (threshold reset), then cycle the power or reset the software afterwards. After cycling the power or resetting the software, the threshold is reset and [Pr. PF51.5 Static friction failure prediction warning selection] changes to "1" (automatic threshold setting).

If a part on the equipment is replaced after the static friction failure prediction function has started, reset the static friction threshold and machine total travel distance.

■ Friction failure prediction function

When the upper and lower thresholds are input to the servo amplifier with the threshold setting method, the servo amplifier starts the static friction failure prediction. For the threshold setting method, refer to the following.

☞ Page 295 Threshold setting method

During the static friction failure prediction, [AL. 0F7 Machine diagnostic warning] is output when the static friction estimated by the friction estimation function exceeds the upper limit threshold. Also, [AL. 0F7 Machine diagnostic warning] is output even when the static friction falls below the lower limit threshold.

After [AL. 0F7 Machine diagnosis warning] is output, if the static friction falls within the range of the upper and lower threshold, [AL. 0F7 Machine diagnostic warning] will be canceled.

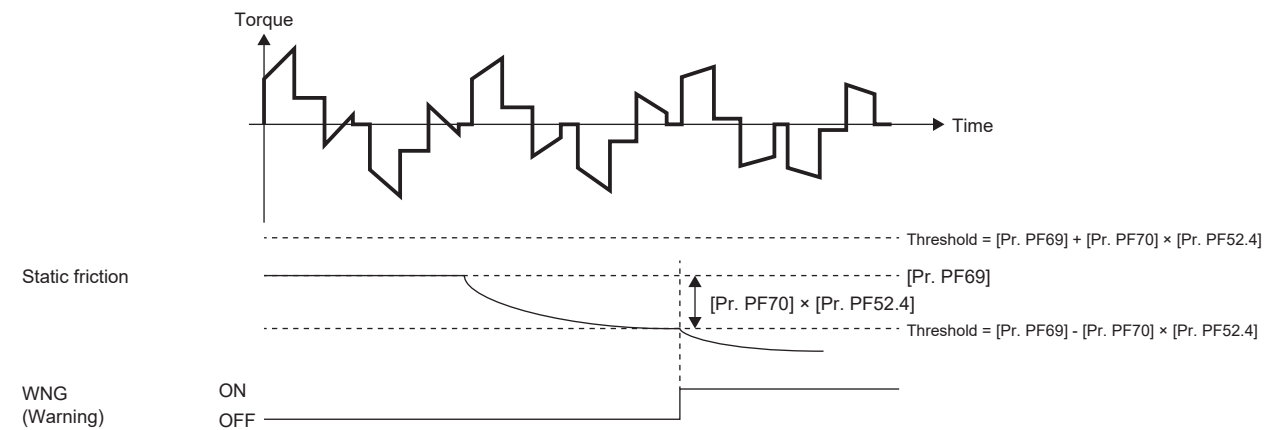

Belt tension deterioration prediction function [G] [B]

■ How to use the belt tension deterioration prediction function

Follow these procedures when using the static friction prediction function.

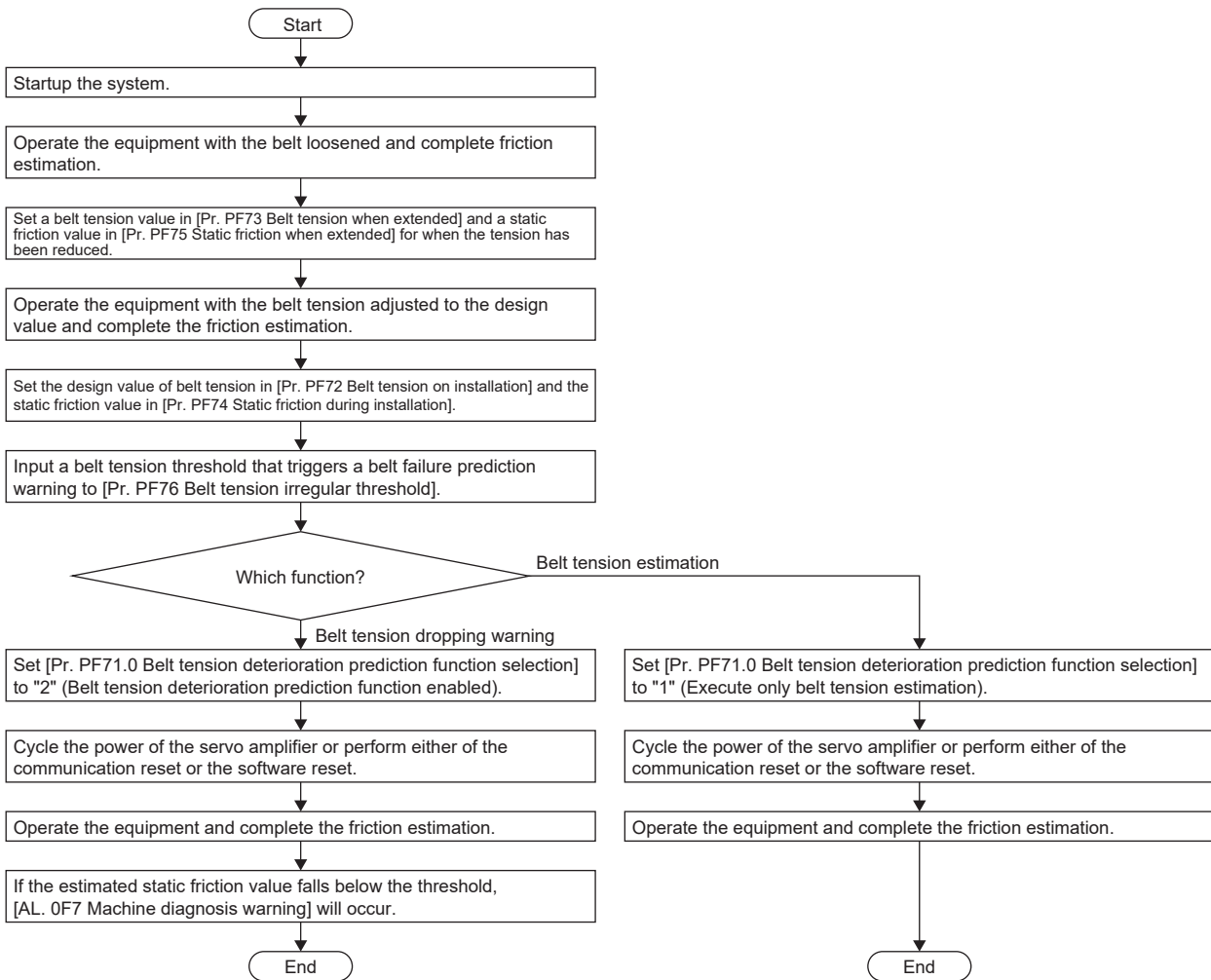

■ Setting method for belt tension when extended

Lower the belt tension below the design value, then attach the belt to the equipment. Measure the belt tension using a tension gauge. To reduce the belt tension, use a method such as shortening the distance between the pulleys or use the initial stretch of the belt. It is recommended to reduce the belt tension to 1/2 of the design value. After attaching the belt to the equipment, measure the belt tension and input the result to [Pr. PF73 Belt tension when extended]. It is recommended to use the friction vibration estimation function to measure the value of belt tension at extension immediately after the friction estimation completes. For friction vibration estimation function, refer to the following.

☞ Page 243 Friction vibration estimation function

Servo parameter	Symbol	Name	Description
PF73	ABT	Belt tension when extended	After the equipment is operated, set a belt tension for when the belt stretches or for when the belt is looser than at the time of the attachment. After the belt has been attached to the equipment, the time taken for the belt to stretch depends on the belt type. For the time taken for the belt to stretch, refer to the catalog or other documents of the belt manufacturer. When the setting is [Pr. PF72 Belt tension on installation] < [Pr. PF73 Belt tension when extended], the belt tension deterioration prediction function is disabled. Initial value: 0 [0.1 N]

■ Setting "Static friction when extended"

After attaching the belt to the equipment, drive the servo motor, and estimate the static friction with the friction vibration estimation function. In accordance with the completed static friction estimation, set [Pr. PF75 Static friction when extended] as follows.

- When estimation of static friction has completed only for the forward rotation side
[Pr. PF75 Static friction when extended] = Static friction on the forward rotation side
- When estimation of static friction has completed only for the reverse rotation side
[Pr. PF75 Static friction when extended] = Static friction on the reverse rotation side
- When estimation of static friction has completed for both the forward and reverse rotation sides
[Pr. PF75 Static friction when extended] = (Static friction at forward + at reverse rotation)/2

Servo parameter	Symbol	Name	Description
PF75	ASF	Static friction when extended	Set a static friction for when the belt stretches or for when the belt is looser than at the time of the attachment. Set the static friction with any of the following values estimated by the friction estimation function depending on the value of [Pr. PF71.1 Belt tension deterioration prediction friction selection]: static friction at forward rotation, static friction at reverse rotation, or the average of the estimated frictions. The belt tension deterioration function is disabled when the setting is: [Pr. PF74 Static friction during installation] < [Pr. PF75 Static friction when extended]. Initial value: 0 [0.1 %]

■ Setting "Belt tension on installation"

Set the design value of belt tension in [Pr. PF72 Belt tension on installation]. Measure the belt tension using a tension gauge. It is recommended to use the friction vibration estimation function to measure the value of belt tension immediately after the friction estimation completes. For friction vibration estimation function, refer to the following.

☞ Page 243 Friction vibration estimation function

Servo parameter	Symbol	Name	Description
PF72	SBT	Belt tension on installation	Set a belt tension for when the belt is attached to the equipment. The servo parameter indicates the reference belt tension threshold used in the belt diagnosis function. Initial value: 0 [0.1 N]

■ Setting "Static friction during installation"

After attaching the belt to the equipment, drive the servo motor, and estimate the static friction with the friction vibration estimation function. It is recommended to perform both forward rotation and reverse rotation in order to estimate the static friction at both rotation directions. In accordance with the estimated static friction, set [Pr. PF74 Static friction during installation] as follows.

- When estimation of static friction has completed only for the forward rotation side
[Pr. PF74 Static friction during installation] = Static friction on the forward rotation side
- When estimation of static friction has completed only for the reverse rotation side
[Pr. PF74 Static friction during installation] = Static friction on the reverse rotation side
- When estimation of static friction has completed for both the forward and reverse rotation sides
[Pr. PF74 Static friction during installation] = (Static friction at forward + at reverse rotation)/2

Servo parameter	Symbol	Name	Description
PF74	SSF	Static friction during installation	Set a static friction for when the belt is attached to the equipment. Set the static friction with any of the following values estimated by the friction estimation function depending on the value of [Pr. PF71.1 Belt tension deterioration prediction friction selection]: static friction at forward rotation, static friction at reverse rotation, or the average of the estimated frictions. Initial value: 0 [0.1 %]

■ Threshold setting for belt tension

Set a threshold to generate [AL. 0F7 Machine diagnosis warning]. When the belt tension estimated value inside the servo amplifier falls below the belt tension threshold, [AL. 0F7 Machine diagnostic warning] occurs.

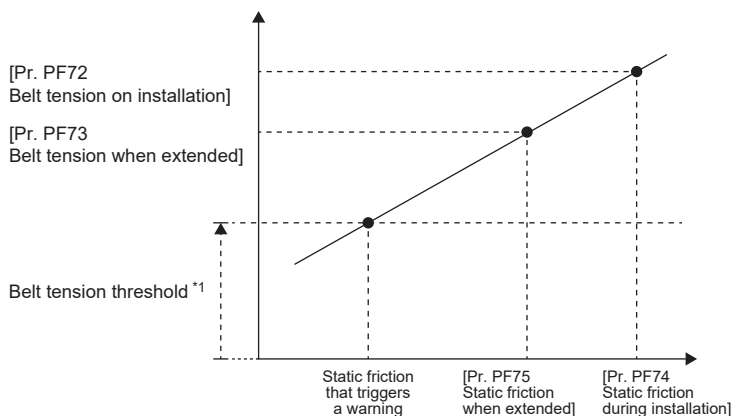

*1 Belt tension threshold = [Pr. PF76 Belt tension irregular threshold]/100 × [Pr. PF72 Belt tension on installation]

Servo parameter	Symbol	Name	Description
PF76	BTS	Belt tension irregular threshold	Set a threshold to generate [AL. 0F7 Machine diagnosis warning]. Set this servo parameter as a percentage of [Pr. PF72 Belt tension on installation]. When using the belt diagnosis function, input a value other than 0. Initial value: 0 [0.1 %]

■ Belt tension prediction warning selection setting

To enable belt tension prediction warning, set [Pr. PF71.0 Belt tension deterioration prediction function selection]. Furthermore, when a value other than 0 is set in [Pr. PF72 Belt tension on installation], [Pr. PF73 Belt tension when extended], [Pr. PF74 Static friction during installation], and [Pr. PF75 Static friction when extended], setting a value other than "0" (disabled) in [Pr. PF71.0 Belt tension deterioration prediction function selection] will estimate the belt tension.

Servo parameter	Symbol	Name	Description
PF71.0	BFP	Belt tension deterioration prediction function selection	Belt tension deterioration prediction function selection 0: Disabled (initial value) 1: Execute only belt tension estimation 2: Belt tension deterioration prediction function enabled After the equipment goes into actual operation, enable the belt tension deterioration prediction function.

■ Belt tension deterioration prediction function

During belt tension prediction, [AL. 0F7 Machine diagnostic warning] occurs when the static friction estimated by the friction estimation function falls below the threshold. After the occurrence of [AL. 0F7 Machine diagnosis warning], if the static friction becomes equal to or higher than the threshold value, [AL. 0F7 Machine diagnostic warning] will be canceled.

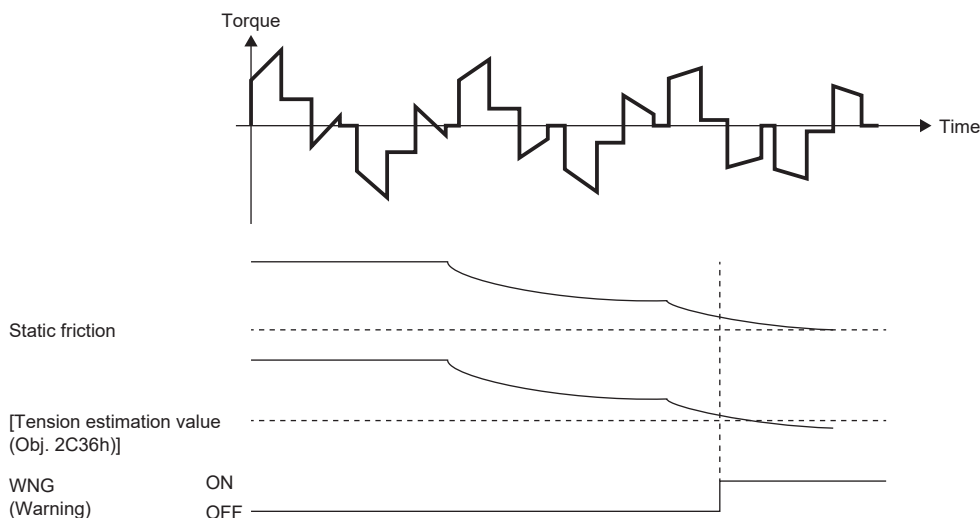

■ Related objects [G]

The following is a description of objects related to the belt tension deterioration prediction function.

For details on the objects, refer to the User's Manual (Object Dictionary).

Index	Sub	Object	Name	Description
2C29h	0	VAR	Fault prediction status	<p>[Bit 0 to 3: Friction failure prediction status]</p> <p>0: Friction failure prediction disabled</p> <p>1: During preparation for friction failure prediction</p> <p>2: During execution of friction failure prediction</p> <p>3: During friction failure prediction warning</p> <p>[Bit 4 to 7: Vibration failure prediction status]</p> <p>0: Vibration failure prediction disabled</p> <p>1: During preparation for vibration failure prediction</p> <p>2: During execution of vibration failure prediction</p> <p>3: During vibration failure prediction warning</p> <p>[Bit 8 to 11: Total travel distance failure prediction status]</p> <p>0: Motor total travel distance failure prediction disabled</p> <p>1: Motor total travel distance failure prediction being executed</p> <p>2: Motor total travel distance failure prediction at warning</p> <p>[Bit 12 to 15: Motor total travel distance calculation status]</p> <p>0: During stop of motor total travel distance calculation</p> <p>1: During calculation of motor total travel distance</p> <p>[Bit 16 to 19: reserved]</p> <p>[Bit 20 to 23: Static friction failure prediction status]</p> <p>0: Static friction failure prediction disabled</p> <p>1: During preparation for static friction failure prediction</p> <p>2: During execution of static friction failure prediction</p> <p>3: During static friction failure prediction warning</p> <p>[Bit 24 to 27: Belt tension deterioration prediction status]</p> <p>0: Belt tension deterioration prediction disabled</p> <p>1: Belt tension deterioration prediction in progress</p> <p>2: During belt tension deterioration warning</p> <p>[Bit 28 to 31: Belt tension estimation status]</p> <p>0: Belt tension estimation in progress</p> <p>1: Belt tension estimation has finished</p> <p>7: Belt tension estimation is not set</p>
2C36h	0	VAR	Tension estimation value	<p>Estimated tension value</p> <p>The estimated tension value used by the belt tension deterioration function is expressed in 0.1 N units.</p>

Belt tension deterioration prediction function [A]

■ How to use the belt tension deterioration prediction function

Follow these procedures when using the static friction prediction function.

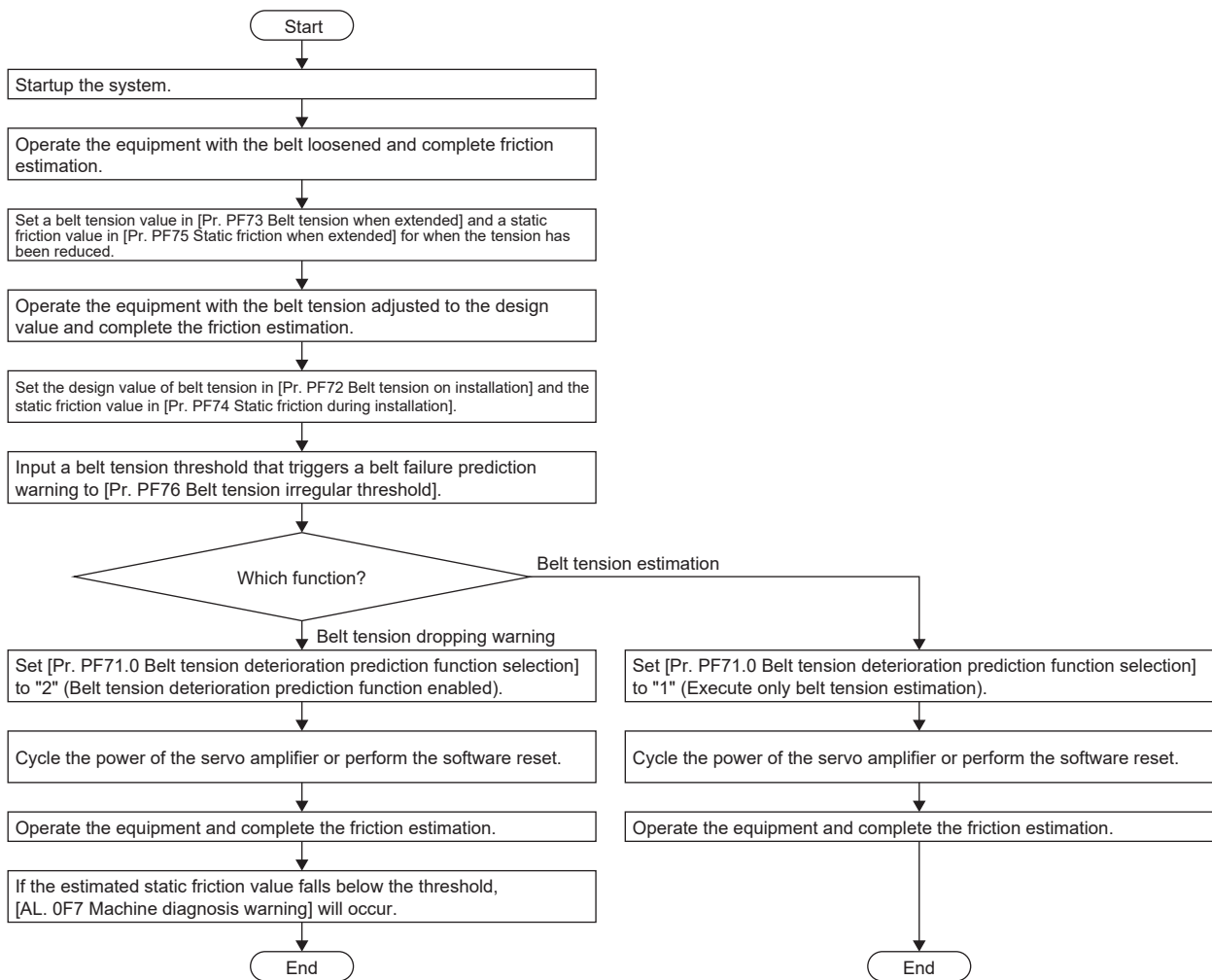

■ Setting method for belt tension when extended

Lower the belt tension below the design value, then attach the belt to the equipment. Measure the belt tension using a tension gauge. To reduce the belt tension, use a method such as shortening the distance between the pulleys or use the initial stretch of the belt. It is recommended to reduce the belt tension to 1/2 of the design value. After attaching the belt to the equipment, measure the belt tension and input the result to [Pr. PF73 Belt tension when extended]. It is recommended to use the friction vibration estimation function to measure the value of belt tension at extension immediately after the friction estimation completes. For friction vibration estimation function, refer to the following.

☞ Page 243 Friction vibration estimation function

Servo parameter	Symbol	Name	Description
PF73	ABT	Belt tension when extended	After the equipment is operated, set a belt tension for when the belt stretches or for when the belt is looser than at the time of the attachment. After the belt has been attached to the equipment, the time taken for the belt to stretch depends on the belt type. For the time taken for the belt to stretch, refer to the catalog or other documents of the belt manufacturer. When the setting is [Pr. PF72 Belt tension on installation] < [Pr. PF73 Belt tension when extended], the belt tension deterioration prediction function is disabled. Initial value: 0 [0.1 N]

■ Setting "Static friction when extended"

After attaching the belt to the equipment, drive the servo motor, and estimate the static friction with the friction vibration estimation function. For friction vibration estimation function, refer to the following.

☞ Page 243 Friction vibration estimation function

In accordance with the completed static friction estimation, set [Pr. PF75 Static friction when extended] as follows.

- When estimation of static friction has completed only for the forward rotation side

[Pr. PF75 Static friction when extended] = Static friction on the forward rotation side

- When estimation of static friction has completed only for the reverse rotation side

[Pr. PF75 Static friction when extended] = Static friction on the reverse rotation side

- When estimation of static friction has completed for both the forward and reverse rotation sides

[Pr. PF75 Static friction when extended] = (Static friction at forward + at reverse rotation)/2

Servo parameter	Symbol	Name	Description
PF75	ASF	Static friction when extended	Set a static friction for when the belt stretches or for when the belt is looser than at the time of the attachment. Set the static friction with any of the following values estimated by the friction estimation function depending on the value of [Pr. PF71.1 Belt tension deterioration prediction friction selection]: static friction at forward rotation, static friction at reverse rotation, or the average of the estimated frictions. The belt tension deterioration function is disabled when the setting is: [Pr. PF74 Static friction during installation] < [Pr. PF75 Static friction when extended]. Initial value: 0 [0.1 %]

■ Setting "Belt tension on installation"

Set the design value of belt tension in [Pr. PF72 Belt tension on installation]. Measure the belt tension using a tension gauge. It is recommended to use the friction vibration estimation function to measure the value of belt tension immediately after the friction estimation completes. For friction vibration estimation function, refer to the following.

☞ Page 243 Friction vibration estimation function

Servo parameter	Symbol	Name	Description
PF72	SBT	Belt tension on installation	Set a belt tension for when the belt is attached to the equipment. The servo parameter indicates the reference belt tension threshold used in the belt diagnosis function. Initial value: 0 [0.1 N]

■ Setting "Static friction during installation"

After attaching the belt to the equipment, drive the servo motor, and estimate the static friction with the friction vibration estimation function. It is recommended to perform both forward rotation and reverse rotation in order to estimate the static friction at both rotation directions. In accordance with the estimated static friction, set [Pr. PF74 Static friction during installation] as follows.

- When estimation of static friction has completed only for the forward rotation side

[Pr. PF74 Static friction during installation] = Static friction on the forward rotation side

- When estimation of static friction has completed only for the reverse rotation side

[Pr. PF74 Static friction during installation] = Static friction on the reverse rotation side

- When estimation of static friction has completed for both the forward and reverse rotation sides

[Pr. PF74 Static friction during installation] = (Static friction at forward + at reverse rotation)/2

Servo parameter	Symbol	Name	Description
PF74	SSF	Static friction during installation	Set a static friction for when the belt is attached to the equipment. Set the static friction with any of the following values estimated by the friction estimation function depending on the value of [Pr. PF71.1 Belt tension deterioration prediction friction selection]: static friction at forward rotation, static friction at reverse rotation, or the average of the estimated frictions. Initial value: 0 [0.1 %]

■ Threshold setting for belt tension

Set a threshold to generate [AL. 0F7 Machine diagnosis warning]. When the belt tension estimated value inside the servo amplifier falls below the belt tension threshold, [AL. 0F7 Machine diagnostic warning] occurs.

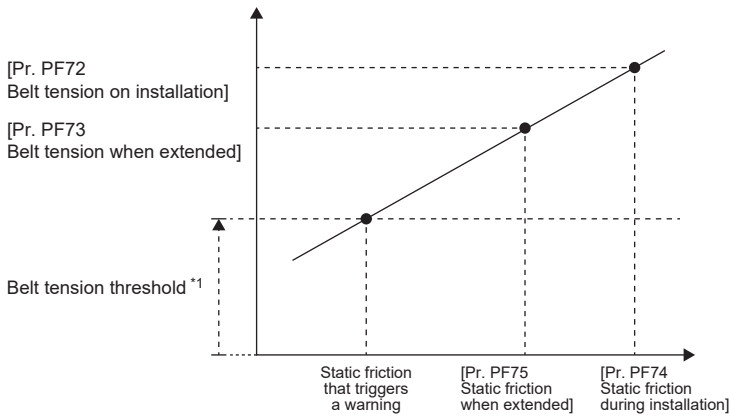

Servo parameter	Symbol	Name	Description
PF76	BTS	Belt tension irregular threshold	Set a threshold to generate [AL. 0F7 Machine diagnosis warning]. Set this servo parameter as a percentage of [Pr. PF72 Belt tension on installation]. When using the belt diagnosis function, input a value other than 0. Initial value: 0 [0.1 %]

■ Belt tension prediction warning selection setting

To enable belt tension prediction warning, set [Pr. PF71.0 Belt tension deterioration prediction function selection]. Furthermore, when a value other than 0 is set in [Pr. PF72 Belt tension on installation], [Pr. PF73 Belt tension when extended], [Pr. PF74 Static friction during installation], and [Pr. PF75 Static friction when extended], setting a value other than "0" (disabled) in [Pr. PF71.0 Belt tension deterioration prediction function selection] will estimate the belt tension.

Servo parameter	Symbol	Name	Description
PF71.0	BFP	Belt tension deterioration prediction function selection	Belt tension deterioration prediction function selection 0: Disabled (initial value) 1: Execute only belt tension estimation 2: Belt tension deterioration prediction function enabled After the equipment goes into actual operation, enable the belt tension deterioration prediction function.

■ Belt tension deterioration prediction function

During belt tension prediction, [AL. 0F7 Machine diagnostic warning] occurs when the static friction estimated by the friction estimation function falls below the threshold. After the occurrence of [AL. 0F7 Machine diagnosis warning], if the static friction becomes equal to or higher than the threshold value, [AL. 0F7 Machine diagnostic warning] will be canceled.

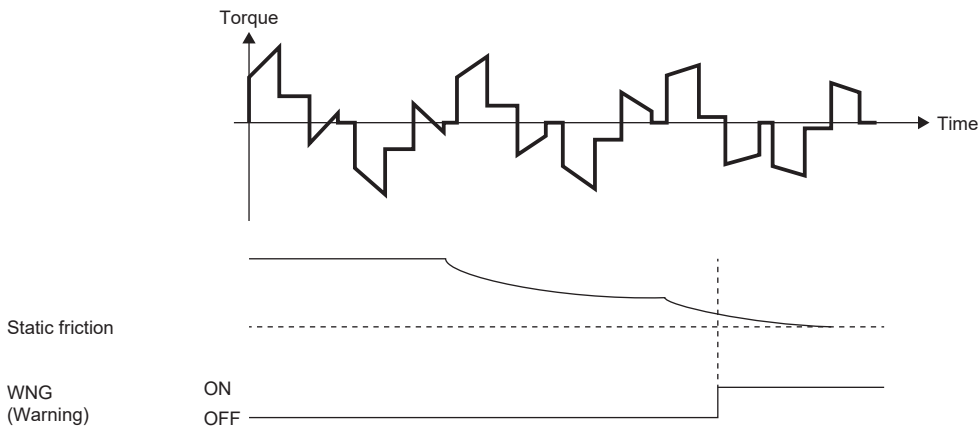

4.6 Drive recorder

This function continuously monitors the servo amplifier status and records the state transition before and after an alarm for a fixed period of time.

By using MR Configurator2 via a network or USB connection, the data recorded inside the servo amplifier can be read in order to analyze alarms.

An engineering tool (such as GX LogViewer and MR Configurator2) can be used to display monitor and waveform data, and reference to servo parameter data and output files in the drive recorder.

MR Configurator2 with software version 1.110Q or later supports saving data in GX LogViewer format (JSON file) with the graph function or drive recorder function.

- When using MR Configurator2 [G] [A]

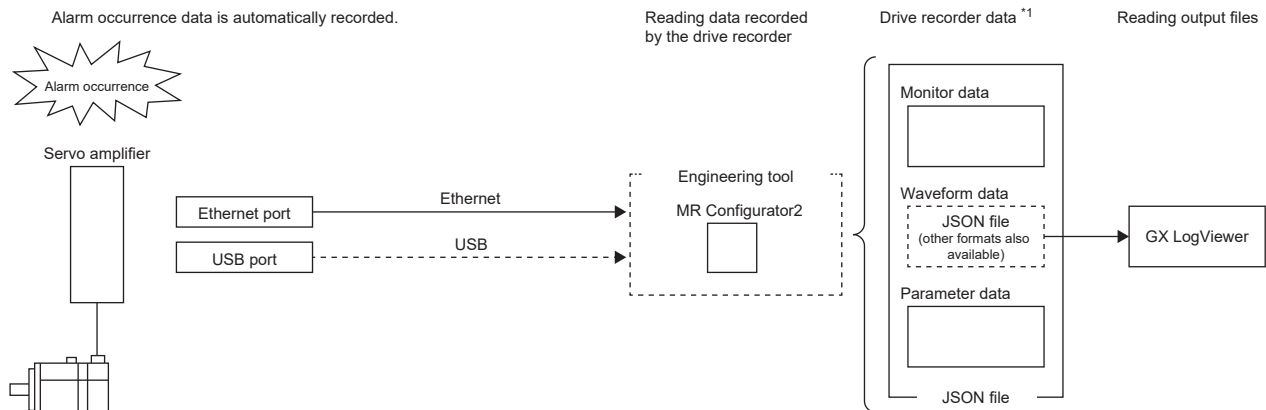

*1 Drive recorder data can be saved as a JSON file.

- When using GX LogViewer [G] [A]

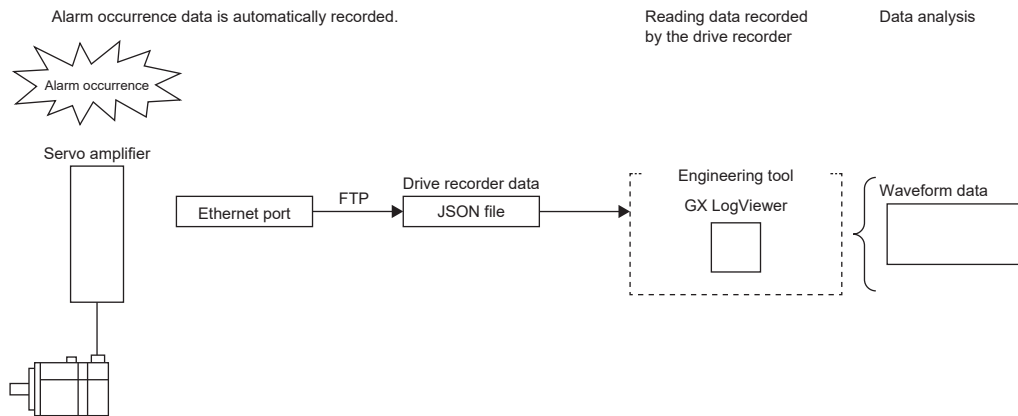

- When using MR Configurator2 [B]

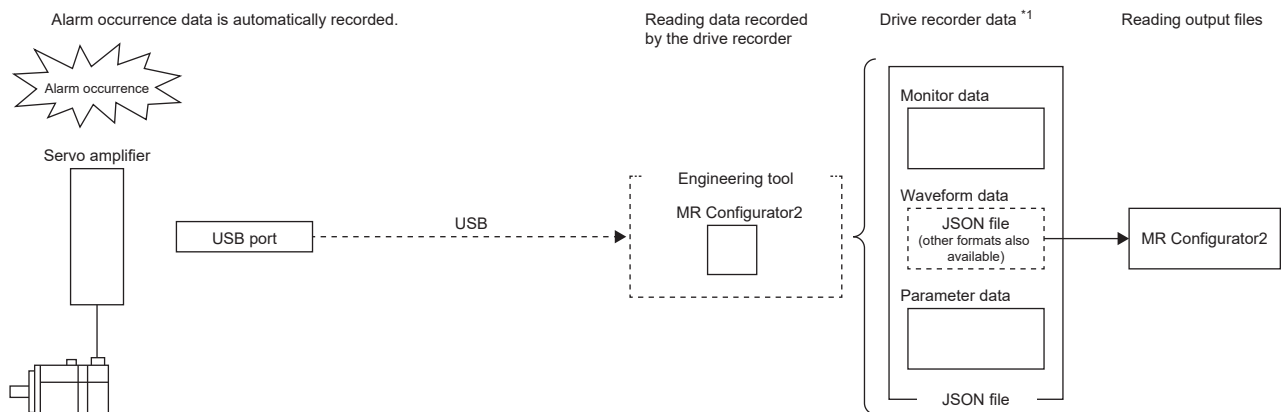

*1 Drive recorder data can be saved as a JSON file.

- The drive recorder does not operate in the following cases.

When using the graph function with an engineering tool.

When using the machine analyzer function.

When [Pr. PF21 Drive recorder switching time setting] is set to "-1" (Drive recorder function disabled).

- For the alarm (common alarm) which applies to all axes of a multi-axis servo amplifier, the drive recorder data is saved on individual axes. For the alarm (axis-specific alarm) which applies to a specific axis of a multi-axis servo amplifier, the drive recorder data is only saved on the axis at which the alarm occurred, and the drive recorder data of other axes is not saved.
- To read recorded data from the drive recorder by using the FTP server function, use a network supporting the function.
- When the drive recorder data (JSON) files on the server are listed by using the FTP server function, the file size will appear as 0 bytes.
- Even if the trigger is satisfied while the save processing on the servo amplifier side is not completed, the drive recorder data of other axes are not saved.

Precautions

- When using the graph function with an engineering tool, the drive recorder function cannot be used. To use the drive recorder function, wait until the time set in [Pr. PF21 Drive recorder switching time setting] passes, cycle the power of the servo amplifier, or perform the software reset after using the graph function.
- If the sampling cycle of an analog trigger or digital trigger is too long, the establishment of the trigger may not be able to be detected. In that case, shorten the sampling cycle.
- If the power supply of the servo amplifier is turned off during data storage of the drive recorder (immediately after alarm occurrence), data at alarm occurrence may not be recorded normally.
- The storage area of the servo amplifier has a limit for the number of writings. When using the manual setting mode with the drive recorder, be sure to consider the number of writings.
- If the drive recorder detects a trigger, the next trigger cannot be detected until the data has been saved.
- In the initial settings, recorded data cannot be read from the drive recorder by using the FTP server function. Change the setting of "drive recorder data readout permission selection" in the network parameter "authorization level". For information on account settings and network parameters, refer to "NETWORK FUNCTION".

 Page 521 NETWORK FUNCTION (ETHERNET) [G] [A]

Specification outline

A specification outline of the drive recorder is shown in this section.

The drive recorder contains the automatic setting mode that uses factory settings and the manual setting mode that collects waveforms by optionally setting the trigger condition, sampling cycle, and other areas with the servo parameters.

In the automatic setting mode, when an alarm occurs in the servo amplifier, conditions of the servo amplifier (such as the servo motor speed and droop pulses) before/after alarm occurrence are recorded. Also, by setting the drive recorder to operate only when a specific alarm occurs, data suitable for the alarm number that has occurred can be acquired. This mode is useful for investigating the cause of alarm occurrence by automatically shortening the sampling period in the vicinity of the alarm occurrence trigger.

Any condition can be set in the manual setting mode, making it useful for acquiring the waveform of a specific condition.

The manual setting mode of the multi-axis servo amplifier can be set to acquire waveforms for all axes if any one of A, B, or C axes satisfies the trigger condition. Refer to [Pr. PF83 Drive recorder - Trigger operation axis common selection].

Item	Automatic setting mode	Manual setting mode
Number of channels *1	Analog 32 bits × 7 channels + digital 1 bit × 8 channels	
Maximum number of records	1024	
Sampling cycle *2	Varies depending on [Pr. PA23 Drive recorder desired alarm trigger setting].	250 μs/500 μs/1 ms/2 ms/4 ms/8 ms/16 ms/32 ms/64 ms/128 ms/256 ms/512 ms/1024 ms
Number of history entries	16	
Trigger condition	Alarm trigger *3	Alarm trigger *3/Analog trigger/Digital trigger
Trigger position	90 %	0 to 100 %
Auxiliary recording data *4	Instantaneous monitor data, system configuration display data, servo parameters	

*1 For data that can be collected, refer to [Pr. PF90 Drive recorder - Analog channel setting 1] to [Pr. PF97 Drive recorder - Digital channel setting 4].

*2 Depending on the timing of the data update, the on/off timing of the digital signal may appear to deviate.

*3 For alarms that are triggered, refer to the following.

☞ Page 338 Waveform recording inapplicable alarm list

*4 For auxiliary recording data, refer to the following. In addition, if the trigger established is other than the alarm trigger, "Alarm occurrence data" is not saved.

☞ Page 339 List of auxiliary recording data

How to use the function [G]

Point

The automatic setting mode is enabled for the drive recorder function in the factory settings. If the initial setting does not meet your needs, set [Pr. PA23 Drive recorder desired alarm trigger setting] and collect data suitable for analyzing the occurrence factors of alarms. If satisfactory data cannot be obtained, use the manual setting mode to collect the necessary data.

When an alarm occurs, data of the generated alarm is recorded inside the servo amplifier. By reading the recorded data, the cause of the alarm can be analyzed. The operation status of the drive recorder can be monitored using [Drive recorder status (Obj. 2C02h)]. An outline of the time and other factors from when the drive recorder data was recorded can be checked by using [Drive recorder history newest (Obj. 2A70h)] to [Drive recorder history15 (Obj. 2A7Fh)].

Refer to the following for using the manual setting mode to record with any data and trigger.

☞ Page 308 Saving the drive recorder data in manual setting mode

Method of reading recorded data

Drive recorder data can be read with an engineering tool (MR Configurator2) via a network or USB connection.

A connection example is shown below.

- Transferring files with direct connection or via a hub (Ethernet/MR Configurator2)

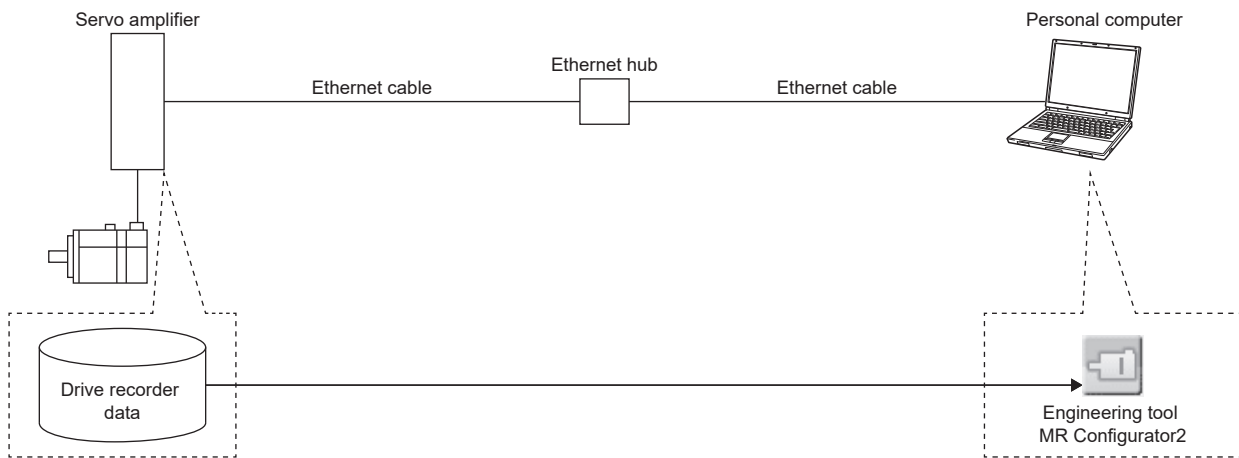

- Transferring files with direct connection (USB/MR Configurator2)

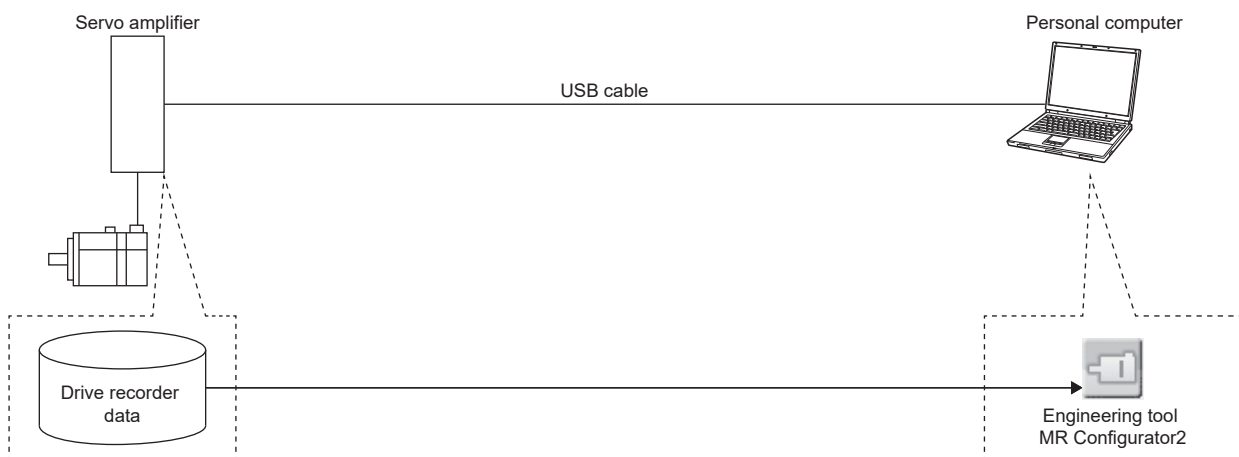

- Transferring files with direct connection or via a hub (Ethernet/GX LogViewer)

To read recorded data from the drive recorder by using the FTP server function, use a network supporting the function.

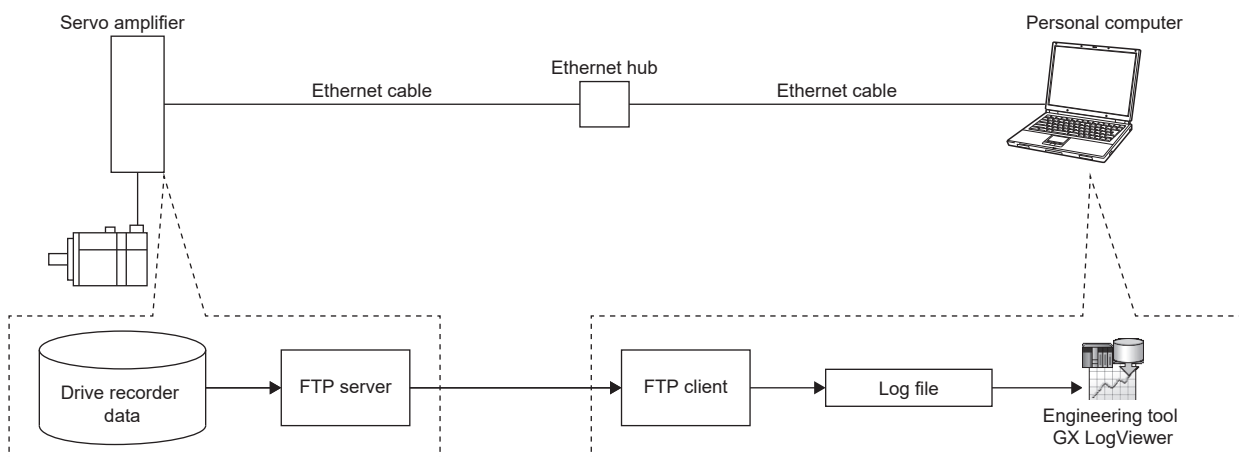

■ Reading recorded data via a network

When reading the recorded data from the drive recorder via a network, use the engineering tool or the FTP server function.

The read data can be checked with GX LogViewer.

The data is saved in a file as shown below.

Path	Remark
/drvrec/dr*_nnnn.json	"*" represents the axis number (1 or higher value), and "nnnn" represents a serial number of the drive recorder data. When data is recorded in the drive recorder, the number will increase. If the number exceeds 9999, it will return to 0 and increase again. The number corresponds with the value of Drive recorder history index in the object dictionary. The file size varies depending on the log data.

■ Read recorded data via a USB connection

When connecting the servo amplifier and the personal computer via a USB connection, read the drive recorder data using an engineering tool (MR Configurator2).

Recorded data deletion method

Drive recorder record data saved inside the servo amplifier are saved up to a maximum of 16 history entries. When 16 history entries are exceeded, the oldest recorded data will be overwritten. To delete the drive recorder data recorded inside the servo amplifier, use [Pr. PF98.0 Drive recorder - Clear history selection] or [Clear drive recorder history (Obj. 2C03h)]. Drive recorder record data can also be deleted by clicking the history clear button on the drive recorder screen of the engineering tool (MR Configurator2).

Saving the drive recorder data in manual setting mode

Precautions

- The storage area of the servo amplifier has a limit for the number of writings. When using the drive recorder with [Pr. PF81.0] set to "2" (continuous sampling), consider the number of write times.

■ Record with desired data and triggers

1. Set [Pr. PF80.0 Drive recorder - Operation mode selection] to "1" (manual setting mode).
2. Set the sampling cycle, trigger condition, and other areas with servo parameters.

Item	Servo parameter	Reference
Sampling cycle	[Pr. PF80.2-3]	☞ Page 313 Servo parameter [G]
Trigger condition	[Pr. PF82] to [Pr. PF86]	
Channels for sampling	[Pr. PF87] to [Pr. PF94]	

3. Set [Pr. PF81.0 Drive recorder - Sampling start selection] to "1" (start a single sampling) or "2" (continuous sampling start). Sampling starts.

■ Reconfiguring parameters

Servo parameters that set the sampling cycle, trigger condition, and other areas cannot be changed during sampling. Use the following procedure to change these parameters.

1. Set [Pr. PF81.0] to "0" (stop sampling) and stop sampling.
2. Set the sampling cycle, trigger condition, and other areas with servo parameters.

Item	Servo parameter	Reference
Sampling cycle	[Pr. PF80.2-3]	☞ Page 313 Servo parameter [G]
Trigger condition	[Pr. PF82] to [Pr. PF86]	
Channels for sampling	[Pr. PF87] to [Pr. PF94]	

3. Set [Pr. PF81.0] to "1" or "2". Sampling starts.

■ Return to automatic setting mode

To save in the automatic setting mode, set [Pr. PF80.0] to "0" (automatic setting). The automatic setting mode operates automatically.

How to use the function [B]

Point

The automatic setting mode is enabled for the drive recorder function in the factory settings. If the initial setting does not meet your needs, set [Pr. PA23 Drive recorder desired alarm trigger setting] and collect data suitable for analyzing the occurrence factors of alarms. If satisfactory data cannot be obtained, use the manual setting mode to collect the necessary data.

When an alarm occurs, data of the generated alarm is recorded inside the servo amplifier. By reading the recorded data, the cause of the alarm can be analyzed.

Refer to the following for using the manual setting mode to record with any data and trigger.

☞ Page 310 Saving the drive recorder data in manual setting mode

Method of reading recorded data

Drive recorder data can be read with an engineering tool (MR Configurator2) via a network or USB connection.

A connection example is shown below.

- Transferring files with direct connection (USB/MR Configurator2)

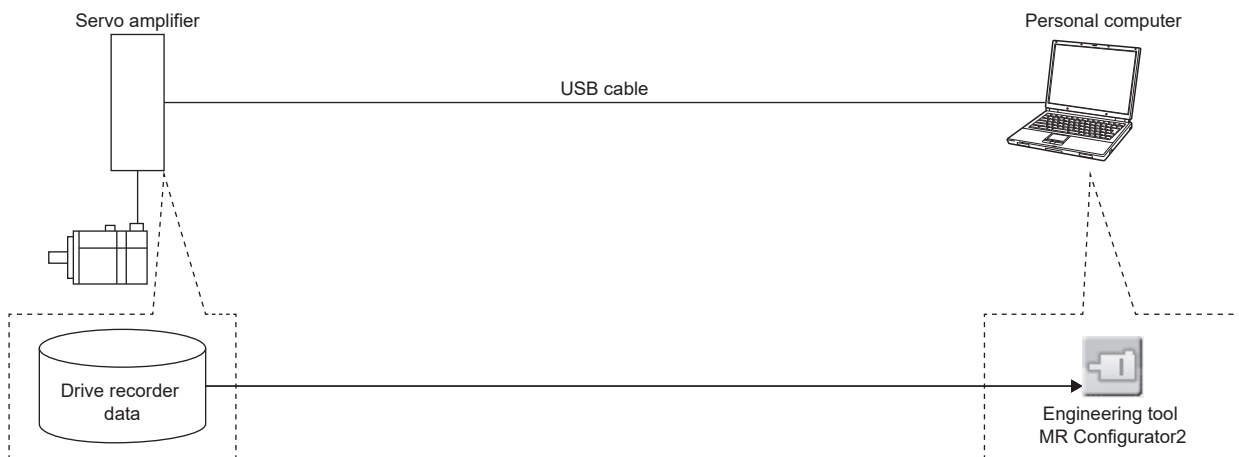

■ Reading recorded data via a network

When reading the recorded data via a network, read the drive recorder data using the engineering tool.

■ Read recorded data via a USB connection

When connecting the servo amplifier and the personal computer via a USB connection, read the drive recorder data using an engineering tool (MR Configurator2).

Recorded data deletion method

Drive recorder record data saved inside the servo amplifier are saved up to a maximum of 16 history entries. When 16 history entries are exceeded, the oldest recorded data will be overwritten. To delete the drive recorder data recorded inside the servo amplifier, use [Pr. PF98.0 Drive recorder - Clear history selection]. Drive recorder record data can also be deleted by clicking the history clear button on the drive recorder screen of the engineering tool (MR Configurator2).

Saving the drive recorder data in manual setting mode

Precautions

- The storage area of the servo amplifier has a limit for the number of writings. When using the drive recorder with [Pr. PF81.0] set to "2" (continuous sampling), consider the number of write times.

■ Record with desired data and triggers

1. Set [Pr. PF80.0 Drive recorder - Operation mode selection] to "1" (manual setting mode).
2. Set the sampling cycle, trigger condition, and other areas with servo parameters.

Item	Servo parameter	Reference
Sampling cycle	[Pr. PF80.2-3]	☞ Page 321 Servo parameter [B]
Trigger condition	[Pr. PF82] to [Pr. PF86]	
Channels for sampling	[Pr. PF87] to [Pr. PF94]	

3. Set [Pr. PF81.0 Drive recorder - Sampling start selection] to "1" (start a single sampling) or "2" (continuous sampling start). Sampling starts.

■ Reconfiguring parameters

Servo parameters that set the sampling cycle, trigger condition, and other areas cannot be changed during sampling. Use the following procedure to change these parameters.

1. Set [Pr. PF81.0] to "0" (stop sampling) and stop sampling.
2. Set the sampling cycle, trigger condition, and other areas with servo parameters.

Item	Servo parameter	Reference
Sampling cycle	[Pr. PF80.2-3]	☞ Page 321 Servo parameter [B]
Trigger condition	[Pr. PF82] to [Pr. PF86]	
Channels for sampling	[Pr. PF87] to [Pr. PF94]	

3. Set [Pr. PF81.0] to "1" or "2". Sampling starts.

■ Return to automatic setting mode

To save in the automatic setting mode, set [Pr. PF80.0] to "0" (automatic setting). The automatic setting mode operates automatically.

How to use the function [A]

Point

The automatic setting mode is enabled for the drive recorder function in the factory settings. If the initial setting does not meet your needs, set [Pr. PA23 Drive recorder desired alarm trigger setting] and collect data suitable for analyzing the occurrence factors of alarms. If satisfactory data cannot be obtained, use the manual setting mode to collect the necessary data.

When an alarm occurs, data of the generated alarm is recorded inside the servo amplifier. By reading the recorded data, the cause of the alarm can be analyzed.

Refer to the following for using the manual setting mode to record with any data and trigger.

☞ Page 308 Saving the drive recorder data in manual setting mode

Method of reading recorded data

Drive recorder data can be read with an engineering tool (MR Configurator2) via a network or USB connection.

A connection example is shown below.

- Transferring files with direct connection (USB/MR Configurator2)

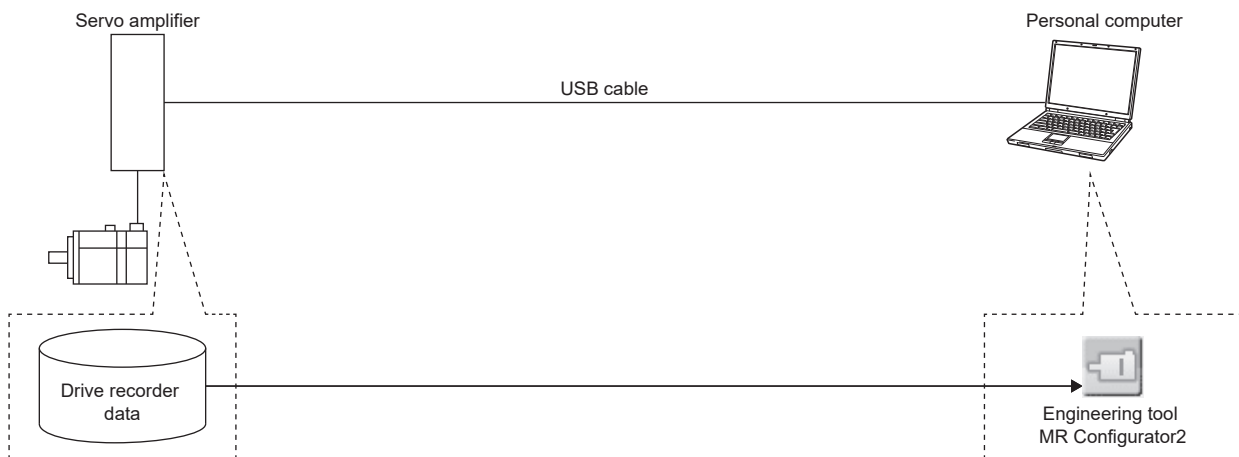

- Transferring files with direct connection or via a hub (Ethernet/GX LogViewer)

To read recorded data from the drive recorder by using the FTP server function, use a network supporting the function.

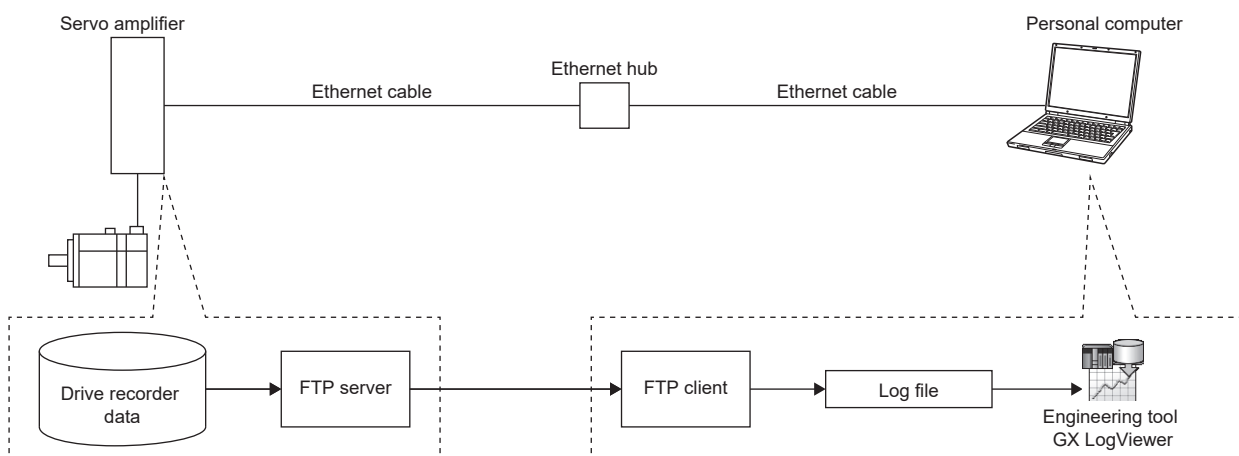

■ Reading recorded data via a network

When reading the recorded data from the drive recorder via a network, use the FTP server function. The read data can be checked with GX LogViewer.

The data is saved in a file as shown below.

File path	Remark
/drvrec/dr1_nnnn.json	"nnnn" represents a serial number of the drive recorder data. When data is recorded in the drive recorder, the number will increase. If the number exceeds 9999, it will return to 0 and increase again. The file size varies depending on the log data.

■ Read recorded data via a USB connection

When connecting the servo amplifier and the personal computer via a USB connection, read the drive recorder data using an engineering tool (MR Configurator2).

Recorded data deletion method

Drive recorder record data saved inside the servo amplifier are saved up to a maximum of 16 history entries. When 16 history entries are exceeded, the oldest recorded data will be overwritten. To delete the drive recorder data recorded inside the servo amplifier, use [Pr. PF98.0 Drive recorder - Clear history selection]. Drive recorder record data can also be deleted by clicking the history clear button on the drive recorder screen of the engineering tool (MR Configurator2).

Saving the drive recorder data in manual setting mode

Precautions

- The storage area of the servo amplifier has a limit for the number of writings. When using the drive recorder with [Pr. PF81.0 Drive recorder - Sampling start selection] set to "2" (continuous sampling), consider the number of write times.

■ Record with desired data and triggers

1. Set [Pr. PF80.0 Drive recorder - Operation mode selection] to "1" (manual setting mode).
2. Set the sampling cycle, trigger condition, and other areas with servo parameters.

Item	Servo parameter	Reference
Sampling cycle	[Pr. PF80.2-3]	☞ Page 326 Servo parameter [A]
Trigger condition	[Pr. PF82] to [Pr. PF86]	
Channels for sampling	[Pr. PF87] to [Pr. PF94]	

3. Set [Pr. PF81.0 Drive recorder - Sampling start selection] to "1" (start a single sampling) or "2" (continuous sampling start). Sampling starts.

■ Reconfiguring parameters

Servo parameters that set the sampling cycle, trigger condition, and other areas cannot be changed during sampling. Use the following procedure to change these parameters.

1. Set [Pr. PF81.0] to "0" (stop sampling) and stop sampling.
2. Set the sampling cycle, trigger condition, and other areas with servo parameters.

Item	Servo parameter	Reference
Sampling cycle	[Pr. PF80.2-3]	☞ Page 326 Servo parameter [A]
Trigger condition	[Pr. PF82] to [Pr. PF86]	
Channels for sampling	[Pr. PF87] to [Pr. PF94]	

3. Set [Pr. PF81.0] to "1" or "2". Sampling starts.

■ Return to automatic setting mode

To save in the automatic setting mode, set [Pr. PF80.0] to "0" (automatic setting). The automatic setting mode operates automatically.

Servo parameter/object dictionary

This section shows the servo parameters and object dictionary related to the drive recorder.

If [Pr. PF80.0 Drive recorder - Operation mode selection] = "0" (automatic setting mode) (initial value), the setting values of [Pr. PF81 Drive recorder - Sampling operation selection] to [Pr. PF94 Drive recorder - Digital channel setting 4] are disabled. The drive recorder operates automatically with the alarm trigger.

Servo parameter [G]

Servo parameter	Symbol	Name	Outline
PF80.0	DRMC	Drive recorder - Operation mode selection	Select the operation mode of drive recorder. 0: Automatic setting mode (initial value) 1: Manual setting mode
PF80.2-3	DRMC	Drive recorder - Sampling cycle selection	Set the sampling cycle. 00: Automatic (250 µs) (initial value) 05: 250 µs 06: 500 µs 07: 1 ms 08: 2 ms 09: 4 ms 0A: 8 ms 0B: 16 ms 0C: 32 ms 0D: 64 ms 0E: 128 ms 0F: 256 ms 10: 512 ms 11: 1.024 s
PF81.0	DRMS	Drive recorder - Sampling start selection	Select to start sampling in manual setting mode. 0: Stop sampling (initial value) 1: Start a single sampling 2: Start a consecutive sampling
PF82.0	DRTM	Drive recorder - Trigger mode selection	Select the trigger mode. 0: Alarm trigger (initial value) 1: Analog trigger/digital trigger
PF82.1	DRTM	Drive recorder - Trigger binding condition selection	Select the binding condition of the trigger. 0: Disabled (initial value) 1: Logical AND of trigger signals 2: Logical OR of trigger signals
PF82.2	DRTM	Drive recorder - Trigger operation selection 1	Select if sampling starts when the channel set in [Pr. PF84.0-1 Drive recorder - Trigger channel selection 1] exceeds the set trigger level (rising) or starts when it falls below the set trigger level (falling). 0: Rising (initial value) 1: Falling
PF82.3	DRTM	Drive recorder - Trigger operation selection 2	Select if sampling starts when the channel set in [Pr. PF84.2-3 Drive recorder - Trigger channel selection 2] exceeds the set trigger level (rising) or starts when it falls below the set trigger level (falling). 0: Rising (initial value) 1: Falling
PF83.0	**DRTAX	Drive recorder - Trigger axis common selection	For a multi-axis servo amplifier, select whether to store only the data of the axis in which the conditions are met or to store the data of all axes when using the manual setting mode and the trigger conditions are met on an analog trigger or digital trigger. 0: Disabled (initial value) 1: Enabled
PF84.0-1	DRTC	Drive recorder - Trigger channel selection 1	Set trigger channel No. 1. Initial value: 01h (Analog channel 1) *1
PF84.2-3	DRTC	Drive recorder - Trigger channel selection 2	Set trigger channel No. 2. Initial value: 81h (Digital channel 1) *1
PF84.4-5	DRTC	Drive recorder - Trigger position setting	For the total sampling time, set the trigger position in hexadecimal from 0 to 100 %. Initial value: 5Ah (90 [%])

Servo parameter	Symbol	Name	Outline
PF85	DRTL1	Drive recorder - Trigger level setting 1	Set the trigger level of [Pr. PF84.0-1 Drive recorder - Trigger channel selection 1] in decimal. Initial value: 0
PF86	DRTL2	Drive recorder - Trigger level setting 2	Set the trigger level of [Pr. PF84.2-3 Drive recorder - Trigger channel selection 2] in decimal. Initial value: 0
PF87.0-2	DRAC1	Drive recorder - Analog channel 1 selection	Set the data to be assigned to analog channel 1. Initial value: 201h (Servo motor speed +) *2
PF87.4-6	DRAC1	Drive recorder - Analog channel 2 selection	Set the data to be assigned to analog channel 2. Initial value: 002h (Torque/instantaneous torque) *2
PF88.0-2	DRAC2	Drive recorder - Analog channel 3 selection	Set the data to be assigned to analog channel 3. Initial value: 003h (Current command) *2
PF88.4-6	DRAC2	Drive recorder - Analog channel 4 selection	Set the data to be assigned to analog channel 4. Initial value: 204h (Droop pulses (1 pulse unit) +) *2
PF89.0-2	DRAC3	Drive recorder - Analog channel 5 selection	Set the data to be assigned to analog channel 5. Initial value: 205h (Speed command +) *2
PF89.4-6	DRAC3	Drive recorder - Analog channel 6 selection	Set the data to be assigned to analog channel 6. Initial value: 009h (Bus voltage) *2
PF90.0-2	DRAC4	Drive recorder - Analog channel 7 selection	Set the data to be assigned to analog channel 7. Initial value: 00Ch (Effective load ratio) *2
PF91.0-3	DRDC1	Drive recorder - Digital channel 1 selection	Set the data to be assigned to digital channel 1. Initial value: 0000h (CSON) *3
PF91.4-7	DRDC1	Drive recorder - Digital channel 2 selection	Set the data to be assigned to digital channel 2. Initial value: 0012h (EM2/EM1) *3
PF92.0-3	DRDC2	Drive recorder - Digital channel 3 selection	Set the data to be assigned to digital channel 3. Initial value: 8010h (ALM2) *3
PF92.4-7	DRDC2	Drive recorder - Digital channel 4 selection	Set the data to be assigned to digital channel 4. Initial value: 8005h (INP) *3
PF93.0-3	DRDC3	Drive recorder - Digital channel 5 selection	Set the data to be assigned to digital channel 5. Initial value: 800Ah (MBR) *3
PF93.4-7	DRDC3	Drive recorder - Digital channel 6 selection	Set the data to be assigned to digital channel 6. Initial value: 8000h (RD) *3
PF94.0-3	DRDC4	Drive recorder - Digital channel 7 selection	Set the data to be assigned to digital channel 7. Initial value: 8015h (STO) *3
PF94.4-7	DRDC4	Drive recorder - Digital channel 8 selection	Set the data to be assigned to digital channel 8. Initial value: 801Dh (IPF) *3
PF95.0	**DRCLR	Drive recorder - Clear history selection	When enabled is selected, the drive recorder history will be cleared at either the next power cycle or at software reset. 0:Disabled (initial value) 1:Enabled
PF21	DRT	Drive recorder switching time setting	Set the drive recorder switching time. When the USB communication is disconnected during the use of the graph function, the function will be switched to the drive recorder function after the time set in this servo parameter has passed. Initial value: 0 (switched after 10 s)
PA23.0-1	DRAT	Alarm detail number setting	To execute the trigger with a desired alarm detail number, set [Pr. PF80.0 Drive recorder - Operation mode selection] = "0" (automatic setting mode) or [Pr. PF82.0 Drive recorder - Trigger mode selection] = "0" (alarm trigger) in [Pr. PF80.0] = "1" (manual setting mode). At "00", only the optional alarm number setting will be enabled. Initial value: 00h
PA23.2-4	DRAT	Alarm number setting	To execute the trigger with a desired alarm number, set [Pr. PF80.0 Drive recorder - Operation mode selection] = "0" (automatic setting mode) or [Pr. PF82.0 Drive recorder - Trigger mode selection] = "0" (alarm trigger) in [Pr. PF80.0] = "1" (manual setting mode). When "000" is set, arbitrary alarm trigger of the drive recorder will be disabled. Initial value: 000h

- *1 Refer to the following for setting values.
 ☞ Page 315 Trigger channel selection [G]
- *2 Refer to the following for setting values.
 ☞ Page 316 Analog channel [G]
- *3 Refer to the following for setting values.
 ☞ Page 318 Digital channel [G]

■ Trigger channel selection [G]

Setting value	Meaning
01	Analog channel 1
02	Analog channel 2
03	Analog channel 3
04	Analog channel 4
05	Analog channel 5
06	Analog channel 6
07	Analog channel 7
81	Digital channel 1
82	Digital channel 2
83	Digital channel 3
84	Digital channel 4
85	Digital channel 5
86	Digital channel 6
87	Digital channel 7
88	Digital channel 8

■ Analog channel [G]

Setting value	Data type	Unit ^{*1}	Category
000	No assigned function	—	—
001	Servo motor speed	r/min	16-bit data
002	Torque/instantaneous torque	0.1 %	
003	Current command	0.1 %	
005	Command pulse frequency (speed unit)	r/min	
007	Droop pulses (1 pulse unit)	pulse	
008	Speed command	r/min	
009	Bus voltage	V	
00C	Effective load ratio	0.1 %	
00D	Regenerative load ratio	0.1 %	
00E	Position within one-revolution	16 pulse	
00F	ABS counter	rev	
010	Load to motor inertia ratio	0.01 times	
011	Torque equivalent to disturbance	0.1 %	
012	Overload alarm margin	0.1 %	
014	Settling time	ms	
015	Overshoot amount	pulse	
01C ^{*2}	Load-side encoder droop pulses (1 pulse unit)	pulse	
01E ^{*2}	Motor-side/load-side position deviation (1 pulse unit)	pulse	
020 ^{*2}	Motor-side/load-side speed deviation	r/min	
021	Servo motor speed (unit of 0.1 r/min)	0.1 r/min	
022	Command pulse frequency (speed unit of 0.1 r/min)	0.1 r/min	
023	Speed command (unit of 0.1 r/min)	0.1 r/min	
024	Torque command	0.1 %	
025	Speed limit value	r/min	
026	Speed limit value (unit of 0.1 r/min)	0.1 r/min	
035	Internal temperature of encoder	°C	
03B	Load-side encoder information 1	16 pulse	
03C	Load-side encoder information 2	rev	
03D ^{*4}	Command number	LSB	
049	Operation mode	LSB	
04C ^{*3}	U-phase current feedback (unit of the rated current)	0.1 %	
04D ^{*3}	V-phase current feedback (unit of the rated current)	0.1 %	
04E ^{*3}	W-phase current feedback (unit of the rated current)	0.1 %	

Setting value	Data type	Unit ^{*1}	Category
201	Servo motor speed +	0.1 r/min	32-bit data
202	Command pulse frequency +	kpulse/s	
203	Command pulse frequency (speed unit) +	0.1 r/min	
204	Droop pulses (1 pulse unit) +	pulse	
205	Speed command +	0.1 r/min	
206	Position within one-revolution +	pulse	
207	Load-side encoder information 1 +	pulse	
208	Load-side encoder information 2 +	rev	
209	Load-side droop pulses +	pulse	
20A ^{*5}	Controller position command +	pulse	
20B	Feedback position +	pulse	
20C	Excessive error alarm margin +	pulse	
20D ^{*4}	Current position (positioning unit) +	pos units	
20E ^{*4}	Command position (positioning unit) +	pos units	
20F ^{*4}	Command remaining distance (positioning unit) +	pos units	
218	Droop pulses (100 pulses unit) +	100 pulse	
219 ^{*2}	Load-side encoder droop pulses (100 pulses unit) +	100 pulse	
21A	Excessive error alarm margin (100 pulses unit) +	100 pulse	
21B	Droop pulses (model position deviation) +	pulse	
21F ^{*5}	Motor-side/load-side position deviation (100 pulse unit) +	100 pulse	
220	Speed command 2 +	0.1 r/min	
23C	Droop pulses (command unit) +	pulse	

*1 "mm/s" is used instead of "r/min" for linear servo motors.

*2 Available on servo amplifiers with firmware version A5 or later.

*3 Available on servo amplifiers with firmware version B0 or later.

*4 Available on servo amplifiers with firmware version B8 or later.

*5 Available on servo amplifiers with firmware version D4 or later.

■ Digital channel [G]

Setting value	Symbol	Name	Classification
0000	CSON	Servo-on command	DI
0001	LSP	Forward rotation stroke end	
0002	LSN	Reverse rotation stroke end	
0005	PC	Proportional control	
0006	RES	Reset	
0012	EM2/1	Forced stop	
0013	CRDY	Ready-on command	
0016	STO1	STO1	
0017	STO2	STO2	
001A	CDP2	Gain switching selection 2	
001B	CDP	Gain switching selection	
001C *1	CLD	Fully closed loop selection	
0034 *1	TPR1	Touch probe 1	
0035 *1	TPR2	Touch probe 2	
0036 *1	TPR3	Touch probe 3	
0049	CFLS	Controller upper stroke limit signal being input	
004A	CRLS	Controller lower stroke limit signal being input	
00A0 *2	STOC	STO command	
00A1 *2	SS1C	SS1 command	
00A2 *2	SS2C	SS2 command	
00A3 *2	SLS1C	SLS1 command	
00A4 *2	SLS2C	SLS2 command	
00A5 *2	SLS3C	SLS3 command	
00A6 *2	SLS4C	SLS4 command	
00A7 *2	SDIPC	SDIP command	
00A8 *2	SDINC	SDIN command	
00A9 *2	SLT1C	SLT1 command	
00AA *2	SLT2C	SLT2 command	
00AB *2	SLT3C	SLT3 command	
00AC *2	SLT4C	SLT4 command	
00AD *2	SLIC	SLI command	

Setting value	Symbol	Name	Classification
8000	RD	Ready	DO
8001	SA	Speed reached	
8002	ZSP	Zero speed detection	
8003	TLC	Limiting torque	
8004	VLC	Limiting speed	
8005	INP	In-position completion	
8007	WNG	Warning	
8008	ALM	Malfunction	
8009	OP	Z-phase output	
800A	MBR	Electromagnetic brake interlock	
800B	DB	External dynamic brake	
800F	BWNG	Battery warning	
8010	ALM2	Malfunction 2	
8013	RDY	In ready-on state	
8015	STO	In STO state	
8016	SMPD	Magnetic pole detection completion	
8017	ZPASS	Z-phase already passed	
8018	CDPS2	Variable gain enabled 2	
8019	CDPS	Variable gain enabled	
801A *1	CLDS	Fully closed loop control in progress	
801B	ABSV	Absolute position erased	
801D	IPF	Instantaneous power failure	
801E	SPC	Proportional control in progress	
801F	MTTR	Tough drive in progress	
8032	DOG	DOG signal input in progress	
803C *3	DOA	General-purpose output A	
803D *3	DOB	General-purpose output B	
803E *3	DOC	General-purpose output C	
8043 *1	CPO	Rough match	
8045 *1	POT	Position range	
8047 *4	MEND	Traveling completion	
8049	ZP2	Homing completion 2	
804B *5	CVST	Converter stop	
80A0 *2	STOS	STO output	
80A1 *2	SS1S	SS1 output	
80A2 *2	SS2S	SS2 output	
80A3 *2	SLS1S	SLS1 output	
80A4 *2	SLS2S	SLS2 output	
80A5 *2	SLS3S	SLS3 output	
80A6 *2	SLS4S	SLS4 output	
80A7 *2	SSMS	SSM output	
80A8 *2	SOSS	SOS output	
80A9 *2	SBCS	SBC output	
80AA *2	SDIPS	SDIP output	
80AB *2	SDINS	SDIN output	
80AC *2	SLT1S	SLT1 output	
80AD *2	SLT2S	SLT2 output	
80AE *2	SLT3S	SLT3 output	
80AF *2	SLT4S	SLT4 output	
80B1 *2	SLIS	SLI output	

- *1 Available on servo amplifiers with firmware version A5 or later.
- *2 Available on servo amplifiers with firmware version B2 or later.
- *3 Available on servo amplifiers with firmware version B6 or later.
- *4 Available on servo amplifiers with firmware version B8 or later.
- *5 Available only on the MR-J5D__G_.

Servo parameter [B]

Servo parameter	Symbol	Name	Outline
PF80.0	DRMC	Drive recorder - Operation mode selection	Select the operation mode of drive recorder. 0: Automatic setting mode (initial value) 1: Manual setting mode
PF80.2-3	DRMC	Drive recorder - Sampling cycle selection	Set the sampling cycle. 00: Automatic (250 μ s) (initial value) 05: 250 μ s 06: 500 μ s 07: 1 ms 08: 2 ms 09: 4 ms 0A: 8 ms 0B: 16 ms 0C: 32 ms 0D: 64 ms 0E: 128 ms 0F: 256 ms 10: 512 ms 11: 1.024 s
PF81.0	DRMS	Drive recorder - Sampling start selection	Select to start sampling in manual setting mode. 0: Stop sampling (initial value) 1: Start a single sampling 2: Start a consecutive sampling
PF82.0	DRTM	Drive recorder - Trigger mode selection	Select the trigger mode. 0: Alarm trigger (initial value) 1: Analog trigger/digital trigger
PF82.1	DRTM	Drive recorder - Trigger binding condition selection	Select the binding condition of the trigger. 0: Disabled (initial value) 1: Logical AND of trigger signals 2: Logical OR of trigger signals
PF82.2	DRTM	Drive recorder - Trigger operation selection 1	Select if sampling starts when the channel set in [Pr. PF84.0-1 Drive recorder - Trigger channel selection 1] exceeds the set trigger level (rising) or starts when it falls below the set trigger level (falling). 0: Rising (initial value) 1: Falling
PF82.3	DRTM	Drive recorder - Trigger operation selection 2	Select if sampling starts when the channel set in [Pr. PF84.2-3 Drive recorder - Trigger channel selection 2] exceeds the set trigger level (rising) or starts when it falls below the set trigger level (falling). 0: Rising (initial value) 1: Falling
PF83.0	**DRTAX	Drive recorder - Trigger axis common selection	For a multi-axis servo amplifier, select whether to store only the data of the axis in which the conditions are met or to store the data of all axes when using the manual setting mode and the trigger conditions are met on an analog trigger or digital trigger. 0: Disabled (initial value) 1: Enabled
PF84.0-1	DRTC	Drive recorder - Trigger channel selection 1	Set trigger channel No. 1. Initial value: 01h (Analog channel 1) *1
PF84.2-3	DRTC	Drive recorder - Trigger channel selection 2	Set trigger channel No. 2. Initial value: 81h (Digital channel 1) *1
PF84.4-5	DRTC	Drive recorder - Trigger position setting	For the total sampling time, set the trigger position in hexadecimal from 0 to 100 %. Initial value: 5Ah (90 [%])
PF85	DRTL1	Drive recorder - Trigger level setting 1	Set the trigger level of [Pr. PF84.0-1 Drive recorder - Trigger channel selection 1] in decimal. Initial value: 0
PF86	DRTL2	Drive recorder - Trigger level setting 2	Set the trigger level of [Pr. PF84.2-3 Drive recorder - Trigger channel selection 2] in decimal. Initial value: 0
PF87.0-2	DRAC1	Drive recorder - Analog channel 1 selection	Set the data to be assigned to analog channel 1. Initial value: 201h (Servo motor speed +) *2

Servo parameter	Symbol	Name	Outline
PF87.4-6	DRAC1	Drive recorder - Analog channel 2 selection	Set the data to be assigned to analog channel 2. Initial value: 002h (Torque/instantaneous torque) *2
PF88.0-2	DRAC2	Drive recorder - Analog channel 3 selection	Set the data to be assigned to analog channel 3. Initial value: 003h (Current command) *2
PF88.4-6	DRAC2	Drive recorder - Analog channel 4 selection	Set the data to be assigned to analog channel 4. Initial value: 204h (Droop pulses (1 pulse unit) +) *2
PF89.0-2	DRAC3	Drive recorder - Analog channel 5 selection	Set the data to be assigned to analog channel 5. Initial value: 205h (Speed command +) *2
PF89.4-6	DRAC3	Drive recorder - Analog channel 6 selection	Set the data to be assigned to analog channel 6. Initial value: 009h (Bus voltage) *2
PF90.0-2	DRAC4	Drive recorder - Analog channel 7 selection	Set the data to be assigned to analog channel 7. Initial value: 00Ch (Effective load ratio) *2
PF91.0-3	DRDC1	Drive recorder - Digital channel 1 selection	Set the data to be assigned to digital channel 1. Initial value: 0000h (CSON) *3
PF91.4-7	DRDC1	Drive recorder - Digital channel 2 selection	Set the data to be assigned to digital channel 2. Initial value: 001Fh (EMG) *3
PF92.0-3	DRDC2	Drive recorder - Digital channel 3 selection	Set the data to be assigned to digital channel 3. Initial value: 8010h (ALM2) *3
PF92.4-7	DRDC2	Drive recorder - Digital channel 4 selection	Set the data to be assigned to digital channel 4. Initial value: 8005h (INP) *3
PF93.0-3	DRDC3	Drive recorder - Digital channel 5 selection	Set the data to be assigned to digital channel 5. Initial value: 800Ah (MBR) *3
PF93.4-7	DRDC3	Drive recorder - Digital channel 6 selection	Set the data to be assigned to digital channel 6. Initial value: 8000h (RD) *3
PF94.0-3	DRDC4	Drive recorder - Digital channel 7 selection	Set the data to be assigned to digital channel 7. Initial value: 8015h (STO) *3
PF94.4-7	DRDC4	Drive recorder - Digital channel 8 selection	Set the data to be assigned to digital channel 8. Initial value: 801Dh (IPF) *3
PF95.0	**DRCLR	Drive recorder - Clear history selection	When enabled is selected, the drive recorder history will be cleared at either the next power cycle or at software reset. 0:Disabled (initial value) 1:Enabled
PF21	DRT	Drive recorder switching time setting	Set the drive recorder switching time. When the USB communication is disconnected during the use of the graph function, the function will be switched to the drive recorder function after the time set in this servo parameter has passed. Initial value: 0 (switched after 10 s)
PA23.0-1	DRAT	Alarm detail number setting	To execute the trigger with a desired alarm detail number, set [Pr. PF80.0 Drive recorder - Operation mode selection] = "0" (automatic setting mode) or [Pr. PF82.0 Drive recorder - Trigger mode selection] = "0" (alarm trigger) in [Pr. PF80.0] = "1" (manual setting mode). At "00", only the optional alarm number setting will be enabled. Initial value: 00h
PA23.2-4	DRAT	Alarm number setting	To execute the trigger with a desired alarm number, set [Pr. PF80.0 Drive recorder - Operation mode selection] = "0" (automatic setting mode) or [Pr. PF82.0 Drive recorder - Trigger mode selection] = "0" (alarm trigger) in [Pr. PF80.0] = "1" (manual setting mode). When "000" is set, arbitrary alarm trigger of the drive recorder will be disabled. Initial value: 000h

*1 Refer to the following for setting values.

☞ Page 323 Trigger channel selection [B]

*2 Refer to the following for setting values.

☞ Page 323 Analog channel [B]

*3 Refer to the following for setting values.

☞ Page 324 Digital channel [B]

■ Trigger channel selection [B]

Setting value	Meaning
01	Analog channel 1
02	Analog channel 2
03	Analog channel 3
04	Analog channel 4
05	Analog channel 5
06	Analog channel 6
07	Analog channel 7
81	Digital channel 1
82	Digital channel 2
83	Digital channel 3
84	Digital channel 4
85	Digital channel 5
86	Digital channel 6
87	Digital channel 7
88	Digital channel 8

■ Analog channel [B]

Setting value	Data type	Unit *1	Category
000	No assigned function	—	—
001	Servo motor speed	r/min	16-bit data
002	Torque/instantaneous torque	0.1 %	
003	Current command	0.1 %	
005	Command pulse frequency (speed unit)	r/min	
007	Droop pulses (1 pulse unit)	pulse	
008	Speed command	r/min	
009	Bus voltage	V	
00C	Effective load ratio	0.1 %	
00D	Regenerative load ratio	0.1 %	
00E	Position within one-revolution	16 pulse	
00F	ABS counter	rev	
010	Load to motor inertia ratio	0.01 times	
011	Torque equivalent to disturbance	0.1 %	
012	Overload alarm margin	0.1 %	
014	Settling time	ms	
015	Overshoot amount	pulse	
01C	Load-side encoder droop pulses (1 pulse unit)	pulse	
01E	Motor-side/load-side position deviation (1 pulse unit)	pulse	
020	Motor-side/load-side speed deviation	r/min	
021	Servo motor speed (unit of 0.1 r/min)	0.1 r/min	
022	Command pulse frequency (speed unit of 0.1 r/min)	0.1 r/min	
023	Speed command (unit of 0.1 r/min)	0.1 r/min	
024	Torque command	0.1 %	
025	Speed limit value	r/min	
026	Speed limit value (unit of 0.1 r/min)	0.1 r/min	
035	Internal temperature of encoder	°C	
03B	Load-side encoder information 1	16 pulse	
03C	Load-side encoder information 2	rev	
04C	U-phase current feedback (unit of the rated current)	0.1 %	
04D	V-phase current feedback (unit of the rated current)	0.1 %	
04E	W-phase current feedback (unit of the rated current)	0.1 %	

Setting value	Data type	Unit ^{*1}	Category
201	Servo motor speed +	0.1 r/min	32-bit data
202	Command pulse frequency +	kpulse/s	
203	Command pulse frequency (speed unit) +	0.1 r/min	
204	Droop pulses (1 pulse unit) +	pulse	
205	Speed command +	0.1 r/min	
206	Position within one-revolution +	pulse	
207	Load-side encoder information 1 +	pulse	
208	Load-side encoder information 2 +	rev	
209	Load-side droop pulses +	pulse	
20A ^{*2}	Controller position command +	pulse	
20B	Feedback position +	pulse	
20C	Excessive error alarm margin +	pulse	
218	Droop pulses (100 pulses unit) +	100 pulse	
219	Load-side encoder droop pulses (100 pulses unit) +	100 pulse	
21A	Excessive error alarm margin (100 pulses unit) +	100 pulse	
21B	Droop pulses (model position deviation) +	pulse	
21F ^{*2}	Motor-side/load-side position deviation (100 pulse unit) +	100 pulse	
220	Speed command 2 +	0.1 r/min	
23C	Droop pulses (command unit) +	pulse	

*1 "mm/s" is used instead of "r/min" for linear servo motors.

*2 Available on servo amplifiers with firmware version D4 or later.

■ Digital channel [B]

Setting value	Symbol	Name	Classification
0000	CSON	Servo-on command	DI
0005	PC	Proportional control	
0006	RES	Reset	
0007	CSV1	Control mode setting 1	
0008	CSV2	Control mode setting 2	
0009	CTL1	Torque limit selection 1	
000A	CTL2	Torque limit selection 2	
0012	EM2/1	Forced stop	
0013	CRDY	Ready-on command	
0016	STO1	STO1	
0017	STO2	STO2	
001A	CDP2	Gain switching selection 2	
001B	CDP	Gain switching selection	
001C	CLD	Fully closed loop selection	
001F	EMG	Controller emergency stop	
0021	CABS	Absolute position reference point data set request	
0022	CZCT	ZCT re-creation request	
0026	CSV3	Continuous operation to torque control mode command	

Setting value	Symbol	Name	Classification
8000	RD	Ready	DO
8001	SA	Speed reached	
8002	ZSP	Zero speed detection	
8003	TLC	Limiting torque	
8004	VLC	Limiting speed	
8005	INP	In-position completion	
8007	WNG	Warning	
8008	ALM	Malfunction	
8009	OP	Z-phase output	
800A	MBR	Electromagnetic brake interlock	
800B	DB	External dynamic brake	
800F	BWNG	Battery warning	
8010	ALM2	Malfunction 2	
8013	RDY	In ready-on state	
8015	STO	In STO state	
8016	SMPD	Magnetic pole detection completion	
8017	ZPASS	Z-phase already passed	
8018	CDPS2	Variable gain enabled 2	
8019	CDPS	Variable gain enabled	
801A	CLDS	Fully closed loop control in progress	
801B	ABSV	Absolute position erased	
801D	IPF	Instantaneous power failure	
801E	SPC	Proportional control in progress	
801F	MTTR	Tough drive in progress	
8020	SSV1	Currently selected control mode 1	
8021	SSV2	Currently selected control mode 2	
8022	STL1	Torque limit selection 1 reception in process	
8023	STL2	Torque limit selection 2 reception in process	
8024	SABSE	Incorrect absolute position reference data set	
8025	SABS	Absolute position reference point data set request completed	
8026	WNGSTOP	Motor stop warning	
8030	FLS	Upper stroke limit input in progress	
8031	RLS	Lower stroke limit input in progress	
8032	DOG	DOG signal input in progress	
8037	SSV3	Continuous operation to torque control mode	

Servo parameter [A]

Servo parameter	Symbol	Name	Outline
PF80.0	DRMC	Drive recorder - Operation mode selection	Select the operation mode of drive recorder. 0: Automatic setting mode (initial value) 1: Manual setting mode
PF80.2-3	DRMC	Drive recorder - Sampling cycle selection	Set the sampling cycle. 00: Automatic (250 μs) (initial value) 05: 250 μs 06: 500 μs 07: 1 ms 08: 2 ms 09: 4 ms 0A: 8 ms 0B: 16 ms 0C: 32 ms 0D: 64 ms 0E: 128 ms 0F: 256 ms 10: 512 ms 11: 1.024 s
PF81.0	DRMS	Drive recorder - Sampling start selection	Select to start sampling in manual setting mode. 0: Stop sampling (initial value) 1: Start a single sampling 2: Start a consecutive sampling
PF82.0	DRTM	Drive recorder - Trigger mode selection	Select the trigger mode. 0: Alarm trigger (initial value) 1: Analog trigger/digital trigger
PF82.1	DRTM	Drive recorder - Trigger binding condition selection	Select the binding condition of the trigger. 0: Disabled (initial value) 1: Logical AND of trigger signals 2: Logical OR of trigger signals
PF82.2	DRTM	Drive recorder - Trigger operation selection 1	Select if sampling starts when the channel set in [Pr. PF84.0-1 Drive recorder - Trigger channel selection 1] exceeds the set trigger level (rising) or starts when it falls below the set trigger level (falling). 0: Rising (initial value) 1: Falling
PF82.3	DRTM	Drive recorder - Trigger operation selection 2	Select if sampling starts when the channel set in [Pr. PF84.2-3 Drive recorder - Trigger channel selection 2] exceeds the set trigger level (rising) or starts when it falls below the set trigger level (falling). 0: Rising (initial value) 1: Falling
PF84.0-1	DRTC	Drive recorder - Trigger channel selection 1	Set trigger channel No. 1. Initial value: 01h (Analog channel 1) *1
PF84.2-3	DRTC	Drive recorder - Trigger channel selection 2	Set trigger channel No. 2. Initial value: 81h (Digital channel 1) *1
PF84.4-5	DRTC	Drive recorder - Trigger position setting	For the total sampling time, set the trigger position in hexadecimal from 0 to 100 %. Initial value: 5Ah (90 [%])
PF85	DRTL1	Drive recorder - Trigger level setting 1	Set the trigger level of [Pr. PF84.0-1 Drive recorder - Trigger channel selection 1] in decimal. Initial value: 0
PF86	DRTL2	Drive recorder - Trigger level setting 2	Set the trigger level of [Pr. PF84.2-3 Drive recorder - Trigger channel selection 2] in decimal. Initial value: 0
PF87.0-2	DRAC1	Drive recorder - Analog channel 1 selection	Set the data to be assigned to analog channel 1. Initial value: 201h (Servo motor speed +) *2
PF87.4-6	DRAC1	Drive recorder - Analog channel 2 selection	Set the data to be assigned to analog channel 2. Initial value: 002h (Torque/instantaneous torque) *2
PF88.0-2	DRAC2	Drive recorder - Analog channel 3 selection	Set the data to be assigned to analog channel 3. Initial value: 003h (Current command) *2
PF88.4-6	DRAC2	Drive recorder - Analog channel 4 selection	Set the data to be assigned to analog channel 4. Initial value: 204h (Droop pulses (1 pulse unit) +) *2

Servo parameter	Symbol	Name	Outline
PF89.0-2	DRAC3	Drive recorder - Analog channel 5 selection	Set the data to be assigned to analog channel 5. Initial value: 205h (Speed command +) *2
PF89.4-6	DRAC3	Drive recorder - Analog channel 6 selection	Set the data to be assigned to analog channel 6. Initial value: 009h (Bus voltage) *2
PF90.0-2	DRAC4	Drive recorder - Analog channel 7 selection	Set the data to be assigned to analog channel 7. Initial value: 00Ch (Effective load ratio) *2
PF91.0-3	DRDC1	Drive recorder - Digital channel 1 selection	Set the data to be assigned to digital channel 1. Initial value: 0000h (SON) *3
PF91.4-7	DRDC1	Drive recorder - Digital channel 2 selection	Set the data to be assigned to digital channel 2. Initial value: 0012h (EM2/1) *3
PF92.0-3	DRDC2	Drive recorder - Digital channel 3 selection	Set the data to be assigned to digital channel 3. Initial value: 8010h (ALM2) *3
PF92.4-7	DRDC2	Drive recorder - Digital channel 4 selection	Set the data to be assigned to digital channel 4. Initial value: 8005h (INP) *3
PF93.0-3	DRDC3	Drive recorder - Digital channel 5 selection	Set the data to be assigned to digital channel 5. Initial value: 800Ah (MBR) *3
PF93.4-7	DRDC3	Drive recorder - Digital channel 6 selection	Set the data to be assigned to digital channel 6. Initial value: 8000h (RD) *3
PF94.0-3	DRDC4	Drive recorder - Digital channel 7 selection	Set the data to be assigned to digital channel 7. Initial value: 8015h (STO) *3
PF94.4-7	DRDC4	Drive recorder - Digital channel 8 selection	Set the data to be assigned to digital channel 8. Initial value: 801Dh (IPF) *3
PF95.0	**DRCLR	Drive recorder - Clear history selection	When enabled is selected, the drive recorder history will be cleared at either the next power cycle or at software reset. 0:Disabled (initial value) 1:Enabled
PF21	DRT	Drive recorder switching time setting	Set the drive recorder switching time. When the USB communication is disconnected during the use of the graph function, the function will be switched to the drive recorder function after the time set in this servo parameter has passed. Initial value: 0 (switched after 10 s)
PA23.0-1	DRAT	Alarm detail number setting	To execute the trigger with a desired alarm detail number, set [Pr. PF80.0 Drive recorder - Operation mode selection] = "0" (automatic setting mode) or [Pr. PF82.0 Drive recorder - Trigger mode selection] = "0" (alarm trigger) in [Pr. PF80.0] = "1" (manual setting mode). At "00", only the optional alarm number setting will be enabled. Initial value: 00h
PA23.2-4	DRAT	Alarm number setting	To execute the trigger with a desired alarm number, set [Pr. PF80.0 Drive recorder - Operation mode selection] = "0" (automatic setting mode) or [Pr. PF82.0 Drive recorder - Trigger mode selection] = "0" (alarm trigger) in [Pr. PF80.0] = "1" (manual setting mode). When "000" is set, arbitrary alarm trigger of the drive recorder will be disabled. Initial value: 000h

*1 Refer to the following for setting values.
 Page 328 Trigger channel selection [A]

*2 Refer to the following for setting values.
 Page 329 Analog channel [A]

*3 Refer to the following for setting values.
 Page 330 Digital channel [A]

■ Trigger channel selection [A]

Setting value	Meaning
01	Analog channel 1
02	Analog channel 2
03	Analog channel 3
04	Analog channel 4
05	Analog channel 5
06	Analog channel 6
07	Analog channel 7
81	Digital channel 1
82	Digital channel 2
83	Digital channel 3
84	Digital channel 4
85	Digital channel 5
86	Digital channel 6
87	Digital channel 7
88	Digital channel 8

■ Analog channel [A]

Setting value	Data type	Unit ^{*1}	Category
000	No assigned function	—	—
001	Servo motor speed	1 r/min	16-bit data
002	Torque/instantaneous torque	0.1 %	
003	Current command	0.1 %	
005	Command pulse frequency (speed unit)	1 r/min	
007	Droop pulses (1 pulse unit)	1 pulse	
008	Speed command	1 r/min	
009	Bus voltage	1 V	
00C	Effective load ratio	0.1 %	
00D	Regenerative load ratio	0.1 %	
00E	Position within one-revolution	16 pulse	
00F	ABS counter	1 rev	
010	Load to motor inertia ratio	0.01 times	
011	Torque equivalent to disturbance	0.1 %	
012	Overload alarm margin	0.1 %	
014	Settling time	1 ms	
015	Overshoot amount	1 pulse	
01C ^{*2}	Load-side encoder droop pulses (1 pulse unit)	1 pulse	
01E ^{*2}	Motor-side/load-side position deviation (1 pulse unit)	1 pulse	
020 ^{*2}	Motor-side/load-side speed deviation	1 r/min	
021	Servo motor speed (0.1 r/min unit)	0.1 r/min	
022	Command pulse frequency (0.1 r/min speed unit)	0.1 r/min	
023	Speed command (0.1 r/min unit)	0.1 r/min	
024	Torque command	0.1 %	
025	Speed limit value	1 r/min	
026	Speed limit value (0.1 r/min unit)	0.1 r/min	
035	Internal temperature of encoder	1 °C	
03B	Load-side encoder information 1	16 pulse	
03C	Load-side encoder information 2	1 rev	
049	Operation mode	1LSB	
04C ^{*3}	U-phase current feedback (unit of the rated current)	0.1 %	
04D ^{*3}	V-phase current feedback (unit of the rated current)	0.1 %	
04E ^{*3}	W-phase current feedback (unit of the rated current)	0.1 %	

Setting value	Data type	Unit ^{*1}	Category
201	Servo motor speed +	0.1 r/min	32-bit data
202	Command pulse frequency +	kpulse/s	
203	Command pulse frequency (speed unit) +	0.1 r/min	
204	Droop pulses (1 pulse unit) +	1 pulse	
205	Speed command +	0.1 r/min	
206	Position within one-revolution +	1 pulse	
207	Load-side encoder information 1 +	1 pulse	
208	Load-side encoder information 2 +	1 pulse	
209	Load-side droop pulses +	1 pulse	
20B	Feedback position +	1 pulse	
20C	Excessive error alarm margin +	1 pulse	
218	Droop pulses (100 pulses unit) +	100 pulse	
219 ^{*2}	Load-side encoder droop pulses (100 pulses unit) +	100 pulse	
21A	Excessive error alarm margin (100 pulses unit) +	100 pulse	
21B	Droop pulses (model position deviation) +	1 pulse	
21F ^{*4}	Motor-side/load-side position deviation (100 pulse unit) +	100 pulse	
220	Speed command 2+	0.1 r/min	
23C	Droop pulses (command unit) +	1 pulse	
23D ^{*4}	Cumulative command pulses +	1 pulse	

*1 "mm/s" is used instead of "r/min" for linear servo motors.

*2 Available on servo amplifiers with firmware version A5 or later.

*3 Available on servo amplifiers with firmware version B0 or later.

*4 Available on servo amplifiers with firmware version D4 or later.

■ Digital channel [A]

Setting value	Symbol	Name	Classification
0001	LSP	Forward rotation stroke end	DI
0002	LSN	Reverse rotation stroke end	
0005	PC	Proportional control	
0006	RES	Reset	
000B	ST1 (ST1/RS2)	Forward rotation start (forward rotation start/reverse rotation selection)	
000C	ST2 (ST2/RS1)	Reverse rotation start (reverse rotation start/forward rotation selection)	
0012	EM2/1	Forced stop	
0016	STO1	STO1	
0017	STO2	STO2	
001A	CDP2	Gain switching selection 2	
001B	CDP	Gain switching selection	
001C ^{*1}	CLD	Fully closed loop selection	
0000	SON	Servo-on	
0003	TL	External torque limit selection	
0004	TL1	Internal torque limit selection	
0007	CR	Clear	
0008	SP1	Speed selection 1	
0009	SP2	Speed selection 2	
000A	SP3	Speed selection 3	
000D	CM1	Electronic gear selection 1	
000E	CM2	Electronic gear selection 2	
000F	LOP	Control switching	
0014	STAB2	Second acceleration/deceleration selection	
001D ^{*1}	MECR	Motor-side/load-side deviation counter clear	
0021	ABSM	ABS transfer mode	
0022	ABSR	ABS request	

Setting value	Symbol	Name	Classification
8000	RD	Ready	DO
8001	SA	Speed reached	
8002	ZSP	Zero speed detection	
8003	TLC	Limiting torque	
8004	VLC	Limiting speed	
8005	INP	In-position	
8007	WNG	Warning	
8008	ALM	Malfunction	
8009	OP	Z-phase output	
800A	MBR	Electromagnetic brake interlock	
800B	DB	External dynamic brake	
800F	BWNG	Battery warning	
8010	ALM2	Malfunction 2	
8015	STO	In STO state	
8016	SMPD	Magnetic pole detection completion	
8018	CDPS2	Variable gain enabled 2	
8019	CDPS	Variable gain enabled	
801A *1	CLDS	Fully closed loop control in progress	
801B	ABSV	Absolute position erased	
801D	IPF	Instantaneous power failure	
801E	SPC	Proportional control in progress	
801F	MTTR	Tough drive in progress	
8020	ABSB0	ABS transmission data Bit0	
8021	ABSB1	ABS transmission data Bit1	
8022	ABST	ABS transmission data ready	
8051	ALMWNG	Malfunction/Warning	
8052	BW9F	AL9F warning	

*1 Available on servo amplifiers with firmware version A5 or later.

Object dictionary [G]

For details on the objects, refer to the User's Manual (Object Dictionary).

Index	Sub	Object	Name	Description
2C02h	00h	VAR	Drive recorder status	Returns the operating status of the drive recorder.
2A70h	00h	ARRAY	Drive recorder history newest	Returns the total number of Sub Indexes.
	01h		Drive recorder history index	Returns the saved index of the drive recorder. *1
	02h		Drive recorder history alarm number	Returns the number of the alarm that occurred when data was recorded using the drive recorder.
	03h		Drive recorder history power on time	Returns the power-on cumulative time when data was recorded using the drive recorder.
	04h		Drive recorder history time (second)	Returns the recording time of the drive recorder as a 32-bit integer (time passed from January 1, 1970, 0:00:00.000000000).
	05h		Drive recorder history time (nanosecond)	Returns the digits after the ones indicating seconds in the recording time of the drive recorder as a 32-bit integer.
	06h		Drive recorder history (time zone)	Returns the time zone when data was recorded using the drive recorder.
	07h		Drive recorder history (summer time)	Returns the daylight saving time when data was recorded using the drive recorder.
2A71h	00h	ARRAY	Drive recorder history 1	Returns the total number of Sub Indexes.
	01h		Drive recorder history index	Returns the saved index of the drive recorder. *1
	02h		Drive recorder history alarm number	Returns the number of the alarm that occurred when data was recorded using the drive recorder.
	03h		Drive recorder history power on time	Returns the power-on cumulative time when data was recorded using the drive recorder.
	04h		Drive recorder history time (second)	Returns the recording time of the drive recorder as a 32-bit integer (time passed from January 1, 1970, 0:00:00.000000000).
	05h		Drive recorder history time (nanosecond)	Returns the digits after the ones indicating seconds in the recording time of the drive recorder as a 32-bit integer.
	06h		Drive recorder history (time zone)	Returns the time zone when data was recorded using the drive recorder.
	07h		Drive recorder history (summer time)	Returns the daylight saving time when data was recorded using the drive recorder.
:	:	:	:	:
2A7Fh	00h	ARRAY	Drive recorder history 15	Returns the total number of Sub Indexes.
	01h		Drive recorder history index	Returns the saved index of the drive recorder. *1
	02h		Drive recorder history alarm number	Returns the number of the alarm that occurred when data was recorded using the drive recorder.
	03h		Drive recorder history power on time	Returns the power-on cumulative time when data was recorded using the drive recorder.
	04h		Drive recorder history time (second)	Returns the recording time of the drive recorder as a 32-bit integer (time passed from January 1, 1970, 0:00:00.000000000).
	05h		Drive recorder history time (nanosecond)	Returns the digits after the ones indicating seconds in the recording time of the drive recorder as a 32-bit integer.
	06h		Drive recorder history (time zone)	Returns the time zone when data was recorded using the drive recorder.
	07h		Drive recorder history (summer time)	Returns the daylight saving time when data was recorded using the drive recorder.
2C03h	00h	VAR	Clear drive recorder history	Writing "1EA5h" clears the drive recorder history. When the data is read, "0000h" is returned.

*1 [Drive recorder history index] displays drive record data using consecutive numbers from 0 to 9999. When data is recorded in the drive recorder, the number will increase. If the number exceeds 9999, it will return to 0 and increase again.

Standard acquisition waveform list [G] [B]

When [Pr. PF80.0 Drive recorder - Operation mode selection] is set to "0" (automatic setting mode), the acquired data is changed by [Pr. PA23 Drive recorder desired alarm trigger setting]. If [Pr. PA23] is set to the initial value (00000000h), the data shown in the "Standard" section of the following table is saved.

If the alarm numbers described in the following table are set with [Pr. PA23], the data in each alarm number section will be saved.

Measurement data with "+" added to the name refers to data with an extended measurement data range and units.

Trigger condition	Data 1	Data 2	Data 3	Data 4	Data 5	Data 6	Data 7	Data 8	Sampling cycle	Measurement time
Standard	Servo motor speed +	Torque	Current command	Droop pulses (1 pulse) +	Speed command +	Bus voltage	Effective load ratio	—	0.500 ms	512 ms
	CSON	[G]: EM2/ EM1 [B]: EMG	ALM2	INP	MBR	RD	STO	IPF		
AL. 010	Servo motor speed +	Torque	Current command	Droop pulses (1 pulse) +	Speed command +	Bus voltage	Effective load ratio	—	0.500 ms	512 ms
	CSON	[G]: EM2/ EM1 [B]: EMG	ALM2	INP	MBR	RD	STO	IPF		
AL. 020	Servo motor speed +	Torque	ABS counter	Position within one-revolution	Current command	Encoder error counter 1	Encoder error counter 2	—	0.500 ms	512 ms
	CSON	[G]: EM2/ EM1 [B]: EMG	ALM2	INP	MBR	RD	STO	IPF		
AL. 021	Servo motor speed +	Torque	ABS counter	Position within one-revolution	Current command	Encoder error counter 1	Encoder error counter 2	—	0.500 ms	512 ms
	CSON	[G]: EM2/ EM1 [B]: EMG	ALM2	INP	MBR	RD	STO	IPF		
AL. 024	Servo motor speed +	Torque	Current command	Position within one-revolution	Bus voltage	U-phase current feedback	V-phase current feedback	—	0.500 ms	512 ms
	CSON	[G]: EM2/ EM1 [B]: EMG	ALM2	INP	MBR	RD	STO	IPF		
AL. 030	Servo motor speed +	Torque	Current command	Droop pulses (1 pulse) +	Bus voltage	Regenerative load ratio	Effective load ratio	—	32 ms	32768 ms
	CSON	[G]: EM2/ EM1 [B]: EMG	ALM2	INP	MBR	RD	STO	IPF		

Trigger condition	Data 1	Data 2	Data 3	Data 4	Data 5	Data 6	Data 7	Data 8	Sampling cycle	Measurement time
AL. 031	Servo motor speed +	Torque	Current command	Command pulse frequency +	Position within one-revolution	Speed command +	Bus voltage	—	0.500 ms	512 ms
	CSO	[G]: EM2/ EM1 [B]: EMG	ALM2	INP	MBR	RD	STO	IPF		
AL. 032	Servo motor speed +	Torque	Current command	Bus voltage	Effective load ratio	U-phase current feedback	V-phase current feedback	—	0.250 ms	256 ms
	CSO	[G]: EM2/ EM1 [B]: EMG	ALM2	INP	MBR	RD	STO	IPF		
AL. 033	Servo motor speed +	Torque	Current command	Speed command +	Bus voltage	Regenerative load ratio	Effective load ratio	—	2 ms	2048 ms
	CSO	[G]: EM2/ EM1 [B]: EMG	ALM2	INP	MBR	RD	STO	IPF		
AL. 035	Servo motor speed +	Torque	Current command	Command pulse frequency +	Droop pulses (1 pulse) +	Speed command	Bus voltage	—	0.500 ms	512 ms
	CSO	[G]: EM2/ EM1 [B]: EMG	ALM2	INP	MBR	RD	STO	IPF		
AL. 042	Servo motor speed +	Torque	Motor-side/ load-side position deviation (100 pulses) + *2	Motor-side/ load-side speed deviation	Command pulse frequency (speed unit) +	Droop pulses (100 pulses) +	Load-side droop pulses (100 pulses) +	—	0.500 ms	512 ms
	CSO	[G]: EM2/ EM1 [B]: EMG	ALM2	INP	MBR	RD	STO	IPF		
AL. 046	Servo motor speed +	Torque	Current command	Internal temperature of encoder	Temperature of servo motor thermistor	Bus voltage	Effective load ratio	—	32 ms	32768 ms
	CSO	[G]: EM2/ EM1 [B]: EMG	ALM2	INP	MBR	RD	STO	IPF		
AL. 050	Servo motor speed +	Torque	Current command	Droop pulses (100 pulses) +	Overload alarm margin	Bus voltage	Effective load ratio	—	32 ms	32768 ms
	CSO	[G]: EM2/ EM1 [B]: EMG	ALM2	INP	MBR	RD	STO	IPF		

Trigger condition	Data 1	Data 2	Data 3	Data 4	Data 5	Data 6	Data 7	Data 8	Sampling cycle	Measurement time
AL. 051	Servo motor speed +	Torque	Current command	Droop pulses (100 pulses) +	Overload alarm margin	Bus voltage	Effective load ratio	—	32 ms	32768 ms
	CSON	[G]: EM2/ EM1 [B]: EMG	ALM2	INP	MBR	RD	STO	IPF		
AL. 052	Servo motor speed +	Torque	Current command	Droop pulses (100 pulses) +	Speed command	Bus voltage	Excessive error alarm margin *1	—	2 ms	2048 ms
	CSON	[G]: EM2/ EM1 [B]: EMG	ALM2	INP	MBR	RD	STO	TLC		
AL. 071	Servo motor speed +	Torque	Load-side encoder information 2	Load-side encoder information 1	Current command	Load-side encoder error counter 1	Load-side encoder error counter 2	—	0.500 ms	512 ms
	CSON	[G]: EM2/ EM1 [B]: EMG	ALM2	INP	MBR	RD	STO	IPF		
AL. 072	Servo motor speed +	Torque	Load-side encoder information 2	Load-side encoder information 1	Current command	Load-side encoder error counter 1	Load-side encoder error counter 2	—	0.500 ms	512 ms
	CSON	[G]: EM2/ EM1 [B]: EMG	ALM2	INP	MBR	RD	STO	IPF		

*1 For servo amplifiers with firmware version earlier than B6, "overload alarm margin" data is obtained.

*2 For servo amplifiers with firmware version earlier than D4, "0" is obtained.

Standard acquisition waveform list [A]

When [Pr. PF80.0 Drive recorder - Operation mode selection] is set to "0" (automatic setting mode), the acquired data is changed by [Pr. PA23 Drive recorder desired alarm trigger setting]. If [Pr. PA23] is set to the initial value (00000000h), the data shown in the "Standard" section of the following table is saved. If the alarm numbers described in the following table are set with [Pr. PA23], the data in each alarm number section will be saved.

Measurement data with "+" added to the name refers to data with an extended measurement data range and units.

Trigger condition	Data 1	Data 2	Data 3	Data 4	Data 5	Data 6	Data 7	Data 8	Sampling cycle	Measurement time
Standard	Servo motor speed +	Torque	Current command	Droop pulses (1 pulse) +	Speed command +	Bus voltage	Effective load ratio	—	0.500 ms	512 ms
	SON	EM2/EM1	ALM2	INP	MBR	RD	STO	IPF		
AL. 010	Servo motor speed +	Torque	Current command	Droop pulses (1 pulse) +	Speed command +	Bus voltage	Effective load ratio	—	0.500 ms	512 ms
	SON	EM2/EM1	ALM2	INP	MBR	RD	STO	IPF		
AL. 020	Servo motor speed +	Torque	ABS counter	Position within one-revolution	Current command	Encoder error counter 1	Encoder error counter 2	—	0.500 ms	512 ms
	SON	EM2/EM1	ALM2	INP	MBR	RD	STO	IPF		
AL. 021	Servo motor speed +	Torque	ABS counter	Position within one-revolution	Current command	Encoder error counter 1	Encoder error counter 2	—	0.500 ms	512 ms
	SON	EM2/EM1	ALM2	INP	MBR	RD	STO	IPF		
AL. 024	Servo motor speed +	Torque	Current command	Position within one-revolution	Bus voltage	U-phase current feedback	V-phase current feedback	—	0.500 ms	512 ms
	SON	EM2/EM1	ALM2	INP	MBR	RD	STO	IPF		
AL. 030	Servo motor speed +	Torque	Current command	Droop pulses (1 pulse) +	Bus voltage	Regenerative load ratio	Effective load ratio	—	32 ms	32768 ms
	SON	EM2/EM1	ALM2	INP	MBR	RD	STO	IPF		
AL. 031	Servo motor speed +	Torque	Current command	Command pulse frequency +	Position within one-revolution	Speed command +	Bus voltage	—	0.500 ms	512 ms
	SON	EM2/EM1	ALM2	INP	MBR	RD	STO	IPF		
AL. 032	Servo motor speed +	Torque	Current command	Bus voltage	Effective load ratio	U-phase current feedback	V-phase current feedback	—	0.250 ms	256 ms
	SON	EM2/EM1	ALM2	INP	MBR	RD	STO	IPF		
AL. 033	Servo motor speed +	Torque	Current command	Speed command +	Bus voltage	Regenerative load ratio	Effective load ratio	—	2 ms	2048 ms
	SON	EM2/EM1	ALM2	INP	MBR	RD	STO	IPF		
AL. 035	Servo motor speed +	Torque	Current command	Command pulse frequency +	Droop pulses (1 pulse) +	Speed command	Bus voltage	—	0.500 ms	512 ms
	SON	EM2/EM1	ALM2	INP	MBR	RD	STO	IPF		

Trigger condition	Data 1	Data 2	Data 3	Data 4	Data 5	Data 6	Data 7	Data 8	Sampling cycle	Measurement time
AL. 042	Servo motor speed +	Torque	Motor-side/ load-side position deviation (100 pulses) + *2	Motor-side/ load-side speed deviation	Command pulse frequency (speed unit) +	Droop pulses (100 pulses) +	Load-side droop pulses (100 pulses) +	—	0.500 ms	512 ms
	SON	EM2/ EM1	ALM2	INP	MBR	RD	STO	IPF		
AL. 046	Servo motor speed +	Torque	Current command	Internal temperature of encoder	Temperature of servo motor thermistor	Bus voltage	Effective load ratio	—	32 ms	32768 ms
	SON	EM2/ EM1	ALM2	INP	MBR	RD	STO	IPF		
AL. 050	Servo motor speed +	Torque	Current command	Droop pulses (100 pulses) +	Overload alarm margin	Bus voltage	Effective load ratio	—	32 ms	32768 ms
	SON	EM2/ EM1	ALM2	INP	MBR	RD	STO	IPF		
AL. 051	Servo motor speed +	Torque	Current command	Droop pulses (100 pulses) +	Overload alarm margin	Bus voltage	Effective load ratio	—	32 ms	32768 ms
	SON	EM2/ EM1	ALM2	INP	MBR	RD	STO	IPF		
AL. 052	Servo motor speed +	Torque	Current command	Droop pulses (100 pulses) +	Speed command	Bus voltage	Excessive error alarm margin *1	—	2 ms	2048 ms
	SON	EM2/ EM1	ALM2	INP	MBR	RD	STO	TLC		
AL. 071	Servo motor speed +	Torque	Load-side encoder information 2	Load-side encoder information 1	Current command	Load-side encoder error counter 1	Load-side encoder error counter 2	—	0.500 ms	512 ms
	SON	EM2/ EM1	ALM2	INP	MBR	RD	STO	IPF		
AL. 072	Servo motor speed +	Torque	Load-side encoder information 2	Load-side encoder information 1	Current command	Load-side encoder error counter 1	Load-side encoder error counter 2	—	0.500 ms	512 ms
	SON	EM2/ EM1	ALM2	INP	MBR	RD	STO	IPF		

*1 For servo amplifiers with firmware version earlier than B6, "overload alarm margin" data is obtained.

*2 For servo amplifiers with firmware version earlier than D4, "0" is obtained.

Waveform recording inapplicable alarm list

Alarms that are not covered in the alarm history are not subject to recording by the drive recorder. For details, refer to the following manual.

📖 MR-J5 User's Manual (Troubleshooting)

The alarms shown in the following table are saved in the alarm history, but are not subject to recording by the drive recorder. The drive recorder does not operate in this case.

Alarm No.	Name
010.1	Voltage drop in the control circuit power
012	Memory error 1
016	Encoder initial communication error 1
017	Board error
019	Memory error 3
01A	Servo motor combination error
01E	Encoder initial communication error 2
01F	Encoder initial communication error 3
025	Absolute position erased
119	Memory error 4

In addition, data may not be recorded when the following alarms occur depending on the circumstances of the alarm occurrence.

Alarm No.	Name
013	CPU error
014	Control process error

List of auxiliary recording data

A list of auxiliary record data saved by the drive recorder is shown.

Instantaneous monitor data

The instantaneous monitor data is saved in the vicinity of the trigger condition establishment.

System configuration display data

The system configuration display data saved by the drive recorder is as follows. Incompatible items are hidden.

Name	Outline
Servo amplifier identification information	The identification information for the servo amplifier is displayed.
Servo amplifier serial No.	Indicates the serial No. of the servo amplifier.
Servo amplifier S/W No.	The servo amplifier S/W No. is displayed.
MAC address	Indicates the MAC address of the servo amplifier.
IP address	Indicates the IP address of the servo amplifier.
Motor model	The model of the servo motor is displayed.
Motor ID	Indicates the servo motor ID.
Motor serial No.	Indicates the serial number of the servo motor.
Encoder resolution	The encoder resolution is displayed. For the linear servo motor control mode, the resolution per electrical angle 360° is displayed.
Accumulated power-on time [h]	Indicates the accumulated power-on time on an hourly basis [h].
Number of inrush relay on/off times [times]	Indicates the number of inrush relay on/off times.
LED display	Indicates the contents of the servo amplifier display (LED).
Converter identification information	Indicates the identification information of the converter.
Converter serial No.	Indicates the serial number of the converter.
Converter S/W No.	Indicates the S/W No. of the converter.

Servo parameter

Servo parameters, such as those for the PA, PB, and PC groups, are saved in the drive recorder.

4.7 Software reset

Software reset is a function to reset the internal status of the servo amplifier and obtain the same effect as cycling the power. By performing the software reset, the setting of the servo parameters can be reflected without cycling the power.

Restriction

- In the case of an alarm caused by hardware failure, thermal protection or other factors, the alarm may not be canceled even if the software reset is performed.
- When MR Configurator2 is connected to the servo amplifier via a network, reconnection may not be possible if the software reset is performed after changing the setting of the network.
- When using servo motors with functional safety, executing software reset may trigger [AL. 016 Encoder initial communication error 1]. If [AL. 016] occurs, cycle the power.

Precautions

- Canceling alarms is not the main purpose of the software reset function. Use of this function is not recommended for alarms that would ordinarily be canceled by cycling the power.
- Perform the software reset while the servo motor is stopped.

Software reset in MR Configurator2

The servo amplifier can be reset with the software reset button in MR Configurator2.

Software reset via network communication [G]

A software reset can be performed by using the remote reset of the controller. For details, refer to the following manual.

Network	Reference manual
CC-Link IE TSN	 MR-J5-G/MR-J5W-G User's Manual (Communication Function)
CC-Link IE Field Network Basic	

Software reset with an object [G]

Available on servo amplifiers with firmware version C4 or later.

Writing "1EA5h" in [Software reset (Obj. 2D5Fh: 00h)] performs the software reset. If a value other than "1EA5h" is written, an error will be returned.

4.8 Software position limit [G]

Specify the upper and lower limits of the command position and current position. If a command position exceeding the limit position is specified, the command position is clamped at the limit position. Specify the limit position relative to the machine home position (position address = 0).

The limit position includes [Home offset (Obj. 607Ch)]. Specify the limit position in consideration of the value in [Home offset (Obj. 607Ch)]. Refer to [Pr. PT08 Homing position data] for details.

[AL. 098 Software position limit warning] occurs when clamp processing is being performed with the command position exceeding the limit value. Operation can be resumed by giving a position command in the reverse direction of the reached software position limit.

In the cyclic synchronous position mode (csp), stop the command when the software position limit is detected. When the command position exceeds 32 bits (-2147483648 to 2147483647), [AL. 069 Command error] occurs. When the command position exceeds the limit range by 30 bits (-536870912 to 536870911), [AL. 069 Command error] also occurs.

If [AL. 069 Command error] occurs, the home position is erased. Perform homing again.

Restriction

- This function is enabled in the cyclic synchronous position mode (csp), profile position mode (pp), point table mode (pt), and JOG operation mode (jg). This function is disabled during homing.

Precautions

- At factory setting, the software position limit is disabled.
- The unit can be changed to 0.001 mm, 0.0001 inch, 0.001 degree, or pulses with the setting of [Pr. PT01.2 Unit for position data].
- Change the settings of this function during servo off, homing mode, velocity mode, and torque mode. When the setting is changed during servo-on in the position mode and positioning mode, [AL. 035 Command frequency error], [AL. 069 Command error], and [AL. 098 Software position limit warning] may occur.

Setting method

Servo parameter setting

Servo parameter	Symbol	Name	Outline
PT15	LMP	Software position limit +	Set the software position limit + value. Initial value: 0
PT17	LMN	Software position limit -	Set the software position limit - value. Initial value: 0

The enabling/disabling conditions of the software position limit are shown in the table below.

[Pr. PT01.2]	Conditions		
	[Pr. PT15] > [Pr. PT17]	[Pr. PT15] < [Pr. PT17]	[Pr. PT15] = [Pr. PT17]
0 (mm) 1 (inch) 3 (pulse)	Enabled	Disabled	Disabled
2 (degree)	Enabled	Enabled	Disabled

■ When [Pr. PT01.2] is set to "2" (degree)

Set [Pr. PT17] as the starting point and [Pr. PT15] as the ending point.

The moving part can move from "-" to "+" in the CCW direction.

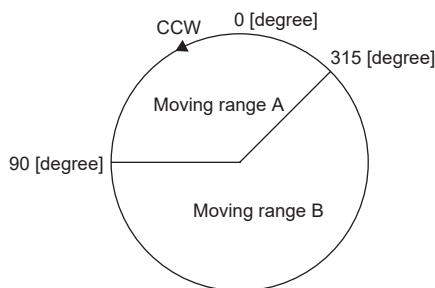

Set servo parameters as follows to specify moving range A.

- [Pr. PT17] = 315.000 degrees
- [Pr. PT15] = 90.000 degree

Set servo parameters as follows to specify moving range B.

- [Pr. PT17] = 90.000 degree
- [Pr. PT15] = 315.000 degree

The setting range is 0 to 359.999 degrees. If a value out of the setting range is set, the value will be converted as shown in the table below. The values of the movable range are the values after conversion.

Setting value	After conversion
360.000 to 2147483.647 degrees	The remainder obtained by dividing the setting value by 360.000
-0.001 to -359.999 degrees	The value obtained by adding 360.000 to the setting value
-360.000 to -2147483.648 degrees	The value obtained by adding 360.000 to the remainder after dividing the setting value by 360.000

When the moving part moves into the range of the software position limit from outside the range, the moving direction is determined by which part of the non-movable area the moving part is in as shown in the following figure. The moving part can move only in the direction with the shortest distance to the movable area.

Ex.

When [Pr. PT17] is set to 315.000 degrees and [Pr. PT15] is set to 90.000 degrees:

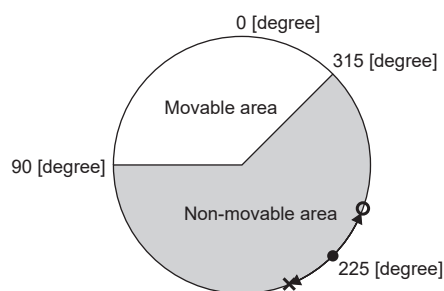
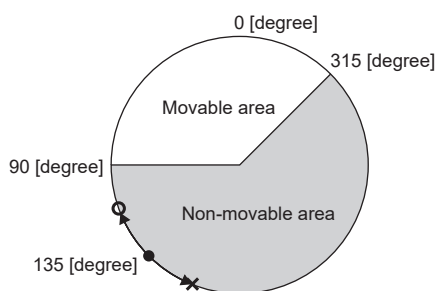

- The moving part can move.
- × The moving part cannot move.

Related objects

The following table shows the related objects.

[Pr. PT15 Software position limit +] is used for [Max position limit (Obj. 607Dh: 02h)]. [Pr. PT17 Software Position Limit -] is used for [Min position limit (Obj. 607Dh: 01h)].

For details on the objects, refer to the User's Manual (Object Dictionary).

Index	Sub	Object	Name	Description
607Dh	0	ARRAY	Software position limit	Number of entries
	1		Min position limit *1	Specify the minimum value of the command position and current position relative to the machine home position (position address = 0). If the command position is below the minimum value, it is clamped to the minimum value which is used as the command position.
	2		Max position limit *1	Specify the maximum value of the command position and current position relative to the machine home position (position address = 0). If the command position exceeds the maximum value, it is clamped to the maximum value which is used as the command position.

*1 When [Min position limit (Obj. 607Dh: 01h)] is set to a value greater than [Max position limit (Obj. 607Dh: 02h)], the function of [Software position limit (Obj. 607Dh)] is disabled.

4.9 Torque limit [G]

The torque limit function limits the torque generated by the servo motor.

The following torque limit can be set.

Item	Outline
Internal torque limit	The maximum torque is limited by the values of [Pr. PA11 Forward rotation torque limit] and [Pr. PA12 Reverse rotation torque limit].
Maximum torque limit 1	The maximum torque is limited by the value of [Max torque (Obj. 6072h)] according to the setting of [Pr. PC78.1 Maximum torque limit 1 selection].

Restriction

- When setting the torque above the maximum torque of the servo motor, the torque is limited by the maximum torque of the servo motor.
- Servo parameters that are mapped to an object from the controller will overwrite those written from the engineering tool.

Precautions

- If the torque limit is canceled during servo-lock, the servo motor may suddenly rotate, depending on the amount of the position deviation from the command position.
- When using the torque limit, check that [Pr. PB06 Load to motor inertia ratio/load to motor mass ratio] is set properly. Improper settings may cause an unexpected operation such as an overshoot.
- When [Pr. PA11 Forward rotation torque limit], [Pr. PA12 Reverse rotation torque limit], and [Pr. PE53 Maximum torque limit 1] are set to "0.0", no torque or thrust is generated.

Setting method

Servo parameter setting

The maximum torque is always limited by the values of [Pr. PA11 Forward rotation torque limit] and [Pr. PA12 Reverse rotation torque limit] during operation.

Set servo parameters in relation to the rated torque or continuous thrust as 100.0 [%].

Servo parameter	Symbol	Name	Outline
PA11	TLP	Forward rotation torque limit	Set the servo parameter when limiting the torque of the servo motor for CCW power running or CW regeneration, or when limiting the thrust of the linear servo motor for positive direction power running or negative direction regeneration.
PA12	TLN	Reverse rotation torque limit	Set the servo parameter when limiting the torque of the servo motor for CW power running or CCW regeneration, or when limiting the thrust of the linear servo motor for positive direction power running or negative direction regeneration.
PE53	TLMX1	Maximum torque limit 1	When [Pr. PC78.1 Maximum torque limit 1 selection] is set to "1" (enabled), the torque generated by the servo motor can be limited with this servo parameter.

Relation between servo parameters and objects

[Pr. PA11] and [Pr. PA12] are used for [Positive torque limit value (Obj. 60E0h)] and [Negative torque limit value (Obj. 60E1h)]. For [Pr. PA14 Travel direction selection] and [Pr. PC29.3 Torque POL reflection selection], the relationship between objects and servo parameters that limit the torque changes as follows.

Setting value		[Pr. PA11 Forward rotation torque limit]	[Pr. PA12 Reverse rotation torque limit]
[Pr. PC29.3]	[Pr. PA14]		
0: Enabled	0	[Positive torque limit value (Obj. 60E0h)]	[Negative torque limit value (Obj. 60E1h)]
	1	[Negative torque limit value (Obj. 60E1h)]	[Positive torque limit value (Obj. 60E0h)]
1: Disabled	0	[Positive torque limit value (Obj. 60E0h)]	[Negative torque limit value (Obj. 60E1h)]
	1	[Positive torque limit value (Obj. 60E0h)]	[Negative torque limit value (Obj. 60E1h)]

Setting value of [Pr. PC78.1]	Torque limit set by [Max torque (Obj. 6072h)]
0: [Pr. PE53] Disabled	Disabled ([Max torque (Obj. 6072h)] returns the maximum torque of the servo motor.)
1: [Pr. PE53] Enabled	Enabled (The torque limit function set by [Pr. PE53] and [Max torque (Obj. 6072h)] is enabled.)

Checking "Limiting torque" status

TLC (Limiting torque) and Bit 13 (S_TLC) of [Status DO1 (Obj. 2D10h)] turn on when the servo motor torque reaches the torque that was limited by the forward rotation torque limit and the reverse rotation torque limit.

4.10 Torque limit [B]

The torque limit function limits the torque generated by the servo motor.

Restriction

- When setting the torque above the maximum torque of the servo motor, the torque is limited by the maximum torque of the servo motor.
-

Precautions

- If the torque limit is canceled during servo-lock, the servo motor may suddenly rotate, depending on the amount of the position deviation from the command position.
- When using the torque limit, check that [Pr. PB06 Load to motor inertia ratio/load to motor mass ratio] is set properly. Improper settings may cause an unexpected operation such as an overshoot.
- When [Pr. PA11 Forward rotation torque limit] and [Pr. PA12 Reverse rotation torque limit] are set to "0.0", no torque or thrust is generated.

Setting method

For details, refer to each controller manual.

Checking "Limiting torque" status

TLC (Limiting torque) turns on when the servo motor torque reaches the limited torque.

4.11 Torque limit [A]

The torque limit function limits the torque generated by the servo motor.

The following torque limit can be set. The torque limit function can be used by switching the following limit vales.

Item	Outline
Internal torque limit	The maximum torque is limited by the values of [Pr. PA11 Forward rotation torque limit] and [Pr. PA12 Reverse rotation torque limit].
Internal torque limit 2	The generated torque is limited by the value of [Pr. PC35 Internal torque limit 2].
External analog torque limit	The maximum torque is limited by the value input to the TLA (analog torque limit).

Restriction

- When setting the torque above the maximum torque of the servo motor, the torque is limited by the maximum torque of the servo motor.
- Analog torque limit cannot be used during torque control mode.

Precautions

- If the torque limit is canceled during servo-lock, the servo motor may suddenly rotate, depending on the amount of the position deviation from the command position.
- When using the torque limit, check that [Pr. PB06 Load to motor inertia ratio/load to motor mass ratio] is set properly. Improper settings may cause an unexpected operation such as an overshoot.
- When [Pr. PA11 Forward rotation torque limit] and [Pr. PA12 Reverse rotation torque limit] are set to "0.0", no torque or thrust is generated.

Setting method

Point

- The rated torque unit is used as a default unit for the torque limit, which differs from the setting for the MR-J4-_A_. To change the unit to the maximum torque unit, change the setting in [Pr. PC50.0 Torque limit unit change].

Page 132 Torque command unit selection function

Servo parameter setting

The maximum torque is always limited by the values of [Pr. PA11 Forward rotation torque limit] and [Pr. PA12 Reverse rotation torque limit] during operation.

Servo parameter	Symbol	Name	Outline
PA11	TLP	Forward rotation torque limit	Set the servo parameter to limit the torque of the servo motor for CCW power running or CW regeneration, or to limit the thrust of the linear servo motor for positive direction power running or negative direction regeneration.
PA12	TLN	Reverse rotation torque limit	Set the servo parameter to limit the torque of the servo motor for CW power running or CCW regeneration, or to limit the thrust of the linear servo motor for positive direction power running or negative direction regeneration.
PC35	TL2	Internal torque limit 2	Set the parameter for limiting the torque of the servo motor or the thrust of the linear servo motor. When the internal torque limit selection signal is turned on, [Pr. PA11] or [Pr. PA12] are compared with the internal torque limit 2 and the lower one will be enabled.

Analog torque limit

The relationship between the applied voltage of TLA (Analog torque limit) and the torque limit value of the servo motor is as follows. The torque limit value relative to the voltage varies by approximately 5 % between motors. At the voltage of less than 0.05 V, torque may vary as it may not be limited sufficiently. Therefore, use this function at the voltage of 0.05 V or more.

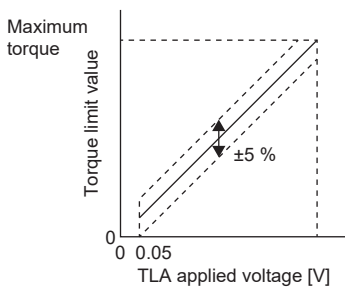

TLA applied voltage vs torque limit value

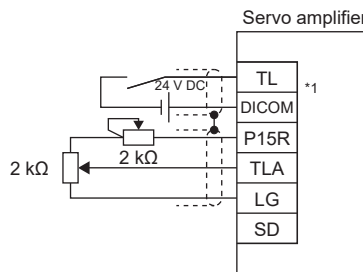

Connection example

Torque limit selection

The torque limit can be selected using TL (External torque limit selection).

In addition, by turning on TL1 (Internal torque limit selection) through servo parameters, [Pr. PC35 Internal torque limit 2] can be selected.

However, if the value for [Pr. PA11] or [Pr. PA12] is less than the limit value selected using TL/TL1, the value for [Pr. PA11] or [Pr. PA12] is enabled.

Input device ^{*1}		Limit value status	Enabled torque limit	
TL1	TL		CCW power running/CW regeneration	CW power running/CCW regeneration
0	0	—	[Pr. PA11]	[Pr. PA12]
0	1	TLA > [Pr. PA11] TLA > [Pr. PA12]	[Pr. PA11]	[Pr. PA12]
		TLA < [Pr. PA11] TLA < [Pr. PA12]	TLA	TLA
1	0	[Pr. PC35] > [Pr. PA11] [Pr. PC35] > [Pr. PA12]	[Pr. PA11]	[Pr. PA12]
		[Pr. PC35] < [Pr. PA11] [Pr. PC35] < [Pr. PA12]	[Pr. PC35]	[Pr. PC35]
1	1	TLA > [Pr. PC35]	[Pr. PC35]	[Pr. PC35]
		TLA < [Pr. PC35]	TLA	TLA

*1 0: off, 1: on

Checking "Limiting torque" status

TLC (Limiting torque) turns on when the servo motor torque reaches the torque that was limited by the forward rotation torque limit, reverse rotation torque limit, internal torque limit, or analog torque limit.

4.12 Speed limit [G]

During the torque mode, this function serves to limit the servo motor speed in order not to generate excessive speed.

Restriction

- Speed limit can be used only in the torque mode.
- When [Velocity limit value (Obj. 2D20h)] is mapped to cyclic communication, values written from engineering tools are overwritten from the controller.

Precautions

- When the servo motor speed reaches the speed limit value, torque control may become unstable.

Setting method

Set the maximum speed to [Pr. PT67 Speed limit]. The speed limit direction and torque command direction are the same direction. There is no speed limit in the torque command direction and the opposite direction. [Pr. PT67] is used for [Velocity limit value (Obj. 2D20h)].

Servo parameter	Symbol	Name	Outline
PT67	VLMT	Speed limit	Set the maximum speed for the torque mode. Initial value: 3000.00 [r/min], [mm/s]

If [Pr. PT01.1 Speed/acceleration/deceleration unit selection] is set to "1" (command unit/s), set the maximum speed in [Pr. PV21 Speed limit extension setting].

Servo parameter	Symbol	Name	Outline
PV21 *1	VLMT E	Speed limit extension setting	Set the maximum speed for the torque mode. Initial value: 2147483647 [command unit/s]

*1 Available on servo amplifiers with firmware version A5 or later.

Checking "Limiting speed" status

When the servo motor speed reaches the speed set in [Pr. PT67 Speed limit], VLC (Limiting speed) and Bit 4 (S_VLC) of [Status DO2 (Obj. 2D12h)] will turn on.

4.13 Speed limit [B]

During the torque mode, this function serves to limit the servo motor speed in order not to generate excessive speed.



- Speed limit can be used only in the torque mode.
-

Precautions

- When the servo motor speed reaches the speed limit value, torque control may become unstable.

Setting method

For details, refer to each controller manual.

Checking "Limiting speed" status

VLC (Limiting speed) turns on when the servo motor speed reaches the limited speed.

4.14 Speed limit [A]

During the torque mode, this function serves to limit the servo motor speed in order not to generate excessive speed.

Restriction

- Speed limit can be used only in the torque mode.

Precautions

- When the servo motor speed reaches the speed limit value, torque control may become unstable.

Setting method

Speed limit value and servo motor speed

The speed is limited to the values set with [Pr. PC05 Internal speed 1] to [Pr. PC11 Internal speed 7] or the value set in the applied voltage of VLA (Analog speed limit). The relation between the applied voltage in VLA (Analog speed limit) and the servo motor speed is shown below. The speed limit direction and torque command direction are the same direction. There is no speed limit in the torque command direction and the opposite direction.

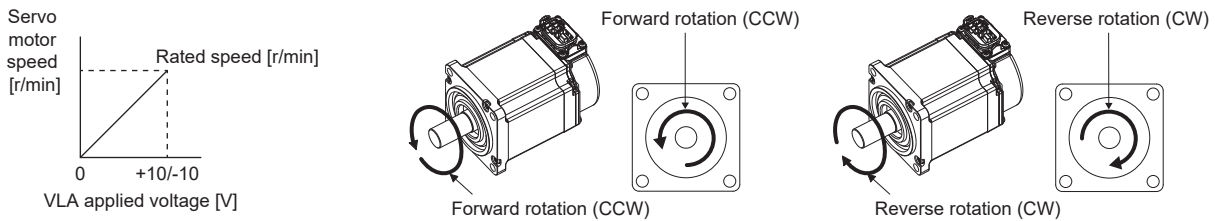

The following table indicates the limit direction according to the combination of RS1 (Forward rotation selection) and RS2 (Reverse rotation selection).

Input device *1		TC (Analog torque command)		Speed limit direction		Internal speed limit
RS1	RS2	Voltage polarity	Torque command direction	VLA (Analog speed limit)		
				Polarity: +	Polarity: -	
1	0	Polarity: +	CCW or positive direction	CCW or positive direction	CCW or positive direction	CCW or positive direction
		Polarity: -	CW or negative direction	CW or negative direction	CW or negative direction	CW or negative direction
0	1	Polarity: +	CCW or positive direction	CW or negative direction	CW or negative direction	CW or negative direction
		Polarity: -	CW or negative direction	CCW or positive direction	CCW or positive direction	CCW or positive direction

*1 0: off, 1: on

Speed limit value selection

The speed limit can be selected with SP1 (Speed selection 1), SP2 (Speed selection 2), and SP3 (Speed selection 3).

Input device ^{*1}			Speed limit
SP3	SP2	SP1	
0	0	0	VLA (Analog speed limit)
0	0	1	[Pr. PC05 Internal speed 1]
0	1	0	[Pr. PC06 Internal speed 2]
0	1	1	[Pr. PC07 Internal speed 3]
1	0	0	[Pr. PC08 Internal speed 4]
1	0	1	[Pr. PC09 Internal speed 5]
1	1	0	[Pr. PC10 Internal speed 6]
1	1	1	[Pr. PC11 Internal speed 7]

*1 0: off, 1: on

When internal speed 1 to 7 are used to limit a speed, the speed does not vary with the ambient temperature.

Checking "Limiting speed" status

VLC turns on when the servo motor speed reaches a speed limited with internal speed 1 to 7 or the analog speed limit.

4.15 A/B/Z-phase pulse output function

This function outputs position information from the servo motor or the load-side encoder in the form of A/B/Z-phase pulses.

Restrictions [G] [B]

- The encoder Z-phase pulse is not output when the MR-J5W_-, the MR-J5D2-_G_, or the MR-J5D3-_G_ is used.
- A/B/Z-phase pulses are not output from the C-axis encoder when the MR-J5W3- or the MR-J5D3-_G_ is used.
- With the linear servo motor, [Pr. PC03.1 Encoder output pulse setting selection] = "0" (output pulse setting) cannot be used. If set to "0", A/B/Z-phase pulse output uses the dividing ratio setting.
- [Pr. PC03.1 Encoder output pulse setting selection] = "4" (A/B-phase pulse through output setting) is for the A/B/Z-phase differential output type encoder. If an encoder other than the A/B/Z-phase differential output type encoder is connected, [AL. 037] will occur.
- When the A/B-phase pulse output function is used for multi-axis servo amplifiers, restrictions vary depending on the network. For detailed contents, refer to the User's Manual (Introduction).
- A/B/Z-phase pulses are not output when using the safety sub-function by network ([Pr. PSA01.0] is "1", [Pr. PSA01.1] is "1") with the MR-J5D2-_G_ or the MR-J5D3-_G_.

Restrictions [A]

- With the linear servo motor, [Pr. PC19.1 Encoder output pulse setting selection] = "0" (output pulse setting) cannot be used. If set to "0", A/B/Z-phase pulse output uses the dividing ratio setting.
- [Pr. PC19.1 Encoder output pulse setting selection] = "4" (A/B-phase pulse through output setting) is for the A/B/Z-phase differential output type encoder. If an encoder other than the A/B/Z-phase differential output type encoder is connected, [AL. 037] will occur.

Precautions

- Set the encoder output pulse to a value that is four times that of the A-phase pulse.
- The encoder output pulse signal uses positive logic.

Setting method [G] [B]

The encoder output pulse function can be used by setting the following servo parameters. For output specifications of the Z-phase pulse, refer to the following.

 Page 359 Z-phase pulse output

Servo parameter	Symbol	Name	Outline
PA15	*ENR	Encoder output pulses	Set the encoder output from the servo amplifier by using the number of output pulses per revolution, dividing ratio, or electronic gear ratio. (after multiplication by 4) The setting value varies depending on [Pr. PC03.1 Encoder output pulse setting selection]. Initial value: 4000 [pulse/rev]
PA16	*ENR2	Encoder output pulses 2	Set a denominator for the electronic gear for when selecting "3" (A-phase/B-phase pulse electronic gear setting) in [Pr. PC03.1 Encoder output pulse setting selection]. This is not used for other settings. Initial value: 1
PC03.0	*ENRS	Encoder output pulse - Phase selection	Set the phase for the A-pulse and the B-pulse. 0: Increasing A-phase 90° in CCW or positive direction (initial value) 1: Increasing A-phase 90° in CW or negative direction
PC03.1	*ENRS	Encoder output pulse setting selection	Select the method for setting the number of output pulses. 0: Output pulse setting (initial value) 1: Dividing ratio setting 3: A-phase/B-phase pulse electronic gear setting 4: A/B-phase pulse through output setting
PC03.2 *1	*ENRS	Encoder selection for encoder output pulse	Select a servo motor encoder or load-side encoder for the encoder to output pulses. 0: Servo motor-side encoder (initial value) 1: Load-side encoder

*1 Available on servo amplifiers with firmware version A5 or later.

Encoder output pulse setting [G] [B]

Set [Pr. PC03.1 Encoder output pulse setting selection]. Set the number of output pulses according to the set value.

■ When [Pr. PC03.2] = "0" (servo motor-side encoder)

Setting value of [Pr. PC03.1]	For rotary servo motors and direct drive motors	For linear servo motors
"0" (output pulse setting)	Set the output pulses per revolution with [Pr. PA15 Encoder output pulses]. If [Pr. PC03.2] is set to "1" (load-side encoder), [AL. 037] will occur. Output pulse = Setting value of [Pr. PA15] [pulse/rev]	The output pulse setting cannot be used. When "0" is set, the condition is the same as when "1" is set.
"1" (dividing ratio setting)	Set the dividing ratio to the resolution per servo motor revolution with [Pr. PA15]. Output pulse = $\frac{\text{Resolution per revolution}}{\text{Setting value of [Pr. PA15]}}$ [pulse/rev]	Set the dividing ratio to the travel distance of the linear servo motor with [Pr. PA15]. Output pulse = $\frac{\text{Travel distance of linear servo motor}}{\text{Setting value of [Pr. PA15]}}$ [pulse]
"3" (A-phase/B-phase pulse electronic gear setting)	Set the A-phase/B-phase pulse electronic gear with [Pr. PA15] and [Pr. PA16 Encoder output pulses 2]. Output pulse = $\frac{\text{Resolution per revolution} \times \text{Setting value of [Pr. PA15]}}{\text{Setting value of [Pr. PA16]}}$ [pulse/rev]	Set the A-phase/B-phase pulse electronic gear with [Pr. PA15] and [Pr. PA16 Encoder output pulses 2]. Output pulse = $\frac{\text{Travel distance of linear servo motor} \times \text{Setting value of [Pr. PA15]}}{\text{Setting value of [Pr. PA16]}}$ [pulse]
"4" (A/B-phase pulse through output setting) *1	<ul style="list-style-type: none"> When a servo amplifier with a firmware version earlier than B2 is being used, [AL. 037] occurs. A/B-phase pulses are output when an A/B/Z-phase differential output type encoder is used. If a different encoder is connected, [AL. 037] occurs. The setting value in [Pr. PC03.0 Encoder output pulse - Phase selection] is not applied. The setting values in [Pr. PA15] and [Pr. PA16] are not applied. Output pulse = A/B-phase pulse of A/B/Z-phase differential output type encoder [pulse]	<ul style="list-style-type: none"> A/B-phase pulses are output when an A/B/Z-phase differential output type encoder is used. If a different encoder is connected, [AL. 037] occurs. The setting value in [Pr. PC03.0 Encoder output pulse - Phase selection] is not applied. The setting values in [Pr. PA15] and [Pr. PA16] are not applied. Output pulse = A/B-phase pulse of A/B/Z-phase differential output type encoder [pulse]









*1 If this value is set when using the rotary servo motor, [AL. 037] occurs.

■ When [Pr. PC03.2] = "1" (load-side encoder)

Setting value of [Pr. PC03.1]	When in the fully closed loop control mode	When the scale measurement function is enabled
"0" (output pulse setting)	[AL. 037] occurs.	
"1" (dividing ratio setting)	Set the dividing ratio to the resolution per servo motor revolution with [Pr. PA15]. Output pulse = $\frac{\text{Resolution per revolution}}{\text{Setting value of [Pr. PA15]}}$ [pulse/rev]	Set the dividing ratio to the travel distance of the scale measurement encoder with [Pr. PA15]. Output pulse = $\frac{\text{Travel distance of scale measurement encoder}}{\text{Setting value of [Pr. PA15]}}$ [pulse]
"3" (A-phase/B-phase pulse electronic gear setting)	Set the A-phase/B-phase pulse electronic gear with [Pr. PA15] and [Pr. PA16]. Output pulse = $\text{Resolution per revolution} \times \frac{\text{Setting value of [Pr. PA15]}}{\text{Setting value of [Pr. PA16]}}$ [pulse/rev]	Set the A-phase/B-phase pulse electronic gear with [Pr. PA15] and [Pr. PA16]. Output pulse = $\frac{\text{Travel distance of scale measurement encoder}}{\text{Setting value of [Pr. PA16]}} \times \frac{\text{Setting value of [Pr. PA15]}}{\text{Setting value of [Pr. PA16]}}$ [pulse]
"4" (A/B-phase pulse through output setting)	<ul style="list-style-type: none"> A/B-phase pulses are output when an A/B/Z-phase differential output type encoder is used. If a different encoder is connected, [AL. 037] occurs. The setting value in [Pr. PC03.0 Encoder output pulse - Phase selection] is not applied. The setting values in [Pr. PA15] and [Pr. PA16] are not applied. Output pulse = A/B-phase pulse of A/B/Z-phase differential output type encoder [pulse]	<ul style="list-style-type: none"> A/B-phase pulses are output when an A/B/Z-phase differential output type encoder is used. If a different encoder is connected, [AL. 037] occurs. A/B/Z-phase differential output type encoders cannot be used in the linear servo motor control mode or the direct drive motor control mode. The setting value in [Pr. PC03.0 Encoder output pulse - Phase selection] is not applied. The setting values in [Pr. PA15] and [Pr. PA16] are not applied. Output pulse = A/B-phase pulse of A/B/Z-phase differential output type encoder [pulse]

Encoder output pulse phase selection

Set [Pr. PC03.0 Encoder output pulse - Phase selection].

Setting value of [Pr. PC03.0]	Servo motor rotation direction/linear servo motor travel direction	
	CCW or positive direction	CW or negative direction
0: Increasing A-phase 90° in CCW or positive direction	A-phase  B-phase 	A-phase  B-phase 
1: Increasing A-phase 90° in CW or negative direction	A-phase  B-phase 	A-phase  B-phase 

Setting method [A]

The encoder output pulse function can be used by setting the following servo parameters. For output specifications of the Z-phase pulse, refer to the following.

☞ Page 359 Z-phase pulse output

Servo parameter	Symbol	Name	Outline
PA15	*ENR	Encoder output pulses	Set the encoder output from the servo amplifier by using the number of output pulses per revolution, dividing ratio, or electronic gear ratio. (after multiplication by 4) The setting value varies depending on [Pr. PC19.1 Encoder output pulse setting selection]. Initial value: 4000 [pulse/rev]
PA16	*ENR2	Encoder output pulses 2	Set a denominator for the electronic gear for when selecting "3" (A-phase/B-phase pulse electronic gear setting) in [Pr. PC19.1 Encoder output pulse setting selection]. This is not used for other settings. Initial value: 1
PC19.0	*ENRS	Encoder output pulse - Phase selection	Set the phase for the A-pulse and the B-pulse. 0: Increasing A-phase 90° in CCW or positive direction (initial value) 1: Increasing A-phase 90° in CW or negative direction
PC19.1	*ENRS	Encoder output pulse setting selection	Select the method for setting the number of output pulses. 0: Output pulse setting (initial value) 1: Dividing ratio setting 2: The same output pulse setting as the command pulse 3: A-phase/B-phase pulse electronic gear setting 4: A/B-phase pulse through output setting
PC19.2 *1	*ENRS	Encoder selection for encoder output pulse	Select a servo motor encoder or load-side encoder for the encoder to output pulses. Initial value: 0 (servo motor encoder)

*1 Available on servo amplifiers with firmware version A5 or later.

Encoder output pulse setting

Set [Pr. PC19.1 Encoder output pulse setting selection]. Set the number of output pulses according to the set value.

■ When [Pr. PC19.2] = "0" (servo motor-side encoder)

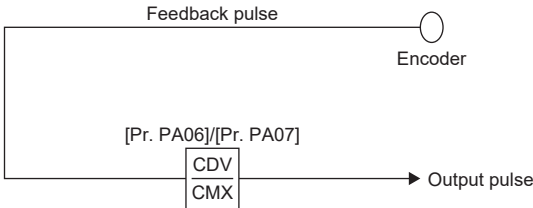
Setting value of [Pr. PC19.1]	For rotary servo motors and direct drive motors	For linear servo motors
"0" (output pulse setting)	Set the output pulses per revolution with [Pr. PA15 Encoder output pulses]. If [Pr. PC19.2] is set to "1" (load-side encoder), [AL. 037 Parameter error] occurs. Output pulse = Setting value of [Pr. PA15] [pulse/rev]	The output pulse setting cannot be used. When "0" is set, the condition is the same as when "1" is set.
"1" (dividing ratio setting)	Set the dividing ratio to the resolution per servo motor revolution with [Pr. PA15]. $\text{Output pulse} = \frac{\text{Resolution per revolution}}{\text{Setting value of [Pr. PA15]}} \text{ [pulse/rev]}$	Set the dividing ratio to the travel distance of the linear servo motor with [Pr. PA15]. $\text{Output pulse} = \frac{\text{Travel distance of linear servo motor}}{\text{Setting value of [Pr. PA15]}} \text{ [pulse]}$
"2" (the same output pulse setting as the command pulse)	Feedback pulses from the encoder are processed and output as follows. Feedback pulses are output in the same pulse unit as the command pulse.  <p>The settings of [Pr. PA15] and [Pr. PA16 Encoder output pulses 2] are not used.</p>	
"3" (A-phase/B-phase pulse electronic gear setting)	Set the A-phase/B-phase pulse electronic gear with [Pr. PA15] and [Pr. PA16]. $\text{Output pulse} = \frac{\text{Resolution per revolution} \times \text{Setting value of [Pr. PA15]}}{\text{Setting value of [Pr. PA16]}} \text{ [pulse/rev]}$	Set the A-phase/B-phase pulse electronic gear with [Pr. PA15] and [Pr. PA16]. $\text{Output pulse} = \frac{\text{Travel distance of linear servo motor} \times \text{Setting value of [Pr. PA15]}}{\text{Setting value of [Pr. PA16]}} \text{ [pulse]}$
"4" (A/B-phase pulse through output setting) *1	<ul style="list-style-type: none"> When a servo amplifier with a firmware version earlier than B2 is being used, [AL. 037] occurs. A/B-phase pulses are output when an A/B/Z-phase differential output type encoder is used. If a different encoder is connected, [AL. 037] occurs. The setting value in [Pr. PC19.0 Encoder output pulse - Phase selection] is not applied. The setting values in [Pr. PA15] and [Pr. PA16] are not applied. Output pulse = A/B-phase pulse of A/B/Z-phase differential output type encoder [pulse]	<ul style="list-style-type: none"> A/B-phase pulses are output when an A/B/Z-phase differential output type encoder is used. If a different encoder is connected, [AL. 037] occurs. The setting value in [Pr. PC19.0 Encoder output pulse phase selection] is not applied. The setting values in [Pr. PA15] and [Pr. PA16] are not applied. Output pulse = A/B-phase pulse of A/B/Z-phase differential output type encoder [pulse]

*1 If this value is set when using the rotary servo motor, [AL. 037] occurs.

■ When [Pr. PC19.2] = "1" (load-side encoder)

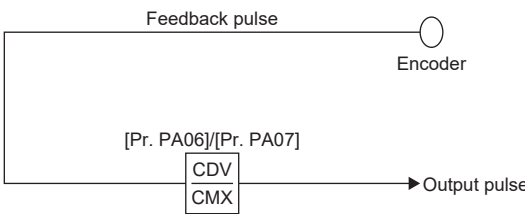
Setting value of [Pr. PC19.1]	When in the fully closed loop control mode
"0" (output pulse setting)	[AL. 037] occurs.
"1" (dividing ratio setting)	Set the dividing ratio to the resolution per servo motor revolution with [Pr. PA15]. $\text{Output pulse} = \frac{\text{Resolution per revolution}}{\text{Setting value of [Pr. PA15]}} \text{ [pulse/rev]}$
"2" (the same output pulse setting as the command pulse)	Feedback pulses from the encoder are processed and output as follows. Feedback pulses are output in the same pulse unit as the command pulse.  <p>The settings of [Pr. PA15] and [Pr. PA16] are not used.</p>
"3" (A-phase/B-phase pulse electronic gear setting)	Set the A-phase/B-phase pulse electronic gear with [Pr. PA15] and [Pr. PA16]. $\text{Output pulse} = \frac{\text{Resolution per revolution} \times \text{Setting value of [Pr. PA15]}}{\text{Setting value of [Pr. PA16]}} \text{ [pulse/rev]}$
"4" (A/B-phase pulse through output setting)	<ul style="list-style-type: none"> A/B-phase pulses are output when an A/B/Z-phase differential output type encoder is used. If a different encoder is connected, [AL. 037] occurs. The setting value in [Pr. PC19.0 Encoder output pulse - Phase selection] is not applied. The setting values in [Pr. PA15] and [Pr. PA16] are not applied. $\text{Output pulse} = \text{A/B-phase pulse of A/B/Z-phase differential output type encoder [pulse]}$

Encoder output pulse phase selection

Set [Pr. PC19.0 Encoder output pulse - Phase selection].

Setting value of [Pr. PC19.0]	Servo motor rotation direction/linear servo motor travel direction	
	CCW or positive direction	CW or negative direction
0: Increasing A-phase 90° in CCW or positive direction	<p>A-phase </p> <p>B-phase </p>	<p>A-phase </p> <p>B-phase </p>
1: Increasing A-phase 90° in CW or negative direction	<p>A-phase </p> <p>B-phase </p>	<p>A-phase </p> <p>B-phase </p>

Z-phase pulse output

Z-phase pulse output specifications

The Z-phase pulse is output by each encoder as follows.

Encoder type	Z-phase pulse output
Linear encoders	<ul style="list-style-type: none"> Incremental: Outputs one pulse every time the Z-phase of the linear encoder is passed. Absolute position: Outputs one pulse for every virtual rotation.
A/B/Z-phase differential output type encoder	Outputs one pulse every time the Z-phase of the scale is passed.

Z-phase pulse output width

The minimum pulse width of the Z-phase pulse output is about 400 μs.

4.16 Degree unit [G]

The degree unit is available on servo amplifiers with firmware version B6 or later.

Summary

Using the degree unit enables positioning in modulo coordinates (axes of rotation).

Restriction

- This function cannot be used in the cyclic synchronous mode.
- This function cannot be used in the linear servo motor control mode. Enabling this function in the linear servo motor control mode will trigger [AL. 037 Parameter error].
- If using this function in the fully closed loop control mode, use a rotary encoder as a load-side encoder. Connecting a linear encoder will trigger [AL. 037].
- If the unit is set to "degree" in the profile position mode, relative position commands are disabled. Attempting to start positioning operation after bit 6 (abs/rel) of [Controlword (Obj. 6040h)] has been set to "1" (relative position command) will trigger [AL. 0F4.8 Control command input error warning] and the operation will not start.

Precautions

- Setting the unit to "degree" will change the setting ranges of some objects.
-  Page 360 Position-related data when the unit is set to "degree"
- Use the electronic gear function to adjust the rotation amount of the servo motor relative to the position command (in degrees). If the number of encoder units is extremely small for the position command (in degrees), the servo motor may not rotate.

Position-related data when the unit is set to "degree"

When the unit is set to "degree", position-related data is different as shown below.

For details on the objects, refer to the User's Manual (Object Dictionary).

Data	Description
[Target position (Obj. 607Ah)]	The range is -360000 to 360000.* ¹ If a value outside the range is set for absolute position commands, [AL. 0F4.4 Target position setting range error warning] will occur.
[Position actual value (Obj. 6064h)]	The range is 0 to 359999.* ¹ An absolute value appears regardless of the sign of [Target position].
[Position demand value (Obj. 6062h)]* ²	The range is 0 to 359999.* ¹
[Min position limit (Obj. 607Dh: 01h)] [Max position limit (Obj. 607Dh: 02h)]	The range is 0 to 359999. If a value outside the range is set, the value will be clamped to the range 0 to 359999.* ¹
[Min position range limit (Obj. 607Bh: 01h)] [Max position range limit (Obj. 607Bh: 02h)]	The range is 0 to 359999.* ¹
[Touch probe pos1 pos value (Obj. 60BAh)] [Touch probe pos1 neg value (Obj. 60BBh)] [Touch probe pos2 pos value (Obj. 60BCh)] [Touch probe pos2 neg value (Obj. 60BDh)]	The range is 0 to 359999.* ¹
[Home offset (Obj. 607Ch)]	The range is 0 to 359999.* ¹
[Point data (Obj. 2801h: 01h)] to [Point data (Obj. 28FFh: 01h)]	The range is -360000 to 360000.* ¹
[Current position (Obj. 2B2Fh)]	The range is 0 to 359999.* ¹
[Command position (Obj. 2B30h)]	The range is 0 to 359999.* ¹
Home position shift distance	The range is 0 to 359999. If a value outside the range is set, the value will be clamped to the range 0 to 359999.* ¹
Homing position data	The range is 0 to 359999. If a value outside the range is set, the value will be clamped to the range 0 to 359999.* ¹

Data	Description
Travel distance after proximity dog	The range is 0 to 359999. If a value outside the range is set, the value will be clamped to the range 0 to 359999.*1
Position range output address	The range is 0 to 359999. If a value outside the range is set, the value will be clamped to the range 0 to 359999.*1

*1 The unit is 0.001 degree.

*2 This object may not be used depending on the network being used.

Setting method

Setting with servo parameters

■ Degree unit selection

Set the unit to "degree" with [Pr. PT01.2 Unit for position data].

☞ Page 128 Position command unit selection function

■ Degree unit rotation direction selection

Use [Pr. PT03.2 Degree unit rotation direction selection] to set the rotation direction for when the unit is set to "degree".

Servo parameter	Symbol	Name	Outline
PT03.2	*FTY	Degree unit rotation direction selection	Set the rotation direction when the unit is set to "degree". 0: Specified rotation direction (initial value) 1: Rotation in the direction with the shortest distance 2: Rotation in the address decreasing direction 3: Rotation in the address increasing direction

Setting with object dictionary

Use [Positioning option code (Obj. 60F2h)] to set the rotation direction for when the unit is set to "degree". Change the setting while the servo motor is stopped (Target reached is on). If the setting is changed while the servo motor is rotating (Target reached is off), the new setting value will be reflected at a positioning start (bit 4 of Controlword is on) after Target reached is turned on.

For details on the objects, refer to the User's Manual (Object Dictionary).

Index	Sub	Object	Name	Description
60F2h	0	VAR	Positioning option code	Set positioning operation conditions.

The following table shows the bits of [Positioning option code] and the settings of [Pr. PT03 Feed function selection].

[Positioning option code]		[Pr. PT03.2]	Defining the rotation directions of axes of rotation
Bit 7	Bit 6		
0	0	0	Rotates to the target position in the direction specified with the sign of the position data.
0	1	2	Rotates in the address decreasing direction regardless of the sign of the position data. *1
1	0	3	Rotates in the address increasing direction regardless of the sign of the position data. *1
1	1	1	Rotates in the direction with the shorter distance from the current position to the target position. If the distance from the current position to the target position is the same in the CCW and CW directions, the servo motor rotates in the CCW direction. *1

*1 Specifying absolute position commands will enable the setting. Specifying relative position commands will rotate the servo motor to the target position in the direction specified with the sign of the position data regardless of the setting.

Sequence

The following shows the operation patterns according to the settings of [Positioning option code (Obj. 60F2h)].

When disabling POL ([Pr. PA14 Travel direction selection] = 0)

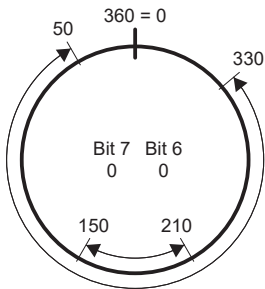

Rotation in the direction specified with the sign of the position data

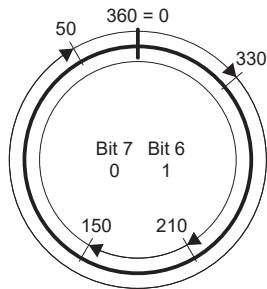

Rotation only in the address decreasing direction

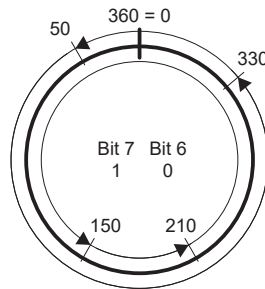

Rotation only in the address increasing direction

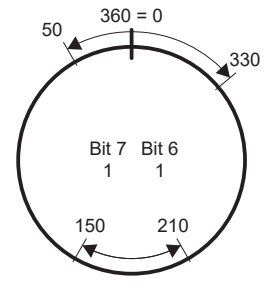

Rotation in the direction with the shortest distance

When enabling POL ([Pr. PA14] = 1)

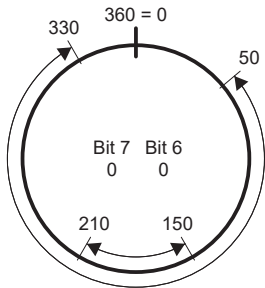

Rotation in the direction specified with the sign of the position data

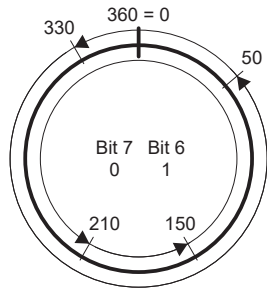

Rotation only in the address decreasing direction

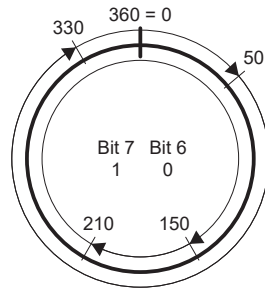

Rotation only in the address increasing direction

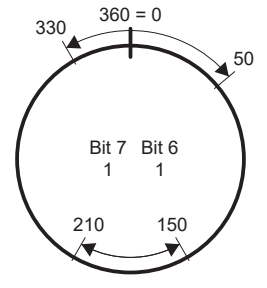

Rotation in the direction with the shortest distance

When using the specified rotation direction ([Pr. PT03.2 Degree unit rotation direction selection] = 0)

When the position data of 270.000 degrees (target position) is specified, the servo motor rotates in CCW direction.

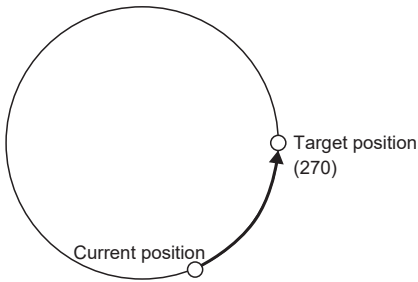

When the position data of -90.000 degrees (target position) is specified, the servo motor rotates in CW direction.

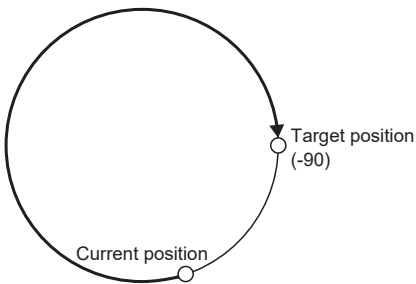

When the position data of -360.000 degrees (target position) is specified, the servo motor rotates in CW direction. (A)

When the position data of 360.000 degrees or 0 degree is specified, the servo motor rotates in CCW direction. (B)

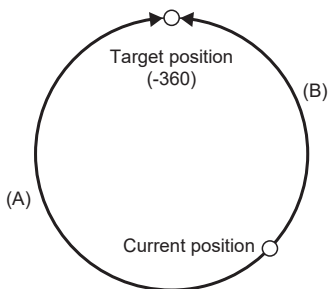

When using the shortest distance ([Pr. PT03.2] = 1)

When the position data of 270.000 degrees (target position) is specified, the servo motor rotates in CCW direction.

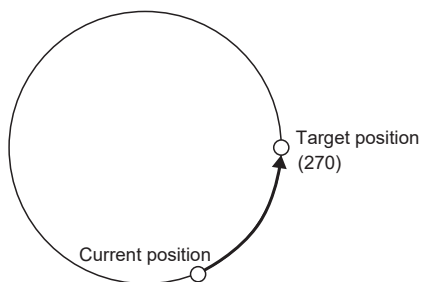

When the position data of -90.000 degrees (target position) is specified, the servo motor rotates in CCW direction.

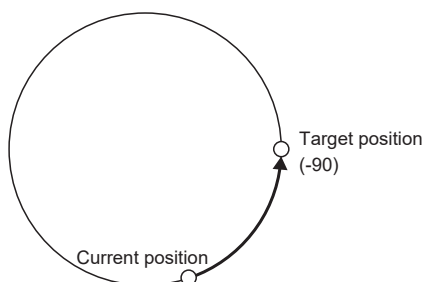

When the current position is 90 and the position data of 270.000 degrees (target position) is specified, the servo motor rotates in CCW direction since the distances in CCW direction and CW direction are the same.

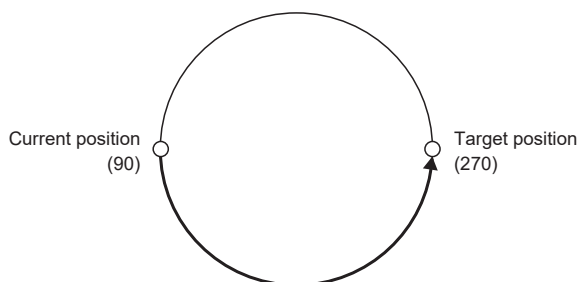

When using the address decreasing direction ([Pr. PT03.2] = 2)

When the position data of 270.000 degrees (target position) is specified, the servo motor rotates in CW direction.

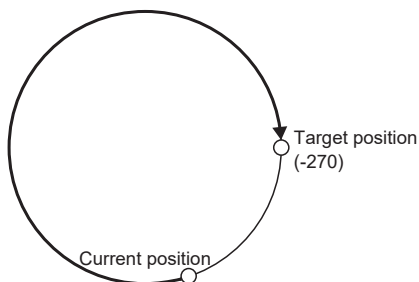

When the position data of -270.000 degrees (target position) is specified, the servo motor rotates in CW direction.

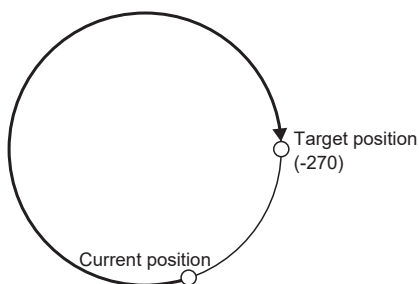

When using the address increasing direction ([Pr. PT03.2] = 3)

When the position data of 270.000 degrees (target position) is specified, the servo motor rotates in CCW direction.

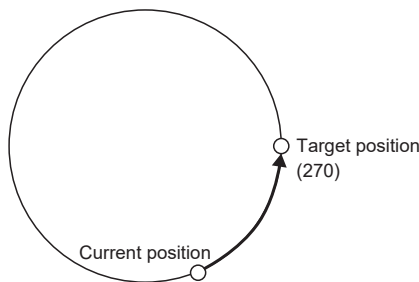

When the position data of -270.000 degrees (target position) is specified, the servo motor rotates in CCW direction.

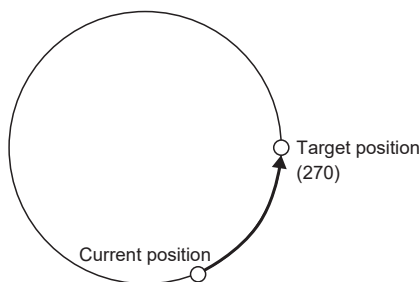

4.17 Infinite feed function [G]

This section explains situations in which the function is used with CC-Link IE TSN and CC-Link IE Field Network Basic. For other networks, refer to the User's Manual (Communication Function).

Outline

When this function is used in an absolute position detection system, even if the servo motor rotates 32768 rev or more in the same direction, [AL. 0E3.1 Multi-revolution counter travel distance exceeded warning] will not occur and the home position will not be erased. Therefore, the current position will be restored after the power is cycled.

When this function is not used, if the servo motor rotates 32768 rev or more in the same direction, [AL. 0E3.1] will occur and the home position will be erased.

Restriction

- This function is available on servo amplifiers with firmware version B6 or later.
- To use this function, set the unit to "degree" with the servo amplifier.

📖 Page 360 Degree unit [G]

Setting method

Set the unit to "degree".

📖 Page 360 Degree unit [G]

When the servo motor rotates 32768 rev or more

The following table shows whether [AL. 0E3.1] will occur, the home position will be erased, and the current position will be restored when the servo motor rotates 32768 rev or more.

Control mode	Unit for position data	[AL. 0E3.1]	Home position	Current position
Cyclic synchronous mode	pulse	Will occur *1	Will be erased	Will not be restored
Profile mode	degree	Will not occur *1	Will not be erased	Will be restored
	pulse	Will occur *1	Will be erased	Will not be restored
Positioning mode (point table method)	mm	Will occur *1	Will be erased	Will not be restored
	inch	Will occur *1	Will be erased	Will not be restored
	degree	Will not occur *1	Will not be erased	Will be restored
	pulse	Will occur *1	Will be erased	Will not be restored

*1 When [Pr. PC29.5 [AL. 0E3 Absolute position counter warning] selection] is set to "0" (disabled), [AL. 0E3.1] will not occur and the home position will not be erased. However, if "0" is set while the unit is other than "degree", the current position will not be restored correctly after the power is cycled. As this will result in an incorrect current position value, set [Pr. PC29.5] to "1" (enabled).

When using the infinite feed function with a controller

When an absolute position detection system is configured in the cyclic synchronous mode with a Motion module manufactured by Mitsubishi Electric, set [Pr. PC29.5 [AL. 0E3 Absolute position counter warning] selection] to "0" (disabled).

For information on the controller, refer to "Absolute Position Control" in the following manual.

📖 MELSEC iQ-R Motion Module User's Manual (Application)

4.18 Servo amplifier life diagnosis function

The servo amplifier life diagnosis function is a function to diagnose the service life of the servo amplifier itself. The approximate service life of the servo amplifier being used can be determined. The servo amplifier life diagnosis function features the following functions.

Cumulative energization time function

Displays the cumulative time that the control circuit power supply of the servo amplifier has been on for, starting at the time of shipment.



- To acquire the energization time, MR Configurator2 or a controller is required.

Precautions

- The interval for recording the cumulative value of energization time is 10 minutes. When turning the servo amplifier off/on frequently within this time, there is a possibility that the cumulative value of energization time deviates from the actual value.
- This function displays the approximate service life. Since the service life varies by the method of use and environmental conditions, replace the servo amplifier after discovering an error.

Setting method

No setting is required to use the cumulative energization time function. The servo amplifier always measures the energization time.

Service life check method

■ How to check with MR Configurator2

When confirming the cumulative energization time value using MR Configurator2, open the life diagnosis screen of MR Configurator2. The cumulative energization time of the servo amplifier can be checked from the life diagnosis screen of MR Configurator2.

■ How to check with objects [G]

When confirming the cumulative energization time value with the controller, obtain the following object. For details on the objects, refer to the User's Manual (Object Dictionary).

Index	Sub	Object	Name	Description
2C18h	0	VAR	Power ON cumulative time	Returns the cumulative energization time of the servo amplifier. Unit: [h]

Relay usage count display function

Displays the number of times the inrush relay has been turned on/off from the time of shipment.

Restriction

- MR Configurator2 or a controller is required to acquire the number of times the inrush relay has been turned on/off.
- For MR-J5D_-_G_, the number of inrush relay on/off times is displayed as "0".

Precautions

- The interval for recording the number of on/off times of the inrush relay is 10 minutes. When turning the servo amplifier off/on frequently within this time, there is a possibility that the number of on/off times of the inrush relay may deviate from the actual value.
- This function displays the approximate service life. Since the service life varies by the method of use and environmental conditions, replace the servo amplifier after discovering an error.

Setting method

No setting is required to display the number of times the inrush relay has been turned on/off. The servo amplifier always measures the number of times the inrush relay has been turned on/off.

Service life check method

■ How to check with MR Configurator2

To check the number of times the inrush relay has been turned on/off with MR Configurator2, open the life diagnosis screen of MR Configurator2. From the life diagnosis screen of MR Configurator2, the number of times the inrush relay of the servo amplifier has been turned on/off can be checked.

■ How to check with objects [G]

When checking the number of times the inrush relay has been turned on/off and the number of times the dynamic brake has been stopped, obtain the following object.

For details on the objects, refer to the User's Manual (Object Dictionary).

Index	Sub	Object	Name	Description
2C19h	0	VAR	Number of inrush relay on/off times	The number of times that the inrush relay of the servo amplifier has been turned on/off is returned. Unit: [times]
2C1Ah	0	VAR	Number of dynamic brake stop times	The number of times that the dynamic brake of the servo amplifier has been stopped is returned. Unit: [times]

4.19 Encoder communication diagnosis function

This servo amplifier has a function to diagnose the failure of the differential driver or receiver used for the encoder communication circuit.

By inputting the diagnostic signal to the encoder communication circuit, an error on the differential driver or receiver is detected.

An encoder communication alarm can be caused by many factors including noise, a servo amplifier failure, an encoder failure, or an encoder cable disconnection; as such, it takes time to identify the alarm cause. This function determines if the alarm is caused by a servo amplifier failure, which helps to identify the alarm cause promptly.

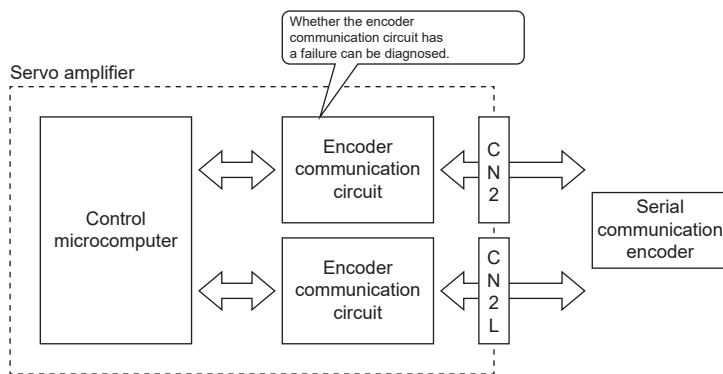

Restriction

- This function cannot be used with A/B/Z-phase differential output type encoders.

Precautions

- When not using a two-wire type encoder cable, diagnose the encoder communication circuit with the encoder cable disconnected to prevent the encoder and the servo amplifier from malfunctioning.
- Remove the encoder cable with the power supply of the servo amplifier turned off.
- MR Configurator2 is required for this function.
- [AL. 118.1 Encoder communication circuit diagnosis in progress] occurs when the encoder communication circuit diagnosis is in progress.
- For an absolute position detection system using a direct drive motor, the absolute position will be erased if the encoder cable is disconnected as doing so interrupts the power supply from the battery.

Usage [G] [B]

To enable the diagnosis mode, set "1" (enabled) in [Pr. PC05.4 Encoder communication circuit diagnosis mode selection] and cycle the power. Remove the encoder cable at power off. During the diagnosis mode, [AL. 118.1 Encoder communication circuit diagnosis in progress] occurs. Perform the diagnosis in accordance with the items displayed on the encoder communication circuit diagnosis screen of MR Configurator2.

Servo parameter	Symbol	Name	Outline
PC05.4	**COP2	Encoder communication circuit diagnosis mode selection	Enable or disable the encoder communication circuit diagnosis mode. [AL. 118.1 Encoder communication circuit diagnosis in progress] occurs during the encoder communication circuit diagnosis mode. 0: Encoder communication circuit diagnosis mode disabled 1: Encoder communication circuit diagnosis mode enabled Initial value: 0h

Usage [A]

To enable the diagnosis mode, set "1" (enabled) in [Pr. PC60.4 Encoder communication circuit diagnosis mode selection] and cycle the power. Remove the encoder cable at power off. During the diagnosis mode, [AL. 118.1 Encoder communication circuit diagnosis in progress] occurs. Perform the diagnosis in accordance with the items displayed on the encoder communication circuit diagnosis screen of MR Configurator2.

Servo parameter	Symbol	Name	Outline
PC60.4	**COPD	Encoder communication circuit diagnosis mode selection	Enable or disable the encoder communication circuit diagnosis mode. [AL. 118.1 Encoder communication circuit diagnosis in progress] occurs during the encoder communication circuit diagnosis mode. 0: Encoder communication circuit diagnosis mode disabled 1: Encoder communication circuit diagnosis mode enabled Initial value: 0h

Diagnostic procedure

Perform the encoder communication circuit diagnosis in accordance with the following procedure.

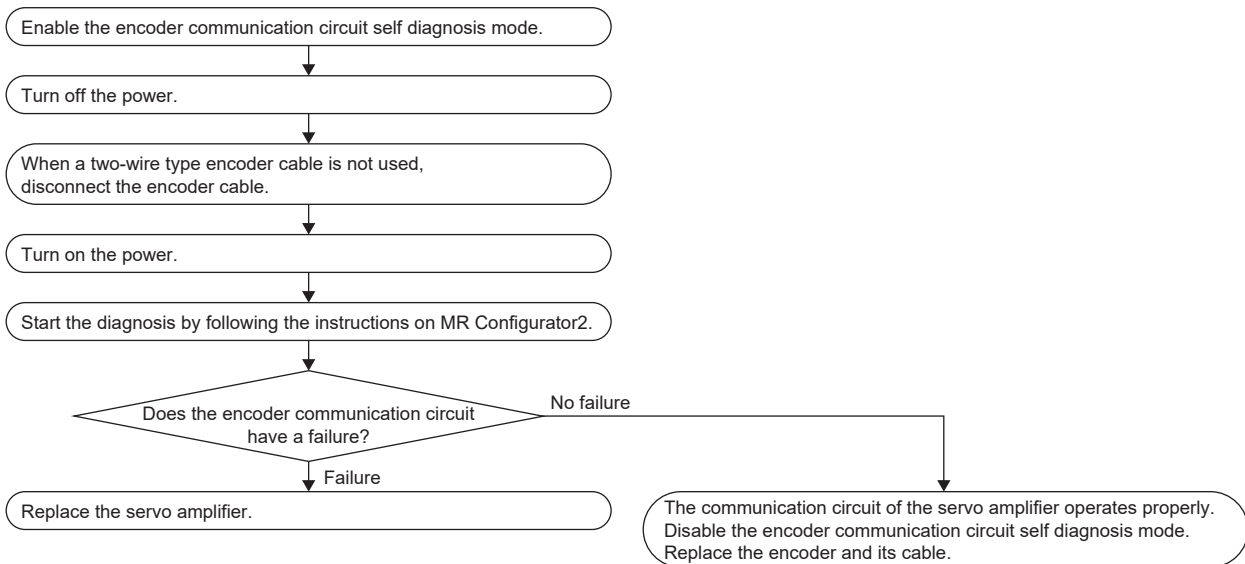

4.20 Disconnection/incorrect wiring detection function

An alarm may occur if the main circuit power supply (L1/L2/L3) is an open phase, and the servo motor load becomes too large. Also, when an open phase has occurred in the servo motor power supply (U/V/W) or the power module has malfunctioned, an overcurrent alarm or overload alarm occurs. These malfunctions are difficult to determine from the outside of the servo amplifier, making it difficult to identify the alarm cause.

With the following function, the MELSERVO-J5 series servo amplifier can quickly identify the malfunction location and shorten the time needed to restore the device.

Input open-phase detection function

This function detects an open phase of the main circuit power supply (L1/L2/L3) of the servo amplifier and generates [AL. 139 Open-phase error] or [AL. 1E9 Open-phase warning] upon open phase detection. This function detects an open phase only for 1-phase of the main circuit power supply (L1/L2/L3) of the servo amplifier. The function does not detect an open phase if the open phase of the main circuit power supply (L1/L2/L3) of the servo amplifier occurs on two or all phases at the same time.

Restrictions [G] [B]

- For MR-J5D_-_G_, this function cannot be used.
- [AL. 1E9 Open-phase warning] and [AL. 139 Open-phase error] are only detected in the servo-on state. In the servo-off state, [AL. 1E9 Open-phase warning] and [AL. 139 Open-phase error] do not occur even if an open phase of the main circuit power supply (L1/L2/L3) of the servo amplifier occurs.
- When using 1-phase AC input or DC input, the input open-phase detection function cannot be used. For 1-phase AC input and DC input, even if an open phase occurs during servo-on when [Pr. PC20.4 Input open-phase detection selection] is set to "1" (warning enabled) or "2" (alarm enabled), [AL. 1E9 Open-phase warning] and [AL. 139 Open-phase error] do not occur.
- However, when the FR-XC-(H) is connected, the input open-phase detection function cannot be used.

Restrictions [A]

- [AL. 1E9 Open-phase warning] and [AL. 139 Open-phase error] are only detected in the servo-on state. In the servo-off state, [AL. 1E9 Open-phase warning] and [AL. 139 Open-phase error] do not occur even if an open phase of the main circuit power supply (L1/L2/L3) of the servo amplifier occurs.
- When using 1-phase AC input or DC input, the input open-phase detection function cannot be used. For 1-phase AC input and DC input, even if an open phase occurs during servo-on when [Pr. PC27.4 Input open-phase detection selection] is set to "1" (warning enabled) or "2" (alarm enabled), [AL. 1E9 Open-phase warning] and [AL. 139 Open-phase error] do not occur.
- However, when the FR-XC-(H) is connected, the input open-phase detection function cannot be used.

Precautions

- If the main circuit power supply (L1/L2/L3) is input while other than "0" (disabled (simple converter not used)) is set in [Pr. PA02.4 Simple converter selection], the input open-phase detection function will generate an alarm or a warning. When using the simple converter, do not input main circuit power supply (L1/L2/L3).

Setting method [G] [B]

■ 200 V class 1-axis servo amplifiers with a capacity of 2.0 kW or less

When [Pr. PC20.4 Input open-phase detection selection] is set to "0" (automatic), the input open-phase detection function is disabled.

The input open-phase detection function is enabled by setting [Pr. PC20.4] to "1" (warning enabled) or "2" (alarm enabled). If "1" (warning enabled) is set, [AL. 1E9 Open-phase warning] will be output when the input open phase occurs. To generate [AL. 139 Open-phase error] when an open phase occurs, set [Pr. PC20.4] to "2" (alarm enabled).

■ 200 V class 1-axis servo amplifiers with a capacity of more than 2.0 kW

When [Pr. PC20.4 Input open-phase detection selection] is set to "0" (automatic), the input open-phase detection function is enabled. If "0" (automatic) is set, [AL. 1E9 Open-phase warning] will be output when an input open phase occurs. To generate [AL. 139 Open-phase error] when an open phase occurs, set [Pr. PC20.4] to "2" (alarm enabled).

■ 200 V class multi-axis servo amplifiers with a capacity of 0.75 kW or less

When [Pr. PC20.4 Input open-phase detection selection] is set to "0" (automatic), the input open-phase detection function is disabled.

The input open-phase detection function is enabled by setting [Pr. PC20.4] to "1" (warning enabled) or "2" (alarm enabled). If "1" (warning enabled) is set, [AL. 1E9 Open-phase warning] will be output when the input open phase occurs. To generate [AL. 139 Open-phase error] when an open phase occurs, set [Pr. PC20.4] to "2" (alarm enabled).

■ 200 V class multi-axis servo amplifiers with a capacity of more than 0.75 kW

When [Pr. PC20.4 Input open-phase detection selection] is set to "0" (automatic), the input open-phase detection function is enabled. If "0" (automatic) is set, [AL. 1E9 Open-phase warning] will be output when an input open phase occurs. To generate [AL. 139 Open-phase error] when an open phase occurs, set [Pr. PC20.4] to "2" (alarm enabled).

■ 400 V class 1-axis servo amplifiers

When [Pr. PC20.4 Input open-phase detection selection] is set to "0" (automatic), the input open-phase detection function is enabled. If "0" (automatic) is set, [AL. 1E9 Open-phase warning] will be output when an input open phase occurs. To generate [AL. 139 Open-phase error] when an open phase occurs, set [Pr. PC20.4] to "2" (alarm enabled).

Servo parameter	Symbol	Name	Outline
PC20.4	*COP7	Input open-phase detection selection	Enable or disable the detection of input open-phase detection function. 0: Automatic (initial value) 1: Warning enabled 2: Alarm enabled 3: Disabled

Setting method [A]

■ 200 V class servo amplifiers with a capacity of 2.0 kW or less

When [Pr. PC27.4 Input open-phase detection selection] is set to "0" (automatic), the input open-phase detection function is disabled.

The input open-phase detection function is enabled by setting [Pr. PC27.4] to "1" (warning enabled) or "2" (alarm enabled). If "1" (warning enabled) is set, [AL. 1E9 Open-phase warning] will be output when the input open phase occurs. To generate [AL. 139 Open-phase error] when an open phase occurs, set [Pr. PC27.4] to "2" (alarm enabled).

■ 200 V class servo amplifiers with a capacity of more than 2.0 kW

When [Pr. PC27.4 Input open-phase detection selection] is set to "0" (automatic), the input open-phase detection function is enabled. If "0" (automatic) is set, [AL. 1E9 Open-phase warning] will be output when an input open phase occurs. To generate [AL. 139 Open-phase error] when an open phase occurs, set [Pr. PC27.4] to "2" (alarm enabled).

■ 400 V class 1-axis servo amplifiers

When [Pr. PC27.4 Input open-phase detection selection] is set to "0" (automatic), the input open-phase detection function is enabled. If "0" (automatic) is set, [AL. 1E9 Open-phase warning] will be output when an input open phase occurs. To generate [AL. 139 Open-phase error] when an open phase occurs, set [Pr. PC27.4] to "2" (alarm enabled).

Servo parameter	Symbol	Name	Outline
PC27.4	*COP6	Input open-phase detection selection	Enable or disable the detection of input open-phase detection function. 0: Automatic (initial value) 1: Warning enabled 2: Alarm enabled 3: Disabled

Related objects [G]

The input open-phase status is output with bit 10 (S_PNLT) of [Status DO5 (Obj. 2D15h)]. Bit 10 is on when an input open-phase has occurred and off when input open-phase has not occurred.

For the MR-J5D_-G_, bit 10 (S_PNLT) of [Status DO 5] is always off.

When the input open-phase detection is enabled at warning occurrence or at alarm occurrence in [Pr. PC20.4 Input open-phase detection selection], bit 10 (S_PNLT) of [Status DO5] turns on when one phase is open.

When the input open-phase detection is disabled, bit 10 (S_PNLT) of [Status DO5] does not turn on when one phase is open.

When using the bit with 1-phase AC input, disable the input open-phase detection in [Pr. PC20.4].

When the input open-phase detection is enabled at warning occurrence or at alarm occurrence, two phases open and all phases open cannot be detected because bit 10 (S_PNLT) of [Status DO5] is always on.

When [Pr. PC20.6 Input open-phase status output selection] is set to "0" (on during servo-on and while one phase is open), bit 10 (S_PNLT) of [Status DO5] turns off when two phases or all phases are open.

When [Pr. PC20.6] is set to "1" (on during servo-on and while one phase, two phases or all phases are open), bit 10 (S_PNLT) of [Status DO5] turns on when two phases or all phases are open.

When [Pr. PC20.6] is set to "2" (on while one phase is open) or "3" (on while one phase, two phases, or all phases are open), bit 10 (S_PNLT) of [Status DO5] turns off in the servo-off state.

Output open-phase detection function

This function detects an open phase due to servo motor power supply cable (U/V/W) disconnection and generates [AL. 139 Open-phase error] after the detection.

Restrictions [G] [B]

- The output open phase detection function will be disabled if an alarm or warning other than [AL. 139 Open-phase error] has occurred.
- If "1" is set in [Pr. PC05.0 Motor-less operation selection], output open phase will not be detected even if the output open-phase detection function has been enabled.
- If "0" (servo motor speed) is set in [Pr. PC19.6 Output open phase - Judgment speed selection], [AL. 139 Open-phase error] will only be detected in the servo-on state while the servo motor speed is 50 [r/min] (linear servo motor: 50 [mm/s], direct drive motor: 25 [r/min]) or faster. The output open phase will not be detected even if the open phase of the servo motor power supply (U/V/W) occurs while in the servo-off state or if the servo motor speed is under 50 [r/min] (linear servo motor: 50 [mm/s], direct drive motor: 25 [r/min]).
- If "1" (speed command) is set in [Pr. PC19.6 Output open phase - Judgment speed selection], [AL. 139 Open-phase error] will only be detected in the servo-on state while the command speed is 50 [r/min] (linear servo motor: 50 [mm/s], direct drive motor: 25 [r/min]) or faster. The output open phase will not be detected even if the open phase of the servo motor power supply (U/V/W) occurs while in the servo-off state or if the command speed is under 50 [r/min] (linear servo motor: 50 [mm/s], direct drive motor: 25 [r/min]).
- The output open-phase detection is not performed when MBR is on.
- If "1" (speed command) is set in [Pr. PC19.6 Output open phase - Judgment speed selection], the output open phase may be detected incorrectly when the servo motor axis is stopped due to a collision or similar impact.
- If [Pr. PA11 Forward rotation torque limit] and [Pr. PA12 Reverse rotation torque limit] are 10.0 % or less, the output open phase may be detected incorrectly when the servo motor load becomes too large.
- If a linear servo motor is used, the open phase may not be detected.

Restrictions [A]

- The output open phase detection function will be disabled if an alarm or warning other than [AL. 139 Open-phase error] has occurred.
- If "1" is set in [Pr. PC60.0 Motor-less operation selection], output open phase will not be detected even if the output open-phase detection function has been enabled.
- If "0" (servo motor speed) is set in [Pr. PC26.6 Output open phase - Judgment speed selection], [AL. 139 Open-phase error] will only be detected in the servo-on state while the servo motor speed is 50 [r/min] (linear servo motor: 50 [mm/s], direct drive motor: 25 [r/min]) or faster. The output open phase will not be detected even if the open phase of the servo motor power supply (U/V/W) occurs while in the servo-off state or if the servo motor speed is under 50 [r/min] (linear servo motor: 50 [mm/s], direct drive motor: 25 [r/min]).
- If "1" (speed command) is set in [Pr. PC26.6 Output open phase - Judgment speed selection], [AL. 139 Open-phase error] will only be detected in the servo-on state while the command speed is 50 [r/min] (linear servo motor: 50 [mm/s], direct drive motor: 25 [r/min]) or faster. The output open phase will not be detected even if the open phase of the servo motor power supply (U/V/W) occurs while in the servo-off state or if the command speed is under 50 [r/min] (linear servo motor: 50 [mm/s], direct drive motor: 25 [r/min]).
- The output open-phase detection is not performed when MBR is on.
- If "1" (speed command) is set in [Pr. PC26.6 Output open phase - Judgment speed selection], the output open phase may be detected incorrectly when the servo motor axis is stopped due to a collision or similar impact.
- If [Pr. PA11 Forward rotation torque limit] and [Pr. PA12 Reverse rotation torque limit] are 10.0 % or less, the output open phase may be detected incorrectly when the servo motor load becomes too large.
- If a linear servo motor is used, the open phase may not be detected.

Precautions

- With the output open-phase detection function, detection is possible only when one of the U, V, or W phases is an open phase.

Setting method [G] [B]

When [Pr. PC19.4 Output open-phase detection selection] is set to "1" (enabled), the output open-phase detection function will be enabled.

Servo parameter	Symbol	Name	Outline
PC19.4	*COP6	Output open-phase detection selection	Enable or disable the detection of output open-phase detection function. 0: Disabled (initial value) 1: Enabled
PC19.6	*COP6	Output open phase - Judgment speed selection	Select the judgment speed of the output open-phase detection function. 0: Servo motor speed (initial value) 1: Speed command In the torque control, set "0" (servo motor speed). When "1" (speed command) is set, [AL. 139.2 Output open-phase error] does not occur.

Setting method [A]

When [Pr. PC26.4 Output open-phase detection selection] is set to "1" (enabled), the output open-phase detection function will be enabled.

Servo parameter	Symbol	Name	Outline
PC26.4	*COP5	Output open-phase detection selection	Enable or disable the detection of output open-phase detection function. 0: Disabled (initial value) 1: Enabled
PC26.6	*COP5	Output open phase - Judgment speed selection	Select the judgment speed of the output open-phase detection function. 0: Servo motor speed (initial value) 1: Speed command In the torque control, set "0" (servo motor speed). When "1" (speed command) is set, [AL. 139.2 Output open-phase error] does not occur.

Servo motor incorrect wiring detection function [G]

This function detects incorrect wiring of a servo motor power cable or encoder cable of the multi-axis servo amplifier. Upon detection of incorrect wiring, [AL. 139 Open-phase error] occurs. This function can prevent fires that originate in the servo motor due to incorrectly wiring a servo amplifier to servo motors of wrong capacities. Incorrect wiring refers to when the servo motor power cable and the encoder cable are connected to servo motors which are different from the intended ones.

Restriction

- For MR-J5D_-_G_, this function cannot be used.
- Enabling this function on other than the MR-J5W_-_G_ triggers [AL. 037 Parameter error].
- If [Pr. PC05.0 Motor-less operation selection] is set to "1" (enabled), incorrect wiring will not be detected even if the servo motor incorrect wiring detection function has been enabled.
- The servo motor incorrect wiring detection function will not operate even if the servo amplifier becomes in the servo-on state during the servo motor rotation. Execute the servo motor incorrect wiring detection function while the servo motor is stopped.

Precautions

- When the servo motor incorrect wiring detection function is enabled, the servo motor may move as follows between the servo-on command and the actual servo-on: up to one pole pitch for a rotary servo motor, and up to one revolution for a linear servo motor.
- The servo motor incorrect wiring detection function will be executed at servo-on. When the servo motor incorrect wiring detection function is enabled, the time until the servo amplifier actually enters in the servo-on state after turning on the servo-on command may be extended by up to 3.0 s.
- This function is executed at servo-on of each axis.
- If the stroke limit is detected, the servo motor incorrect wiring detection function will be stopped. For servo amplifiers with firmware version D4 or later, [AL. 139.4_Limit detection error at servo motor incorrect wiring detection] occurs.
- The incorrect wiring may not be detected when different servo motors with similar capacities are wired incorrectly.
- Do not use this function when using a servo motor not manufactured by Mitsubishi Electric. Otherwise, a large current may flow because of this function.

Setting method

Enable/disable the servo motor incorrect wiring detection function in [Pr. PC16.4 Servo motor incorrect wiring detection function selection], and set when to execute the function in [Pr. PC16.5 Servo motor incorrect wiring detection function execution method selection]. Execute the servo motor incorrect wiring detection function when changing the wiring of the servo amplifier.

1. After setting "1" (enabled) in [Pr. PC16.4], cycle the power or perform the software reset or the communication reset.
2. Turn on the servo-on command.
3. The servo motor incorrect wiring detection function will be executed. Upon detection of incorrect wiring of the servo motor, [AL. 139 Open-phase error] occurs. The servo-on state becomes active if the servo motor wiring is correct. The time until the servo amplifier actually enters in the servo-on state after the servo-on command is turned on may be extended by up to 3.0 s.
4. If "0" (initial value) is set in [Pr. PC16.5], [Pr. PC16.4] will be changed to "0" (disabled) after the servo motor incorrect wiring detection function is executed.
5. The servo motor incorrect wiring detection function will not be executed from the next servo-on. The time until the servo amplifier actually enters in the servo-on state after the servo-on command is turned on will be the same as when the function is disabled. To use the servo motor incorrect wiring detection function after changing the wiring, repeat procedure 1.

Servo parameter	Symbol	Name	Outline
PC16.4	*COP3A	Servo motor incorrect wiring detection function selection	Set the servo motor incorrect wiring detection function to either enabled or disabled. 0: Servo motor incorrect wiring detection disabled 1: Servo motor incorrect wiring detection enabled
PC16.5	*COP3A	Servo motor incorrect wiring detection function execution method selection	Set the execution method for the servo motor incorrect wiring detection function. 0: Detect servo motor incorrect wiring at initial servo-on after enabling servo motor incorrect wiring detection 1: Detect servo motor incorrect wiring at initial servo-on after cycling the power

4.21 Overload protection (electronic thermal) function

An electronic thermal is built in the servo amplifier to protect the servo motor, servo amplifier and servo motor power wires from overloads.

Operation exceeding the overload protection characteristics will cause [AL. 050 Overload 1] or [AL. 051 Overload 2].

Precautions

- After [AL. 050 Overload 1] or [AL. 051 Overload 2] occurs, allow about 30 minutes of cooling time.

4.22 Command offset [G]

Available on servo amplifiers with firmware version A5 or later.

The command offset function compensates position/speed/torque commands by adding a desired offset amount to the commands. Position offset, velocity offset, and torque offset can be set.

Functions	Outline
Position offset	<ul style="list-style-type: none"> In the position mode, an offset can be added to [Target position (Obj. 607Ah)].
Velocity offset	<ul style="list-style-type: none"> In the velocity mode, an offset can be added to [Target velocity (Obj. 60FFh)]. In the position mode and positioning mode, an offset (speed feed forward) can be added to the speed command calculated internally to drive the servo motor.
Torque offset	<ul style="list-style-type: none"> In the torque mode and continuous operation to torque control mode, an offset can be added to [Target torque (Obj. 6071h)]. In the position mode, positioning mode, and velocity mode, an offset (torque feed forward) can be added to the torque command calculated internally to drive the servo motor.

Restriction

- The type of the command offset function that can be used differs depending on the control mode.

 Page 381 Applicable control modes

Precautions

- If the offset value difference between position/velocity/torque offsets is too large, the servo motor may rotate due to the sudden change in torque when the control mode is switched. Check the setting value of the command offset function when switching modes.
- If the position/velocity/torque offset value is too large, the servo motor may rotate due to the sudden change in torque at servo-on. Check the setting value of the command offset function when switching modes.
- Set "0" for the command offset function while the servo amplifier is in the servo-off state, and reset the value after servo-on.
- [Torque offset (Obj. 60B2h)] can be used simultaneously with [Pr. PE47 Unbalanced torque offset]. If a value other than "0" is set for both the servo parameter and the object, the setting values of both [Torque offset (Obj. 60B2h)] and [Pr. PE47 Unbalanced torque offset] are added to the torque command.
- If the velocity offset is used in the position mode and positioning mode, a position deviation may occur at the command stop and positioning may not finish as a result.
- When using super trace control, do not use the velocity offset. To adjust the speed feed forward during super trace control, use [Pr. PB04 Feed forward gain].

Setting method

Set the position offset with [Position offset (Obj. 60B0h)], the velocity offset with [Velocity offset (Obj. 60B1h)], and the torque offset with [Torque offset (Obj. 60B2h)].

For details on the objects, refer to the User's Manual (Object Dictionary).

Index	Sub	Object	Name	Description
60B0h	—	VAR	Position offset	Position offset Unit: pos units
60B1h	—	VAR	Velocity offset	Velocity offset Unit: vel units
60B2h	—	VAR	Torque offset	Torque offset Unit: 0.1 % (with rated torque being 100 %)

Applicable control modes

The following shows enabled/disabled command offsets for each control mode. For control modes of which command offsets are disabled, the setting values of the disabled command offsets are invalid.

In the test operation mode, the command offset function is disabled.

Control mode	Command offset		
	Position offset	Velocity offset	Torque offset
Cyclic synchronous position mode (csp)	○	○	○
Cyclic synchronous velocity mode (csv)	—	○	○
Cyclic synchronous torque mode (cst)	—	—	○
Profile position mode (pp)	—	○	○
Profile velocity mode (pv)	—	○	○
Profile torque mode (tq)	—	—	○
Homing mode (hm)	—	—	—
Point table mode (pt)	—	○	○
JOG operation mode (jg)	—	○	○
Continuous operation to torque control mode (ct)	—	—	○
Slave axis torque mode (sit)	—	—	○

○: Enabled, —: Disabled

Function block diagram

Page 22 Control mode [G]

4.23 Excessive error alarm detection function

Outline

The excessive error alarm detection function generates an alarm when the difference between the position command and the feedback position become large. The excessive error alarm trigger level can be changed with parameters.

Setting method [G] [B]

The excessive error alarm trigger level can be changed with the following servo parameters.

Servo parameter	Symbol	Name	Outline
PC01	ERZ	Excessive error alarm trigger level	<p>Set an excessive error alarm trigger level.</p> <p>If using a rotary servo motor or direct drive motor, set the level in units of rev. If 200 rev or higher is set, the value will be clamped to 200 rev.</p> <p>If using a linear servo motor, set the level in units of mm.</p> <p>When the value is set to "0", the alarm trigger level for rotary servo motors and direct drive motors is 3 rev. The alarm trigger level for linear servo motors is 100 mm.</p> <p>The unit can be changed with [Pr. PC06.3].</p> <p>Initial setting: 0 (3 [rev] or 100 [mm])</p>
PC06.3	*COP3	Excessive error alarm trigger level/excessive error warning trigger level - Unit selection	<p>Select the unit used when setting the excessive error alarm trigger level in [Pr. PC01] and the excessive error warning trigger level in [Pr. PC38 Excessive error warning trigger level].</p> <p>This servo parameter is enabled only in the position mode and positioning mode.</p> <p>0: [rev] or [mm] 1: [0.1 rev] or [0.1 mm] 2: [0.01 rev] or [0.01 mm] 3: [0.001 rev] or [0.001 mm] Initial setting: 0 ([rev] or [mm])</p>

Setting method [A]

The excessive error alarm trigger level can be changed with the following servo parameters.

Servo parameter	Symbol	Name	Outline
PC43	ERZ	Excessive error alarm trigger level	<p>Set an excessive error alarm trigger level.</p> <p>If using a rotary servo motor or direct drive motor, set the level in units of rev. If 200 rev or higher is set, the value will be clamped to 200 rev.</p> <p>If using a linear servo motor, set the level in units of mm.</p> <p>When the value is set to "0", the alarm trigger level for rotary servo motors and direct drive motors is 3 rev. The alarm trigger level for linear servo motors is 100 mm.</p> <p>The unit can be changed with [Pr. PC24.3].</p> <p>Initial setting: 0 (3 [rev] or 100 [mm])</p>
PC24.3	*COP3	Excessive error alarm trigger level/excessive error warning trigger level - Unit selection	<p>Select the unit used when setting the excessive error alarm trigger level in [Pr. PC43] and the excessive error warning trigger level in [Pr. PC73 Excessive error warning trigger level].</p> <p>This setting value is enabled in the position mode.</p> <p>0: [rev] or [mm] 1: [0.1 rev] or [0.1 mm] 2: [0.01 rev] or [0.01 mm] 3: [0.001 rev] or [0.001 mm] Initial setting: 0 ([rev] or [mm])</p>

Excessive error alarm trigger level adjustment method [G] [B]

Checking the excessive error alarm margin

Monitor the excessive error alarm margin using the graph function of MR Configurator2. The pulse of the excessive error alarm margin is at a maximum when the position command and feedback position match. [AL. 052 Excessive error] occurs when the excessive error alarm margin is 0 pulse. Calculate the differential pulse using the maximum and minimum pulses in "excessive error alarm margin".

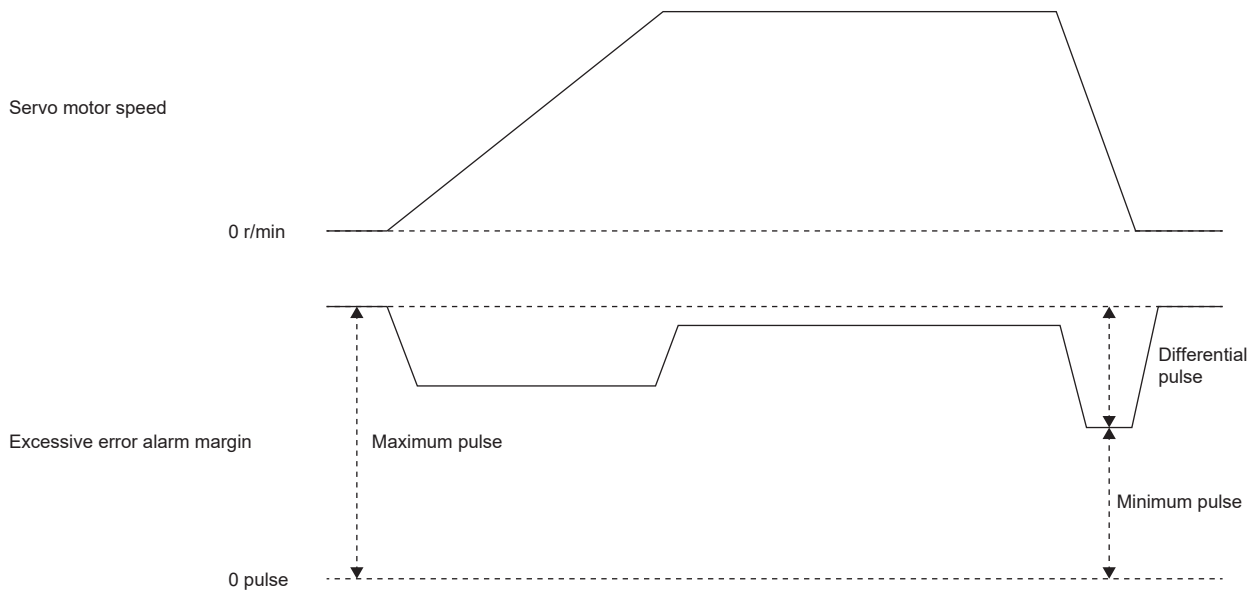

Adjusting the excessive error alarm trigger level

Adjust the excessive error alarm trigger level with [Pr. PC01] and [Pr. PC06.3] so that the following calculation formula is satisfied.

$[\text{Pr. PC01}] \times \text{unit set in } [\text{Pr. PC06.3}] > \text{Difference in excessive error alarm margin} / \text{resolution per revolution}$

In the fully closed loop control mode, the resolution per revolution is the load-side encoder resolution.

When using a linear encoder, the value shown below is the resolution per revolution.

$([\text{Pr. PL02 Linear encoder resolution setting} - \text{Numerator}] / [\text{Pr. PL03 Linear encoder resolution setting} - \text{Denominator}]) \times 1000$

Excessive error alarm trigger level adjustment method [A]

Checking the excessive error alarm margin

Monitor the excessive error alarm margin using the graph function of MR Configurator2. The pulse of the excessive error alarm margin is at a maximum when the position command and feedback position match. [AL. 052 Excessive error] occurs when the excessive error alarm margin is 0 pulse. Calculate the differential pulse using the maximum and minimum pulses in "excessive error alarm margin".

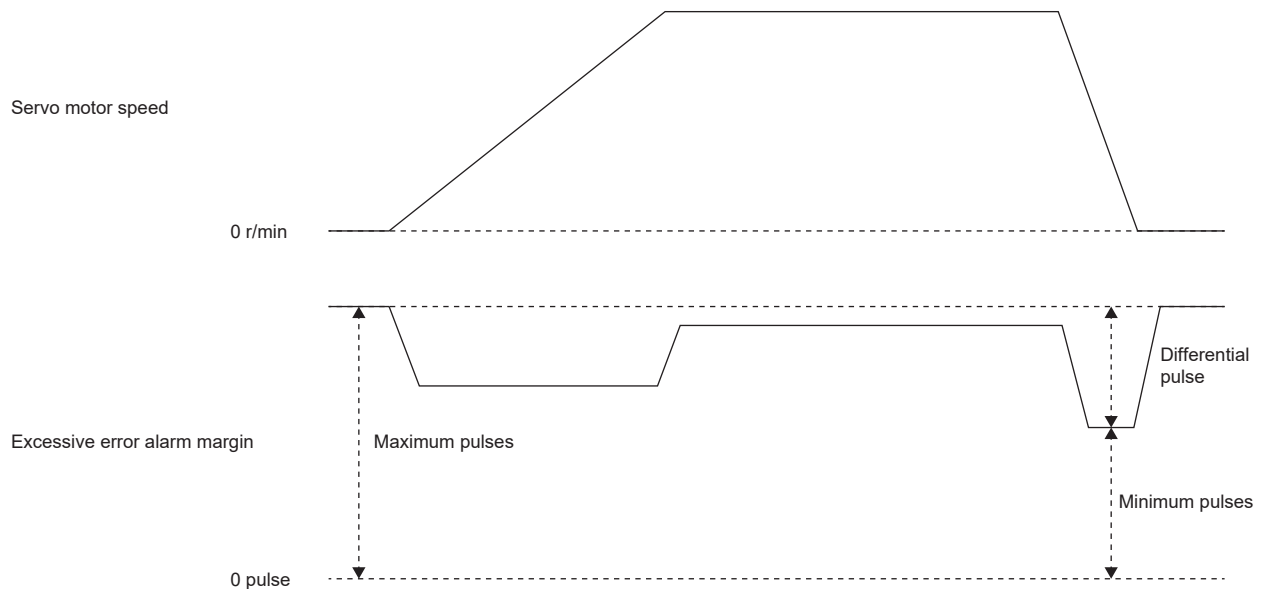

Adjusting the excessive error alarm trigger level

Adjust the excessive error alarm trigger level with [Pr. PC43] and [Pr. PC24.3] so that the following calculation formula is satisfied.

$[\text{Pr. PC43}] \times \text{unit set in } [\text{Pr. PC24.3}] > \text{Difference in excessive error alarm margin} / \text{resolution per revolution}$

In the fully closed loop control mode, the resolution per revolution is the load-side encoder resolution.

When using a linear encoder, the value shown below is the resolution per revolution.

$([\text{Pr. PL02 Linear encoder resolution setting} - \text{Numerator}] / [\text{Pr. PL03 Linear encoder resolution setting} - \text{Denominator}]) \times 1000$

4.24 Override function [G]

Point

The override function can be used in the following modes.

- Point table mode (pt)
- JOG operation mode (jg)
- Homing mode (hm)
- Profile position mode (pp)

The override function cannot be used for the test operation (JOG operation and positioning operation) of MR Configurator2.

When using the override function, change the setting value of [Pr. PT38.1_Override selection] to "3" (the override function is enabled).

When the value obtained by multiplying the command speed by the setting value of [Speed override (Obj. 2DB0h: 00h)] exceeds the maximum speed of the servo motor to be used, the actual servo motor speed is limited to the maximum speed of the servo motor to be used.

In the JOG operation mode (jg) or profile position mode (pp), the actual servo motor speed is calculated by multiplying the command speed set in [Profile velocity (Obj. 6081h)] limited by [Max profile velocity (Obj. 607Fh)] by the setting value of [Speed override (Obj. 2DB0h)].

The servo motor speed can be changed by using [Speed override (Obj. 2DB0h: 00h)]. The value obtained by multiplying the command speed by the setting value of [Speed override (Obj. 2DB0h: 00h)] is the actual servo motor speed.

Setting method

■ Setting with servo parameters

Servo parameter	Symbol	Name	Outline
PT38.1	**TOP7	Override selection	Select the override function. 0:The override function is disabled. 3:The override function is enabled.

■ Setting with object dictionary

Index	Sub	Object	Name	Description
2DB0h	00h	VAR	Speed override	The override value is returned and set.
2D07h	00h	VAR	Control DI 7	The override setting is enabled when bit 7 (C_OVR) is on.

Timing chart

Point table mode

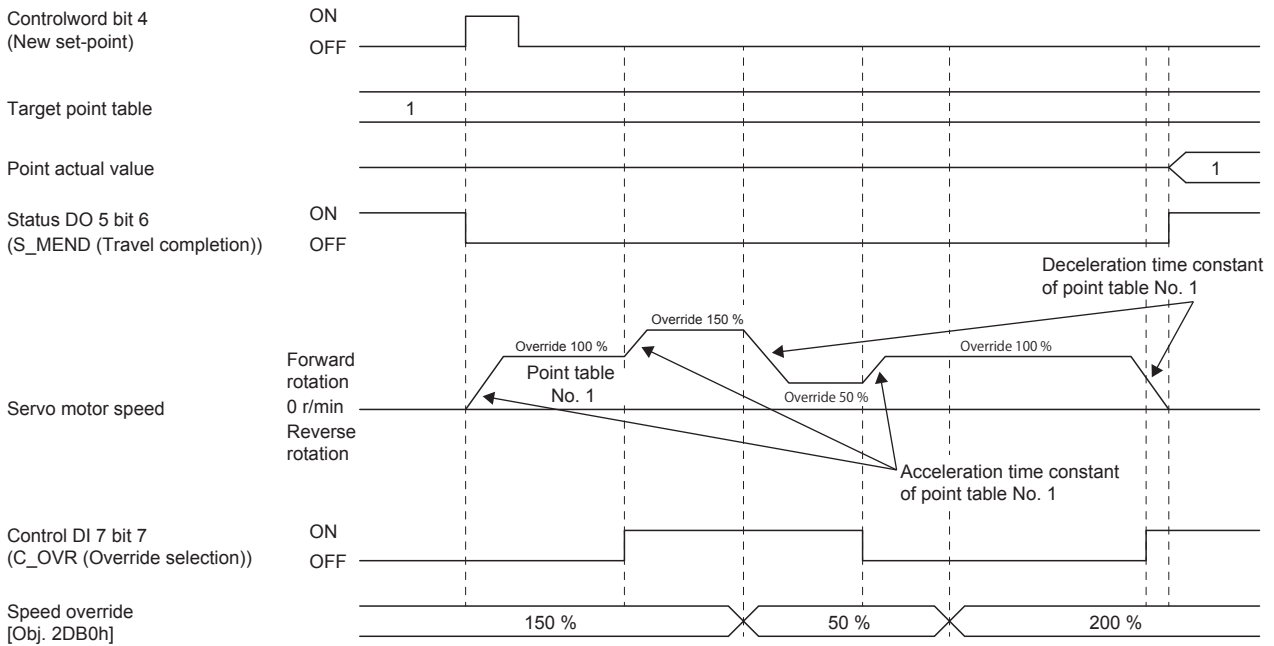

Profile position mode (Single set-point)

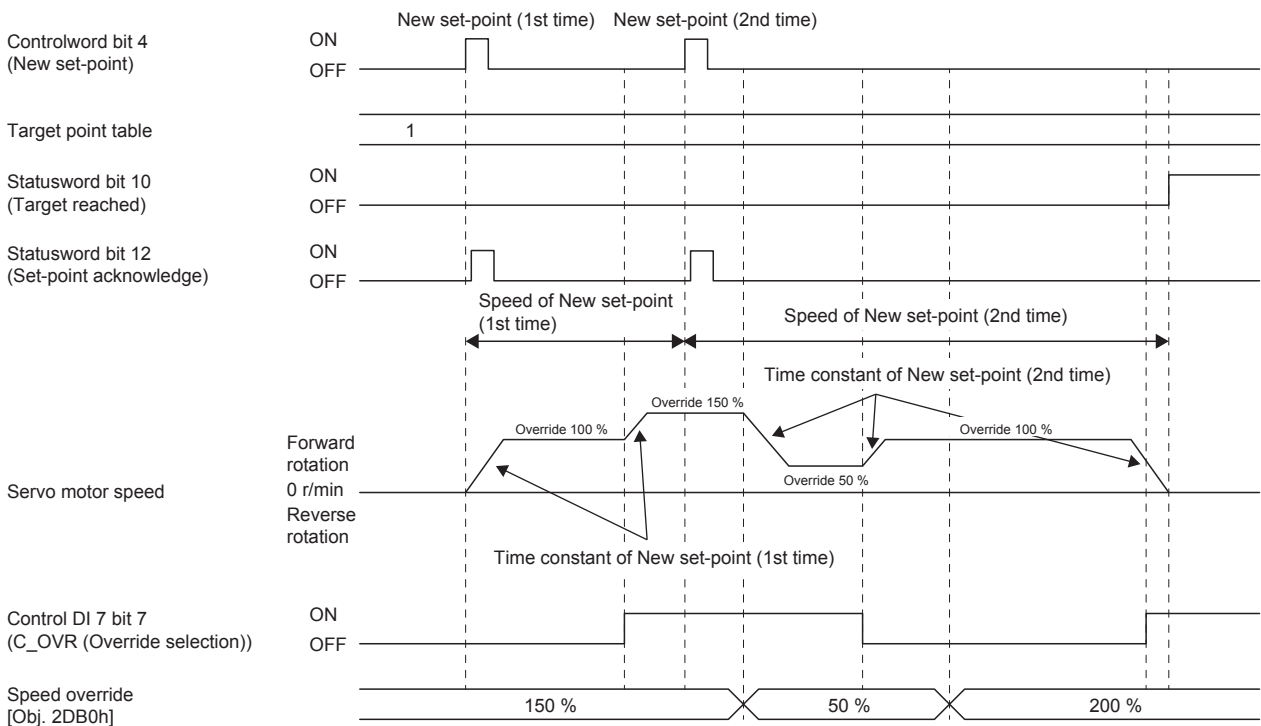

Point table mode (Set of set-points)

The following shows a timing chart when bit 9 (Change on set-point) of [Controlword (Obj. 6040h)] is "0".

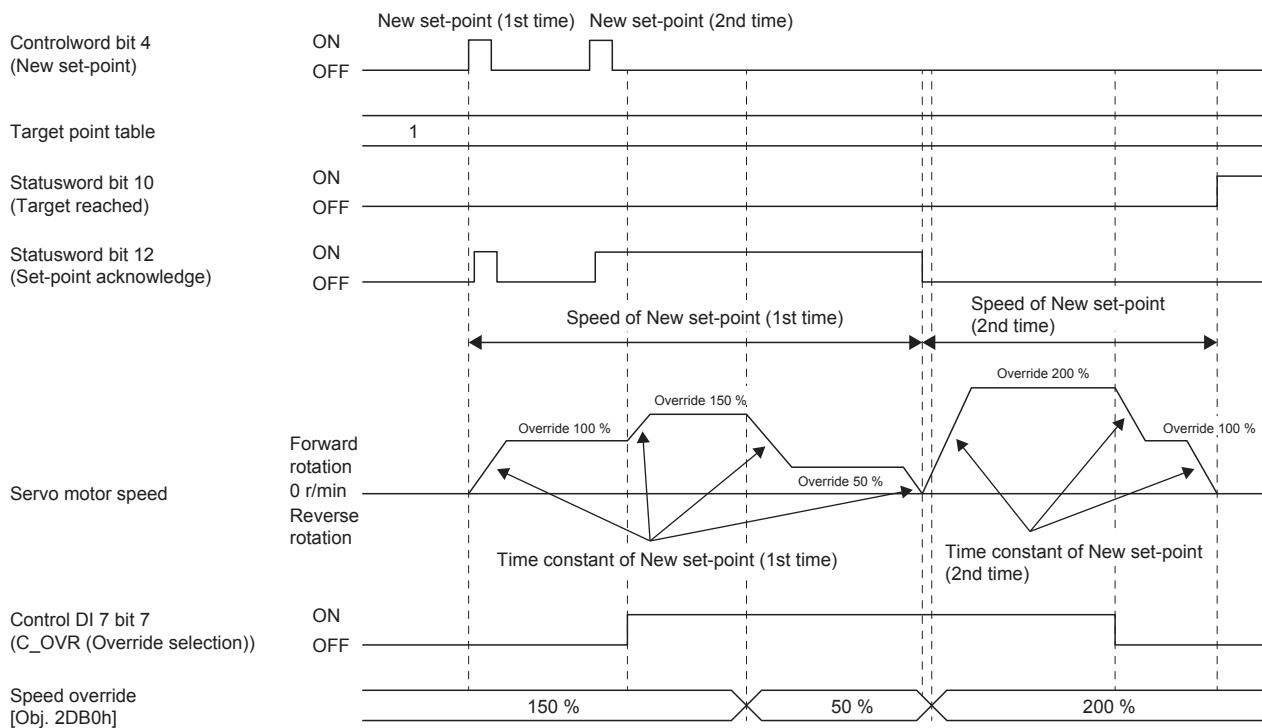

5 MONITORING

Outline [G]

The status of servo motor speed, torque, bus voltage, and other areas of the servo amplifier can be checked with the engineering tools and analog monitor. This chapter shows an example when using MR Configurator2 as the engineering tool. Items that can be monitored with "Display All" can also be monitored by objects. For details, refer to "Monitor Objects" in the User's Manual (Object Dictionary).

Outline [B]

The status of servo motor speed, torque, bus voltage, and other areas of the servo amplifier can be checked with the engineering tools and analog monitor. This chapter shows an example when using MR Configurator2 as the engineering tool. Refer to the following for the method using the optional data monitor function.

☞ Page 427 Optional data monitor function [B]

Outline [A]

The status of servo motor speed, torque, bus voltage, and other areas of the servo amplifier can be checked with the engineering tools and analog monitor. This chapter shows an example when using MR Configurator2 as the engineering tool. For the 7-segment LED status display of the servo amplifier, refer to "Status display" in the following manual.

📖 MR-J5-A User's Manual (Introduction)

5.1 Explanation of monitor signals

The name and description of the monitor signals used in the servo amplifier and the signal block diagram are as follows.

Name and description of the monitor signals

The following shows the types of monitor signals.

Monitor signal	Description
Monitor signal (analog)	The data, such as the servo motor speed, indicated in an analog form
Monitor signal (digital)	The data, such as INP (In-position), indicated by on and off of bits
Analog monitor	The data to output the servo amplifier status using voltage

This chapter shows the name and description of each monitor signal. The unit and other areas may differ depending on the control mode and display method. For "Display All" and the display of the graph in the monitor, refer to the following.

☞ Page 409 Checking with MR Configurator2

For the analog monitor, refer to the following.

☞ Page 412 Analog monitor [G]

☞ Page 417 Analog monitor [B]



☞ Page 422 Analog monitor [A]

Monitor signal (analog) and analog monitor [G]

On MR Configurator2, the status of the monitor signal (analog) can be obtained by using the "Display All" function and the graph function.

Refer to the list in this section for the signals which can be obtained with the "Display All" function and the graph function.

Signals that can be set with the analog monitor are also shown in the lists.

Name	Description	Availability		
		Display All	Graph function	Analog monitor
Cumulative feedback pulses	The feedback pulses from the servo motor encoder are counted and displayed. The displayed value is limited within the range of "-999999999 to 999999999". When the value exceeds the upper or lower limit, it changes to "0". The value is negative in reverse rotation. In the fully closed loop control mode, the value is in load-side encoder units with the gear taken into consideration. The fully closed loop control mode can be used for servo amplifiers with firmware version A5 or later.	○	—	—
Servo motor speed	The servo motor speed is displayed.	○	○	○
Droop pulses	The number of droop pulses in the deviation counter is displayed. The value is negative in reverse rotation. The number of pulses is displayed in the units of encoder pulses.	○	○	○
Cumulative command pulses	Position command input pulses are counted and displayed. The displayed value is limited within the range of "-999999999 to 999999999". When the value exceeds the upper or lower limit, it changes to "0". The value is negative under the reverse command. When other than "3" (pulse) is set in [Pr. PT01.2 Unit for position data], "0" is displayed.	○	—	—
Command pulse frequency	The frequency of the position command input pulses is displayed. When other than "3" (pulse) is set in [Pr. PT01.2 Unit for position data], "0" is displayed.	○	○	—
Command pulse frequency (speed unit)	The command pulse frequency is converted and displayed in the servo motor speed unit.	—	○	—
Regenerative load ratio	The ratio of regenerative power to permissible regenerative power is displayed as a percentage.	○	○	—
Effective load ratio	The continuous effective load current is displayed. The effective load ratio in relation to the rated current (= 100 %) is displayed.	○	○	—
Peak load ratio	The rated torque is displayed as 100 %. The maximum value of the torque generated in the past 15 seconds is displayed.	○	—	—
Torque/instantaneous torque	The instantaneous torque is displayed. The rated torque is displayed as 100 %. The value of the generated torque is displayed in real time.	○	○	○
Position within one-revolution	The position within one-revolution is displayed in the encoder pulse unit. In the fully closed loop control mode, the position within one-revolution is displayed in the servo motor encoder unit. The fully closed loop control mode can be used for servo amplifiers with firmware version A5 or later. For the linear servo motor control mode, the value of manufacturer setting is displayed.	○	○	—
ABS counter	The travel distance from the home position is displayed as a multi-revolution counter value of the absolute position encoder in the absolute position detection system. For the fully closed loop control mode, the ABS counter is displayed in the servo motor encoder unit. The fully closed loop control mode can be used for servo amplifiers with firmware version A5 or later. For the linear servo motor control mode, the value of manufacturer setting is displayed. For details, refer to "Checking the detected absolute position data" in the following manuals.  MR-J5 User's Manual (Hardware)  MR-J5D User's Manual (Hardware)	○	○	—

Name	Description	Availability		
		Display All	Graph function	Analog monitor
Load to motor inertia ratio	The estimated ratio of the load inertia moment to the servo motor inertia moment is displayed.	○	○	—
Bus voltage	The bus voltage of the converter part of the servo amplifier (between P+ and N-) is displayed.	○	○	○
Load-side encoder cumulative feedback pulses *2	The feedback pulses from the load-side encoder are counted and displayed. The displayed value is limited within the range of "-999999999 to 999999999". When the value exceeds the upper or lower limit, it changes to "0". The value is negative in reverse rotation.	○	—	—
Load-side encoder droop pulses *2	Droop pulses of the deviation counter between a load-side position and a command are displayed.	○	○	○
Load-side encoder information 1	The following values are displayed for each encoder connected to the load-side. For a rotary servo motor, the position within one-revolution is displayed. For an absolute position linear encoder, absolute position data is displayed. For an incremental linear encoder, the Z-phase counter (distance from the linear encoder home position (reference mark)) (32-bit data) is displayed after the Z-phase is passed. The value before the Z-phase is passed is undefined. For an A/B/Z-phase differential output linear encoder, the Z-phase counter (distance from the linear encoder home position (Z-phase)) (16-bit data) is displayed after the Z-phase is passed. Before the Z-phase is passed, a free-run counter is displayed with the position where the power is turned on set as "0". For an A/B/Z-phase differential output rotary encoder, the position within one-revolution is displayed.	○	○	—
Load-side encoder information 2	The following values are displayed for each encoder connected to the load-side. For a rotary servo motor, a multi-revolution ABS counter, that holds the counter value even when the power is cycled, is displayed. For the HK-MT_VW, however, a multi-revolution counter, that returns to "0" when the power is cycled, is displayed. For an absolute position linear encoder, "0" is displayed. For an incremental linear encoder, "0" is displayed. For an A/B/Z-phase differential output linear encoder, "0" is displayed. For an A/B/Z-phase differential output rotary encoder, "0" is displayed.	○	○	—
Temperature of servo motor thermistor	The thermistor temperature is displayed for the servo motor with a thermistor. For the servo motors without a thermistor, "9999" is displayed. For the servo motor with a thermistor, refer to the user's manual for the servo motor being used.	○	○	—
Motor side cumulative F/B pulses (BeforeGear)	The feedback pulses from the servo motor encoder are counted and displayed. (Servo motor encoder unit) The displayed value is limited within the range of "-999999999 to 999999999". When the value exceeds the upper or lower limit, it changes to "0". The value is negative in reverse rotation.	○	—	—
Electrical angle	The servo motor electrical angle is displayed. For the linear servo motor control mode, the value of manufacturer setting is displayed.	○	—	—
Motor/load side position deviation *2	The position deviation between the servo motor-side and load-side is displayed. This function can be used for fully closed loop control. The number of pulses is displayed in the load-side encoder unit.	○	○	○
Motor/load side speed deviation *2	The speed deviation between the servo motor-side and load-side is displayed. This function can be used for fully closed loop control.	○	○	○
Internal temperature of encoder	The internal temperature detected by the encoder is displayed. For the linear servo motor, "9999" is displayed.	○	○	○
Settling time	The period of time (settling time) from the completion of the command to INP (In-position) on is displayed.	○	○	—

Name	Description	Availability		
		Display All	Graph function	Analog monitor
Oscillation detection frequency	The frequency at the time of oscillation detection is displayed.	○	—	—
Number of tough drive operations	The number of times the tough drive function has activated is displayed.	○	—	—
Unit power consumption	For the MR-J5_-G_ or the MR-J5W_-G_, the unit power consumption is displayed. A positive value is displayed during power running, and a negative value is displayed during regeneration. For the MR-J5D_-G_, the power consumption of the converter unit connected with the protection coordination cable is displayed. When multiple MR-J5D_-G_ are connected to the converter unit, "0" is displayed for the second and subsequent MR-J5D_-G_.	○	—	—
Unit total power consumption	For the MR-J5_-G_ and the MR-J5W_-G_, the unit total power consumption is displayed. For the MR-J5D_-G_, the total power consumption of the converter unit connected with the protection coordination cable is displayed. When multiple MR-J5D_-G_ are connected to the converter unit, "0" is displayed for the second and subsequent MR-J5D_-G_.	○	—	—
Excessive error alarm margin	The margin for the excessive error alarm trigger level is displayed in the encoder pulse unit. The excessive error alarm is triggered when the margin is 0 pulse.	—	○	—
Overload alarm margin	The margins for the alarm levels of [AL. 050 Overload 1] and [AL. 051 Overload 2] are displayed as a percentage.	—	○	—
Overshoot amount	The overshoot amount during position mode and positioning mode is displayed in units of encoder pulses.	—	○	—
Torque equivalent to disturbance	The difference between the necessary torque and the actually required torque (torque current value) to drive the servo motor is displayed as the torque equivalent to disturbance.	—	○	—
Current position *4	In the profile position mode (pp) and point table mode (pt), the current position of the command unit with the machine home position set as "0" is displayed. In other control modes, the current position of the command unit is displayed.	○	○	—
Command position *4	In the profile position mode (pp) and point table mode (pt), the command current position with the machine home position set as "0" is displayed.	○	○	—
Controller position command *6	This indicates the position command from the controller in the cyclic synchronous position mode (csp).	—	○	—
Command remaining distance *4	In the profile position mode (pp) and point table mode (pt), the selected profile position or the remaining distance to the command position of the point table is displayed. In other control modes, "0" is displayed.	○	○	—
Command number *4	In the positioning mode (point table method), the selected point table number is displayed. In other control modes, "0" is displayed. The selected number is displayed during a temporary stop or in JOG operation mode.	○	○	—
Current command	This indicates the current command applied to the servo motor.	—	○	○
Speed command	This indicates the speed command being applied to the servo motor. In the position mode and positioning mode, the speed command calculated from the position command and command filter is displayed.	—	○	—
Command speed output 1	The command speed to be used for position control is displayed as the command output of the analog monitor.	—	—	○
Command speed output 2	The command speed to be used for speed control is displayed as the command output of the analog monitor.	—	—	○
Torque command	The torque command in the torque mode or the target torque value in the continuous operation to torque control mode is displayed. "0" is displayed in the position mode, positioning mode, and velocity mode.	—	○	—
Speed limit value	The speed limit value in the torque mode or continuous operation to torque control mode is displayed. "0" is displayed in the position mode, positioning mode, and velocity mode.	—	○	—
U-phase current feedback *1	This indicates the U-phase current value applied to the servo motor in internal units.	—	○	—
V-phase current feedback *1	This indicates the V-phase current value applied to the servo motor in internal units.	—	○	—

Name	Description	Availability		
		Display All	Graph function	Analog monitor
Encoder error counter *1	This indicates the cumulative number of errors during communication with the encoder.	—	○	—
Load-side encoder error counter *1	This indicates the cumulative number of errors during communication with the load side encoder.	—	○	—
Operation mode	The control mode number of the servo amplifier indicated in [Modes of operation display (Obj. 6061h)] is displayed.	—	○	—
Droop pulses (model position deviation)	Droop pulses of the deviation counter between a servo motor-side position and a model position are displayed.	—	○	—
Speed command 2 *2	This indicates the speed command being applied to the servo motor.	—	○	—
Droop pulses (command unit) *2	The number of droop pulses in the deviation counter is displayed. The number of pulses is displayed in the command unit.	—	○	—
U-phase current feedback (unit of the rated current) *3	The value of the U-phase current flowing in the servo motor is displayed in increments of 0.1 % in relation to the rated current as 100 %.	—	○	—
V-phase current feedback (unit of the rated current) *3	The value of the V-phase current flowing in the servo motor is displayed in increments of 0.1 % in relation to the rated current as 100 %.	—	○	—
W-phase current feedback (unit of the rated current) *3	The value of the W-phase current flowing in the servo motor is displayed in increments of 0.1 % in relation to the rated current as 100 %.	—	○	—
Converter effective load ratio *5	The effective value of the continuous effective load output of the converter unit is displayed in relation to the rated output as 100 %. For models other than the MR-J5D_-_G_, "0" is displayed.	○	—	—
Converter regenerative load ratio *5	The ratio of regenerative power to the rated output of the converter unit is displayed in percentage. For models other than the MR-J5D_-_G_, "0" is displayed.	○	—	—
Feedback position	The current position of the servo motor is displayed.	—	○	—

*1 This is selectable when using the drive recorder.

*2 Available on servo amplifiers with firmware version A5 or later.

*3 Available on servo amplifiers with firmware version B0 or later.

*4 Available on servo amplifiers with firmware version B8 or later.

*5 Available on servo amplifiers with firmware version C0 or later.

*6 Available on servo amplifiers with firmware version D4 or later.

Monitor signal (analog) and analog monitor [B]

On MR Configurator2, the status of the monitor signal (analog) can be obtained by using the "Display All" function and the graph function.

Refer to the list in this section for the signals which can be obtained with the "Display All" function and the graph function.

Signals that can be set with the analog monitor are also shown in the lists.

Name	Description	Availability		
		Display All	Graph function	Analog monitor
Cumulative feedback pulses	The feedback pulses from the servo motor encoder are counted and displayed. The displayed value is limited within the range of "-999999999 to 999999999". When the value exceeds the upper or lower limit, it changes to "0". The value is negative in reverse rotation. In the fully closed loop control mode, the value is in load-side encoder units with the gear taken into consideration.	○	—	—
Servo motor speed	The servo motor speed is displayed.	○	○	○
Droop pulses	The number of droop pulses in the deviation counter is displayed. The value is negative in reverse rotation. The number of pulses is displayed in the units of encoder pulses.	○	○	○
Cumulative command pulses	Position command input pulses are counted and displayed. The displayed value is limited within the range of "-999999999 to 999999999". When the value exceeds the upper or lower limit, it changes to "0". The value is negative under the reverse command.	○	—	—
Command pulse frequency	The frequency of the position command input pulses is displayed.	○	○	—
Command pulse frequency (speed unit)	The command pulse frequency is converted and displayed in the servo motor speed unit.	—	○	—
Regenerative load ratio	The ratio of regenerative power to permissible regenerative power is displayed as a percentage.	○	○	—
Effective load ratio	The continuous effective load current is displayed. The effective load ratio in relation to the rated current (= 100 %) is displayed.	○	○	—
Peak load ratio	The rated torque is displayed as 100 %. The maximum value of the torque generated in the past 15 seconds is displayed.	○	—	—
Torque/instantaneous torque	The instantaneous torque is displayed. The rated torque is displayed as 100 %. The value of the generated torque is displayed in real time.	○	○	○
Position within one-revolution	The position within one-revolution is displayed in the encoder pulse unit. In the fully closed loop control mode, the position within one-revolution is displayed in the servo motor encoder unit. For the linear servo motor control mode, the value of manufacturer setting is displayed.	○	○	—
ABS counter	The travel distance from the home position is displayed as a multi-revolution counter value of the absolute position encoder in the absolute position detection system. For the fully closed loop control mode, the ABS counter is displayed in the servo motor encoder unit. For the linear servo motor control mode, the value of manufacturer setting is displayed. For details, refer to "Checking the detected absolute position data" in the following manuals.  MR-J5 User's Manual (Hardware)	○	○	—
Load to motor inertia ratio	The estimated ratio of the load inertia moment to the servo motor inertia moment is displayed.	○	○	—
Bus voltage	The bus voltage of the converter part of the servo amplifier (between P+ and N-) is displayed.	○	○	○
Load-side encoder cumulative feedback pulses	The feedback pulses from the load-side encoder are counted and displayed. The displayed value is limited within the range of "-999999999 to 999999999". When the value exceeds the upper or lower limit, it changes to "0". The value is negative in reverse rotation.	○	—	—

Name	Description	Availability		
		Display All	Graph function	Analog monitor
Load-side encoder droop pulses	Droop pulses of the deviation counter between a load-side position and a command are displayed.	○	○	○
Load-side encoder information 1	The following values are displayed for each encoder connected to the load-side. For a rotary servo motor, the position within one-revolution is displayed. For an absolute position linear encoder, absolute position data is displayed. For an incremental linear encoder, the Z-phase counter (distance from the linear encoder home position (reference mark)) (32-bit data) is displayed after the Z-phase is passed. The value before the Z-phase is passed is undefined. For an A/B/Z-phase differential output linear encoder, the Z-phase counter (distance from the linear encoder home position (Z-phase)) (16-bit data) is displayed after the Z-phase is passed. Before the Z-phase is passed, a free-run counter is displayed with the position where the power is turned on set as "0". For an A/B/Z-phase differential output rotary encoder, the position within one-revolution is displayed.	○	○	—
Load-side encoder information 2	The following values are displayed for each encoder connected to the load-side. For a rotary servo motor, a multi-revolution ABS counter, that holds the counter value even when the power is cycled, is displayed. For the HK-MT_VW, however, a multi-revolution counter, that returns to "0" when the power is cycled, is displayed. For an absolute position linear encoder, "0" is displayed. For an incremental linear encoder, "0" is displayed. For an A/B/Z-phase differential output linear encoder, "0" is displayed. For an A/B/Z-phase differential output rotary encoder, "0" is displayed.	○	○	—
Temperature of servo motor thermistor	The thermistor temperature is displayed for the servo motor with a thermistor. For the servo motors without a thermistor, "9999" is displayed. For the servo motor with a thermistor, refer to the user's manual for the servo motor being used.	○	○	—
Motor side cumulative F/B pulses (BeforeGear)	The feedback pulses from the servo motor encoder are counted and displayed. (Servo motor encoder unit) The displayed value is limited within the range of "-999999999 to 999999999". When the value exceeds the upper or lower limit, it changes to "0". The value is negative in reverse rotation.	○	—	—
Electrical angle	The servo motor electrical angle is displayed. For the linear servo motor control mode, the value of manufacturer setting is displayed.	○	—	—
Motor/load side position deviation	The position deviation between the servo motor-side and load-side is displayed. This function can be used for fully closed loop control. The number of pulses is displayed in the load-side encoder unit.	○	○	○
Motor/load side speed deviation	The speed deviation between the servo motor-side and load-side is displayed. This function can be used for fully closed loop control.	○	○	○
Internal temperature of encoder	The internal temperature detected by the encoder is displayed. For the linear servo motor, "9999" is displayed.	○	○	○
Settling time	The period of time (settling time) from the completion of the command to INP (In-position) on is displayed.	○	○	—
Oscillation detection frequency	The frequency at the time of oscillation detection is displayed.	○	—	—
Number of tough drive operations	The number of times the tough drive function has activated is displayed.	○	—	—
Unit power consumption	The unit power consumption is displayed. A positive value is displayed during power running, and a negative value is displayed during regeneration.	○	—	—
Unit total power consumption	The unit total power consumption is displayed.	○	—	—

Name	Description	Availability		
		Display All	Graph function	Analog monitor
Excessive error alarm margin	The margin for the excessive error alarm trigger level is displayed in the encoder pulse unit. The excessive error alarm is triggered when the margin is 0 pulse.	—	○	—
Overload alarm margin	The margins for the alarm levels of [AL. 050 Overload 1] and [AL. 051 Overload 2] are displayed as a percentage.	—	○	—
Overshoot amount	The overshoot amount during position mode is displayed in units of encoder pulses.	—	○	—
Torque equivalent to disturbance	The difference between the necessary torque and the actually required torque (torque current value) to drive the servo motor is displayed as the torque equivalent to disturbance.	—	○	—
Controller position command *2	This indicates the position command from the controller in the position mode.	—	○	—
Current command	This indicates the current command applied to the servo motor.	—	○	○
Speed command	This indicates the speed command being applied to the servo motor. In the position mode, the speed command calculated from the position command and command filter is displayed.	—	○	—
Command speed output 1	The command speed to be used for position control is displayed as the command output of the analog monitor.	—	—	○
Command speed output 2	The command speed to be used for speed control is displayed as the command output of the analog monitor.	—	—	○
Torque command	The torque command in the torque mode or the target torque value in the continuous operation to torque control mode is displayed. "0" is displayed in the position mode and velocity mode.	—	○	—
Speed limit value	The speed limit value in the torque mode or continuous operation to torque control mode is displayed. "0" is displayed in the position mode and velocity mode.	—	○	—
U-phase current feedback *1	This indicates the U-phase current value applied to the servo motor in internal units.	—	○	—
V-phase current feedback *1	This indicates the V-phase current value applied to the servo motor in internal units.	—	○	—
Encoder error counter *1	This indicates the cumulative number of errors during communication with the encoder.	—	○	—
Load-side encoder error counter *1	This indicates the cumulative number of errors during communication with the load side encoder.	—	○	—
Droop pulses (model position deviation)	Droop pulses of the deviation counter between a servo motor-side position and a model position are displayed.	—	○	—
Speed command 2	This indicates the speed command being applied to the servo motor.	—	○	—
Droop pulses (command unit)	The number of droop pulses in the deviation counter is displayed. The number of pulses is displayed in the command unit.	—	○	—
U-phase current feedback (unit of the rated current)	The value of the U-phase current flowing in the servo motor is displayed in increments of 0.1 % in relation to the rated current as 100 %.	—	○	—
V-phase current feedback (unit of the rated current)	The value of the V-phase current flowing in the servo motor is displayed in increments of 0.1 % in relation to the rated current as 100 %.	—	○	—
W-phase current feedback (unit of the rated current)	The value of the W-phase current flowing in the servo motor is displayed in increments of 0.1 % in relation to the rated current as 100 %.	—	○	—
Feedback position	The current position of the servo motor is displayed.	—	○	—

*1 This is selectable when using the drive recorder.

*2 Available on servo amplifiers with firmware version D4 or later.

Monitor signal (analog) and analog monitor [A]

On MR Configurator2, the status of the monitor signal (analog) can be obtained by using the "Display All" function and the graph function.

Refer to the list in this section for the signals which can be obtained with the "Display All" function and the graph function.

Signals that can be set with the analog monitor are also shown in the lists.

Name	Description	Availability		
		Display All	Graph function	Analog monitor
Cumulative feedback pulses	The feedback pulses from the servo motor encoder are counted and displayed. The displayed value is limited within the range of "-999999999 to 999999999". When the value exceeds the upper or lower limit, it changes to "0". The value is negative in reverse rotation. In the fully closed loop control mode, the value is in load-side encoder units with the gear taken into consideration. The fully closed loop control mode can be used for servo amplifiers with firmware version A5 or later.	○	—	—
Servo motor speed	The servo motor speed is displayed.	○	○	○
Droop pulses	The number of droop pulses in the deviation counter is displayed. The value is negative in reverse rotation. The number of pulses is displayed in the units of encoder pulses.	○	○	○
Cumulative command pulses	Position command input pulses are counted and displayed. The displayed value is limited within the range of "-999999999 to 999999999". When the value exceeds the upper or lower limit, it changes to "0". The value is negative under the reverse command.	○	—	—
Command pulse frequency	The frequency of the position command input pulses is displayed.	○	○	○
Command pulse frequency (speed unit)	The command pulse frequency is converted and displayed in the servo motor speed unit.	—	○	—
Analog speed command voltage/Analog speed limit voltage	In the speed control mode, the analog speed command voltage is displayed; in the torque control mode, the analog speed limit voltage is displayed.	○	—	—
Analog torque command voltage/Analog torque limit voltage	In the position/speed control mode, the analog torque limit voltage is displayed; in the torque control mode, the analog speed command voltage is displayed.	○	—	—
Regenerative load ratio	The ratio of regenerative power to permissible regenerative power is displayed as a percentage.	○	○	—
Effective load ratio	The continuous effective load current is displayed. The effective value in relation to the rated current (= 100 %) is displayed.	○	○	—
Peak load ratio	The rated torque is displayed as 100 %. The maximum value of the torque generated in the past 15 seconds is displayed.	○	—	—
Torque/instantaneous torque	The instantaneous torque is displayed. The rated torque is displayed as 100 %. The value of the generated torque is displayed in real time.	○	○	○
Position within one-revolution	The position within one-revolution is displayed in the encoder pulse unit. In the fully closed loop control mode, the position within one-revolution is displayed in the servo motor encoder unit. The fully closed loop control mode can be used for servo amplifiers with firmware version A5 or later. For the linear servo motor control mode, the value of manufacturer setting is displayed.	○	○	—
ABS counter	The travel distance from the home position is displayed as a multi-revolution counter value of the absolute position encoder in the absolute position detection system. For the fully closed loop control mode, the ABS counter is displayed in the servo motor encoder unit. The fully closed loop control mode can be used for servo amplifiers with firmware version A5 or later. For the linear servo motor control mode, the value of manufacturer setting is displayed. For details, refer to "Checking the detected absolute position data" in the following manuals.  MR-J5 User's Manual (Hardware)	○	○	—

Name	Description	Availability		
		Display All	Graph function	Analog monitor
Load to motor inertia ratio	The estimated ratio of the load inertia moment to the servo motor inertia moment is displayed.	<input type="radio"/>	<input type="radio"/>	—
Bus voltage	The bus voltage of the converter part of the servo amplifier (between P+ and N-) is displayed.	<input type="radio"/>	<input type="radio"/>	<input type="radio"/>
Load-side encoder cumulative feedback pulses *2	The feedback pulses from the load-side encoder are counted and displayed. The displayed value is limited within the range of "-999999999 to 999999999". When the value exceeds the upper or lower limit, it changes to "0". The value is negative in reverse rotation.	<input type="radio"/>	—	—
Load-side encoder droop pulses *2	Droop pulses of the deviation counter between a load-side position and a command are displayed.	<input type="radio"/>	<input type="radio"/>	<input type="radio"/>
Load-side encoder information 1	The following values are displayed for each encoder connected to the load-side. For a rotary servo motor, the position within one-revolution is displayed. For an absolute position linear encoder, absolute position data is displayed. For an incremental linear encoder, the Z-phase counter (distance from the linear encoder home position (reference mark)) (32-bit data) is displayed after the Z-phase is passed. The value before the Z-phase is passed is undefined. For an A/B/Z-phase differential output linear encoder, the Z-phase counter (distance from the linear encoder home position (Z-phase)) (16-bit data) is displayed after the Z-phase is passed. Before the Z-phase is passed, a free-run counter is displayed with the position where the power is turned on set as "0". For an A/B/Z-phase differential output rotary encoder, the position within one-revolution is displayed.	<input type="radio"/>	<input type="radio"/>	—
Load-side encoder information 2	The following values are displayed for each encoder connected to the load-side. For a rotary servo motor, a multi-revolution ABS counter, that holds the counter value even when the power is cycled, is displayed. For the HK-MT_VW, however, a multi-revolution counter, that returns to "0" when the power is cycled, is displayed. For an absolute position linear encoder, "0" is displayed. For an incremental linear encoder, "0" is displayed. For an A/B/Z-phase differential output linear encoder, "0" is displayed. For an A/B/Z-phase differential output rotary encoder, "0" is displayed.	<input type="radio"/>	<input type="radio"/>	—
Temperature of servo motor thermistor	The thermistor temperature is displayed for the servo motor with a thermistor. For the servo motors without a thermistor, "9999" is displayed. For the servo motor with a thermistor, refer to the user's manual for the servo motor being used.	<input type="radio"/>	<input type="radio"/>	—
Motor side cumulative F/B pulses (BeforeGear)	The feedback pulses from the servo motor encoder are counted and displayed. (Servo motor encoder unit) The displayed value is limited within the range of "-999999999 to 999999999". When the value exceeds the upper or lower limit, it changes to "0". The value is negative in reverse rotation.	<input type="radio"/>	—	—
Electrical angle	The servo motor electrical angle is displayed. For the linear servo motor control mode, the value of manufacturer setting is displayed.	<input type="radio"/>	—	—
Motor/load side position deviation *2	The position deviation between the servo motor-side and load-side is displayed. This function can be used for fully closed loop control. The number of pulses is displayed in the load-side encoder unit.	<input type="radio"/>	<input type="radio"/>	<input type="radio"/>
Motor/load side speed deviation *2	The speed deviation between the servo motor-side and load-side is displayed. This function can be used for fully closed loop control.	<input type="radio"/>	<input type="radio"/>	<input type="radio"/>
Internal temperature of encoder	The internal temperature detected by the encoder is displayed. For the linear servo motor, "9999" is displayed.	<input type="radio"/>	<input type="radio"/>	<input type="radio"/>
Settling time	The period of time (settling time) from the completion of the command to INP (In-position) on is displayed.	<input type="radio"/>	<input type="radio"/>	—

Name	Description	Availability		
		Display All	Graph function	Analog monitor
Oscillation detection frequency	The frequency at the time of oscillation detection is displayed.	○	—	—
Number of tough drive operations	The number of times the tough drive function has activated is displayed.	○	—	—
Unit power consumption	The unit power consumption is displayed. The positive value is displayed in power running. The negative value is displayed in regeneration.	○	—	—
Unit total power consumption	The unit total power consumption is displayed.	○	—	—
Excessive error alarm margin	The margin for the excessive error alarm trigger level is displayed in the encoder pulse unit. The excessive error alarm is triggered when the margin is 0 pulse.	—	○	—
Overload alarm margin	The margins for the alarm levels of [AL. 050 Overload 1] and [AL. 051 Overload 2] are displayed as a percentage.	—	○	—
Overshoot amount	The overshoot amount during position mode is displayed in units of encoder pulses.	—	○	—
Torque equivalent to disturbance	The difference between the necessary torque and the actually required torque (torque current value) to drive the servo motor is displayed as the torque equivalent to disturbance.	—	○	—
Current command	This indicates the current command applied to the servo motor.	—	○	○
Speed command	This indicates the speed command being applied to the servo motor. In the position mode, the speed command calculated from the position command and command filter is displayed.	—	○	—
Command speed output 2	The command speed to be used for speed control is displayed as the command output of the analog monitor.	—	—	○
Torque command	The target torque value of the torque command in the torque mode is displayed. "0" is displayed in the position mode and velocity mode.	—	○	—
Speed limit value	The speed limit value in the torque mode is displayed. "0" is displayed in the position mode and velocity mode.	—	○	—
U-phase current feedback* ¹	This indicates the U-phase current value applied to the servo motor in internal units.	—	○	—
V-phase current feedback* ¹	This indicates the V-phase current value applied to the servo motor in internal units.	—	○	—
Encoder error counter* ¹	This indicates the cumulative number of errors during communication with the encoder.	—	○	—
Load-side encoder error counter* ¹	This indicates the cumulative number of errors during communication with the load side encoder.	—	○	—
Operation mode	The control modes of the servo amplifier are displayed. The following shows the value of each control mode. Position control mode: -20 Speed control mode: -21 Torque control mode: -22 Test operation mode (JOG operation): -1 Test operation mode (Positioning operation): -2 Test operation mode (Output signal (DO) forced output): -4 Test operation mode (Machine analyzer): -6	—	○	—
Droop pulses (model position deviation)	Droop pulses of the deviation counter between a servo motor-side position and a model position are displayed.	—	○	—
Speed command 2 * ²	This indicates the speed command being applied to the servo motor.	—	○	—
Droop pulses (command unit) * ²	The number of droop pulses in the deviation counter is displayed. The number of pulses is displayed in the command unit.	—	○	—
U-phase current feedback (unit of the rated current) * ³	The value of the U-phase current flowing in the servo motor is displayed in increments of 0.1 % in relation to the rated current as 100 %.	—	○	—
V-phase current feedback (unit of the rated current) * ³	The value of the V-phase current flowing in the servo motor is displayed in increments of 0.1 % in relation to the rated current as 100 %.	—	○	—
W-phase current feedback (unit of the rated current) * ³	The value of the W-phase current flowing in the servo motor is displayed in increments of 0.1 % in relation to the rated current as 100 %.	—	○	—
Feedback position	The current position of the servo motor is displayed.	—	○	—

*1 This is selectable when using the drive recorder.

*2 Available on servo amplifiers with firmware version A5 or later.

*3 Available on servo amplifiers with firmware version B0 or later.

Monitor signal (digital) [G]

The status of the monitor signal (digital) can be obtained by using the I/O monitor and graph functions of MR Configurator2. As for DI/DO in the table, DI indicates the monitor signal (digital) input to a servo amplifier; DO indicates the monitor signal (digital) output from a servo amplifier.

The on/off status of DI is as follows:

- On: Either the external input signal or input from the controller is on.
- Off: The external input signal and the input from the controller are off.

Symbol	Device name	Description	DI/DO
ABSV	Absolute position erased	Refer to "Signal (device) explanation" in the following manual.	DO
ALM	Malfunction	MR-J5 User's Manual (Hardware)	DO
BWNG	Battery warning	MR-J5D User's Manual (Hardware)	DO
WNGSTOP	Motor stop warning		DO
CDP	Gain switching		DI
CDP2	Gain switching 2		DI
CDPS	Variable gain enabled		DO
CDPS2	Variable gain enabled 2		DO
CLD *1	Fully closed loop selection		DI
CLDS *1	Fully closed loop control in progress		DO
CPO *1	Rough match	When the command remaining distance is less than the value of the rough match output range set in [Pr. PT12], CPO turns on. CPO is turned off during base circuit shut-off. CPO turns on at servo-on.	DO
CVST *5	Converter stop	Refer to "Signal (device) explanation" in the following manual. MR-J5D User's Manual (Hardware)	DO
DOA *3	General-purpose output A	Refer to "Signal (device) explanation" in the following manual.	DO
DOB *3	General-purpose output B	MR-J5 User's Manual (Hardware)	
DOC *3	General-purpose output C	MR-J5D User's Manual (Hardware)	
DOG	Proximity dog		DI
EM1	Forced stop 1		DI
EM2	Forced stop 2		DI
INP	In-position		DO
LSN	Reverse rotation stroke end		DI
LSP	Forward rotation stroke end		DI
MBR	Electromagnetic brake interlock		DO
MEND *4	Traveling completion	When the droop pulse is within the in-position range set in [Pr. PA10 In-position range] and the command remaining distance is "0", MEND switches on. When the servo-on signal is turned on, MEND switches on. MEND is off in the servo-off state.	DO
MTTR	Tough drive in progress	Refer to "Signal (device) explanation" in the following manual.	DO
PC	Proportional control	MR-J5 User's Manual (Hardware) MR-J5D User's Manual (Hardware)	DI
POT *1	Position range	When the actual current position is within the range set in [Pr. PT19] and [Pr. PT21], POT turns on. POT turns off unless homing operation has completed or if the base circuit shut-off is in progress.	DO
RD	Ready	Refer to "Signal (device) explanation" in the following manual. MR-J5 User's Manual (Hardware) MR-J5D User's Manual (Hardware)	DO
RDY	In ready-on state	RDY is turned on in ready-on state.	DO
SA	Speed reached	Refer to "Signal (device) explanation" in the following manual. MR-J5 User's Manual (Hardware) MR-J5D User's Manual (Hardware)	DO
STO	In STO state	When the energy supply to a servo motor is being electrically shut off by the STO function, STO is on.	DO
STO1	STO1	When STO1 is conducted, the STO1 signal is on.	DI
STO2	STO2	When STO2 is conducted, the STO2 signal is on.	DI

Symbol	Device name	Description	DI/DO
STOC *2	STO command	Operation command of the safety sub-function STO. The STO function is activated when OFF is input from the controller. ☞ Page 435 Input device	DI
SS1C *2	SS1 command	Operation command of the safety sub-function SS1. The SS1 function is activated when OFF is input from the controller. ☞ Page 435 Input device	DI
SS2C *2	SS2 command	Operation command of the safety sub-function SS2. The SS2 function is activated when OFF is input from the controller. ☞ Page 435 Input device	DI
SLS1C *2	SLS1 command	Operation command of the safety sub-function SLS1. The SLS1 function is activated when OFF is input from the controller. [Pr. PSA07 SLS deceleration monitor time 1] and [Pr. PSA11 SLS speed 1] are used as functional safety parameters. ☞ Page 435 Input device	DI
SLS2C *2	SLS2 command	Operation command of the safety sub-function SLS2. The SLS2 function is activated when OFF is input from the controller. [Pr. PSA08 SLS deceleration monitor time 2] and [Pr. PSA12 SLS speed 2] are used as functional safety parameters.	DI
SLS3C *2	SLS3 command	Operation command of the safety sub-function SLS3. The SLS3 function is activated when OFF is input from the controller. [Pr. PSA09 SLS deceleration monitor time 3] and [Pr. PSA13 SLS speed 3] are used as functional safety parameters.	DI
SLS4C *2	SLS4 command	Operation command of the safety sub-function SLS4. The SLS4 function is activated when OFF is input from the controller. [Pr. PSA10 SLS deceleration monitor time 4] and [Pr. PSA14 SLS speed 4] are used as functional safety parameters.	DI
SDIPC *2	SDIP command	Operation command of the safety sub-function SDIP. The SDIP function is activated when OFF is input from the controller. ☞ Page 435 Input device	DI
SDINC *2	SDIN command	Operation command of the safety sub-function SDIN. The SDIN function is activated when OFF is input from the controller. ☞ Page 435 Input device	DI
SLT1C *2	SLT1 command	Operation command of the safety sub-function SLT1. The SLT1 function is activated when OFF is input from the controller. [Pr. PSB10 SLT torque upper limit value 1] and [Pr. PSB14 SLT torque lower limit value 1] are used as functional safety parameters. ☞ Page 435 Input device	DI
SLT2C *2	SLT2 command	Operation command of the safety sub-function SLT2. The SLT2 function is activated when OFF is input from the controller. [Pr. PSB11 SLT torque upper limit value 2] and [Pr. PSB15 SLT torque lower limit value 2] are used as functional safety parameters.	DI
SLT3C *2	SLT3 command	Operation command of the safety sub-function SLT3. The SLT3 function is activated when OFF is input from the controller. [Pr. PSB12 SLT torque upper limit value 3] and [Pr. PSB16 SLT torque lower limit value 3] are used as functional safety parameters.	DI
SLT4C *2	SLT4 command	Operation command of the safety sub-function SLT4. The SLT4 function is activated when OFF is input from the controller. [Pr. PSB13 SLT torque upper limit value 4] and [Pr. PSB17 SLT torque lower limit value 4] are used as functional safety parameters.	DI
SLIC *2	SLI command	Operation command of the safety sub-function SLI. The SLI function is activated when OFF is input from the controller. ☞ Page 435 Input device	DI
STOS *2	STO output	Operation status of the safety sub-function STO. STO output is turned off while the STO function is operating. ☞ Page 436 Output device	DO
SS1S *2	SS1 output	Operation status of the safety sub-function SS1. SS1 output is turned off while the SS1 function is operating. ☞ Page 436 Output device	DO
SS2S *2	SS2 output	Operation status of the safety sub-function SS2. SS2 output is turned off while the SS2 function is operating. ☞ Page 436 Output device	DO
SLS1S *2	SLS1 output	Operation status of the safety sub-function SLS1. SLS1 output is turned off while the SLS1 function is operating. ☞ Page 436 Output device	DO

Symbol	Device name	Description	DI/DO
SLS2S *2	SLS2 output	Operation status of the safety sub-function SLS2. SLS2 output is turned off while the SLS2 function is operating. ☞ Page 436 Output device	DO
SLS3S *2	SLS3 output	Operation status of the safety sub-function SLS3. SLS3 output is turned off while the SLS3 function is operating. ☞ Page 436 Output device	DO
SLS4S *2	SLS4 output	Operation status of the safety sub-function SLS4. SLS4 output is turned off while the SLS4 function is operating. ☞ Page 436 Output device	DO
SSMS *2	SSM output	Indicates that the servo motor speed is equal to or less than the SSM speed while speed monitoring by the SSM function is in operation. ☞ Page 436 Output device	DO
SOSS *2	SOS output	Operation status of the safety sub-function SOS. SOS output is turned off while the SOS function is operating. ☞ Page 436 Output device	DO
SBCS *2	SBC output	Operation status of the safety sub-function STO. SBC output is turned off while the STO function is operating. ☞ Page 436 Output device	DO
SDIPS *2	SDIP output	Operation status of the safety sub-function SDIP. SDIP output is turned off while the SDIP function is operating. ☞ Page 436 Output device	DO
SDINS *2	SDIN output	Operation status of the safety sub-function SDIN. SDIN output is turned off while the SDIN function is operating. ☞ Page 436 Output device	DO
SLT1S *2	SLT1 output	Operation status of the safety sub-function SLT1. SLT1 output is turned off while the SLT1 function is operating. ☞ Page 436 Output device	DO
SLT2S *2	SLT2 output	Operation status of the safety sub-function SLT2. SLT2 output is turned off while the SLT2 function is operating. ☞ Page 436 Output device	DO
SLT3S *2	SLT3 output	Operation status of the safety sub-function SLT3. SLT3 output is turned off while the SLT3 function is operating. ☞ Page 436 Output device	DO
SLT4S *2	SLT4 output	Operation status of the safety sub-function SLT4. SLT4 output is turned off while the SLT4 function is operating. ☞ Page 436 Output device	DO
SLIS *2	SLI output	Operation status of the safety sub-function SLI. SLI output is turned off while the SLI function is operating. ☞ Page 436 Output device	DO
TLC	Limiting torque	Refer to "Signal (device) explanation" in the following manual. ☞MR-J5 User's Manual (Hardware) ☞MR-J5D User's Manual (Hardware)	DO
TPR1 *1	Touch probe 1		DI
TPR2 *1	Touch probe 2		DI
TPR3 *1	Touch probe 3		DI
VLC	Limiting speed		DO
WNG	Warning		DO
ZP2	Homing completion 2	When homing finishes successfully, ZP2 turns on.	DO
ZSP	Zero speed detection	Refer to "Signal (device) explanation" in the following manual. ☞MR-J5 User's Manual (Hardware) ☞MR-J5D User's Manual (Hardware)	DO

*1 Available on servo amplifiers with firmware version A5 or later.

*2 Available on servo amplifiers with firmware version B2 or later.

*3 Available on servo amplifiers with firmware version B6 or later.

*4 Available on servo amplifiers with firmware version B8 or later.

*5 Available on servo amplifiers with firmware version C0 or later.

Monitor signal (digital) [B]

The status of the monitor signal (digital) can be obtained by using the I/O monitor and graph functions of MR Configurator2. As for DI/DO in the table, DI indicates the monitor signal (digital) input to a servo amplifier; DO indicates the monitor signal (digital) output from a servo amplifier.

The on/off status of DI is as follows:

- On: Either the external input signal or input from the controller is on.
- Off: The external input signal and the input from the controller are off.

Symbol	Device name	Description	DI/DO
ABSV	Absolute position erased	Refer to "Signal (device) explanation" in the following manual.	DO
ALM	Malfunction	MR-J5 User's Manual (Hardware)	DO
BWNG	Battery warning		DO
WNGSTOP	Motor stop warning		DO
CDP	Gain switching		DI
CDP2	Gain switching 2		DI
CDPS	Variable gain enabled		DO
CDPS2	Variable gain enabled 2		DO
CLD	Fully closed loop selection		DI
CLDS	Fully closed loop control in progress		DO
DOG	Proximity dog		DI
EM1	Forced stop 1		DI
EM2	Forced stop 2		DI
INP	In-position		DO
FLS	Upper stroke limit		DI
RLS	Lower stroke limit		DI
MBR	Electromagnetic brake interlock		DO
MTTR	Tough drive in progress		DO
PC	Proportional control		DI
RD	Ready		DO
RDY	In ready-on state	RDY is turned on in ready-on state.	DO
SA	Speed reached	Refer to "Signal (device) explanation" in the following manual.	DO
TLC	Limiting torque	MR-J5 User's Manual (Hardware)	DO
VLC	Limiting speed		DO
WNG	Warning		DO
ZSP	Zero speed detection	Refer to "Signal (device) explanation" in the following manual. MR-J5 User's Manual (Hardware)	DO
CABS	Absolute position reference point data set request	Turns on when an absolute position reference point data set request is received from the controller. When it turns on, the absolute position reference point data is updated.	DI
CSV1	Control mode setting 1	Updated by the commands from the controller (control mode).	DI
CSV2	Control mode setting 2	For details on each control mode setting, refer to the following. Page 403 Controller command control mode	DI
CSV3	Continuous operation to torque control mode command		DI
CZCT	ZCT re-creation request	Turns on when a ZCT re-creation request is received from the controller.	DI
EMG	Controller emergency stop	Emergency stop command from the controller	DI
RES	Reset	An alarm can be reset by turning on RES (Reset). Some alarms cannot be deactivated by RES (Reset). For details, refer to "List of alarm No./warning No." in the following manual. MR-J5 User's Manual (Troubleshooting)	DI
SABS	Absolute position reference point data set request completed	Turns on when the absolute position reference point data is updated by homing.	DO
SABSE	Incorrect absolute position reference data set	Turns on when the absolute position reference point data cannot be updated by homing properly.	DO

Symbol	Device name	Description	DI/DO
SSV1	Currently selected control mode 1	The control mode currently selected is displayed.	DO
SSV2	Currently selected control mode 2	For details on each control mode setting, refer to the following.  Page 403 Currently selected control mode	DO
SSV3	Continuous operation to torque control mode		DO
STO	In STO state	When the energy supply to a servo motor is being electrically shut off by the STO function, STO is on.	DO
STO1	STO1	When STO1 is conducted, the STO1 signal is on.	DI
STO2	STO2	When STO2 is conducted, the STO2 signal is on.	DI

Controller command control mode

Each control mode and the on/off state of devices are as follows.

Control mode	CSV1	CSV2	CSV3
Position control mode	0 (off)	0 (off)	0 (off)
Speed control mode	1 (on)	0 (off)	0 (off)
Torque limit mode	0 (off)	1 (on)	0 (off)
Continuous operation to torque control mode	Undefined	Undefined	1 (on)

Currently selected control mode

Each control mode and the on/off state of devices are as follows.

Control mode	SSV1	SSV2	SSV3
Position control mode	0 (off)	0 (off)	0 (off)
Speed control mode	1 (on)	0 (off)	0 (off)
Torque limit mode	0 (off)	1 (on)	0 (off)
Continuous operation to torque control mode	Undefined	Undefined	1 (on)

Monitor signal (digital) [A]

The status of the monitor signal (digital) can be obtained by using the I/O monitor and graph functions of MR Configurator2. As for DI/DO in the table, DI indicates the monitor signal (digital) input to a servo amplifier; DO indicates the monitor signal (digital) output from a servo amplifier.

The on/off status of DI is as follows:

- On: Either the external input signal or input from the controller is on.

- Off: The external input signal and the input from the controller are off.

Symbol	Device name	Description	DI/DO
ABSB0	ABS transmission data bit 0	Refer to "Signal (device) explanation" in the following manual. MR-J5 User's Manual (Hardware)	DO
ABSB1	ABS transmission data bit 1		DO
ABSM	ABS transfer mode		DI
ABSR	ABS request		DI
ABST	ABS transmission data ready		DO
ABSV	Absolute position erased		DO
ALM	Malfunction		DO
ALMWNG	Malfunction/Warning		DO
BW9F	AL9F warning		DO
BWNG	Battery warning		DO
WNGSTOP	Motor stop warning		DO
CDP	Gain switching		DI
CDP2	Gain switching 2		DI
CDPS	Variable gain enabled		DO
CDPS2	Variable gain enabled 2		DO
CLD ^{*1}	Fully closed loop selection		DI
CLDS ^{*1}	Fully closed loop control in progress		DO
CM1	Electronic gear selection 1		DI
CM2	Electronic gear selection 2		DI
CR	Clear		DI
EM1	Forced stop 1		DI
EM2	Forced stop 2		DI
INP	In-position		DO
LOP	Control switching		DI
LSN	Reverse rotation stroke end		DI
LSP	Forward rotation stroke end		DI
MBR	Electromagnetic brake interlock		DO
MTTR	Tough drive in progress		DO
OP	Z-phase output		DO
PC	Proportional control		DI
PEN ^{*1}	Command input permission signal	DI	
PENS ^{*1}	Command pulse train input permitted	DO	
RD	Ready	DO	
RES	Reset	DI	
RS1	Forward rotation selection	DI	
RS2	Reverse rotation selection	DI	
SA	Speed reached	DO	
SON	Servo-on	DI	
SP1	Speed selection 1	DI	
SP2	Speed selection 2	DI	
SP3	Speed selection 3	DI	
ST1	Forward rotation start	DI	
ST2	Reverse rotation start	DI	
STAB2	Second acceleration/deceleration selection	DI	
STO	In STO state	When the energy supply to a servo motor is being electrically shut off by the STO function, the STO signal is on.	DO
STO1	STO1	When STO1 is conducted, the STO1 signal is on.	DI
STO2	STO2	When STO2 is conducted, the STO2 signal is on.	DI

Symbol	Device name	Description	DI/DO
TL	External torque limit selection	Refer to "Signal (device) explanation" in the following manual. MR-J5 User's Manual (Hardware)	DI
TL1	Internal torque limit selection		DI
TLC	Limiting torque		DO
VLC	Limiting speed		DO
WNG	Warning		DO
ZSP	Zero speed detection		DO

*1 Available on servo amplifiers with firmware version A5 or later.

Signal block diagram

The following signal block diagram indicates the points at where the monitor signals (analog) and analog monitors are detected.

Semi closed loop control [G] [B]

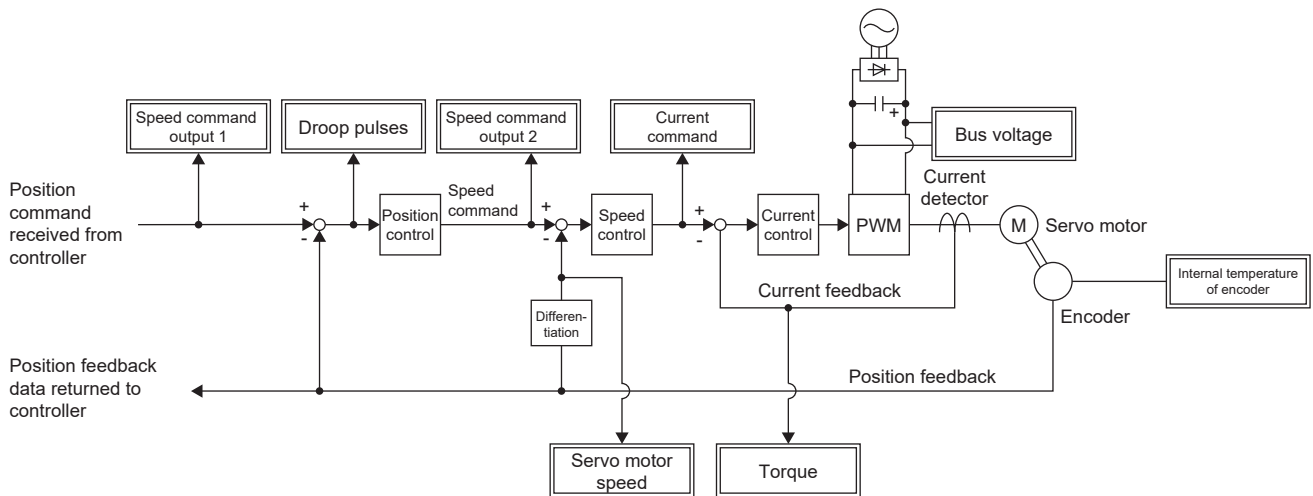

Fully closed loop control [G] [B]

This control can be used on servo amplifiers with firmware version A5 or later.

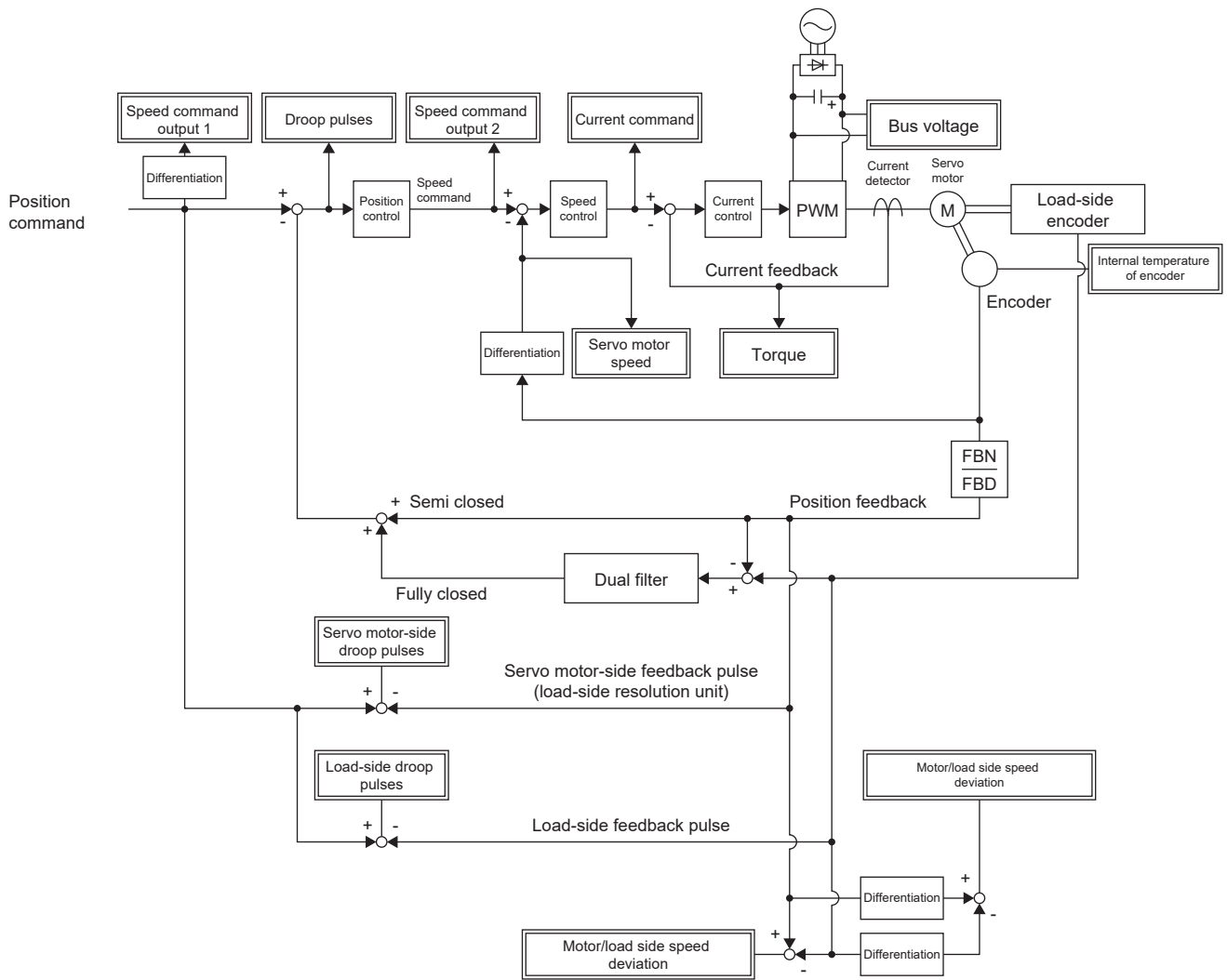

Semi closed loop control [A]

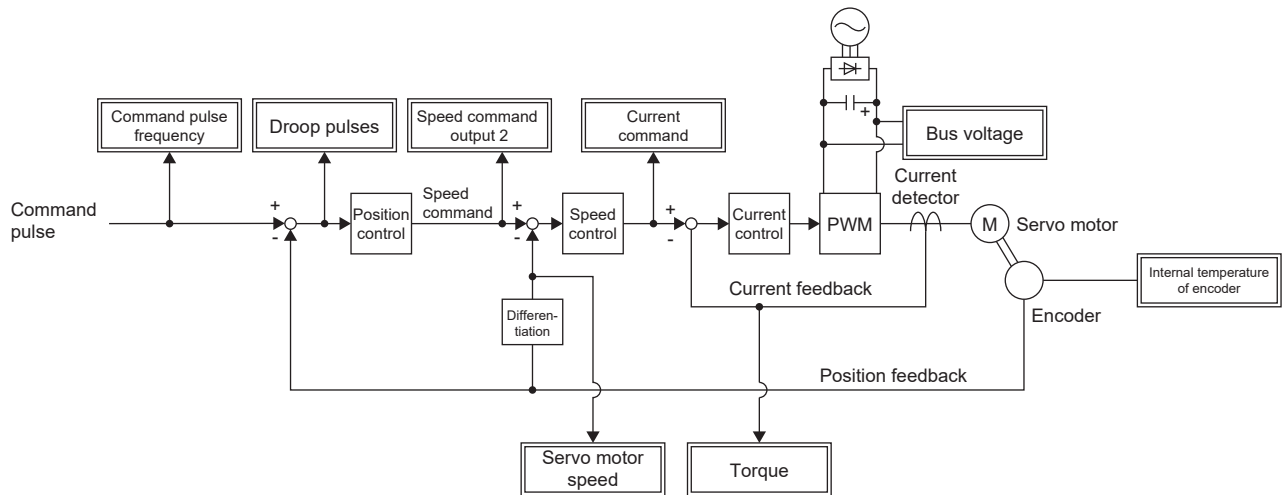

Fully closed loop control [A]

This control can be used on servo amplifiers with firmware version A5 or later.

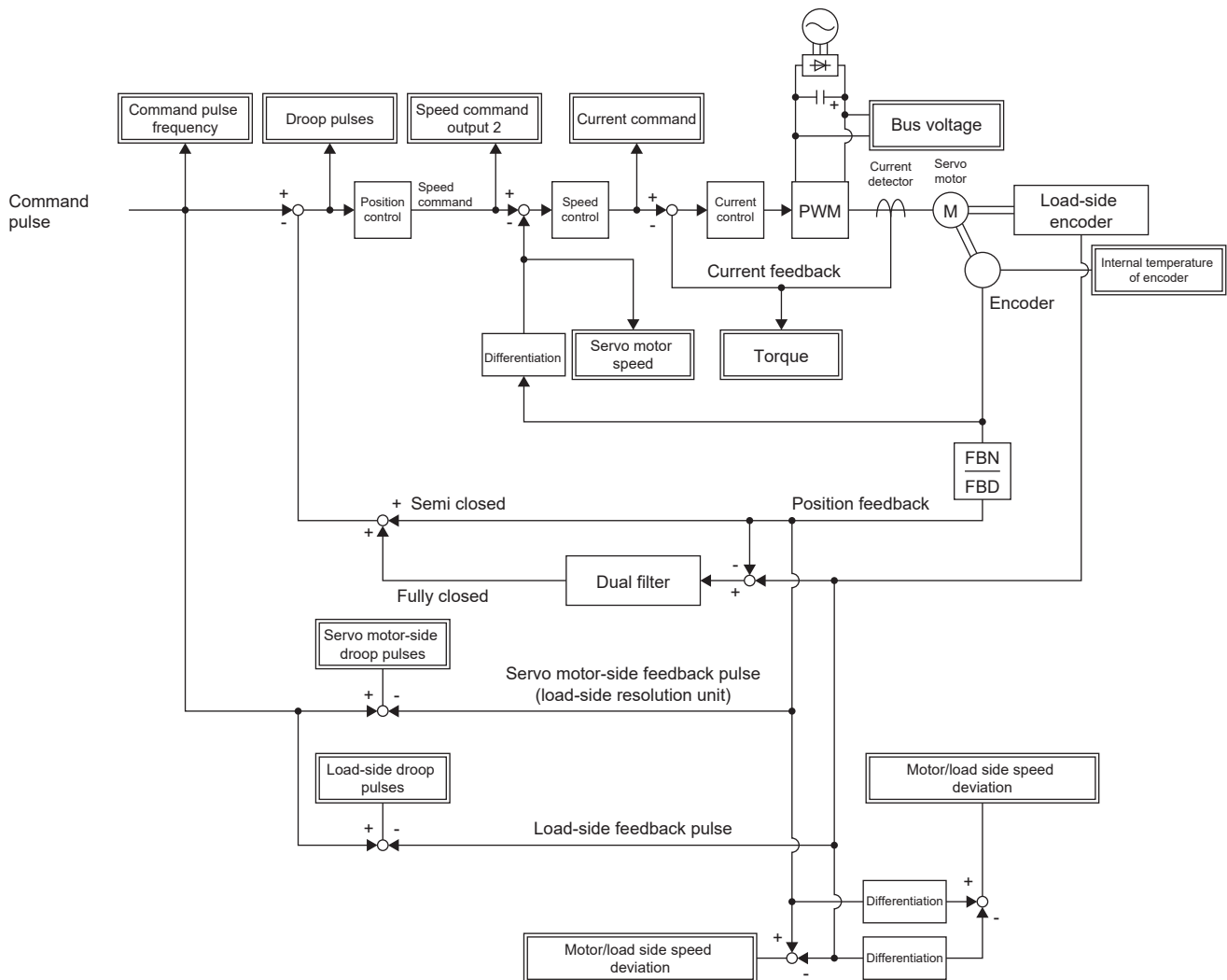

5.2 Checking with MR Configurator2

By using this engineering tool, the status of the servo amplifier (including the servo motor speed, torque, and bus voltage) can be checked.

In the "Display All" function, the analog data signals of the servo amplifier can be displayed in a list and be readily checked. In the graph function, the monitor signals can be saved with the high-speed sampling cycle, and the change of signals can be checked when the gains of the servo amplifier are adjusted. In addition, as the I/O monitor displays the status of the I/O signals of the servo amplifier, the status of the wiring and signals can be checked.

Refer to the following for the signals which can be checked with the "Display All" function and the graph function.

☞ Page 388 Explanation of monitor signals

The signals set in the I/O device are displayed in the I/O monitor display.

"Display All" function

The analog data signals of the servo amplifier can be displayed with the "Display All" function of MR Configurator2. In "Display All", the status of the servo amplifier can be updated periodically and displayed.

Graph function

The monitor signals of the selected servo amplifier can be measured and displayed in the graph. For setting details, refer to "Help" of MR Configurator2.

Display method

1. Open the graph display screen in MR Configurator2.

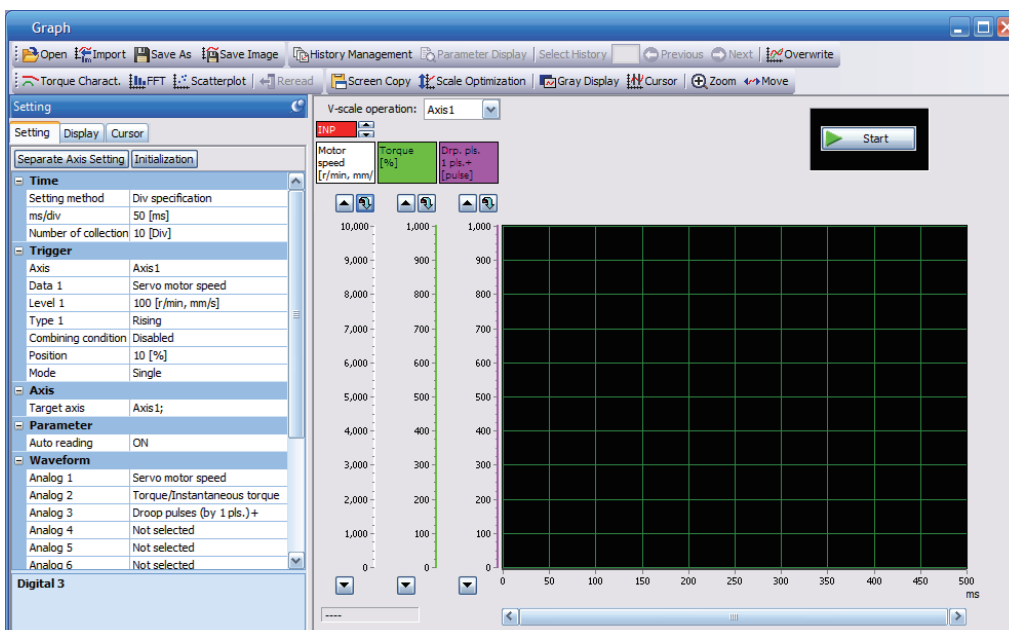

2. Set the sampling time, trigger, and other areas as required, then start measurement.

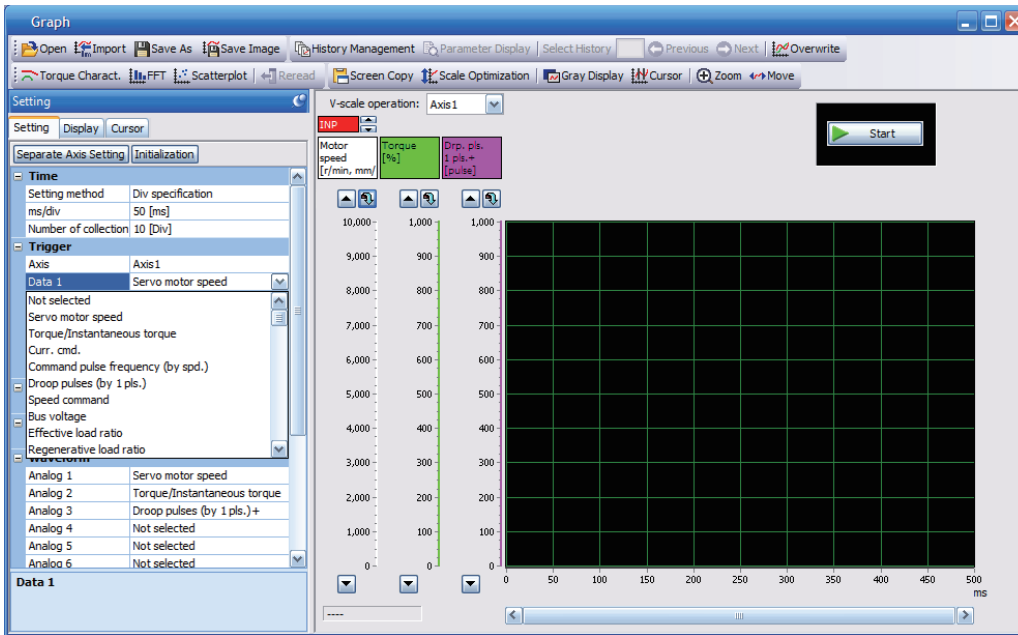

3. The waveform is displayed upon completion of measurement. The obtained data can be checked by clicking "Zoom", "Cursor", and other buttons.

MR Configurator2 with software version 1.110Q or later supports saving data in GX LogViewer format (JSON file) with the graph function or drive recorder function. The file is saved with a ".json" extension by default.

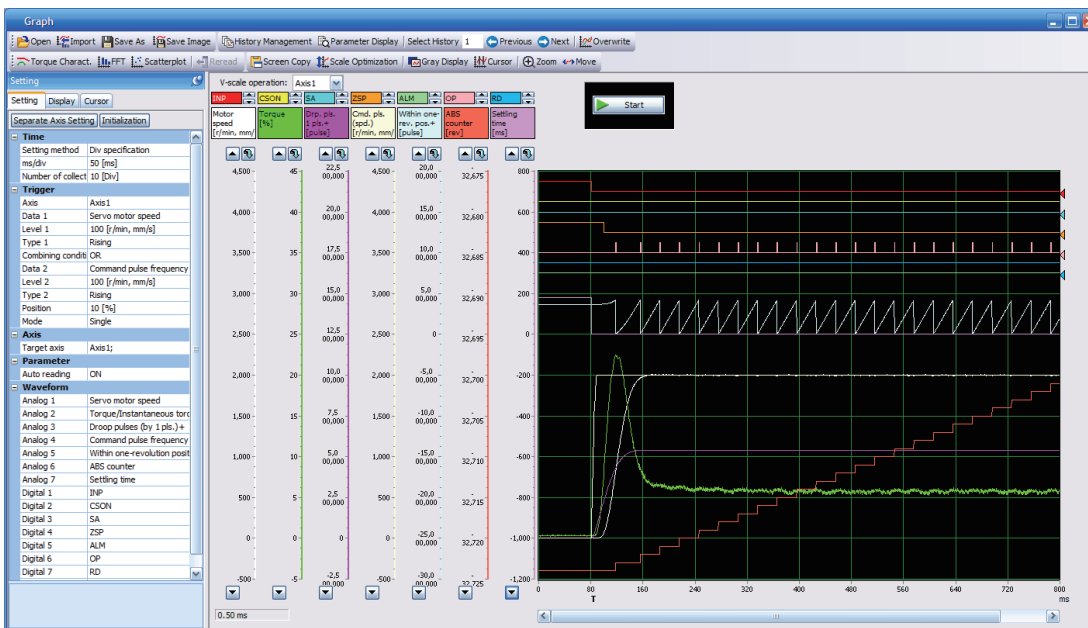

I/O monitor display

The I/O signals of the servo amplifier, on/off status of the I/O device, and voltage of the analog monitor can be displayed. The input/output status of the signals and wiring can be checked at device startup, etc.

System configuration display

System information including the serial No. and model of the servo amplifier, servo motor, and other equipment are displayed. The items displayed in the configuration window vary depending on the servo amplifier and software version of MR Configurator2, as well as whether it is viewed from the diagnosis tab of MR Configurator2 or the drive recorder. When MR Configurator2 is connected to the servo amplifier, the values are displayed.

Displayed items [G]

The following items can be checked in the system configuration window. For the linear servo motor control mode, the encoder resolution per electrical angle 360° is displayed.

- Servo amplifier identification information
- Servo amplifier serial No.
- Servo amplifier S/W No.
- Optional unit identification information
- Optional unit serial No.
- Optional unit S/W No.
- MAC address
- IP address
- Motor model
- Motor ID
- Motor serial No.
- Encoder resolution
- Encoder maximum multi-revolution [rev]
- Accumulated power-on time [h]
- Number of inrush relay on/off times [times]
- Number of dynamic brake stops [times]
- LED display
- Converter identification information
- Converter serial No.
- Converter S/W No.

Displayed items [B] [A]

The following items can be checked in the system configuration window. For the linear servo motor control mode, the encoder resolution per electrical angle 360° is displayed.

- Servo amplifier identification information
- Servo amplifier serial No.
- Servo amplifier S/W No.
- Optional unit identification information
- Optional unit serial No.
- Optional unit S/W No.
- Motor model
- Motor ID
- Motor serial No.
- Encoder resolution
- Encoder maximum multi-revolution [rev]
- Accumulated power-on time [h]
- Number of inrush relay on/off times [times]
- Number of dynamic brake stops [times]

For the MR-J5_-_B_, the following items can also be checked.

- LED display

5.3 Analog monitor [G]



The voltage of the analog monitor output may be irregular at power-on.

The status of the servo amplifier, such as the servo motor speed, torque, and bus voltage, can be output with the voltage to two channels at the same time.

Setting method

Which signal to be output by analog monitor 1 or analog monitor 2 can be selected, and the offset voltage of each analog monitor can be set using the extension setting parameters in MR Configurator2. The setting range of the offset voltage is -999 mV to 999 mV.

Servo parameter	Symbol	Name	Outline
PC09.0-1	MOD1	Analog monitor 1 output selection	Select the signal to be output to analog monitor 1. Refer to the following for setting values. Page 413 Setting details
PC09.3	MOD1	Analog monitor output 1 output axis selection	Select the axis to be monitored with analog monitor 1. This servo parameter can be used with MR-J5W_-_G_. 0: A-axis (initial value) 1: B-axis 2: C-axis
PC10.0-1	MOD2	Analog monitor 2 output selection	Select the signal to be output to analog monitor 2. Refer to the following for setting values. Page 413 Setting details
PC10.3	MOD2	Analog monitor output 2 output axis selection	Select the axis to be monitored with analog monitor 2. This servo parameter can be used with MR-J5W_-_G_. 0: A-axis (initial value) 1: B-axis 2: C-axis
PC11	MO1	Analog monitor 1 offset	Set the offset voltage of MO1 (Analog monitor 1). Initial value: 0 [mV]
PC12	MO2	Analog monitor 2 offset	Set the offset voltage of MO2 (Analog monitor 2). Initial value: 0 [mV]

Setting details

Point

When using a linear servo motor, the terms below have the following meanings.

CCW direction → Positive direction

CW direction → Negative direction

Torque → Thrust

In the factory setting, the servo motor speed is output to MO1 (analog monitor 1), and the torque is output to MO2 (analog monitor 2). However, by setting [Pr. PC09 Analog monitor 1 output] and [Pr. PC10 Analog monitor 2 output], the contents can be changed as shown in the following table.

Refer to the following for a description of each signal and the points detected.

Page 388 Explanation of monitor signals

Setting value	Output item	Description
00	Servo motor speed	
01	Torque/Thrust	
02	Servo motor speed	
03	Torque/Thrust	
04	Current command ^{*7}	

Setting value	Output item	Description
05	Command speed output 1 ^{*2}	
06	Servo motor-side droop pulses (± 10 V/100 pulses) ^{*1*2*3*4}	
07	Servo motor-side droop pulses (± 10 V/1000 pulses) ^{*1*2*3*4}	
08	Servo motor-side droop pulses (± 10 V/10000 pulses) ^{*1*2*3*4}	
09	Servo motor-side droop pulses (± 10 V/100000 pulses) ^{*1*2*3*4}	
0D	Bus voltage ^{*6}	

Setting value	Output item	Description
0E	Command speed output 2^2	
10	Load-side droop pulses (± 10 V/100 pulses) $^*2^*3^*4^*5$	
11	Load-side droop pulses (± 10 V/1000 pulses) $^*2^*3^*4^*5$	
12	Load-side droop pulses (± 10 V/10000 pulses) $^*2^*3^*4^*5$	
13	Load-side droop pulses (± 10 V/100000 pulses) $^*2^*3^*4^*5$	
14	Load-side droop pulses (± 10 V/1 Mpulses) $^*2^*3^*4^*5$	

Setting value	Output item	Description
15	Motor/load side position deviation (± 10 V/100000 pulses) ^{*2*3*4*5}	
16	Motor/load side speed deviation ^{*5}	
17	Internal temperature of encoder (± 10 V/ ± 128 °C)	
18	Servo motor-side droop pulses (± 10 V/1 Mpulses) ^{*1*2*3}	

*1 This is in the units of encoder pulses.

*2 This cannot be used in the torque mode.

*3 This cannot be used in the velocity mode.

*4 The value is in the load-side encoder unit in fully closed loop control. In semi closed loop control, the value is in the servo motor encoder unit.

*5 Available on servo amplifiers with firmware version A5 or later.

*6 For 400 V class servo amplifiers, the bus voltage is +8 V/800 V.

*7 The maximum current command (maximum torque command) matches the maximum current/rated current ratio of the servo motor.

5.4 Analog monitor [B]

Point

The voltage of the analog monitor output may be irregular at power-on.

The status of the servo amplifier, such as the servo motor speed, torque, and bus voltage, can be output with the voltage to two channels at the same time.

For the MR-J5_ _B_, this function is available only with 1-axis servo amplifiers.

Setting method

Which signal to be output by analog monitor 1 or analog monitor 2 can be selected, and the offset voltage of each analog monitor can be set using the extension setting parameters in MR Configurator2. The setting range of the offset voltage is -999 mV to 999 mV.

Servo parameter	Symbol	Name	Outline
PC09.0-1	MOD1	Analog monitor 1 output selection	Select the signal to be output to analog monitor 1. Refer to the following for setting values. Page 418 Setting details
PC10.0-1	MOD2	Analog monitor 2 output selection	Select the signal to be output to analog monitor 2. Refer to the following for setting values. Page 418 Setting details
PC11	MO1	Analog monitor 1 offset	Set the offset voltage of MO1 (Analog monitor 1). Initial value: 0 [mV]
PC12	MO2	Analog monitor 2 offset	Set the offset voltage of MO2 (Analog monitor 2). Initial value: 0 [mV]

Setting details

Point

When using a linear servo motor, the terms below have the following meanings.

- CCW direction → Positive direction
- CW direction → Negative direction
- Torque → Thrust

In the factory setting, the servo motor speed is output to MO1 (analog monitor 1), and the torque is output to MO2 (analog monitor 2). However, by setting [Pr. PC09 Analog monitor 1 output] and [Pr. PC10 Analog monitor 2 output], the contents can be changed as shown in the following table.

Refer to the following for a description of each signal and the points detected.

☞ Page 388 Explanation of monitor signals

Setting value	Output item	Description
00	Servo motor speed	
01	Torque/Thrust	
02	Servo motor speed	
03	Torque/Thrust	
04	Current command *6	

Setting value	Output item	Description
05	Command speed output 1 ^{*2}	
06	Servo motor-side droop pulses (± 10 V/100 pulses) ^{*1*2*3*4}	
07	Servo motor-side droop pulses (± 10 V/1000 pulses) ^{*1*2*3*4}	
08	Servo motor-side droop pulses (± 10 V/10000 pulses) ^{*1*2*3*4}	
09	Servo motor-side droop pulses (± 10 V/100000 pulses) ^{*1*2*3*4}	
0D	Bus voltage ^{*5}	

Setting value	Output item	Description
0E	Command speed output 2 * ²	
10	Load-side droop pulses (± 10 V/100 pulses) * ² * ³ * ⁴	
11	Load-side droop pulses (± 10 V/1000 pulses) * ² * ³ * ⁴	
12	Load-side droop pulses (± 10 V/10000 pulses) * ² * ³ * ⁴	
13	Load-side droop pulses (± 10 V/100000 pulses) * ² * ³ * ⁴	
14	Load-side droop pulses (± 10 V/1 Mpulses) * ² * ³ * ⁴	

Setting value	Output item	Description
15	Motor/load side position deviation (± 10 V/100000 pulses) *2*3*4	
16	Motor/load side speed deviation	
17	Internal temperature of encoder (± 10 V/ ± 128 °C)	
18	Servo motor-side droop pulses (± 10 V/1 Mpulses) ^{*1*2*3}	

*1 This is in the units of encoder pulses.

*2 This cannot be used in the torque control mode.

*3 This cannot be used in the velocity mode.

*4 The value is in the load-side encoder unit in fully closed loop control. In semi closed loop control, the value is in the servo motor encoder unit.

*5 For 400 V class servo amplifiers, the bus voltage is +8 V/800 V.

*6 The maximum current command (maximum torque command) matches the maximum current/rated current ratio of the servo motor.

5.5 Analog monitor [A]



Point

The voltage of the analog monitor output may be irregular at power-on.

The status of the servo amplifier, such as the servo motor speed, torque, and bus voltage, can be output with the voltage to two channels at the same time.

Setting method

Which signal to be output by analog monitor 1 or analog monitor 2 can be selected, and the offset voltage of each analog monitor can be set using the extension setting parameters in MR Configurator2. The setting range of the offset voltage is -9999 mV to 9999 mV.

Servo parameter	Symbol	Name	Outline
PC14.0-1	MOD1	Analog monitor 1 output selection	Select the signal to be output to analog monitor 1. Refer to the following for setting values.  Page 423 Setting details
PC15.0-1	MOD2	Analog monitor 2 output selection	Select the signal to be output to analog monitor 2. Refer to the following for setting values.  Page 423 Setting details
PC39	MO1	Analog monitor 1 offset	Set the offset voltage of MO1 (Analog monitor 1). Initial value: 0 [mV]
PC40	MO2	Analog monitor 2 offset	Set the offset voltage of MO2 (Analog monitor 2). Initial value: 0 [mV]

Setting details

Point 

When using a linear servo motor, the terms below have the following meanings.

CCW direction → Positive direction

CW direction → Negative direction

Torque → Thrust

In the factory setting, the servo motor speed is output to MO1 (analog monitor 1), and the torque is output to MO2 (analog monitor 2). However, by setting the [Pr. PC14 Analog monitor 1 output] and [Pr. PC15 Analog monitor 2 output], the contents can be changed as shown in the following table.

Refer to the following for a description of each signal and the points detected.

 Page 388 Explanation of monitor signals

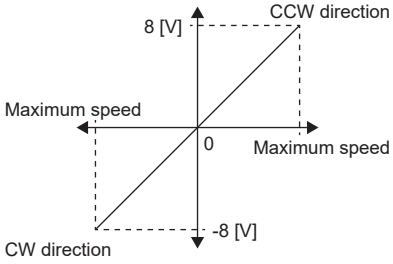
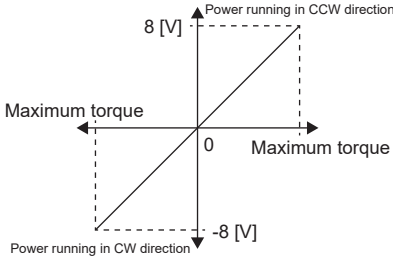
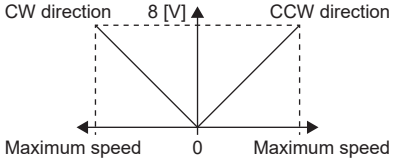
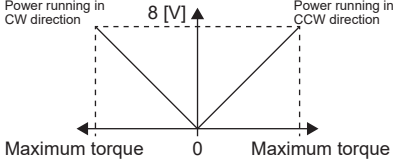
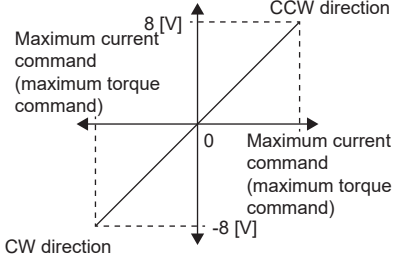
Setting value	Output item	Description
00	Servo motor speed	
01	Torque/Thrust	
02	Servo motor speed	
03	Torque/Thrust	
04	Current command ^{*7}	

Setting value	Output item	Description
05	Command pulse frequency (± 10 V/ ± 4 Mpulses/s)	
06	Servo motor-side droop pulses (± 10 V/100 pulses) *1*2*3*4	
07	Servo motor-side droop pulses (± 10 V/1000 pulses) *1*2*3*4	
08	Servo motor-side droop pulses (± 10 V/10000 pulses) *1*2*3*4	
09	Servo motor-side droop pulses (± 10 V/100000 pulses) *1*2*3*4	
0D	Bus voltage *6	

Setting value	Output item	Description
0E	Command speed output 2 ²	
10	Load-side droop pulses (± 10 V/100 pulses) ^{*2*3*4*5}	
11	Load-side droop pulses (± 10 V/1000 pulses) ^{*2*3*4*5}	
12	Load-side droop pulses (± 10 V/10000 pulses) ^{*2*3*4*5}	
13	Load-side droop pulses (± 10 V/100000 pulses) ^{*2*3*4*5}	
14	Load-side droop pulses (± 10 V/1 Mpulses) ^{*2*3*4*5}	

Setting value	Output item	Description
15	Servo motor-side/load-side position deviation (± 10 V/100000 pulses) *2*3*4*5	
16	Motor/load side speed deviation *5	
17	Internal temperature of encoder (± 10 V/ ± 128 °C)	
18	Servo motor-side droop pulses (± 10 V/1 Mpulses) *1*2*3	

*1 This is in the units of encoder pulses.

*2 This cannot be used in the torque control mode.

*3 This cannot be used in the speed control mode.

*4 The value is in the load-side encoder unit in fully closed loop control. In semi closed loop control, the value is in the servo motor encoder unit.

*5 Available on servo amplifiers with firmware version A5 or later.

*6 For 400 V class servo amplifiers, the bus voltage is +8 V/800 V.

*7 The maximum current command (maximum torque command) matches the maximum current/rated current ratio of the servo motor.

5.6 Optional data monitor function [B]

The optional data monitor function monitors data in the servo amplifier using the controller. With the optional data monitor, data types of registered monitors can be set. For details on usage, units of each data type, and others, refer to the manual for the controller being used.

Registered monitor

Data type	Description
Effective load ratio	The continuous effective load current is displayed. The effective value in relation to the rated current (= 100 %) is displayed.
Regenerative load ratio	The ratio of regenerative power to permissible regenerative power is displayed as a percentage.
Peak load ratio	The rated torque is displayed as 100 %. The maximum value of the torque generated in the past 15 seconds is displayed.
Position feedback	The feedback pulses from the servo motor encoder are counted and displayed. The value is negative in reverse rotation. In the fully closed loop control mode, the value in the load-side encoder unit with the gear taken into consideration is displayed.
Encoder position within one-revolution	The position within one-revolution is displayed in the encoder pulse unit. In the fully closed loop control mode, the position within one-revolution is displayed in the servo motor encoder unit.
Encoder multi-revolution counter	The rotation amount of the servo motor is displayed.
Load to motor inertia ratio	The estimated ratio of the load inertia moment to the servo motor inertia moment is displayed.
Load to motor mass ratio	The load to mass of the linear servo motor primary-side ratio is displayed.
Model control gain	The model control gain value is displayed.
Bus voltage	The bus voltage of the converter part of the servo amplifier (between P+ and N-) is displayed.
Cumulative current value	The cumulative current value of the servo motor is displayed.
Servo motor speed	The servo motor speed is displayed.
Servo motor speed	The linear servo motor speed is displayed at linear servo motor driving.
Selected droop pulse	The droop pulse set in [Pr. PE10.2 Droop pulse monitor selection for controller display] is displayed.
Unit power consumption	The unit power consumption is displayed. The positive value is displayed in power running. The negative value is displayed in regeneration.
Unit total power consumption	The unit total power consumption is displayed.
Instantaneous torque	The instantaneous torque is displayed. The rated torque is displayed as 100 %. The value of the generated torque is displayed in real time.
Instantaneous thrust	The instantaneous thrust is displayed at linear servo motor driving. The continuous thrust is displayed as 100 %. The value of the generated thrust is displayed in real time.
Load-side encoder information 1	The following values are displayed for each encoder connected to the load-side. For a rotary servo motor, a cycle counter is displayed. For an absolute position linear encoder, absolute position data is displayed. For an incremental linear encoder, the Z-phase counter (distance from the linear encoder home position (reference mark)) (32-bit data) is displayed after the Z-phase is passed. The value before the Z-phase is passed is undefined. For an A/B/Z-phase differential output linear encoder, the Z-phase counter (distance from the linear encoder home position (Z-phase)) (16-bit data) is displayed after the Z-phase is passed. Before the Z-phase is passed, a free-run counter is displayed with the position where the power is turned on set as "0". To display the cycle counter for an A/B/Z-phase differential output rotary encoder, set the load-side encoder resolution in [Pr. PE51 Load-side encoder resolution setting]. For details, refer to the following manual. □MR-J5-B/MR-J5W-B User's Manual (Parameters)
Load-side encoder information 2	The following values are displayed for each encoder connected to the load-side. For a rotary servo motor, a multi-revolution ABS counter, that holds the counter value even when the power is cycled, is displayed. For the HK-MT_VW, however, a multi-revolution counter, that returns to "0" when the power is cycled, is displayed. For an absolute position linear encoder, "0" is displayed. For an incremental linear encoder, "0" is displayed. For an A/B/Z-phase differential output linear encoder, "0" is displayed. For an A/B/Z-phase differential output rotary encoder, "0" is displayed.
Scale free-run counter	A free-run counter for the load-side encoder, which set the position where the power is turned on as "0", is displayed.

Data type	Description
Z-phase counter	<p>The following values are displayed for each linear encoder connected to the servo motor-side.</p> <p>For an absolute position linear encoder, "0" is displayed.</p> <p>For an incremental linear encoder, the Z-phase counter (distance from the linear encoder home position (reference mark)) (32-bit data) is displayed after the Z-phase is passed. The value before the Z-phase is passed is undefined.</p> <p>For an A/B/Z-phase differential output linear encoder, the Z-phase counter (distance from the linear encoder home position (Z-phase)) (32-bit data) is displayed after the Z-phase is passed. Before the Z-phase is passed, a free-run counter, which set the position where the power is turned on as "0", is displayed.</p>
Temperature of servo motor thermistor	<p>The thermistor temperature is displayed for the servo motor with a thermistor.</p> <p>For the servo motors without a thermistor, "9999" is displayed.</p> <p>For the servo motor with a thermistor, refer to the user's manual for the servo motor being used.</p>
Torque equivalent to disturbance	<p>The difference between the necessary torque and the actually required torque (torque current value) to drive the servo motor is displayed as the torque equivalent to disturbance.</p>
Thrust equivalent to disturbance	<p>The difference between the necessary thrust and the actually required thrust (thrust current value) to drive the linear servo motor is displayed as the thrust equivalent to disturbance.</p>
Overload alarm margin	<p>The margins for the alarm levels of [AL. 050 Overload 1] and [AL. 051 Overload 2] are displayed as a percentage.</p>
Excessive error alarm margin	<p>The margin for the excessive error alarm trigger level is displayed in the encoder pulse unit. The excessive error alarm occurs when the margin is 0 pulse.</p>
Settling time	<p>The period of time (settling time) from the completion of the command to INP (In-position) on is displayed.</p>
Overshoot amount	<p>The overshoot amount during position mode is displayed in units of encoder pulses.</p>
Motor/load side position deviation	<p>In the fully closed loop control mode, a deviation between the servo motor-side position and load-side position is displayed. The number of pulses is displayed in the load-side encoder unit.</p>
Motor/load side speed deviation	<p>In the fully closed loop control mode, a deviation between the servo motor-side speed and load-side speed is displayed.</p>
Internal temperature of encoder	<p>The internal temperature detected by the encoder is displayed.</p> <p>For the linear servo motor, "9999" is displayed.</p>

Transient command

Data type	Description
Motor serial No. (first eight characters)	The serial number of the servo motor is displayed.
Motor serial No. (last eight characters)	It is not displayed when a linear servo motor is connected.
Servo motor ID (SSCNET III/H)	The servo motor ID sent from the encoder is displayed. The type of the connected servo motor can be checked in reference to the servo motor ID. For details, refer to the following manual. [] Rotary Servo Motor User's Manual (For MR-J5)
Encoder resolution	The resolution of the encoder is displayed.
Servo amplifier serial No. (first eight characters)	The serial number of the servo amplifier is displayed.
Servo amplifier serial No. (last eight characters)	
Servo amplifier identification information (first eight characters)	The name of the servo amplifier is displayed.
Servo amplifier identification information (last eight characters)	
Servo amplifier S/W No. (first eight characters)	The software version of the servo amplifier is displayed.
Servo amplifier S/W No. (last eight characters)	
Accumulated power-on time	The accumulated time since the servo amplifier was powered on is displayed.
Number of inrush relay on/off times	The number of times the inrush relay of the servo amplifier has been turned on/off is displayed.
Read alarm records	The maximum number of records in the alarm history of the connected servo amplifier is displayed.
Alarm history • Details #1, #2	The alarm history / Details #1, #2 are displayed in hexadecimal.
Alarm history • Details #3, #4	The alarm history / Details #3, #4 are displayed in hexadecimal.
Alarm history • Details #5, #6	The alarm history / Details #5, #6 are displayed in hexadecimal.
Alarm history • Details #7, #8	The alarm history / Details #7, #8 are displayed in hexadecimal.
Alarm history • Details • Occurrence time	The alarm history data of the specific number # is displayed.
Alarm occurrence time #1, #2	The alarm occurrence time #1, #2 are displayed.
Alarm occurrence time #3, #4	The alarm occurrence time #3, #4 are displayed.
Alarm occurrence time #5, #6	The alarm occurrence time #5, #6 are displayed.
Alarm occurrence time #7, #8	The alarm occurrence time #7, #8 are displayed.
Alarm history clear command	Clears the alarm history.
Home position [Command position]	The home position is displayed.
Bus voltage	The bus voltage of the converter part of the servo amplifier (between P+ and N-) is displayed.
Regenerative load ratio	The ratio of regenerative power to permissible regenerative power is displayed as a percentage.
Effective load ratio	The continuous effective load current is displayed. The effective load ratio in relation to the rated current (= 100 %) is displayed.
Peak load ratio	The rated torque is displayed as 100 %. The maximum value of the torque generated in the past 15 seconds is displayed.
Load to motor inertia ratio	The estimated ratio of the load inertia moment to the servo motor inertia moment is displayed.
Model control gain	The model control gain value is displayed.
LED display	The 7-segment LED display value is displayed.
Load-side encoder information 1	The following values are displayed for each encoder connected to the load-side. For a rotary servo motor, a multi-revolution ABS counter, that holds the counter value even when the power is cycled, is displayed. For the HK-MT_VW, however, a multi-revolution counter, that returns to "0" when the power is cycled, is displayed. For an absolute position linear encoder, absolute position data is displayed. For an incremental linear encoder, a free-run counter of the load-side encoder with the position where the power is turned on set as "0" is displayed. For an A/B/Z-phase differential output linear encoder, a free-run counter of the load-side encoder with the position where the power is turned on set as "0" is displayed. For an A/B/Z-phase differential output rotary encoder, a free-run counter of the load-side encoder with the position where the power is turned on set as "0" is displayed.

Data type	Description
Load-side encoder information 2	The following values are displayed for each encoder connected to the load-side. For a rotary servo motor, the cycle counter is displayed. For an absolute position linear encoder, "0" is displayed. For an incremental linear encoder, the Z-phase counter (distance from the linear encoder home position (reference mark)) (32-bit data) is displayed after the Z-phase is passed. The value before the Z-phase is passed is undefined. For an A/B/Z-phase differential output linear encoder, the latched free-run counter is displayed when the Z-phase is passed. For an A/B/Z-phase differential output rotary encoder, the latched free-run counter is displayed when the Z-phase is passed.
Speed feedback	The speed of the servo motor is displayed.
Temperature of servo motor thermistor	The thermistor temperature is displayed for the servo motor with a thermistor. For the servo motors without a thermistor, "9999" is displayed. For the servo motor with a thermistor, refer to the user's manual for the servo motor being used.
Z-phase counter	The following values are displayed for each linear encoder connected to the servo motor-side. For an absolute position linear encoder, "0" is displayed. For an incremental linear encoder, the Z-phase counter (distance from the linear encoder home position (reference mark)) (32-bit data) is displayed after the Z-phase is passed. The value before the Z-phase is passed is undefined. For an A/B/Z-phase differential output linear encoder, the Z-phase counter (distance from the linear encoder home position (Z-phase)) (32-bit data) is displayed after the Z-phase is passed. Before the Z-phase is passed, a free-run counter is displayed with the position where the power is turned on set as "0".
Unit power consumption	The unit power consumption is displayed. The positive value is displayed in power running. The negative value is displayed in regeneration.
Unit total power consumption	The unit total power consumption is displayed.
Torque equivalent to disturbance	The difference between the necessary torque and the actually required torque (torque current value) to drive the servo motor is displayed as the torque equivalent to disturbance.
Instantaneous torque	The instantaneous torque is displayed. The rated torque is displayed as 100 %. The value of the generated torque is displayed in real time.
Overload alarm margin	The margins for the alarm levels of [AL. 050 Overload 1] and [AL. 051 Overload 2] are displayed as a percentage.
Excessive error alarm margin	The margin for the excessive error alarm trigger level is displayed in the encoder pulse unit. The excessive error alarm occurs when the margin is 0 pulse.
Settling time	The period of time (settling time) from the completion of the command to INP (In-position) on is displayed.
Overshoot amount	The overshoot amount during position mode is displayed in units of encoder pulses.
Motor/load side position deviation	In the fully closed loop control mode, a deviation between the servo motor-side position and load-side position is displayed. The number of pulses is displayed in the load-side encoder unit.
Motor/load side speed deviation	In the fully closed loop control mode, a deviation between the servo motor-side speed and load-side speed is displayed.
Internal temperature of encoder	The internal temperature detected by the encoder is displayed. For the linear servo motor, "9999" is displayed.
Machine diagnostic status	The machine diagnostic status is displayed. [Bit 0 to 3: Friction estimation status at forward rotation] **1*2 0:Estimation in progress. (normal) 1:Estimation has finished. (normal) 2:The motor may have rotated/traveled more frequently in one direction than the other. (warning) 3:The servo motor speed may be too slow for friction estimation. (warning) 4:The change in the servo motor speed may be too small for friction estimation. (warning) 5:The acceleration/deceleration time constants may be too short for friction estimation. (warning) 6:The operation time may be insufficient. (warning) [Bit 4 to 7: Friction estimation status at forward rotation] **1*2 0:Estimation in progress. (normal) 1:Estimation has finished. (normal) 2:The motor may have rotated/traveled more frequently in one direction than the other. (warning) 3:The servo motor speed may be too slow for friction estimation. (warning) 4:The change in the servo motor speed may be too small for friction estimation. (warning) 5:The acceleration/deceleration time constants may be too short for friction estimation. (warning) 6:The operation time may be insufficient. (warning) [Bit 8 to 11: Vibration estimation status] 0:Estimation in progress. 1:Estimation has finished. [Bit 12 to 15: reserved]
Friction estimation value	The friction value estimated by the machine diagnostic function is displayed.
Vibration estimation value	The vibration value estimated by the machine diagnostic function is displayed.

Data type	Description
Failure prediction status	<p>The failure prediction status is displayed.</p> <p>[Bit 0 to 3: Friction failure prediction status]</p> <p>0:Friction failure prediction disabled</p> <p>1:During preparation for friction failure prediction</p> <p>2:During execution of friction failure prediction</p> <p>3:During friction failure prediction warning</p> <p>[Bit 4 to 7: Vibration failure prediction status]</p> <p>0:Vibration failure prediction disabled</p> <p>1:During preparation for vibration failure prediction</p> <p>2:During execution of vibration failure prediction</p> <p>3:During vibration failure prediction warning</p> <p>[Bit 8 to 11: Total travel distance failure prediction status]</p> <p>0:Motor total travel distance failure prediction disabled</p> <p>1:Motor total travel distance failure prediction being executed</p> <p>2:Motor total travel distance failure prediction at warning</p> <p>[Bit 12 to 15: Motor total travel distance calculation status]</p> <p>0:During stop of motor total travel distance calculation</p> <p>1:During calculation of motor total travel distance</p> <p>[Bit 16 to 19: Motor total travel distance 2 failure prediction status]</p> <p>0:Motor total travel distance 2 failure prediction disabled</p> <p>1:Motor total travel distance 2 failure prediction being executed</p> <p>2:Motor total travel distance 2 failure prediction at warning</p> <p>[Bit 20 to 23: Static friction failure prediction status]</p> <p>0:Static friction failure prediction disabled</p> <p>1:During preparation for static friction failure prediction</p> <p>2:During execution of static friction failure prediction</p> <p>3:During static friction failure prediction warning</p> <p>[Bit 24 to 27: Belt tension deterioration prediction status]</p> <p>0:Belt tension deterioration prediction disabled</p> <p>1:Belt tension deterioration prediction in progress</p> <p>2:During belt tension deterioration warning</p> <p>[Bit 28 to 31: Belt tension estimation status]</p> <p>0:Belt tension estimation in progress</p> <p>1:Belt tension estimation has finished</p> <p>7:Belt tension estimation is not set</p>
Friction failure prediction -Threshold	The threshold used for friction failure prediction is displayed in increments of 0.1 % in relation to the rated torque as 100 %.
Vibration failure prediction -Threshold	The threshold used for vibration failure prediction is displayed in increments of 0.1 % in relation to the rated torque as 100 %.
Failure prediction - Preparation progress	The threshold creation progress used for failure prediction is displayed as a percentage. Creation of the threshold for failure prediction finishes at 100 %.
Machine total travel distance	The machine total travel distance is displayed in increments of 10 rev.
Estimated tension value	The estimated tension value used by the belt tension deterioration prediction function is expressed in 0.1 N units

*1 When warning conditions for 2 to 6 are established at the same time, the smallest number is returned.

*2 Once an estimation finishes even after a warning has occurred, the status will change to "Estimation has finished".

6 FUNCTIONAL SAFETY

6.1 Functions and configuration

Outline

For the compatible servo amplifiers and firmware versions, refer to "Functional safety" in the User's Manual (Introduction). For the connection diagram and wiring, refer to "USING STO FUNCTION" and "USING FUNCTIONAL SAFETY" in the following manuals.

 MR-J5 User's Manual (Hardware)

 MR-J5D User's Manual (Hardware)

Features of functions

■ When using the safety sub-functions via a network

Point

This manual describes the safety sub-function using CC-Link IE TSN. For other networks, refer to the User's Manual (Communication Function).

For the MR-J5-_G_-RJ, MR-J5W_-_G_, and MR-J5D_-_G_, the safety sub-function can be used via a network. This helps to minimize wiring.

For the available safety sub-functions and safety levels, refer to "Functional safety" in the User's Manual (Introduction).

Functional safety is supported by the following controllers of CC-Link IE TSN.







Category	Model
Motion module	RD78G(H)
Master/local module	RJ71GN11-T2

■ When using the safety sub-functions by wiring to the CN8 connector (safety sub-function control by input device)

The safety sub-functions can be used by using an input device.

Outline of safety sub-functions

The functions that can be used for functional safety are as follows.

Function	Description	Detailed explanation
STO (Safe torque off)	This function electrically shuts off the servo motor driving energy with input signals from external devices (shut-off by the secondary-side output). This is equivalent to the stop category 0 of IEC/EN 60204-1.	 Page 483 STO function
SS1 (Safe stop 1)	This function starts deceleration with input signals from external devices. After the specified time to confirm the motor stop, the STO function is executed (SS1). This is equivalent to the stop category 1 of IEC/EN 60204-1.	 Page 486 SS1 function
SS2 (Safe stop 2)	This function starts deceleration with input signals from external devices. After the specified time to confirm the motor stop, the SOS function is executed (SS2). This is equivalent to the stop category 2 of IEC/EN 60204-1.	 Page 494 SS2/SOS function
SOS (Safe operating stop)	This function monitors whether the servo motor stops within the prescribed range. Energy is supplied to the servo motor.	
SLS (Safely-limited speed)	This function monitors whether the speed is within the prescribed speed limit. If the speed exceeds the specified speed limit, the STO will shut off energy.	 Page 500 SLS function
SSM (Safe speed monitor)	This function outputs signals when the servo motor speed is below the prescribed speed.	 Page 504 SSM function
SBC (Safe brake control)	This function outputs signals for controlling the external brake.	 Page 505 SBC function
SDI (Safe direction)	This function monitors whether the servo motor travels in the specified direction. If the servo motor travels in a direction different from the specified direction, the STO will shut off energy.	 Page 506 SDI function

Function	Description	Detailed explanation
SLI (Safely-limited increment)	This function monitors whether the travel distance of the servo motor is within the specified range. If the travel distance of the servo motor exceeds the specified range, the STO will shut off energy.	☞ Page 509 SLI function
SLT (Safely-limited torque)	This function monitors whether the torque is below the specified torque. If the torque exceeds the specified torque, the STO will shut off energy.	☞ Page 511 SLT function
Status monitor (SM: Status monitor)	This function outputs the statuses of the safety sub-functions as signals. This is a function designed specifically for the safety sub-functions and differs from the function defined in IEC/EN 61800-5-2.	☞ Page 515 Status monitor (SM) function

Risk assessments

To satisfy social demands for the provision of highly safe machine and equipment in which risk has been reduced to an acceptable level, perform risk assessments to identify potential hazards in this machine and equipment and objectively evaluate risk through rational steps. Users must determine all risk assessments and residual risks for the machine and equipment as a whole. The company or individual(s) in charge of the system configuration are fully responsible for the installation and commissioning of the safety system. Additionally, if compliance with the European Machinery Directive is required, certification for the relevant safety standards is required for the whole system.

Perform all risk assessments and obtain safety level certifications for the machine or the whole system. Use of a third-party certification body for the final safety certification of the system is recommended.

The residual risks related to the safety sub-functions of the product are described below.

Common residual risks in each function

- At the time of shipping, it is necessary to check the settings of the safety-related components with programming tools and the monitor/display contents on the display, record and save the setting data of the safety-related components, and store programming tools used. Perform these actions using a check sheet or the like.
- Safety is not assured during machine assembly or until processes such as installation, wiring, and adjustments have been completed properly. For the installation, wiring, and adjustments, follow the installation guide of each servo amplifier.
- Only qualified personnel are authorized to install, start up, repair, and adjust the machines in which components are installed. Only trained engineers should install and operate the equipment. (Remark: ISO 13849-1:2015 Attachment F Table F.1 No. 5)
- Separate the wiring related to the safety sub-functions from the other signal wiring. (Remark: ISO 13849-1:2015 Attachment F Table F.1 No. 1)
- Protect the cables by appropriate means (routing them in a cabinet, using cable guards, etc.).
- In addition to securing the appropriate clearance/creepage distance according to the voltage used, we recommend using switches, relays, and sensors. etc., that comply with safety standards. When using a switch, relay, sensor, etc., that does not comply with the safety standards, use one that has been certified to be safe by the user or that has been carefully evaluated by the user. (Remark: ISO 13849-1:2015 Attachment F Table F.1 No. 3)
- The time until detection of a safety monitoring error depends on the parameter settings.

Residual risks in each function

Function	Residual risks
Speed monitoring (SLS)	<ul style="list-style-type: none"> • The speed monitoring function guarantees the servo motor speed, but it does not guarantee the actual safety speed of the machine. Set the parameters so that the safety speed of the machine is the same as the safety speed of the specified servo motor. • It is necessary to check that the speed of the monitored servo axis is the same as the actual speed by using a tachometer, etc., taking into consideration the error caused by the command and encoder resolution. • Malfunctions of working parts, such as shaft slips and timing belt falling off, are not covered by the warranty. Be sure to eliminate risks in working parts in advance. • The speed monitor error detection time is set in units of 1 ms. Errors of shorter duration than this time are not detected. • Upon detection of a speed that exceeds the specified speed, the safety monitor error (shut-off signal off) does not occur within the speed error detection time set by the parameter. Make sure that safety can be ensured during this period.
Safety speed monitor (SSM)	When SSM is used as a restart trigger, implement it according to IEC/EN 60204-1.
Safety brake control (SBC)	This function only guarantees that power to the mechanical brake is properly supplied. It cannot detect errors in mechanical brake mechanisms and brake wear.
Safe operating stop (SOS)	If the same stop position is maintained for a long time, periodically move the servo motor stop position slightly to avoid cumulative malfunctions at the same stop position.
Safety-limited increment (SLI)	If the stopped state continues for a long time after the specified movement of the servo motor axis (coil in the case of a linear servo motor) is completed, switch to the SOS function.
Safe direction (SDI)	If the stopped state continues for a long time after the specified movement of the servo motor axis (coil in the case of a linear servo motor) is completed, switch to the SOS function.

6.2 Signal

Explanation of signals

Input device

Assign a device to the input signal of the CN8-4/CN8-5 pin with [Pr. PSD02 Input device selection DI1]. Refer to the following for details.

☞ Page 444 Input device

For safety sub-function control by network, input via a network is possible. Refer to the following for details.

☞ Page 450 Safety sub-function control by network

Device	Symbol	Connector pin No.	Function	State of the input pin in which the function is enabled
STO command	STOC	CN8-4 CN8-5	The STO function is activated by the STO command. ☞ Page 483 STO function	Open
SS1 command	SS1C		The SS1 function is activated by the SS1 command. ☞ Page 486 SS1 function	Open
SS2 command	SS2C		The SS2/SOS function is activated by the SS2 command. ☞ Page 494 SS2/SOS function	Open
SLS1 command	SLS1C		The SLS function 1 is activated by the SLS1 command. [Pr. PSA07 SLS deceleration monitor time 1] and [Pr. PSA11 SLS speed 1] are used as parameters. ☞ Page 500 SLS function	Open
SDIP command	SDIPC		The SDI function is activated in the address increasing direction by the SDIP command. ☞ Page 506 SDI function	Open
SDIN command	SDINC		The SDI function is activated in the address decreasing direction by the SDIN command. ☞ Page 506 SDI function	Open
SLI command	SLIC		The SLI function is activated by the SLI command. ☞ Page 509 SLI function	Open
SLT1 command	SLT1C		The SLT function 1 is activated by the SLT1 command. [Pr. PSB10 SLT torque upper limit value 1] and [Pr. PSB14 SLT torque lower limit value 1] are used as parameters. ☞ Page 511 SLT function	Open

Output device

The status monitor (SM) of the safety sub-functions is output as the output signal of the CN8-6/CN8-7 pin. The output device can be assigned to the output signal of the CN8-6/CN8-7 pin with [Pr. PSD08 Output device selection DO1]. Refer to the following for details.

☞ Page 447 Output device

For safety sub-function control by network, output via a network is possible. In that case, the output signal of the CN8-6/CN8-7 pin can be used at the same time.

Device	Symbol	Connector pin No.	Function	Status of output pin during operation
SSM output	SSMS	CN8-6 CN8-7	Indicates that the servo motor speed is equal to or less than the SSM speed while speed monitoring by the SSM function is in operation. ☞ Page 504 SSM function	Closed
SBC output	SBCS		Outputs a control signal of the electromagnetic brake. ☞ Page 505 SBC function	Open
STO output	STOS		This is a monitor output signal indicating that the STO function is activated. ☞ Page 483 STO function	Open
SOS output	SOSS		This is a monitor output signal indicating that the servo motor in the stop state is being monitored with the SS2/SOS functions. ☞ Page 494 SS2/SOS function	Open
SS1 output	SS1S		This is a monitor output signal indicating that the SS1 function is activated. ☞ Page 486 SS1 function	Open
SS2 output	SS2S		This is a monitor output signal indicating that the SS2/SOS function is activated. ☞ Page 494 SS2/SOS function	Open
SLS1 output	SLS1S		This is a monitor output signal indicating that the SLS function 1 is activated. ☞ Page 500 SLS function	Open
SLS2 output	SLS2S		This is a monitor output signal indicating that the SLS function 2 is activated. ☞ Page 500 SLS function	Open
SLS3 output	SLS3S		This is a monitor output signal indicating that the SLS function 3 is activated. ☞ Page 500 SLS function	Open
SLS4 output	SLS4S		This is a monitor output signal indicating that the SLS function 4 is activated. ☞ Page 500 SLS function	Open
SDIP output	SDIPS		This is a monitor output signal indicating that the SDI function is activated. ☞ Page 506 SDI function	Open
SDIN output	SDINS		This is a monitor output signal indicating that the SDI function is activated. ☞ Page 506 SDI function	Open
SLI output	SLIS		This is a monitor output signal indicating that the SLI function is activated. ☞ Page 509 SLI function	Open
SLT1 output	SLT1S		This is a monitor output signal indicating that the SLT function 1 is activated. ☞ Page 511 SLT function	Open
SLT2 output	SLT2S		This is a monitor output signal indicating that the SLT function 2 is activated. ☞ Page 511 SLT function	Open
SLT3 output	SLT3S		This is a monitor output signal indicating that the SLT function 3 is activated. ☞ Page 511 SLT function	Open
SLT4 output	SLT4S		This is a monitor output signal indicating that the SLT function 4 is activated. ☞ Page 511 SLT function	Open

Power-on sequence

In a system using servo motors with functional safety, for the initial diagnosis of the encoder, ensure about 0.5 s to 2 s in addition to the startup time of the servo amplifier. For the startup time of the servo amplifier, refer to "Power-on procedure" in the following manual.

 MR-J5 User's Manual (Hardware)

 MR-J5D User's Manual (Hardware)

6.3 Setting method

Turning on servo amplifier for the first time

When using the safety sub-functions, follow the steps below for startup. If the steps described in "Turning on servo amplifier for the first time" in the User's Manual (Introduction) have been already performed, attach the short-circuit connector to the CN8 connector of the servo amplifier, and then follow the steps in this section.

Procedure	Description	Reference
1. Wiring check	Confirm that the CN8 wiring is correct by visual inspection or by using a method such as the DO forced output function. Be sure to remove the short-circuit connector when using the safety sub-functions by a network.	☞ Page 440 DO forced output
2. Setting functional safety parameters	Set the functional safety parameters by referring to the setting method for each function.	☞ Page 438 Setting functional safety parameters ☞ Page 439 Functional safety parameters that must be set ☞ Page 441 Safety sub-function
3. Setting a password	Lock the functional safety parameters with a password so that they cannot be changed easily.	☞ Page 438 Setting functional safety parameters
4. Verifying functional safety parameters	Read each functional safety parameter and check that it has been set correctly.	—
5. Operation check of safety sub-functions	Check whether the safety sub-functions activate properly.	—

Setting functional safety parameters

The functional safety parameters can be set with MR Configurator2. Make the settings related to the safety sub-functions in these parameter groups. For functional safety parameters, set a password so that the parameters cannot be changed. The default password is "000000".

The differences between these parameter groups and other parameter groups are as follows.

- Lock the functional safety parameters with a password so that they cannot be changed easily.
- After changing the settings, cycle the power.
- After changing the settings, check that the functional safety parameters are correct according to the procedure.
- The functional safety parameters cannot be saved in the Motion controller/Motion module and safety programmable controller.
- Set the functional safety parameters with MR Configurator2.

Functional safety parameter setting procedure

To set the functional safety parameters, follow the steps below.

1. From the menu of MR Configurator2, select "Safety Parameter Setting".
2. When the password authentication dialog is displayed, enter the password. The default password is "000000".
3. Set the functional safety parameters in the "Safety Parameter Setting" window.
4. Click "Read" to read the password. Check that the functional safety parameters are set as intended.

For multi-axis servo amplifiers, if the functional safety parameter setting method is "Common", the latest setting value is applied to all axes. Verify the functional safety parameters after completing the settings for all axes.

5. Cycle the power or reset the software. The set functional safety parameters are enabled after the power is cycled or the software is reset.

Changing the password

Set a password so that the functional safety parameters cannot be changed easily. Once a password is set, the functional safety parameters cannot be changed without password authentication. No password authentication is required to read the functional safety parameters. To change the password, follow the steps below.

1. From the menu of MR Configurator2, select "Change Password".
2. Set a password. Set a character string of up to 6 alphanumeric characters for the password. Passwords are case sensitive.
3. The set password is enabled after the power is cycled or the software is reset.

If the password is forgotten

If the set password is forgotten, initializing the servo amplifier can reset the password.

1. From the menu of MR Configurator2, select "Initialize Password".
2. The password is initialized after the power is cycled or the software is reset. The functional safety parameters are restored to the factory setting, so set them again.

Functional safety parameters that must be set

Be sure to set the functional safety parameters shown here.

Parameter	Name
PSA01.0	Safety sub-function activation setting
PSA01.1	Input mode selection
PSA02	Functional safety setting
PSA03	SS1/SS2 deceleration monitor time
PSA20	Servo motor encoder resolution
PSA23	Servo motor rated speed
PSC03	Functional safety - Rotation direction selection/travel direction selection
PSL02	Functional safety - Linear encoder resolution setting - Numerator
PSL03	Functional safety - Linear encoder resolution setting - Denominator

[Pr. PSA01.0 Safety sub-function activation setting]

Set [Pr. PSA01.0] to "1" after confirming the content of the functional safety parameters.

[Pr. PSA01.1 Input mode selection]

Set safety sub-function control by input device or safety sub-function control by network.

[Pr. PSA02 Functional safety setting]

Make the settings in accordance with the system configuration. The recommended parameter settings and achievable safety level differ depending on the system configuration. Refer to the following for details.

☞ Page 441 Achievable safety level

[Pr. PSA03 SS1/SS2 deceleration monitor time]

Since the SS1 function is used when an error is found during self-diagnosis, set functional safety parameters of the SS1 function in advance. Set a proper value by referring to the following.

☞ Page 486 SS1 function

[Pr. PSA20 Servo motor encoder resolution]

Set the encoder resolution of the connected servo motor. If the set encoder resolution does not match the encoder resolution of the connected servo motor, [AL. 537 Parameter setting range error (safety sub-function)] occurs. For linear servo motors, the setting cannot be configured if position monitoring or speed monitoring is not executed.

[Pr. PSA23 Servo motor rated speed]

To execute speed monitoring, set the rated speed of the connected servo motor.

If the rated speed of the connected servo motor differs from the setting of this functional safety parameter, [AL. 537 Parameter setting range error (safety sub-function)] occurs.

[Pr. PSC03 Functional safety - Rotation direction selection/travel direction selection]

Set the same value as [Pr. PA14 Travel direction selection] to [PSC03.0 Rotation direction selection/travel direction selection].

If a different value is set, [AL. 537 Parameter setting range error (safety sub-function)] occurs.

Hereinafter, [Pr. PA14] and [Pr. PSC03.0] are referred to as "POL".

When using this functional safety parameter, pay attention to the following safety sub-function.

■ SDI function

The monitoring direction by the SDIP command is the address increasing direction (CCW or positive direction).

The monitoring direction when POL is set to "1" is the address increasing direction (CW or negative direction).

Note that when POL is set to "1", the monitoring direction and servo motor rotation/travel direction are different.

[Pr. PSL02 Functional safety - Linear encoder resolution setting - Numerator] [Pr. PSL03 Functional safety - Linear encoder resolution setting - Denominator]

When executing position monitoring or speed monitoring for a linear servo motor, set the same value as [Pr. PL02 Linear encoder resolution setting - Numerator] and [Pr. PL03 Linear encoder resolution setting - Denominator]. If a different value is set, [AL. 537 Parameter setting range error (safety sub-function)] occurs.

Test operation

Outline

It is possible to temporarily disable the safety sub-functions to perform the test operation. Set [Pr. PSA01.1 Input mode selection] to "2". In test operation mode, some diagnosis functions and safety sub-functions are disabled. This mode can be used for JOG operation, positioning operation, machine analyzer, etc., at the stage when the startup of safety devices has not been completed. Note the following points regarding the test operation mode.

- Set the mode to the test operation mode.
- Input/output diagnosis is not performed.
- The safety sub-functions will be disabled, so perform the operation with caution.
- If the servo motor operates abnormally, stop the servo motor with EM2 (Forced stop 2).

For details regarding the test operation, refer to "Test operation" in the User's Manual (Introduction).

To terminate the test operation, set "0" or "1" in [Pr. PSA01.1 Input mode selection] in accordance with the system used.

DO forced output

This function forcibly switches the output signal of the CN8-6/CN8-7 pin on and off regardless of the servo status. Use this function for purposes such as checking the signal output wiring. Operate this function on the DO Forced Output screen of MR Configurator2.

This function can be used only when [Pr. PSA01 Input mode selection] is set to "2" (test operation mode).

- Clicking "ON" or "OFF" on the DO Forced Output screen will change the DO output. Deselecting "Switch the dual output at the same time" can output the signals of the CN8-6/CN8-7 pin respectively.

6.4 Safety sub-function

Achievable safety level

The achievable safety level and available safety sub-functions depend on the device to be connected. Moreover, it is necessary to set the parameters according to the device to be connected. The servo motors and parameter settings required to achieve each functional safety level are given below.

When the safety sub-function is enabled ([Pr. PSA01.0 Safety sub-function activation setting] is set to "1"), the communication cycle is restricted. For details, refer to "Restrictions on the MR-J5_-_G_" in the User's Manual (Introduction).

Shut off/Monitoring function

■ Safety sub-function control by network

Safety sub-function				Servo motor with functional safety	Operation mode *1			Semi/Full *1		Encoder *1		Parameter setting
STO function SS1 function	SLT function	SLS function SDI function Deceleration monitoring function	SS2/SOS function SLI function		Standard	Linear	DD	Semi closed	Fully closed	Mitsubishi Electric serial	A/B/Z-phase	Position/Speed monitor setting [Pr. PSA02.1]
Category 3, PL d, SIL 2	Category 3, PL d, SIL 2	—	—	Not required	○	○	○	○	○	○	○	0
		Category 3, PL d, SIL 2	—	Not required	○	○	○	○	×	○	○	2
Category 4, PL e, SIL 3	Category 3, PL d, SIL 2	—	—	Not required	○	○	○	○	○	○	○	0
		Category 3, PL d, SIL 2	—	Not required	○	○	○	○	×	○	○	2
		Category 4, PL e, SIL 3	Category 4, PL e, SIL 3	Required	○	×	×	○	×	○	×	1

*1 ○: Indicates that this item is supported in this configuration. ×: Indicates that this item is not supported in this configuration.

■ When using the safety sub-functions by wiring to the CN8 connector (safety sub-function control by input device)

- For safety sub-function control by safety programmable controller and safety controller

Safety sub-function				Servo motor with functional safety	Operation mode *3			Semi/Full *3		Encoder *3		Parameter setting
STO function SS1 function	SLT function	SLS function SDI function Deceleration monitoring function	SS2/SOS function SLI function		Standard	Linear	DD	Semi closed	Fully closed	Mitsubishi Electric serial	A/B/Z-phase	Position/Speed monitor setting [Pr. PSA02.1]
Category 3, PL d, SIL 2 *1	Category 3, PL d, SIL 2 *1	—	—	Not required	○	○	○	○	○	○	○	0
		Category 3, PL d, SIL 2 *1	—	Not required	○	○	○	○	×	○	○	2
Category 4, PL e, SIL 3 *2	Category 3, PL d, SIL 2 *1	—	—	Not required	○	○	○	○	○	○	○	0
		Category 3, PL d, SIL 2 *1	—	Not required	○	○	○	○	×	○	○	2
		Category 4, PL e, SIL 3 *2	Category 4, PL e, SIL 3 *2	Required	○	×	×	○	×	○	×	1

*1 Set the I/O diagnosis pulses of the controller to disabled (Not used).

*2 Set the I/O diagnosis pulses of the controller to enabled (Used). The controller must be SIL 3 compliant.

*3 ○: Indicates that this item is supported in this configuration. ×: Indicates that this item is not supported in this configuration.

- For safety sub-function control using emergency stop push button switch, safety switch, enable switch

Safety sub-function				Servo motor with functional safety	Operation mode *1			Semi/Full *1		Encoder *1		Parameter setting
STO function SS1 function	SLT function	SLS function SDI function Deceleration monitoring function	SS2/SOS function SLI function		Standard	Linear	DD	Semi closed	Fully closed	Mitsubishi Electric serial	A/B/Z-phase	Position/Speed monitor setting
Category 3, PL d, SIL 2	Category 3, PL d, SIL 2	—	—	Not required	○	○	○	○	○	○	○	0
		Category 3, PL d, SIL 2	—	Not required	○	○	○	○	×	○	○	2
		Category 3, PL d, SIL 2	Category 3, PL d, SIL 2	Required	○	×	×	○	×	○	×	1

*1 ○: Indicates that this item is supported in this configuration. ×: Indicates that this item is not supported in this configuration.

Output function

Required safety level				Servo motor with functional safety	Operation mode *2			Semi/Full *2		Encoder *2		Parameter setting	
STOS SS1S SBCS	SLT1S SLT2S SLT3S SLT4S	SLS1S SLS2S SLS3S SLS4S SSMS SDIPS SDINS	SOSS SS2S SLIS		Standard	Linear	DD	Semi closed	Fully closed	Mitsubishi Electric serial	A/B/Z-phase	Position/Speed monitor setting	Internal test pulse diagnosis
												[Pr. PSA02.1]	[Pr. PSA29.0]
Category 3, PL d, SIL 2	Category 3, PL d, SIL 2	—	—	Not required	○	○	○	○	○	○	○	0	0 *1
		Category 3, PL d, SIL 2	—	Not required	○	○	○	○	×	○	○	2	0 *1
Category 4, PL e, SIL 3	Category 3, PL d, SIL 2	—	—	Not required	○	○	○	○	○	○	○	0	1
		Category 3, PL d, SIL 2	—	Not required	○	○	○	○	×	○	○	2	1
		Category 4, PL e, SIL 3	Category 4, PL e, SIL 3	Required	○	×	×	○	×	○	×	1	1

*1 It is recommended to check (diagnose) that the output devices operate properly at least once every 24 hours.

*2 ○: Indicates that this item is supported in this configuration. ×: Indicates that this item is not supported in this configuration.

I/O function

Input device

■ Outline

Input devices cannot be used for safety sub-function control by network. Input devices for functional safety have the following characteristics.

- Input device selection

A device can be freely assigned to the input signal of the CN8-4/CN8-5 pin by parameter.

- Duplication of the input wiring

Input errors can be detected immediately by verifying the input signal with duplicated wiring.

- Diagnosis with test pulses

Failure diagnosis including external wiring can be performed by sending pulse signals that are temporarily turned off when the input signals are on.

- Noise elimination filter

This is a function that can reduce noise for input signals.

■ Input device selection

- Input device selection

Select the input device to be assigned to the input signal of the CN8-4/CN8-5 pin with [Pr. PSD02 Input device selection DI1].

CN8 pin No.	Parameter
4	[Pr. PSD02 Input device selection DI1]
5	

For details on each input device, refer to the following items. For multi-axis servo amplifiers, axes to use input signals can be selected from any of the following: One input signal activates the safety sub-function for the A-axis only, or activates the safety sub-function for the A, B, and C-axes at the same time.

Input signal	Reference
STOC (STO command)	☞ Page 483 STO function
SS1C (SS1 command)	☞ Page 486 SS1 function
SS2C (SS2 command)	☞ Page 494 SS2/SOS function
SLS1C (SLS1 command)	☞ Page 500 SLS function
SLS2C (SLS2 command)	
SLS3C (SLS3 command)	
SLS4C (SLS4 command)	
SDIPC (SDIP command)	☞ Page 506 SDI function
SDINC (SDIN command)	
SLIC (SLI command)	☞ Page 509 SLI function
SLT1C (SLT1 command)	☞ Page 511 SLT function
SLT2C (SLT2 command)	
SLT3C (SLT3 command)	
SLT4C (SLT4 command)	

- Input device automatic activation selection

Setting [Pr. PSD01 Input device automatic activation selection] activates the operation command of each function automatically.

The automatically activated input device will be enabled regardless of the input device condition, and the corresponding function will operate automatically.

For the input devices that can be automatically activated, refer to [Pr. PSD01 Input device automatic activation selection].

■ Duplication of the input wiring

- Duplication of the input wiring

Switch the CN8-4/CN8-5 pin within the permissible time for mismatches.

This function continuously monitors whether signals of duplicated input are matched. When a mismatch is detected, the corresponding input device is treated as off. The following shows the operation sequence when SLS1C (SLS1 command) is assigned to the input signal of the CN8-4/CN8-5 pin. SLS1C (SLS1 command) is off while the CN8-4 and CN8-5 pin are mismatched. SLS1C (SLS1 command) is on when both the CN8-4 pin and CN8-5 pin turn on. If the mismatch continues for longer than the permissible time for mismatches specified by the parameter, [AL. 557 Input device mismatch detection (safety sub-function)] occurs and the SS1 function is activated.

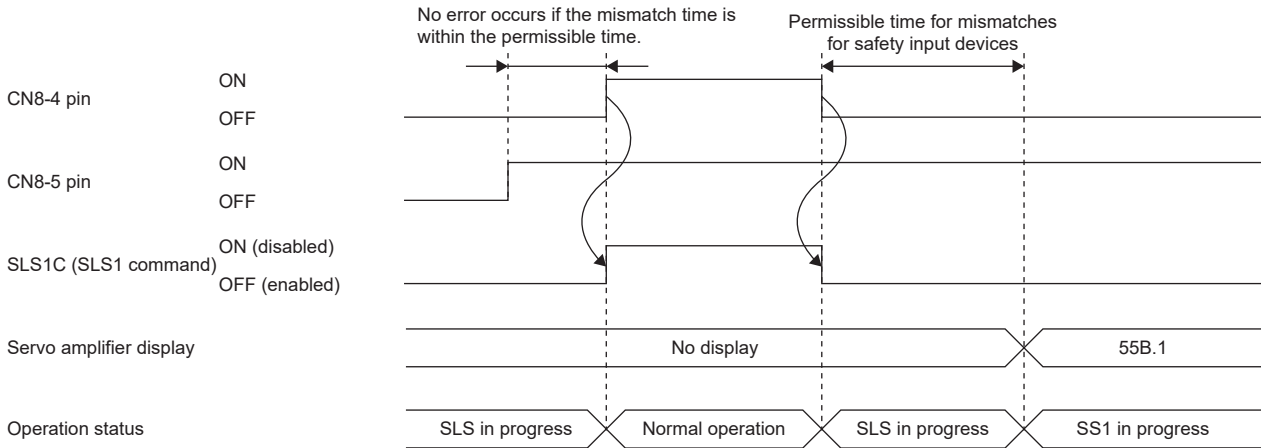

- Setting functional safety parameters

For the input devices that are assigned with [Pr. PSD02 Input device selection DI1], set the following parameter. Setting the permissible time for mismatches to 0 disables the diagnosis.

Parameter	Name
PSD18	Permissible time for mismatches DI1

■ Diagnosis with test pulses

- When connecting a device that has a diagnosis function (safety controller, etc.)

Use the diagnosis function of the device to diagnose the external wiring.

Check that the wiring is properly done so as to allow execution of the test pulse diagnosis.

Input off-pulses at different timings to the CN8-4 pin and CN8-5 pin periodically.

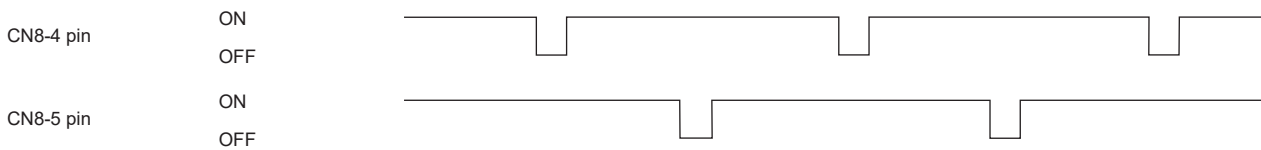

■ Noise elimination filter

- Outline

The noise elimination filter is a function to set a filtering time to reduce the noise of input signals. Set the filtering time of the noise elimination filter with [Pr. PSD12 Input device - Noise elimination filter time DI1].

The longer the noise elimination filter time, the better the resistance to chattering and noise, but the slower the response to the input signals. The shorter the noise elimination filter time, the faster the response to the input signals, but the less resistance to chattering and noise.

When the test pulses are superimposed on the input signals, the noise elimination filter time needs to be set considering the off-time of the test pulses. The following table shows the specific settings of the noise elimination filter time.

Configuration		Noise elimination filter time
Using a switch		Set 1.00 ms or more.
Using a device	Test pulses are in superposition in the output signal of the device.	Set a time that is at least 1.00 ms longer than the off time for test pulses output by the machine.
	Test pulses are not in superposition in the output signal of the device.	Set 1.00 ms or more.

- Setting functional safety parameters

For input devices to which the function is assigned with [Pr. PSD02 Input device selection DI1], set the noise elimination filter time in [Pr. PSD12 Input device - Noise elimination filter time DI1].

Parameter	Name
PSD12	Input device - Noise elimination filter time DI1

Because the response time of the input device changes according to the noise elimination filter time, refer also to the following.

☞ Page 446 Response time of input device

■ Response time of input device

The response time of the input device changes according to the noise elimination filter time set in [Pr. PSD12 Input device - Noise elimination filter time DI1].

The following shows a sequence when STOC (STO command) is assigned to the input signal of the CN8-4/CN8-5 pin. A delay equal to the input device noise elimination filter time occurs in the response time from when signals are input to input devices until the corresponding functions switch between enabled/disabled.

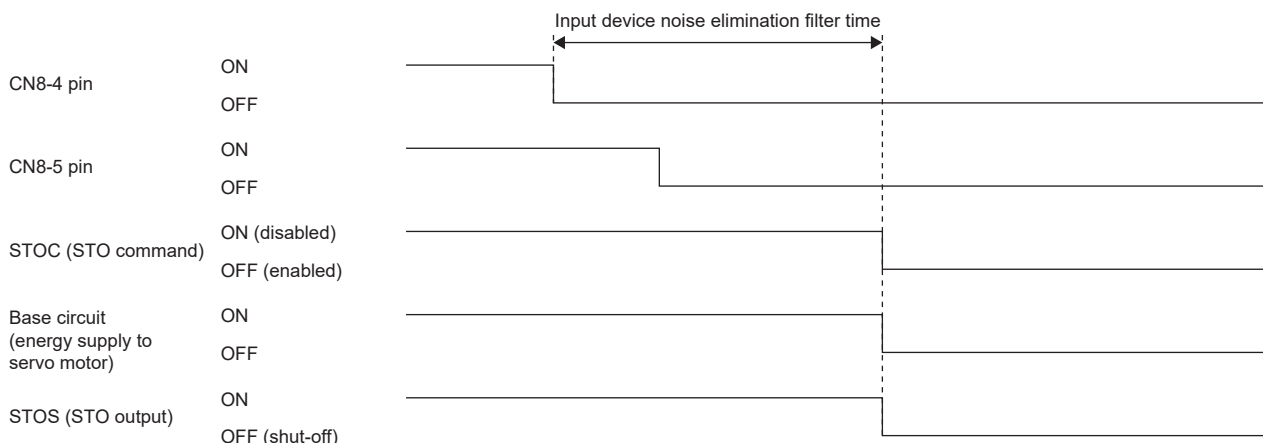

Output device

■ Outline

The output device of the status monitor function (SM) has the following characteristics.

- Output device selection

A device can be freely assigned to the output signal of the CN8-6/CN8-7 pin by parameter.

- Duplication of output

The same signal is duplicated for output with duplicated wiring. As a result, even if an error occurs in one of the output devices, the functionality will not be lost.

- Diagnosis with test pulses

Failure diagnosis including external wiring is performed by sending pulse signals that are temporarily turned off when the output signals are on.

Enabled/disabled can be selected with [Pr. PSD29 Output device - Test pulse diagnosis execution selection].

■ Output device selection

Select the output device to be assigned to the output signal of the CN8-6/CN8-7 pin with [Pr. PSD08 Output device selection DO1].

CN8 pin No.	Parameter
6	[Pr. PSD08 Output device selection DO1]
7	

For details on each output device, refer to the items in the following table. For multi-axis servo amplifiers, axes for outputs can be selected from any of the following: The A-axis only, or the A, B, and C-axes as an AND output.

Output signal	Reference
STOS (STO output)	☞ Page 483 STO function
SS1S (SS1 output)	☞ Page 486 SS1 function
SS2S (SS2 output)	☞ Page 494 SS2/SOS function
SLS1S (SLS1 output)	☞ Page 500 SLS function
SLS2S (SLS2 output)	
SLS3S (SLS3 output)	
SLS4S (SLS4 output)	
SSMS (SSM output)	☞ Page 504 SSM function
SOSS (SOS output)	☞ Page 494 SS2/SOS function
SBCS (SBC output)	☞ Page 505 SBC function
SDIPS (SDIP output)	☞ Page 506 SDI function
SDINS (SDIN output)	
SLIS (SLI output)	☞ Page 509 SLI function
SLT1S (SLT1 output)	☞ Page 511 SLT function
SLT2S (SLT2 output)	
SLT3S (SLT3 output)	
SLT4S (SLT4 output)	

■ Diagnosis with test pulses

- Test pulse diagnosis function

When the output signal of the CN8-6/CN8-7 pin is on, off-pulses are output periodically to diagnose wiring abnormalities.

The following shows the operation sequence when STOS (STO output) is assigned to the output signal of the CN8-6/CN8-7 pin. When STOS (STO output) is on, off-pulses are output to the CN8-6/CN8-7 pin periodically. Off-pulses are output from the CN8-6 pin and CN8-7 pin at different timings. The width of the off-pulses can be set with [Pr. PSD30 Output device - Test pulse off time]. Set the off-pulse width so that external devices are not affected by the output of off-pulses.

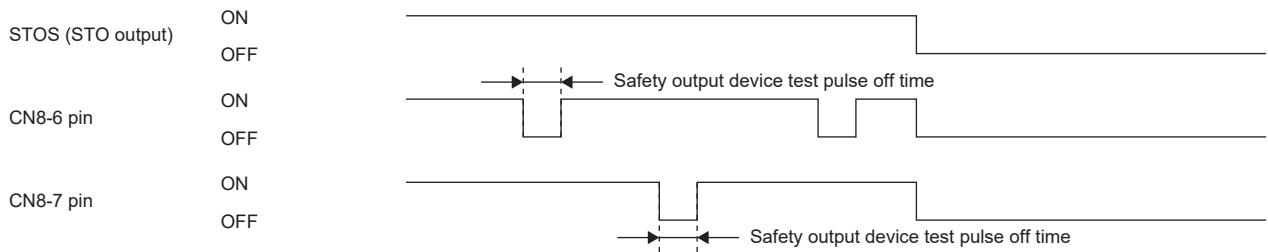

If an error is detected by the test pulse diagnosis, [AL. 556 Output device diagnosis error (safety sub-function)] occurs.

Whether or not to perform diagnosis on output devices using test pulses can be selected with [Pr. PSD29 Output device - Test pulse diagnosis execution selection].

- Setting functional safety parameters

For the output devices that are assigned with [Pr. PSD08 Output device selection DO1], set the following parameters.

Parameter	Name
PSD29	Output device - Test pulse diagnosis execution selection
PSD30	Output device - Test pulse off time

Set whether to execute test pulse diagnosis in [Pr. PSD29 Output device - Test pulse diagnosis execution selection]. Set the off time of the test pulses output from the output device in [Pr. PSD30 Output device - Test pulse off time].

The achievable safety level is influenced by the devices used and the setting of this functional safety parameter. Refer to the following for details.

☞ Page 441 Achievable safety level

■ Status of I/O signals at startup and error detection

- At startup

After power-on, each output device constantly outputs the OFF signal until completion of the diagnosis. After the diagnosis is completed, the devices assigned with [Pr. PSD08 Output device selection DO1] are output.

The diagnosis completion timing differs depending on whether safety sub-function control is by an input device or by a network. For safety sub-function control by input device, refer to the following.

☞ Page 444 Input device

For safety sub-function control by network refer to the following.

☞ Page 450 Safety sub-function control by network

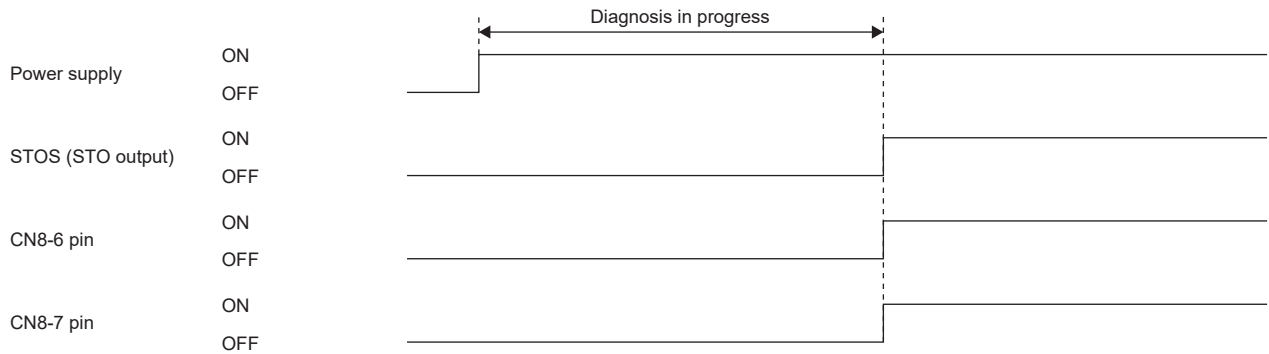

- At error detection

When an error is detected in a servo amplifier and an alarm that disables SSM occurs, each output device turns off.

If some other type of alarm occurs, the output from the assigned devices will continue.

Safety sub-function control by network



This manual describes the safety sub-function using CC-Link IE TSN. For other networks, refer to the User's Manual (Communication Function).

The safety sub-function via a network cannot be used with CC-Link IE Field Network Basic.

■ Outline

Input devices cannot be used for safety sub-function control by network. Assigning safety-specific I/O signals to the safety device of the master station can perform the control. Safety sub-function control by network has the following characteristics.

- Transmission of each function command input via a network (for the MR-J5-_G_-RJ)

The following commands can be transmitted via a network.

Master station → Device station *1		
Bit	Input command	Description
0	STOC (STO command)	0: The STO function of the servo amplifier is activated and the energy supply is shut off. 1: The STO status is canceled and normal operation resumes.
1	SS1C (SS1 command)	0: The SS1 function is activated. 1: The SS1 function is canceled.
2	SS2C (SS2 command)	0: The SS2 function is activated. 1: The SS2 function is canceled.
3	Not used	Set to "0".
4		
5	SDIPC (SDIP command)	0: The SDIP function is activated. 1: The SDIP function is canceled.
6	SDINC (SDIN command)	0: The SDIN function is activated. 1: The SDIN function is canceled.
7	Not used	Set to "0".
8	SLS1C (SLS1 command)	0: The SLS1 function is activated. 1: The SLS1 function is canceled.
9	SLS2C (SLS2 command)	0: The SLS2 function is activated. 1: The SLS2 function is canceled.
10	SLS3C (SLS3 command)	0: The SLS3 function is activated. 1: The SLS3 function is canceled.
11	SLS4C (SLS4 command)	0: The SLS4 function is activated. 1: The SLS4 function is canceled.
12	Not used	Set to "0".
13		
14		
14	SLIC (SLI command)	0: The SLI function is activated. 1: The SLI function is canceled.
15	Not used	Set to "0".
16		
17		
18		
19		
20		
21		
22		
23		
24	SLT1C (SLT1 command)	0: The SLT1 function is activated. 1: The SLT1 function is canceled.
25	SLT2C (SLT2 command)	0: The SLT2 function is activated. 1: The SLT2 function is canceled.
26	SLT3C (SLT3 command)	0: The SLT3 function is activated. 1: The SLT3 function is canceled.
27	SLT4C (SLT4 command)	0: The SLT4 function is activated. 1: The SLT4 function is canceled.

Master station → Device station *1

Bit	Input command	Description
28	Not used	Set to "0".
29		
30		
31		

*1 When using a Mitsubishi Electric safety programmable controller, use the safety output device "SA¥Y". For details on the safety device, refer to the following manual.

📖 MELSEC iQ-R CPU Module User's Manual (Application)

- Transmission of each function command input via a network (for the MR-J5W2-_G_)

The following commands can be transmitted via a network.

Master station → Device station *1			
Bit	Input command	Axis	Description
0	STOC (STO command)	A-axis	0:The STO function of the drive unit is activated and the energy supply is shut off. 1:The STO status is canceled and normal operation resumes.
1	SS1C (SS1 command)		0:The SS1 function is activated. 1:The SS1 function is canceled.
2	SS2C (SS2 command)		0:The SS2 function is activated. 1:The SS2 function is canceled.
3	Not used		Set to "0".
4			
5	SDIPC (SDIP command)		0:The SDIP function is activated. 1:The SDIP function is canceled.
6	SDINC (SDIN command)		0:The SDIN function is activated. 1:The SDIN function is canceled.
7	Not used		Set to "0".
8	SLS1C (SLS1 command)		0:The SLS1 function is activated. 1:The SLS1 function is canceled.
9	SLS2C (SLS2 command)		0:The SLS2 function is activated. 1:The SLS2 function is canceled.
10	SLS3C (SLS3 command)		0:The SLS3 function is activated. 1:The SLS3 function is canceled.
11	SLS4C (SLS4 command)		0:The SLS4 function is activated. 1:The SLS4 function is canceled.
12	Not used		Set to "0".
13			
14	SLIC (SLI command)		0:The SLI function is activated. 1:The SLI function is canceled.
15	Not used		Set to "0".
16			
17			
18			
19			
20			
21			
22			
23			
24	SLT1C (SLT1 command)		0:The SLT1 function is activated. 1:The SLT1 function is canceled.
25	SLT2C (SLT2 command)		0:The SLT2 function is activated. 1:The SLT2 function is canceled.
26	SLT3C (SLT3 command)		0:The SLT3 function is activated. 1:The SLT3 function is canceled.
27	SLT4C (SLT4 command)		0:The SLT4 function is activated. 1:The SLT4 function is canceled.
28	Not used		Set to "0".
29			
30			
31			

Master station → Device station *1			
Bit	Input command	Axis	Description
32	STOC (STO command)	B-axis	0:The STO function of the drive unit is activated and the energy supply is shut off. 1:The STO status is canceled and normal operation resumes.
33	SS1C (SS1 command)		0:The SS1 function is activated. 1:The SS1 function is canceled.
34	SS2C (SS2 command)		0:The SS2 function is activated. 1:The SS2 function is canceled.
35	Not used		Set to "0".
36			
37	SDIPC (SDIP command)		0:The SDIP function is activated. 1:The SDIP function is canceled.
38	SDINC (SDIN command)		0:The SDIN function is activated. 1:The SDIN function is canceled.
39	Not used		Set to "0".
40	SLS1C (SLS1 command)		0:The SLS1 function is activated. 1:The SLS1 function is canceled.
41	SLS2C (SLS2 command)		0:The SLS2 function is activated. 1:The SLS2 function is canceled.
42	SLS3C (SLS3 command)		0:The SLS3 function is activated. 1:The SLS3 function is canceled.
43	SLS4C (SLS4 command)		0:The SLS4 function is activated. 1:The SLS4 function is canceled.
44	Not used		Set to "0".
45			
46	SLIC (SLI command)		0:The SLI function is activated. 1:The SLI function is canceled.
47	Not used		Set to "0".
48			
49			
50			
51			
52			
53			
54			
55			
56	SLT1C (SLT1 command)		0:The SLT1 function is activated. 1:The SLT1 function is canceled.
57	SLT2C (SLT2 command)		0:The SLT2 function is activated. 1:The SLT2 function is canceled.
58	SLT3C (SLT3 command)		0:The SLT3 function is activated. 1:The SLT3 function is canceled.
59	SLT4C (SLT4 command)		0:The SLT4 function is activated. 1:The SLT4 function is canceled.
60	Not used		Set to "0".
61			
62			
63			

*1 When using a Mitsubishi Electric safety programmable controller, use the safety output device "SA¥Y". For details on the safety device, refer to the following manual.

 MELSEC iQ-R CPU Module User's Manual (Application)

- Transmission of each function command input via a network (for the MR-J5W3-_G_)

The following commands can be transmitted via a network.

Master station → Device station *1			
Bit	Input command	Axis	Description
0	STOC (STO command)	A-axis	0:The STO function of the drive unit is activated and the energy supply is shut off. 1:The STO status is canceled and normal operation resumes.
1	SS1C (SS1 command)		0:The SS1 function is activated. 1:The SS1 function is canceled.
2	SS2C (SS2 command)		0:The SS2 function is activated. 1:The SS2 function is canceled.
3	Not used		Set to "0".
4			
5	SDIPC (SDIP command)		0:The SDIP function is activated. 1:The SDIP function is canceled.
6	SDINC (SDIN command)		0:The SDIN function is activated. 1:The SDIN function is canceled.
7	Not used		Set to "0".
8	SLS1C (SLS1 command)		0:The SLS1 function is activated. 1:The SLS1 function is canceled.
9	SLS2C (SLS2 command)		0:The SLS2 function is activated. 1:The SLS2 function is canceled.
10	SLS3C (SLS3 command)		0:The SLS3 function is activated. 1:The SLS3 function is canceled.
11	SLS4C (SLS4 command)		0:The SLS4 function is activated. 1:The SLS4 function is canceled.
12	Not used		Set to "0".
13			
14	SLIC (SLI command)		0:The SLI function is activated. 1:The SLI function is canceled.
15	Not used		Set to "0".
16			
17			
18			
19			
20			
21			
22			
23			
24	SLT1C (SLT1 command)		0:The SLT1 function is activated. 1:The SLT1 function is canceled.
25	SLT2C (SLT2 command)		0:The SLT2 function is activated. 1:The SLT2 function is canceled.
26	SLT3C (SLT3 command)		0:The SLT3 function is activated. 1:The SLT3 function is canceled.
27	SLT4C (SLT4 command)		0:The SLT4 function is activated. 1:The SLT4 function is canceled.
28	Not used		Set to "0".
29			
30			
31			

Master station → Device station *1			
Bit	Input command	Axis	Description
32	STOC (STO command)	B-axis	0:The STO function of the drive unit is activated and the energy supply is shut off. 1:The STO status is canceled and normal operation resumes.
33	SS1C (SS1 command)		0:The SS1 function is activated. 1:The SS1 function is canceled.
34	SS2C (SS2 command)		0:The SS2 function is activated. 1:The SS2 function is canceled.
35	Not used		Set to "0".
36			
37	SDIPC (SDIP command)		0:The SDIP function is activated. 1:The SDIP function is canceled.
38	SDINC (SDIN command)		0:The SDIN function is activated. 1:The SDIN function is canceled.
39	Not used		Set to "0".
40	SLS1C (SLS1 command)		0:The SLS1 function is activated. 1:The SLS1 function is canceled.
41	SLS2C (SLS2 command)		0:The SLS2 function is activated. 1:The SLS2 function is canceled.
42	SLS3C (SLS3 command)		0:The SLS3 function is activated. 1:The SLS3 function is canceled.
43	SLS4C (SLS4 command)		0:The SLS4 function is activated. 1:The SLS4 function is canceled.
44	Not used		Set to "0".
45			
46	SLIC (SLI command)		0:The SLI function is activated. 1:The SLI function is canceled.
47	Not used		Set to "0".
48			
49			
50			
51			
52			
53			
54			
55			
56	SLT1C (SLT1 command)		0:The SLT1 function is activated. 1:The SLT1 function is canceled.
57	SLT2C (SLT2 command)		0:The SLT2 function is activated. 1:The SLT2 function is canceled.
58	SLT3C (SLT3 command)		0:The SLT3 function is activated. 1:The SLT3 function is canceled.
59	SLT4C (SLT4 command)		0:The SLT4 function is activated. 1:The SLT4 function is canceled.
60	Not used		Set to "0".
61			
62			
63			

Master station → Device station *1			
Bit	Input command	Axis	Description
64	STOC (STO command)	C-axis	0:The STO function of the drive unit is activated and the energy supply is shut off. 1:The STO status is canceled and normal operation resumes.
65	SS1C (SS1 command)		0:The SS1 function is activated. 1:The SS1 function is canceled.
66	SS2C (SS2 command)		0:The SS2 function is activated. 1:The SS2 function is canceled.
67	Not used		Set to "0".
68			
69	SDIPC (SDIP command)		0:The SDIP function is activated. 1:The SDIP function is canceled.
70	SDINC (SDIN command)		0:The SDIN function is activated. 1:The SDIN function is canceled.
71	Not used		Set to "0".
72	SLS1C (SLS1 command)		0:The SLS1 function is activated. 1:The SLS1 function is canceled.
73	SLS2C (SLS2 command)		0:The SLS2 function is activated. 1:The SLS2 function is canceled.
74	SLS3C (SLS3 command)		0:The SLS3 function is activated. 1:The SLS3 function is canceled.
75	SLS4C (SLS4 command)		0:The SLS4 function is activated. 1:The SLS4 function is canceled.
76	Not used		Set to "0".
77			
78	SLIC (SLI command)		0:The SLI function is activated. 1:The SLI function is canceled.
79	Not used		Set to "0".
80			
81			
82			
83			
84			
85			
86			
87			
88	SLT1C (SLT1 command)		0:The SLT1 function is activated. 1:The SLT1 function is canceled.
89	SLT2C (SLT2 command)		0:The SLT2 function is activated. 1:The SLT2 function is canceled.
90	SLT3C (SLT3 command)		0:The SLT3 function is activated. 1:The SLT3 function is canceled.
91	SLT4C (SLT4 command)		0:The SLT4 function is activated. 1:The SLT4 function is canceled.
92	Not used		Set to "0".
93			
94			
95			

*1 When using a Mitsubishi Electric safety programmable controller, use the safety output device "SA¥Y". For details on the safety device, refer to the following manual.

 MELSEC iQ-R CPU Module User's Manual (Application)

- Transmission of each function command input via a network (for the MR-J5D1-_G_)

The following commands can be transmitted via a network.

Master station → Device station *1		
Bit	Input command	Description
0	STOC (STO command)	0:The STO function of the servo amplifier is activated and the energy supply is shut off. 1:The STO status is canceled and normal operation resumes.
1	SS1C (SS1 command)	0:The SS1 function is activated. 1:The SS1 function is canceled.
2	SS2C (SS2 command)	0:The SS2 function is activated. 1:The SS2 function is canceled.
3	Not used	Set to "0".
4		
5	SDIPC (SDIP command)	0:The SDIP function is activated. 1:The SDIP function is canceled.
6	SDINC (SDIN command)	0:The SDIN function is activated. 1:The SDIN function is canceled.
7	Not used	Set to "0".
8	SLS1C (SLS1 command)	0:The SLS1 function is activated. 1:The SLS1 function is canceled.
9	SLS2C (SLS2 command)	0:The SLS2 function is activated. 1:The SLS2 function is canceled.
10	SLS3C (SLS3 command)	0:The SLS3 function is activated. 1:The SLS3 function is canceled.
11	SLS4C (SLS4 command)	0:The SLS4 function is activated. 1:The SLS4 function is canceled.
12	Not used	Set to "0".
13		
14	SLIC (SLI command)	0:The SLI function is activated. 1:The SLI function is canceled.
15	Not used	Set to "0".
16		
17		
18		
19		
20		
21		
22		
23		
24	SLT1C (SLT1 command)	0:The SLT1 function is activated. 1:The SLT1 function is canceled.
25	SLT2C (SLT2 command)	0:The SLT2 function is activated. 1:The SLT2 function is canceled.
26	SLT3C (SLT3 command)	0:The SLT3 function is activated. 1:The SLT3 function is canceled.
27	SLT4C (SLT4 command)	0:The SLT4 function is activated. 1:The SLT4 function is canceled.
28	Not used	Set to "0".
29		
30		
31		

*1 When using a Mitsubishi Electric safety programmable controller, use the safety output device "SA¥Y". For details on the safety device, refer to the following manual.

 MELSEC iQ-R CPU Module User's Manual (Application)

- Transmission of each function command input via a network (for the MR-J5D2-_G_)

The following commands can be transmitted via a network.

Master station → Device station *1			
Bit	Input command	Axis	Description
0	STOC (STO command)	A-axis	0:The STO function of the drive unit is activated and the energy supply is shut off. 1:The STO status is canceled and normal operation resumes.
1	SS1C (SS1 command)		0:The SS1 function is activated. 1:The SS1 function is canceled.
2	SS2C (SS2 command)		0:The SS2 function is activated. 1:The SS2 function is canceled.
3	Not used		Set to "0".
4			
5	SDIPC (SDIP command)		0:The SDIP function is activated. 1:The SDIP function is canceled.
6	SDINC (SDIN command)		0:The SDIN function is activated. 1:The SDIN function is canceled.
7	Not used		Set to "0".
8	SLS1C (SLS1 command)		0:The SLS1 function is activated. 1:The SLS1 function is canceled.
9	SLS2C (SLS2 command)		0:The SLS2 function is activated. 1:The SLS2 function is canceled.
10	SLS3C (SLS3 command)		0:The SLS3 function is activated. 1:The SLS3 function is canceled.
11	SLS4C (SLS4 command)		0:The SLS4 function is activated. 1:The SLS4 function is canceled.
12	Not used		Set to "0".
13			
14	SLIC (SLI command)		0:The SLI function is activated. 1:The SLI function is canceled.
15	Not used		Set to "0".
16			
17			
18			
19			
20			
21			
22			
23			
24	SLT1C (SLT1 command)		0:The SLT1 function is activated. 1:The SLT1 function is canceled.
25	SLT2C (SLT2 command)		0:The SLT2 function is activated. 1:The SLT2 function is canceled.
26	SLT3C (SLT3 command)		0:The SLT3 function is activated. 1:The SLT3 function is canceled.
27	SLT4C (SLT4 command)		0:The SLT4 function is activated. 1:The SLT4 function is canceled.
28	Not used		Set to "0".
29			
30			
31			

Master station → Device station *1			
Bit	Input command	Axis	Description
32	STOC (STO command)	B-axis	0:The STO function of the drive unit is activated and the energy supply is shut off. 1:The STO status is canceled and normal operation resumes.
33	SS1C (SS1 command)		0:The SS1 function is activated. 1:The SS1 function is canceled.
34	SS2C (SS2 command)		0:The SS2 function is activated. 1:The SS2 function is canceled.
35	Not used		Set to "0".
36			
37	SDIPC (SDIP command)		0:The SDIP function is activated. 1:The SDIP function is canceled.
38	SDINC (SDIN command)		0:The SDIN function is activated. 1:The SDIN function is canceled.
39	Not used		Set to "0".
40	SLS1C (SLS1 command)		0:The SLS1 function is activated. 1:The SLS1 function is canceled.
41	SLS2C (SLS2 command)		0:The SLS2 function is activated. 1:The SLS2 function is canceled.
42	SLS3C (SLS3 command)		0:The SLS3 function is activated. 1:The SLS3 function is canceled.
43	SLS4C (SLS4 command)		0:The SLS4 function is activated. 1:The SLS4 function is canceled.
44	Not used		Set to "0".
45			
46	SLIC (SLI command)		0:The SLI function is activated. 1:The SLI function is canceled.
47	Not used		Set to "0".
48			
49			
50			
51			
52			
53			
54			
55			
56	SLT1C (SLT1 command)		0:The SLT1 function is activated. 1:The SLT1 function is canceled.
57	SLT2C (SLT2 command)		0:The SLT2 function is activated. 1:The SLT2 function is canceled.
58	SLT3C (SLT3 command)		0:The SLT3 function is activated. 1:The SLT3 function is canceled.
59	SLT4C (SLT4 command)		0:The SLT4 function is activated. 1:The SLT4 function is canceled.
60	Not used		Set to "0".
61			
62			
63			

*1 When using a Mitsubishi Electric safety programmable controller, use the safety output device "SA¥Y". For details on the safety device, refer to the following manual.

 MELSEC iQ-R CPU Module User's Manual (Application)

- Transmission of each function command input via a network (for the MR-J5D3-_G_)

The following commands can be transmitted via a network.

Master station → Device station *1			
Bit	Input command	Axis	Description
0	STOC (STO command)	A-axis	0:The STO function of the drive unit is activated and the energy supply is shut off. 1:The STO status is canceled and normal operation resumes.
1	SS1C (SS1 command)		0:The SS1 function is activated. 1:The SS1 function is canceled.
2	SS2C (SS2 command)		0:The SS2 function is activated. 1:The SS2 function is canceled.
3	Not used		Set to "0".
4			
5	SDIPC (SDIP command)		0:The SDIP function is activated. 1:The SDIP function is canceled.
6	SDINC (SDIN command)		0:The SDIN function is activated. 1:The SDIN function is canceled.
7	Not used		Set to "0".
8	SLS1C (SLS1 command)		0:The SLS1 function is activated. 1:The SLS1 function is canceled.
9	SLS2C (SLS2 command)		0:The SLS2 function is activated. 1:The SLS2 function is canceled.
10	SLS3C (SLS3 command)		0:The SLS3 function is activated. 1:The SLS3 function is canceled.
11	SLS4C (SLS4 command)		0:The SLS4 function is activated. 1:The SLS4 function is canceled.
12	Not used		Set to "0".
13			
14	SLIC (SLI command)		0:The SLI function is activated. 1:The SLI function is canceled.
15	Not used		Set to "0".
16			
17			
18			
19			
20			
21			
22			
23			
24	SLT1C (SLT1 command)		0:The SLT1 function is activated. 1:The SLT1 function is canceled.
25	SLT2C (SLT2 command)		0:The SLT2 function is activated. 1:The SLT2 function is canceled.
26	SLT3C (SLT3 command)		0:The SLT3 function is activated. 1:The SLT3 function is canceled.
27	SLT4C (SLT4 command)		0:The SLT4 function is activated. 1:The SLT4 function is canceled.
28	Not used		Set to "0".
29			
30			
31			

Master station → Device station *1			
Bit	Input command	Axis	Description
32	STOC (STO command)	B-axis	0:The STO function of the drive unit is activated and the energy supply is shut off. 1:The STO status is canceled and normal operation resumes.
33	SS1C (SS1 command)		0:The SS1 function is activated. 1:The SS1 function is canceled.
34	SS2C (SS2 command)		0:The SS2 function is activated. 1:The SS2 function is canceled.
35	Not used		Set to "0".
36			
37	SDIPC (SDIP command)		0:The SDIP function is activated. 1:The SDIP function is canceled.
38	SDINC (SDIN command)		0:The SDIN function is activated. 1:The SDIN function is canceled.
39	Not used		Set to "0".
40	SLS1C (SLS1 command)		0:The SLS1 function is activated. 1:The SLS1 function is canceled.
41	SLS2C (SLS2 command)		0:The SLS2 function is activated. 1:The SLS2 function is canceled.
42	SLS3C (SLS3 command)		0:The SLS3 function is activated. 1:The SLS3 function is canceled.
43	SLS4C (SLS4 command)		0:The SLS4 function is activated. 1:The SLS4 function is canceled.
44	Not used		Set to "0".
45			
46	SLIC (SLI command)		0:The SLI function is activated. 1:The SLI function is canceled.
47	Not used		Set to "0".
48			
49			
50			
51			
52			
53			
54			
55			
56	SLT1C (SLT1 command)		0:The SLT1 function is activated. 1:The SLT1 function is canceled.
57	SLT2C (SLT2 command)		0:The SLT2 function is activated. 1:The SLT2 function is canceled.
58	SLT3C (SLT3 command)		0:The SLT3 function is activated. 1:The SLT3 function is canceled.
59	SLT4C (SLT4 command)		0:The SLT4 function is activated. 1:The SLT4 function is canceled.
60	Not used		Set to "0".
61			
62			
63			

Master station → Device station *1			
Bit	Input command	Axis	Description
64	STOC (STO command)	C-axis	0:The STO function of the drive unit is activated and the energy supply is shut off. 1:The STO status is canceled and normal operation resumes.
65	SS1C (SS1 command)		0:The SS1 function is activated. 1:The SS1 function is canceled.
66	SS2C (SS2 command)		0:The SS2 function is activated. 1:The SS2 function is canceled.
67	Not used		Set to "0".
68			
69	SDIPC (SDIP command)		0:The SDIP function is activated. 1:The SDIP function is canceled.
70	SDINC (SDIN command)		0:The SDIN function is activated. 1:The SDIN function is canceled.
71	Not used		Set to "0".
72	SLS1C (SLS1 command)		0:The SLS1 function is activated. 1:The SLS1 function is canceled.
73	SLS2C (SLS2 command)		0:The SLS2 function is activated. 1:The SLS2 function is canceled.
74	SLS3C (SLS3 command)		0:The SLS3 function is activated. 1:The SLS3 function is canceled.
75	SLS4C (SLS4 command)		0:The SLS4 function is activated. 1:The SLS4 function is canceled.
76	Not used		Set to "0".
77			
78	SLIC (SLI command)		0:The SLI function is activated. 1:The SLI function is canceled.
79	Not used		Set to "0".
80			
81			
82			
83			
84			
85			
86			
87			
88	SLT1C (SLT1 command)		0:The SLT1 function is activated. 1:The SLT1 function is canceled.
89	SLT2C (SLT2 command)		0:The SLT2 function is activated. 1:The SLT2 function is canceled.
90	SLT3C (SLT3 command)	0:The SLT3 function is activated. 1:The SLT3 function is canceled.	
91	SLT4C (SLT4 command)	0:The SLT4 function is activated. 1:The SLT4 function is canceled.	
92	Not used	Set to "0".	
93			
94			
95			



*1 When using a Mitsubishi Electric safety programmable controller, use the safety output device "SA¥Y". For details on the safety device, refer to the following manual.

 MELSEC iQ-R CPU Module User's Manual (Application)

- Feedback of various function outputs via a network (for MR-J5- G_-RJ)

STOS (STO output), SOSS (SOS output), SSMS (SSM output), etc., can be transmitted through the network.

Device station → Master station *1		
Bit	Function output	Description
0	STOS (STO output)	0: Indicates that the STO status has been canceled. 1: Indicates that the STO function is activated and the energy supply has been shut off.
1	SSMS (SSM output)	0: Indicates that the servo motor speed exceeds the set SSM speed. (Off when the SSM function is disabled.) 1: Indicates that the servo motor speed is equal to or less than the set SSM speed.
2	Not used	—
3	SOSS (SOS output)	0: Indicates that the SOS function is not activated. 1: Indicates that the SOS function is activated by the SS2 function.
4	Not used	—
5	SDIPS (SDIP output)	0: Indicates that the SDIP function is not activated. 1: Indicates that the SDIP function is activated.
6	SDINS (SDIN output)	0: Indicates that the SDIN function is not activated. 1: Indicates that the SDIN function is activated.
7	SNERR (Safety communication error 1)	0: Indicates that no error related to safety communication is occurring. 1: Indicates that an error related to safety communication is occurring.
8	SLS1S (SLS1 output)	0: Indicates that the SLS1 function is not activated. 1: Indicates that the SLS1 function is activated.
9	SLS2S (SLS2 output)	0: Indicates that the SLS2 function is not activated. 1: Indicates that the SLS2 function is activated.
10	SLS3S (SLS3 output)	0: Indicates that the SLS3 function is not activated. 1: Indicates that the SLS3 function is activated.
11	SLS4S (SLS4 output)	0: Indicates that the SLS4 function is not activated. 1: Indicates that the SLS4 function is activated.
12	SS1S (SS1 output)	0: Indicates that the SS1 function is not activated. 1: Indicates that the SS1 function is activated.
13	SS2S (SS2 output)	0: Indicates that the SS2 function is not activated. 1: Indicates that the SS2 function is activated.
14	SLIS (SLI output)	0: Indicates that the SLI function is not activated. 1: Indicates that the SLI function is activated.
15	Not used	—
16		
17	SNERR2 (Safety communication error 2) *2	0: Indicates that the command signal for a safety sub-function that is disabled in [Pr. PSA02 Functional safety setting] is not input. 1: Indicates that the command signal for a safety sub-function that is not used is input.
18	SBCS (SBC output)	0: Indicates that the STO status has been canceled and the energy supply to the electromagnetic brake has not been shut off. 1: Indicates that the STO function is activated and the energy supply to the electromagnetic brake has been shut off.
19	Not used	—
20		
21		
22		
23		
24	SLT1S (SLT1 output)	0: Indicates that the SLT1 function is not activated. 1: Indicates that the SLT1 function is activated.
25	SLT2S (SLT2 output)	0: Indicates that the SLT2 function is not activated. 1: Indicates that the SLT2 function is activated.
26	SLT3S (SLT3 output)	0: Indicates that the SLT3 function is not activated. 1: Indicates that the SLT3 function is activated.
27	SLT4S (SLT4 output)	0: Indicates that the SLT4 function is not activated. 1: Indicates that the SLT4 function is activated.
28	Not used	—
29		
30		
31		

- *1 When using a Mitsubishi Electric safety programmable controller, use the safety input device "SA~~Y~~X". For details on the safety device, refer to the following manual.
 MELSEC iQ-R CPU Module User's Manual (Application)
- *2 The specifications of the SNERR2 signal sent from the servo amplifier differ depending on the setting value of [Pr. PSC05.2 SNERR2 signal selection]. For details, refer to the following manual.
 MR-J5-G/MR-J5W-G User's Manual (Parameters)

- Feedback of various function outputs via a network (for the MR-J5W2-_G_)

STOS (STO output), SOSS (SOS output), SSMS (SSM output), etc., can be transmitted through the network.

Device station → Master station *1			
Bit	Function output	Axis	Description
0	STOS (STO output)	A-axis	0:Indicates that the STO status has been canceled. 1:Indicates that the STO function is activated and the energy supply has been shut off.
1	SSMS (SSM output)		0:Indicates that the servo motor speed exceeds the set SSM speed. (Off when the SSM function is disabled.) 1:Indicates that the servo motor speed is equal to or less than the set SSM speed.
2	Not used		—
3	SOSS (SOS output)		0:Indicates that the SOS function is not activated. 1:Indicates that the SOS function is activated by the SS2 function.
4	Not used		—
5	SDIPS (SDIP output)		0:Indicates that the SDIP function is not activated. 1:Indicates that the SDIP function is activated.
6	SDINS (SDIN output)		0:Indicates that the SDIN function is not activated. 1:Indicates that the SDIN function is activated.
7	SNERR (Safety communication error 1)		0:Indicates that no error related to safety communication is occurring. 1:Indicates that an error related to safety communication is occurring.
8	SLS1S (SLS1 output)		0:Indicates that the SLS1 function is not activated. 1:Indicates that the SLS1 function is activated.
9	SLS2S (SLS2 output)		0:Indicates that the SLS2 function is not activated. 1:Indicates that the SLS2 function is activated.
10	SLS3S (SLS3 output)		0:Indicates that the SLS3 function is not activated. 1:Indicates that the SLS3 function is activated.
11	SLS4S (SLS4 output)		0:Indicates that the SLS4 function is not activated. 1:Indicates that the SLS4 function is activated.
12	SS1S (SS1 output)		0:Indicates that the SS1 function is not activated. 1:Indicates that the SS1 function is activated.
13	SS2S (SS2 output)		0:Indicates that the SS2 function is not activated. 1:Indicates that the SS2 function is activated.
14	SLIS (SLI output)		0:Indicates that the SLI function is not activated. 1:Indicates that the SLI function is activated.
15	Not used		—
16			
17	SNERR2 (Safety communication error 2) *2		0:Indicates that the command signal for a safety sub-function that is disabled in [Pr. PSA02 Functional safety setting] is not input. 1:Indicates that the command signal for a safety sub-function that is not used is input.
18	SBCS (SBC output)		0:Indicates that the STO status has been canceled and the energy supply to the electromagnetic brake has not been shut off. 1:Indicates that the STO function is activated and the energy supply to the electromagnetic brake has been shut off.
19	Not used		—
20			
21			
22			
23			
24	SLT1S (SLT1 output)		0:Indicates that the SLT1 function is not activated. 1:Indicates that the SLT1 function is activated.
25	SLT2S (SLT2 output)		0:Indicates that the SLT2 function is not activated. 1:Indicates that the SLT2 function is activated.
26	SLT3S (SLT3 output)		0:Indicates that the SLT3 function is not activated. 1:Indicates that the SLT3 function is activated.
27	SLT4S (SLT4 output)		0:Indicates that the SLT4 function is not activated. 1:Indicates that the SLT4 function is activated.
28	Not used		—
29			
30			
31			

Device station → Master station *1			
Bit	Function output	Axis	Description
32	STOS (STO output)	B-axis	0:Indicates that the STO status has been canceled. 1:Indicates that the STO function is activated and the energy supply has been shut off.
33	SSMS (SSM output)		0:Indicates that the servo motor speed exceeds the set SSM speed. (Off when the SSM function is disabled.) 1:Indicates that the servo motor speed is equal to or less than the set SSM speed.
34	Not used		—
35	SOSS (SOS output)		0:Indicates that the SOS function is not activated. 1:Indicates that the SOS function is activated by the SS2 function.
36	Not used		—
37	SDIPS (SDIP output)		0:Indicates that the SDIP function is not activated. 1:Indicates that the SDIP function is activated.
38	SDINS (SDIN output)		0:Indicates that the SDIN function is not activated. 1:Indicates that the SDIN function is activated.
39	SNERR (Safety communication error 1)		0:Indicates that no error related to safety communication is occurring. 1:Indicates that an error related to safety communication is occurring.
40	SLS1S (SLS1 output)		0:Indicates that the SLS1 function is not activated. 1:Indicates that the SLS1 function is activated.
41	SLS2S (SLS2 output)		0:Indicates that the SLS2 function is not activated. 1:Indicates that the SLS2 function is activated.
42	SLS3S (SLS3 output)		0:Indicates that the SLS3 function is not activated. 1:Indicates that the SLS3 function is activated.
43	SLS4S (SLS4 output)		0:Indicates that the SLS4 function is not activated. 1:Indicates that the SLS4 function is activated.
44	SS1S (SS1 output)		0:Indicates that the SS1 function is not activated. 1:Indicates that the SS1 function is activated.
45	SS2S (SS2 output)		0:Indicates that the SS2 function is not activated. 1:Indicates that the SS2 function is activated.
46	SLIS (SLI output)		0:Indicates that the SLI function is not activated. 1:Indicates that the SLI function is activated.
47	Not used		—
48			
49	SNERR2 (Safety communication error 2) *2		0:Indicates that the command signal for a safety sub-function that is disabled in [Pr. PSA02 Functional safety setting] is not input. 1:Indicates that the command signal for a safety sub-function that is not used is input.
50	SBCS (SBC output)		0:Indicates that the STO status has been canceled and the energy supply to the electromagnetic brake has not been shut off. 1:Indicates that the STO function is activated and the energy supply to the electromagnetic brake has been shut off.
51	Not used		—
52			
53			
54			
55			
56	SLT1S (SLT1 output)	0:Indicates that the SLT1 function is not activated. 1:Indicates that the SLT1 function is activated.	
57	SLT2S (SLT2 output)	0:Indicates that the SLT2 function is not activated. 1:Indicates that the SLT2 function is activated.	
58	SLT3S (SLT3 output)	0:Indicates that the SLT3 function is not activated. 1:Indicates that the SLT3 function is activated.	
59	SLT4S (SLT4 output)	0:Indicates that the SLT4 function is not activated. 1:Indicates that the SLT4 function is activated.	
60	Not used	—	
61			
62			
63			

- *1 When using a Mitsubishi Electric safety programmable controller, use the safety input device "SA \neq X". For details on the safety device, refer to the following manual.
📖 MELSEC iQ-R CPU Module User's Manual (Application)
- *2 The specifications of the SNERR2 signal sent from the servo amplifier differ depending on the setting value of [Pr. PSC05.2 SNERR2 signal selection]. For details, refer to the following manual.
📖 MR-J5-G/MR-J5W-G User's Manual (Parameters)

- Feedback of various function outputs via a network (for the MR-J5W3-_G)

STOS (STO output), SOSS (SOS output), SSMS (SSM output), etc., can be transmitted through the network.

Device station → Master station *1			
Bit	Function output	Axis	Description
0	STOS (STO output)	A-axis	0:Indicates that the STO status has been canceled. 1:Indicates that the STO function is activated and the energy supply has been shut off.
1	SSMS (SSM output)		0:Indicates that the servo motor speed exceeds the set SSM speed. (Off when the SSM function is disabled.) 1:Indicates that the servo motor speed is equal to or less than the set SSM speed.
2	Not used		—
3	SOSS (SOS output)		0:Indicates that the SOS function is not activated. 1:Indicates that the SOS function is activated by the SS2 function.
4	Not used		—
5	SDIPS (SDIP output)		0:Indicates that the SDIP function is not activated. 1:Indicates that the SDIP function is activated.
6	SDINS (SDIN output)		0:Indicates that the SDIN function is not activated. 1:Indicates that the SDIN function is activated.
7	SNERR (Safety communication error 1)		0:Indicates that no error related to safety communication is occurring. 1:Indicates that an error related to safety communication is occurring.
8	SLS1S (SLS1 output)		0:Indicates that the SLS1 function is not activated. 1:Indicates that the SLS1 function is activated.
9	SLS2S (SLS2 output)		0:Indicates that the SLS2 function is not activated. 1:Indicates that the SLS2 function is activated.
10	SLS3S (SLS3 output)		0:Indicates that the SLS3 function is not activated. 1:Indicates that the SLS3 function is activated.
11	SLS4S (SLS4 output)		0:Indicates that the SLS4 function is not activated. 1:Indicates that the SLS4 function is activated.
12	SS1S (SS1 output)		0:Indicates that the SS1 function is not activated. 1:Indicates that the SS1 function is activated.
13	SS2S (SS2 output)		0:Indicates that the SS2 function is not activated. 1:Indicates that the SS2 function is activated.
14	SLIS (SLI output)		0:Indicates that the SLI function is not activated. 1:Indicates that the SLI function is activated.
15	Not used		—
16			
17	SNERR2 (Safety communication error 2) *2		0:Indicates that the command signal for a safety sub-function that is disabled in [Pr. PSA02 Functional safety setting] is not input. 1:Indicates that the command signal for a safety sub-function that is not used is input.
18	SBCS (SBC output)		0:Indicates that the STO status has been canceled and the energy supply to the electromagnetic brake has not been shut off. 1:Indicates that the STO function is activated and the energy supply to the electromagnetic brake has been shut off.
19	Not used		—
20			
21			
22			
23			
24	SLT1S (SLT1 output)		0:Indicates that the SLT1 function is not activated. 1:Indicates that the SLT1 function is activated.
25	SLT2S (SLT2 output)		0:Indicates that the SLT2 function is not activated. 1:Indicates that the SLT2 function is activated.
26	SLT3S (SLT3 output)		0:Indicates that the SLT3 function is not activated. 1:Indicates that the SLT3 function is activated.
27	SLT4S (SLT4 output)		0:Indicates that the SLT4 function is not activated. 1:Indicates that the SLT4 function is activated.
28	Not used		—
29			
30			
31			

Device station → Master station *1

Bit	Function output	Axis	Description
32	STOS (STO output)	B-axis	0:Indicates that the STO status has been canceled. 1:Indicates that the STO function is activated and the energy supply has been shut off.
33	SSMS (SSM output)		0:Indicates that the servo motor speed exceeds the set SSM speed. (Off when the SSM function is disabled.) 1:Indicates that the servo motor speed is equal to or less than the set SSM speed.
34	Not used		—
35	SOSS (SOS output)		0:Indicates that the SOS function is not activated. 1:Indicates that the SOS function is activated by the SS2 function.
36	Not used		—
37	SDIPS (SDIP output)		0:Indicates that the SDIP function is not activated. 1:Indicates that the SDIP function is activated.
38	SDINS (SDIN output)		0:Indicates that the SDIN function is not activated. 1:Indicates that the SDIN function is activated.
39	SNERR (Safety communication error 1)		0:Indicates that no error related to safety communication is occurring. 1:Indicates that an error related to safety communication is occurring.
40	SLS1S (SLS1 output)		0:Indicates that the SLS1 function is not activated. 1:Indicates that the SLS1 function is activated.
41	SLS2S (SLS2 output)		0:Indicates that the SLS2 function is not activated. 1:Indicates that the SLS2 function is activated.
42	SLS3S (SLS3 output)		0:Indicates that the SLS3 function is not activated. 1:Indicates that the SLS3 function is activated.
43	SLS4S (SLS4 output)		0:Indicates that the SLS4 function is not activated. 1:Indicates that the SLS4 function is activated.
44	SS1S (SS1 output)		0:Indicates that the SS1 function is not activated. 1:Indicates that the SS1 function is activated.
45	SS2S (SS2 output)		0:Indicates that the SS2 function is not activated. 1:Indicates that the SS2 function is activated.
46	SLIS (SLI output)		0:Indicates that the SLI function is not activated. 1:Indicates that the SLI function is activated.
47	Not used		—
48			
49	SNERR2 (Safety communication error 2) *2		0:Indicates that the command signal for a safety sub-function that is disabled in [Pr. PSA02 Functional safety setting] is not input. 1:Indicates that the command signal for a safety sub-function that is not used is input.
50	SBCS (SBC output)		0:Indicates that the STO status has been canceled and the energy supply to the electromagnetic brake has not been shut off. 1:Indicates that the STO function is activated and the energy supply to the electromagnetic brake has been shut off.
51	Not used		—
52			
53			
54			
55			
56	SLT1S (SLT1 output)		0:Indicates that the SLT1 function is not activated. 1:Indicates that the SLT1 function is activated.
57	SLT2S (SLT2 output)		0:Indicates that the SLT2 function is not activated. 1:Indicates that the SLT2 function is activated.
58	SLT3S (SLT3 output)		0:Indicates that the SLT3 function is not activated. 1:Indicates that the SLT3 function is activated.
59	SLT4S (SLT4 output)		0:Indicates that the SLT4 function is not activated. 1:Indicates that the SLT4 function is activated.
60	Not used		—
61			
62			
63			

Device station → Master station *1



Bit	Function output	Axis	Description
64	STOS (STO output)	C-axis	0:Indicates that the STO status has been canceled. 1:Indicates that the STO function is activated and the energy supply has been shut off.
65	SSMS (SSM output)		0:Indicates that the servo motor speed exceeds the set SSM speed. (Off when the SSM function is disabled.) 1:Indicates that the servo motor speed is equal to or less than the set SSM speed.
66	Not used		—
67	SOSS (SOS output)		0:Indicates that the SOS function is not activated. 1:Indicates that the SOS function is activated by the SS2 function.
68	Not used		—
69	SDIPS (SDIP output)		0:Indicates that the SDIP function is not activated. 1:Indicates that the SDIP function is activated.
70	SDINS (SDIN output)		0:Indicates that the SDIN function is not activated. 1:Indicates that the SDIN function is activated.
71	SNERR (Safety communication error 1)		0:Indicates that no error related to safety communication is occurring. 1:Indicates that an error related to safety communication is occurring.
72	SLS1S (SLS1 output)		0:Indicates that the SLS1 function is not activated. 1:Indicates that the SLS1 function is activated.
73	SLS2S (SLS2 output)		0:Indicates that the SLS2 function is not activated. 1:Indicates that the SLS2 function is activated.
74	SLS3S (SLS3 output)		0:Indicates that the SLS3 function is not activated. 1:Indicates that the SLS3 function is activated.
75	SLS4S (SLS4 output)		0:Indicates that the SLS4 function is not activated. 1:Indicates that the SLS4 function is activated.
76	SS1S (SS1 output)		0:Indicates that the SS1 function is not activated. 1:Indicates that the SS1 function is activated.
77	SS2S (SS2 output)		0:Indicates that the SS2 function is not activated. 1:Indicates that the SS2 function is activated.
78	SLIS (SLI output)		0:Indicates that the SLI function is not activated. 1:Indicates that the SLI function is activated.
79	Not used		—
80			
81	SNERR2 (Safety communication error 2) *2		0:Indicates that the command signal for a safety sub-function that is disabled in [Pr. PSA02 Functional safety setting] is not input. 1:Indicates that the command signal for a safety sub-function that is not used is input.
82	SBCS (SBC output)		0:Indicates that the STO status has been canceled and the energy supply to the electromagnetic brake has not been shut off. 1:Indicates that the STO function is activated and the energy supply to the electromagnetic brake has been shut off.
83	Not used		—
84			
85			
86			
87			
88	SLT1S (SLT1 output)		0:Indicates that the SLT1 function is not activated. 1:Indicates that the SLT1 function is activated.
89	SLT2S (SLT2 output)		0:Indicates that the SLT2 function is not activated. 1:Indicates that the SLT2 function is activated.
90	SLT3S (SLT3 output)	0:Indicates that the SLT3 function is not activated. 1:Indicates that the SLT3 function is activated.	
91	SLT4S (SLT4 output)	0:Indicates that the SLT4 function is not activated. 1:Indicates that the SLT4 function is activated.	
92	Not used	—	
93			
94			
95			

- *1 When using a Mitsubishi Electric safety programmable controller, use the safety input device "SA \neq X". For details on the safety device, refer to the following manual.
📖 MELSEC iQ-R CPU Module User's Manual (Application)
- *2 The specifications of the SNERR2 signal sent from the servo amplifier differ depending on the setting value of [Pr. PSC05.2 SNERR2 signal selection]. For details, refer to the following manual.
📖 MR-J5-G/MR-J5W-G User's Manual (Parameters)

- Feedback of various function outputs via a network (for the MR-J5D1-_G_)

STOS (STO output), SOSS (SOS output), SSMS (SSM output), etc., can be transmitted through the network.

Device station → Master station *1		
Bit	Function output	Description
0	STOS (STO output)	0: Indicates that the STO status has been canceled. 1: Indicates that the STO function is activated and the energy supply has been shut off.
1	SSMS (SSM output)	0: Indicates that the servo motor speed exceeds the set SSM speed. (Off when the SSM function is disabled.) 1: Indicates that the servo motor speed is equal to or less than the set SSM speed.
2	Not used	—
3	SOSS (SOS output)	0: Indicates that the SOS function is not activated. 1: Indicates that the SOS function is activated by the SS2 function.
4	Not used	—
5	SDIPS (SDIP output)	0: Indicates that the SDIP function is not activated. 1: Indicates that the SDIP function is activated.
6	SDINS (SDIN output)	0: Indicates that the SDIN function is not activated. 1: Indicates that the SDIN function is activated.
7	SNERR (Safety communication error 1)	0: Indicates that no error related to safety communication is occurring. 1: Indicates that an error related to safety communication is occurring.
8	SLS1S (SLS1 output)	0: Indicates that the SLS1 function is not activated. 1: Indicates that the SLS1 function is activated.
9	SLS2S (SLS2 output)	0: Indicates that the SLS2 function is not activated. 1: Indicates that the SLS2 function is activated.
10	SLS3S (SLS3 output)	0: Indicates that the SLS3 function is not activated. 1: Indicates that the SLS3 function is activated.
11	SLS4S (SLS4 output)	0: Indicates that the SLS4 function is not activated. 1: Indicates that the SLS4 function is activated.
12	SS1S (SS1 output)	0: Indicates that the SS1 function is not activated. 1: Indicates that the SS1 function is activated.
13	SS2S (SS2 output)	0: Indicates that the SS2 function is not activated. 1: Indicates that the SS2 function is activated.
14	SLIS (SLI output)	0: Indicates that the SLI function is not activated. 1: Indicates that the SLI function is activated.
15	Not used	—
16		
17	SNERR2 (Safety communication error 2) *2	0: Indicates that the command signal for a safety sub-function that is disabled in [Pr. PSA02 Functional safety setting] is not input. 1: Indicates that the command signal for a safety sub-function that is not used is input.
18	SBCS (SBC output)	0: Indicates that the STO status has been canceled and the energy supply to the electromagnetic brake has not been shut off. 1: Indicates that the STO function is activated and the energy supply to the electromagnetic brake has been shut off.
19	Not used	—
20		
21		
22		
23		
24	SLT1S (SLT1 output)	0: Indicates that the SLT1 function is not activated. 1: Indicates that the SLT1 function is activated.
25	SLT2S (SLT2 output)	0: Indicates that the SLT2 function is not activated. 1: Indicates that the SLT2 function is activated.
26	SLT3S (SLT3 output)	0: Indicates that the SLT3 function is not activated. 1: Indicates that the SLT3 function is activated.
27	SLT4S (SLT4 output)	0: Indicates that the SLT4 function is not activated. 1: Indicates that the SLT4 function is activated.
28	Not used	—
29		
30		
31		



- *1 When using a Mitsubishi Electric safety programmable controller, use the safety input device "SA \neq X". For details on the safety device, refer to the following manual.
 MELSEC iQ-R CPU Module User's Manual (Application)
- *2 The specifications of the SNERR2 signal sent from the servo amplifier differ depending on the setting value of [Pr. PSC05.2 SNERR2 signal selection]. For details, refer to the following manual.
 MR-J5-G/MR-J5W-G User's Manual (Parameters)

- Feedback of various function outputs via a network (for the MR-J5D2-_G_)

STOS (STO output), SOSS (SOS output), SSMS (SSM output), etc., can be transmitted through the network.

Device station → Master station *1			
Bit	Function output	Axis	Description
0	STOS (STO output)	A-axis	0:Indicates that the STO status has been canceled. 1:Indicates that the STO function is activated and the energy supply has been shut off.
1	SSMS (SSM output)		0:Indicates that the servo motor speed exceeds the set SSM speed. (Off when the SSM function is disabled.) 1:Indicates that the servo motor speed is equal to or less than the set SSM speed.
2	Not used		—
3	SOSS (SOS output)		0:Indicates that the SOS function is not activated. 1:Indicates that the SOS function is activated by the SS2 function.
4	Not used		—
5	SDIPS (SDIP output)		0:Indicates that the SDIP function is not activated. 1:Indicates that the SDIP function is activated.
6	SDINS (SDIN output)		0:Indicates that the SDIN function is not activated. 1:Indicates that the SDIN function is activated.
7	SNERR (Safety communication error 1)		0:Indicates that no error related to safety communication is occurring. 1:Indicates that an error related to safety communication is occurring.
8	SLS1S (SLS1 output)		0:Indicates that the SLS1 function is not activated. 1:Indicates that the SLS1 function is activated.
9	SLS2S (SLS2 output)		0:Indicates that the SLS2 function is not activated. 1:Indicates that the SLS2 function is activated.
10	SLS3S (SLS3 output)		0:Indicates that the SLS3 function is not activated. 1:Indicates that the SLS3 function is activated.
11	SLS4S (SLS4 output)		0:Indicates that the SLS4 function is not activated. 1:Indicates that the SLS4 function is activated.
12	SS1S (SS1 output)		0:Indicates that the SS1 function is not activated. 1:Indicates that the SS1 function is activated.
13	SS2S (SS2 output)		0:Indicates that the SS2 function is not activated. 1:Indicates that the SS2 function is activated.
14	SLIS (SLI output)		0:Indicates that the SLI function is not activated. 1:Indicates that the SLI function is activated.
15	Not used		—
16			
17	SNERR2 (Safety communication error 2) *2		0:Indicates that the command signal for a safety sub-function that is disabled in [Pr. PSA02 Functional safety setting] is not input. 1:Indicates that the command signal for a safety sub-function that is not used is input.
18	SBCS (SBC output)		0:Indicates that the STO status has been canceled and the energy supply to the electromagnetic brake has not been shut off. 1:Indicates that the STO function is activated and the energy supply to the electromagnetic brake has been shut off.
19	Not used		—
20			
21			
22			
23			
24	SLT1S (SLT1 output)		0:Indicates that the SLT1 function is not activated. 1:Indicates that the SLT1 function is activated.
25	SLT2S (SLT2 output)		0:Indicates that the SLT2 function is not activated. 1:Indicates that the SLT2 function is activated.
26	SLT3S (SLT3 output)		0:Indicates that the SLT3 function is not activated. 1:Indicates that the SLT3 function is activated.
27	SLT4S (SLT4 output)		0:Indicates that the SLT4 function is not activated. 1:Indicates that the SLT4 function is activated.
28	Not used		—
29			
30			
31			

Device station → Master station *1			
Bit	Function output	Axis	Description
32	STOS (STO output)	B-axis	0:Indicates that the STO status has been canceled. 1:Indicates that the STO function is activated and the energy supply has been shut off.
33	SSMS (SSM output)		0:Indicates that the servo motor speed exceeds the set SSM speed. (Off when the SSM function is disabled.) 1:Indicates that the servo motor speed is equal to or less than the set SSM speed.
34	Not used		—
35	SOSS (SOS output)		0:Indicates that the SOS function is not activated. 1:Indicates that the SOS function is activated by the SS2 function.
36	Not used		—
37	SDIPS (SDIP output)		0:Indicates that the SDIP function is not activated. 1:Indicates that the SDIP function is activated.
38	SDINS (SDIN output)		0:Indicates that the SDIN function is not activated. 1:Indicates that the SDIN function is activated.
39	SNERR (Safety communication error 1)		0:Indicates that no error related to safety communication is occurring. 1:Indicates that an error related to safety communication is occurring.
40	SLS1S (SLS1 output)		0:Indicates that the SLS1 function is not activated. 1:Indicates that the SLS1 function is activated.
41	SLS2S (SLS2 output)		0:Indicates that the SLS2 function is not activated. 1:Indicates that the SLS2 function is activated.
42	SLS3S (SLS3 output)		0:Indicates that the SLS3 function is not activated. 1:Indicates that the SLS3 function is activated.
43	SLS4S (SLS4 output)		0:Indicates that the SLS4 function is not activated. 1:Indicates that the SLS4 function is activated.
44	SS1S (SS1 output)		0:Indicates that the SS1 function is not activated. 1:Indicates that the SS1 function is activated.
45	SS2S (SS2 output)		0:Indicates that the SS2 function is not activated. 1:Indicates that the SS2 function is activated.
46	SLIS (SLI output)		0:Indicates that the SLI function is not activated. 1:Indicates that the SLI function is activated.
47	Not used		—
48			
49	SNERR2 (Safety communication error 2) *2		0:Indicates that the command signal for a safety sub-function that is disabled in [Pr. PSA02 Functional safety setting] is not input. 1:Indicates that the command signal for a safety sub-function that is not used is input.
50	SBCS (SBC output)		0:Indicates that the STO status has been canceled and the energy supply to the electromagnetic brake has not been shut off. 1:Indicates that the STO function is activated and the energy supply to the electromagnetic brake has been shut off.
51	Not used		—
52			
53			
54			
55			
56	SLT1S (SLT1 output)		0:Indicates that the SLT1 function is not activated. 1:Indicates that the SLT1 function is activated.
57	SLT2S (SLT2 output)		0:Indicates that the SLT2 function is not activated. 1:Indicates that the SLT2 function is activated.
58	SLT3S (SLT3 output)		0:Indicates that the SLT3 function is not activated. 1:Indicates that the SLT3 function is activated.
59	SLT4S (SLT4 output)		0:Indicates that the SLT4 function is not activated. 1:Indicates that the SLT4 function is activated.
60	Not used		—
61			
62			
63			

- *1 When using a Mitsubishi Electric safety programmable controller, use the safety input device "SA \neq X". For details on the safety device, refer to the following manual.
 MELSEC iQ-R CPU Module User's Manual (Application)
- *2 The specifications of the SNERR2 signal sent from the servo amplifier differ depending on the setting value of [Pr. PSC05.2 SNERR2 signal selection]. For details, refer to the following manual.
 MR-J5-G/MR-J5W-G User's Manual (Parameters)



- Feedback of various function outputs via a network (for the MR-J5D3-_G_)

STOS (STO output), SOSS (SOS output), SSMS (SSM output), etc., can be transmitted through the network.

Device station → Master station *1			
Bit	Function output	Axis	Description
0	STOS (STO output)	A-axis	0:Indicates that the STO status has been canceled. 1:Indicates that the STO function is activated and the energy supply has been shut off.
1	SSMS (SSM output)		0:Indicates that the servo motor speed exceeds the set SSM speed. (Off when the SSM function is disabled.) 1:Indicates that the servo motor speed is equal to or less than the set SSM speed.
2	Not used		—
3	SOSS (SOS output)		0:Indicates that the SOS function is not activated. 1:Indicates that the SOS function is activated by the SS2 function.
4	Not used		—
5	SDIPS (SDIP output)		0:Indicates that the SDIP function is not activated. 1:Indicates that the SDIP function is activated.
6	SDINS (SDIN output)		0:Indicates that the SDIN function is not activated. 1:Indicates that the SDIN function is activated.
7	SNERR (Safety communication error 1)		0:Indicates that no error related to safety communication is occurring. 1:Indicates that an error related to safety communication is occurring.
8	SLS1S (SLS1 output)		0:Indicates that the SLS1 function is not activated. 1:Indicates that the SLS1 function is activated.
9	SLS2S (SLS2 output)		0:Indicates that the SLS2 function is not activated. 1:Indicates that the SLS2 function is activated.
10	SLS3S (SLS3 output)		0:Indicates that the SLS3 function is not activated. 1:Indicates that the SLS3 function is activated.
11	SLS4S (SLS4 output)		0:Indicates that the SLS4 function is not activated. 1:Indicates that the SLS4 function is activated.
12	SS1S (SS1 output)		0:Indicates that the SS1 function is not activated. 1:Indicates that the SS1 function is activated.
13	SS2S (SS2 output)		0:Indicates that the SS2 function is not activated. 1:Indicates that the SS2 function is activated.
14	SLIS (SLI output)		0:Indicates that the SLI function is not activated. 1:Indicates that the SLI function is activated.
15	Not used		—
16			
17	SNERR2 (Safety communication error 2) *2		0:Indicates that the command signal for a safety sub-function that is disabled in [Pr. PSA02 Functional safety setting] is not input. 1:Indicates that the command signal for a safety sub-function that is not used is input.
18	SBCS (SBC output)		0:Indicates that the STO status has been canceled and the energy supply to the electromagnetic brake has not been shut off. 1:Indicates that the STO function is activated and the energy supply to the electromagnetic brake has been shut off.
19	Not used		—
20			
21			
22			
23			
24	SLT1S (SLT1 output)		0:Indicates that the SLT1 function is not activated. 1:Indicates that the SLT1 function is activated.
25	SLT2S (SLT2 output)		0:Indicates that the SLT2 function is not activated. 1:Indicates that the SLT2 function is activated.
26	SLT3S (SLT3 output)		0:Indicates that the SLT3 function is not activated. 1:Indicates that the SLT3 function is activated.
27	SLT4S (SLT4 output)		0:Indicates that the SLT4 function is not activated. 1:Indicates that the SLT4 function is activated.
28	Not used		—
29			
30			
31			

Device station → Master station *1			
Bit	Function output	Axis	Description
32	STOS (STO output)	B-axis	0:Indicates that the STO status has been canceled. 1:Indicates that the STO function is activated and the energy supply has been shut off.
33	SSMS (SSM output)		0:Indicates that the servo motor speed exceeds the set SSM speed. (Off when the SSM function is disabled.) 1:Indicates that the servo motor speed is equal to or less than the set SSM speed.
34	Not used		—
35	SOSS (SOS output)		0:Indicates that the SOS function is not activated. 1:Indicates that the SOS function is activated by the SS2 function.
36	Not used		—
37	SDIPS (SDIP output)		0:Indicates that the SDIP function is not activated. 1:Indicates that the SDIP function is activated.
38	SDINS (SDIN output)		0:Indicates that the SDIN function is not activated. 1:Indicates that the SDIN function is activated.
39	SNERR (Safety communication error 1)		0:Indicates that no error related to safety communication is occurring. 1:Indicates that an error related to safety communication is occurring.
40	SLS1S (SLS1 output)		0:Indicates that the SLS1 function is not activated. 1:Indicates that the SLS1 function is activated.
41	SLS2S (SLS2 output)		0:Indicates that the SLS2 function is not activated. 1:Indicates that the SLS2 function is activated.
42	SLS3S (SLS3 output)		0:Indicates that the SLS3 function is not activated. 1:Indicates that the SLS3 function is activated.
43	SLS4S (SLS4 output)		0:Indicates that the SLS4 function is not activated. 1:Indicates that the SLS4 function is activated.
44	SS1S (SS1 output)		0:Indicates that the SS1 function is not activated. 1:Indicates that the SS1 function is activated.
45	SS2S (SS2 output)		0:Indicates that the SS2 function is not activated. 1:Indicates that the SS2 function is activated.
46	SLIS (SLI output)		0:Indicates that the SLI function is not activated. 1:Indicates that the SLI function is activated.
47	Not used		—
48			
49	SNERR2 (Safety communication error 2) *2		0:Indicates that the command signal for a safety sub-function that is disabled in [Pr. PSA02 Functional safety setting] is not input. 1:Indicates that the command signal for a safety sub-function that is not used is input.
50	SBCS (SBC output)		0:Indicates that the STO status has been canceled and the energy supply to the electromagnetic brake has not been shut off. 1:Indicates that the STO function is activated and the energy supply to the electromagnetic brake has been shut off.
51	Not used		—
52			
53			
54			
55			
56	SLT1S (SLT1 output)	0:Indicates that the SLT1 function is not activated. 1:Indicates that the SLT1 function is activated.	
57	SLT2S (SLT2 output)	0:Indicates that the SLT2 function is not activated. 1:Indicates that the SLT2 function is activated.	
58	SLT3S (SLT3 output)	0:Indicates that the SLT3 function is not activated. 1:Indicates that the SLT3 function is activated.	
59	SLT4S (SLT4 output)	0:Indicates that the SLT4 function is not activated. 1:Indicates that the SLT4 function is activated.	
60	Not used	—	
61			
62			
63			

Device station → Master station *1			
Bit	Function output	Axis	Description
64	STOS (STO output)	C-axis	0:Indicates that the STO status has been canceled. 1:Indicates that the STO function is activated and the energy supply has been shut off.
65	SSMS (SSM output)		0:Indicates that the servo motor speed exceeds the set SSM speed. (Off when the SSM function is disabled.) 1:Indicates that the servo motor speed is equal to or less than the set SSM speed.
66	Not used		—
67	SOSS (SOS output)		0:Indicates that the SOS function is not activated. 1:Indicates that the SOS function is activated by the SS2 function.
68	Not used		—
69	SDIPS (SDIP output)		0:Indicates that the SDIP function is not activated. 1:Indicates that the SDIP function is activated.
70	SDINS (SDIN output)		0:Indicates that the SDIN function is not activated. 1:Indicates that the SDIN function is activated.
71	SNERR (Safety communication error 1)		0:Indicates that no error related to safety communication is occurring. 1:Indicates that an error related to safety communication is occurring.
72	SLS1S (SLS1 output)		0:Indicates that the SLS1 function is not activated. 1:Indicates that the SLS1 function is activated.
73	SLS2S (SLS2 output)		0:Indicates that the SLS2 function is not activated. 1:Indicates that the SLS2 function is activated.
74	SLS3S (SLS3 output)		0:Indicates that the SLS3 function is not activated. 1:Indicates that the SLS3 function is activated.
75	SLS4S (SLS4 output)		0:Indicates that the SLS4 function is not activated. 1:Indicates that the SLS4 function is activated.
76	SS1S (SS1 output)		0:Indicates that the SS1 function is not activated. 1:Indicates that the SS1 function is activated.
77	SS2S (SS2 output)		0:Indicates that the SS2 function is not activated. 1:Indicates that the SS2 function is activated.
78	SLIS (SLI output)		0:Indicates that the SLI function is not activated. 1:Indicates that the SLI function is activated.
79	Not used		—
80			
81	SNERR2 (Safety communication error 2) *2		0:Indicates that the command signal for a safety sub-function that is disabled in [Pr. PSA02 Functional safety setting] is not input. 1:Indicates that the command signal for a safety sub-function that is not used is input.
82	SBCS (SBC output)		0:Indicates that the STO status has been canceled and the energy supply to the electromagnetic brake has not been shut off. 1:Indicates that the STO function is activated and the energy supply to the electromagnetic brake has been shut off.
83	Not used		—
84			
85			
86			
87			
88	SLT1S (SLT1 output)		0:Indicates that the SLT1 function is not activated. 1:Indicates that the SLT1 function is activated.
89	SLT2S (SLT2 output)	0:Indicates that the SLT2 function is not activated. 1:Indicates that the SLT2 function is activated.	
90	SLT3S (SLT3 output)	0:Indicates that the SLT3 function is not activated. 1:Indicates that the SLT3 function is activated.	
91	SLT4S (SLT4 output)	0:Indicates that the SLT4 function is not activated. 1:Indicates that the SLT4 function is activated.	
92	Not used	—	
93			
94			
95			

- *1 When using a Mitsubishi Electric safety programmable controller, use the safety input device "SA \neq X". For details on the safety device, refer to the following manual.
 MELSEC iQ-R CPU Module User's Manual (Application)
- *2 The specifications of the SNERR2 signal sent from the servo amplifier differ depending on the setting value of [Pr. PSC05.2 SNERR2 signal selection]. For details, refer to the following manual.
 MR-J5-G/MR-J5W-G User's Manual (Parameters)

■ Setting GX Works3

To use the safety sub-function in the safety communications, set the station-specific mode using the following procedure.

1. Configure the master station network settings with GX Works3.
2. Select module parameter (network) from the module information of the Motion module, and open the network configuration settings.
3. Set "Motion mode (safety)" in the station-specific mode setting when setting the network configuration.

■ Setting method for transmission interval monitor time and safety refresh monitor time

For the safety sub-function control by network, calculate the transmission interval monitor time for the servo amplifier and master module according to the Safety Application Guide.

Use the following value for the safety remote station refresh response time (SRref).

Safety remote station refresh response time	Communication cycle	
	MR-J5-_G_-RJ/MR-J5D1-_G_	MR-J5W2-_G_/MR-J5D3-_G_/MR-J5D2-_G_/MR-J5D3-_G_
8.0 ms	125 μs or more	500 μs or more

Set the safety communication - communication cycle according to the value of the transmission interval monitor time.

Set the transmission interval monitor time for the servo amplifier so that the following two equations can be satisfied.

$$TM \geq SRref \times 2$$

$$TM \geq SCmst \times 2 + LS \times 2$$

SRref: Safety refresh response processing time [ms]

TM: Transmission interval monitor time [ms]

SCmst: Master station safety cycle time [ms]

LS: Communication cycle interval [ms]

For the setting values of "transmission interval monitor time" and "safety refresh monitor time" of the master module, refer to the user's manual for the master module used.

 MELSEC iQ-R CPU Module User's Manual (Application)

 MELSEC iQ-R CC-Link IE TSN User's Manual (Application)

■ Setting functional safety parameters

To perform safety monitoring using the safety communications, set the following parameters.

Parameter	Name
PSC01	Transmission interval monitor time
PSC06	Safety verification code

- Transmission interval monitor time

Select the transmission interval monitor time.

 Page 481 Setting method for transmission interval monitor time and safety refresh monitor time

- Safety verification code

Set the value used to identify the servo amplifier. Match the safety verification code to the value set in the safety communication setting of the master station. If this parameter is set to a non-matching value, [AL. 580.3 Safety verification code mismatch] occurs.

Servo motor with functional safety

By using a servo motor with functional safety, various speed monitoring functions and position monitoring functions can be realized without using external encoders to duplicate encoders.

When using a servo motor with functional safety, set [Pr. PSA02.1 Position/Speed monitor setting] to "1". When not using a servo motor with functional safety, set this parameter to a value other than "1". Refer to the following for details.

☞ Page 441 Achievable safety level

Position feedback fixing diagnosis function

■ Outline

The position feedback fixing diagnosis function sets the STO state when the position data from the encoder is fixed and [AL. 52A Position feedback error (safety sub-function)] occurs.

■ Operation outline

The position feedback fixing diagnosis function is enabled when the safety sub-function is enabled and the status is other than the STO state. If there is no change in position feedback for the time set in [Pr. PSA22 Position feedback error detection time], [AL. 52A Position feedback error (safety sub-function)] occurs and the STO function is activated.

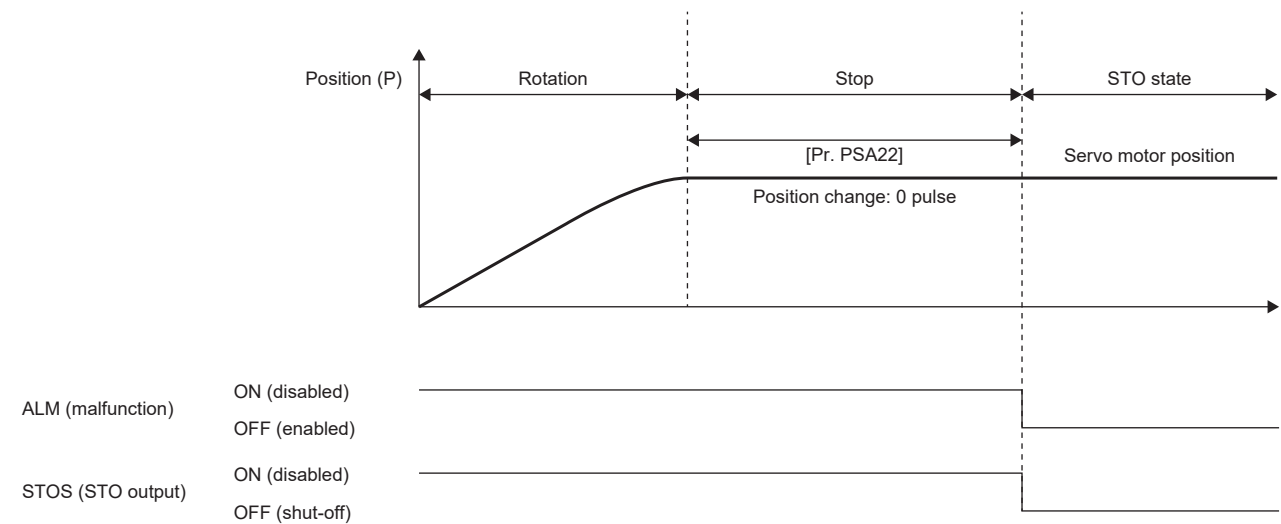

STO function

Outline

This function electrically shuts off the servo motor driving energy with input signals from external devices (shut-off by the secondary-side output). This is equivalent to the stop category 0 of IEC/EN 60204-1. The function is also used for an emergency stop when an internal diagnosis error is detected. Use the function while the servo motor is stopped.

Operation sequence

■ STOC (STO command)

After servo-off, turn off STOC (STO command) while the servo motor is stopped. Turning off STOC (STO command) will activate the STO function. While STO is activated, the energy supply to the servo motor is shut off and the dynamic brake is activated. The servo motor returns to normal operation by turning STOC (STO command) back on.

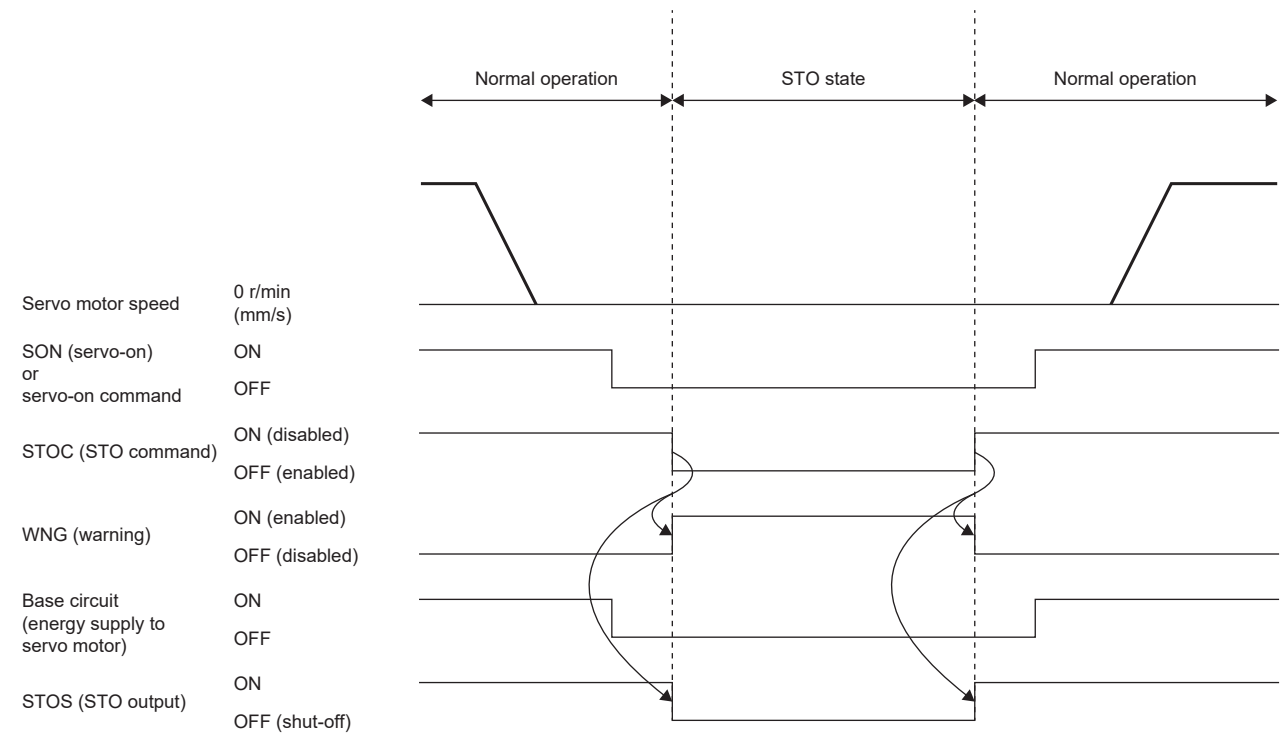

Alarm occurrence

The STO function is activated also when an alarm occurs. While STO is activated, the energy supply to the servo motor is shut off and the dynamic brake is activated. For the alarms that activate STO, refer to "List of alarm No./warning No." in the following manual.

MR-J5 User's Manual (Troubleshooting)

For how to return to normal operation, refer to the following.

Page 517 At alarm occurrence

This timing chart is for the STO/DB stop method.

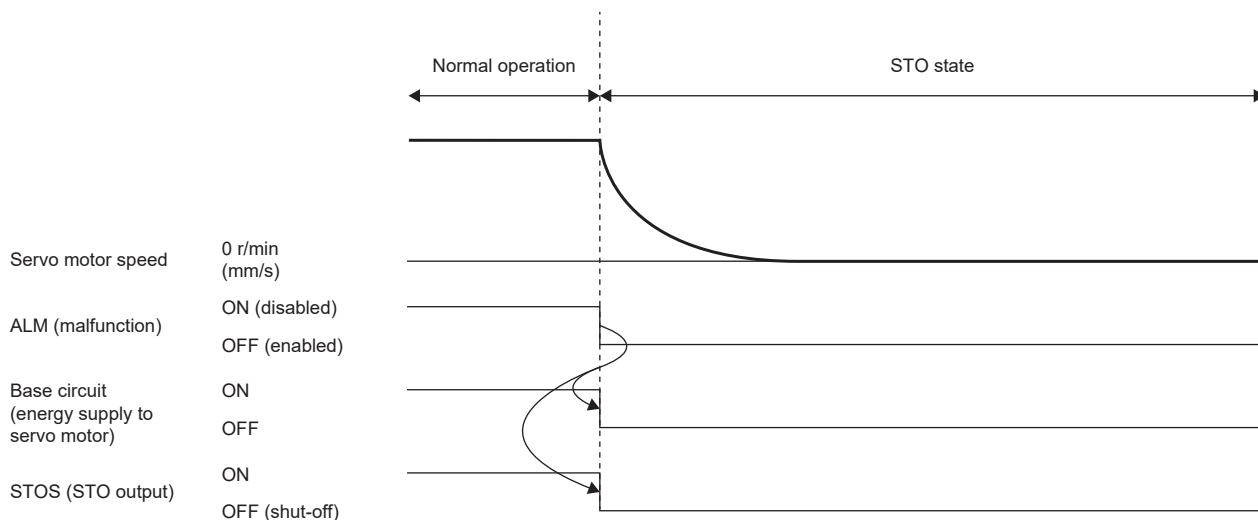

STO shut-off during servo motor operation

Point

- Turning off STOC (STO command) during operation will shut off energy without generating an alarm.
- Note that activating the STO function during servo motor operation will shorten the service life of the dynamic brake relay.

After servo-off, turn off STOC (STO command) while the servo motor is stopped. To decelerate at the same time, use the SS1 function.

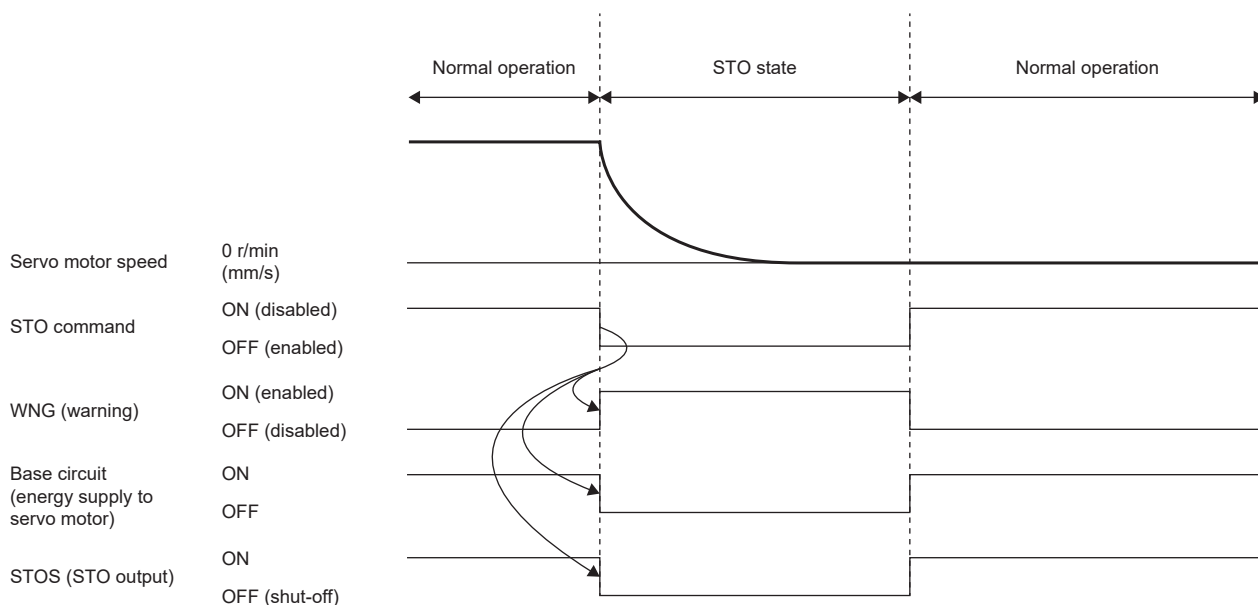

■ Setting functional safety parameters

Refer to the following to set the functional safety parameters.

☞ Page 439 Functional safety parameters that must be set

When using the safety sub-function control by input device, refer to the following.

☞ Page 444 Input device

When using output devices, refer to the following.

☞ Page 447 Output device

When using the safety sub-function control by network, refer to the following.

☞ Page 450 Safety sub-function control by network

SS1 function

Outline

This function starts deceleration with input signals from external devices. After the specified time to confirm the motor stop, the STO function is executed (SS1). This is equivalent to the stop category 1 of IEC/EN 60204-1.

Since the SS1 function is also used for emergency stop when an internal diagnostic error is detected, refer to the following to set the functional safety parameters.

☞ Page 493 Setting functional safety parameters

There are two types of SS1 function: time monitoring and deceleration monitoring. Deceleration monitoring uses encoder information to monitor whether deceleration is performed correctly. Deceleration monitoring can be switched with [Pr. PSA02 Functional safety setting].

Sequence outline

■ SS1C (SS1 command)

The operation sequence of the time monitoring function of the SS1 function is shown below.

The SS1 function is activated by turning off SS1C (SS1 command). First, the servo motor decelerates by either the dynamic brake, electronic dynamic brake, or forced stop. At the same time, the time from when the SS1 function is activated is measured, and the STO function is activated when the time set in [Pr. PSA03 SS1/SS2 deceleration monitor time] has elapsed. The servo motor returns to normal operation by turning SS1C (SS1 command) back on.

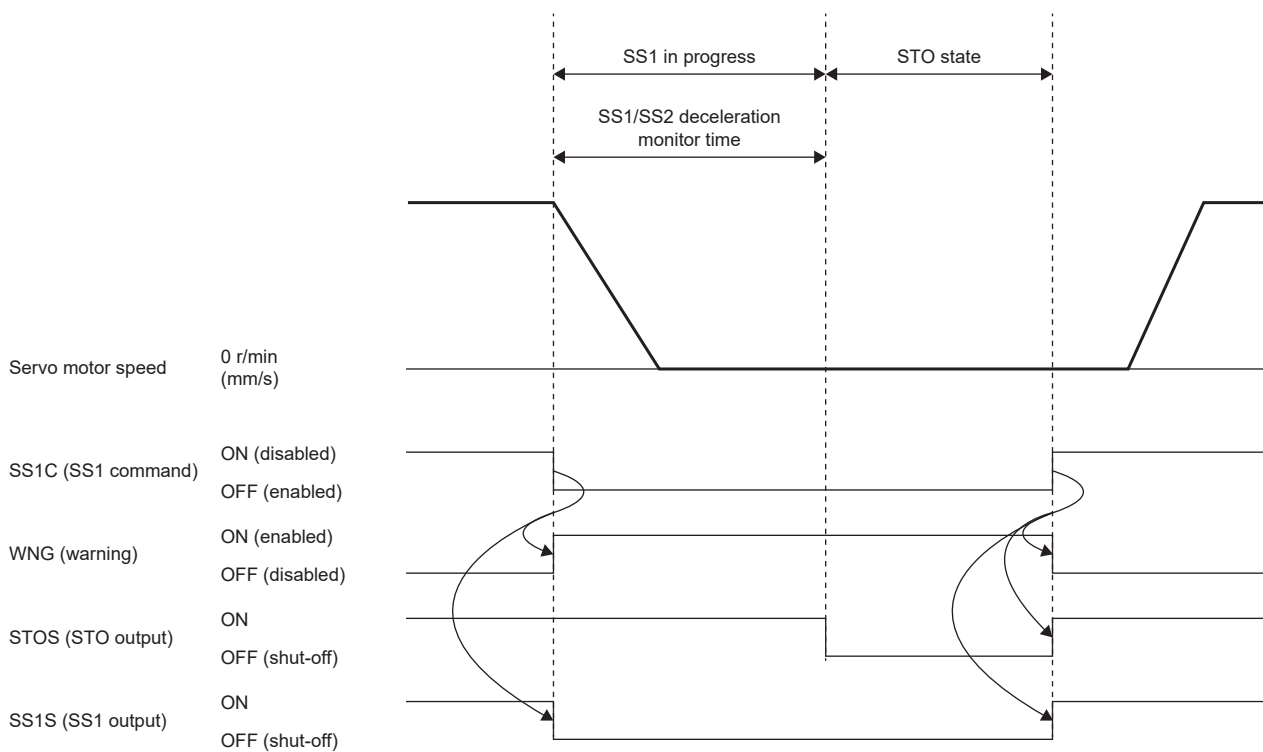

■ Alarm occurrence

The SS1 function is activated also when an alarm occurs. After an alarm occurs, the servo motor decelerates by either the dynamic brake, electronic dynamic brake, or forced stop. At the same time, the time from when the SS1 function is activated is measured, and the STO function is activated when the time set in [Pr. PSA03 SS1/SS2 deceleration monitor time] has elapsed. For the alarms that activate the SS1 function, refer to "List of alarm No./warning No." in the following manual.

📖 MR-J5 User's Manual (Troubleshooting)

For how to return to normal operation, refer to the following.

📖 Page 517 At alarm occurrence

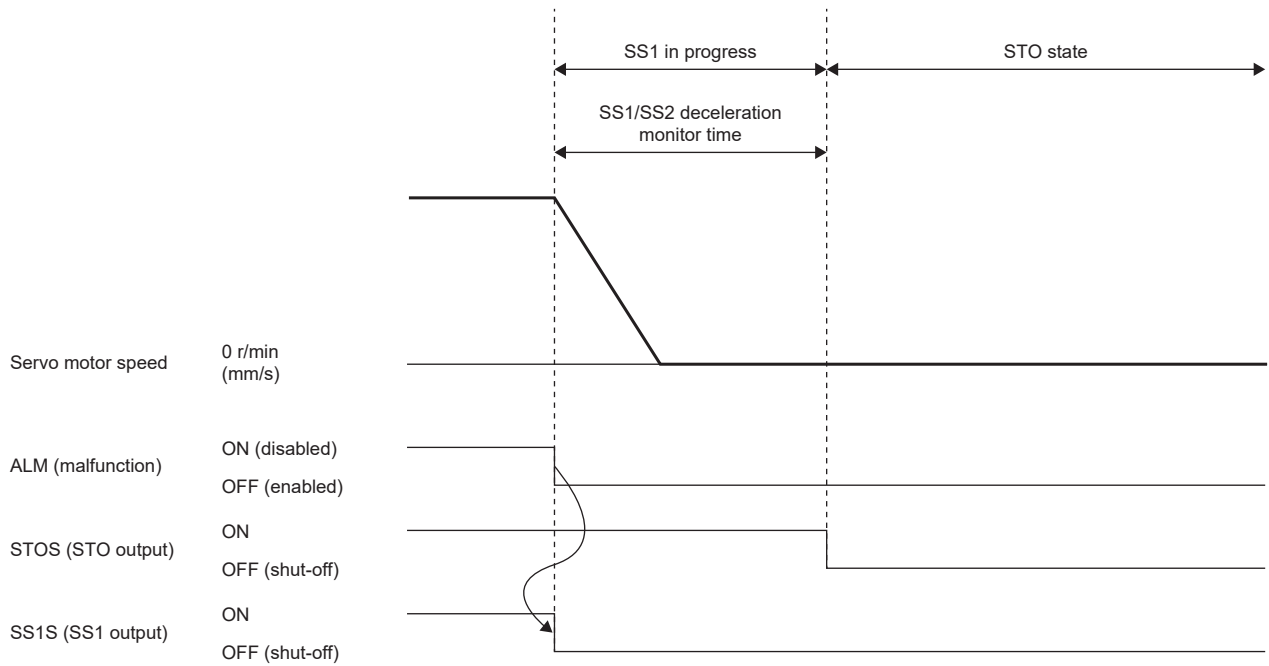

Deceleration monitoring function

When the SS1 command is input, this function starts deceleration and monitors whether the servo motor decelerates according to the deceleration time constant. If the deceleration set by the functional safety parameter cannot be performed, the STO function is executed. The STO function is activated even when the time specified by [Pr. PSA03 SS1/SS2 deceleration monitor time] has elapsed since the SS1 function was activated.

Deceleration completion monitoring

Speed monitoring will start after the SS1 command has been turned off and the time set in [Pr. PSA26 SS1/SS2 deceleration monitor delay time] has passed.

During deceleration, when both the absolute value of the speed command and the absolute value of the speed feedback become equal to or less than the value set in [Pr. PSA04 Safety sub-function - Stop speed], deceleration is considered to have been completed. After the time set in [Pr. PSA15 Safety sub-function - Speed detection delay time] has elapsed, the STO function is executed.

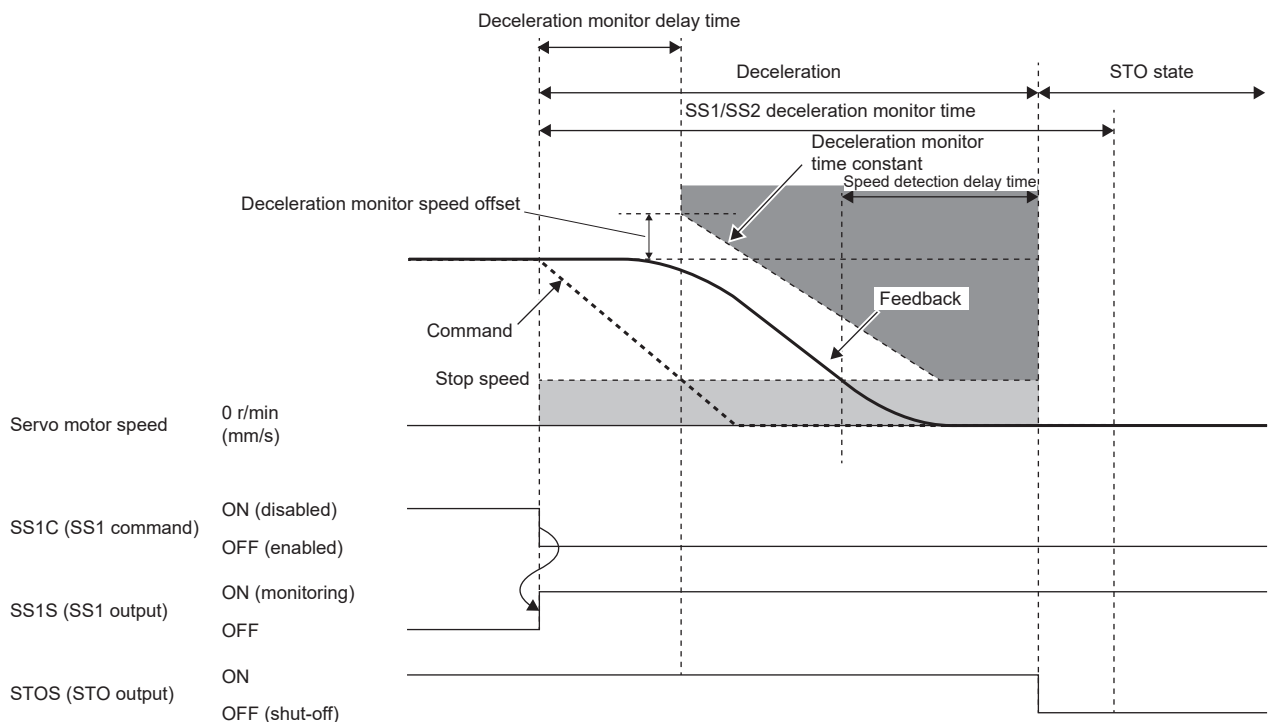

Deceleration speed excess monitoring

This function monitors whether the servo motor does not exceed the observation speed specified by [Pr. PSA24 SS1/SS2 deceleration monitor time constant] when the motor decelerates from the speed where [Pr. PSA25 SS1/SS2 deceleration monitor speed offset] is added to the speed at the timing the SS1 command is turned off.

If the observation speed is exceeded, the STO function is activated after the time set in [Pr. PSA15 Safety sub-function - Speed detection delay time] has lapsed.

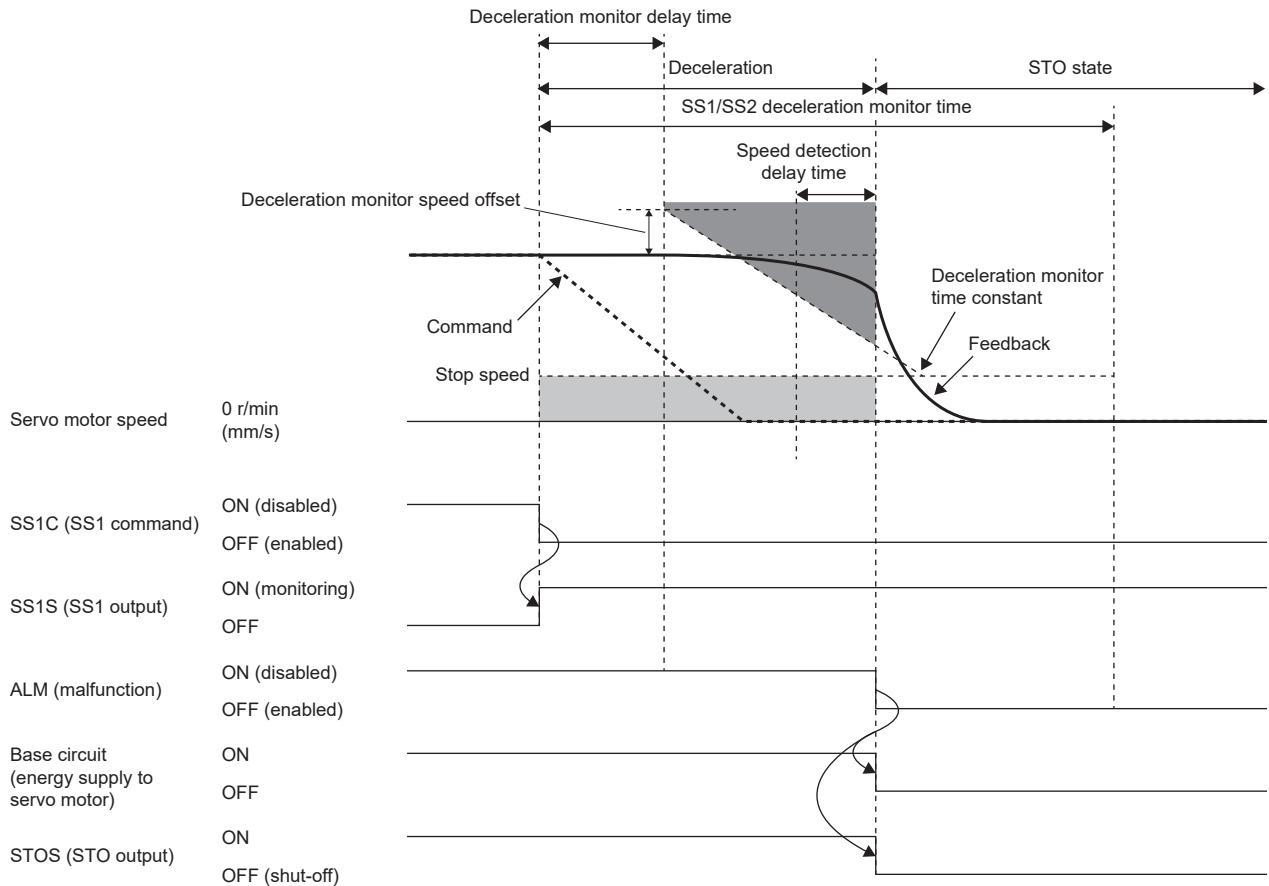

Stop methods

■ Classification of stop methods

The stop method of the servo motor is determined by the parameter settings or the factor that activated the SS1 function. The following table lists the stop methods for the servo motor when the SS1 function is activated.

Servo amplifier parameter		Servo motor ^{*3}	Control mode during operation of the SS1 function ^{*4}	Stop methods ^{*1}			
				When activated by SS1C (SS1 command)	When activated by alarm occurrence ^{*2}		
[Pr. PA04.3 Forced stop deceleration function selection]	[Pr. PF06.0 Electronic dynamic brake selection]				When the alarm stop method is SS1/SD	When the alarm stop method is SS1/EDB	
Enabled	Automatic	Specific servo motor	Torque control mode	EDB	EDB	EDB	
			Other than torque control mode	SD	SD	EDB	
		Other than specific servo motor	Torque control mode	DB	DB	DB	
			Other than torque control mode	SD	SD	DB	
	Disabled			Torque control mode	DB	DB	DB
				Other than torque control mode	SD	SD	DB
Disabled	Automatic	Specific servo motor	—	EDB	EDB	EDB	
		Other than specific servo motor	—	DB	DB	DB	
	Disabled			—	DB	DB	

*1 There are three stop methods: DB, EDB, and SD.

DB: Dynamic brake stop (for a servo amplifier without the dynamic brake, the servo motor coasts)

EDB: Stop with electronic dynamic brake

SD: Forced stop deceleration

*2 The stop method differs depending on the alarm stop method. For the stop method of each alarm, refer to Chapter 6.

*3 For specific servo motors, refer to "[Pr. PF06.0 Electronic dynamic brake selection]" in the following manual.

MR-J5-G/MR-J5W-G User's Manual (Parameters)

*4 The stop method in continuous operation to torque control mode is the same as that in the torque control mode.

■ Stop by forced stop deceleration (SD)

For the operation of the forced stop deceleration, refer to the following.

☞ Page 173 Forced stop deceleration function

When the SS1 function is activated, the servo motor decelerates in accordance with the value set in [Pr. PC24 Deceleration time constant at forced stop]. Once the servo motor speed changes to a speed equal to or less than the speed set in [Pr. PC07 Zero speed] after completion of the deceleration command, the base circuit shuts off and the dynamic brake is activated after the delay time set in [Pr. PC02 Electromagnetic brake sequence output] has elapsed. If the SS1/SS2 deceleration monitor time is shorter than the deceleration stop time, the STO function is activated during deceleration. When performing deceleration monitoring, if [Pr. PSA24 SS1/SS2 deceleration monitor time constant] is shorter than [Pr. PC24], the observation speed will be exceeded and the STO function is activated.

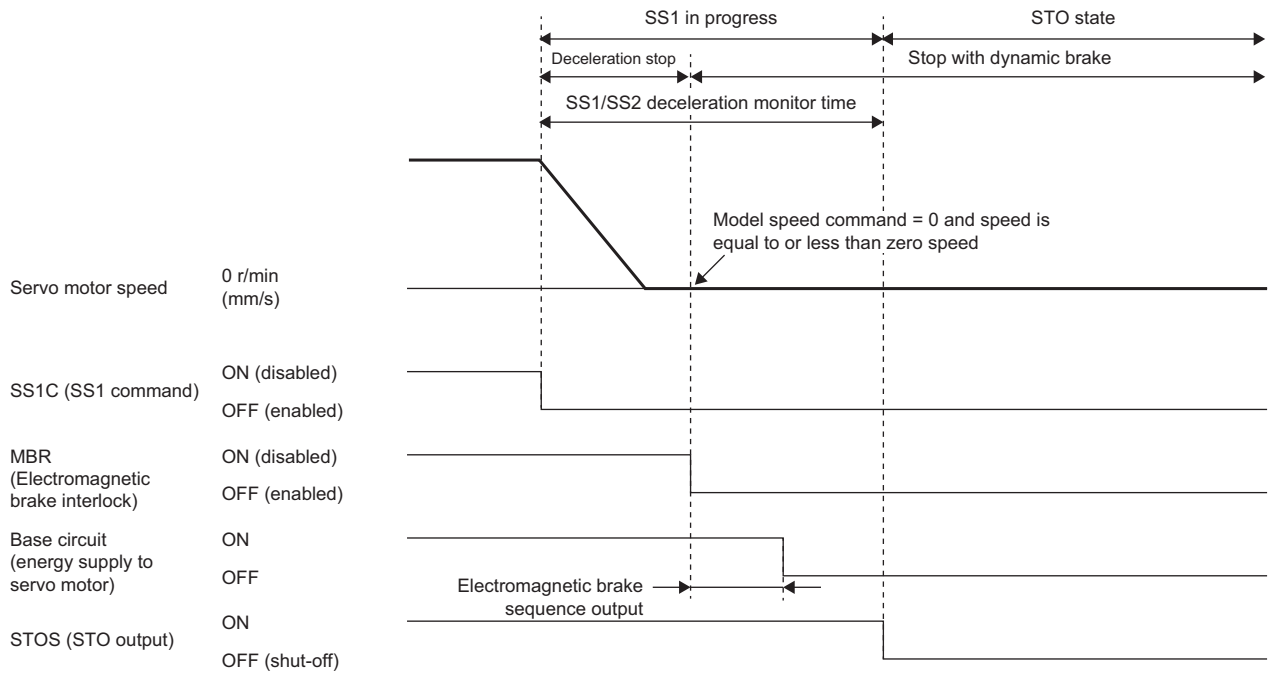

■ Dynamic brake stop (DB)

When the SS1 function is activated, dynamic brake stop is executed. For the dynamic brake operation, refer to "Dynamic brake characteristics" in the following manual.

📖 MR-J5 User's Manual (Hardware)

📖 MR-J5D User's Manual (Hardware)

When the deceleration monitoring function is enabled, if the deceleration monitor time constant is shorter than the braking time during dynamic brake operation, the observation speed will be exceeded and an alarm will occur.

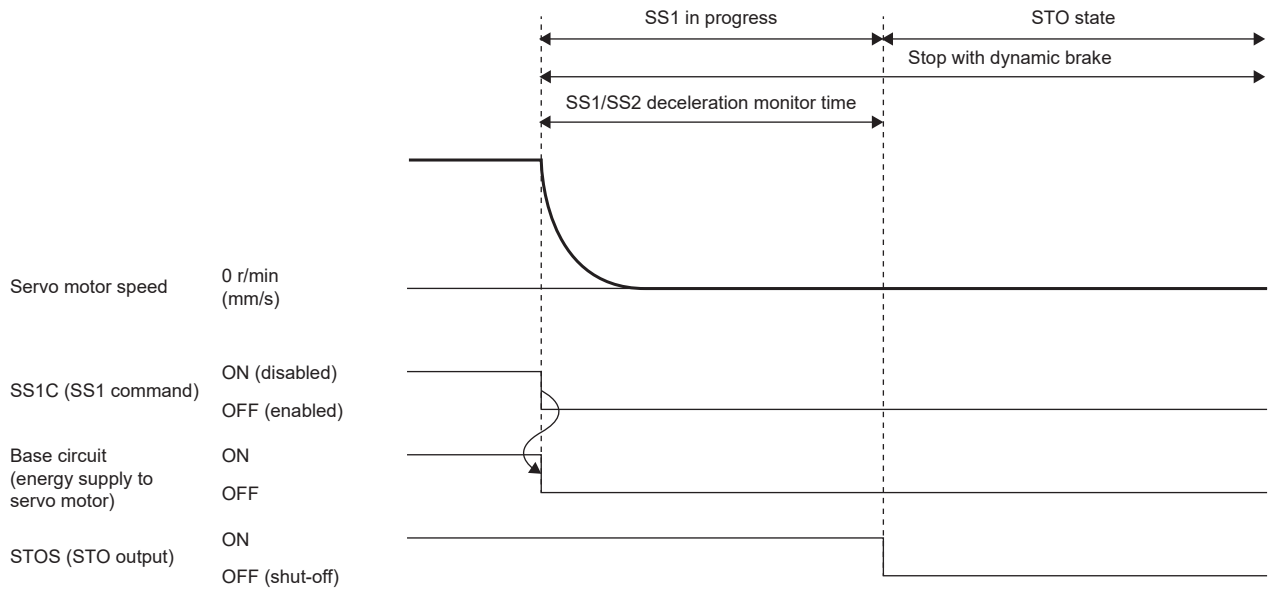

■ Electronic dynamic brake stop (EDB)

When the SS1 function is activated, the electronic dynamic brake stop is executed. The dynamic brake is activated when the elapsed time from the start of the SS1 function reaches the time set in [Pr. PF12 Electronic dynamic brake operating time]. If the value set in [Pr. PSA03 SS1/SS2 deceleration monitor time] is shorter than that of [Pr. PF12], the dynamic brake will be activated when the elapsed time reaches [Pr. PSA03].

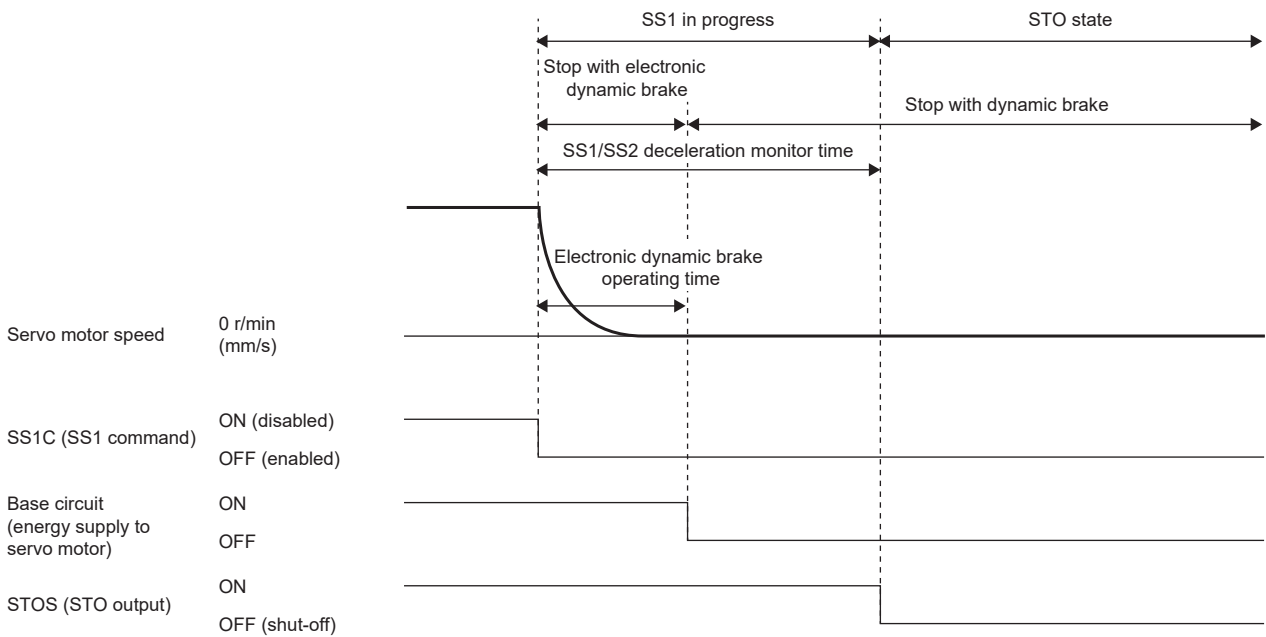

Setting functional safety parameters

Refer to the following to set the functional safety parameters.

☞ Page 439 Functional safety parameters that must be set

When using the safety sub-function control by input device, refer to the following.

☞ Page 444 Input device

When using output devices, refer to the following.

☞ Page 447 Output device

When using the safety sub-function control by network, refer to the following.

☞ Page 450 Safety sub-function control by network

Since the SS1 function is used for an emergency stop when an error is detected in the diagnosis, set the time required for the servo motor to stop in [Pr. PSA03 SS1/SS2 deceleration monitor time].

SS2/SOS function

Outline

When SS2C (SS2 command) turns off, the SS2/SOS function executes stop monitoring (SOS) of the servo motor after standby until a delay time set in advance is elapsed or until the servo motor stop is detected.

Sequence outline

The SS2/SOS function is activated by turning off SS2C (SS2 command).

Once the function is executed, it performs deceleration stop monitoring at first. Then, the function waits until the speed reaches or falls below a certain point or until the specified time elapses. During this time, execute the deceleration command from the controller. For details on speed monitoring and delay time monitoring during deceleration, refer to the following.

☞ Page 495 Deceleration stop monitoring

After the deceleration is completed, stop monitoring is performed. During stop monitoring, speed command monitoring, speed feedback monitoring, position feedback monitoring, and position command monitoring are performed. For details, refer to the following.

☞ Page 497 Stop monitoring

SOSS (SOS output) outputs ON during stop monitoring.

The SS2/SOS function ends by turning on SS2C (SS2 command).

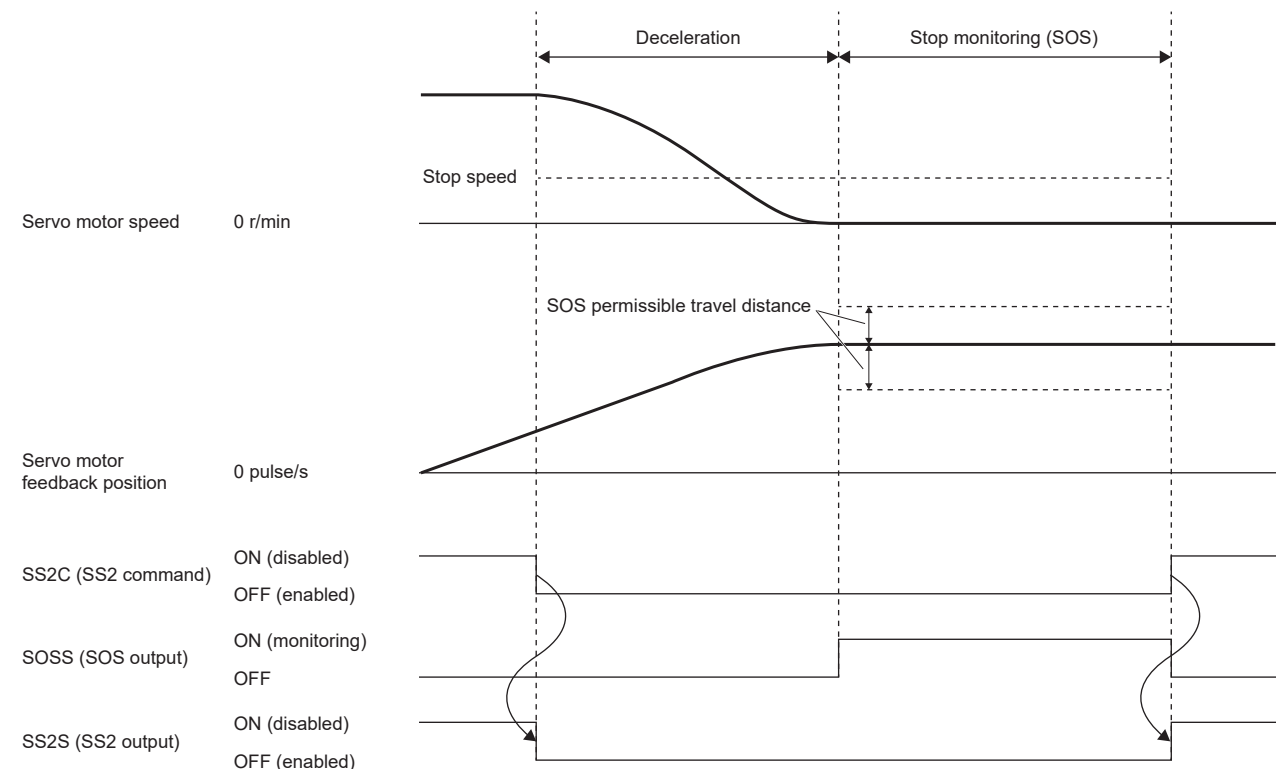

Deceleration stop monitoring

■ Speed monitoring during deceleration

During deceleration, when both the absolute value of the speed command and the absolute value of the speed feedback become equal to or less than the value set in [Pr. PSA04 Safety sub-function - Stop speed], deceleration is considered to have been completed, and stop monitoring (SOS) starts. However, there will be a delay equal to the time set in [Pr. PSA15 Safety sub-function - Speed detection delay time] until stop monitoring starts after the speed falls to or below the stop speed.

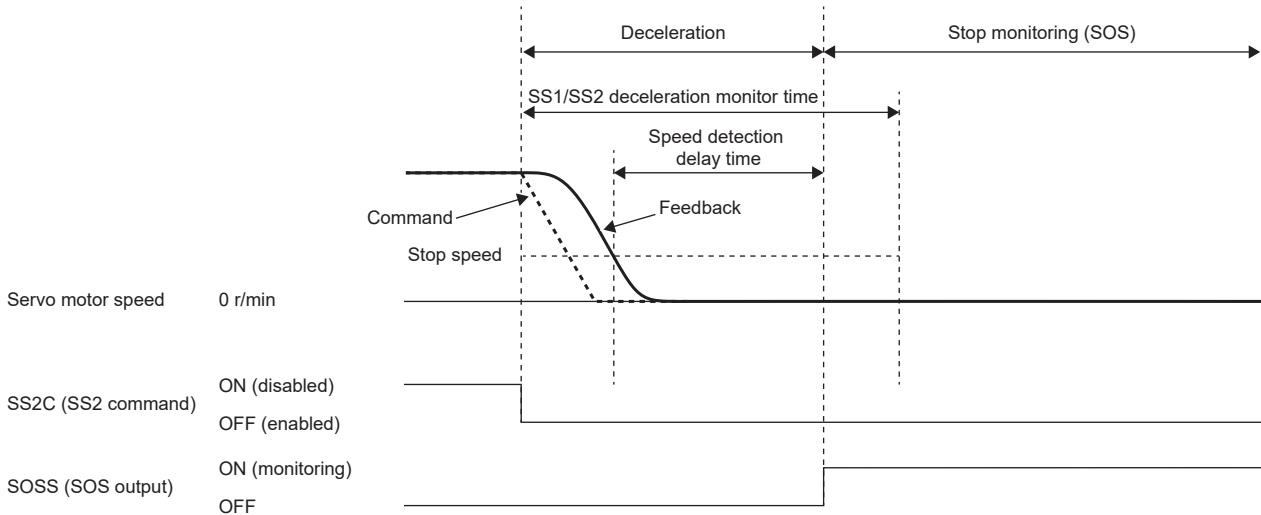

■ Delay time monitoring during deceleration

If the elapsed time after the SS2/SOS function is activated exceeds the value set in [Pr. PSA03 SS1/SS2 deceleration monitor time], it is considered that deceleration has ended and stop monitoring (SOS) is activated.

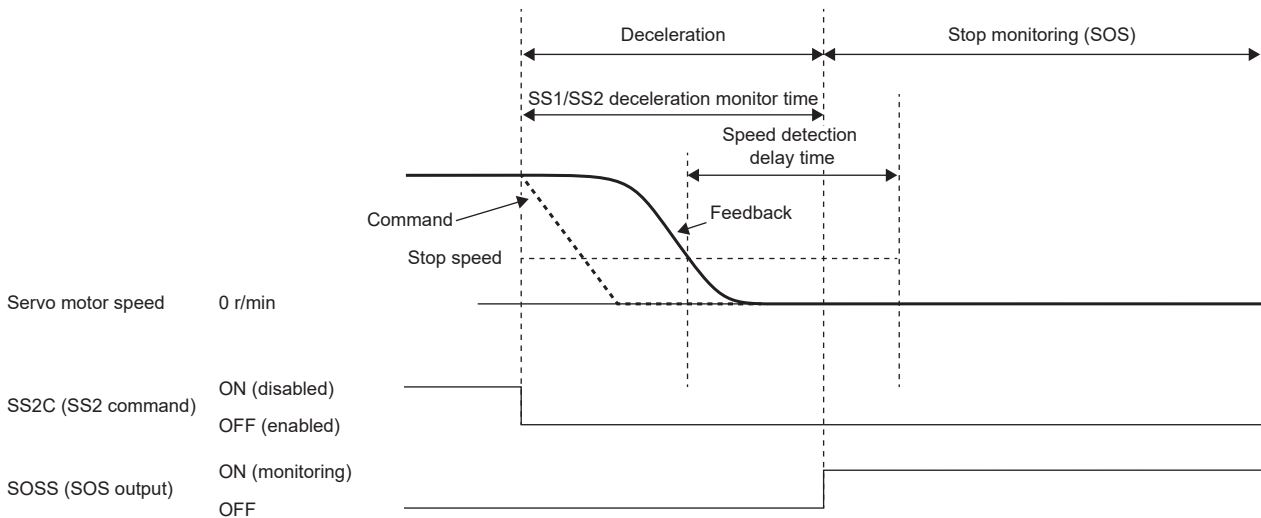

Deceleration monitoring

When [Pr. PSA02.2 Time/Deceleration monitor setting] is set to "1", speed monitoring can be performed.

After the SS2 command is turned off and the time set in [Pr. PSA26 SS1/SS2 deceleration monitor delay time] has elapsed, speed monitoring starts. This function monitors whether the servo motor does not exceed the speed specified by [Pr. PSA24 SS1/SS2 deceleration monitor time constant] from the speed at the moment that the SS2 command is turned off.

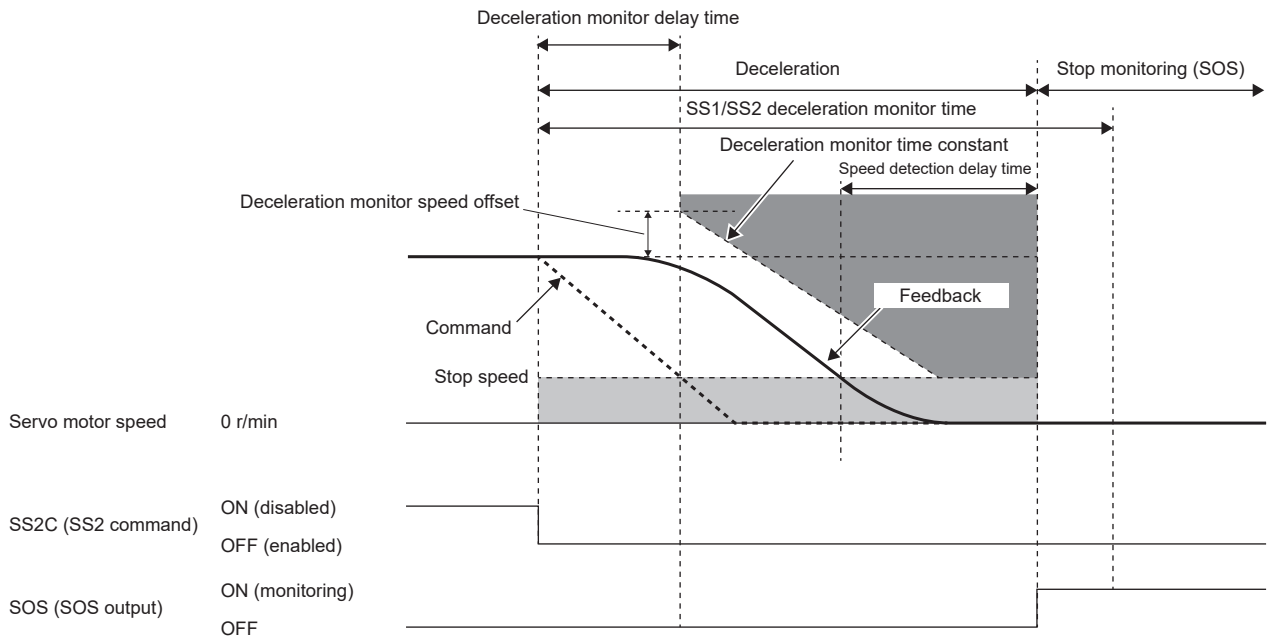

When the servo motor speed is exceeded, the STO function is activated. For the threshold used for judgment, the offset can be set in [Pr. PSA25 SS1/SS2 deceleration monitor speed offset].

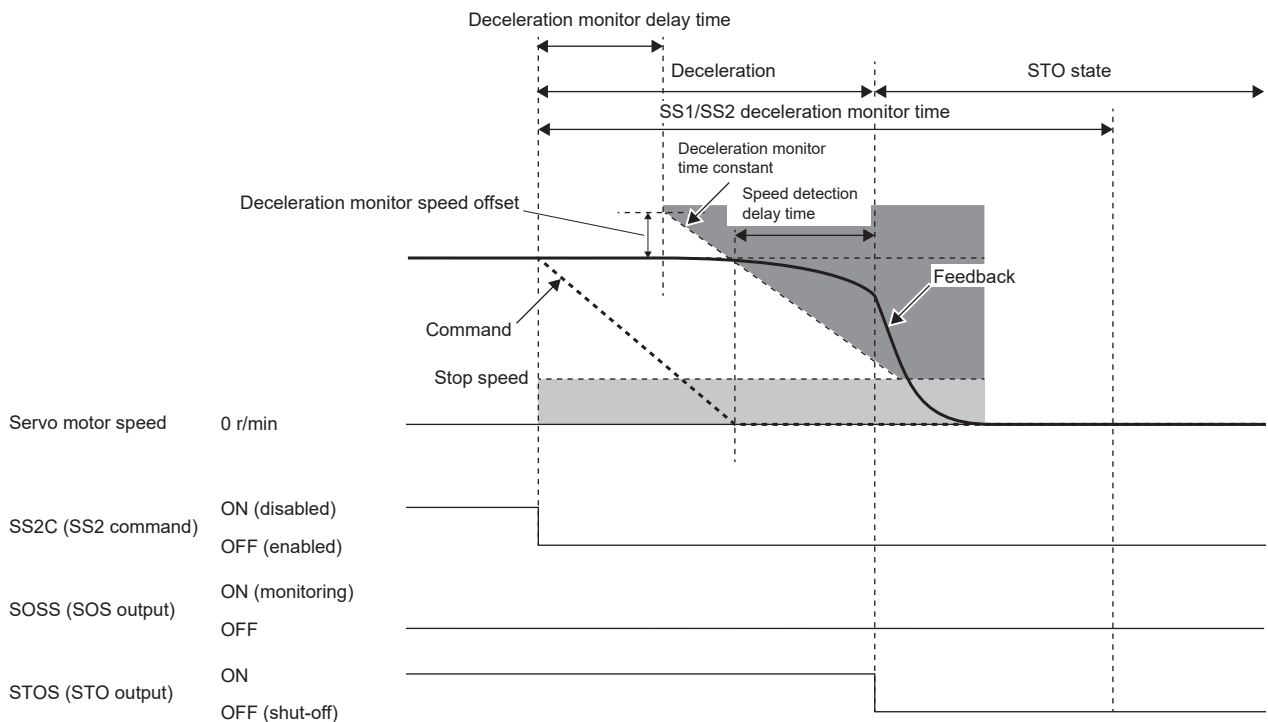

Stop monitoring

The SOS function monitors both the command speed and feedback speed.

Speed command monitoring

During stop monitoring, this function monitors whether the absolute value of the command speed is within the value set in [Pr. PSA04 Safety sub-function - Stop speed]. If the time of the speed command remains exceeded for the duration set in [Pr. PSA15 Safety sub-function - Speed detection delay time], the STO function is activated.

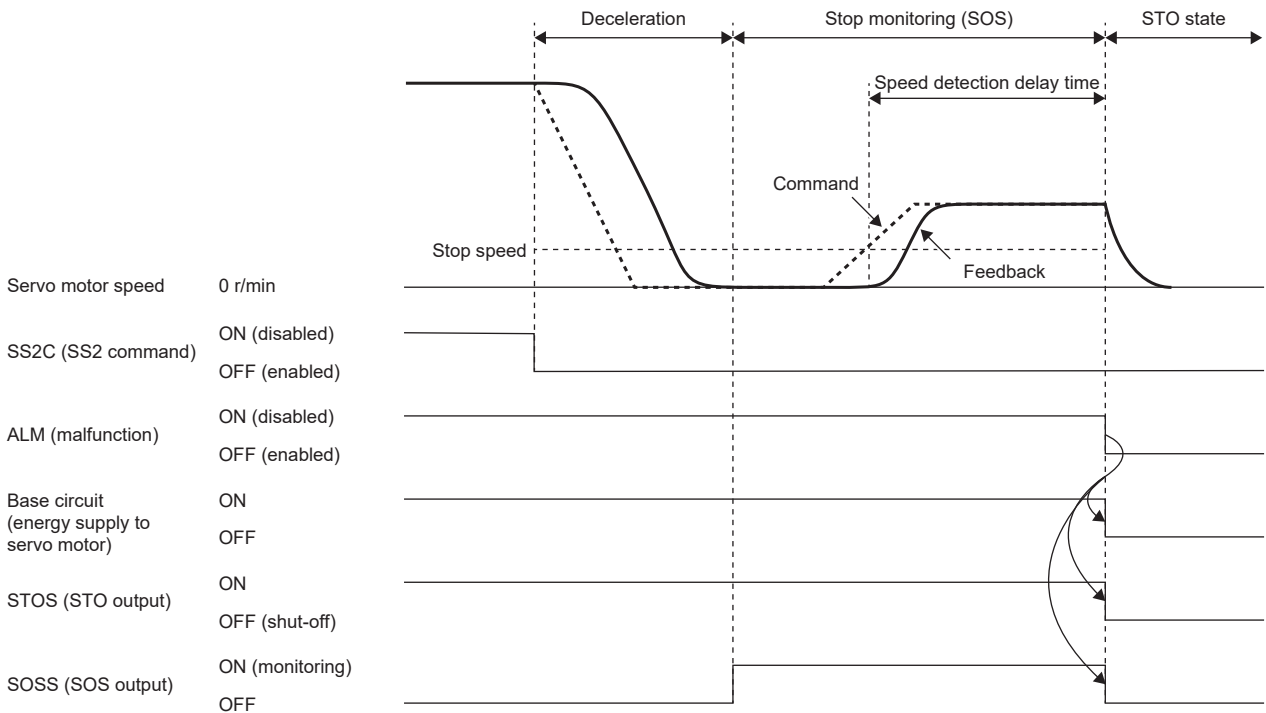

Speed feedback monitoring

During stop monitoring, this function monitors whether the absolute value of the speed feedback is within the value set in [Pr. PSA04 Safety sub-function - Stop speed]. If the time of the speed feedback remains exceeded for the duration set in [Pr. PSA15 Safety sub-function - Speed detection delay time], the STO function is activated.

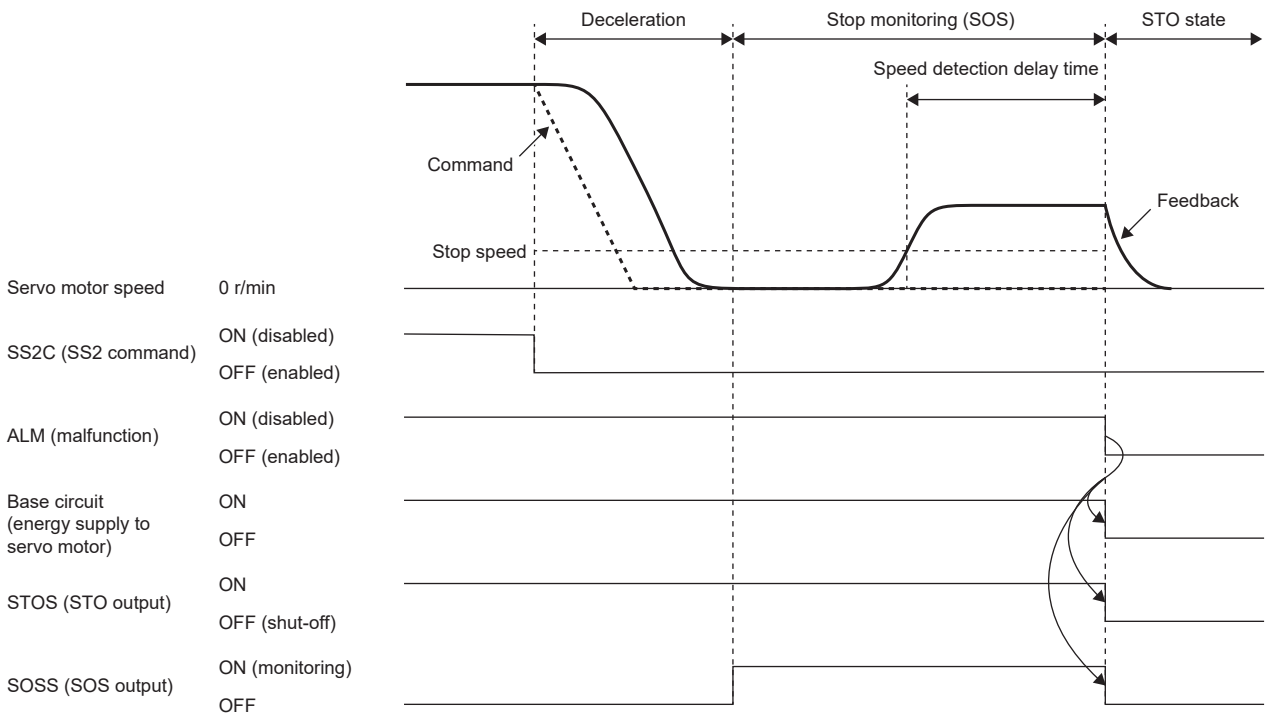

■ Position feedback monitoring at stop

During stop monitoring, this function monitors whether the absolute value of the amount of position feedback change from when stop monitoring (SOS) starts is within the value set in [Pr. PSA05 SOS permissible travel distance]. If the travel distance remains deviated for the duration set in [Pr. PSA17 Safety sub-function - Position detection delay time], the STO function is activated.

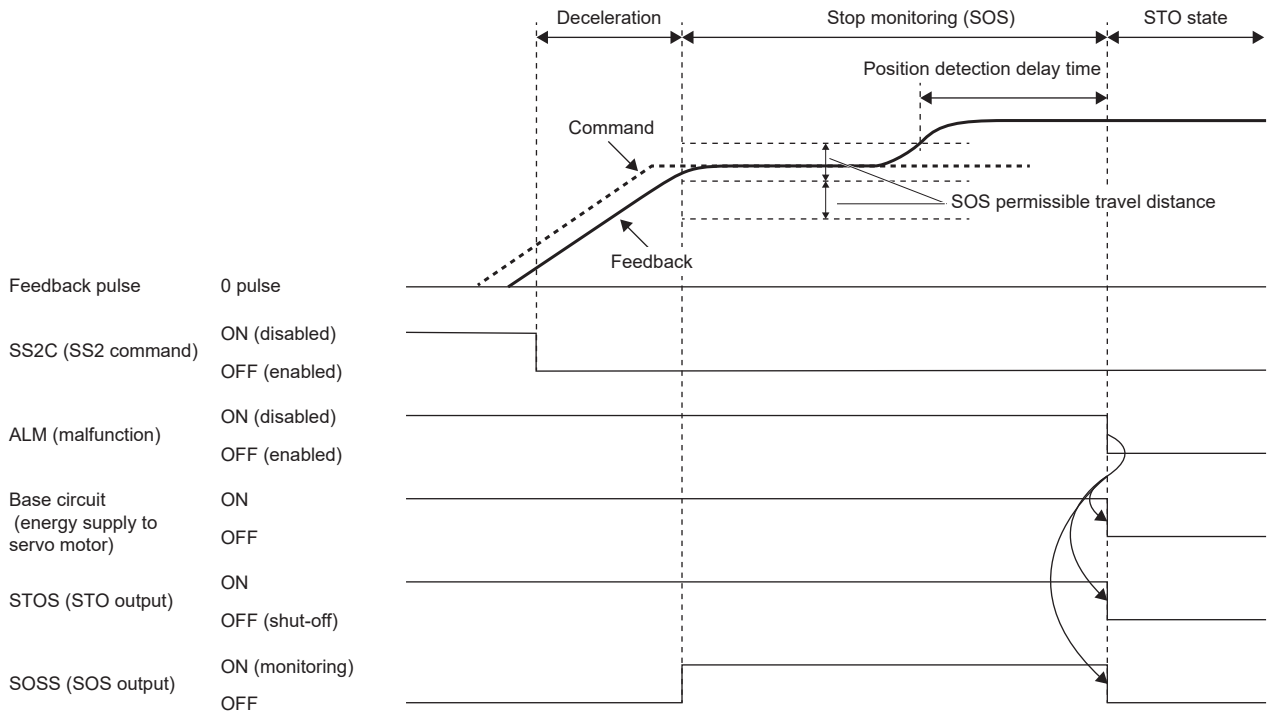

Setting functional safety parameters

Refer to the following to set the functional safety parameters.

☞ Page 439 Functional safety parameters that must be set

When using the safety sub-function control by input device, refer to the following.

☞ Page 444 Input device

When using output devices, refer to the following.

☞ Page 447 Output device

When using the safety sub-function control by network, refer to the following.

☞ Page 450 Safety sub-function control by network

To use the SS2/SOS function, a servo motor with functional safety is required. For servo motors with functional safety, refer to the following.

☞ Page 482 Servo motor with functional safety

When using the SS2/SOS function, set the following parameters.

Parameter	Name
PSA03	SS1/SS2 deceleration monitor time
PSA04	Safety sub-function - Stop speed
PSA05	SOS permissible travel distance
PSA06	SOS permissible travel distance unit selection
PSA15	Safety sub-function - Speed detection delay time
PSA17	Safety sub-function - Position detection delay time
PSA24	SS1/SS2 deceleration monitor time constant
PSA25	SS1/SS2 deceleration monitor speed offset
PSA26	SS1/SS2 deceleration monitor delay time

■ SS1/SS2 deceleration monitor time

Refer to the operation sequence and set the sufficient time for the servo motor to stop.

■ Safety sub-function - Stop speed

Refer to the operation sequence and set a servo motor speed at which the servo motor is considered to have been stopped.

■ SOS permissible travel distance, SOS permissible travel distance unit selection

Refer to the operation sequence and set the travel distance to be permitted during stop monitoring.

■ Safety sub-function - Speed detection delay time

The delay time from when the speed falls below the stop speed during deceleration to when stop monitoring starts, and the delay time from when the stop speed is exceeded during stop monitoring to when the STO function is activated can be changed with [Pr. PSA15 Safety sub-function - Speed detection delay time].

■ Safety sub-function - Position detection delay time

The delay time from when the travel distance exceeds the threshold to when the STO function is activated can be changed with [Pr. PSA17 Safety sub-function - Position detection delay time].

■ SS1/SS2 deceleration monitor delay time

Refer to the operation sequence and set the time required for the deceleration monitoring to start after SS2C (SS2 command) is turned off.

■ SS1/SS2 deceleration monitor time constant

Refer to the operation sequence and set a time constant suitable for the deceleration command of the controller.

■ SS1/SS2 deceleration monitor speed offset

An offset can be set for the start speed of the deceleration monitor time constant. Set this parameter if overshoot occurs at the start of deceleration, etc.

SLS function

Outline

This function monitors whether the speed is within the prescribed speed limit. If the speed exceeds the specified speed limit, the STO will shut off energy. Upon detection that the servo motor speed exceeds the SLS speed, the STO function is activated. The SLS function monitors both the command speed and feedback speed.

Sequence outline

The SLS function is activated by turning off SLS_C (SLS_command). After SLS_C (SLS_command) is turned off, speed monitoring starts after the delay time specified by the functional safety parameter has elapsed. During speed monitoring, the function monitors whether the servo motor speed is within the SLS speed set by the functional safety parameter. Speed monitoring ends by turning on SLS_C (SLS_command).

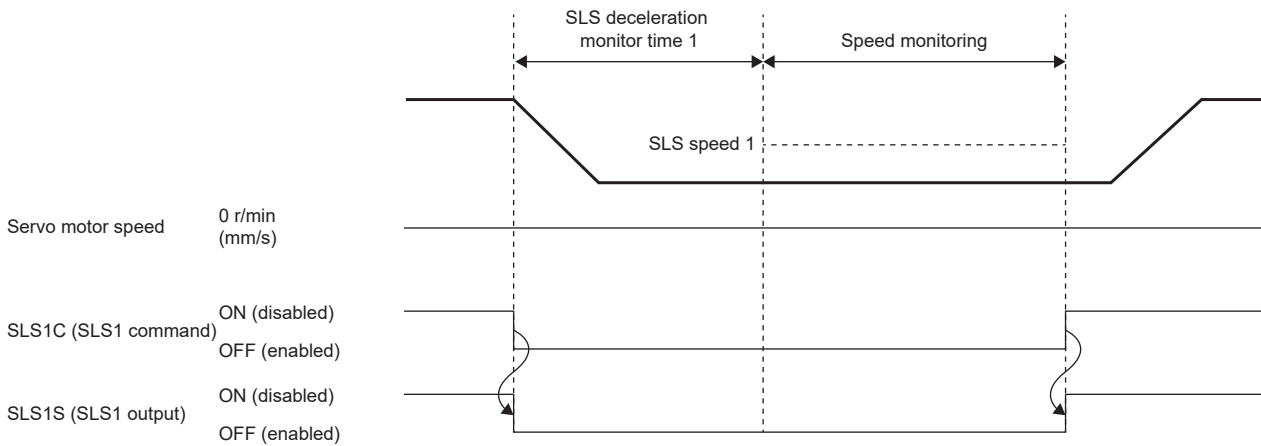

Parameter switching

Four sets of SLS speed and SLS deceleration monitor time can be set with the SLS function. The following table lists the SLS deceleration monitor time and SLS speed that are enabled by the SLS1 command, the SLS2 command, the SLS3 command, and the SLS4 command.

SLS command	SLS deceleration monitor time	SLS speed
SLS1 command	[Pr. PSA07 SLS deceleration monitor time 1]	[Pr. PSA11 SLS speed 1]
SLS2 command	[Pr. PSA08 SLS deceleration monitor time 2]	[Pr. PSA12 SLS speed 2]
SLS3 command	[Pr. PSA09 SLS deceleration monitor time 3]	[Pr. PSA13 SLS speed 3]
SLS4 command	[Pr. PSA10 SLS deceleration monitor time 4]	[Pr. PSA14 SLS speed 4]

The following shows a sequence when the SLS1 command and SLS2 command are simultaneously turned off. When multiple speed monitoring instances are executed simultaneously, the smallest SLS speed threshold is enabled. In the following sequence, SLS speed 2 is a smaller value than SLS speed 1, so if both the SLS1 command and the SLS2 command are enabled, monitoring by SLS speed 2 is enabled.

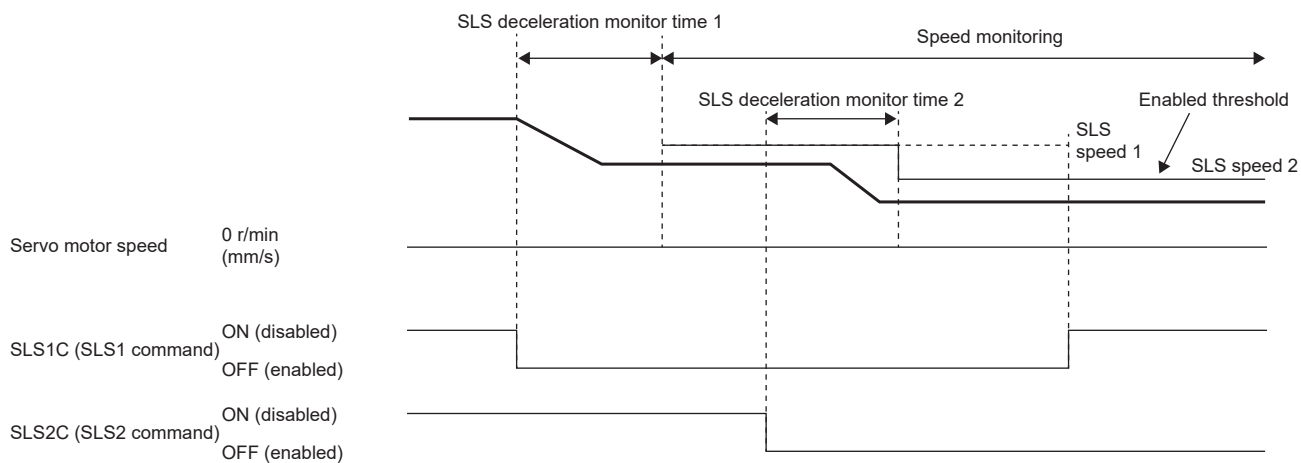

Speed monitoring

■ Speed monitoring command

During speed monitoring, this function monitors whether the absolute value of the speed command is within the SLS speed. Upon detection that the speed command exceeds the SLS speed, the STO function is activated. However, there will be a delay equal to the time set in [Pr. PSA15 Safety sub-function - Speed detection delay time] from when the SLS speed is exceeded until the STO function is activated.

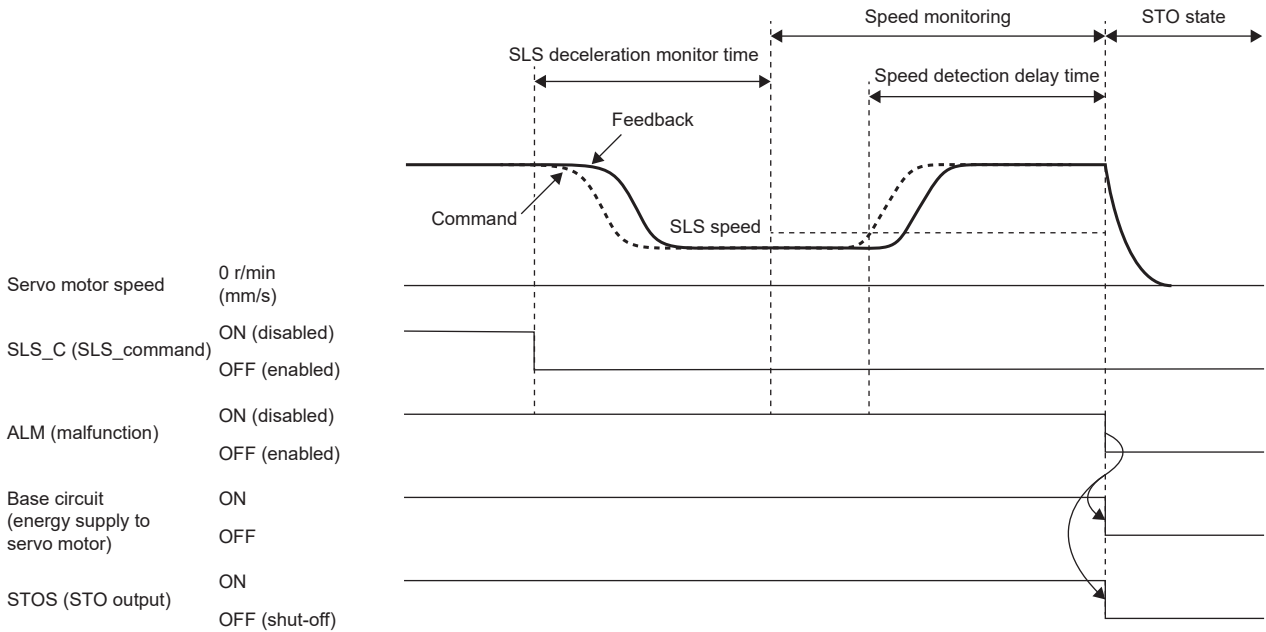

■ Speed feedback monitoring

During speed monitoring, this function monitors whether the absolute value of the speed feedback is within the SLS speed. If the time of the speed feedback remains exceeded for the duration set in [Pr. PSA15 Safety sub-function - Speed detection delay time], the STO function is activated.

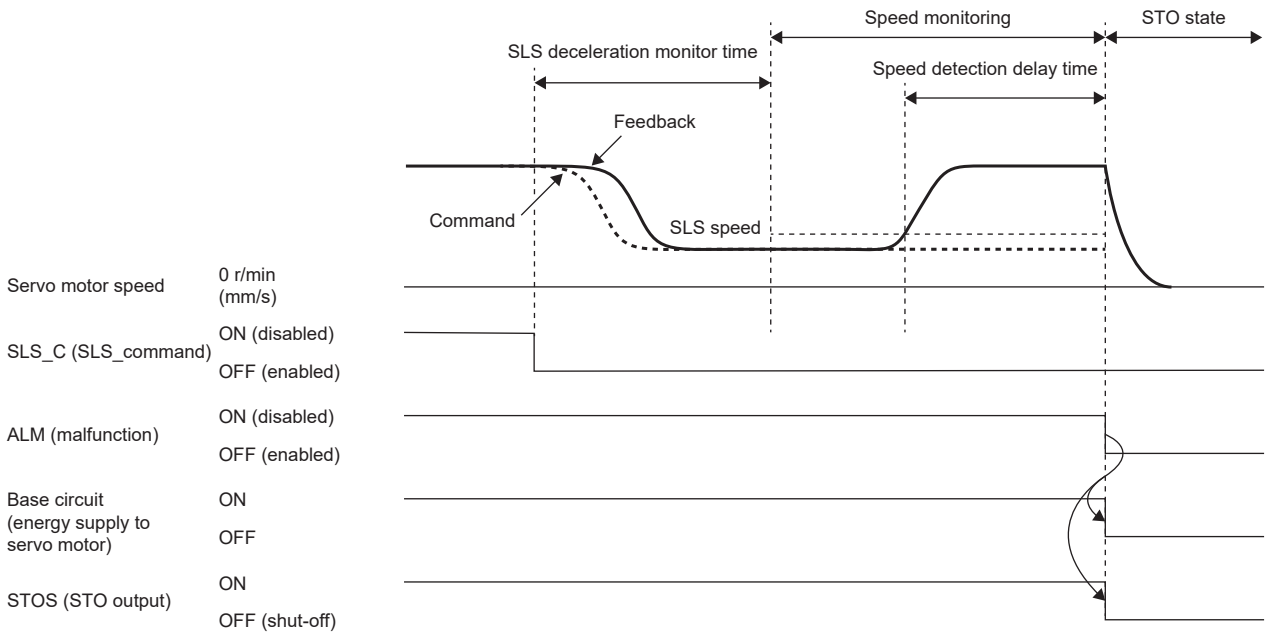

Setting functional safety parameters

Refer to the following to set the functional safety parameters.

☞ Page 439 Functional safety parameters that must be set

When using the safety sub-function control by input device, refer to the following.

☞ Page 444 Input device

When using output devices, refer to the following.

☞ Page 447 Output device

When using the safety sub-function control by network, refer to the following.

☞ Page 450 Safety sub-function control by network

When using the SLS function, set the following parameters.

Parameter	Name
PSA07	SLS deceleration monitor time 1
PSA08	SLS deceleration monitor time 2
PSA09	SLS deceleration monitor time 3
PSA10	SLS deceleration monitor time 4
PSA11	SLS speed 1
PSA12	SLS speed 2
PSA13	SLS speed 3
PSA14	SLS speed 4
PSA15	Safety sub-function - Speed detection delay time

■ SLS deceleration monitor time 1 to SLS deceleration monitor time 4

Refer to the operation sequence and set the time required for the speed monitoring to start after SLS_C (SLS_command) is turned off. Set the sufficient time for the servo motor to decelerate to or below the SLS speed. Although there are parameters corresponding to SLS1C (SLS1 command) to SLS4C (SLS4 command), it is not necessary to set the parameters corresponding to commands that are not enabled.

■ SLS speed 1 to SLS speed 4

Refer to the operation sequence and set the speed threshold for speed monitoring. Although there are parameters corresponding to SLS1C (SLS1 command) to SLS4C (SLS4 command), it is not necessary to set the parameters corresponding to commands that are not enabled.

■ SLS speed detection delay time

Set the error detection time for the detected speed. The setting value of this parameter changes the delay time from when the SLS speed is exceeded during speed monitoring to when the STO function is activated.

SSM function

Outline

This function outputs signals when the servo motor speed is below the prescribed speed.

Operation sequence

■ SSMS (SSM output)

In the SSM function, SSMS (SSM output) is on when both the speed command and speed feedback are equal to or less than the speed set in [Pr. PSA18 SSM speed]. This function monitors whether the absolute value of the speed command and the absolute value of the speed feedback are within the SSM speed.

Upon detection that either exceeds the SSM speed, SSMS (SSM output) is turned off.

If both the absolute value of the speed command and the absolute value of the speed feedback are lower than the SSM speed by the amount set in [Pr. PSA19 SSM hysteresis width], SSMS (SSM output) is turned on. By properly setting [Pr. PSA19], chattering of SSMS (SSM output) can be prevented when the servo motor speed fluctuates in the vicinity of the SSM speed.

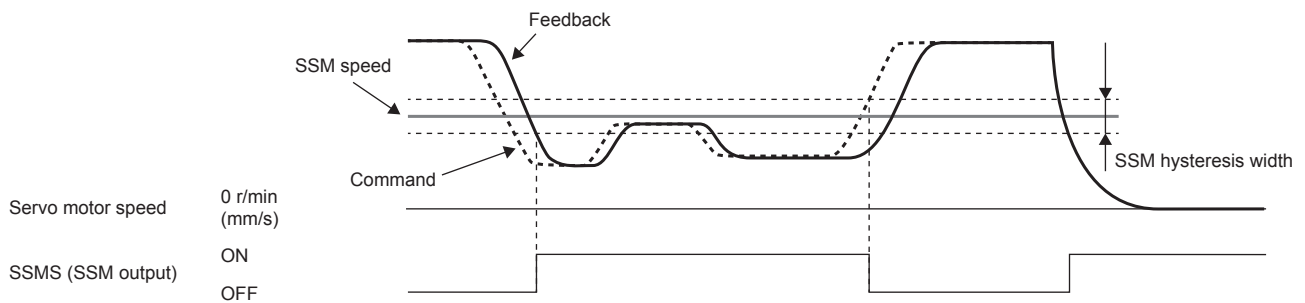

Setting functional safety parameters

When using the SSM function, set the following parameters.

Parameter	Name
PSA18	SSM speed
PSA19	SSM hysteresis width

■ SSM speed

Refer to the operation sequence and set the speed threshold for speed monitoring.

■ SSM hysteresis width

Refer to the operation sequence and set the hysteresis width needed to prevent SSMS (SSM output) chattering.

SBC function

Point

- Use SBCS (SBC output) for electromagnetic brake operation. It is not necessary to use MBR (electromagnetic brake interlock).

Outline

This function outputs signals for controlling the external brake.

Operation sequence

The following shows the operation sequence while SS1 is being activated and when returning from the STO state. The electromagnetic brake is activated when SBCS (SBC output) is off. By properly setting [Pr. PC02 Electromagnetic brake sequence output] and [Pr. PSA03 SS1/SS2 deceleration monitor time], the electromagnetic brake can be activated without dropping the vertical axis. The vertical axis freefall prevention function can also be used.

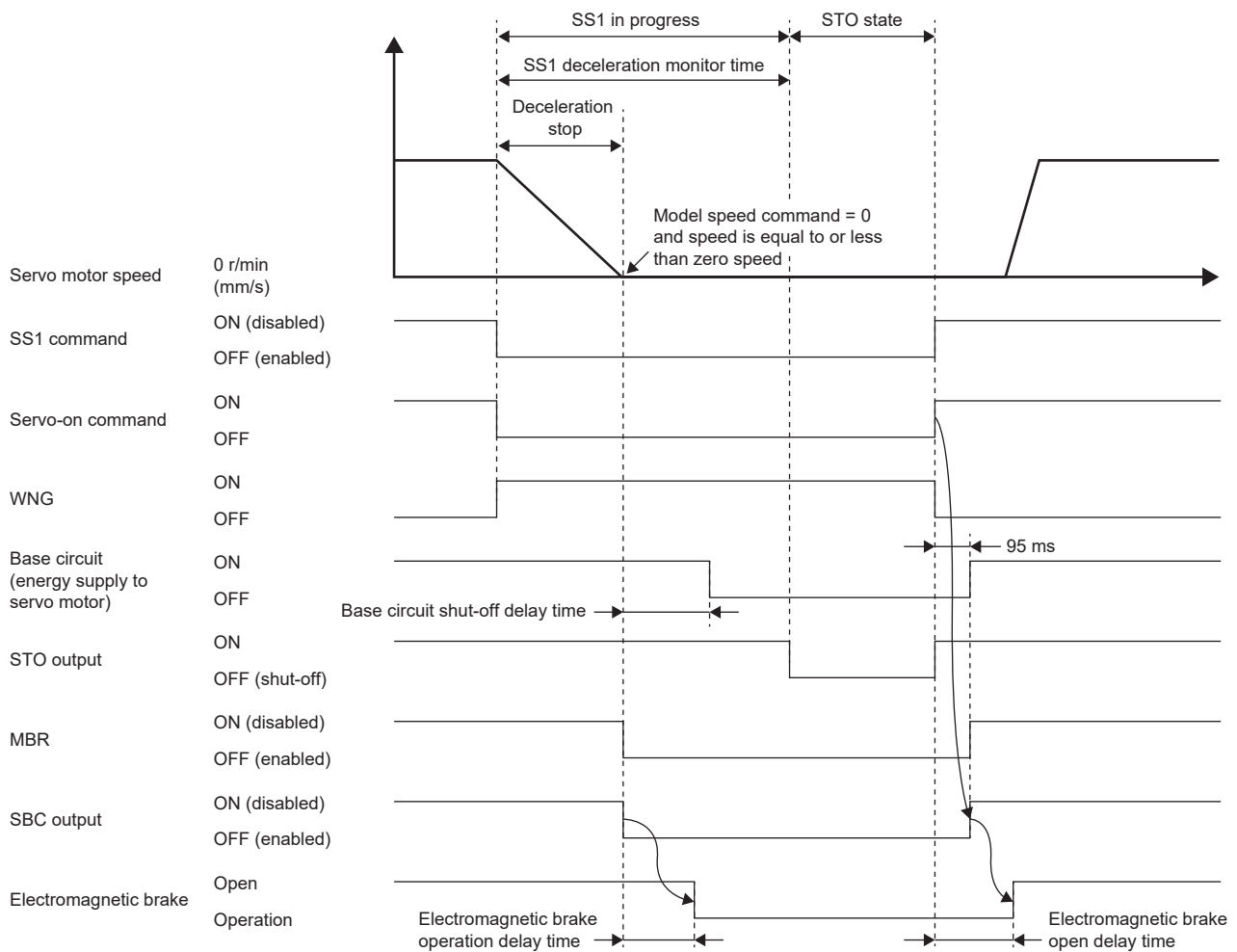

Precautions

When the power is shut off by the STO function, the dynamic brake stops from activation of the STO function until activation of the electromagnetic brake. Be aware that if the axis is a vertical axis, it may drop.

Setting functional safety parameters

Refer to the following to set the functional safety parameters.

☞ Page 439 Functional safety parameters that must be set

☞ Page 447 Output device

SDI function

Outline

This function monitors whether the servo motor travels in the specified direction. If the servo motor travels in a direction different from the specified direction, the STO function will be activated.

Operation sequence

The SDI function is activated by turning off SDIPC (SDIP command) or SDINC (SDIN command). When SDIPC (SDIP command) is turned off, the function monitors the address increasing direction. When SDINC (SDIN command) is turned off, the function monitors the address decreasing direction. The function starts monitoring when either the time set in [Pr. PSA27 SDI positive direction monitor delay time] or [Pr. PSA28 SDI negative direction monitor delay time] has elapsed after SDIPC (SDIP command) or SDINC (SDIN command) is turned off. During monitoring, the function monitors whether the speed is within [Pr. PSA04 Safety sub-function - Stop speed] for the specified monitoring direction. Monitoring ends by turning on SDIPC (SDIP command) or SDINC (SDIN command).

The SDI direction monitor delay time can be specified individually for the address increasing direction and for the address decreasing direction.

SDI command	Monitoring direction	Applied SDI direction monitor delay time
SDIP command	Address increasing direction	[Pr. PSA27 SDI positive direction monitor delay time]
SDIN command	Address decreasing direction	[Pr. PSA28 SDI negative direction monitor delay time]

The operation sequence by SDIPC (SDIP command) is shown below. The function monitors the address increasing direction.

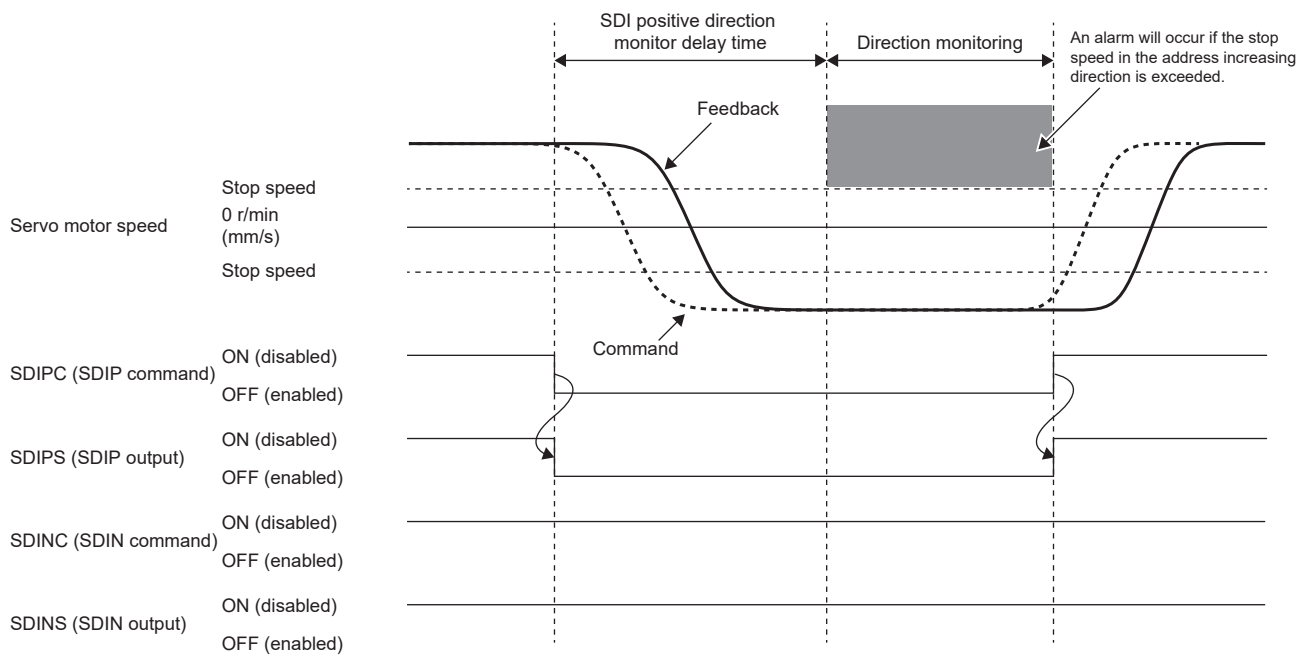

The operation sequence by SDINC (SDIN command) is shown below. The function monitors the address decreasing direction.

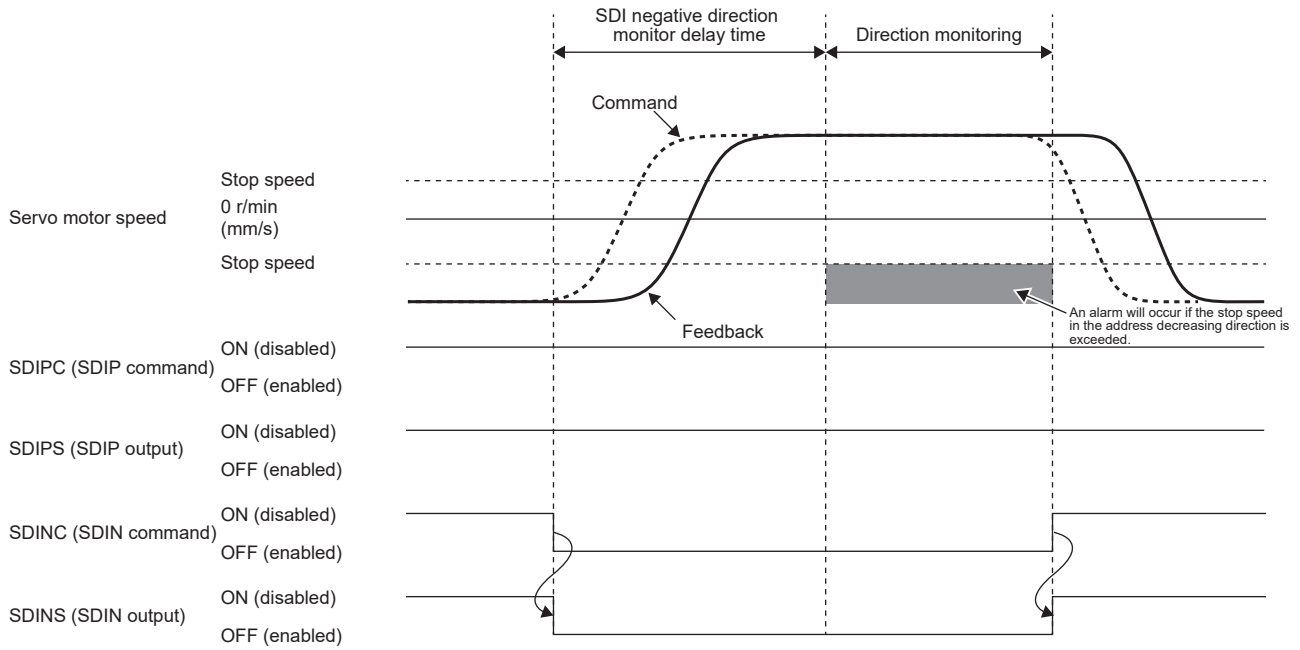

Direction monitoring

■ Speed command exceeded

During direction monitoring, the function monitors whether the speed is within the stop speed in the monitoring direction specified by the speed command. Upon detection that the speed command exceeds the stop speed, the STO function is activated. However, there will be a delay equal to the time set in [Pr. PSA15 Safety sub-function - Speed detection delay time] from when the stop speed is exceeded until the STO function is activated.

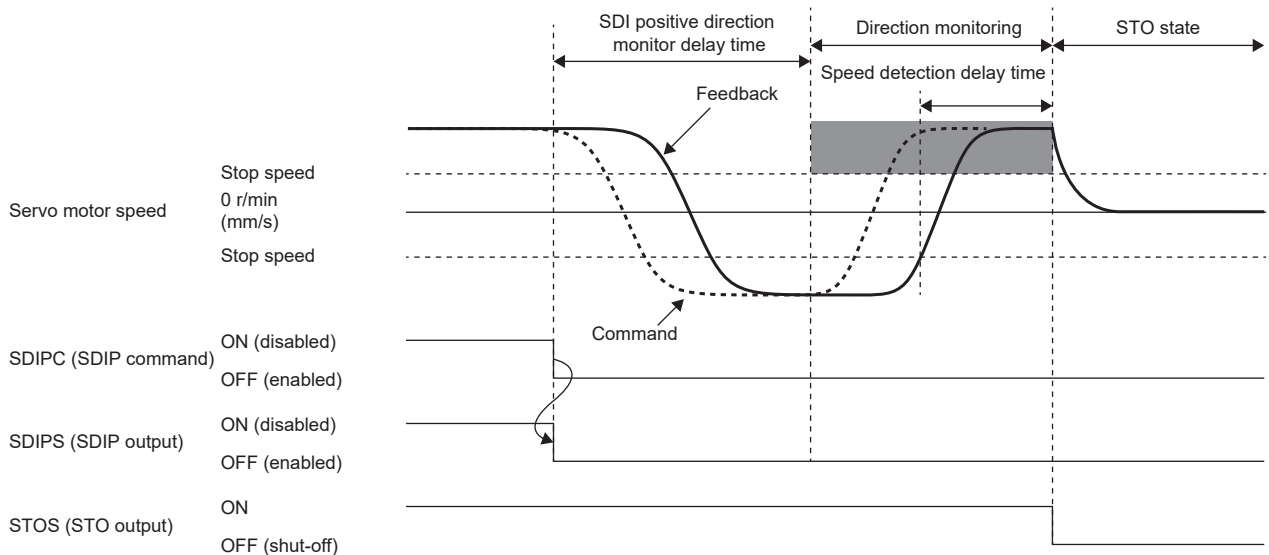

■ Speed feedback exceeded

During direction monitoring, the function monitors whether the speed is within the stop speed of the monitoring direction specified by the speed feedback. If the time of the speed feedback remains exceeded for the duration set in [Pr. PSA15 Safety sub-function - Speed detection delay time], the STO function is activated.

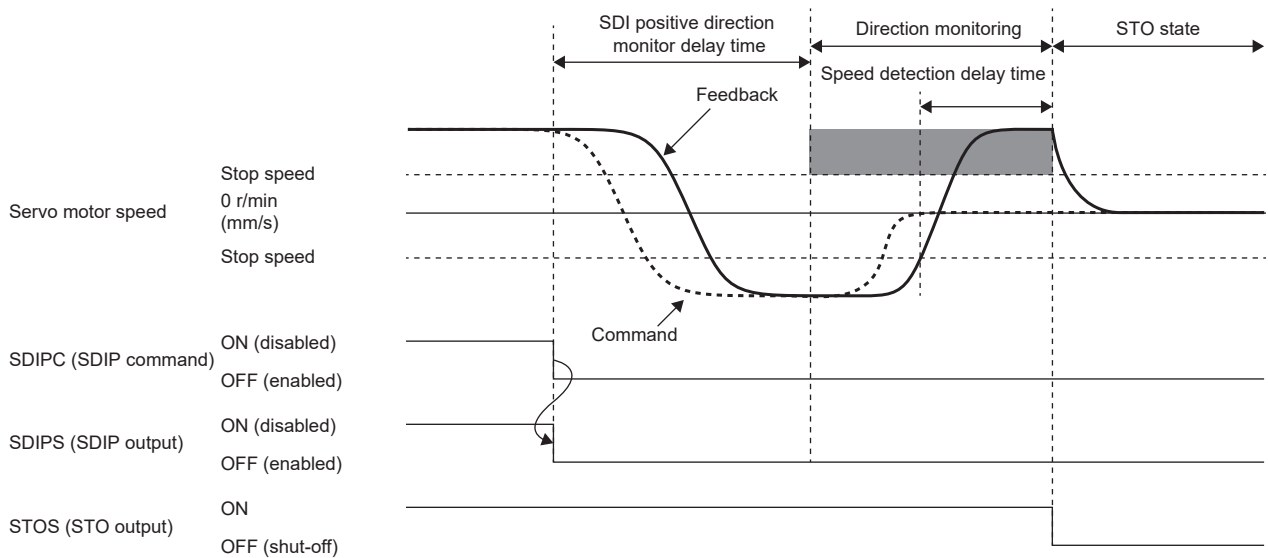

Setting functional safety parameters

Refer to the following to set the functional safety parameters.

☞ Page 439 Functional safety parameters that must be set

When using the safety sub-function control by input device, refer to the following.

☞ Page 444 Input device

When using output devices, refer to the following.

☞ Page 447 Output device

When using the safety sub-function control by network, refer to the following.

☞ Page 450 Safety sub-function control by network

When using the SDI function, set the following parameters.

Parameter	Name
PSA04	Safety sub-function - Stop speed
PSA15	Safety sub-function - Speed detection delay time
PSA27	SDI positive direction monitor delay time
PSA28	SDI negative direction monitor delay time

SLI function

Outline

This function monitors whether the travel distance of the servo motor is within the specified range. If the travel distance of the servo motor exceeds the specified permissible travel distance, the STO function is activated.

Operation sequence

The SLI function is activated by turning off SLIC (SLI command). The function starts monitoring right after SLIC (SLI command) is turned off. The function monitors whether the travel distance after the position monitoring starts is within the range specified by the parameter. The function monitors whether the travel distance in the address decreasing direction is equal to or greater than the SLI permissible travel distance (negative direction), and the travel distance in the address increasing direction is equal to or smaller than the SLI permissible travel distance (positive direction).

Monitoring ends by turning on SLIC (SLI command).

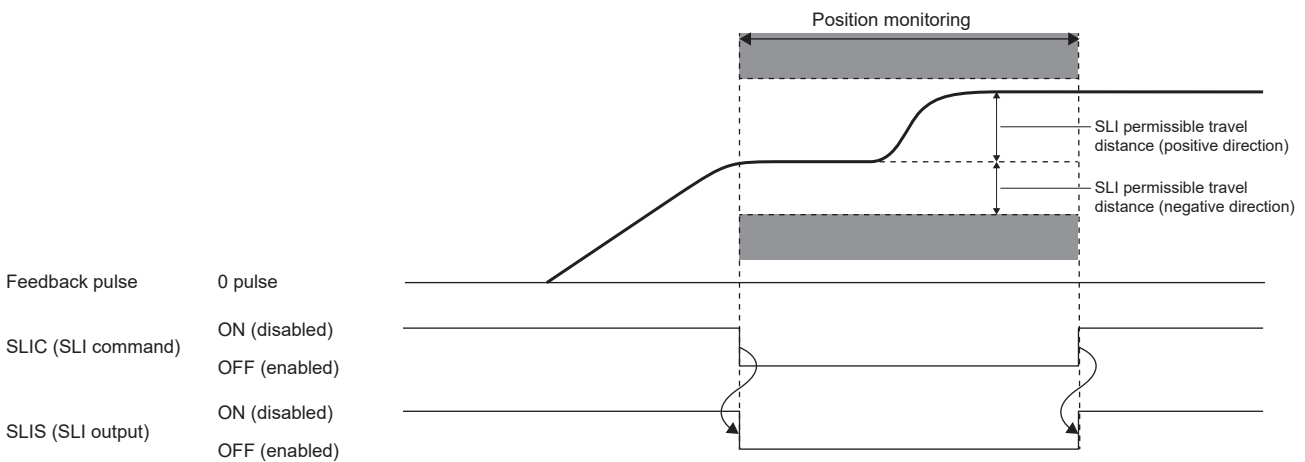

Position monitoring

Position feedback monitoring

During position monitoring, the function monitors whether the travel distance of the position feedback is within the SLI permissible travel distance. Upon detection that the travel distance after the position monitoring starts exceeds the SLI permissible travel distance, the STO function is activated. However, there will be a delay equal to the time set in [Pr. PSA17 Safety sub-function - Position detection delay time] from when the SLI permissible travel distance is exceeded until the STO function is activated.

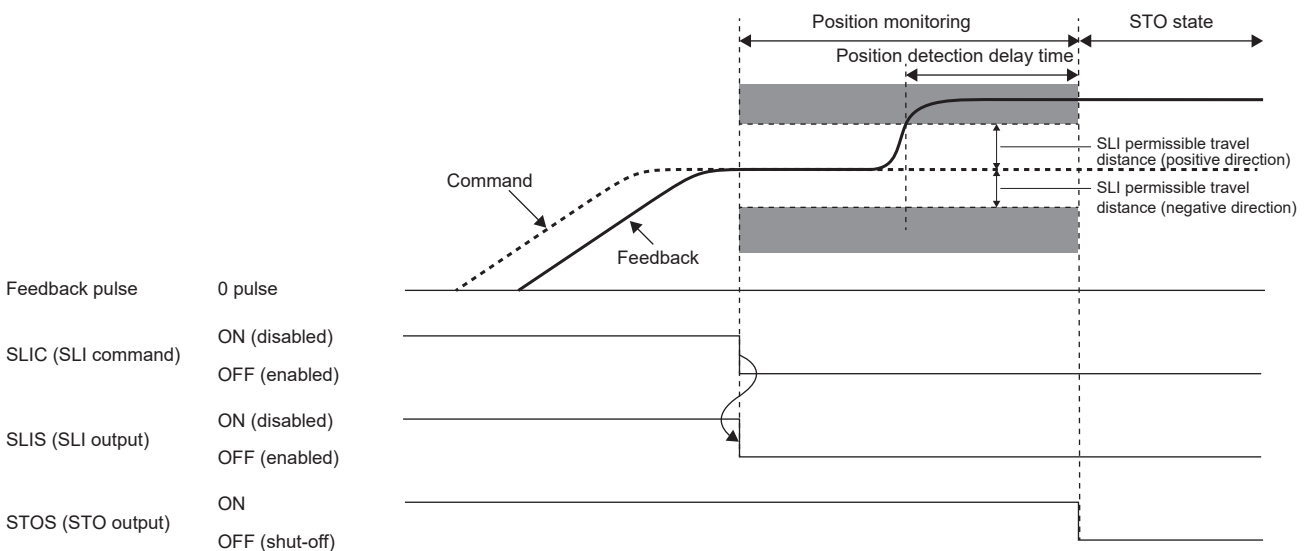

Combination with stop monitoring

In the SLI function, if stop monitoring after operation completion is required, perform SOS monitoring using the SS2 command.

The following is an example of the operation sequence of stop monitoring after the operation is completed.

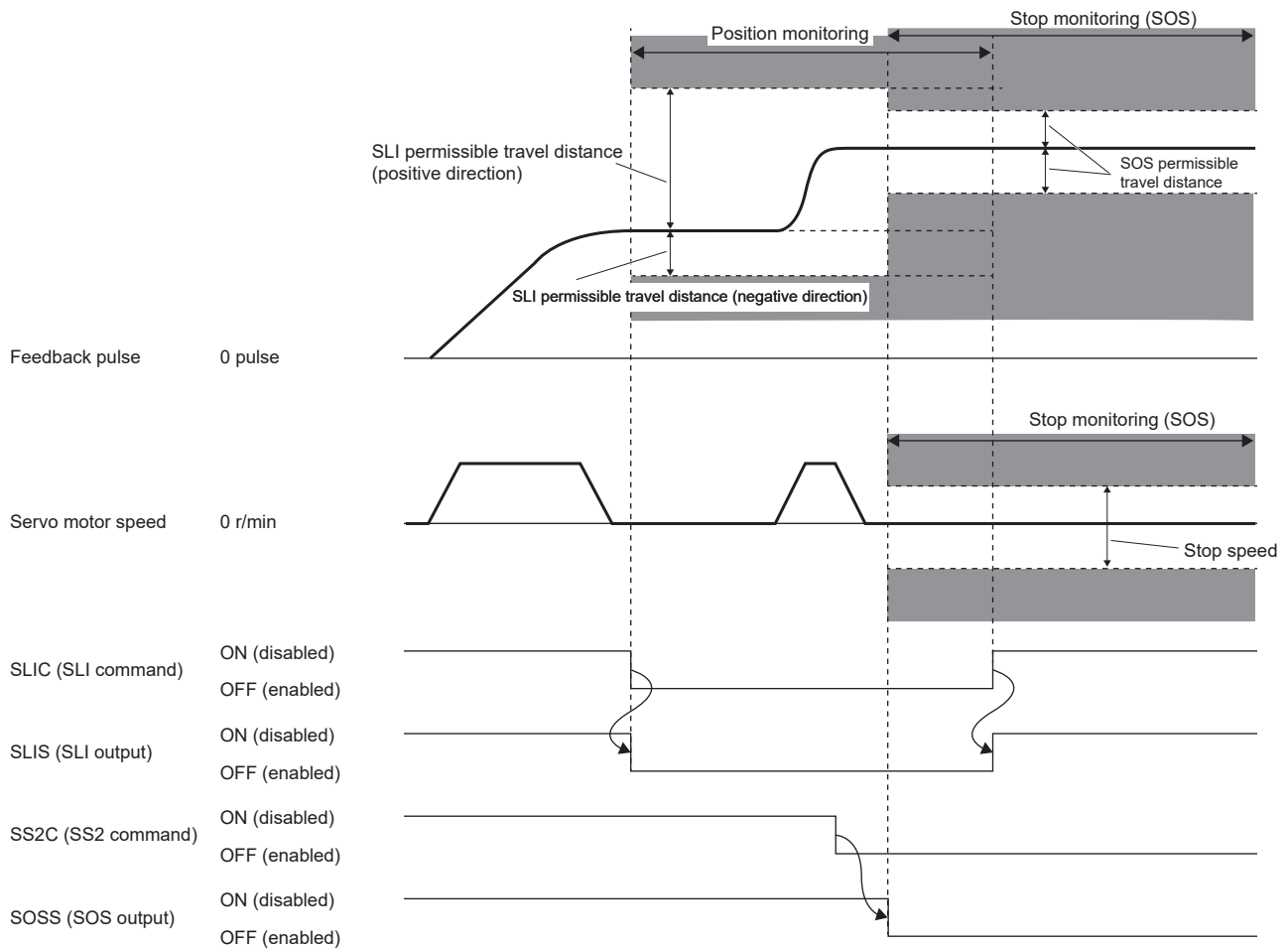

Setting functional safety parameters

Refer to the following to set the functional safety parameters.

☞ Page 439 Functional safety parameters that must be set

When using the safety sub-function control by input device, refer to the following.

☞ Page 444 Input device

When using output devices, refer to the following.

☞ Page 447 Output device

When using the safety sub-function control by network, refer to the following.

☞ Page 450 Safety sub-function control by network

When using the SLI function, set the following parameters.

Parameter	Name
PSB01	SLI permissible travel distance - Unit selection
PSB02	SLI permissible travel distance - Positive direction 1
PSB06	SLI permissible travel distance - Negative direction 1
PSA17	Safety sub-function - Position detection delay time

SLT function

Outline

This function monitors whether the torque is within the specified value. Upon detection that the torque exceeds the SLT torque, the STO function is activated.

Operation sequence

The SLT function is activated by turning off SLTC (SLT command). The function starts torque monitoring right after SLTC (SLT command) is turned off. During torque monitoring, the function monitors whether the torque command and the torque feedback is within the specified range. Torque monitoring ends by turning on SLTC (SLT command).

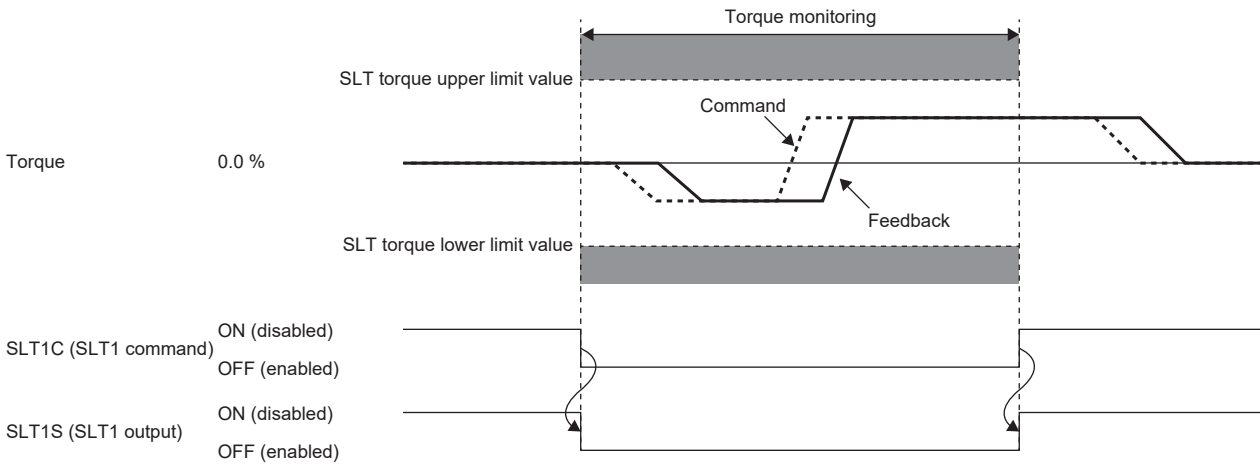

Parameter switching

Four sets of SLT torque upper limit value and SLT torque lower limit value can be set with the SLT function. Four commands (SLT1 command, SLT2 command, SLT3 command, and SLT4 command) corresponding to the respective thresholds can be used. The relationship between the commands and the applied SLT torque upper limit value and SLT torque lower limit value is as follows.

Command	Applied SLT command upper limit value	Applied SLT command lower limit value
SLT1 command	[Pr. PSB10 SLT torque upper limit value 1]	[Pr. PSB14 SLT torque lower limit value 1]
SLT2 command	[Pr. PSB11 SLT torque upper limit value 2]	[Pr. PSB15 SLT torque lower limit value 2]
SLT3 command	[Pr. PSB12 SLT torque upper limit value 3]	[Pr. PSB16 SLT torque lower limit value 3]
SLT4 command	[Pr. PSB13 SLT torque upper limit value 4]	[Pr. PSB17 SLT torque lower limit value 4]

The following shows a sequence when the SLT1 command and SLT2 command are turned off. When multiple torque monitoring instances are executed simultaneously, the smallest SLT upper limit value and the largest SLT torque lower limit value thresholds are enabled. In the following sequence, SLT torque 2 is a more valid than SLT torque 1, so monitoring by SLT torque 2 is enabled while both the SLT1 command and SLT2 command are enabled.

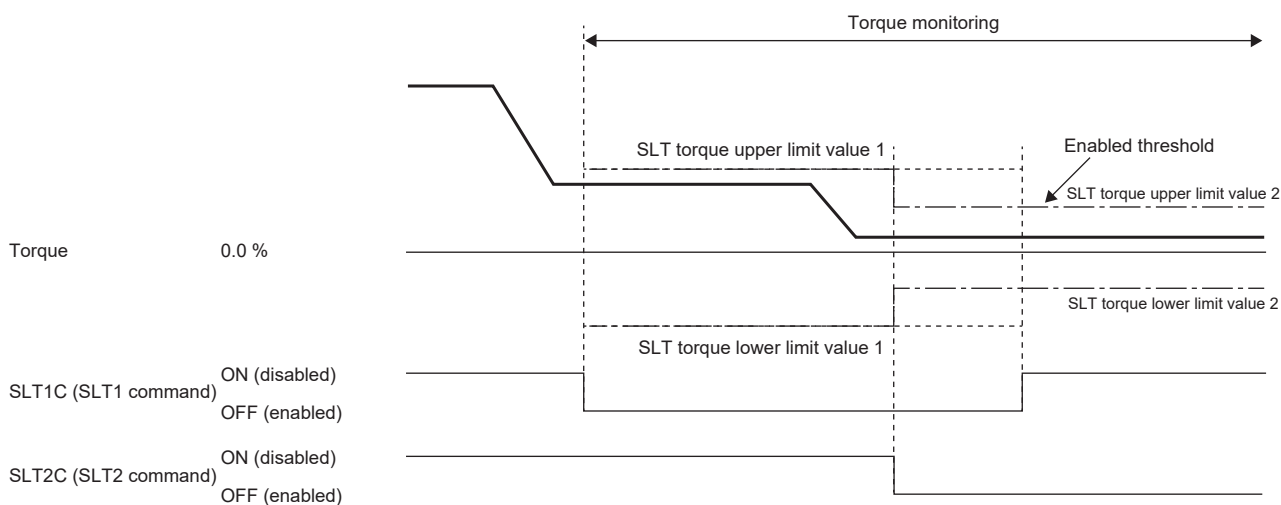

Torque monitoring

■ Torque command monitoring

During torque monitoring, the function monitors whether the torque command does not exceed the SLT torque upper limit value and does not fall below the SLT torque lower limit value. Upon detection that the torque command exceeds or falls below the SLT torque, the STO function is activated. However, there will be a delay equal to the time set in [Pr. PSB18 SLT torque detection delay time] from the detection until the STO function is activated.

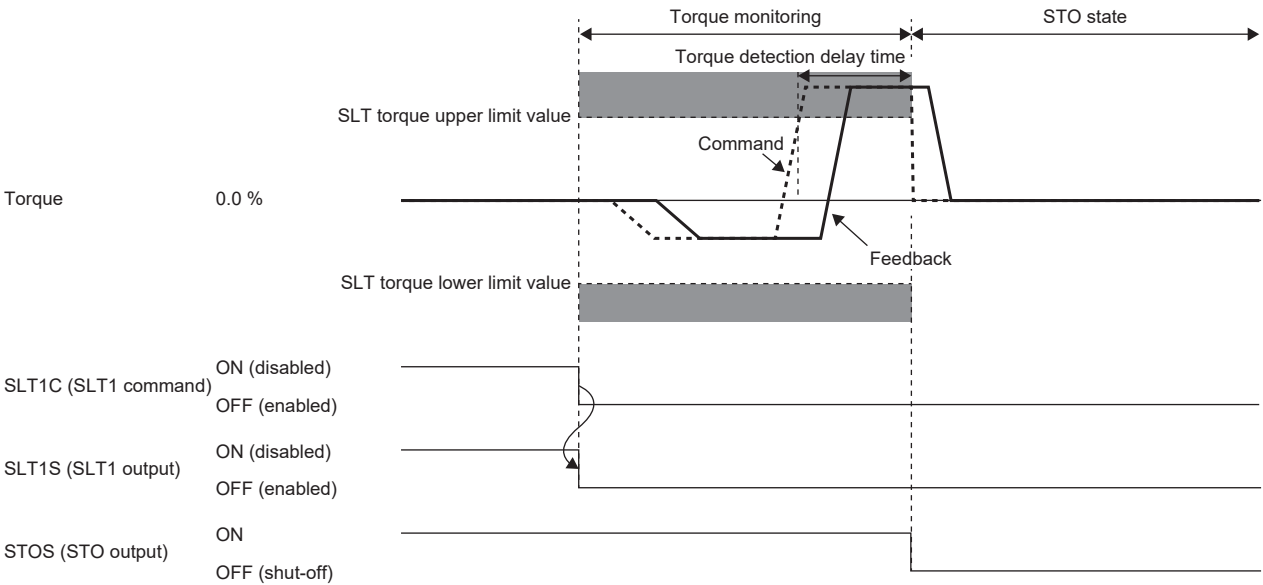

■ Torque feedback monitoring

During torque monitoring, the function monitors whether the torque feedback is within the SLT torque. If the time of the torque feedback remains exceeded for the duration set in [Pr. PSB18 SLT torque detection delay time], the STO function is activated.

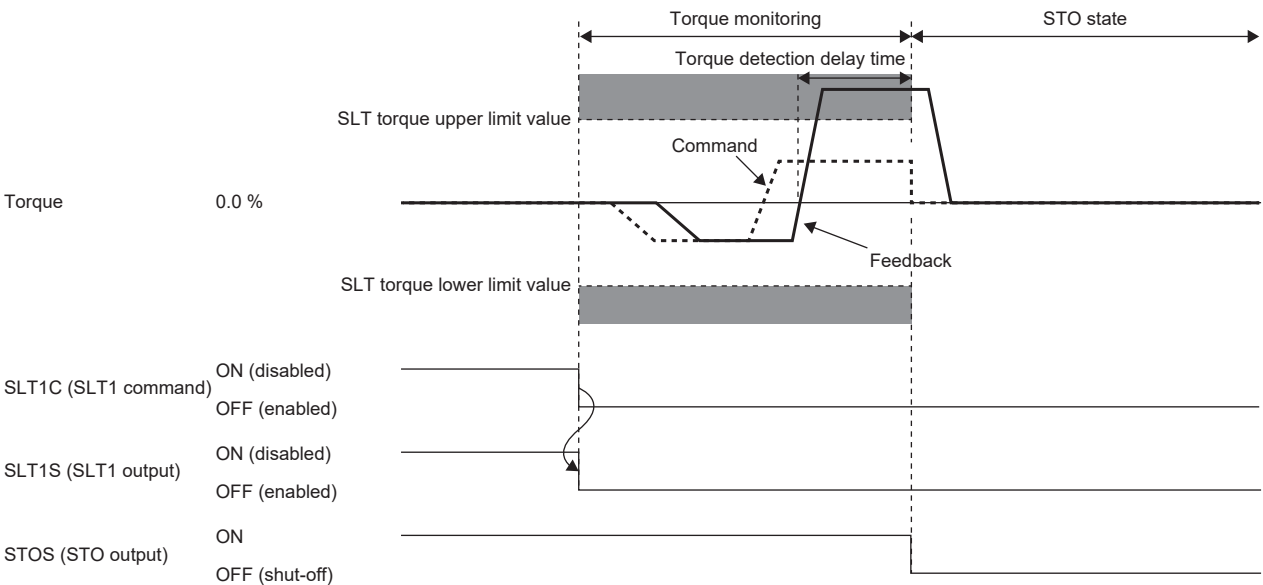

Setting functional safety parameters

Refer to the following to set the functional safety parameters.

☞ Page 439 Functional safety parameters that must be set

When using the safety sub-function control by input device, refer to the following.

☞ Page 444 Input device

When using output devices, refer to the following.

☞ Page 447 Output device

When using the safety sub-function control by network, refer to the following.

☞ Page 450 Safety sub-function control by network

When using the SLT function, set the following parameters.

Parameter	Name
PSB10	SLT torque upper limit value 1
PSB11	SLT torque upper limit value 2
PSB12	SLT torque upper limit value 3
PSB13	SLT torque upper limit value 4
PSB14	SLT torque lower limit value 1
PSB15	SLT torque lower limit value 2
PSB16	SLT torque lower limit value 3
PSB17	SLT torque lower limit value 4
PSB18	SLT torque detection delay time

■ SLT torque 1 to SLT torque 4

Refer to the operation sequence and set the threshold for torque monitoring. Although there are parameters corresponding to SLT1C (SLT1 command) to SLT4C (SLT4 command), it is not necessary to set the parameters corresponding to commands that are not enabled.

■ SLT torque detection delay time

Set the error detection time for the detected torque. The setting value of this parameter changes the delay time from when the SLT torque exceeds during torque monitoring to when the STO function is activated.

Status monitor (SM) function

This function outputs each status of SSM, SBC, SDI, SLI, SLT, STO, SOS, SS1, SS2, and SLS in signals. This is a function designed specifically for the safety sub-functions and differs from the function defined in IEC/EN 61800-5-2. For details on the devices, refer to the following.

☞ Page 444 I/O function

Multiple operation commands for safety sub-functions

For operation commands for safety sub-functions, operation commands with the same function may be input simultaneously. (For example, SS1C (SS1 command) input and SS1 input due to an alarm occurrence may occur simultaneously.)

When there are multiple operation triggers for a function, that function is activated when any one of them is valid. The following shows the operation sequence when an alarm occurs while SS1 is activated by SS1C (SS1 command).

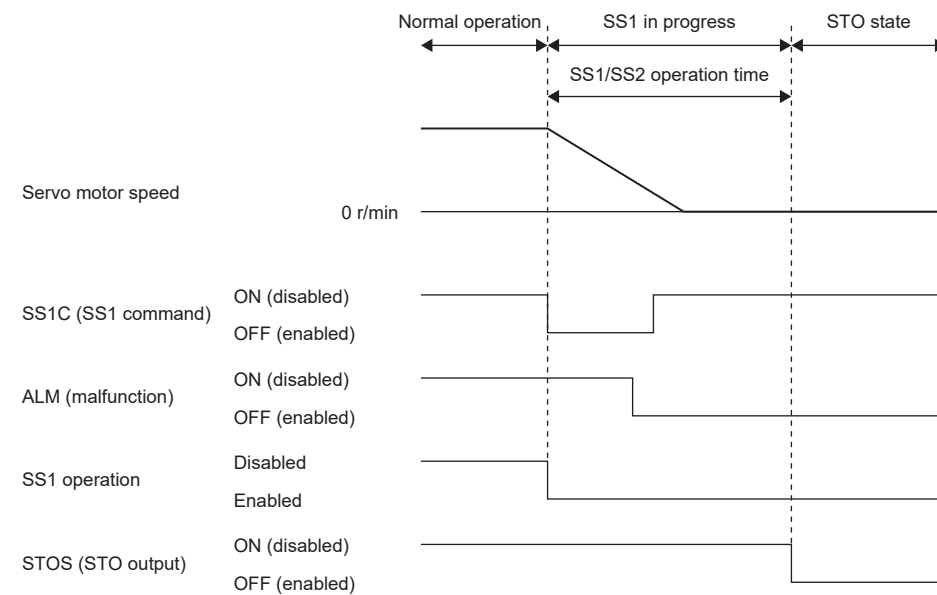

There are two triggers for the SS1 function, namely SS1C (SS1 command) input and ALM (Malfunction), but the only timer that counts the SS1/SS2 deceleration monitor time is the one that was counting from SS1C (SS1 command) that was input first. When SS1C (SS1 command) returns to on, the SS1 function is enabled by ALM (Malfunction), and thus the SS1 function continues the operation.

Simultaneous operation of STO and SS1 functions

If SS1C (SS1 command) is turned off while the STO function is being executed, deceleration operation and time counting by the SS1 function are not performed and the STO state continues.

As shown in the following sequence, if the SS1C (SS1 command) is turned off during the STO state by STOC (STO command), time counting of the SS1 function is not executed. Even if STOC (STO command) is turned on, the STO state by SS1C (SS1 command) continues and the STO state is not released.

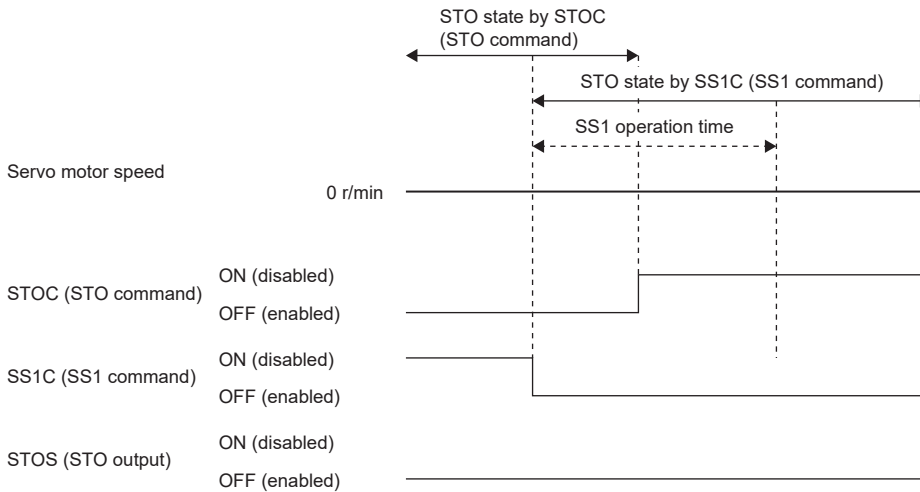

Moreover, if STOC (STO command) is turned off while the SS1 function is being executed, both the deceleration operation of SS1 and time counting are suspended.

At alarm occurrence

This function displays an alarm and warning when an error occurs during operation. When an alarm and warning occur, refer to the following manual and take the appropriate action.

📖 MR-J5 User's Manual (Troubleshooting)

Outline

■ Stop methods

The following stop methods are available when functional safety is used.

Stop methods	Explanation
DB	Stops with dynamic brake (for a servo amplifier without the dynamic brake, the servo motor coasts).
EDB	The time constant τ for the electronic dynamic brake will be shorter than that of the normal dynamic brake. Therefore, the coasting distance will be shorter than that of a normal dynamic brake.
SD	Performs forced stop deceleration.
STO/DB	Stops with dynamic brake by activating the STO function. For the operation sequence of this stop method, refer to the following. 📖 Page 483 STO function
SS1/EDB	Stops with electronic dynamic brake by activating the SS1 function. For the operation sequence of this stop method, refer to the following. 📖 Page 486 SS1 function
SS1/SD	Activates the SS1 function. Performs forced stop deceleration. For the operation sequence of this stop method, refer to the following. 📖 Page 486 SS1 function

For STO/DB, SS1/EDB, and SS1/SD, the STO state continues until the power is turned on again or the alarm is reset.

■ Safety sub-function stopped

If a serious error is detected, the safety sub-function stops. When the function stops, output devices output OFF.

■ Alarm reset

After the cause of the alarm is removed, the alarm can be cleared with one of the following methods.

- Alarm reset
- Communication reset
- Power cycling

Alarm reset method for safety sub-function

■ Safety sub-function control by input device

When the cause of an alarm occurrence is removed and alarm reset is executed with all the enabled input devices on, the STO is released and the operation returns to normal. STO is released even if the pin (unused pin) to which an input device is not assigned in [Pr. PSD02 Input device selection DI1] remains off.

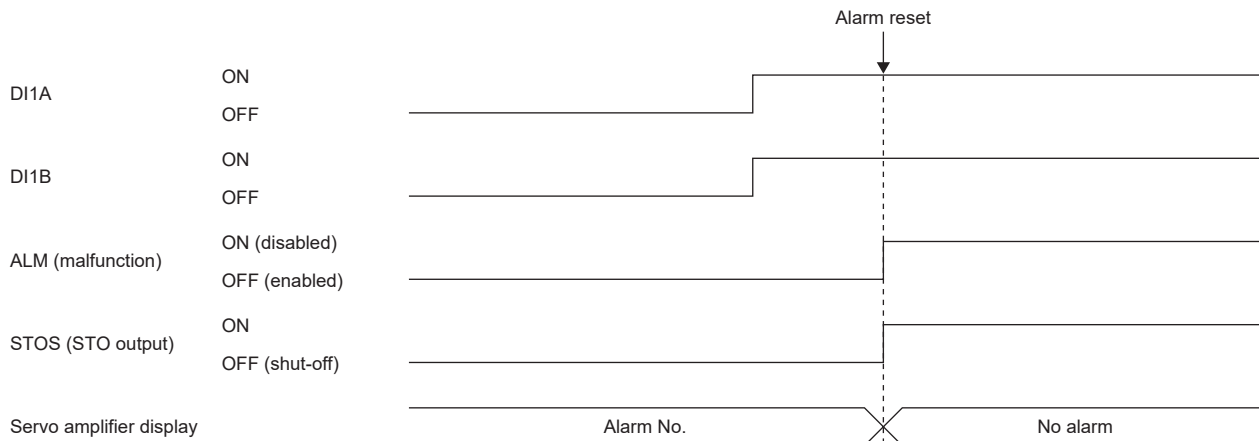

■ Safety sub-function control by network

Performing the following operation releases the STO and the operation returns to normal.

1. Remove the cause of the alarm.
2. Turn on STOC (STO command).
3. Reset the alarm.

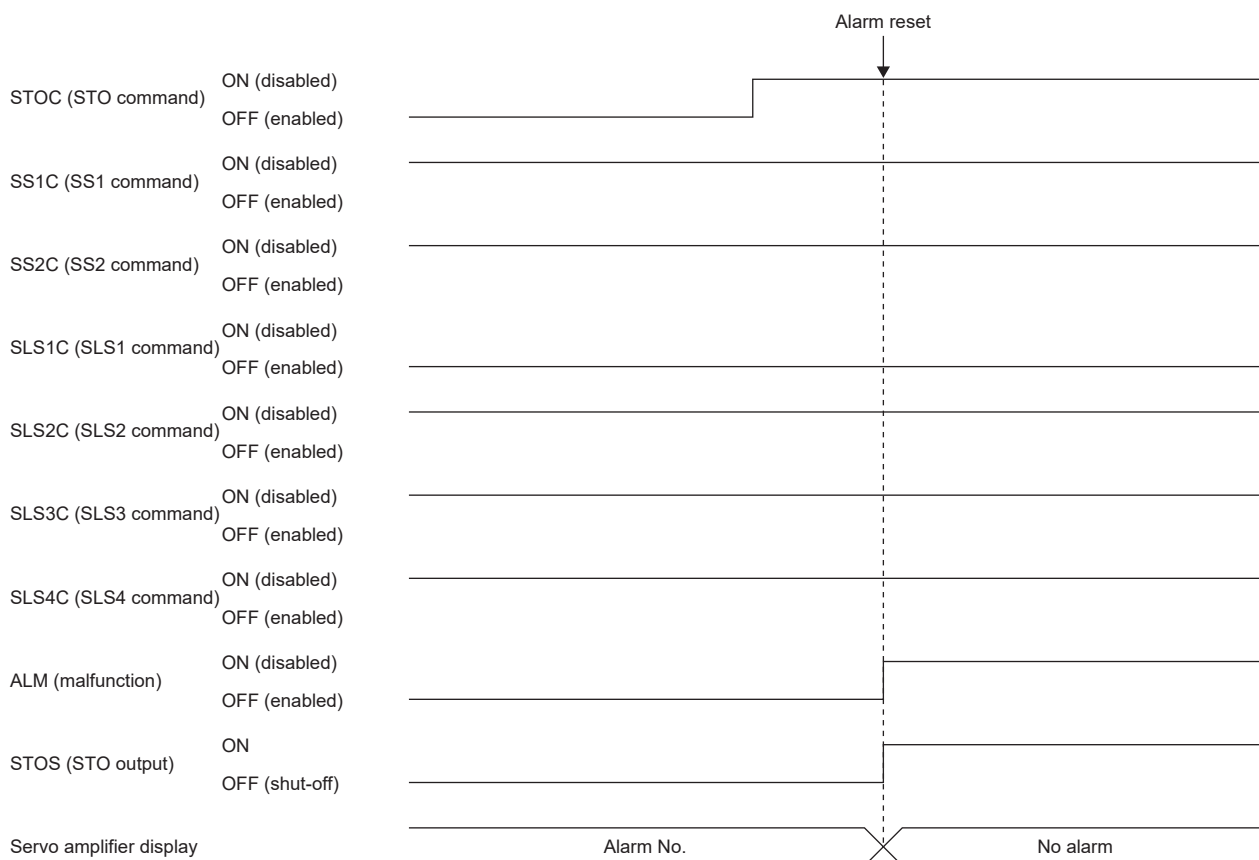

6.5 Troubleshooting

Parameter combinations that trigger [AL. 537.2 Parameter combination error A (safety sub-function)]

If the parameters shown in this section are set incorrectly, [AL. 537.2] occurs.

Parameters related to [Pr. PSA01 Safety sub-function mode selection] and [Pr. PSA02 Functional safety setting]

[Pr. PSA01.1 Input mode selection]		0 "Safety sub-function control by input device"			1 "Safety sub-function control by network"			2 "Test operation"	
[Pr. PSA02.1 Position/Speed monitor setting]		0 "Do not monitor the position/speed."	1 "Monitor the position/speed using a servo motor with functional safety."	2 "Monitor the speed without using a servo motor with functional safety."	0 "Do not monitor the position /speed."	1 "Monitor the position/speed using a servo motor with functional safety."	2 "Monitor the speed without using a servo motor with functional safety."	—	
Settable range	[Pr. PSA02.2 Time/Deceleration monitor setting]	0	0, 1		0	0, 1		—	
	[Pr. PSA02.3 Operation mode selection]	—	Same value as [Pr. PA01.1 Operation mode selection]		—	Same value as [Pr. PA01.1]		—	
	[Pr. PSD01 Input device automatic activation selection]	SLS1C to SLS4C	0	Each bit 0 to 1		0			—
		SLT1C to SLT4C	Each bit 0 to 1			0			—
		SDIPC, SDINC	0	Each bit 0 to 1		0			—
	[Pr. PSD02 Input device selection DI1]	01 (STOC) 02 (SS1C) 0A (SLT1C) to 0D (SLT4C)	01 (STOC) to 0E (SLIC)	01 (STOC) 02 (SS1C) 04 (SLS1C) to 0D (SLT4C)	—	—	—	—	
	[Pr. PSD08 Output device selection DO1]	01 (STOS) 02 (SS1S) 0A (SBCS) 0D (SLT1S) to 10 (SLT4S)	01 (STOS) to 12 (SLIS)	01 (STOS) 02 (SS1S) 04 (SLS1S) to 08 (SSMS) 0A (SBCS) to 10 (SLT4S)	—	—	—	—	
	[Pr. PSA20 Servo motor encoder resolution]	—	Sets the servo motor encoder resolution.		—	Sets the servo motor encoder resolution.		—	
	[Pr. PSA23 Servo motor rated speed]	—	Sets the servo motor rated speed.		—	Sets the servo motor rated speed.		—	
	[Pr. PSC03 Functional safety - Rotation direction selection/travel direction selection]	—	Same values as [Pr. PA14 Travel direction selection]		—	Same value as [Pr. PA14]		—	
[Pr. PSL03 Functional safety - Linear encoder resolution setting - Denominator]	—	Same values as [Pr. PL02 Linear encoder resolution setting - Numerator]		—	Same value as [Pr. PL02]		—		
[Pr. PSL02 Functional safety - Linear encoder resolution setting - Numerator]	—	Same value as [Pr. PL03 Linear encoder resolution setting - Denominator]		—	Same value as [Pr. PL03]		—		

Parameters related to [Pr. PSA02.1 Position/Speed monitor setting] and operation mode

[Pr. PSA02.1 Position/Speed monitor setting]		0 "Do not monitor the position/speed."	1 "Monitor the position/speed using a servo motor with functional safety."	2 "Monitor the speed without using a servo motor with functional safety."
[Pr. PSA02.3 Operation mode selection]	0: Standard control mode	<input type="radio"/>	<input checked="" type="radio"/>	<input type="radio"/>
	4: Linear servo motor control mode	<input type="radio"/>	—	<input type="radio"/>
	6: Direct drive motor control mode	<input type="radio"/>	—	<input type="radio"/>

○: Available ◎: Available (servo motor with functional safety is required)

[Pr. PSA02.1 Position/Speed monitor setting] and fully closed loop control selection parameters

When [Pr. PA01.4 Fully closed loop operation mode selection] is set to "1 (enabled)", set [Pr. PSA02.1 Position/Speed monitoring setting] to "0" (do not monitor the position/speed).

Parameters related to [Pr. PSA18 SSM speed]

Make the setting value of [Pr. PSA18 SSM speed] greater than that of [Pr. PSA19 SSM hysteresis width].

Parameters related to [Pr. PSA23 Servo motor rated speed]

For [Pr. PSA23 Servo motor rated speed], set the rated speed of the connected servo motor.

Parameters related to [Pr. PSB10 SLT torque upper limit value 1] to [Pr. PSB13 SLT torque upper limit value 4]

Set a larger value than the SLT torque lower limit value to the SLT torque upper limit value.

Function	Setting details
SLT1	[Pr. PSB10 SLT torque upper limit value 1] ≥ [Pr. PSB14 SLT torque lower limit value 1]
SLT2	[Pr. PSB11 SLT torque upper limit value 2] ≥ [Pr. PSB15 SLT torque lower limit value 2]
SLT3	[Pr. PSB12 SLT torque upper limit value 3] ≥ [Pr. PSB16 SLT torque lower limit value 3]
SLT4	[Pr. PSB13 SLT torque upper limit value 4] ≥ [Pr. PSB17 SLT torque lower limit value 4]

7 NETWORK FUNCTION (ETHERNET) [G] [A]

The function explained in this chapter is available for the following servo amplifiers.

- MR-J5-_A(-RJ)
- MR-J5-_G(-RJ)
- MR-J5W_-_G
- MR-J5D_-_G

This is a function that uses an Ethernet communication to access servo amplifiers remotely. The network function of the servo amplifier is as follows.

Function	Description
FTP server function	This function enables file transfer with the servo amplifier. It is available on servo amplifiers with firmware version A5 or later.

Precautions

- To ensure the safety of the system against unauthorized network access, take security measures such as using a firewall.

Communication speed

The factory setting for communication speed may switch depending on the parameter setting value and firmware version. Change the setting as necessary. Details on the communication speed are as follows.

■ Communication speed combinations [G]

[Pr. PN13.0-3 Network protocol setting]	[Pr. NPA12 Communication speed]	Communication speed
0000h (CC-Link IE TSN) (initial value)	2 (initial value)	1 Gbps
0000h (CC-Link IE TSN) (initial value)	1	100 Mbps
0004h (CC-Link IE Field Network Basic) *1	2 (initial value)	100 Mbps
0004h (CC-Link IE Field Network Basic) *1	1	100 Mbps

*1 Available on servo amplifiers with firmware version C0 or later.

■ Communication speed combinations [A]

[Pr. NPA12 Communication speed]	Communication speed	
	Supported firmware version	
	B6 to B9	C0 or later
2 (initial value)	1 Gbps	Automatic (1 Gbps/100 Mbps)
1	100 Mbps	100 Mbps

7.1 IP address setting

Setting an IP address [G]

Refer to "IP address setting function" in the following manual.

📖 MR-J5-G/MR-J5W-G User's Manual (Communication Function)

Setting an IP address [A]

Set an IP address with [Pr. NPA02 IP address]. After setting the parameter, cycle the power to apply the settings. The table shows the initial values.

Network parameter	Initial value
[Pr. NPA02 IP address]	192.168.3.1
[Pr. NPA04 Subnet mask]	255.255.255.0

7.2 Managing accounts

To use the network function, set an account. Accounts can be set with the following network parameters. Up to 8 accounts can be set.

Account	User name	Authorization level	Password
User information No.1	[Pr. NPB04]	[Pr. NPB05]	[Pr. NPB06]
User information No.2	[Pr. NPB07]	[Pr. NPB08]	[Pr. NPB09]
User information No.3	[Pr. NPB10]	[Pr. NPB11]	[Pr. NPB12]
User information No.4	[Pr. NPB13]	[Pr. NPB14]	[Pr. NPB15]
User information No.5	[Pr. NPB16]	[Pr. NPB17]	[Pr. NPB18]
User information No.6	[Pr. NPB19]	[Pr. NPB20]	[Pr. NPB21]
User information No.7	[Pr. NPB22]	[Pr. NPB23]	[Pr. NPB24]
User information No.8	[Pr. NPB25]	[Pr. NPB26]	[Pr. NPB27]

The following account is set from the factory.

Network parameter	Initial value
[Pr. NPB04 User name No.1]	user
[Pr. NPB05 Authorization level No.1]	0000001h
[Pr. NPB06 Password No.1]	user

Setting an account

Set an account with MR Configurator2. Set the user information No. 1 account with [Pr. NPB04 User name No.1], [Pr. NPB05 Authorization level No.1], and [Pr. NPB06 Password No.1].

User name

Set a user name according to the following rule.

Item	Usable character
Number of characters	1 to 32
Type of characters	<ul style="list-style-type: none">• Single-byte letters (lowercase)• Single-byte letters (uppercase)• Single-byte numeric characters

If no name (0 characters) is set in the user name, the account will be disabled, causing the network function to be unavailable.

Authorization level

The authorization level setting can be used to set whether accounts have the authority to use the network function. Set "Permitted" in the authorization level setting to use the desired function. To prevent access to unnecessary functions, it is recommended to set "Prohibited" for them. For details on the authorization level, refer to "User authentication parameters" in the following manual.

 MR-J5-G/MR-J5W-G User's Manual (Parameters)

 MR-J5-A User's Manual (Parameters)

Password

Set a password in the password setting window. Double-clicking the network parameter input field will display the password setting window. Enter the desired password in the password field and password (reentry) field, then click "OK" to set the password.

Set a password according to the following rule.

Item	Usable character
Number of characters	4 to 32
Type of characters	<ul style="list-style-type: none">• Single-byte letters (lowercase)• Single-byte letters (uppercase)• Single-byte numeric characters• Special characters "Special characters" refers to the following characters: `~!@#\$%^&*()_+ - = { } ¥ : " ; ' < > ? , . / []` (additionally, a single-byte space can be used).

Precautions

To prevent unauthorized access, it is recommended to change the default account.

Ensure that no duplicate user names are set among accounts. Accounts with duplicate user names may be unavailable.

To disable the account setting performed via an Ethernet connection, set [Pr. NPB01 User authentication and authorization setting] to "1" (USB only). In the initial setting, the account setting is enabled via USB and Ethernet connection. For details, refer to "User authentication parameters" in the following manuals.

 MR-J5-G/MR-J5W-G User's Manual (Parameters)

 MR-J5-A User's Manual (Parameters)

If the user name or password is forgotten, set it with MR Configurator2 again. When [Pr. NPB01] is set to "1" (USB only), accounts cannot be set via an Ethernet connection. Set accounts via a USB connection.

Resetting network parameters to the factory setting will initialize accounts. Set accounts again.

7.3 FTP server function

FTP (File Transfer Protocol) is a protocol to transfer files between network-connected devices. The FTP server function is supported. Devices with the FTP client function can access files in the servo amplifier via FTP communication. The following shows the port numbers used for the FTP server.

Port No.	Description
20	Data transfer port
21	Control port

Restrictions

Use the FTP server function in an active mode connection. If a firewall is set in the FTP client (such as a personal computer), change the firewall settings to allow FTP (TCP/IP) communications.

Up to one user can access the FTP server of the servo amplifier at the same time. Do not allow multiple users to access the server at the same time.

The file name must meet the following requirements. Only files with a name meeting the requirements can be used.

Item	Requirement	
File name length	1 to 32 characters (including the file extension)	
Usable characters	Single-byte numeric characters	0 to 9
	Single-byte letters (lowercase)	a to z
	Single-byte letters (uppercase)	A to Z
	Single-byte space	" "
	Single-byte hyphen	"-"
	Single-byte period	"."
	Single-byte square bracket	"[", "]"

Precautions

Restrictions are applied to each directory.

 Page 525 Directory structure



If the authorization level is set to "00000000h", the relevant account cannot log into the FTP server. To make the account access the FTP server function, set the authorization level to a value other than "00000000h".

Files and directories can be named only with ASCII characters. Do not transfer files and directories with characters such as UNICODE format characters. Doing so may cause an unexpected operation.

Do not write unrelated files.

Directory structure

The following shows the directories that can be accessed from the FTP client.

[A]	[G]	Directory	Function	Details
<input type="radio"/>	<input type="radio"/>	/fw/	Firmware update	 Page 525 Firmware update
<input type="radio"/>	<input type="radio"/>	/drvrec/	Drive recorder	 Page 304 Drive recorder

fw directory

To allow an account to access the fw directory, set Bit 0 of the relevant authorization level to "1".

The fw directory allows firmware updates of the servo amplifier.

 Page 525 Firmware update

The fw directory only allows file writing. Since the fw directory does not allow file reading, files in the directory do not appear.

drvrec directory

To allow an account to access the drvrec directory, set Bit 2 of the relevant authorization level to "1".

The drvrec directory provides drive recorder data using the FTP server function.

 Page 304 Drive recorder

Files and subdirectories cannot be created in the drvrec directory. Additionally, files in the directory cannot be deleted or changed.

The size of files in the drvrec directory appears as 0 bytes regardless of the actual size.

Steps of accessing the FTP server

1. IP address setting

Set an IP address to connect the servo amplifier to the network.

 Page 521 IP address setting

2. Account setting

Set an account to log into the FTP server of the servo amplifier with MR Configurator2.

 Page 522 Managing accounts

3. Connection

Start the FTP client, then specify the IP address of the servo amplifier for the connection. Using the set account user name and password allows to log into the server.

4. File transfer

Use the FTP client to access the target directory to transfer files.

5. Disconnection

Use the FTP client to disconnect the FTP server.

7.4 Firmware update

The MR-J5 series servo amplifier has a function to update the firmware. This function can update the servo amplifier firmware to the desired version. To update the firmware, a special firmware update tool is required. For information on the firmware update tool and firmware update file, contact your local sales office.

8 NETWORK FUNCTION (SSCNET III/H) [B]

This chapter describes communications with servo amplifiers using SSCNET III/H communication. For items not described in this chapter, refer to each controller manual.

8.1 Functions and configuration

Point

- When high-accuracy synchronization is required, configure a system using the same series of servo amplifiers.

Communication specifications

Item	Description	Remark
SSCNET III/H communication baud rate	150 Mbps	—
Maximum distance between stations	Max. 100 m	—
SSCNET III/H communication cycle	0.222 ms, 0.444 ms, 0.888 ms	The communication cycle depends on the controller specifications and the number of the connected axes.

System configuration

Compatible controller

Point

- Mistakenly connecting a non-compatible controller when connecting to a network for the first time after shipment from the factory may generate [AL. 03E Operation mode error]. Recover the factory setting with "MR Mode Change", use a correct controller, and configure the correct settings before connection.

■ MR-J5-_B_

Controller				Servo amplifier (MR-J5-_B_)
Name		Model	Firmware version *1	Firmware version
MELSEC-Q	Motion CPU	Q17_DS CPU	Available for products with software version 00Y or later.	C4 or later
	Simple motion	QD77MS_	Available for products with serial numbers whose first five digits are 23092 or higher.	C4 or later
MELSEC iQ-R	Motion CPU	R_MTCPU	Available for products with software version 24 or later.	C4 or later
	Simple motion	RD77MS_	Available for products with software version 13 or later.	C4 or later

*1 For how to check the firmware version, refer to each controller manual.

8.2 Application function

Master-slave operation function

Point

- Configure settings so that all the master and slave axes for the same machine are stopped by the controller forced stop when a master or slave axis stops due to an alarm or other reasons. When they are not stopped simultaneously by the controller forced stop, the servo motor may operate unexpectedly and the machine can be damaged.
- All the master and slave axes for the same machine must turn on/off EM1 (Forced stop 1) simultaneously. When EM1 (Forced stop 1) is not turned on/off simultaneously, the servo motor may operate unexpectedly and the machine can be damaged.
- To use the master-slave operation function, configure a system only with the MR-J5-_B_. Combining different series of products such as the MR-J5_-_B_ and MR-J4_-_B_ will cause an error on the controller. For details, refer to each controller manual.
- The master-slave operation function can be used only when the forced stop deceleration function is disabled. When the forced stop deceleration function is enabled, [AL. 037 Parameter error] occurs.
- The master-slave operation function cannot be used with the continuous operation to torque control operation simultaneously.
- For details on the software versions of the controller that are compatible with the master-slave operation function and others, refer to each controller manual.
- When the function is used in a vertical axis system, set the same value to the parameters regarding the dynamic brake and electromagnetic brake to prevent the axes from dropping.
- The servo-on command of the master axis and slave axis must be turned on/off simultaneously. If the servo-on command is turned on only for a slave axis, torque will not be generated. Therefore, an excessive load may be applied to the electromagnetic brake of the master axis when using the function in a vertical axis system.

Outline

The master-slave operation function transmits the torque of the master axis in driver communication, and uses the torque as a command to activate slave axes.

Additional wiring is not required because transmission of data from the master axis to slave axes is performed through SSCNET III/H.

System architecture

Point

- The master axis and slave axes are recommended to be used in a linked condition for the reason of machine components. When they are not linked, the speed may reach a speed limit level, causing [AL. 031 Overspeed].
- Slave axes use the control command from the master axis. Therefore, the controller mainly controls parameter settings, servo-on command, and acquisition of monitor information from a servo amplifier. Commands regarding absolute positioning control, such as setting absolute position detection and requesting home position setting, from the controller to slave axes must not be made.
- Configure the settings so that servo-off will be applied to all the master and slave axes when a master or slave axis stops due to an alarm or other reason.
- When the STO signal of a servo amplifier is used, configure the settings so that the master axis and slave axes will be turned off simultaneously.

The control modes compatible with the master-slave operation function are as follows.

Model *1	Forced stop deceleration function	Semi closed/fully closed	Operation mode	Master axis	Slave axis
MR-J5-_B_	Disabled	Semi closed loop control mode	Standard control mode	○	○
		Fully closed loop control mode	Standard control mode	○	—

*1 Multi-axis servo amplifiers cannot be used. For error details, refer to each controller manual.

Configuring the master-slave operation setting for an axis which is not compatible with the master-slave operation function will generate [AL. 037 Parameter error].

Up to eight master axes can be set per one SSCNET III/H system. Although there is no limit for the number of slave axes for each master axis, the total number of the master and slave axes must be within the maximum number of axes.

In addition, when the SSCNET III/H communication is shut off due to malfunction of a servo amplifier, the communications cannot be performed with malfunctioning axis and following axes. Therefore, when connecting SSCNET III/H cables, connect the master axis at the position which is closest to the controller.

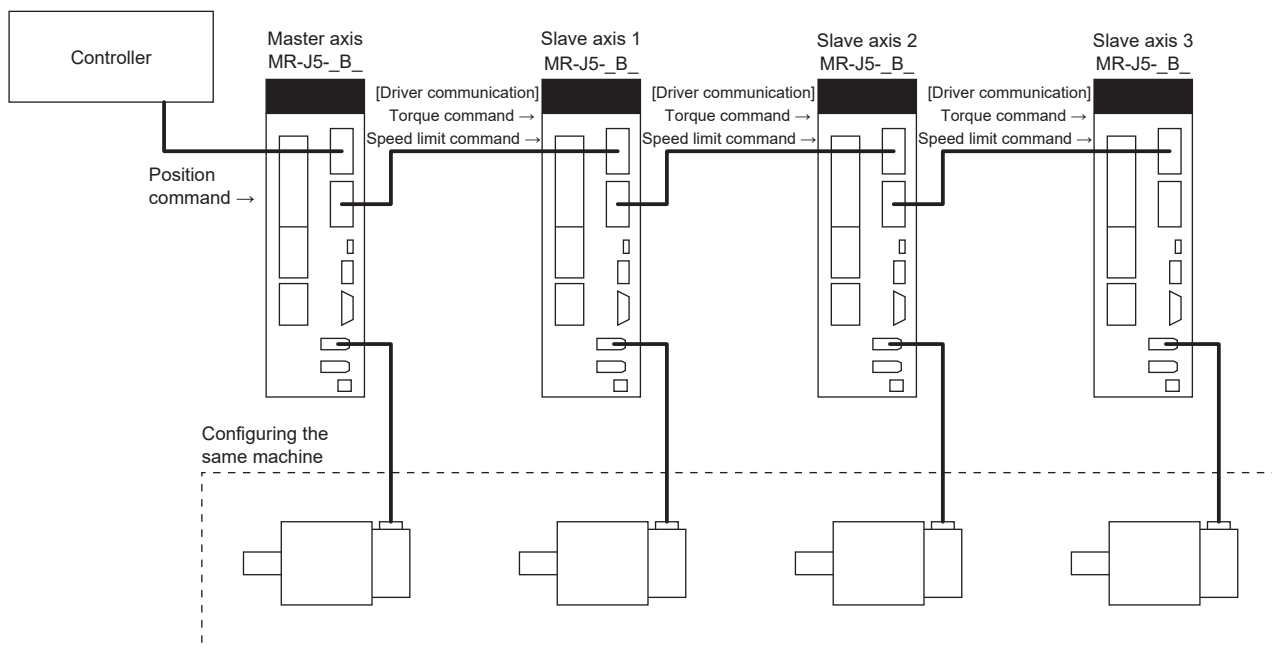

Master-slave control with torque command method

■ Related servo parameter

Set the servo parameters for using the master-slave operation function.

For details, refer to the following manual.

📖 MR-J5-B/MR-J5W-B User's Manual (Parameters)

Servo parameter	Description	Initial value	Setting value		Setting details
			Master axis	Slave axis	
PA04.3	Forced stop deceleration function selection	2	0	0	Used to disable the forced stop deceleration function
PA14	Travel direction selection	0	📖 Page 530 Travel direction setting		Used to set a torque generation direction
PD15.0 *1	Master axis operation selection	0	1	0	Master-slave setting
PD15.1 *1	Slave axis operation selection	0	0	1	
PD16 *1	Driver communication setting - Master - Transmit data selection 1	00000000	00000038	00000000	Communication data from master to slave • Torque command • Speed limit value
PD17 *1	Driver communication setting - Master - Transmit data selection 2	00000000	0000003A	00000000	
PD20 *1	Driver communication setting - Slave - Master axis No. selection 1	0	0	0 to 32	Master axis number for transmitting data
PD30	Master-slave operation - Slave-side torque command coefficient	0	0	0 to 500	Ratio of torque command of slave axis, ratio of speed limit value, and setting of speed limit minimum value
PD31	Master-slave operation - Slave-side speed limit coefficient	0	0	0 to 500	
PD32	Master-slave operation - Slave-side speed limit adjusted value	0	0	0 to 32767	

*1 Set the servo parameters using the controller. If incorrect settings are configured, the SSCNET III/H communication may not be performed properly.

Travel direction setting

Travel directions of the mechanical system may differ among a controller command, master axis, and slave axes. Set the travel direction with [Pr. PA14 Travel direction selection] to align the directions that the mechanical system travels along. Failure to configure settings in accordance with the procedure may cause overload or other problems as the servo motor generates a reverse direction torque against the direction that the mechanical system moves in.

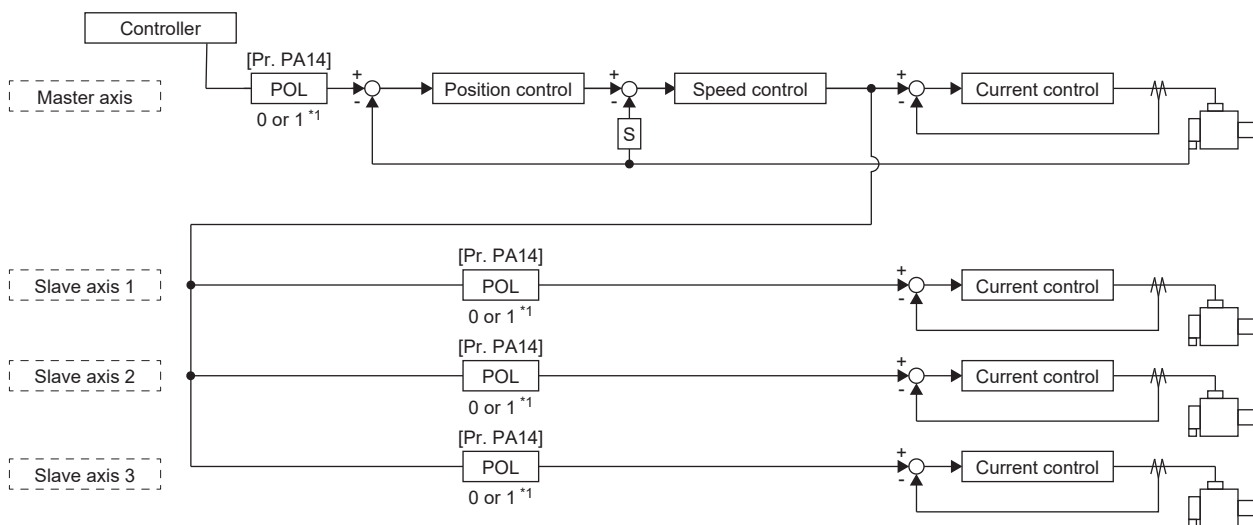

*1 Setting "1" will reverse the polarity.

Servo parameter	Symbol	Name and function
PA14	*POL	<p>Travel direction selection</p> <ul style="list-style-type: none"> For master axis <p>Select a servo motor rotation direction of the master axis for the controller command.</p> <p>0: Servo motor CCW rotation in the positioning address increasing direction 1: Servo motor CW rotation in the positioning address increasing direction</p> <hr/> <ul style="list-style-type: none"> For slave axis <p>Select a servo motor rotation direction of a slave axis for the command from the master axis.</p> <p>0: The torque command polarity from the master axis is used as is. 1: Reverses the torque command polarity from the master axis.</p>

The following shows an example of setting the travel direction of a platform truck with one master axis and three slave axes. To set the servo motor rotation direction in accordance with the moving direction, the torque command polarity for slave axis 1 should be the same as that of the master axis and the polarity of slave axes 2 and 3 should be reversed from the master axis.

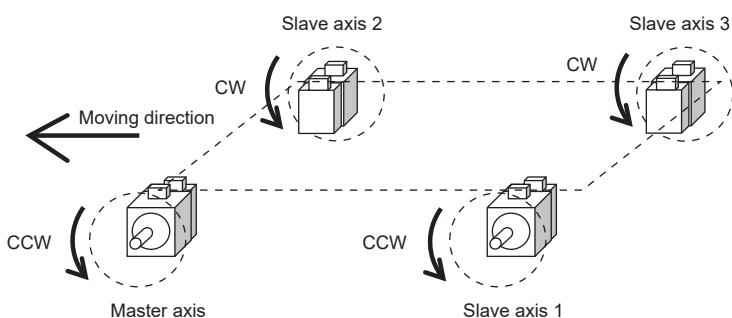

Axis	[Pr. PA14]
Master axis	0
Slave axis 1	0
Slave axis 2	1
Slave axis 3	1

9 COMMUNICATION FUNCTION (MITSUBISHI ELECTRIC AC SERVO PROTOCOL) [A]

This function is available on servo amplifiers with firmware version B6 or later.

MR-J5-A_ can use the RS-422/RS-485 (1:n communication with up to 32 axes) serial communication function (Mitsubishi Electric AC servo protocol) for operations such as operating servos, changing servo parameters, and using the monitoring function.

9.1 Structure

System architecture

Diagrammatic sketch

Up to 32 axes of servo amplifiers (stations 0 to 31) can be operated and controlled on the same bus.

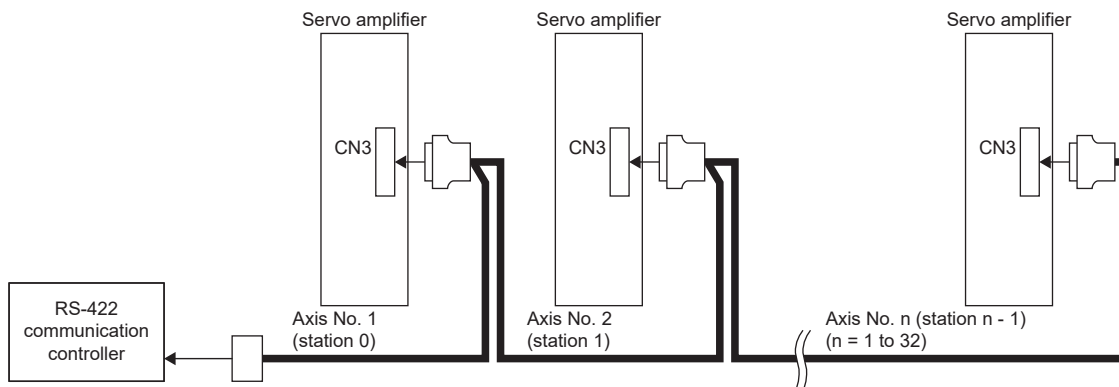

Wiring diagram

■ Half-duplex wiring

- Half-duplex wiring

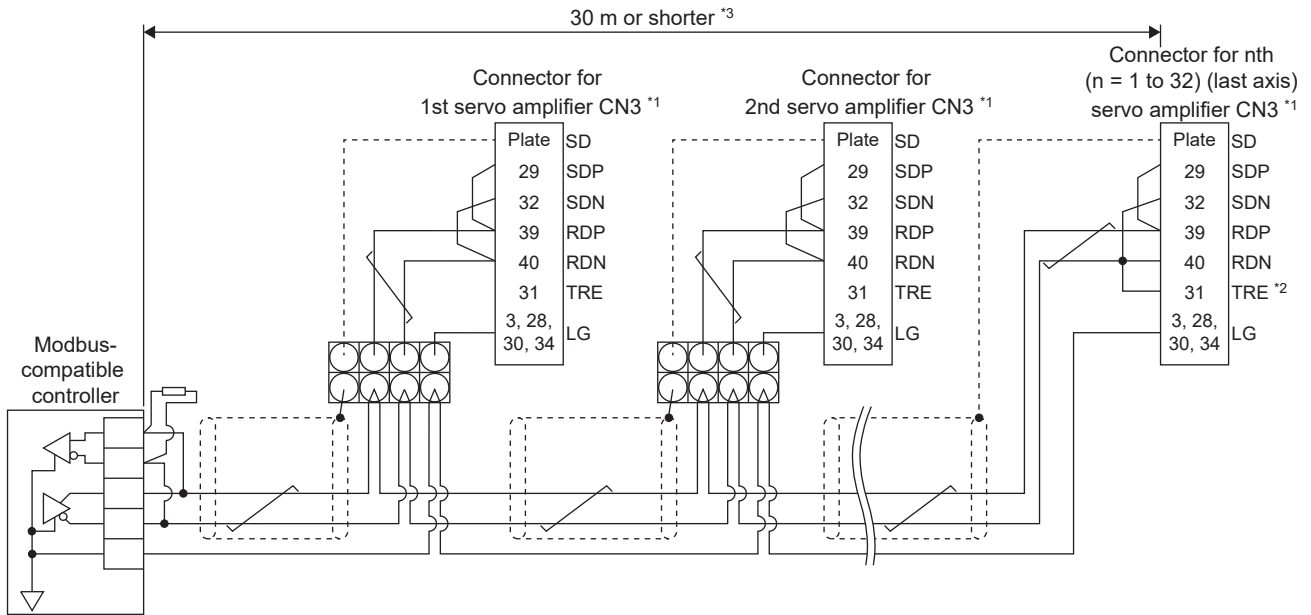

*1 Connector set MR-J3CN1 (3M or equivalent)
 Connector: 10150-3000PE
 Shell kit: 10350-52F0-008

*2 Connect between TRE and RDN of the final axis servo amplifier.

*3 The overall length is 30 m or less in low-noise environment.

*4 If the RS-422 compatible controller does not have a termination resistor, terminate it with a 150 Ω resistor.

■ Full-duplex wiring

- Full-duplex wiring

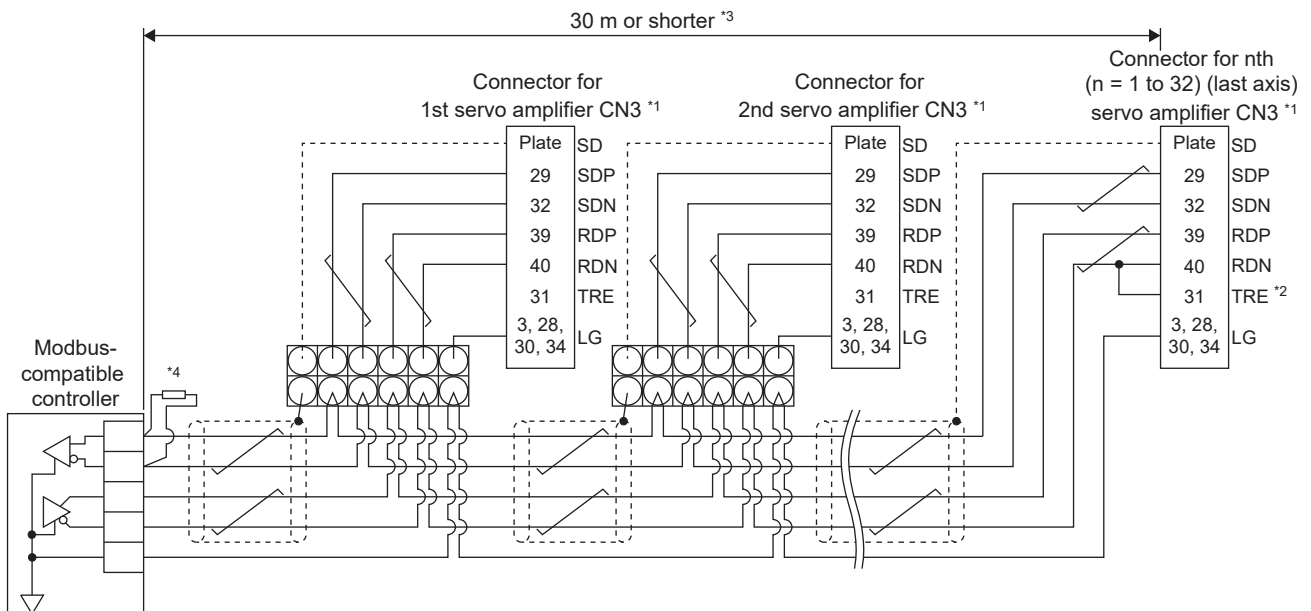

*1 Connector set MR-J3CN1 (3M or equivalent)
 Connector: 10150-3000PE
 Shell kit: 10350-52F0-008

*2 Connect between TRE and RDN of the final axis servo amplifier.

*3 The overall length is 30 m or less in low-noise environment.

*4 If the RS-422 compatible controller does not have a termination resistor, terminate it with a 150 Ω resistor.

Precautions for using the RS-422/USB communication function

Note the following to prevent an electric shock or malfunction of the servo amplifier.

Connecting the power of a personal computer

Connect the power of a personal computer with the following procedure.

■ When using a personal computer with an AC power supply

- When using a personal computer with a three-core power plug or a power plug with a grounding wire, use a three-pin socket or ground the grounding wire.
 - When using a personal computer that has a two-core power plug and has no grounding wire, connect the personal computer to the servo amplifier with the following procedure.
1. Disconnect the power plug of the personal computer from the AC power socket.
 2. Check that the power plug of the personal computer has been disconnected from the AC power socket, then connect the computer to the servo amplifier.
 3. Connect the power plug of the personal computer to the AC power socket.

■ When using a personal computer with battery

The computer can be used as it is.

Connection with other devices using servo amplifier communication function

When the servo amplifier is charged with electricity due to connection with a personal computer and the charged servo amplifier is connected with other devices, the servo amplifier or the connected devices may malfunction. Connect the servo amplifier and other devices with the following procedure.

1. Shut off the power of the device to be connected with the servo amplifier.
2. Shut off the power of the servo amplifier that was connected with the personal computer, and check that the charge light is off.
3. Connect the device with the servo amplifier.
4. Turn on the power of the servo amplifier and the connected device.

9.2 Communication specifications

Outline of communication specifications

The servo amplifier returns data upon receipt of a command. The device that gives the command (such as a personal computer) is a master station, and the device (servo amplifier) that returns data in response to the command is a slave station. When fetching data successively, give commands to the slave station from the master station repeatedly so that the slave station sends data.

Item	Description	
Baud rate [bps]	9600/19200/38400/57600/115200 asynchronous system	
Transfer code	Start bit Data bit Parity bit Stop bit	1 bit 8 bits 1 bit (even number) 1 bit
Transfer method	Character method	Half-duplex communication method

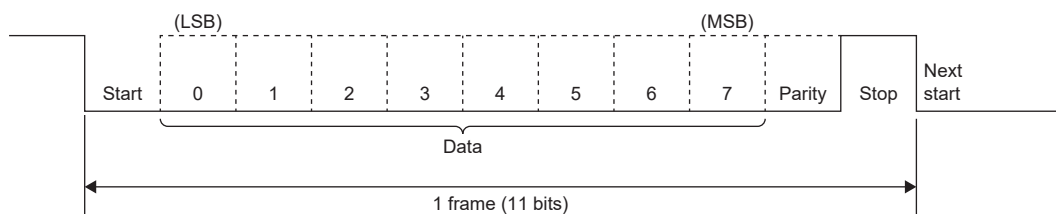

Setting servo parameters

When the RS-422 communication function is used to operate the servo, set the communication specifications of the servo amplifier with servo parameters.

The settings of the servo parameters are enabled after the power is cycled.

Serial communication baud rate

Select a communication speed with [Pr. PC21.1 RS-422 communication - Baud rate selection]. Match this value to the communication speed of the sending side (master station).

Servo parameter	Description
PC21.1	RS-422 communication - Baud rate selection 0: 9600 [bps] (initial value) 1: 19200 [bps] 2: 38400 [bps] 3: 57600 [bps] 4: 115200 [bps]

RS-422 communication response delay time

Set the time from when the servo amplifier (slave station) receives communication data until when it returns data. Setting [Pr. PC21.2 RS-422 communication - Response delay time selection] to "1" (enabled) will return data in 800 μ s or longer.

Servo parameter	Description
PC21.2	RS-422 communication - Response delay time selection 0: Disabled (initial value) 1: Enabled Setting "1" will return data with a delay of 800 μ s or longer.

Setting station numbers

Set the station No. of the servo amplifier in [Pr. PC20 Station No. setting]. The setting range is 0 to 31.

9.3 Protocol

Transmission data configuration

Up to 32 axes can be connected to the bus. Therefore, to determine the destination servo amplifier of data communication, a station No. is added to the command, data No., etc. Set one station number to one servo amplifier using servo parameters. Transmission data is enabled for the servo amplifier of the specified station No.

When "*" is set as the station No. to be added to the transmission data, the transmission data is enabled for all servo amplifiers being connected. However, when return data is required from the servo amplifier in response to the transmission data, set "0" as the station No. of the servo amplifier which must provide the return data.

Transmission of data from the controller to the servo

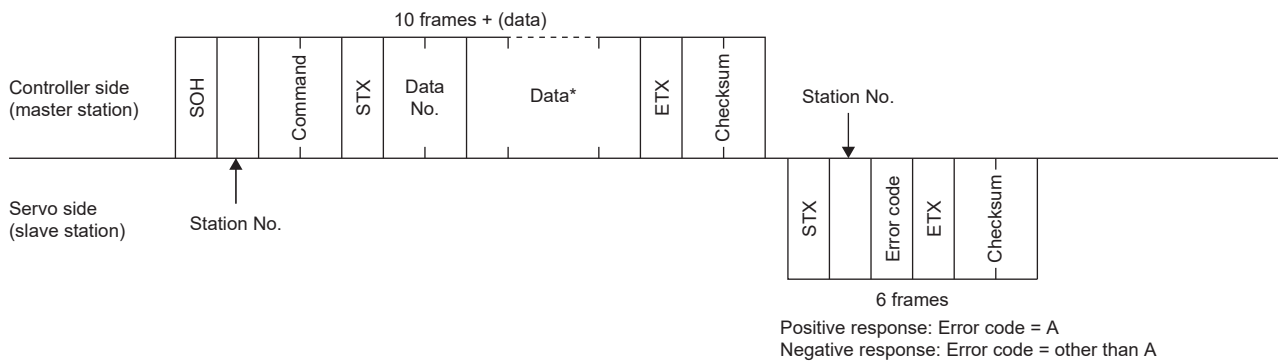

Transmission of data request from the controller to the servo

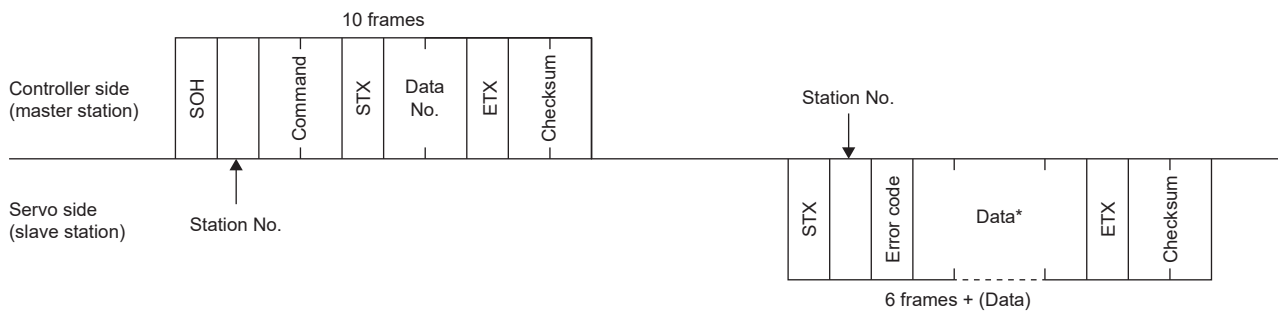

Recovery of communication status by time-out

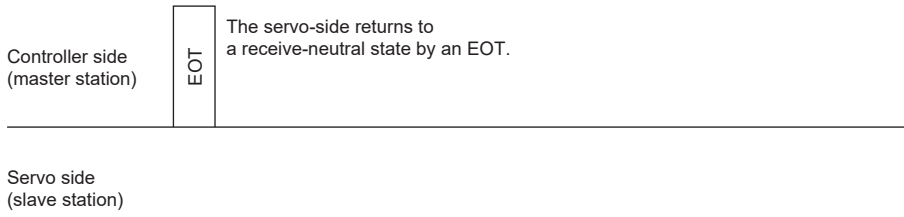

Data frames

The data length varies depending on the command.

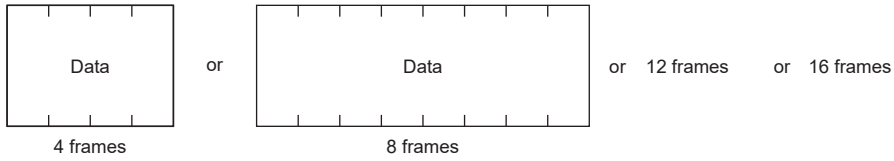

Character codes

Control codes

Code name	Hexadecimal (ASCII code)	Description	Personal computer terminal key operation (general)
SOH	01H	start of head	ctrl + A
STX	02H	start of text	ctrl + B
ETX	03H	end of text	ctrl + C
EOT	04H	end of transmission	ctrl + D

Codes for data

Use ASCII codes.

b8	0	0	0	0	0	0	0	0	0
b7	0	0	0	0	1	1	1	1	1
b6	0	0	1	1	0	0	1	1	1
b5	0	1	0	1	0	1	0	1	1

b8 to b5	b4	b3	b2	b1	R \ C	0	1	2	3	4	5	6	7
	0	0	0	0	0	NUL	DLE	Space	@	P	`	p	
	0	0	0	1	1	SOH	DC ₁	!	1	A	Q	a	q
	0	0	1	0	2	STX	DC ₂	"	2	B	R	b	r
	0	0	1	1	3	ETX	DC ₃	#	3	C	S	c	s
	0	1	0	0	4			\$	4	D	T	d	t
	0	1	0	1	5			%	5	E	U	e	u
	0	1	1	0	6			&	6	F	V	f	v
	0	1	1	1	7			'	7	G	W	g	w
	1	0	0	0	8			(8	H	X	h	x
	1	0	0	1	9)	9	I	Y	i	y
	1	0	1	0	10			*	:	J	Z	j	z
	1	0	1	1	11			+	;	K	[k	{
	1	1	0	0	12			,	<	L	¥	l	
	1	1	0	1	13			-	=	M]	m	}
	1	1	1	0	14			.	>	N	^	n	~
	1	1	1	1	15			/	?	O	_	o	DEL

Station numbers

The station numbers are from 0 to 31 (32 stations) and ASCII codes are used to specify stations.

Station No.	0	1	2	3	4	5	6	7	8	9	10	11	12	13	14	15
ASCII code	0	1	2	3	4	5	6	7	8	9	A	B	C	D	E	F
Station No.	16	17	18	19	20	21	22	23	24	25	26	27	28	29	30	31
ASCII code	G	H	I	J	K	L	M	N	O	P	Q	R	S	T	U	V

For example, transmit "30H" in hexadecimal for station No. "0" (axis 1).

Error codes

Error codes are used in the following cases and an error code of single-code length is transmitted.

Once the data from the master station is received, the slave station sends the corresponding error code to the master station. An error code sent in upper case indicates that the servo is in a normal state, and one in lower case indicates that an alarm has occurred on the servo.

Error code		Error name	Explanation	Remark
In normal state	At alarm occurrence			
[A]	[a]	Normal	Transmitted data was processed normally.	Positive response
[B]	[b]	Parity error	A parity error occurred in the transmitted data.	Negative response
[C]	[c]	Checksum error	A checksum error occurred in the transmitted data.	
[D]	[d]	Character error	An unsupported character was transmitted.	
[E]	[e]	Command error	An unsupported command was transmitted.	
[F]	[f]	Data No. error	An unsupported data No. was transmitted.	

Checksum

The checksum is an ASCII-coded hexadecimal representing the last two digits of the sum of ASCII-coded hexadecimal numbers up to ETX, with the exception of the first control code (STX or SOH).

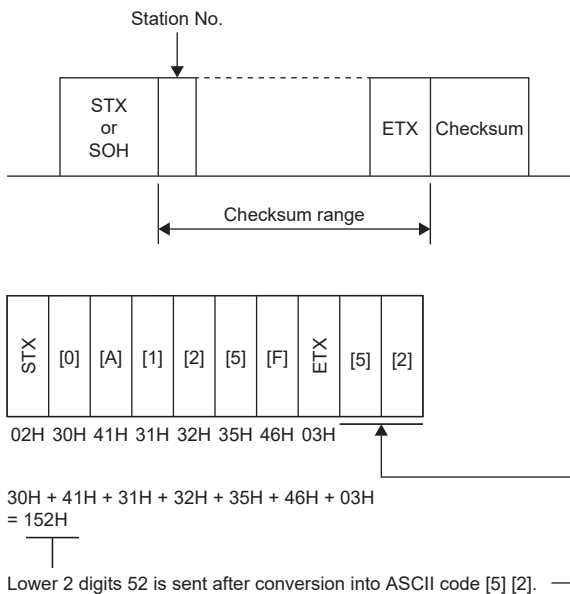

Time-out processing

The master station transmits EOT when the slave station does not start a return processing (STX is not received) in 300 ms after the master station ended communication processing. Then, the master station retransmits the message in 100 ms. Time-out occurs if the slave station does not answer after the master station has performed the above communication processing three times. (communication error)

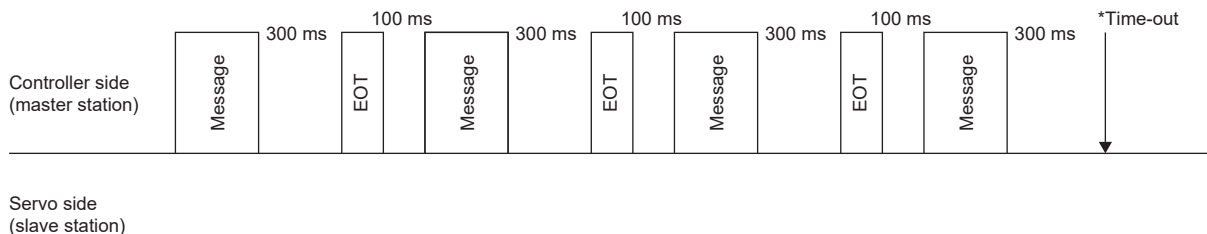

Retry processing

When a fault occurs in communication between the master and slave stations, the error code in the response data from the slave station is a negative response code ([B] to [F], [b] to [f]). In this case, the master station retransmits the message which was sent at the occurrence of the fault (retry processing). A communication error occurs if the above processing is repeated and results in the error three or more consecutive times.

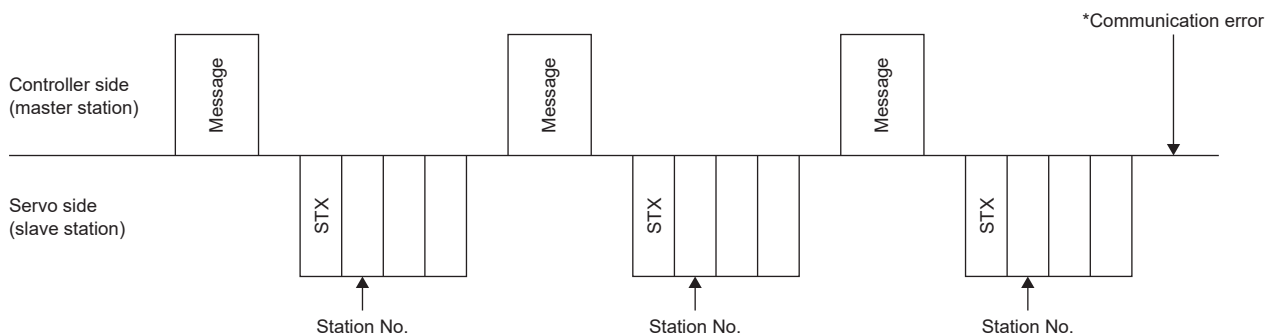

Similarly, when the master station detects a fault (e.g. checksum, parity) in the response data from the slave station, the master station retransmits the message which was sent at the occurrence of the fault. A communication error occurs if the retry processing is performed three times.

Initialization

After the slave station is switched on, it cannot return to communication until the internal initialization processing terminates. Therefore, at power-on, start ordinary communication after doing the following:

- Wait for 3.5 s or longer after the slave station is switched on.
- Check that normal communication can be made by reading servo parameters or other data which does not pose any safety problems.

Communication procedure example

The following example reads the set value of alarm history (last alarm) from the servo amplifier of station 0.

Data item	Value	Description
Station No.	0	Servo amplifier station No. 0
Command	33	Reading command
Data No.	10	Alarm history (last alarm)

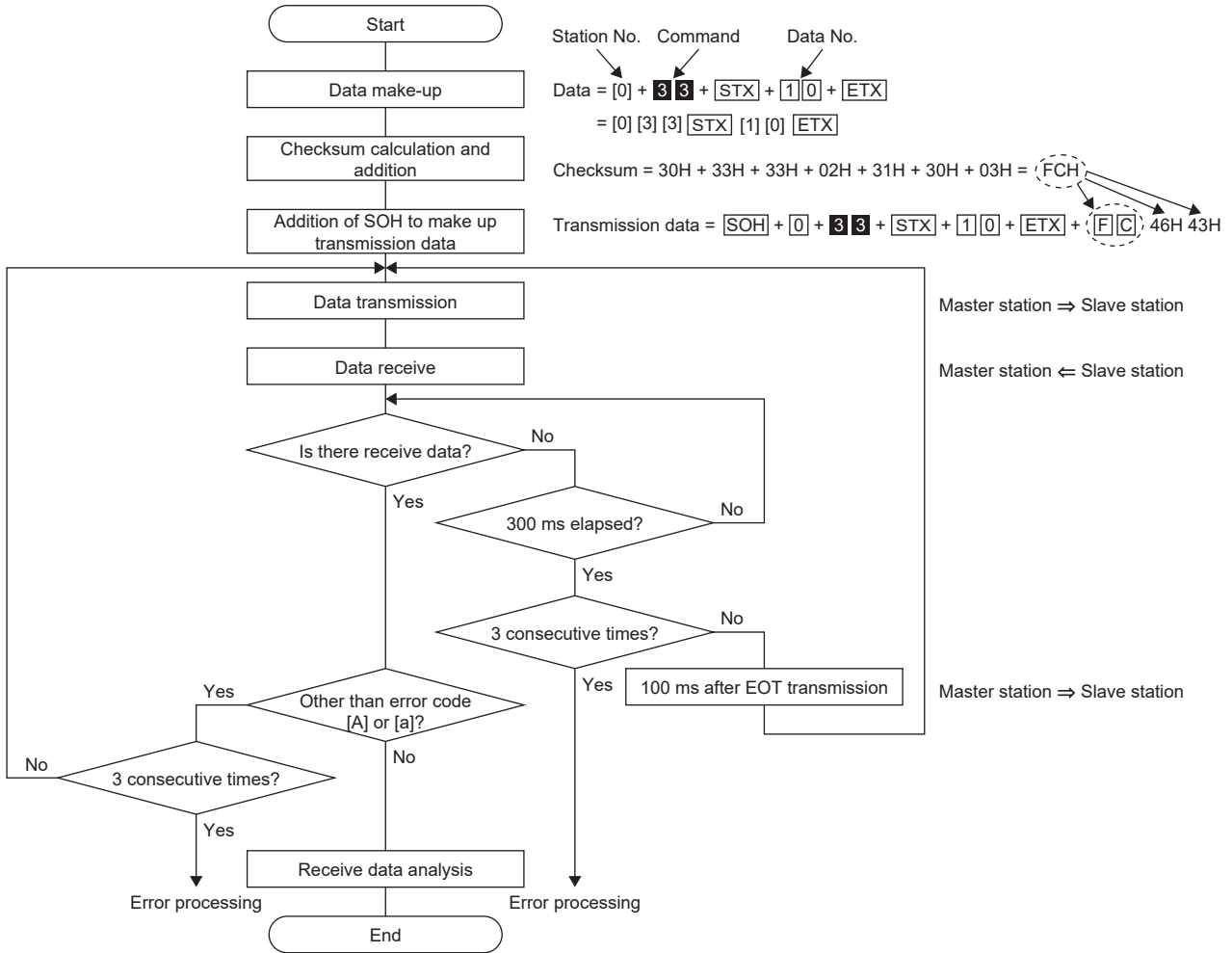

9.4 Command and data No. list

The following lists commands. Even if a command or data No. is the same between different models, its description may differ.

Reading command

Status display (command [0] [1])

Command	Data No.	Description	Status display	Frame length
[0] [1]	[0] [0]	Status display symbol and unit	Cumulative feedback pulses	16
	[0] [1]		Servo motor speed ^{**2}	
	[0] [2]		Droop pulses	
	[0] [3]		Cumulative command pulses	
	[0] [4]		Command pulse frequency (speed unit)	
	[0] [5]		Analog speed command voltage/Analog speed limit voltage	
	[0] [6]		Analog torque command voltage/Analog torque limit voltage	
	[0] [7]		Regenerative load ratio	
	[0] [8]		Effective load ratio	
	[0] [9]		Peak load ratio	
	[0] [A]		Instantaneous torque	
	[0] [B]		Position within one-revolution	
	[0] [C]		ABS counter	
	[0] [D]		Load to motor inertia ratio	
	[0] [E]		Bus voltage	
	[0] [F]		Load-side encoder cumulative feedback pulses	
	[1] [0]		Load-side encoder droop pulses	
	[1] [1]		Load-side encoder information 1	
	[1] [2]		Load-side encoder information 2	
	[1] [6]		Temperature of servo motor thermistor	
	[1] [7]		Cumulative feedback pulses (servo motor unit)	
	[1] [8]		Electrical angle	
	[1] [E]		Motor/load side position deviation	
	[1] [F]		Motor/load side speed deviation	
	[2] [0]		Internal temperature of encoder	
	[2] [1]		Settling time	
	[2] [2]		Oscillation detection frequency	
	[2] [3]		Number of tough drive operations	
	[2] [8]		Unit power consumption	
	[2] [9]		Unit total power consumption	

*1 When [Pr. PC29.4 Speed monitor unit selection] is set to "0", the decimal point position of read data becomes "0".

*2 When [Pr. PC29.4 Speed monitor unit selection] is set to "1", the decimal point position of read data becomes "2".

Command	Data No.	Description	Status display	Frame length
[0] [1]	[8] [0]	Status display data value and processing information	Cumulative feedback pulses	12
	[8] [1]		Servo motor speed *1*2	
	[8] [2]		Droop pulses	
	[8] [3]		Cumulative command pulses	
	[8] [4]		Command pulse frequency (speed unit)	
	[8] [5]		Analog speed command voltage/Analog speed limit voltage	
	[8] [6]		Analog torque command voltage/Analog torque limit voltage	
	[8] [7]		Regenerative load ratio	
	[8] [8]		Effective load ratio	
	[8] [9]		Peak load ratio	
	[8] [A]		Instantaneous torque	
	[8] [B]		Position within one-revolution	
	[8] [C]		ABS counter	
	[8] [D]		Load to motor inertia ratio	
	[8] [E]		Bus voltage	
	[8] [F]		Load-side encoder cumulative feedback pulses	
	[9] [0]		Load-side encoder droop pulses	
	[9] [1]		Load-side encoder information 1	
	[9] [2]		Load-side encoder information 2	
	[9] [6]		Temperature of servo motor thermistor	
	[9] [7]		Cumulative feedback pulses (servo motor unit)	
	[9] [8]		Electrical angle	
	[9] [E]		Motor/load side position deviation	
	[9] [F]		Motor/load side speed deviation	
	[A] [0]		Internal temperature of encoder	
	[A] [1]		Settling time	
	[A] [2]		Oscillation detection frequency	
	[A] [3]		Number of tough drive operations	
	[A] [8]		Unit power consumption	
	[A] [9]		Unit total power consumption	

*1 When [Pr. PC29.4 Speed monitor unit selection] is set to "0", the decimal point position of read data becomes "0".

*2 When [Pr. PC29.4 Speed monitor unit selection] is set to "1", the decimal point position of read data becomes "2".

Servo parameters (commands [0] [4]/[1] [5]/[1] [6]/[1] [7]/[0] [8]/[0] [9])

Command	Data No.	Description	Frame length
[0] [4]	[0] [1]	Reading a servo parameter group 0000: Basic setting servo parameters ([Pr. PA_ _]) 0001: Gain/filter servo parameters ([Pr. PB_ _]) 0002: Extension setting servo parameters ([Pr. PC_ _]) 0003: I/O setting servo parameters ([Pr. PD_ _]) 0004: Extension setting 2 servo parameters ([Pr. PE_ _]) 0005: Extension setting 3 servo parameters ([Pr. PF_ _]) 000B: Motor extension setting servo parameters ([Pr. PL_ _])	4
[1] [5]	[0] [1] to [F] [F]	Current values of servo parameters The current values of the parameters in the servo parameter group specified with the command [8] [5] + data No. [0] [0] can be read. Always specify a servo parameter group with the command [8] [5] + data No. [0] [0] before reading the current values. The decimal converted from the data No. value (hexadecimal) corresponds to the servo parameter No.	12
[1] [6]	[0] [1] to [F] [F]	Upper limit value of each servo parameter setting range The permissible upper limit values of the parameters in the servo parameter group specified with the command [8] [5] + data No. [0] [0] can be read. Always specify a servo parameter group with the command [8] [5] + data No. [0] [0] before reading the upper limit values. The decimal converted from the data No. value (hexadecimal) corresponds to the servo parameter No.	12
[1] [7]	[0] [1] to [F] [F]	Lower limit value of each servo parameter setting range The permissible lower limit values of the parameters in the servo parameter group specified with the command [8] [5] + data No. [0] [0] can be read. Always specify a servo parameter group with the command [8] [5] + data No. [0] [0] before reading the lower limit values. The decimal converted from the data No. value (hexadecimal) corresponds to the servo parameter No.	12
[0] [8]	[0] [1] to [F] [F]	Servo parameter symbols The symbol of the parameters in the servo parameter group specified with the command [8] [5] + data No. [0] [0] can be read. Always specify a servo parameter group with the command [8] [5] + data No. [0] [0] before reading the symbol. The decimal converted from the data No. value (hexadecimal) corresponds to the servo parameter No.	12
[0] [9]	[0] [1] to [F] [F]	Servo parameters writable/not writable Whether the parameters in the servo parameter group specified with the command [8] [5] + data No. [0] [0] are writable can be read. Always specify a servo parameter group with the command [8] [5] + data No. [0] [0] before reading whether the parameters are writable. 0000: Writable 0001: Not writable	4

External I/O signals (command [1] [2])

Command	Data No.	Description	Frame length
[1] [2]	[0] [0]	Input device status	8
	[4] [0]	External input pin status	
	[6] [0]	Status of input devices switched on via communication	
	[8] [0]	Output device status	
	[C] [0]	External output pin status	

Alarm history (command [3] [3])

Command	Data No.	Description	Order of alarm occurrence	Frame length
[3] [3]	[1] [0]	Alarm No. in alarm history	Last alarm	4
	[1] [1]		Second last alarm	
	[1] [2]		Third last alarm	
	[1] [3]		Fourth last alarm	
	[1] [4]		Fifth last alarm	
	[1] [5]		Sixth last alarm	
	[1] [6]		Seventh last alarm	
	[1] [7]		Eighth last alarm	
	[1] [8]		Ninth last alarm	
	[1] [9]		Tenth last alarm	
	[1] [A]		Eleventh last alarm	
	[1] [B]		Twelfth last alarm	
	[1] [C]		Thirteenth last alarm	
	[1] [D]		Fourteenth last alarm	
	[1] [E]		Fifteenth last alarm	
	[1] [F]		Sixteenth last alarm	
	[3] [3]		[2] [0]	
[2] [1]		Second last alarm		
[2] [2]		Third last alarm		
[2] [3]		Fourth last alarm		
[2] [4]		Fifth last alarm		
[2] [5]		Sixth last alarm		
[2] [6]		Seventh last alarm		
[2] [7]		Eighth last alarm		
[2] [8]		Ninth last alarm		
[2] [9]		Tenth last alarm		
[2] [A]		Eleventh last alarm		
[2] [B]		Twelfth last alarm		
[2] [C]		Thirteenth last alarm		
[2] [D]		Fourteenth last alarm		
[2] [E]		Fifteenth last alarm		
[2] [F]		Sixteenth last alarm		
[3] [3]		[4] [0]	Alarm detail No. in alarm history	Last alarm detail No.
	[4] [1]	Second last alarm detail No.		
	[4] [2]	Third last alarm detail No.		
	[4] [3]	Fourth last alarm detail No.		
	[4] [4]	Fifth last alarm detail No.		
	[4] [5]	Sixth last alarm detail No.		
	[4] [6]	Seventh last alarm detail No.		
	[4] [7]	Eighth last alarm detail No.		
	[4] [8]	Ninth last alarm detail No.		
	[4] [9]	Tenth last alarm detail No.		
	[4] [A]	Eleventh last alarm detail No.		
	[4] [B]	Twelfth last alarm detail No.		
	[4] [C]	Thirteenth last alarm detail No.		
	[4] [D]	Fourteenth last alarm detail No.		
	[4] [E]	Fifteenth last alarm detail No.		
	[4] [F]	Sixteenth last alarm detail No.		

Current alarm (command [0] [2])

Command	Data No.	Description	Frame length
[0] [2]	[0] [0]	Current alarm No. The J5 series displays alarm numbers in three digits. [AL. 030] appears as 0030h. [AL. 130] appears as 0130h.	4
	[0] [3]	Current alarm No. and detail No.	8

Status display at alarm occurrence (command [3] [5])

Command	Data No.	Description	Status display	Frame length
[3] [5]	[0] [0]	Status display symbol and unit	Cumulative feedback pulses	16
	[0] [1]		Servo motor speed ^{*1} *2	
	[0] [2]		Droop pulses	
	[0] [3]		Cumulative command pulses	
	[0] [4]		Command pulse frequency (speed unit)	
	[0] [5]		Analog speed command voltage/Analog speed limit voltage	
	[0] [6]		Analog torque command voltage/Analog torque limit voltage	
	[0] [7]		Regenerative load ratio	
	[0] [8]		Effective load ratio	
	[0] [9]		Peak load ratio	
	[0] [A]		Instantaneous torque	
	[0] [B]		Position within one-revolution	
	[0] [C]		ABS counter	
	[0] [D]		Load to motor inertia ratio	
	[0] [E]		Bus voltage	
	[0] [F]		Load-side encoder cumulative feedback pulses	
	[1] [0]		Load-side encoder droop pulses	
	[1] [1]		Load-side encoder information 1	
	[1] [2]		Load-side encoder information 2	
	[1] [6]		Temperature of servo motor thermistor	
	[1] [7]		Cumulative feedback pulses (servo motor unit)	
	[1] [8]		Electrical angle	
	[1] [E]		Motor/load side position deviation	
	[1] [F]		Motor/load side speed deviation	
	[2] [0]		Internal temperature of encoder	
	[2] [1]		Settling time	
	[2] [2]		Oscillation detection frequency	
	[2] [3]		Number of tough drive operations	
	[2] [8]		Unit power consumption	
	[2] [9]		Unit total power consumption	

*1 When [Pr. PC29.4 Speed monitor unit selection] is set to "0", the decimal point position of read data becomes "0".

*2 When [Pr. PC29.4 Speed monitor unit selection] is set to "1", the decimal point position of read data becomes "2".

Command	Data No.	Description	Status display	Frame length
[3] [5]	[8] [0]	Status display data value and processing information	Cumulative feedback pulses	12
	[8] [1]		Servo motor speed ^{**2}	
	[8] [2]		Droop pulses	
	[8] [3]		Cumulative command pulses	
	[8] [4]		Command pulse frequency (speed unit)	
	[8] [5]		Analog speed command voltage/Analog speed limit voltage	
	[8] [6]		Analog torque command voltage/Analog torque limit voltage	
	[8] [7]		Regenerative load ratio	
	[8] [8]		Effective load ratio	
	[8] [9]		Peak load ratio	
	[8] [A]		Instantaneous torque	
	[8] [B]		Position within one-revolution	
	[8] [C]		ABS counter	
	[8] [D]		Load to motor inertia ratio	
	[8] [E]		Bus voltage	
	[8] [F]		Load-side encoder cumulative feedback pulses	
	[9] [0]		Load-side encoder droop pulses	
	[9] [1]		Load-side encoder information 1	
	[9] [2]		Load-side encoder information 2	
	[9] [6]		Temperature of servo motor thermistor	
	[9] [7]		Cumulative feedback pulses (servo motor unit)	
	[9] [8]		Electrical angle	
	[9] [E]		Motor/load side position deviation	
	[9] [F]		Motor/load side speed deviation	
	[A] [0]		Internal temperature of encoder	
	[A] [1]		Settling time	
	[A] [2]		Oscillation detection frequency	
	[A] [3]		Number of tough drive operations	
	[A] [8]		Unit power consumption	
	[A] [9]		Unit total power consumption	

*1 When [Pr. PC29.4 Speed monitor unit selection] is set to "0", the decimal point position of read data becomes "0".

*2 When [Pr. PC29.4 Speed monitor unit selection] is set to "1", the decimal point position of read data becomes "2".

Test operation mode (command [0] [0])

Command	Data No.	Description	Frame length
[0] [0]	[1] [2]	Reading the test operation mode 0000: Normal mode (not test operation mode) 0001: JOG operation 0002: Positioning operation 0004: Output signal (DO) forced output	4

Firmware version (command [0] [2])

Command	Data No.	Description	Frame length
[0] [2]	[7] [0]	Firmware version	16

Absolute position (command [0] [2])

Command	Data No.	Description	Frame length
[0] [2]	[9] [0]	Absolute position in units of servo motor-side pulses	8
	[9] [1]	Absolute position in the command unit	8

Writing commands

Status display (command [8] [1])

Command	Data No.	Description	Setting range	Frame length
[8] [1]	[0] [0]	Deleting status display data	1EA5	4

Servo parameters (commands [9] [4]/[8] [5])

Command	Data No.	Description	Setting range	Frame length
[9] [4]	[0] [1] to [F] [F]	Writing servo parameters The values of the parameters in the servo parameter group specified with the command [8] [5] + data No. [0] [0] can be written. Always specify a servo parameter group with the command [8] [5] + data No. [0] [0] before writing the values. The decimal converted from the data No. value (hexadecimal) corresponds to the servo parameter No.	Differs depending on the servo parameter.	12
[8] [5]	[0] [0]	Writing a servo parameter group 0000: Basic setting servo parameters ([Pr. PA_ _ _]) 0001: Gain/filter servo parameters ([Pr. PB_ _ _]) 0002: Extension setting servo parameters ([Pr. PC_ _ _]) 0003: I/O setting servo parameters ([Pr. PD_ _ _]) 0004: Extension setting 2 servo parameters ([Pr. PE_ _ _]) 0005: Extension setting 3 servo parameters ([Pr. PF_ _ _]) 000B: Motor extension setting servo parameters ([Pr. PL_ _ _])	0000 to 0005, 000B	4

External I/O signals (command [9] [2])

Command	Data No.	Description	Setting range	Frame length
[9] [2]	[6] [0]	Communication input device signal	☞ Page 558 Input device on/off	8

Alarm history (command [8] [2])

Command	Data No.	Description	Setting range	Frame length
[8] [2]	[2] [0]	Alarm history clear	1EA5	4

Current alarm (command [8] [2])

Command	Data No.	Description	Setting range	Frame length
[8] [2]	[0] [0]	Alarm clear	1EA5	4

I/O device prohibition (command [9] [0])

Command	Data No.	Description	Setting range	Frame length
[9] [0]	[0] [0]	Turns off the input device, external analog input signal, and pulse train input, except EM2, LSP and LSN, independently of the external on/off status.	1EA5	4
	[0] [3]	Disables all output devices (DO).	1EA5	4
	[1] [0]	Cancels the prohibition of the input device, external analog input signal and pulse train input, except EM2, LSP and LSN.	1EA5	4
	[1] [3]	Cancels the prohibition of the output device.	1EA5	4

Test operation mode (commands [8] [B]/[9] [2]/[A] [0])

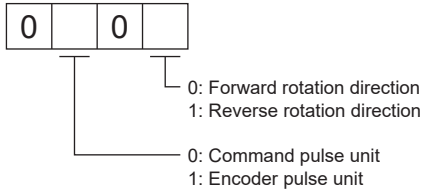
Command	Data No.	Description	Setting range	Frame length
[8] [B]	[0] [0]	Selecting test operation mode 0000: Test operation mode cancel 0001: JOG operation 0002: Positioning operation 0004: Output signal (DO) forced output	0000 to 0002, 0004	4
[9] [2]	[0] [0]	Input signal for test operation	☞ Page 559 Input device on/off (test operation)	8
	[A] [0]	Forced output of signal pin	☞ Page 564 Output signal pin on/off (output signal (DO) forced output)	8
[A] [0]	[1] [0]	Writes the servo motor speed in the test operation mode (JOG operation and positioning operation).	0000 to 7FFF	4
	[1] [1]	Writes the acceleration/deceleration time constant in the test operation mode (JOG operation and positioning operation).	00000000 to 7FFFFFFF	8
	[2] [0]	Set the travel distance in the test operation mode (positioning operation).	00000000 to 7FFFFFFF	8
	[2] [1]	Select the positioning direction of the test operation (positioning operation). 	0000 to 0101	4
	[4] [0]	This is a start command for the test operation (positioning operation).	1EA5	4
[4] [1]	Use this to make a temporary stop during the test operation (positioning operation). "_" in data indicates a blank. STOP: Temporary stop GO __: Restart for remaining distance CLR _: Remaining distance clear	STOP GO __ CLR _	4	

9.5 Detailed explanations of commands

Data processing

When the master station transmits a command + data No. or a command + data No. + data to a slave station, the servo amplifier returns a response or data in accordance with the purpose.

Numerical values in transmitted and received data are represented in decimal, hexadecimal, etc.

Therefore, data must be processed in accordance with the application.

Since whether data must be processed or not and how to process data depend on the monitoring, servo parameters, etc., follow the detailed explanation of the corresponding command.

The following shows how to process received data and write processed data.

Processing read data

When the display type is 0, convert the eight-character data from hexadecimal to decimal, and place a decimal point according to the decimal point information.

When the display type is 1, use the eight-character data unchanged.

The following example indicates how to process the received data for status display "00300000929".

The received data is as follows.

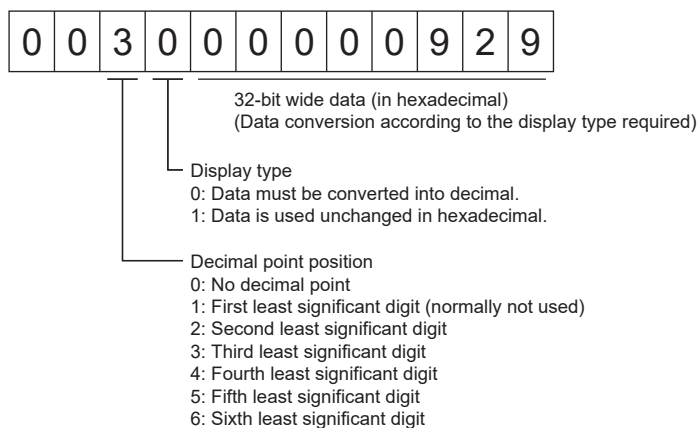

Since the display type is "0" in this case, convert the hexadecimal data into decimal.

00000929h → 2345

As the decimal point position is "3", place a decimal point in the third least significant digit.

"23.45" is displayed.

Writing processed data

When the data to be written is handled as decimal, the decimal point position must be specified. If it is not specified, the data cannot be written. When the data is handled as hexadecimal, specify "0" as the decimal point position.

The data to be transmitted is the following value.

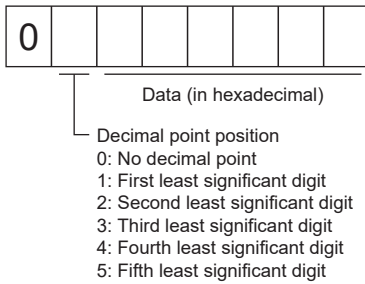

The following example shows how to process the set data when a value of "15.5" is transmitted.

Since the decimal point position is the second least significant digit, the decimal point position data is "2".

As the data to be transmitted is hexadecimal, convert the decimal data into hexadecimal.

155 → 9B

Therefore, transmit "0200009B".

Status display

Reading the status display name and unit

The status display name and unit can be read.

■ Transmission

Transmit the command [0] [1] and the data No. corresponding to the status display item to be read, [0] [0] to [0] [E] and [2] [0] to [2] [9].

■ Return

The slave station returns the requested status display name and unit.

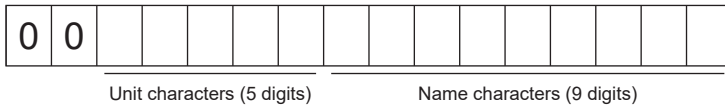

Reading status display data

Status display data and processing information can be read.

■ Transmission

Transmit the command [0] [1] and the data No. corresponding to the status display item to be read, [8] [0] to [8] [E] and [A] [0] to [A] [9].

■ Return

The slave station returns the requested status display data.

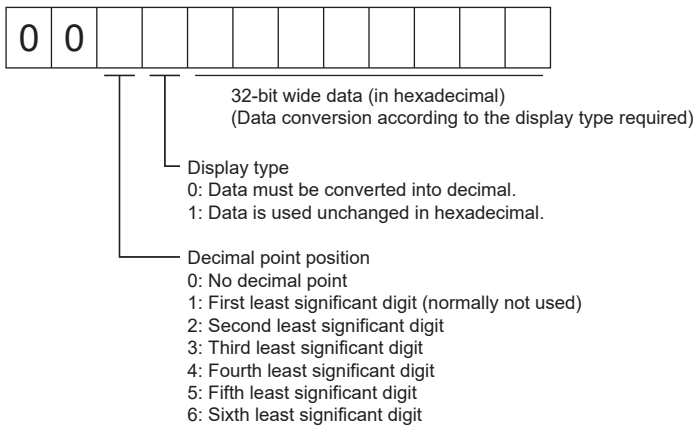

Clearing status display data

The cumulative feedback pulse data of the status display is cleared. Transmit this command immediately after reading the status display item. The slave station clears the transmitted status display item data to "0".

Command	Data No.	Data
[8] [1]	[0] [0]	1EA5

For example, after transmitting the command [0] [1] and data No. [8] [0] and receiving the status display data, transmitting the command [8] [1], data No. [0] [0], and data [1EA5] will clear the cumulative feedback pulse value to "0".

Servo parameter

Specifying a servo parameter group

To read or write servo parameter setting values or other data, specify the group of servo parameters to be operated in advance. Write data to the servo amplifier as follows to specify the servo parameter group.

Command	Data No.	Transmission data	Servo parameter group
[8] [5]	[0] [0]	0000	Basic setting servo parameters ([Pr. PA_ _])
		0001	Gain/filter servo parameters ([Pr. PB_ _])
		0002	Extension setting servo parameters ([Pr. PC_ _])
		0003	I/O setting servo parameters ([Pr. PD_ _])
		0004	Extension setting 2 servo parameters ([Pr. PE_ _])
		0005	Extension setting 3 servo parameters ([Pr. PF_ _])
		000B	Motor extension setting servo parameters ([Pr. PL_ _])

Reading a servo parameter group

The set servo parameter group can be read from the slave station.

■ Transmission

Transmit the command [0] [4] + data No. [0] [1].

■ Return

The slave station returns the set servo parameter group.

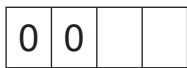

Servo parameter group
 00: Basic setting servo parameters ([Pr. PA_ _])
 01: Gain/filter servo parameters ([Pr. PB_ _])
 02: Extension setting servo parameters ([Pr. PC_ _])
 03: I/O setting servo parameters ([Pr. PD_ _])
 04: Extension setting 2 servo parameters ([Pr. PE_ _])
 05: Extension setting 3 servo parameters ([Pr. PF_ _])
 0B: Motor extension setting servo parameters ([Pr. PL_ _])

Reading a symbol

The symbol of servo parameters can be read. Specify a servo parameter group in advance.

■ Transmission

Transmit the command [0] [8] and the data No. [0] [1] to [F] [F] corresponding to the servo parameter No.

The data No. is represented in hexadecimal. The decimal converted from the data No. value corresponds to the servo parameter No.

■ Return

The slave station returns the symbol of the requested servo parameter.



Symbol characters (9 digits)

Reading setting values

The setting values of servo parameters can be read. Specify a servo parameter group in advance.

■ Transmission

Transmit the command [1] [5] and the data No. corresponding to the servo parameter No. [0] [1] to [F] [F]. The data No. is represented in hexadecimal. The decimal converted from the data No. value corresponds to the servo parameter No.

■ Return

The slave station returns the data and processing information of the requested servo parameter No.

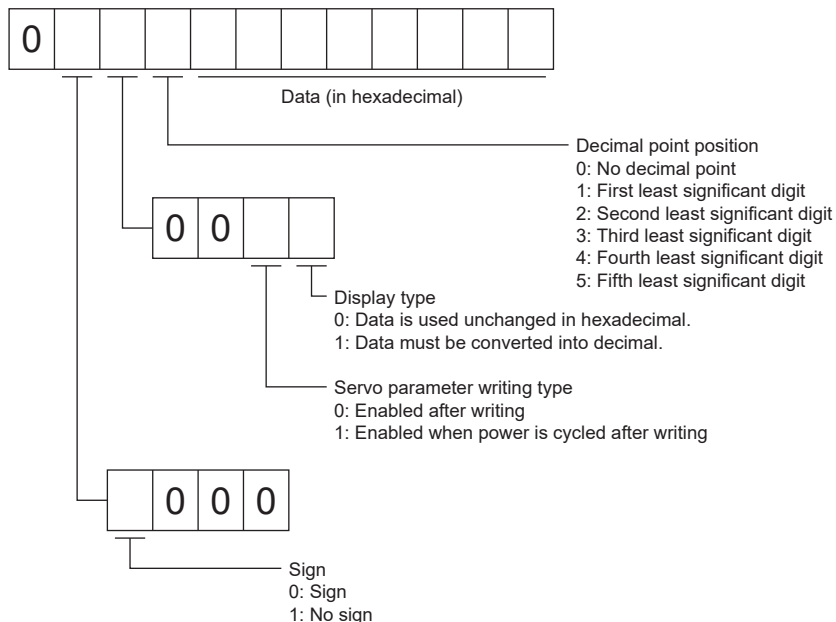

For example, data "00120000270F" means 999.9 (decimal display format) and data "000000003ABC" means 3ABC (hexadecimal display format).

When the display type is "0" (hexadecimal) and the decimal point position is other than "0", the display type is a special hexadecimal display format and "F" of the data value is handled as a blank. Data "0001FFFFFF053" means 053 (special hexadecimal display format).

"000000000000" is transmitted when the read servo parameter is the one that cannot be written/referenced according to [Pr. PA19] (parameter writing prohibited).

Reading setting ranges

The setting ranges of servo parameters can be read. Specify a servo parameter group in advance.

■ Transmission

When reading an upper limit value, transmit the command [1] [6] and the data No. [0] [1] to [F] [F] corresponding to the servo parameter No. When reading a lower limit value, transmit the command [1] [7] and the data No. [0] [1] to [F] [F] corresponding to the servo parameter No.

The data No. is represented in hexadecimal. The decimal converted from the data No. value corresponds to the servo parameter No.

■ Return

The slave station returns the data and processing information of the requested servo parameter No.

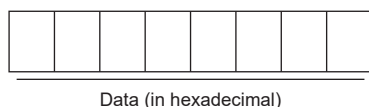

For example, data "FFFFFFEC" means "-20".

Writing setting values

Restriction

- If setting values need to be changed with a high frequency (i.e. one time or more per hour), write the setting values to the RAM, not to the non-volatile memory.
- After writing the setting values to the non-volatile memory using a servo parameter writing command, wait for at least 3 seconds before turning off the servo amplifier. If the power is turned off before 3 seconds have passed, the servo parameter may be returned to the original value.

■ Writing servo parameters

Write servo parameter setting values to the RAM of the servo amplifier. Specify a servo parameter group in advance. Write any value within the settable range. For information on the settable range, refer to the following manual or read the setting range.

 Page 554 Reading setting ranges

 MR-J5-A User's Manual (Parameters)

Transmit the command [9] [4] + data No. + set data.

The data No. is represented in hexadecimal. The decimal converted from the data No. value corresponds to the servo parameter No. When the data to be written is decimal, the decimal point position must be specified. If it is not specified, the data cannot be written. When the data is handled as hexadecimal, specify "0" as the decimal point position.

Check that the writing data is within the upper/lower limit value before writing.

After the writing process, read the same servo parameter data to verify that the data has been written correctly.

To write data to the RAM, set the write mode to "3". To write data to the non-volatile memory, set the write mode to "0".

Command	Data No.	Data
[9] [4]	[0] [1] to [F] [F]	See below.

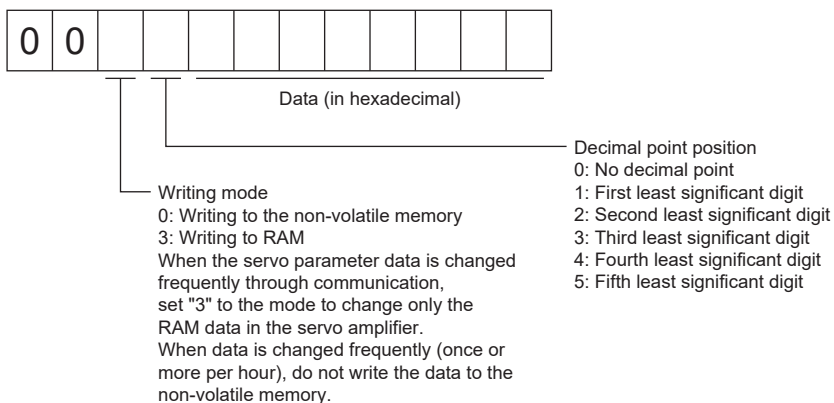

External I/O signal status (DIO diagnosis)

Reading the input device status

The input device status can be read.

■ Transmission

Transmit the command [1] [2] + data No. [0] [0].

■ Return

The slave station returns the input device status.

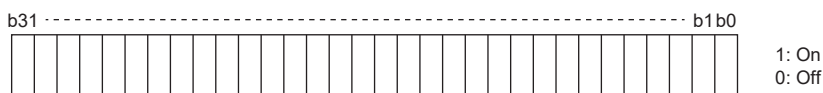

Each bit command is transmitted to the master station as hexadecimal data.

Bit	Symbol	Bit	Symbol	Bit	Symbol	Bit	Symbol
0	SON	8	SP1	16	—	24	—
1	LSP	9	SP2	17	—	25	—
2	LSN	10	SP3	18	EM1/EM2	26	CDP2
3	TL	11	ST1/RS2	19	—	27	CDP
4	TL1	12	ST2/RS1	20	STAB2	28	CLD
5	PC	13	CM1	21	—	29	MECR
6	RES	14	CM2	22	STO1	30	—
7	CR	15	LOP	23	STO2	31	—

Reading the external input pin status

The on/off state of the external input pin can be read.

■ Transmission

Transmit the command [1] [2] + data No. [4] [0].

■ Return

The on/off state of the input pin is returned.

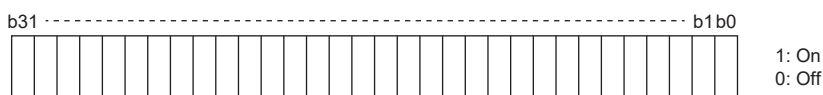

Each bit command is transmitted to the master station as hexadecimal data.

Bit	CN3 connector pin	Bit	CN3 connector pin	Bit	CN3 connector pin	Bit	CN3 connector pin
0	43	8	18	16	—	24	—
1	44	9	45	17	—	25	—
2	42	10	10 ^{*1}	18	—	26	—
3	15	11	35 ^{*1}	19	—	27	—
4	19	12	—	20	—	28	—
5	41	13	—	21	—	29	—
6	16	14	—	22	—	30	—
7	17	15	—	23	—	31	—

*1 When the pulse train input is selected with [Pr. PD44 Input device selection 11H] or [Pr. PD46 Input device selection 12H], the bit will be always 0 (off).

Reading the status of input devices switched on via communication

The on/off state of input devices switched on via communication can be read.

■ Transmission

Transmit the command [1] [2] + data No. [6] [0].

■ Return

The slave station returns the input device status.

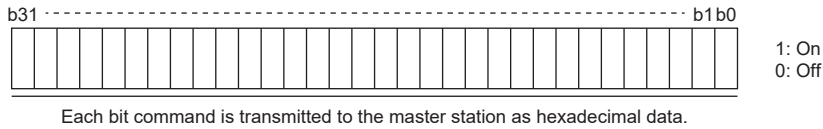

The bit is the same as that of [1] [2] + [0] [0].

Reading the external output pin status

The on/off state of the external output pin can be read.

■ Transmission

Transmit the command [1] [2] + data No. [C] [0].

■ Return

The slave station returns the output pin status.

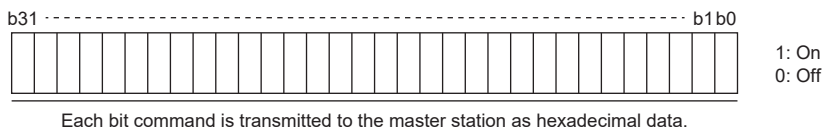

Bit	CN3 connector pin	Bit	CN3 connector pin	Bit	CN3 connector pin	Bit	CN3 connector pin
0	49	8	14	16	—	24	—
1	24	9	—	17	—	25	—
2	23	10	—	18	—	26	—
3	25	11	—	19	—	27	—
4	22	12	—	20	—	28	—
5	48	13	—	21	—	29	—
6	33	14	—	22	—	30	—
7	13	15	—	23	—	31	—

Reading the output device status

The on/off state of the output device can be read.

■ Transmission

Transmit the command [1] [2] + data No. [8] [0].

■ Return

The slave station returns the I/O device status.



Each bit command is transmitted to the master station as hexadecimal data.

Bit	Symbol	Bit	Symbol	Bit	Symbol	Bit	Symbol
0	RD	8	ALM	16	—	24	CDPS2
1	SA	9	OP	17	—	25	CDPS
2	ZSP	10	MBR	18	—	26	CLDS
3	TLC	11	DB	19	—	27	ABSV
4	VLC	12	—	20	—	28	—
5	INP	13	—	21	STO	29	—
6	—	14	—	22	—	30	—
7	WNG	15	BWNG	23	—	31	MTTR

Input device on/off

Each input device can be switched on/off via communication. However, when the device to be switched off is in the external input signal, switch off the input signal as well. The on/off states of all devices in the servo amplifier are the states of the last received data. Therefore, when there is a device which must be kept on, transmit data which turns the device on every time. Transmit the command [9] [2] + data No. [6] [0] + data.



Each bit command is transmitted to the master station as hexadecimal data.

The bit is the same as that of [1] [2] + [0] [0].

Disabling/enabling I/O devices (DIO)

Inputs can be disabled regardless of the I/O device status. When inputs are disabled, the input signals (devices) are recognized as follows. However, EM2 (Forced stop 2), LSP (Forward rotation stroke end), and LSN (Reverse rotation stroke end) cannot be disabled.

Signal	State
Input device (DI)	Off
External analog input signal	0 V
Pulse train input	None

Input devices

Input devices (excluding EM2, LSP, and LSN), external analog input signals, and pulse train inputs can be disabled or enabled.

- Disabling

Command	Data No.	Data
[9] [0]	[0] [0]	1EA5

- Enabling

Command	Data No.	Data
[9] [0]	[1] [0]	1EA5

Output devices

Output devices can be disabled or enabled.

- Disabling

Command	Data No.	Data
[9] [0]	[0] [3]	1EA5

- Enabling

Command	Data No.	Data
[9] [0]	[1] [3]	1EA5

Input device on/off (test operation)

Each input device can be turned on/off for test operation. However, when the device to be switched off is in the external input signal, switch off the input signal as well.

Transmit the command [9] [2] + data No. [0] [0] + data.

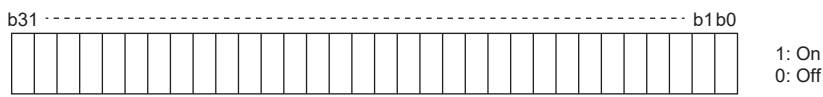

Each bit command is transmitted to the master station as hexadecimal data.

The bit is the same as that of [1] [2] + [0] [0].

Test operation mode

Even during operation, the servo amplifier can be switched to the test operation mode. In this case, switching to the test operation mode will shut off the base circuit to coast the servo motor.

Precautions

- The test operation mode is designed for checking operation. Do not use it for an actual operation.
- If communication stops for 0.5 s or longer during test operation, the servo motor decelerates to a stop, resulting in servo-lock. To prevent this, keep the communication all the time by monitoring the status display, etc.

How to set up and cancel test operation mode

■ Setting up test operation mode

Set the test operation mode type with the following procedure.

1. Selecting test operation mode

Transmit the command [8] [B] + data No. [0] [0] + data to set the test operation mode.

Command	Data No.	Transmission data	Selecting test operation mode
[8] [B]	[0] [0]	0001	JOG operation
		0002	Positioning operation
		0004	Output signal (DO) forced output

2. Checking test operation mode

Read the set test operation mode from the slave station, and check that the mode has been set correctly.

- Transmission

Transmit the command [0] [0] + data No. [1] [2].

- Return

The slave station returns the set test operation mode.

0	0	0	
---	---	---	--

Test operation mode reading
0: Normal mode (not test operation mode)
1: JOG operation
2: Positioning operation
4: Output signal (DO) forced output

■ Canceling test operation mode

To cancel the test operation mode, transmit the command [8] [B] + data No. [0] [0] + data.

Command	Data No.	Transmission data	Selecting test operation mode
[8] [B]	[0] [0]	0000	Test operation mode cancel

JOG operation

Transmit the command, data No., and data as follows to execute JOG operation.

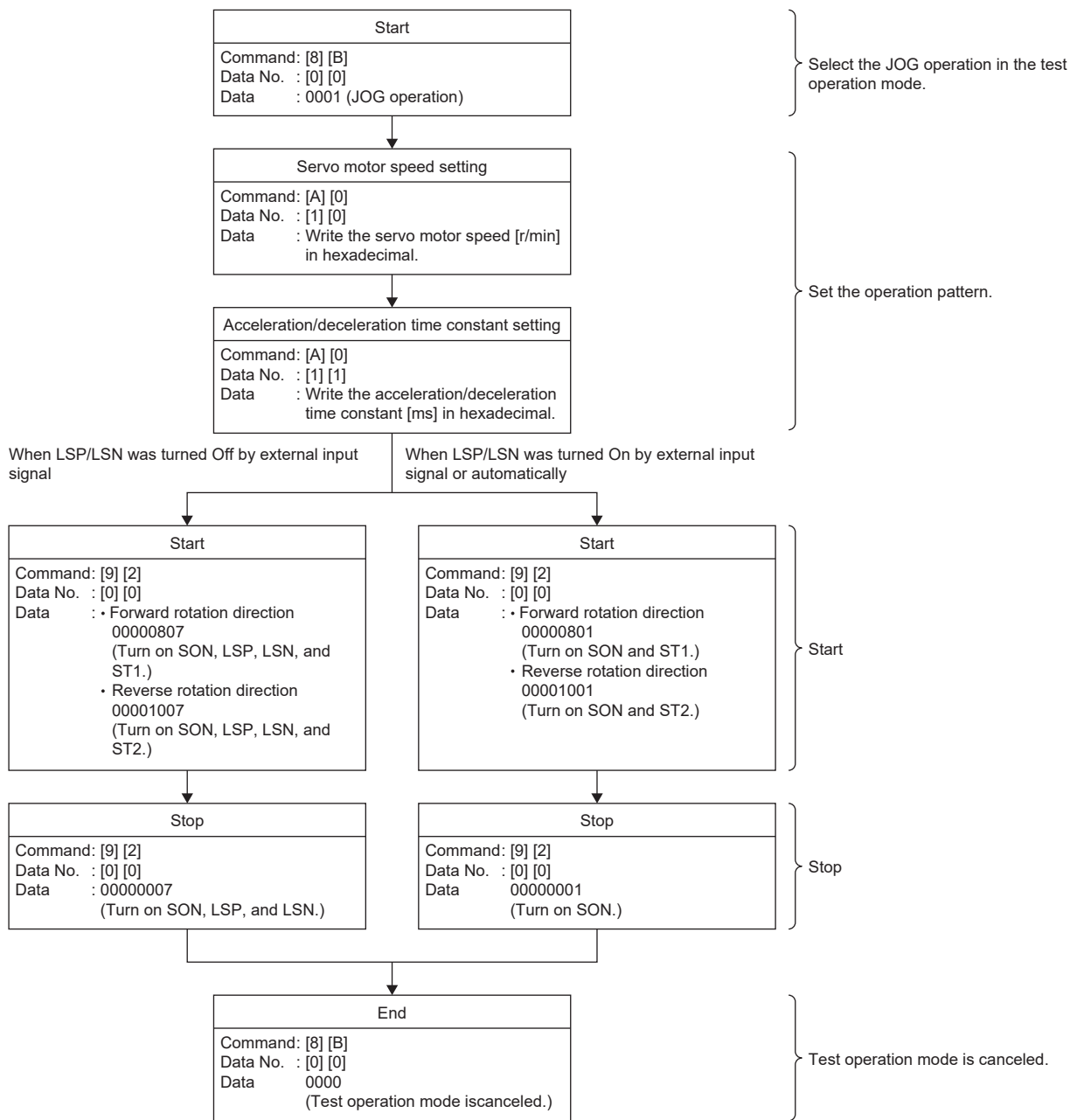

Positioning operation

■ Operation procedure

Transmit the command, data No., and data as follows to execute positioning operation.

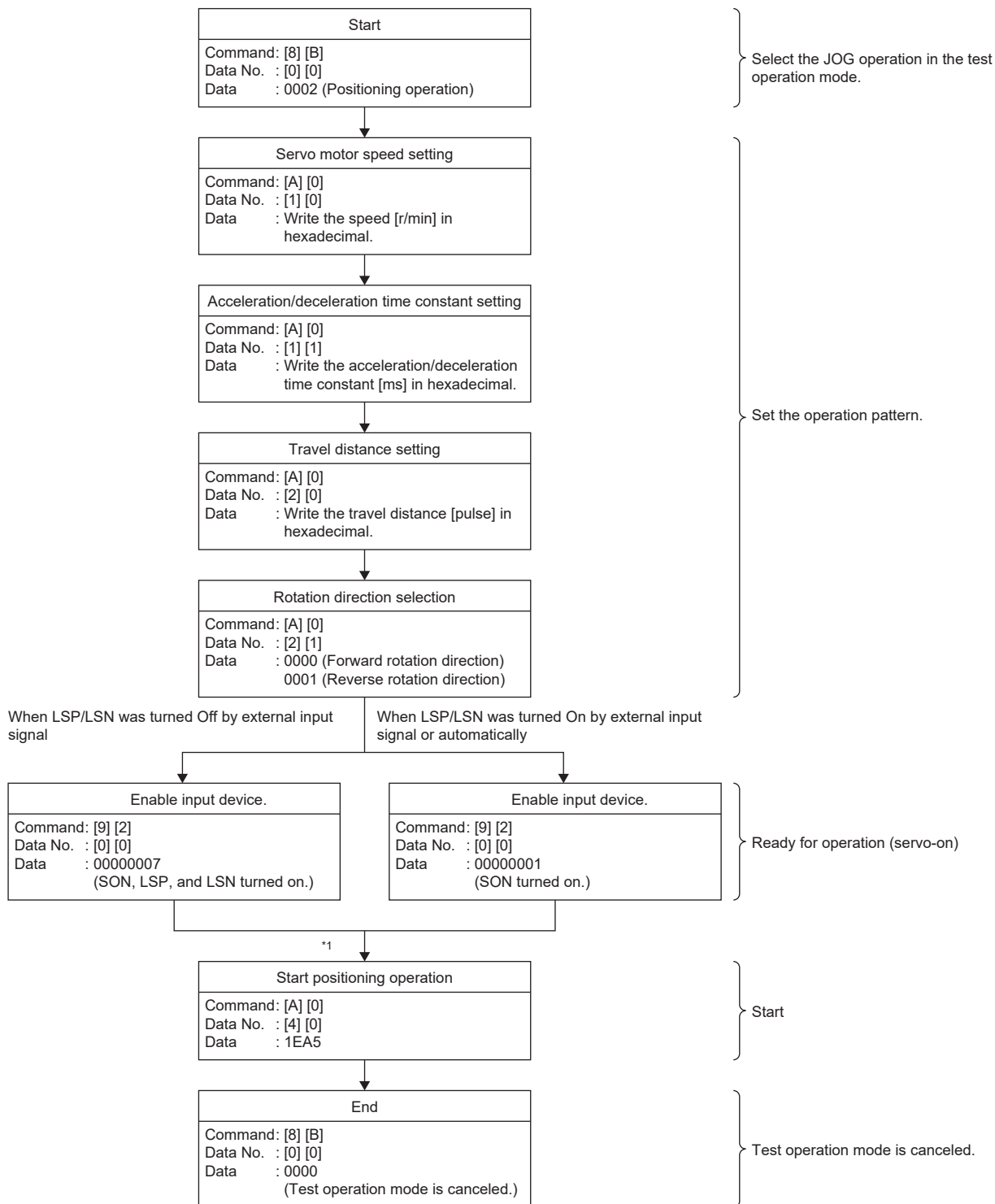

*1 A delay of 100 ms.

■ Temporary stop/restart/remaining distance clear

Transmitting the following command, data No., and data during positioning operation will decelerate the servo motor to a stop.

Command	Data No.	Data
[A] [0]	[4] [1]	STOP

Transmitting the following command, data No., and data during a temporary stop will restart the servo motor.

Command	Data No.	Data ^{*1}
[A] [0]	[4] [1]	GO __

*1 " _ " indicates a blank.

Transmitting the following command, data No., and data during a temporary stop will stop positioning operation and erase the remaining travel distance.

Command	Data No.	Data ^{*1}
[A] [0]	[4] [1]	CLR _

*1 " _ " indicates a blank.

Output signal pin on/off (output signal (DO) forced output)

In the test operation mode, the output signal pins can be turned on/off regardless of the servo status. Use the command [9] [0] to disable external input signals in advance.

Selecting the output signal (DO) forced output of the test operation mode

Transmit the command [8] [B] + data No. [0] [0] + data "0004" to select the output signal (DO) forced output.

0	0	0	0	0	0	0	4
---	---	---	---	---	---	---	---

Selection of test operation mode
4: Output signal (DO) forced output

External output signal on/off

Transmit the following communication command.

Command	Data No.	Setting data
[9] [2]	[A] [0]	See below.

b31 ----- b1 b0



1: On
0: Off

Each bit command is transmitted to the master station as hexadecimal data.

Bit	CN3 connector pin	Bit	CN3 connector pin	Bit	CN3 connector pin	Bit	CN3 connector pin
0	49	8	14	16	—	24	—
1	24	9	—	17	—	25	—
2	23	10	—	18	—	26	—
3	25	11	—	19	—	27	—
4	22	12	—	20	—	28	—
5	48	13	—	21	—	29	—
6	33	14	—	22	—	30	—
7	13	15	—	23	—	31	—

Output signal (DO) forced output

To stop the output signal (DO) forced output, transmit the command [8] [B] + data No. [0] [0] + data.

Command	Data No.	Transmission data	Selecting test operation mode
[8] [B]	[0] [0]	0000	Test operation mode cancel

Alarm history

Precautions

- If an alarm occurs while the alarm history is being obtained, there may be a mismatch among the alarm numbers, alarm detail numbers, and alarm occurrence times.

For example, if an alarm occurs after the number of the second last alarm has been read using the command [3] [3] [1] [1], the alarm history will be updated. In this situation, attempting to read the time of the second last alarm using the command [3] [3] [2] [1] will obtain the time of a different alarm.

It is recommended that the alarm history is read under conditions where an alarm will not occur, such as during servo-off.

Reading alarm numbers

The numbers of the alarms that occurred in the past can be read. The numbers of the 0th alarm (last alarm) through the 15th alarm (sixteenth last alarm) can be read.

■ Transmission

Transmit the command [3] [3] + data No. [0] [1] to [1] [F].

■ Return

The alarm No. corresponding to the data No. can be obtained.

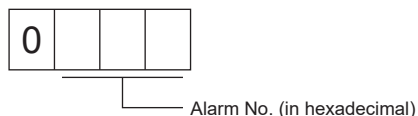

For example, "0032" means [AL. 032] and "00FF" means [AL. _ _ _] (no alarm).

Reading alarm detail numbers

Alarm detail numbers can be read in the same manner as alarm numbers.

■ Transmission

Transmit the command [3] [3] + data No. [4] [0] to [4] [F].

■ Return

The alarm detail number corresponding to the data No. can be obtained.

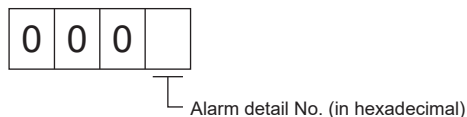

Reading alarm occurrence times

The times at which alarms occurred in the past can be read.

Alarm occurrence time corresponding to the data No. is provided in terms of the total time beginning with operation start, with the minute unit omitted.

■ Transmission

Transmit the command [3] [3] + data No. [2] [0] to [2] [F].

■ Return



Alarm occurrence time (in hexadecimal)
The hexadecimal must be converted into a decimal.

For example, data "01F5" means that the alarm occurred 501 hours after operation has started.

Clearing the alarm history

The alarm history can be cleared.

Transmit the command [8] [2] + data No. [2] [0].

Command	Data No.	Data
[8] [2]	[2] [0]	1EA5

Current alarm

Reading the current alarm

The number of the current alarm can be read.

■ Transmission

Transmit the command [0] [2] + data No. [0] [0].

■ Return

The slave station returns the alarm currently occurring.

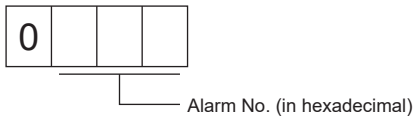

For example, "0032" means [AL. 032] and "00FF" means [AL. ___] (no alarm).

Reading the current alarm and detail No.

■ Transmission

Transmit the command [0] [2] + data No. [0] [3].

■ Return

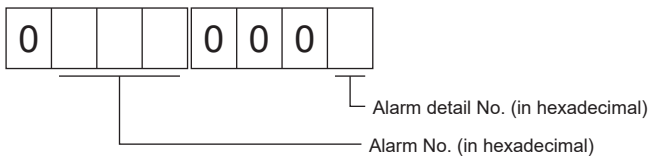

For example, "00320001" means [AL. 032.1] and "00FF0000" means [AL. ___] (no alarm).

Reading the status display at alarm occurrence

Status display data at alarm occurrence can be read. When the data No. corresponding to the status display item is transmitted, the data value and data processing information will be returned.

■ Transmission

Transmit the command [3] [5] and the data No. corresponding to the status display item to be read, [8] [0] to [8] [E] and [A] [0] to [A] [9].

■ Return

The slave station returns the requested status display data at alarm occurrence.

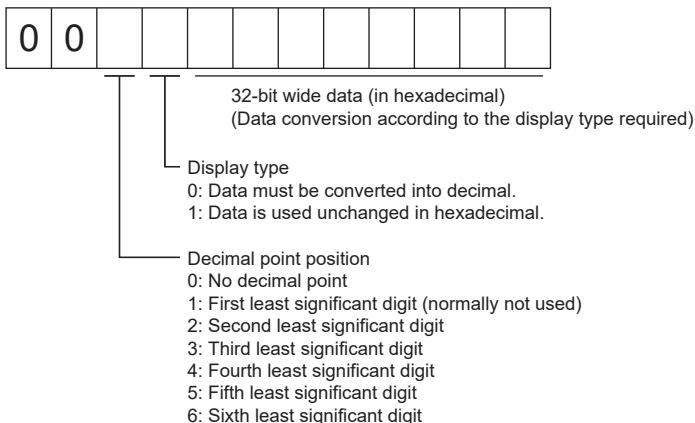

Resetting the current alarm

In the same manner as the reset (RES) on, reset the servo amplifier alarm to make the servo amplifier ready to operate. After removing the cause of the alarm, reset the alarm with no command entered.

Command	Data No.	Data
[8] [2]	[0] [0]	1EA5

Version

Firmware version

The firmware version of the servo amplifier can be read.

■ Transmission

Transmit the command [0] [2] + data No. [7] [0].

■ Return

The slave station returns the requested firmware version.

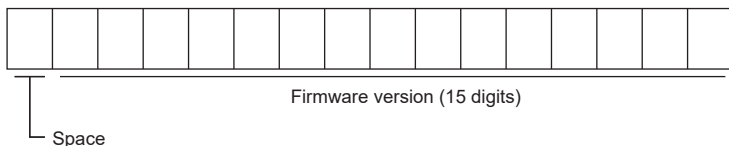

For example, data "BCD-B58W100 B6" means firmware version B6.

Absolute position monitoring

Absolute position in units of servo motor-side pulses

The absolute position can be read in units of servo motor-side pulses. However, an overflow will occur if the position is 32 or more revolutions away from the home position.

■ Transmission

Transmit the command [0] [2] + data No. [9] [0].

■ Return

The slave station returns the requested servo motor-side pulses.



Absolute position is sent back in hexadecimal in the servo motor-side pulse unit.
(Data must be converted into decimal.)

For example, data "000186A0" means 100000 pulses in units of motor-side pulses.

Absolute position in the command unit

The absolute position can be read in the command unit.

■ Transmission

Transmit the command [0] [2] + data No. [9] [1].

■ Return

The slave station returns the requested command pulses.



Absolute position is sent back in hexadecimal in the command unit.
(Data must be converted into decimal.)

For example, data "000186A0" means 100000 pulses in the command unit.

10 POSITIONING MODE (POINT TABLE METHOD) (CP) [G]

The positioning mode (point table method) is available on servo amplifiers with firmware version B8 or later.

When using this function, set [Pr. PA01.0 Control mode selection] to "6" (positioning mode (point table)).

This is a method for performing positioning in accordance with the point table by setting the positioning data to the point table (up to 255 points).

Select a point table number and execute the positioning operation with the start signal. JOG operation and homing can be executed.

Point table number	Position data	Servo motor speed	Acceleration time constant	Deceleration time constant	Dwell	Auxiliary function	M code
1	1000	2000.00	200	200	0	1	1
2	2000	1600.00	100	100	0	0	2
:	:	:	:	:	:	:	:
255	3000	3000.00	100	100	0	2	99

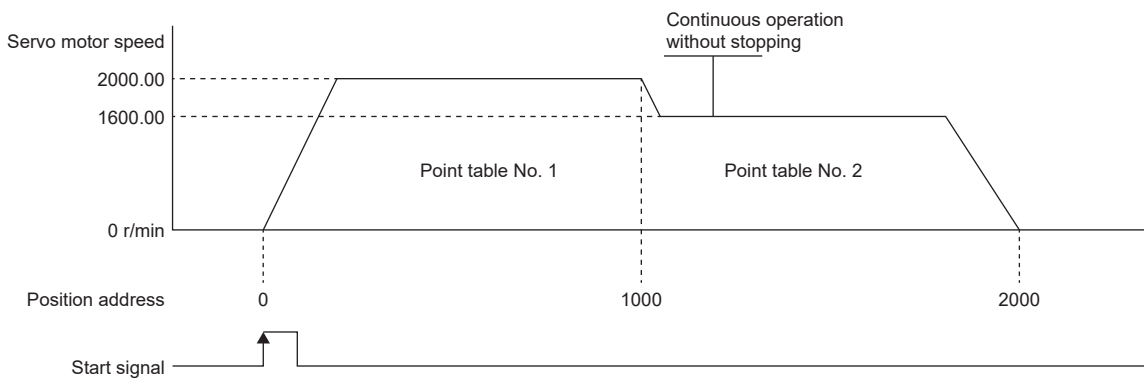

For details on the objects, refer to the User's Manual (Object Dictionary).

10.1 Operation mode and selection method

Operation mode

The following shows the operation modes of the positioning mode (point table method) (CP).

Control mode	Operation mode	Explanation
Positioning mode (Point table method) (CP)	Point table mode (pt)	Operates the servo motor according to the preset point table. ☞ Page 572 Point table mode (pt)
	JOG operation mode (jg)	Enables desired positioning for machine adjustment and home positioning. ☞ Page 596 JOG operation mode (jg)
	Homing mode (hm)	Matches the commanded coordinates with the machine coordinates. ☞ Page 54 Homing mode (hm)

Operation mode selection method

The operation mode selection method is as follows.

Operation mode	Operation mode option	Servo parameter	Object
		[Pr. PA01.0 Control mode selection]	[Modes of operation (Obj. 6060h)]
Point table mode (pt)	Single positioning operation	6	-101
	Continuous positioning operation		
	Speed change operation		
JOG operation mode (jg)	JOG operation		-100
Homing mode (hm)	Various homing		6

10.2 Point table mode (pt)

Point table mode (pt)

Select the preset point table with [Target point table (Obj. 2D60h)], and start operation with bit 4 (New set-point) of [Controlword (Obj. 6040h)]. The command method of the point table mode (pt) is the absolute value command method.

Absolute value command method

Set the target address for the position data.

■ mm/inch/pulse unit

Set the target position in within the following range.

Unit	Setting range
0.001 mm	-2147483648 to 2147483647
0.0001 inch	
pulse	

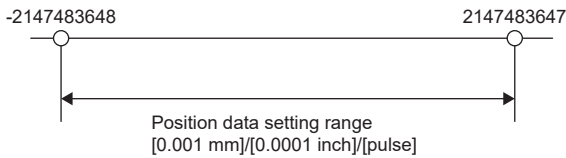

■ Degree unit

When [Pr. PA14 Travel direction selection] is "0" (initial value), set the target position with the CCW direction as + and the CW direction as -.

When the direction is specified by absolute value, the direction of rotation can be specified by + or -.

Ex.

The following shows a setting example when [Pr. PA14] is set to "0".

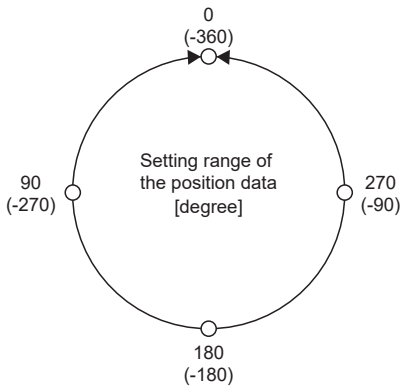

- Coordinate system in degree unit

Coordinates are determined with respect to the position of 0 degree.

+ direction: 0, 90, 180, 270, 0, in that order.

- direction: 0, -90, -180, -270, -360 in that order.

270 degrees and -90 degrees are the same position.

0 degree, 360 degrees, and -360 degrees are the same position.

The direction for moving to the target position is the direction set in [Pr. PT03.2 Degree unit rotation direction selection].

[Pr. PT03.2]	Servo motor rotation direction
0 (Specified rotation direction)	Rotates to the target position in the direction specified with the sign of the position data.
1 (Rotation in the direction with the shortest distance)	Rotates in the direction with the shorter distance from the current position to the target position. If the distance from the current position to the target position is the same in the CCW and CW directions, the servo motor rotates in the CCW direction.
2 (Rotation in the address decreasing direction)	Rotates in the address decreasing direction regardless of the sign of the position data.
3 (Rotation in the address increasing direction)	Rotates in the address increasing direction regardless of the sign of the position data.

Point table operation (absolute value command method)

This a method used by specifying the absolute and relative position commands with the auxiliary function of the point table.

Point table



Set each value of the point table with [Point table 001 (Obj. 2801h)] to [Point table 255 (Obj. 28FFh)].

Set the position data, servo motor speed, acceleration time constant/acceleration, deceleration time constant/deceleration, dwell time, auxiliary function, and M code in the point table.

When "0", "1", "8", or "9" is set for the auxiliary function, the absolute position command method is applied to the point table.

When "2", "3", "10", or "11" is set for the auxiliary function, the relative position command method is applied to the point table.

If a value outside the range is set in the point table, the setting value will be clamped to the maximum value or minimum value. If a value out of the range is set due to the change of the command unit or connected servo motor, [AL. 037 Parameter error] occurs.

Object		Item	Setting range	Unit	Description
Index	Sub				
2801h to 28FFh	1	Position data	-2147483648 to 2147483647 *1	0.001 mm 0.0001 inch 0.001 degree pulse	<ul style="list-style-type: none"> When using the point table as the absolute position command method Set the target address (absolute value). When using the point table as the relative position command method Set the travel distance. The "-" sign can be added to change the command to the reverse rotation command.
	2	Servo motor speed	0 to maximum speed *4	0.01 r/min *2 0.01 mm/s *1*2 0.001 mm/s *3 0.0001 inch/s *3 0.001 degree/s *3 pulse/s *3	Set the command speed of the servo motor while positioning is executed. The setting value should be equal to or less than the maximum speed of the servo motor.
	3	Acceleration time constant	0 to 20000	ms *2	Set a time for the servo motor to reach the rated speed.
		Acceleration	0 to 2147483647	0.001 mm/s ² 0.0001 inch/s ² 0.001 degree/s ² pulse/s ²	Set the acceleration to reach the set servo motor speed. (Acceleration time [s] = Servo motor speed/Acceleration) When "0" is set, the servo motor accelerates in accordance with the time constant set in [Pr. PT49 Speed acceleration time constant].
	4	Deceleration time constant	0 to 20000	ms *2	Set the time required for the servo motor to stop from the rated speed.
		Deceleration	0 to 2147483647	0.001 mm/s ² 0.0001 inch/s ² 0.001 degree/s ² pulse/s ²	Set the deceleration to stop the servo motor from the set servo motor speed. (Deceleration time [s] = Servo motor speed/Deceleration) When "0" is set, the servo motor decelerates in accordance with the time constant set in [Pr. PT50 Speed deceleration time constant].
	5	Dwell time	0 to 20000	ms	Set the dwell time. When "0" or "2" is set in the auxiliary function, the dwell time is disabled. When "1", "3", "8", "9", "10", or "11" is set in the auxiliary function and the dwell time is set to 0, continuous operation is executed. When the dwell time is set, the position command of the selected point table is completed, and the position command for the next point table is started after the set dwell time elapses.
6	Auxiliary function	0 to 3, 8 to 11	—	Set the auxiliary function. When a different direction is set, the servo motor rotates in the reverse direction after the smoothing zero (command output) is confirmed. Setting "1" or "3" for the point table number 255 triggers a point table error.  Page 579 Continuous positioning operation (absolute value command method) <ul style="list-style-type: none"> When using the point table in the absolute position command method 0: Execute the operation of one selected point table. 1: Execute the continuous operation without stopping the next point table. 8: Execute the continuous operation without stopping the point table selected at startup. 9: Execute the continuous operation without stopping the point table number 1. When using the point table in the relative position command method 2: Execute the operation of one selected point table. 3: Execute the continuous operation without stopping the next point table. 10: Execute the continuous operation without stopping the point table selected at startup. 11: Execute the continuous operation without stopping the point table number 1. 	
7	M code	0 to 255	—	Set the code to be output when the positioning is completed. M codes can be read with [M code actual value (Obj. 2D6Ah)]. Refer to the following for the M code update setting.  Page 592 Temporary stop/restart	

- *1 When degree is set, the setting range is -360000 to 360000.
- *2 In the linear servo motor control mode, the unit is mm/s.
- *3 The setting unit of the speed and acceleration/deceleration can be changed using [Pr. PT01.1 Speed/acceleration/deceleration unit selection].
- *4 The setting value will be clamped at the maximum speed. When changing the speed to the permissible speed, set the speed in [Pr. PA28.4 Speed range limit selection].

Parameter setting

Set the following parameters to perform the point table operation.

■ Rotation direction selection ([Pr. PA14 Travel direction selection])

Select the servo motor rotation direction or the linear servo motor travel direction when bit 4 (New set-point) of [Controlword (Obj. 6040h)] is turned on.

[Pr. PA14]	Servo motor rotation direction/linear servo motor travel direction Turn on bit 4 (New set-point) of [Controlword]
0	Forward rotation (CCW) or positive direction with + position data Reverse rotation (CW) or negative direction with - position data
1	Reverse rotation (CW) or negative direction with + position data Forward rotation (CCW) or positive direction with - position data

The servo motor rotation direction is as follows.

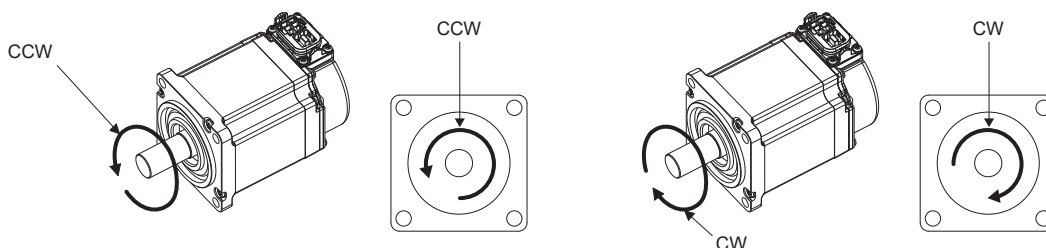

The positive and negative directions of the linear servo motor are as follows.

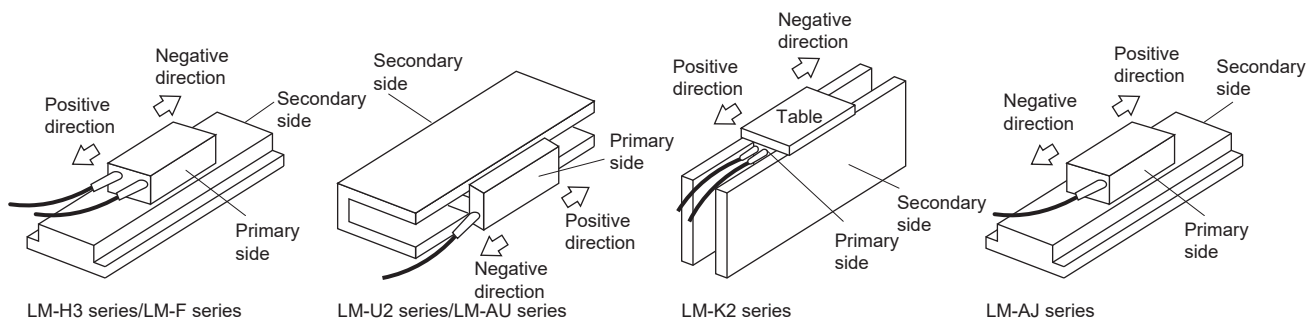

■ Position data unit ([Pr. PT01.2 Unit for position data])

Set the unit for position data.

[Pr. PT01.2]	Position data unit	Position data input range
0	mm	-2147483648 to +2147483647
1	inch	-2147483648 to +2147483647
2	degree	-360000 to +360000
3	pulse	-2147483648 to +2147483647

■ Speed data/acceleration/deceleration data unit ([Pr. PT01.1 Speed/acceleration/deceleration unit selection])

Set the unit of speed data and acceleration/deceleration data.

Setting of [Pr. PT01.1]	Unit for position data	Speed data unit	Acceleration/deceleration data unit
0	—	r/min, mm/s ^{*1}	ms
1	mm	mm/s ^{*2}	mm/s ²
	inch	inch/s ^{*2}	inch/s ²
	degree	degree/s ^{*2}	degree/s ²
	pulse	pulse/s ^{*2}	pulse/s ²

*1 In the linear servo motor control mode, the unit is mm/s.

*2 The setting of the command unit. The actual servo motor speed [encoder pulse unit] is calculated by multiplying the set speed data by the electronic gear ratio.

Operation

When the point table is selected with [Target point table (Obj. 2D60h)] and bit 4 (New set-point) of [Controlword (Obj. 6040h)] is turned on, positioning is performed on the position data with the set speed, acceleration time constant/acceleration, and deceleration time constant/deceleration.

Item	Object	Setting details
Point table mode (pt) selection	[Modes of operation (Obj. 6060h)]	Set to "-101".
Point table selection	[Target point table]	Set the point table number to be used.
Start	[Controlword]	Turn on bit 4 (New set-point) of [Controlword].

Timing chart of the point table operation

The unit of the speed data and acceleration data of the point table can be changed with [Pr. PT01.1 Speed/acceleration/deceleration unit selection]. In the following timing chart, the units are r/min for speed data and ms for acceleration/deceleration data.

[Point actual value (Obj. 2D69h)] and [M code actual value (Obj. 2D6Ah)] display the previous value until the operation is completed.

The accuracy of the acceleration/deceleration time and dwell time can be improved by setting [Pr. PT02.7_ Internal position command - Process speed selection] to "1" (high speed).

Single positioning operation (absolute value command method)

When bit 4 (New set-point) of [Controlword (Obj. 6040h)] is turned on while the servo is on and the servo motor is stopped, positioning operation will be performed.

The following shows the timing chart.

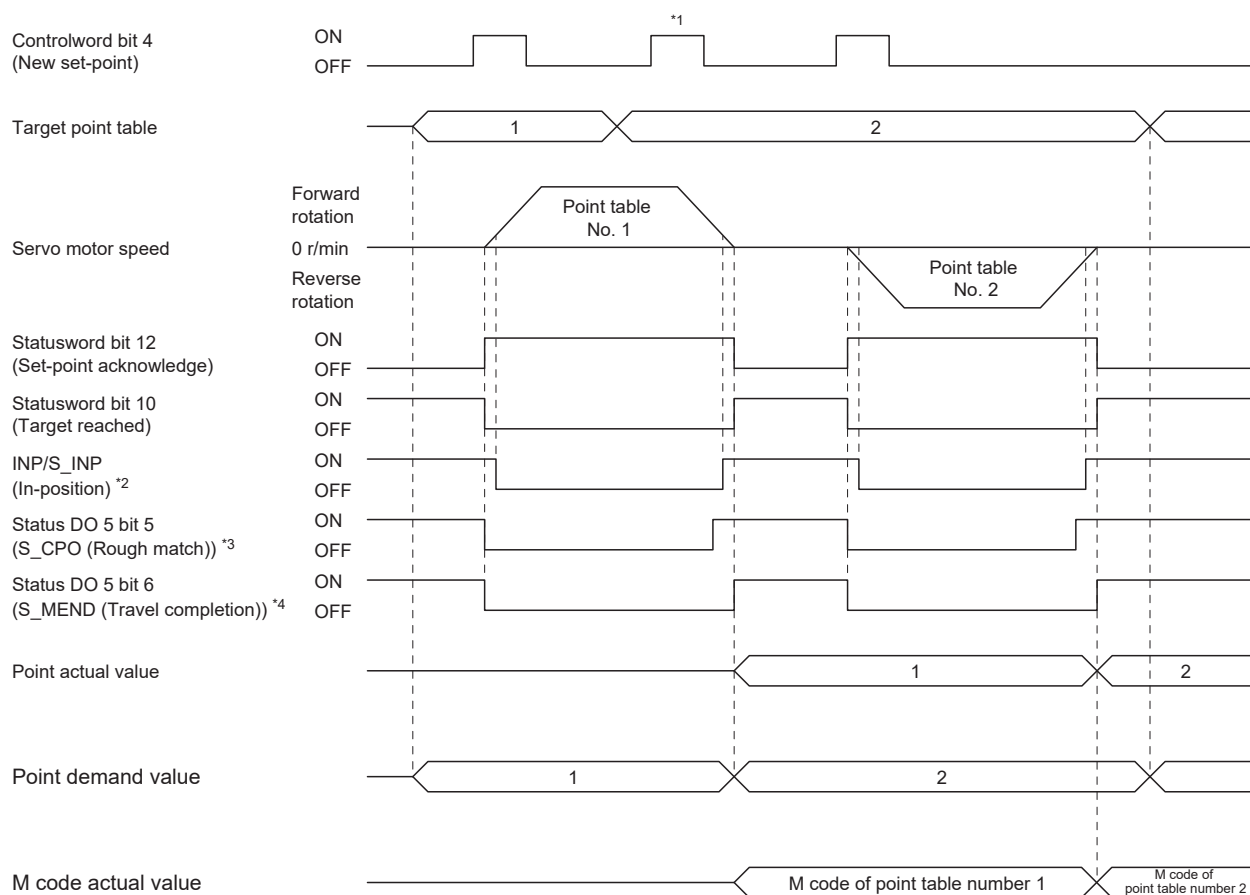

- *1 It is disabled even if bit 4 (New set-point) of [Controlword (Obj. 6040h)] is turned on while the servo motor is rotating.
- *2 The bit turns on when the droop pulse of the command unit is equal to or less than the setting value of [Pr. PA10 In-position range].
- *3 The bit turns on when the command remaining distance is equal to or less than the setting value of [Pr. PT12_Rough match output range (CRP)].
- *4 The bit turns on when S_INP (in-position) is on and command remaining distance is "0".

Continuous positioning operation (absolute value command method)

Select one point table and turn on bit 4 (New set-point) of [Controlword (Obj. 6040h)] to continuously operate the point table with consecutive numbers.

The following shows the timing chart.

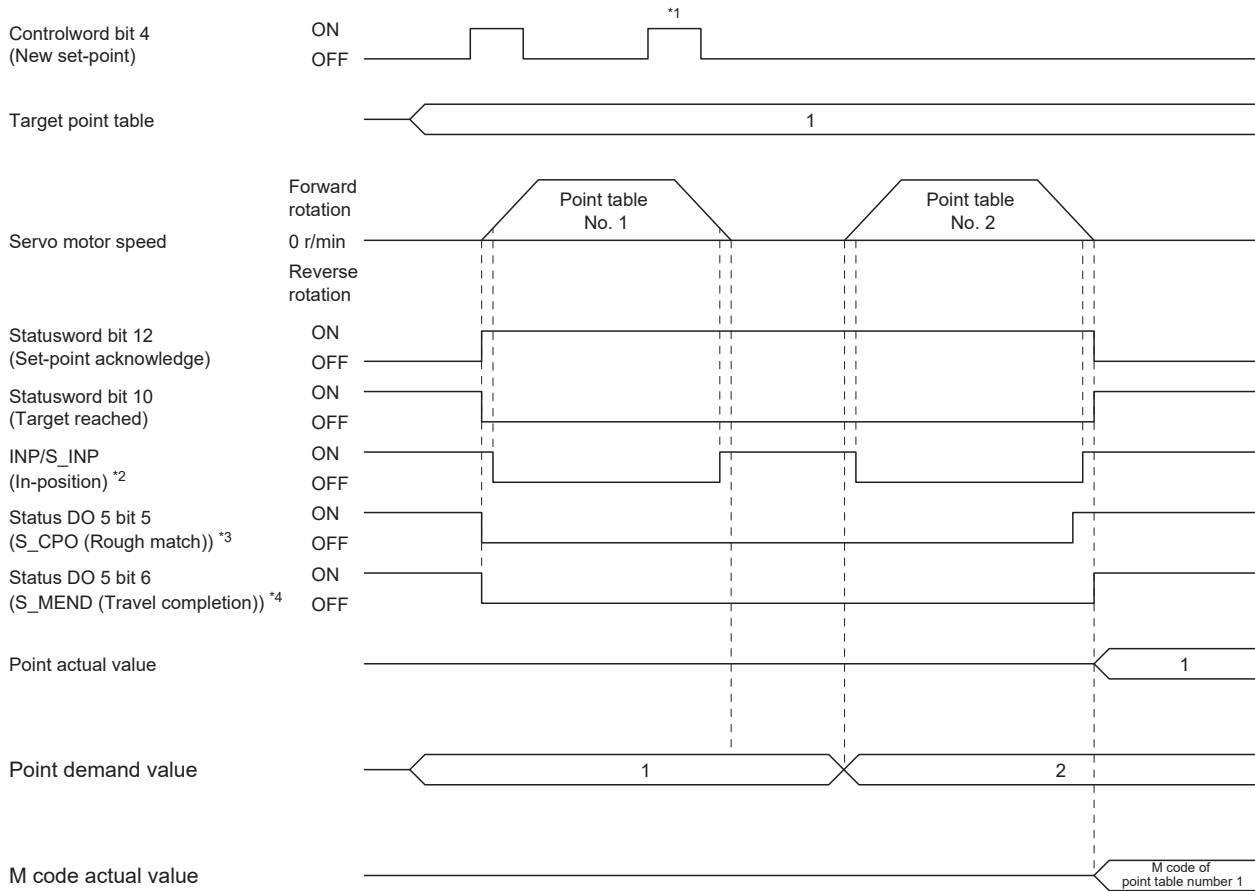

*1 It is disabled even if bit 4 (New set-point) of [Controlword (Obj. 6040h)] is turned on while the servo motor is rotating.

*2 The bit turns on when the droop pulse of the command unit is equal to or less than the setting value of [Pr. PA10 In-position range].

*3 The bit turns on when the command remaining distance is equal to or less than the setting value of [Pr. PT12_Rough match output range (CRP)]. The bit is off during continuous operation.

*4 The bit turns on when S_INP (in-position) is on and command remaining distance is "0". The bit is off during continuous operation.

Continuous operation can be performed by specifying absolute and relative position commands with the auxiliary function of the point table.

The selection method is as follows.

Point table setting		
Dwell time	Auxiliary function	
	When the position data is an absolute position	When the position data is a relative position
1 or more	1	3

■ When positioning to the same direction

The following shows an example of behavior for the following setting values.

In this example, point table number 1 is the absolute position command method, point table number 2 is the relative position command method, and point table number 3 is the absolute position command method.

Point table number	Position data [pulse]	Servo motor speed [r/min]	Acceleration time constant [ms]	Deceleration time constant [ms]	Dwell time [ms]	Auxiliary function	M code
1	500	3000.00	100	150	100	1	5
2	500	2000.00	150	200	200	3	10
3	1500	1000.00	300	100	Disabled	0 ^{*1}	15

*1 Always set "0" or "2" for the auxiliary function of the last point table among consecutive point tables.

0: When using the point table as the absolute position command method

2: When using the point table as the relative position command method

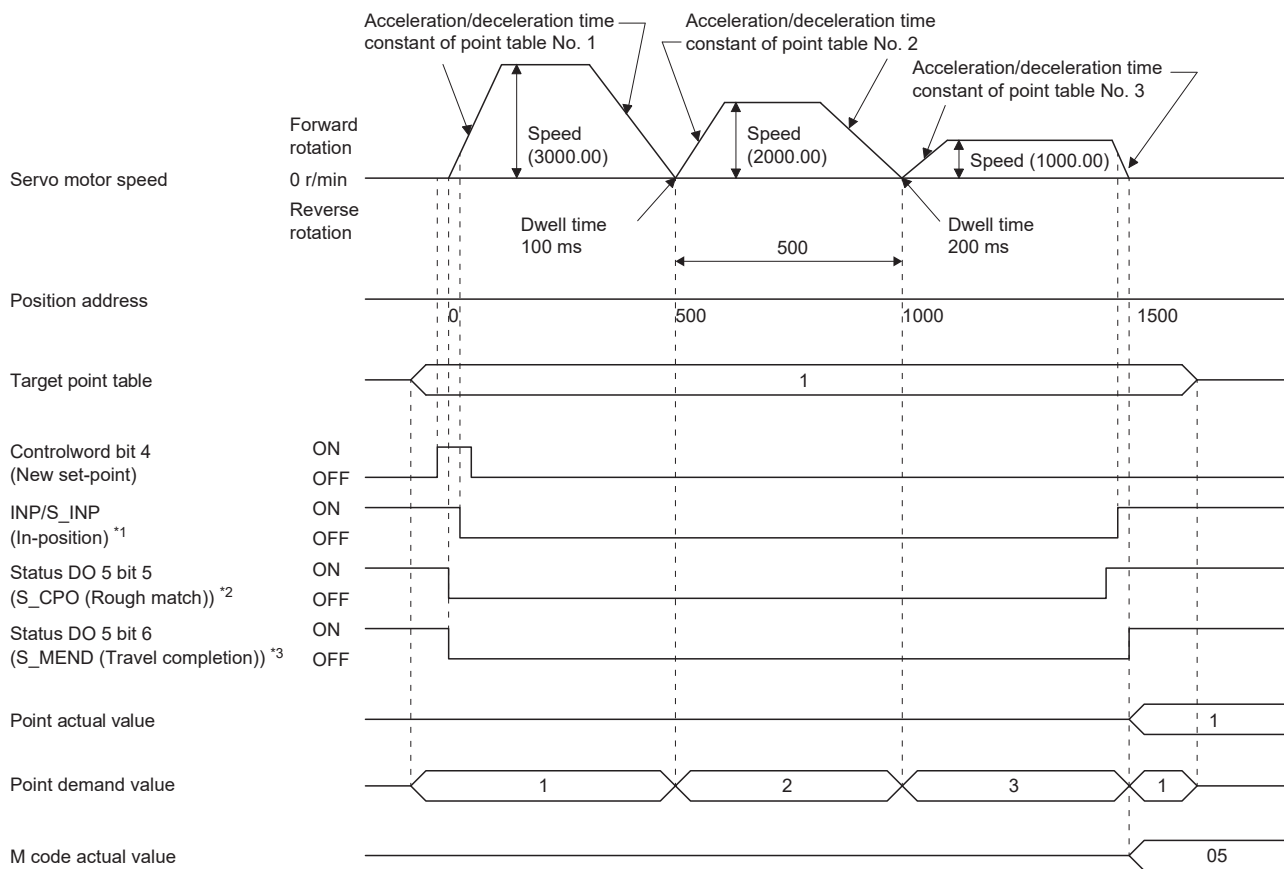

*1 The bit turns on when the droop pulse of the command unit is equal to or less than the setting value of [Pr. PA10 In-position range].

*2 The bit turns on when the command remaining distance is equal to or less than the setting value of [Pr. PT12_Rough match output range (CRP)]. The bit is off during continuous operation.

*3 The bit turns on when S_INP (in-position) is on and command remaining distance is "0". The bit is off during continuous operation.

■ When positioning in the opposite direction in the middle of operation

The following shows an example of behavior for the following setting values.

In this example, point table number 1 is the absolute position command method, point table number 2 is the relative position command method, and point table number 3 is the absolute position command method.

Point table number	Position data [pulse]	Servo motor speed [r/min]	Acceleration time constant [ms]	Deceleration time constant [ms]	Dwell time [ms]	Auxiliary function	M code
1	500	3000.00	100	150	100	1	5
2	700	2000.00	150	200	200	3	10
3	800	1000.00	300	100	Disabled	0 ^{*1}	15

*1 Always set "0" or "2" for the auxiliary function of the last point table among consecutive point tables.

0: When using the point table as the absolute position command method

2: When using the point table as the relative position command method

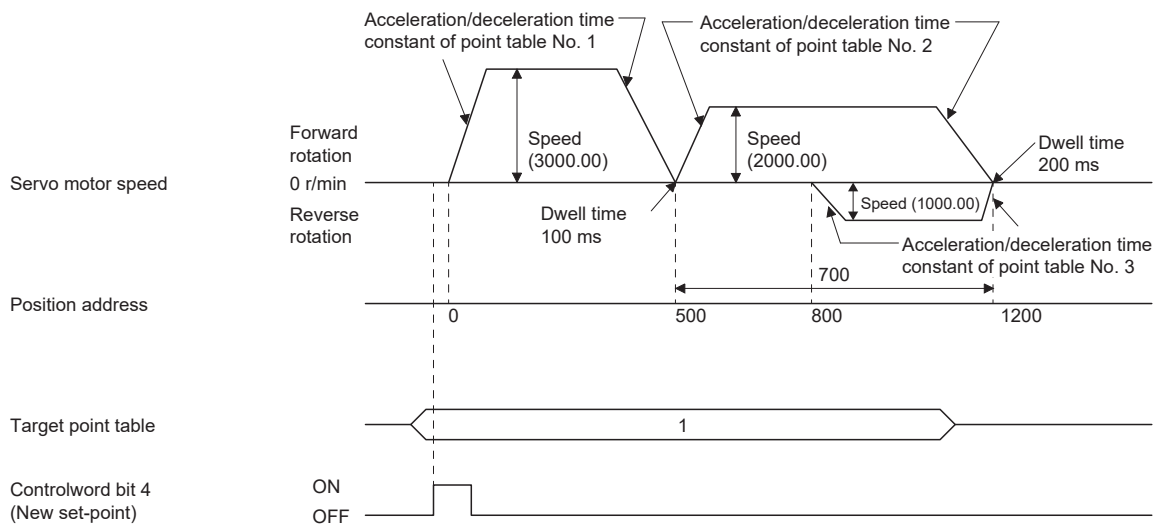

For the operation timing of S_INP (in-position), S_CPO (rough match), S_MEND (traveling completion), [Point actual value (Obj. 2D69h)], [Point demand value (Obj. 2D68h)] and [M code actual value (Obj. 2D6Ah)], refer to "When positioning to the same direction".

☞ Page 580 When positioning to the same direction

■ When the position data is in degree unit

The following shows an example of behavior for the following setting values.

In this example, point table number 1 and point table number 2 are the absolute position command method, point table number 3 is the relative position command method, and point table number 4 is the absolute position command method.

Point table number	Position data [degree]	Servo motor speed [r/min]	Acceleration time constant [ms]	Deceleration time constant [ms]	Dwell time [ms]	Auxiliary function	M code
1	120.000	1000.00	100	150	100	1	5
2	-320.000	500.00	150	100	200	1	10
3	-230.000	3000.00	200	300	150	3	15
4	70.000	1500.00	300	100	Disabled	0 ^{*1}	20

*1 Always set "0" or "2" for the auxiliary function of the last point table among consecutive point tables.

0: When using the point table as the absolute position command method

2: When using the point table as the relative position command method

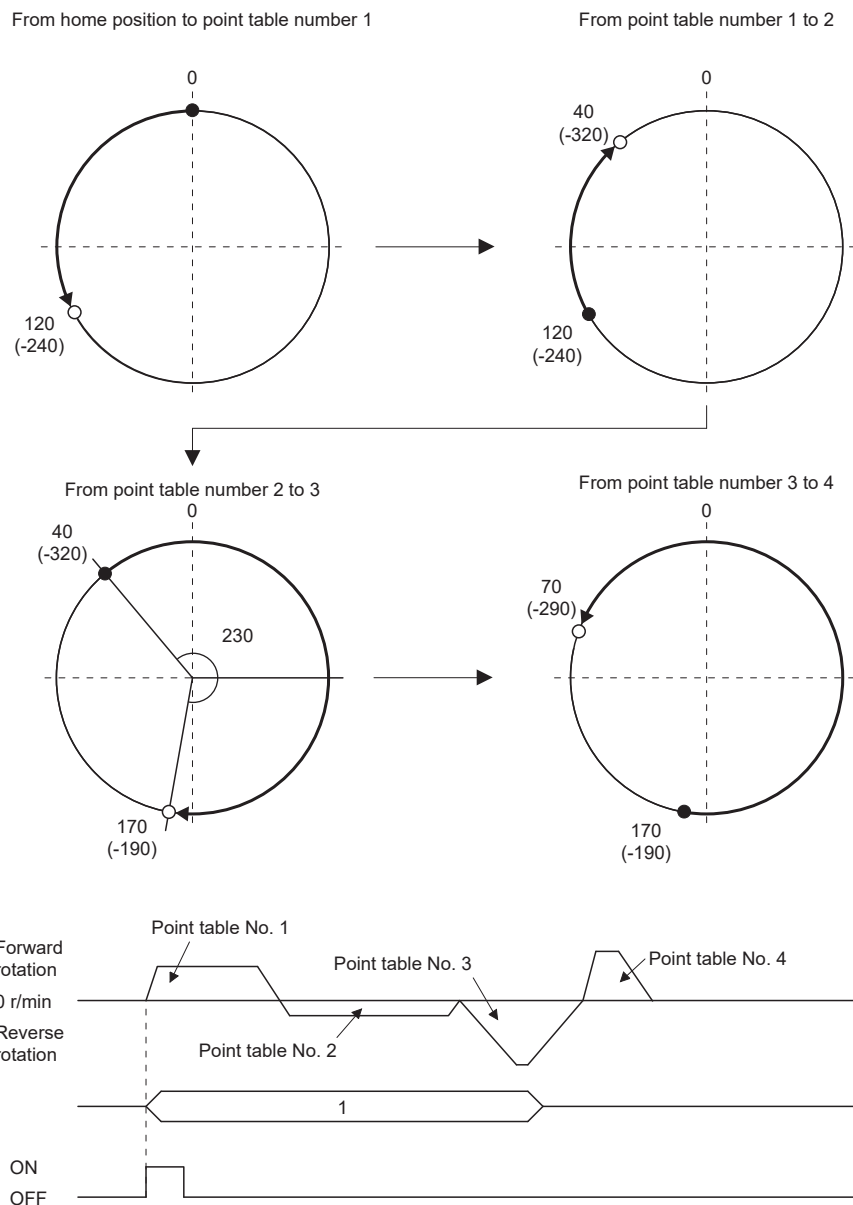

For the operation timing of S_INP (in-position), S_CPO (rough match), S_MEND (traveling completion), [Point actual value (Obj. 2D69h)], [Point demand value (Obj. 2D68h)] and [M code actual value (Obj. 2D6Ah)], refer to "When positioning to the same direction".

☞ Page 580 When positioning to the same direction

Speed change operation (absolute value command method)

The speed, acceleration/deceleration time constants, and acceleration/deceleration during the positioning operation can be changed by setting the auxiliary function of the point table.

Use the point tables as many as speeds, acceleration/deceleration time constants, and acceleration/deceleration to be set. When "1" or "3" is set for the auxiliary function, the operation is performed at the speed set in the next point table during positioning.

If the auxiliary function is set to "1" or "3" up to point table number 254, operation can be performed at a maximum speed of 255th gear.

Set the auxiliary function of the last point table to "0" or "2".

When performing the speed change operation, always set the dwell time to "0".

When "1" or more is set, continuous positioning operation is enabled.

The following shows a setting example.

Point table number	Dwell time [ms] ^{*1}	Auxiliary function	Variable speed operation
1	0	1	Consecutive point table data
2	0	3	
3	Disabled	0 ^{*2}	
4	0	3	Consecutive point table data
5	0	1	
6	Disabled	2 ^{*2}	

*1 Set to "0".

*2 Always set "0" or "2" for the auxiliary function of the last point table among consecutive point tables.

■ When positioning to the same direction

The following shows an example of behavior for the following setting values.

In this example, point table number 1 is the absolute position command method, point table number 2 is the relative position command method, and point table number 3 is the absolute position command method.

Point table number	Position data [pulse]	Servo motor speed [r/min]	Acceleration time constant [ms]	Deceleration time constant [ms]	Dwell time [ms] *1	Auxiliary function	M code
1	500	3000.00	100	150	0	1	5
2	300	2000.00	10	100	0	3	10
3	1000	1000.00	150	70	0	1	15
4	600	500.00	200	120	Disabled	2 *2	20

*1 Set to "0".

*2 Always set "0" or "2" for the auxiliary function of the last point table among consecutive point tables.

0: When using the point table as the absolute position command method

2: When using the point table as the relative position command method

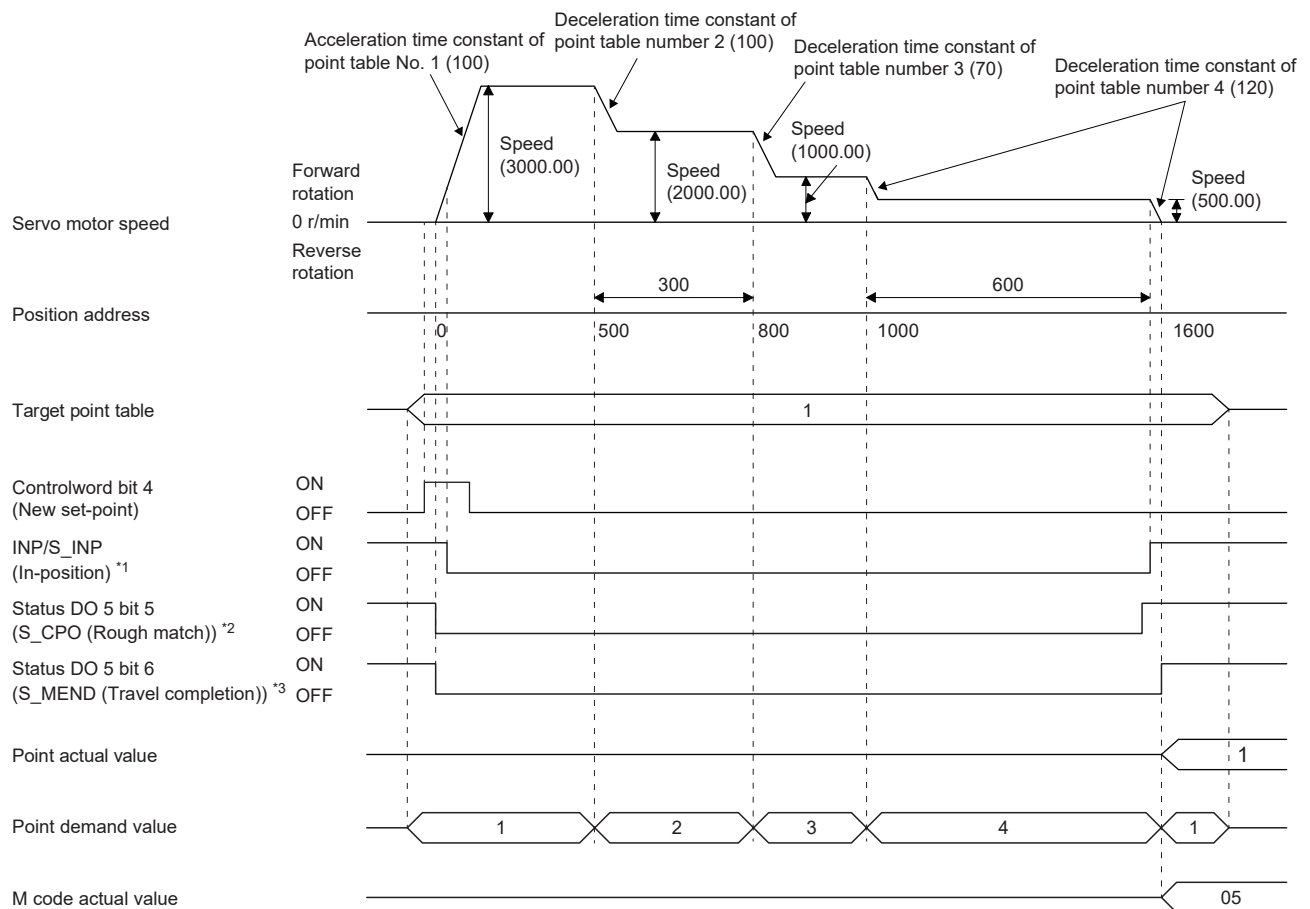

*1 The bit turns on when the droop pulse of the command unit is equal to or less than the setting value of [Pr. PA10 In-position range].

*2 The bit turns on when the command remaining distance is equal to or less than the setting value of [Pr. PT12_Rough match output range (CRP)]. The bit is off during continuous operation.

*3 The bit turns on when S_INP (in-position) is on and command remaining distance is "0". The bit is off during continuous operation.

■ When positioning in the opposite direction in the middle of operation

The following shows an example of behavior for the following setting values.

In this example, point table number 1 is the absolute position command method, point table number 2 is the relative position command method, and point table number 3 is the absolute position command method.

Point table number	Position data [pulse]	Servo motor speed [r/min]	Acceleration time constant [ms]	Deceleration time constant [ms]	Dwell time [ms] ^{*1}	Auxiliary function	M code
1	500	3000.00	100	150	0	1	5
2	700	2000.00	50	130	0	3	10
3	800	1000.00	120	100	Disabled	0 ^{*2}	15

*1 Set to "0".

*2 Always set "0" or "2" for the auxiliary function of the last point table among consecutive point tables.

0: When using the point table as the absolute position command method

2: When using the point table as the relative position command method

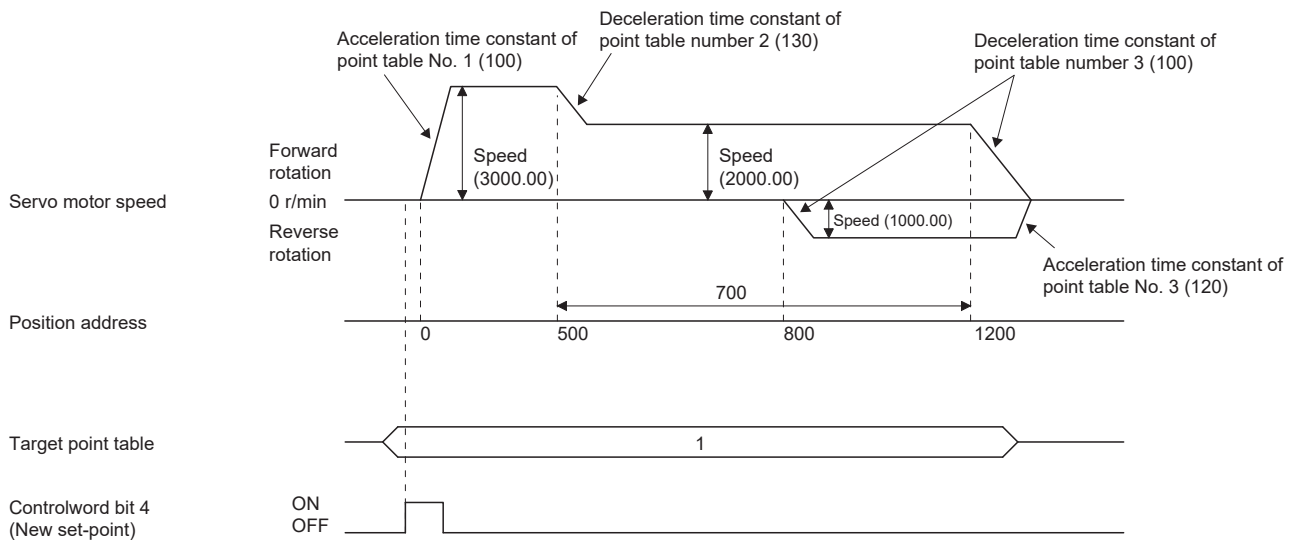

For the operation timing of S_INP (in-position), S_CPO (rough match), S_MEND (traveling completion), [Point actual value (Obj. 2D69h)], [Point demand value (Obj. 2D68h)] and [M code actual value (Obj. 2D6Ah)], refer to "When positioning to the same direction".

☞ Page 584 When positioning to the same direction

Repetitive positioning operation (absolute value command method)

Set the auxiliary function of the point table to return to the operation pattern of the set point table number and enable the repetitive positioning operation.

When "8" or "10" is set for the auxiliary function, continuous operation or speed change operation is performed up to the point table, and after positioning is completed, continuous operation or speed change operation is performed again from the operation pattern of the point table number at startup.

When "9" or "11" is set for the auxiliary function, continuous operation or speed change operation is performed up to the point table, and after positioning is completed, continuous operation or speed change operation is performed again from the operation pattern of the point table number 1.

■ When performing repetitive positioning operation with the absolute position command method

Ex.

The following shows the behavior when "8" is set for the auxiliary function of the point table number 4.

Point table number	Position data [pulse]	Servo motor speed [r/min]	Acceleration time constant [ms]	Deceleration time constant [ms]	Dwell time [ms]	Auxiliary function	M code
1	400	1500.00	200	100	150	1	1
2	500	3000.00	100	150	100	1	5
3	500	2000.00	150	200	200	3	10
4	1500	1000.00	300	100	150	8	15

Operation sequence

1. Start with the point table number 2.
2. Execute the point table number 3.
3. Execute the point table number 4.
4. Execute the point table number 2 again at startup with the auxiliary function "8" of the point table number 4.
5. Repeat the above steps in the order of 2, 3, 4, 2, 3, 4.

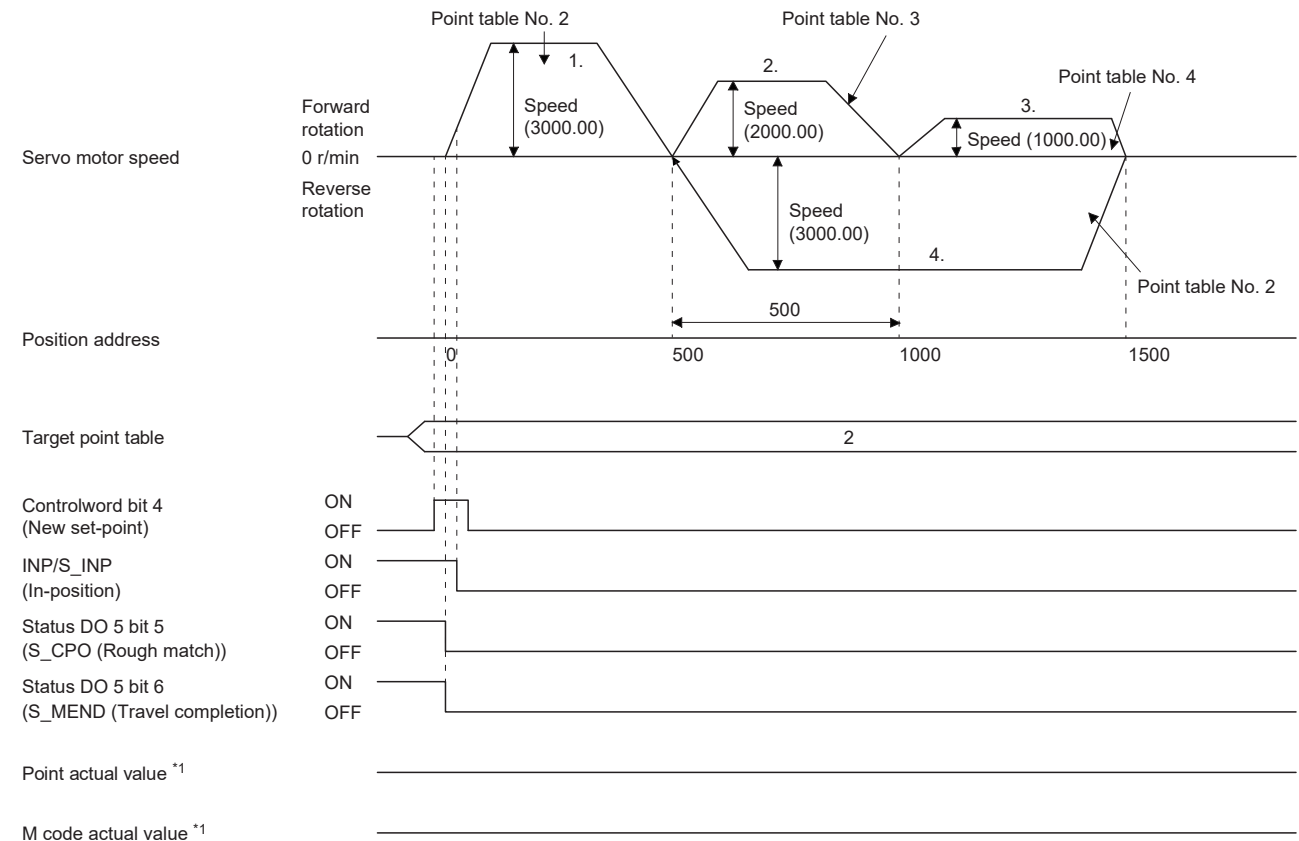

*1 In repetitive positioning operation, [Point actual value (Obj. 2D69h)] and [M code actual value (Obj. 2D6Ah)] are not output.

Ex.

The following shows the behavior when "9" is set for the auxiliary function of the point table number 3.

Point table number	Position data [pulse]	Servo motor speed [r/min]	Acceleration time constant [ms]	Deceleration time constant [ms]	Dwell time [ms]	Auxiliary function	M code
1	0	3000.00	100	150	100	1	5
2	500	2000.00	150	200	200	1	10
3	1500	1000.00	300	100	150	9	15

Operation sequence

1. Start with the point table number 2.
2. Execute the point table number 3.
3. Execute the point table number 1 with the auxiliary function "9" of the point table number 3.
4. Repeat the above steps in the order of 1, 2, 3, 1, 2, 3.

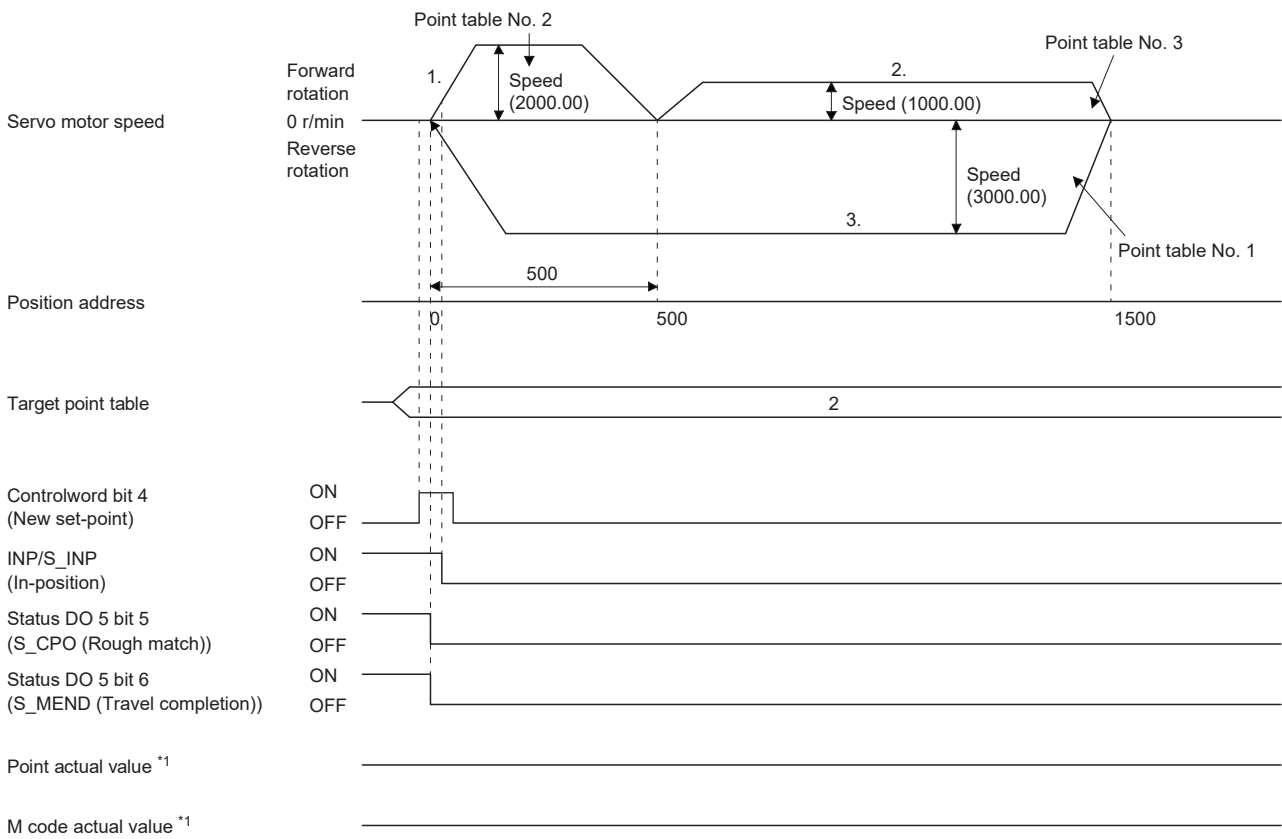

*1 In repetitive positioning operation, [Point actual value (Obj. 2D69h)] and [M code actual value (Obj. 2D6Ah)] are not output.

■ When performing repetitive positioning operation with the relative position command method

Ex.

The following shows the behavior when "10" is set for the auxiliary function of the point table number 4.

Point table number	Position data [pulse]	Servo motor speed [r/min]	Acceleration time constant [ms]	Deceleration time constant [ms]	Dwell time [ms]	Auxiliary function	M code
1	400	1500.00	200	100	150	1	1
2	500	3000.00	100	150	100	3	5
3	1000	2000.00	150	200	200	1	10
4	500	1000.00	300	100	150	10	15

Operation sequence

1. Start with the point table number 2.
2. Execute the point table number 3.
3. Execute the point table number 4.
4. Execute the point table number 2 again at startup with the auxiliary function "10" of the point table number 4.
5. Repeat the above steps in the order of 1, 2, 3, 4, 2, 3, 4.

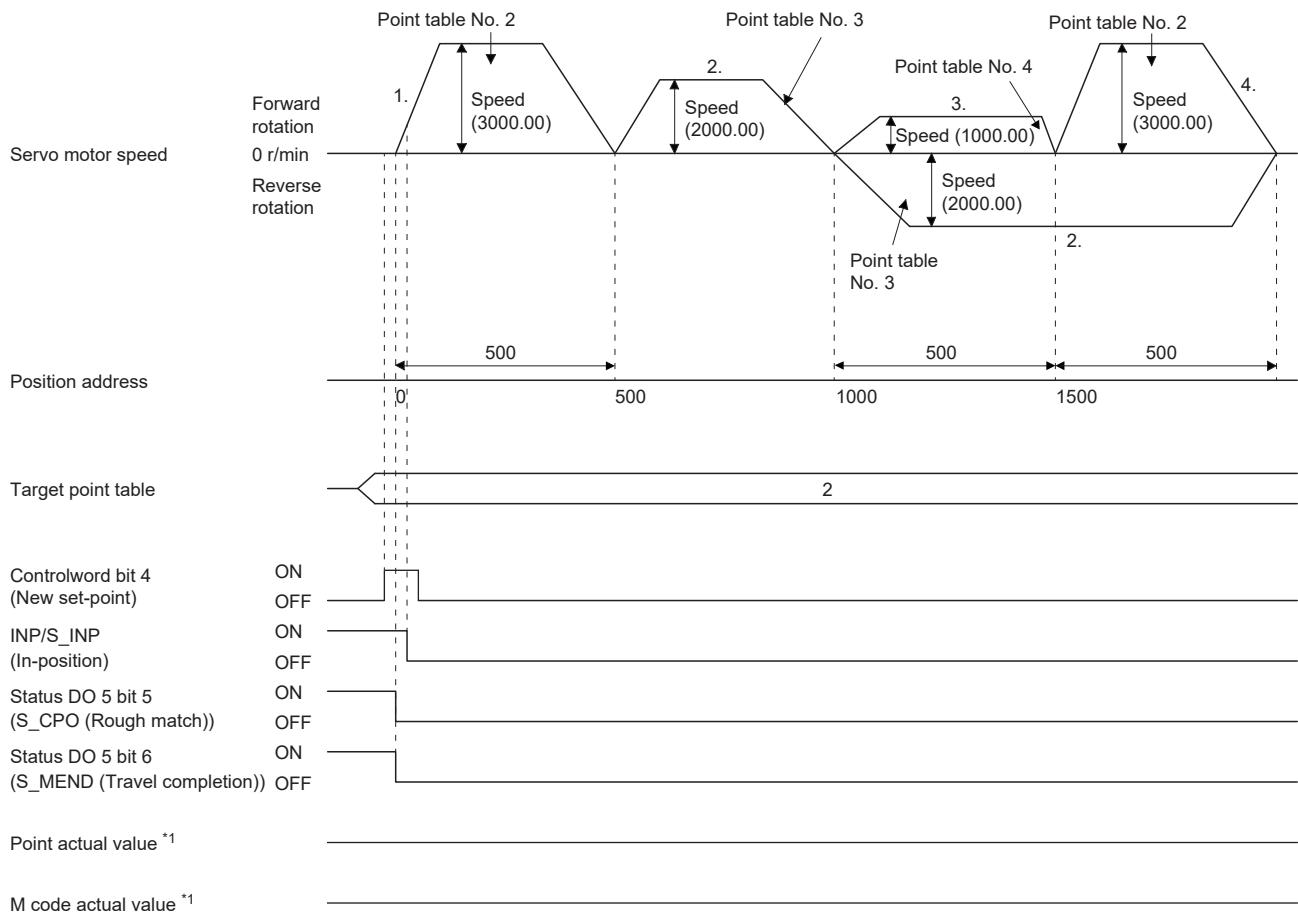

*1 In repetitive positioning operation, [Point actual value (Obj. 2D69h)] and [M code actual value (Obj. 2D6Ah)] are not output.

Ex.

The following shows the behavior when "11" is set for the auxiliary function of the point table number 3.

Point table number	Position data [pulse]	Servo motor speed [r/min]	Acceleration time constant [ms]	Deceleration time constant [ms]	Dwell time [ms]	Auxiliary function	M code
1	500	3000.00	100	150	100	3	5
2	1000	2000.00	150	200	200	1	10
3	500	1000.00	300	100	150	11	15

Operation sequence

1. Start with the point table number 2.
2. Execute the point table number 3.
3. Execute the point table number 1 with the auxiliary function "11" of the point table number 3.
4. Repeat the above steps in the order of 1, 2, 3, 1, 2, 3.

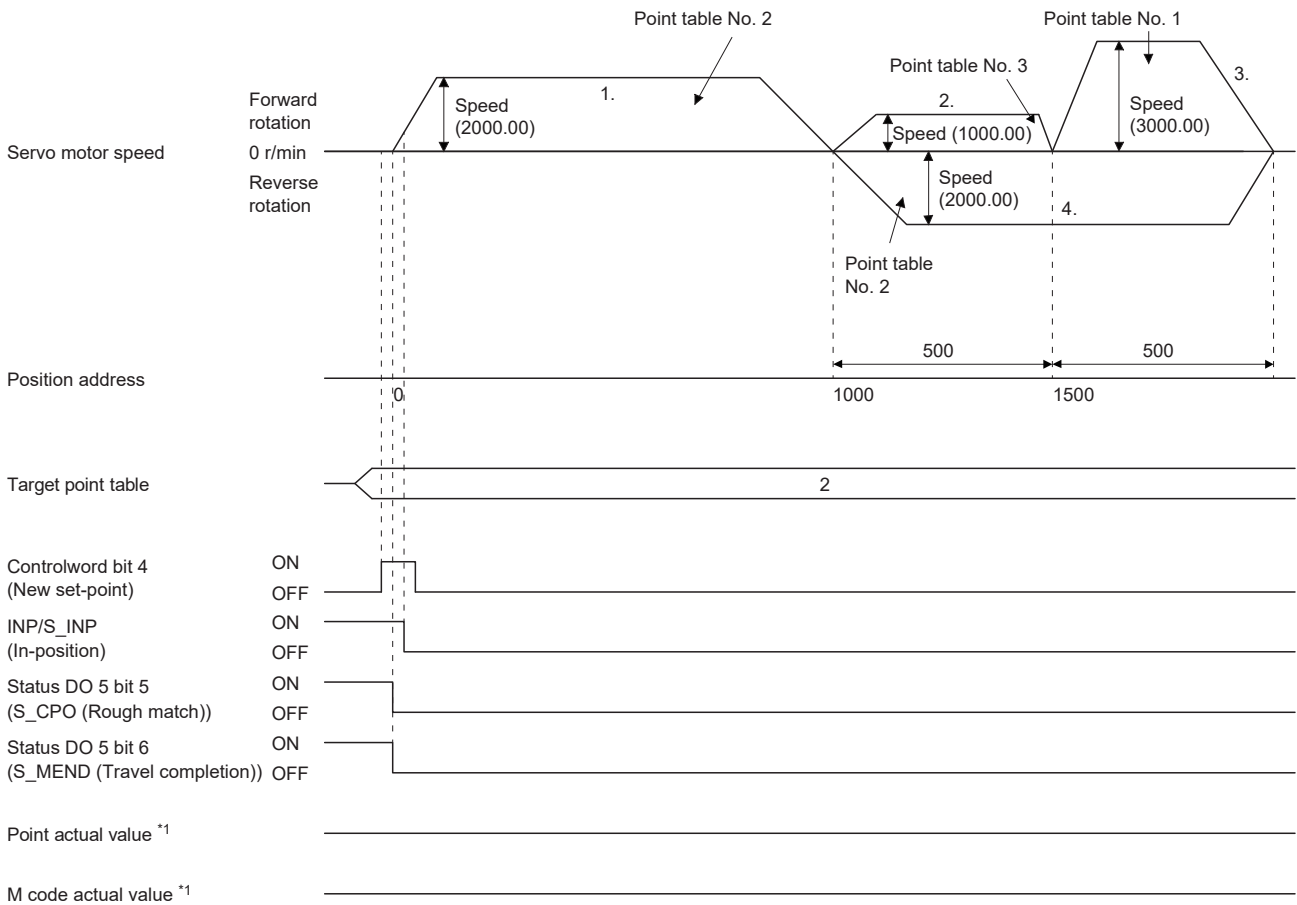

*1 In repetitive positioning operation, [Point actual value (Obj. 2D69h)] and [M code actual value (Obj. 2D6Ah)] are not output.

■ When performing speed change operation with the absolute position command method

Ex.

The following shows the behavior when "8" is set for the auxiliary function of the point table number 3.

Point table number	Position data [pulse]	Servo motor speed [r/min]	Acceleration time constant [ms]	Deceleration time constant [ms]	Dwell time [ms]	Auxiliary function	M code
1	500	3000.00	100	150	0	1	5
2	500	2000.00	110	160	0	3	10
3	1500	1000.00	90	140	0	8	15

Operation sequence

1. Start with the point table number 1.
2. Change the speed, and execute the point table number 2.
3. Change the speed, and execute the point table number 3.
4. Execute the point table number 1 at startup with the auxiliary function "8" of the point table number 3.
5. Repeat the above steps in the order of 1, 2, 3, 4, 2, 3, 4.

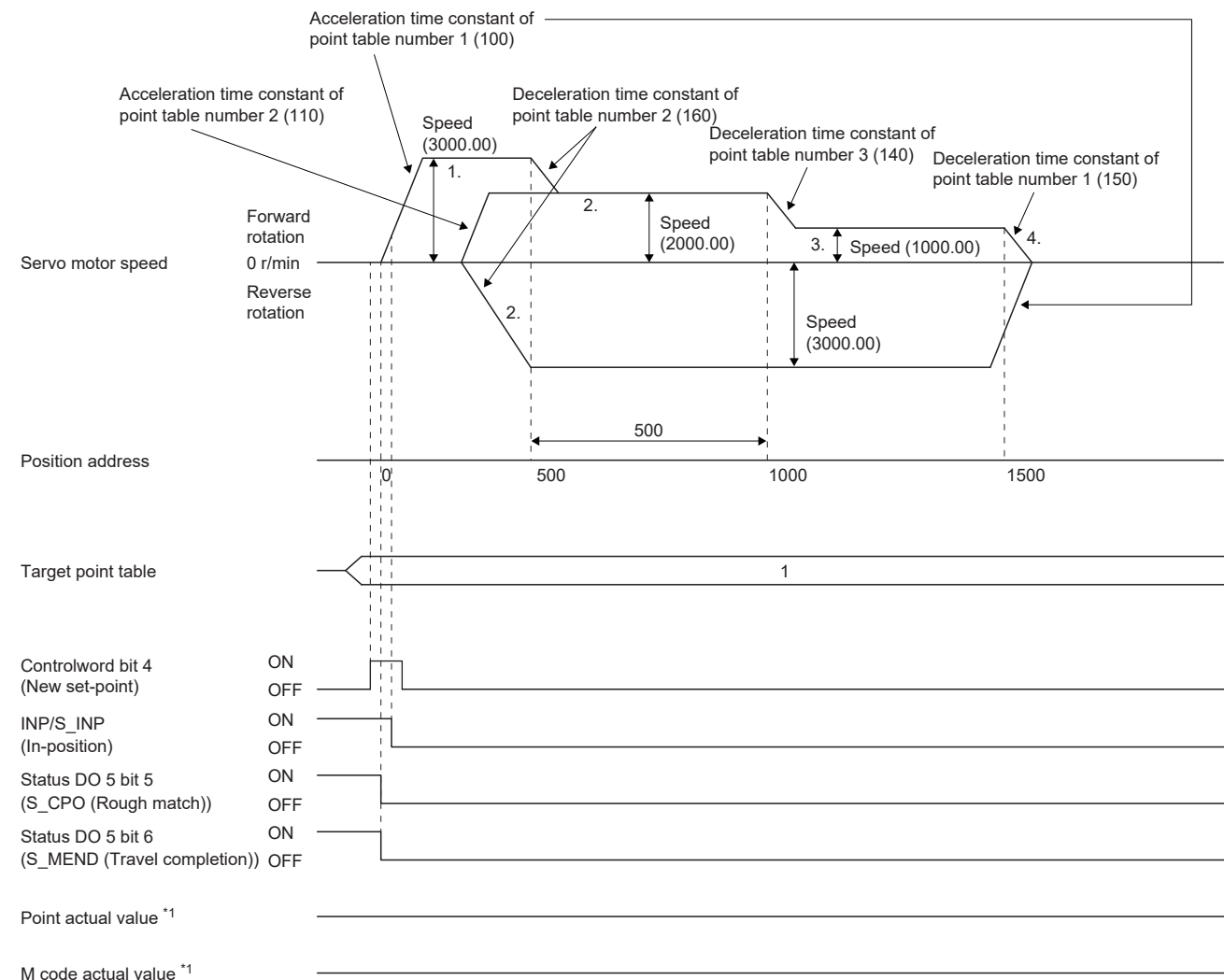

*1 In repetitive positioning operation, [Point actual value (Obj. 2D69h)] and [M code actual value (Obj. 2D6Ah)] are not output.

■ When performing speed change operation with the relative position command method

Ex.

The following shows the behavior when "10" is set for the auxiliary function of the point table number 3.

Point table number	Position data [pulse]	Servo motor speed [r/min]	Acceleration time constant [ms]	Deceleration time constant [ms]	Dwell time [ms]	Auxiliary function	M code
1	500	3000.00	100	150	0	3	5
2	1000	2000.00	110	160	0	1	10
3	500	1000.00	90	140	0	10	15

Operation sequence

1. Start with the point table number 1.
2. Change the speed, and execute the point table number 2.
3. Change the speed, and execute the point table number 3.
4. Change the speed, and execute the point table number 1 with the auxiliary function "10" of the point table number 3.
5. Repeat the above steps in the order of 1, 2, 3, 4, 2, 3, 4.

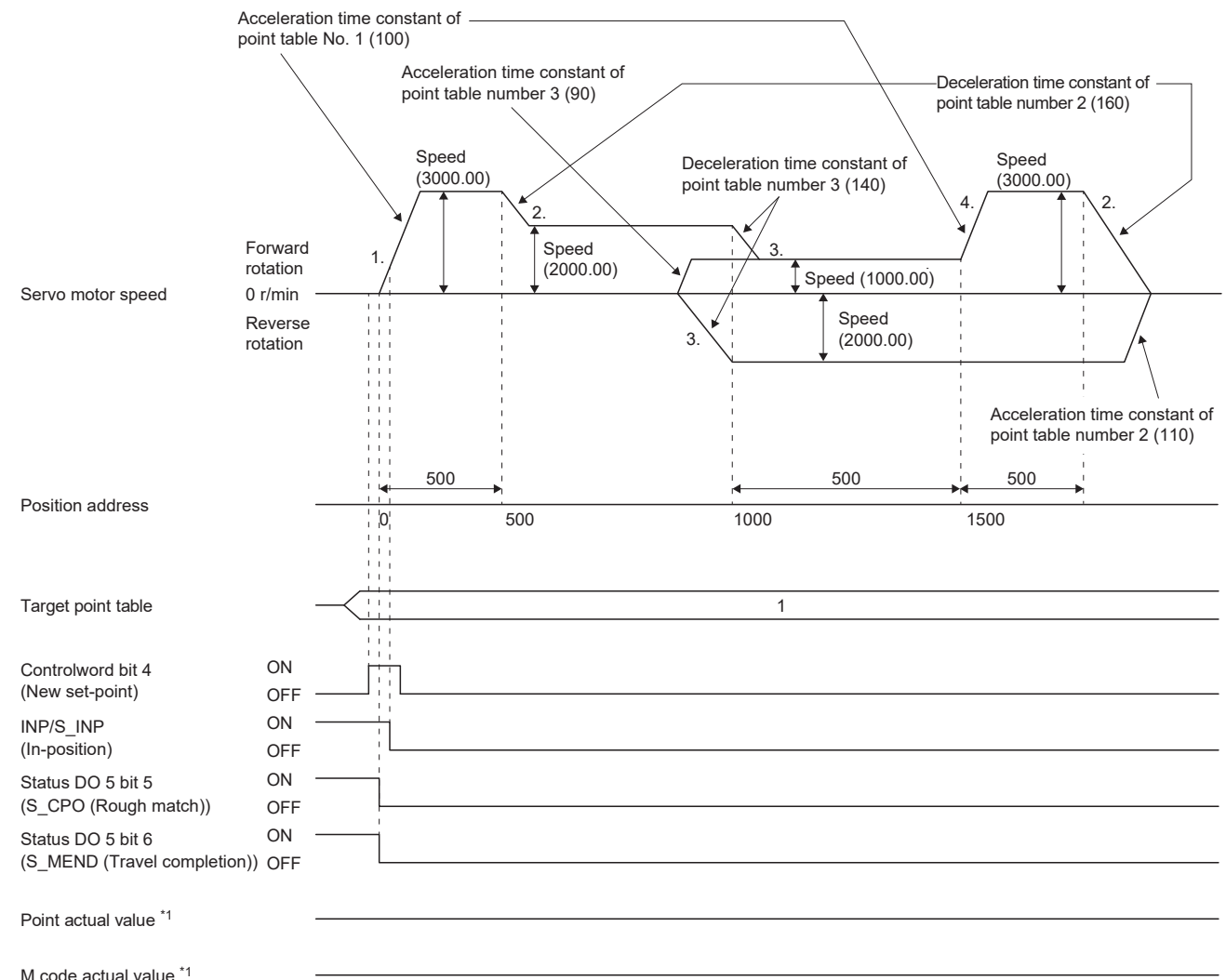

*1 In repetitive positioning operation, [Point actual value (Obj. 2D69h)] and [M code actual value (Obj. 2D6Ah)] are not output.

Temporary stop/restart

When bit 8 (HALT) of [Controlword (Obj. 6040h)] is turned on during point table operation, the servo motor decelerates and stops temporarily at the deceleration time constant/deceleration of the point table being executed. When bit 8 (HALT) of [Controlword (Obj. 6040h)] is turned off during temporary stop, traveling for the remaining distance is started.

Even if bit 4 (New set-point) of [Controlword (Obj. 6040h)] is turned on during temporary stop, operation is not started.

If any of the following conditions are met during temporary stop, the remaining travel distance is cleared.

- Bit 4 (New set-point) of [Controlword (Obj. 6040h)] was turned on.
- Switched to the servo-off state.
- Stroke limit or software position limit was detected.
- Control reset was executed.

The temporarily stopped M code update setting can be changed in "M code update setting" of [Pr. PT83.2_Positioning function selection 2].

Setting value of "M code update setting" (BIN)	Behavior
0	After the remaining travel distance is cleared, the M code is updated. In addition, the M code changes to "0" under the following conditions. <ul style="list-style-type: none"> • When an alarm has occurred • When the control mode is switched to JOG operation mode (jg)
1	After the remaining travel distance is cleared, the M code is updated. In addition, the M code changes to "0" under the following conditions. <ul style="list-style-type: none"> • When an alarm has occurred • When [AL. 0E6 Servo forced stop warning], [AL. 0E9 Main circuit off warning], [AL. 0EA ABS servo-on warning], or [AL. 0EB The other axis error warning] has occurred • When the control mode is switched to JOG operation mode (jg)

The following shows the conditions under which the temporary stop/restart input functions.

Operation status	Operation mode		
	Point table mode (pt)	JOG operation mode (jg)	Homing mode (hm)
Stopped	—	—	—
Accelerating	Temporary stop	Temporary stop	Stop
At constant speed	Temporary stop	Temporary stop	Stop
Decelerating	—	—	—
Temporarily stopped	Restart	Restart	Stop

■ When the servo motor is rotating

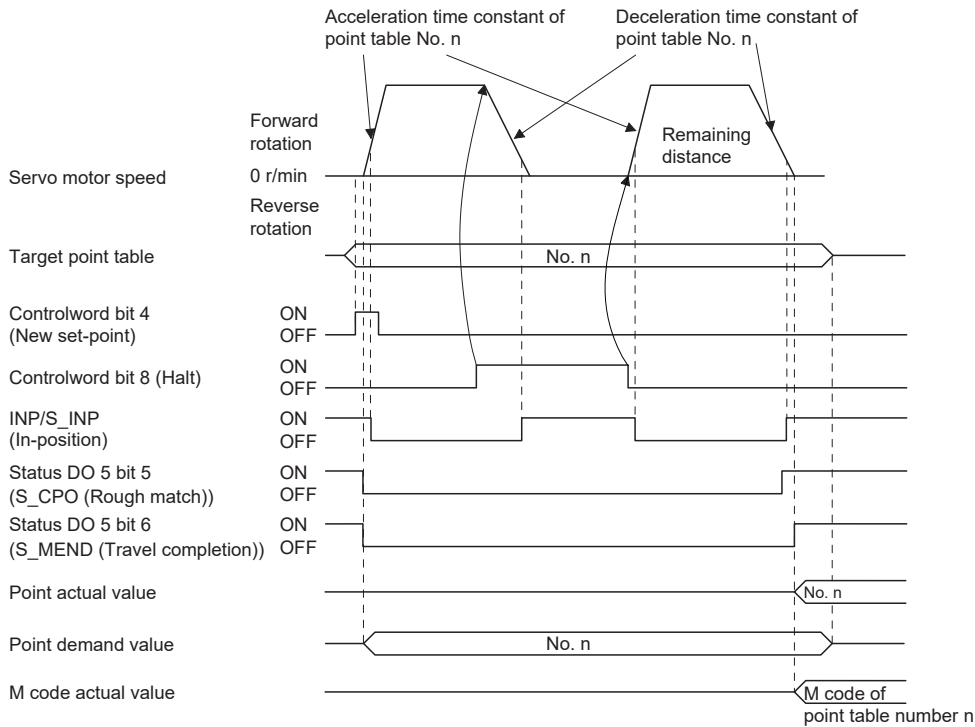

■ During dwell

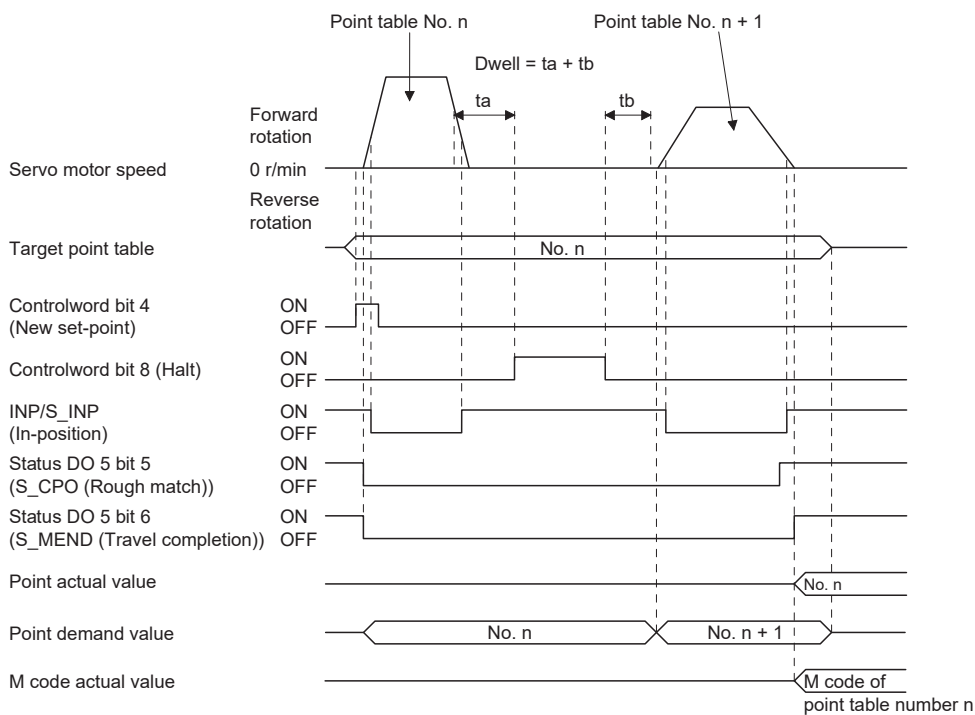

Interruption of point table operation

To interrupt the point table operation or change the operation pattern, stop the operation with bit 8 (HALT) of [Controlword (Obj. 6040h)], and turn on bit 4 (New set-point) of [Controlword (Obj. 6040h)]. The remaining distance is cleared.

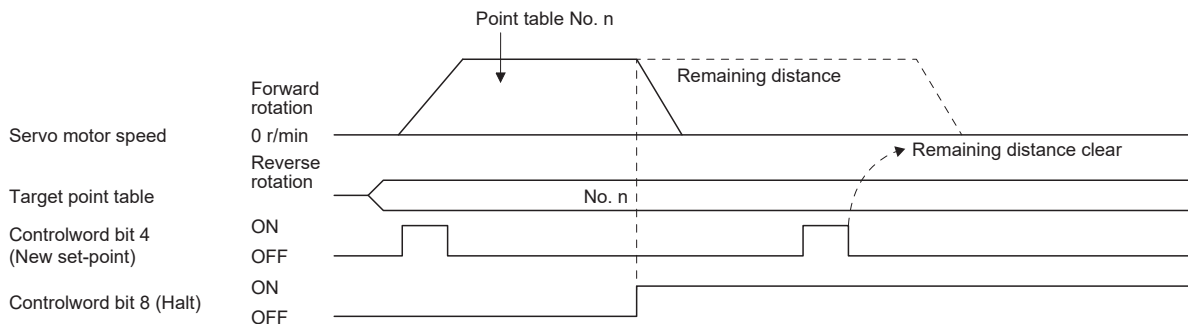

■ Timing chart of M code update

- When "M code update setting" of [Pr. PT83.2_Positioning function selection 2] is "0"

After New set-point, the M code is updated to the M code to correspond to the number of Target point table.

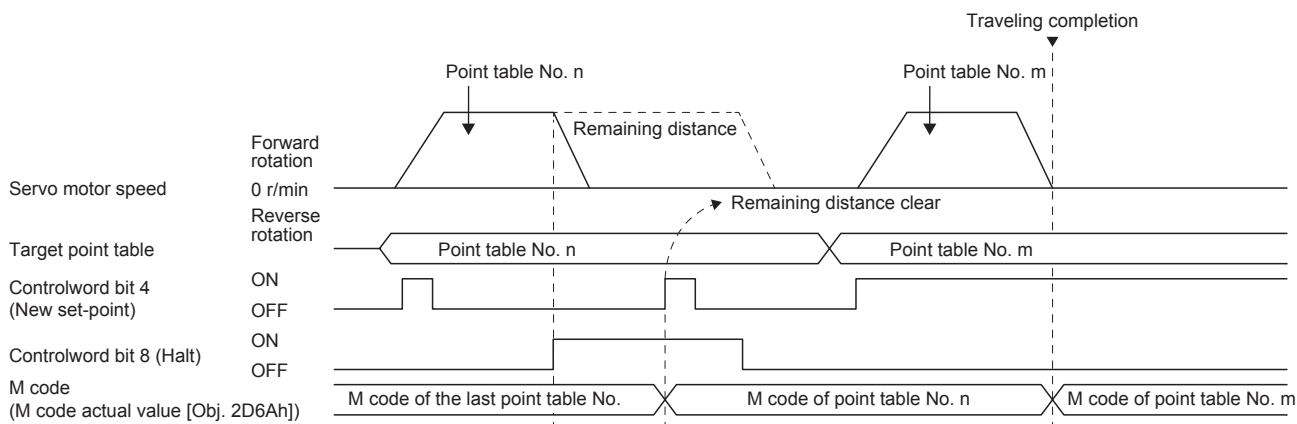

- When "M code update setting" of [Pr. PT83.2_Positioning function selection 2] is "0"

Because the positioning operation is not finished, the M code is not updated from the value before positioning operation even after New set-point.

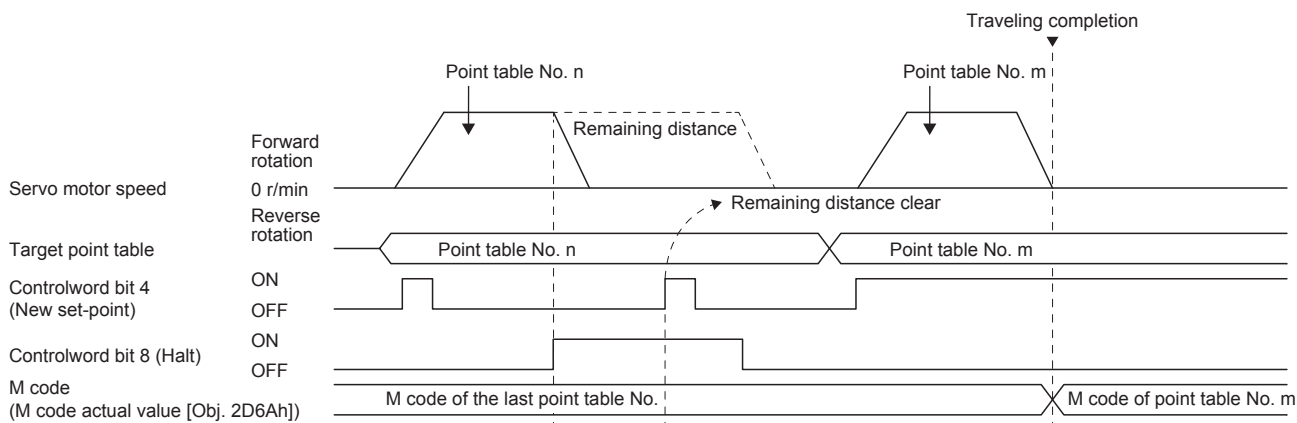

Positioning function to the home position

This function allows positioning to the home position to return to the home position after the home position has been determined by homing after power-on. For the absolute position detection system, homing is not required after power-on. If positioning to the home is performed when homing has not been completed, [AL. 090.1 Homing incomplete warning] will occur.

After power-on, perform homing in advance.

Set the objects and servo parameters as follows.

Item *1	Object/servo parameter	Setting details
Point table mode (pt) selection	[Modes of operation (Obj. 6060h)]	Set to "-101".
Point table selection	[Target point table (Obj. 2D60h)]	Set to "-1".
Homing speed	[Speed during search for switch (Obj. 6099: 01h)]	Set the servo motor speed for traveling to the home position.
Acceleration time constant	<ul style="list-style-type: none"> [Homing acceleration (Obj. 609Ah)] [Pr. PT56 Homing acceleration time constant] 	Set the acceleration time constant.
Acceleration	<ul style="list-style-type: none"> [Homing acceleration (Obj. 609Ah)] [Pr. PV15 Homing acceleration] 	Set the acceleration to reach the set servo motor speed. (Acceleration time [s] = Servo motor speed / Acceleration)
Deceleration time constant	<ul style="list-style-type: none"> When [Pr. PT55.0 Homing deceleration time constant selection] is set to "0" [Homing acceleration (Obj. 609Ah)] <ul style="list-style-type: none"> When [Pr. PT55.0] is set to "1" [Pr. PT57 Homing deceleration time constant]	Set the deceleration time constant.
Deceleration	<ul style="list-style-type: none"> When [Pr. PT55.0 Homing deceleration time constant selection] is set to "0" [Homing acceleration (Obj. 609Ah)] <ul style="list-style-type: none"> When [Pr. PT55.0] is set to "1" [Pr. PV17 Homing deceleration]	Set the deceleration to stop the servo motor from the set servo motor speed. (Deceleration time [s] = Servo motor speed / Deceleration)

*1 The setting unit of the speed data and acceleration/deceleration data can be switched with [Pr. PT01.1].

Set the homing speed of the home positioning function with [Speed during search for switch (Obj. 6099h: 01h)].

Set the acceleration time constant/acceleration with [Homing acceleration (Obj. 609Ah)].

The usage method of the deceleration time constant/deceleration differs depending on the setting value of [Pr. PT55.0 Homing deceleration time constant selection].

Select [Homing acceleration (Obj. 609Ah)], [Pr. PT57 Homing deceleration time constant], or [Pr. PV17 Homing deceleration]. When bit 15 (S_ZP2) of [Status DO2 (Obj. 2D12h)] is on and bit 10 (Target reached) of [Statusword (Obj. 6041h)] is on, turning on bit 4 (New set-point) of [Controlword (Obj. 6040h)] executes positioning to the home position.

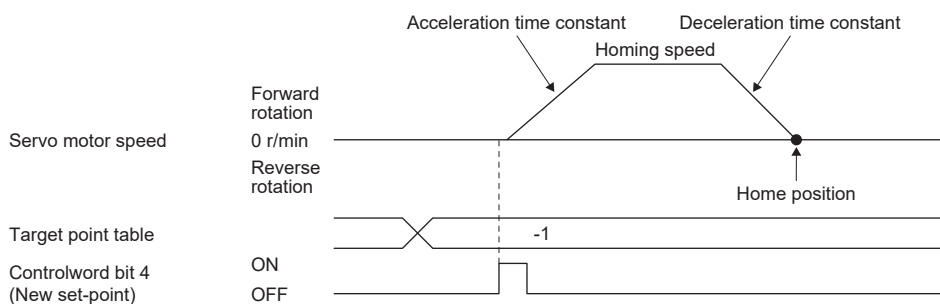

10.3 JOG operation mode (jg)

Point

When [Pr. PT01.1 Speed/acceleration/deceleration unit selection] is set to "1" (command unit/s, command unit/s²), the setting ranges of the servo motor speed and acceleration/deceleration differ from those in the point table mode (pt). Therefore, it is recommended that the same range be used as in the point table mode (pt).

For machine adjustment and home positioning, JOG operation enables desired positioning.

JOG operation

Setting

Set the objects and servo parameters as follows according to the purpose of use. When the JOG operation is used, [Target point table (Obj. 2D60h)] is disabled.

Item *1	Object/servo parameter	Setting details
JOG operation mode (jg) selection	[Modes of operation (Obj. 6060h)]	Set to "-100".
Servo motor rotation direction	[Pr. PA14 Travel direction selection]	☞ Page 597 Servo motor rotation direction
JOG speed	[Profile velocity (Obj. 6081h)]	Set the servo motor speed.
Acceleration time constant	[Profile Acceleration (Obj. 6083h)]	Set the acceleration time constant.
Acceleration		Set the acceleration to reach the set servo motor speed. (Acceleration time [s] = Servo motor speed / Acceleration)
Deceleration time constant	[Profile deceleration (Obj. 6084h)]	Set the deceleration time constant.
Deceleration		Set the deceleration to stop the servo motor from the set servo motor speed. (Deceleration time [s] = Servo motor speed / Deceleration)
S-pattern acceleration/deceleration time constant	[Pr. PT51 S-pattern acceleration/deceleration time constant]	Set the S-pattern acceleration/deceleration time constant.
Speed limit	[Max profile velocity (Obj. 607Fh)]	Set the speed limit value.
Acceleration limit *2	[Max acceleration (Obj. 60C5h)]	Set the acceleration limit value.
Deceleration limit *2	[Max deceleration (Obj. 60C6h)]	Set the deceleration limit value.

*1 The setting unit of the speed data and acceleration/deceleration data can be switched with [Pr. PT01.1].

*2 Available on servo amplifiers with firmware version C0 or later.

Servo motor rotation direction

Select the servo motor rotation direction when bit 4 (Rotation start) of [Controlword (Obj. 6040h)] is turned on.

[Pr. PA14 Travel direction selection]	Servo motor rotation direction	
	[Controlword (Obj. 6040h)] bit 5 (Direction) OFF	[Controlword (Obj. 6040h)] bit 5 (Direction) ON
0	Rotate in CCW direction	Rotate in CW direction
1	Rotate in CW direction	Rotate in CCW direction

10

- When [Pr. PA14] is set to "0"

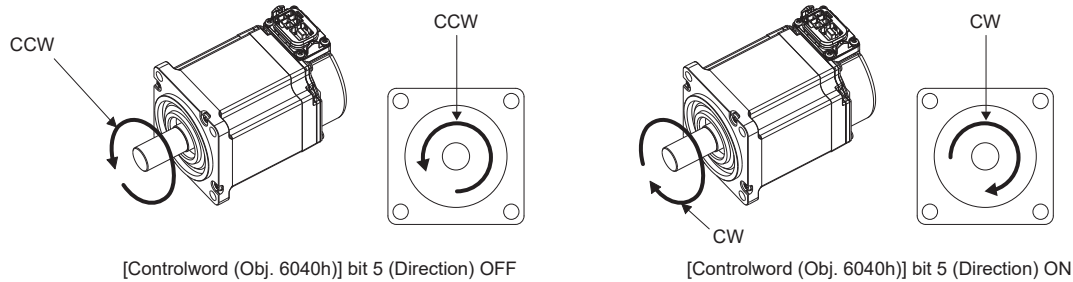

- When [Pr. PA14] is set to "1"

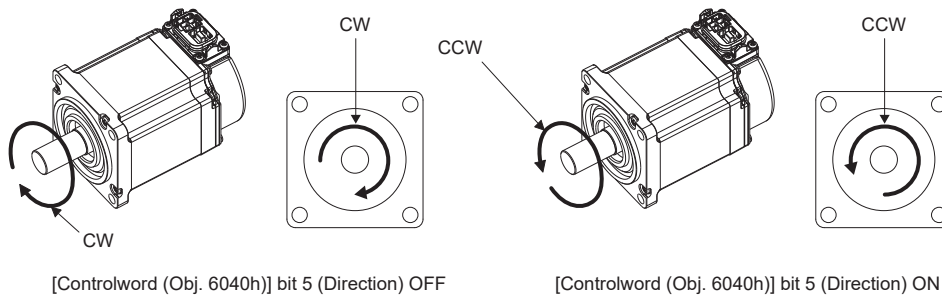

Operation

When [Controlword (Obj. 6040h)] bit 4 (Rotation start) is turned on, the servo motor operates at the set JOG speed, acceleration time constant/acceleration, and deceleration time constant/deceleration.

☞ Page 596 Setting

When [Controlword (Obj. 6040h)] bit 4 (Rotation start) and [Controlword (Obj. 6040h)] bit 5 (Direction) are turned on, the servo motor rotates in the reverse direction.

☞ Page 597 Servo motor rotation direction

Timing chart

■ When operating at a constant speed

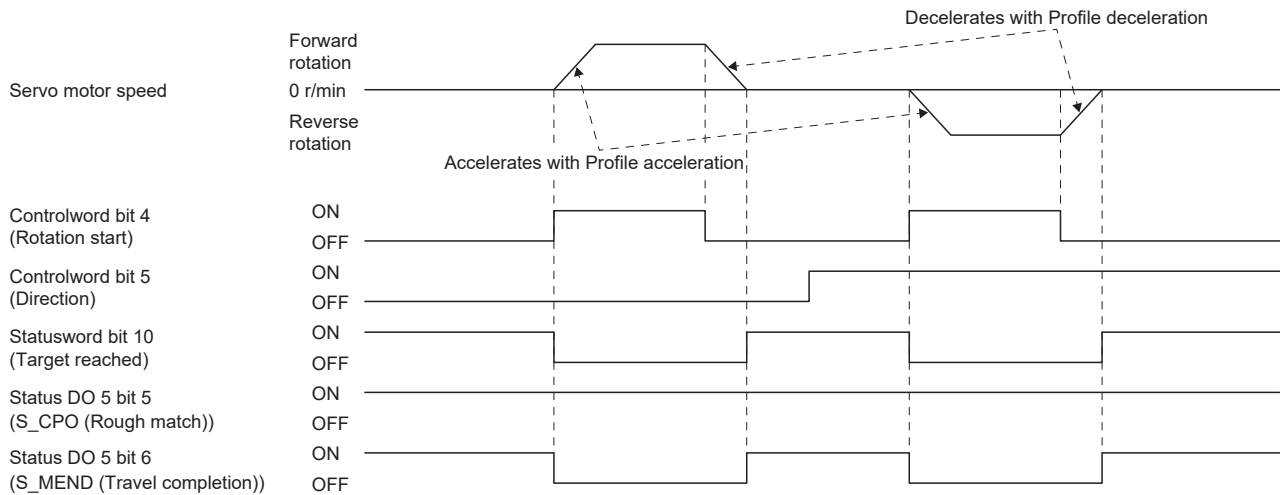

■ When changing the speed during operation

The servo motor speed can be changed during operation by changing [Profile velocity (Obj. 6081h)]. The servo motor speed cannot be changed during deceleration.

The acceleration time constant/acceleration and deceleration time constant/deceleration can be changed while the servo motor is stopped.

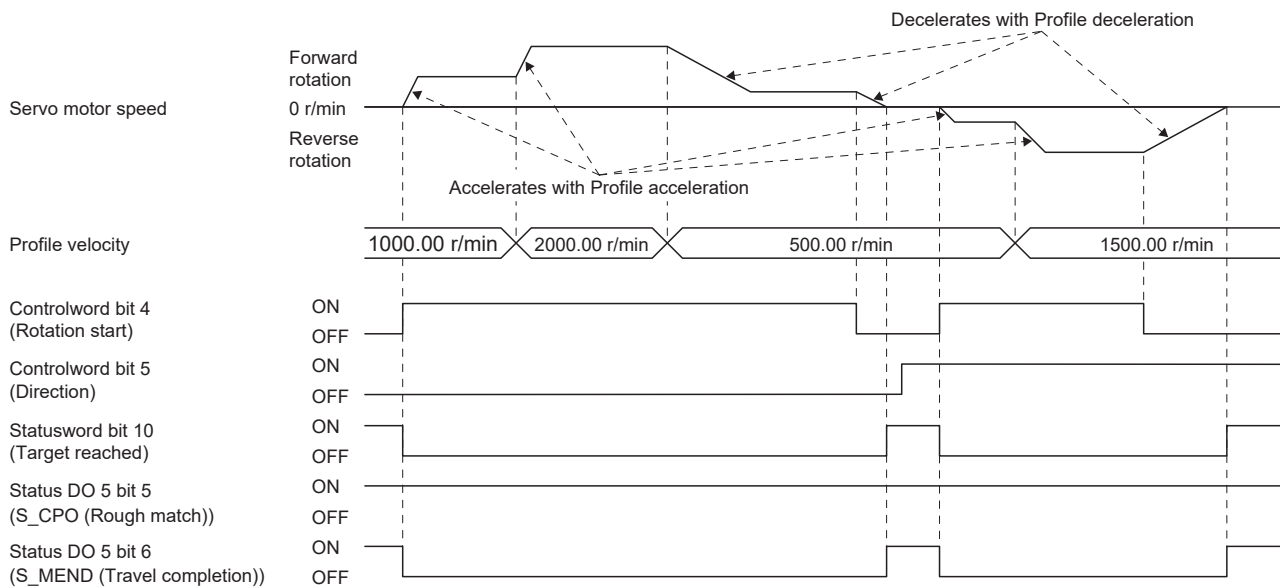

Temporary stop/restart

When bit 8 (Halt) of [Controlword (Obj. 6040h)] is turned on during JOG operation, the motor will decelerate and stop temporarily at the deceleration time constant/deceleration [Profile deceleration (Obj. 6084h)] being executed. When bit 8 (Halt) of [Controlword (Obj. 6040h)] is turned off during temporary stop, JOG operation is restarted. When bit 4 (Rotation start) of [Controlword (Obj. 6040h)] is off, operation is not restarted.

Even if bit 4 (Rotation start) of [Controlword (Obj. 6040h)] is turned on during temporarily stop, operation is not started.

If any of the following conditions are met during temporary stop, temporary stop is released.

- Switched to the servo-off state.
- Stroke limit or software position limit was detected.
- Control reset was executed.

The conditions under which the temporary stop/restart input functions are the same as the point table operation.

☞ Page 592 Temporary stop/restart

■ When the servo motor is rotating

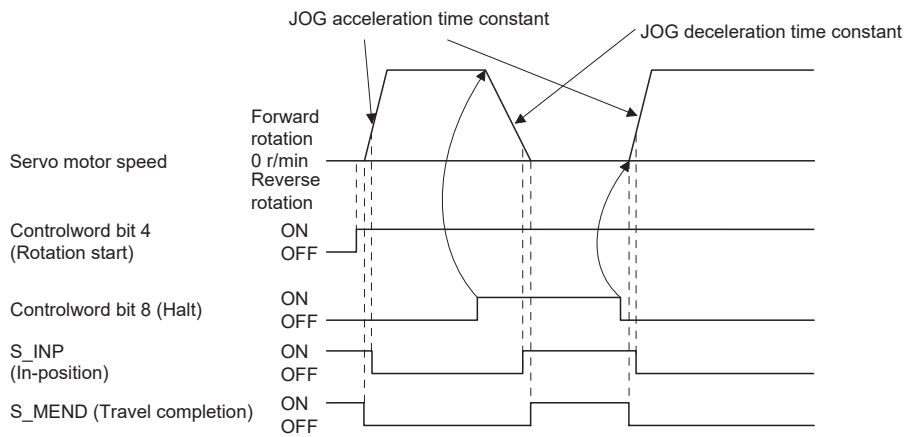

■ When operation is restarted while temporary stop

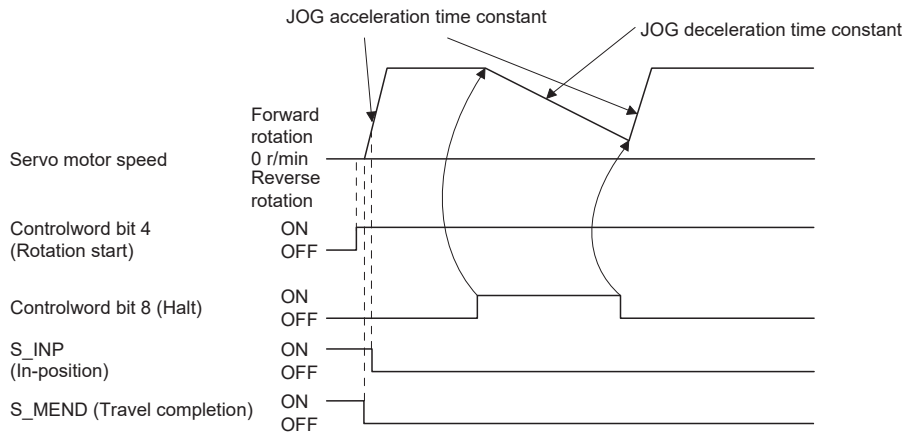

10.4 How to Set Point Table

Setting method using MR Configurator2

The setting of the point table can be used in MR Configurator2 with software version 1.120A or later.

The point table can be set in the positioning mode (point table method).

The positioning mode (point table method) is available on servo amplifiers with firmware version B8 or later.

Setting procedure

Click "Positioning-data" in the menu bar, and click "Point Table" in the menu.

The following window is displayed.

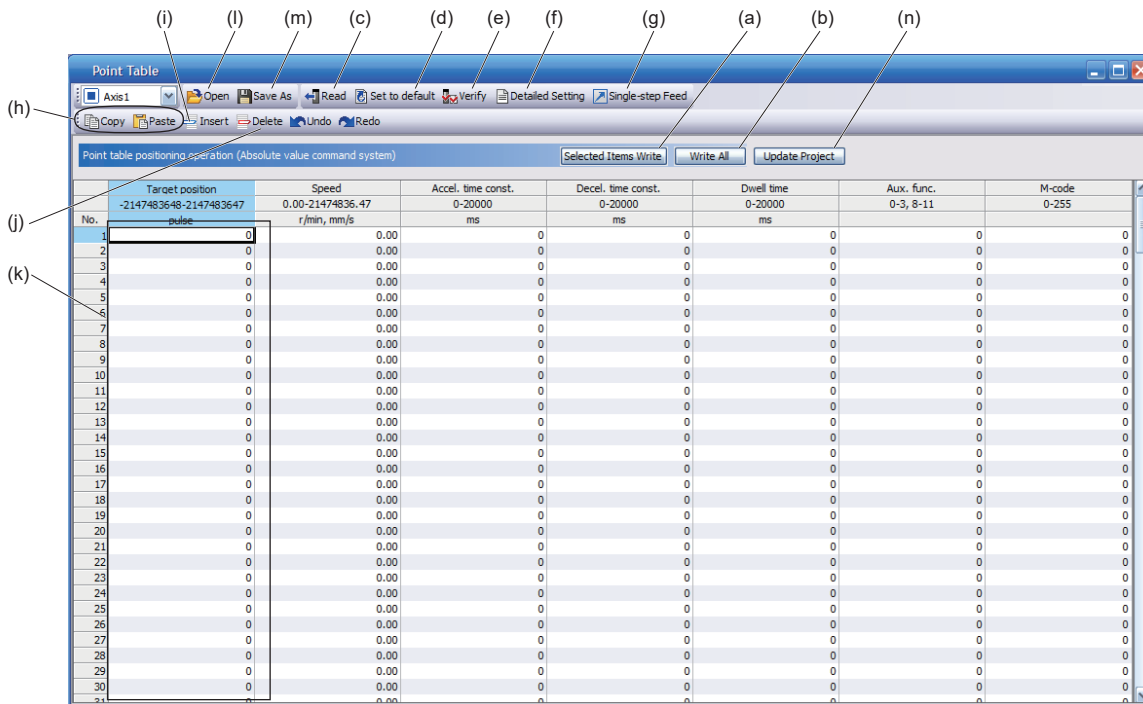

■ Writing point table data (a)

Select the changed point table data, and click "Selected Items Write" to write the point table data whose setting has been changed to the servo amplifier.

■ Writing point table data in batch (b)

Click "Write all" to write all the point table data to the servo amplifier.

■ Reading point table data in batch (c)

Click "Read" to read and display all the point table data read from the servo amplifier.

■ Default setting of point table data (d)

Click "Set to default" to initialize all the data of point table number 1 to 255. The data being edited is initialized as well.

■ Verification of point table data (e)

Click "Verify" to verify all the displayed data and data of the servo amplifier.

■ Detailed setting of point table data (f)

Click "Detailed Setting" to change the position data range and unit of the point table window.

Page 601 Description of the detailed setting window

■ Single-step feed (g)

Click "Single-step Feed" to perform the single step feed test operation. For details, refer to "Single-step Feed" in the User's Manual (Introduction).

■ **Copy and paste of point table data (h)**

Click "Copy" to copy the selected point table data. Click "Paste" to paste the copied point table data.

■ **Inserting point table data (i)**

Click "Insert" to insert one block before the selected point table number. The blocks after the selected point table number are shifted down by one block.

■ **Deleting point table data (j)**

Click "Delete" to delete all the data on the selected point table number. The blocks after the selected point table number are shifted up by one block.

■ **Point table data change (k)**

Select the data to be changed, enter the new value, and confirm with the Enter key. The display range and unit can be changed with "Point table data detailed setting (f)".

■ **Reading point table data (l)**

Click "Open" to read the point table data.

■ **Saving point table data (m)**

Click "Save As" to save the point table data.

■ **Updating the project (n)**

Click "Update Project" to update the point table of the project.

Description of the detailed setting window

The speed and acceleration/deceleration unit can be changed in the detailed setting.

For the settings of [Pr. PT01.1 Speed/acceleration/deceleration unit selection], check the next "Point table".

☞ Page 573 Point table

Click "Update Project" in the point table window to apply the settings to the corresponding parameters.

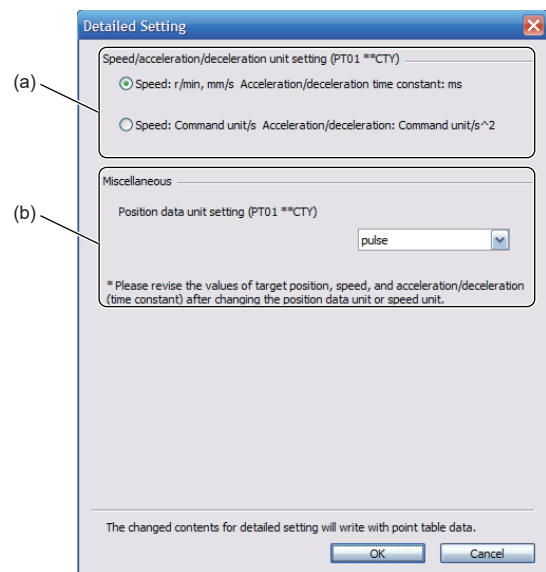

■ **Setting speed and acceleration/deceleration unit (a)**

Select the unit of speed from r/min, mm/s, or command unit/s.

The unit of acceleration/deceleration is automatically selected to ms or command unit/s² according to the unit of speed.

■ **Setting of position data unit (b)**

Select the unit of position data from mm, inch, degree, or pulse.

Setting method using objects

The master (controller) can change the point table of the servo amplifier by writing a value to the following object via SDO communication. However, once the power supply is shut off, the changed setting is not maintained at the next startup. To maintain the changed setting even after the power supply is shut-off, save the point table setting value to the non-volatile memory by using [Store Parameters (Obj. 1010h)].

Index	Sub	Obj.	Name	Description
2801h	0	ARRAY	Point table 001	Number of entries
	1		Point data	Set the position data of point table number 1.
	2		Speed	Set the servo motor speed of point table number 1.
	3		Acceleration	Set the acceleration time constant/acceleration of point table number 1.
	4		Deceleration	Set the deceleration time constant/deceleration of point table number 1.
	5		Dwell	Set the dwell time of point table number 1.
	6		Auxiliary	Set the auxiliary function of point table number 1.
	7		M code	Set the M code of point table number 1.
⋮	⋮	⋮	⋮	⋮
28FFh	0	ARRAY	Point table 255	Number of entries
	1		Point data	Set the position data of point table number 255.
	2		Speed	Set the servo motor speed of point table number 255.
	3		Acceleration	Set the acceleration time constant/acceleration of point table number 255.
	4		Deceleration	Set the deceleration time constant/deceleration of point table number 255.
	5		Dwell	Set the dwell time of point table number 255.
	6		Auxiliary	Set the auxiliary function of point table number 255.
	7		M code	Set the M code of point table number 255.

REVISIONS

*The manual number is given on the bottom left of the back cover.

Revision date	*Manual number	Description
July 2019	SH(NA)-030300ENG-A	First edition
January 2020	SH(NA)-030300ENG-B	<p>■The following functions are added: Profile mode, command unit selection function, S-pattern acceleration/deceleration time constants, acceleration/deceleration, command pulse train monitoring function, scale measurement function, touch probe, command offset</p> <p>■Added: Section 2.1, Section 3.6, Section 3.17, Section 3.20, Section 4.3, Section 4.4, Section 4.19</p>
July 2020	SH(NA)-030300ENG-C	<p>■The following functions are added: Continuous operation to torque control mode, limit switch release position assessment function, A/B/Z-phase differential output type rotary encoder, functional safety, network function</p> <p>■Added: Section 3.6, Chapter 6, Chapter 7</p>
November 2020	SH(NA)-030300ENG-D	<p>■The following functions are added: Communication function (Mitsubishi Electric AC servo protocol), degree unit, 400 V class servo amplifier, touch probe, regenerative option</p> <p>■Added: Section 3.7, Section 4.8, Section 4.14, Section 4.15, Chapter 8</p>
January 2021	SH(NA)-030300ENG-E	<p>■The following function is added: Positioning mode (point table method)</p> <p>■Added/edited: Section 1.1, Section 2.1, Section 3.4, Section 3.7, Section 3.9, Section 3.17, Section 3.18, Section 3.19, Section 3.20, Section 4.6, Section 4.8, Section 4.14, Section 4.15, Section 4.20, Section 5.1, Chapter 9</p>
May 2021	SH(NA)-030300ENG-F	<p>■The following model and function are added: MR-J5D_-_G_, CC-Link IE Field Network Basic</p> <p>■Added/edited: Section 1.1, Section 2.1, Section 3.2, Section 3.3, Section 3.7, Section 3.12, Section 3.13, Section 3.14, Section 3.15, Section 3.16, Section 3.17, Section 3.20, Section 4.1, Section 4.2, Section 4.3, Section 4.4, Section 4.6, Section 4.7, Section 4.10, Section 4.13, Section 4.16, Section 4.18, Section 5.1, Section 5.2, Section 5.3, Section 6.1, Section 6.2, Section 6.3, Section 6.4, Section 6.5, Chapter 7, Chapter 8, Section 9.2, Section 9.3</p>
July 2022	SH(NA)-030300ENG-G	<p>■The following model and function are added: MR-J5_-_B_, master-slave operation function</p> <p>■Added/edited: Chapter 1, Section 2.1, Section 2.2, Section 3.3, Section 3.5, Section 3.6, Section 3.9, Section 3.12, Section 3.14, Section 3.15, Section 3.17, Section 3.18, Section 3.19, Section 3.20, Section 3.21, Section 4.1, Section 4.2, Section 4.3, Section 4.4, Section 4.5, Section 4.6, Section 4.7, Section 4.10, Section 4.13, Section 4.15, Section 4.16, Section 4.17, Section 4.19, Section 4.20, Section 4.23, Chapter 5, Section 6.1, Chapter 7, Chapter 8, Chapter 10</p>
January 2023	SH(NA)-030300ENG-H	<p>■The following function is added: Override function</p> <p>■Added/edited: Section 1.1, Section 2.1, Section 2.3, Section 3.5, (Section 3.8), Section 3.16, Section 3.17, Section 3.19, Section 3.21, Section 3.22, Section 4.1, Section 4.3, Section 4.5, Section 4.6, Section 4.16, Section 4.18, Section 4.20, Section 4.24, Section 5.1, Section 5.2, Section 5.5, Section 6.4, Section 10.2, Section 10.3</p>
July 2023	SH(NA)-030300ENG-J	<p>■The following function is added: Functional safety (Multi-axis servo amplifier via a network)</p> <p>■Added/edited: Section 1.1, Section 3.5, Section 4.4, Section 4.5, Section 4.21, Section 5.1, Section 5.3, Section 5.4, Section 6.1, Section 6.4</p>

This manual confers no industrial property rights or any rights of any other kind, nor does it confer any patent licenses. Mitsubishi Electric Corporation cannot be held responsible for any problems involving industrial property rights which may occur as a result of using the contents noted in this manual.

© 2019 MITSUBISHI ELECTRIC CORPORATION

WARRANTY

Warranty

1. Warranty period and coverage

We will repair any failure or defect hereinafter referred to as "failure" in our FA equipment hereinafter referred to as the "Product" arisen during warranty period at no charge due to causes for which we are responsible through the distributor from which you purchased the Product or our service provider. However, we will charge the actual cost of dispatching our engineer for an on-site repair work on request by customer in Japan or overseas countries. We are not responsible for any on-site readjustment and/or trial run that may be required after a defective unit are repaired or replaced.

[Term]

For terms of warranty, please contact your original place of purchase.

[Limitations]

(1) You are requested to conduct an initial failure diagnosis by yourself, as a general rule.

It can also be carried out by us or our service company upon your request and the actual cost will be charged. However, it will not be charged if we are responsible for the cause of the failure.

(2) This limited warranty applies only when the condition, method, environment, etc. of use are in compliance with the terms and conditions and instructions that are set forth in the instruction manual and user manual for the Product and the caution label affixed to the Product.

(3) Even during the term of warranty, the repair cost will be charged on you in the following cases;

1. a failure caused by your improper storing or handling, carelessness or negligence, etc., and a failure caused by your hardware or software problem
2. a failure caused by any alteration, etc. to the Product made on your side without our approval
3. a failure which may be regarded as avoidable, if your equipment in which the Product is incorporated is equipped with a safety device required by applicable laws and has any function or structure considered to be indispensable according to a common sense in the industry
4. a failure which may be regarded as avoidable if consumable parts designated in the instruction manual, etc. are duly maintained and replaced
5. any replacement of consumable parts (battery, fan, smoothing capacitor, etc.)
6. a failure caused by external factors such as inevitable accidents, including without limitation fire and abnormal fluctuation of voltage, and acts of God, including without limitation earthquake, lightning and natural disasters
7. a failure generated by an unforeseeable cause with a scientific technology that was not available at the time of the shipment of the Product from our company
8. any other failures which we are not responsible for or which you acknowledge we are not responsible for

2. Term of warranty after the stop of production

(1) We may accept the repair at charge for another seven (7) years after the production of the product is discontinued. The announcement of the stop of production for each model can be seen in our Sales and Service, etc.

(2) Please note that the Product (including its spare parts) cannot be ordered after its stop of production.

3. Service in overseas countries

Our regional FA Center in overseas countries will accept the repair work of the Product. However, the terms and conditions of the repair work may differ depending on each FA Center. Please ask your local FA center for details.

4. Exclusion of loss in opportunity and secondary loss from warranty liability

Regardless of the gratis warranty term, Mitsubishi shall not be liable for compensation to:

- (1) Damages caused by any cause found not to be the responsibility of Mitsubishi.
- (2) Loss in opportunity, lost profits incurred to the user by Failures of Mitsubishi products.
- (3) Special damages and secondary damages whether foreseeable or not, compensation for accidents, and compensation for damages to products other than Mitsubishi products.
- (4) Replacement by the user, maintenance of on-site equipment, start-up test run and other tasks.

5. Change of Product specifications

Specifications listed in our catalogs, manuals or technical documents may be changed without notice.

6. Application and use of the Product

- (1) For the use of our AC Servo, its applications should be those that may not result in a serious damage even if any failure or malfunction occurs in AC Servo, and a backup or fail-safe function should operate on an external system to AC Servo when any failure or malfunction occurs.
- (2) Our AC Servo is designed and manufactured as a general purpose product for use at general industries. Therefore, applications substantially influential on the public interest for such as atomic power plants and other power plants of electric power companies, and also which require a special quality assurance system, including applications for railway companies and government or public offices are not recommended, and we assume no responsibility for any failure caused by these applications when used.
In addition, applications which may be substantially influential to human lives or properties for such as airlines, medical treatments, railway service, incineration and fuel systems, man-operated material handling equipment, entertainment machines, safety machines, etc. are not recommended, and we assume no responsibility for any failure caused by these applications when used. We will review the acceptability of the abovementioned applications, if you agree not to require a specific quality for a specific application. Please contact us for consultation.
- (3) Mitsubishi Electric shall have no responsibility or liability for any problems involving programmable controller trouble and system trouble caused by DoS attacks, unauthorized access, computer viruses, and other cyberattacks.

TRADEMARKS

MELSERVO is a trademark or registered trademark of Mitsubishi Electric Corporation in Japan and/or other countries. All other product names and company names are trademarks or registered trademarks of their respective companies.

SH(NA)-030300ENG-J(2307)MEE

MODEL:

MODEL CODE:

MITSUBISHI ELECTRIC CORPORATION

HEAD OFFICE: TOKYO BLDG., 2-7-3, MARUNOUCHI, CHIYODA-KU, TOKYO 100-8310, JAPAN
NAGOYA WORKS: 1-14, YADA-MINAMI 5-CHOME, HIGASHI-KU, NAGOYA 461-8670, JAPAN

When exported from Japan, this manual does not require application to the
Ministry of Economy, Trade and Industry for service transaction permission.

Specifications subject to change without notice.

Compliance with the indicated global standards and regulations is current as of the release date of this manual.