

Mitsubishi Electric AC Servo System

MITSUBISHI ELECTRIC SERVO SYSTEM  
**MELSERVO-JET**

MR-JET  
User's Manual  
(Function)

---

-MR-JET-\_G  
-MR-JET-\_G-N1



# SAFETY INSTRUCTIONS

---

Please read the instructions carefully before using the equipment.

To use the equipment correctly, do not attempt to install, operate, maintain, or inspect the equipment until you have read through this manual, installation guide, and appended documents carefully. Do not use the equipment until you have a full knowledge of the equipment, safety information and instructions.

In this manual, the safety instruction levels are classified into "WARNING" and "CAUTION".



## WARNING

Indicates that incorrect handling may cause hazardous conditions, resulting in death or severe injury.



## CAUTION

Indicates that incorrect handling may cause hazardous conditions, resulting in medium or slight injury.

Note that the CAUTION level may lead to a serious consequence depending on conditions.

Please follow the instructions of both levels because they are important to personnel safety.

Forbidden actions and required actions are indicated by the following diagrammatic symbols.



Indicates a forbidden action. For example, "No Fire" is indicated by .



Indicates a required action. For example, grounding is indicated by .

In this manual, precautions for hazards that can lead to property damage, instructions for other functions, and other information are shown separately in the "Point" area.

After reading this manual, keep it accessible to the operator.

## [Installation/wiring]

---

### **WARNING**

- To prevent an electric shock, turn off the power and wait for 15 minutes or more before starting wiring and/or inspection.
  - To prevent an electric shock, ground the servo amplifier.
  - To prevent an electric shock, any person who is involved in wiring should be fully competent to do the work.
  - To prevent an electric shock, mount the servo amplifier before wiring.
  - To prevent an electric shock, connect the protective earth (PE) terminal of the servo amplifier to the protective earth (PE) of the cabinet, then connect the grounding lead wire to the ground.
  - To prevent an electric shock, do not touch the conductive parts.
- 

## [Setting/adjustment]

---

### **WARNING**

- To prevent an electric shock, do not operate the switches with wet hands.
- 

## [Operation]

---

### **WARNING**

- To prevent an electric shock, do not operate the switches with wet hands.
- 

## [Maintenance]

---

### **WARNING**

- To prevent an electric shock, any person who is involved in inspection should be fully competent to do the work.
  - To prevent an electric shock, do not operate the switches with wet hands.
-

# ABOUT THE MANUAL

## Point

e-Manuals are Mitsubishi Electric FA electronic book manuals that can be browsed with a dedicated tool.

e-Manuals enable the following:

- Searching for desired information in multiple manuals at the same time (manual cross searching)
- Jumping from a link in a manual to another manual for reference
- Browsing for hardware specifications by scrolling over the components shown in product illustrations
- Bookmarking frequently referenced information
- Copying sample programs to engineering tools

If using the servo for the first time, prepare and use the following related manuals to ensure that the servo is used safely. For the related manuals, refer to the User's Manual (Introduction).

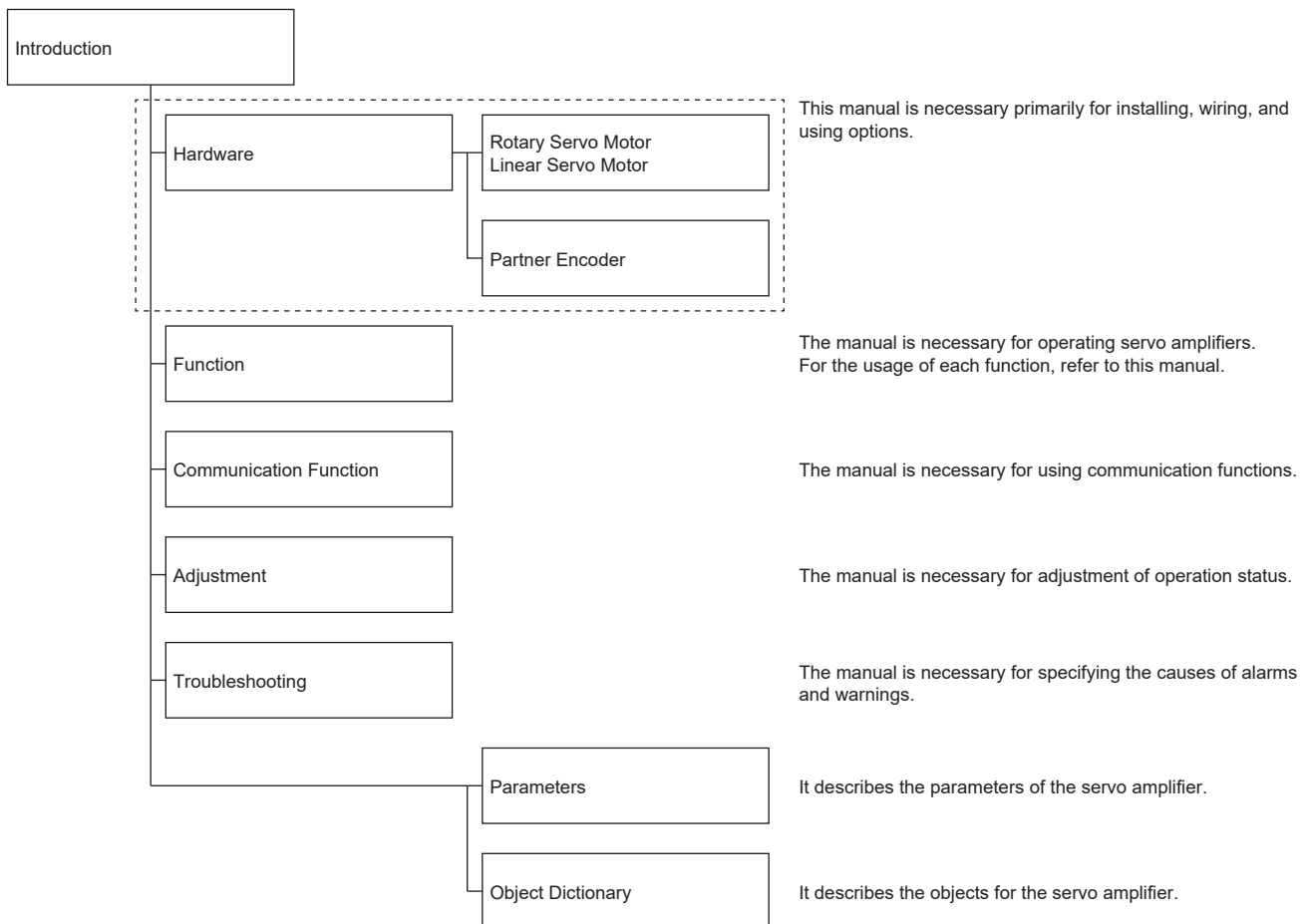

This manual covers the following servo amplifiers.

- MR-JET-\_G/MR-JET-\_G-N1

## Global standards and regulations

Compliance with the indicated global standards and regulations is current as of the release date of this manual. Some standards and regulations may have been modified or withdrawn.

# OBJECT UNITS

This section explains the pos units, vel units, and acc units used in this manual.

The degree unit is available on servo amplifiers with firmware version B6 or later.

The mm unit and inch unit are available on servo amplifiers with firmware version B8 or later in the positioning mode (point table method).

## pos units

The standard unit can be changed using [Pr. PT01.2 Unit for position data] as shown in the following table.

Setting value	Standard unit
0	mm
1	inch
2	degree
3	pulse

## vel units

The speed unit can be changed using [Pr. PT01.1 Speed/acceleration/deceleration unit selection] as shown in the following table. The command unit can be changed to "0.001 mm", "0.0001 inch", "0.001 degree", or "pulse" using [Pr. PT01.2].

Setting value	Unit
0	0.01 r/min, 0.01 mm/s *1
1	Command unit/s

\*1 "0.01 mm/s" is used in the linear servo motor control mode.

## acc units

The acceleration unit can be changed using [Pr. PT01.1] as shown in the following table. The command unit can be changed to "0.001 mm", "0.0001 inch", "0.001 degree", or "pulse" using [Pr. PT01.2].

Setting value	Unit
0	ms
1	Command unit/s <sup>2</sup>

# U.S. CUSTOMARY UNITS

U.S. customary units are not shown in this manual. Convert the values if necessary according to the following table.

Quantity	SI (metric) unit	U.S. customary unit
Mass	1 [kg]	2.2046 [lb]
Length	1 [mm]	0.03937 [inch]
Torque	1 [N·m]	141.6 [oz·inch]
Moment of inertia	1 [(× 10 <sup>-4</sup> kg·m <sup>2</sup> )]	5.4675 [oz·inch <sup>2</sup> ]
Load (thrust load/axial load)	1 [N]	0.2248 [lbf]
Temperature	N [°C] × 9/5 + 32	N [°F]

# CONTENTS

SAFETY INSTRUCTIONS . . . . .	1
ABOUT THE MANUAL . . . . .	3
OBJECT UNITS. . . . .	4
U.S. CUSTOMARY UNITS . . . . .	4
<b>CHAPTER 1 FUNCTION</b>	<b>9</b>
1.1 Function explanation . . . . .	9
<b>CHAPTER 2 CONTROL MODE</b>	<b>14</b>
2.1 Control mode . . . . .	14
Control switching . . . . .	15
Cyclic synchronous position mode (csp) . . . . .	16
Cyclic synchronous velocity mode (csv) . . . . .	18
Cyclic synchronous torque mode (cst) . . . . .	20
Profile position mode (pp) . . . . .	22
Profile velocity mode (pv) . . . . .	26
Profile torque mode (tq) . . . . .	30
Point table mode (pt) . . . . .	33
JOG operation mode (jg) . . . . .	36
Continuous operation to torque control mode (ct) . . . . .	39
Homing mode (hm) . . . . .	44
<b>CHAPTER 3 BASIC FUNCTION</b>	<b>79</b>
3.1 Outline of servo parameter and object dictionary . . . . .	79
Servo parameter . . . . .	79
Object dictionary . . . . .	81
3.2 Rotation/travel direction selection. . . . .	82
Setting methods of functions . . . . .	83
3.3 Stroke limit function . . . . .	86
Explanation of the stroke limit signal names . . . . .	86
Setting methods of functions . . . . .	87
Stop method at stroke limit detection . . . . .	90
Servo parameter list . . . . .	91
Limit switch release position assessment function . . . . .	92
3.4 Command unit selection function . . . . .	93
Position command unit selection function . . . . .	93
Speed command unit selection function . . . . .	96
3.5 Electronic gear function . . . . .	97
Setting method . . . . .	97
Setting example . . . . .	98
3.6 In-position range setting. . . . .	105
Setting method . . . . .	105
3.7 Assigning I/O devices . . . . .	106
Setting method . . . . .	106
3.8 Regenerative option selection . . . . .	107
Regenerative option . . . . .	107
3.9 Alarm function . . . . .	108
Operation status at alarm occurrence . . . . .	108

Operation status at warning occurrence .....	108
Returning from an alarm .....	109
Returning from a warning .....	109
Alarm history .....	110
Stop method at occurrence of alarms/warnings .....	111
Timing chart for alarm occurrence .....	112
<b>3.10 Forced stop deceleration function .....</b>	<b>114</b>
Setting method .....	114
Timing chart .....	115
<b>3.11 Electromagnetic brake interlock function .....</b>	<b>116</b>
Base circuit shut-off delay time function .....	116
Setting method .....	117
Timing chart .....	118
<b>3.12 Vertical axis freefall prevention function .....</b>	<b>125</b>
Setting method .....	125
Timing chart .....	126
<b>3.13 Acceleration/deceleration function .....</b>	<b>127</b>
Acceleration/deceleration time constant .....	127
S-pattern acceleration/deceleration time constant .....	129
Acceleration/deceleration .....	130
<b>3.14 Quick stop .....</b>	<b>132</b>
Setting method .....	133
Timing chart .....	135
<b>3.15 Halt .....</b>	<b>137</b>
Objects for setting .....	137
Timing chart .....	138
<b>CHAPTER 4 APPLICABLE FUNCTIONS .....</b>	<b>139</b>
<hr/>	
<b>4.1 Tough drive function .....</b>	<b>141</b>
Vibration tough drive .....	141
Instantaneous power failure tough drive .....	141
<b>4.2 Touch probe .....</b>	<b>145</b>
Outline .....	145
Setting method .....	146
<b>4.3 Machine diagnosis .....</b>	<b>155</b>
Friction vibration estimation function .....	155
<b>4.4 Drive recorder .....</b>	<b>160</b>
Specification outline .....	162
How to use the function .....	162
Servo parameter/object dictionary .....	165
Standard acquisition waveform list .....	173
Waveform recording inapplicable alarm list .....	174
List of auxiliary recording data .....	175
<b>4.5 Software reset .....</b>	<b>176</b>
Software reset in MR Configurator2 .....	176
Software reset via network communication .....	176
Software reset with an object .....	176
<b>4.6 Software position limit .....</b>	<b>177</b>
Setting method .....	177
<b>4.7 Torque limit .....</b>	<b>180</b>



Setting method .....	181
Checking "Limiting torque" status .....	181
<b>4.8 Speed limit .....</b>	<b>182</b>
Setting method .....	182
Checking "Limiting speed" status .....	182
<b>4.9 Degree unit .....</b>	<b>183</b>
Summary .....	183
Position-related data when the unit is set to "degree" .....	184
Setting method .....	185
Sequence .....	186
<b>4.10 Infinite feed function .....</b>	<b>190</b>
Outline .....	190
Setting method .....	190
When the servo motor rotates 32768 rev or more .....	190
When using the infinite feed function with a controller .....	190
<b>4.11 Servo amplifier life diagnosis function .....</b>	<b>191</b>
Cumulative energization time function .....	191
Relay usage count display function .....	192
<b>4.12 Encoder communication diagnosis function .....</b>	<b>193</b>
Usage .....	193
<b>4.13 Disconnection/incorrect wiring detection function .....</b>	<b>194</b>
Output open-phase detection function .....	194
<b>4.14 Overload protection (electronic thermal) function .....</b>	<b>195</b>
<b>4.15 Command offset .....</b>	<b>196</b>
<b>4.16 Excessive error alarm detection function .....</b>	<b>198</b>
Outline .....	198
Setting method .....	198
Excessive error alarm trigger level adjustment method .....	199
<b>4.17 Override function .....</b>	<b>200</b>

---

**CHAPTER 5 MONITORING 203**

<b>5.1 Explanation of monitor signals .....</b>	<b>203</b>
Name and description of the monitor signals .....	203
Signal block diagram .....	209
<b>5.2 Checking with MR Configurator2 .....</b>	<b>211</b>
"Display All" function .....	211
Graph function .....	212
I/O monitor display .....	213
System configuration display .....	214

---

**CHAPTER 6 NETWORK FUNCTION 215**

<b>6.1 IP address setting .....</b>	<b>216</b>
Setting an IP address .....	216
<b>6.2 Managing accounts .....</b>	<b>216</b>
Setting an account .....	217
Precautions .....	217
<b>6.3 FTP server function .....</b>	<b>218</b>
Restrictions .....	218
Precautions .....	218
Directory structure .....	219

Steps of accessing the FTP server .....	219
<b>6.4 Firmware update .....</b>	<b>219</b>
<b>CHAPTER 7 POSITIONING MODE (POINT TABLE METHOD) (CP)</b>	<b>220</b>
<b>7.1 Operation mode and selection method .....</b>	<b>221</b>
Operation mode .....	221
Operation mode selection method .....	221
<b>7.2 Point table mode (pt) .....</b>	<b>222</b>
Point table mode (pt) .....	222
Point table operation (absolute value command method) .....	223
Timing chart of the point table operation .....	227
Positioning function to the home position .....	245
<b>7.3 JOG operation mode (jg) .....</b>	<b>246</b>
JOG operation .....	246
<b>7.4 How to Set Point Table .....</b>	<b>250</b>
Setting method using MR Configurator2 .....	250
Setting method using objects .....	252
REVISIONS .....	254
WARRANTY .....	255
TRADEMARKS .....	256

# 1 FUNCTION

## 1.1 Function explanation

This section lists the functions mentioned in this manual. For details of the functions, refer to each section indicated in the detailed explanation column.



For the functions which are not listed here, refer to "FUNCTION" in the User's Manual (Introduction).

### Control mode

Functions	Detailed functions	Description	Ver. *1 MR-JET	Detailed explanation
CiA 402 control mode	Cyclic synchronous position mode (csp)	This function operates the servo motor in the cyclic synchronous position mode.	A4	☞ Page 16 Cyclic synchronous position mode (csp)
	Cyclic synchronous velocity mode (csv)	This function operates the servo motor in the cyclic synchronous velocity mode.	A4	☞ Page 18 Cyclic synchronous velocity mode (csv)
	Cyclic synchronous torque mode (cst)	This function operates the servo motor in the cyclic synchronous torque mode.	A4	☞ Page 20 Cyclic synchronous torque mode (cst)
	Profile position mode (pp)	This function operates the servo motor in the profile position mode.	B2	☞ Page 22 Profile position mode (pp)
	Profile velocity mode (pv)	This function operates the servo motor in the profile velocity mode.	B2	☞ Page 26 Profile velocity mode (pv)
	Profile torque mode (tq)	This function operates the servo motor in the profile torque mode.	B2	☞ Page 30 Profile torque mode (tq)
	Homing mode (hm)	This function either operates the servo motor in the homing mode or performs homing.	A4	☞ Page 44 Homing mode (hm)
Point table method	Point table mode (pt)	This function operates the servo motor according to the setting values by selecting the point table with preset 255 points.	B8	☞ Page 33 Point table mode (pt)
	JOG operation mode (jg)	This control mode enables desired positioning for machine adjustment and home positioning.	B8	☞ Page 36 JOG operation mode (jg)
Thrust/torque control	Continuous operation to torque control mode (ct)	This function enables smooth switching to torque control from the position control mode or speed control mode without stopping the servo motor. This eliminates rapid change of speed and torque, contributing to reduction in load to the machine and high-quality product molding.	B0	☞ Page 39 Continuous operation to torque control mode (ct)

\*1 "Ver." indicates the supported firmware version of the servo amplifier. The functions are available on servo amplifiers with the indicated firmware version or later.

### Network

Functions	Detailed functions	Description	Ver. *1 MR-JET	Detailed explanation
Remote maintenance	Firmware update	This function updates the firmware of the servo amplifier.	A4	☞ Page 219 Firmware update

\*1 "Ver." indicates the supported firmware version of the servo amplifier. The function is available on servo amplifiers with the indicated firmware version or later.

## Operation function

Functions	Detailed functions	Description	Ver. *1 MR-JET	Detailed explanation
Stop function	Quick Stop	This function stops the servo motor with a specified method and switches to the servo-off status.	A4	☞ Page 132 Quick stop
	Halt	This function stops the servo motor while the servo-on status is maintained.	A4	☞ Page 137 Halt
	Stroke limit function	This function uses LSP (Forward rotation stroke end) and LSN (Reverse rotation stroke end) to limit the travel interval of the servo motor.	A4	☞ Page 86 Stroke limit function
		This function limits the travel interval of the servo motor using FLS (Upper stroke limit) and RLS (Lower stroke limit) via a controller.	A4	☞ Page 86 Stroke limit function
	Software position limit	This function uses servo parameters to limit the travel intervals by address. A function equivalent to the stroke limit function can be set with the servo parameter.	A4	☞ Page 177 Software position limit
Command generation	Rotation/travel direction selection	This function sets the rotation direction of the servo motor without changing the command polarity.	A4	☞ Page 82 Rotation/travel direction selection
	Electronic gear	This function performs positioning control with the value obtained by multiplying the position command from the upper controller by a set electronic gear ratio.	A4	☞ Page 97 Electronic gear function
	Acceleration/deceleration function	This function enables smooth acceleration/deceleration.	A4	☞ Page 127 Acceleration/deceleration function
	S-pattern acceleration/deceleration time constant	This function performs smooth acceleration and deceleration.	B2	☞ Page 129 S-pattern acceleration/deceleration time constant
	Torque limit	This function limits the servo motor torque.	A4	☞ Page 180 Torque limit
	Speed limit	This function limits the servo motor speed in the torque control mode.	A4	☞ Page 182 Speed limit
	Command offset	This function compensates the position/speed/torque commands by adding a desired amount of offset to the commands.	A4	☞ Page 196 Command offset

\*1 "Ver." indicates the supported firmware version of the servo amplifier. The functions are available on servo amplifiers with the indicated firmware version or later.

## Positioning function

Functions	Detailed functions	Description	Ver. *1 MR-JET	Detailed explanation
Override function	Override function	This function can change the servo motor speed via communication. The value can be changed to 0% to 360% of the set speed.	D4	☞ Page 200 Override function
Absolute position	Infinite feed function	In an absolute position detection system, even if the servo motor rotates 32768 rev or more in the same direction, [AL. 0E3.1 Multi-revolution counter travel distance exceeded warning] will not occur and the home position will not be erased. Therefore, the current position will be restored after the power is cycled. When this function is not used, if the servo motor rotates 32768 rev or more in the same direction, [AL. 0E3.1] will occur and the home position will be erased.	B6	☞ Page 190 Infinite feed function

\*1 "Ver." indicates the supported firmware version of the servo amplifier. The functions are available on servo amplifiers with the indicated firmware version or later.

## I/O, monitor

Functions	Detailed functions	Description	Ver. *1 MR-JET	Detailed explanation
DI/DO	Input signal selection (device selection)	This function assigns input devices such as LSP (Forward rotation stroke end) to certain pins of the connector.	A4	☞ Page 106 Assigning I/O devices
	Output signal selection (device setting)	This function assigns output devices such as MBR (Electromagnetic brake interlock) to certain pins of the connector.	A4	☞ Page 106 Assigning I/O devices
Monitor	Power monitoring function	This function calculates the running power and the regenerative power from the data in the servo amplifier such as speed and current. The power consumption and other values are displayed on MR Configurator2.	A4	☞ Page 203 MONITORING
Touch probe *2	Current position latch function	This function latches the current position when TPR1 (Touch probe 1), TPR2 (Touch probe 2), or TPR3 (Touch probe 3) is turned on.	C4	☞ Page 145 Touch probe

\*1 "Ver." indicates the supported firmware version of the servo amplifier. The functions are available on servo amplifiers with the indicated firmware version or later.

\*2 Available on servo amplifiers with firmware version C0 or later and manufactured in July 2022 or later.

## Option

Functions	Detailed functions	Description	Ver. *1 MR-JET	Detailed explanation
Regenerative capacity enhancement	Regenerative option	Use this function if the built-in regenerative resistor of the servo amplifier does not have sufficient regenerative capacity for the generated regenerative power.	A4	☞ Page 107 Regenerative option selection

\*1 "Ver." indicates the supported firmware version of the servo amplifier. The function is available on servo amplifiers with the indicated firmware version or later.

## Protective functions

Functions	Detailed functions	Description	Ver. *1 MR-JET	Detailed explanation
Alarm	Alarm function	This function displays an alarm or warning when an error occurs during operation. When an alarm occurs, ALM (Malfunction) turns off and stops the servo motor. When a warning occurs, WNG (Warning) will turn on. The servo motor may stop or continue operation depending on the warning.	A4	☞ Page 108 Alarm function
Power error detection	Disconnection detection function	This function detects a disconnection in the servo motor power supply output.	A4	☞ Page 194 Disconnection/incorrect wiring detection function
Coasting distance reduction	Forced stop deceleration function	This function decelerates the servo motor to a stop at EM2 (Forced stop 2) off or when there is an alarm.	A4	☞ Page 114 Forced stop deceleration function
Drop protection	Electromagnetic brake interlock function	This function operates the electromagnetic brake at servo off and error occurrence, and prevents the vertical axis from dropping.	A4	☞ Page 116 Electromagnetic brake interlock function
	Vertical axis freefall prevention function	This function moves the axis up by the mechanical backlash amount of the electromagnetic brake to prevent damage to machines.	A4	☞ Page 125 Vertical axis freefall prevention function

\*1 "Ver." indicates the supported firmware version of the servo amplifier. The functions are available on servo amplifiers with the indicated firmware version or later.

## Instantaneous power failure measures

Functions	Detailed functions	Description	Ver. *1 MR-JET	Detailed explanation
Tough drive	Tough drive function	This function makes the equipment continue operating even under conditions where an alarm would normally occur. There are two types of tough drive function: the vibration tough drive and the instantaneous power failure tough drive.	A4	☞ Page 141 Tough drive function

\*1 "Ver." indicates the supported firmware version of the servo amplifier. The function is available on servo amplifiers with the indicated firmware version or later.

## Diagnostics

Functions	Detailed functions	Description	Ver. *1 MR-JET	Detailed explanation
Drive data diagnosis	Drive recorder	This function continuously monitors the servo status and records the state transition before and after an alarm for a fixed period of time. The recorded data can be checked by the Waveform-Display button on the drive recorder window of MR Configurator2 being clicked.	A4	☞ Page 160 Drive recorder
	Graph function	This function obtains the servo status in the graph.	A4	☞ Page 212 Graph function
Failure diagnosis	Encoder communication diagnosis function	This function diagnoses with MR Configurator2 whether the encoder communication error is caused by the circuit malfunction of the servo amplifier or by the malfunction of the cables/encoder.	A4	☞ Page 193 Encoder communication diagnosis function
Service life diagnosis	Servo amplifier life diagnosis function	This function enables checking of the cumulative energization time, the number of the inrush relay on/off times, and the number of dynamic brake usage times. It gives an indication of the replacement time for parts on the servo amplifier with a service life (such as the capacitor and the relay) before they malfunction. MR Configurator2 is required for this function.	A4	☞ Page 191 Servo amplifier life diagnosis function
	Motor life diagnosis function	This function predicts failures of the equipment and the servo motor based on the machine total travel distance. It gives an indication of the replacement time for the servo motor.	A4	☞ Page 155 Machine diagnosis
	Machine diagnosis function	This function uses the data in the servo amplifier to estimate the friction and vibrational component of the drive system in the equipment and to recognize an error in machine parts such as ball screws and bearings.	A4	
System diagnosis	System configuration information	This function uses MR Configurator2 to monitor the servo amplifier model, connected servo motor, encoder, and other information.	A4	☞ Page 214 System configuration display

\*1 "Ver." indicates the supported firmware version of the servo amplifier. The functions are available on servo amplifiers with the indicated firmware version or later.

## History

Functions	Detailed functions	Description	Ver. *1 MR-JET	Detailed explanation
—	Alarm history	This function saves information of the alarm that occurred in the servo amplifier. The information is saved in chronological order and used for occasions such as analyzing the cause of the alarm.	A4	☞ Page 110 Alarm history

\*1 "Ver." indicates the supported firmware version of the servo amplifier. The function is available on servo amplifiers with the indicated firmware version or later.

# 2 CONTROL MODE

## 2.1 Control mode

The method for driving a servo motor varies depending on each control mode. The characteristics of each control mode are shown in the following.

Category	Control mode	Symbol	Description
CiA 402 control mode	Cyclic synchronous position mode	csp	This is a control mode to drive servo motors by receiving a position command at a constant period in the synchronous communication with a controller. Use an absolute position address for the command.
	Cyclic synchronous velocity mode	csv	This is a control mode to drive servo motors by receiving a speed command at a constant period in the synchronous communication with a controller.
	Cyclic synchronous torque mode	cst	This is a control mode to drive servo motors by receiving a torque command at a constant period in the synchronous communication with a controller.
	Profile position mode <sup>*2</sup>	pp	This is a positioning mode to drive servo motors by receiving an end position command via either synchronous or asynchronous communication with a controller. Use an absolute position address or a relative position address for the command.
	Profile velocity mode <sup>*2</sup>	pv	This is a control mode to drive servo motors by receiving a target speed command via either synchronous or asynchronous communication with a controller.
	Profile torque mode <sup>*2</sup>	tq	This is a control mode to drive servo motors by receiving a target torque command via either synchronous or asynchronous communication with a controller.
	Homing mode	hm	This is a control mode to perform homing with the method specified by the controller.
Positioning mode (Point table method) (CP) <sup>*3</sup>	Point table mode	pt	This is a control mode to drive the servo motor in accordance with the setting value by selecting the point table with the preset 255 points.
	JOG operation mode	jg	This is a control mode that enables desired positioning for machine adjustment and home positioning.
Thrust/torque control	Continuous operation to torque control mode <sup>*1</sup>	ct	This function enables smooth switching to torque control from the position control mode or speed control mode without stopping the servo motor. This eliminates rapid change of speed and torque, contributing to reduction in load to the machine and high-quality product molding.

\*1 Available on servo amplifiers with firmware version B0 or later.

\*2 Available on servo amplifiers with firmware version B2 or later.

\*3 Available on servo amplifiers with firmware version B8 or later.



# Control switching

## Point

- The initial control mode setting is the cyclic synchronous position mode. When using the cyclic synchronous position mode, perform position follow-up with the controller at servo-on.
- To use the profile mode, switch to the mode in the servo-off state. After the control mode is switched, turn on the servo-on.
- If the control mode is switched without performing position follow-up, unexpected movements such as sudden acceleration of the servo motor may occur.

The control mode can be switched with [Modes of operation (Obj. 6060h)]. Switching the control modes with [Modes of operation (Obj. 6060h)] applies to the cyclic modes (csp, csv, and cst), profile modes (pp, pv, and tq), homing mode (hm), and continuous operation to torque control mode (ct).

For details of the control switching, refer to the User's Manual (Communication Function).

The positioning mode (point table method), can be switched to point table mode (pt), JOG operation mode (jg), home position mode (hm).

## Control switching in positioning mode

The control mode is switched (pt, jg, and hm) only if the condition for control switching is met, following which [Modes of operation display (Obj. 6061h)] is changed. If the condition for control switching is not met, the control mode will not be switched and the value in [Modes of operation display (Obj. 6061h)] will not be changed. The condition for control switching is "Motor being stopped".

"Motor being stopped" means that bit 3 of [Status DO 2 (Obj. 2D12h: 00h)] (S\_ZSP) is on, and bit 6 of [Status DO 5 (Obj. 2D15h: 00h)] (S\_MEND) is on.

In the servo off-state, control switching can be performed if S\_ZSP is on.

## Precautions

- Changes to the OMS Bit of [Controlword (Obj. 6040h)] are not accepted until control switching finishes. Before inputting commands, check that the control mode has been switched by referring to [Modes of operation display (Obj. 6061h)].
- Switch the control modes when the start command is turned off. (For example, when "Homing operation start" is turned off in homing mode (hm).)

The following shows a timing chart of control switching from the point table mode (pt) to JOG operation mode (jg).

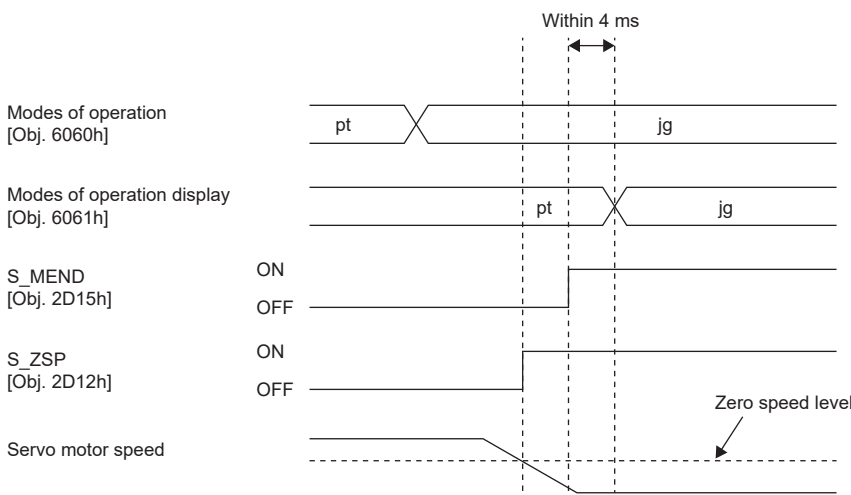

# Cyclic synchronous position mode (csp)

The functions and related objects of the cyclic synchronous position mode (csp) are shown in the following.

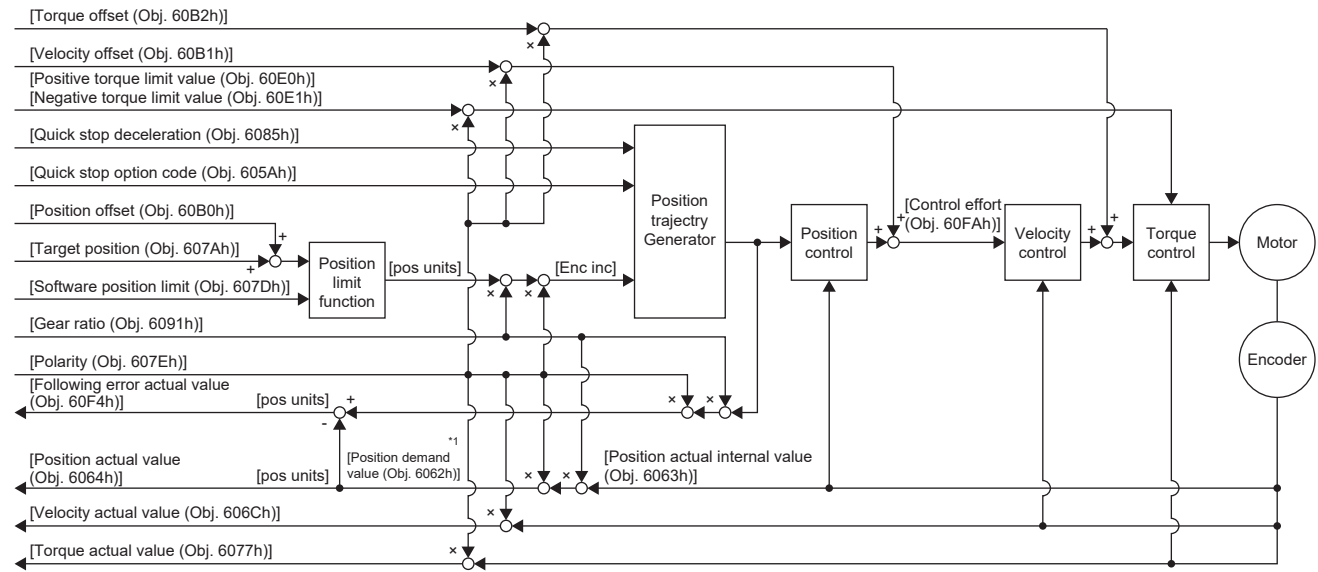

\*1 This object may not be used depending on the network being used. For details, refer to the User's Manual (Object Dictionary).

## Related objects

For details on the objects, refer to the User's Manual (Object Dictionary).

Index	Sub	Object	Name	Description
607Ah	—	VAR	Target position	Command position Unit: pos units
607Bh	0	ARRAY	Position range limit	Number of entries
	1		Min position range limit	Minimum value of the position range limit Unit: pos units
	2		Max position range limit	Maximum value of the position range limit Unit: pos units
607Dh	0	ARRAY	Software position limit	Number of entries
	1		Min position limit	Minimum position address Unit: pos units
	2		Max position limit	Maximum position address Unit: pos units
6085h	—	VAR	Quick stop deceleration	Deceleration at deceleration to a stop with Quick stop Unit: acc units
605Ah	—	VAR	Quick stop option code	Operation setting for Quick stop Page 132 Quick stop
6080h	—	VAR	Max motor speed	Servo motor maximum speed Unit: r/min, mm/s
6063h	—	VAR	Position actual internal value	Current position Unit: Enc inc
6064h	—	VAR	Position actual value	Current position Unit: pos units
606Ch	—	VAR	Velocity actual value	Current speed Unit: vel units
6077h	—	VAR	Torque actual value	Current torque Unit: 0.1 % (with rated torque being 100 %)
6092h	0	ARRAY	Feed constant	Travel distance per revolution of an output shaft
	1		Feed	Travel distance setting
	2		Shaft revolutions	Number of servo motor shaft revolutions Unit: rev
60F4h	—	VAR	Following error actual value	Droop pulses Unit: pos units

Index	Sub	Object	Name	Description
60FAh	—	VAR	Control effort	Position control loop output (speed command) Unit: vel units
60E0h	—	VAR	Positive torque limit value	Torque limit value (forward) Unit: 0.1 % (with rated torque being 100 %)
60E1h	—	VAR	Negative torque limit value	Torque limit value (reverse) Unit: 0.1 % (with rated torque being 100 %)
6091h	0	ARRAY	Gear ratio	Gear ratio
	1		Motor revolutions	Number of revolutions of the servo motor shaft (numerator) ☞ Page 97 Electronic gear function
	2		Shaft revolutions	Number of revolutions of the drive shaft (denominator) ☞ Page 97 Electronic gear function
607Eh	—	VAR	Polarity	Polarity selection Bit 7: Position POL Bit 6: Velocity POL Bit 5: Torque POL ☞ Page 82 Rotation/travel direction selection
60A8h	—	VAR	SI unit position	SI unit position It is automatically set in [Pr. PT01.2 Unit for position data].
60A9h	—	VAR	SI unit velocity	SI unit velocity The SI unit velocity is returned. It is automatically set in [Pr. PT01.2 Unit for position data].
60B0h	—	VAR	Position offset	Position offset Unit: pos units
60B1h	—	VAR	Velocity offset	Velocity offset Unit: vel units
60B2h	—	VAR	Torque offset	Torque offset Unit: 0.1 % (with rated torque being 100 %)
6062h *1	—	VAR	Position demand value	Command position (absolute position) The command position inside the servo amplifier is returned. Unit: pos units

\*1 This object may not be used depending on the network being used. For details, refer to the User's Manual (Object Dictionary).

## Controlword/Statusword

By changing [Controlword (Obj. 6040h)], control commands can be given to the servo amplifier. The control status can also be checked with [Statusword (Obj. 6041h)].

Some bits of [Controlword (Obj. 6040h)] and [Statusword (Obj. 6041h)] vary depending on the control mode. The bits that vary depending on the control mode are listed in the following tables.

### ■Controlword OMS Bit (csp)

Bit	Symbol	Description
4	(reserved)	The value at reading is undefined. Set "0" when writing.
5	(reserved)	
6	(reserved)	
8	(reserved)	
9	(reserved)	

### ■Statusword OMS Bit (csp)

Bit	Symbol	Description
10	(reserved)	The value at reading is undefined.
12	Drive follows the command value (Target position ignored)	0: [Target position (Obj. 607Ah)] is being discarded. 1: [Target position (Obj. 607Ah)] is being used as a position control loop input.
13	Following error	0: No following error 1: Following error When the time set in [Following error time out (Obj. 6066h)] elapses in a state where the value of [Following error actual value (Obj. 60F4h)] exceeds the value set in [Following error window (Obj. 6065h)], this bit changes to "1".

# Cyclic synchronous velocity mode (csv)

The functions and related objects of the cyclic synchronous velocity mode (csv) are shown in the following.

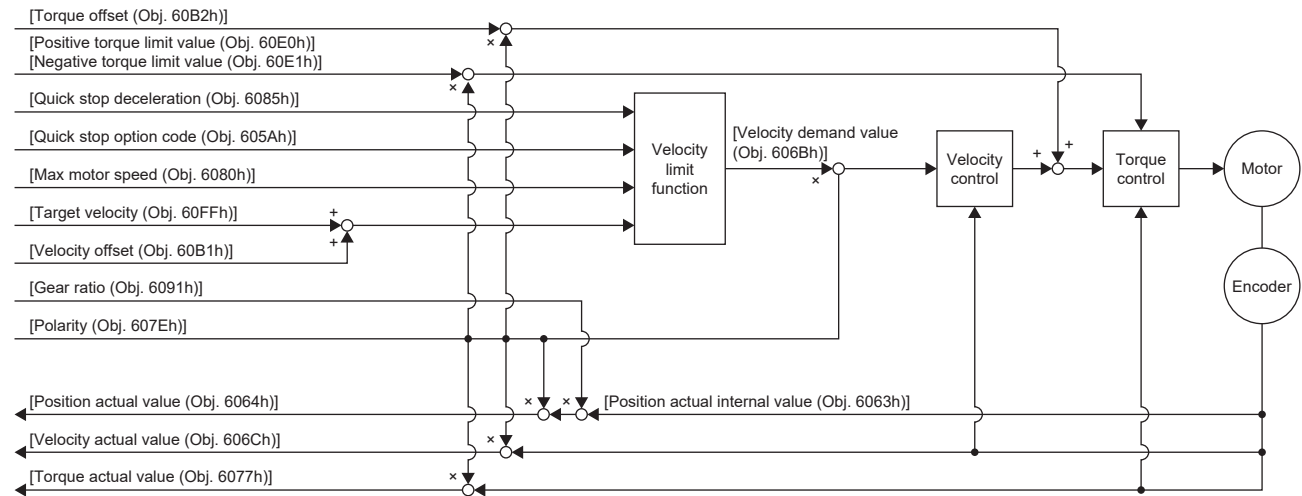

## Related objects

For details on the objects, refer to the User's Manual (Object Dictionary).

Index	Sub	Object	Name	Description
60FFh	—	VAR	Target velocity	Command speed Unit: vel units
6085h	—	VAR	Quick stop deceleration	Deceleration at deceleration to a stop with Quick stop Unit: acc units
605Ah	—	VAR	Quick stop option code	Operation setting for Quick stop ☞ Page 132 Quick stop
6080h	—	VAR	Max motor speed	Servo motor maximum speed Unit: r/min, mm/s
606Bh	—	VAR	Velocity demand value	Command speed (after limit) Unit: vel units
6063h	—	VAR	Position actual internal value	Current position Unit: Enc inc
6064h	—	VAR	Position actual value	Current position Unit: pos units
606Ch	—	VAR	Velocity actual value	Current speed Unit: vel units
6077h	—	VAR	Torque actual value	Current torque Unit: 0.1 % (with rated torque being 100 %)
6092h	0	ARRAY	Feed constant	Travel distance per revolution of an output shaft
	1		Feed	Travel distance setting
	2		Shaft revolutions	Number of servo motor shaft revolutions Unit: rev
60E0h	—	VAR	Positive torque limit value	Torque limit value (forward) Unit: 0.1 % (with rated torque being 100 %)
60E1h	—	VAR	Negative torque limit value	Torque limit value (reverse) Unit: 0.1 % (with rated torque being 100 %)
6091h	0	ARRAY	Gear ratio	Gear ratio
	1		Motor revolutions	Number of revolutions of the servo motor shaft (numerator) ☞ Page 97 Electronic gear function
	2		Shaft revolutions	Number of revolutions of the drive shaft (denominator) ☞ Page 97 Electronic gear function
607Eh	—	VAR	Polarity	Polarity selection Bit 7: Position POL Bit 6: Velocity POL Bit 5: Torque POL ☞ Page 82 Rotation/travel direction selection

Index	Sub	Object	Name	Description
60A8h	—	VAR	SI unit position	SI unit position It is automatically set in [Pr. PT01.2 Unit for position data].
60A9h	—	VAR	SI unit velocity	SI unit velocity The SI unit velocity is returned. It is automatically set in [Pr. PT01.2 Unit for position data].
60B1h	—	VAR	Velocity offset	Velocity offset Unit: vel units
60B2h	—	VAR	Torque offset	Torque offset Unit: 0.1 % (with rated torque being 100 %)

## Controlword/Statusword

By changing [Controlword (Obj. 6040h)], control commands can be given to the servo amplifier. The control status can also be checked with [Statusword (Obj. 6041h)].

Some bits of [Controlword (Obj. 6040h)] and [Statusword (Obj. 6041h)] vary depending on the control mode. The bits that vary depending on the control mode are listed in the following tables.

### ■Controlword OMS Bit (csv)

Bit	Symbol	Description
4	(reserved)	The value at reading is undefined. Set "0" when writing.
5	(reserved)	
6	(reserved)	
8	(reserved)	
9	(reserved)	

### ■Statusword OMS Bit (csv)

Bit	Symbol	Description
10	(reserved)	The value at reading is undefined.
12	Drive follows the command value (Target position ignored)	0: [Target velocity (Obj. 60FFh)] is being discarded. 1: [Target velocity (Obj. 60FFh)] is being used as a speed control loop input.
13	(reserved)	The value at reading is undefined.

# Cyclic synchronous torque mode (cst)

The functions and related objects of the cyclic synchronous torque mode (cst) are shown in the following.

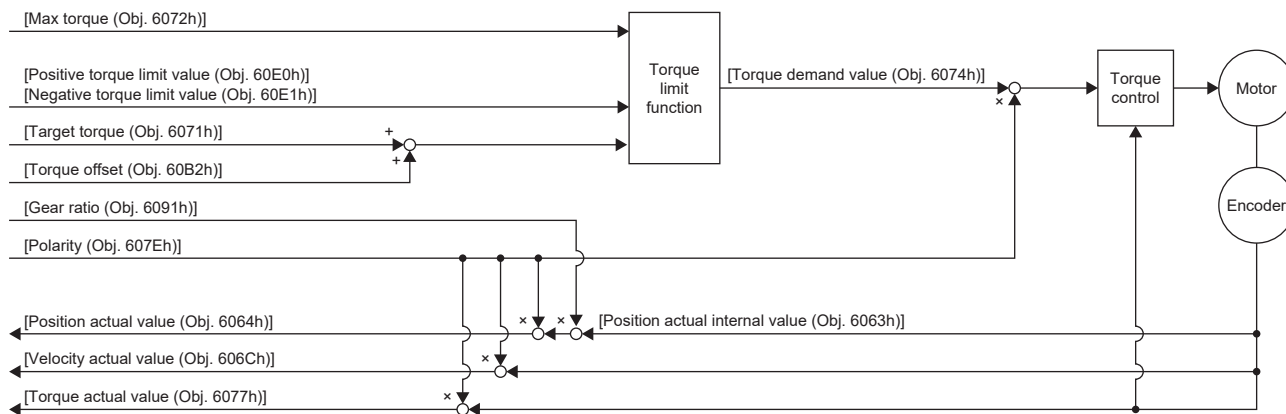

## Related objects

For details on the objects, refer to the User's Manual (Object Dictionary).

Index	Sub	Object	Name	Description
6071h	—	VAR	Target torque	Command torque Unit: 0.1 % (with rated torque being 100 %)
6072h	—	VAR	Max torque	Maximum torque Unit: 0.1 % (with rated torque being 100 %)
6074h	—	VAR	Torque demand value	Command torque (after limit) Unit: 0.1 % (with rated torque being 100 %)
6063h	—	VAR	Position actual internal value	Current position Unit: Enc inc
6064h	—	VAR	Position actual value	Current position Unit: pos units
606Ch	—	VAR	Velocity actual value	Current speed Unit: vel units
6077h	—	VAR	Torque actual value	Current torque Unit: 0.1 % (with rated torque being 100 %)
6092h	0	ARRAY	Feed constant	Travel distance per revolution of an output shaft
	1		Feed	Travel distance setting
	2		Shaft revolutions	Number of servo motor shaft revolutions Unit: rev
60E0h	—	VAR	Positive torque limit value	Torque limit value (forward) Unit: 0.1 % (with rated torque being 100 %)
60E1h	—	VAR	Negative torque limit value	Torque limit value (reverse) Unit: 0.1 % (with rated torque being 100 %)
6091h	0	ARRAY	Gear ratio	Gear ratio
	1		Motor revolutions	Number of revolutions of the servo motor shaft (numerator) Page 97 Electronic gear function
	2		Shaft revolutions	Number of revolutions of the drive shaft (denominator) Page 97 Electronic gear function
607Eh	—	VAR	Polarity	Polarity selection Bit 7: Position POL Bit 6: Velocity POL Bit 5: Torque POL Page 82 Rotation/travel direction selection
2D20h	—	VAR	Velocity limit value	Speed limit value Unit: vel units
60A8h	—	VAR	SI unit position	SI unit position It is automatically set in [Pr. PT01.2 Unit for position data].
60A9h	—	VAR	SI unit velocity	SI unit velocity The SI unit velocity is returned. It is automatically set in [Pr. PT01.2 Unit for position data].

Index	Sub	Object	Name	Description
60B2h	—	VAR	Torque offset	Torque offset Unit: 0.1 % (with rated torque being 100 %)

## Controlword/Statusword

By changing [Controlword (Obj. 6040h)], control commands can be given to the servo amplifier. The control status can also be checked with [Statusword (Obj. 6041h)].

Some bits of [Controlword (Obj. 6040h)] and [Statusword (Obj. 6041h)] vary depending on the control mode. The bits that vary depending on the control mode are listed in the following tables.

### ■Controlword OMS Bit (cst)

Bit	Symbol	Description
4	(reserved)	The value at reading is undefined. Set "0" when writing.
5	(reserved)	
6	(reserved)	
8	(reserved)	
9	(reserved)	

### ■Statusword OMS Bit (cst)

Bit	Symbol	Description
10	(reserved)	The value at reading is undefined.
12	Drive follows the command value (Target position ignored)	0: [Target torque (Obj. 6071h)] is being discarded. 1: [Target torque (Obj. 6071h)] is being used as a torque control loop input.
13	(reserved)	The value at reading is undefined.

# Profile position mode (pp)

This mode is available on servo amplifiers with firmware version B2 or later.

The following shows the functions and related objects of the profile position mode (pp).

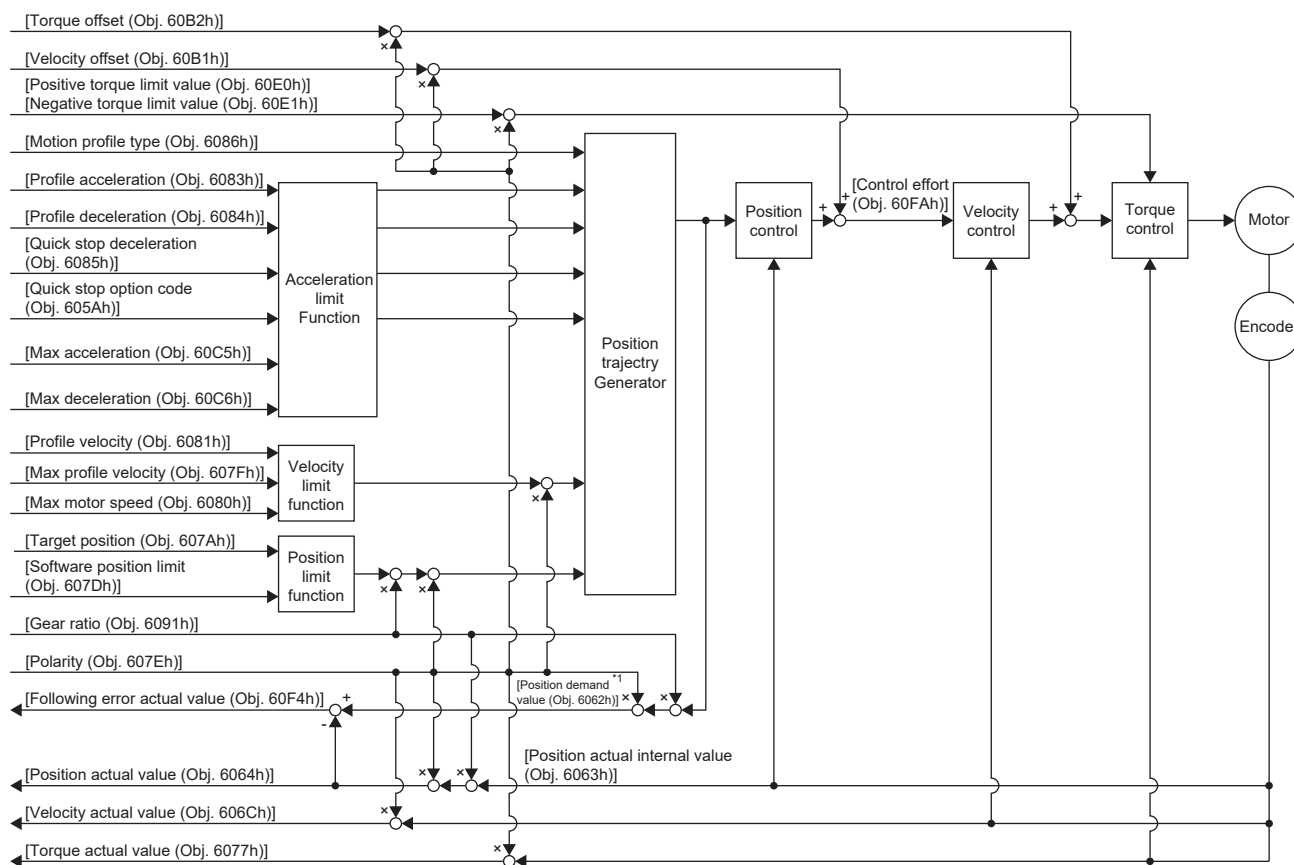

\*1 This object may not be used depending on the network being used. For details, refer to the User's Manual (Object Dictionary).

## Related objects

For details on the objects, refer to the User's Manual (Object Dictionary).

Index	Sub	Object	Name	Description
607Ah	—	VAR	Target position	Command position Unit: pos units
607Bh	0	ARRAY	Position range limit	Number of entries
	1		Min position range limit	Minimum value of the position range limit Unit: pos units
	2		Max position range limit	Maximum value of the position range limit Unit: pos units
607Dh	0	ARRAY	Software position limit	Number of entries
	1		Min position limit	Minimum position address Unit: pos units
	2		Max position limit	Maximum position address Unit: pos units
607Fh	—	VAR	Max profile velocity	Maximum speed Unit: vel units
6080h	—	VAR	Max motor speed	Servo motor maximum speed Unit: r/min, mm/s
6081h	—	VAR	Profile velocity	Speed after acceleration finished Unit: vel units
6083h	—	VAR	Profile acceleration	Acceleration at start of movement to target position Unit: acc units
6084h	—	VAR	Profile deceleration	Deceleration at arrival to target position Unit: acc units



Index	Sub	Object	Name	Description
6085h	—	VAR	Quick stop deceleration	Deceleration at deceleration to a stop with Quick stop Unit: acc units
6086h	—	VAR	Motion profile type	Acceleration/deceleration type selection -1: S-pattern 0: Linear ramp (not supported) 1: Sin <sup>2</sup> ramp (not supported) 2: Jerk-free ramp (not supported) 3: Jerk-limited ramp (not supported)
605Ah	—	VAR	Quick stop option code	Operation setting for Quick stop ☞ Page 132 Quick stop
60C5h *2	—	VAR	Max acceleration	Acceleration limit value Unit: Command unit/s <sup>2</sup>
60C6h *2	—	VAR	Max deceleration	Deceleration limit value Unit: Command unit/s <sup>2</sup>
6063h	—	VAR	Position actual internal value	Current position Unit: Enc inc
6064h	—	VAR	Position actual value	Current position Unit: pos units
606Ch	—	VAR	Velocity actual value	Current speed Unit: vel units
6077h	—	VAR	Torque actual value	Current torque Unit: 0.1 % (with rated torque being 100 %)
6092h	0	ARRAY	Feed constant	Travel distance per revolution of an output shaft
	1		Feed	Travel distance setting Unit: pos units
	2		Shaft revolutions	Number of servo motor shaft revolutions Unit: rev
60F4h	—	VAR	Following error actual value	Droop pulses Unit: pos units
60FAh	—	VAR	Control effort	Position control loop output (speed command) Unit: vel units
60E0h	—	VAR	Positive torque limit value	Torque limit value (forward) Unit: 0.1 % (with rated torque being 100 %)
60E1h	—	VAR	Negative torque limit value	Torque limit value (reverse) Unit: 0.1 % (with rated torque being 100 %)
6091h	0	ARRAY	Gear ratio	Gear ratio
	1		Motor revolutions	Number of revolutions of the servo motor shaft (numerator) ☞ Page 97 Electronic gear function
	2		Shaft revolutions	Number of revolutions of the drive shaft (denominator) ☞ Page 97 Electronic gear function
607Eh	—	VAR	Polarity	Polarity selection Bit 7: Position POL Bit 6: Velocity POL Bit 5: Torque POL ☞ Page 82 Rotation/travel direction selection
60A8h	—	VAR	SI unit position	SI unit position It is automatically set in [Pr. PT01.2 Unit for position data].
60A9h	—	VAR	SI unit velocity	SI unit velocity The SI unit velocity is returned. It is automatically set in [Pr. PT01.2 Unit for position data].
60B1h	—	—	Velocity offset	Velocity offset Unit: vel units
60B2h	—	—	Torque offset	Torque offset Unit: 0.1 % (with rated torque being 100 %)
6062h *1	—	VAR	Position demand value	Command position (absolute position) The command position inside the servo amplifier is returned. Unit: pos units

\*1 This object may not be used depending on the network being used. For details, refer to the User's Manual (Object Dictionary).

\*2 Available on servo amplifiers with firmware version C0 or later.

## Controlword/Statusword

By changing [Controlword (Obj. 6040h)], control commands can be given to the servo amplifier. The control status can also be checked with [Statusword (Obj. 6041h)].

Some bits of [Controlword (Obj. 6040h)] and [Statusword (Obj. 6041h)] vary or are common depending on the control mode. The bits that vary depending on the control mode are listed in the following tables.

### ■Controlword OMS Bit (pp)

Bit	Symbol	Description
4	New set-point	Obtains a new positioning servo parameter at bit rising.
5	Change set immediately	0: Set of set-points 1: Single set-point (The positioning servo parameter update is immediately accepted.)
6	abs/rel	0: Absolute position command 1: Relative position command
8	HALT	0: Drives the servo motor. 1: Stops the servo motor according to [Halt option code (Obj. 605Dh)].
9	Change on set-point	Enabled only in Set of set-points (when the bit 5 of [Obj. 6040h: 00h] is "0"). 0: Shifts to the next positioning after completing the current positioning. 1: Shifts to the next positioning after performing positioning up to the current set-point with the setting of [profile velocity (Obj. 6081h)].  Page 25 Set of set-points

### ■Statusword OMS Bit (pp)

Bit	Symbol	Description
10	Target reached	0: Halt (Bit 8) = 0: Target position not reached. 0: Halt (Bit 8) = 1: Axis decelerates. 1: Halt (Bit 8) = 0: Target position reached. 1: Halt (Bit 8) = 1: Velocity of axis is 0. Judgment condition of Target position reached: When the time set in [Position window time (Obj. 6068h)] elapses in a state where the difference between the values in [Position actual value (Obj. 6064h)] and [Target position (Obj. 607Ah)] is equal to or below the value set in [Position window (Obj. 6067h)], the state changes to "Target position reached".
12	Set-point acknowledge	0: Positioning completed (waiting for next command) 1: Positioning in progress (When Single set-point (When bit 5 of [Obj. 6040h: 00h] is "1"), setpoint can be overwritten.)
13	Following error	0: No following error 1: Following error

## Single Set-point

Update of positioning servo parameters during a positioning operation is immediately accepted. (The current positioning operation is canceled and the next positioning operation is started.)

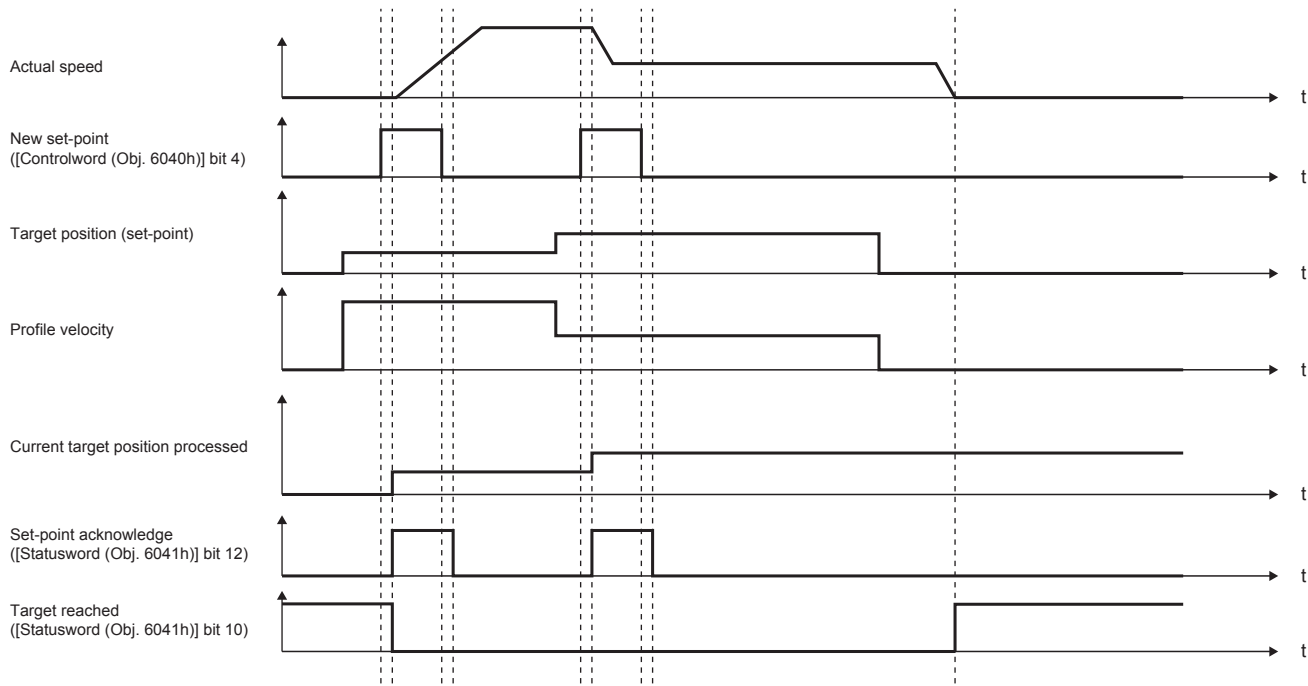

## Set of set-points

After the current positioning operation finishes, the next positioning starts. Use the setting value of Change on set-point (Controlword Bit 9) to switch whether the positioning operation is to be stopped at the first positioning point when the positioning servo parameter is updated before completion of the positioning operation.

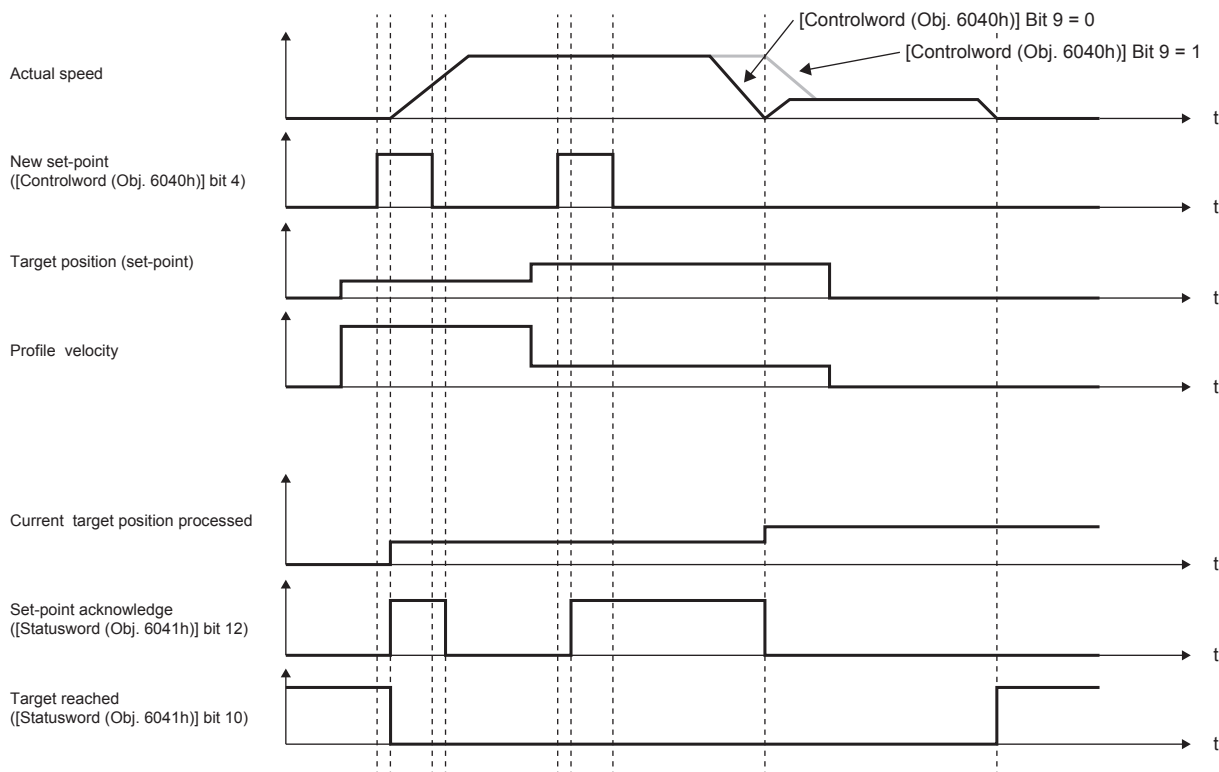

# Profile velocity mode (pv)

This mode is available on servo amplifiers with firmware version B2 or later.

The following shows the functions and related objects of the profile velocity mode (pv).

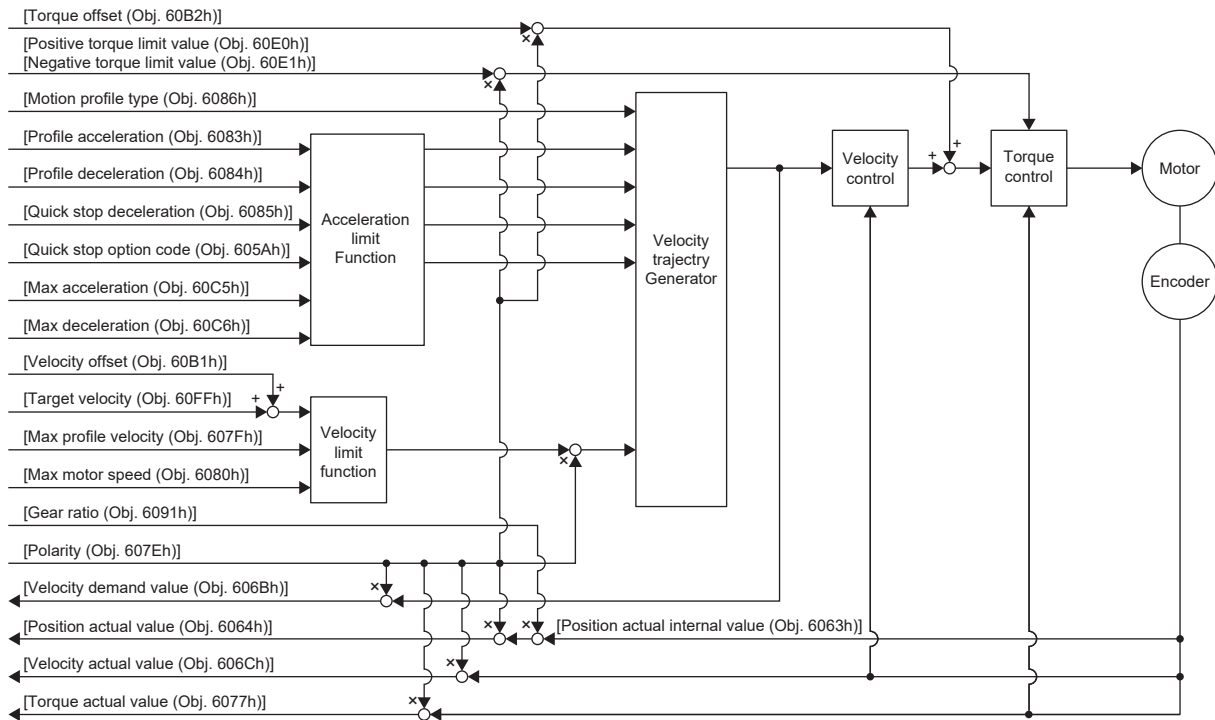

## Related objects

For details on the objects, refer to the User's Manual (Object Dictionary).

Index	Sub	Object	Name	Description
60FFh	—	VAR	Target velocity	Command speed Unit: vel units
607Fh	—	VAR	Max profile velocity	Maximum speed Unit: vel units
6080h	—	VAR	Max motor speed	Servo motor maximum speed Unit: r/min, mm/s
6083h	—	VAR	Profile acceleration	Acceleration at start of movement to target position Unit: acc units
6084h	—	VAR	Profile deceleration	Deceleration at arrival to target position Unit: acc units
6085h	—	VAR	Quick stop deceleration	Deceleration at deceleration to a stop with Quick stop Unit: acc units
6086h	—	VAR	Motion profile type	Acceleration/deceleration type selection -1: S-pattern 0: Linear ramp (not supported) 1: Sin <sup>2</sup> ramp (not supported) 2: Jerk-free ramp (not supported) 3: Jerk-limited ramp (not supported)
605Ah	—	VAR	Quick stop option code	Operation setting for Quick stop ☞ Page 132 Quick stop
6063h	—	VAR	Position actual internal value	Current position Unit: Enc inc
6064h	—	VAR	Position actual value	Current position Unit: pos units
606Bh	—	VAR	Velocity demand value	Speed command (after trajectory generation)
606Ch	—	VAR	Velocity actual value	Current speed Unit: vel units

Index	Sub	Object	Name	Description
6077h	—	VAR	Torque actual value	Current torque Unit: 0.1 % (with rated torque being 100 %)
6092h	0	ARRAY	Feed constant	Travel distance per revolution of an output shaft
	1		Feed	Travel distance setting
	2		Shaft revolutions	Number of servo motor shaft revolutions Unit: rev
60C5h *1	—	VAR	Max acceleration	Acceleration limit value Unit: Command unit/s <sup>2</sup>
60C6h *1	—	VAR	Max deceleration	Deceleration limit value Unit: Command unit/s <sup>2</sup>
60E0h	—	VAR	Positive torque limit value	Torque limit value (forward) Unit: 0.1 % (with rated torque being 100 %)
60E1h	—	VAR	Negative torque limit value	Torque limit value (reverse) Unit: 0.1 % (with rated torque being 100 %)
6091h	0	ARRAY	Gear ratio	Gear ratio
	1		Motor revolutions	Number of revolutions of the servo motor shaft (numerator) ☞ Page 97 Electronic gear function
	2		Shaft revolutions	Number of revolutions of the drive shaft (denominator) ☞ Page 97 Electronic gear function
607Eh	—	VAR	Polarity	Polarity selection Bit 7: Position POL Bit 6: Velocity POL Bit 5: Torque POL ☞ Page 82 Rotation/travel direction selection
606Dh	—	VAR	Velocity window	Speed error threshold for judging Target reached Unit: vel units
606Eh	—	VAR	Velocity window time	Target reached judgment time Unit: ms
606Fh	—	VAR	Velocity threshold	Zero speed threshold for judging Speed Unit: vel units
6070h	—	VAR	Velocity threshold time	Speed judgment time Unit: ms
60A8h	—	VAR	SI unit position	SI unit position It is automatically set in [Pr. PT01.2 Unit for position data].
60A9h	—	VAR	SI unit velocity	SI unit velocity The SI unit velocity is returned. It is automatically set in [Pr. PT01.2 Unit for position data].
60B1h	—	VAR	Velocity offset	Velocity offset Unit: vel units
60B2h	—	VAR	Torque offset	Torque offset Unit: 0.1 % (with rated torque being 100 %)

\*1 Available on servo amplifiers with firmware version C0 or later.

## Controlword/Statusword

By changing [Controlword (Obj. 6040h)], control commands can be given to the servo amplifier. The control status can also be checked with [Statusword (Obj. 6041h)].

Some bits of [Controlword (Obj. 6040h)] and [Statusword (Obj. 6041h)] vary or are common depending on the control mode. The bits that vary depending on the control mode are listed in the following tables.

### ■Controlword OMS Bit (pv)

Bit	Symbol	Description
4	(reserved)	The value at reading is undefined. Set "0" when writing.
5	(reserved)	
6	(reserved)	
8	HALT	0: Drives the servo motor. 1: Stops the servo motor according to [Halt option code (Obj. 605Dh)].
9	(reserved)	The value at reading is undefined. Set "0" when writing.

### ■Statusword OMS Bit (pv)

Bit	Symbol	Description
10	Target reached	0: Halt (Bit 8) = 0: Target velocity not reached. 0: Halt (Bit 8) = 1: Axis decelerates. 1: Halt (Bit 8) = 0: Target velocity reached. 1: Halt (Bit 8) = 1: Velocity of axis is 0. Judgment condition of Target velocity reached: When the time set in [Velocity window time (Obj. 606Eh)] elapses in a state where the difference between the values in [Velocity actual value (Obj. 606Ch)] and [Target velocity (Obj. 60FFh)] is equal to or below the value set in [Velocity window (Obj. 606Dh)], the state changes to "Target velocity reached".
12	Speed	0: Speed is not equal 0 1: Speed is equal 0 Judgment condition of Speed is not equal 0: When the time set in [Velocity threshold time (Obj. 6070h)] elapses in a state where the absolute value of [Velocity actual value (Obj. 606Ch)] is equal to or above the setting value of [Velocity threshold (Obj. 606Fh)], the bit changes to "Speed is not equal 0".
13	Max slippage error	0: Maximum slippage not reached 1: Maximum slippage reached (not supported) Max slippage is the maximum slippage of the asynchronous servo motor.

# Operation sequence

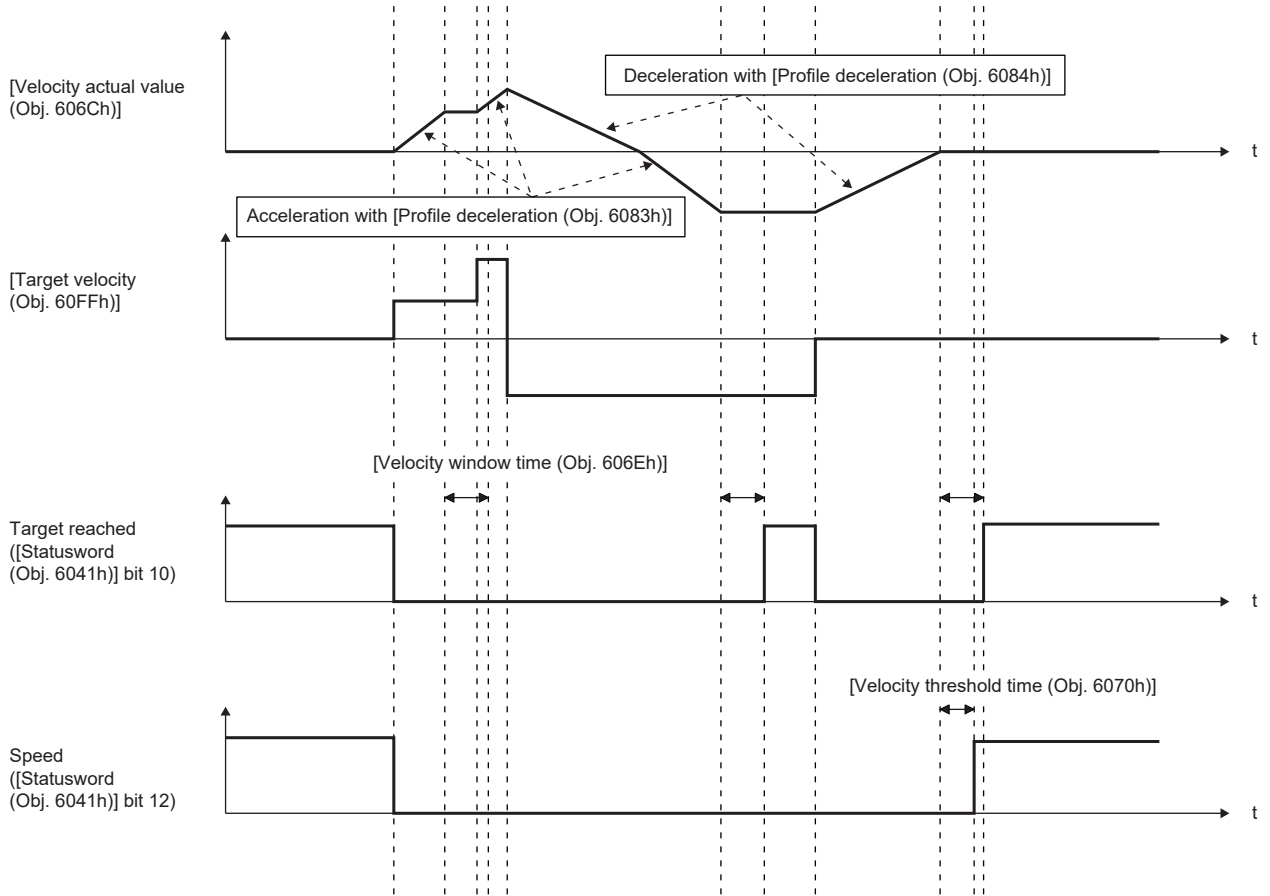

# Profile torque mode (tq)

This mode is available on servo amplifiers with firmware version B2 or later.

The following shows the functions and related objects of the profile torque mode (tq).

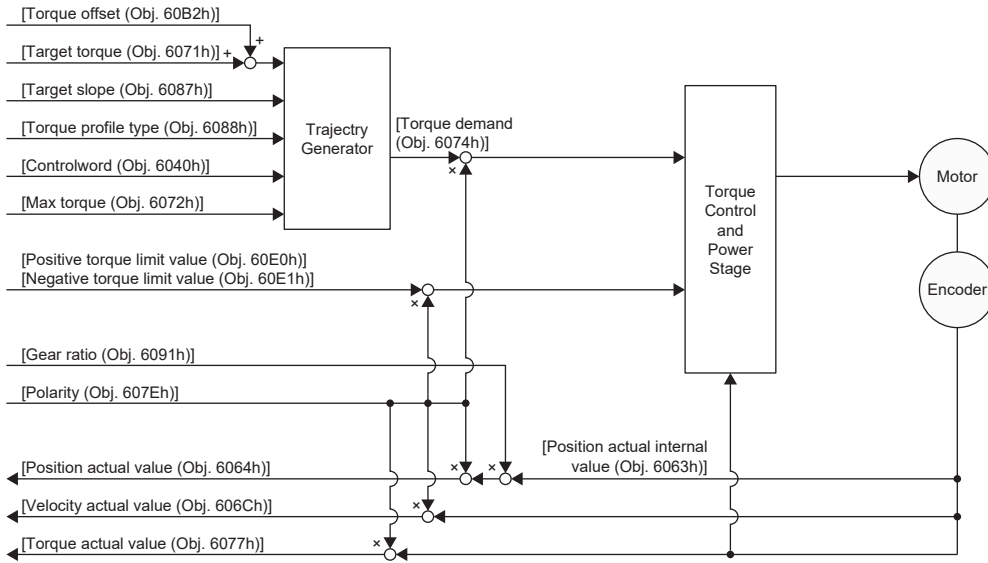

## Related objects

For details on the objects, refer to the User's Manual (Object Dictionary).

Index	Sub	Object	Name	Description
6040h	—	VAR	Controlword	Common control command
6071h	—	VAR	Target torque	Command torque Unit: 0.1 % (with rated torque being 100 %)
6072h	—	VAR	Max torque	Maximum torque Unit: 0.1 % (with rated torque being 100 %)
6074h	—	VAR	Torque demand value	Command torque (after limit) Unit: 0.1 % (with rated torque being 100 %)
6087h	—	VAR	Torque slope	Torque variation Unit: 0.1 %/s (with rated torque being 100 %)
6088h	—	VAR	Torque profile type	Torque variation pattern 0: Linear ramp 1: Sin <sup>2</sup> ramp (not supported)
6063h	—	VAR	Position actual internal value	Current position Unit: Enc inc
6064h	—	VAR	Position actual value	Current position Unit: pos units
606Ch	—	VAR	Velocity actual value	Current speed Unit: vel units
6077h	—	VAR	Torque actual value	Current torque Unit: 0.1 % (with rated torque being 100 %)
6092h	0	ARRAY	Feed constant	Travel distance per revolution of an output shaft
	1		Feed	Travel distance setting
	2		Shaft revolutions	Number of servo motor shaft revolutions Unit: rev
60E0h	—	VAR	Positive torque limit value	Torque limit value (forward) Unit: 0.1 % (with rated torque being 100 %)
60E1h	—	VAR	Negative torque limit value	Torque limit value (reverse) Unit: 0.1 % (with rated torque being 100 %)



Index	Sub	Object	Name	Description
6091h	0	ARRAY	Gear ratio	Gear ratio
	1		Motor revolutions	Number of revolutions of the servo motor shaft (numerator) ☞ Page 97 Electronic gear function
	2		Shaft revolutions	Number of revolutions of the drive shaft (denominator) ☞ Page 97 Electronic gear function
607Eh	—	VAR	Polarity	Polarity selection Bit 7: Position POL Bit 6: Velocity POL Bit 5: Torque POL ☞ Page 82 Rotation/travel direction selection
2D20h	—	VAR	Velocity limit value	Speed limit value Unit: vel units
60A8h	—	VAR	SI unit position	SI unit position It is automatically set in [Pr. PT01.2 Unit for position data].
60A9h	—	VAR	SI unit velocity	SI unit velocity The SI unit velocity is returned. It is automatically set in [Pr. PT01.2 Unit for position data].
60B2h	—	VAR	Torque offset	Torque offset Unit: 0.1 % (with rated torque being 100 %)

## Controlword/Statusword

By changing [Controlword (Obj. 6040h)], control commands can be given to the servo amplifier. The control status can also be checked with [Statusword (Obj. 6041h)].

Some bits of [Controlword (Obj. 6040h)] and [Statusword (Obj. 6041h)] vary or are common depending on the control mode. The bits that vary depending on the control mode are listed in the following tables.

### ■Controlword OMS Bit (tq)

Bit	Symbol	Description
4	(reserved)	The value at reading is undefined. Set "0" when writing.
5	(reserved)	
6	(reserved)	
8	HALT	0: Drives the servo motor. 1: Stops the servo motor according to [Halt option code (Obj. 605Dh)].
9	(reserved)	The value at reading is undefined. Set "0" when writing.

### ■Statusword OMS Bit (tq)

Bit	Symbol	Description
10	Target reached (not supported)	0: Halt (Bit 8) = 0: Target torque not reached. 0: Halt (Bit 8) = 1: Axis decelerates. 1: Halt (Bit 8) = 0: Target torque reached. 1: Halt (Bit 8) = 1: Velocity of axis is 0. Judgment condition of Target torque reached: When the time set in [Torque window time] elapses in a state where the difference between the values in [Torque actual value (Obj. 6077h)] and [Target torque (Obj. 6071h)] is equal to or below the value set in [Torque window], the state changes to "Target torque reached".
12	(reserved)	The value at reading is undefined.
13	(reserved)	

## Operation sequence

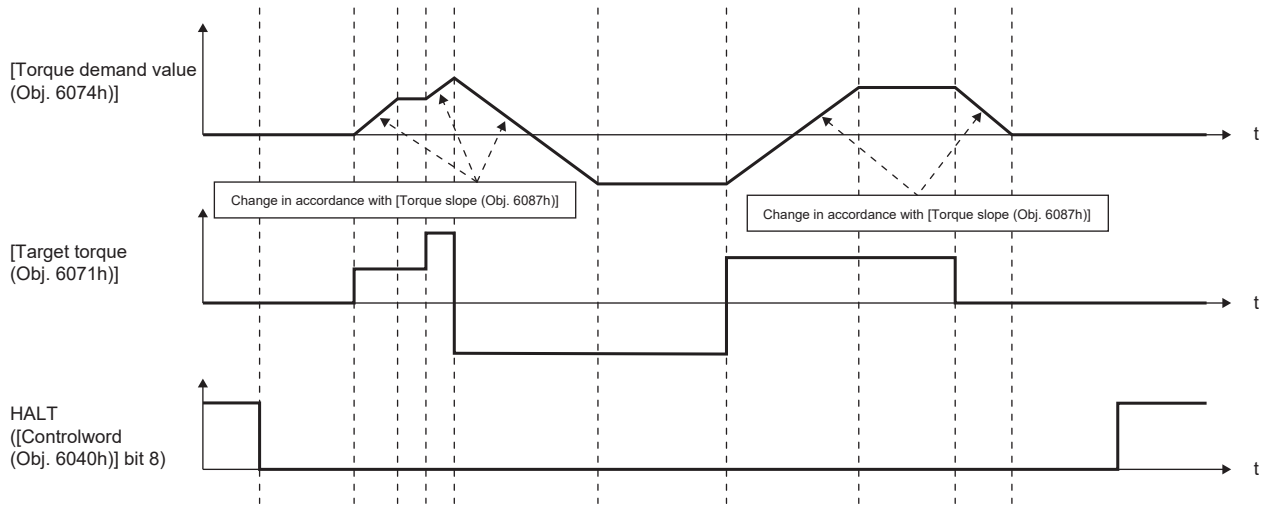

# Point table mode (pt)

Available on servo amplifiers with firmware version B8 or later.

The following shows the functions and related objects of the point table mode (pt).

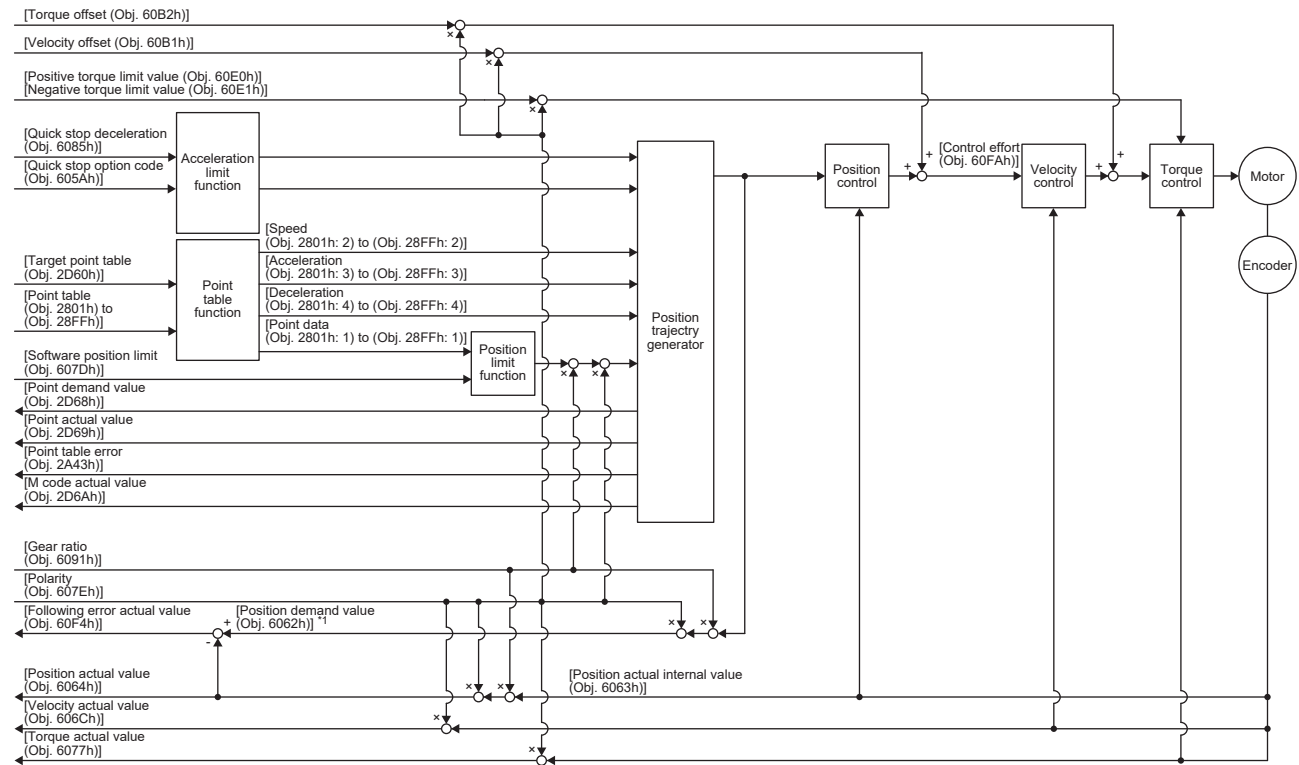

\*1 This object may not be used depending on the network being used. For details, refer to the User's Manual (Object Dictionary).

## Related objects

For details on the objects, refer to the User's Manual (Object Dictionary).

Index	Sub	Object	Name	Description
607Bh	0	ARRAY	Position range limit	Number of entries
	1		Min position range limit	Minimum value of the position range limit Unit: pos units
	2		Max position range limit	Maximum value of the position range limit Unit: pos units
607Dh	0	ARRAY	Software position limit	Number of entries
	1		Min position limit	Minimum position address Unit: pos units
	2		Max position limit	Maximum position address Unit: pos units
6085h	—	VAR	Quick stop deceleration	Deceleration at deceleration to a stop with Quick stop Unit: acc units
605Ah	—	VAR	Quick stop option code	Operation setting for Quick stop Page 132 Quick stop
6080h	—	VAR	Max motor speed	Servo motor maximum speed Unit: r/min, mm/s
6063h	—	VAR	Position actual internal value	Current position Unit: Enc inc
6064h	—	VAR	Position actual value	Current position Unit: pos units
606Ch	—	VAR	Velocity actual value	Current speed Unit: vel units
6077h	—	VAR	Torque actual value	Current torque Unit: 0.1 % (with rated torque being 100 %)

Index	Sub	Object	Name	Description
6092h	0	ARRAY	Feed constant	Travel distance per revolution of an output shaft
	1		Feed	Travel distance setting
	2		Shaft revolutions	Number of servo motor shaft revolutions Unit: rev
60F4h	—	VAR	Following error actual value	Drop pulses Unit: pos units
60FAh	—	VAR	Control effort	Position control loop output (speed command) Unit: vel units
60E0h	—	VAR	Positive torque limit value	Torque limit value (forward) Unit: 0.1 % (with rated torque being 100 %)
60E1h	—	VAR	Negative torque limit value	Torque limit value (reverse) Unit: 0.1 % (with rated torque being 100 %)
6091h	0	ARRAY	Gear ratio	Gear ratio
	1		Motor revolutions	Number of revolutions of the servo motor shaft (numerator) ☞ Page 97 Electronic gear function
	2		Shaft revolutions	Number of revolutions of the drive shaft (denominator) ☞ Page 97 Electronic gear function
607Eh	—	VAR	Polarity	Polarity selection Bit 7: Position POL Bit 6: Velocity POL Bit 5: Torque POL ☞ Page 82 Rotation/travel direction selection
60A8h	—	VAR	SI unit position	SI unit position It is automatically set in [Pr. PT01.2 Unit for position data].
60A9h	—	VAR	SI unit velocity	SI unit velocity The SI unit velocity is returned. It is automatically set in [Pr. PT01.2 Unit for position data].
60AAh	—	VAR	SI unit acceleration	SI unit acceleration The SI unit acceleration is returned. It is automatically set in [Pr. PT01.2 Unit for position data] or [Pr. PT01.1 Speed/acceleration/deceleration unit selection].
6086h	—	VAR	Motion profile type	Acceleration/deceleration type selection -1: S-pattern 0: Linear ramp (not supported) 1: Sin <sup>2</sup> ramp (not supported) 2: Jerk-free ramp (not supported) 3: Jerk-limited ramp (not supported)
2D60h	—	VAR	Target point table	Point table command 0: Does not operate. 1 to 255: Executes the specified point table. -1: Positioning to the home
2D68h	—	VAR	Point demand value	Point table request The point table number which is currently being commanded is returned. When the servo motor is stopped, the setting value of [Target point Table (Obj. 2D60h)] is returned.
2D69h	—	VAR	Point actual value	Current point table The point table number at which execution has completed is returned.
2801h to 28FFh	0	ARRAY	Point table 001 to 255	Number of entries (point table data)
	1		Point data	Position data Unit: pos units
	2		Speed	Speed data Unit: vel units
	3		Acceleration	Acceleration time constant Unit: acc units
	4		Deceleration	Deceleration time constant Unit: acc units
	5		Dwell	Dwell Unit: ms
	6		Auxiliary	Auxiliary function
7	M code	M code		

Index	Sub	Object	Name	Description
2A43h	0	ARRAY	Point table error	Number of entries (point table data)
	1		Point table error No.	Point table error number During [AL. 037.3 Point table setting error] occurrence, the point table number that triggers the alarm is returned.
	2		Point table error factor	Point table error element During [AL. 037.3] occurrence, the element of the point table that triggers the alarm is returned. The bit is turned on to indicate the error status.
2D6Ah	—	VAR	M code actual value	Current M code The M code of the point table at which execution has completed is returned.
60B1h	—	VAR	Velocity offset	Velocity offset Unit: vel units
60B2h	—	VAR	Torque offset	Torque offset Unit: 0.1 % (with rated torque being 100 %)
6062h *1	—	VAR	Position demand value	Command position (absolute position) The command position inside the servo amplifier is returned. Unit: pos units

\*1 This object may not be used depending on the network being used. For details, refer to the User's Manual (Object Dictionary).

## Controlword/Statusword

By changing [Controlword (Obj. 6040h)], control commands can be given to the servo amplifier. The control status can also be checked with [Statusword (Obj. 6041h)].

Some bits of [Controlword (Obj. 6040h)] and [Statusword (Obj. 6041h)] vary depending on the control mode. The bits that vary depending on the control mode are listed in the following tables.

### ■Controlword OMS Bit (pt)

Bit	Symbol	Description
4	New set-point	Operation is started from the point table specified with [Target point table (Obj. 2D60h)] at bit rising.
5	(reserved)	The value at reading is undefined. Set "0" when writing.
6	(reserved)	
8	HALT	0: Performs positioning. 1: Stops the servo motor according to [Halt option code (Obj. 605Dh)].
9	(reserved)	The value at reading is undefined. Set "0" when writing.

### ■Statusword OMS Bit (pt)

Bit	Symbol	Description
10	Target reached	0 (Halt (Bit 8) = 0) : Target position not reached. 0 (Halt (Bit 8) = 1) : Axis decelerates 1 (Halt (Bit 8) = 0) : Target position reached. 1 (Halt (Bit 8) = 1) : Velocity of axis is 0 Judgment condition of Target position reached When the difference between the current position and point table command position has stayed within [Position window (Obj. 6067h)] for [Position window time (Obj. 6068h)] or longer, the state changes to "Target position reached".
12	Set-point acknowledge	0: Positioning completed (waiting for next command) 1: Positioning in progress
13	Following error	0: No following error 1: Following error Judgment condition of Following error: When the time set in [Following error time out (Obj. 6066h)] elapses in a state where [Following error actual value (Obj. 60F4h)] exceeds the value set in [Following error window (Obj. 6065h)], this bit changes to "1".

# JOG operation mode (jg)

Available on servo amplifiers with firmware version B8 or later.

The following shows the functions of the JOG operation mode (jg) as well as related objects.

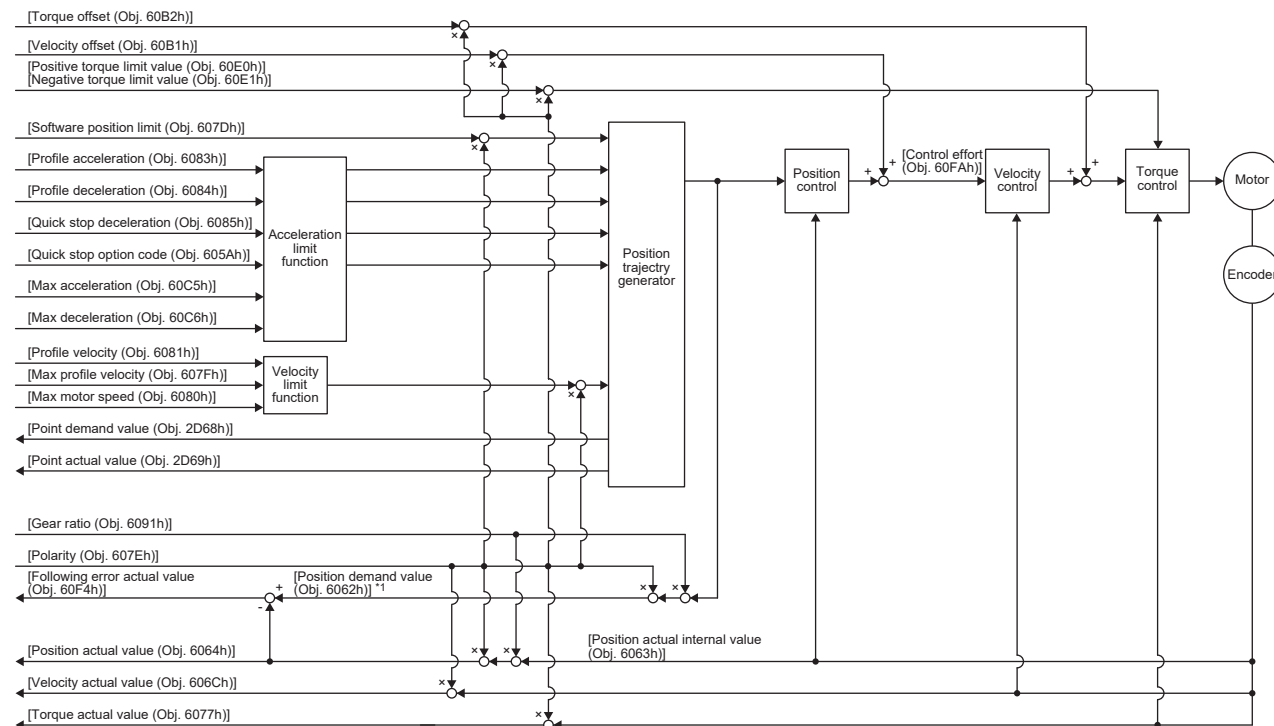

\*1 This object may not be used depending on the network being used. For details, refer to the User's Manual (Object Dictionary).

## Related objects

For details on the objects, refer to the User's Manual (Object Dictionary).

Index	Sub	Object	Name	Description
607Bh	0	ARRAY	Position range limit	Number of entries
	1		Min position range limit	Minimum value of the position range limit Unit: pos units
	2		Max position range limit	Maximum value of the position range limit Unit: pos units
607Dh	0	ARRAY	Software position limit	Number of entries
	1		Min position limit	Minimum position address Unit: pos units
	2		Max position limit	Maximum position address Unit: pos units
607Fh	—	VAR	Max profile velocity	Maximum speed Unit: vel units
6080h	—	VAR	Max motor speed	Servo motor maximum speed Unit: r/min, mm/s
6081h	—	VAR	Profile velocity	Speed after acceleration finished Unit: vel units
6083h	—	VAR	Profile acceleration	Acceleration at start of movement to target position Unit: acc units
6084h	—	VAR	Profile deceleration	Deceleration at arrival to target position Unit: acc units
6085h	—	VAR	Quick stop deceleration	Deceleration at deceleration to a stop with Quick stop Unit: acc units
605Ah	—	VAR	Quick stop option code	Operation setting for Quick stop Page 132 Quick stop
6063h	—	VAR	Position actual internal value	Current position Unit: Enc inc

Index	Sub	Object	Name	Description
6064h	—	VAR	Position actual value	Current position Unit: pos units
606Ch	—	VAR	Velocity actual value	Current speed Unit: vel units
6077h	—	VAR	Torque actual value	Current torque Unit: 0.1 % (with rated torque being 100 %)
6092h	0	ARRAY	Feed constant	Travel distance per revolution of an output shaft
	1		Feed	Travel distance setting Unit: pos units
	2		Shaft revolutions	Number of servo motor shaft revolutions Unit: rev
60C5h *2	—	VAR	Max acceleration	Acceleration limit value Unit: Command unit/s <sup>2</sup>
60C6h *2	—	VAR	Max deceleration	Deceleration limit value Unit: Command unit/s <sup>2</sup>
60F4h	—	VAR	Following error actual value	Droop pulses Unit: pos units
60FAh	—	VAR	Control effort	Position control loop output (speed command) Unit: vel units
60E0h	—	VAR	Positive torque limit value	Torque limit value (forward) Unit: 0.1 % (with rated torque being 100 %)
60E1h	—	VAR	Negative torque limit value	Torque limit value (reverse) Unit: 0.1 % (with rated torque being 100 %)
6091h	0	ARRAY	Gear ratio	Gear ratio
	1		Motor revolutions	Number of revolutions of the servo motor shaft (numerator) ☞ Page 97 Electronic gear function
	2		Shaft revolutions	Number of revolutions of the drive shaft (denominator) ☞ Page 97 Electronic gear function
607Eh	—	VAR	Polarity	Polarity selection Bit 7: Position POL Bit 6: Velocity POL Bit 5: Torque POL ☞ Page 82 Rotation/travel direction selection
60A8h	—	VAR	SI unit position	SI unit position It is automatically set in [Pr. PT01.2 Unit for position data].
60A9h	—	VAR	SI unit velocity	SI unit velocity The SI unit velocity is returned. It is automatically set in [Pr. PT01.2 Unit for position data].
60AAh	—	VAR	SI unit acceleration	SI unit acceleration The SI unit acceleration is returned. It is automatically set in [Pr. PT01.2 Unit for position data] or [Pr. PT01.1 Speed/acceleration/deceleration unit selection].
6086h	—	VAR	Motion profile type	Acceleration/deceleration type selection -1: S-pattern 0: Linear ramp (not supported) 1: Sin <sup>2</sup> ramp (not supported) 2: Jerk-free ramp (not supported) 3: Jerk-limited ramp (not supported)
2D68h	—	VAR	Point demand value	Point table request Always "0".
2D69h	—	VAR	Point actual value	Current point table The previous value is retained.
60B1h	—	VAR	Velocity offset	Velocity offset Unit: vel units
60B2h	—	VAR	Torque offset	Torque offset Unit: 0.1 % (with rated torque being 100 %)
6062h *1	—	VAR	Position demand value	Command position (absolute position) The command position inside the servo amplifier is returned. Unit: pos units

\*1 This object may not be used depending on the network being used. For details, refer to the User's Manual (Object Dictionary).

\*2 Available on servo amplifiers with firmware version C0 or later.

## Controlword/Statusword

By changing [Controlword (Obj. 6040h)], control commands can be given to the servo amplifier. The control status can also be checked with [Statusword (Obj. 6041h)].

Some bits of [Controlword (Obj. 6040h)] and [Statusword (Obj. 6041h)] vary or are common depending on the control mode. The bits that vary depending on the control mode are listed in the following tables.

### ■Controlword OMS Bit (jg)

Bit	Symbol	Description
4	Rotation start	0: Servo motor stop 1: Servo motor start
5	Direction	0: Forward rotation (Address increasing) 1: Reverse rotation (Address decreasing)
6	(reserved)	The value at reading is undefined. Set "0" when writing.
8	HALT	0: Performs positioning. 1: Stops the servo motor according to [Halt option code (Obj. 605Dh)].
9	(reserved)	The value at reading is undefined. Set "0" when writing.

### ■Statusword OMS Bit (jg)

Bit	Symbol	Description
10	Target reached	0 (Halt (Bit 8) = 0) : Target position not reached. 0 (Halt (Bit 8) = 1) : Axis decelerates 1 (Halt (Bit 8) = 0) : Target position reached. 1 (Halt (Bit 8) = 1) : Velocity of axis is 0 Judgment condition of Target position reached When the difference between the current position and command position has stayed within [Position window (Obj. 6067h)] for [Position window time (Obj. 6068h)] or longer, the state becomes "Target position reached".
12	(reserved)	The value at reading is undefined.
13	Following error	0: No following error 1: Following error Judgment condition of Following error: When the time set in [Following error time out (Obj. 6066h)] elapses in a state where [Following error actual value (Obj. 60F4h)] exceeds the value set in [Following error window (Obj. 6065h)], this bit changes to "1".



# Continuous operation to torque control mode (ct)

This mode is available on servo amplifiers with firmware version B0 or later.

## Restrictions

The following functions are not available in the continuous operation to torque control mode. Therefore, if an alarm occurs, the servo motor will stop using the method DB or EDB, or coast.

- Base circuit shut-off delay time function
- Forced stop deceleration function
- Vertical axis freefall prevention function
- Stroke limit function
- Software position limit
- Auto tuning function
- Vibration suppression control 1, 2
- Slight vibration suppression control
- One-touch tuning
- Quick tuning function

## Precautions

The relation between the setting value of the command torque and the servo motor torque generation direction can be changed with the setting values of [Pr. PA14 Travel direction selection] and [Pr. PC29.3 Torque POL reflection selection]. The servo motor outputs the torque calculated by adding up the command torque and the values set in [Pr. PE47 Unbalanced torque offset] and [Torque offset (Obj. 60B2h)].

Switching from the csv mode to the continuous operation to torque control mode while a large value is set in [Velocity offset (Obj. 60B1h)] may cause a shock.

In the continuous operation to torque control mode, the response to the torque command is affected. Do not set servo parameters as shown below.

- [Pr. PB12 Overshoot amount compensation] is set to a value other than "0".
- [Pr. PB24.1 PI-PID switching control selection] is set to "3".

## Functions and the related objects

The following shows the functions of the continuous operation to torque control mode (ct) and the related objects.

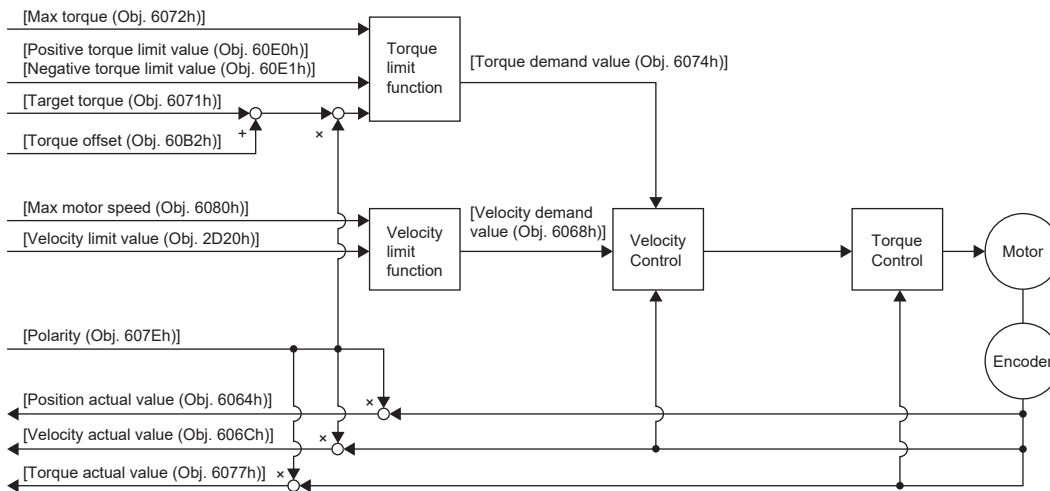

### ■ Related objects

For details on the objects, refer to the User's Manual (Object Dictionary).

Index	Sub	Object	Name	Description
6080h	—	VAR	Max motor speed	Servo motor maximum speed Unit: r/min
606Bh	—	VAR	Velocity demand value	Command speed (after limit) Unit: vel units
6071h	—	VAR	Target torque	Command torque Unit: 0.1 % (with rated torque being 100 %)
6072h	—	VAR	Max torque	Maximum torque Unit: 0.1 % (with rated torque being 100 %)
6074h	—	VAR	Torque demand value	Command torque (after limit) Unit: 0.1 % (with rated torque being 100 %)
6063h	—	VAR	Position actual internal value	Current position Unit: Enc inc
6064h	—	VAR	Position actual value	Current position Unit: Pos units
606Ch	—	VAR	Velocity actual value	Current speed Unit: vel units
6077h	—	VAR	Torque actual value	Current torque Unit: 0.1 % (with rated torque being 100 %)
6092h	0	ARRAY	Feed constant	Travel distance per revolution of an output shaft
	1		Feed	Travel distance setting
	2		Shaft revolutions	Number of servo motor shaft revolutions Unit: rev
60E0h	—	VAR	Positive torque limit value	Torque limit value (forward) Unit: 0.1 % (with rated torque being 100 %)
60E1h	—	VAR	Negative torque limit value	Torque limit value (reverse) Unit: 0.1 % (with rated torque being 100 %)
6091h	0	ARRAY	Gear ratio	Gear ratio
	1		Motor revolutions	Number of revolutions of the servo motor shaft (numerator) ☞ Page 97 Electronic gear function
	2		Shaft revolutions	Number of revolutions of the drive shaft (denominator) ☞ Page 97 Electronic gear function
607Eh	—	VAR	Polarity	Polarity selection Bit 7: Position POL Bit 6: Velocity POL Bit 5: Torque POL ☞ Page 82 Rotation/travel direction selection
2D20h	—	VAR	Velocity limit value	Speed limit value Unit: vel units

Index	Sub	Object	Name	Description
60A8h	—	VAR	SI unit position	SI unit position It is automatically set in [Pr. PT01.2 Unit for position data].
60A9h	—	VAR	SI unit velocity	SI unit velocity The SI unit velocity is returned. It is automatically set in [Pr. PT01.2 Unit for position data].
60B2h	—	VAR	Torque offset	Torque offset Unit: 0.1 % (with rated torque being 100 %)

### ■Controlword/Statusword

By changing [Controlword (Obj. 6040h)], control commands can be given to the servo amplifier. The control status can also be checked with [Statusword (Obj. 6041h)].

Some bits of [Controlword (Obj. 6040h)] and [Statusword (Obj. 6041h)] vary depending on the control mode. The bits that vary depending on the control mode are listed in the following tables.

- Controlword OMS Bit (ct)

Bit	Symbol	Description
4	(reserved)	The value at reading is undefined. Set "0" when writing.
5	(reserved)	
6	(reserved)	
8	(reserved)	
9	(reserved)	

- Statusword OMS Bit (ct)

Bit	Symbol	Description
10	(reserved)	The value at reading is undefined.
12	Target torque ignored	0: [Target torque (Obj. 6071h)] is being discarded. 1: [Target torque (Obj. 6071h)] is being used as a continuous operation to torque control loop input.
13	(reserved)	The value at reading is undefined.

### ■Control mode switching

For information on the control switching, refer to "Control switching for continuous operation to torque control mode (ct)" in the User's Manual (Communication Function).

### ■Setting the torque feedback control gain

In the continuous operation to torque control mode, use the initial value of [Pr. PB03 Torque feedback loop gain] for the torque feedback gain. If the response is not satisfactory, adjust the torque feedback gain.

 Page 43 Parameter adjustment method

## Behavior

### ■ Behavior of the continuous operation to torque control mode

If a workpiece comes into contact with a target object in the continuous operation to torque control mode, the torque control is performed assuming that the command torque is the sum of the values set in [Target torque (Obj. 6071h)], [Pr. PE47 Unbalanced torque offset], and [Torque offset (Obj. 60B2h)]. If a workpiece does not come into contact with a target object, the mode attempts to move the servo motor using the speed limit value set in [Velocity limit value (Obj. 2D20h)]. The command torque and speed limit value can be changed in the continuous operation to torque control mode.

### ■ Current value in the continuous operation to torque control mode

[Position actual internal value (Obj. 6063h)] and [Position actual value (Obj. 6064h)] are continuously updated even in the continuous operation to torque control mode. However, since the software position limit is disabled, [AL. 098 Software position limit warning] will not occur even if [Position actual value (Obj. 6064h)] exceeds the software position limit value.

### ■ Switching between csp and continuous operation to torque control mode

The following shows a timing chart when the mode is switched between the csp mode and continuous operation to torque control mode.

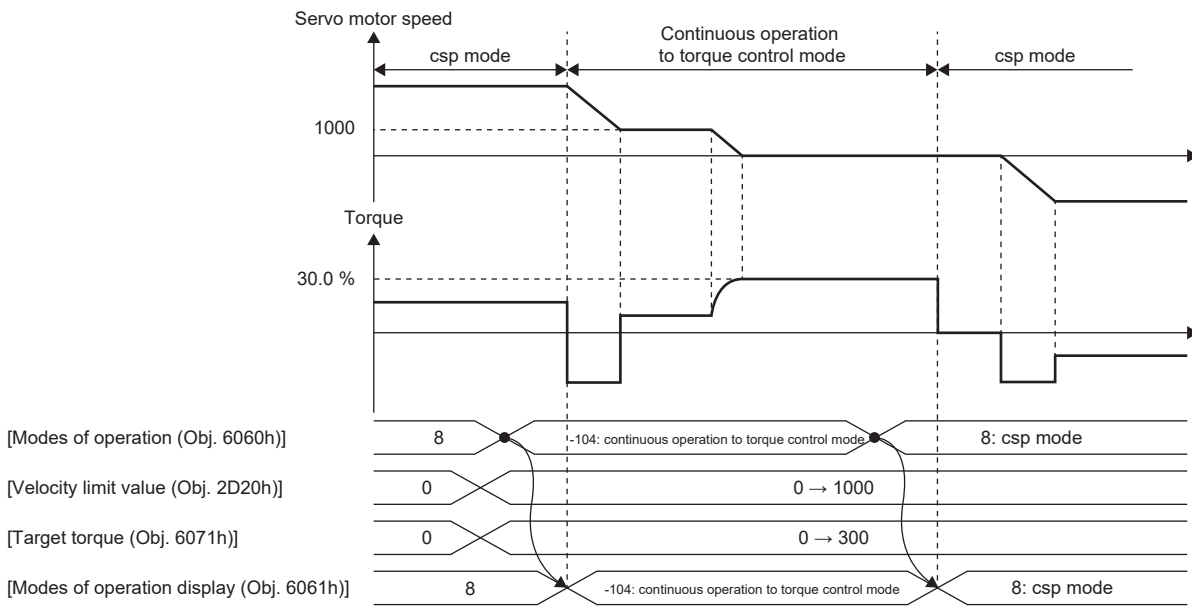

## ■Switching between csv and continuous operation to torque control mode

The following shows a timing chart when the mode is switched between the csv mode and continuous operation to torque control mode.

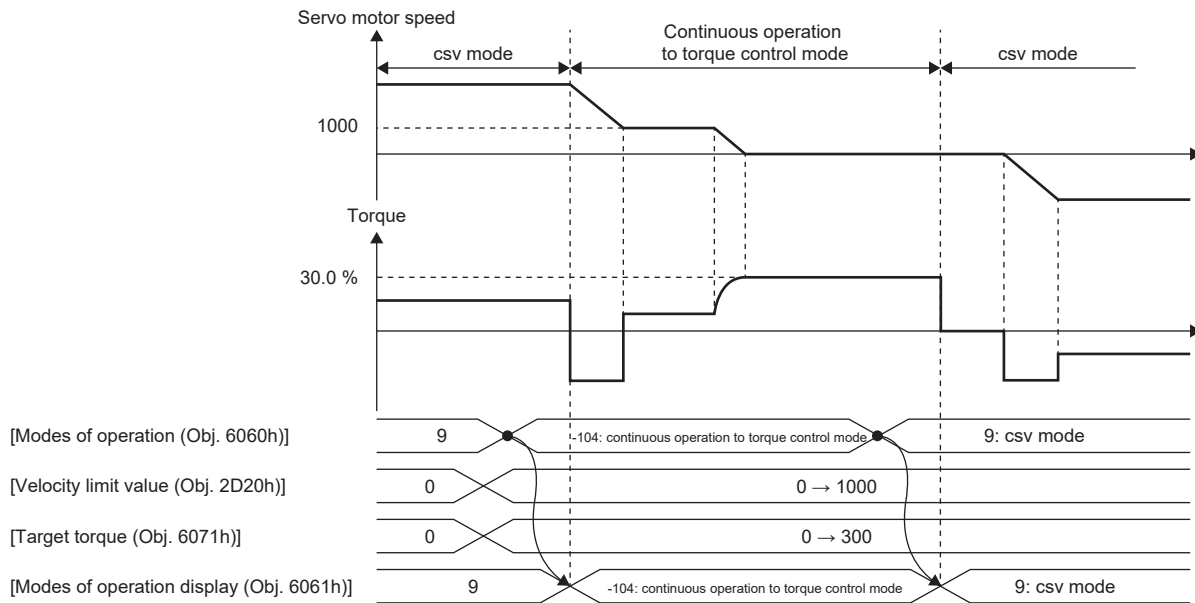

## ■Parameter adjustment method

When using the continuous operation to torque control mode, adjust parameters using the following steps.

### 1. Adjusting servo stability

Adjust servo stability so that the operation is performed normally without vibration in the position mode or speed mode.

### 2. Setting the torque feedback gain

Restore the value of [Pr. PB03 Torque feedback loop gain] to the initial value.

### 3. Adjusting the torque feedback gain

If the servo motor speed or torque fluctuates when a workpiece comes into contact with a target object, decrease the value of [Pr. PB03]. Decreasing the value of [Pr. PB03] will help suppress fluctuation in servo motor speed or torque when a workpiece comes into contact with a target object. However, doing so will decrease trackability to the command torque.

# Homing mode (hm)

The following shows the functions of the homing mode (hm) as well as related objects.

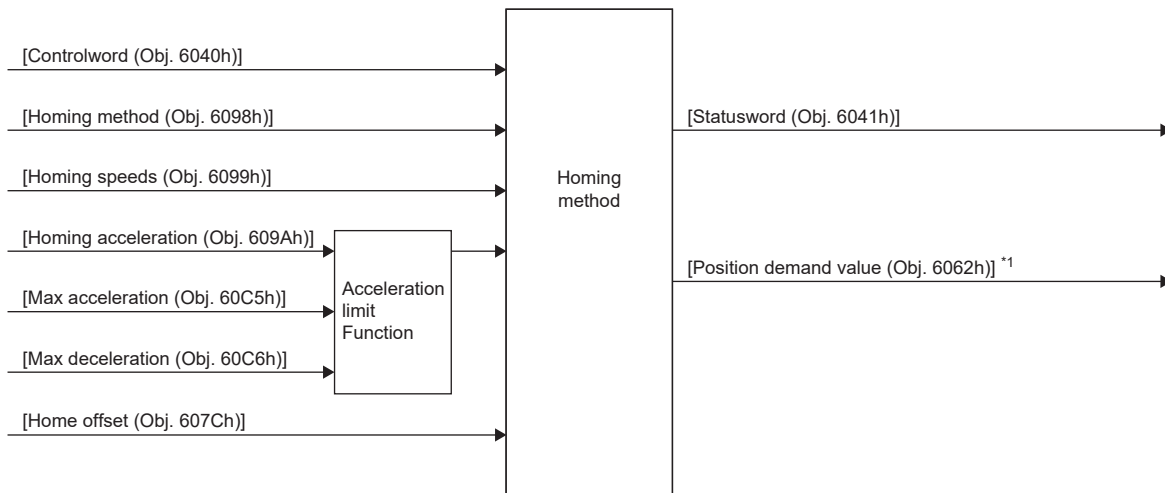

\*1 This object may not be used depending on the network being used. For details, refer to the User's Manual (Object Dictionary).

## Related objects

For details on the objects, refer to the User's Manual (Object Dictionary).

Index	Sub	Object	Name	Description
607Ch	0	VAR	Home offset	Set the difference between zero position of the machine coordinate system and homing position. After homing finishes, the value set to this object is subtracted from the homing position, and at the same time, [Position demand value (Obj. 6062h)] and [Position actual value (Obj. 6064h)] are changed. The setting made by this object is reflected upon completion of the homing operation or when the servo amplifier connects to the network. The setting is not reflected when homing is incomplete.
6098h	0	VAR	Homing Method	Specify a homing method. Refer to the following for the supported homing methods. ☞ Page 46 Homing method list
6099h	0	ARRAY	Homing Speeds	Number of entries of the homing speed
	1		Speed during search for switch	Specify the travel speed until dog detection. *2 (vel units) Range: 0 to servo motor maximum speed
	2		Speed during search for zero	Specify the travel speed to the home position after dog detection. *1 *2 (vel units) Range: 0 to servo motor maximum speed
609Ah	0	VAR	Homing acceleration	Acceleration/deceleration time constant at homing Unit: acc units
60C5h *4	—	VAR	Max acceleration	Acceleration limit value Unit: Command unit/s <sup>2</sup>
60C6h *4	—	VAR	Max deceleration	Deceleration limit value Unit: Command unit/s <sup>2</sup>
60E3h	0	ARRAY	Supported Homing Method	Number of entries of the supported homing method
	1		1st supported homing method	—
	to		—	—
	41		41st supported homing method	—
6062h *3	—	VAR	Position demand value	Command position (absolute position) The command position inside the servo amplifier is returned. Unit: pos units

- \*1 In the homing mode (hm), the servo motor is brought to a quick stop according to the deceleration time constant when the stroke end is detected. Set the homing speed carefully.
- \*2 If the set speed exceeds 8000 r/min (mm/s), the speed is clamped at 8000 r/min (mm/s).
- \*3 This object may not be used depending on the network being used. For details, refer to the User's Manual (Object Dictionary).
- \*4 Available on servo amplifiers with firmware version C0 or later.

## Controlword/Statusword

By changing [Controlword (Obj. 6040h)], control commands can be given to the servo amplifier. The control status can also be checked with [Statusword (Obj. 6041h)].

Some bits of [Controlword (Obj. 6040h)] and [Statusword (Obj. 6041h)] vary depending on the control mode. The bits that vary depending on the control mode are listed in the following tables.

### ■Controlword OMS Bit (hm)

Bit	Symbol	Description
4	HOS	Homing operation start 0: Do not start homing procedure 1: Start or continue homing procedure
5	(reserved)	The value at reading is undefined. Set "0" when writing.
6	(reserved)	
8	HALT	Halt 0: Drives the servo motor. 1: Stops the servo motor according to [Halt option code (Obj. 605Dh)].
9	(reserved)	The value at reading is undefined. Set "0" when writing.

### ■Statusword OMS Bit (hm)



- Before updating the position after homing finishes, check that both Bit 12 and Bit 10 of Statusword have been changed to "1".

Bit	Symbol	Description
10	Target reached	Refer to the following table for the description.
12	Homing attained	
13	Homing error	

The following shows the definition of Bit 10, Bit 12, and Bit 13 of Statusword in the hm mode.

Bit 13	Bit 12	Bit 10	Definition
0	0	0	Homing procedure is in progress.
0	0	1	Homing procedure is interrupted or not started.
0	1	0	Homing is attained, but target is not reached.
0	1	1	Homing procedure is completed successfully.
1	0	0	Homing error occurred, velocity is not 0.
1	0	1	Homing error occurred, velocity is 0.
1	1	—	reserved

## Homing method list

In the following cases, make sure that the Z-phase has been passed once before performing homing. If the Z-phase has not been passed, [AL. 090.5 Homing incomplete warning] will occur.

- When using an incremental linear encoder in the linear servo motor control mode
- When using an incremental external encoder in the fully closed loop control mode

To execute homing securely, move the linear servo motor to the opposite stroke end with csv or other operation modes from the controller, then start homing. [Digital inputs (Obj. 60FDh)] can be used to check whether the linear servo motor has reached the stroke end.

When changing the mode after homing finishes, set [Target position (Obj. 607Ah)] to "0", then change the control mode.

If using an A/B/Z-phase differential output rotary encoder without a Z-phase, do not perform dog type homing or homing using a Z-phase. Doing so may cause the servo motor to keep driving without homing being completed. Perform data set type homing or homing without using a Z-phase.

If an A/B/Z-phase differential output type encoder is used, the accuracy of homing using the Z-phase depends on the Z-phase width in relation to the A and B-phases.

For servo amplifiers with firmware version D4 or later, the setting of [Pr. PA14 Travel direction selection (\*POL)] can be reflected to the homing direction depending on the setting value of [Pr. PT55.1 Homing POL reflection selection].

To specify the homing method in the homing mode (hm), use [Homing Method (Obj. 6098h)]. The homing methods in the following table are supported.

Method No.	Homing methods	Homing direction *3		Description	Home position shift function
		[Pr. PA14] = 0	[Pr. PA14] = 1		
-1	Dog type homing (Rear end detection - Z-phase reference)	Forward rotation (CCW) or positive direction	Reverse rotation (CW) or negative direction	Performs homing using the Z-phase pulse after a moving part has moved past the proximity dog. Deceleration starts from the front end of the proximity dog. After the rear end is passed, the position specified by the first Z-phase signal or the position of the first Z-phase signal shifted by the specified home position shift distance is used as the home position.	Available
-33		Reverse rotation (CW) or negative direction	Forward rotation (CCW) or positive direction		Available
-2	Count type homing (Front end detection - Z-phase reference)	Forward rotation (CCW) or positive direction	Reverse rotation (CW) or negative direction	Performs homing using the encoder pulse count after a moving part came into contact with the proximity dog. Deceleration starts from the front end of the proximity dog. After the front end is passed, the position specified by the first Z-phase signal after the set distance or the position of the Z-phase signal shifted by the set home position shift distance is set as the home position.	Available
-34		Reverse rotation (CW) or negative direction	Forward rotation (CCW) or positive direction		Available
-3	Data set type homing	—	—	Performs homing without a dog. The current position is set as the home position. Homing can be executed in the Operational enabled state. Homing cannot be executed in the servo-off status.	Not available
-4	Stopper type homing (Stopper position reference)	Forward rotation (CCW) or positive direction	Reverse rotation (CW) or negative direction	Performs homing with a workpiece pressed against a mechanical stopper. A workpiece is pressed against a mechanical stopper, and the stop position is set as the home position.	Not available
-36		Reverse rotation (CW) or negative direction	Forward rotation (CCW) or positive direction		Not available
-6	Dog type homing (Rear end detection - rear end reference)	Forward rotation (CCW) or positive direction	Reverse rotation (CW) or negative direction	Performs homing with reference to the rear end of the proximity dog. Deceleration starts from the front end of the proximity dog. After the rear end is passed, the position is shifted by the travel distance after proximity dog and the home position shift distance. The position after the shifts is set as the home position.	Available
-38		Reverse rotation (CW) or negative direction	Forward rotation (CCW) or positive direction		Available



Method No.	Homing methods	Homing direction *3		Description	Home position shift function
		[Pr. PA14] = 0	[Pr. PA14] = 1		
-7	Count type homing (Front end detection - front end reference)	Forward rotation (CCW) or positive direction	Reverse rotation (CW) or negative direction	Performs homing with reference to the front end of the proximity dog. Deceleration starts from the front end of the proximity dog. The position is shifted by the travel distance after the proximity dog and the home position shift distance. The position after the shifts is set as the home position.	Available
-39		Reverse rotation (CW) or negative direction	Forward rotation (CCW) or positive direction		Available
-8	Dog cradle type homing	Forward rotation (CCW) or positive direction	Reverse rotation (CW) or negative direction	Performs homing using the first Z-phase pulse with reference to the front end of the proximity dog. The position specified by either the first Z-phase signal after the front end of the proximity dog is detected or the position of the first Z-phase signal shifted by the home position shift distance can be set as the home position.	Available
-40		Reverse rotation (CW) or negative direction	Forward rotation (CCW) or positive direction		Available
-9	Dog type last Z-phase reference homing	Forward rotation (CCW) or positive direction	Reverse rotation (CW) or negative direction	Performs homing using the last Z-phase pulse with reference to the front end of the proximity dog. After the front end of the proximity dog is detected, the position is shifted away from the proximity dog in the reverse direction. Then, the position specified by the first Z-phase signal or the position of the first Z-phase signal shifted by the home position shift distance is used as the home position.	Available
-41		Reverse rotation (CW) or negative direction	Forward rotation (CCW) or positive direction		Available
-10	Dog type front end reference homing	Forward rotation (CCW) or positive direction	Reverse rotation (CW) or negative direction	Performs homing with reference to the front end of the proximity dog in the direction of the front end. Starting from the front end of the proximity dog, the position is shifted by the travel distance after the proximity dog and the home position shift distance. The position after the shifts is set as the home position.	Available
-42		Reverse rotation (CW) or negative direction	Forward rotation (CCW) or positive direction		Available
-11	Dogless Z-phase reference homing	Forward rotation (CCW) or positive direction	Reverse rotation (CW) or negative direction	Performs homing with reference to the first Z-phase in the direction of the dog front end. The position specified by the first Z-phase signal or the position of the first Z-phase signal shifted by the home position shift distance is used as the home position.	Available
-43		Reverse rotation (CW) or negative direction	Forward rotation (CCW) or positive direction		Available
1 **	Homing on negative limit switch and index pulse	Reverse rotation (CW) or negative direction	Forward rotation (CCW) or positive direction	After the reverse rotation stroke end is detected, the position moves in the opposite direction. Then, the position specified by either the first Z-phase signal after leaving the stroke end or the position of the first Z-phase signal shifted by the home position shift distance can be set as the home position. If the position is shifted in the forward rotation direction, and the forward rotation stroke end is detected before the Z-phase signal is detected, [AL. 090 Homing incomplete warning] will occur. When FLS/RLS is used, this homing method is available on servo amplifiers with firmware version C0 or later.	Available

Method No.	Homing methods	Homing direction <sup>*3</sup>		Description	Home position shift function
		[Pr. PA14] = 0	[Pr. PA14] = 1		
2 <sup>*1</sup>	Homing on positive limit switch and index pulse	Forward rotation (CCW) or positive direction	Reverse rotation (CW) or negative direction	After the forward rotation stroke end is detected, the position moves in the opposite direction. Then, the position specified by either the first Z-phase signal after leaving the stroke end or the position of the first Z-phase signal shifted by the home position shift distance can be set as the home position. If the position is shifted in the reverse rotation direction, and the reverse rotation stroke end is detected before the Z-phase signal is detected, [AL. 090 Homing incomplete warning] will occur. When FLS/RLS is used, this homing method is available on servo amplifiers with firmware version C0 or later.	Available
3	Homing on positive home switch and index pulse	Forward rotation (CCW) or positive direction	Reverse rotation (CW) or negative direction	This is the same as the dog type last Z-phase reference homing. If the stroke end is detected during homing, [AL. 090 Homing incomplete warning] will occur.	Available
4	Homing on positive home switch and index pulse	Forward rotation (CCW) or positive direction	Reverse rotation (CW) or negative direction	This is the same as the dog cradle type homing. If the stroke end is detected during homing, [AL. 090 Homing incomplete warning] will occur.	Available
5	Homing on negative home switch and index pulse	Reverse rotation (CW) or negative direction	Forward rotation (CCW) or positive direction	This is the same as the dog type last Z-phase reference homing. If the stroke end is detected during homing, [AL. 090 Homing incomplete warning] will occur.	Available
6	Homing on negative home switch and index pulse	Reverse rotation (CW) or negative direction	Forward rotation (CCW) or positive direction	This is the same as the dog cradle type homing. If the stroke end is detected during homing, [AL. 090 Homing incomplete warning] will occur.	Available
7	Homing on home switch and index pulse	Forward rotation (CCW) or positive direction	Reverse rotation (CW) or negative direction	This is the same as the dog type last Z-phase reference homing.	Available
8	Homing on home switch and index pulse	Forward rotation (CCW) or positive direction	Reverse rotation (CW) or negative direction	This is the same as the dog cradle type homing.	Available
9 <sup>*2</sup>	Homing on home switch and index pulse	Forward rotation (CCW) or positive direction	Reverse rotation (CW) or negative direction	With reference to the rear end of the proximity dog, the home position is the Z-phase pulse immediately before the rear end of the dog. With this homing method, the position shifted by the home position shift distance is used as the home position.	Available
10 <sup>*2</sup>	Homing on home switch and index pulse	Forward rotation (CCW) or positive direction	Reverse rotation (CW) or negative direction	With reference to the rear end of the proximity dog, the home position is the Z-phase pulse immediately before the rear end of the dog. With this homing method, the position shifted by the home position shift distance is used as the home position.	Available
11	Homing on home switch and index pulse	Reverse rotation (CW) or negative direction	Forward rotation (CCW) or positive direction	This is the same as the dog type last Z-phase reference homing.	Available
12	Homing on home switch and index pulse	Reverse rotation (CW) or negative direction	Forward rotation (CCW) or positive direction	This is the same as the dog cradle type homing.	Available
13 <sup>*2</sup>	Homing on home switch and index pulse	Reverse rotation (CW) or negative direction	Forward rotation (CCW) or positive direction	This is the same as Homing method 9.	Available
14 <sup>*2</sup>	Homing on home switch and index pulse	Reverse rotation (CW) or negative direction	Forward rotation (CCW) or positive direction	This is the same as Homing method 10.	Available

Method No.	Homing methods	Homing direction *3		Description	Home position shift function
		[Pr. PA14] = 0	[Pr. PA14] = 1		
17 *2	Homing without index pulse	Reverse rotation (CW) or negative direction	Forward rotation (CCW) or positive direction	After the reverse rotation stroke end is detected, the position is shifted away from the stroke end in the forward direction, where the home position is set. With this homing method, the position shifted by the home position shift distance is used as the home position. If the position is shifted in the forward rotation direction, and the forward rotation stroke end is detected, [AL. 090 Homing incomplete warning] will occur.	Available
18 *2	Homing without index pulse	Forward rotation (CCW) or positive direction	Reverse rotation (CW) or negative direction	After the forward rotation stroke end is detected, the position is shifted away from the stroke end in the reverse direction, where the home position is set. With this homing method, the position shifted by the home position shift distance is used as the home position. If the position is shifted in the reverse rotation direction, and the reverse rotation stroke end is detected, [AL. 090 Homing incomplete warning] will occur.	Available
19	Homing without index pulse	Forward rotation (CCW) or positive direction	Reverse rotation (CW) or negative direction	This is the same as the dog type front end reference homing. If the stroke end is detected during homing, [AL. 090 Homing incomplete warning] will occur.	Available
20	Homing without index pulse	Forward rotation (CCW) or positive direction	Reverse rotation (CW) or negative direction	Although this type is the same as the dog cradle type homing, the stop position is not on the Z-phase. Starting from the front end of the dog, the position is shifted by the travel distance after proximity dog and the home position shift distance. The position after the shifts is set as the home position. If the stroke end is detected during homing, [AL. 090 Homing incomplete warning] will occur.	Available
21	Homing without index pulse	Reverse rotation (CW) or negative direction	Forward rotation (CCW) or positive direction	This is the same as the dog type front end reference homing. If the stroke end is detected during homing, [AL. 090 Homing incomplete warning] will occur.	Available
22	Homing without index pulse	Reverse rotation (CW) or negative direction	Forward rotation (CCW) or positive direction	Although this type is the same as the dog cradle type homing, the stop position is not on the Z-phase. Starting from the front end of the dog, the position is shifted by the travel distance after proximity dog and the home position shift distance. The position after the shifts is set as the home position. If the stroke end is detected during homing, [AL. 090 Homing incomplete warning] will occur.	Available
23	Homing without index pulse	Forward rotation (CCW) or positive direction	Reverse rotation (CW) or negative direction	This is the same as the dog type front end reference homing.	Available
24	Homing without index pulse	Forward rotation (CCW) or positive direction	Reverse rotation (CW) or negative direction	Although this type is the same as the dog cradle type homing, the stop position is not on the Z-phase. Starting from the front end of the dog, the position is shifted by the travel distance after proximity dog and the home position shift distance. The position after the shifts is set as the home position.	Available
27	Homing without index pulse	Reverse rotation (CW) or negative direction	Forward rotation (CCW) or positive direction	This is the same as the dog type front end reference homing.	Available

Method No.	Homing methods	Homing direction *3		Description	Home position shift function
		[Pr. PA14] = 0	[Pr. PA14] = 1		
28	Homing without index pulse	Reverse rotation (CW) or negative direction	Forward rotation (CCW) or positive direction	Although this type is the same as the dog cradle type homing, the stop position is not on the Z-phase. Starting from the front end of the dog, the position is shifted by the travel distance after proximity dog and the home position shift distance. The position after the shifts is set as the home position.	Available
33	Homing on index pulse	Reverse rotation (CW) or negative direction	Forward rotation (CCW) or positive direction	Although this type is the same as the dogless Z-phase reference homing, the creep speed is applied as the movement start speed.	Available
34	Homing on index pulse	Forward rotation (CCW) or positive direction	Reverse rotation (CW) or negative direction	Although this type is the same as the dogless Z-phase reference homing, the creep speed is applied as the movement start speed.	Available
35	Homing on current position	—	—	The current position is set as the home position. Homing can be executed even when the servo amplifier is not in the Operational enabled state. Homing can be executed in the servo-off status as well.	Not available
37	Homing on current position	—	—	The current position is set as the home position. Homing can be executed even when the servo amplifier is not in the Operational enabled state. Homing can be executed in the servo-off status as well.	Not available

\*1 Available on servo amplifiers with firmware version B2 or later.

\*2 Available on servo amplifiers with firmware version C0 or later.

\*3 When "1" is set in [Pr. PT55.1 Homing POL reflection selection] for servo amplifiers with firmware version D4 or later, the setting value of [Pr. PA14 Travel direction selection (\*POL)] is reflected at homing.

## Home position shift function

The home position shift function can set the position shifted by the value set in [Pr. PT07] from the reference home position in each homing method as the home position.

### Restriction

For the homing methods available in the home position shift function, refer to the following list.

☞ Page 46 Homing method list

2

## Precautions

- The timing charts of the homing method operation examples are described assuming the home position shift distance is a positive value. Setting the home position shift distance to a negative value will move the position in the opposite direction.
- If the home position shift distance is a positive value, the servo motor will not stop even if it reaches the reference position in accordance with the homing method. The servo motor will stop after it moves by the shift distance. If the home position shift distance is a negative value, the servo motor will move to the reference position once in the set homing method. After that, the servo motor will move by the set shift distance.
- The creep speed is applied when the servo motor moves by the home position shift distance.

## Setting method

Set the home position shift distance in [Pr. PT07 Home position shift distance].

### Ex.

Dog type homing is shown in the timing charts.

- When the home position shift distance is a positive value

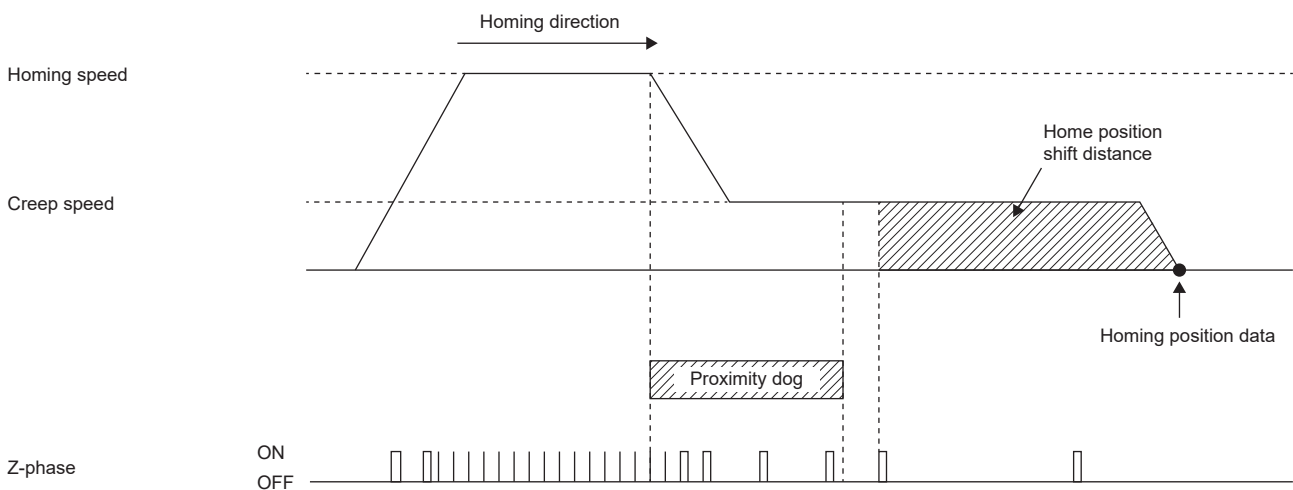

- When the home position shift distance is a negative value

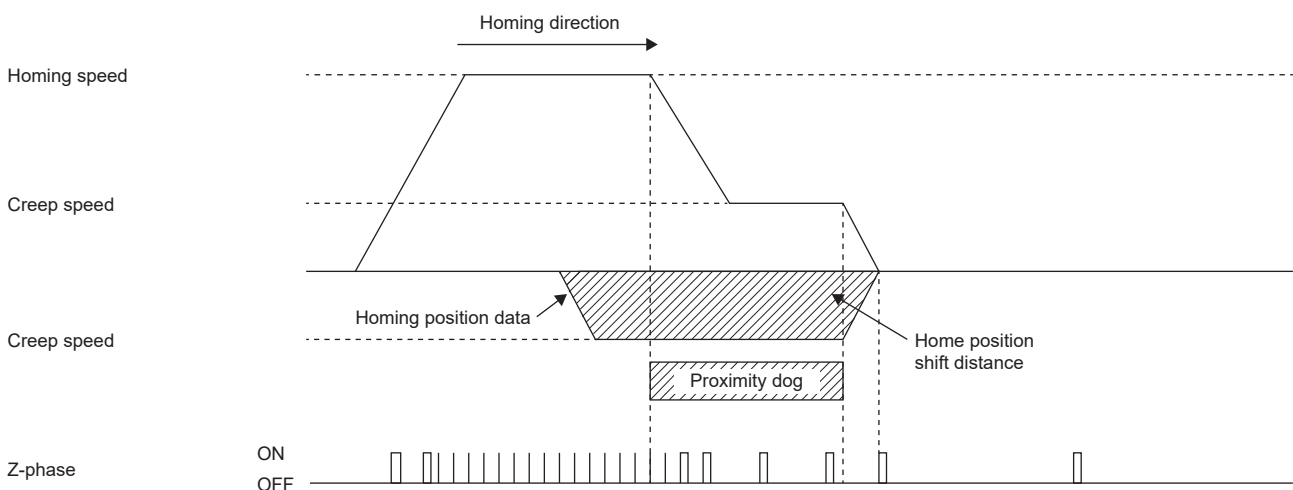

## Conditions for erasing absolute position data

For an incremental system, the absolute position data is erased in the following situations:

- If homing is not being executed.
- If homing is in progress.
- If [AL. 069 Command error] occurs.

For an absolute position detection system, the absolute position data is erased in the following situations:

- If homing is not being executed.
- If homing is in progress.
- If [AL. 069 Command error] occurs.
- If [AL. 025 Absolute position erased] or [AL. 0E3 Absolute position counter warning] occurs.
- If the electronic gear ([Pr. PA06] or [Pr. PA07]) is changed.
- If the setting of [Pr. PA03.0 Absolute position detection system selection] is changed.
- If [Pr. PA14 Travel direction selection] is changed.
- If [Pr. PA01.1 Operation mode] is changed.

## CiA 402-type Homing method

### Point

- For details on signal polarity and other I/O device assignments, refer to the following.  
☞ Page 106 Assigning I/O devices

The following shows the CiA 402-type homing.

### Method 1: Homing on negative limit switch and index pulse

This homing method uses the stroke end as reference and sets the Z-phase right after the stroke end as a home position. After the reverse rotation stroke end is detected, the position is shifted away from the stroke end at creep speed in the forward rotation direction. Then, the position specified by the first Z-phase signal or the position of the first Z-phase signal shifted by the home position shift distance is used as the home position.

Note that if the position is shifted in the forward rotation direction, and the forward rotation stroke end is detected before the Z-phase signal is detected, [AL. 090 Homing incomplete warning] will occur.

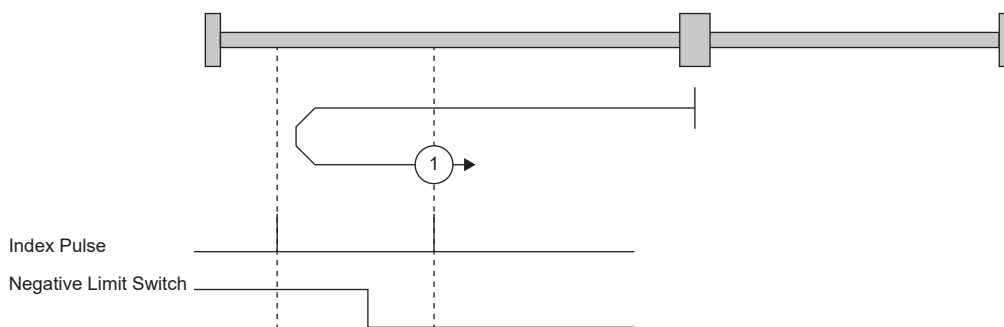

### Method 2: Homing on positive limit switch and index pulse

This homing method uses the stroke end as reference and sets the Z-phase right after the stroke end as a home position. After the forward rotation stroke end is detected, the position is shifted away from the stroke end at creep speed in the reverse rotation direction. Then, the position specified by the first Z-phase signal or the position of the first Z-phase signal shifted by the home position shift distance is used as the home position.

Note that if the position is shifted in the reverse rotation direction, and the reverse rotation stroke end is detected before the Z-phase signal is detected, [AL. 090 Homing incomplete warning] will occur.

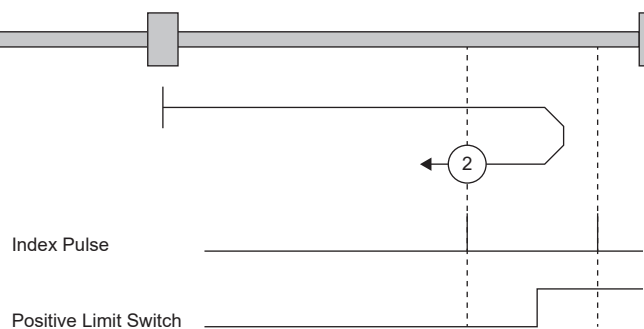

### Method 3 and Method 4: Homing on positive home switch and index pulse

These homing methods use the front end of the proximity dog as reference and set the Z-phase right before and right after the dog as a home position.

Method 3 has the same operation as the dog type last Z-phase reference homing, and Method 4 has the same operation as the dog cradle type homing at a forward rotation start. However, if the stroke end is detected during homing, [AL. 090] occurs.

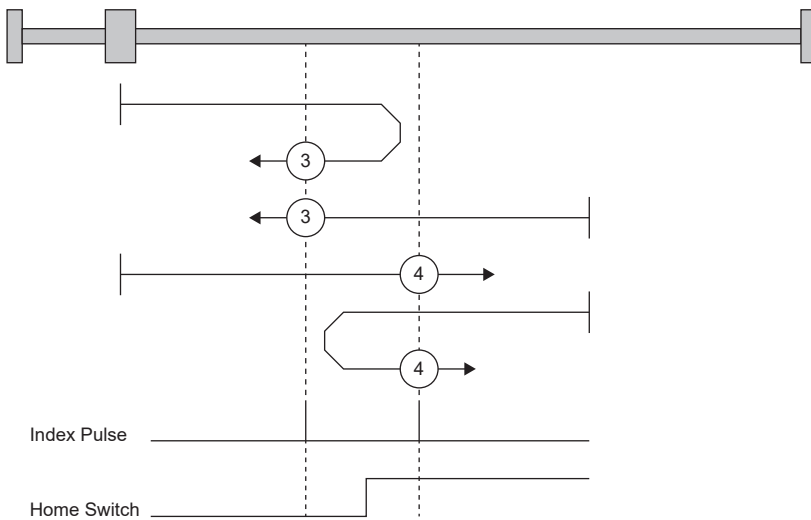

### Method 5 and Method 6: Homing on negative home switch and index pulse

These homing methods use the front end of the proximity dog as reference and set the Z-phase right before and right after the dog as a home position. Method 5 and 6 are the same as Method 3 and 4 except that the starting direction is forward in Method 3 and 4, and reverse in Method 5 and 6.

### Method 7, Method 8, Method 11, and Method 12: Homing on home switch and index pulse

These methods include the operation at stroke end detection in addition to the operation of Method 3 to Method 6. Thus, the home position is the same as that of Method 3 to Method 6. Method 7 has the same operation as dog type last Z-phase reference homing. Method 8 has the same operation as dog cradle type homing at a forward rotation start. Method 11 and 12 are the same as Method 7 and 8 except that the starting direction is forward in Method 7 and 8, and reverse in Method 11 and 12.

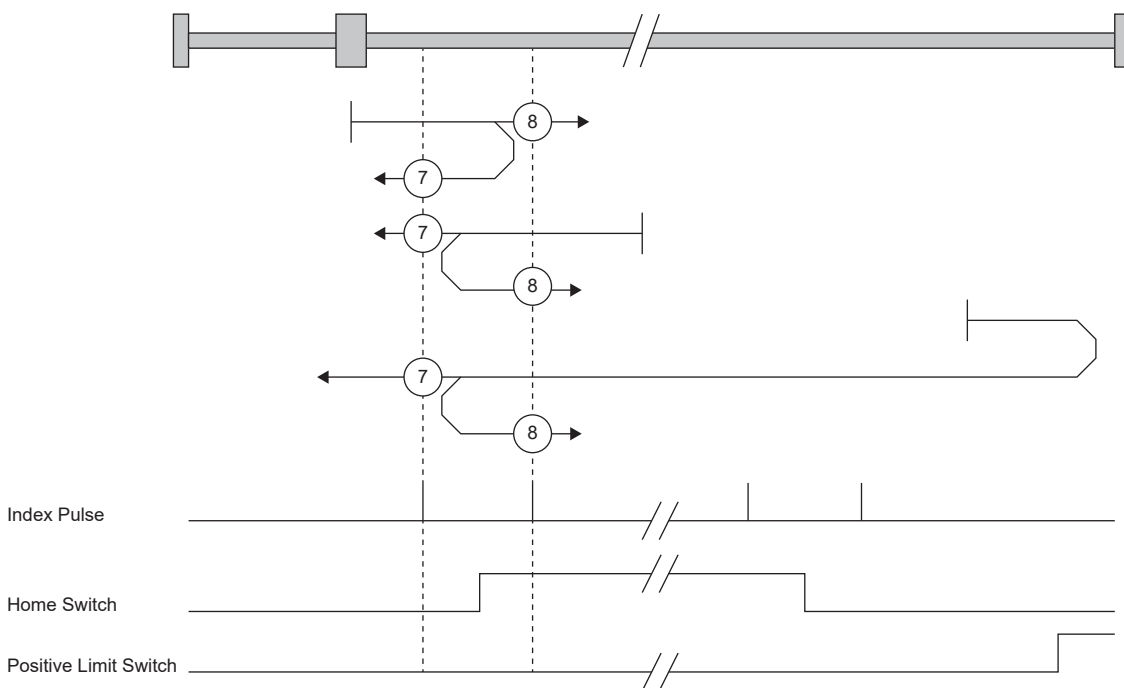



### ■Method 9, Method 10, Method 13, and Method 14: Homing on home switch and index pulse

These homing methods use the Home switch (dog) and Index pulse (Z-phase). The homing direction is forward rotation (CCW) or positive direction.

In Method 9, the home position is the Z-phase immediately before the rear end of the dog, and in Method 10, the home position is the Z-phase immediately after the rear end of the dog. When the forward rotation stroke end is detected, the moving direction is reverse rotation (CW) or reverse direction.

Method 13 and Method 14 are similar to Method 9 and Method 10, except that the homing direction is reverse rotation (CW) or reverse direction.

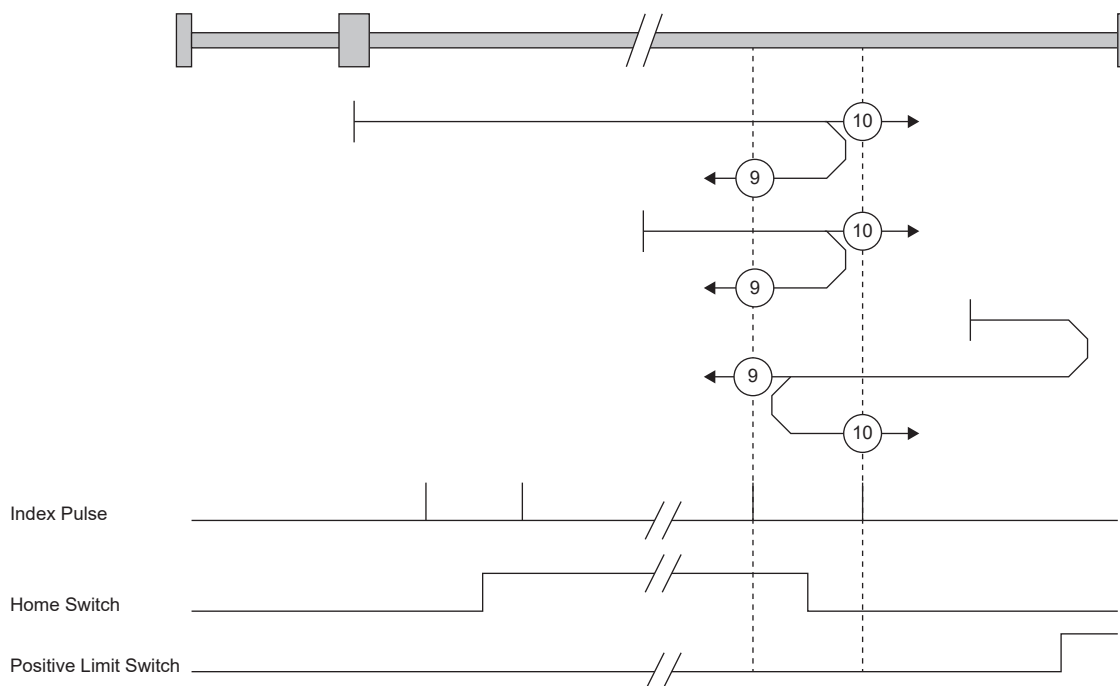

### ■Method 17 to Method 30: Homing without index pulse

Method 17 to Method 30 have the same movement as Method 1 to Method 14, but these methods set the home position on the dog or stroke end, but not on the Z-phase. The following figure shows the operation of the homing methods of Method 19 and Method 20. Method 19 and Method 20 have the same operation as Method 3 and Method 4; however, these types set the home position on the dog but not on the Z-phase. Also, Method 19 has the same operation as the dog type front end reference homing. Method 20 has the same operation as the dog cradle type homing; however, the stop position is on the dog but not on the Z-phase.

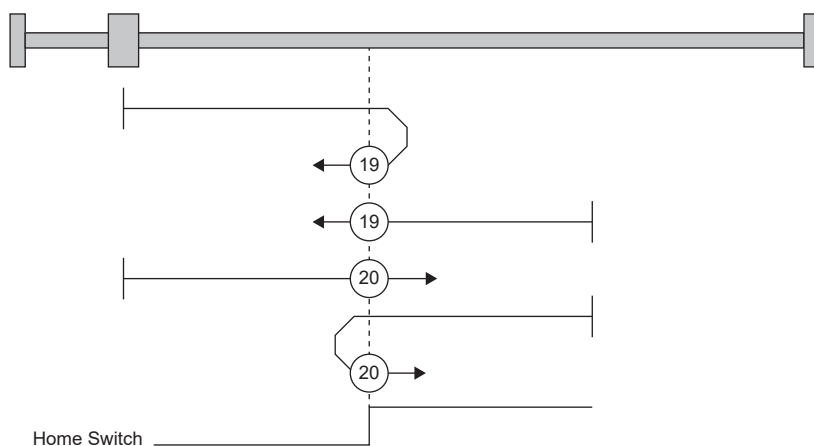

### Method 33 and Method 34: Homing on index pulse

These homing methods set the Z-phase detected first as a home position. The operation is the same as that of the dogless Z-phase reference homing except that the creep speed is applied at the start.

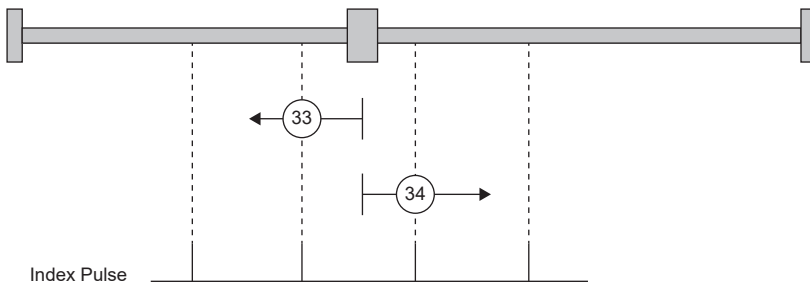

### Method 35 and Method 37: Homing on current position

These homing methods set the current position as a home position. The operation is the same as that of the data set type homing, however, homing can be executed even in the servo-off status.

Homing cannot be executed in the servo-off status when Motion modules manufactured by Mitsubishi Electric (RD78G(H)/FX5-SSC-G) are used. For details, refer to each controller manual.

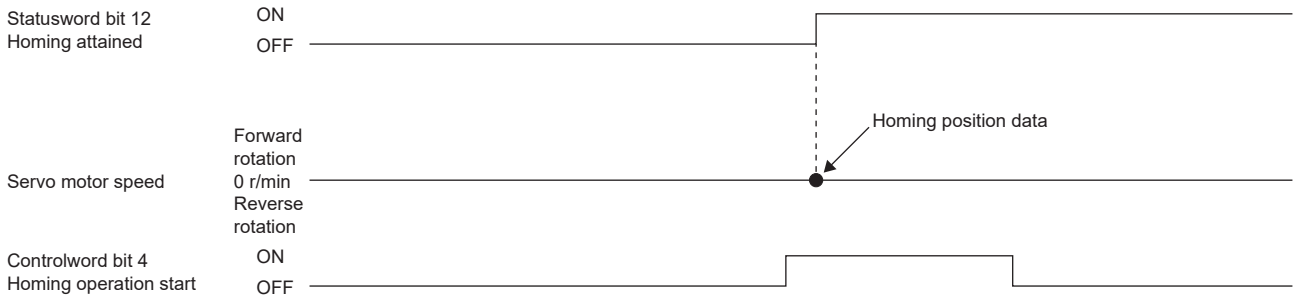

## Operation example of the CiA 402-type Homing method

The following shows an operation example of the homing in the CiA 402-type Homing method when [Pr. PA14\_Travel direction selection] is set to "0".

The homing direction when [Pr. PA14] is "1" is opposite to the figure.

When [Pr. PT55.1 Homing POL reflection selection] is set to "1" for servo amplifiers with firmware version D4 or later, the setting value of [Pr. PA14] is reflected at homing.

### Method 1 (Homing on negative limit switch and index pulse) and Method 2 (Homing on positive limit switch and index pulse)

The following figure shows the operation of Homing method 2 when the home position shift distance is a positive value. The homing direction of Homing method 1 is opposite to that of Homing method 2.

#### Point

- If there is a stroke end near the Z-phase, the homing completion position varies. The recommended detection position for the stroke end can be found by rotating the servo motor about a half-turn away.

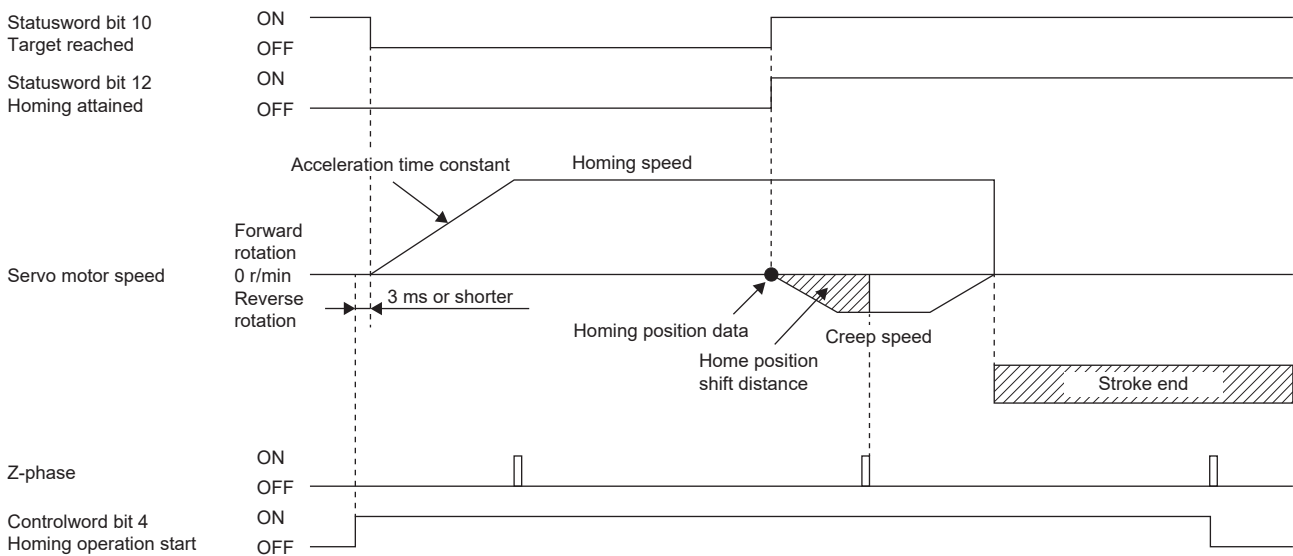

- When homing is started from the stroke end

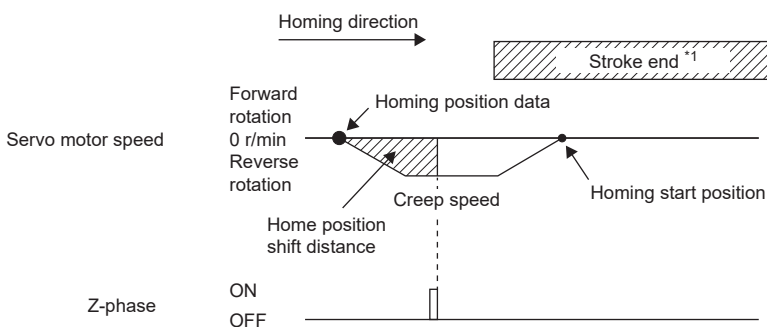

\*1 This cannot be used with the software limit.

### ■Method 3 (Homing on positive home switch and index pulse) and Method 5 (Homing on negative home switch and index pulse)

The following figure shows the operation of Homing method 3 when the home position shift distance is a positive value. The homing direction of Homing method 5 is opposite to that of Homing method 3.

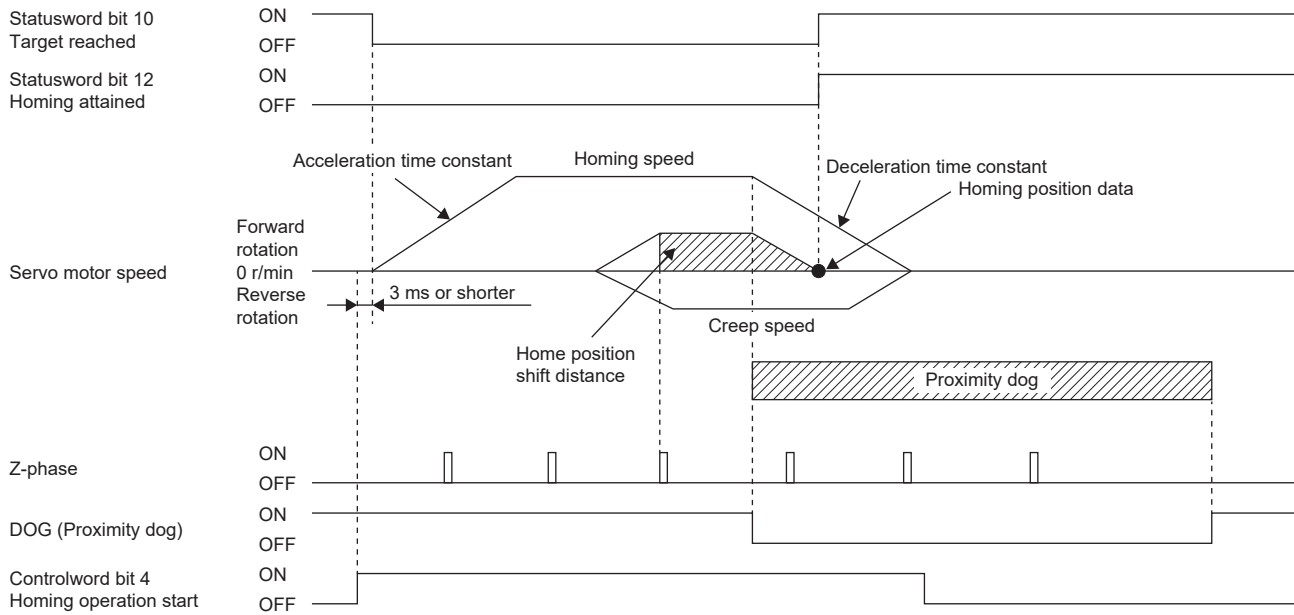

- When homing is started from the proximity dog



The homing start position is automatically moved back to the position just before the proximity dog, and homing starts from here.

- When the stroke end is detected

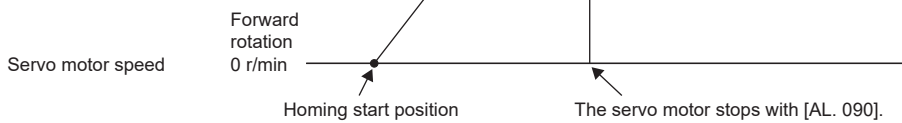

**Method 4 (Homing on positive home switch and index pulse) and Method 6 (Homing on negative home switch and index pulse)**

The following figure shows the operation of Homing method 4 when the home position shift distance is a positive value. The homing direction of Homing method 6 is opposite to that of Homing method 4.

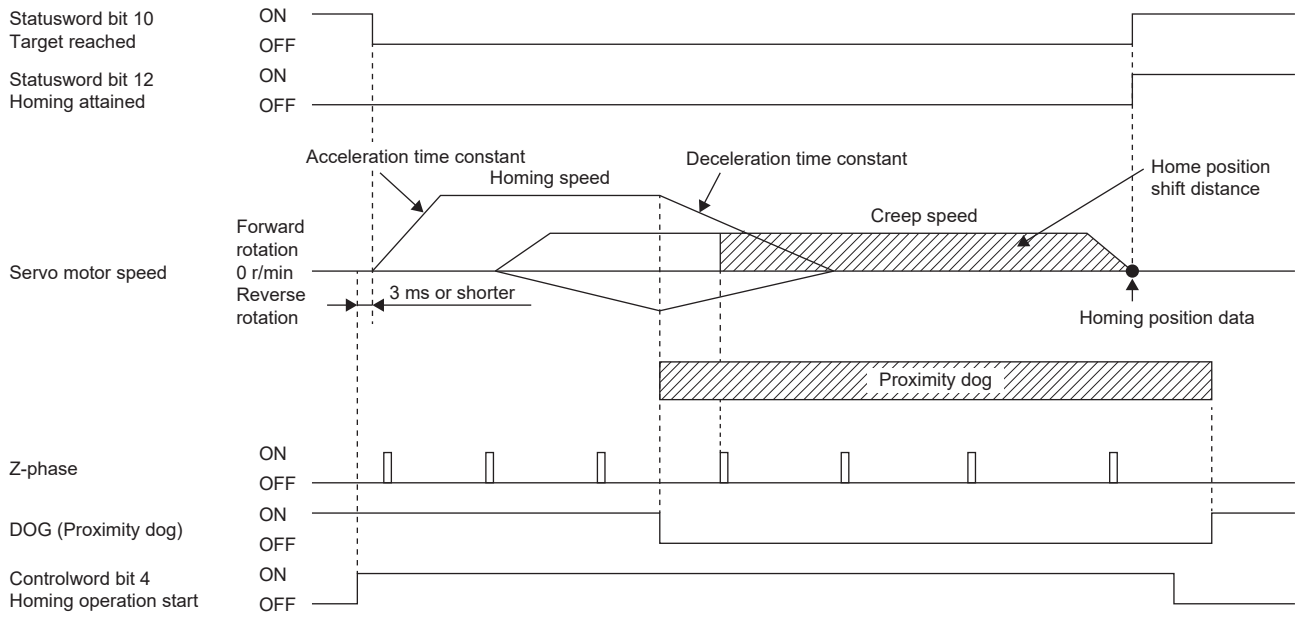

- When homing is started from the proximity dog

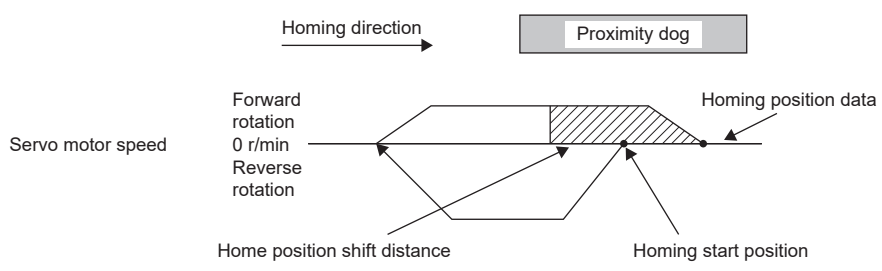

- When the stroke end is detected

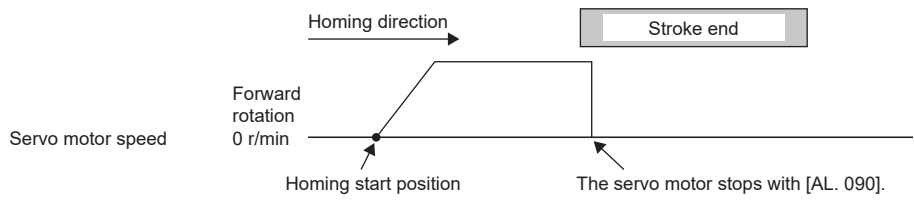

## Method 7 and Method 11 (Homing on home switch and index pulse)

The following figure shows the operation of Homing method 7 when the home position shift distance is a positive value. The homing direction of Homing method 11 is opposite to that of Homing method 7.

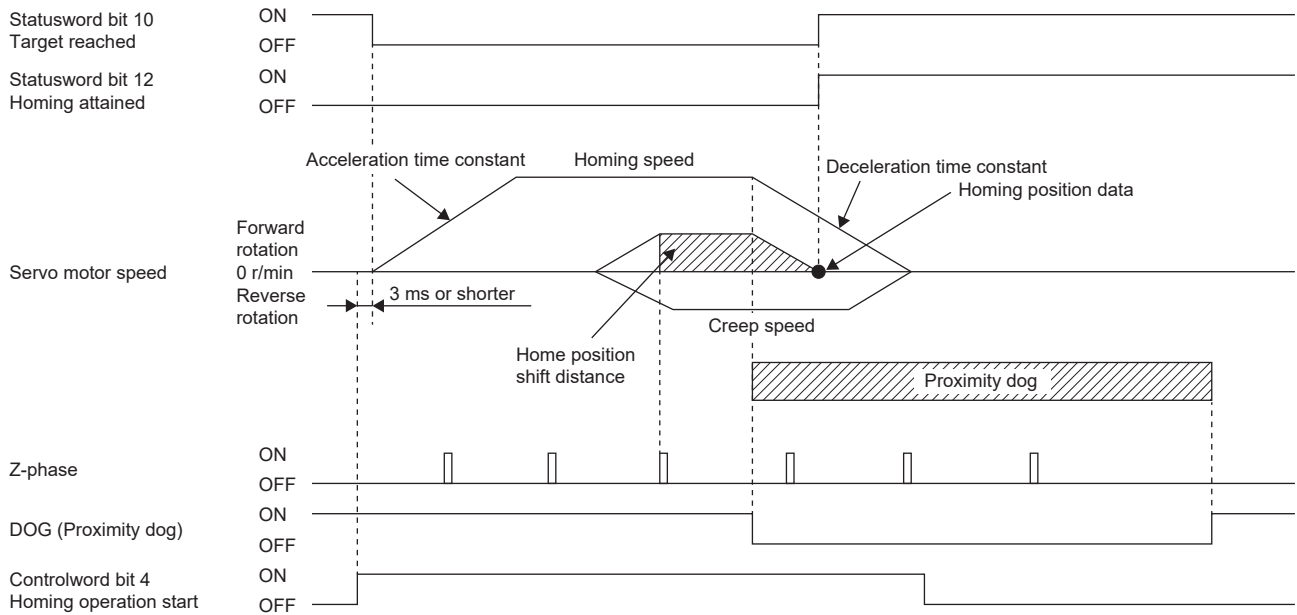

- When homing is started from the proximity dog

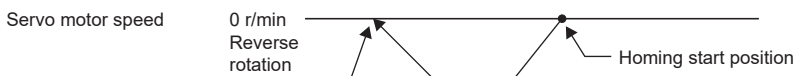

The homing start position is automatically moved back to the position just before the proximity dog, and homing starts from here.

- When the servo motor returns at the stroke end

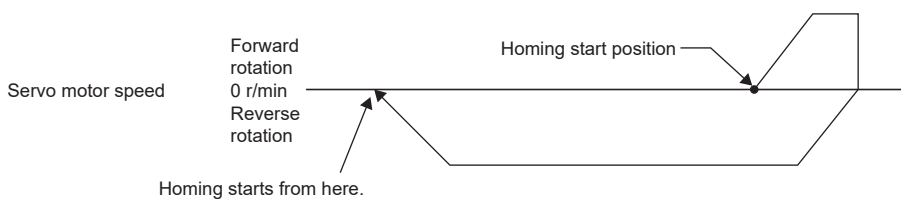

Homing starts from here.

\*1 This cannot be used with the software limit.

### Method 8 and Method 12 (Homing on home switch and index pulse)

The following figure shows the operation of Homing method 8 when the home position shift distance is a positive value. The homing direction of Homing method 12 is opposite to that of Homing method 8.

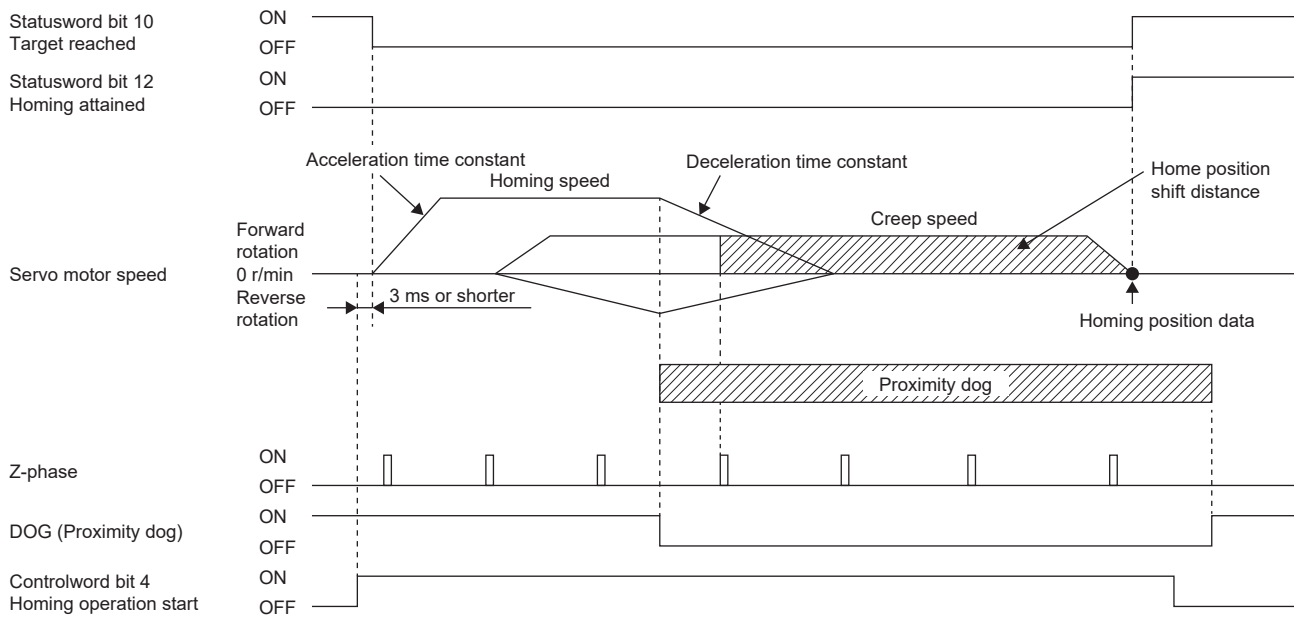

- When homing is started from the proximity dog

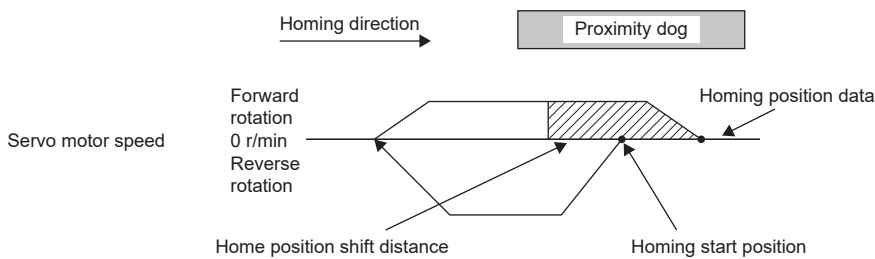

- When the servo motor returns at the stroke end

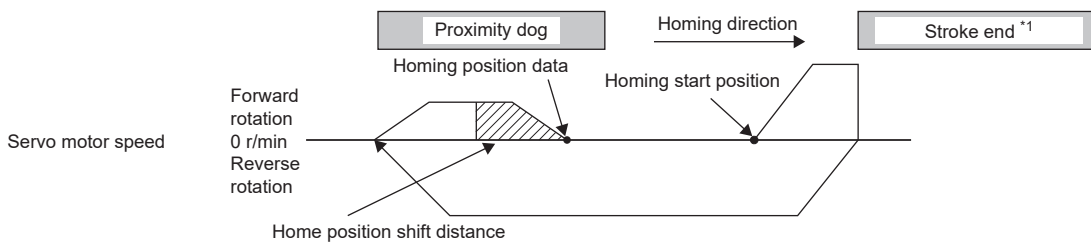

\*1 This cannot be used with the software limit.

## Method 9 and Method 13 (Homing on home switch and index pulse)

The following figure shows the operation of Homing method 9 when the home position shift distance is a positive value. The homing direction of Homing method 13 is opposite to that of Homing method 9.

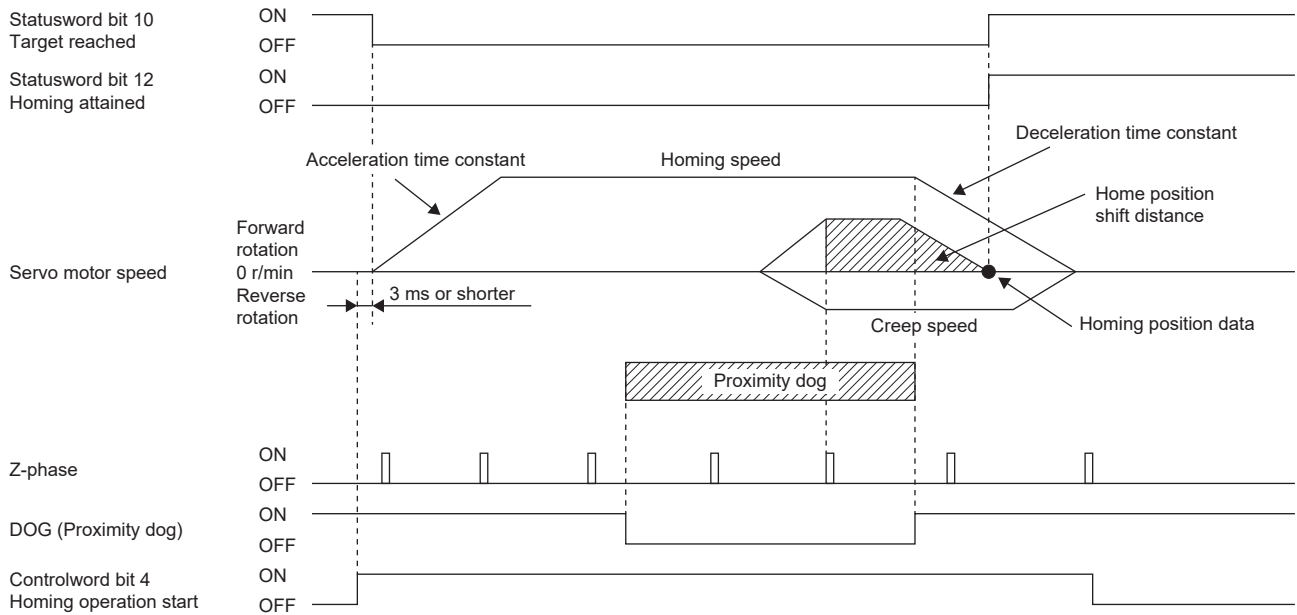

- When the servo motor returns at the stroke end

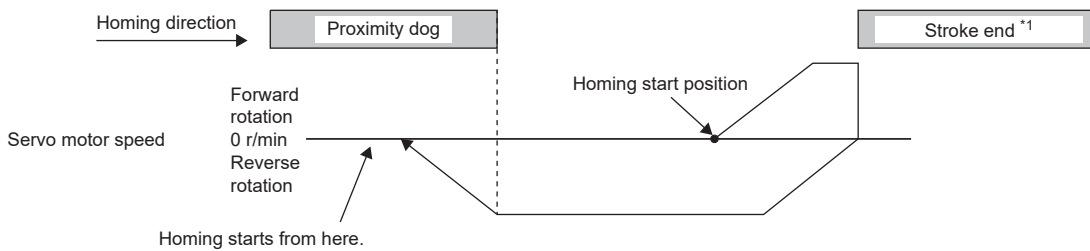

\*1 This cannot be used with the software limit.



### Method 10 and Method 14 (Homing on home switch and index pulse)

The following figure shows the operation of Homing method 10 when the home position shift distance is a positive value. The homing direction of Homing method 14 is opposite to that of Homing method 10.

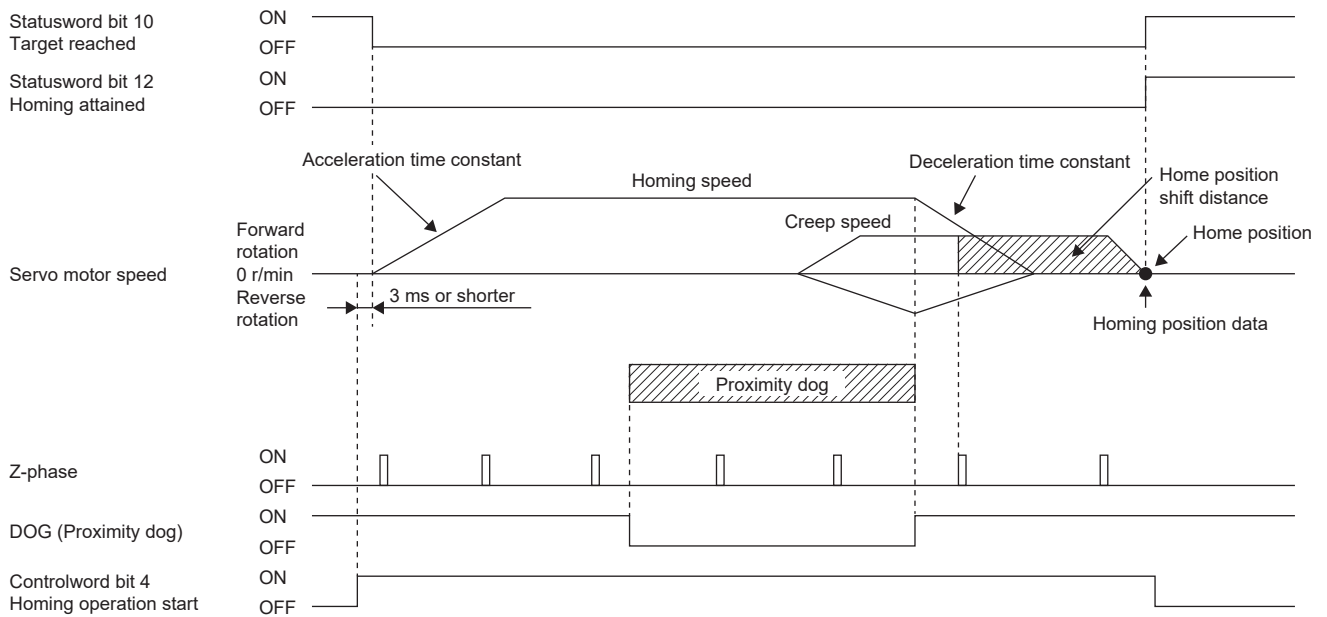

- When the servo motor returns at the stroke end

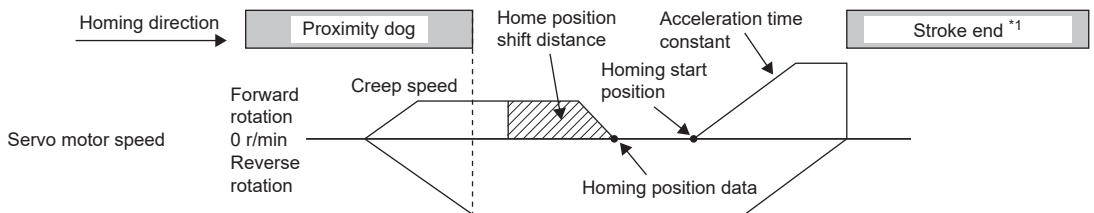

\*1 This cannot be used with the software limit.

## ■Method 17 (Homing on negative limit switch) and Method 18 (Homing on positive limit switch)

The following figure shows the operation of Homing method 18 when the home position shift distance is a positive value. The homing direction of Homing method 17 is opposite to that of Homing method 18.

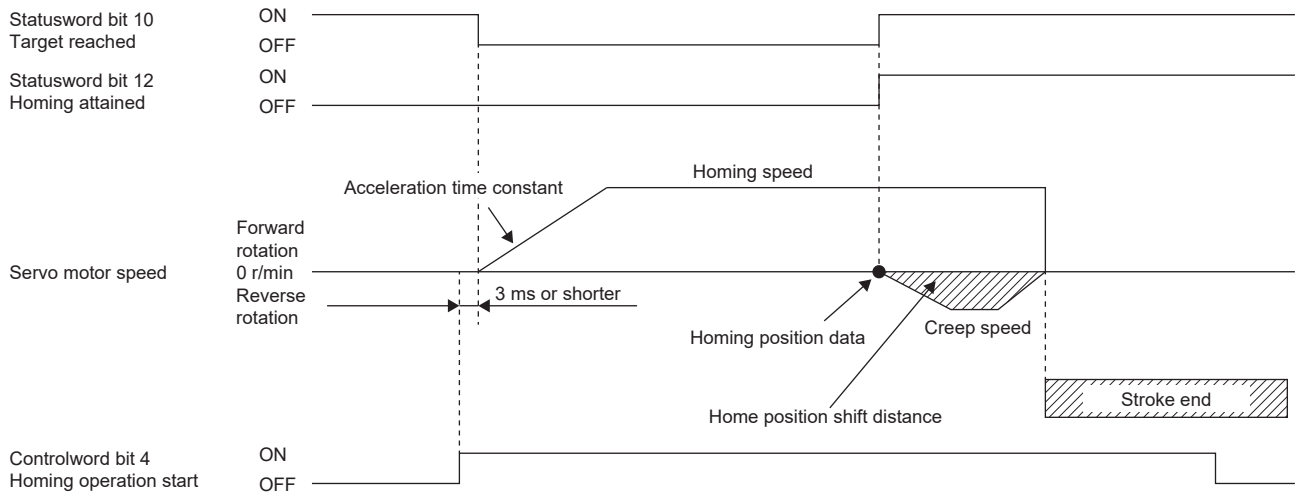

- When the servo motor returns at the stroke end

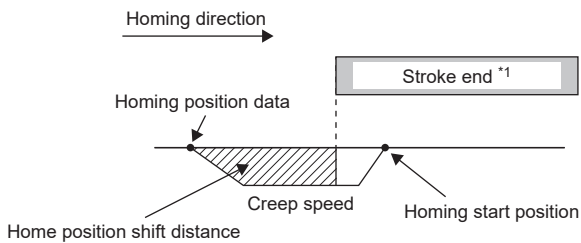

\*1 This cannot be used with the software limit.

### Method 19 and Method 21 (Homing without index pulse)

The following figure shows the operation of Homing method 19 when the home position shift distance is a positive value. The homing direction of Homing method 21 is opposite to that of Homing method 19.

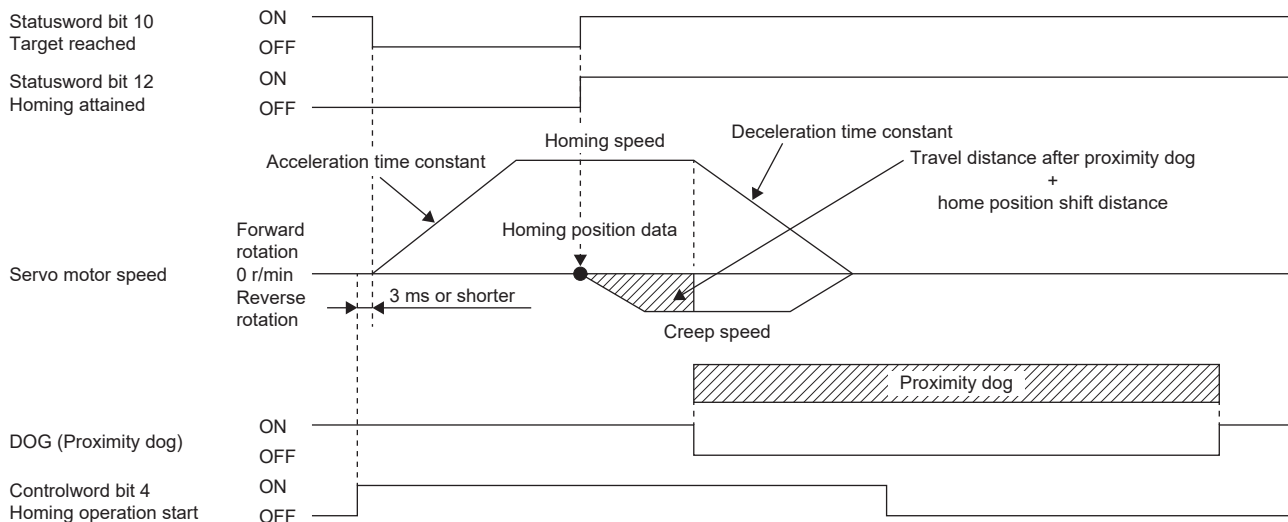

- When homing is started from the proximity dog

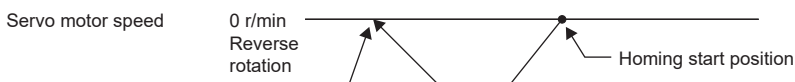

The homing start position is automatically moved back to the position just before the proximity dog, and homing starts from here.

- When the stroke end is detected

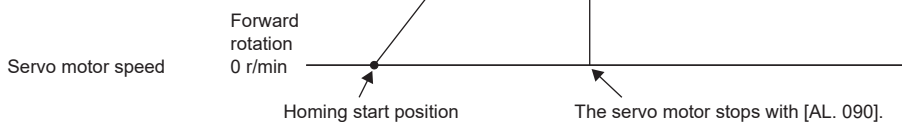

## Method 20 and Method 22 (Homing without index pulse)

The following figure shows the operation of Homing method 20 when the home position shift distance is a positive value. The homing direction of Homing method 22 is opposite to that of Homing method 20.

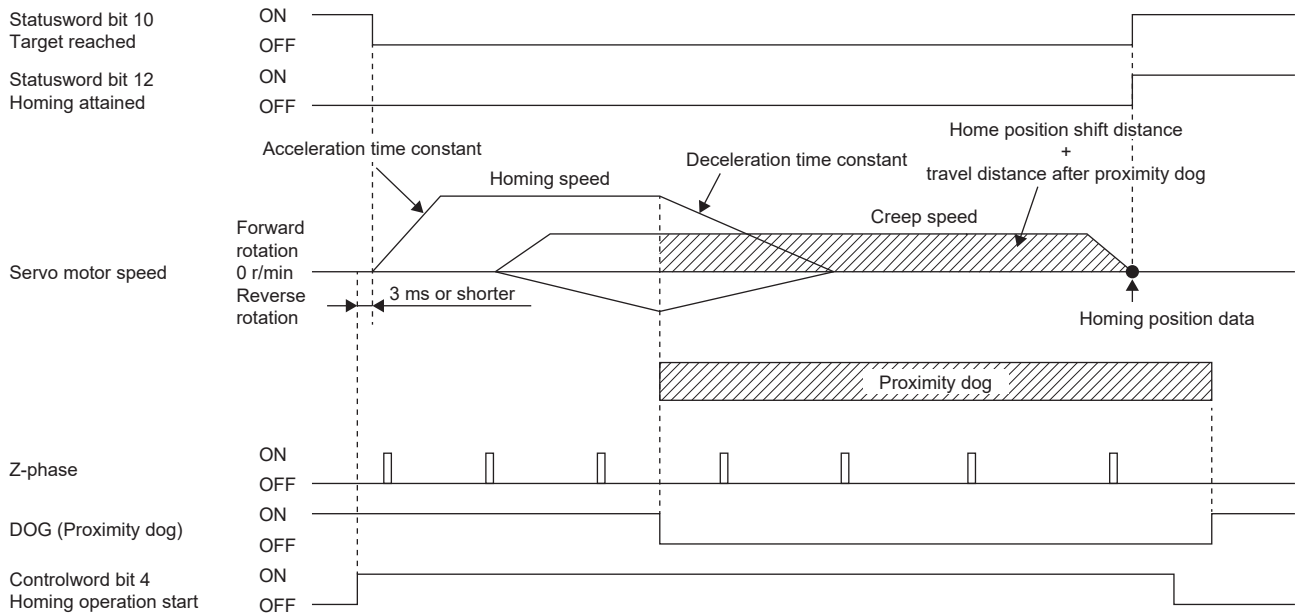

- When homing is started from the proximity dog

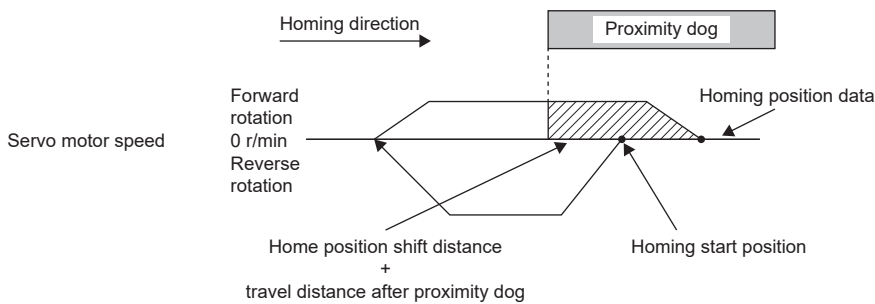

- When the stroke end is detected

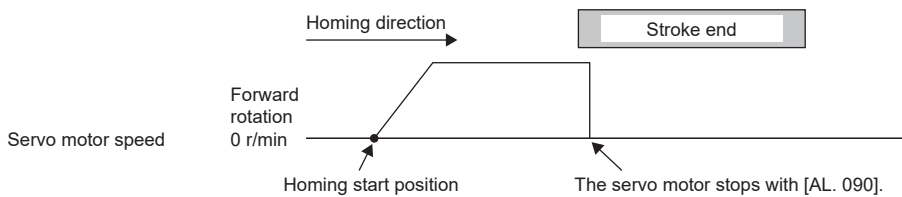

### Method 23 and Method 27 (Homing without index pulse)

The following figure shows the operation of Homing method 23 when the home position shift distance is a positive value. The homing direction of Homing method 27 is opposite to that of Homing method 23.

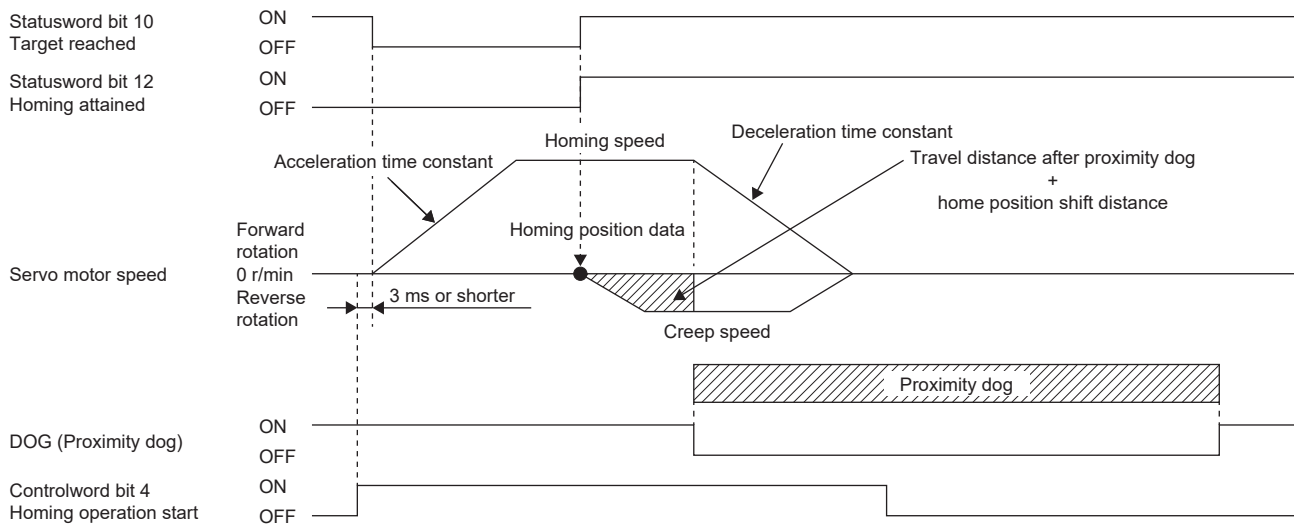

- When homing is started from the proximity dog

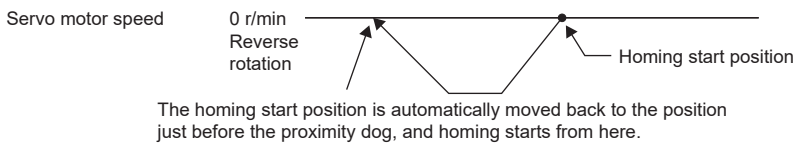

- When the servo motor returns at the stroke end

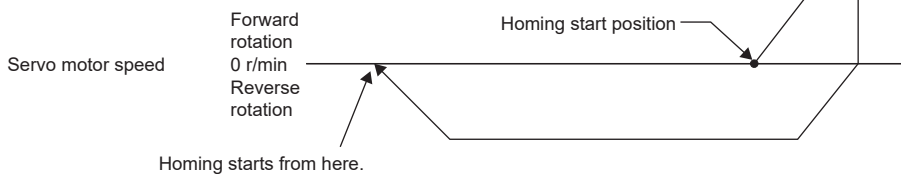

\*1 This cannot be used with the software limit.

## Method 24 and Method 28 (Homing without index pulse)

The following figure shows the operation of Homing method 24 when the home position shift distance is a positive value. The homing direction of Homing method 28 is opposite to that of Homing method 24.

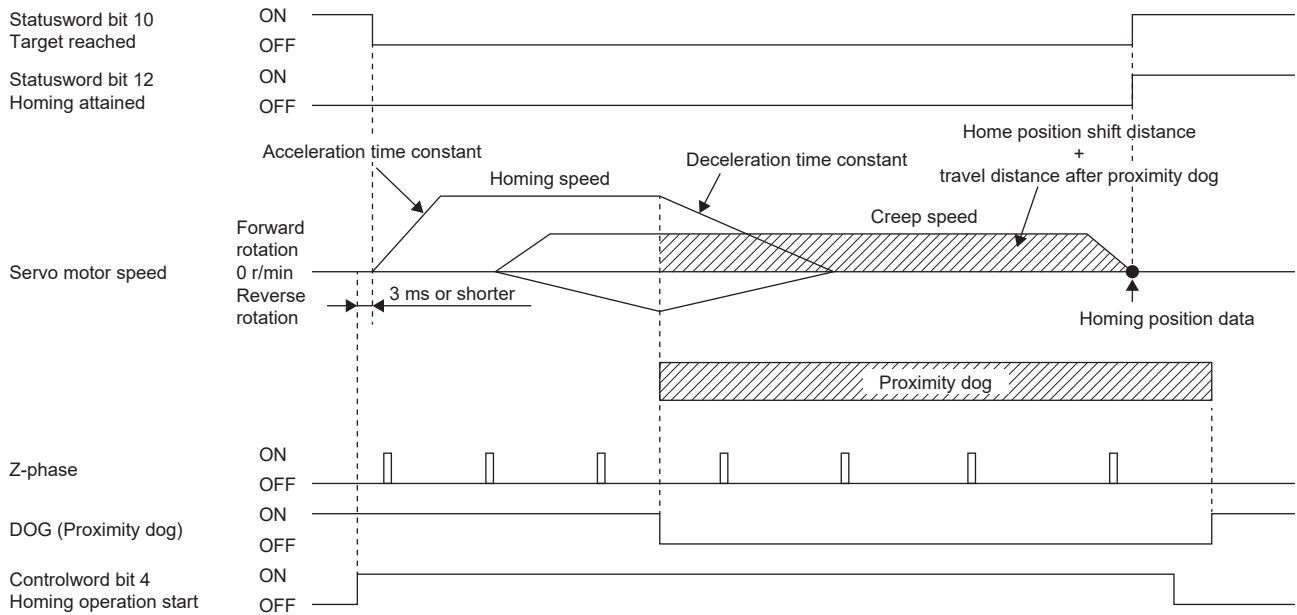

- When homing is started from the proximity dog

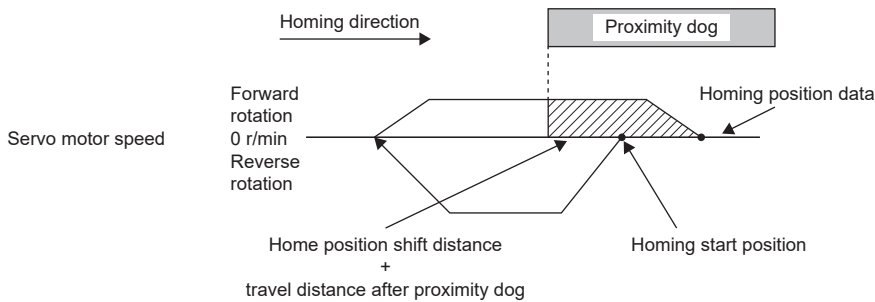

- When the servo motor returns at the stroke end

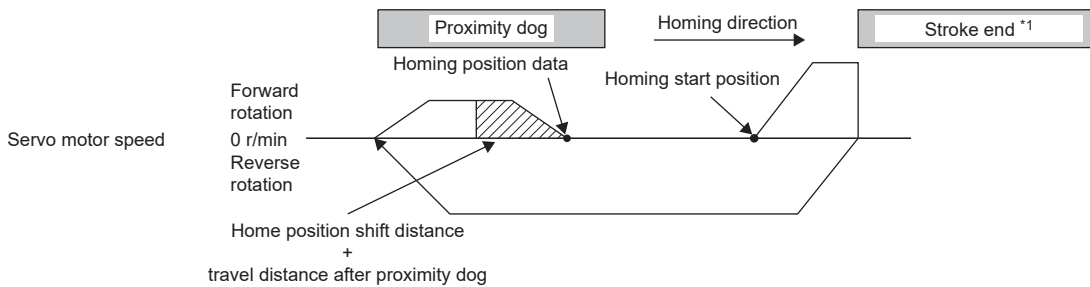

\*1 This cannot be used with the software limit.

### Method 33 and Method 34 (Homing on index pulse)

The following figure shows the operation of Homing method 34 when the home position shift distance is a positive value. The homing direction of Homing method 33 is opposite to that of Homing method 34.

**Point**

- When homing is performed from near the Z-phase, the homing completion position varies. The recommended start position for homing can be found by rotating the servo motor about a half-turn away from the homing direction.

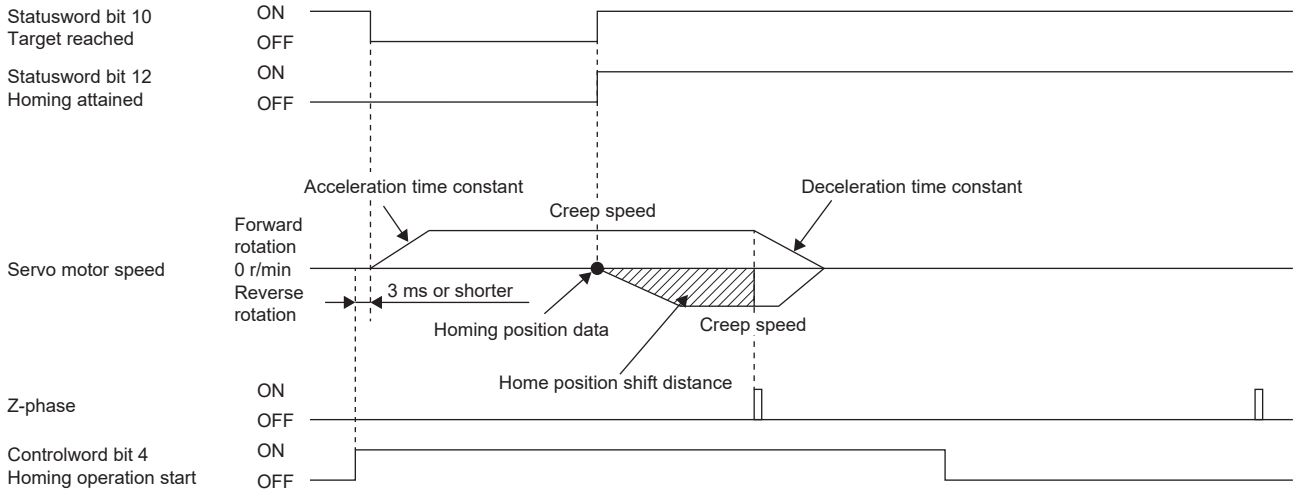

- When the stroke end is detected

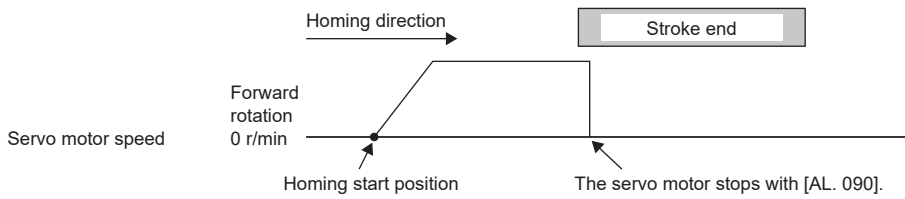

### Method 35 and Method 37 (Homing on current position)

The following figure shows the operation of Homing method 35 and Homing method 37. Homing can be executed even in the servo-off status.

Homing cannot be executed in the servo-off status when Motion modules manufactured by Mitsubishi Electric (RD78G(H)/FX5-SSC-G) are used. For details, refer to each controller manual.

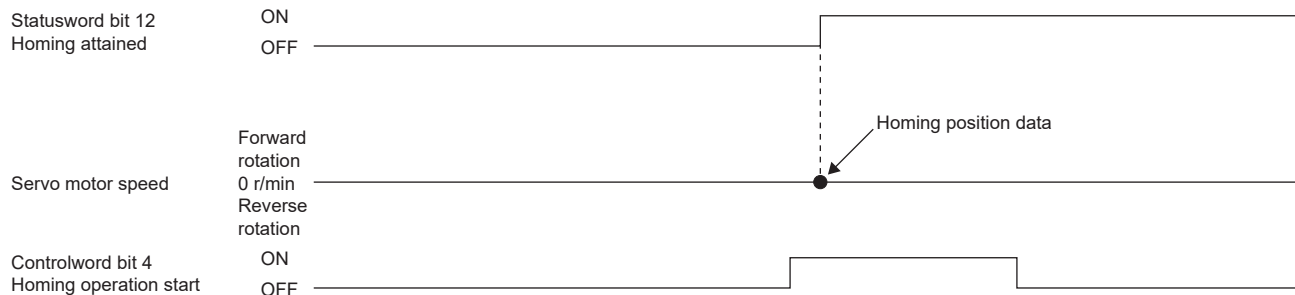

## Operation example of Manufacturer-specific Homing method

### Point

- For details on signal polarity and other I/O device assignments, refer to the following.

☞ Page 106 Assigning I/O devices

The following shows an operation example of the Manufacturer-specific homing when [Pr. PA14\_Travel direction selection] is set to "0".

The homing direction when [Pr. PA14] is "1" is opposite to the figure.

When [Pr. PT55.1 Homing POL reflection selection] is set to "1" for servo amplifiers with firmware version D4 or later, the setting value of [Pr. PA14] is reflected at homing.

### Method -1 and Method -33 (Dog type homing)

The following figure shows the operation of Homing method -1 when the home position shift distance is a positive value. The homing direction of Homing method -33 is opposite to that of Homing method -1.

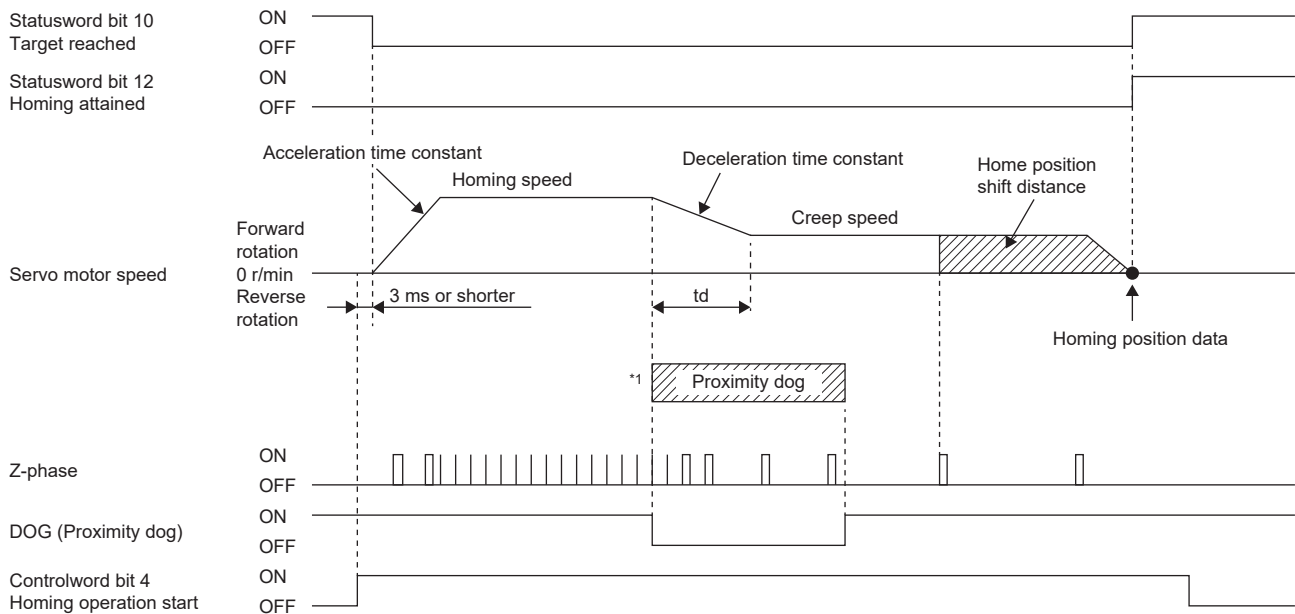

- \*1 After the front end of the proximity dog is detected, if the distance after proximity dog is traveled without reaching the creep speed, [AL. 090] occurs. Set the travel distance after proximity dog enough for the servo motor to decelerate from the homing speed to the creep speed.

- When homing is started from the proximity dog



The homing start position is automatically moved back to the position just before the proximity dog, and homing starts from here.

- When the servo motor returns at the stroke end

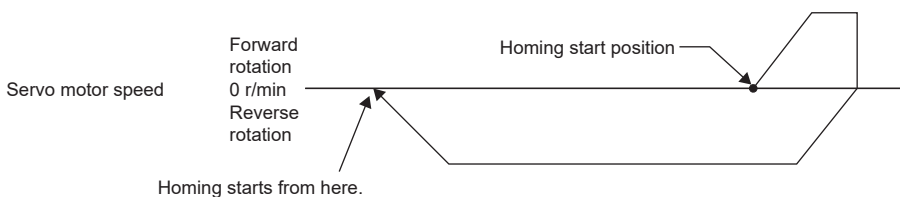

- \*1 This cannot be used with the software limit.



## Method -2 and Method -34 (Count type homing)

### Point

For the count type homing, after the front end of the proximity dog is detected, the position is shifted by the distance set in the travel distance after proximity dog. Then, the first Z-phase is set as the home position. Therefore, when the on-time of the proximity dog is 10 ms or more, the length of the proximity dog has no restrictions. Use this homing when the dog type homing cannot be used because the length of the proximity dog cannot be reserved or other cases.

2

The following figure shows the operation of Homing method -2 when the home position shift distance is a positive value. The homing direction of Homing method -34 is opposite to that of Homing method -2.

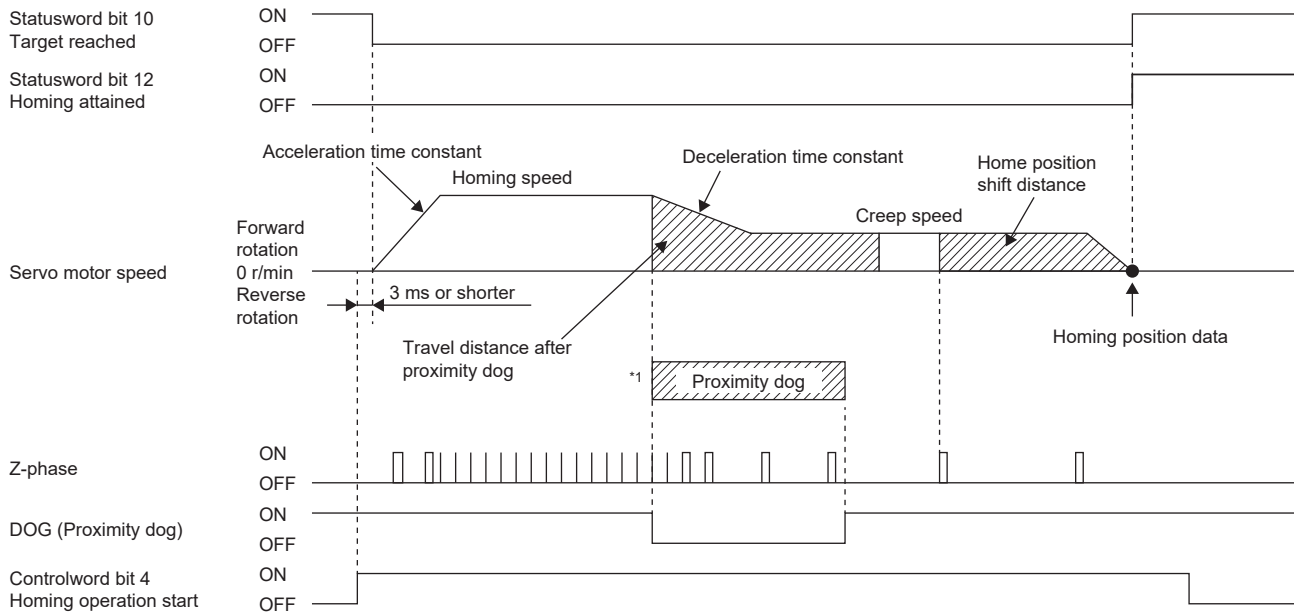

\*1 After the front end of the proximity dog is detected, if the distance after proximity dog is traveled without reaching the creep speed, [AL. 090] occurs. Set the travel distance after proximity dog enough for the servo motor to decelerate from the homing speed to the creep speed.

- When homing is started from the proximity dog



The homing start position is automatically moved back to the position just before the proximity dog, and homing starts from here.

- When the servo motor returns at the stroke end

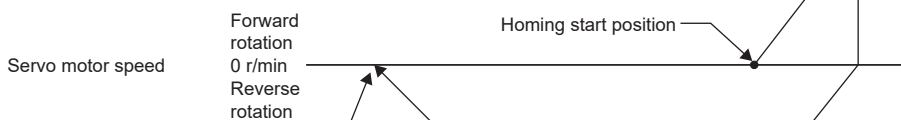

Homing starts from here.

\*1 This cannot be used with the software limit.

### Method -3 (Data set type homing)

The following figure shows the operation of Homing method -3. Data set type homing cannot be executed in the servo-off status.

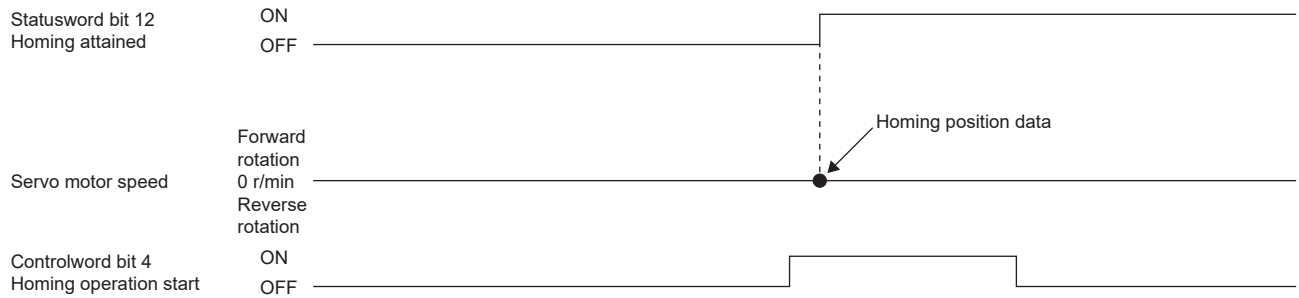

### Method -4 and Method -36 (Stopper type homing)



Since the workpiece collides with the mechanical stopper, the homing speed must be low enough.

The following figure shows the operation of Homing method -4. The homing direction of Homing method -36 is opposite to that of Homing method -4.

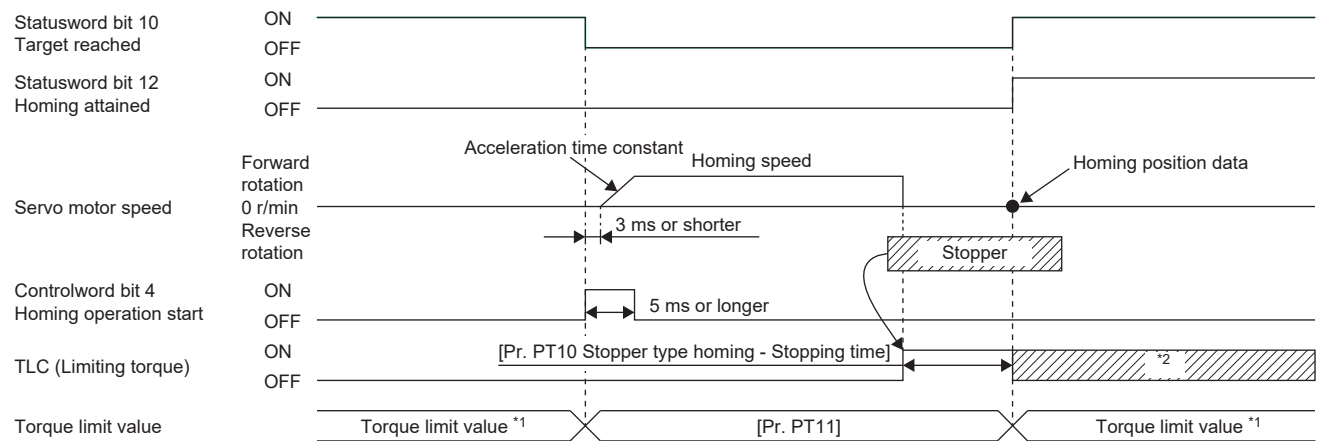

\*1 When Method -4 is set, the torque limit value of [Positive torque limit value (Obj. 60E0h)] is applied. When Method -36 is set, the torque limit value of [Negative torque limit value (Obj. 60E1h)] is applied.

\*2 If the torque limit value has been reached, TLC remains on even after homing finishes.

- When the stroke end is detected

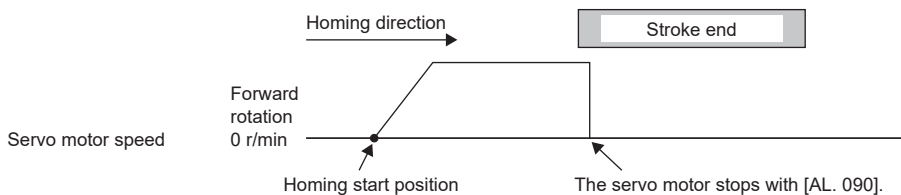

## Method -6 and Method -38 (Dog type rear end reference homing)

**Point**

This homing method depends on the timing of reading DOG (Proximity dog) that has detected the rear end of the proximity dog. Therefore, when the creep speed is set to 100 r/min and homing is performed, the home position has the following error.

$$\pm (\text{Encoder resolution}) \times 100/65536 [\text{pulse}]$$

The error in the home position becomes larger as the creep speed increases.

The following figure shows the operation of Homing method -6 when the home position shift distance is a positive value. The homing direction of Homing method -38 is opposite to that of Homing method -6.

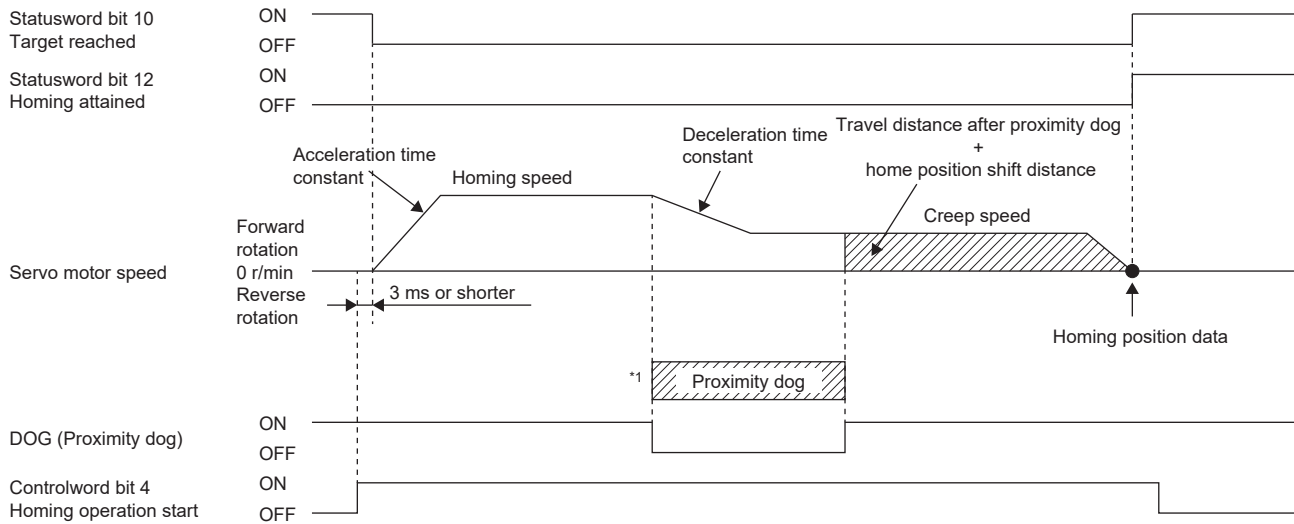

\*1 After the front end of the proximity dog is detected, if the rear end of the proximity dog is detected without reaching the creep speed, [AL. 090] occurs. Revise the length of the proximity dog, or revise both the homing speed and creep speed.

- When homing is started from the proximity dog

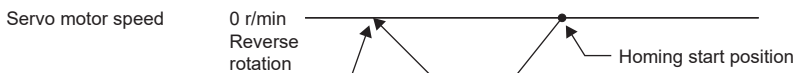

The homing start position is automatically moved back to the position just before the proximity dog, and homing starts from here.

- When the servo motor returns at the stroke end

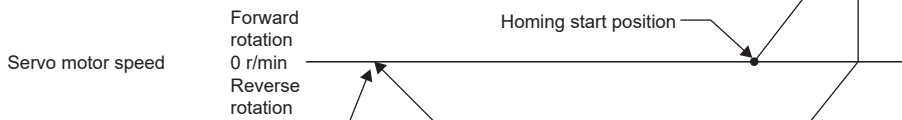

Homing starts from here.

\*1 This cannot be used with the software limit.

## Method -7 and Method -39 (Count type front end reference homing)

### Point

This homing method depends on the timing of reading DOG (Proximity dog) that has detected the front end of the proximity dog. Therefore, when the creep speed is set to 100 r/min and homing is performed, the home position has the following error.

$$\pm (\text{Encoder resolution}) \times 100/65536 [\text{pulse}]$$

The error in the home position becomes larger as the homing speed increases.

The following figure shows the operation of Homing method -7 when the home position shift distance is a positive value. The homing direction of Homing method -39 is opposite to that of Homing method -7.

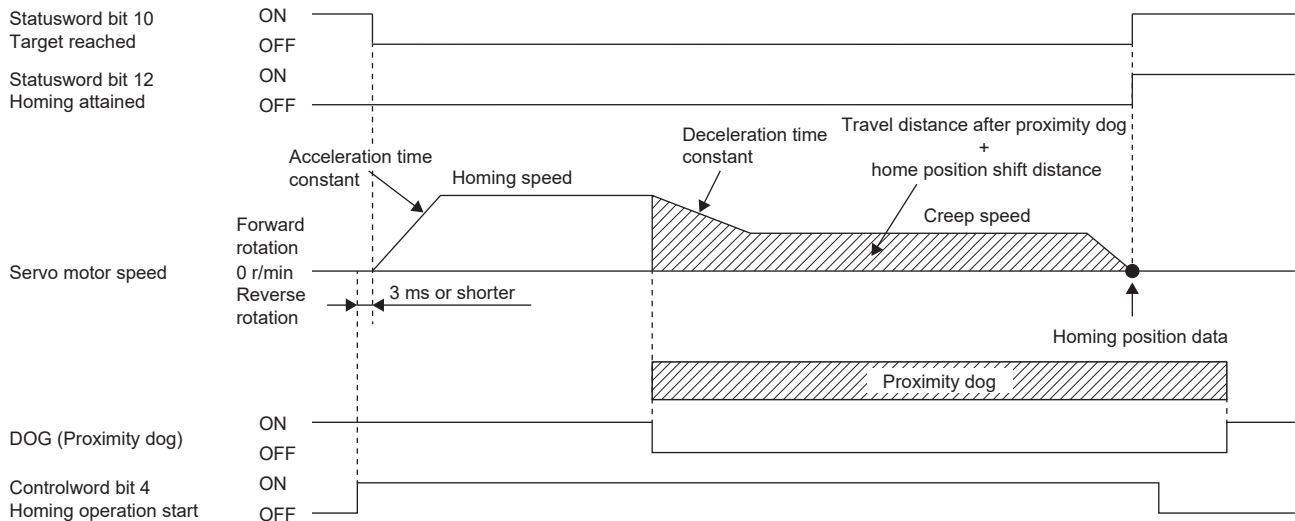

- When homing is started from the proximity dog

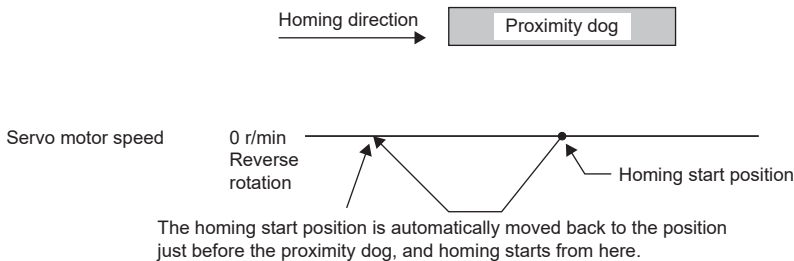

- When the servo motor returns at the stroke end

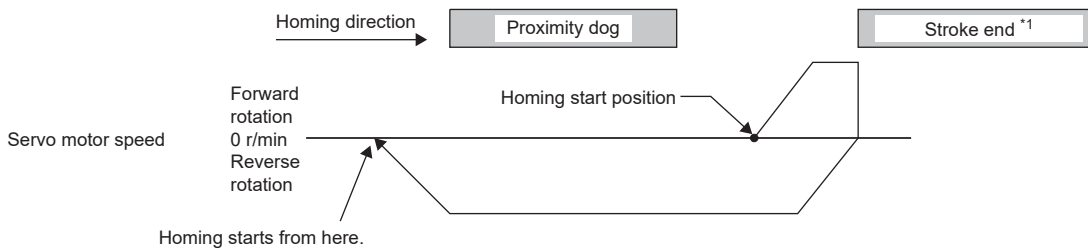

\*1 This cannot be used with the software limit.

### Method -8 and Method -40 (Dog cradle type homing)

The following figure shows the operation of Homing method -8 when the home position shift distance is a positive value. The homing direction of Homing method -40 is opposite to that of Homing method -8.

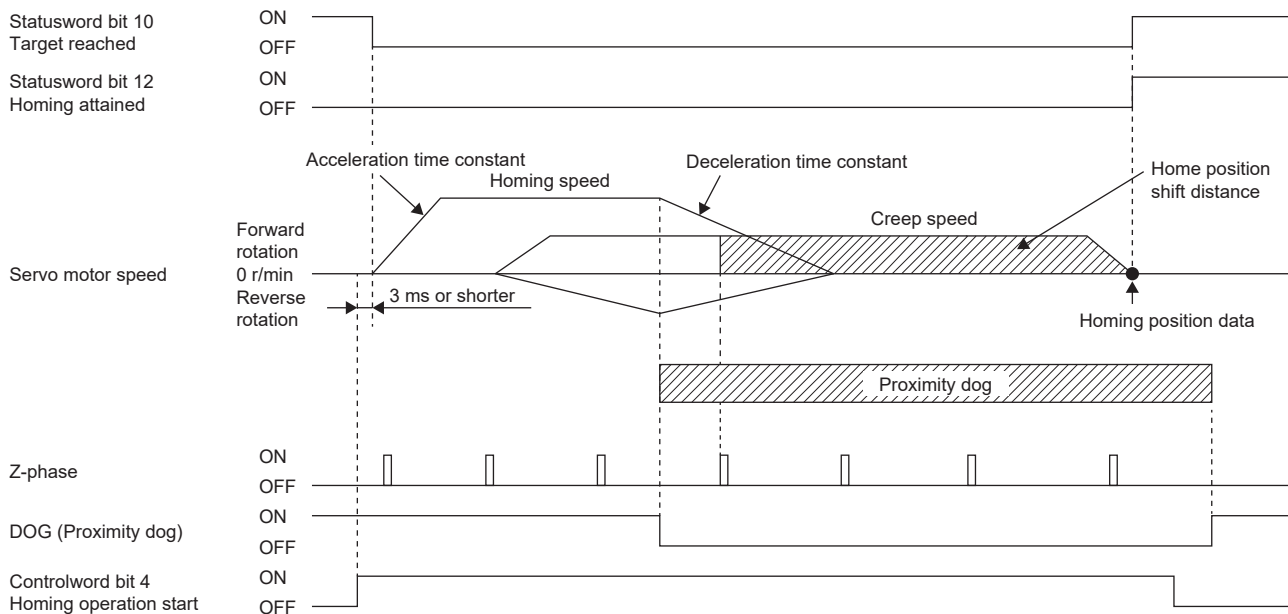

- When homing is started from the proximity dog

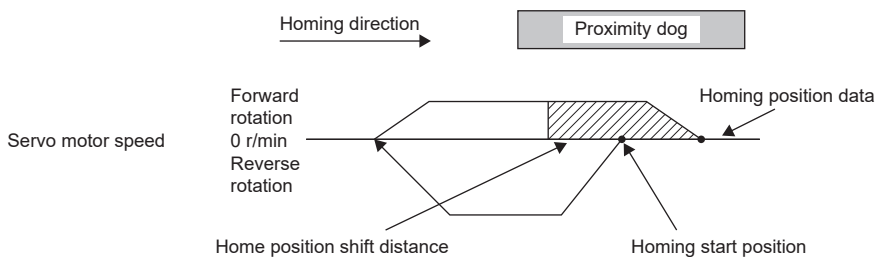

- When the servo motor returns at the stroke end

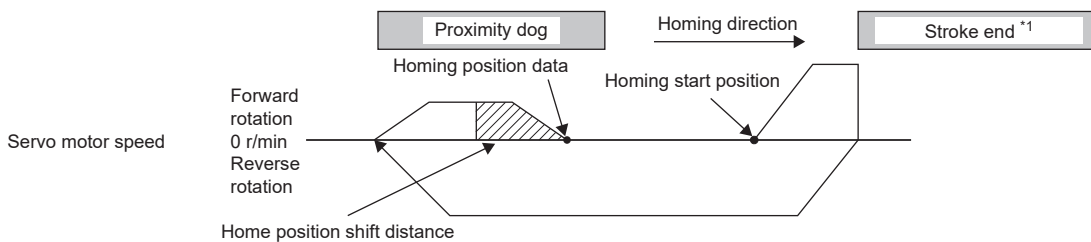

\*1 This cannot be used with the software limit.

## Method -9 and Method -41 (Dog type last Z-phase reference homing)

The following figure shows the operation of Homing method -9 when the home position shift distance is a positive value. The homing direction of Homing method -41 is opposite to that of Homing method -9.

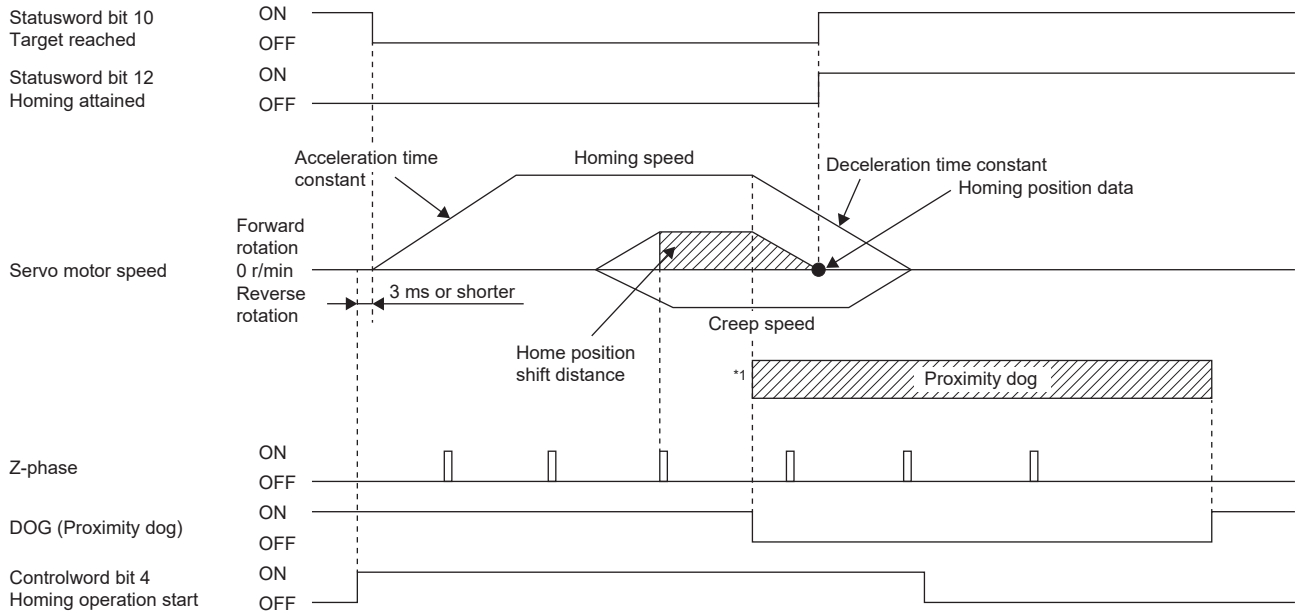

\*1 After the front end of the proximity dog is detected, if the rear end of the proximity dog is detected without stop, [AL. 090] occurs. Revise the length of the proximity dog, or revise both the homing speed and creep speed.

- When homing is started from the proximity dog

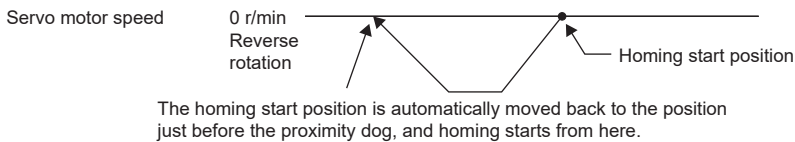

- When the servo motor returns at the stroke end

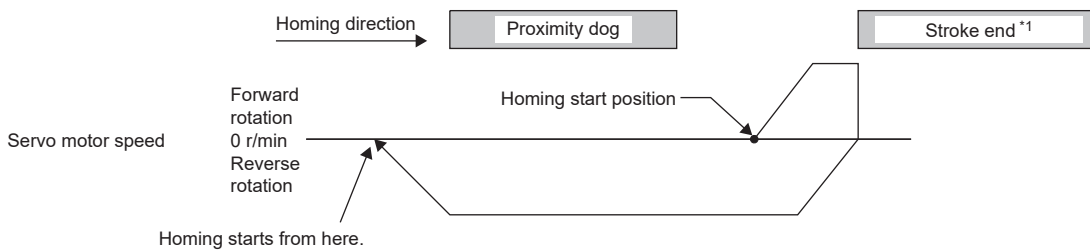

\*1 This cannot be used with the software limit.

### Method -10 and Method -42 (Dog type front end reference homing)

The following figure shows the operation of Homing method -10 when the home position shift distance is a positive value. The homing direction of Homing method -42 is opposite to that of Homing method -10.

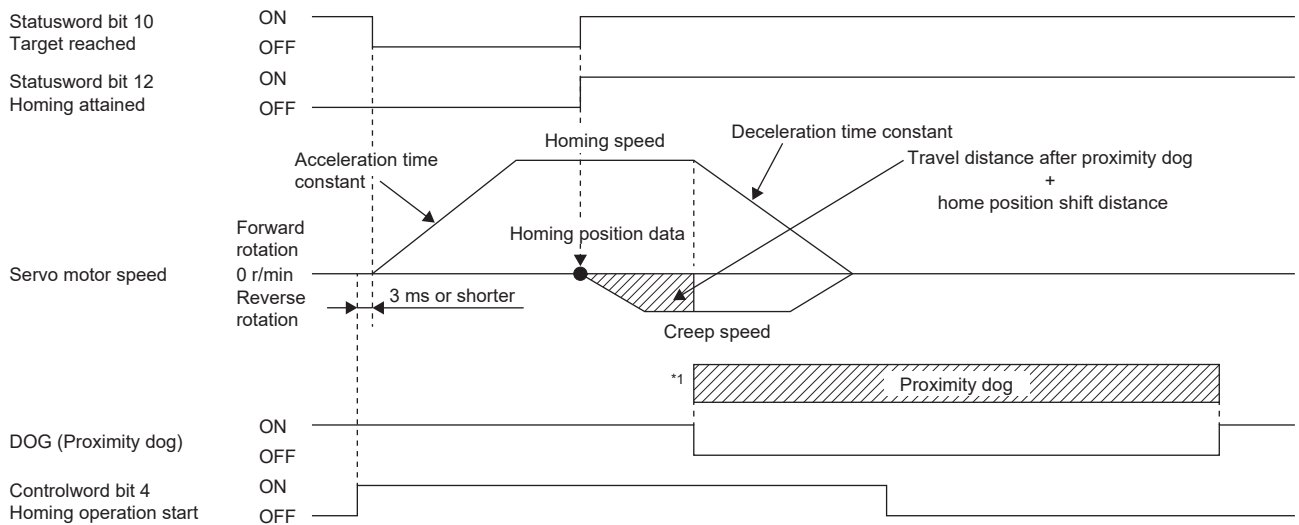

\*1 After the front end of the proximity dog is detected, if the rear end of the proximity dog is detected without reaching the creep speed, [AL. 090] occurs. Revise the length of the proximity dog, or revise both the homing speed and creep speed.

- When homing is started from the proximity dog

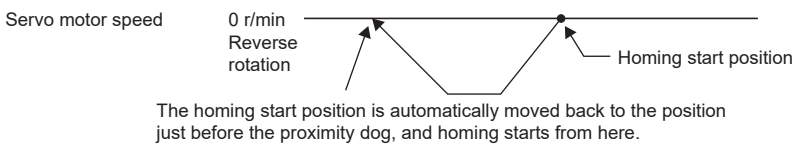

- When the servo motor returns at the stroke end

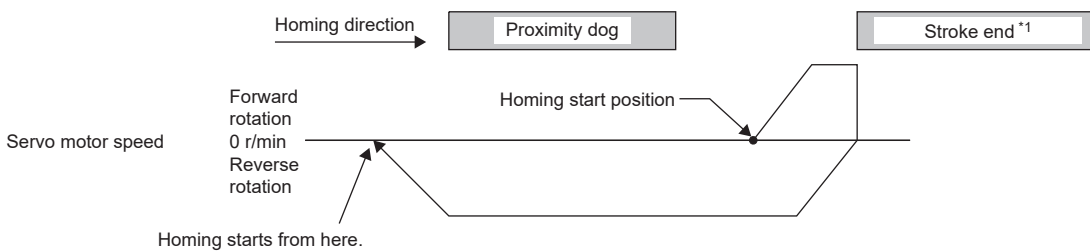

\*1 This cannot be used with the software limit.

## Method -11 and Method -43 (Dogless Z-phase reference homing)

The following figure shows the operation of Homing method -11 when the home position shift distance is a positive value. The homing direction of Homing method -43 is opposite to that of Homing method -11.

### Point

- When homing is performed from near the Z-phase, the homing completion position varies. The recommended start position for homing can be found by rotating the servo motor about a half-turn away from the homing direction.

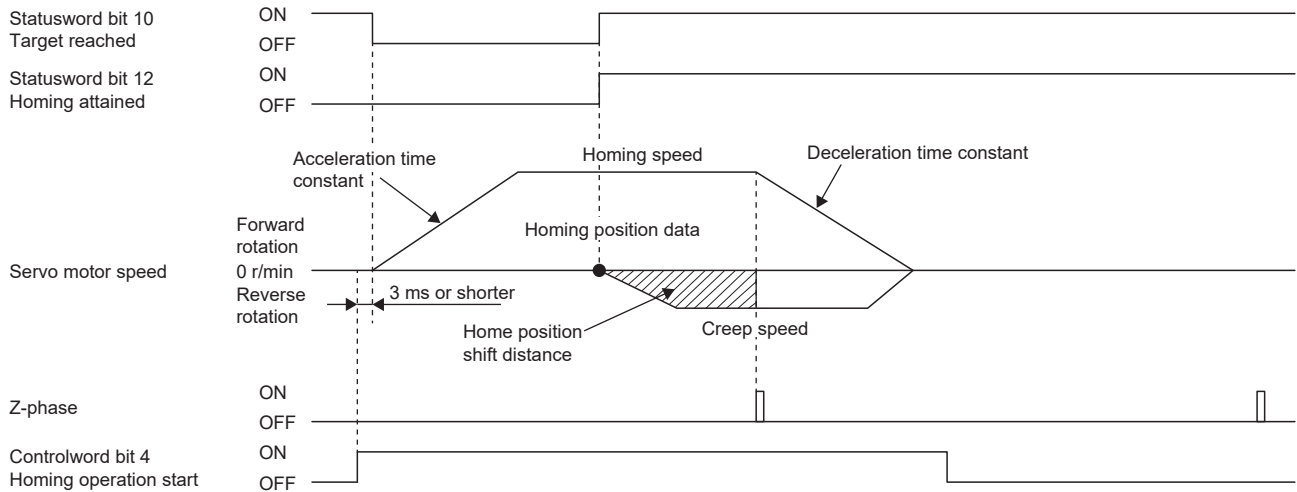

- When the stroke end is detected

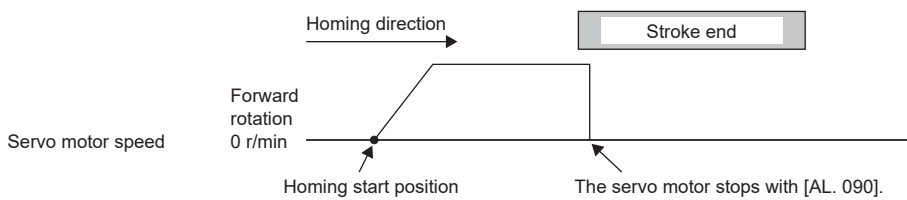



# 3 BASIC FUNCTION

This chapter explains each function that is used for basic operation of the servo amplifier. Set each function as required. For advanced operation of the servo amplifier, refer to the following.

☞ Page 139 APPLICABLE FUNCTIONS

## Precautions

- To prevent a malfunction and machine damage, on the first operation after setting, check the operating condition with a low speed command.

## 3.1 Outline of servo parameter and object dictionary

On MR-JET servo amplifiers, the functions of the servo amplifiers are set with servo parameters, and objects enable communication of data such as command values and feedback values with controllers.

### Servo parameter



For the servo parameters that updates data periodically in the cyclic communication, do not write a value with an engineering tool or other tools, as the values will be overwritten from the controller.

Each function of the servo amplifiers can be set with the servo parameters. The servo parameters are stored in the non-volatile memory in the servo amplifier. Initial values are set for the servo parameters in the factory setting. Change the setting with engineering tools or other methods as necessary.

The servo parameters related to the basic functions explained in this manual are shown in the following example.

If the servo parameter name is "Travel direction selection" and the number is "PA14"

[Pr. PA14 Travel direction selection]

Servo parameter	Symbol	Name	Outline
PA14	*POL	Travel direction selection	The rotation direction of the servo motor or the travel direction of the linear servo motor can be set. Initial value: 0 (CCW or positive direction)

In addition, the servo parameters in which the symbols are preceded by \* are enabled by the following conditions.

- \*: After setting, cycle the power, or reset either the controller or the software.
- \*\*: After setting, cycle the power or reset the software.

For a servo parameter which uses one particular digit to select a function, the position of its digit indicates the detail number of the servo parameter, and the value in hexadecimal which is set to the digit indicates the selected function.

For example, the detail number of the servo parameter in the last digit is expressed as [Pr. PA01.0]. In addition, a servo parameter which uses a combination of several digits to select a function, is expressed using "-" as seen in [Pr. PA01.0-1].

The following is an example of the servo parameter number PA01 with the setting values of "FEDCBA98" in hexadecimal.

- When setting a servo parameter with one particular digit

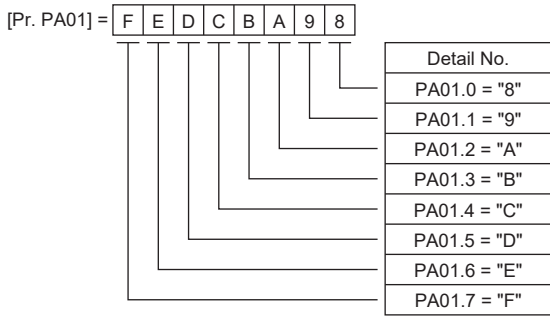

- When setting a servo parameter using a combination of several digits

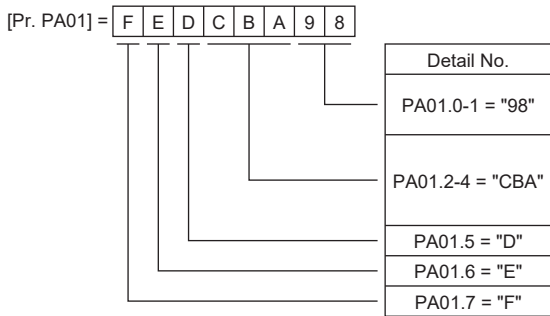

For example, if the servo parameter name is "Function selection A-1", the setting digit name is "Forced stop deceleration function selection", and the setting digit is the fourth last digit in PA04, the servo parameter is expressed as shown below.

[Pr. PA04.3 Forced stop deceleration function selection]

Servo parameter	Symbol	Name	Outline
PA04.3	*AOP1	Forced stop deceleration function selection	Set "Forced stop deceleration function" to enabled/disabled. Initial value: 1h (enabled)

# Object dictionary

MR-JET servo amplifiers communicate information such as position commands and position feedback via a network. For identification, each information is assigned to a unique number from 0000h to FFFFh called Index, and the assigned information is called an object.

For example, the command position is the object that is assigned to the Index of 607Ah. A servo amplifier has a huge number of objects, which are called an object dictionary in the aggregate.

The basic functions described in this manual also describe the method of use of the objects, as there are operations that give commands to the servo amplifier through objects, as well as operations that notify status to the controller through objects.

When using a controller manufactured by Mitsubishi Electric, any concern regarding the Objects is alleviated as the controller itself has the functions to set and obtain the Object values necessary to implement each function. When the respective object values are needed to be obtained and set specifically, use the servo cyclic transmission function or the servo transient transmission function. For details, refer to each controller manual.

The objects related to the basic functions explained in this manual are shown in the following example.

**Ex.**

[Target position (Obj. 607Ah)]

Index	Sub	Object	Name	Description
607Ah	—	VAR	Target position	Command position Unit: pos units

For details on how to save the content set in the object, refer to "Saving object dictionary data" in the User's Manual (Communication Function).

## 3.2 Rotation/travel direction selection

The rotation direction of a servo motor or the travel direction of a linear servo motor can be changed according to position commands, speed commands, and torque commands. Set the directions with servo parameters or objects in accordance with the system configurations.

The servo motor rotation direction is as follows.

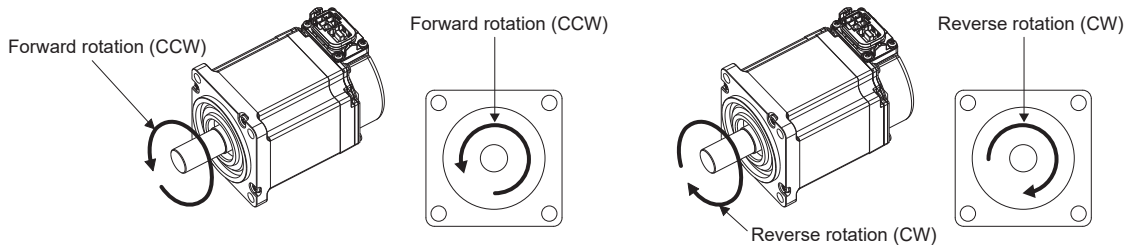

The positive and negative directions of the linear servo motor are as follows.

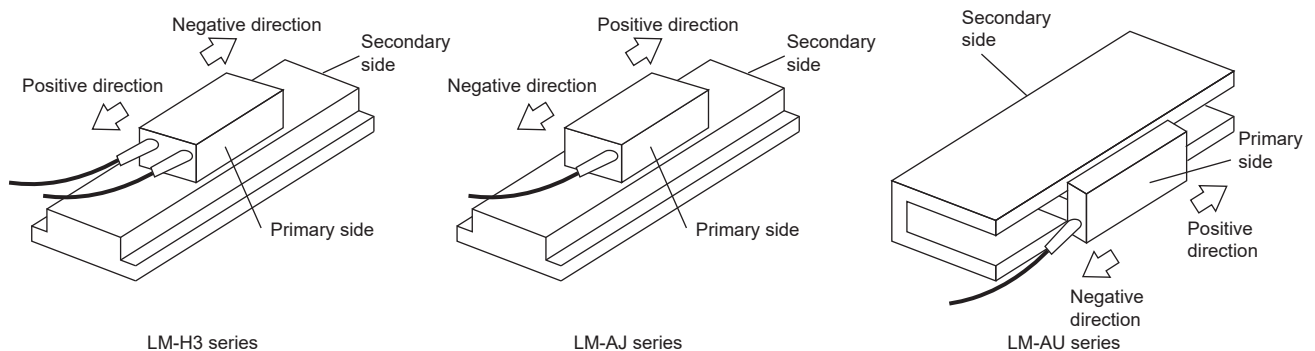

### Restriction

- When the setting of the servo motor rotation direction is changed, the status changes to "Homing incomplete". Execute homing again.

### Precautions

- The setting of the rotation/travel direction selection does not change the "Display All" function and "Graph" function in MR Configurator2.
- Some objects can be changed with the setting of the rotation/travel direction selection, and some cannot. Refer to the following for details.

☞ Page 85 Target object

# Setting methods of functions

## Setting with servo parameters

The rotation/travel direction can be changed without changing the polarity of the command from the controller. With regards to the commands from the controller, and in the feedback information to be transmitted to the controller, the position/speed information is changed with the setting of [Pr. PA14 Travel direction selection].

Torque information changes with the combination of [Pr. PA14] and [Pr. PC29.3 Torque POL reflection selection].

The rotation/travel direction setting is common for all the control modes. For example, when the torque polarity is changed with [Pr. PA14] and [Pr. PC29.3], the torque information polarity will also change in the position mode.

The servo parameters related to the setting of the rotation/travel direction selection are as follows:

Servo parameter	Symbol	Name	Outline
PA14	*POL	Travel direction selection	The rotation direction of the servo motor and the travel direction of the linear servo motor can be set. Initial value: 0 (CCW or positive direction)
PC29.3	*COPB	Torque POL reflection selection	Torque POL reflection selection can be set. The torque polarity can be changed with the combination of this servo parameter and [Pr. PA14]. Initial value: 1h (disabled)

The following tables show the rotation/travel direction of the position information, speed information, and torque information that is changed in servo parameter settings.

### ■Position information

[Pr. PA14] Setting value	Servo motor rotation direction/linear servo motor travel direction	
	Positioning address increasing direction	Positioning address decreasing direction
0	CCW or positive direction	CW or negative direction
1	CW or negative direction	CCW or positive direction

### ■Speed information

[Pr. PA14] Setting value	Servo motor rotation direction/linear servo motor travel direction	
	Speed handled by the controller: positive	Speed handled by the controller: negative
0	CCW or positive direction	CW or negative direction
1	CW or negative direction	CCW or positive direction

### ■Torque information

Setting value		Servo motor rotation direction/linear servo motor travel direction	
[Pr. PA14]	[Pr. PC29.3]	Torque handled by the controller: positive	Torque handled by the controller: negative
0	0: Enabled	CCW or positive direction	CW or negative direction
	1: Disabled		
1	0: Enabled	CW or negative direction	CCW or positive direction
	1: Disabled		

## Setting with object dictionary

[Polarity (Obj. 607Eh)] enables the rotation/travel direction to be changed without changing the polarity of the command from the controller. The setting of [Polarity (Obj. 607Eh)] for the position information and speed information corresponds to [Pr. PA14 Travel direction selection]. The setting of [Polarity (Obj. 607Eh)] for the torque information corresponds to [Pr. PA14 Travel direction selection] and "Torque POL reflection selection" in [Pr. PC29].

A change in the setting of [Polarity (Obj. 607Eh)] is not applied immediately.

The table below shows the relations between the object definition, object setting values, and the servo parameters. Settings can only be made with the combinations indicated here.

Bit	Description
0	(reserved) The value at reading is undefined. Set "0" when writing.
1	
2	
3	
4	
5	0: Servo motor CCW rotation at positive torque 1: Servo motor CW rotation at positive torque
6	0: Servo motor CCW rotation at positive speed 1: Servo motor CW rotation at positive speed
7	0: Servo motor CCW rotation in the positioning address increasing direction 1: Servo motor CW rotation in the positioning address increasing direction

The below table shows the relations between the object setting value of [Polarity (Obj. 607Eh)] and the servo parameters.

Object			Servo parameter		Description
[Polarity (Obj. 607Eh)]			[Pr. PA14]	[Pr. PC29.3]	
Bit7	Bit6	Bit5			
0	0	0	0	1	The polarity does not change.
1	1	0	1	1	The polarity of the position and speed is reversed.
1	1	1	1	0	The polarity of the position, speed, and torque is reversed.

## Target object

The following shows the objects in which the polarity is reversed by the setting of [Polarity (Obj. 607Eh)] and by the settings of [Pr. PA14] and [Pr. PC29.3].

- [Target position (Obj. 607Ah)]
- [Target velocity (Obj. 60FFh)]
- [Target torque (Obj. 6071h)]
- [Position demand value (Obj. 6062h)]

Available on servo amplifiers with firmware version B6 or later.

- [Position actual value (Obj. 6064h)]
- [Velocity demand value (Obj. 606Bh)]

Whether to reverse the polarity with [Polarity (Obj. 607Eh)] can be set by setting one of the following values in [Pr. PC76.2 Internal command speed POL reflection selection].

"0": Automatic setting (POL setting enabled)

"1" (POL setting enabled): The polarity is reversed with [Polarity (Obj. 607Eh)].

"2" (POL setting disabled): The polarity is not reversed with [Polarity (Obj. 607Eh)].

- [Velocity actual value (Obj. 606Ch)]
- [Torque demand value (Obj. 6074h)]
- [Torque actual value (Obj. 6077h)]
- [Position offset (Obj. 60B0h)]
- [Current actual value (Obj. 6078h)]

Available on servo amplifiers with firmware version B6 or later.

- [Velocity offset (Obj. 60B1h)]
- [Torque offset (Obj. 60B2h)]
- [Positive torque limit value (Obj. 60E0h)]

With the settings of [Pr. PA14] and [Pr. PC29.3], the corresponding servo parameters are changed as follows:

[Pr. PA14]	[Pr. PC29.3]	Supported servo parameter
0	1 (disabled)	[Pr. PA11 Forward rotation torque limit]
	0 (enabled)	
1	1 (disabled)	[Pr. PA12 Reverse rotation torque limit]
	0 (enabled)	

- [Negative torque limit value (Obj. 60E1h)]

With the settings of [Pr. PA14] and [Pr. PC29.3], the corresponding servo parameters are changed as follows:

[Pr. PA14]	[Pr. PC29.3]	Supported servo parameter
0	1 (disabled)	[Pr. PA12 Reverse rotation torque limit]
	0 (enabled)	
1	1 (disabled)	[Pr. PA11 Forward rotation torque limit]
	0 (enabled)	

- [Digital inputs (Obj. 60FDh)]

The corresponding status is changed in accordance with the setting of [Pr. PA14] as follows:

[Pr. PA14]	Negative limit switch (bit 0)	Positive limit switch (bit 1)
0	LSN (Reverse rotation stroke end)	LSP (Forward rotation stroke end)
1	LSP (Forward rotation stroke end)	LSN (Reverse rotation stroke end)

## 3.3 Stroke limit function

The stroke limit function is a function that limits the travel distance of servo motors. On a system configuration where the movable range is limited, wire the stroke limit signal and use this function to prevent machine damage due to a collision. When the stroke limit signal is detected, a warning regarding the detected signal occurs, and the servo motor stops based on the stop method described in this section.

When a system configuration without the limited movable range is used and therefore the stroke limit function is not necessary, set the stroke limit signal to always on.

### Restriction

- The stroke limit signal cannot be used in the torque mode. When a linear servo motor is used in the torque mode, the stroke limit signal can be used only while magnetic pole detection is being executed.
- In the continuous operation to torque control mode, the stroke limit signal is available only when the magnetic pole is detected using a linear servo motor. The stroke limit signal will be unavailable after the magnetic pole detection is completed.

### Precautions

- The stroke limit signal is the signal for a normally closed contact. The limit is released when the contact is on (shorted), and the limit is in progress when the contact is off (open).
- Depending on the stop method setting of the stroke limit and the commands from the controller, the home position may be erased when the servo motor is stopped by the stroke limit signal being detected during operation. If the home position is erased, perform homing again.

## Explanation of the stroke limit signal names

There are two sets of stroke limit signals: FLS (Upper stroke limit)/RLS (Lower stroke limit) and LSP (Forward rotation stroke end)/LSN (Reverse rotation stroke end). The characteristics of both signals are shown in the following table. The signal names differ depending on whether the stroke limit signal is used on the controller or on the servo amplifier. Use the signal that is appropriate for the system configuration being used.

To wire limit switches to the servo amplifier, wire the limit switch installed in CCW direction to LSP (Forward rotation stroke end), and wire the limit switch installed in CW direction to LSN (Reverse rotation stroke end).

To wire limit switches to the controller, wire the limit switch installed in the increasing direction of the positioning address to FLS (Upper stroke limit), and wire the limit switch installed in the decreasing direction to RLS (Lower stroke limit). Then, input the signals from the controller.

Name	Symbol	Purpose of the signal
Upper stroke limit	FLS	The limit signal which suppresses the operation in the positioning address increasing direction with regard to the command from the controller
Lower stroke limit	RLS	The limit signal which suppresses the operation in the positioning address decreasing direction with regard to the command from the controller
Forward rotation stroke end	LSP	The limit signal which suppresses the operation in the servo motor CCW direction
Reverse rotation stroke end	LSN	The limit signal which suppresses the operation in the servo motor CW direction



## Setting methods of functions

Refer to the following table, and make the appropriate settings for the system configuration.

Item	Reference
When wiring the limit switch to the servo amplifier	☞ Page 87 When wiring the limit switch to the servo amplifier
When wiring the limit switch to equipment other than the servo amplifier	☞ Page 89 When wiring the limit switch to equipment other than the servo amplifier
When setting the movable range with the position data	☞ Page 89 When setting the movable range with the position data
When the movable range is not limited	☞ Page 89 When the movable range is not limited

3

### When wiring the limit switch to the servo amplifier

Refer to the system configuration example shown in this section, and input the signal of the limit switch to the servo amplifier. Set [Pr. PD41.3 Sensor input method selection] to "0" to use the initial setting (Input from the servo amplifier (LSP/LSN/DOG)). Set the limit switch installed in CCW or the positive direction to LSP, and set the limit switch installed in CW or the negative direction to LSN. In the initial setting, LSP is assigned to the CN3-2 pin, and LSN is assigned to the CN3-12 pin. The information from the stroke end that is transmitted to the controller changes depending on the setting in [Pr. PA14 Travel direction selection].

When [Pr. PA14 Travel direction selection] is set to "0" (with an increasing positioning address or travel in the positive direction)

Signal names of the stroke end		Signal names of the corresponding stroke limits	
Symbol	Signal name	Symbol	Signal name
LSP	Forward rotation stroke end	FLS	Upper stroke limit
LSN	Reverse rotation stroke end	RLS	Lower stroke limit

When [Pr. PA14 Travel direction selection] is set to "1" (travel in CW direction with an increasing positioning address)

Signal names of the stroke end		Signal names of the corresponding stroke limits	
Symbol	Signal name	Symbol	Signal name
LSP	Forward rotation stroke end	RLS	Lower stroke limit
LSN	Reverse rotation stroke end	FLS	Upper stroke limit

## ■ System configuration example

- [Pr. PA14 Travel direction selection] = "0" (CCW or the positive direction)

Set LSP (Upper stroke end) for the limit signal that suppresses the operation in CCW or the positive direction. The on/off status of LSP (Forward rotation stroke end) is outputted as FLS (Upper stroke limit) to the controller, and the on/off status of LSN (Reverse rotation stroke end) is outputted as RLS (Lower stroke limit).

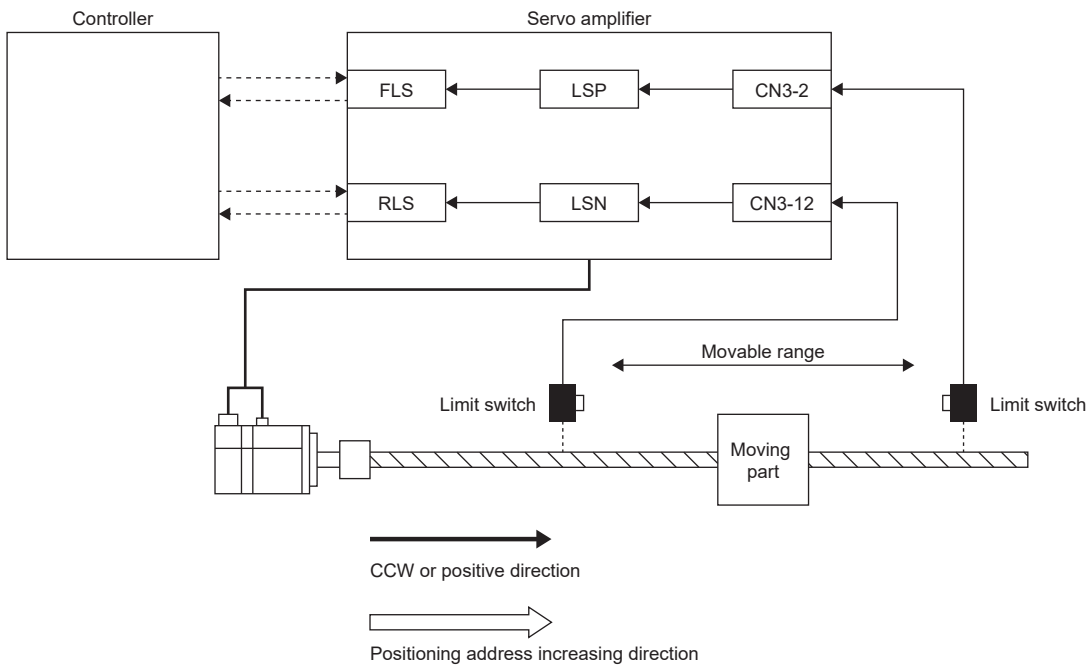

- [Pr. PA14 Travel direction selection] = "1" (CW or the negative direction)

This example shows a case where CCW or the positive direction of the servo amplifier is different from the positioning address increasing direction of the controller. The on/off status of LSN (Reverse rotation stroke end) is outputted as FLS (Upper stroke limit) to the controller, and the on/off status of LSP (Forward rotation stroke end) is outputted as RLS (Lower stroke limit).

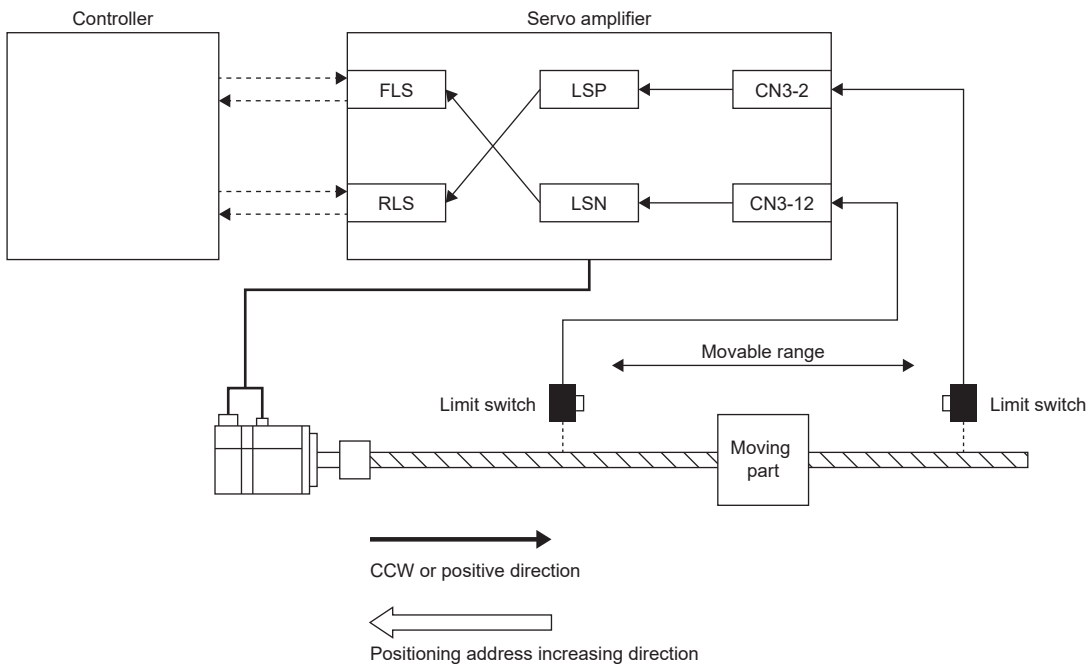

## When wiring the limit switch to equipment other than the servo amplifier

By wiring the limit switch to equipment other than the servo amplifier, such as a controller, the stroke limit function is enabled to be used with input signals from the controller. Refer to the system configuration example shown in this section when installing the limit switch.

Set [Pr. PD41.3 Sensor input method selection] to "1" (input from controller (C\_FLS/C\_RLS/C\_DOG)). From the controller to the servo amplifier, input the limit switch installed in the positioning address increasing direction as FLS (Upper stroke limit), and the limit switch installed in the decreasing direction as RLS (Lower stroke limit).

For details of the controller settings, refer to controller manuals.

### ■System configuration example

The following shows an example where the limit switch is wired to the controller. To FLS (Upper stroke limit), input the limit signal which suppresses the operation in the positioning address increasing direction against the command from the controller. The limit switch does not need to be wired to the servo amplifier.

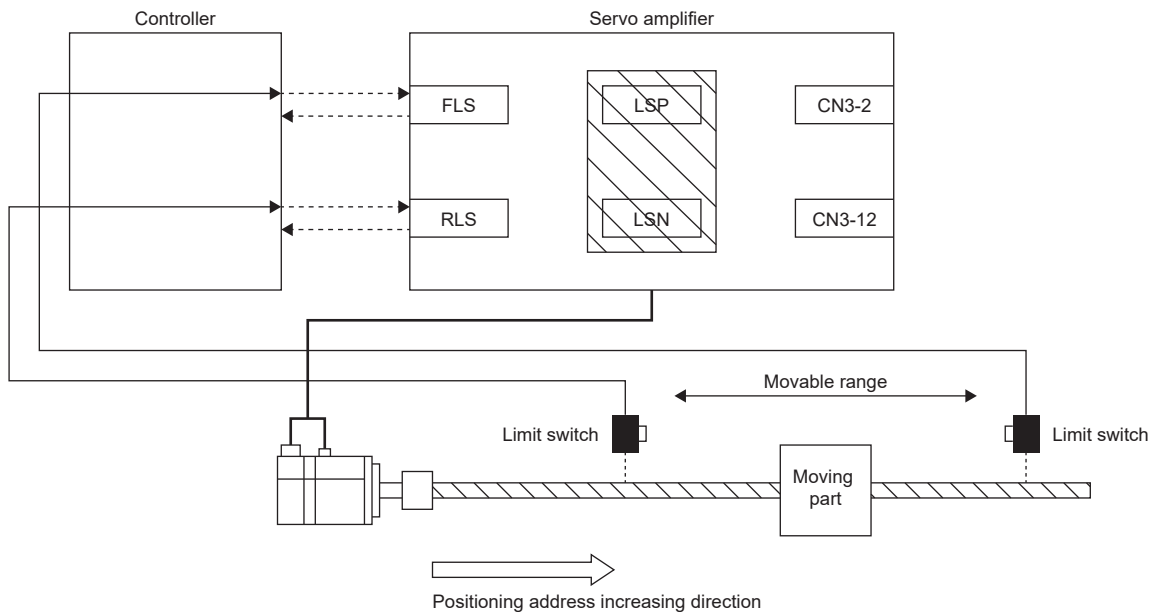

## When setting the movable range with the position data

Use software position limit to specify the upper and lower limits in order to limit the movable range.

☞ Page 177 Software position limit

## When the movable range is not limited

On a system configuration without the limited movable range, such as a conveyor, set LSP/LSN to be automatically turned on. As the signal is set to be always turned on, the servo motor does not stop with the stroke limit. This can be set from the "Basic Setting" of "Digital I/O" on MR Configurator2.

# Stop method at stroke limit detection

When LSP (Forward rotation stroke end)/LSN (Reverse rotation stroke end) or FLS (Upper stroke limit)/RLS (Lower stroke limit) is turned off, the servo motor stops with the stop method shown in this section.

In the cyclic synchronous position mode (csp), stop the command when the stroke end is detected. When the command position exceeds the position where the stroke end is detected by 30 bits, [AL. 069 Command error] occurs. If [AL. 069 Command error] occurs, the home position is erased. Perform homing again.

☞ Page 44 Homing mode (hm)

Operation status		Remark
<b>During rotation at constant speed</b>	<b>During deceleration to a stop</b>	The servo motor stops after having traveled for the droop pulses. Perform homing again.
<p>— No S-pattern acceleration/deceleration            - - - With S-pattern acceleration/deceleration</p> <p>Servo motor speed</p> <p>0 r/min (0 mm/s)</p> <p>LSP or LSN ON OFF</p>	<p>— No S-pattern acceleration/deceleration            - - - With S-pattern acceleration/deceleration</p> <p>Servo motor speed</p> <p>0 r/min (0 mm/s)</p> <p>LSP or LSN ON OFF</p>	

When the stroke limit signal is detected, perform the following return methods.

Control mode	Return method
Cyclic synchronous position mode	After following up [Target position (Obj. 607Ah)] with [Position actual value (Obj. 6061h)], input the position command of the direction opposite to the limit. Make sure that Bit 12 of [Statusword (Obj. 6041h)] is 0 before inputting the position command.
Cyclic synchronous velocity mode	Input the speed command of the direction opposite to the limit to [Target velocity (Obj. 60FFh)]. Make sure that Bit 12 of [Statusword (Obj. 6041h)] is 0 before inputting the speed command.
Profile position mode	Input the position command of the direction opposite to the limit to [Target position (Obj. 607Ah)].
Profile velocity mode	Input the speed command of the direction opposite to the limit to [Target velocity (Obj. 60FFh)].
Point table mode	Perform positioning operation by the point table in the opposite direction to the limit.
JOG operation mode	Perform JOG operation in the opposite direction to the limit.

## Servo parameter list

The settings related to the stroke limit function can be performed directly with the servo parameters. Perform the settings as required.

Servo parameter	Symbol	Name	Outline
PC19.0	*COP6	[AL. 099 Stroke limit warning] selection	Enable or disable [AL. 099 Stroke limit warning]. When "Disabled" is selected, [AL. 099 Stroke limit warning] does not occur when LSP (Forward rotation stroke end) or LSN (Reverse rotation stroke end) is off, but the stroke limit does still stop the operation. 0: Enabled (initial value) 1: Disabled
PD01.2	*DIA1	Input signal automatic ON selection	Set LSP (Forward rotation stroke end) and LSN (Reverse rotation stroke end) to "Disabled" (use for an external input signal) or "Enabled" (Automatic on). Initial value: 0h (Disabled (Use for an external input signal.))
PD03.0-1	*DI1	Device selection	Assign any input device to the CN3-2 pin. Initial value: 0Ah (LSP (Forward rotation stroke end))
PD04.0-1	*DI2	Device selection	Assign any input device to the CN3-12 pin. Initial value: 0Bh (LSN (Reverse rotation stroke end))
PD05.0-1	*DI3	Device selection	Assign any input device to the CN3-19 pin. Initial value: 22h (DOG (Proximity dog))
PD41.2	*DOP4	Limit switch enabled status selection	0: Limit switch always enabled (initial value) 1: Enabled only for homing mode
PD41.3	*DOP4	Sensor input method selection	0: Input from servo amplifier (LSP/LSN/DOG) (initial value) 1: Input from controller (C_FLS/C_RLS/C_DOG)
PL08.2	*LIT3	Magnetic pole detection - Stroke limit enabled/disabled selection	Select whether to enable or disable the stroke limit function during magnetic pole detection. 0: Enabled (initial value) 1: Disabled

# Limit switch release position assessment function

## Outline

The limit switch release position assessment function is available on servo amplifiers with firmware version B2 or later. This function can be used in the cyclic synchronous position mode (csp) or cyclic synchronous velocity mode (csv). Use this function in the following cases: After the limit switch has been detected, the moving part passes through the limit switch detection position and stops. If the moving part passes through the limit switch detection position and stops, commands in the direction where the moving part has moved cannot be accepted until the warning release conditions are met.

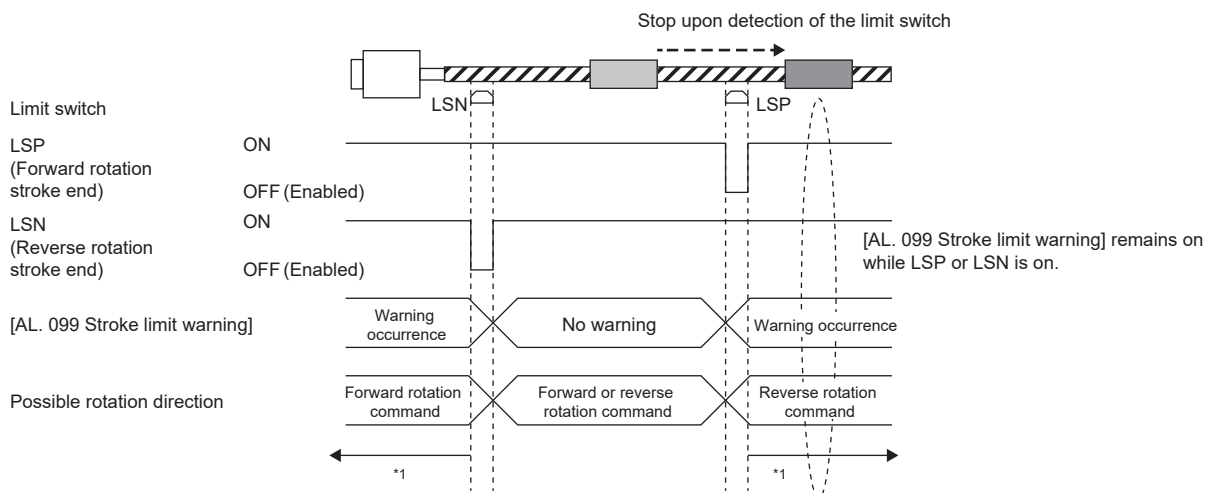

\*1 Page 92 Precautions

## Precautions

Check that the moving part is currently located in the area between the limit switches before operation. This function cannot work properly in the following situations:

- Turning on the power while the moving part is outside the area between the limit switches.
- Resetting the controller while the moving part is outside the area between the limit switches.
- Performing homing while the moving part is outside the area between the limit switches.
- Switching the control mode while the moving part is outside the area between the limit switches.
- The limit switches are on for less than 10 ms.

## Setting methods of functions

[Pr. PT38.4 Limit switch release position assessment function selection] can be used to select whether [AL. 099 Stroke limit warning] is released without or after a limit position assessment. The stroke limit warning will be released after all the release conditions have been met.

[Pr. PT38.4]	Limit switch release position assessment function
0	Disabled
1	Enabled

### ■Limit position assessment

When the moving part returns to the position where the stroke end was detected, the warning release conditions will be met.

# 3.4 Command unit selection function

## Position command unit selection function

The position command unit selection function and degree unit are available on servo amplifiers with firmware version B6 or later.

The mm unit and inch unit are available on servo amplifiers with firmware version B8 or later in the positioning mode (point table method).

The position command unit selection function can be used to select the position data command unit (mm/inch/pulse/degree) according to the system being used.

For information on which control mode can be used with the unit "degree", refer to "Selecting control mode (Modes of operation)" in the User's Manual (Communication Function).

Command unit	Explanation
mm inch pulse	This unit is suitable for line coordinate systems. (For example, X-Y tables)
degree	This unit is suitable for rotating coordinate systems. (For example, index tables)

### Restriction

- In the cyclic synchronous mode, "degree" cannot be used as the unit of position data. Setting "degree" will not allow switching to the cyclic synchronous mode.

### Precautions

- To adjust the rotation amount/travel distance of the servo motor relative to the position data in the command unit, use the electronic gear function.

 Page 97 Electronic gear function

- The setting units of servo parameters vary depending on the command unit. For details, refer to the units of servo parameters.

## Function block diagram

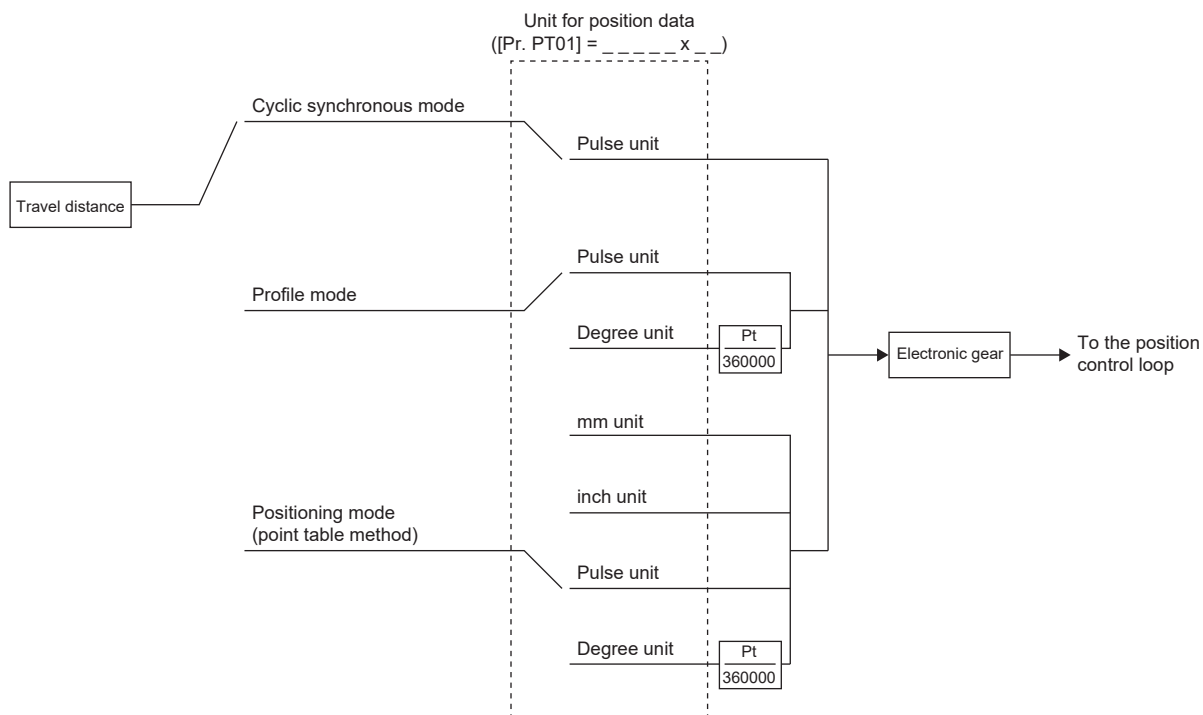

The following shows the setting units for travel distance in each command unit.

Command unit	Setting unit of the travel distance
mm	0.001 [mm]
inch	0.0001 [inch]
pulse	1 [pulse]
degree	0.001 [degree]



## Setting method

### ■Setting with servo parameters

Use [Pr. PT01.2 Unit for position data] to set the command unit of position data.

Servo parameter	Symbol	Name	Outline
PT01.2	**CTY	Unit for position data	Set the unit of position data. 0: mm 1: inch 2: degree 3: pulse (initial value)

3

### ■Setting with object dictionary

For details on the objects, refer to the User's Manual (Object Dictionary).

Index	Sub	Object	Name	Description
6092	0	ARRAY	Feed constant	Travel distance per revolution of an output shaft
	1		Feed	Travel distance setting
	2		Shaft revolutions	Number of servo motor shaft revolutions
60A8h	—	VAR	SI unit position	SI unit position A value is automatically set in accordance with "Unit for position data" of [Pr. PT01.2 Unit for position data].

[Feed (Obj. 6092h: 01h)] is automatically set in accordance with [Pr. PT01.2 Unit for position data]. Do not write a value to [Feed (Obj. 6092h: 01h)]. Doing so will cause an error.

[Shaft revolutions (Obj. 6092h: 02h)] is automatically set. Do not write a value to [Shaft revolutions (Obj. 6092h: 02h)]. Doing so will cause an error.

The values of [Feed constant (Obj. 6092h)] are as follows.

[Pr. PT01.2 Unit for position data]	Feed	Shaft revolutions
0: mm	Servo motor encoder resolution	1
1: inch		1
2: degree	360000	1
3: pulse	Servo motor encoder resolution	1

[Position actual value (Obj. 6064h)] is calculated from [Gear ratio (Obj. 6091h)] and [Feed constant (Obj. 6092h)] as follows.

$$[\text{Position actual value (Obj. 6064h)}] = \frac{[\text{Position actual internal value (Obj. 6063h)}] \times [\text{Feed constant (Obj. 6092h)}]}{[\text{Position encoder resolution (Obj. 608Fh)}] \times [\text{Gear ratio (Obj. 6091h)}]}$$

If the unit is set to "degree", the result can be any value from 0 to 359999.

A value is automatically set in [SI unit position (Obj. 60A8h)] in accordance with the setting of [Pr. PT01.2 Unit for position data].

The values of [SI unit position] are as follows.

[Pr. PT01.2]	Value
0: mm	FA010000 (0.001 mm)
1: inch	FCC00000 (0.0001 inch)
2: degree	FD410000 (0.001 degree)
3: pulse	00000000 (pulse)

# Speed command unit selection function

This is a function to select setting units for speed data. Either r/min (mm/s) or command unit/s can be selected.

Setting unit	Explanation
r/min, mm/s	Use this when setting the speed data as servo motor speed (encoder unit).
Command unit/s	Use this when setting the speed data in command units. [Pr. PT01.2 Unit for position data] can be used to change the command unit to "mm, inch, pulse" or "degree".

## Precautions

- The servo parameter for setting the speed data varies depending on the unit selected in [Pr. PT01.1 Speed/acceleration/deceleration unit selection]. However, the same object is used for setting the acceleration/deceleration data regardless of the unit selected.
- Depending on the unit selected in [Pr. PT01.1], both the speed data and the unit of acceleration/deceleration data are changed.

## Setting method

Select the speed data setting unit in [Pr. PT01.1 Speed/acceleration/deceleration unit selection].

Servo parameter	Symbol	Name	Outline
PT01.1	**CTY	Speed/acceleration/deceleration unit selection	Select a speed unit. 0: r/min, mm/s 1: Command unit/s

## Relevant speed data and acceleration/deceleration data

[Pr. PT01.1 Speed/acceleration/deceleration unit selection]		Object interlocked with servo parameter
0	1	
[Pr. PT65 Profile speed command]	[Pr. PV01 Profile speed command extension setting]	[Profile velocity (Obj. 6081h)]
[Pr. PT66 Maximum profile speed]	[Pr. PV03 Maximum profile speed extension setting]	[Max profile velocity (Obj. 607Fh)]
[Pr. PT49 Speed acceleration time constant]	[Pr. PV05 Profile acceleration]	[Profile acceleration (Obj. 6083h)]
[Pr. PT50 Speed deceleration time constant]	[Pr. PV07 Profile deceleration]	[Profile deceleration (Obj. 6084h)]
[Pr. PC24 Deceleration time constant at forced stop]	[Pr. PV09 Deceleration at forced stop]	[Quick stop deceleration (Obj. 6085h)]
[Pr. PT05 Homing speed]	[Pr. PV11 Homing speed extension setting]	[Speed during search for switch (Obj. 6099h: 01h)]
[Pr. PT06 Creep speed]	[Pr. PV13 Creep speed extension setting]	[Speed during search for zero (Obj. 6099h: 02h)]
[Pr. PT56 Homing acceleration time constant]	[Pr. PV15 Homing acceleration]	[Homing acceleration (Obj. 609Ah)]
[Pr. PT57 Homing deceleration time constant]	[Pr. PV17 Homing deceleration]	—
[Pr. PC72 Speed reached 2 - Output range]	[Pr. PV19 Speed reached 2 - Output range - Extension setting]	[Velocity window (Obj. 606Dh)]
[Pr. PC65 Zero speed 2 level]	[Pr. PV20 Zero speed 2 level extension setting]	[Velocity threshold (Obj. 606Fh)]
[Pr. PT67 Speed limit]	[Pr. PV21 Speed limit extension setting]	[Velocity limit value (Obj. 2D20h)]

# 3.5 Electronic gear function

Electronic gear function is a function that multiplies the electronic gear ratio to the position command, and sets the ratio of the rotation amount/travel distance of the servo motor to the rotation amount/travel distance of the command unit as desired. For the position feedback, the inverse number of the electronic gear ratio is multiplied.

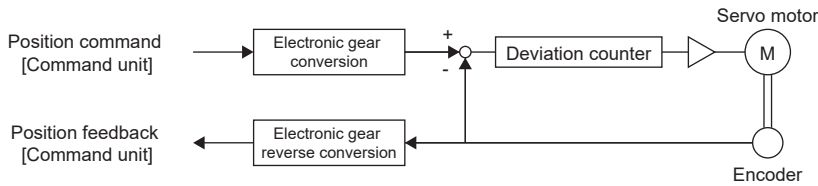

**Restriction**

- Set the electronic gear within the range of conditions. If a value out of the range is set, [AL. 037 Parameter error] occurs.

**Precautions**

- To prevent unexpected operation, set the electronic gear correctly.
- If an excessive command pulse frequency is inputted from the controller in the cyclic synchronous position mode, [AL. 031 Overspeed] or [AL. 035 Command frequency error] may occur, depending on the value of the electronic gear ratio.

## Setting method

### Setting with servo parameters

Servo parameter	Symbol	Name	Outline
PA06	CMX	Electronic gear numerator	Set the electronic gear numerator. Initial value: 1
PA07	CDV	Electronic gear denominator	Set the electronic gear denominator. Initial value: 1

### Setting with object dictionary

Set the electronic gear numerator for [Motor revolutions (Obj. 6091h: 01h)], and electronic gear denominator for [Shaft revolutions (Obj. 6091h: 02h)].

For details on the objects, refer to the User's Manual (Object Dictionary).

Index	Sub	Object	Name	Description
6091h	0	ARRAY	Gear ratio	Gear ratio
	1		Motor revolutions	Number of revolutions of the servo motor shaft (numerator) This corresponds to [Pr. PA06].
	2		Shaft revolutions	Number of revolutions of the drive shaft (denominator) This corresponds to [Pr. PA07].

## Setting example

### Point

The electronic gears on the position command side are illustrated in the function block diagrams. The inverse number of the electronic gear ratio is multiplied to the position feedback side.

### In the cyclic synchronous position mode

Adjust [Pr. PA06 Electronic gear numerator] and [Pr. PA07 Electronic gear denominator] so that the travel distance set in the controller matches the travel distance on the machine. [Motor revolutions (Obj. 6091h: 01h)] and [Shaft revolutions (Obj. 6091h: 02h)] can also be used for the setting.

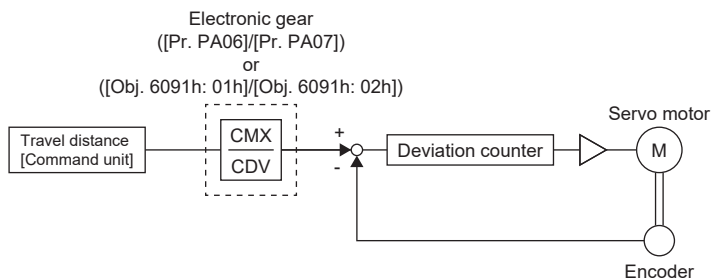

$P_t$ : Servo motor encoder resolution [pulse/rev]

$\Delta S$ : Travel distance per servo motor revolution [command unit/rev]

CMX: Electronic gear numerator

CDV: Electric gear denominator

$$CMX/CDV = P_t/\Delta S$$

The following setting example shows how to calculate the electronic gear.

### Point

The following specification symbols are necessary for calculation of the electronic gear.

Pb: Ball screw lead [mm]

1/n: Reduction ratio

$P_t$ : Servo motor encoder resolution [pulse/rev]

$\Delta L_0$ : Travel distance per command pulse [mm/pulse]

$\Delta S$ : Travel distance per servo motor revolution [mm/rev]

$\Delta \theta^\circ$ : Angle per pulse [ $^\circ$ /pulse]

$\Delta \theta$ : Angle per revolution [ $^\circ$ /rev]

**Ex.**

Setting example for a ball screw

The following shows an example where the ball screw is moved at 10 μm per pulse.

Machine specifications

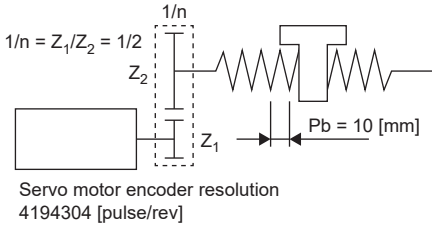

Ball screw lead  $P_b = 10$  [mm]

Reduction ratio:  $1/n = Z_1/Z_2 = 1/2$

$Z_1$ : Number of gear teeth on servo motor side

$Z_2$ : Number of gear teeth on load gear

Servo motor encoder resolution:  $P_t = 4194304$  [pulse/rev]

$$\frac{CMX}{CDV} = \Delta L_0 \cdot \frac{P_t}{\Delta S} = \Delta L_0 \cdot \frac{P_t}{1/n \cdot P_b} = 10 \times 10^{-3} \cdot \frac{4194304}{1/2 \cdot 10} = \frac{4194304}{500} = \frac{1048576}{125}$$

Therefore, set  $CMX = 1048576$  and  $CDV = 125$ .

**Ex.**

Setting example for conveyors

The following shows the example where the conveyor is rotated at 0.01° per pulse.

Machine specifications

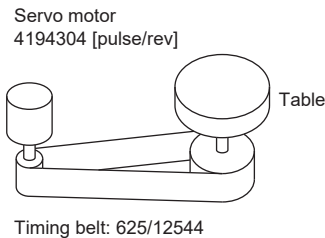

Table: 360°/rev

Reduction ratio:  $1/n = 625/12544$

Servo motor encoder resolution:  $P_t = 4194304$  [pulse/rev]

$$\frac{CMX}{CDV} = \Delta \theta \cdot \frac{P_t}{\Delta \theta} = 0.01 \cdot \frac{4194304}{625/12544 \cdot 360} = \frac{52613349376}{22500000} = \frac{1644167168}{703125}$$

Therefore, set  $CMX = 1644167168$  and  $CDV = 703125$ .

**Point**

If the servo motor rotates in one direction endlessly on systems such as an index table, the error in rounding off accumulates, resulting in the index position mismatch.

For example, even if 36000 pulses are input for the command in the previous example, the following result is obtained for the table. Therefore, a positioning to the same position cannot be performed on the table.

$$36000 \cdot \frac{1642991168}{703125} \cdot \frac{1}{4194304} \cdot \frac{625}{12544} \cdot 360 = 360.0000001^\circ$$

Reduce the value so that the calculated values before and after reduction are as close as possible.

## For profile position mode

### ■When setting "3" (pulse) in [Pr. PT01.2 Unit for position data]

Adjust [Pr. PA06 Electronic gear numerator] and [Pr. PA07 Electronic gear denominator] so that the travel distance set in the servo amplifier matches the travel distance on the machine. [Motor revolutions (Obj. 6091h: 01h)] and [Shaft revolutions (Obj. 6091h: 02h)] can also be used for the setting.

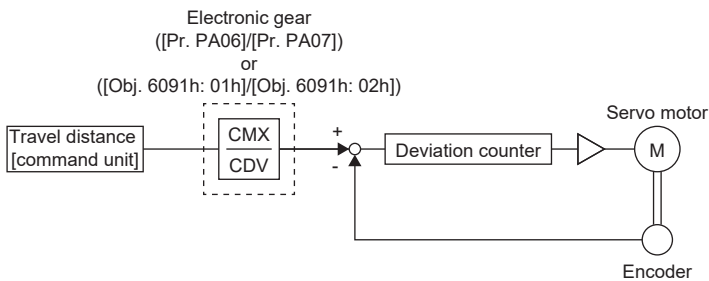

$P_t$ : Servo motor encoder resolution [pulse/rev]

$\Delta S$ : Travel distance per servo motor revolution [command unit/rev]

CMX: Electronic gear numerator

CDV: Electronic gear denominator

$$CMX/CDV = P_t/\Delta S$$

The following setting example shows how to calculate the electronic gear.

#### Point

To calculate the electronic gear, the following specification symbols are required.

Pb: Ball screw lead [mm]

1/n: Reduction ratio

$P_t$ : Servo motor encoder resolution [pulse/rev]

$\Delta S$ : Travel distance per servo motor revolution [mm/rev]

**Ex.**

Setting example for a ball screw

Machine specifications

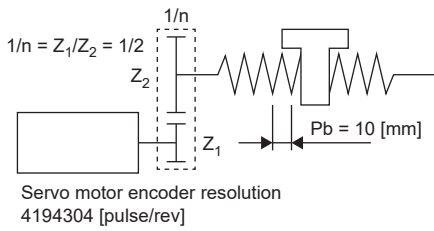
Ball screw lead  $P_b = 10$  [mm]Reduction ratio:  $1/n = Z_1/Z_2 = 1/2$  $Z_1$ : Number of gear teeth on servo motor side $Z_2$ : Number of gear teeth on load gearServo motor encoder resolution:  $P_t = 4194304$  [pulse/rev]

$$\frac{CMX}{CDV} = \frac{P_t}{\Delta S} = \frac{P_t}{1/n \cdot P_b \cdot \alpha^{*1}} = \frac{4194304}{1/2 \cdot 10 \cdot 1000} = \frac{4194304}{5000} = \frac{524288}{625}$$

Therefore, set  $CMX = 524288$  and  $CDV = 625$ .\*1 When the command unit is "pulse", convert as  $\alpha = 1$ .**Ex.**

Setting example for conveyors

Machine specifications

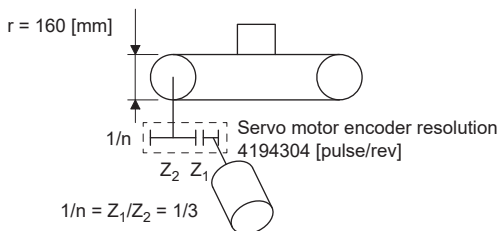
Pulley diameter:  $r = 160$  [mm]Reduction ratio:  $1/n = Z_1/Z_2 = 1/3$  $Z_1$ : Number of gear teeth on servo motor side $Z_2$ : Number of gear teeth on load gearServo motor encoder resolution:  $P_t = 4194304$  [pulse/rev]

$$\frac{CMX}{CDV} = \frac{P_t}{\Delta S} = \frac{P_t}{1/n \cdot r \cdot \pi \cdot \alpha^{*1}} = \frac{4194304}{1/3 \cdot 160 \cdot \pi \cdot 1000} = \frac{4194304}{167551.61} \approx \frac{524288}{20944}$$

Reduce  $CMX$  and  $CDV$  to the setting range or less and round off each value to the nearest whole number.Therefore, set  $CMX = 524288$  and  $CDV = 20944$ .\*1 When the command unit is "pulse", convert as  $\alpha = 1$ .

## ■When setting "2" (degree) in [Pr. PT01.2 Unit for position data]

Set the number of gear teeth on machine side with [Pr. PA06 Electronic gear numerator] and the number of gear teeth on servo motor side with [Pr. PA07 Electronic gear denominator]. [Motor revolutions (Obj. 6091h: 01h)] and [Shaft revolutions (Obj. 6091h: 02h)] can also be used for the setting.

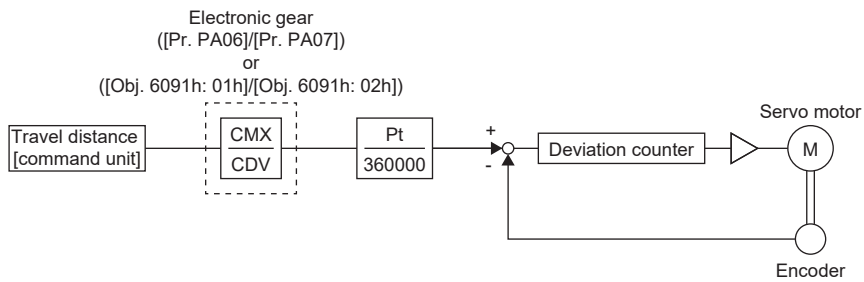

$P_t$ : Servo motor encoder resolution [pulse/rev]

CMX: Number of gear teeth on machine side

CDV: Number of gear teeth on servo motor side

### Ex.

If the number of gear teeth on machine side is 25 and the number of gear teeth on servo motor side is 11, set [Pr. PA06] to 25 and [Pr. PA07] to 11.

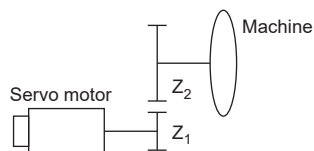

$P_t$  (servo motor resolution): 4194304 pulses/rev

$Z_1$ : Number of gear teeth on servo motor side

$Z_2$ : Number of gear teeth on machine side

$Z_1: Z_2 = 11: 25$



## For positioning mode (point table method)

### ■When setting "3" (pulse) in [Pr. PT01.2 Unit for position data]

Adjust [Pr. PA06 Electronic gear numerator] and [Pr. PA07 Electronic gear denominator] so that the travel distance set in the servo amplifier matches the travel distance on the machine. [Motor revolutions (Obj. 6091h: 01h)] and [Shaft revolutions (Obj. 6091h: 02h)] can also be used for the setting.

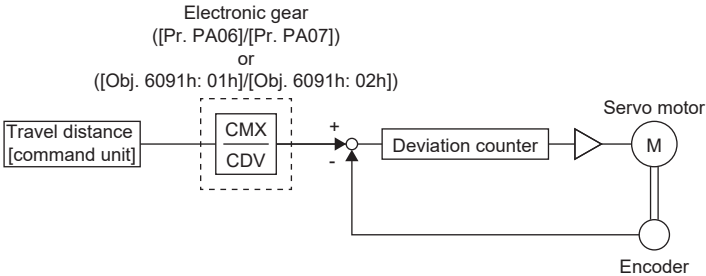

$P_t$ : Servo motor encoder resolution [pulse/rev]

$\Delta S$ : Travel distance per servo motor revolution [command unit/rev]

CMX: Electronic gear numerator

CDV: Electronic gear denominator

$$CMX/CDV = P_t/\Delta S$$

The following setting example shows how to calculate the electronic gear.

### Point

To calculate the electronic gear, the following specification symbols are required.

Pb: Ball screw lead [mm]

1/n: Reduction ratio

$P_t$ : Servo motor encoder resolution [pulse/rev]

$\Delta S$ : Travel distance per servo motor revolution [mm/rev]

### Ex.

Setting example for a ball screw

Machine specifications

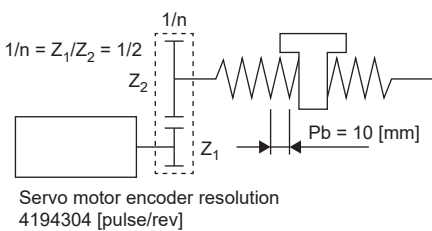

Ball screw lead  $P_b = 10$  [mm]

Reduction ratio:  $1/n = Z_1/Z_2 = 1/2$

$Z_1$ : Number of gear teeth on servo motor side

$Z_2$ : Number of gear teeth on load gear

Servo motor encoder resolution:  $P_t = 4194304$  [pulse/rev]

$$\frac{CMX}{CDV} = \frac{P_t}{\Delta S} = \frac{P_t}{1/n \cdot P_b \cdot \alpha^{*1}} = \frac{4194304}{1/2 \cdot 10 \cdot 1000} = \frac{4194304}{5000} = \frac{524288}{625}$$

Therefore, set  $CMX = 524288$  and  $CDV = 625$ .

\*1 When the command unit is "mm", convert as  $\alpha = 1000$ . When the command unit is "inch", convert as  $\alpha = 10000$ . When the command unit is "pulse", convert as  $\alpha = 1$ .

**Ex.**

Setting example for conveyors

Machine specifications

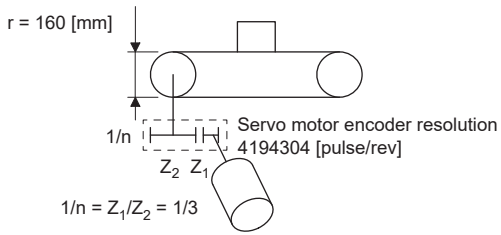
Pulley diameter:  $r = 160$  [mm]Reduction ratio:  $1/n = Z_1/Z_2 = 1/3$  $Z_1$ : Number of gear teeth on servo motor side $Z_2$ : Number of gear teeth on load gearServo motor encoder resolution:  $P_t = 4194304$  [pulse/rev]

$$\frac{CMX}{CDV} = \frac{P_t}{\Delta S} = \frac{P_t}{1/n \cdot r \cdot \pi \cdot \alpha^{*1}} = \frac{4194304}{1/3 \cdot 160 \cdot \pi \cdot 1000} = \frac{4194304}{167551.61} \approx \frac{524288}{20944}$$

Reduce CMX and CDV to the setting range or less and round off each value to the nearest whole number.

Therefore, set  $CMX = 524288$  and  $CDV = 20944$ .

\*1 When the command unit is "mm", convert as  $\alpha = 1000$ . When the command unit is "inch", convert as  $\alpha = 10000$ . When the command unit is "pulse", convert as  $\alpha = 1$ .

**■When setting "2" (degree) in [Pr. PT01.2 Unit for position data]**

Same as the profile positioning mode.

☞ Page 102 When setting "2" (degree) in [Pr. PT01.2 Unit for position data]

## 3.6 In-position range setting

The positioning completion status can be checked with INP (in-position). When the number of droop pulses falls within or less than the range set in servo parameters, INP (in-position) turns on. In addition, the range unit for the in-position and the conditions to turn on the in-position can be changed with servo parameters.

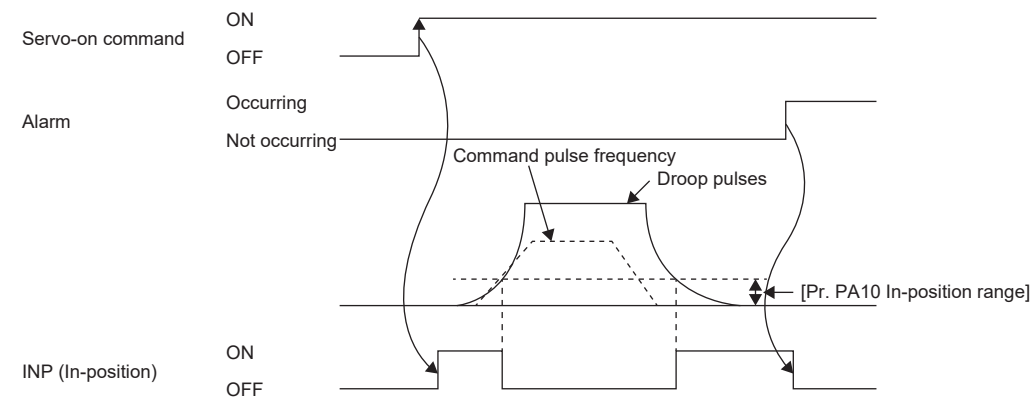

### Restriction

- INP is always off in the velocity mode, torque mode, and continuous operation to torque control mode.

### Precautions

- If the value of [Pr. PA10 In-position range] is set too large and the servo motor is operated at a low speed, INP may always be turned on. In this case, lower the setting value until the in-position signal stops being outputted.
- After the in-position has fallen to within or below the range, the in-position may turn on and off repeatedly if the droop pulses exceed the in-position range due to overshoot, vibration, or oscillation. In that case, take actions such as adjusting the gain and reviewing the operation pattern.

In the super trace control, droop pulses are near 0 during the servo motor control. Thus, the INP (In-position) signal may remain on. To prevent the INP (In-position) signal from remaining on, set the servo parameters as follows.

[Pr. PD13.2 INP output signal ON condition selection] = "1" (Within the in-position range and at the completion of command output)

## Setting method

The servo parameters related to the in-position setting are as follows.

Servo parameter	Symbol	Name	Outline
PA10	INP	In-position range	Set the in-position range. Initial value: 1600 [pulse]
PC06.0	*COP3	In-position range unit selection	Select a unit of the in-position range. 0: Command input pulse unit (initial value) 1: Servo motor encoder pulse unit
PD13.2	*DOP2	INP output signal ON condition selection	Select the in-position on condition. 0: Within the in-position range (initial value) 1: Within the in-position range and at the completion of command output 2: Within the in-position range, at the completion of command output, and at start signal off

## 3.7 Assigning I/O devices

External I/O signals for the servo amplifier can be assigned to I/O devices. Also, some signals can be assigned to the I/O devices without wiring (Automatic ON). In addition, if the external input signal causes chattering due to noise or other factors, the input filter can be used to suppress the effect of noise. The polarity of the DI pin can also be set. Configure settings in accordance with the system configuration.

### Restrictions

- "Automatic ON" can be set to some input devices, but not to other input devices. For the input devices to which "Automatic ON" can be set, refer to [Pr. PD01 Input signal automatic ON selection 1].

### Precautions

- If signals for machine protection such as the LSP (forward rotation stroke end) and LSN (reverse rotation stroke end) are set to "Automatic ON", protection by the servo amplifier is disabled. Therefore, ensure the safety for the entire system.
- If the polarity of the DI pin is set to "ON with 0 V input", the DI pin may turn on when the input circuit malfunctions. For this reason, it is not recommended to set the polarity of DI pins to which signals related to machine protection such as LSP (forward rotation stroke end) or LSN (reverse rotation stroke end) are assigned to "ON with 0 V input". If doing this setting, ensure the safety in the entire system.

## Setting method

### Servo parameter list

Input/output device selection, input signal automatic ON selection, input signal filter selection, and DI pin polarity selection settings can be performed directly with servo parameters.

#### ■MR-JET\_G\_

Servo parameter	Symbol	Name	Outline
PD01.2	*DIA1	Input signal automatic ON selection	Set LSP (Forward rotation stroke end) and LSN (Reverse rotation stroke end) to "Disabled" (use for an external input signal) or "Enabled" (Automatic on). Initial value: 0h (Use for an external input signal)
PD03.0-1	*DI1	Device selection	Assign any input device to the CN3-2 pin. Initial value: 0Ah (LSP (Forward rotation stroke end))
PD04.0-1	*DI2	Device selection	Assign any input device to the CN3-12 pin. Initial value: 0Bh (LSN (Reverse rotation stroke end))
PD05.0-1	*DI3	Device selection	Assign any input device to the CN3-19 pin. Initial value: 22h (DOG (Proximity dog))
PD07.0-1	*DO1	Device selection	Assign any output device to the CN3-13 pin. Initial value: 05h (MBR (Electromagnetic brake interlock))
PD08.0-1	*DO2	Device selection	Assign any output device to the CN3-9 pin. Initial value: 04h (INP (In-position))
PD09.0-1	*DO3	Device selection	Assign any output device to the CN3-15 pin. Initial value: 03h (ALM (Malfunction))
PD11.0	*DIF	Input signal filter selection	Select an input signal filter. Initial value: 7h (3.500 [ms])
PD60.0	*DIP	DI pin polarity selection	Select the DI pin polarity. Initial value: 0h (ON with 24 V input)
PT29.0	*TOP3	Device input polarity 1	Select the proximity dog input polarity. Initial value: 0h (Dog detection with off)

## 3.8 Regenerative option selection

If the generated regenerative power is too large and the regenerative capacity of the built-in regenerative resistor of the servo amplifier is insufficient, use the regenerative option to improve the regenerative capacity and consume the generated regenerative power. Set [Pr. PA02.0-1 Regenerative option selection] in accordance with the regenerative resistor in use.

Refer to "Regenerative option" in the following manual for the details of the regenerative options.

📖 MR-JET User's Manual (Hardware)

### Regenerative option

For the regenerative options, select the Mitsubishi Electric-specified regenerative resistor (MR-RB series).

3

#### Precautions

- To prevent a fire from occurring, use servo amplifiers with regenerative options in the specified combinations.

#### Setting method

Servo parameter	Symbol	Name	Outline
PA02.0-1	**REG	Regenerative option selection	Select a regenerative option. Incorrect setting may cause the regenerative option to burn. If a selected regenerative option is not for use with the servo amplifier, [AL. 037 Parameter error] occurs. 00: Regenerative option is not used. <ul style="list-style-type: none"><li>• No regenerative resistors are used on servo amplifiers with a capacity of 100 W/ 200 W.</li><li>• Built-in regenerative resistors are used on servo amplifiers with a capacity of 0.4 kW to 3 kW.</li></ul> 02: MR-RB032 03: MR-RB12 05: MR-RB30 06: MR-RB50 (A cooling fan is required.) 0D: MR-RB14 0E: MR-RB34

## 3.9 Alarm function

This function displays an alarm or warning when an error occurs during operation. When an alarm occurs, ALM (Malfunction) turns off and the servo motor stops. When a warning occurs, the servo motor may not stop for each warning number.

The stop method changes depending on whether the forced stop deceleration function is enabled or disabled. However, even if the forced stop deceleration function is enabled, the forced stop deceleration may not be effective and the servo motor may stop with the dynamic brake or other methods, depending on the alarm that has occurred.





After releasing the alarm or warning, resume the operation.

Refer to the following manual for the details of alarms and warnings.

 MR-JET User's Manual (Troubleshooting)



### Operation status at alarm occurrence

The following shows the status of servo amplifiers at alarm occurrence.

Status	Reference
The No. of the alarm that has occurred is shown on the 7-segment LED.	Refer to "Switch setting and display of the servo amplifier" in the User's Manual (Introduction).
When an alarm is detected during operation, the servo motor stops safely with the methods specified in accordance with the alarm No.	 Page 111 Stop method at occurrence of alarms/warnings
The occurred alarm is recorded as the alarm history. In the alarm history, the latest 16 alarms are recorded so that the types of alarms that have occurred in the past can be checked.	 Page 110 Alarm history
The conditions of the servo amplifier (such as the servo motor speed and droop pulses) before/after alarm occurrence are recorded with the drive recorder. This is useful for analyzing the cause of alarm occurrence.	 Page 160 Drive recorder
The ALM (Malfunction) of the output device signal is turned off.	—
The occurrence status of alarms and warnings can be monitored with MR Configurator2 or via a network.	 Page 110 Alarm history

### Operation status at warning occurrence

The following shows the status of servo amplifiers at a warning occurrence.

Status	Reference
The No. of the warning that has occurred is shown on the 7-segment LED.	Refer to "Switch setting and display of the servo amplifier" in the User's Manual (Introduction).
The operation is continued. However, when a warning that stops the servo motor occurs, the servo motor is stopped using the method determined by the warning.	 Page 111 Stop method at occurrence of alarms/warnings
Output device signals such as WNG (Warning) are turned off. In addition, at an occurrence of a warning to stop the servo motor, WNGSTOP (Motor stop warning) is turned off.	—
The occurrence status of alarms and warnings can be monitored with MR Configurator2 or via a network.	 Page 110 Alarm history

## Returning from an alarm

### Point

When an alarm occurs, remove its cause, check that the operation signal is not being inputted, ensure safety, and reset the alarm before restarting the operation.

Remove the cause of the alarm in accordance with the following manual.

 MR-JET User's Manual (Troubleshooting)

The following table shows how to deactivate the alarm.

Alarm deactivation	Explanation
Alarm reset	<ul style="list-style-type: none"><li>• Error reset command from the controller</li><li>• Click "Occurred Alarm Reset" in the "Alarm Display" window of MR Configurator2.</li></ul>
Communication reset	Disconnect/reconnect network.
Power cycling	<ul style="list-style-type: none"><li>• Cycle the power.</li><li>• Perform the software reset with commands from the controller and MR Configurator2.</li></ul>

## Returning from a warning

Some warnings are automatically canceled after the cause is removed, and other warnings are canceled after the cause is removed and the alarm is reset.

Remove the cause of the warning in accordance with the following manual.

 MR-JET User's Manual (Troubleshooting)

# Alarm history

The No. of the alarm that has occurred and the time at which it occurred can be recorded in the history. In the alarm history, the latest 16 alarms are recorded so that the types of alarms that have occurred in the past can be checked.

The alarm history can be cleared with [Pr. PC21.0 Alarm clear history selection] or on the alarm display of MR Configurator2.

## Method for checking with MR Configurator2

1. Connect the servo amplifier and a personal computer and select "Alarm Display" from "Diagnosis" in MR Configurator2.
2. The alarm display shows the alarm No., detail number, accumulated time after power-on, and actual time.

## Related objects

By using the objects, the alarm occurrence status and alarm history can be checked.

For details on the objects, refer to the User's Manual (Object Dictionary).

Index	Sub	Object	Name	Description	
2A00h	0	RECORD	Alarm history newest	The number of sub objects (7) is returned.	
	1	RECORD	Alarm number	The Alarm No. and detail number of the alarm that has occurred are returned. (32 bits)	
	2	RECORD	Alarm time (Hour)	The accumulated power-on time from time of factory shipment until an alarm occurrence is returned.	
	3	RECORD	Alarm2 No.	The value "0000h" is returned. (16 bits)	
	4	RECORD	Alarm time (second)	The alarm occurrence time is returned as a 32-bit integer (time passed from January 1, 1970, 0:00:00).	
	5	RECORD	Alarm time (nanosecond)	The digits after the ones indicating seconds in the alarm occurrence time are returned as a 32-bit integer.	
	6	RECORD	Alarm time (time zone)	The time zone at an alarm occurrence time is returned as a 32-bit integer.	
2A01h	7	RECORD	Alarm time (summer time)	The daylight saving time at an alarm occurrence time is returned as a 32-bit integer.	
	0	RECORD	Alarm history 1	The number of sub objects (7) is returned.	
	1	RECORD	Alarm number	The Alarm No. and detail number of the second alarm are returned. (32 bits)	
	2	RECORD	Alarm time (Hour)	The occurrence time of the second alarm is returned.	
	3	RECORD	Alarm2 No.	The value "0000h" is returned. (16 bits)	
	4	RECORD	Alarm time (second)	The occurrence time of the second alarm is returned as a 32-bit integer (time passed from January 1, 1970, 0:00:00).	
	5	RECORD	Alarm time (nanosecond)	In the second alarm occurrence time, the digits after the ones indicating seconds are returned as a 32-bit integer.	
:	6	RECORD	Alarm time (time zone)	The time zone at the second alarm occurrence time is returned as a 32-bit integer.	
	7	RECORD	Alarm time (summer time)	The daylight saving time at the second alarm occurrence time is returned as a 32-bit integer.	
	:	:	:	:	
	2A0Fh	0	RECORD	Alarm history 15	The number of sub objects (7) is returned.
		1	RECORD	Alarm number	The Alarm No. and detail number of the 16th alarm are returned. (32 bits)
		2	RECORD	Alarm time (Hour)	The occurrence time of the 16th alarm is returned.
		3	RECORD	Alarm2 No.	The value "0000h" is returned. (16 bits)
4		RECORD	Alarm time (second)	The occurrence time of the 16th alarm is returned as a 32-bit integer (time passed from January 1, 1970, 0:00:00).	
5		RECORD	Alarm time (nanosecond)	In the 16th alarm occurrence time, the digits after the ones indicating seconds are returned as a 32-bit integer.	
6		RECORD	Alarm time (time zone)	The time zone at the 16th alarm occurrence time is returned as a 32-bit integer.	
2A40h	7	RECORD	Alarm time (summer time)	The daylight saving time at the 16th alarm occurrence time is returned as a 32-bit integer.	
	—	VAR	Clear alarm history	Writing "1EA5h" enables the alarm history to be cleared.	
	2A41h	—	VAR	Current alarm	The number of the current alarm is returned. (32 bits)
	2A42h	—	VAR	Current alarm2	The number of the current alarm is returned. (16 bits)



Index	Sub	Object	Name	Description
2A43h	0	ARRAY	Point table error	The number of sub objects (2) is returned.
	1	ARRAY	Point table error No.	The point table error number is returned.
	2	ARRAY	Point table error factor	The point table error element is returned.
2A44h	—	VAR	Parameter error number	The number of the servo parameter errors are returned.
2A45h	0	ARRAY	Parameter error list	The number of sub objects (254) is returned.
	1	ARRAY	Parameter error list 1	When [AL. 037 Parameter error] occurs, the first servo parameter number that caused the alarm is returned.
	:	:	:	:
	254	ARRAY	Parameter error list 254	When [AL. 037 Parameter error] has occurred, the 254th servo parameter number that caused the alarm is returned.
2A46h	—	VAR	Reset alarm	Writing the value "1EA5h" resets the alarm.

## Stop method at occurrence of alarms/warnings

The servo motor stop methods at alarm occurrence are as follows: forced stop deceleration, stop with dynamic brake, and stop with electronic dynamic brake. For the servo motor stop method of each alarm number, refer to the following manual.

📖MR-JET User's Manual (Troubleshooting)

### Forced stop deceleration

The servo motor stops with the dynamic brake after forced stop deceleration.

### Stop with dynamic brake

The servo motor stops with the dynamic brake without forced stop deceleration. For a servo amplifier without the dynamic brake, the servo motor coasts.

### Stop with electronic dynamic brake

When a specific servo motor is used, the servo motor stops with the electronic dynamic brake without forced stop deceleration. When other than the specific servo motor is used, the servo motor stops with dynamic brake.

For the specific servo motors, refer to "Precautions relating to the dynamic brake characteristics" in the following manuals.

📖MR-JET User's Manual (Hardware)

## Timing chart for alarm occurrence

### Point

- In the torque mode and continuous operation to torque control mode, the forced stop deceleration function cannot be used.
- When the servo motor is at a stop due to an alarm or other factors, commands from the controller are not accepted. When restarting the operation in the cyclic synchronous position mode, confirm the position command.

## When using the forced stop deceleration function

### Point

- When [Pr. PA04.3 Forced stop deceleration function selection] is set to "2" (Forced stop deceleration function enabled).
- For a machine in which multiple axes are connected to each other, such as a tandem configuration, set [Pr. PA04.3] to "0" (Forced stop deceleration function disabled). If an alarm occurs with the forced stop deceleration function disabled, the servo motor will stop with dynamic brake.

### Stopping with forced stop deceleration function

When an alarm is detected, the servo motor stops using forced stop deceleration and MBR and ALM are turned off.

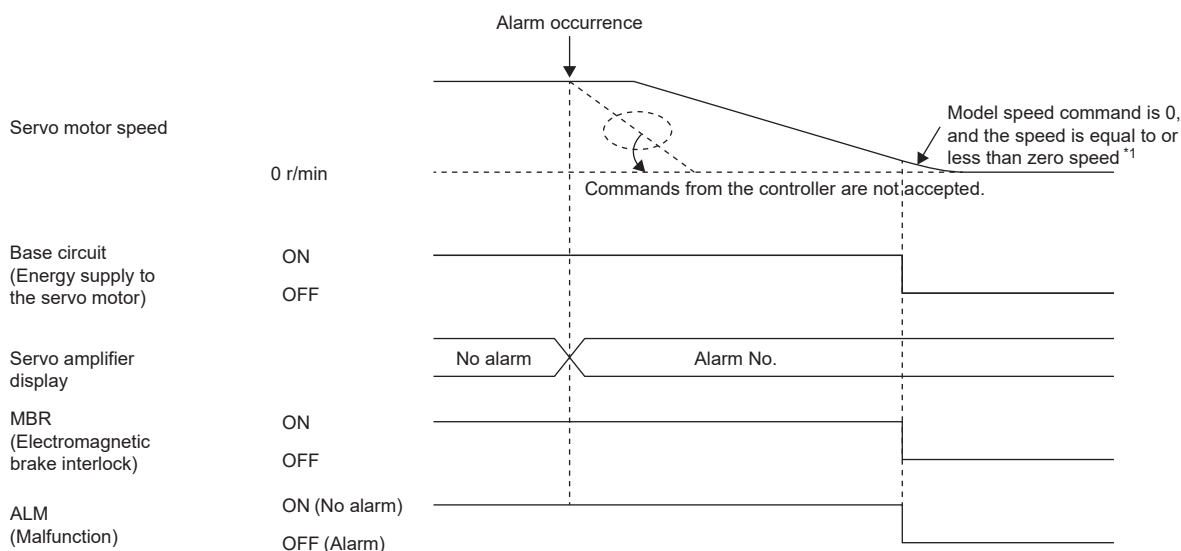

\*1 The model speed command is a speed command generated in the servo amplifier for forced stop deceleration of the servo motor.

### ■ Stopping with dynamic brake

When an alarm is detected, MRB and ALM are turned off, and the servo motor stops using the dynamic brake and electromagnetic brake.

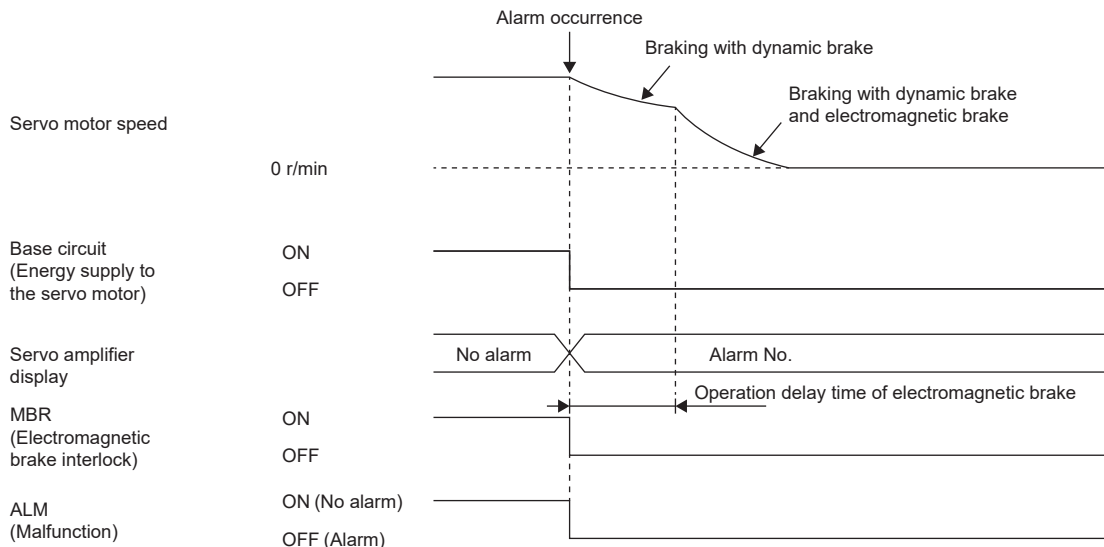

### ■ When network communication shut-off or communication time-out has occurred

The dynamic brake may operate depending on the communication shut-off status.

Communication shut-off or communication time-out may not be detected, depending on the network. For details, refer to the User's Manual (Communication Function).

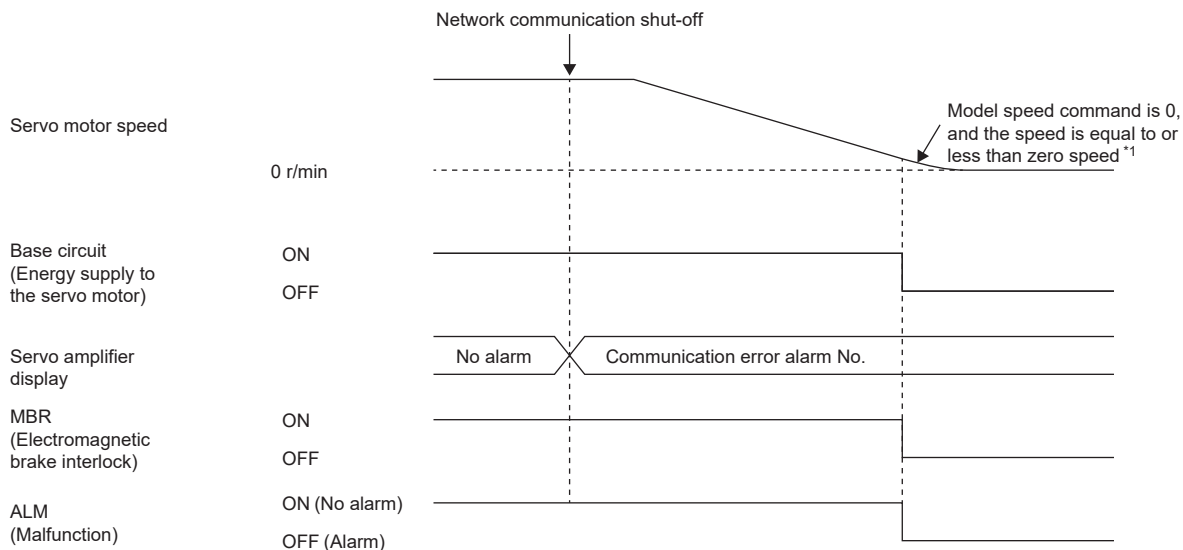

\*1 The model speed command is a speed command generated in the servo amplifier for forced stop deceleration of the servo motor.

### When the forced stop deceleration function is not used

**Point**

When [Pr. PA04.3 Forced stop deceleration function selection] is set to "0" (Forced stop deceleration function disabled).

The operation status during an alarm occurrence or network communication shut-off is the same as in the stop method with dynamic brake shown in this section.

## 3.10 Forced stop deceleration function

Forced stop deceleration function is a function that decelerates the servo motor with commands when EM2 (Forced stop 2) is turned off, and stops the servo motor with the dynamic brake when the servo motor rotates at the zero speed or less. This enables the servo motor to stop with shorter coasting distance than stopping only with dynamic brake. When the forced stop deceleration function is activated, [AL. 0E6 Servo forced stop warning] is shown in the display. The amount of time to reach 0 [r/min] from the rated speed and the range of zero speed detection can be set with the servo parameters.

The forced stop deceleration function can even be operated through commands from the network by using Quick stop.

 Page 132 Quick stop

### Restriction

- In the torque mode and continuous operation to torque control mode, the forced stop deceleration function cannot be used.

### Precautions

- The forced stop deceleration does not operate on alarms that are not subject to the forced stop deceleration function.
- When the network communication is shut off, forced stop deceleration operates. Refer to the following.
  -  Page 113 When network communication shut-off or communication time-out has occurred
- Disable the forced stop deceleration function for a machine in which multiple axes are connected to each other, such as a tandem configuration. If an alarm occurs with the forced stop deceleration function disabled, the servo motor will stop with dynamic brake.
- Turn off EM2 (Forced stop 2), then turn off the servo-on command (from controller) and ready-on command (from controller). If the ready-on command (from controller) is turned off before EM2 is turned off, the base circuit shut-off delay and vertical axis freefall prevention do not function.
- During normal operation, do not use EM2 (Forced stop 2) to alternate between stop and drive. Doing so may shorten the service life of the servo amplifier.
- If an alarm that operates the dynamic brake occurs during forced stop deceleration, the braking distance until the servo motor stops will be longer than the braking distance when the forced stop deceleration is properly operated.
- To prevent a malfunction in the dynamic brake or fire, do not drive the servo motor with an external force when the power is shut off or an alarm or other factors trigger to activate the dynamic brake.

### Setting method

Set [Pr. PA04.3 Forced stop deceleration function selection] to enable/disable the forced stop deceleration function. Setting [Pr. PA04.3] to "2" (Forced stop deceleration function enabled) operates the forced stop deceleration function when EM2 (Forced stop 2) is turned off. In addition, set the level of ZSP (Zero speed detection) and the amount of time to reach 0 [r/min] from the rated speed by using [Pr. PC07 Zero speed] and [Pr. PC24 Deceleration time constant at forced stop].

Servo parameter	Symbol	Name	Outline
PA04.3	*AOP1	Forced stop deceleration function selection	Set "Forced stop deceleration function" to enabled/disabled. 0: Forced stop deceleration function disabled (EM1 is used) 2: Forced stop deceleration function enabled (EM2 is used) (initial value)
PC07	ZSP	Zero speed	Set the level of ZSP (Zero speed detection). Initial value: 50 [r/min], [mm/s]
PC24	RSBR	Deceleration time constant at forced stop	Set the deceleration time constant at forced stop. Initial value: 100 [ms]

# Timing chart

When EM2 (Forced stop 2) is turned off, the servo motor decelerates in accordance with the value of [Pr. PC24 Deceleration time constant at forced stop]. Once the servo motor speed becomes below [Pr. PC07 Zero speed] after completion of the deceleration command, the base circuit will be shut off and the dynamic brake will activate.

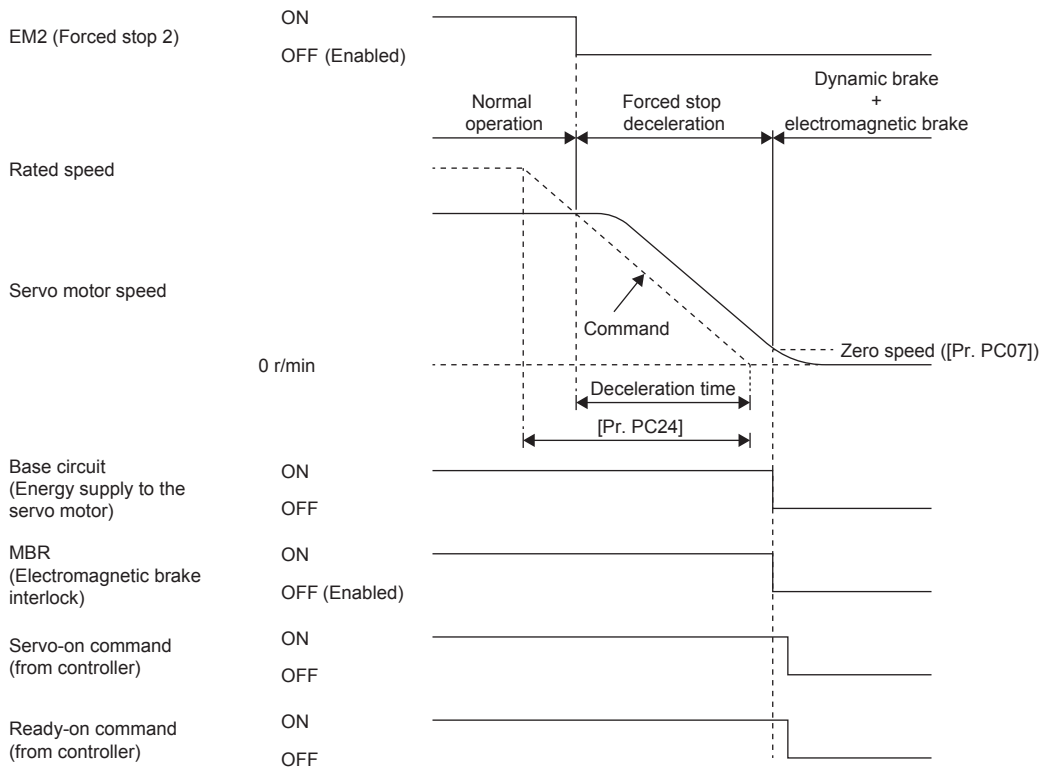

## 3.11 Electromagnetic brake interlock function

---

For servo motors with an electromagnetic brake, this function activates the electromagnetic brake at servo-off, upon an error occurrence, and at other necessary times. By using the electromagnetic brake, the position can be maintained so that the servo motor will not move due to external force. When this function is used on a system with a vertical axis, a drop in vertical lift applications can be prevented.

### Base circuit shut-off delay time function

---

The base circuit shut-off delay time function is used in the following cases to prevent the vertical axis from dropping due to delayed electromagnetic brake operations:

- Under servo-off command
- At forced stop (EM2 is turned off)
- At alarm occurrence
- At network communication shut-off occurrence

The delay time used between the MBR (Electromagnetic brake interlock) shut-off and the base circuit shut-off can be set in servo parameters.

#### **Restriction**

- This function does not operate on alarms that are not subject to the forced stop deceleration function.
  - When the forced stop deceleration function is disabled, this function does not operate at forced stop (EM2 is turned off) or upon an alarm occurrence or network communication shut-off.
- 

#### Precautions

- This function does not operate when the ready-off command is input. To use this function, set [Pr. PC41.3 Electromagnetic brake sequence output function selection] to "1" (Switched On/Ready to switch on/Switch on disabled).

## Setting method

### Point

For specifications such as the power supply capacity and operation delay time of the electromagnetic brake, refer to "Characteristics of electromagnetic brake" in the following manual.

 Rotary Servo Motor User's Manual (For MR-JET)

For a selection example of a surge absorber for the electromagnetic brake, refer to "Characteristics of electromagnetic brake" in the following manual.

 Rotary Servo Motor User's Manual (For MR-JET)

When the electromagnetic brake is placed in servo-off status, MBR and the base circuit both shut off following a short delay. Set this delay time (Tb) in [Pr. PC02 Electromagnetic brake sequence output]. Refer to the following.

 Page 118 When using the forced stop deceleration function

Servo parameter	Symbol	Name	Outline
PC02	MBR	Electromagnetic brake sequence output	Set the delay time used between the MBR (Electromagnetic brake interlock) shut-off and the base circuit shut-off. Initial value: 0 [ms]
PD07.0-1	*DO1	Device selection	Select a function of the output device pin.
PD08.0-1	*DO2	Device selection	
PD09.0-1	*DO3	Device selection	

# Timing chart

## When using the forced stop deceleration function

### Point

When [Pr. PA04.3 Forced stop deceleration function selection] is set to "2" (Forced stop deceleration function enabled).

### Turning the servo-on command on/off

When the servo-on command is turned off, the servo lock is released after  $T_b$  [ms], following which the servo motor coasts. If the electromagnetic brake is enabled during servo-lock, its service life may be shortened. Therefore, when using this function with the vertical axis, set  $T_b$  to about 1.5 times of the minimum delay time where the moving part will not drop down.

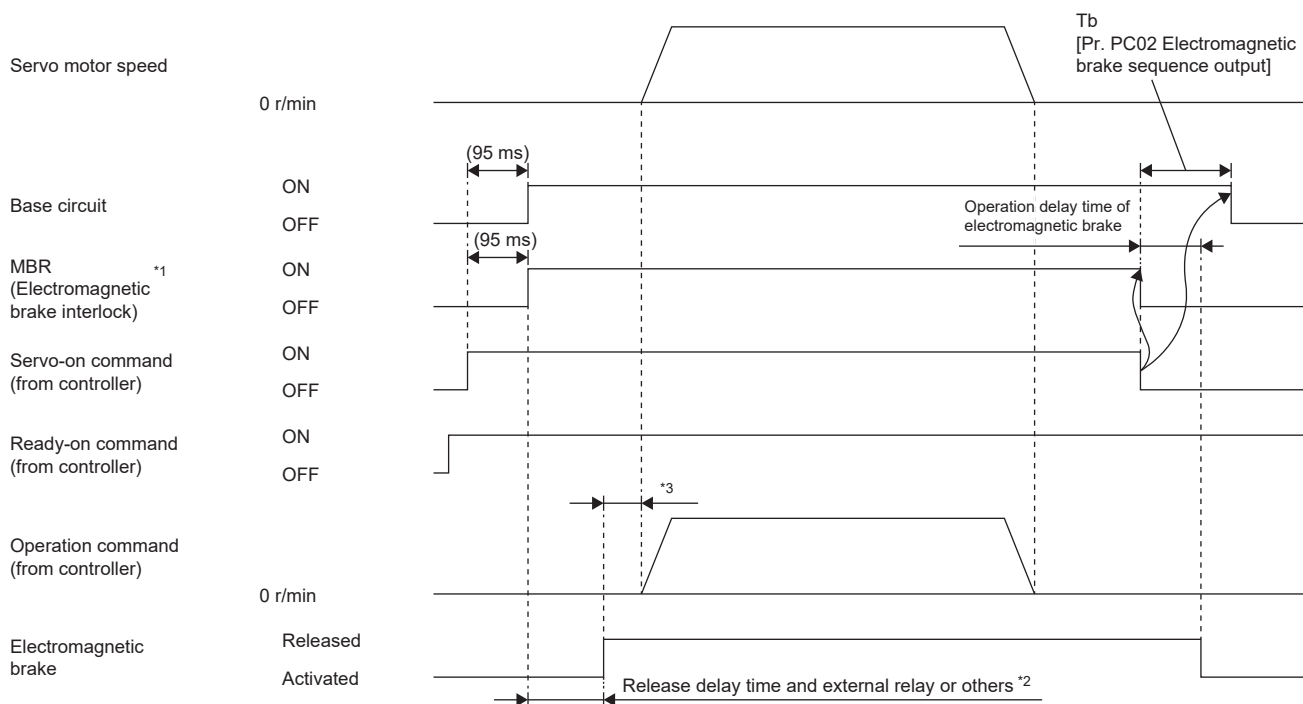

\*1 ON: Electromagnetic brake is not activated  
 OFF: Electromagnetic brake is activated

\*2 The electromagnetic brake is released after the release delay time of the electromagnetic brake and the operation time of external circuit relay or other operations. For the release delay time of electromagnetic brake, refer to "Characteristics of electromagnetic brake" in the following manual.

Rotary Servo Motor User's Manual (For MR-JET)

\*3 Give an operation command from the controller after the electromagnetic brake is released.



## ■Turning the quick stop command (from controller) or EM2 (Forced stop 2) on/off

### Point

In the torque mode and continuous operation to torque control mode, the forced stop deceleration function cannot be used.

Turn off the quick stop command (from controller) or EM2 (Forced stop 2), then turn off the servo-on command (from controller) and ready-on command (from controller). If the ready-on command (from controller) is turned off before the quick stop command (from controller) or EM2 is turned off, Tb [Pr. PC02 Electromagnetic brake sequence output] does not function.

MBR is turned off after the servo motor stops through forced stop deceleration, then the base circuit is turned off after the base circuit shut-off delay time.

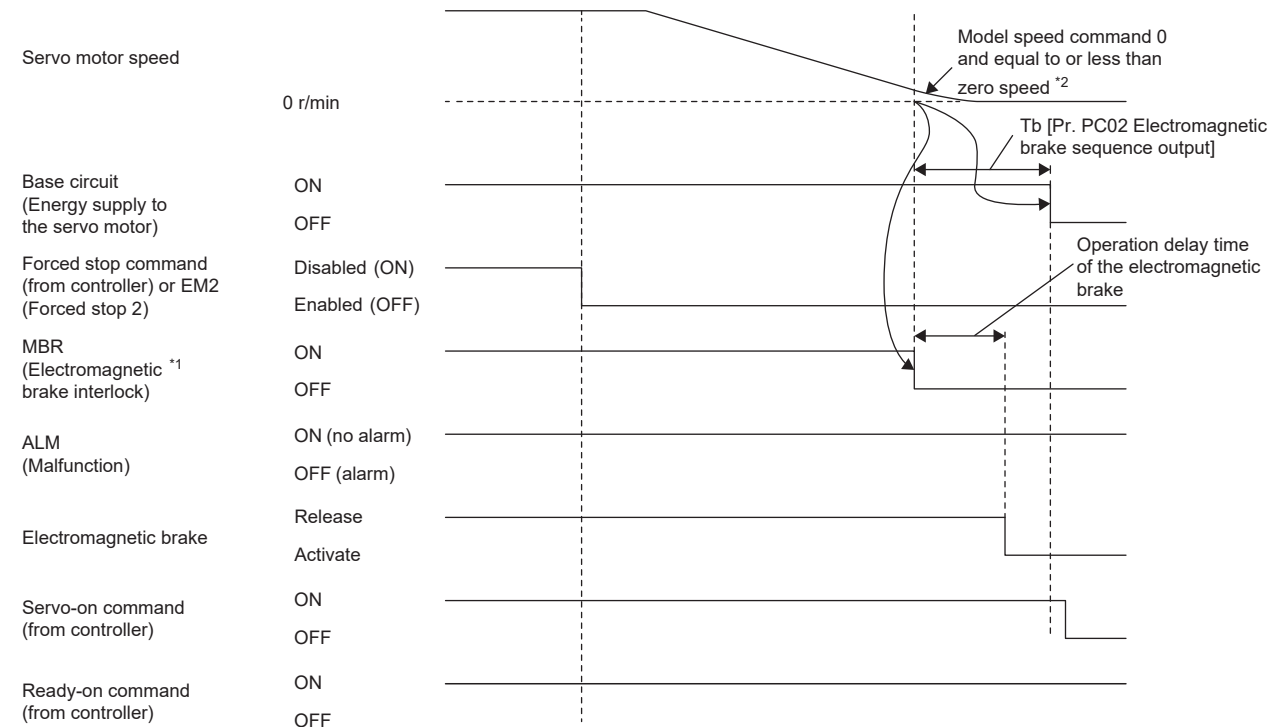

\*1 ON: Electromagnetic brake is not activated  
OFF: Electromagnetic brake is activated

\*2 The model speed command is a speed command generated in the servo amplifier for forced stop deceleration of the servo motor.

## ■ Alarm occurrence

- When forced stop deceleration is enabled

MBR is turned off after the servo motor stops through forced stop deceleration, then the base circuit and ALM are turned off after the base circuit shut-off delay time.

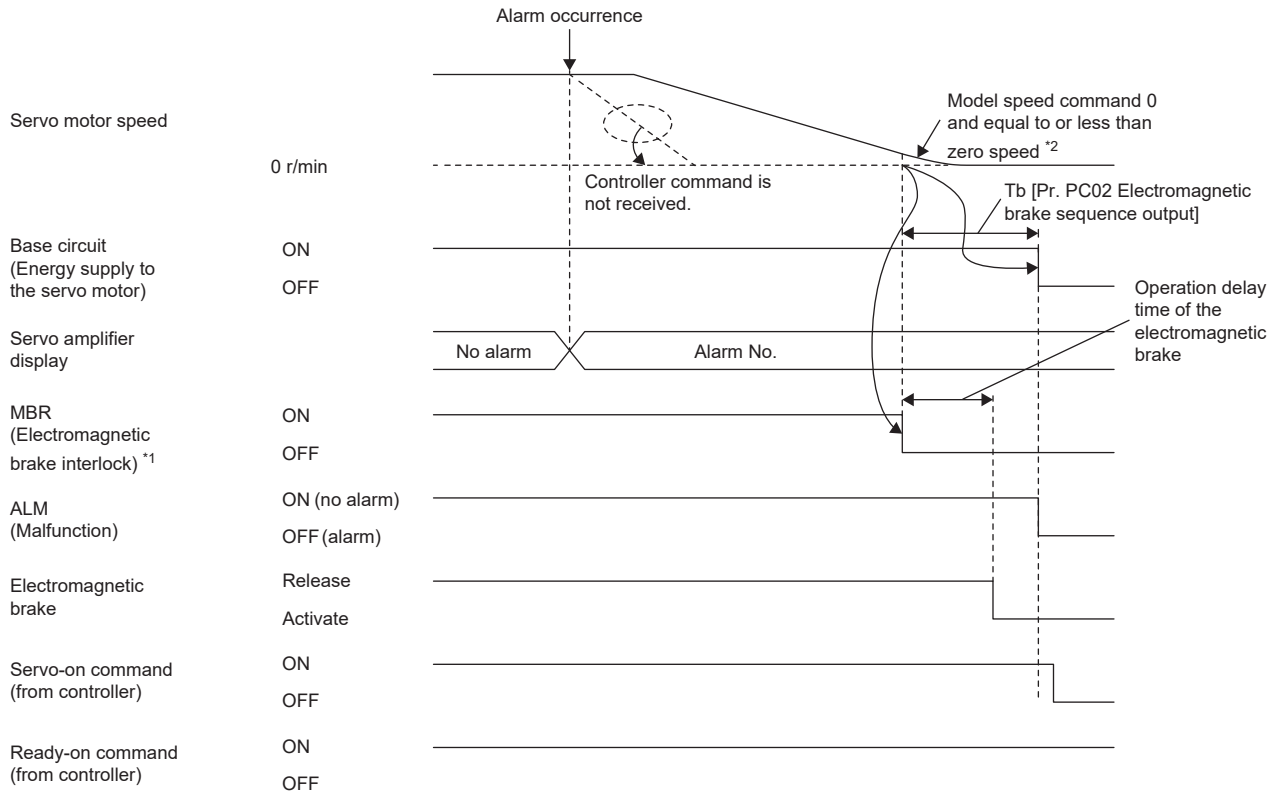

\*1 ON: Electromagnetic brake is not activated

OFF: Electromagnetic brake is activated

\*2 The model speed command is a speed command generated in the servo amplifier for forced stop deceleration of the servo motor.

- When forced stop deceleration becomes disabled

The servo motor stops using the same method as with the dynamic brake.

☞ Page 113 Stopping with dynamic brake

- When network communication shut-off has occurred

MBR is turned off after the servo motor stops through forced stop deceleration, then the base circuit and ALM are turned off after the base circuit shut-off delay time. The dynamic brake may operate depending on the communication shut-off status.

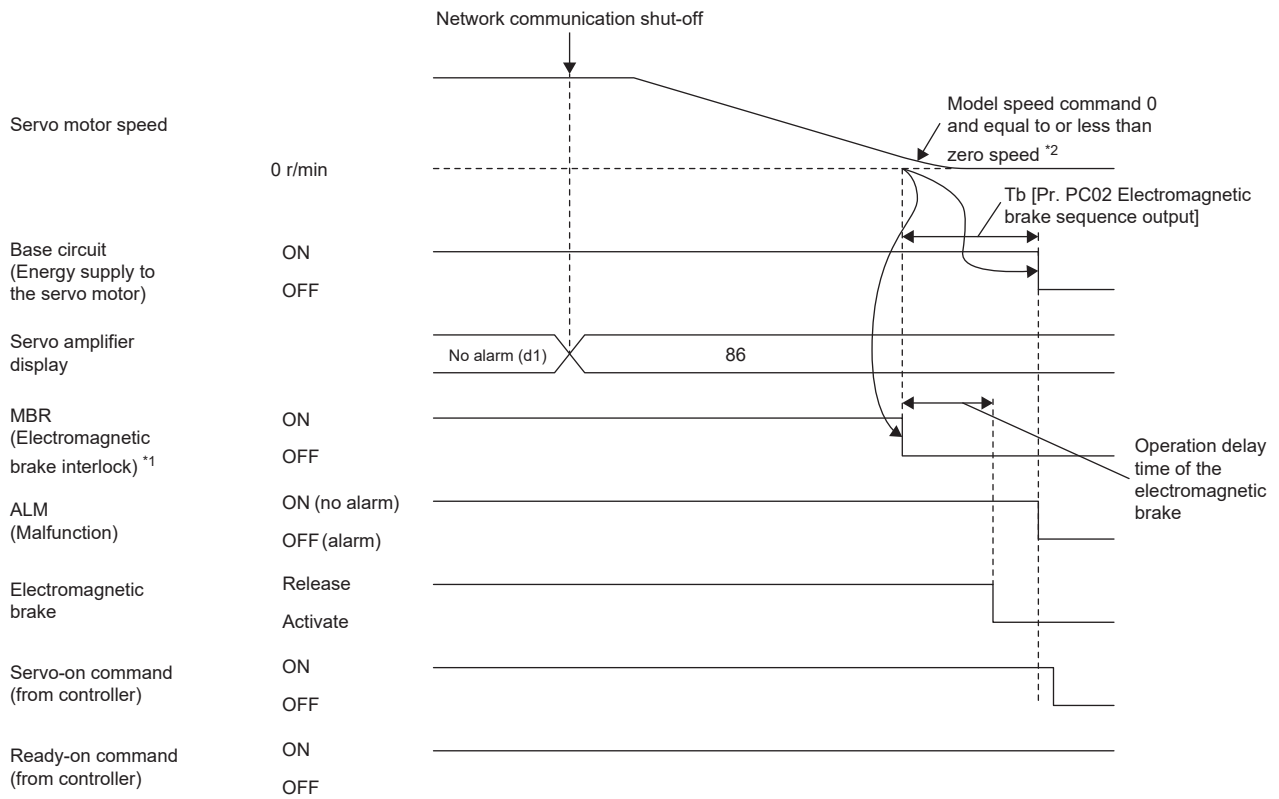

\*1 ON: Electromagnetic brake is not activated  
 OFF: Electromagnetic brake is activated

\*2 The model speed command is a speed command generated in the servo amplifier for forced stop deceleration of the servo motor.

## ■ Power off

When the base circuit is turned off, the servo motor is stopped with the dynamic brake and electromagnetic brake.

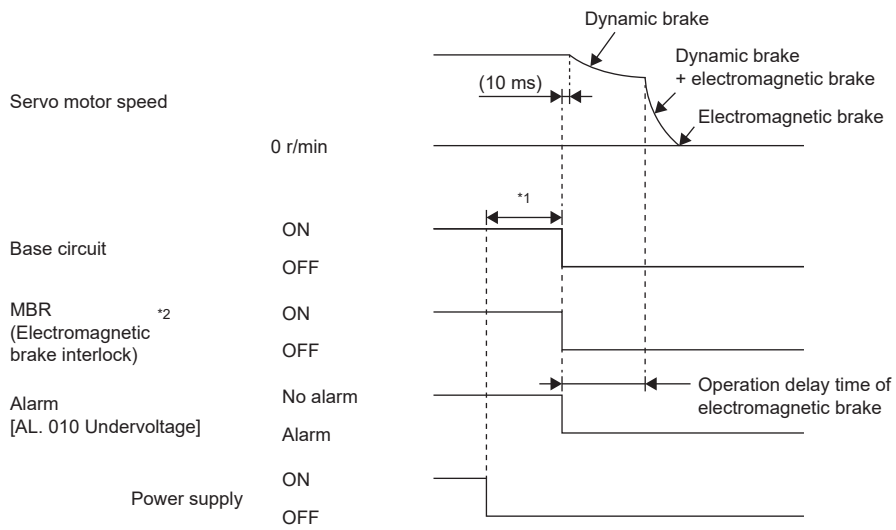

\*1 The length of time varies depending on the operation status.

\*2 ON: Electromagnetic brake is not activated

OFF: Electromagnetic brake is activated

## ■ Ready-off command from controller

After the base circuit is turned off with the ready-off command, the servo motor is stopped with the dynamic brake and electromagnetic brake.

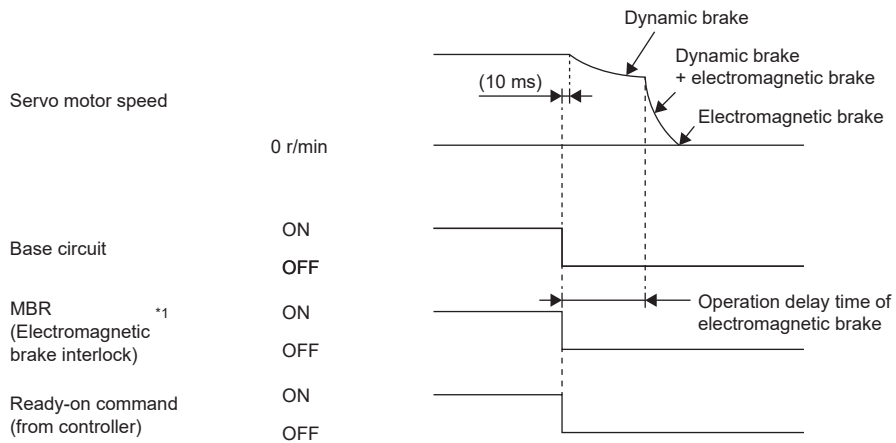

\*1 ON: Electromagnetic brake is not activated  
 OFF: Electromagnetic brake is activated

## When the forced stop deceleration function is not used

### Point

When [Pr. PA04.3 Forced stop deceleration function selection] is set to "0" (Forced stop deceleration function disabled).

### Turning the servo-on command on/off

Page 118 Turning the servo-on command on/off

### Turning the quick stop command (from controller) or EM1 (Forced stop 1) on/off

When the off command is inputted, the servo motor is stopped with the dynamic brake and electromagnetic brake.

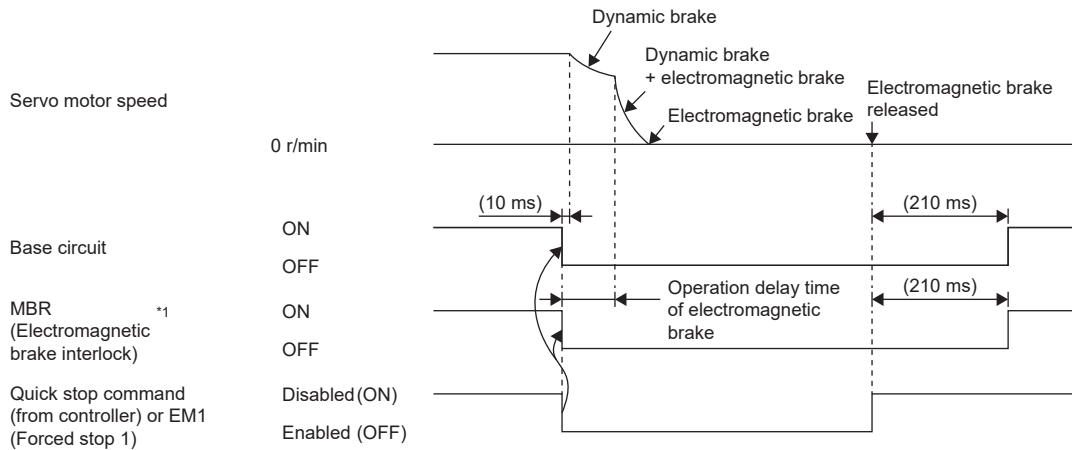

\*1 ON: Electromagnetic brake is not activated  
OFF: Electromagnetic brake is activated

### Alarm occurrence

When an alarm occurs, the servo motor stops using the same method as with the dynamic brake.

Page 113 Stopping with dynamic brake

### Power off

Page 122 Power off

### Ready-off command from controller

Page 123 Ready-off command from controller

## 3.12 Vertical axis freefall prevention function

When the servo motor is used to operate a vertical axis, the servo motor electromagnetic brake and the base circuit shut-off delay time function can be used to prevent the vertical axis from dropping at forced stop; however, the axis may fall by several  $\mu\text{m}$  due to mechanical clearance of the servo motor electromagnetic brake. The vertical axis freefall prevention function is a function that is used to prevent fall-based damage to the machine by pulling up the shaft slightly when such a risk exists.

### Point

- Once each of the servo parameters is set, this function operates when the servo motor speed is at or below the zero speed, the EM2 (forced stop 2) is off, an alarm occurs, or the network communication shuts off.

### Restriction

- This function does not operate on alarms that are not subject to the forced stop deceleration function.
- This function can be used in the position mode, point table mode, homing mode, and JOG operation mode.

### Precautions

- Refer to the setting method shown in this section, and check if each servo parameter has been set. If not set, this function does not operate.
- Check that the forced stop deceleration function is enabled. If disabled, this function does not operate.

## Setting method

Set the freefall prevention compensation amount with [Pr. PC31 Vertical axis freefall prevention compensation amount]. After that, turn off the EM2 (Forced stop 2) during a servo motor stop, then adjust the base circuit shut-off delay time in [Pr. PC02 Electromagnetic brake sequence output] in accordance with the travel distance ([Pr. PC31]). Adjust the time considering the freefall prevention compensation amount by checking the servo motor speed, torque ripple, and other areas.

Servo parameter	Symbol	Name	Outline
PC02	MBR	Electromagnetic brake sequence output	Set the base circuit shut-off delay time. Initial value: 0 [ms]
PC31	RSUP1	Vertical axis freefall prevention compensation amount	Set the freefall prevention compensation amount. Initial value: 0 [0.0001 rev], [0.01 mm]

# Timing chart

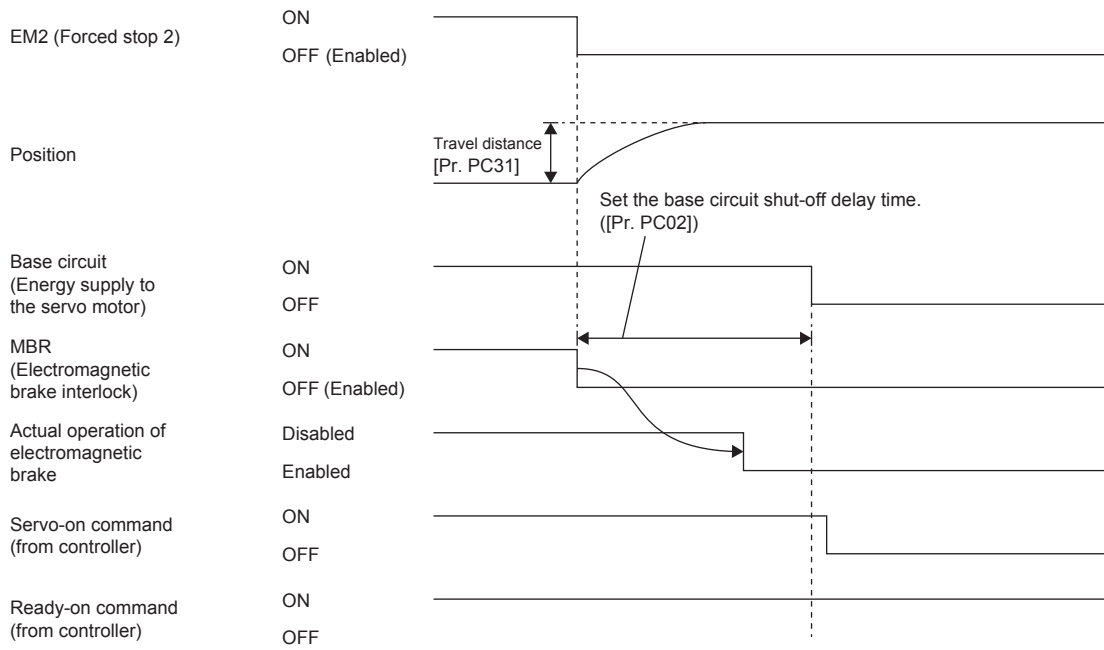



# 3.13 Acceleration/deceleration function

This function enables smooth acceleration/deceleration. The following methods are available for the acceleration/deceleration function.

Item	Explanation	Reference
Acceleration/deceleration time constant method	This is a method for performing acceleration/deceleration in accordance with the specified acceleration/deceleration time constants [ms]. Set [Pr. PT01.1 Speed/acceleration/deceleration unit selection] to "0" to enable this method.	<a href="#">Page 127 Acceleration/deceleration time constant</a> <a href="#">Page 129 S-pattern acceleration/deceleration time constant</a>
Acceleration/deceleration method	This is a method for performing acceleration/deceleration in accordance with the specified acceleration/deceleration [command unit/s <sup>2</sup> ]. Using this method together with S-pattern acceleration/deceleration time constant enables smoother acceleration/deceleration. Set [Pr. PT01.1 Speed/acceleration/deceleration unit selection] to "1" to enable this method.	<a href="#">Page 130 Acceleration/deceleration</a> <a href="#">Page 129 S-pattern acceleration/deceleration time constant</a>

## Acceleration/deceleration time constant

The acceleration/deceleration time constant is the period of time taken to reach the rated speed from 0 [r/min] (0 [mm/s]) or to reach 0 [r/min] (0 [mm/s]) from the rated speed for the commands or limits. The control mode influences whether the acceleration/deceleration time constant is set in each control mode.

**Ex.**

For a servo motor with a rated speed of 3000 [r/min], set 3 [s] to accelerate from 0 [r/min] to 1000 [r/min] in 1 [s].

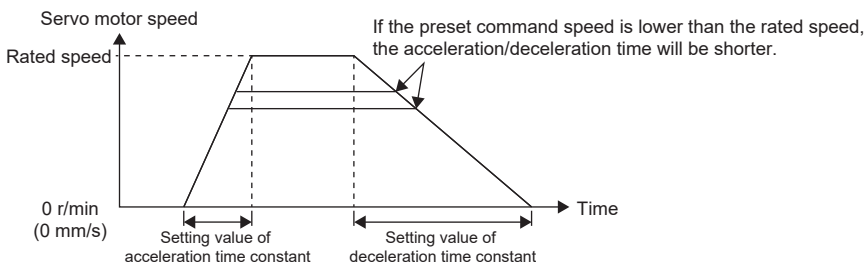



### Precautions

- Refer to the different servo parameters, point tables, and objects in each control mode.

## Setting method

The setting method varies for each control mode. Refer to the following table. In addition, the deceleration time constant of the forced stop deceleration function can be set with [Pr. PC24 Deceleration time constant at forced stop].

 Page 114 Forced stop deceleration function

Control mode	Symbol	Description
Cyclic synchronous position mode	csp	Determined by the commands from the controller.
Cyclic synchronous velocity mode	csv	Set according to the manual of the controller to be used.
Cyclic synchronous torque mode	cst	
Profile position mode *1	pp	Can be set with [Profile acceleration (Obj. 6083h)] and [Profile deceleration (Obj. 6084h)]. Can also be set with [Pr. PT49 Speed acceleration time constant] and [Pr. PT50 Speed deceleration time constant].
Profile velocity mode *1	pv	Can be set with [Profile acceleration (Obj. 6083h)] and [Profile deceleration (Obj. 6084h)]. Can also be set with [Pr. PT49 Speed acceleration time constant] and [Pr. PT50 Speed deceleration time constant].
Profile torque mode *1	tq	The amount of torque change can be set with [Torque slope (Obj. 6087h)].
Homing mode	hm	This mode can be set with [Homing acceleration (Obj. 609Ah)].  Page 44 Homing mode (hm)
Point table mode *2	pt	 Page 250 How to Set Point Table
JOG operation mode *2	jg	 Page 246 JOG operation mode (jg)

\*1 Available on servo amplifiers with firmware version B2 or later.

\*2 Available on servo amplifiers with firmware version B8 or later.

## S-pattern acceleration/deceleration time constant

This time constant is available on servo amplifiers with firmware version B2 or later.

Setting S-pattern acceleration/deceleration time constant enables smooth start/stop of the servo motor.

This function operates when [Pr. PT51 S-pattern acceleration/deceleration time constants] is set.

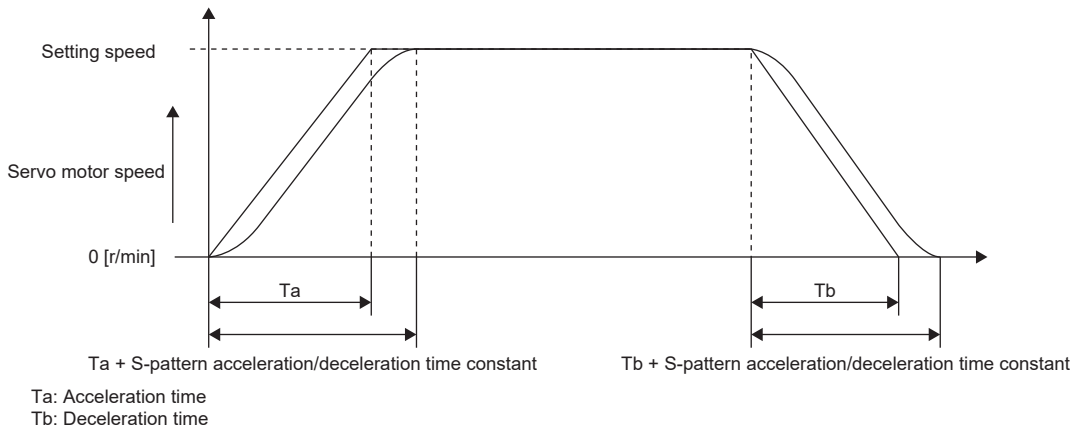

### Restriction

- This function is enabled in the profile position mode, profile velocity mode, point table mode, and JOG operation mode.
- This function is disabled when [Pr. PT51] is set to "0".
- In the point table mode and JOG operation mode, the time from start to output of MEND (traveling completion) becomes longer by the set amount of S-pattern acceleration/deceleration time constant.
- This function is disabled in the homing mode.
- If the S-pattern acceleration/deceleration time constants are set to values of 1000 ms or more in the profile position mode, point table mode, and JOG operation mode, the value is clamped to 1000 ms.

### Precautions

- If the setting of acceleration or deceleration time is too long, the timing error may occur on the arc part against the setting of the S-pattern acceleration/deceleration time constant.
- If the S-pattern acceleration/deceleration time constant is set longer than the constant speed time, the speed may not reach the command speed.
- The upper time limit on the arc part of the S-pattern acceleration/deceleration is limited by the acceleration time and deceleration time. Refer to [Pr. PT51] for details.

### Setting method

Servo parameter	Symbol	Name	Outline
PT51	STC	S-pattern acceleration/ deceleration time constant	Set the S-pattern acceleration/deceleration time constant. Initial value: 0 [ms]

# Acceleration/deceleration

Acceleration/deceleration is performed in accordance with the specified acceleration/deceleration [command unit/s<sup>2</sup>]. Unlike the acceleration/deceleration time constants, acceleration/deceleration can be performed independent of the rated speed of the servo motor.

The control mode influences whether the acceleration/deceleration is set in the control mode.

## Setting example

To accelerate at 0.5 [s] from 0 [command unit/s] to 1500 [command unit/s], set 3000 [command unit/s<sup>2</sup>] for the acceleration.  
To decelerate at 2 [s] from 1500 [command unit/s] to 0 [command unit/s], set 750 [command unit/s<sup>2</sup>] for the deceleration.

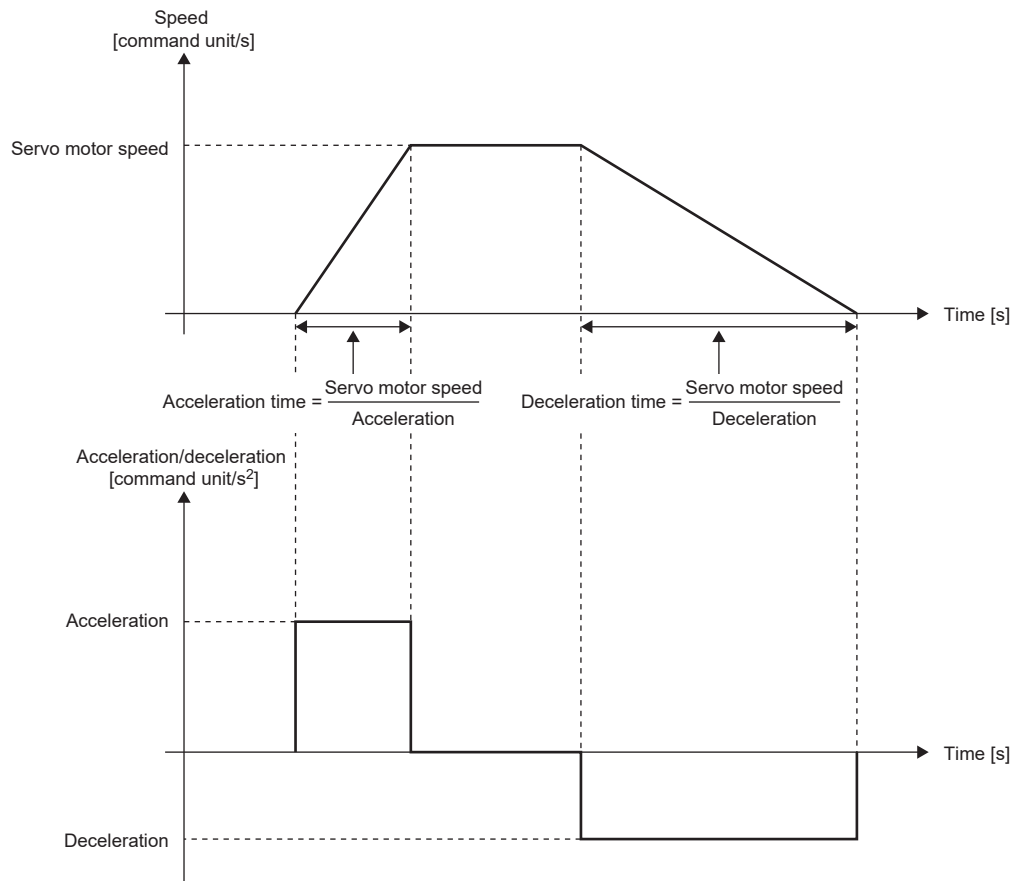

## Precautions

- The servo parameter for setting the acceleration/deceleration data varies depending on the unit selected in [Pr. PT01.1 Speed/acceleration/deceleration unit selection]. However, the same object is used for setting the acceleration/deceleration data regardless of the unit selected. Refer to [Pr. PT01.1] for details. For the precautions for each acceleration/deceleration data, refer to the setting servo parameters, point table, and objects.

## Setting method

Select an acceleration/deceleration unit in [Pr. PT01.1 Speed/acceleration/deceleration unit selection]. When [Pr. PT01.1] is set to "1" (command unit/s<sup>2</sup>), select the command unit with [Pr. PT01.2 Unit for position data].

Servo parameter	Symbol	Name	Outline
PT01.1	**CTY	Speed/acceleration/deceleration unit selection	Select an acceleration/deceleration unit. 0: ms 1: Command unit/s <sup>2</sup>
PT01.2		Unit for position data	Select the unit for position data. 0: mm 1: inch 2: degree 3: pulse

## Relevant acceleration/deceleration data

☞ Page 96 Relevant speed data and acceleration/deceleration data

## 3.14 Quick stop

---

With Quick stop defined in CiA 402, the servo motor can be stopped by the forced stop deceleration. For details of the forced stop deceleration, refer to the following.

 Page 114 Forced stop deceleration function

When the Quick stop command in [Controlword (Obj. 6040h)] is turned off, the servo motor decelerates to a stop in accordance with the setting of [Quick stop option code (Obj. 605Ah)], following which the status changes to "Switch On Disabled" (servo-off) or "Quick Stop Active" (servo-on maintained).

### Point

- When canceling Quick stop in the cyclic synchronous position mode (csp), update [Target position (Obj. 607Ah)] and [Position offset (Obj. 60B0h)] to [Position actual value (Obj. 6064h)]. If Quick stop is canceled without performing position follow-up, unexpected movements such as sudden acceleration of the servo motor may occur.
- When [Pr. PA04.3 Forced stop deceleration function selection] is set to "0" (forced stop deceleration function disabled), the servo motor stops with the dynamic brake regardless of the setting value of [Quick stop option code (Obj. 605Ah)].
- The Quick stop command is accepted only when the PDS state transition is in the "Operation Enabled" state.

### Restriction

- This function can be used in the cyclic synchronous mode (csp/csv/cst), profile mode (pp/pv/tq), point table mode (pt), JOG operation mode (jg), and homing mode (hm).
  - In the torque mode or continuous operation to torque control mode (ct), the servo motor stops with the dynamic brake without deceleration to a stop.
  - If an alarm that causes forced stop deceleration has occurred during the deceleration stop operation with Quick stop, the PDS state transition will shift to "Fault reaction active". After the servo motor stops at the deceleration time constant of Quick stop, the servo-off state will be established.
  - If a warning that causes forced stop deceleration has occurred during the deceleration stop operation with Quick stop, the PDS state transition maintains "Quick stop active". After the servo motor stops at the deceleration time constant of Quick stop, the servo-off state will be established.
  - If a warning causes deceleration stop with Quick stop during the deceleration stop operation, the PDS state transition will shift to "Quick stop active". After the servo motor stops at the deceleration time constant of the deceleration stop caused by the warning, the servo-off state will be established.
  - When the Quick stop command is turned off at the command stop of the controller, the command stop takes precedence and the servo motor stops with the dynamic brake without deceleration to a stop.
-

# Setting method

## Setting with servo parameters

[Pr. PT68.0 Quick stop method selection] can be used to specify the deceleration stop operation method. [Pr. PT68.0] corresponds to [Quick stop option code (Obj. 605Ah)].

Servo parameter	Name	Outline
PC24	Deceleration time constant at forced stop	Set the deceleration time constant at forced stop.* <sup>1</sup> Initial value: 100 [ms]
PV09	Deceleration at forced stop	Set the deceleration to be used for the forced stop deceleration function.* <sup>1</sup> Initial value: 0 [command unit/s <sup>2</sup> ]
PT68.0	Quick stop method selection	Select the quick stop method. Forced stop deceleration by turning off EM2 (Forced stop 2) is the same as "2" (servo-off after deceleration to a stop with [Quick stop deceleration (Obj. 6085h)]) regardless of the setting value of this servo parameter. When [Pr. PA04.3 Forced stop deceleration function selection] is set to "0" (forced stop deceleration function disabled), the servo motor stops with the dynamic brake regardless of the setting value of this servo parameter. 0: Stop with dynamic brake * <sup>2</sup> 1: Servo-off after deceleration to a stop at the deceleration time constant of any of the control modes * <sup>2</sup> * <sup>4</sup> 2: Servo-off after deceleration to a stop with [Quick stop option code (Obj. 605Ah)] 5: Maintain servo-on after deceleration to a stop at the deceleration time constant of any of the control modes * <sup>2</sup> * <sup>3</sup> * <sup>4</sup> * <sup>5</sup> 6: Maintain servo-on after deceleration to a stop with [Quick stop option code (Obj. 605Ah)] * <sup>2</sup> * <sup>3</sup> * <sup>5</sup> * <sup>6</sup> Initial value: 2

- \*1 The servo parameter to be set varies depending on the unit selected in [Pr. PT01.1 Speed/acceleration/deceleration unit selection]. However, the same object is used for setting the acceleration/deceleration data regardless of the unit selected. For details, refer to "[Pr. PT01.1 Speed/acceleration/deceleration unit selection]" in the User's Manual (Parameters).
- \*2 Available on servo amplifiers with firmware version D0 or later.
- \*3 Not available for CC-Link IE Field Network Basic.
- \*4 For the deceleration time constants of the control modes, refer to "[Quick stop option code (Obj. 605Ah)]" in the User's Manual (Object Dictionary).
- \*5 When the controller being used cannot perform follow-up in the "Quick stop active" state (during servo-on), do not use this setting value in the cyclic synchronous position mode (csp). For information on whether the controller being used can perform follow-up in the "Quick stop active" state, refer to the manual for the controller.
- \*6 When canceling Quick stop in the cyclic synchronous position mode (csp), cancel it after servo-off or perform position follow-up with the controller. If Quick stop is canceled without performing position follow-up, the servo motor may suddenly accelerate.

## Settings with objects

For details on the objects, refer to the User's Manual (Object Dictionary).

Index	Sub	Object	Name	Description
6085h	—	VAR	Quick stop deceleration	Deceleration at deceleration to a stop with Quick stop Unit: acc units
605Ah	—	VAR	Quick stop option code	Refer to the following table for the description.

The methods and operations supported in [Quick stop option code (Obj. 605Ah)] are shown in the following table.

Setting value	Description
0 *1	Stop with dynamic brake The state shifts immediately to "Switch On Disabled" (ready-off/servo-off), and the servo motor stops with the dynamic brake.
1 *1	Servo-off after deceleration to a stop at the deceleration time constant of any of the control modes In the cyclic synchronous positioning/velocity mode (csp/csv), the servo motor decelerates to a stop with [Quick stop deceleration (Obj. 6085h)] and the state shifts to "Switch On Disabled" (ready-off/servo-off). In the cyclic synchronous torque mode (cst), the profile torque mode (tq), and the continuous operation to torque control mode (ct), the state immediately shifts to "Switch On Disabled" (ready-off/servo-off) and the servo motor stops with the dynamic brake. In the profile positioning/velocity mode (pp/pv) and JOG operation mode (jg), the servo motor decelerates to a stop with [Profile deceleration (Obj. 6084h)] and the state shifts to "Switch On Disabled" (ready-off/servo-off). In the homing mode (hm), the servo motor decelerates to a stop with [Homing acceleration (Obj. 609Ah)] and the state shifts to "Switch On Disabled" (ready-off/servo-off). In the point table mode (pt), the servo motor decelerates to a stop at the deceleration time constant of the point table number during positioning operation, and the state shifts to "Switch On Disabled" (ready-off/servo-off).
2	Servo-off after deceleration to a stop with [Quick stop deceleration (Obj. 6085h)] In the cyclic synchronous positioning/velocity mode (csp/csv), profile positioning/velocity mode (pp/pv), point table mode (pt), JOG operation mode (jg), and homing mode (hm), the servo motor decelerates to a stop with [Quick stop deceleration (Obj. 6085h)] and the state shifts to "Switch On Disabled" (ready-off/servo-off). In the cyclic synchronous torque mode (cst), the profile torque mode (tq), and the continuous operation to torque control mode (ct), the state immediately shifts to "Switch On Disabled" (ready-off/servo-off) and the servo motor stops with the dynamic brake.
3 (not supported)	—
4 (not supported)	—
5 *1*2*3*4	Maintain servo-on after deceleration to a stop at the deceleration time constant of any of the control modes In the cyclic synchronous positioning/velocity mode (csp/csv), the servo motor decelerates to a stop with [Quick stop deceleration (Obj. 6085h)] and the state remains as "Quick Stop Active". (Servo-on is maintained.) In the cyclic synchronous torque mode (cst), the profile torque mode (tq), and the continuous operation to torque control mode (ct), the state immediately shifts to "Switch On Disabled" (ready-off/servo-off) and the servo motor stops with the dynamic brake. In the profile positioning/velocity mode (pp/pv) and JOG operation mode (jg), the servo motor decelerates to a stop with [Profile deceleration (Obj. 6084h)] and the state remains as "Quick Stop Active". (Servo-on is maintained.) In the homing mode (hm), the servo motor decelerates to a stop with [Homing acceleration (Obj. 609Ah)] and the state remains as "Quick Stop Active". (Servo-on is maintained.) In the point table mode (pt), the servo motor decelerates to a stop at the deceleration time constant of the point table number during positioning operation, and the state remains as "Quick Stop Active". (Servo-on is maintained.)
6 *1*2*3*4	Maintain servo-on after deceleration to a stop with [Quick stop deceleration (Obj. 6085h)] In the cyclic synchronous positioning/velocity mode (csp/csv), profile positioning/velocity mode (pp/pv), point table mode (pt), JOG operation mode (jg), and homing mode (hm), the servo motor decelerates to a stop with [Quick stop deceleration (Obj. 6085h)] and the state remains as "Quick Stop Active". (Servo-on is maintained.) In the cyclic synchronous torque mode (cst), the profile torque mode (tq), and the continuous operation to torque control mode (ct), the state immediately shifts to "Switch On Disabled" (ready-off/servo-off) and the servo motor stops with the dynamic brake.
7 (not supported)	—
8 (not supported)	—

\*1 Available on servo amplifiers with firmware version D0 or later.

\*2 When canceling Quick stop in the cyclic synchronous position mode (csp), cancel it after servo-off or perform position follow-up with the controller. If Quick stop is canceled without performing position follow-up, the servo motor may suddenly accelerate.

\*3 Not available for CC-Link IE Field Network Basic.

\*4 When the controller being used cannot perform follow-up in the "Quick stop active" state (during servo-on), do not use this setting value in the cyclic synchronous position mode (csp). For information on whether the controller being used can perform follow-up in the "Quick stop active" state, refer to the manual for the controller.



# Timing chart

## When [Quick stop option code (Obj. 605Ah)] is set to "1"

The servo motor decelerates to a stop at the deceleration time constant of any of the control modes, then the state shifts to "Switch On Disabled". For the deceleration time constant, refer to the User's Manual (Object Dictionary).

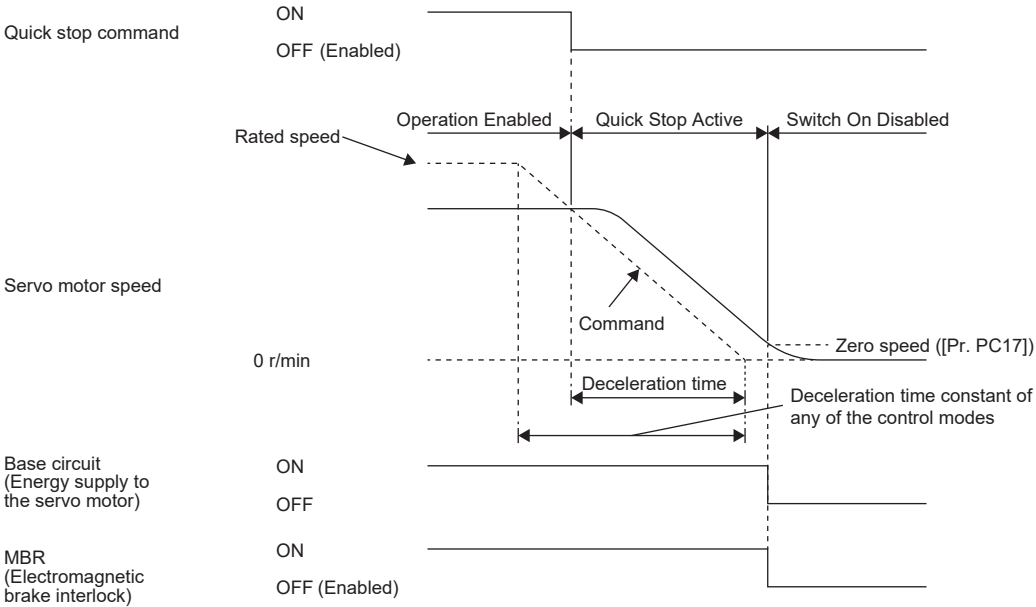

## When [Quick stop option code (Obj. 605Ah)] is set to "2"

The servo motor decelerates to a stop with [Quick stop deceleration (Obj. 6085h)], and the state shifts to "Switch On Disabled".

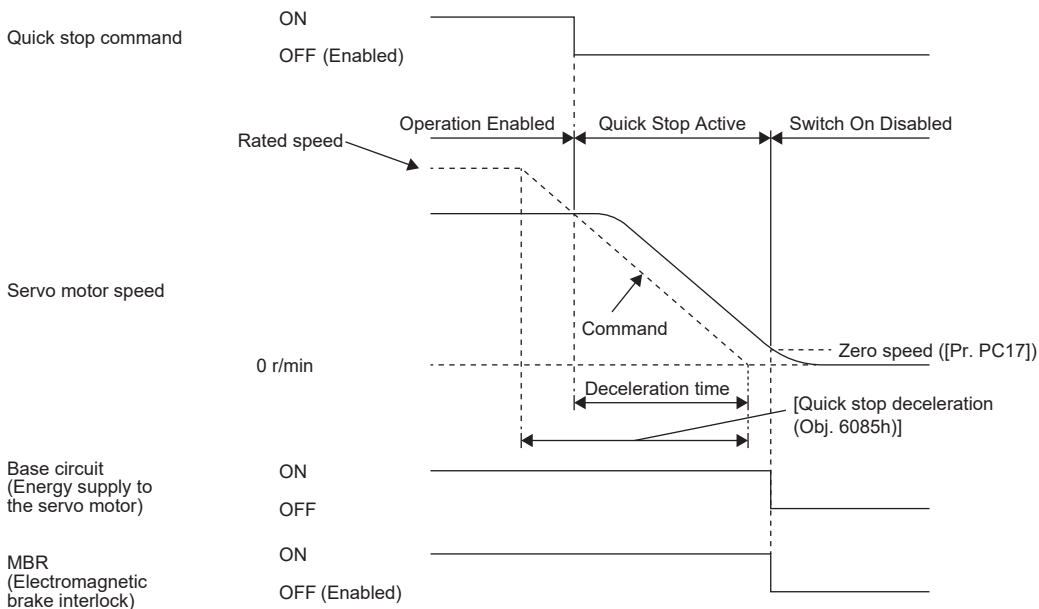

## When [Quick stop option code (Obj. 605Ah)] is set to "5"

The servo motor decelerates to a stop at the deceleration time constant of any of the control modes, then the state remains as "Quick Stop Active" (servo-on). For the deceleration time constant, refer to the User's Manual (Object Dictionary).

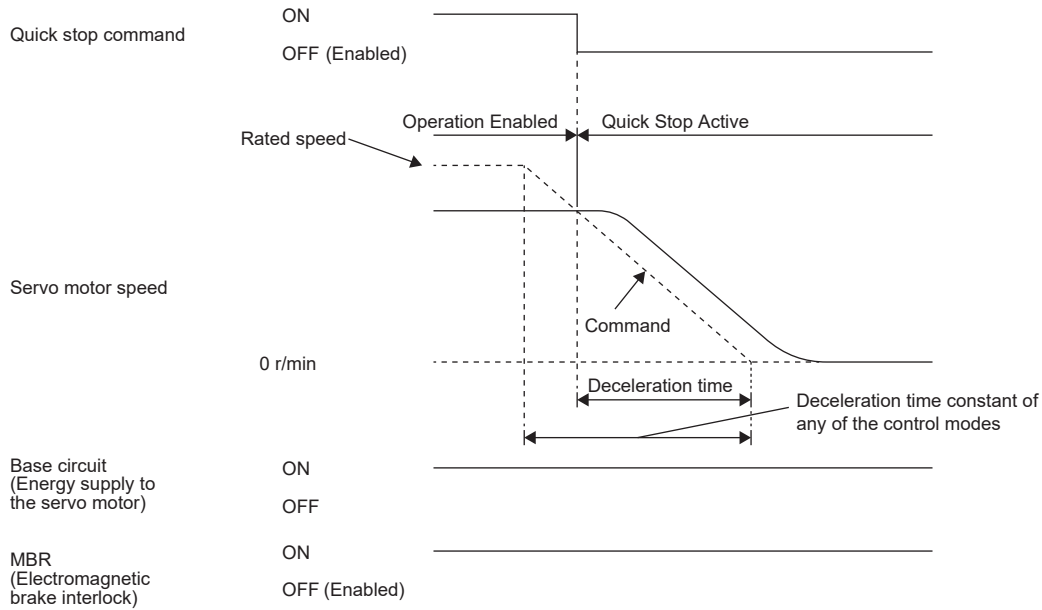

## When [Quick stop option code (Obj. 605Ah)] is set to "6"

After deceleration to a stop with [Quick stop deceleration (Obj. 6085h)], the state remains as "Quick Stop Active" (servo-on).

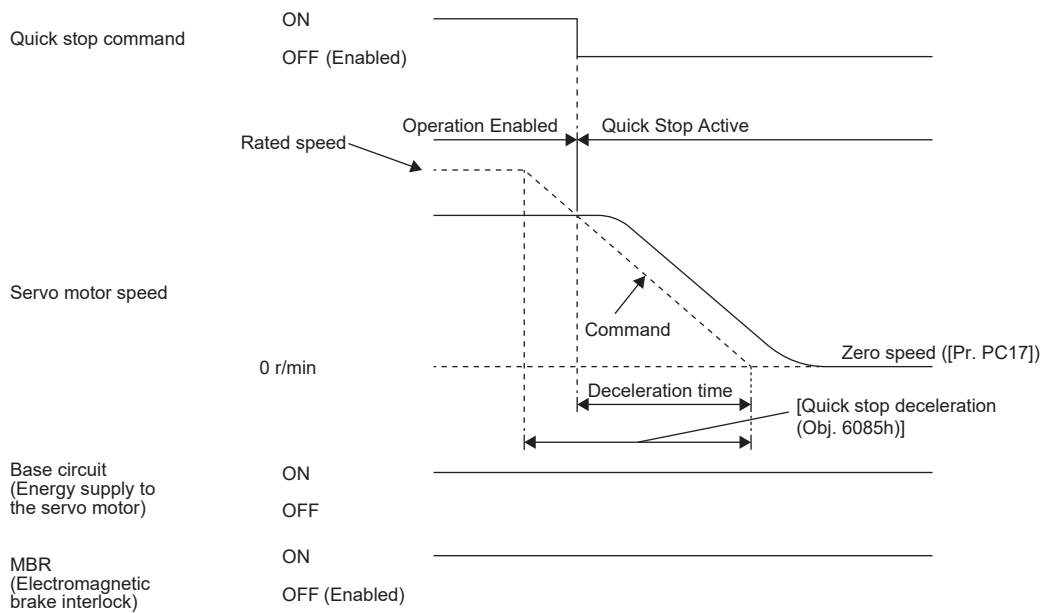

## 3.15 Halt

Halt defined in CiA 402 enables temporary stop of the servo motor.

When 1 is set in Bit 8 (HALT) of [Controlword (Obj. 6040h)], the servo motor decelerates to a stop with the deceleration time constant of [Profile deceleration (Obj. 6084h)] or [Homing acceleration (Obj. 609Ah)], and then the state remains as "Operation Enable" (Servo-on), in accordance with the setting of [Halt option code (Obj. 605Dh)]. When Halt Bit is set to 0 during the deceleration stop operation, the servo motor decelerates to a stop and returns to the operable state.

### Restriction

- This function can be used in the profile mode (pp/pv/tq), point table mode (pt), JOG operation mode (jg), and homing mode (hm). The other control modes can be operated regardless of the Halt Bit status.
- In the profile torque mode (tq), [Torque demand value (Obj. 6074h)] is set to 0 regardless of [Halt option code (Obj. 605Dh)]. The amount of torque change at this time can be set using [Torque slope (Obj. 6087h)].

## Objects for setting

For details on the objects, refer to the User's Manual (Object Dictionary).

Index	Sub	Object	Name	Description
605Dh	—	VAR	Halt option code	Setting for executing the Halt function Refer to the following table for the description.
6084h	—	VAR	Profile deceleration	Deceleration at arrival to target position Unit: acc units
609Ah	—	VAR	Homing acceleration	Acceleration/deceleration time constant at homing Unit: acc units
6074h	—	VAR	Torque demand value	Command torque (after limit) Unit: 0.1 % (with rated torque being 100 %)
6087h	—	VAR	Torque slope	Torque variation Unit: 0.1 %/s (with rated torque being 100 %)
2801h to 28FFh *1	4	VAR	Deceleration	Deceleration time constant of point table Unit: acc units

\*1 Available on servo amplifiers with firmware version B8 or later.

The following table shows descriptions of [Halt option code (Obj. 605Dh)].

Setting value	Description
1	The servo motor decelerates to a stop in accordance with [Profile deceleration (Obj. 6084h)] during the profile positioning/velocity mode (pp/pv) and JOG operation mode (jg), in accordance with the point table deceleration time constant/point table deceleration during the point table mode (pt), and in accordance with [Homing acceleration (Obj. 609Ah)] during the homing mode (hm), and the servo motor remains "Operation Enabled". During the profile torque mode (tq), [Torque demand value (Obj. 6074h)] becomes "0" stopping the servo motor in accordance with the amount of torque change set in [Torque slope (Obj. 6087h)], and the state remains "Operation Enabled".
2 (not supported)	After deceleration to a stop in accordance with [Quick stop deceleration (Obj. 6085h)], the state remains as "Operation Enabled". (Servo-on is maintained.)
3 (not supported)	After deceleration to a stop by limiting the current, the state remains as "Operation Enabled". (Servo-on is maintained.)
4 (not supported)	After deceleration to a stop by limiting the voltage, the state remains as "Operation Enabled". (Servo-on is maintained.)

# Timing chart

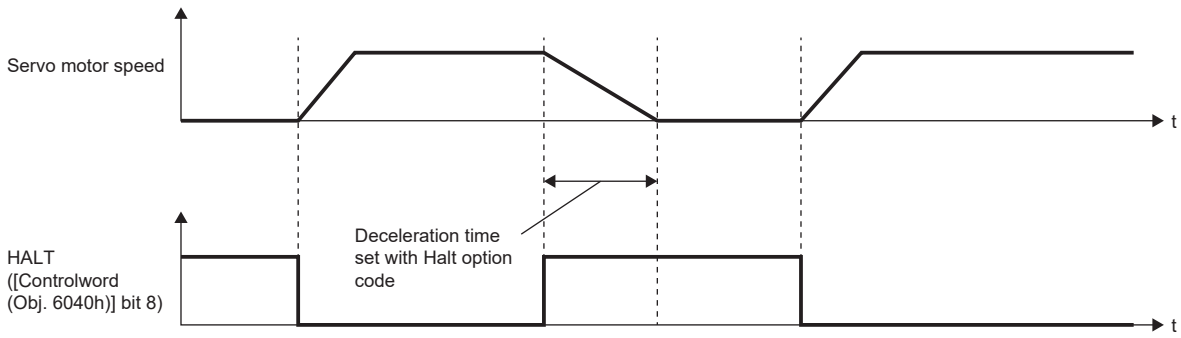

# 4 APPLICABLE FUNCTIONS

This chapter explains the applicable functions. Please select the applicable function to be used from the following table.

## Function to operate safely

Applicable function	Outline	Reference
Software position limit	Prevents a moving part from colliding with the equipment.	☞ Page 177 Software position limit
Torque limit	Prevents the servo motor from outputting a higher torque than the specified value.	☞ Page 180 Torque limit
Speed limit	Prevents the servo motor from operating faster than the specified speed.	☞ Page 182 Speed limit
Excessive error alarm detection function	Prevents the motor feedback position from deviating from the position command by more than a predetermined value.	☞ Page 198 Excessive error alarm detection function

## Functions to enhance the failure detection capability of the servo amplifier

Applicable function	Outline	Reference
Machine diagnosis	Diagnoses mechanical parts failure of the drive system.	☞ Page 155 Machine diagnosis
Servo amplifier life diagnosis	Use this function to check the service life of the servo amplifier.	☞ Page 191 Servo amplifier life diagnosis function
Encoder communication diagnosis function	Diagnoses encoder communication circuit failure.	☞ Page 193 Encoder communication diagnosis function
Disconnection detection function	Detects disconnection of the servo motor power supply wires.	☞ Page 194 Disconnection/incorrect wiring detection function

## Functions to prevent the drive of servo motor from stopping

Applicable function	Outline	Reference
Tough drive function	Prevents the equipment from being stopped by an instantaneous power failure or a vibration.	☞ Page 141 Tough drive function

## Functions to perform advanced control in specific applications

Applicable function	Outline	Reference
Degree unit <sup>*1</sup>	Enables control in modulo coordinates (axes of rotation) such as a tool changer in the positioning mode.	☞ Page 183 Degree unit
Infinite feed length <sup>*1</sup>	Generates 32767 or more revolutions from the home position in the absolute position detection system.	☞ Page 190 Infinite feed function
Override function <sup>*2</sup>	Changes the servo motor speed in the point table mode or profile position mode.	☞ Page 200 Override function

\*1 Available on servo amplifiers with firmware version B6 or later.

\*2 Available on servo amplifiers with firmware version D4 or later.

## Functions to store data sampled at high speed from the servo amplifier, then communicate/output it to the controller

Applicable function	Outline	Reference
Drive recorder	Stores data at alarm occurrence. The stored data can be used for a cause analysis.	☞ Page 160 Drive recorder
Touch probe <sup>*1</sup>	Accurately latches the positions at the rising and falling edges of TPR1 (Touch probe 1), TPR2 (Touch probe 2), and TPR3 (Touch probe 3), and detects them with precision of 1 μs. To latch the current position, turn the touch probe signal on.	☞ Page 145 Touch probe

\*1 Available on servo amplifiers with firmware version C0 or later and manufactured in July 2022 or later.

## Function to shorten operating time

Applicable function	Outline	Reference
Parameter automatic setting	Transmits servo parameter data from the controller with SLMP communication via CC-Link IE TSN.	Refer to "Parameter automatic setting" in the User's Manual (Communication Function).
Software reset	The same processing performed at power cycle of the servo amplifier is performed without the need for actual cycling. Resets the status of the servo amplifier.	 Page 176 Software reset

## Performance-improving function

Applicable function	Outline	Reference
Command offset	This function adds an arbitrary offset amount for the position/speed/torque commands. Use this function to correct the target command or to improve the response to the target command.	 Page 196 Command offset

# 4.1 Tough drive function

Tough drive function is a function that allows the operation to continue without stopping the device, even when an alarm would occur normally. This function also features the vibration tough drive and the instantaneous power failure tough drive.

## Vibration tough drive

Vibration tough drive function is a function to: 1) prevent vibration, as the mechanical resonance frequency changes due to aging of the machine; and 2) instantaneously reset the filter when machine resonance occurs. For details, refer to "Vibration tough drive" in the following manual.

📖MR-JET User's Manual (Adjustment)

## Instantaneous power failure tough drive

The instantaneous power failure tough drive function avoids the occurrence of [AL. 010 Undervoltage], even when an instantaneous power failure occurs during operation. Operating continuously without stopping the system is feasible. When the instantaneous power failure tough drive activates, the function will increase the tolerance against instantaneous power failure using the electrical energy charged in the capacitor in the servo amplifier and will change an alarm level of [AL. 010 Undervoltage] simultaneously. The [AL. 010.1 Voltage drop in the control circuit power] detection time for the power supply can be changed by [Pr. PF25 Instantaneous power failure tough drive detection time]. In addition, [AL. 010.2 Voltage drop in the main circuit power] detection level for the bus voltage is changed automatically.

### Precautions

- MBR (Electromagnetic brake interlock) is on during the instantaneous power failure tough drive.
- When the load of instantaneous power failure is large, [AL. 010.2] caused by the bus voltage drop may occur regardless of the set value of [Pr. PF25 Instantaneous power failure tough drive detection time].

### Setting method

Set [Pr. PA20.2 Instantaneous power failure tough drive selection] to "1" (enabled).

To set the time until the occurrence of [AL. 010.1 Voltage drop in the control circuit power], use [Pr. PF25 Instantaneous power failure tough drive detection time].

To extend the time until the occurrence of [AL. 010.2 Voltage drop in the main circuit power], set [Pr. PA26.0 Torque limit function selection at instantaneous power failure] to "1" (enabled).

Servo parameter	Symbol	Name	Outline
PA20.2	*TDS	Instantaneous power failure tough drive selection	Enable or disable the instantaneous power failure tough drive. 0: Disabled (initial value) 1: Enabled
PA26.0	*AOP5	Torque limit function selection at instantaneous power failure	Enable or disable the torque limit function at instantaneous power failure. 0: Disabled (initial value) 1: Enabled
PF25	CVAT	Instantaneous power failure tough drive - Detection time	Set the time until the occurrence of [AL. 010.1 Voltage drop in the control circuit power]. Initial setting: 200 [ms]

## Timing chart

### ■ Instantaneous power failure time > [Pr. PF25 Instantaneous power failure tough drive detection time]

The alarm occurs when the instantaneous power failure time exceeds [Pr. PF25 Instantaneous power failure tough drive detection time]. MTTR (Tough drive in progress) turns on after the instantaneous power failure is detected.

MBR (Electromagnetic brake interlock) turns off when the alarm occurs.

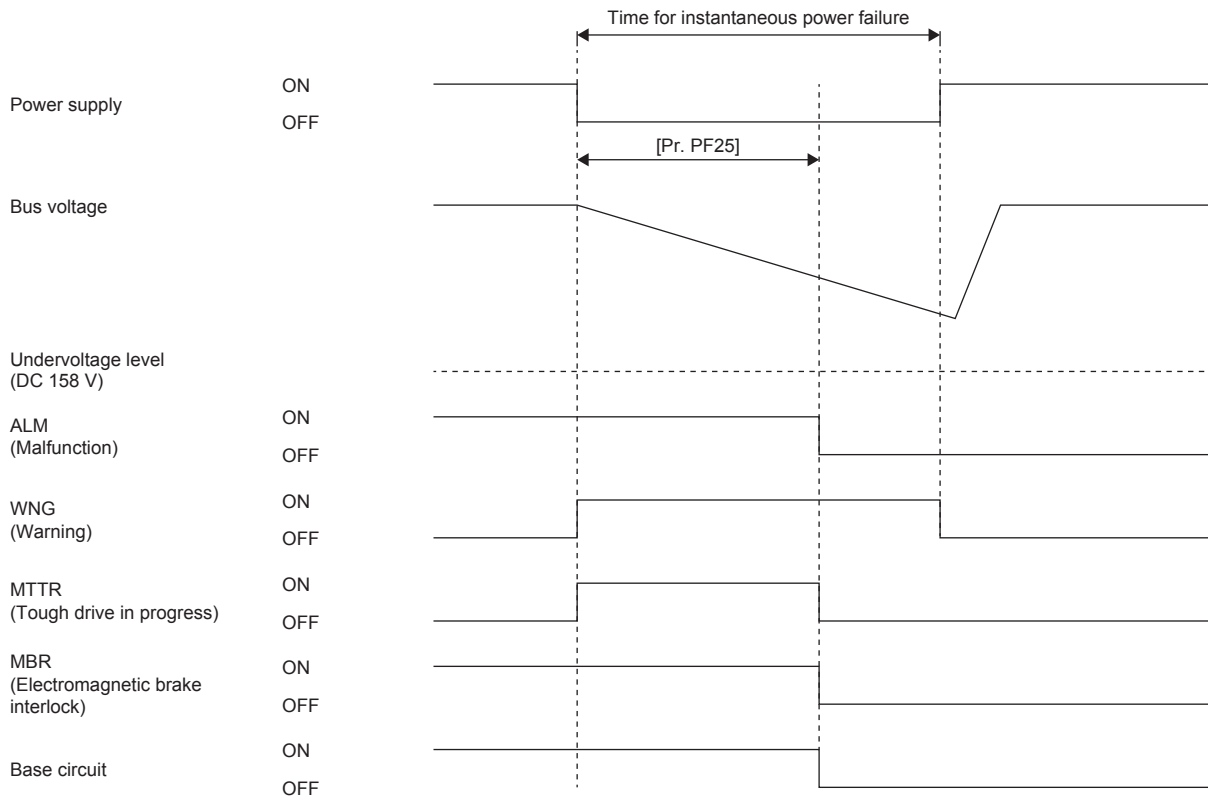



## ■ Instantaneous power failure time < [Pr. PF25 Instantaneous power failure tough drive detection time]

The operation status differs depending on how much the bus voltage decreases.

- When the bus voltage does not decrease to the undervoltage level or lower within instantaneous power failure time.

The operation continues without generating an alarm.

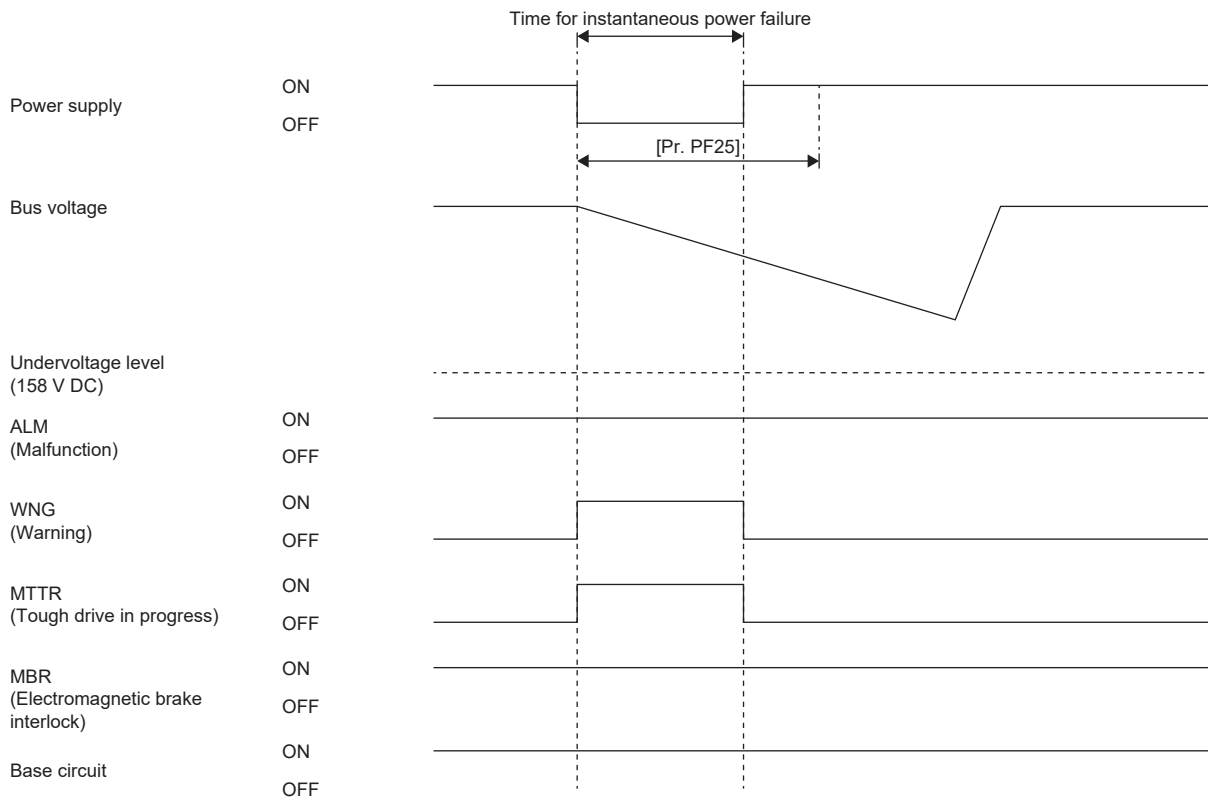

- When the bus voltage decreases to the undervoltage level or lower within instantaneous power failure time. [AL. 010 Undervoltage] occurs when the bus voltage decreases to the undervoltage level or lower even if the instantaneous power failure tough drive is enabled.

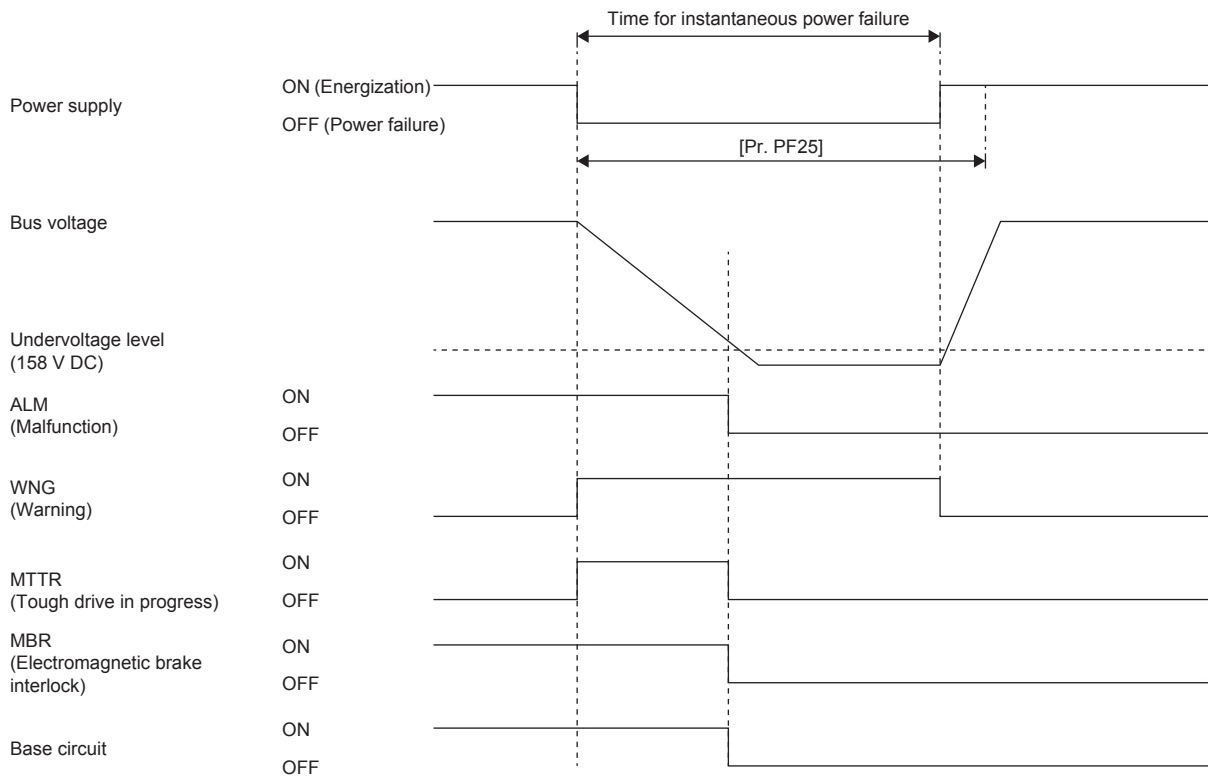

## 4.2 Touch probe

---

### Outline

---

The touch probe function latches the current position by inputting a signal from a sensor or the like. Position feedback at the rising edge and falling edge of an input device can be detected with precision of 1  $\mu$ s and stored into an object according to specified conditions.

#### **Restriction**

- Available on servo amplifiers with firmware version C0 or later and manufactured in July 2022 or later.
  - For input device assignment, the touch probe function has restrictions on pins that can be set.  
 Page 146 Setting method
  - If semi-closed loop control/fully closed loop control switching is performed while this function operates, the position may not be detected correctly.
  - When multiple linear encoder home positions exist during the full stroke of the linear encoder, the trigger cannot be set to the zero point of the encoder.
- 

### Precautions

If the external input signal causes chattering due to noise or other factors, the position may not be detected correctly. Review the surrounding environment.

## Setting method

The touch probe function memorizes position feedback and stores it in each object according to the conditions specified with [Touch probe function (Obj. 60B8h)] or [Touch probe function 2 (Obj. 2DE8h)].

Refer to the following table for the settings of input/output devices.

☞ Page 106 Assigning I/O devices

☞ Page 147 Input device settings

Refer to the following for the timing chart.

☞ Page 153 Timing chart

The following table shows the objects and input devices to use touch probes.

Touch probe	Target object			Input device	
	Index	Name	Bit range	Name	Symbol
Touch probe1	60B8h	Touch probe function	Bit 0 to 7	Touch probe 1	TPR1
	60B9h	Touch probe status	Bit 0 to 7		
	60BAh	Touch probe 1 positive edge	—		
	60BBh	Touch probe 1 negative edge	—		
	60D1h	Touch probe time stamp 1 positive value	—		
	60D2h	Touch probe time stamp 1 negative value	—		
Touch probe2	60B8h	Touch probe function	Bit 8 to 15	Touch probe 2	TPR2
	60B9h	Touch probe status	Bit 8 to 15		
	60BCh	Touch probe 2 positive edge	—		
	60BDh	Touch probe 2 negative edge	—		
	60D3h	Touch probe time stamp 2 positive value	—		
	60D4h	Touch probe time stamp 2 negative value	—		
Touch probe3	2DE8h	Touch probe function 2	Bit 0 to 7	Touch probe 3	TPR3
	2DE9h	Touch probe status 2	Bit 0 to 7		
	2DEAh	Touch probe 3 positive edge	—		
	2DEBh	Touch probe 3 negative edge	—		
	2DF8h	Touch probe time stamp 3 positive value	—		
	2DF9h	Touch probe time stamp 3 negative value	—		

## Input device settings

TPR1, TPR2, and TPR3 are not assigned to the input devices in the initial setting. When using this function, assign TPR1, TPR2, and TPR3. The following table shows the connector pin numbers to which input devices TPR1, TPR2, and TPR3 can be assigned and the servo parameters used for the assignment.

Connector pin No.	Servo parameter	Initially assigned device
CN3-10 *1	[Pr. PD38 Input device selection 4]	—
CN3-1 *1	[Pr. PD39 Input device selection 5]	—

\*1 Available on servo amplifiers with firmware version C0 or later and manufactured in July 2022 or later.

## Servo parameter





The filter settings of [Pr. PD11.0 Input signal filter selection] are disabled for pins to which TPR1, TPR2, or TPR3 is assigned.

Servo parameter	Symbol	Name	Outline
PD38.0-1 *1	*DI4	Input device selection 4	Assign any input device to the CN3-10 pin. Initial value: 2Ch (TPR1)
PD39.0-1 *1	*DI5	Input device selection 5	Assign any input device to the CN3-1 pin. Initial value: 2Dh (TPR2)
PT26.4 *1	*TOP2	Touch probe latch position selection	Select a touch probe latch position. Initial value: 0

\*1 Available on servo amplifiers with firmware version C0 or later and manufactured in July 2022 or later.

## Object dictionary

For details on the objects, refer to the User's Manual (Object Dictionary).

Index	Sub	Object	Name	Description
60B8h	—	VAR	Touch probe function	 Page 149 Details on [Touch probe function (Obj. 60B8h)]
60B9h	—	VAR	Touch probe status	 Page 151 Details on [Touch probe status (Obj. 60B9h)]
60BAh	—	VAR	Touch probe 1 positive edge	The rising edge position of TPR1 (Touch probe 1) is stored. (pos units)
60BBh	—	VAR	Touch probe 1 negative edge	The falling edge position of TPR1 (Touch probe 1) is stored. (pos units)
60D1h	—	VAR	Touch probe time stamp 1 positive value	The time stamp at the rising edge of TPR1 (Touch probe 1) is stored. (ns)
60D2h	—	VAR	Touch probe time stamp 1 negative value	The time stamp at the falling edge of TPR1 (Touch probe 1) is stored. (ns)
60BCh	—	VAR	Touch probe 2 positive edge	The rising edge position of TPR2 (Touch probe 2) is stored. (pos units)
60BDh	—	VAR	Touch probe 2 negative edge	The falling edge position of TPR2 (Touch probe 2) is stored. (pos units)
60D3h	—	VAR	Touch probe time stamp 2 positive value	The time stamp at the rising edge of TPR2 (Touch probe 2) is stored. (ns)
60D4h	—	VAR	Touch probe time stamp 2 negative value	The time stamp at the falling edge of TPR2 (Touch probe 2) is stored. (ns)
2DE8h	—	VAR	Touch probe function 2	 Page 150 Details on [Touch probe function 2 (Obj. 2DE8h)]
2DE9h	—	VAR	Touch probe status 2	 Page 152 Details on [Touch probe status 2 (Obj. 2DE9h)]
2DEAh	—	VAR	Touch probe 3 positive edge	The rising edge position of TPR3 (Touch probe 3) is stored. (pos units)
2DEBh	—	VAR	Touch probe 3 negative edge	The falling edge position of TPR3 (Touch probe 3) is stored. (pos units)
2DF8h	—	VAR	Touch probe time stamp 3 positive value	The time stamp at the rising edge of TPR3 (Touch probe 3) is stored. (ns)
2DF9h	—	VAR	Touch probe time stamp 3 negative value	The time stamp at the falling edge of TPR3 (Touch probe 3) is stored. (ns)

## ■Details on [Touch probe function (Obj. 60B8h)]

Bit	Description
0	0: Touch probe 1 disabled 1: Touch probe 1 enabled
1	0: Single trigger mode 1: Continuous trigger mode
2	0: Triggered by inputting touch probe 1 1: Triggered at the zero point of the encoder
3	(reserved) The value at reading is undefined. Set "0" when writing.
4	0: Stop sampling the rising edge of touch probe 1 1: Start sampling the rising edge of touch probe 1 If input of touch probe 1 is set as a trigger (bit 2 = 0), the position feedback latched at the rising edge of touch probe 1 is stored in [Touch probe 1 positive edge (Obj. 60BAh)], and the time stamp in [Touch probe time stamp 1 positive value (Obj. 60D1h)]. If the zero point of the encoder is set as a trigger (bit 2 = 1), the position feedback at passing the zero point of the encoder *1 is stored in [Touch probe 1 positive edge (Obj. 60BAh)].
5	0: Stop sampling the falling edge of touch probe 1 1: Start sampling the falling edge of touch probe 1 If input of touch probe 1 is set as a trigger (bit 2 = 0), the position feedback latched at the falling edge of touch probe 1 is stored in [Touch probe 1 negative edge (Obj. 60BBh)], and the time stamp in [Touch probe time stamp 1 negative value (Obj. 60D2h)]. If the zero point of the encoder is set as a trigger (bit 2 = 1), the position feedback at passing the zero point of the encoder *1 is stored in [Touch probe 1 negative edge (Obj. 60BBh)].
6	(reserved) The value at reading is undefined. Set "0" when writing.
7	
8	0: Touch probe 2 disabled 1: Touch probe 2 enabled
9	0: Single trigger mode 1: Continuous trigger mode
10	0: Triggered by inputting touch probe 2 1: Triggered at the zero point of the encoder
11	(reserved) The value at reading is undefined. Set "0" when writing.
12	0: Stop sampling the rising edge of touch probe 2 1: Start sampling the rising edge of touch probe 2 If input of touch probe 2 is set as a trigger (bit 10 = 0), the position feedback latched at the rising edge of touch probe 2 is stored in [Touch probe 2 positive edge (Obj. 60BCh)], and the time stamp in [Touch probe time stamp 2 positive value (Obj. 60D3h)]. If the zero point of the encoder is set as a trigger (bit 10 = 1), the position feedback at passing the zero point of the encoder *1 is stored in [Touch probe 2 positive edge (Obj. 60BCh)].
13	0: Stop sampling the falling edge of touch probe 2 1: Start sampling the falling edge of touch probe 2 If input of touch probe 2 is set as a trigger (bit 10 = 0), the position feedback latched at the falling edge of touch probe 2 is stored in [Touch probe 2 negative edge (Obj. 60BDh)], and the time stamp in [Touch probe time stamp 2 negative value (Obj. 60D4h)]. If the zero point of the encoder is set as a trigger (bit 10 = 1), the position feedback at passing the zero point of the encoder *1 is stored in [Touch probe 2 negative edge (Obj. 60BDh)].
14	(reserved) The value at reading is undefined. Set "0" when writing.
15	

\*1 For linear servo motors, the zero point of the encoder is a position between homing stop intervals [pulse] (changeable with [Pr. PL01.2 Homing stop interval setting]) based on the linear encoder home position.

## ■Details on [Touch probe function 2 (Obj. 2DE8h)]

Bit	Description
0	0: Touch probe 3 disabled 1: Touch probe 3 enabled
1	0: Single trigger mode 1: Continuous trigger mode
2	0: Triggered by inputting touch probe 3 1: Triggered at the zero point of the encoder
3	(reserved) The value at reading is undefined. Set "0" when writing.
4	0: Stop sampling the rising edge of touch probe 3 1: Start sampling the rising edge of touch probe 3 If input of touch probe 3 is set as a trigger (bit 2 = 0), the position feedback latched at the rising edge of touch probe 3 is stored in [Touch probe 3 positive edge (Obj. 2DEAh)], and the time stamp in [Touch probe time stamp 3 positive value (Obj. 2DF8h)]. If the zero point of the encoder is set as a trigger (bit 2 = 1), the position feedback at passing the zero point of the encoder *1 is stored in [Touch probe 3 positive edge (Obj. 2DEAh)].
5	0: Stop sampling the falling edge of touch probe 3 1: Start sampling the falling edge of touch probe 3 If input of touch probe 3 is set as a trigger (bit 2 = 0), the position feedback latched at the falling edge of touch probe 3 is stored in [Touch probe 3 negative edge (Obj. 2DEBh)], and the time stamp in [Touch probe time stamp 3 negative value (Obj. 2DF9h)]. If the zero point of the encoder is set as a trigger (bit 2 = 1), the position feedback at passing the zero point of the encoder *1 is stored in [Touch probe 3 negative edge (Obj. 2DEBh)].
6	(reserved) The value at reading is undefined. Set "0" when writing.
7	
8 to 15	

\*1 For linear servo motors, the zero point of the encoder is a position between homing stop intervals [pulse] (changeable with [Pr. PL01.2 Homing stop interval setting]) based on the linear encoder home position.



## ■Details on [Touch probe status (Obj. 60B9h)]

Bit	Description
0	0: Touch probe 1 disabled 1: Touch probe 1 enabled
1	0: The data at the rising edge of touch probe 1 has not been stored. 1: The data at the rising edge of touch probe 1 has been stored. When the position feedback is stored in [Touch probe 1 positive edge (Obj. 60BAh)] and the time stamp is stored in [Touch probe time stamp 1 positive value (Obj. 60D1h)], "1" is set. This bit is cleared to "0" when bit 4 of [Touch probe function (Obj. 60B8h)] is set to "0".
2	0: The data at the falling edge of touch probe 1 has not been stored. 1: The data at the falling edge of touch probe 1 has been stored. When the position feedback is stored in [Touch probe 1 negative edge (Obj. 60BBh)] and the time stamp is stored in [Touch probe time stamp 1 negative value (Obj. 60D2h)], "1" is set. This bit is cleared to "0" when bit 5 of [Touch probe function (Obj. 60B8h)] is set to "0".
3 to 5	(reserved) The value at reading is undefined. Set "0" when writing.
6	Toggle status for latch completion at the rising edge of touch probe 1 0 or 1: When bit 1 of [Touch probe function (Obj. 60B8h)] is set to "1" (continuous trigger mode), the status toggles between "0" and "1" every time the position feedback is stored in [Touch probe 1 positive edge (Obj. 60BAh)] and the time stamp is stored in [Touch probe time stamp 1 positive value (Obj. 60D1h)].
7	Toggle status for latch completion at the falling edge of touch probe 1 0 or 1: When bit 1 of [Touch probe function (Obj. 60B8h)] is set to "1" (continuous trigger mode), the status toggles between "0" and "1" every time the position feedback is stored in [Touch probe 1 negative edge (Obj. 60BBh)] and the time stamp is stored in [Touch probe time stamp 1 negative value (Obj. 60D2h)].
8	0: Touch probe 2 disabled 1: Touch probe 2 enabled
9	0: The data at the rising edge of touch probe 2 has not been stored. 1: The data at the rising edge of touch probe 2 has been stored. When the position feedback is stored in [Touch probe 2 positive edge (Obj. 60BCh)] and the time stamp is stored in [Touch probe time stamp 2 positive value (Obj. 60D3h)], "1" is set. This bit is cleared to "0" when bit 9 of [Touch probe function (Obj. 60B8h)] is set to "0".
10	0: The data at the falling edge of touch probe 2 has not been stored. 1: The data at the falling edge of touch probe 2 has been stored. When the position feedback is stored in [Touch probe 2 negative edge (Obj. 60BDh)] and the time stamp is stored in [Touch probe time stamp 2 negative value (Obj. 60D4h)], "1" is set. This bit is cleared to "0" when bit 10 of [Touch probe function (Obj. 60B8h)] is set to "0".
11 to 13	(reserved) The value at reading is undefined. Set "0" when writing.
14	Toggle status for latch completion at the rising edge of touch probe 2 0 or 1: When bit 9 of [Touch probe function (Obj. 60B8h)] is set to "1" (continuous trigger mode), the status toggles between "0" and "1" every time the position feedback is stored in [Touch probe 2 positive edge (Obj. 60BCh)] and the time stamp is stored in [Touch probe time stamp 2 positive value (Obj. 60D3h)].
15	Toggle status for latch completion at the falling edge of touch probe 2 0 or 1: When bit 9 of [Touch probe function (Obj. 60B8h)] is set to "1" (continuous trigger mode), the status toggles between "0" and "1" every time the position feedback is stored in [Touch probe 2 negative edge (Obj. 60BDh)] and the time stamp is stored in [Touch probe time stamp 2 negative value (Obj. 60D4h)].

## ■Details on [Touch probe status 2 (Obj. 2DE9h)]

Bit	Description
0	0: Touch probe 3 disabled 1: Touch probe 3 enabled
1	0: The position at the rising edge of touch probe 3 has not been stored. 1: The position at the rising edge of touch probe 3 has been stored. When the position feedback is stored in [Touch probe 3 positive edge (Obj. 2DEAh)] and the time stamp is stored in [Touch probe time stamp 3 positive value (Obj. 2DF8h)], "1" is set. This bit is cleared to "0" when bit 4 of [Touch probe function 2 (Obj. 2DE8h)] is set to "0".
2	0: The position at the falling edge of touch probe 3 has not been stored. 1: The position at the falling edge of touch probe 3 has been stored. When the position feedback is stored in [Touch probe 3 negative edge (Obj. 2DEBh)] and the time stamp is stored in [Touch probe time stamp 3 negative value (Obj. 2DF9h)], "1" is set. This bit is cleared to "0" when bit 5 of [Touch probe function 2 (Obj. 2DE8h)] is set to "0".
3 to 5	(reserved) The value at reading is undefined.
6	Toggle status for latch completion at the rising edge of touch probe 3 0 or 1: When bit 1 of [Touch probe function 2 (Obj. 2DE8h)] is set to "1" (continuous trigger mode), the status toggles between "0" and "1" every time the position feedback is stored in [Touch probe 3 positive edge (Obj. 2DEAh)] and the time stamp is stored in [Touch probe time stamp 3 positive value (Obj. 2DF8h)].
7	Toggle status for latch completion at the falling edge of touch probe 3 0 or 1: When bit 1 of [Touch probe function 2 (Obj. 2DE8h)] is set to "1" (continuous trigger mode), the status toggles between "0" and "1" every time the position feedback is stored in [Touch probe 3 negative edge (Obj. 2DEBh)] and the time stamp is stored in [Touch probe time stamp 3 negative value (Obj. 2DF9h)].
8 to 15	(reserved) The value at reading is undefined.

## Timing chart

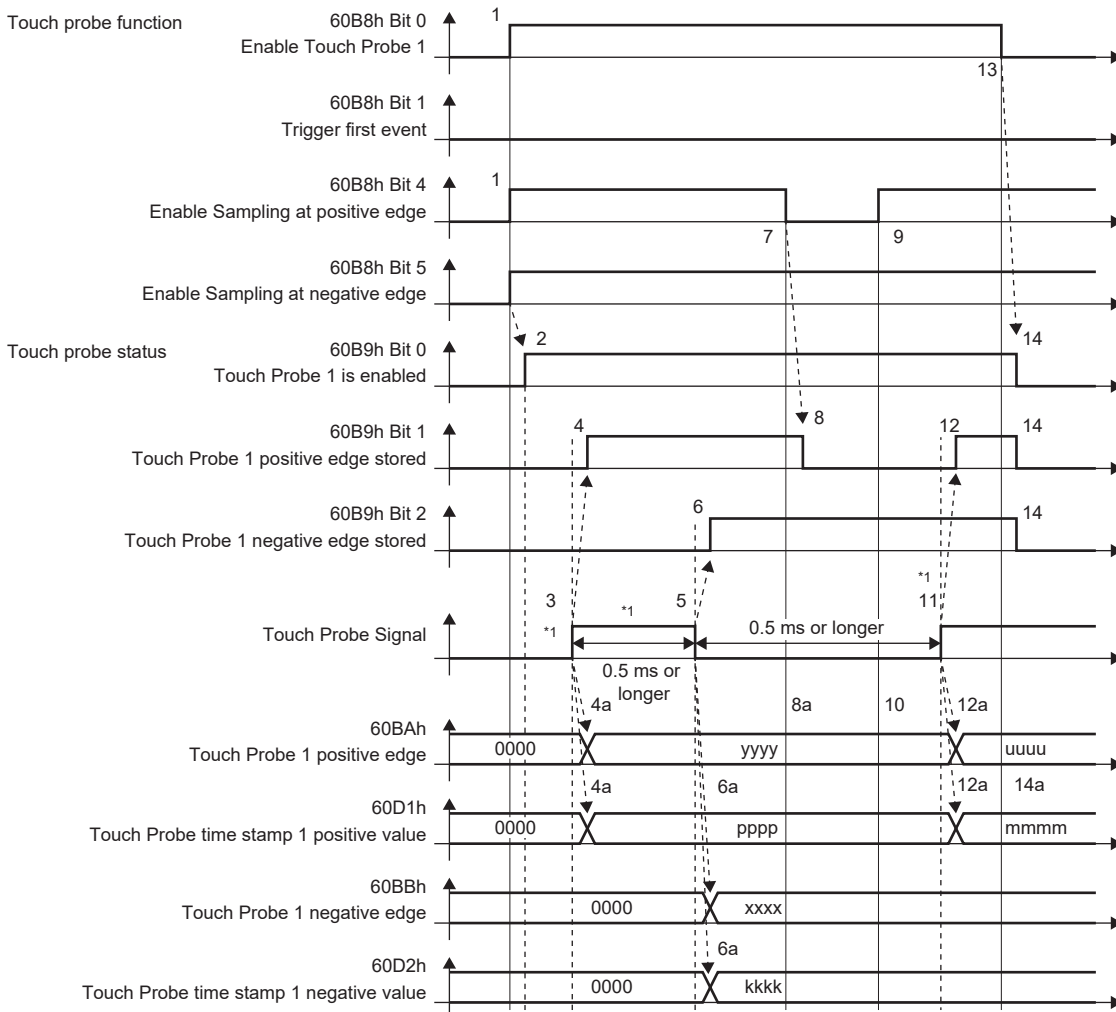

\*1 Change "Touch Probe Signal" so that both the on-time and off-time are 0.5 ms or longer.

Transition No.	Object	Description
1	60B8h Bit 0, 4, 5 = 1	Enables Touch Probe1. The rising edge and falling edge are enabled.
2	→ 60B9h Bit 0 = 1	Turns on the Touch Probe1 enable status.
3	—	Turns on Touch Probe Signal (TPR1).
4	→ 60B9h Bit 1 = 1	Turns on the Touch Probe1 positive edge stored status.
4a	→ 60BAh, 60D1h	Sets the latched position feedback for Touch probe 1 positive edge and the latched time stamp for Touch probe time stamp 1 positive value.
5	—	Turns off Touch Probe Signal (TPR1).
6	→ 60B9h Bit 2 = 1	Turns on the Touch Probe1 negative edge stored status.
6a	→ 60BBh, 60D2h	Sets the latched position feedback for Touch probe 1 negative edge and the latched time stamp for Touch probe time stamp 1 negative value.
7	60B8h Bit 4 = 0	Turns off Sample positive edge. Rising edge detection is disabled.
8	→ 60B9h Bit 1 = 0	Turns off the Touch Probe1 positive edge stored status.
8a	→ 60BAh, 60D1h	Touch probe 1 positive edge and Touch probe time stamp 1 positive value do not change.
9	60B8h Bit 4 = 1	Turns on Sample positive edge. Rising edge detection is enabled.
10	→ 60BAh, 60D1h	Touch probe 1 positive edge and Touch probe time stamp 1 positive value do not change.
11	—	Turns on Touch Probe Signal (TPR1).
12	→ 60B9h Bit 1 = 1	Turns on the Touch Probe1 positive edge stored status.
12a	→ 60BAh, 60D1h	Sets the latched position feedback for Touch probe 1 positive edge and the latched time stamp for Touch probe time stamp 1 positive value.
13	60B8h Bit 0 = 0	Disables Touch Probe1.

Transition No.	Object	Description
14	→ 60B9h Bit 0, 1, 2 = 0	Clears all the status bits.
14a	→ 60BAh, 60BBh, 60D1h, 60D2h	Touch probe 1 positive/negative edge and Touch probe time stamp 1 positive/negative value do not change.

The following shows a timing chart of Bit 6 of [Touch probe status (Obj. 60B9h)]. Bit 7 of [Touch probe status (Obj. 60B9h)] changes when latching completes at the falling edge.

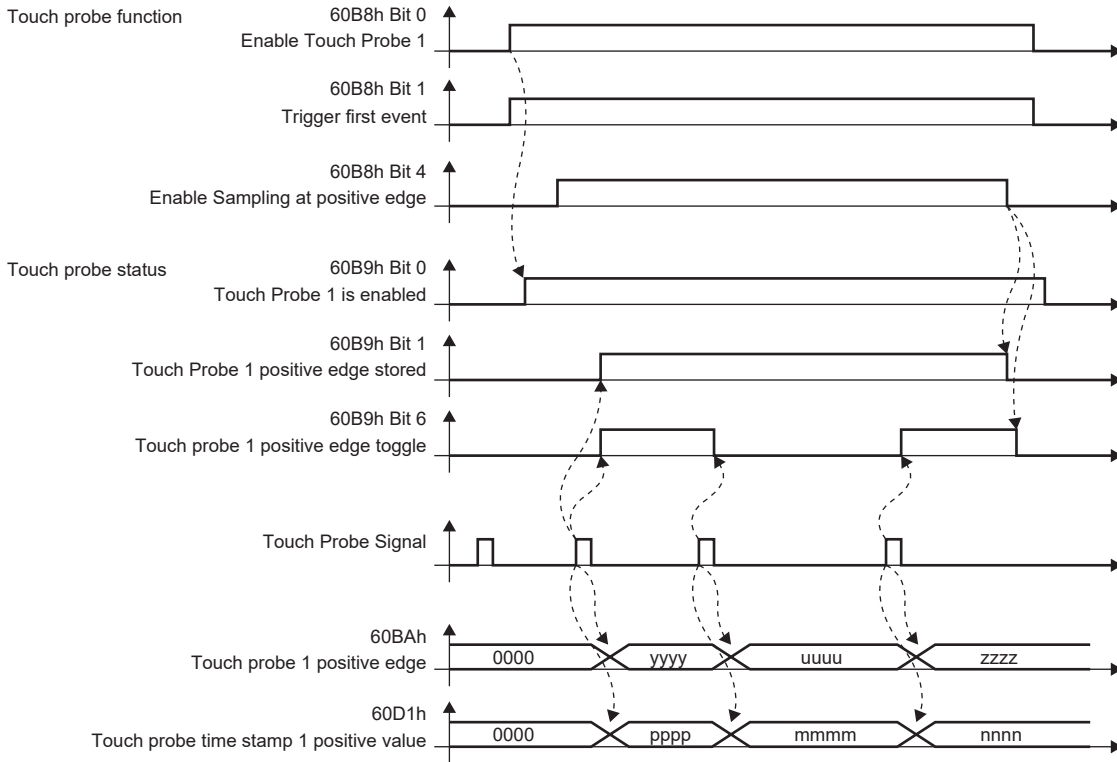

## 4.3 Machine diagnosis

The machine diagnosis function estimates the friction and vibrational component of the drive system in the equipment based on the data in the servo amplifier and detects errors in machine parts such as ball screws and bearings. The machine diagnosis function features the following functions:

Diagnosis target	Diagnosis item	Diagnosis function	Outline	Detailed explanation
Linear guide Ball screw	Static friction/dynamic friction	Friction estimation function	The friction estimation function estimates and detects the static friction (including gravity) and the dynamic friction of guides and ball screws after operation is performed in any operation pattern.	Page 155 Friction vibration estimation function
	Servo motor vibration torque	Vibration estimation function	The vibration estimation function estimates and detects the vibration level both during servo motor operation and at a servo motor stop, and vibration frequency both during servo motor operation and at a servo motor stop, after operation is performed in any operation pattern.	Page 155 Friction vibration estimation function

### Friction vibration estimation function

In the friction vibration estimation function, the friction estimation function estimates the friction of the drive system in the equipment, and the vibration estimation function estimates the minute vibration level and vibration frequency based on the data in the servo amplifier. The friction estimation function estimates and detects the static friction (including gravity) and the dynamic friction of guides and ball screws after operation is performed in any operation pattern. The vibration estimation function estimates and detects the vibration level both during servo motor operation and at a servo motor stop, and vibration frequency both during servo motor operation and at a servo motor stop, after operation is performed in any operation pattern.

#### Restriction

- If the vibration frequency is extremely low or high, vibration estimation cannot be performed. For example, low frequency vibrations of several 10 Hz cannot be detected on a low rigidity machine.
- When there is vibration with multiple frequencies at the same time, such as multiple mechanical resonances, the vibration frequency may not be estimated properly.
- Vibration frequency may not be estimated properly if the torque reaches the limit value. To prevent the excessive torque vibrations, set a longer acceleration/deceleration time for the command, or slightly decrease the gains.

#### Precautions

- It is recommended that the values estimated by the friction vibration estimation function be saved at the start of operation. By comparing the value estimated by the friction vibration estimation function after the start of operation and with the value at the start of operation, how much the machine is aged after operation can be learned, which is useful for preventive maintenance.

## Setting method

### ■Friction estimation function

1. Startup the system.
2. When the maximum operation speed is under the rated speed, set [Pr. PF31] to half of the maximum speed during operation. Alternatively, set [Pr. PF34.6] to "1" (automatic setting) to automatically calculate [Pr. PF31].
3. Drive the servo motor.
4. The static friction and the dynamic friction (at rated speed) are estimated.
5. Save the data of the estimated static friction and dynamic friction.

Servo parameter	Symbol	Name	Description
PF31	FRIC	Machine diagnosis function - Friction estimate area judgment speed at low speed	Set the servo motor speed to divide the friction estimation area between low-speed and high-speed in the friction estimation process of machine diagnosis. When the maximum operation speed is under the rated speed, it is recommended to set half the value of the maximum operation speed. <sup>*1*2</sup> Setting [Pr. PF34.6 Friction estimate area judgment speed setting] to "1" (automatic setting) will automatically calculate the servo parameter value from the operation pattern during servo motor driving. When this servo parameter value is calculated automatically, this servo parameter value is automatically rewritten to the calculation result. Initial value: 0 [r/min], [mm/s]
PF31	*MFP	Friction estimate area judgment speed setting	Set the setting method for Machine diagnosis function - Friction estimate area judgment speed at low speed. 0: Manual setting (initial value) 1: Automatic setting When "1" (automatic setting) is set, [Pr. PF31] will be calculated according to the servo motor operation pattern. After the calculation, [Pr. PF31] is rewritten to the calculation result, and the servo parameter will change to "0" (manual setting). When "1" (automatic setting) is set, friction estimation stops.

\*1 When "0" is set, the value is set to half the rated speed.

\*2 Clamped at maximum speed. When changing the speed to the permissible speed, set the speed in [Pr. PA28.4 Speed range limit selection].

### ■Vibration estimation function

Setting is not required. The servo amplifier constantly estimates the vibration in the operation pattern.

1. Startup the system.
2. Drive the servo motor.
3. The vibration level and vibration frequency are estimated.
4. Save the estimated vibration level and vibration frequency.

## Friction estimation function

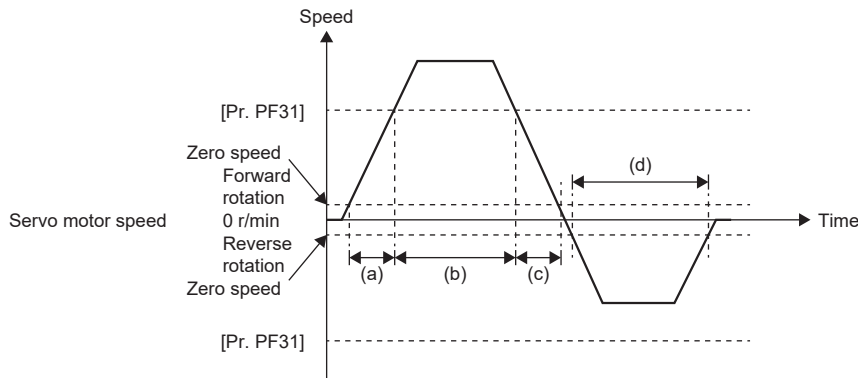

To perform friction estimation, the servo motor must be rotated at zero speed or higher, and operated for 150 s both in the high and low-speed sections. The high speed indicates the section where the absolute value of the servo motor speed is equal to or higher than [Pr. PF31 Machine diagnosis function - Friction estimate area judgment speed at low speed], whereas the low speed indicates the section where the absolute value of the servo motor speed is less than [Pr. PF31]. For the above operation pattern, when (a) + (c) is 150 s or more and (b) is 150 s or more, the friction in the forward rotation direction is estimated. The friction in the reverse rotation direction is estimated even if time (d) is 150 s or more because the servo motor is not operated in the high-speed section. In this case, decrease the setting value of [Pr. PF31] to perform friction estimation. When [Pr. PF31] is set to "0", the threshold is 1/2 of the rated speed.

For the following operation pattern, it takes approximately 20 min. to finish friction estimation.

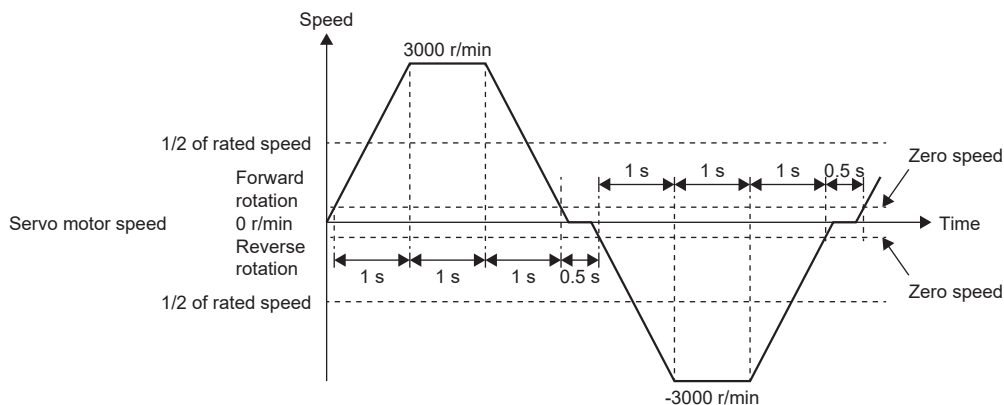

The friction estimation function estimates the static friction both at forward rotation and reverse rotation, and the dynamic friction (at rated speed) both at forward rotation and reverse rotation. To estimate these values, it is unnecessary to perform to-and-fro positioning operation. When the servo motor is operated in acceleration/deceleration for forward rotation, only the static friction and dynamic friction (at rated speed) at forward rotation can be estimated. When the servo motor is operated in acceleration/deceleration for reverse rotation, only the static friction and dynamic friction (at rated speed) at reverse rotation can be estimated.

The progress of the friction estimation can be checked by using MR Configurator2 or a controller. When using MR Configurator2 to check the progress, open the machine diagnosis screen. The progress can also be checked by the controller by using [Friction estimate status (Obj. 2C31h)].

## Vibration estimation function

The vibration estimation function monitors torque vibrations to estimate high-frequency, minute vibration levels and vibration frequencies. An increase in the vibration level and a change in the vibration frequency due to excess play or deterioration in guides, ball screws, and belts can be observed.

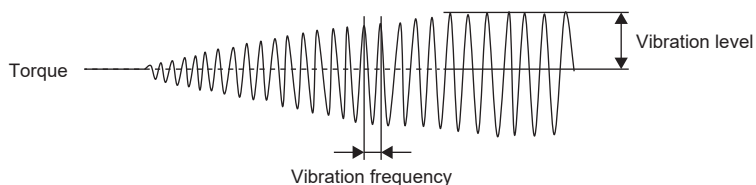

The vibration estimation function estimates the vibration level and vibration frequency respectively during servo motor operation and at a servo motor stop. Vibration levels and frequencies during servo motor operation and during servo motor stop are estimated separately.



## Related objects

For details on the objects, refer to the User's Manual (Object Dictionary).

index	Sub	Object	Name	Description
2C20h	0	VAR	Machine diagnostic status	<p>The machine diagnostic status is returned.</p> <p>[Bit 0 to 3: Friction estimation status at forward rotation] <sup>*1*2</sup></p> <p>0: Estimation in progress. (normal)</p> <p>1: Estimation has finished. (normal)</p> <p>2: The motor may have rotated more frequently in one direction than the other. (warning)</p> <p>3: The servo motor speed may be too slow for friction estimation. (warning)</p> <p>4: The change in the servo motor speed may be too small for friction estimation. (warning)</p> <p>5: The acceleration/deceleration time constants may be too short for friction estimation. (warning)</p> <p>6: The operation time may be insufficient. (warning)</p> <p>[Bit 4 to 7: Friction estimation status at reverse rotation] <sup>*1*2</sup></p> <p>0: Estimation in progress. (normal)</p> <p>1: Estimation has finished. (normal)</p> <p>2: The motor may have rotated more frequently in one direction than the other. (warning)</p> <p>3: The servo motor speed may be too slow for friction estimation. (warning)</p> <p>4: The change in the servo motor speed may be too small for friction estimation. (warning)</p> <p>5: The acceleration/deceleration time constants may be too short for friction estimation. (warning)</p> <p>6: The operation time may be insufficient. (warning)</p> <p>[Bit 8 to 11: Vibration estimation status]</p> <p>0: Estimation in progress.</p> <p>1: Estimation has finished.</p> <p>[Bit 12 to 15: reserved]</p>
2C21h	0	VAR	Static friction torque at forward rotation	<p>The static friction at forward rotation torque is returned.</p> <p>Unit: 0.1 % (with rated torque being 100 %)</p>
2C22h	0	VAR	Dynamic friction torque at forward rotation (at rated speed)	<p>The dynamic friction at forward rotation torque at the rated speed is returned.</p> <p>Unit: 0.1 % (with rated torque being 100 %)</p>
2C23h	0	VAR	Static friction torque at reverse rotation	<p>The static friction at reverse rotation torque is returned.</p> <p>Unit: 0.1 % (with rated torque being 100 %)</p>
2C24h	0	VAR	Dynamic friction torque at reverse rotation (at rated speed)	<p>The dynamic friction at reverse rotation torque at the rated speed is returned.</p> <p>Unit: 0.1 % (with rated torque being 100 %)</p>
2C25h	0	VAR	Oscillation frequency during motor stop	<p>The vibration frequency during stop/servo-lock is returned.</p> <p>Unit: [Hz]</p>
2C26h	0	VAR	Vibration level during motor stop	<p>The vibration level during stop/servo-lock is returned.</p> <p>Unit: 0.1 % (with rated torque being 100 %)</p>
2C27h	0	VAR	Oscillation frequency during motor operating	<p>The vibration frequency during operation is returned.</p> <p>Unit: [Hz]</p>
2C28h	0	VAR	Vibration level during motor operating	<p>The vibration level during operation is returned.</p> <p>Unit: 0.1 % (with rated torque being 100 %)</p>
2C31h	0	VAR	Friction estimate status	<p>The progress of friction estimation is returned.</p> <p>Unit: [%]</p>

\*1 When warning conditions for 2 to 6 are established at the same time, the smallest number is returned.

\*2 Once an estimation finishes even after a warning has occurred, the status will change to "Estimation has finished".

## 4.4 Drive recorder

This function continuously monitors the servo amplifier status and records the state transition before and after an alarm for a fixed period of time.

By using MR Configurator2 via a network or USB connection, the data recorded inside the servo amplifier can be read in order to analyze alarms.

An engineering tool (such as GX LogViewer and MR Configurator2) can be used to display monitor and waveform data, and reference to servo parameter data and output files in the drive recorder.

MR Configurator2 with software version 1.110Q or later supports saving data in GX LogViewer format (JSON file) with the graph function or drive recorder function.

- When using MR Configurator2

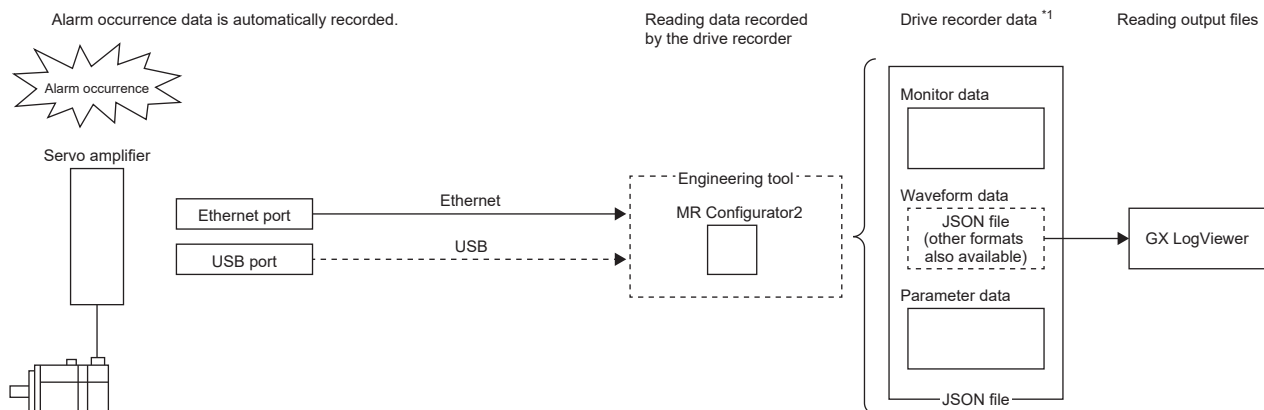

\*1 Drive recorder data can be saved as a JSON file.

- When using GX LogViewer

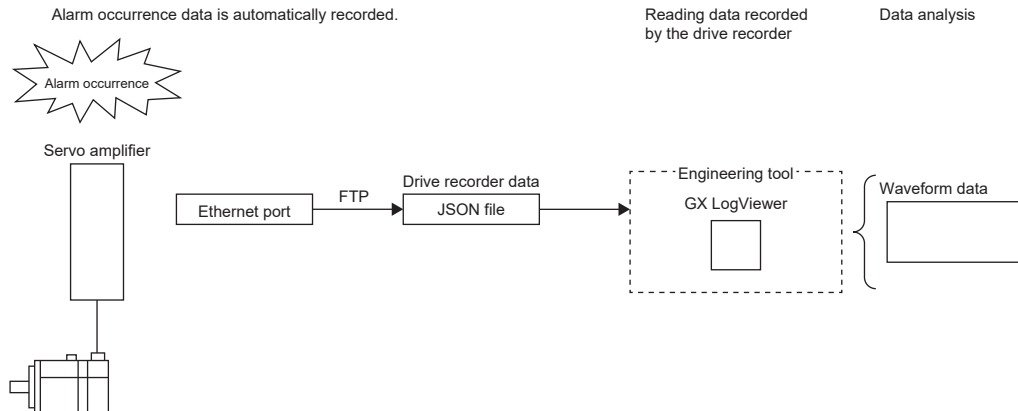

### Restriction

- The drive recorder does not operate in the following cases.
  - When using the graph function with an engineering tool.
  - When using the machine analyzer function.
  - When [Pr. PF21 Drive recorder switching time setting] is set to "-1" (Drive recorder function disabled).
- To read recorded data from the drive recorder by using the FTP server function, use a network supporting the function.
- When the drive recorder data (JSON) files on the server are listed by using the FTP server function, the file size will appear as 0 bytes.

## Precautions

- When using the graph function with an engineering tool, the drive recorder function cannot be used. To use the drive recorder function, wait until the time set in [Pr. PF21 Drive recorder switching time setting] passes, cycle the power of the servo amplifier, or perform the software reset after using the graph function.
- If the sampling cycle of an analog trigger or digital trigger is too long, the establishment of the trigger may not be able to be detected. In that case, shorten the sampling cycle.
- If the power supply of the servo amplifier is turned off during data storage of the drive recorder (immediately after alarm occurrence), data at alarm occurrence may not be recorded normally.
- The storage area of the servo amplifier has a limit for the number of writings. When using the manual setting mode with the drive recorder, be sure to consider the number of writings.
- If the drive recorder detects a trigger, the next trigger cannot be detected until the data has been saved.
- In the initial settings, recorded data cannot be read from the drive recorder by using the FTP server function. Change the setting of "drive recorder data readout permission selection" in the network parameter "authorization level". For information on account settings and network parameters, refer to "NETWORK FUNCTION".

Page 215 NETWORK FUNCTION

## Specification outline

A specification outline of the drive recorder is shown in this section.

The drive recorder contains the automatic setting mode that uses factory settings and the manual setting mode that collects waveforms by optionally setting the trigger condition, sampling cycle, and other areas with the servo parameters.

In the automatic setting mode, when an alarm occurs in the servo amplifier, conditions of the servo amplifier (such as the servo motor speed and droop pulses) before/after alarm occurrence are recorded. Also, by setting the drive recorder to operate only when a specific alarm occurs, data suitable for the alarm number that has occurred can be acquired. This mode is useful for investigating the cause of alarm occurrence by automatically shortening the sampling period in the vicinity of the alarm occurrence trigger.

Any condition can be set in the manual setting mode, making it useful for acquiring the waveform of a specific condition.

Item	Automatic setting mode	Manual setting mode
Number of channels *1	Analog 32 bits × 7 channels + digital 1 bit × 8 channels	
Maximum number of records	1024	
Sampling cycle *2	Varies depending on [Pr. PA23 Drive recorder desired alarm trigger setting].	250 μs/500 μs/1 ms/2 ms/4 ms/8 ms/16 ms/32 ms/64 ms/128 ms/256 ms/512 ms/1024 ms
Number of history entries	16	
Trigger condition	Alarm trigger *3	Alarm trigger *3/Analog trigger/Digital trigger
Trigger position	90 %	0 to 100 %
Auxiliary recording data *4	Instantaneous monitor data, system configuration display data, servo parameters	

\*1 For data that can be collected, refer to [Pr. PF90 Drive recorder - Analog channel setting 1] to [Pr. PF97 Drive recorder - Digital channel setting 4].

\*2 Depending on the timing of the data update, the on/off timing of the digital signal may appear to deviate.

\*3 For alarms that are triggered, refer to the following.

 Page 174 Waveform recording inapplicable alarm list

\*4 For auxiliary recording data, refer to the following. In addition, if the trigger established is other than the alarm trigger, "Alarm occurrence data" is not saved.

 Page 175 List of auxiliary recording data

## How to use the function

### Point

The automatic setting mode is enabled for the drive recorder function in the factory settings. If the initial setting does not meet your needs, set [Pr. PA23 Drive recorder desired alarm trigger setting] and collect data suitable for analyzing the occurrence factors of alarms. If satisfactory data cannot be obtained, use the manual setting mode to collect the necessary data.

When an alarm occurs, data of the generated alarm is recorded inside the servo amplifier. By reading the recorded data, the cause of the alarm can be analyzed. The operation status of the drive recorder can be monitored using [Drive recorder status (Obj. 2C02h)]. An outline of the time and other factors from when the drive recorder data was recorded can be checked by using [Drive recorder history newest (Obj. 2A70h)] to [Drive recorder history15 (Obj. 2A7Fh)].

Refer to the following for using the manual setting mode to record with any data and trigger.

 Page 164 Saving the drive recorder data in manual setting mode

## Method of reading recorded data

Drive recorder data can be read with an engineering tool (MR Configurator2) via a network or USB connection.

A connection example is shown below.

- Transferring files with direct connection or via a hub (Ethernet/MR Configurator2)

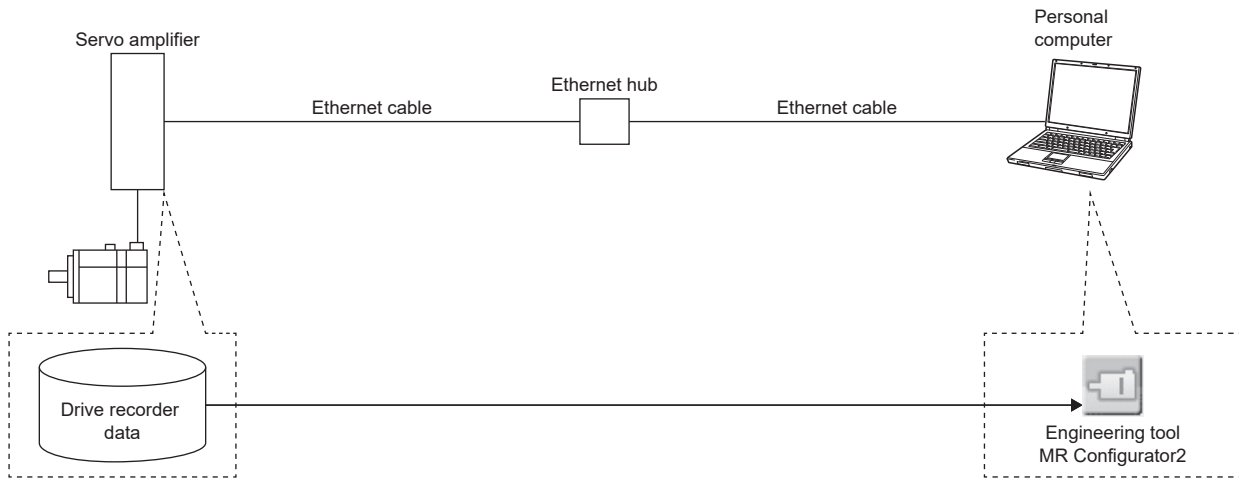

- Transferring files with direct connection (USB/MR Configurator2)

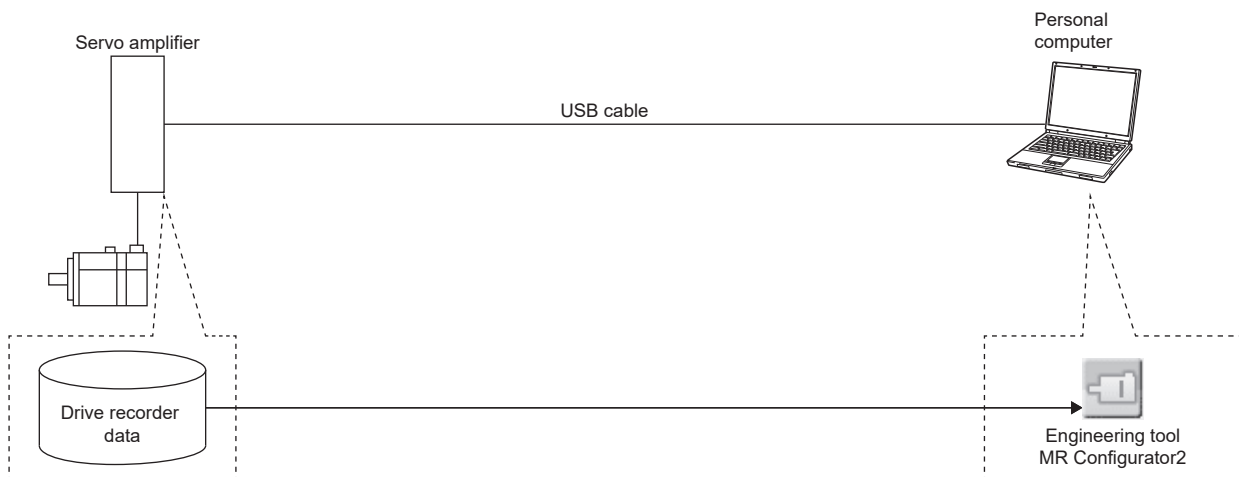

- Transferring files with direct connection or via a hub (Ethernet/GX LogViewer)

To read recorded data from the drive recorder by using the FTP server function, use a network supporting the function.

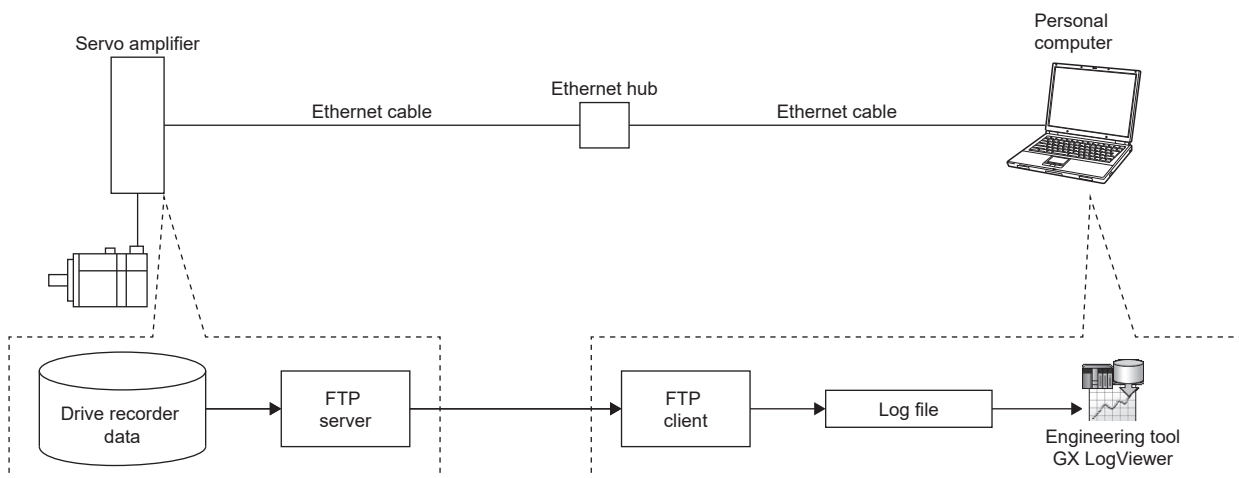

## ■Reading recorded data via a network

When reading the recorded data from the drive recorder via a network, use the engineering tool or the FTP server function. The read data can be checked with GX LogViewer. The data is saved in a file as shown below.

Path	Remark
/drvrec/dr1_nnnn.json	"nnnn" represents a serial number of the drive recorder data. When data is recorded in the drive recorder, the number will increase. If the number exceeds 9999, it will return to 0 and increase again. The number corresponds with the value of Drive recorder history index in the object dictionary. The file size varies depending on the log data.

## ■Read recorded data via a USB connection

When connecting the servo amplifier and the personal computer via a USB connection, read the drive recorder data using an engineering tool (MR Configurator2).

## Recorded data deletion method

Drive recorder record data saved inside the servo amplifier are saved up to a maximum of 16 history entries. When 16 history entries are exceeded, the oldest recorded data will be overwritten. To delete the drive recorder data recorded inside the servo amplifier, use [Pr. PF98.0 Drive recorder - Clear history selection] or [Clear drive recorder history (Obj. 2C03h)]. Drive recorder record data can also be deleted by clicking the history clear button on the drive recorder screen of the engineering tool (MR Configurator2).

## Saving the drive recorder data in manual setting mode

### Precautions

- The storage area of the servo amplifier has a limit for the number of writings. When using the drive recorder with [Pr. PF81.0] set to "2" (continuous sampling), consider the number of write times.

## ■Record with desired data and triggers

1. Set [Pr. PF80.0 Drive recorder - Operation mode selection] to "1" (manual setting mode).
2. Set the sampling cycle, trigger condition, and other areas with servo parameters.

Item	Servo parameter	Reference
Sampling cycle	[Pr. PF80.2-3]	☞ Page 165 Servo parameters
Trigger condition	[Pr. PF82] to [Pr. PF86]	
Channels for sampling	[Pr. PF87] to [Pr. PF94]	

3. Set [Pr. PF81.0 Drive recorder - Sampling start selection] to "1" (start a single sampling) or "2" (continuous sampling start). Sampling starts.

## ■Reconfiguring parameters

Servo parameters that set the sampling cycle, trigger condition, and other areas cannot be changed during sampling. Use the following procedure to change these parameters.

1. Set [Pr. PF81.0] to "0" (stop sampling) and stop sampling.
2. Set the sampling cycle, trigger condition, and other areas with servo parameters.

Item	Servo parameter	Reference
Sampling cycle	[Pr. PF80.2-3]	☞ Page 165 Servo parameters
Trigger condition	[Pr. PF82] to [Pr. PF86]	
Channels for sampling	[Pr. PF87] to [Pr. PF94]	

3. Set [Pr. PF81.0] to "1" or "2". Sampling starts.

## ■Return to automatic setting mode

To save in the automatic setting mode, set [Pr. PF80.0] to "0" (automatic setting). The automatic setting mode operates automatically.

# Servo parameter/object dictionary

This section shows the servo parameters and object dictionary related to the drive recorder.

If [Pr. PF80.0 Drive recorder - Operation mode selection] = "0" (automatic setting mode) (initial value), the setting values of [Pr. PF81 Drive recorder - Sampling operation selection] to [Pr. PF94 Drive recorder - Digital channel setting 4] are disabled. The drive recorder operates automatically with the alarm trigger.

## Servo parameters

Servo parameter	Symbol	Name	Outline
PF80.0	DRMC	Drive recorder - Operation mode selection	Select the operation mode of drive recorder. 0: Automatic setting mode (initial value) 1: Manual setting mode
PF80.2-3	DRMC	Drive recorder - Sampling cycle selection	Set the sampling cycle. 00: Automatic (250 µs) (initial value) 05: 250 µs 06: 500 µs 07: 1 ms 08: 2 ms 09: 4 ms 0A: 8 ms 0B: 16 ms 0C: 32 ms 0D: 64 ms 0E: 128 ms 0F: 256 ms 10: 512 ms 11: 1.024 s
PF81.0	DRMS	Drive recorder - Sampling start selection	Select to start sampling in manual setting mode. 0: Stop sampling (initial value) 1: Start a single sampling 2: Start a consecutive sampling
PF82.0	DRTM	Drive recorder - Trigger mode selection	Select the trigger mode. 0: Alarm trigger (initial value) 1: Analog trigger/digital trigger
PF82.1	DRTM	Drive recorder - Trigger binding condition selection	Select the binding condition of the trigger. 0: Disabled (initial value) 1: Logical AND of trigger signals 2: Logical OR of trigger signals
PF82.2	DRTM	Drive recorder - Trigger operation selection 1	Select if sampling starts when the channel set in [Pr. PF84.0-1 Drive recorder - Trigger channel selection 1] exceeds the set trigger level (rising) or starts when it falls below the set trigger level (falling). 0: Rising (initial value) 1: Falling
PF82.3	DRTM	Drive recorder - Trigger operation selection 2	Select if sampling starts when the channel set in [Pr. PF84.2-3 Drive recorder - Trigger channel selection 2] exceeds the set trigger level (rising) or starts when it falls below the set trigger level (falling). 0: Rising (initial value) 1: Falling
PF84.0-1	DRTC	Drive recorder - Trigger channel selection 1	Set trigger channel No. 1. Initial value: 01h (Analog channel 1) *1
PF84.2-3	DRTC	Drive recorder - Trigger channel selection 2	Set trigger channel No. 2. Initial value: 81h (Digital channel 1) *1
PF84.4-5	DRTC	Drive recorder - Trigger position setting	For the total sampling time, set the trigger position in hexadecimal from 0 to 100 %. Initial value: 5Ah (90 [%])
PF85	DRTL1	Drive recorder - Trigger level setting 1	Set the trigger level of [Pr. PF84.0-1 Drive recorder - Trigger channel selection 1] in decimal. Initial value: 0
PF86	DRTL2	Drive recorder - Trigger level setting 2	Set the trigger level of [Pr. PF84.2-3 Drive recorder - Trigger channel selection 2] in decimal. Initial value: 0

Servo parameter	Symbol	Name	Outline
PF87.0-2	DRAC1	Drive recorder - Analog channel 1 selection	Set the data to be assigned to analog channel 1. Initial value: 201h (Servo motor speed +) *2
PF87.4-6	DRAC1	Drive recorder - Analog channel 2 selection	Set the data to be assigned to analog channel 2. Initial value: 002h (Torque/instantaneous torque) *2
PF88.0-2	DRAC2	Drive recorder - Analog channel 3 selection	Set the data to be assigned to analog channel 3. Initial value: 003h (Current command) *2
PF88.4-6	DRAC2	Drive recorder - Analog channel 4 selection	Set the data to be assigned to analog channel 4. Initial value: 204h (Droop pulses (1 pulse unit) +) *2
PF89.0-2	DRAC3	Drive recorder - Analog channel 5 selection	Set the data to be assigned to analog channel 5. Initial value: 205h (Speed command +) *2
PF89.4-6	DRAC3	Drive recorder - Analog channel 6 selection	Set the data to be assigned to analog channel 6. Initial value: 009h (Bus voltage) *2
PF90.0-2	DRAC4	Drive recorder - Analog channel 7 selection	Set the data to be assigned to analog channel 7. Initial value: 00Ch (Effective load ratio) *2
PF91.0-3	DRDC1	Drive recorder - Digital channel 1 selection	Set the data to be assigned to digital channel 1. Initial value: 0000h (CSON) *3
PF91.4-7	DRDC1	Drive recorder - Digital channel 2 selection	Set the data to be assigned to digital channel 2. Initial value: 0012h (EM2/1) *3
PF92.0-3	DRDC2	Drive recorder - Digital channel 3 selection	Set the data to be assigned to digital channel 3. Initial value: 8010h (ALM2) *3
PF92.4-7	DRDC2	Drive recorder - Digital channel 4 selection	Set the data to be assigned to digital channel 4. Initial value: 8005h (INP) *3
PF93.0-3	DRDC3	Drive recorder - Digital channel 5 selection	Set the data to be assigned to digital channel 5. Initial value: 800Ah (MBR) *3
PF93.4-7	DRDC3	Drive recorder - Digital channel 6 selection	Set the data to be assigned to digital channel 6. Initial value: 8000h (RD) *3
PF94.0-3	DRDC4	Drive recorder - Digital channel 7 selection	Set the data to be assigned to digital channel 7. Initial value: 8015h (STO) *3
PF94.4-7	DRDC4	Drive recorder - Digital channel 8 selection	Set the data to be assigned to digital channel 8. Initial value: 801Dh (IPF) *3
PF95.0	**DRCLR	Drive recorder - Clear history selection	When enabled is selected, the drive recorder history will be cleared at either the next power cycle or at software reset. 0: Disabled (initial value) 1: Enabled
PF21	DRT	Drive recorder switching time setting	Set the drive recorder switching time. When the USB communication is disconnected during the use of the graph function, the function will be switched to the drive recorder function after the time set in this servo parameter has passed. Initial value: 0 (switched after 10 s)
PA23.0-1	DRAT	Alarm detail number setting	To execute the trigger with a desired alarm detail number, set [Pr. PF80.0 Drive recorder - Operation mode selection] = "0" (automatic setting mode) or [Pr. PF82.0 Drive recorder - Trigger mode selection] = "0" (alarm trigger) in [Pr. PF80.0] = "1" (manual setting mode). At "00", only the optional alarm number setting will be enabled. Initial value: 00h
PA23.2-4	DRAT	Alarm number setting	To execute the trigger with a desired alarm number, set [Pr. PF80.0 Drive recorder - Operation mode selection] = "0" (automatic setting mode) or [Pr. PF82.0 Drive recorder - Trigger mode selection] = "0" (alarm trigger) in [Pr. PF80.0] = "1" (manual setting mode). When "000" is set, arbitrary alarm trigger of the drive recorder will be disabled. Initial value: 000h

\*1 Refer to the following for setting values.

☞ Page 167 Trigger channel selection

\*2 Refer to the following for setting values.

☞ Page 168 Analog channel

\*3 Refer to the following for setting values.

☞ Page 170 Digital channel



## ■ Trigger channel selection

Setting value	Meaning
01	Analog channel 1
02	Analog channel 2
03	Analog channel 3
04	Analog channel 4
05	Analog channel 5
06	Analog channel 6
07	Analog channel 7
81	Digital channel 1
82	Digital channel 2
83	Digital channel 3
84	Digital channel 4
85	Digital channel 5
86	Digital channel 6
87	Digital channel 7
88	Digital channel 8

## ■Analog channel

Setting value	Data type	Unit <sup>*1</sup>	Category
000	No assigned function	—	—
001	Servo motor speed	r/min	16-bit data
002	Torque/instantaneous torque	0.1 %	
003	Current command	0.1 %	
005	Command pulse frequency (speed unit)	r/min	
007	Droop pulses (1 pulse unit)	pulse	
008	Speed command	r/min	
009	Bus voltage	V	
00C	Effective load ratio	0.1 %	
00D	Regenerative load ratio	0.1 %	
00E	Position within one-revolution	16 pulse	
00F	ABS counter	rev	
010	Load to motor inertia ratio	0.01 times	
011	Torque equivalent to disturbance	0.1 %	
012	Overload alarm margin	0.1 %	
014	Settling time	ms	
015	Overshoot amount	pulse	
01C <sup>*4</sup>	Load-side encoder droop pulses (1 pulse unit)	pulse	
01E <sup>*4</sup>	Motor-side/load-side position deviation (1 pulse unit)	pulse	
020 <sup>*4</sup>	Motor-side/load-side speed deviation	r/min	
021	Servo motor speed (unit of 0.1 r/min)	0.1 r/min	
022	Command pulse frequency (speed unit of 0.1 r/min)	0.1 r/min	
023	Speed command (unit of 0.1 r/min)	0.1 r/min	
024	Torque command	0.1 %	
025	Speed limit value	r/min	
026	Speed limit value (unit of 0.1 r/min)	0.1 r/min	
035	Internal temperature of encoder	°C	
03B <sup>*4</sup>	Load-side encoder information 1	16 pulse	
03C <sup>*4</sup>	Load-side encoder information 2	rev	
03D <sup>*3</sup>	Command number	LSB	
049	Operation mode	LSB	
04C <sup>*2</sup>	U-phase current feedback (unit of the rated current)	0.1 %	
04D <sup>*2</sup>	V-phase current feedback (unit of the rated current)	0.1 %	
04E <sup>*2</sup>	W-phase current feedback (unit of the rated current)	0.1 %	

Setting value	Data type	Unit <sup>*1</sup>	Category
201	Servo motor speed +	0.1 r/min	32-bit data
202	Command pulse frequency +	kpulse/s	
203	Command pulse frequency (speed unit) +	0.1 r/min	
204	Droop pulses (1 pulse unit) +	pulse	
205	Speed command +	0.1 r/min	
206	Position within one-revolution +	pulse	
207 <sup>*4</sup>	Load-side encoder information 1 +	pulse	
208 <sup>*4</sup>	Load-side encoder information 2 +	rev	
209 <sup>*4</sup>	Load-side droop pulses +	pulse	
20A <sup>*5</sup>	Controller position command +	pulse	
20B	Feedback position +	pulse	
20C	Excessive error alarm margin +	pulse	
20D <sup>*3</sup>	Current position (positioning unit) +	pos units	
20E <sup>*3</sup>	Command position (positioning unit) +	pos units	
20F <sup>*3</sup>	Command remaining distance (positioning unit) +	pos units	
218	Droop pulses (100 pulses unit) +	100 pulse	
219 <sup>*4</sup>	Load-side encoder droop pulses (100 pulses unit) +	100 pulse	
21A	Excessive error alarm margin (100 pulses unit) +	100 pulse	
21B	Droop pulses (model position deviation) +	pulse	
21F <sup>*5</sup>	Motor-side/load-side position deviation (100 pulses unit) +	100 pulse	
220	Speed command 2 +	0.1 r/min	
23C	Droop pulses (command unit) +	pulse	

\*1 "mm/s" is used instead of "r/min" for linear servo motors.

\*2 Available on servo amplifiers with firmware version B0 or later.

\*3 Available on servo amplifiers with firmware version B8 or later.

\*4 Available on servo amplifiers with firmware version C4 or later.

\*5 Available on servo amplifiers with firmware version D4 or later.

## ■ Digital channel

Setting value	Symbol	Name	Classification	
0000	CSON	Servo-on command	DI	
0001	LSP	Forward rotation stroke end		
0002	LSN	Reverse rotation stroke end		
0005	PC	Proportional control		
0006	RES	Reset		
0012	EM2/1	Forced stop		
0013	CRDY	Ready-on command		
0016 *1	STO1	STO1		
0017 *1	STO2	STO2		
001A	CDP2	Gain switching selection 2		
001B	CDP	Gain switching selection		
001C *5	CLD	Fully closed loop selection		
0034 *5	TPR1	Touch probe 1		
0035 *5	TPR2	Touch probe 2		
0036 *5	TPR3	Touch probe 3		
0049	CFLS	Controller upper stroke limit signal being inputted		
004A	CRLS	Controller lower stroke limit signal being inputted		
8000	RD	Ready		DO
8001	SA	Speed reached		
8002	ZSP	Zero speed detection		
8003	TLC	Limiting torque		
8004	VLC	Limiting speed		
8005	INP	In-position completion		
8007	WNG	Warning		
8008	ALM	Malfunction		
8009	OP	Z-phase output		
800A	MBR	Electromagnetic brake interlock		
800B	DB	External dynamic brake		
800F	BWNG	Battery warning		
8010	ALM2	Malfunction 2		
8013	RDY	In ready-on state		
8015 *1	STO	In STO state		
8016	SMPD	Magnetic pole detection completion		
8017	ZPASS	Z-phase already passed		
8018	CDPS2	Variable gain enabled 2		
8019	CDPS	Variable gain enabled		
801A *5	CLDS	Fully closed loop control in progress		
801B	ABSV	Absolute position erased		
801D	IPF	Instantaneous power failure		
801E	SPC	Proportional control in progress		
801F	MTTR	Tough drive in progress		
8032	DOG	DOG signal input in progress		
803C *3	DOA	General-purpose output A		
803D *3	DOB	General-purpose output B		
803E *3	DOC	General-purpose output C		
8043 *2	CPO	Rough match		
8045 *2	POT	Position range		
8047 *4	MEND	Traveling completion		
8049	ZP2	Homing completion 2		

- \*1 This signal cannot be used.
- \*2 Available on servo amplifiers with firmware version B2 or later.
- \*3 Available on servo amplifiers with firmware version B6 or later.
- \*4 Available on servo amplifiers with firmware version B8 or later.
- \*5 Available on servo amplifiers with firmware version C4 or later.

## Object dictionary

For details on the objects, refer to the User's Manual (Object Dictionary).

Index	Sub	Object	Name	Description
2C02h	00h	VAR	Drive recorder status	Returns the operating status of the drive recorder.
2A70h	00h	ARRAY	Drive recorder history newest	Returns the total number of Sub Indexes.
	01h		Drive recorder history index	Returns the saved index of the drive recorder. *1
	02h		Drive recorder history alarm number	Returns the number of the alarm that occurred when data was recorded using the drive recorder.
	03h		Drive recorder history power on time	Returns the power-on cumulative time when data was recorded using the drive recorder.
	04h		Drive recorder history time (second)	Returns the recording time of the drive recorder as a 32-bit integer (time passed from January 1, 1970, 0:00:00.000000000).
	05h		Drive recorder history time (nanosecond)	Returns the digits after the ones indicating seconds in the recording time of the drive recorder as a 32-bit integer.
	06h		Drive recorder history (time zone)	Returns the time zone when data was recorded using the drive recorder.
	07h		Drive recorder history (summer time)	Returns the daylight saving time when data was recorded using the drive recorder.
2A71h	00h	ARRAY	Drive recorder history 1	Returns the total number of Sub Indexes.
	01h		Drive recorder history index	Returns the saved index of the drive recorder. *1
	02h		Drive recorder history alarm number	Returns the number of the alarm that occurred when data was recorded using the drive recorder.
	03h		Drive recorder history power on time	Returns the power-on cumulative time when data was recorded using the drive recorder.
	04h		Drive recorder history time (second)	Returns the recording time of the drive recorder as a 32-bit integer (time passed from January 1, 1970, 0:00:00.000000000).
	05h		Drive recorder history time (nanosecond)	Returns the digits after the ones indicating seconds in the recording time of the drive recorder as a 32-bit integer.
	06h		Drive recorder history (time zone)	Returns the time zone when data was recorded using the drive recorder.
	07h		Drive recorder history (summer time)	Returns the daylight saving time when data was recorded using the drive recorder.
:	:	:	:	:
2A7Fh	00h	ARRAY	Drive recorder history 15	Returns the total number of Sub Indexes.
	01h		Drive recorder history index	Returns the saved index of the drive recorder. *1
	02h		Drive recorder history alarm number	Returns the number of the alarm that occurred when data was recorded using the drive recorder.
	03h		Drive recorder history power on time	Returns the power-on cumulative time when data was recorded using the drive recorder.
	04h		Drive recorder history time (second)	Returns the recording time of the drive recorder as a 32-bit integer (time passed from January 1, 1970, 0:00:00.000000000).
	05h		Drive recorder history time (nanosecond)	Returns the digits after the ones indicating seconds in the recording time of the drive recorder as a 32-bit integer.
	06h		Drive recorder history (time zone)	Returns the time zone when data was recorded using the drive recorder.
	07h		Drive recorder history (summer time)	Returns the daylight saving time when data was recorded using the drive recorder.
2C03h	00h	VAR	Clear drive recorder history	Writing "1EA5h" clears the drive recorder history. When the data is read, "0000h" is returned.

\*1 [Drive recorder history index] displays drive record data using consecutive numbers from 0 to 9999. When data is recorded in the drive recorder, the number will increase. If the number exceeds 9999, it will return to 0 and increase again.

# Standard acquisition waveform list

When [Pr. PF80.0 Drive recorder - Operation mode selection] is set to "0" (automatic setting mode), the acquired data is changed by [Pr. PA23 Drive recorder desired alarm trigger setting]. If [Pr. PA23] is set to the initial value (0000000h), the data shown in the "Standard" section of the following table is saved.

If the alarm numbers described in the following table are set with [Pr. PA23], the data in each alarm number section will be saved.

Measurement data with "+" added to the name refers to data with an extended measurement data range and units.

Trigger condition	Data 1	Data 2	Data 3	Data 4	Data 5	Data 6	Data 7	Data 8	Sampling cycle	Measurement time
Standard	Servo motor speed +	Torque	Current command	Droop pulses (1 pulse) +	Speed command +	Bus voltage	Effective load ratio	—	0.500 ms	512 ms
	CSON	EM2/EM1	ALM2	INP	MBR	RD	STO <sup>*1</sup>	IPF		
AL. 010	Servo motor speed +	Torque	Current command	Droop pulses (1 pulse) +	Speed command +	Bus voltage	Effective load ratio	—	0.500 ms	512 ms
	CSON	EM2/EM1	ALM2	INP	MBR	RD	STO <sup>*1</sup>	IPF		
AL. 020	Servo motor speed +	Torque	ABS counter	Position within one-revolution	Current command	Encoder error counter 1	Encoder error counter 2	—	0.500 ms	512 ms
	CSON	EM2/EM1	ALM2	INP	MBR	RD	STO <sup>*1</sup>	IPF		
AL. 021	Servo motor speed +	Torque	ABS counter	Position within one-revolution	Current command	Encoder error counter 1	Encoder error counter 2	—	0.500 ms	512 ms
	CSON	EM2/EM1	ALM2	INP	MBR	RD	STO <sup>*1</sup>	IPF		
AL. 024	Servo motor speed +	Torque	Current command	Position within one-revolution	Bus voltage	U-phase current feedback	V-phase current feedback	—	0.500 ms	512 ms
	CSON	EM2/EM1	ALM2	INP	MBR	RD	STO <sup>*1</sup>	IPF		
AL. 030	Servo motor speed +	Torque	Current command	Droop pulses (1 pulse) +	Bus voltage	Regenerative load ratio	Effective load ratio	—	32 ms	32768 ms
	CSON	EM2/EM1	ALM2	INP	MBR	RD	STO <sup>*1</sup>	IPF		
AL. 031	Servo motor speed +	Torque	Current command	Command pulse frequency +	Position within one-revolution	Speed command +	Bus voltage	—	0.500 ms	512 ms
	CSON	EM2/EM1	ALM2	INP	MBR	RD	STO <sup>*1</sup>	IPF		
AL. 032	Servo motor speed +	Torque	Current command	Bus voltage	Effective load ratio	U-phase current feedback	V-phase current feedback	—	0.250 ms	256 ms
	CSON	EM2/EM1	ALM2	INP	MBR	RD	STO <sup>*1</sup>	IPF		
AL. 033	Servo motor speed +	Torque	Current command	Speed command +	Bus voltage	Regenerative load ratio	Effective load ratio	—	2 ms	2048 ms
	CSON	EM2/EM1	ALM2	INP	MBR	RD	STO <sup>*1</sup>	IPF		
AL. 035	Servo motor speed +	Torque	Current command	Command pulse frequency +	Droop pulses (1 pulse) +	Speed command	Bus voltage	—	0.500 ms	512 ms
	CSON	EM2/EM1	ALM2	INP	MBR	RD	STO <sup>*1</sup>	IPF		
AL. 042	Servo motor speed +	Torque	Motor-side/load-side position deviation (100 pulses) + <sup>*3</sup>	Motor-side/load-side speed deviation	Command pulse frequency (speed unit) +	Droop pulses (100 pulses) +	Load-side droop pulses (100 pulses) +	—	0.500 ms	512 ms
	CSON	EM2/EM1	ALM2	INP	MBR	RD	STO <sup>*1</sup>	IPF		

Trigger condition	Data 1	Data 2	Data 3	Data 4	Data 5	Data 6	Data 7	Data 8	Sampling cycle	Measurement time
AL. 046	Servo motor speed +	Torque	Current command	Internal temperature of encoder	Temperature of servo motor thermistor	Bus voltage	Effective load ratio	—	32 ms	32768 ms
	CSON	EM2/EM1	ALM2	INP	MBR	RD	STO *1	IPF		
AL. 050	Servo motor speed +	Torque	Current command	Droop pulses (100 pulses) +	Overload alarm margin	Bus voltage	Effective load ratio	—	32 ms	32768 ms
	CSON	EM2/EM1	ALM2	INP	MBR	RD	STO *1	IPF		
AL. 051	Servo motor speed +	Torque	Current command	Droop pulses (100 pulses) +	Overload alarm margin	Bus voltage	Effective load ratio	—	32 ms	32768 ms
	CSON	EM2/EM1	ALM2	INP	MBR	RD	STO *1	IPF		
AL. 052	Servo motor speed +	Torque	Current command	Droop pulses (100 pulses) +	Speed command	Bus voltage	Excessive error alarm margin *2	—	2 ms	2048 ms
	CSON	EM2/EM1	ALM2	INP	MBR	RD	STO *1	TLC		

\*1 Not available on this servo amplifier.

\*2 For servo amplifiers with firmware version earlier than B6, "overload alarm margin" data is obtained.

\*3 For servo amplifiers with firmware version earlier than D4, "0" is obtained.

## Waveform recording inapplicable alarm list

Alarms that are not covered in the alarm history are not subject to recording by the drive recorder. For details, refer to the following manual.

 MR-JET User's Manual (Troubleshooting)

The alarms shown in the following table are saved in the alarm history, but are not subject to recording by the drive recorder. The drive recorder does not operate in this case.

Alarm No.	Name
010.1	Voltage drop in the control circuit power
012	Memory error 1
016	Encoder initial communication error 1
017	Board error
019	Memory error 3
01A	Servo motor combination error
01E	Encoder initial communication error 2
01F	Encoder initial communication error 3
025	Absolute position erased
119	Memory error 4

In addition, data may not be recorded when the following alarms occur depending on the circumstances of the alarm occurrence.

Alarm No.	Name
013	CPU error
014	Control process error



## List of auxiliary recording data

A list of auxiliary record data saved by the drive recorder is shown.

### Instantaneous monitor data

The instantaneous monitor data is saved in the vicinity of the trigger condition establishment.

### System configuration display data

The system configuration display data saved by the drive recorder is as follows. Incompatible items are hidden.

Name	Outline
Servo amplifier identification information	The identification information for the servo amplifier is displayed.
Servo amplifier serial No.	Indicates the serial No. of the servo amplifier.
Servo amplifier S/W No.	The servo amplifier S/W No. is displayed.
MAC address	Indicates the MAC address of the servo amplifier.
IP address	Indicates the IP address of the servo amplifier.
Motor model	The model of the servo motor is displayed.
Motor ID	Indicates the servo motor ID.
Motor serial No.	Indicates the serial number of the servo motor.
Encoder resolution	The encoder resolution is displayed. For the linear servo motor control mode, the resolution per electrical angle 360° is displayed.
Accumulated power-on time [h]	Indicates the accumulated power-on time on an hourly basis [h].
Number of inrush relay on/off times [times]	Indicates the number of inrush relay on/off times.
LED display	Indicates the contents of the servo amplifier display (LED).

### Servo parameter

Servo parameters, such as those for the PA, PB, and PC groups, are saved in the drive recorder.

## 4.5 Software reset

Software reset is a function to reset the internal status of the servo amplifier and obtain the same effect as cycling the power. By performing the software reset, the setting of the servo parameters can be reflected without cycling the power.

### Restriction

- In the case of an alarm caused by hardware failure, thermal protection or other factors, the alarm may not be canceled even if the software reset is performed.
- When MR Configurator2 is connected to the servo amplifier via a network, reconnection may not be possible if the software reset is performed after changing the setting of the network.

### Precautions

- Canceling alarms is not the main purpose of the software reset function. Use of this function is not recommended for alarms that would ordinarily be canceled by cycling the power.
- Perform the software reset while the servo motor is stopped.

## Software reset in MR Configurator2

The servo amplifier can be reset with the software reset button in MR Configurator2.

## Software reset via network communication

A software reset can be performed by using the remote reset of the controller. For details, refer to the following manual.

Network	Reference manual
CC-Link IE TSN	 MR-JET-G User's Manual (Communication Function)
CC-Link IE Field Network Basic	

## Software reset with an object

Available on servo amplifiers with firmware version C4 or later.

Writing "1EA5h" in [Software reset (Obj. 2D5Fh: 00h)] performs the software reset. If a value other than "1EA5h" is written, an error will be returned.

## 4.6 Software position limit

Specify the upper and lower limits of the command position and current position. If a command position exceeding the limit position is specified, the command position is clamped at the limit position. Specify the limit position relative to the machine home position (position address = 0).

The limit position includes [Home offset (Obj. 607Ch)]. Specify the limit position in consideration of the value in [Home offset (Obj. 607Ch)]. Refer to [Pr. PT08 Homing position data] for details.

[AL. 098 Software position limit warning] occurs when clamp processing is being performed with the command position exceeding the limit value. Operation can be resumed by giving a position command in the reverse direction of the reached software position limit.

In the cyclic synchronous position mode (csp), stop the command when the software position limit is detected. When the command position exceeds 32 bits (-2147483648 to 2147483647), [AL. 069 Command error] occurs. When the command position exceeds the limit range by 30 bits (-536870912 to 536870911), [AL. 069 Command error] also occurs.

If [AL. 069 Command error] occurs, the home position is erased. Perform homing again.

### Restriction

- This function is enabled in the cyclic synchronous position mode (csp), profile position mode (pp), point table mode (pt), and JOG operation mode (jg). This function is disabled during homing.

### Precautions

- At factory setting, the software position limit is disabled.
- The unit can be changed to 0.001 mm, 0.0001 inch, 0.001 degree, or pulses with the setting of [Pr. PT01.2 Unit for position data].
- Change the settings of this function during servo off, homing mode, velocity mode, and torque mode. When the setting is changed during servo-on in the position mode and positioning mode, [AL. 035 Command frequency error], [AL. 069 Command error], and [AL. 098 Software position limit warning] may occur.

## Setting method

### Servo parameter setting

Servo parameter	Symbol	Name	Outline
PT15	LMP	Software position limit +	Set the software position limit + value. Initial value: 0
PT17	LMN	Software position limit -	Set the software position limit - value. Initial value: 0

The enabling/disabling conditions of the software position limit are shown in the table below.

[Pr. PT01.2]	Conditions		
	[Pr. PT15] > [Pr. PT17]	[Pr. PT15] < [Pr. PT17]	[Pr. PT15] = [Pr. PT17]
0 (mm) 1 (inch) 3 (pulse)	Enabled	Disabled	Disabled
2 (degree)	Enabled	Enabled	Disabled

### ■When [Pr. PT01.2] is set to "2" (degree)

Set [Pr. PT17] as the starting point and [Pr. PT15] as the ending point.

The moving part can move from "-" to "+" in the CCW direction.

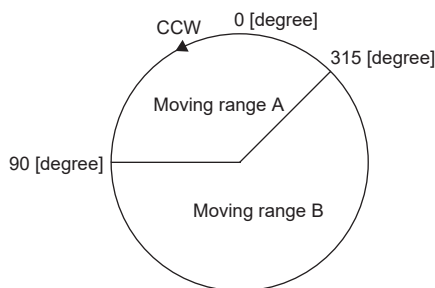

Set servo parameters as follows to specify moving range A.

- [Pr. PT17] = 315.000 degrees
- [Pr. PT15] = 90.000 degrees

Set servo parameters as follows to specify moving range B.

- [Pr. PT17] = 90.000 degrees
- [Pr. PT15] = 315.000 degrees

The setting range is 0 to 359.999 degrees. If a value out of the setting range is set, the value will be converted as shown in the table below. The values of the movable range are the values after conversion.

Setting value	After conversion
360.000 to 2147483.647 degrees	The remainder obtained by dividing the setting value by 360.000
-0.001 to -359.999 degrees	The value obtained by adding 360.000 to the setting value
-360.000 to -2147483.648 degrees	The value obtained by adding 360.000 to the remainder after dividing the setting value by 360.000

When the moving part moves into the range of the software position limit from outside the range, the moving direction is determined by which part of the non-movable area the moving part is in as shown in the following figure. The moving part can move only in the direction with the shortest distance to the movable area.

**Ex.**

When [Pr. PT17] is set to 315.000 degrees and [Pr. PT15] is set to 90.000 degrees:

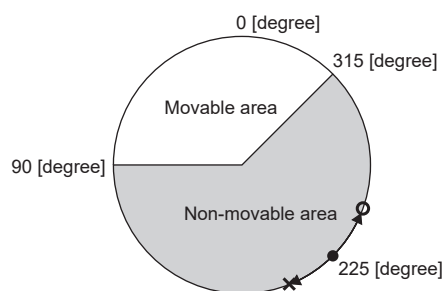
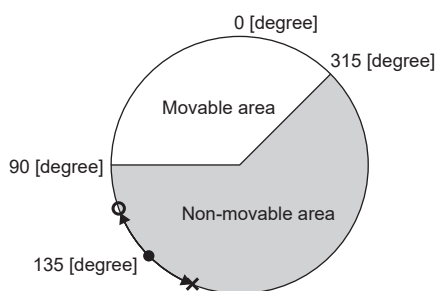

- The moving part can move.
- × The moving part cannot move.

## Related objects

The following table shows the related objects.

[Pr. PT15 Software position limit +] is used for [Max position limit (Obj. 607Dh: 02h)]. [Pr. PT17 Software Position Limit -] is used for [Min position limit (Obj. 607Dh: 01h)].

For details on the objects, refer to the User's Manual (Object Dictionary).

Index	Sub	Object	Name	Description
607Dh	0	ARRAY	Software position limit	Number of entries
	1		Min position limit *1	Specify the minimum value of the command position and current position relative to the machine home position (position address = 0). If the command position is below the minimum value, it is clamped to the minimum value which is used as the command position.
	2		Max position limit *1	Specify the maximum value of the command position and current position relative to the machine home position (position address = 0). If the command position exceeds the maximum value, it is clamped to the maximum value which is used as the command position.

\*1 When [Min position limit (Obj. 607Dh: 01h)] is set to a value greater than [Max position limit (Obj. 607Dh: 02h)], the function of [Software position limit (Obj. 607Dh)] is disabled.

# 4.7 Torque limit

The torque limit function limits the torque generated by the servo motor.  
The following torque limit can be set.

Item	Outline
Internal torque limit	The maximum torque is limited by the values of [Pr. PA11 Forward rotation torque limit] and [Pr. PA12 Reverse rotation torque limit].
Maximum torque limit 1	The maximum torque is limited by the value of [Max torque (Obj. 6072h)] according to the setting of [Pr. PC78.1 Maximum torque limit 1 selection].

### Restriction

- When setting the torque above the maximum torque of the servo motor, the torque is limited by the maximum torque of the servo motor.
- Servo parameters that are mapped to an object from the controller will overwrite those written from the engineering tool.

### Precautions

- If the torque limit is canceled during servo-lock, the servo motor may suddenly rotate, depending on the amount of the position deviation from the command position.
- When using the torque limit, check that [Pr. PB06 Load to motor inertia ratio/load to motor mass ratio] is set properly. Improper settings may cause an unexpected operation such as an overshoot.
- When [Pr. PA11 Forward rotation torque limit], [Pr. PA12 Reverse rotation torque limit], and [Pr. PE53 Maximum torque limit 1] are set to "0.0", no torque or thrust is generated.

# Setting method

## Servo parameter setting

The maximum torque is always limited by the values of [Pr. PA11 Forward rotation torque limit] and [Pr. PA12 Reverse rotation torque limit] during operation.

Set servo parameters in relation to the rated torque or continuous thrust as 100.0 [%].

Servo parameter	Symbol	Name	Outline
PA11	TLP	Forward rotation torque limit	Set the servo parameter when limiting the torque of the servo motor for CCW power running or CW regeneration, or when limiting the thrust of the linear servo motor for positive direction power running or negative direction regeneration.
PA12	TLN	Reverse rotation torque limit	Set the servo parameter when limiting the torque of the servo motor for CW power running or CCW regeneration, or when limiting the thrust of the linear servo motor for positive direction power running or negative direction regeneration.
PE53	TLMX1	Maximum torque limit 1	When [Pr. PC78.1 Maximum torque limit 1 selection] is set to "1" (enabled), the torque generated by the servo motor can be limited with this servo parameter.

## Relation between servo parameters and objects

[Pr. PA11] and [Pr. PA12] are used for [Positive torque limit value (Obj. 60E0h)] and [Negative torque limit value (Obj. 60E1h)]. For [Pr. PA14 Travel direction selection] and [Pr. PC29.3 Torque POL reflection selection], the relationship between objects and servo parameters that limit the torque changes as follows.

Setting value		[Pr. PA11 Forward rotation torque limit]	[Pr. PA12 Reverse rotation torque limit]
[Pr. PC29.3]	[Pr. PA14]		
0: Enabled	0	[Positive torque limit value (Obj. 60E0h)]	[Negative torque limit value (Obj. 60E1h)]
	1	[Negative torque limit value (Obj. 60E1h)]	[Positive torque limit value (Obj. 60E0h)]
1: Disabled	0	[Positive torque limit value (Obj. 60E0h)]	[Negative torque limit value (Obj. 60E1h)]
	1	[Positive torque limit value (Obj. 60E0h)]	[Negative torque limit value (Obj. 60E1h)]

[Pr. PC78.1] setting value	Torque limit set by [Max torque (Obj. 6072h)]
0: [Pr. PE53] Disabled	Disabled ([Max torque (Obj. 6072h)] returns the maximum torque of the servo motor.)
1: [Pr. PE53] Enabled	Enabled (The torque limit function set by [Pr. PE53] and [Max torque (Obj. 6072h)] is enabled.)

## Checking "Limiting torque" status

TLC (Limiting torque) and Bit 13 (S\_TLC) of [Status DO1 (Obj. 2D10h)] turn on when the servo motor torque reaches the torque that was limited by the forward rotation torque limit and the reverse rotation torque limit.

# 4.8 Speed limit

During the torque mode, this function serves to limit the servo motor speed in order not to generate excessive speed.

### Restriction

- Speed limit can be used only in the torque mode.
- When [Velocity limit value (Obj. 2D20h)] is mapped to cyclic communication, values written from engineering tools are overwritten from the controller.

### Precautions

- When the servo motor speed reaches the speed limit value, torque control may become unstable.

## Setting method

Set the maximum speed to [Pr. PT67 Speed limit]. The speed limit direction and torque command direction are the same direction. There is no speed limit in the torque command direction and the opposite direction. [Pr. PT67] is used for [Velocity limit value (Obj. 2D20h)].

Servo parameter	Symbol	Name	Outline
PT67	VLMT	Speed limit	Set the maximum speed for the torque mode. Initial value: 3000.00 [r/min], [mm/s]

If [Pr. PT01.1 Speed/acceleration/deceleration unit selection] is set to "1" (command unit/s), set the maximum speed in [Pr. PV21 Speed limit extension setting].

Servo parameter	Symbol	Name	Outline
PV21	VLMT E	Speed limit extension setting	Set the maximum speed for the torque mode. Initial value: 2147483647 [command unit/s]

## Checking "Limiting speed" status

When the servo motor speed reaches the speed set in [Pr. PT67 Speed limit], VLC (Limiting speed) and Bit 4 (S\_VLC) of [Status DO2 (Obj. 2D12h)] will turn on.



## 4.9 Degree unit

This unit is available on servo amplifiers with firmware version B6 or later.

### Summary

Using the degree unit enables positioning in modulo coordinates (axes of rotation).

#### Restriction

- This function cannot be used in the cyclic synchronous mode.
- This function cannot be used in the linear servo motor control mode. Enabling this function in the linear servo motor control mode will trigger [AL. 037 Parameter error].
- If using this function in the fully closed loop control mode, use a rotary encoder as a load-side encoder. Connecting a linear encoder will trigger [AL. 037].
- If the unit is set to "degree" in the profile position mode, relative position commands are disabled. Attempting to start positioning operation after bit 6 (abs/rel) of [Controlword (Obj. 6040h)] has been set to "1" (relative position command) will trigger [AL. 0F4.8 Control command input error warning] and the operation will not start.

4

### Precautions

- Setting the unit to "degree" will change the setting ranges of some objects.  
 Page 184 Position-related data when the unit is set to "degree"
- Use the electronic gear function to adjust the rotation amount of the servo motor relative to the position command (in degrees). If the number of encoder units is extremely small for the position command (in degrees), the servo motor may not rotate.

## Position-related data when the unit is set to "degree"

When the unit is set to "degree", position-related data is different as shown below.

For details on the objects, refer to the User's Manual (Object Dictionary).

Data	Description
[Target position (Obj. 607Ah)]	The range is -360000 to 360000. *1 If a value outside the range is set for absolute position commands, [AL. 0F4.4 Target position setting range error warning] will occur.
[Position actual value (Obj. 6064h)]	The range is 0 to 359999. *1 An absolute value appears regardless of the sign of [Target position].
[Position demand value (Obj. 6062h)] *2	The range is 0 to 359999. *1
[Min position limit (Obj. 607Dh: 01h)] [Max position limit (Obj. 607Dh: 02h)]	The range is 0 to 359999. If a value outside the range is set, the value will be clamped to the range 0 to 359999. *1
[Min position range limit (Obj. 607Bh: 01h)] [Max position range limit (Obj. 607Bh: 02h)]	The range is 0 to 359999. *1
[Home offset (Obj. 607Ch)]	The range is 0 to 359999. *1
[Touch probe pos1 pos value (Obj. 60BAh)] [Touch probe pos1 neg value (Obj. 60BBh)] [Touch probe pos2 pos value (Obj. 60BCh)] [Touch probe pos2 neg value (Obj. 60BDh)]	The range is 0 to 359999. *1
[Point data (Obj. 2801h: 01h)] to [Point data (Obj. 28FFh: 01h)]	The range is -360000 to 360000. *1
[Current position (Obj. 2B2Fh)]	The range is 0 to 359999. *1
[Command position (Obj. 2B30h)]	The range is 0 to 359999. *1
Home position shift distance	The range is 0 to 359999. If a value outside the range is set, the value will be clamped to the range 0 to 359999. *1
Homing position data	The range is 0 to 359999. If a value outside the range is set, the value will be clamped to the range 0 to 359999. *1
Travel distance after proximity dog	The range is 0 to 359999. If a value outside the range is set, the value will be clamped to the range 0 to 359999. *1
Position range output address	The range is 0 to 359999. If a value outside the range is set, the value will be clamped to the range 0 to 359999. *1

\*1 The unit is 0.001 degree.

\*2 This object may not be used depending on the network being used.

# Setting method

## Setting with servo parameters

### ■Degree unit selection

Set the unit to "degree" with [Pr. PT01.2 Unit for position data].

☞ Page 93 Position command unit selection function

### ■Degree unit rotation direction selection

Use [Pr. PT03.2 Degree unit rotation direction selection] to set the rotation direction for when the unit is set to "degree".

Servo parameter	Symbol	Name	Outline
PT03.2	*FTY	Degree unit rotation direction selection	Set the rotation direction when the unit is set to "degree". 0: Specified rotation direction (initial value) 1: Rotation in the direction with the shortest distance 2: Rotation in the address decreasing direction 3: Rotation in the address increasing direction

## Setting with object dictionary

Use [Positioning option code (Obj. 60F2h)] to set the rotation direction for when the unit is set to "degree". Change the setting while the servo motor is stopped (Target reached is on). If the setting is changed while the servo motor is rotating (Target reached is off), the new setting value will be reflected at a positioning start (bit 4 of Controlword is on) after Target reached is turned on.

For details on the objects, refer to the User's Manual (Object Dictionary).

Index	Sub	Object	Name	Description
60F2h	0	VAR	Positioning option code	Set positioning operation conditions.

The following table shows the bits of [Positioning option code] and the settings of [Pr. PT03 Feed function selection].

[Positioning option code]		[Pr. PT03.2]	Defining the rotation directions of axes of rotation
Bit 7	Bit 6		
0	0	0	Rotates to the target position in the direction specified with the sign of the position data.
0	1	2	Rotates in the address decreasing direction regardless of the sign of the position data. *1
1	0	3	Rotates in the address increasing direction regardless of the sign of the position data. *1
1	1	1	Rotates in the direction with the shorter distance from the current position to the target position. If the distance from the current position to the target position is the same in the CCW and CW directions, the servo motor rotates in the CCW direction. *1

\*1 Specifying absolute position commands will enable the setting. Specifying relative position commands will rotate the servo motor to the target position in the direction specified with the sign of the position data regardless of the setting.

# Sequence

The following shows the operation patterns according to the settings of [Positioning option code (Obj. 60F2h)].

## When disabling POL ([Pr. PA14 Travel direction selection] = 0)

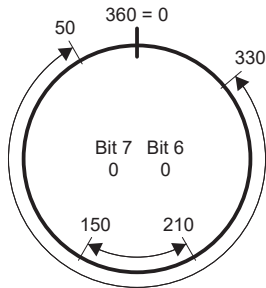

Rotation in the direction specified with the sign of the position data

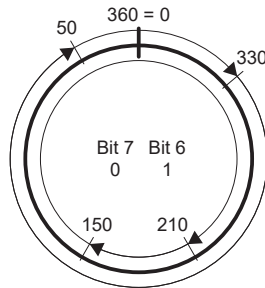

Rotation only in the address decreasing direction

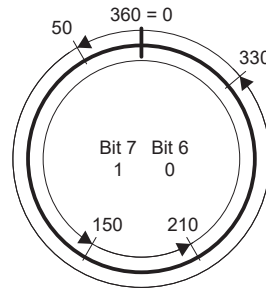

Rotation only in the address increasing direction

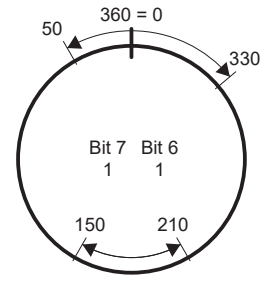

Rotation in the direction with the shortest distance

## When enabling POL ([Pr. PA14] = 1)

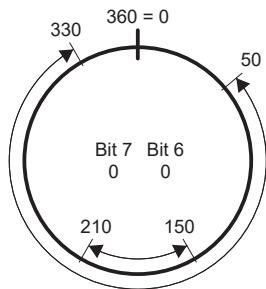

Rotation in the direction specified with the sign of the position data

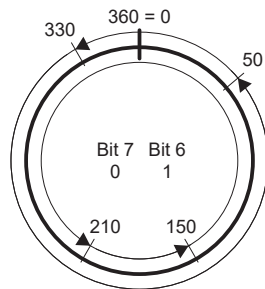

Rotation only in the address decreasing direction

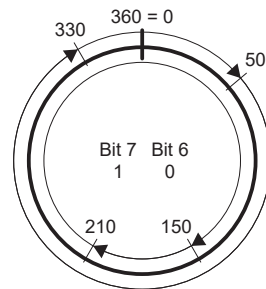

Rotation only in the address increasing direction

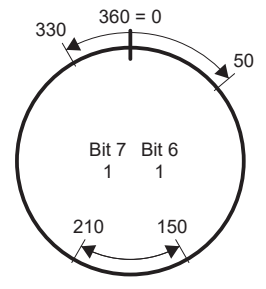

Rotation in the direction with the shortest distance

**When using the specified rotation direction ([Pr. PT03.2 Degree unit rotation direction selection] = 0)**

When the position data of 270.000 degrees (target position) is specified, the servo motor rotates in CCW direction.

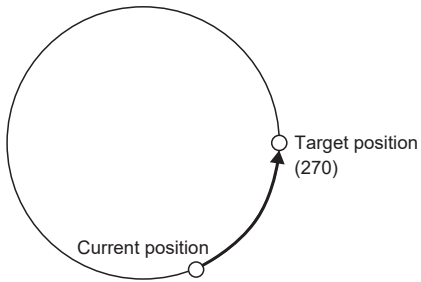

When the position data of -90.000 degrees (target position) is specified, the servo motor rotates in CW direction.

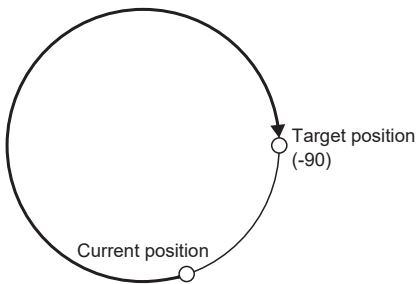

When the position data of -360.000 degrees (target position) is specified, the servo motor rotates in CW direction. (A)

When the position data of 360.000 degrees or 0 degree is specified, the servo motor rotates in CCW direction. (B)

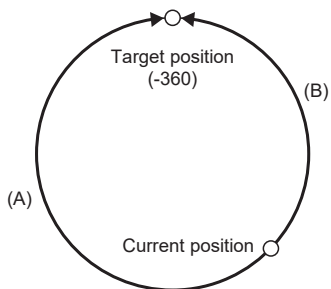

## When using the shortest distance ([Pr. PT03.2] = 1)

When the position data of 270.000 degrees (target position) is specified, the servo motor rotates in CCW direction.

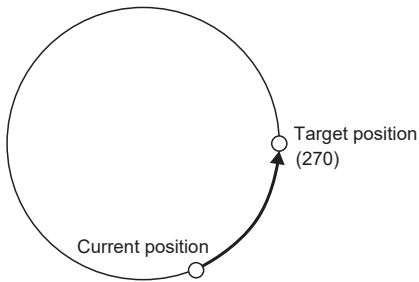

When the position data of -90.000 degrees (target position) is specified, the servo motor rotates in CCW direction.

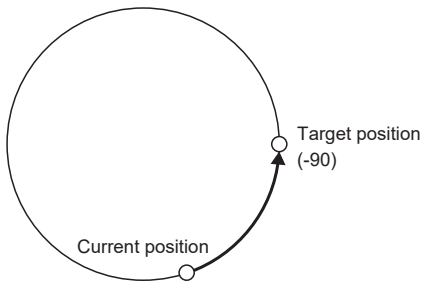

When the current position is 90 and the position data of 270.000 degrees (target position) is specified, the servo motor rotates in CCW direction since the distances in CCW direction and CW direction are the same.

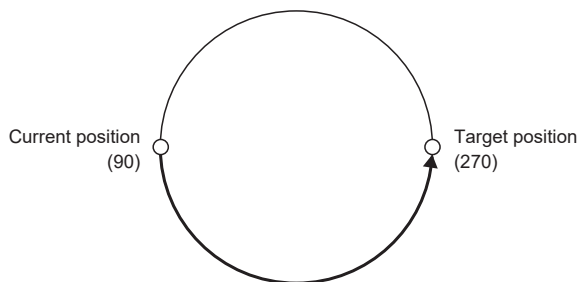

## When using the address decreasing direction ([Pr. PT03.2] = 2)

When the position data of 270.000 degrees (target position) is specified, the servo motor rotates in CW direction.

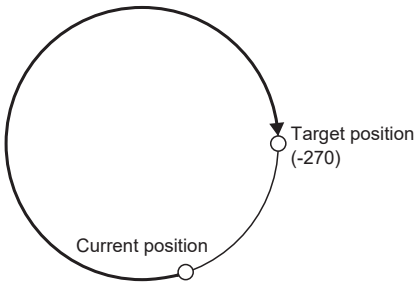

When the position data of -270.000 degrees (target position) is specified, the servo motor rotates in CW direction.

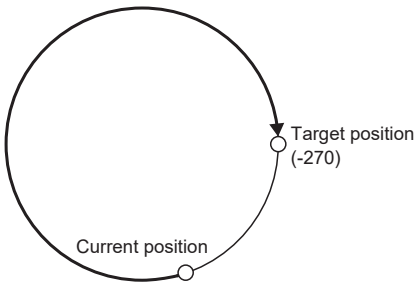

## When using the address increasing direction ([Pr. PT03.2] = 3)

When the position data of 270.000 degrees (target position) is specified, the servo motor rotates in CCW direction.

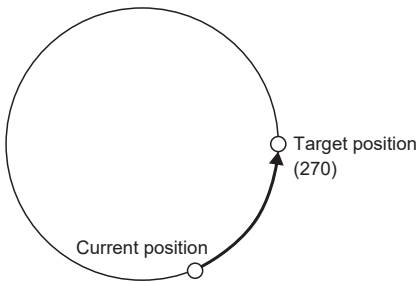

When the position data of -270.000 degrees (target position) is specified, the servo motor rotates in CCW direction.

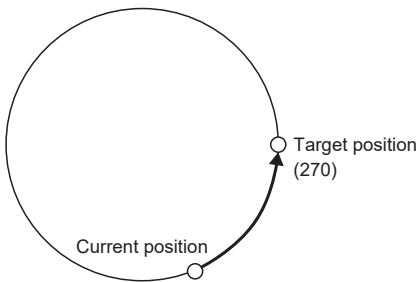

# 4.10 Infinite feed function

This section explains situations in which the function is used with CC-Link IE TSN and CC-Link IE Field Network Basic. For other networks, refer to the User's Manual (Communication Function).

## Outline

When this function is used in an absolute position detection system, even if the servo motor rotates 32768 rev or more in the same direction, [AL. 0E3.1 Multi-revolution counter travel distance exceeded warning] will not occur and the home position will not be erased. Therefore, the current position will be restored after the power is cycled.

When this function is not used, if the servo motor rotates 32768 rev or more in the same direction, [AL. 0E3.1] will occur and the home position will be erased.

### Restriction

- This function is available on servo amplifiers with firmware version B6 or later.
- To use this function, set the unit to "degree" with the servo amplifier.

☞ Page 183 Degree unit

## Setting method

Set the unit to "degree".

☞ Page 183 Degree unit

## When the servo motor rotates 32768 rev or more

The following table shows whether [AL. 0E3.1] will occur, the home position will be erased, and the current position will be restored when the servo motor rotates 32768 rev or more.

Control mode	Unit for position data	[AL. 0E3.1]	Home position	Current position
Cyclic synchronous mode	pulse	Will occur *1	Will be erased	Will not be restored
Profile mode	degree	Will not occur *1	Will not be erased	Will be restored
	pulse	Will occur *1	Will be erased	Will not be restored
Positioning mode (point table method)	mm	Will occur *1	Will be erased	Will not be restored
	inch	Will occur *1	Will be erased	Will not be restored
	degree	Will not occur *1	Will not be erased	Will be restored
	pulse	Will occur *1	Will be erased	Will not be restored

\*1 When [Pr. PC29.5 [AL. 0E3 Absolute position counter warning] selection] is set to "0" (disabled), [AL. 0E3.1] will not occur and the home position will not be erased. However, if "0" is set while the unit is other than "degree", the current position will not be restored correctly after the power is cycled. As this will result in an incorrect current position value, set [Pr. PC29.5] to "1" (enabled).

## When using the infinite feed function with a controller

When an absolute position detection system is configured in the cyclic synchronous mode with a Motion module manufactured by Mitsubishi Electric, set [Pr. PC29.5 [AL. 0E3 Absolute position counter warning] selection] to "0" (disabled).

For information on the controller, refer to "Absolute Position Control" in the following manual.

☞ MELSEC iQ-R Motion Module User's Manual (Application)



# 4.11 Servo amplifier life diagnosis function

The servo amplifier life diagnosis function is a function to diagnose the service life of the servo amplifier itself. The approximate service life of the servo amplifier being used can be determined. The servo amplifier life diagnosis function features the following functions.

## Cumulative energization time function

Displays the cumulative time that the power supply of the servo amplifier has been on for, starting at the time of shipment.



- To acquire the energization time, MR Configurator2 or a controller is required.

### Precautions

- The interval for recording the cumulative value of energization time is 10 minutes. When turning the servo amplifier off/on frequently within this time, there is a possibility that the cumulative value of energization time deviates from the actual value.
- This function displays the approximate service life. Since the service life varies by the method of use and environmental conditions, replace the servo amplifier after discovering an error.

### Setting method

No setting is required to use the cumulative energization time function. The servo amplifier always measures the energization time.

### Service life check method

#### ■How to check with MR Configurator2

When confirming the cumulative energization time value using MR Configurator2, open the life diagnosis screen of MR Configurator2. The cumulative energization time of the servo amplifier can be checked from the life diagnosis screen of MR Configurator2.

#### ■How to check with objects

When confirming the cumulative energization time value with the controller, obtain the following object.

For details on the objects, refer to the User's Manual (Object Dictionary).

Index	Sub	Object	Name	Description
2C18h	0	VAR	Power ON cumulative time	Returns the cumulative energization time of the servo amplifier. Unit: [h]

# Relay usage count display function

Displays the number of times the inrush relay has been turned on/off from the time of shipment.



- MR Configurator2 or a controller is required to acquire the number of times the inrush relay has been turned on/off.

## Precautions

- The interval for recording the number of on/off times of the inrush relay is 10 minutes. When turning the servo amplifier off/on frequently within this time, there is a possibility that the number of on/off times of the inrush relay and the usage count of the dynamic brake may deviate from the actual value.
- This function displays the approximate service life. Since the service life varies by the method of use and environmental conditions, replace the servo amplifier after discovering an error.

## Setting method

No setting is required to display the number of times the inrush relay has been turned on/off. The servo amplifier always measures the number of times the inrush relay has been turned on/off.

## Service life check method

### ■How to check with MR Configurator2

To check the number of times the inrush relay has been turned on/off with MR Configurator2, open the life diagnosis screen of MR Configurator2. From the life diagnosis screen of MR Configurator2, the number of times the inrush relay of the servo amplifier has been turned on/off and usage count of the dynamic brake can be checked.

### ■How to check with objects

When checking the number of times the inrush relay has been turned on/off and the number of times the dynamic brake has been stopped, obtain the following object.

For details on the objects, refer to the User's Manual (Object Dictionary).

Index	Sub	Object	Name	Description
2C19h	0	VAR	Number of inrush relay on/off times	Returns the number of times the inrush relay of the servo amplifier has been turned on/off. Unit: [times]
2C1Ah	0	VAR	Number of dynamic brake stop times	The number of times that the dynamic brake of the servo amplifier has been stopped is returned. Unit: [times]

# 4.12 Encoder communication diagnosis function

This servo amplifier has a function to diagnose the failure of the differential driver or receiver used for the encoder communication circuit.

By inputting the diagnostic signal to the encoder communication circuit, an error on the differential driver or receiver is detected.

An encoder communication alarm can be caused by many factors including noise, a servo amplifier failure, an encoder failure, or an encoder cable disconnection; as such, it takes time to identify the alarm cause. This function determines if the alarm is caused by a servo amplifier failure, which helps to identify the alarm cause promptly.

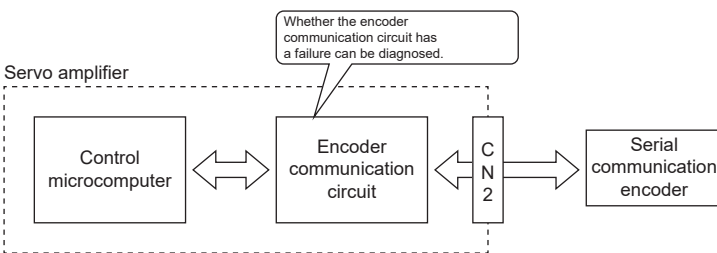

## Precautions

- When not using a two-wire type encoder cable, diagnose the encoder communication circuit with the encoder cable disconnected to prevent the encoder and the servo amplifier from malfunctioning.
- Remove the encoder cable with the power supply of the servo amplifier turned off.
- MR Configurator2 is required for this function.
- [AL. 118.1 Encoder communication circuit diagnosis in progress] occurs when the encoder communication circuit diagnosis is in progress.

## Usage

To enable the diagnosis mode, set "1" (enabled) in [Pr. PC05.4 Encoder communication circuit diagnosis mode selection] and cycle the power. Remove the encoder cable at power off. During the diagnosis mode, [AL. 118.1 Encoder communication circuit diagnosis in progress] occurs. Perform the diagnosis in accordance with the items displayed on the encoder communication circuit diagnosis screen of MR Configurator2.

Servo parameter	Symbol	Name	Outline
PC05.4	**COP2	Encoder communication circuit diagnosis mode selection	Enable or disable the encoder communication circuit diagnosis mode. [AL. 118.1 Encoder communication circuit diagnosis in progress] occurs during the encoder communication circuit diagnosis mode. 0: Encoder communication circuit diagnosis mode disabled 1: Encoder communication circuit diagnosis mode enabled Initial value: 0h

# 4.13 Disconnection/incorrect wiring detection function

## Output open-phase detection function

This function detects an open phase due to servo motor power supply cable (U/V/W) disconnection and generates [AL. 139 Open-phase error] after the detection.

### Restrictions

- The output open phase detection function will be disabled if an alarm or warning other than [AL. 139 Open-phase error] has occurred.
- If "1" is set in [Pr. PC05.0 Motor-less operation selection], output open phase will not be detected even if the output open-phase detection function has been enabled.
- If "0" (servo motor speed) is set in [Pr. PC19.6 Output open phase - Judgment speed selection], [AL. 139 Open-phase error] will only be detected in the servo-on state while the servo motor speed is 50 [r/min] (linear servo motor: 50 [mm/s]) or faster. The output open phase will not be detected even if the open phase of the servo motor power supply (U/V/W) occurs while in the servo-off state or if the servo motor speed is under 50 [r/min].
- If "1" (speed command) is set in [Pr. PC19.6 Output open phase - Judgment speed selection], [AL. 139 Open-phase error] will only be detected in the servo-on state while the command speed is 50 [r/min] or faster. The output open phase will not be detected even if the open phase of the servo motor power supply (U/V/W) occurs while in the servo-off state or if the command speed is under 50 [r/min].
- The output open-phase detection is not performed when MBR is on.
- If "1" (speed command) is set in [Pr. PC19.6 Output open phase - Judgment speed selection], the output open phase may be detected incorrectly when the servo motor axis is stopped due to a collision or similar impact.
- If [Pr. PA11 Forward rotation torque limit] and [Pr. PA12 Reverse rotation torque limit] are 10.0 % or less, the output open phase may be detected incorrectly when the servo motor load becomes too large.

### Precautions

- With the output open-phase detection function, detection is possible only when one of the U, V, or W phases is an open phase.

### Setting method

When [Pr. PC19.4 Output open-phase detection selection] is set to "1" (enabled), the output open-phase detection function will be enabled.

Servo parameter	Symbol	Name	Outline
PC19.4	*COP6	Output open-phase detection selection	Enable or disable the detection of output open-phase detection function. 0: Disabled (initial value) 1: Enabled
PC19.6	*COP6	Output open phase - Judgment speed selection	Select the judgment speed of the output open-phase detection function. 0: Servo motor speed (initial value) 1: Speed command In the torque control, set "0" (servo motor speed). When "1" (speed command) is set, [AL. 139.2 Output open-phase error] does not occur.

## 4.14 Overload protection (electronic thermal) function

---

An electronic thermal is built in the servo amplifier to protect the servo motor, servo amplifier and servo motor power wires from overloads.

Operation exceeding the overload protection characteristics will cause [AL. 050 Overload 1] or [AL. 051 Overload 2].

### Precautions

- After [AL. 050 Overload 1] or [AL. 051 Overload 2] occurs, allow about 30 minutes of cooling time.

# 4.15 Command offset

The command offset function compensates position/speed/torque commands by adding a desired offset amount to the commands. Position offset, velocity offset, and torque offset can be set.

Functions	Outline
Position offset	<ul style="list-style-type: none"><li>• In the position mode, an offset can be added to [Target position (Obj. 607Ah)].</li></ul>
Velocity offset	<ul style="list-style-type: none"><li>• In the velocity mode, an offset can be added to [Target velocity (Obj. 60FFh)].</li><li>• In the position mode and positioning mode, an offset (speed feed forward) can be added to the speed command calculated internally to drive the servo motor.</li></ul>
Torque offset	<ul style="list-style-type: none"><li>• In the torque mode and continuous operation to torque control mode, an offset can be added to [Target torque (Obj. 6071h)].</li><li>• In the position mode, positioning mode, and velocity mode, an offset (torque feed forward) can be added to the torque command calculated internally to drive the servo motor.</li></ul>

### Restriction

- The type of the command offset function that can be used differs depending on the control mode.

 Page 197 Applicable control modes

### Precautions

- If the offset value difference between position/velocity/torque offsets is too large, the servo motor may rotate due to the sudden change in torque when the control mode is switched. Check the setting value of the command offset function when switching modes.
- If the position/velocity/torque offset value is too large, the servo motor may rotate due to the sudden change in torque at servo-on. Check the setting value of the command offset function when switching modes.
- Set "0" for the command offset function while the servo amplifier is in the servo-off state, and reset the value after servo-on.
- [Torque offset (Obj. 60B2h)] can be used simultaneously with [Pr. PE47 Unbalanced torque offset]. If a value other than "0" is set for both the servo parameter and the object, the setting values of both [Torque offset (Obj. 60B2h)] and [Pr. PE47 Unbalanced torque offset] are added to the torque command.
- If the velocity offset is used in the position mode and positioning mode, a position deviation may occur at the command stop and positioning may not finish as a result.
- When using super trace control, do not use the velocity offset. To adjust the speed feed forward during super trace control, use [Pr. PB04 Feed forward gain].

## Setting method

Set the position offset with [Position offset (Obj. 60B0h)], the velocity offset with [Velocity offset (Obj. 60B1h)], and the torque offset with [Torque offset (Obj. 60B2h)].

For details on the objects, refer to the User's Manual (Object Dictionary).

Index	Sub	Object	Name	Description
60B0h	—	VAR	Position offset	Position offset Unit: pos units
60B1h	—	VAR	Velocity offset	Velocity offset Unit: vel units
60B2h	—	VAR	Torque offset	Torque offset Unit: 0.1 % (with rated torque being 100 %)

## Applicable control modes

The following shows enabled/disabled command offsets for each control mode. For control modes of which command offsets are disabled, the setting values of the disabled command offsets are invalid.

In the test operation mode, the command offset function is disabled.

Control mode	Command offset		
	Position offset	Velocity offset	Torque offset
Cyclic synchronous position mode (csp)	○	○	○
Cyclic synchronous velocity mode (csv)	—	○	○
Cyclic synchronous torque mode (cst)	—	—	○
Profile position mode (pp)	—	○	○
Profile velocity mode (pv)	—	○	○
Profile torque mode (tq)	—	—	○
Homing mode (hm)	—	—	—
Point table mode (pt)	—	○	○
JOG operation mode (jg)	—	○	○
Continuous operation to torque control mode (ct)	—	—	○

○: Enabled, —: Disabled

## Function block diagram

Page 14 CONTROL MODE

# 4.16 Excessive error alarm detection function

## Outline

The excessive error alarm detection function generates an alarm when the difference between the position command and the feedback position become large. The excessive error alarm trigger level can be changed with parameters.

## Setting method

The excessive error alarm trigger level can be changed with the following servo parameters.

Servo parameter	Symbol	Name	Outline
PC01	ERZ	Excessive error alarm trigger level	Set an excessive error alarm trigger level. If using a rotary servo motor, set the level in units of rev. If 200 rev or higher is set, the value will be clamped to 200 rev. If using a linear servo motor, set the level in units of mm. When the value is set to "0", the alarm trigger level for rotary servo motors is 3 rev. The alarm trigger level for linear servo motors is 100 mm. The unit can be changed with [Pr. PC06.3]. Initial setting: 0 (3 [rev] or 100 [mm])
PC06.3	*COP3	Excessive error alarm trigger level/excessive error warning trigger level - Unit selection	Select the unit used when setting the excessive error alarm trigger level in [Pr. PC01] and the excessive error warning trigger level in [Pr. PC38 Excessive error warning trigger level]. This servo parameter is enabled only in the position mode and positioning mode. 0: [rev] or [mm] 1: [0.1 rev] or [0.1 mm] 2: [0.01 rev] or [0.01 mm] 3: [0.001 rev] or [0.001 mm] Initial setting: 0 ([rev] or [mm])



# Excessive error alarm trigger level adjustment method

## Checking the excessive error alarm margin

Monitor the excessive error alarm margin using the graph function of MR Configurator2. The pulse of the excessive error alarm margin is at a maximum when the position command and feedback position match. [AL. 052 Excessive error] occurs when the excessive error alarm margin is 0 pulse. Calculate the differential pulse using the maximum and minimum pulses in "excessive error alarm margin".

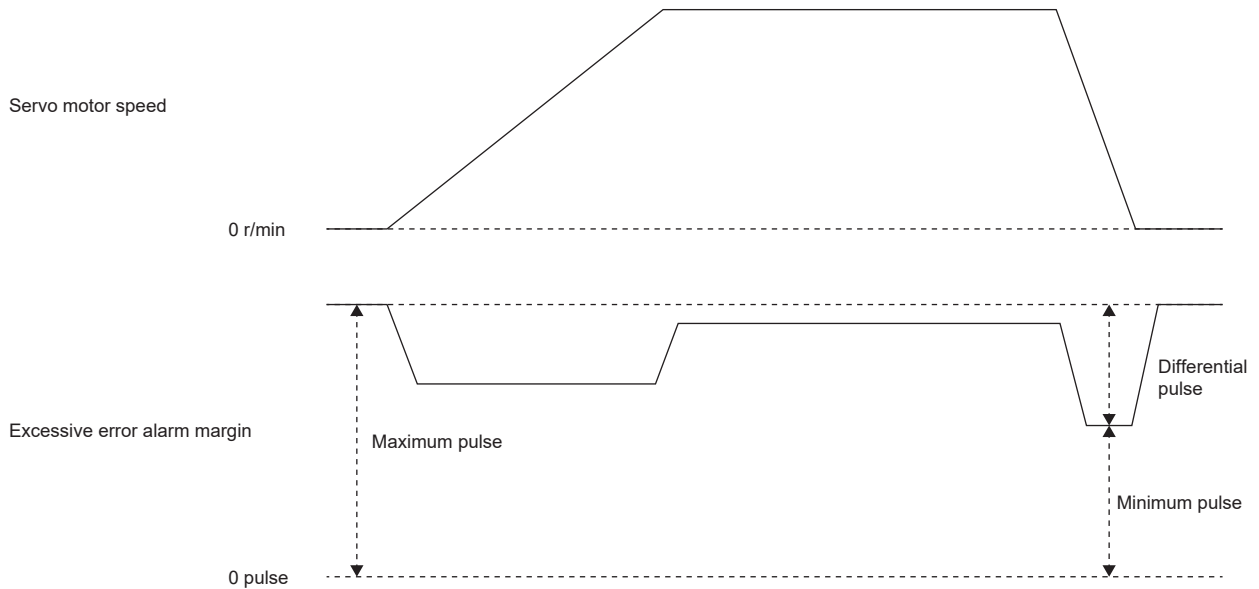

## Adjusting the excessive error alarm trigger level

Adjust the excessive error alarm trigger level with [Pr. PC01] and [Pr. PC06.3] so that the following calculation formula is satisfied.

$$[\text{Pr. PC01}] \times \text{unit set in } [\text{Pr. PC06.3}] > \text{Difference in excessive error alarm margin} / \text{resolution per revolution}$$

In the fully closed loop control mode, the resolution per revolution is the load-side encoder resolution.

When using a linear encoder, the value shown below is the resolution per revolution.

$$([\text{Pr. PL02 Linear encoder resolution setting} - \text{Numerator}] / [\text{Pr. PL03 Linear encoder resolution setting} - \text{Denominator}]) \times 1000$$

# 4.17 Override function

## Point

The override function can be used in the following modes.

- Point table mode (pt)
- JOG operation mode (jg)
- Homing mode (hm)
- Profile position mode (pp)

The override function cannot be used for the test operation (JOG operation and positioning operation) of MR Configurator2.

When using the override function, change the setting value of [Pr. PT38.1\_Override selection] to "3" (the override function is enabled).

When the value obtained by multiplying the command speed by the setting value of [Speed override (Obj. 2DB0h: 00h)] exceeds the maximum speed of the servo motor to be used, the actual servo motor speed is limited to the maximum speed of the servo motor to be used.

In the JOG operation mode (jg) or profile position mode (pp), the actual servo motor speed is calculated by multiplying the command speed set in [Profile velocity (Obj. 6081h)] limited by [Max profile velocity (Obj. 607Fh)] by the setting value of [Speed override (Obj. 2DB0h)].

The servo motor speed can be changed by using [Speed override (Obj. 2DB0h: 00h)]. The value obtained by multiplying the command speed by the setting value of [Speed override (Obj. 2DB0h: 00h)] is the actual servo motor speed.

## Setting method

### ■Setting with servo parameters

Servo parameter	Symbol	Name	Outline
PT38.1	**TOP7	Override selection	Select the override function. 0: The override function is disabled. 3: The override function is enabled.

### ■Setting with object dictionary

Index	Sub	Object	Name	Description
2DB0h	00h	VAR	Speed override	The override value is returned and set.
2D07h	00h	VAR	Control DI 7	The override setting is enabled when bit 7 (C_OVR) is on.

# Timing chart

## Point table mode

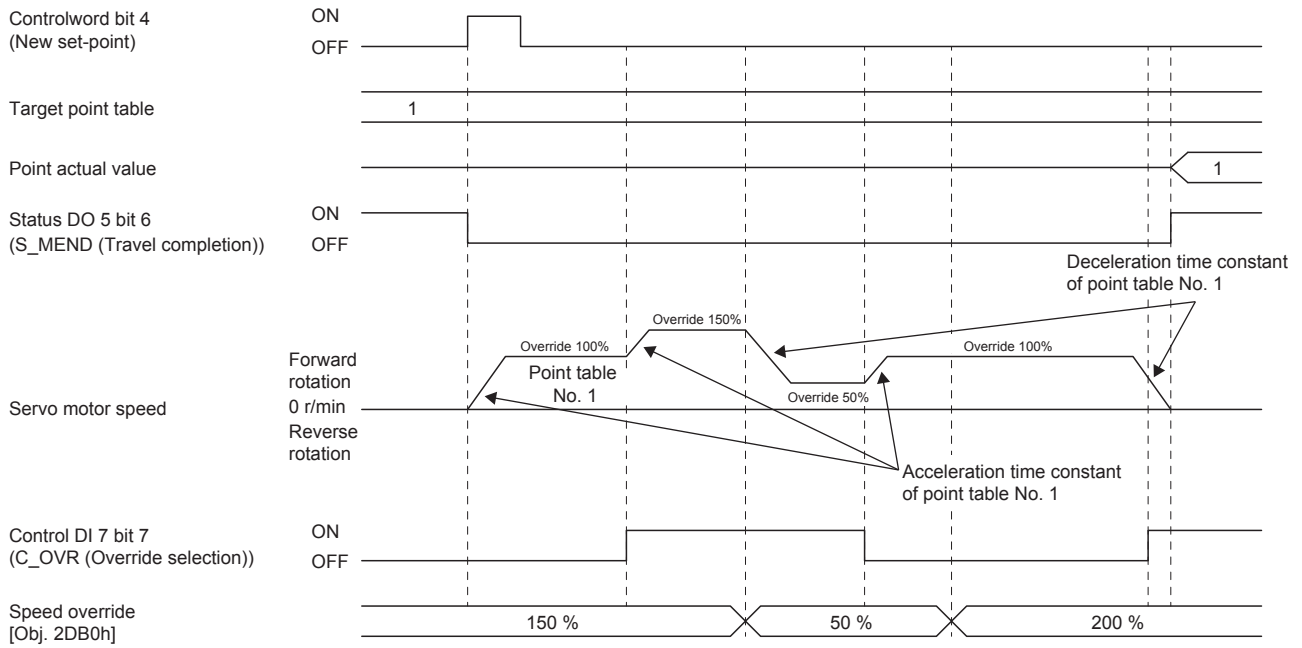

4

## Profile position mode (Single set-point)

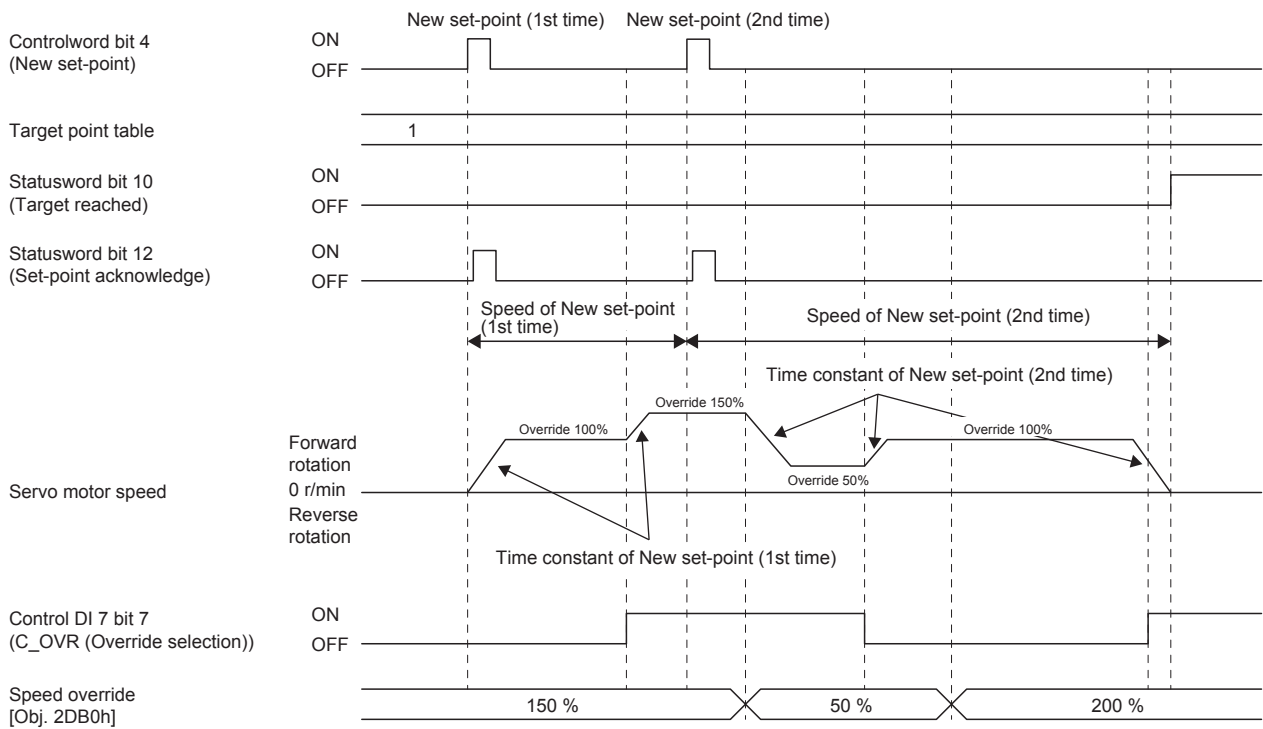

## ■ Point table mode (Set of set-points)

The following shows a timing chart when bit 9 (Change on set-point) of [Controlword (Obj. 6040h)] is "0".

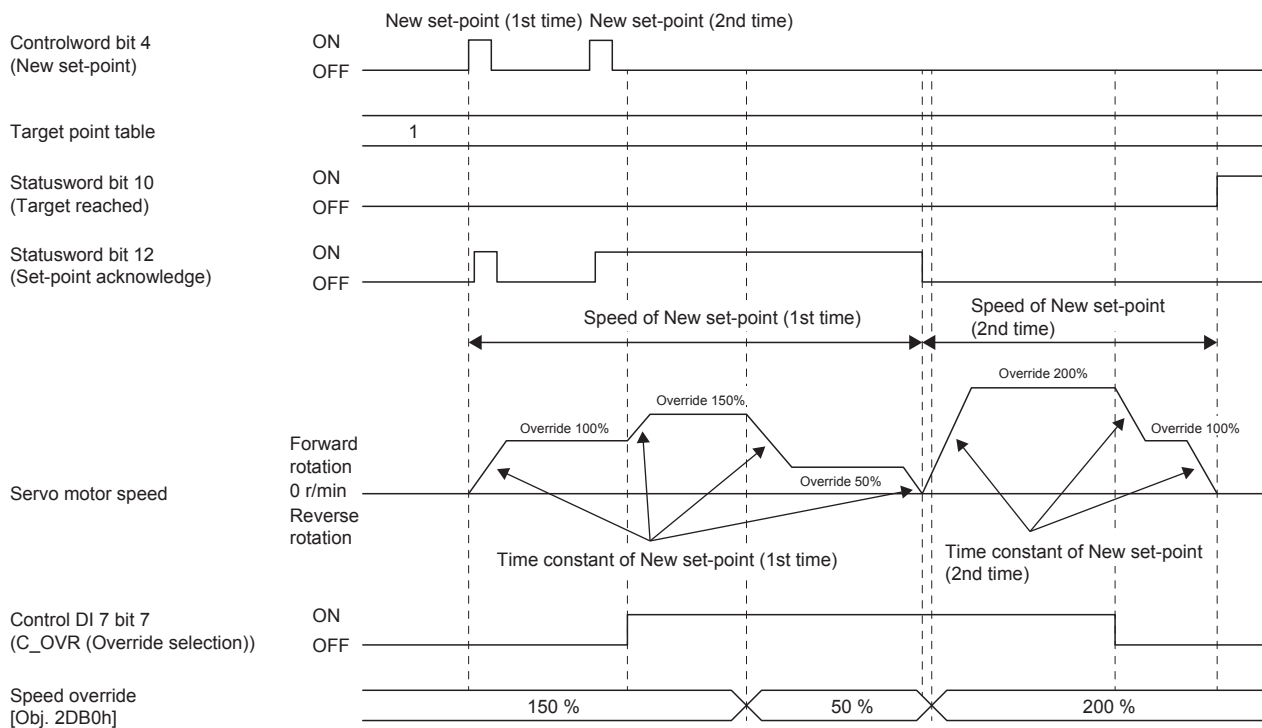

# 5 MONITORING

## Summary

The status of servo motor speed, torque, bus voltage, and other areas of the servo amplifier can be checked with the engineering tools. This chapter shows an example when using MR Configurator2 as the engineering tool.

Items that can be monitored with "Display All" can also be monitored by objects. For details, refer to User's Manual (Object Dictionary).

## 5.1 Explanation of monitor signals

The name and description of the monitor signals used in the servo amplifier and the signal block diagram are as follows.

### Name and description of the monitor signals

The following shows the types of monitor signals.

Monitor signal	Description
Monitor signal (analog)	The data, such as the servo motor speed, indicated in an analog form
Monitor signal (digital)	The data, such as INP (In-position), indicated by on and off of bits

This chapter shows the name and description of each monitor signal. The unit and other areas may differ depending on the control mode and display method. For "Display All" and the display of the graph in the monitor, refer to the following.

 Page 211 Checking with MR Configurator2

## Monitor signal (analog)

On MR Configurator2, the status of the monitor signal (analog) can be obtained by using the "Display All" function and the graph function.

Refer to the list in this section for the signals which can be obtained with the "Display All" function and the graph function.

Name	Description	Availability	
		Display All	Graph function
Cumulative feedback pulses	The feedback pulses from the servo motor encoder are counted and displayed. The displayed value is limited within the range of "-999999999 to 999999999". When the value exceeds the upper or lower limit, it changes to "0". The value is negative in reverse rotation. In the fully closed loop control mode, the value is in load-side encoder units with the gear taken into consideration. The fully closed loop control mode can be used for servo amplifiers with firmware version C4 or later.	○	—
Servo motor speed	The servo motor speed is displayed.	○	○
Droop pulses	The number of droop pulses in the deviation counter is displayed. The value is negative in reverse rotation. The number of pulses is displayed in the units of encoder pulses.	○	○
Cumulative command pulses	Position command input pulses are counted and displayed. The displayed value is limited within the range of "-999999999 to 999999999". When the value exceeds the upper or lower limit, it changes to "0". The value is negative under the reverse command. When other than "3" (pulse) is set in [Pr. PT01.2 Unit for position data], "0" is displayed.	○	—
Command pulse frequency	The frequency of the position command input pulses is displayed. When other than "3" (pulse) is set in [Pr. PT01.2 Unit for position data], "0" is displayed.	○	○
Command pulse frequency (speed unit)	The command pulse frequency is converted and displayed in the servo motor speed unit.	—	○
Regenerative load ratio	The ratio of regenerative power to permissible regenerative power is displayed as a percentage.	○	○
Effective load ratio	The continuous effective load current is displayed. The effective load ratio in relation to the rated current (= 100 %) is displayed.	○	○
Peak load ratio	The rated torque is displayed as 100 %. The maximum value of the torque generated in the past 15 seconds is displayed.	○	—
Torque/instantaneous torque	The instantaneous torque is displayed. The rated torque is displayed as 100 %. The value of the generated torque is displayed in real time.	○	○
Position within one-revolution	The position within one-revolution is displayed in the encoder pulse unit. In the fully closed loop control mode, the position within one-revolution is displayed in the servo motor encoder unit. The fully closed loop control mode can be used for servo amplifiers with firmware version C4 or later. For the linear servo motor control mode, the value of manufacturer setting is displayed. The linear servo motor control mode is available on servo amplifiers with firmware version A8 or later.	○	○
ABS counter	The travel distance from the home position is displayed as a multi-revolution counter value of the absolute position encoder in the absolute position detection system. For the fully closed loop control mode, the ABS counter is displayed in the servo motor encoder unit. The fully closed loop control mode can be used for servo amplifiers with firmware version C4 or later. For the linear servo motor control mode, the value of manufacturer setting is displayed. The linear servo motor control mode is available on servo amplifiers with firmware version A8 or later. For details, refer to "Checking the detected absolute position data" in the following manuals.  MR-JET User's Manual (Hardware)	○	○
Load to motor inertia ratio	The estimated ratio of the load inertia moment to the servo motor inertia moment is displayed.	○	○
Bus voltage	The bus voltage of the converter part of the servo amplifier (between P+ and N-) is displayed.	○	○
Load-side encoder cumulative feedback pulses *4	The feedback pulses from the load-side encoder are counted and displayed. The displayed value is limited within the range of "-999999999 to 999999999". When the value exceeds the upper or lower limit, it changes to "0". The value is negative in reverse rotation.	○	—

Name	Description	Availability	
		Display All	Graph function
Load-side encoder droop pulses <sup>*4</sup>	Droop pulses of the deviation counter between a load-side position and a command are displayed.	○	○
Load-side encoder information 1 <sup>*4</sup>	The following values are displayed for each encoder connected to the load-side. For a rotary servo motor, the position within one-revolution is displayed. For an absolute position linear encoder, absolute position data is displayed. For an incremental linear encoder, the Z-phase counter (distance from the linear encoder home position (reference mark)) (32-bit data) is displayed after the Z-phase is passed. The value before the Z-phase is passed is undefined. For an A/B/Z-phase differential output linear encoder, the Z-phase counter (distance from the linear encoder home position (Z-phase)) (16-bit data) is displayed after the Z-phase is passed. Before the Z-phase is passed, a free-run counter is displayed with the position where the power is turned on set as "0". For an A/B/Z-phase differential output rotary encoder, the position within one-revolution is displayed.	○	○
Load-side encoder information 2 <sup>*4</sup>	The following values are displayed for each encoder connected to the load-side. For a rotary servo motor, a multi-revolution ABS counter, that holds the counter value even when the power is cycled, is displayed. For an absolute position linear encoder, "0" is displayed. For an incremental linear encoder, "0" is displayed. For an A/B/Z-phase differential output linear encoder, "0" is displayed. For an A/B/Z-phase differential output rotary encoder, "0" is displayed.	○	○
Temperature of servo motor thermistor	The thermistor temperature is displayed for the servo motor with a thermistor. For the servo motors without a thermistor, "9999" is displayed. For the servo motor with a thermistor, refer to the user's manual for the servo motor being used.	○	○
Motor side cumulative F/B pulses (BeforeGear)	The feedback pulses from the servo motor encoder are counted and displayed. (Servo motor encoder unit) The displayed value is limited within the range of "-999999999 to 999999999". When the value exceeds the upper or lower limit, it changes to "0". The value is negative in reverse rotation.	○	—
Electrical angle	The servo motor electrical angle is displayed. For the linear servo motor control mode, the value of manufacturer setting is displayed. The linear servo motor control mode is available on servo amplifiers with firmware version A8 or later.	○	—
Motor/load side position deviation <sup>*4</sup>	The position deviation between the servo motor-side and load-side is displayed. This function can be used for fully closed loop control. The number of pulses is displayed in the load-side encoder unit.	○	○
Motor/load side speed deviation <sup>*4</sup>	The speed deviation between the servo motor-side and load-side is displayed. This function can be used for fully closed loop control.	○	○
Internal temperature of encoder	The internal temperature detected by the encoder is displayed. For the linear servo motor, "9999" is displayed.	○	○
Settling time	The period of time (settling time) from the completion of the command to INP (In-position) on is displayed.	○	○
Oscillation detection frequency	The frequency at the time of oscillation detection is displayed.	○	—
Number of tough drive operations	The number of times the tough drive function has activated is displayed.	○	—
Unit power consumption	The unit power consumption is displayed. A positive value is displayed during power running, and a negative value is displayed during regeneration.	○	—
Unit total power consumption	The unit total power consumption is displayed.	○	—
Excessive error alarm margin	The margin for the excessive error alarm trigger level is displayed in the encoder pulse unit. The excessive error alarm is triggered when the margin is 0 pulse.	—	○
Overload alarm margin	The margins for the alarm levels of [AL. 050 Overload 1] and [AL. 051 Overload 2] are displayed as a percentage.	—	○
Overshoot amount	The overshoot amount during position mode and positioning mode is displayed in units of encoder pulses.	—	○
Torque equivalent to disturbance	The difference between the necessary torque and the actually required torque (torque current value) to drive the servo motor is displayed as the torque equivalent to disturbance.	—	○
Current position <sup>*3</sup>	In the profile position mode (pp) and point table mode (pt), the current position of the command unit with the machine home position set as "0" is displayed. In other control modes, the current position of the command unit is displayed.	○	○

Name	Description	Availability	
		Display All	Graph function
Command position *3	In the profile position mode (pp) and point table mode (pt), the command current position with the machine home position set as "0" is displayed.	○	○
Controller position command *5	This indicates the position command from the controller in the cyclic synchronous position mode (csp).	—	○
Command remaining distance *3	In the profile position mode (pp) and point table mode (pt), the selected profile position or the remaining distance to the command position of the point table is displayed. In other control modes, "0" is displayed.	○	○
Command number *3	In the positioning mode (point table method), the selected point table number is displayed. In other control modes, "0" is displayed. The selected number is displayed during a temporary stop or in JOG operation mode.	○	○
Current command	This indicates the current command applied to the servo motor.	—	○
Speed command	This indicates the speed command being applied to the servo motor. In the position mode and positioning mode, the speed command calculated from the position command and command filter is displayed.	—	○
Torque command	The torque command in the torque mode or the target torque value in the continuous operation to torque control mode is displayed. "0" is displayed in the position mode, positioning mode, and velocity mode.	—	○
Speed limit value	The speed limit value in the torque mode or continuous operation to torque control mode is displayed. "0" is displayed in the position mode, positioning mode, and velocity mode.	—	○
U-phase current feedback *1	This indicates the U-phase current value applied to the servo motor in internal units.	—	—
V-phase current feedback *1	This indicates the V-phase current value applied to the servo motor in internal units.	—	—
Encoder error counter *1	This indicates the cumulative number of errors during communication with the encoder.	—	—
Load-side encoder error counter *1*4	This indicates the cumulative number of errors during communication with the load side encoder.	—	○
Operation mode	The control mode number of the servo amplifier indicated in [Modes of operation display (Obj. 6061h)] is displayed.	—	○
Droop pulses (model position deviation)	Droop pulses of the deviation counter between a servo motor-side position and a model position are displayed.	—	○
Speed command 2	This indicates the speed command being applied to the servo motor.	—	○
Droop pulses (command unit)	The number of droop pulses in the deviation counter is displayed. The number of pulses is displayed in the command unit.	—	○
U-phase current feedback (unit of the rated current) *2	The value of the U-phase current flowing in the servo motor is displayed in increments of 0.1 % in relation to the rated current as 100 %.	—	○
V-phase current feedback (unit of the rated current) *2	The value of the V-phase current flowing in the servo motor is displayed in increments of 0.1 % in relation to the rated current as 100 %.	—	○
W-phase current feedback (unit of the rated current) *2	The value of the W-phase current flowing in the servo motor is displayed in increments of 0.1 % in relation to the rated current as 100 %.	—	○
Feedback position	The current position of the servo motor is displayed.	—	○

\*1 This is selectable when using the drive recorder.

\*2 Available on servo amplifiers with firmware version B0 or later.

\*3 Available on servo amplifiers with firmware version B8 or later.

\*4 Available on servo amplifiers with firmware version C4 or later.

\*5 Available on servo amplifiers with firmware version D4 or later.



## Monitor signal (digital)

The status of the monitor signal (digital) can be obtained by using the I/O monitor and graph functions of MR Configurator2. As for DI/DO in the table, DI indicates the monitor signal (digital) inputted to a servo amplifier; DO indicates the monitor signal (digital) outputted from a servo amplifier.

The on/off status of DI is as follows:

- On: Either the external input signal or input from the controller is on.
- Off: The external input signal and the input from the controller are off.

Symbol	Device name	Description	DI/DO
ABSV	Absolute position erased	Refer to "Signal (device) explanation" in the following manual.	DO
ALM	Malfunction	☞MR-JET User's Manual (Hardware)	DO
BWNG	Battery warning		DO
WNGSTOP	Motor stop warning		DO
CDP	Gain switching		DI
CDP2	Gain switching 2		DI
CDPS	Variable gain enabled		DO
CDPS2	Variable gain enabled 2		DO
CLD *4	Fully closed loop selection		DI
CLDS *4	Fully closed loop control in progress		DO
DOA *2	General-purpose output A		DO
DOB *2	General-purpose output B		
DOC *2	General-purpose output C		
DOG	Proximity dog		DI
EM1	Forced stop 1		DI
EM2	Forced stop 2		DI
INP	In-position		DO
LSN	Reverse rotation stroke end		DI
LSP	Forward rotation stroke end		DI
MBR	Electromagnetic brake interlock		DO
MEND *3	Traveling completion	When the droop pulse is within the in-position range set in [Pr. PA10 In-position range] and the command remaining distance is "0", MEND switches on. When the servo-on signal is turned on, MEND switches on. MEND is off in the servo-off state.	DO
MTTR	Tough drive in progress	Refer to "Signal (device) explanation" in the following manual.	DO
PC	Proportional control	☞MR-JET User's Manual (Hardware)	DI
RD	Ready		DO
RDY	In ready-on state	RDY is turned on in ready-on state.	DO
SA	Speed reached	Refer to "Signal (device) explanation" in the following manual. ☞MR-JET User's Manual (Hardware)	DO
TLC	Limiting torque	Refer to "Signal (device) explanation" in the following manual.	DO
TPR1 *4	Touch probe 1	☞MR-JET User's Manual (Hardware)	DI
TPR2 *4	Touch probe 2		DI
TPR3 *4	Touch probe 3		DI
VLC	Limiting speed		DO
WNG	Warning		DO
ZP2	Homing completion 2	When homing finishes successfully, S_ZP2 turns on.	DO
ZSP	Zero speed detection	Refer to "Signal (device) explanation" in the following manual. ☞MR-JET User's Manual (Hardware)	DO
CPO *1	Rough match	When the command remaining distance is less than the value of the rough match output range set in [Pr. PT12], CPO turns on. CPO is turned off during base circuit shut-off. CPO turns on at servo-on.	DO
POT *1	Position range	When the actual current position is within the range set in [Pr. PT19] and [Pr. PT21], POT turns on. POT turns off unless homing operation has completed or if the base circuit shut-off is in progress.	DO

- \*1 Available on servo amplifiers with firmware version B2 or later.
- \*2 Available on servo amplifiers with firmware version B6 or later.
- \*3 Available on servo amplifiers with firmware version B8 or later.
- \*4 Available on servo amplifiers with firmware version C4 or later.

# Signal block diagram

The following signal block diagram indicates the points at where the monitor signals (analog) are detected.

## Semi closed loop control

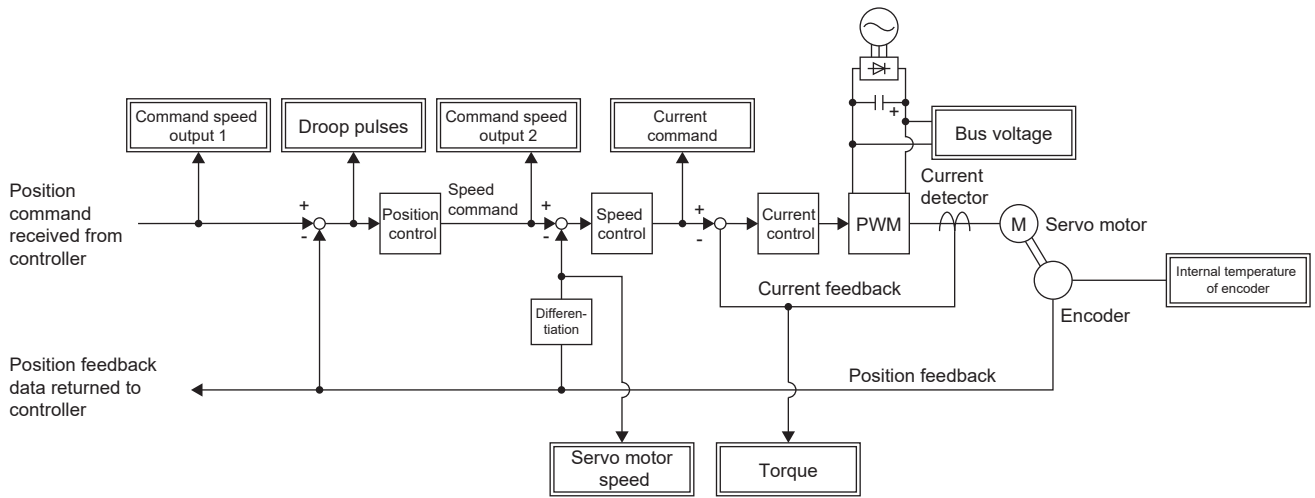

## Fully closed loop control

This control can be used on servo amplifiers with firmware version C4 or later.

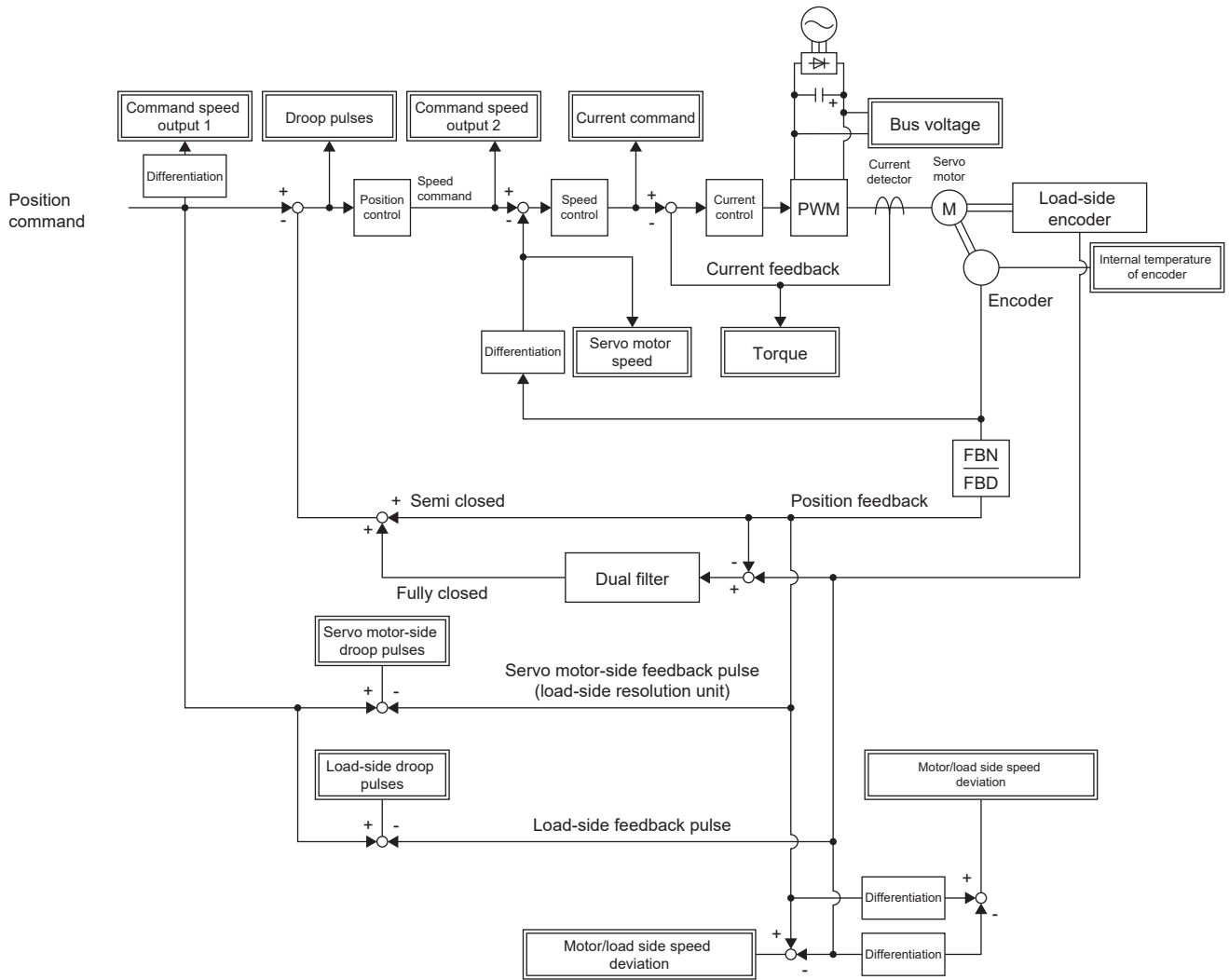

## 5.2 Checking with MR Configurator2

---

By using this engineering tool, the status of the servo amplifier (including the servo motor speed, torque, and bus voltage) can be checked.

In the "Display All" function, the analog data signals of the servo amplifier can be displayed in a list and be readily checked. In the graph function, the monitor signals can be saved with the high-speed sampling cycle, and the change of signals can be checked when the gains of the servo amplifier are adjusted. In addition, as the I/O monitor displays the status of the I/O signals of the servo amplifier, the status of the wiring and signals can be checked.

Refer to the following for the signals which can be checked with the "Display All" function and the graph function.

 Page 203 Explanation of monitor signals

The signals set in the I/O device are displayed in the I/O monitor display.

### "Display All" function

---

The analog data signals of the servo amplifier can be displayed with the "Display All" function of MR Configurator2. In "Display All", the status of the servo amplifier can be updated periodically and displayed.

# Graph function

The monitor signals of the selected servo amplifier can be measured and displayed in the graph. For setting details, refer to "Help" of MR Configurator2.

## Display method

1. Open the graph display screen in MR Configurator2.

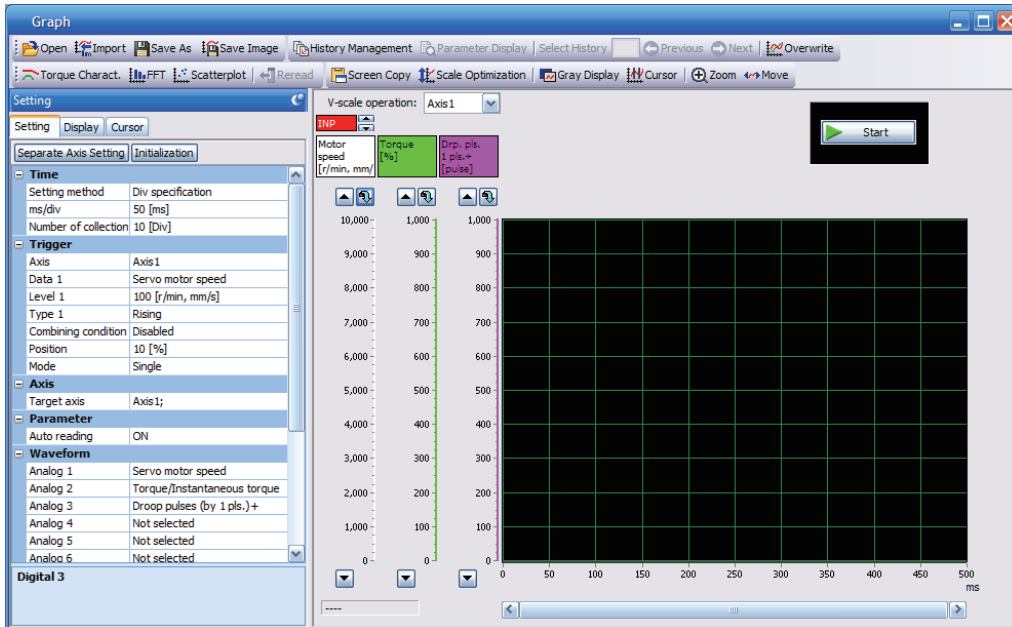

2. Set the sampling time, trigger, and other areas as required, then start measurement.

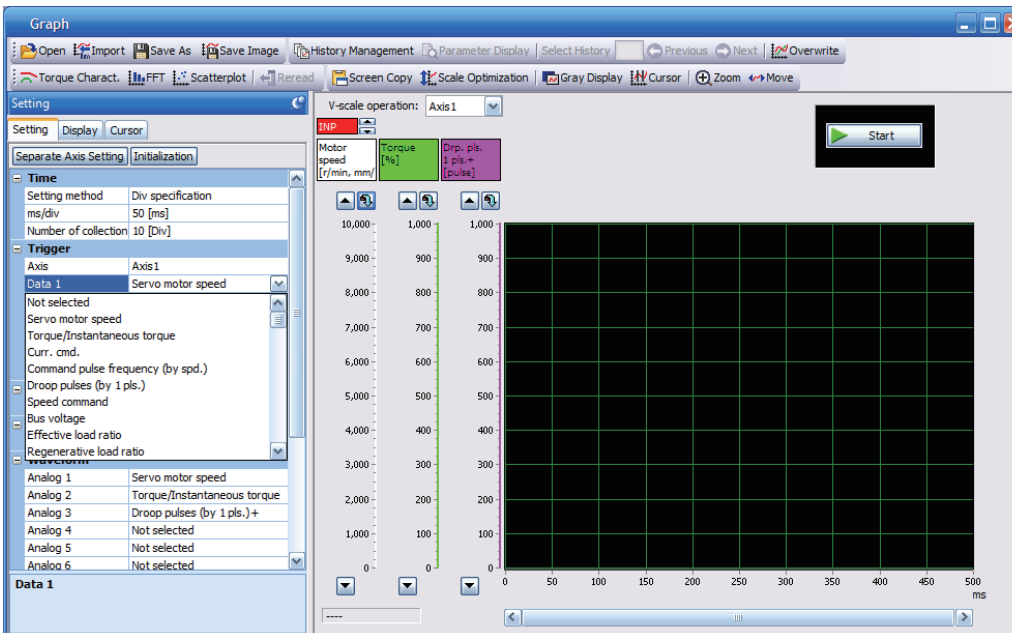

- The waveform is displayed upon completion of measurement. The obtained data can be checked by clicking "Zoom", "Cursor", and other buttons.

MR Configurator2 with software version 1.110Q or later supports saving data in GX LogViewer format (JSON file) with the graph function or drive recorder function. The file is saved with a ".json" extension by default.

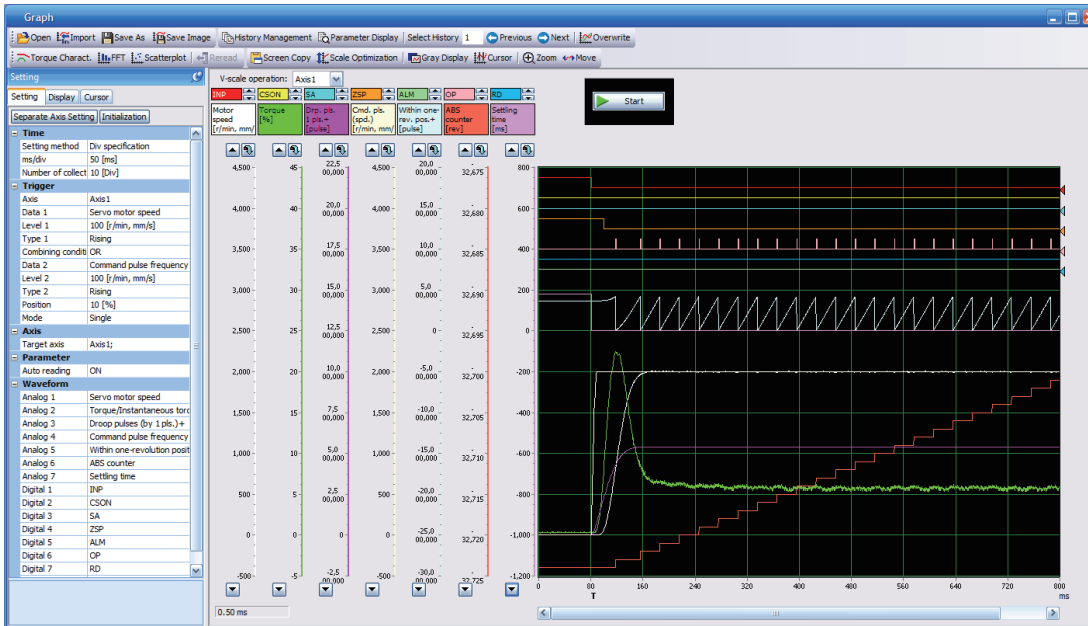

## I/O monitor display

The I/O signals of the servo amplifier and the on/off status of the I/O device can be displayed. The input/output status of the signals and wiring can be checked at device startup and throughout the project creation progress.

## System configuration display

---

System information including the serial No. and model of the servo amplifier, servo motor, and other equipment are displayed. The items displayed in the configuration window vary depending on the servo amplifier and software version of MR Configurator2, as well as whether it is viewed from the diagnosis tab of MR Configurator2 or the drive recorder. When MR Configurator2 is connected to the servo amplifier, the values are displayed.

### Displayed items

The following items can be checked in the system configuration window. For the linear servo motor control mode, the encoder resolution per electrical angle 360° is displayed.

- Servo amplifier identification information
- Servo amplifier serial No.
- Servo amplifier S/W No.
- Optional unit identification information
- MAC address
- IP address
- Motor model
- Motor ID
- Motor serial No.
- Encoder resolution
- Encoder maximum multi-revolution [rev]
- Accumulated power-on time [h]
- Number of inrush relay on/off times [times]
- Number of dynamic brake stops [times]
- LED display



# 6 NETWORK FUNCTION

The function explained in this chapter is available for the following servo amplifier.

MR-JET-\_G

This is a function that uses an Ethernet communication to access servo amplifiers remotely. The network function of the servo amplifier is as follows.

Function	Description
FTP server function	This function enables file transfer with the servo amplifier.

## Precautions

- To ensure the safety of the system against unauthorized network access, take security measures such as using a firewall.

## Communication speed

The factory setting for communication speed may switch depending on the parameter setting value and firmware version. Change the setting as necessary. Details on the communication speed are as follows.

### ■Communication speed combinations

[Pr. PN13.0-3 Network protocol setting]	[Pr. NPA12 Communication speed]	Communication speed
0000h (CC-Link IE TSN) (initial value)	2 (initial value)	1 Gbps
0000h (CC-Link IE TSN) (initial value)	1	100 Mbps
0004h (CC-Link IE Field Network Basic) *1	2 (initial value)	100 Mbps
0004h (CC-Link IE Field Network Basic) *1	1	100 Mbps

\*1 Available on servo amplifiers with firmware version C0 or later.

# 6.1 IP address setting

## Setting an IP address

Refer to "IP address setting function" in the following manual.

📖MR-JET-G User's Manual (Communication Function)

# 6.2 Managing accounts

To use the network function, set an account. Accounts can be set with the following network parameters. Up to 8 accounts can be set.

Account	User name	Authorization level	Password
User information No.1	[Pr. NPB04]	[Pr. NPB05]	[Pr. NPB06]
User information No.2	[Pr. NPB07]	[Pr. NPB08]	[Pr. NPB09]
User information No.3	[Pr. NPB10]	[Pr. NPB11]	[Pr. NPB12]
User information No.4	[Pr. NPB13]	[Pr. NPB14]	[Pr. NPB15]
User information No.5	[Pr. NPB16]	[Pr. NPB17]	[Pr. NPB18]
User information No.6	[Pr. NPB19]	[Pr. NPB20]	[Pr. NPB21]
User information No.7	[Pr. NPB22]	[Pr. NPB23]	[Pr. NPB24]
User information No.8	[Pr. NPB25]	[Pr. NPB26]	[Pr. NPB27]

The following account is set from the factory.

Network parameter	Initial setting
[Pr. NPB04 User name No.1]	user
[Pr. NPB05 Authorization level No.1]	00000001h
[Pr. NPB06 Password No.1]	user

# Setting an account

Set an account with MR Configurator2. Set the user information No. 1 account with [Pr. NPB04 User name No.1], [Pr. NPB05 Authorization level No.1], and [Pr. NPB06 Password No.1].

## User name

Set a user name according to the following rule.

Item	Usable character
Number of characters	1 to 32
Type of characters	<ul style="list-style-type: none"><li>• Single-byte letters (lowercase)</li><li>• Single-byte letters (uppercase)</li><li>• Single-byte numeric characters</li></ul>

If no name (0 characters) is set in the user name, the account will be disabled, causing the network function to be unavailable.

## Authorization level

The authorization level setting can be used to set whether accounts have the authority to use the network function. Set "Permitted" in the authorization level setting to use the desired function. To prevent access to unnecessary functions, it is recommended to set "Prohibited" for them. For details on the authorization level, refer to "User authentication parameters" in the following manual.

 MR-JET-G User's Manual (Parameters)

## Password

Set a password in the password setting window. Double-clicking the network parameter input field will display the password setting window. Enter the desired password in the password field and password (reentry) field, then click "OK" to set the password.

Set a password according to the following rule.

Item	Usable character
Number of characters	4 to 32
Type of characters	<ul style="list-style-type: none"><li>• Single-byte letters (lowercase)</li><li>• Single-byte letters (uppercase)</li><li>• Single-byte numeric characters</li><li>• Special characters</li></ul> "Special characters" refers to the following characters: ` ~ ! @ # \$ % ^ & * ( ) _ + - = { }   ¥ : " ; ' < > ? , . / [ ] (additionally, a single-byte space can be used).

## Precautions

To prevent unauthorized access, it is recommended to change the default account.

Ensure that no duplicate user names are set among accounts. Accounts with duplicate user names may be unavailable.

To disable the account setting performed via an Ethernet connection, set [Pr. NPB01 User authentication and authorization setting] to "1" (USB only). In the initial setting, the account setting is enabled via USB and Ethernet connection. For details, refer to "User authentication parameters" in the following manual.

 MR-JET-G User's Manual (Parameters)

If the user name or password is forgotten, set it with MR Configurator2 again. When [Pr. NPB01] is set to "1" (USB only), accounts cannot be set via an Ethernet connection. Set accounts via a USB connection.

Resetting network parameters to the factory setting will initialize accounts. Set accounts again.

## 6.3 FTP server function

FTP (File Transfer Protocol) is a protocol to transfer files between network-connected devices. The FTP server function is supported. Devices with the FTP client function can access files in the servo amplifier via FTP communication. The following shows the port numbers used for the FTP server.

Port No.	Description
20	Data transfer port
21	Control port

### Restrictions

Use the FTP server function in an active mode connection. If a firewall is set in the FTP client (such as a personal computer), change the firewall settings to allow an FTP (TCP/IP) communication.

Up to one user can access the FTP server of the servo amplifier at the same time. Do not allow multiple users to access the server at the same time.

The file name must meet the following requirements. Only files with a name meeting the requirements can be used.

Item	Requirement	
File name length	1 to 32 characters (including the file extension)	
Usable characters	Single-byte numeric characters	0 to 9
	Single-byte letters (lowercase)	a to z
	Single-byte letters (uppercase)	A to Z
	Single-byte space	" "
	Single-byte hyphen	"-"
	Single-byte period	"."
	Single-byte square bracket	"[", "]"

### Precautions

Restrictions are applied to each directory.

 Page 219 Directory structure



If the authorization level is set to "00000000h", the relevant account cannot log into the FTP server. To make the account access the FTP server function, set the authorization level to a value other than "00000000h".

Files and directories can be named only with ASCII characters. Do not transfer files and directories with characters such as UNICODE format characters. Doing so may cause an unexpected operation.

Do not write unrelated files.

# Directory structure

The following shows the directories that can be accessed from the FTP client.

Directory	Function	Details
/fw/	Firmware update	 Page 219 Firmware update
/drvrec/	Drive recorder	 Page 160 Drive recorder

## fw directory

To allow an account to access the fw directory, set Bit 0 of the relevant authorization level to "1".

The fw directory allows firmware updates of the servo amplifier.

 Page 219 Firmware update

The fw directory only allows file writing. Since the fw directory does not allow file reading, files in the directory do not appear.

## drvrec directory

To allow an account to access the drvrec directory, set Bit 2 of the relevant authorization level to "1".

The drvrec directory provides drive recorder data using the FTP server function.

 Page 160 Drive recorder

Files and subdirectories cannot be created in the drvrec directory. Additionally, files in the directory cannot be deleted or changed.

The size of files in the drvrec directory appears as 0 bytes regardless of the actual size.

# Steps of accessing the FTP server

### 1. IP address setting

Set an IP address to connect the servo amplifier to the network.

 Page 216 IP address setting

### 2. Account setting

Set an account to log into the FTP server of the servo amplifier with MR Configurator2.

 Page 216 Managing accounts

### 3. Connection

Start the FTP client, then specify the IP address of the servo amplifier for the connection. Using the set account user name and password allows to log into the server.

### 4. File transfer

Use the FTP client to access the target directory to transfer files.

### 5. Disconnection

Use the FTP client to disconnect the FTP server.

## 6.4 Firmware update

The MR-JET series servo amplifier has a function to update the firmware. This function can update the servo amplifier firmware to the desired version. To update the firmware, a special firmware update tool is required. For information on the firmware update tool and firmware update file, contact your local sales office.

# 7 POSITIONING MODE (POINT TABLE METHOD) (CP)

The positioning mode (point table method) is available on servo amplifiers with firmware version B8 or later.

When using this function, set [Pr. PA01.0 Control mode selection] to "6" (positioning mode (point table)).

This is a method for performing positioning in accordance with the point table by setting the positioning data to the point table (up to 255 points).

Select a point table number and execute the positioning operation with the start signal. JOG operation and homing can be executed.

Point table number	Position data	Servo motor speed	Acceleration time constant	Deceleration time constant	Dwell	Auxiliary function	M code
1	1000	2000.00	200	200	0	1	1
2	2000	1600.00	100	100	0	0	2
:	:	:	:	:	:	:	:
255	3000	3000.00	100	100	0	2	99

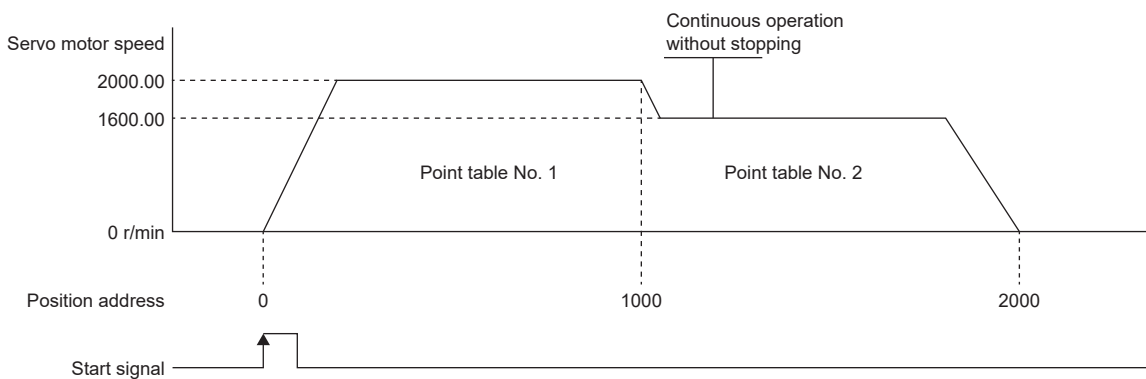

For details on the objects, refer to the User's Manual (Object Dictionary).

# 7.1 Operation mode and selection method

## Operation mode

The following shows the operation modes of the positioning mode (point table method) (CP).

Control mode	Operation mode	Explanation
Positioning mode (Point table method) (CP)	Point table mode (pt)	Operates the servo motor according to the preset point table. ☞ Page 222 Point table mode (pt)
	JOG operation mode (jg)	Enables desired positioning for machine adjustment and home positioning. ☞ Page 246 JOG operation mode (jg)
	Homing mode (hm)	Matches the commanded coordinates with the machine coordinates. ☞ Page 44 Homing mode (hm)

## Operation mode selection method

The operation mode selection method is as follows.

Operation mode	Operation mode option	Servo parameter	Object
		[Pr. PA01.0 Control mode selection]	[Modes of operation (Obj. 6060h)]
Point table mode (pt)	Single positioning operation	6	-101
	Continuous positioning operation		
	Speed change operation		
JOG operation mode (jg)	JOG operation		-100
Homing mode (hm)	Various homing		6

## 7.2 Point table mode (pt)

### Point table mode (pt)

Select the preset point table with [Target point table (Obj. 2D60h)], and start operation with bit 4 (New set-point) of [Controlword (Obj. 6040h)]. The command method of the point table mode (pt) is the absolute value command method.

#### Absolute value command method

Set the target address for the position data.

#### ■mm/inch/pulse unit

Set the target position in within the following range.

Unit	Setting range
0.001 mm	-2147483648 to 2147483647
0.0001 inch	
pulse	

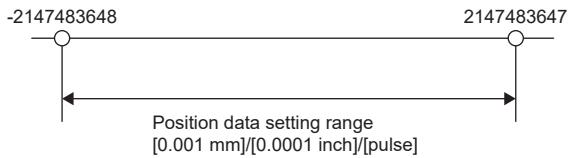



## ■Degree unit

When [Pr. PA14 Travel direction selection] is "0" (initial value), set the target position with the CCW direction as + and the CW direction as -.

When the direction is specified by absolute value, the direction of rotation can be specified by + or -.

**Ex.**

The following shows a setting example when [Pr. PA14] is set to "0".

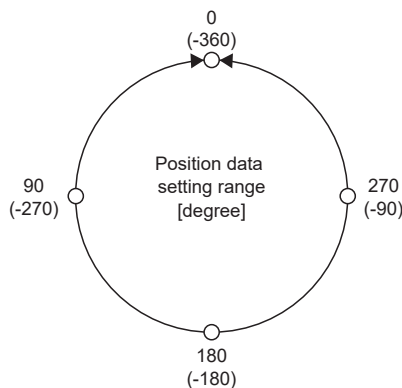

- Coordinate system in degree unit

Coordinates are determined with respect to the position of 0 degree.

+ direction: 0, 90, 180, 270, 0, in that order.

- direction: 0, -90, -180, -270, -360 in that order.

270 degrees and -90 degrees are the same position.

0 degree, 360 degrees, and -360 degrees are the same position.

The direction for moving to the target position is the direction set in [Pr. PT03.2 Degree unit rotation direction selection].

[Pr. PT03.2]	Servo motor rotation direction
0 (Specified rotation direction)	Rotates to the target position in the direction specified with the sign of the position data.
1 (Rotation in the direction with the shortest distance)	Rotates in the direction with the shorter distance from the current position to the target position. If the distance from the current position to the target position is the same in the CCW and CW directions, the servo motor rotates in the CCW direction.
2 (Rotation in the address decreasing direction)	Rotates in the address decreasing direction regardless of the sign of the position data.
3 (Rotation in the address increasing direction)	Rotates in the address increasing direction regardless of the sign of the position data.

## Point table operation (absolute value command method)

This a method used by specifying the absolute and relative position commands with the auxiliary function of the point table.

### Point table



Set each value of the point table with [Point table 001 (Obj. 2801h)] to [Point table 255 (Obj. 28FFh)].

Set the position data, servo motor speed, acceleration time constant/acceleration, deceleration time constant/deceleration, dwell time, auxiliary function, and M code to the point table.

When "0", "1", "8", or "9" is set for the auxiliary function, the absolute position command method is applied to the point table.

When "2", "3", "10", or "11" is set for the auxiliary function, the relative position command method is applied to the point table.

If a value outside the range is set in the point table, the setting value will be clamped to the maximum value or minimum value. If a value out of the range is set due to the change of the command unit or connected servo motor, [AL. 037 Parameter error] occurs.

Object		Item	Setting range	Unit	Description
Index	Sub				
2801h to 28FFh	1	Position data	-2147483648 to 2147483647 *1	0.001 mm 0.0001 inch 0.001 degree pulse	<ul style="list-style-type: none"> <li>When using the point table as the absolute position command method Set the target address (absolute value).</li> <li>When using the point table as the relative position command method Set the travel distance. The "-" sign can be added to change the command to the reverse rotation command.</li> </ul>
	2	Servo motor speed	0 to maximum speed *4	0.01 r/min *2 0.01 mm/s *1*2  0.001 mm/s *3 0.0001 inch/s *3 0.001 degree/s *3 pulse/s *3	Set the command speed of the servo motor while positioning is executed.  The setting value should be equal to or less than the maximum speed of the servo motor.
	3	Acceleration time constant	0 to 20000	ms *2	Set a time for the servo motor to reach the rated speed.
		Acceleration	0 to 2147483647	0.001 mm/s <sup>2</sup> 0.0001 inch/s <sup>2</sup> 0.001 degree/s <sup>2</sup> pulse/s <sup>2</sup>	Set the acceleration to reach the set servo motor speed. (Acceleration time [s] = Servo motor speed/Acceleration) When "0" is set, the servo motor accelerates in accordance with the time constant set in [Pr. PT49 Speed acceleration time constant].
	4	Deceleration time constant	0 to 20000	ms *2	Set the time required for the servo motor to stop from the rated speed.
		Deceleration	0 to 2147483647	0.001 mm/s <sup>2</sup> 0.0001 inch/s <sup>2</sup> 0.001 degree/s <sup>2</sup> pulse/s <sup>2</sup>	Set the deceleration to stop the servo motor from the set servo motor speed. (Deceleration time [s] = Servo motor speed/Deceleration) When "0" is set, the servo motor decelerates in accordance with the time constant set in [Pr. PT50 Speed deceleration time constant].
	5	Dwell time	0 to 20000	ms	Set the dwell time. When "0" or "2" is set in the auxiliary function, the dwell time is disabled. When "1", "3", "8", "9", "10", or "11" is set in the auxiliary function and the dwell time is set to 0, continuous operation is executed. When the dwell time is set, the position command of the selected point table is completed, and the position command for the next point table is started after the set dwell time elapses.
6	Auxiliary function	0 to 3, 8 to 11	—	Set the auxiliary function. When a different direction is set, the servo motor rotates in the reverse direction after the smoothing zero (command output) is confirmed. Setting "1" or "3" for the point table number 255 triggers a point table error.  Page 228 Continuous positioning operation (absolute value command method) <ul style="list-style-type: none"> <li>When using the point table in the absolute position command method 0: Execute the operation of one selected point table. 1: Execute the continuous operation without stopping the next point table. 8: Execute the continuous operation without stopping the point table selected at startup. 9: Execute the continuous operation without stopping the point table number 1.</li> <li>When using the point table in the relative position command method 2: Execute the operation of one selected point table. 3: Execute the continuous operation without stopping the next point table. 10: Execute the continuous operation without stopping the point table selected at startup. 11: Execute the continuous operation without stopping the point table number 1.</li> </ul>	
7	M code	0 to 255	—	Set the code to be outputted when the positioning is completed. M codes can be read with [M code actual value (Obj. 2D6Ah)]. Refer to the following for the M code update setting.  Page 242 Temporary stop/restart	

- \*1 When degree is set, the setting range is -360000 to 360000.
- \*2 In the linear servo motor control mode, the unit is mm/s.
- \*3 The setting unit of the speed and acceleration/deceleration can be changed using [Pr. PT01.1 Speed/acceleration/deceleration unit selection].
- \*4 The setting value will be clamped at the maximum speed. When changing the speed to the permissible speed, set the speed in [Pr. PA28.4 Speed range limit selection].

## Parameter setting

Set the following parameters to perform the point table operation.

### ■Rotation direction selection ([Pr. PA14 Travel direction selection])

Select the servo motor rotation direction or the linear servo motor travel direction when bit 4 (New set-point) of [Controlword (Obj. 6040h)] is turned on.

[Pr. PA14]	Servo motor rotation direction/linear servo motor travel direction Turn on bit 4 (New set-point) of [Controlword]
0	Forward rotation (CCW) or positive direction with + position data Reverse rotation (CW) or negative direction with - position data
1	Reverse rotation (CW) or negative direction with + position data Forward rotation (CCW) or positive direction with - position data

The servo motor rotation direction is as follows.

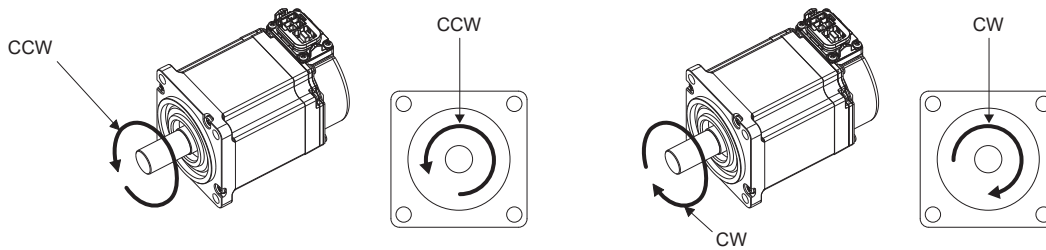

The positive and negative directions of the linear servo motor are as follows.

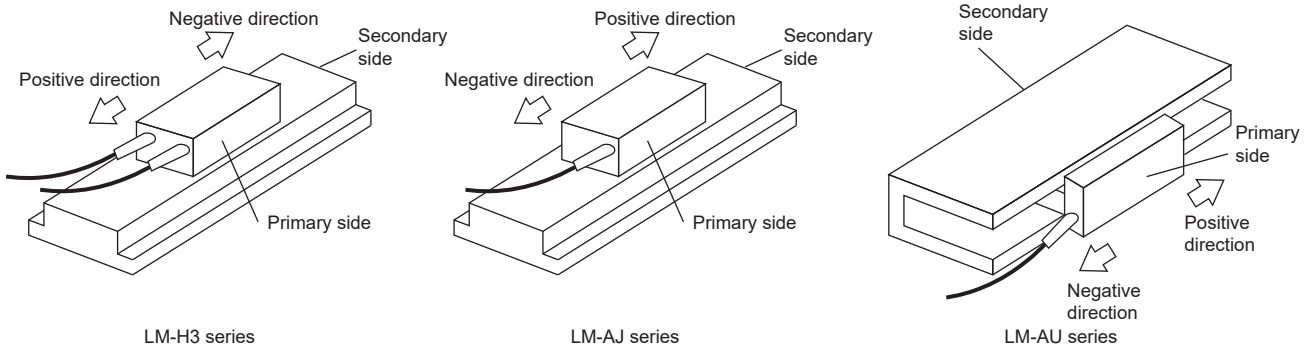

### ■Position data unit ([Pr. PT01.2 Unit for position data])

Set the unit of position data.

[Pr. PT01.2]	Position data unit	Position data input range
0	mm	-2147483648 to +2147483647
1	inch	-2147483648 to +2147483647
2	degree	-360000 to +360000
3	pulse	-2147483648 to +2147483647

## ■Speed data / acceleration/deceleration data unit ([Pr. PT01.1 Speed/acceleration/deceleration unit selection])

Set the unit of speed data and acceleration/deceleration data.

Setting of [Pr. PT01.1]	Unit for position data	Speed data unit	Acceleration/deceleration data unit
0	—	r/min,mm/s *1	ms
1	mm	mm/s *2	mm/s <sup>2</sup>
	inch	inch/s *2	inch/s <sup>2</sup>
	degree	degree/s *2	degree/s <sup>2</sup>
	pulse	pulse/s *2	pulse/s <sup>2</sup>

\*1 In the linear servo motor control mode, the unit is mm/s.

\*2 The setting of the command unit. The actual servo motor speed [encoder pulse unit] is calculated by multiplying the set speed data by the electronic gear ratio.

## Operation

When the point table is selected with [Target point table (Obj. 2D60h)] and bit 4 (New set-point) of [Controlword (Obj. 6040h)] is turned on, positioning is performed on the position data with the set speed, acceleration time constant/acceleration, and deceleration time constant/deceleration.

Item	Object	Setting details
Point table mode (pt) selection	[Modes of operation (Obj. 6060h)]	Set to "-101".
Point table selection	[Target point table]	Set the point table number to be used.
Start	[Controlword]	Turn on bit 4 (New set-point) of [Controlword].

# Timing chart of the point table operation

The unit of the speed data and acceleration data of the point table can be changed with [Pr. PT01.1 Speed/acceleration/deceleration unit selection]. In the following timing chart, the units are r/min for speed data and ms for acceleration/deceleration data.

[Point actual value (Obj. 2D69h)] and [M code actual value (Obj. 2D6Ah)] display the previous value until the operation is completed.

The accuracy of the acceleration/deceleration time and dwell time can be improved by setting [Pr. PT02.7\_ Internal position command - Process speed selection] to "1" (high speed).

## Single positioning operation (absolute value command method)

When bit 4 (New set-point) of [Controlword (Obj. 6040h)] is turned on while the servo is on and the servo motor is stopped, positioning operation will be performed.

The following shows the timing chart.

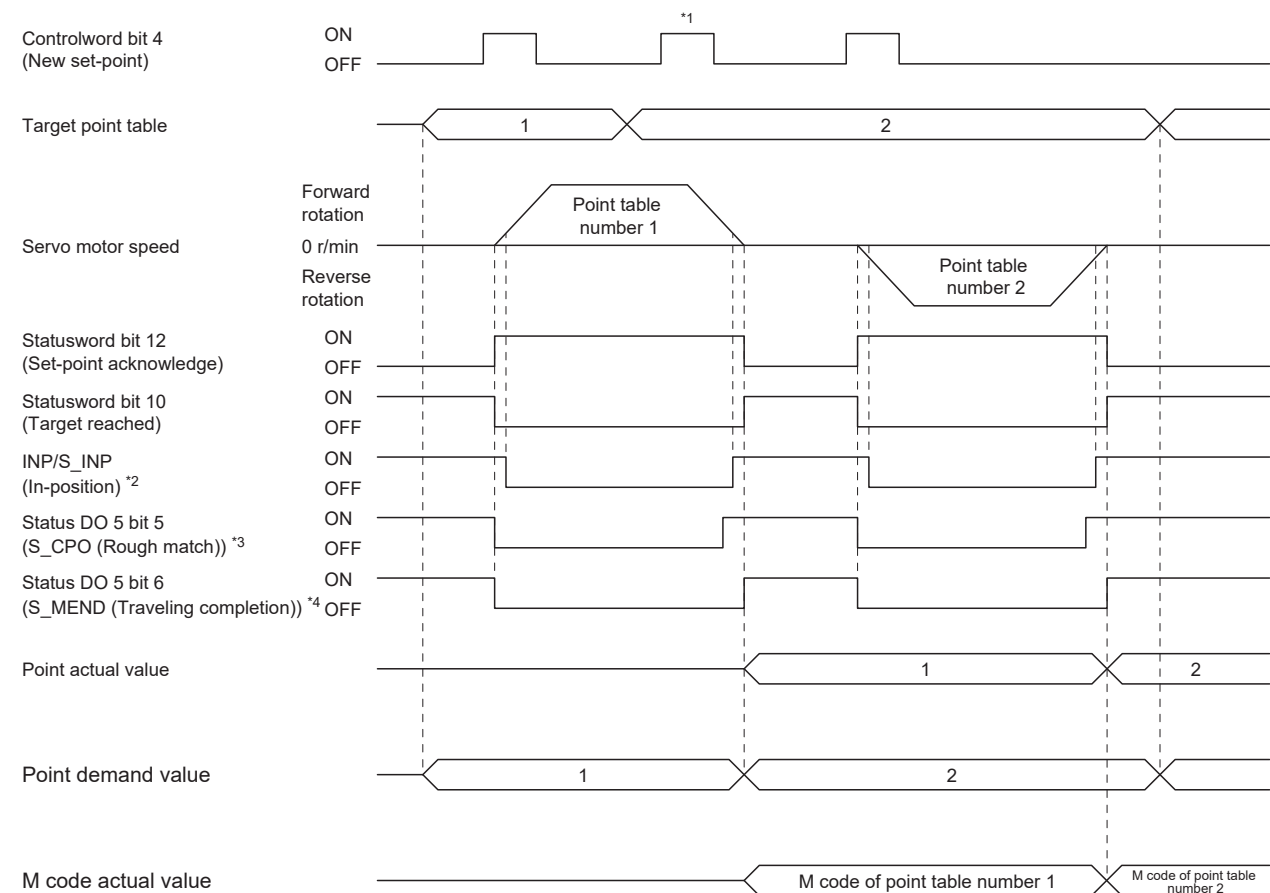

- \*1 It is disabled even if bit 4 (New set-point) of [Controlword (Obj. 6040h)] is turned on while the servo motor is rotating.
- \*2 The bit turns on when the droop pulse of the command unit is equal to or less than the setting value of [Pr. PA10 In-position range].
- \*3 The bit turns on when the command remaining distance is equal to or less than the setting value of [Pr. PT12\_Rough match output range (CRP)].
- \*4 The bit turns on when S\_INP (in-position) is on and command remaining distance is "0".

## Continuous positioning operation (absolute value command method)

Select one point table and turn on bit 4 (New set-point) of [Controlword (Obj. 6040h)] to continuously operate the point table with consecutive numbers.

The following shows the timing chart.

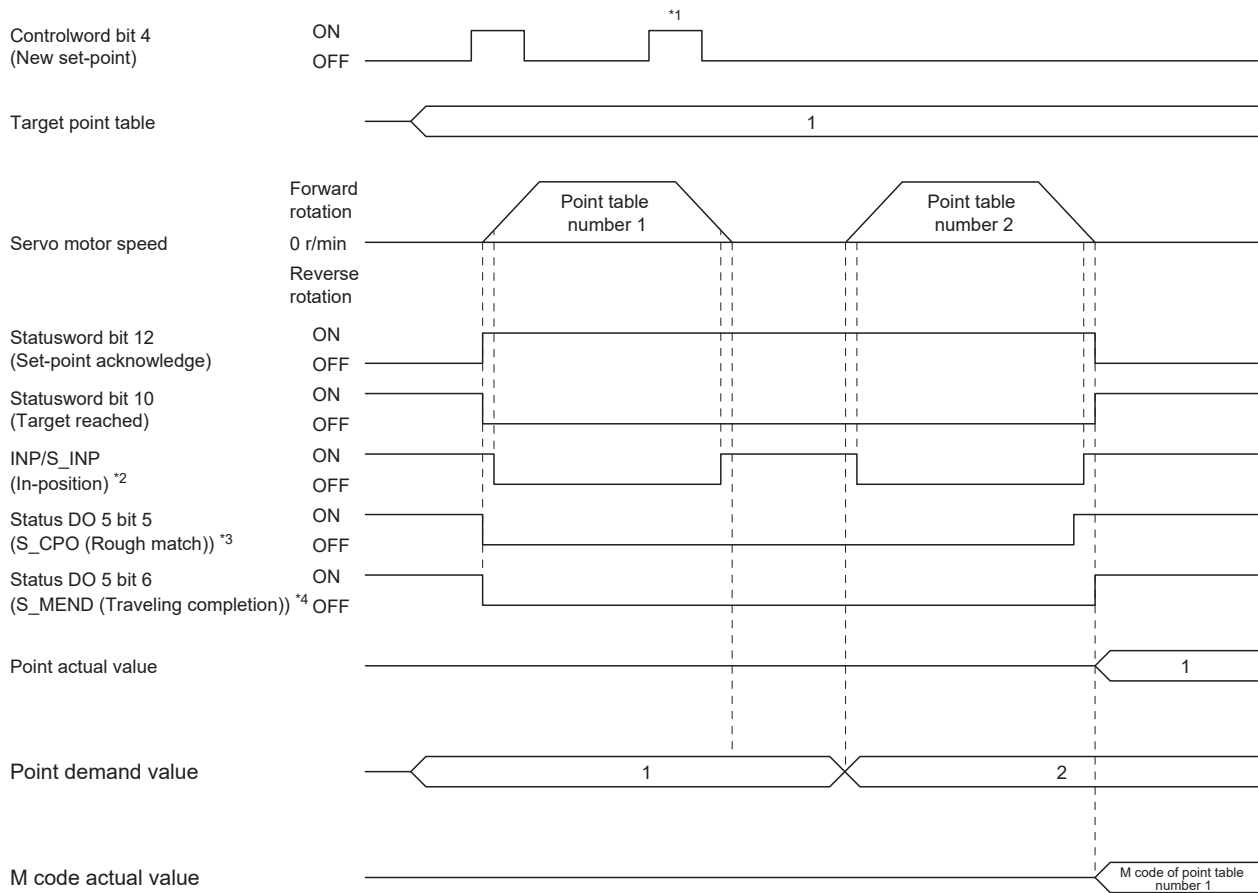

\*1 It is disabled even if bit 4 (New set-point) of [Controlword (Obj. 6040h)] is turned on while the servo motor is rotating.

\*2 The bit turns on when the droop pulse of the command unit is equal to or less than the setting value of [Pr. PA10 In-position range].

\*3 The bit turns on when the command remaining distance is equal to or less than the setting value of [Pr. PT12\_Rough match output range (CRP)]. The bit is off during continuous operation.

\*4 The bit turns on when S\_INP (in-position) is on and command remaining distance is "0". The bit is off during continuous operation.

Continuous operation can be performed by specifying absolute and relative position commands with the auxiliary function of the point table.

The selection method is as follows.

Point table setting		
Dwell time	Auxiliary function	
	When the position data is an absolute position	When the position data is a relative position
1 or more	1	3

## ■When positioning to the same direction

The following shows an example of behavior for the following setting values.

In this example, point table number 1 is the absolute position command method, point table number 2 is the relative position command method, and point table number 3 is the absolute position command method.

Point table number	Position data [pulse]	Servo motor speed [r/min]	Acceleration time constant [ms]	Deceleration time constant [ms]	Dwell time [ms]	Auxiliary function	M code
1	500	3000.00	100	150	100	1	5
2	500	2000.00	150	200	200	3	10
3	1500	1000.00	300	100	Disabled	0 <sup>*1</sup>	15

\*1 Set "0" or "2" for the auxiliary function of the last point table among consecutive point tables.

0: When using the point table as the absolute position command method

2: When using the point table as the relative position command method

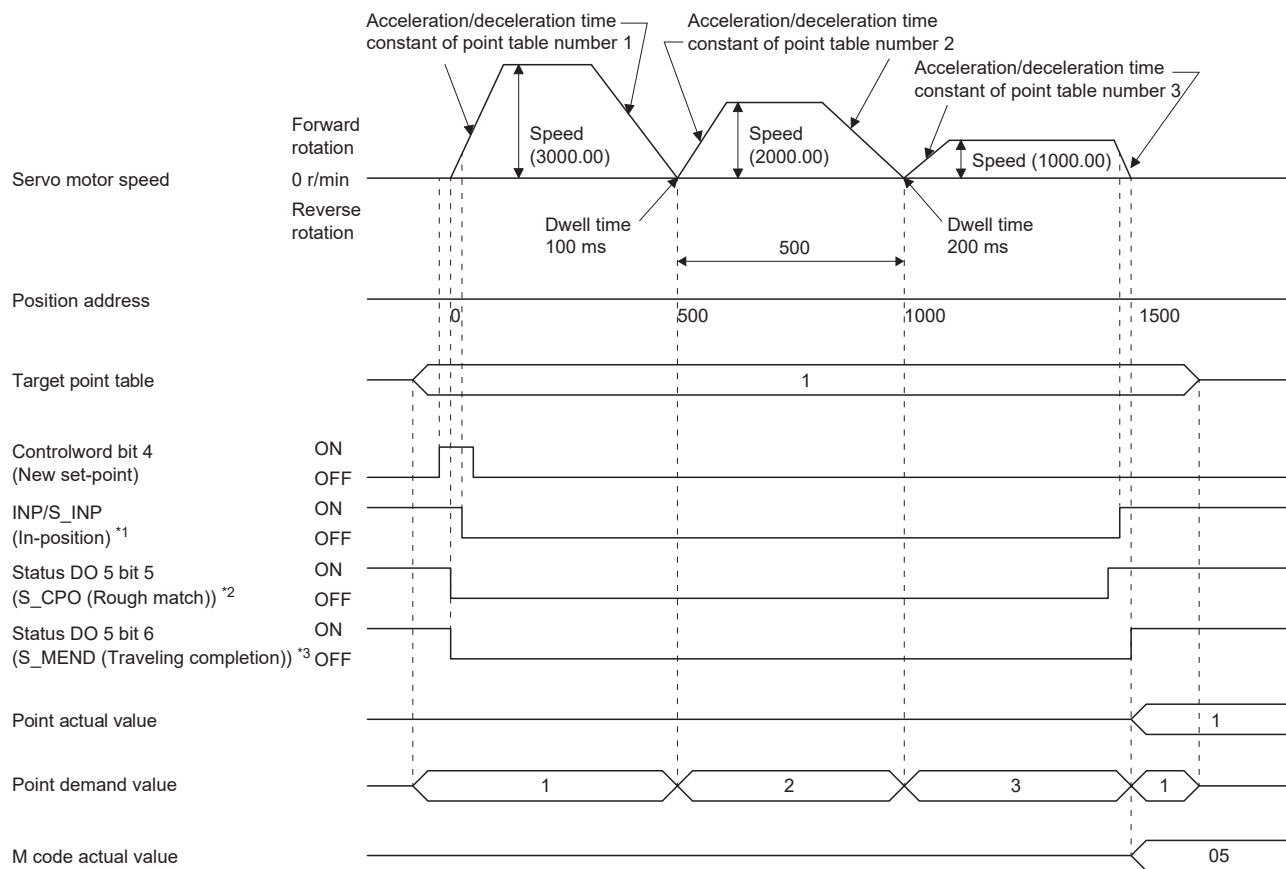

\*1 The bit turns on when the droop pulse of the command unit is equal to or less than the setting value of [Pr. PA10 In-position range].

\*2 The bit turns on when the command remaining distance is equal to or less than the setting value of [Pr. PT12\_Rough match output range (CRP)]. The bit is off during continuous operation.

\*3 The bit turns on when S\_INP (in-position) is on and command remaining distance is "0". The bit is off during continuous operation.

## ■When positioning in the opposite direction in the middle of operation

The following shows an example of behavior for the following setting values.

In this example, point table number 1 is the absolute position command method, point table number 2 is the relative position command method, and point table number 3 is the absolute position command method.

Point table number	Position data [pulse]	Servo motor speed [r/min]	Acceleration time constant [ms]	Deceleration time constant [ms]	Dwell time [ms]	Auxiliary function	M code
1	500	3000.00	100	150	100	1	5
2	700	2000.00	150	200	200	3	10
3	800	1000.00	300	100	Disabled	0 <sup>*1</sup>	15

\*1 Set "0" or "2" for the auxiliary function of the last point table among consecutive point tables.

0: When using the point table as the absolute position command method

2: When using the point table as the relative position command method

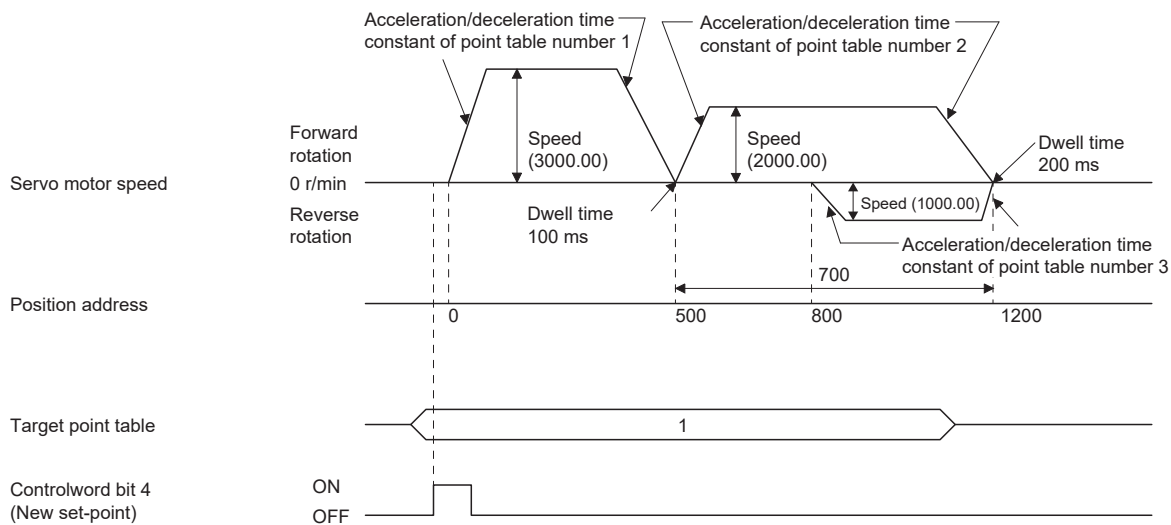

For the operation timing of S\_INP (in-position), S\_CPO (rough match), S\_MEND (traveling completion), [Point actual value (Obj. 2D69h)], [Point demand value (Obj. 2D68h)] and [M code actual value (Obj. 2D6Ah)], refer to "When positioning to the same direction".

☞ Page 229 When positioning to the same direction



## ■When the position data is in degree unit

The following shows an example of behavior for the following setting values.

In this example, point table number 1 and point table number 2 are the absolute position command method, point table number 3 is the relative position command method, and point table number 4 is the absolute position command method.

Point table number	Position data [degree]	Servo motor speed [r/min]	Acceleration time constant [ms]	Deceleration time constant [ms]	Dwell time [ms]	Auxiliary function	M code
1	120.000	1000.00	100	150	100	1	5
2	-320.000	500.00	150	100	200	1	10
3	-230.000	3000.00	200	300	150	3	15
4	70.000	1500.00	300	100	Disabled	0 <sup>*1</sup>	20

\*1 Set "0" or "2" for the auxiliary function of the last point table among consecutive point tables.

0: When using the point table as the absolute position command method

2: When using the point table as the relative position command method

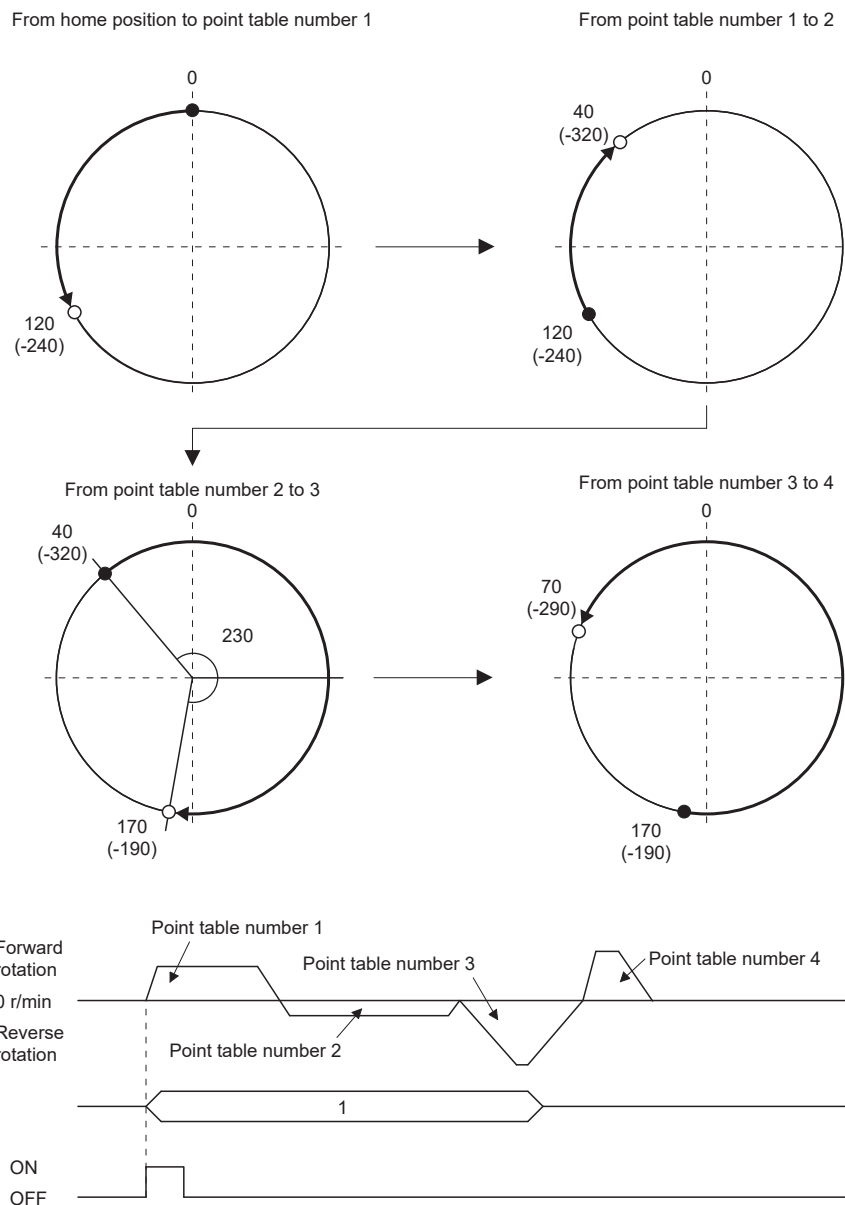

For the operation timing of S\_INP (in-position), S\_CPO (rough match), S\_MEND (traveling completion), [Point actual value (Obj. 2D69h)], [Point demand value (Obj. 2D68h)] and [M code actual value (Obj. 2D6Ah)], refer to "When positioning to the same direction".

☞ Page 229 When positioning to the same direction

## Speed change operation (absolute value command method)

The speed, acceleration/deceleration time constants, and acceleration/deceleration during the positioning operation can be changed by setting the auxiliary function of the point table.

Use the point tables as many as speeds, acceleration/deceleration time constants, and acceleration/deceleration to be set. When "1" or "3" is set for the auxiliary function, the operation is performed at the speed set in the next point table during positioning.

If the auxiliary function is set to "1" or "3" up to point table number 254, operation can be performed at a maximum speed of 255th gear.

Set the auxiliary function of the last point table to "0" or "2".

When performing the speed change operation, always set the dwell time to "0".

When "1" or more is set, continuous positioning operation is enabled.

The following shows a setting example.

Point table number	Dwell time [ms] <sup>*1</sup>	Auxiliary function	Variable speed operation
1	0	1	Consecutive point table data
2	0	3	
3	Disabled	0 <sup>*2</sup>	
4	0	3	Consecutive point table data
5	0	1	
6	Disabled	2 <sup>*2</sup>	

\*1 Set to "0".

\*2 Set "0" or "2" for the auxiliary function of the last point table among consecutive point tables.

## ■When positioning to the same direction

The following shows an example of behavior for the following setting values.

In this example, point table number 1 is the absolute position command method, point table number 2 is the relative position command method, and point table number 3 is the absolute position command method.

Point table number	Position data [pulse]	Servo motor speed [r/min]	Acceleration time constant [ms]	Deceleration time constant [ms]	Dwell time [ms] *1	Auxiliary function	M code
1	500	3000.00	100	150	0	1	5
2	300	2000.00	10	100	0	3	10
3	1000	1000.00	150	70	0	1	15
4	600	500.00	200	120	Disabled	2 *2	20

\*1 Set to "0".

\*2 Set "0" or "2" for the auxiliary function of the last point table among consecutive point tables.

0: When using the point table as the absolute position command method

2: When using the point table as the relative position command method

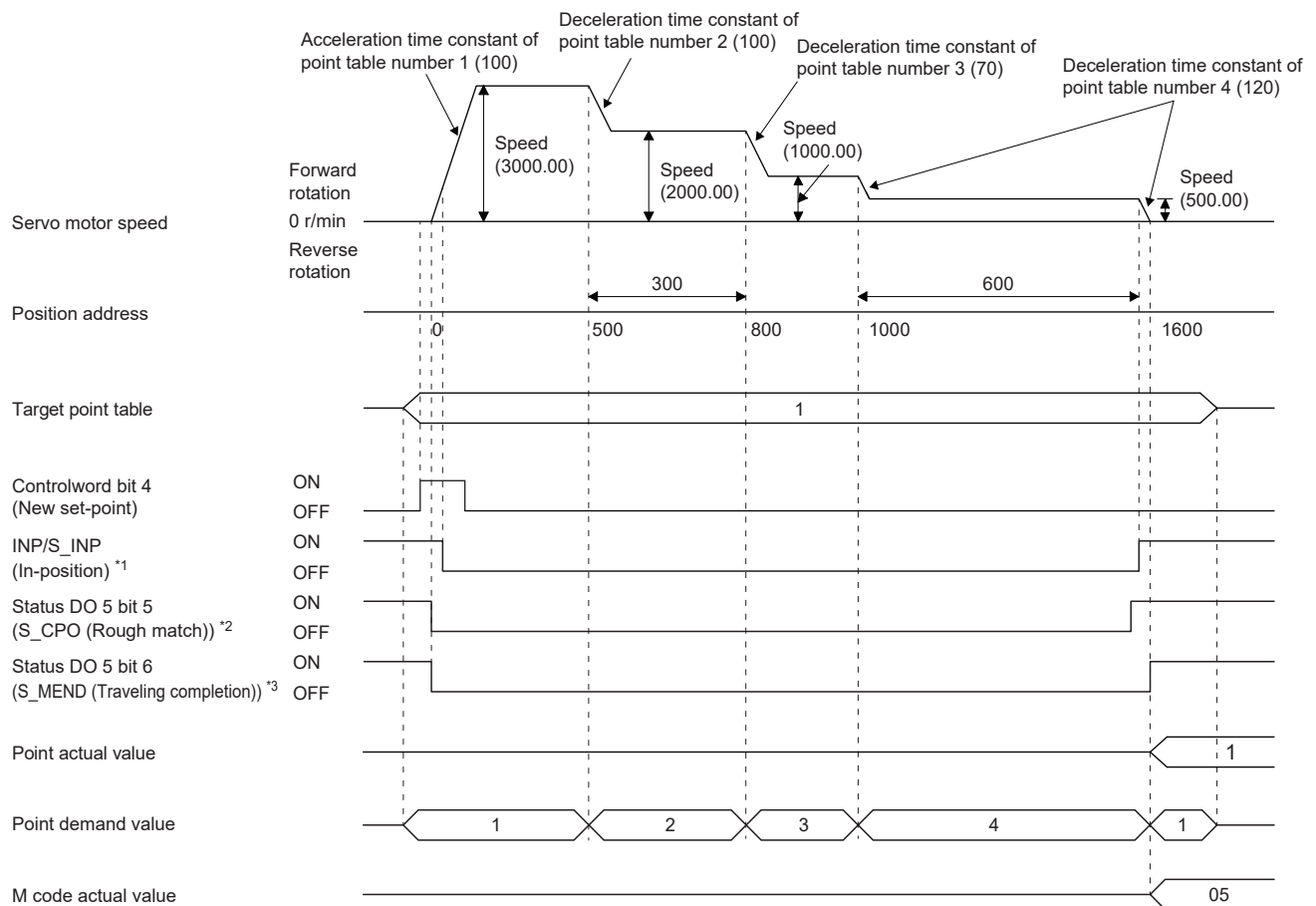

\*1 The bit turns on when the droop pulse of the command unit is equal to or less than the setting value of [Pr. PA10 In-position range].

\*2 The bit turns on when the command remaining distance is equal to or less than the setting value of [Pr. PT12\_Rough match output range (CRP)]. The bit is off during continuous operation.

\*3 The bit turns on when S\_INP (in-position) is on and command remaining distance is "0". The bit is off during continuous operation.

## ■When positioning in the opposite direction in the middle of operation

The following shows an example of behavior for the following setting values.

In this example, point table number 1 is the absolute position command method, point table number 2 is the relative position command method, and point table number 3 is the absolute position command method.

Point table number	Position data [pulse]	Servo motor speed [r/min]	Acceleration time constant [ms]	Deceleration time constant [ms]	Dwell time [ms] *1	Auxiliary function	M code
1	500	3000.00	100	150	0	1	5
2	700	2000.00	50	130	0	3	10
3	800	1000.00	120	100	Disabled	0 *2	15

\*1 Set to "0".

\*2 Set "0" or "2" for the auxiliary function of the last point table among consecutive point tables.

0: When using the point table as the absolute position command method

2: When using the point table as the relative position command method

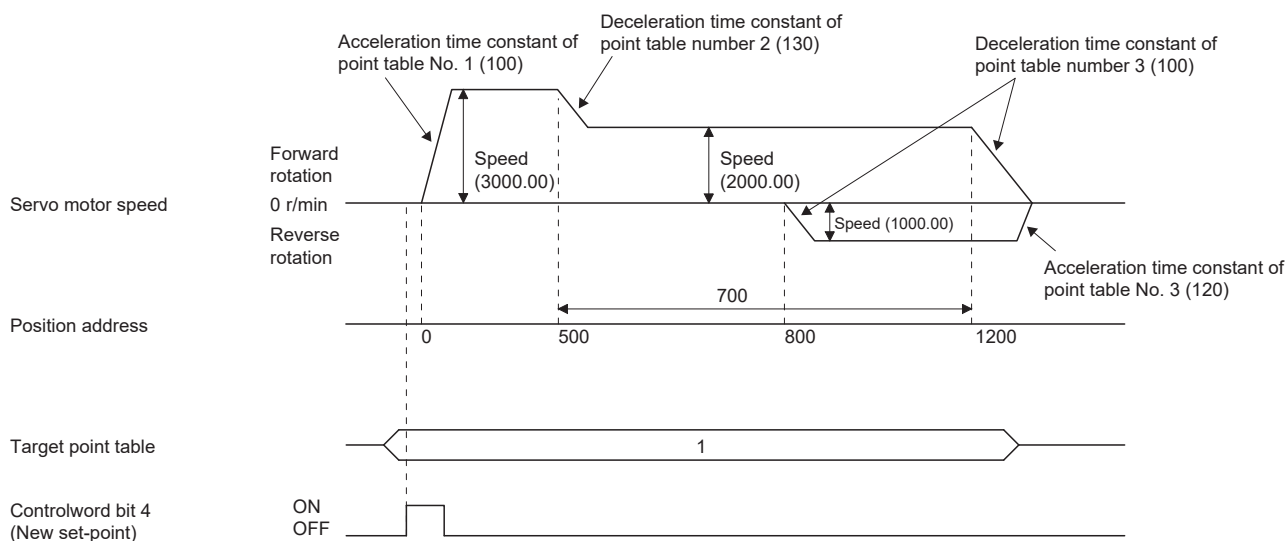

For the operation timing of S\_INP (in-position), S\_CPO (rough match), S\_MEND (traveling completion), [Point actual value (Obj. 2D69h)], [Point demand value (Obj. 2D68h)] and [M code actual value (Obj. 2D6Ah)], refer to "When positioning to the same direction".

☞ Page 233 When positioning to the same direction

## Repetitive positioning operation (absolute value command method)

Set the auxiliary function of the point table to return to the operation pattern of the set point table number and enable the repetitive positioning operation.

When "8" or "10" is set for the auxiliary function, continuous operation or speed change operation is performed up to the point table, and after positioning is completed, continuous operation or speed change operation is performed again from the operation pattern of the point table number at startup.

When "9" or "11" is set for the auxiliary function, continuous operation or speed change operation is performed up to the point table, and after positioning is completed, continuous operation or speed change operation is performed again from the operation pattern of the point table number 1.

### ■When performing repetitive positioning operation with the absolute position command method

Ex.

The following shows the behavior when "8" is set for the auxiliary function of the point table number 4.

Point table number	Position data [pulse]	Servo motor speed [r/min]	Acceleration time constant [ms]	Deceleration time constant [ms]	Dwell time [ms]	Auxiliary function	M code
1	400	1500.00	200	100	150	1	1
2	500	3000.00	100	150	100	1	5
3	500	2000.00	150	200	200	3	10
4	1500	1000.00	300	100	150	8	15

Operation sequence

1. Start with the point table number 2.
2. Execute the point table number 3.
3. Execute the point table number 4.
4. Execute the point table number 2 again at startup with the auxiliary function "8" of the point table number 4.
5. Repeat the above steps in the order of 2, 3, 4, 2, 3, 4.

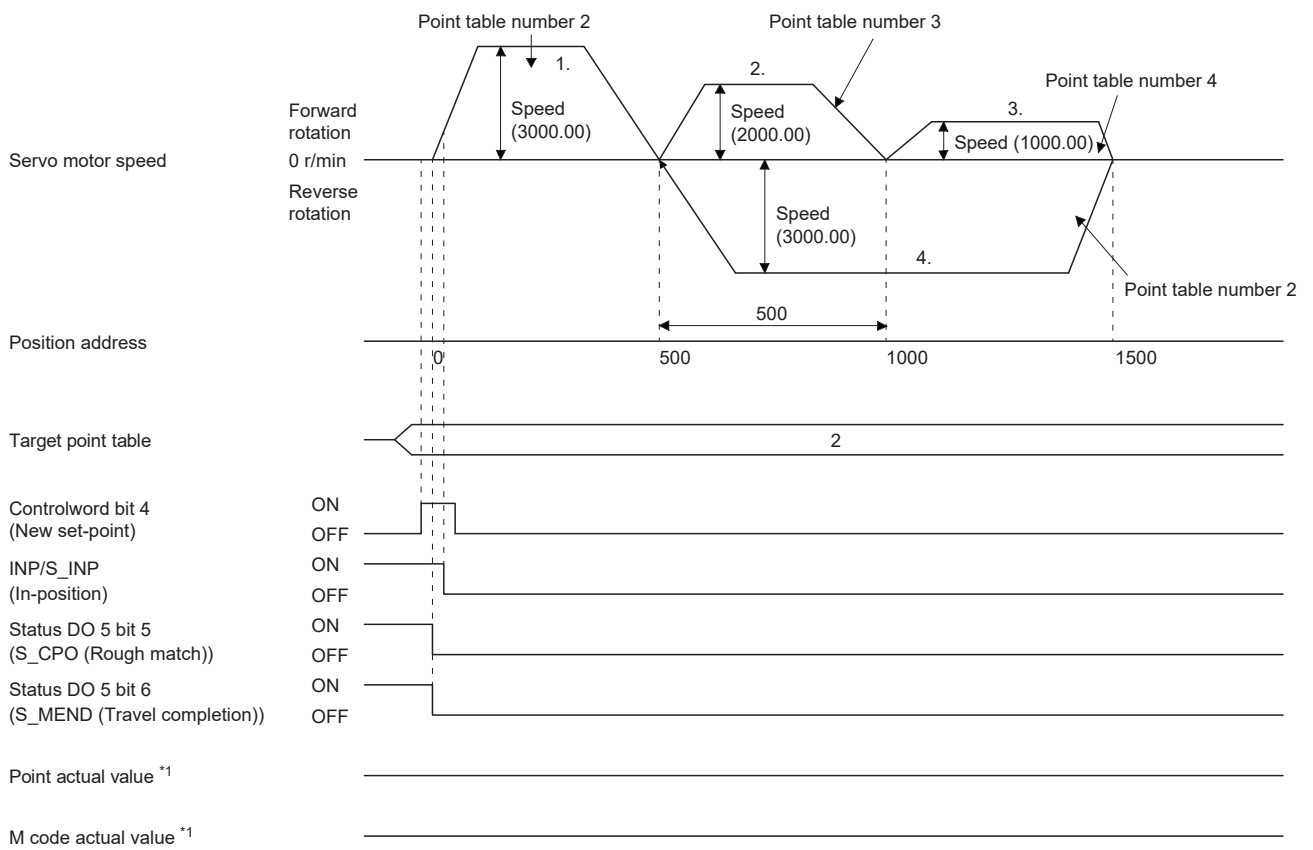

\*1 In repetitive positioning operation, [Point actual value (Obj. 2D69h)] and [M code actual value (Obj. 2D6Ah)] are not outputted.

**Ex.**

The following shows the behavior when "9" is set for the auxiliary function of the point table number 3.

Point table number	Position data [pulse]	Servo motor speed [r/min]	Acceleration time constant [ms]	Deceleration time constant [ms]	Dwell time [ms]	Auxiliary function	M code
1	0	3000.00	100	150	100	1	5
2	500	2000.00	150	200	200	1	10
3	1500	1000.00	300	100	150	9	15

Operation sequence

1. Start with the point table number 2.
2. Execute the point table number 3.
3. Execute the point table number 1 with the auxiliary function "9" of the point table number 3.
4. Repeat the above steps in the order of 1, 2, 3, 1, 2, 3.

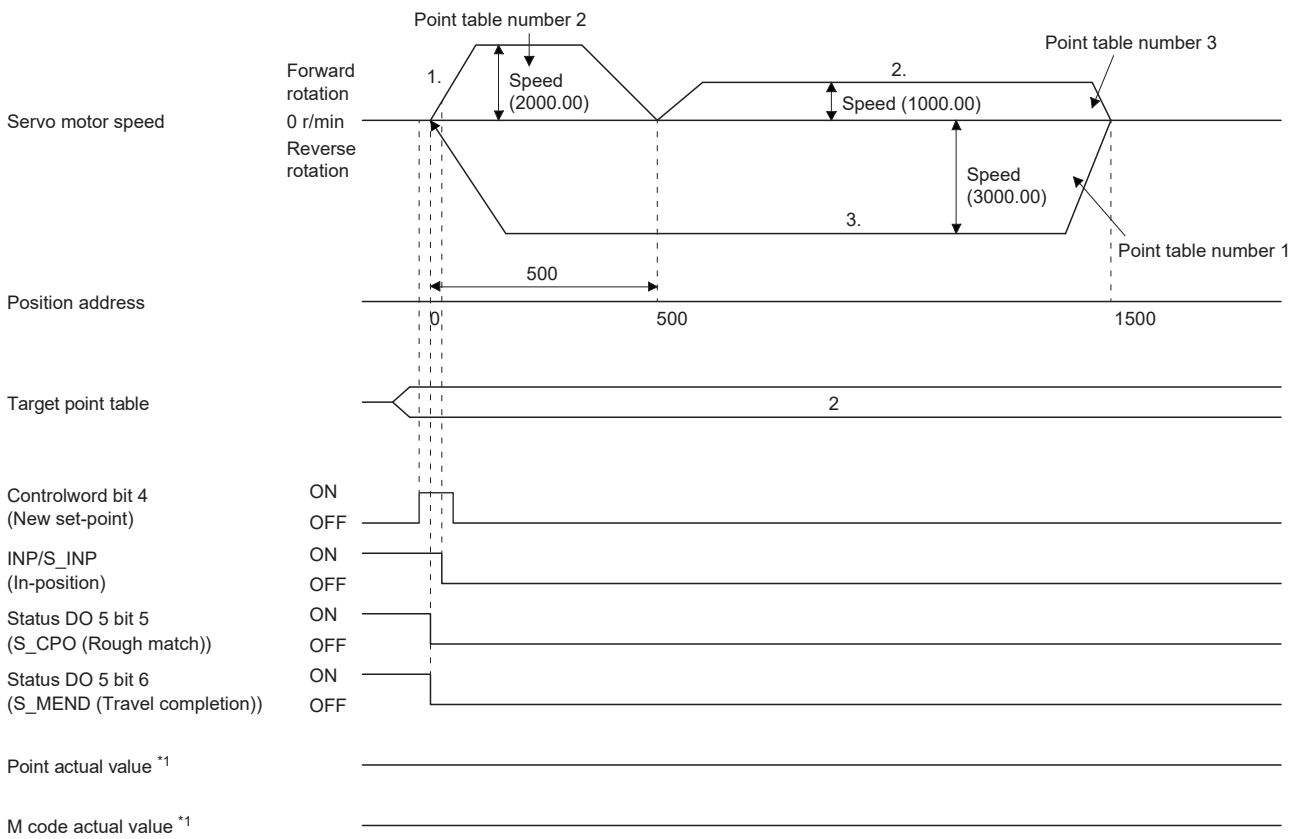

\*1 In repetitive positioning operation, [Point actual value (Obj. 2D69h)] and [M code actual value (Obj. 2D6Ah)] are not outputted.

**When performing repetitive positioning operation with the relative position command method**

**Ex.**

The following shows the behavior when "10" is set for the auxiliary function of the point table number 4.

Point table number	Position data [pulse]	Servo motor speed [r/min]	Acceleration time constant [ms]	Deceleration time constant [ms]	Dwell time [ms]	Auxiliary function	M code
1	400	1500.00	200	100	150	1	1
2	500	3000.00	100	150	100	3	5
3	1000	2000.00	150	200	200	1	10
4	500	1000.00	300	100	150	10	15

Operation sequence

1. Start with the point table number 2.
2. Execute the point table number 3.
3. Execute the point table number 4.
4. Execute the point table number 2 again at startup with the auxiliary function "10" of the point table number 4.
5. Repeat the above steps in the order of 1, 2, 3, 4, 2, 3, 4.

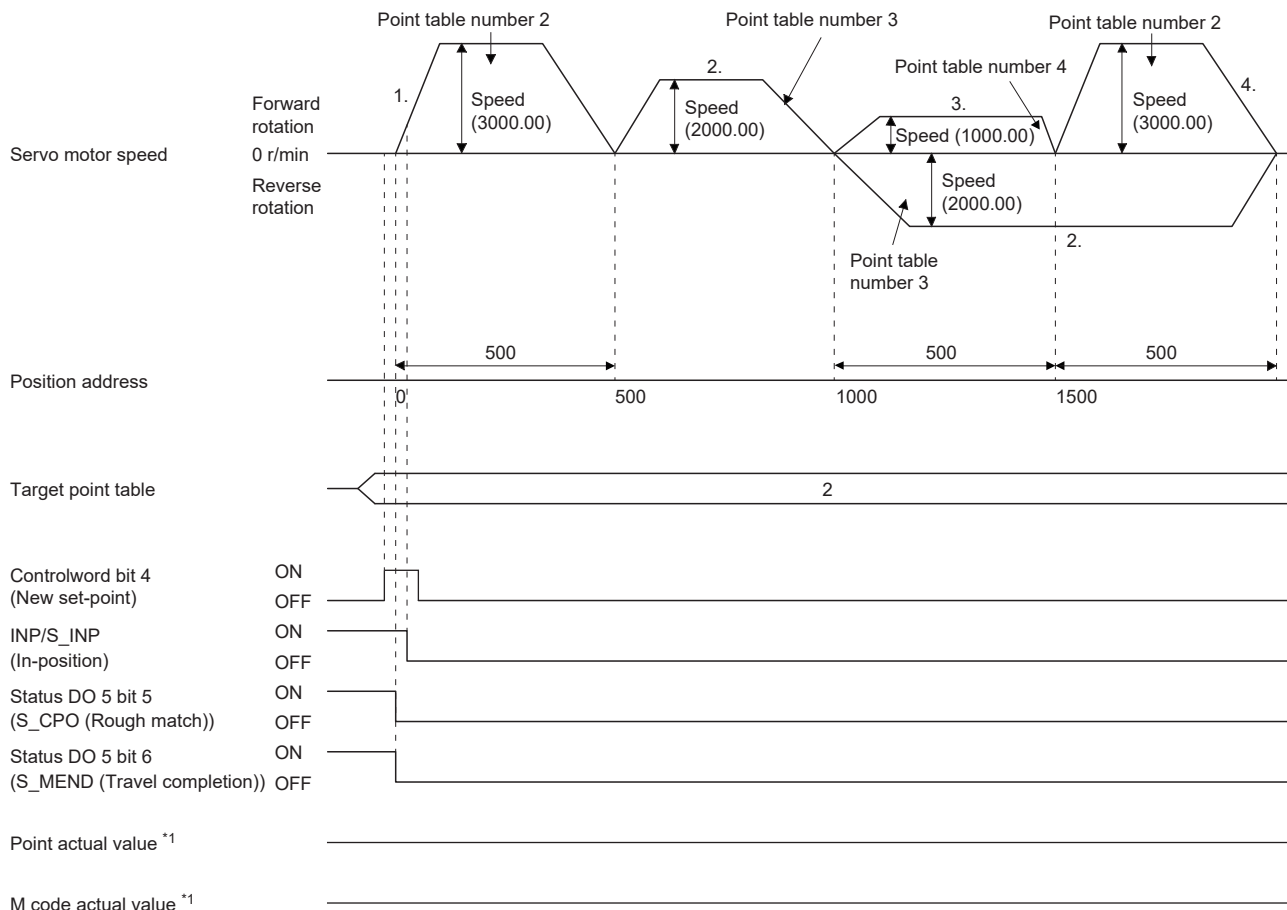

\*1 In repetitive positioning operation, [Point actual value (Obj. 2D69h)] and [M code actual value (Obj. 2D6Ah)] are not outputted.



**Ex.**

The following shows the behavior when "11" is set for the auxiliary function of the point table number 3.

Point table number	Position data [pulse]	Servo motor speed [r/min]	Acceleration time constant [ms]	Deceleration time constant [ms]	Dwell time [ms]	Auxiliary function	M code
1	500	3000.00	100	150	100	3	5
2	1000	2000.00	150	200	200	1	10
3	500	1000.00	300	100	150	11	15

Operation sequence

1. Start with the point table number 2.
2. Execute the point table number 3.
3. Execute the point table number 1 with the auxiliary function "11" of the point table number 3.
4. Repeat the above steps in the order of 1, 2, 3, 1, 2, 3.

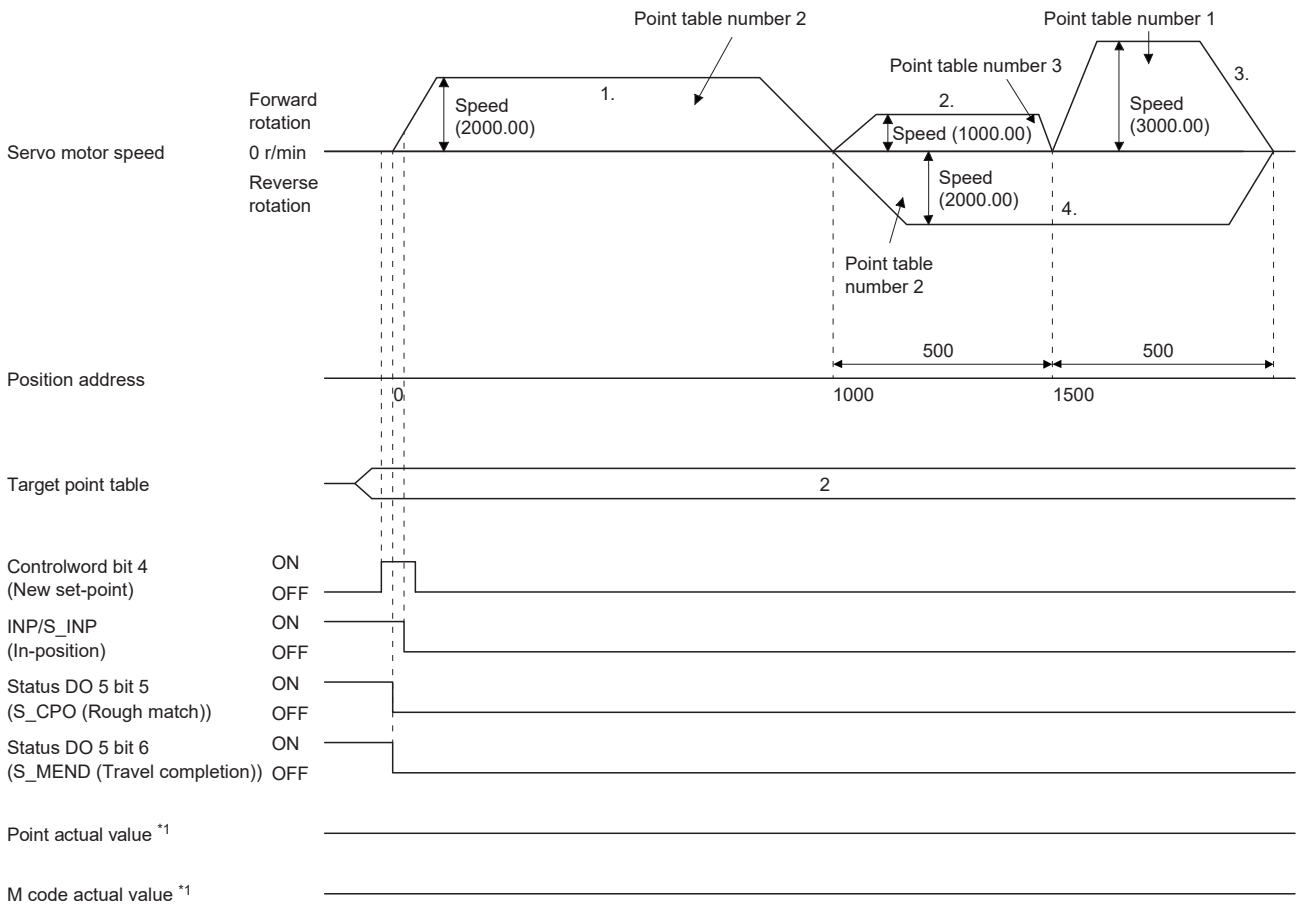

\*1 In repetitive positioning operation, [Point actual value (Obj. 2D69h)] and [M code actual value (Obj. 2D6Ah)] are not outputted.

## ■When performing speed change operation with the absolute position command method

Ex.

The following shows the behavior when "8" is set for the auxiliary function of the point table number 3.

Point table number	Position data [pulse]	Servo motor speed [r/min]	Acceleration time constant [ms]	Deceleration time constant [ms]	Dwell time [ms]	Auxiliary function	M code
1	500	3000.00	100	150	0	1	5
2	500	2000.00	110	160	0	3	10
3	1500	1000.00	90	140	0	8	15

Operation sequence

1. Start with the point table number 1.
2. Change the speed, and execute the point table number 2.
3. Change the speed, and execute the point table number 3.
4. Execute the point table number 1 at startup with the auxiliary function "8" of the point table number 3.
5. Repeat the above steps in the order of 1, 2, 3, 4, 2, 3, 4.

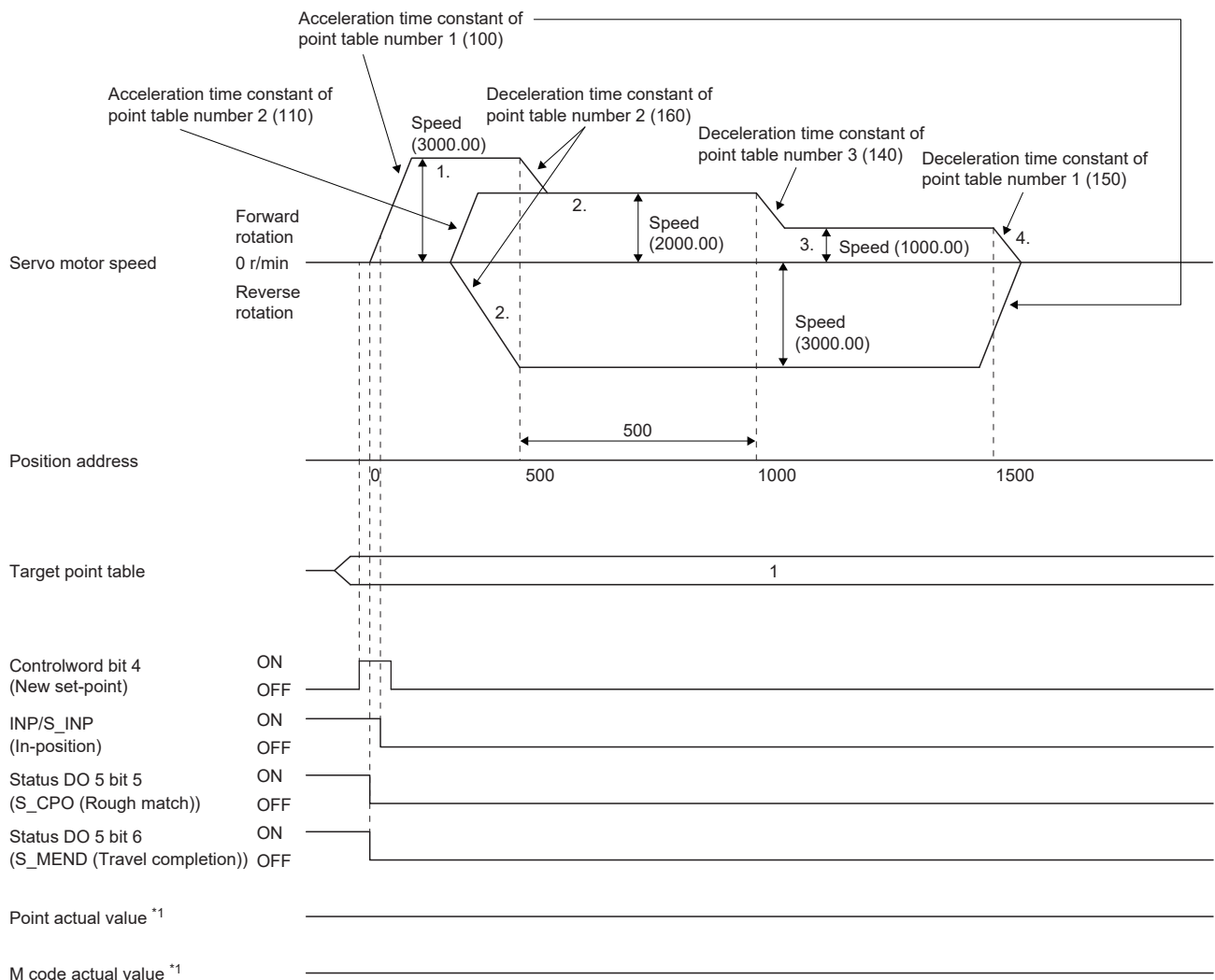

\*1 In repetitive positioning operation, [Point actual value (Obj. 2D69h)] and [M code actual value (Obj. 2D6Ah)] are not outputted.

## ■When performing speed change operation with the relative position command method

**Ex.**

The following shows the behavior when "10" is set for the auxiliary function of the point table number 3.

Point table number	Position data [pulse]	Servo motor speed [r/min]	Acceleration time constant [ms]	Deceleration time constant [ms]	Dwell time [ms]	Auxiliary function	M code
1	500	3000.00	100	150	0	3	5
2	1000	2000.00	110	160	0	1	10
3	500	1000.00	90	140	0	10	15

Operation sequence

1. Start with the point table number 1.
2. Change the speed, and execute the point table number 2.
3. Change the speed, and execute the point table number 3.
4. Change the speed, and execute the point table number 1 with the auxiliary function "10" of the point table number 3.
5. Repeat the above steps in the order of 1, 2, 3, 4, 2, 3, 4.

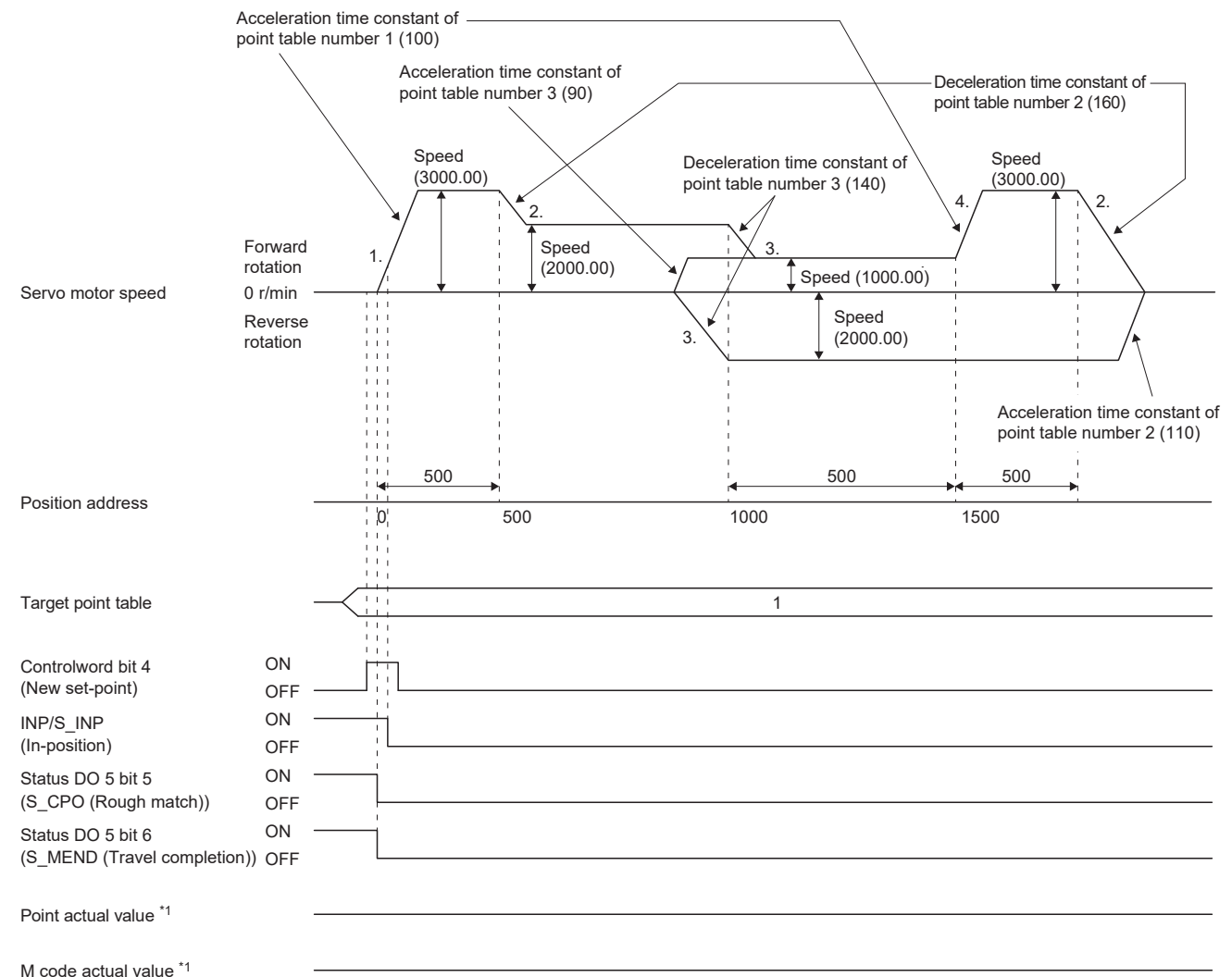

\*1 In repetitive positioning operation, [Point actual value (Obj. 2D69h)] and [M code actual value (Obj. 2D6Ah)] are not outputted.

## Temporary stop/restart

When bit 8 (HALT) of [Controlword (Obj. 6040h)] is turned on during point table operation, the servo motor decelerates and stops temporarily at the deceleration time constant/deceleration of the point table being executed. When bit 8 (HALT) of [Controlword (Obj. 6040h)] is turned off during temporary stop, traveling for the remaining distance is started. Even if bit 4 (New set-point) of [Controlword (Obj. 6040h)] is turned on during temporary stop, operation is not started. If any of the following conditions are met during temporary stop, the remaining travel distance is cleared.

- Bit 4 (New set-point) of [Controlword (Obj. 6040h)] was turned on.
- Switched to the servo-off state.
- Stroke limit or software position limit was detected.
- Control reset was executed.

The temporarily stopped M code update setting can be changed in "M code update setting" of [Pr. PT83.2\_Positioning function selection 2].

Setting value of "M code update setting" (BIN)	Behavior
0	After the remaining travel distance is cleared, the M code is updated. In addition, the M code changes to "0" under the following conditions. <ul style="list-style-type: none"> <li>• When an alarm has occurred</li> <li>• When the control mode is switched to JOG operation mode (jg)</li> </ul>
1	After the remaining travel distance is cleared, the M code is not updated. In addition, the M code changes to "0" under the following conditions. <ul style="list-style-type: none"> <li>• When an alarm has occurred</li> <li>• When [AL. 0E6 Servo forced stop warning] or [AL. 0E9 Main circuit OFF warning] has occurred</li> <li>• When the control mode is switched to JOG operation mode (jg)</li> </ul>

The following shows the conditions under which the temporary stop/restart input functions.

Operation status	Operation mode		
	Point table mode (pt)	JOG operation mode (jg)	Homing mode (hm)
Stopped	—	—	—
Accelerating	Temporary stop	Temporary stop	Stop
At constant speed	Temporary stop	Temporary stop	Stop
Decelerating	—	—	—
Temporarily stopped	Restart	Restart	Stop

### ■When the servo motor is rotating

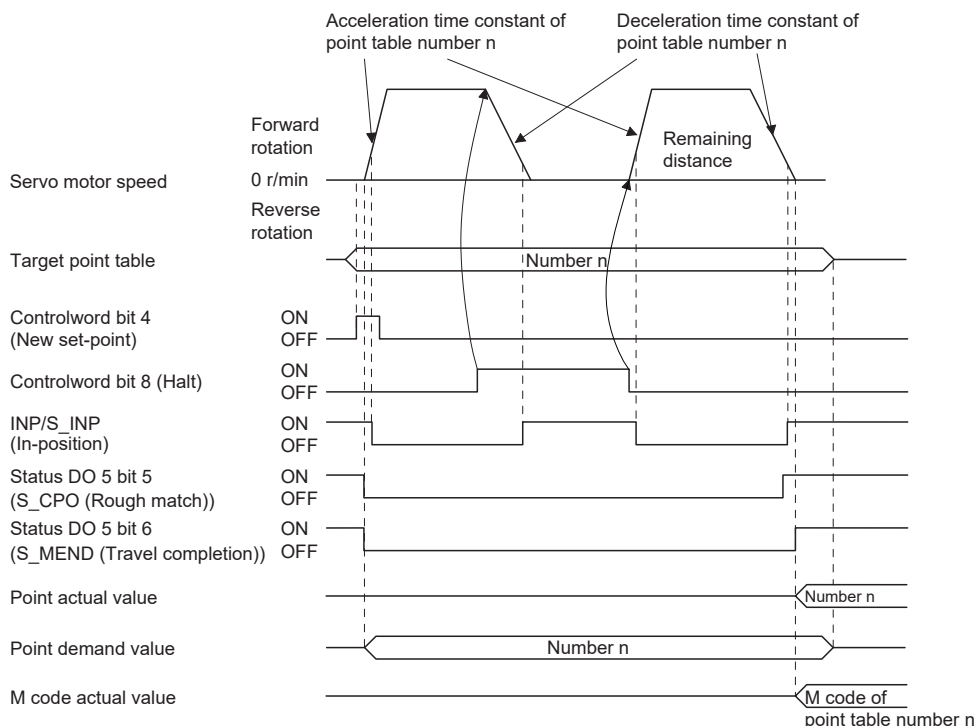

## ■ During dwell

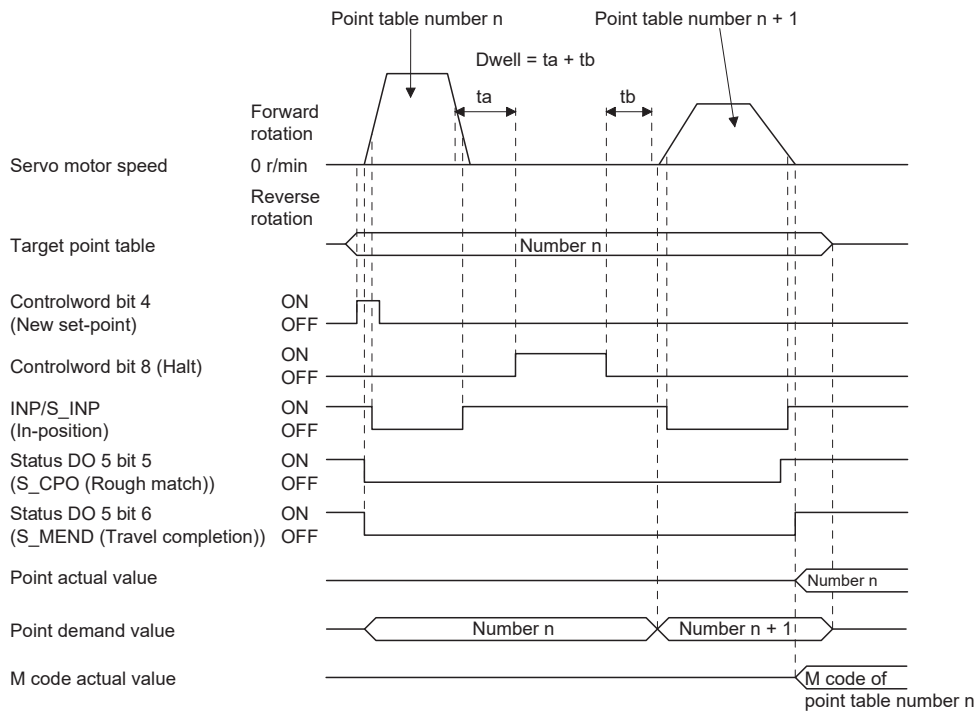

## Interruption of point table operation

To interrupt the point table operation or change the operation pattern, stop the operation with bit 8 (HALT) of [Controlword (Obj. 6040h)], and turn on bit 4 (New set-point) of [Controlword (Obj. 6040h)]. The remaining distance is cleared.

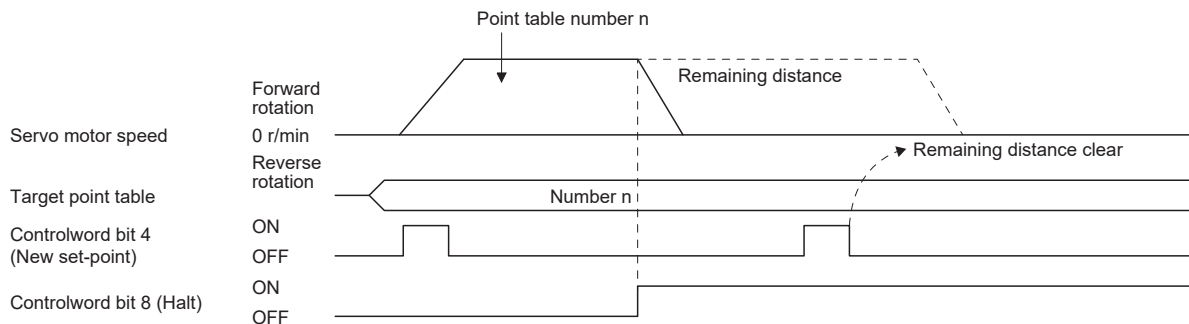

## Timing chart of M code update

- When "M code update setting" of [Pr. PT83.2\_Positioning function selection 2] is "0"

After New set-point, the M code is updated to the M code to correspond to the number of Target point table.

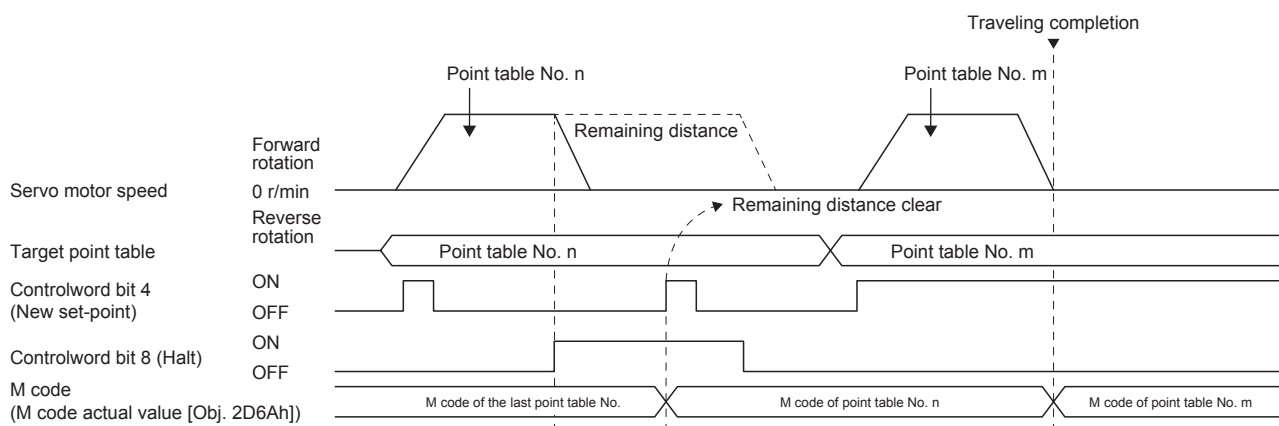

- When "M code update setting" of [Pr. PT83.2\_Positioning function selection 2] is "0"

Because the positioning operation is not finished, the M code is not updated from the value before positioning operation even after New set-point.

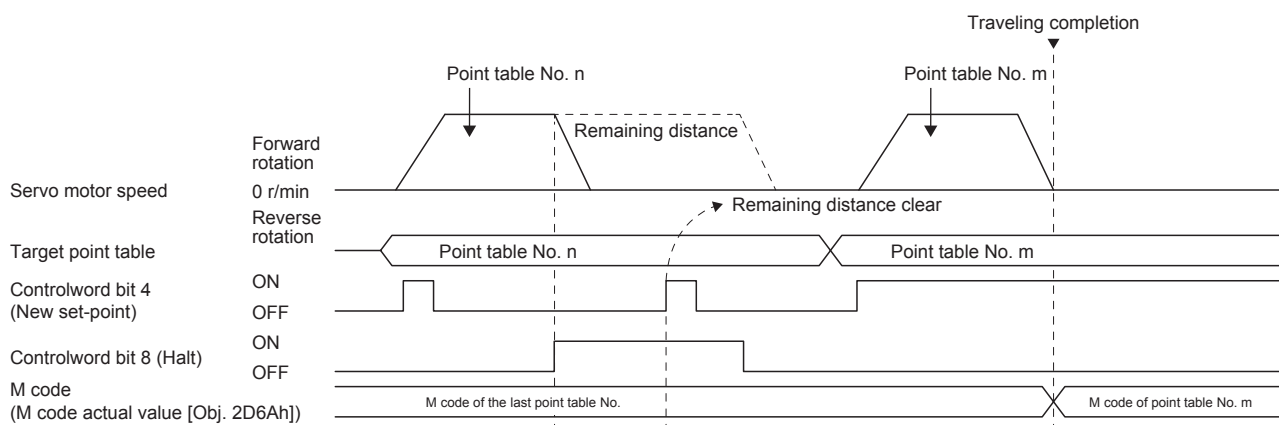

# Positioning function to the home position

This function allows positioning to the home position to return to the home position after the home position has been determined by homing after power-on. For the absolute position detection system, homing is not required after power-on. If positioning to the home is performed when homing has not been completed, [AL. 090.1 Homing incomplete warning] will occur.

After power-on, perform homing in advance.

Set the objects and servo parameters as follows.

Item *1	Object/servo parameter	Setting details
Point table mode (pt) selection	[Modes of operation (Obj. 6060h)]	Set to "-101".
Point table selection	[Target point table (Obj. 2D60h)]	Set to "-1".
Homing speed	[Speed during search for switch (Obj. 6099: 01h)]	Set the servo motor speed for traveling to the home position.
Acceleration time constant	<ul style="list-style-type: none"> <li>[Homing acceleration (Obj. 609Ah)]</li> <li>[Pr. PT56 Homing acceleration time constant]</li> </ul>	Set the acceleration time constant.
Acceleration	<ul style="list-style-type: none"> <li>[Homing acceleration (Obj. 609Ah)]</li> <li>[Pr. PV15 Homing acceleration]</li> </ul>	Set the acceleration to reach the set servo motor speed. (Acceleration time [s] = Servo motor speed / Acceleration)
Deceleration time constant	<ul style="list-style-type: none"> <li>When [Pr. PT55.0 Homing deceleration time constant selection] is set to "0"</li> <li>[Homing acceleration (Obj. 609Ah)]</li> <li>When [Pr. PT55.0] is set to "1"</li> <li>[Pr. PT57 Homing deceleration time constant]</li> </ul>	Set the deceleration time constant.
Deceleration	<ul style="list-style-type: none"> <li>When [Pr. PT55.0 Homing deceleration time constant selection] is set to "0"</li> <li>[Homing acceleration (Obj. 609Ah)]</li> <li>When [Pr. PT55.0] is set to "1"</li> <li>[Pr. PV17 Homing deceleration]</li> </ul>	Set the deceleration to stop the servo motor from the set servo motor speed. (Deceleration time [s] = Servo motor speed / Deceleration)

\*1 The setting unit of the speed data and acceleration/deceleration data can be switched with [Pr. PT01.1].

Set the homing speed of the home positioning function with [Speed during search for switch (Obj. 6099h: 01h)].

Set the acceleration time constant/acceleration with [Homing acceleration (Obj. 609Ah)].

The usage method of the deceleration time constant/deceleration differs depending on the setting value of [Pr. PT55.0 Homing deceleration time constant selection].

Select [Homing acceleration (Obj. 609Ah)], [Pr. PT57 Homing deceleration time constant], or [Pr. PV17 Homing deceleration]. When bit 15 (S\_ZP2) of [Status DO2 (Obj. 2D12h)] is on and bit 10 (Target reached) of [Statusword (Obj. 6041h)] is on, turning on bit 4 (New set-point) of [Controlword (Obj. 6040h)] executes positioning to the home position.

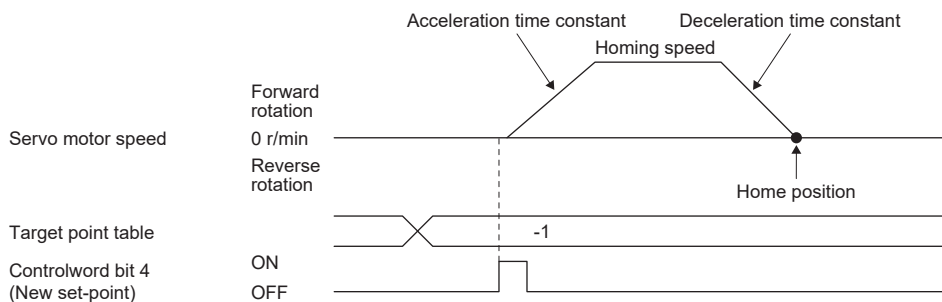

## 7.3 JOG operation mode (jg)

### Point

When [Pr. PT01.1 Speed/acceleration/deceleration unit selection] is set to "1" (command unit/s, command unit/s<sup>2</sup>), the setting ranges of the servo motor speed and acceleration/deceleration differ from those in the point table mode (pt). Therefore, it is recommended that the same range be used as in the point table mode (pt).

For machine adjustment and home positioning, JOG operation enables desired positioning.

## JOG operation

### Setting

Set the objects and servo parameters as follows according to the purpose of use. When the JOG operation is used, [Target point table (Obj. 2D60h)] is disabled.

Item *1	Object/servo parameter	Setting details
JOG operation mode (jg) selection	[Modes of operation (Obj. 6060h)]	Set to "-100".
Servo motor rotation direction	[Pr. PA14 Travel direction selection]	☞ Page 247 Servo motor rotation direction
JOG speed	[Profile velocity (Obj. 6081h)]	Set the servo motor speed.
Acceleration time constant	[Profile Acceleration (Obj. 6083h)]	Set the acceleration time constant.
Acceleration		Set the acceleration to reach the set servo motor speed. (Acceleration time [s] = Servo motor speed / Acceleration)
Deceleration time constant	[Profile deceleration (Obj. 6084h)]	Set the deceleration time constant.
Deceleration		Set the deceleration to stop the servo motor from the set servo motor speed. (Deceleration time [s] = Servo motor speed / Deceleration)
S-pattern acceleration/deceleration time constant	[Pr. PT51 S-pattern acceleration/deceleration time constant]	Set the S-pattern acceleration/deceleration time constant.
Speed limit	[Max profile velocity (Obj. 607Fh)]	Set the speed limit value.
Acceleration limit *2	[Max acceleration (Obj. 60C5h)]	Set the acceleration limit value.
Deceleration limit *2	[Max deceleration (Obj. 60C6h)]	Set the deceleration limit value.

\*1 The setting unit of the speed data and acceleration/deceleration data can be switched with [Pr. PT01.1].

\*2 Available on servo amplifiers with firmware version C0 or later.



## Servo motor rotation direction

Select the servo motor rotation direction when bit 4 (Rotation start) of [Controlword (Obj. 6040h)] is turned on.

[Pr. PA14 Travel direction selection]	Servo motor rotation direction	
	[Controlword (Obj. 6040h)] bit 5 (Direction) OFF	[Controlword (Obj. 6040h)] bit 5 (Direction) ON
0	Rotate in CCW direction	Rotate in CW direction
1	Rotate in CW direction	Rotate in CCW direction

- When [Pr. PA14] is set to "0"

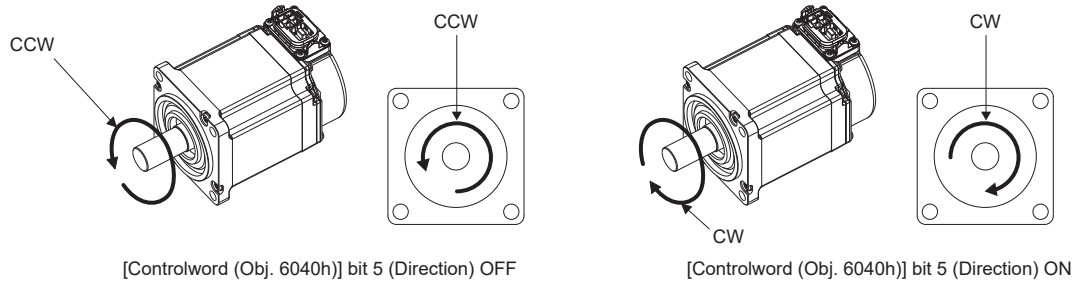

- When [Pr. PA14] is set to "1"

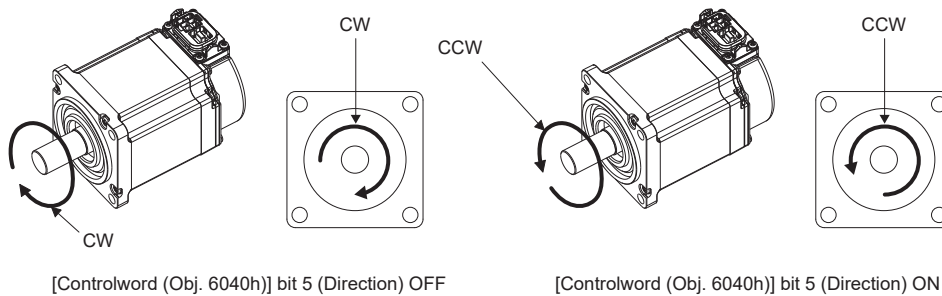

## Operation

When [Controlword (Obj. 6040h)] bit 4 (Rotation start) is turned on, the servo motor operates at the set JOG speed, acceleration time constant/acceleration, and deceleration time constant/deceleration.

☞ Page 246 Setting

When [Controlword (Obj. 6040h)] bit 4 (Rotation start) and [Controlword (Obj. 6040h)] bit 5 (Direction) are turned on, the servo motor rotates in the reverse direction.

☞ Page 247 Servo motor rotation direction

## Timing chart

### ■When operating at a constant speed

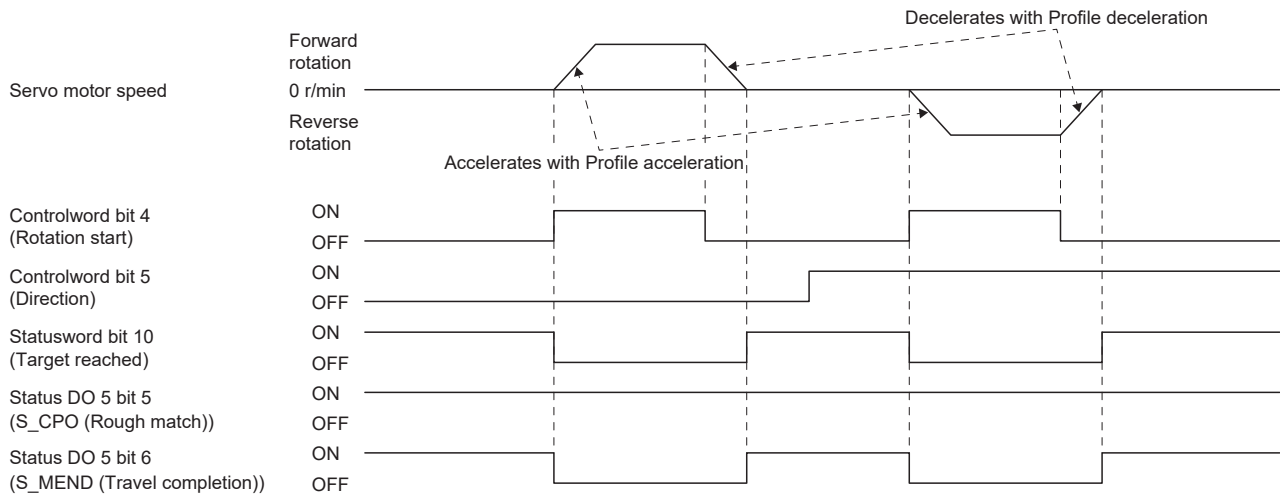

### ■When changing the speed during operation

The servo motor speed can be changed during operation by changing [Profile velocity (Obj. 6081h)]. The servo motor speed cannot be changed during deceleration.

The acceleration time constant/acceleration and deceleration time constant/deceleration can be changed while the servo motor is stopped.

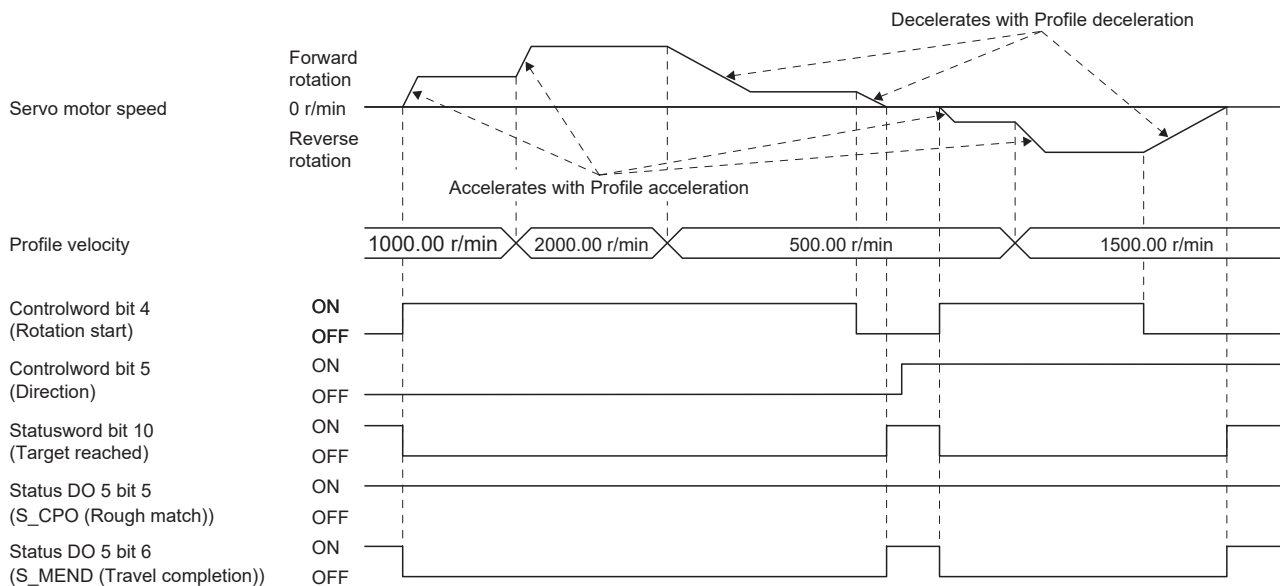

## Temporary stop/restart

When bit 8 (Halt) of [Controlword (Obj. 6040h)] is turned on during JOG operation, the motor will decelerate and stop temporarily at the deceleration time constant/deceleration [Profile deceleration (Obj. 6084h)] being executed. When bit 8 (Halt) of [Controlword (Obj. 6040h)] is turned off during temporary stop, JOG operation is restarted. When bit 4 (Rotation start) of [Controlword (Obj. 6040h)] is off, operation is not restarted.

Even if bit 4 (Rotation start) of [Controlword (Obj. 6040h)] is turned on during temporarily stop, operation is not started.

If any of the following conditions are met during temporary stop, temporary stop is released.

- Switched to the servo-off state.
- Stroke limit or software position limit was detected.
- Control reset was executed.

The conditions under which the temporary stop/restart input functions are the same as the point table operation.

☞ Page 242 Temporary stop/restart

### ■When the servo motor is rotating

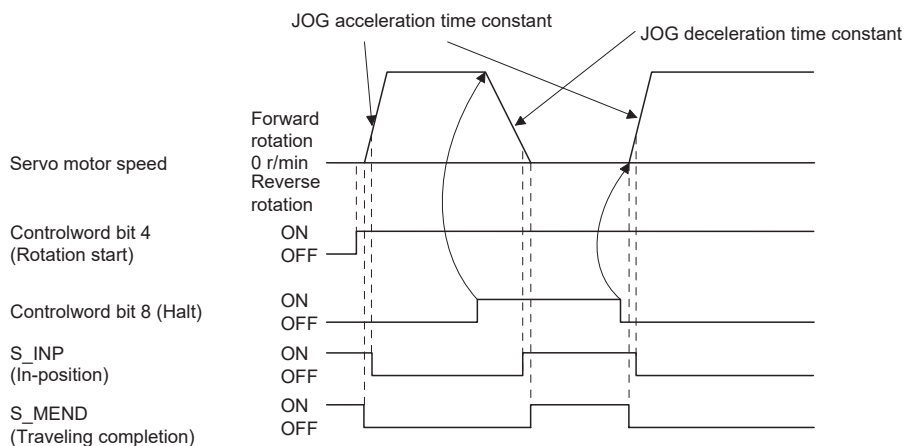

### ■When operation is restarted while temporary stop

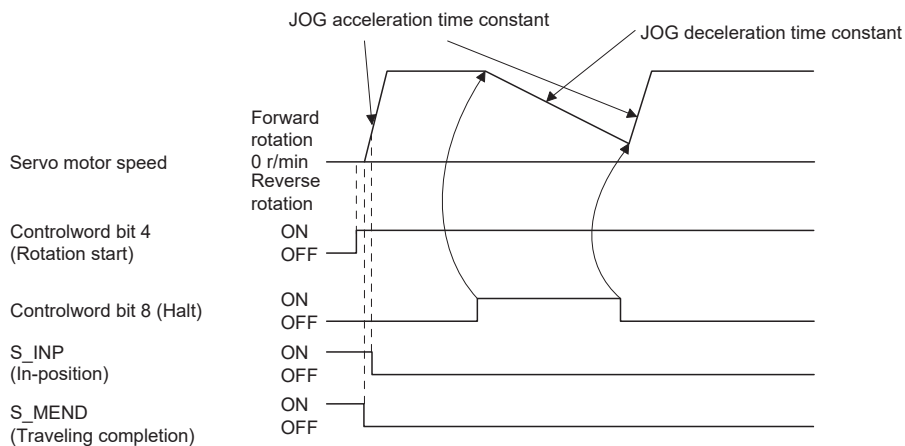

# 7.4 How to Set Point Table

## Setting method using MR Configurator2

The setting of the point table can be used in MR Configurator2 with software version 1.120A or later.

The point table can be set in the positioning mode (point table method).

The positioning mode (point table method) is available on servo amplifiers with firmware version B8 or later.

### Setting procedure

Click "Positioning-data" in the menu bar, and click "Point Table" in the menu.

The following window is displayed.

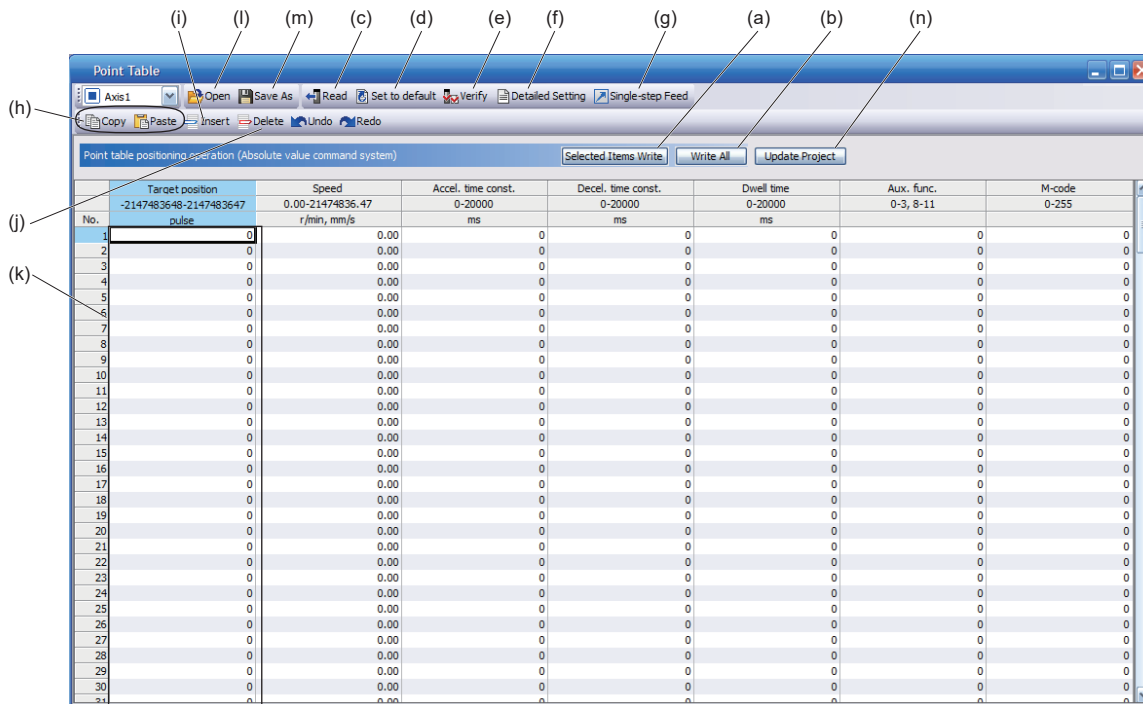

#### ■Writing point table data (a)

Select the changed point table data, and click "Selected Items Write" to write the point table data whose setting has been changed to the servo amplifier.

#### ■Writing point table data in batch (b)

Click "Write all" to write all the point table data to the servo amplifier.

#### ■Reading point table data in batch (c)

Click "Read" to read and display all the point table data read from the servo amplifier.

#### ■Default setting of point table data (d)

Click "Set to default" to initialize all the data of point table number 1 to 255. The data being edited is initialized as well.

#### ■Verification of point table data (e)

Click "Verify" to verify all the displayed data and data of the servo amplifier.

#### ■Detailed setting of point table data (f)

Click "Detailed Setting" to change the position data range and unit of the point table window.

☞ Page 251 Description of the detailed setting window

#### ■Single-step feed (g)

Click "Single-step Feed" to perform the single step feed test operation. For details, refer to "Single-step Feed" in the User's Manual (Introduction).

### ■Copy and paste of point table data (h)

Click "Copy" to copy the selected point table data. Click "Paste" to paste the copied point table data.

### ■Inserting point table data (i)

Click "Insert" to insert one block before the selected point table number. The blocks after the selected point table number are shifted down by one block.

### ■Deleting point table data (j)

Click "Delete" to delete all the data on the selected point table number. The blocks after the selected point table number are shifted up by one block.

### ■Point table data change (k)

Select the data to be changed, enter the new value, and confirm with the Enter key. The display range and unit can be changed with "Point table data detailed setting (f)".

### ■Reading point table data (l)

Click "Open" to read the point table data.

### ■Saving point table data (m)

Click "Save As" to save the point table data.

### ■Updating the project (n)

Click "Update Project" to update the point table of the project.

## Description of the detailed setting window

The speed and acceleration/deceleration unit can be changed in the detailed setting.

For the settings of [Pr. PT01.1 Speed/acceleration/deceleration unit selection], check the next "Point table".

☞ Page 223 Point table

Click "Update Project" in the point table window to apply the settings to the corresponding parameters.

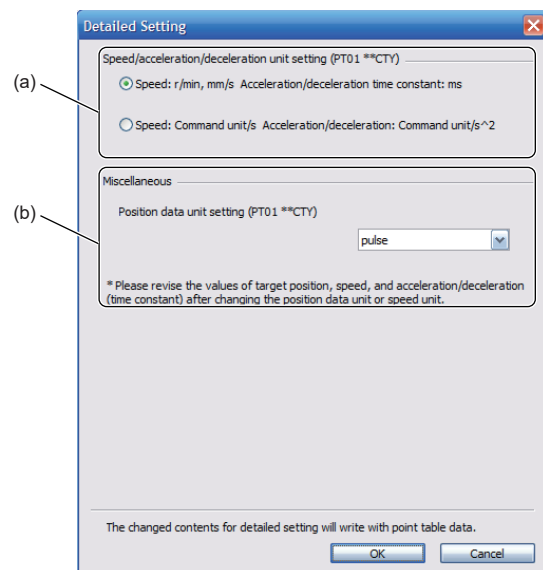

### ■Setting speed and acceleration/deceleration unit (a)

Select the unit of speed from r/min, mm/s, or command unit/s.

The unit of acceleration/deceleration is automatically selected to ms or command unit/s<sup>2</sup> according to the unit of speed.

### ■Setting of position data unit (b)

Select the unit of position data from mm, inch, degree, or pulse.

## Setting method using objects

The master (controller) can change the point table of the servo amplifier by writing a value to the following object via SDO communication. However, once the power supply is shut off, the changed setting is not maintained at the next startup. To maintain the changed setting even after the power supply is shut-off, save the point table setting value to the non-volatile memory by using [Store Parameters (Obj. 1010h)].

Index	Sub	Obj.	Name	Description
2801h	0	ARRAY	Point table 001	Number of entries
	1		Point data	Set the position data of point table number 1.
	2		Speed	Set the servo motor speed of point table number 1.
	3		Acceleration	Set the acceleration time constant/acceleration of point table number 1.
	4		Deceleration	Set the deceleration time constant/deceleration of point table number 1.
	5		Dwell	Set the dwell time of point table number 1.
	6		Auxiliary	Set the auxiliary function of point table number 1.
	7		M code	Set the M code of point table number 1.
⋮	⋮	⋮	⋮	⋮
28FFh	0	ARRAY	Point table 255	Number of entries
	1		Point data	Set the position data of point table number 255.
	2		Speed	Set the servo motor speed of point table number 255.
	3		Acceleration	Set the acceleration time constant/acceleration of point table number 255.
	4		Deceleration	Set the deceleration time constant/deceleration of point table number 255.
	5		Dwell	Set the dwell time of point table number 255.
	6		Auxiliary	Set the auxiliary function of point table number 255.
	7		M code	Set the M code of point table number 255.



# REVISIONS

\*The manual number is given on the bottom left of the back cover.

Revision date	*Manual number	Description
November 2019	IB(NA)-0300458ENG-A	First edition
July 2020	IB(NA)-0300458ENG-B	<p>■The following functions are added: Profile mode, linear servo motor control mode, continuous operation to torque control mode, limit switch release position assessment function, network function</p> <p>■Added: Section 3.4, Chapter 6</p>
November 2020	IB(NA)-0300458ENG-C	<p>■The following function is added: Degree unit</p> <p>■Added: Section 3.5, Section 4.5, Section 4.8, Section 4.9</p>
March 2021	IB(NA)-0300458ENG-D	<p>■The following function is added: Positioning mode (point table method)</p> <p>■Added/edited: Section 1.1, Section 2.1, Section 3.2, Section 3.3, Section 3.5, Section 3.13, Section 3.14, Section 3.15, Section 3.16, Section 4.3, Section 4.5, Section 4.8, Section 4.9, Section 4.14, Section 5.1, Chapter 7</p>
July 2021	IB(NA)-0300458ENG-E	<p>■The following function is added: CC-Link IE Field Network Basic</p> <p>■Added/edited: Section 2.1, Section 3.5, Section 3.8, Section 3.10, Section 3.12, Section 3.16, Section 3.17, Section 4.3, Section 4.4, Section 5.1, Section 6.1, Section 6.2, Section 7.2, Section 7.3</p>
July 2022	IB(NA)-0300458ENG-F	<p>■The following function is added: Fully closed loop system, touch probe</p> <p>■Added/edited: Section 1.1, Section 2.1, Section 3.2, Section 3.3, Section 3.5, Section 3.8, Section 3.9, Section 3.10, Section 3.11, Section 3.12, Section 3.14, Section 3.15, Section 3.16, Section 4.1, Section 4.2, Section 4.3, Section 4.4, Section 4.5, Section 4.6, Section 4.7, Section 4.9, Section 4.10, Section 4.15, Section 4.16, Section 5.1, Chapter 6, Section 6.2, Section 7.2</p>
January 2023	IB(NA)-0300458ENG-G	<p>■The following function is added: Override function</p> <p>■Added/edited: Section 1.1, Section 2.1, Section 3.3, Section 3.10, Section 3.11, Section 3.13, Section 3.15, Section 3.16, Section 4.1, Section 4.3, Section 4.4, Section 4.9, Section 4.11, Section 4.13, Section 4.17, Section 5.1, Section 5.2, Section 7.2, Section 7.3</p>
July 2023	IB(NA)-0300458ENG-H	<p>■Edited: Section 4.2, Section 4.3, Section 4.4, Section 4.14</p>

This manual confers no industrial property rights or any rights of any other kind, nor does it confer any patent licenses. Mitsubishi Electric Corporation cannot be held responsible for any problems involving industrial property rights which may occur as a result of using the contents noted in this manual.

© 2019 MITSUBISHI ELECTRIC CORPORATION



# WARRANTY

---

## Warranty

### **1. Warranty period and coverage**

We will repair any failure or defect hereinafter referred to as "failure" in our FA equipment hereinafter referred to as the "Product" arisen during warranty period at no charge due to causes for which we are responsible through the distributor from which you purchased the Product or our service provider. However, we will charge the actual cost of dispatching our engineer for an on-site repair work on request by customer in Japan or overseas countries. We are not responsible for any on-site readjustment and/or trial run that may be required after a defective unit are repaired or replaced.

[Term]

For terms of warranty, please contact your original place of purchase.

[Limitations]

(1) You are requested to conduct an initial failure diagnosis by yourself, as a general rule.

It can also be carried out by us or our service company upon your request and the actual cost will be charged. However, it will not be charged if we are responsible for the cause of the failure.

(2) This limited warranty applies only when the condition, method, environment, etc. of use are in compliance with the terms and conditions and instructions that are set forth in the instruction manual and user manual for the Product and the caution label affixed to the Product.

(3) Even during the term of warranty, the repair cost will be charged on you in the following cases;

1. a failure caused by your improper storing or handling, carelessness or negligence, etc., and a failure caused by your hardware or software problem
2. a failure caused by any alteration, etc. to the Product made on your side without our approval
3. a failure which may be regarded as avoidable, if your equipment in which the Product is incorporated is equipped with a safety device required by applicable laws and has any function or structure considered to be indispensable according to a common sense in the industry
4. a failure which may be regarded as avoidable if consumable parts designated in the instruction manual, etc. are duly maintained and replaced
5. any replacement of consumable parts (battery, fan, smoothing capacitor, etc.)
6. a failure caused by external factors such as inevitable accidents, including without limitation fire and abnormal fluctuation of voltage, and acts of God, including without limitation earthquake, lightning and natural disasters
7. a failure generated by an unforeseeable cause with a scientific technology that was not available at the time of the shipment of the Product from our company
8. any other failures which we are not responsible for or which you acknowledge we are not responsible for

### **2. Term of warranty after the stop of production**

(1) We may accept the repair at charge for another seven (7) years after the production of the product is discontinued. The announcement of the stop of production for each model can be seen in our Sales and Service, etc.

(2) Please note that the Product (including its spare parts) cannot be ordered after its stop of production.

### **3. Service in overseas countries**

Our regional FA Center in overseas countries will accept the repair work of the Product. However, the terms and conditions of the repair work may differ depending on each FA Center. Please ask your local FA center for details.

### **4. Exclusion of loss in opportunity and secondary loss from warranty liability**

Regardless of the gratis warranty term, Mitsubishi shall not be liable for compensation to:

- (1) Damages caused by any cause found not to be the responsibility of Mitsubishi.
- (2) Loss in opportunity, lost profits incurred to the user by Failures of Mitsubishi products.
- (3) Special damages and secondary damages whether foreseeable or not, compensation for accidents, and compensation for damages to products other than Mitsubishi products.
- (4) Replacement by the user, maintenance of on-site equipment, start-up test run and other tasks.

### **5. Change of Product specifications**

Specifications listed in our catalogs, manuals or technical documents may be changed without notice.

### **6. Application and use of the Product**

- (1) For the use of our AC Servo, its applications should be those that may not result in a serious damage even if any failure or malfunction occurs in AC Servo, and a backup or fail-safe function should operate on an external system to AC Servo when any failure or malfunction occurs.
- (2) Our AC Servo is designed and manufactured as a general purpose product for use at general industries. Therefore, applications substantially influential on the public interest for such as atomic power plants and other power plants of electric power companies, and also which require a special quality assurance system, including applications for railway companies and government or public offices are not recommended, and we assume no responsibility for any failure caused by these applications when used.  
In addition, applications which may be substantially influential to human lives or properties for such as airlines, medical treatments, railway service, incineration and fuel systems, man-operated material handling equipment, entertainment machines, safety machines, etc. are not recommended, and we assume no responsibility for any failure caused by these applications when used. We will review the acceptability of the abovementioned applications, if you agree not to require a specific quality for a specific application. Please contact us for consultation.
- (3) Mitsubishi Electric shall have no responsibility or liability for any problems involving programmable controller trouble and system trouble caused by DoS attacks, unauthorized access, computer viruses, and other cyberattacks.

# TRADEMARKS

---

MELSERVO is a trademark or registered trademark of Mitsubishi Electric Corporation in Japan and/or other countries. All other product names and company names are trademarks or registered trademarks of their respective companies.



IB(NA)-0300458ENG-H(2307)MEE

MODEL:

MODEL CODE:

## **MITSUBISHI ELECTRIC CORPORATION**

HEAD OFFICE: TOKYO BLDG., 2-7-3, MARUNOUCHI, CHIYODA-KU, TOKYO 100-8310, JAPAN  
NAGOYA WORKS: 1-14, YADA-MINAMI 5-CHOME, HIGASHI-KU, NAGOYA 461-8670, JAPAN

When exported from Japan, this manual does not require application to the  
Ministry of Economy, Trade and Industry for service transaction permission.

Specifications subject to change without notice.

Compliance with the indicated global standards and regulations is current as of the release date of this manual.