



INVERTER

Plug-in option

FR-A8NP E KIT

INSTRUCTION MANUAL

PROFIBUS-DP

communication function

PRE-OPERATION INSTRUCTIONS	1
INSTALLATION	2
WIRING	3
INVERTER SETTING	4
FUNCTIONS	5
PROFIBUS DEVICE DATA	6
PPO TYPE SUPPORT SPECIFICATION	7
PPO TYPE NON-SUPPORT SPECIFICATION	8
TROUBLESHOOTING	9

Safety instructions

Thank you for choosing this Mitsubishi Electric inverter plug-in option.

This Instruction Manual provides handling information and precautions for use of this product. Incorrect handling might cause an unexpected fault. Before using this product, read all relevant instruction manuals carefully to ensure proper use.

Please forward this Instruction Manual to the end user.

Do not attempt to install, operate, maintain or inspect this product until you have read this Instruction Manual and supplementary documents carefully. Do not use this product until you have a full knowledge of this product mechanism, safety information and instructions. In this Instruction Manual, the safety instruction levels are classified into "WARNING" and "CAUTION".

 **WARNING** Incorrect handling may cause hazardous conditions, resulting in death or severe injury.

 **CAUTION** Incorrect handling may cause hazardous conditions, resulting in medium or slight injury, or may cause only material damage.

Note that even the  **CAUTION** level may lead to a serious consequence depending on conditions. Be sure to follow the instructions of both levels as they are critical to personnel safety.

◆ Electric shock prevention

WARNING

- Do not remove the front cover or the wiring cover while the power of the inverter is ON, and do not run the inverter with the front cover or the wiring cover removed. Otherwise you may access the exposed high voltage terminals or the charging part of the circuitry and get an electric shock.
- Even if power is OFF, do not remove the front cover of the inverter except for wiring or periodic inspection as you may accidentally touch the charged circuits and get an electric shock.
- Before wiring or inspection, check that the display of the inverter operation panel is OFF. Any person who is involved in wiring or inspection shall wait for 10 minutes or longer after power OFF and check that there are no residual voltage using a tester or the like. The capacitor is charged with high voltage for some time after power OFF, and it is dangerous.
- Any person who is involved in wiring or inspection of this product shall be fully competent to do the work.
- This product must be installed before wiring. Otherwise you may get an electric shock or be injured.
- Do not touch this product or handle the cables with wet hands. Doing so may cause an electric shock.
- Do not subject the cables to scratches, excessive stress, heavy loads or pinching. Doing so may cause an electric shock.

◆ Injury prevention

CAUTION

- The voltage applied to each terminal must be as specified in the Instruction Manual. Otherwise an explosion or damage may occur.
- The cables must be connected to the correct terminals. Otherwise an explosion or damage may occur.
- The polarity (+ and -) must be correct. Otherwise an explosion or damage may occur.
- While power is ON or for some time after power OFF, do not touch the inverter as it will be extremely hot. Doing so may cause burns.

◆ Additional instructions

The following instructions must be also followed. If this product is handled incorrectly, it may cause unexpected fault, an injury, or an electric shock.

CAUTION

Transportation and installation

- Do not install or operate this product if it is damaged or has parts missing.
- Do not stand or place heavy objects on this product.
- Ensure the mounting orientation of this product is correct.
- Foreign conductive objects must be prevented from entering the inverter. That includes screws and metal fragments or other flammable substance such as oil.
- If halogens (including fluorine, chlorine, bromine, and iodine) contained in fumigants for wood packages enter this product, the product may be damaged. Prevent the entry of fumigant residuals or use an alternative method such as heat disinfection. Note that sterilization or disinfection of wood packages should be performed before packing the product.

Test operation

- Before starting operation, confirm or adjust the parameter settings. Failure to do so may cause some machines to make unexpected motions.

WARNING

Usage

- Do not modify this product.
- Do not remove any part which is not instructed to be removed in the Instruction Manuals. Doing so may lead to a failure or damage of this product.

CAUTION

Usage

- As all parameters return to their initial values after Parameter clear or All parameter clear is performed, the needed parameters for operation of the inverter and this product must be set again before the operation is started.
- To avoid damage to this product due to static electricity, static electricity in your body must be discharged before you touch this product.
- To maintain the security (confidentiality, integrity, and availability) of the inverter and the system against unauthorized access, DoS*1 attacks, computer viruses, and other cyberattacks from external devices via network, take appropriate measures such as firewalls, virtual private networks (VPNs), and antivirus solutions. We shall have no responsibility or liability for any problems involving inverter trouble and system trouble by DoS attacks, unauthorized access, computer viruses, and other cyberattacks.

Maintenance, inspection and parts replacement

- Do not carry out a megger (insulation resistance) test.

Disposal

- This product must be treated as industrial waste.

*1 DoS: A denial-of-service (DoS) attack disrupts services by overloading systems or exploiting vulnerabilities, resulting in a denial-of-service (DoS) state. product must be treated as industrial waste.

General instruction

- For clarity, illustrations in this Instruction Manual may be drawn with covers or safety guards removed. Ensure all covers and safety guards are properly installed prior to starting operation.
-

— CONTENTS —

Safety instructions	1
<hr/>	
1 PRE-OPERATION INSTRUCTIONS	7
<hr/>	
1.1 Unpacking and product confirmation.....	7
1.2 Component names	9
1.3 Specifications	10
1.3.1 Inverter option specifications	10
1.3.2 Communication specifications	10
2 INSTALLATION	11
<hr/>	
2.1 Pre-installation instructions	11
2.2 Installation procedure	11
2.3 Node address switch setting	19
3 WIRING	20
<hr/>	
3.1 Terminals.....	20
3.2 Wiring.....	21
4 INVERTER SETTING	24
<hr/>	
4.1 Parameter list.....	24
4.2 Operation mode setting	25
4.2.1 Operation mode switching and communication startup mode (Pr.79, Pr.340).....	25
4.3 Operation at communication error occurrence	28
4.3.1 Operation selection at communication error occurrence (Pr.500 to Pr.502, Pr.779)	28
4.3.2 Fault and measures	33
4.4 Inverter reset.....	34



5	FUNCTIONS	36
5.1	Output from the inverter to the network	36
5.2	Input to the inverter from the network.....	37
6	PROFIBUS DEVICE DATA	38
6.1	Device data (GSD file)	38
6.2	Slave user parameter	42
7	PPO TYPE SUPPORT SPECIFICATION	43
7.1	PROFIBUS profiles	43
7.2	ID definitions	44
7.3	Buffer memory configuration	45
7.4	Buffer memory details.....	46
7.5	Outline of PNU	52
7.6	PROFIBUS PNU.....	53
7.6.1	Real-time monitor.....	53
7.6.2	Parameter clear	53
7.6.3	Operation mode read/write	54
7.6.4	Set frequency read.....	54
7.6.5	Terminal input read	54
7.6.6	Inverter reset.....	54
7.6.7	Node address read	55
7.6.8	Fault history read	55
7.6.9	PNU list read.....	59
7.7	Standard parameters.....	60
7.8	PROFIBUS-DP communication function setting	62
7.8.1	Torque command / torque limit via PROFIBUS communication (Pr.804).....	62
7.8.2	Frequency command with sign (Pr.541)	63

8	PPO TYPE NON-SUPPORT SPECIFICATION	64
8.1	PROFIBUS profiles	64
8.2	ID definitions	65
8.3	Buffer memory configuration	66
8.4	Buffer memory details.....	67
8.5	Outline of PNU	71
8.6	PROFIBUS PNU (module type A5NP)	71
8.6.1	Real-time monitor area (IND = H0000 (IND = H00, PP = H00))	71
8.6.2	System environment variable (sev) area (IND = H01PP (IND = H01, PP = H00, H01))	72
8.7	Standard parameters.....	75
8.7.1	Normal parameter area (IND = H0200 (IND = H02, PP = H00)).....	75
8.7.2	Pr.900 to calibration parameter (frequency) area (IND = H0300 (IND = H03, PP = H00))	76
8.7.3	Pr.900 to calibration parameter (%) area (IND = H0400 (IND = H04, PP = H00)).....	77
9	TROUBLESHOOTING	78
APPENDIX		80
Appendix 1	Instructions for compliance with the EU Directives	80
Appendix 2	Instructions for EAC	81
Appendix 3	Restricted Use of Hazardous Substances in Electronic and Electrical Products	82
Appendix 4	Referenced Standard (Requirement of Chinese standardized law)	83
Appendix 5	Compliance with the UK certification scheme	84
REVISIONS		86









1 PRE-OPERATION INSTRUCTIONS

1.1 Unpacking and product confirmation

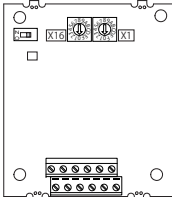
Take the plug-in option out of the package, check the product name, and confirm that the product is as you ordered and intact. This product is a plug-in option made for the FR-E800 series inverter.

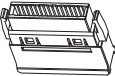
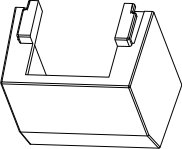
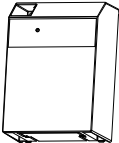
◆ Product confirmation

Check the enclosed items.

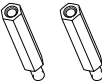
<p>Plug-in option: 1</p> 	<p>Mounting screw (M3 × 8 mm): 2 (Refer to page 12, 14.)</p> 	<p>Junction connector: 1 (Refer to page 12, 14.)</p> 	<p>Option small cover: 1 (Refer to page 14.)</p> 	<p>Front cover for plug-in option (with lenses): 1 (Refer to page 12, 14.)</p> 
<p>Recessed neck screw (M3 × 7 mm): 1 (Refer to page 12, 14.)</p> 	<p>Straight spacer: 1 (Refer to page 12, 14.)</p> 	<p>L-shaped spacer: 1 (Refer to page 12, 14.)</p> 	<p>Hexagon spacer: 2 (Refer to page 12, 14.)</p> 	

NOTE

- PROFIBUS is a trademark of PROFIBUS & PROFINET International.

◆ SERIAL number check

The FR-A8NP can be used with the models of inverters listed below which have the following SERIAL number. Check the SERIAL number indicated on the inverter rating plate or package.

Rating plate example

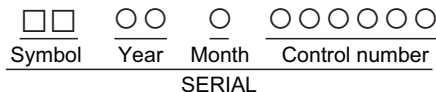
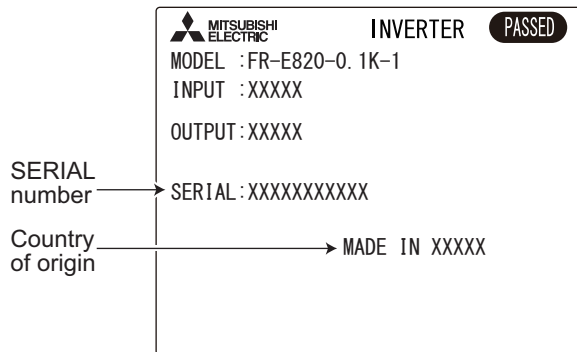



The SERIAL consists of two symbols, three characters indicating the production year and month, and six characters indicating the control number. The last two digits of the production year is indicated as the Year, and the Month is indicated by 1 to 9, X (October), Y (November), or Z (December).

Model	Country of origin indication	SERIAL number
FR-E820-0008(0.1K) to 0900(22K) FR-E840-0016(0.4K) to 0440(22K) FR-E860-0017(0.75K) to 0120(7.5K) FR-E820S-0008(0.1K) to 0110(2.2K)	MADE in Japan	□□ 205 ○○○○○○ or later

1.2 Component names

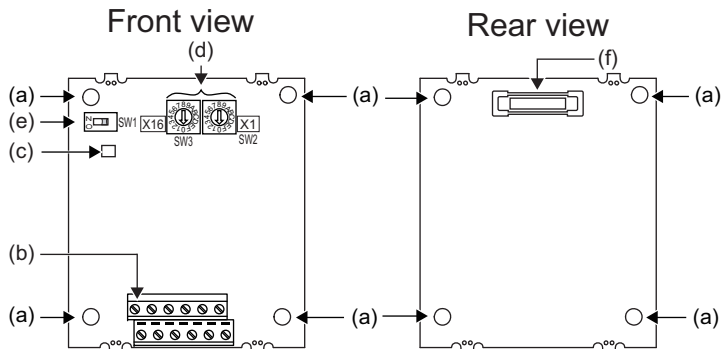
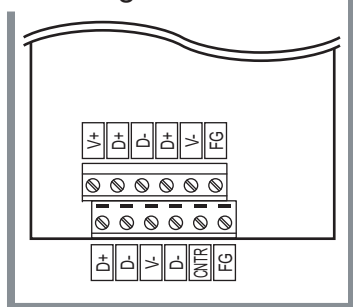
Pin assignment



Symbol	Name	Description	Refer to page
a	Mounting hole	Fixes the option to the inverter with screws, or installs spacers.	11
b	Terminal block	Connect the communication cable.	23
c	Operation status (LED)	ON/OFF indicator of the LED indicates inverter operation status. OFF: Inverter power OFF Red (ON): A communication error with the master occurred Green (ON): During communication with the master	—
d	Node address switch	Set the inverter address within the range of H00 to H7D.	19
e	Switch for manufacturer setting	Switch for manufacturer setting. Do not change from the initially-set status (OFF ).	—
f	Board mounted option connector	Used to connect this product to the option connector on the inverter.	11

1.3 Specifications

1.3.1 Inverter option specifications

Item	Description
Type	Inverter plug-in option type
Number of nodes occupied	One inverter occupies one node.
Connection cable	Cable which supports 12.0 Mbps communication (EIA-485 (RS-485) standard)

1.3.2 Communication specifications

Wiring length	Communication speed
1200 m or less	9600 bps, 19.2 kbps, 93.75 kbps
600 m or less	187.5 kbps
200 m or less	500 kbps, 1.5 Mbps
100 m or less	3.0 Mbps, 6.0 Mbps, 12.0 Mbps

2 INSTALLATION

2.1 Pre-installation instructions

Check that the inverter's input power and the control circuit power are both OFF.

CAUTION

- Do not install or remove this product while the inverter power is ON. Doing so may damage the inverter or this product.
- To avoid damage due to static electricity, static electricity in your body must be discharged before you touch this product.

2.2 Installation procedure

◆ Installing the option

The FR-E800 series inverter has only one plug-in option connector.

NOTE

- Ensure the control circuit terminals are wired before installing the plug-in option. They cannot be wired after the plug-in option is installed.
 - When installing the plug-in option, prevent cables being caught between parts. Otherwise the inverter and the option may be damaged.
-

■ For the **FR-E820-0175(3.7K) or lower, FR-E840-0170(7.5K) or lower, and FR-E860-0120(7.5K) or lower**

1. Remove the inverter front cover. (Refer to the FR-E800 Instruction Manual (Connection) for instructions to remove the cover.)
2. Use a nipper or the like to cut off the bottom of the front cover for plug-in option.

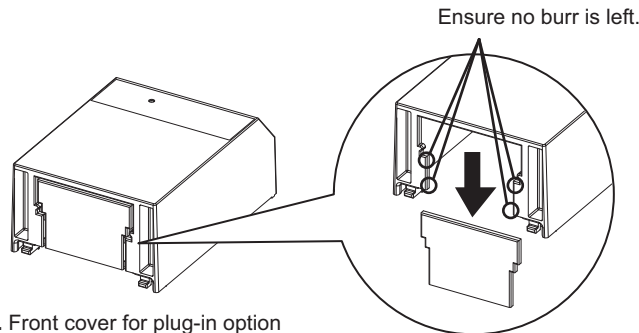

2. Front cover for plug-in option
3. Fit the L-shaped spacer, straight spacer, and junction connector to the plug-in option as shown in the figure on the [page 13](#). Fit the junction connector to the guide of the connector of the plug-in option, and insert the junction connector as far as it goes. Fit the L-shaped spacer to the plug-in option so that the lower edge of the option placed on the ridge of the spacer.

4. Remove the body screws of the inverter, then install the hexagon spacers to the inverter (tightening torque 0.33 to 0.40 N·m).
5. Fit the junction connector, which has been connected to the plug-in option, to the guide of the option connector on the inverter, and insert the junction connector as far as it goes.
6. Fasten this product to the inverter using the two mounting screws through the holes at the upper left and lower right (tightening torque 0.33 to 0.40 N·m). If the connector is not inserted deep enough, the screws cannot be tightened properly. Check the connector.
7. Connect cables to the terminal block of the plug-in option. (Refer to [page 20](#) for the wiring.)
8. After wiring of the plug-in option has been completed, mount the front cover for the plug-in option to the inverter.

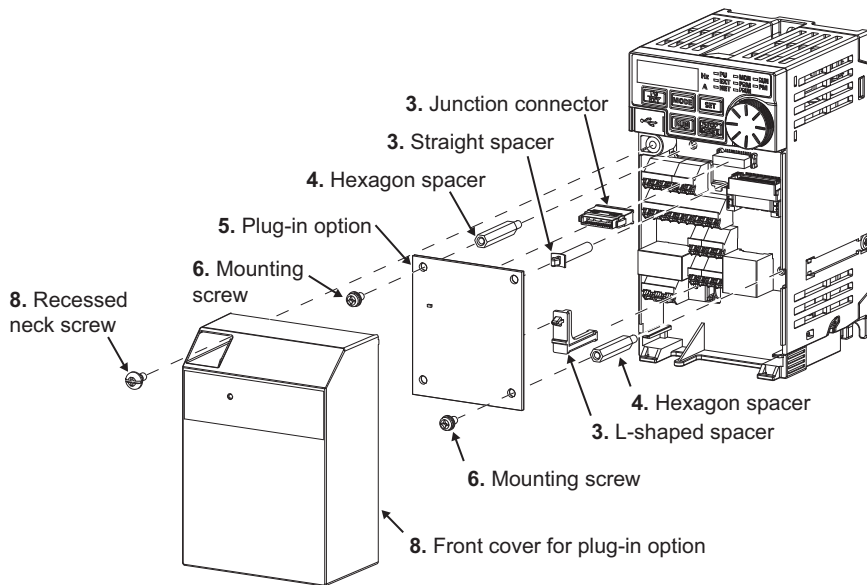

■ For the FR-E820-0240(5.5K) or higher and FR-E840-0230(11K) or higher

1. Remove the upper front cover and the lower front cover from the inverter. (Refer to the FR-E800 Instruction Manual (Connection) for instructions to remove the covers.)
2. Use a nipper or the like to cut off the dummy cover of the lower front cover in order to install the option small cover.

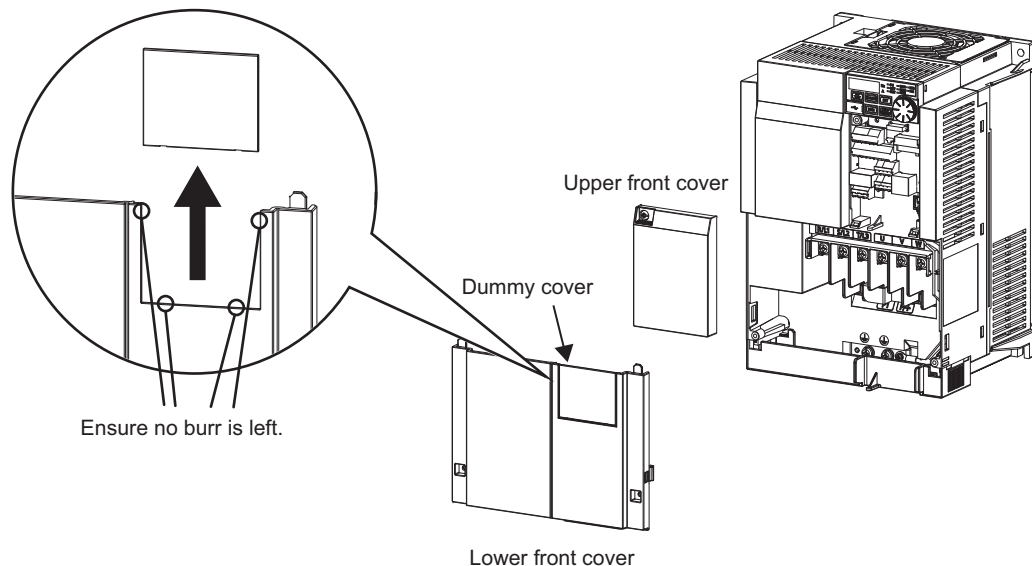

3. Use a nipper or the like to cut off the bottom of the front cover for plug-in option. (For details, refer to [page 12](#).)
4. Fit the L-shaped spacer, straight spacer, and junction connector to the plug-in option as shown in the figure on the [page 16](#). Fit the junction connector to the guide of the connector of the plug-in option, and insert the junction connector as far as it goes. Fit the L-shaped spacer to the plug-in option so that the lower edge of the option placed on the ridge of the spacer.

5. Remove the body screws of the inverter, then install the hexagon spacers to the inverter (tightening torque 0.33 to 0.40 N·m).
6. Fit the junction connector, which has been connected to the plug-in option, to the guide of the option connector on the inverter, and insert the junction connector as far as it goes.
7. Fasten this product to the inverter using the two mounting screws through the holes at the upper left and lower right (tightening torque 0.33 to 0.40 N·m). If the connector is not inserted deep enough, the screws cannot be tightened properly. Check the connector.
8. Connect cables to the terminal block of the plug-in option. (Refer to [page 20](#) for the wiring.)
9. After wiring of the plug-in option has been completed, mount the front cover for the plug-in option to the inverter.
10. Install the option small cover to the front cover for plug-in option by inserting the small cover into the front cover and slide it toward the rear of the inverter.

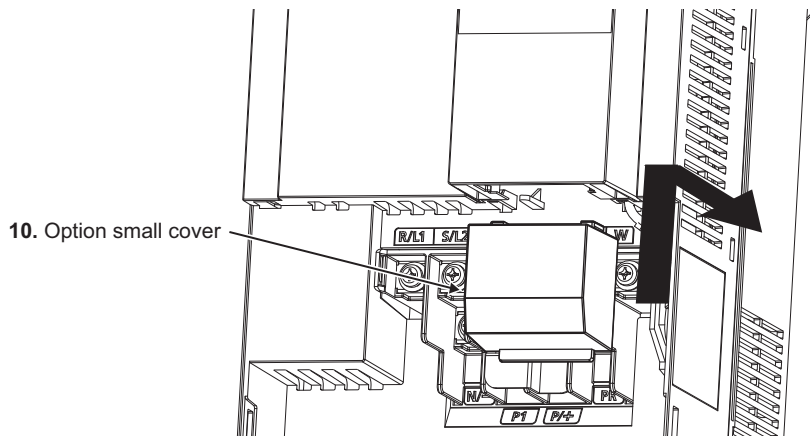

11. Install the lower front cover to the inverter.

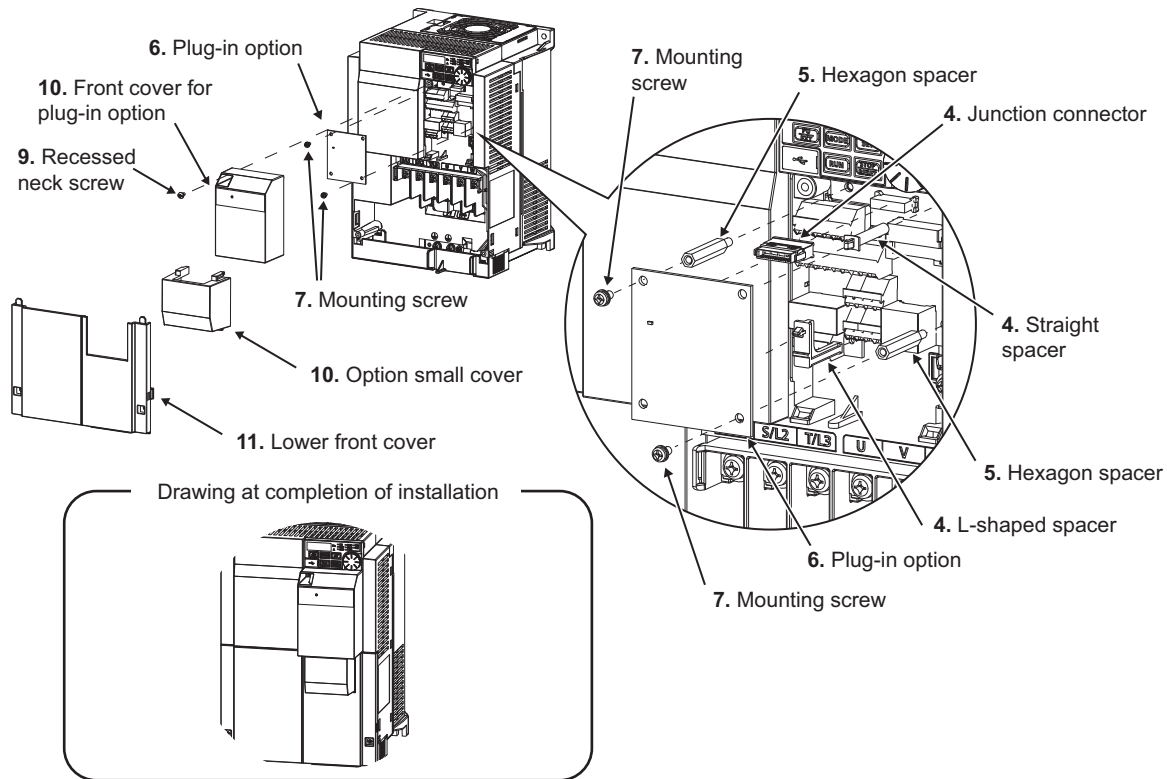

◆ Insertion positions for screws and spacers

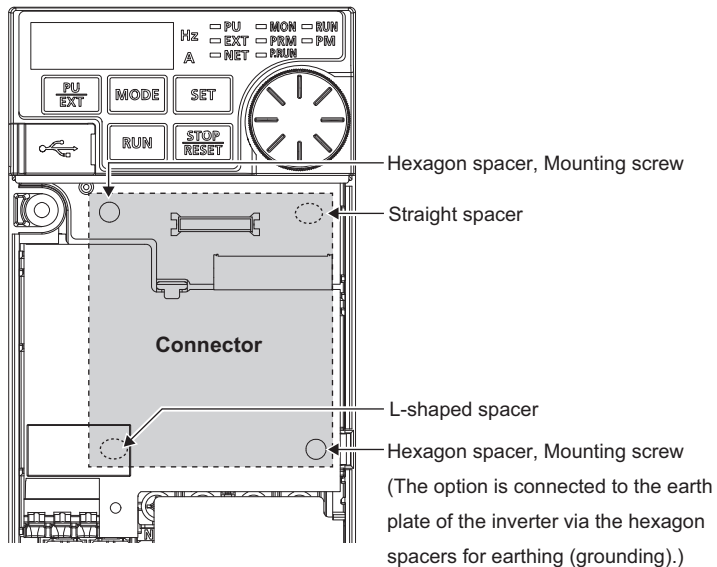

NOTE

- When the junction connector is installed to the plug-in option, the option is fixed with the hooks of the connector. The junction connector cannot be removed from the plug-in option.
- When removing the front cover for plug-in option from the inverter, note that the recessed neck screw cannot be removed from the front cover for plug-in option.
- When the body screws of the inverter are removed to install the hexagon spacers (in Step 4 on [page 13](#) or Step 5 on [page 15](#)), make sure that the control circuit board does not fall off due to the weight of cables.
- When installing/removing the plug-in option, hold the sides of the option. Do not press on the parts on the option circuit board. Stress applied to the parts by pressing, etc. may cause a failure.
- Be careful not to drop mounting screws during the installation or removal of the plug-in option.
- When the inverter cannot recognize the option due to improper installation or any other reason, the protective function (E.1) is activated and the inverter cannot be operated.

Mounted position	Fault indication
Option connector	E. 1

- When removing the plug-in option, remove the two screws at the upper left and lower right, and then pull it straight out. Pressure applied to the option connector and to the option board may break the option.

2.3 Node address switch setting

Set the node address between "H00" and "H7D" using the node address switches on the FR-A8NP board. (Refer to [page 9](#).)
The setting is applied at the next power-ON.

Set the arrow (↑) of the corresponding switches to a number or an alphabet to set a desired address.

- Setting example

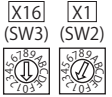
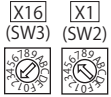
Node address 1	Node address 38 (H26)
<p>Set the "↑" of X16 (SW3) to "0" and the "↑" of X1 (SW2) to "1".</p> 	<p>Set the "↑" of X16 (SW3) to "2" and the "↑" of X1 (SW2) to "6".</p> 

2

NOTE

- Set the inverter node address before switching ON the inverter and do not change the setting while power is ON. Otherwise you may get an electric shock.
- Set the node address switch to the switch number (alphabet) position correctly. If the switch is set between numbers, normal data communication cannot be established.

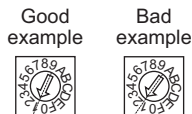

- When the node address switches are set to any of H7E to HFF, the node address is recognized as H7D.
- The node addresses, H00, H01, H02, H7C, and H7D, may not be available for some master modules.
- You cannot set the same node address to other devices on the network. (Doing so disables proper communication.)

3 WIRING

3.1 Terminals

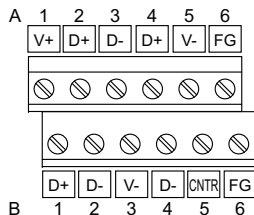

Terminal no.	Terminal name	Definition
1-A	V+ (VP) ^{*1}	Voltage output (approx. 5 V to V-)
1-B	D+ (RXD/TXD-P)	Sends and receives PROFIBUS signal+ (B-line)
2-A	D+ (RXD/TXD-P) ^{*1}	Sends and receives PROFIBUS signal+ (B-line)
2-B	D- (RXD/TXD-N)	Sends and receives PROFIBUS signal- (A-line)
3-A	D- (RXD/TXD-N) ^{*1}	Sends and receives PROFIBUS signal- (A-line)
3-B	V- (DGND)	GND of D+/D-
4-A	D+ (RXD/TXD-P) ^{*1}	(To connect a terminating resistor)
4-B	D- (RXD/TXD-N) ^{*1}	(To connect a terminating resistor)
5-A	V- (DGND) ^{*1}	GND of D+/D-
5-B	CNTR ^{*2}	Control signal (sending request from the inverter)
6-A	FG	(Connected to the earth of the inverter unit)
6-B	FG	(Connected to the earth of the inverter unit)

^{*1} When connecting a terminating resistor, connect the terminating resistor to these terminals. (Refer to [page 23](#).)

^{*2} It may not be necessary depending on the master used.

3.2 Wiring

Use the network connection cable which supports 12.0 Mbps communication.

1. Strip off the sheath of the PROFIBUS communication dedicated cable and wind wires and shield cables to use.

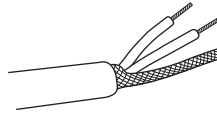

Strip off the sheath for the below length. If the length of the sheath peeled is too long, a short circuit may occur with neighboring wires. If the length is too short, wires might come off.

Wire the stripped cable after twisting it to prevent it from becoming loose. In addition, do not solder it.

Cable stripping length

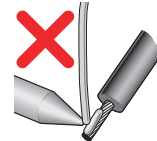
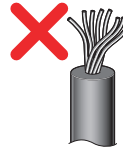
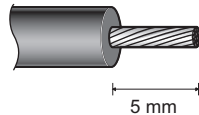

Use a ferrule terminal as necessary.

When using the ferrule terminal, use care so that the twisted wires do not come out.

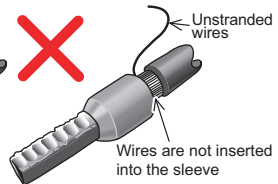
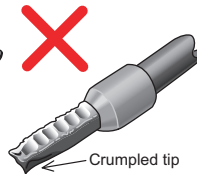
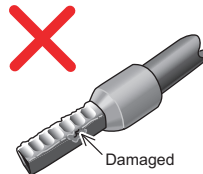
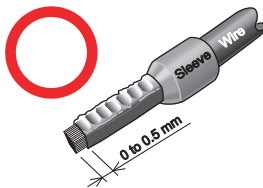

NOTE

Ferrule terminal commercially available (as of October 2020. The product may be changed without notice.)

Terminal screw size	Wire size (mm ²)	Ferrule terminal model		Manufacturer	Crimping tool name
		with insulation sleeve	without insulation sleeve		
M2	0.3	AI 0,34-6TQ	A 0,34-7	Phoenix Contact Co., Ltd.	CRIMPFOX 6
	0.5	AI 0,5-6WH	A 0,5-6		

- Loosen the terminal screw and insert the cable into the terminal.
Tighten each cable with fixing screws to the recommended tightening torque.

<Cable connection example>

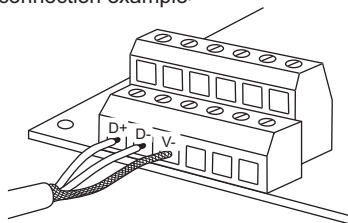

<Connection example of multiple inverters>

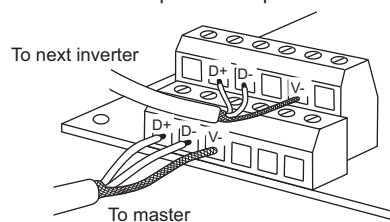

Screw size	Tightening torque	Cable size	Screwdriver
M2	0.22 N•m to 0.25 N•m	0.3 mm ² to 0.75 mm ²	Small ⊖ flat-blade screwdriver (Tip thickness: 0.4 mm /tip width: 2.5 mm)

NOTE

- Undertightening can cause cable disconnection or malfunction. Overtightening can cause a short circuit or malfunction due to damage to the screw or unit.

3. Terminating resistor
 Connect terminating resistors to the both ends of a network if the both ends are FR-A8NP-mounted inverters.

Connection example

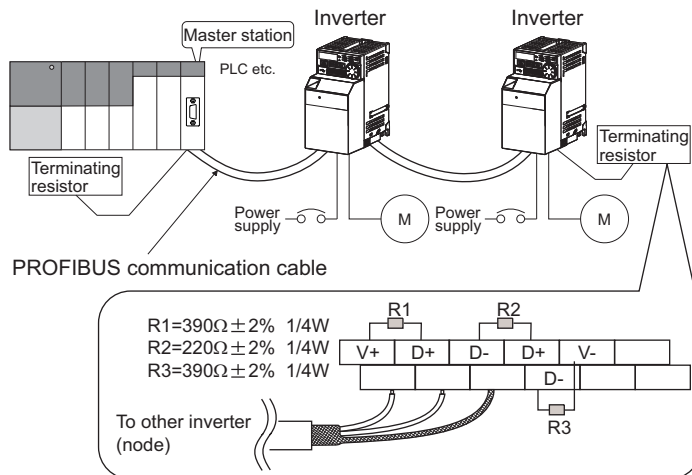

CAUTION

- After wiring, wire offcuts must not be left in the inverter. They may cause an error, failure, or malfunction.

4 INVERTER SETTING

4.1 Parameter list

The following parameters are used for the communication option (FR-A8NP).
Set the values according to need.

Pr.	Pr. group	Name	Setting range	Minimum setting increments	Initial value	Refer to page
79	D000	Operation mode selection	0 to 4, 6, 7	1	0	25
338	D010	Communication operation command source	0, 1	1	0	*3
339	D011	Communication speed command source	0, 1, 2	1	0	*3
340	D001	Communication startup mode selection	0, 1, 10	1	[E800] 0 [E800-(SC)E] 10	25
342	N001	Communication EEPROM write selection	0, 1	1	0	*4
349*1	N010*1	Communication reset selection	0, 1	1	0	35
500*1	N011*1	Communication error execution waiting time	0 to 999.8 s	0.1 s	0 s	28
501*1	N012*1	Communication error occurrence count display	0	1	0	29
502	N013	Stop mode selection at communication error	0 to 2, 6	1	0	29
541*1	N100*1	Frequency command sign selection	0, 1	1	0	63
550*2	D012*2	NET mode operation command source selection	[E800] 0, 2, 9999 [E800-(SC)E] 0, 5, 9999	1	9999	*3
779	N014	Operation frequency during communication error	0 to 590 Hz, 9999	0.01 Hz	9999	29
804	D400	Torque command source selection	0, 1, 3 to 6	1	0	62

- *1 Parameters which can be displayed when the plug-in option (FR-A8NP) is mounted.
- *2 The setting is applied after an inverter reset or power-ON.
- *3 For the parameter details, refer to the FR-E800 Instruction Manual (Function).
- *4 For the parameter details, refer to the FR-E800 Instruction Manual (Communication).

4.2 Operation mode setting

4.2.1 Operation mode switching and communication startup mode (Pr.79, Pr.340)

◆ Operation mode switching conditions

Check the following before switching the operation mode.

- The inverter is at a stop.
- Both the STF and STR signals are off.
- The **Pr.79 Operation mode selection** setting is correct.

(Check the setting on the operation panel of the inverter.)

◆ Operation mode selection at power ON and at restoration from instantaneous power failure

The operation mode at power ON and at restoration from instantaneous power failure can be selected.

Set a value other than "0" in **Pr.340 Communication startup mode selection** to select the network operation mode.

After started in network operation mode, parameter write from the network is enabled.

NOTE

- Change of the **Pr.340** setting is valid when powering on or resetting the inverter.
- **Pr.340** can be changed with the operation panel independently of the operation mode.
- Ensure that the communication setting of the inverter is completed before setting **Pr.340** ≠ "0".
- For the details of **Pr.79** and **Pr.340**, refer to the FR-E800 Instruction Manual (Function).

Pr.340 setting	Pr.79 setting	Operation mode at power ON or power restoration	Operation mode switchover
0	0 (initial value)	External operation mode	Switching among the External, PU, and NET operation mode is enabled. ^{**1} ³
	1	PU operation mode	PU operation mode fixed
	2	External operation mode	Switching between the External and Net operation mode is enabled. ^{*3} Switching to the PU operation mode is disallowed.
	3, 4	External/PU combined operation mode	Operation mode switching is disallowed.
	6 ^{*4}	External operation mode	Switching among the External, PU, and NET operation mode is enabled while running. ^{*3}
	7	X12 (MRS) signal ON: external operation mode	Switching among the External, PU, and NET operation mode is enabled. ^{**1} ³
X12 (MRS) signal OFF: external operation mode		External operation mode fixed (Forcibly switched to External operation mode.)	
1	0	NET operation mode	Same as when Pr.340 = "0"
	1	PU operation mode	
	2	NET operation mode	
	3, 4	External/PU combined operation mode	
	6 ^{*4}	NET operation mode	
	7	X12 (MRS) signal ON: NET operation mode	
X12 (MRS) signal OFF: external operation mode			

Pr.340 setting	Pr.79 setting	Operation mode at power ON or power restoration	Operation mode switchover
10	0	NET operation mode	Switching between the PU and NET operation mode is enabled. *2*3
	1	PU operation mode	Same as when Pr.340 = "0"
	2	NET operation mode	NET operation mode fixed
	3, 4	External/PU combined operation mode	Same as when Pr.340 = "0"
	6*4	NET operation mode	Switching between the PU and NET operation mode is enabled while running. *2*3
	7	External operation mode	Same as when Pr.340 = "0"

*1 Operation mode cannot be directly changed between the PU operation mode and Network operation mode.

*2 Switching between the PU and NET operation modes is available with the key on the operation panel or the X65 signal.

*3 Refer to [page 54, 73](#) for a switching method from the network.

*4 When **Pr.128** = "50, 51, 60, or 61", the same operation mode as when **Pr.79** = "0" is selected.

4.3 Operation at communication error occurrence

4.3.1 Operation selection at communication error occurrence (Pr.500 to Pr.502, Pr.779)

You can select operations at communication error occurrences by setting **Pr.500 to Pr.502, Pr.779** under network operation.

◆ **Waiting time for the communication line error output after a communication error**

Waiting time for the communication error output after a communication line error occurrence can be set.

Pr.	Name	Setting range	Minimum setting increments	Initial value
500	Communication error execution waiting time	0 to 999.8 s	0.1 s	0 s

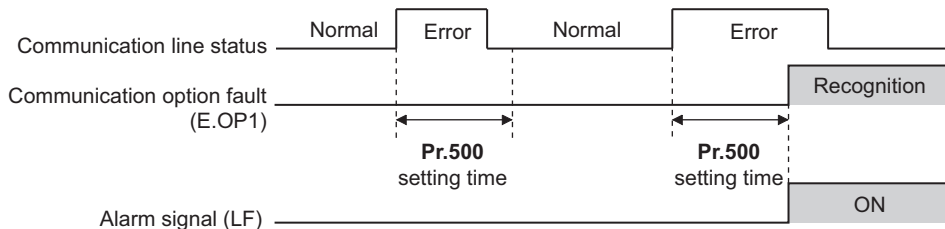

When a communication line error occurs and lasts longer than the time set in **Pr.500**, it is recognized as a communication error. If the communication returns to normal within the time, it is not recognized as a communication error, and the operation continues.

◆ Displaying and clearing the communication error count

The cumulative count of communication error occurrences can be displayed. Write "0" to clear this cumulative count.

Pr.	Name	Setting range	Minimum setting increments	Initial value
501	Communication error occurrence count display	0	1	0

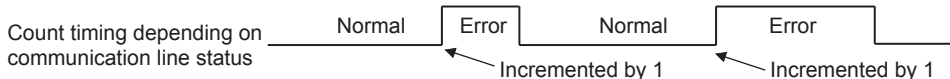

At the point of communication line error occurrence, **Pr.501 Communication error occurrence count display** is incremented by 1.

The cumulative count of communication error occurrences is counted from 0 to 65535. When the count exceeds 65535, the displayed value is cleared and the counting starts over from 0 again.

NOTE

- Communication error count is temporarily stored in the RAM memory. The error count is stored in EEPROM only once per hour. If power reset or inverter reset is performed, **Pr.501** setting will be the one that is last stored to EEPROM depending on the reset timing.

◆ Inverter operation at a communication error occurrence

How the inverter operates at a communication line error or an option unit fault can be set.

Pr.	Name	Setting range	Description
502	Stop mode selection at communication error	0 (initial value), 1, 2, 6	Refer to page 30 .
779*1	Operation frequency during communication error	0 to 590 Hz	When a communication error occurs, the inverter operates at the set frequency.
		9999 (initial value)	The inverter operates at the frequency set before the communication error occurs.

*1 Valid when **Pr.502** = "6".

◆ About setting

- Operation at an error occurrence

Fault description	Pr.502 setting	Operation	Indication	Fault output
Communication line	0	Continued ^{*1}	Normal ^{*1}	Not output ^{*1}
	1			
	2			
	6			
Communication option	0	Output shutoff	"E. 1"	Provided
	1, 2	Output to decelerate and stop the motor	"E. 1" after stop	Provided after stop
	6	Operation continued at the set frequency of Pr.779 ^{*2}	"CF" warning	Not output

^{*1} When the communication returns to normal within the time period set in **Pr.500**, the communication option fault (E.OP1) does not occur.

^{*2} Under position control, the operation is continued to the target position. When the communication operation command source is changed to the External mode and the LX signal is not input via an external input terminal, the inverter output is shut off.

- Operation after the time in **Pr.500** elapses after an error occurrence

Fault description	Pr.502 setting	Operation	Indication	Fault output
Communication line	0	Output shutoff	"E.OP1"	Provided
	1	Output to decelerate and stop the motor	"E.OP1" after stop	Provided after stop
	2			Not output
	6	Operation continued at the set frequency of Pr.779 ^{*4}	"CF" warning	
Communication option itself	0	Output stop status continues. ^{*3}	"E.1" kept ^{*3}	Kept provided ^{*3}
	1, 2			
	6	Operation continued at the set frequency of Pr.779 ^{*4*5}	"CF" warning	Not output

- *3 When an error occurs, the inverter outputs a command to decelerate the motor or shuts off the output, and outputs the fault, independently of the **Pr.500** setting.
- *4 When the frequency command source is changed from NET to any other source, frequency commands given from an external device are enabled.
- *5 Under position control, the operation is continued to the target position. When the communication operation command source is changed to the External mode and the LX signal is not input via an external input terminal, the inverter output is shut off.

• Operation at error removal

Fault description	Pr.502 setting	Operation	Indication	Fault output
Communication line	0	Output stop status continues.	"E.OP1" kept	Kept provided
	1			
	2	Restart ^{*6}	Normal	Not output
	6	Normal		
Communication option itself	0	Output stop status continues.	"E. 1" kept	Kept provided
	1, 2			
	6	Operation continued at the set frequency of Pr.779 ^{*7}	"CF" warning	Not output

*6 When the communication error is removed during deceleration, the motor re-accelerates.

*7 Under position control, the motor does not re-accelerate even when the communication error is removed during deceleration.

NOTE

- The protective function [E.OP1 (fault data: HA1)] is activated at error occurrences on the communication line. The protective function [E.1 (fault data: HF1)] is activated at error occurrences in the communication circuit inside the option.
- Fault output indicates the fault (ALM) signal and fault bit output.
- When the fault output setting is active, fault records are stored in the fault history. (A fault record is written to the fault history at a fault output.)
- When the fault output setting is not active, fault record is overwritten to the fault history temporarily but not stored. After the error is removed, the fault indication is reset, changing the display back to normal, and the last fault is displayed in the fault history.
- When **Pr.502** is set to "1, 2", the normal deceleration time setting (such as **Pr.8/Pr.44/Pr.45** setting) is applied. The Pr.464 or Pr.1223 deceleration time setting, whichever is smaller, is applied for position control.
- When a communication line error occurs while **Pr.502** = "2", the motor re-accelerates if the error is removed during deceleration. The operation command and the speed command before the fault occurred will be applied for restarting. The normal acceleration time setting (such as **Pr.7/Pr.44** setting) is applied for restart. (Acceleration is not restarted if the error is that of the option unit itself.)

CAUTION

- When **Pr.502** = "6", operation continues even if a communication option fault (E.OP1) or an option fault (E.1) is displayed. When setting "6" in **Pr.502**, provide a safety stop countermeasure other than via communication. For example, input a signal through an external terminal (RES, MRS, or X92) or press the PU stop on the operation panel.

4.3.2 Fault and measures

◆ Inverter operation in each operation mode at error occurrences

Location	Status		Operation mode		
			Network operation ^{*1}	External operation	PU operation
Inverter	Inverter operation		Output shutoff	Output shutoff	Output shutoff
	Data communication		Continued	Continued	Continued
Communication line	Inverter operation		Output shutoff ^{*2}	Continued	Continued
	Data communication		Stop	Stop	Stop
Communication option	Communication option connection error	Inverter operation	Output shutoff ^{*2}	Output shutoff ^{*2}	Output shutoff ^{*2}
		Data communication	Continued	Continued	Continued
	Error of communication option itself	Inverter operation	Output shutoff ^{*2}	Continued	Continued
		Data communication	Stop	Stop	Stop

*1 When the communication option is set as the operation command source.

*2 Depends on the Pr.502 setting.

◆ Measures at error occurrences

Fault indication	Name	Measures
E.OP1	Communication option fault	<ul style="list-style-type: none"> • Check the LED status of the option unit and remove the cause of the alarm (Refer to page 9 for LED indication status). • Inspect the master.
E.1	Option fault	Check the connection between the inverter and option unit for poor contact, etc. and remove the cause of the error.

*1 When a fault other than the above is displayed, refer to the FR-E800 Instruction Manual (Maintenance) to remove the cause of the fault.

4.4 Inverter reset

◆ Operation conditions of inverter reset

Which resetting method is allowed or not allowed in each operation mode is described below.

Resetting method			Operation mode		
			Network operation	External operation	PU operation
Reset from the network	Inverter reset (Refer to page 54.) ^{*1}		Allowed	Disallowed	Disallowed
	Error reset (STW (bit 7)) at inverter fault (Refer to page 48.) ^{*2}	Pr.349 = 0	Allowed	Allowed	Allowed
		Pr.349 = 1		Disallowed	Disallowed
Turn on the inverter RES signal (terminal RES)			Allowed	Allowed	Allowed
Switch off inverter power			Allowed	Allowed	Allowed
Reset on the operation panel	Inverter reset		Allowed	Allowed	Allowed
	Reset at inverter fault		Allowed	Allowed	Allowed

*1 Inverter reset can be made any time.

*2 Reset can be made only when the protective function of the inverter is activated. (Available with PPO type 1 to 5 only)

NOTE

- When a communication line error has occurred, reset cannot be made from the network.
- The inverter is set to the External operation mode if it has been reset in Network operation mode in the initial status. To resume the network operation, the inverter must be switched to the Network operation mode again. Set a value other than "0" in **Pr.340** to start in the Network operation mode. (Refer to [page 25.](#))
- Communication continues during inverter reset. (The inverter cannot be controlled for about 1 second after release of a reset command.)

◆ Error reset operation selection at inverter fault

An error reset command from communication option can be invalid in the External operation mode or PU operation mode.

An error reset command from the network is requested by STW (bit 7) (PPO type 1 to 5). (Refer to [page 48](#).)

Pr.	Name	Initial value	Setting range	Function
349	Communication reset selection	0	0	Error reset is enabled independently of operation mode.
			1	Error reset is enabled only in the network operation mode.

5 FUNCTIONS

5.1 Output from the inverter to the network

Main items to be output from the inverter (FR-A8NP) to the network and their descriptions are explained below.

Item	Description	Refer to page	
		PPO type support specification	PPO type non-support specification
Inverter monitor	Monitor various items such as inverter output frequency and output current.	48, 53	71
Parameter read	Read parameter settings of the inverter.	46, 60	67, 75
Inverter status	Monitor output signal of the inverter.	48	69
Operation mode read	Read the operation mode of the inverter.	48, 54	73
Set frequency read	Read the frequency set in the inverter.	54	74
Terminal input read	Read the analog value of terminal 2, 4.	54	74
Node address read	Read node address of the inverter.	55	—
Alarm definition read	Monitor alarm history occurred in the inverter, and energization time, output frequency, output current and output voltage at alarm occurrence are monitored.	55	74
PNU list read	Read the available PNU number.	59	—

NOTE

- Refer to the FR-E800 Instruction Manual (Function) for functions controllable from the network in each operation mode.

5.2 Input to the inverter from the network

Main items which can be commanded from the network to the inverter and their descriptions are explained below.

Item	Description	Refer to page	
		PPO type support specifications	PPO type non-support specifications
Frequency setting	Set the running frequency of the inverter.	48	74
Operation mode write	Set the operation mode of the inverter.	54	73
Run command	Set the control input command such as forward operation signal (STF) and reverse rotation signal (STR).	48	73
Inverter reset	Reset the inverter.	54	72
Parameter write	Set parameters of the inverter.	46, 60	67, 75
Parameter clear	Return parameters to the initial values.	53	72
Input terminal function	Use the function of the inverter input terminal.	48	73

NOTE

- Refer to the FR-E800 Instruction Manual (Function) for functions controllable from the network in each operation mode.

6 PROFIBUS DEVICE DATA

6.1 Device data (GSD file)

A GSD file is required to connect the inverter (FR-A8NP) to the PROFIBUS network and use PROFIBUS configuration software. The GSD file contains information on the communication setting of the inverter (FR-A8NP).

GSD file can be downloaded from the web site.

Mitsubishi Electric FA Global website
www.MitsubishiElectric.co.jp/fa

The download is free.
Contact your sales representative for details.

When editing this file, use a text editor.

For installation instructions, refer to the instruction manual of the PROFIBUS-DP Configuration Software. Although this product complies with PPO type specification, it includes specifications which do not support PPO type specification (FR-A5NP intercompatibility protocol). This manual states the section supporting PPO type specification as PPO type support specification and the section not supporting PPO type as PPO type non-support specification.



NOTE

- You cannot use the device data which does not include PPO supporting specification (data for the FR-A5NP).
-

- Details of the GSD file

Parameter	Value	Description ^{*1}
#Profibus_DP		File header
GSD_Revision	2	ID version of GSD file
Vendor_Name	"Mitsubishi Electric"	Manufacturer name ^{*2}
Model_Name	"FR-A8NP"	Product name
Revision	—	Product version
Ident_Number	H0EA8	Device number
Protocol_Ident	0	PROFIBUS-DP is 0 fixed.
Station_Type	0	DP slave is 0 fixed.
FMS_Supp	0	FMS (Field-Bus Message Specifications) not supported.
Hardware_Release	—	Hardware version
Software_Release	—	Software version
9.6_supp	1	Communication speed 9600 bps support
19.2_supp	1	Communication speed 19.2 kbps support
93.75_supp	1	Communication speed 93.75 kbps support
187.5_supp	1	Communication speed 187.5 kbps support
500_supp	1	Communication speed 500 kbps support
1.5M_supp	1	Communication speed 1.5 Mbps support
3M_supp	1	Communication speed 3.0 Mbps support
6M_supp	1	Communication speed 6.0 Mbps support
12M_supp	1	Communication speed 12.0 Mbps support
MaxTsdr_9.6	15	Longest time 15 bit times at communication speed 9600 bps
MaxTsdr_19.2	15	Longest time 15 bit times at communication speed 19.2 kbps
MaxTsdr_93.75	15	Longest time 15 bit times at communication speed 93.75 kbps
MaxTsdr_187.5	15	Longest time 15 bit times at communication speed 187.5 kbps
MaxTsdr_500	15	Longest time 15 bit times at communication speed 500 kbps
MaxTsdr_1.5M	25	Longest time 25 bit times at communication speed 1.5 Mbps

Parameter	Value	Description *1
MaxTsd_r_3M	50	Longest time 50 bit times at communication speed 3.0 Mbps
MaxTsd_r_6M	100	Longest time 100 bit times at communication speed 6.0 Mbps
MaxTsd_r_12M	200	Longest time 200 bit times at communication speed 12.0 Mbps
Redundancy	0	Redundancy not supported.
Repeater_Ctrl_Sig	2	Installed as TTL level via RTS signal from module.
24V_Pins	0	24 V power supply for maintenance device connection is not used.
Freeze_Mode_supp	1	Freeze mode supported.
Sync_Mode_supp	1	Synchronous mode supported.
Auto_Baud_supp	1	Automatic baud rate detection support
Set_Slave_Add_supp	0	Slave address is not set.
Min_Slave_Intervall	1	100 µs interval between 2 polling cycles
Modular_Station	1	Modular device specified.
Max_Module	1	Maximum number of modules: 1
Max_Input_Len	28	Input data: Maximum 28 bytes
Max_output_Len	28	Output data: Maximum 28 bytes
Max_Data_Len	56	Input and output data: Maximum 28 + 28 = 56 bytes
Fail_Safe	0	Failsafe not supported
Max_Diag_Data_Len	6	Diagnostic data of 6 bytes secured (no external diagnosis)
Slave_Family	1	Drives defined as function class (Main Family)
PrmText	1	Text selection 1 registration
Text(0)	"No byte swapping"	If Bit 0 = 0, "No byte swapping"
Text(1)	"Byte swapping"	If Bit 0 = 1, "Byte swapping"
EndPrmText		
ExtUserPrmData	1 "Byte swapping"	Byte swapping selection 1 registration on text base
Bit(0) 0 0-1		Bit 0 = default 0, range 0 to 1
Prm_Text_Ref	1	Text selection 1 is used.
EndExtUserPrmData		
Max_User_Prm_Data_Len	2	User parameter of 2 bytes secured

Parameter	Value	Description *1
Ext_User_Prm_Data_Const(0)	H01	Initial value of user parameter's 1 byte
Ext_User_Prm_Data_Const(1)	H00	Initial value of user parameter's 2 byte
Ext_User_Prm_Data_Ref(1)	1	Byte swapping selection 1 is used on text base in user parameter's 2 byte.
Module	"PPO type 1" HF3, HF1	PPO type 1 selection
EndModule		
Module	"PPO type 2" HF3, HF5	PPO type 2 selection
EndModule		
Module	"PPO type 3" HF1	PPO type 3 selection
EndModule		
Module	"PPO type 4" HF5	PPO type 4 selection
EndModule		
Module	"PPO type 5" HF3, HF9	PPO type 5 selection
EndModule		
Module	"500 series" H75	FR-A5NP intercompatibility protocol selection
EndModule		

*1 Description is not included in the ASCII file itself.

*2 Use "Mitsubishi" if the maximum number of characters of the Vendor-Name of the master used is 10.

6.2 Slave user parameter

By changing the slave user parameter value, you can use the byte swapping function (byte inversion function).
 Setting "1" at Address H1 (Bit 0) enable the byte swapping function.
 Since "—" is an unused bit, set "0".

Address	Functions							
H0	For manufacturer setting (Always set "1".)							
H1	Bit 7	Bit 6	Bit 5	Bit 4	Bit 3	Bit 2	Bit 1	Bit 0
	—	—	—	—	—	—	—	0: Byte swapping function disabled 1: Byte swapping function enabled

- Example of when the byte swapping function is disabled (address H1 (Bit 0) = "0")

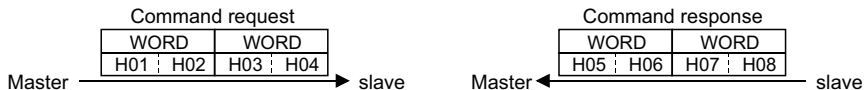

- Example of when the byte swapping function is enabled (address H1 (Bit 0) = "1")

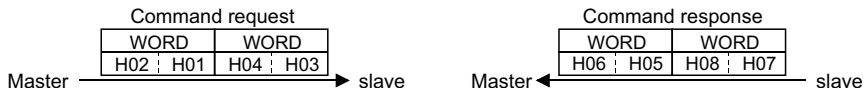

The data is byte swapped in the slave to be a receiving/sending data.

7 PPO TYPE SUPPORT SPECIFICATION

7.1 PROFIBUS profiles

The option unit operates as a "slave of the PROFIBUS DP master" or a "controller equivalent to PROFIBUS DP master class 1 on an RS-485 network".

The PROFIBUS profile (data buffer) can be selected from among six different types, "PPO type1" to "PPO type5", and "A5NP". (For the module type "A5NP" profile, refer to [page 64](#).)

Module type is changed with the slave module setting. For details, refer to the instruction manual of the Network Master Configuration Software. The configuration of PPO type is as follows.

◆ PROFIBUS format

The following shows the configuration of the PPO type in the PROFIBUS format

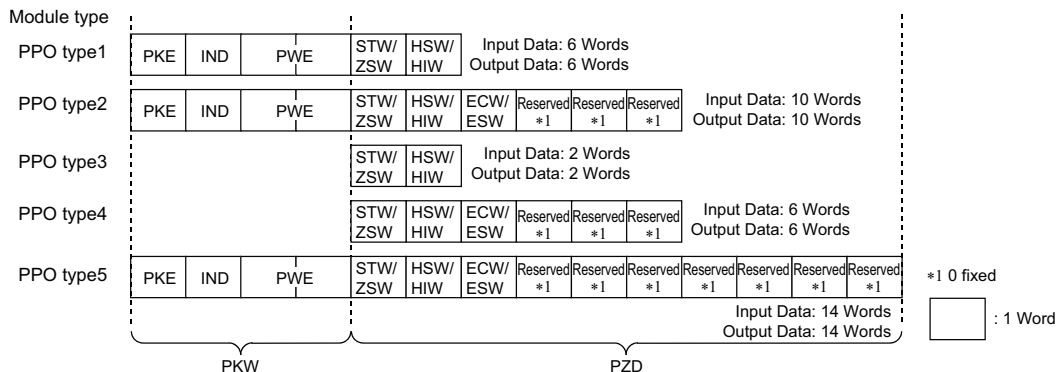

7.2 ID definitions

ID		Definition
PKW (Refer to page 46.)	PKE	PNU number (PNU) and task or response Id (AK)
	IND	Sub-Index number and Ext-Index number
	PWE	Set 0 since high bits (Bits 16 to 31) are not used. Low bits (Bits 0 to 15): Parameter value
PZD (Refer to page 48.)	STW/ZSW	STW: Control Word (command request) ^{*1}
		ZSW: Status Word (command response) ^{*1}
	HSW/HIW	HSW: Set frequency (command request) ^{*1}
		HIW: Output frequency (command response) ^{*1}
	ECW/ESW	ECW: Extended Control Word (command request) ^{*1}
		ESW: Extended Status Word (command response) ^{*1}
Reserved	Reserved area for extension	

*1 Command request: Message from the master to the slave
 Command response: Message from the slave to the master

7.3 Buffer memory configuration

The buffer memory configuration is shown below.

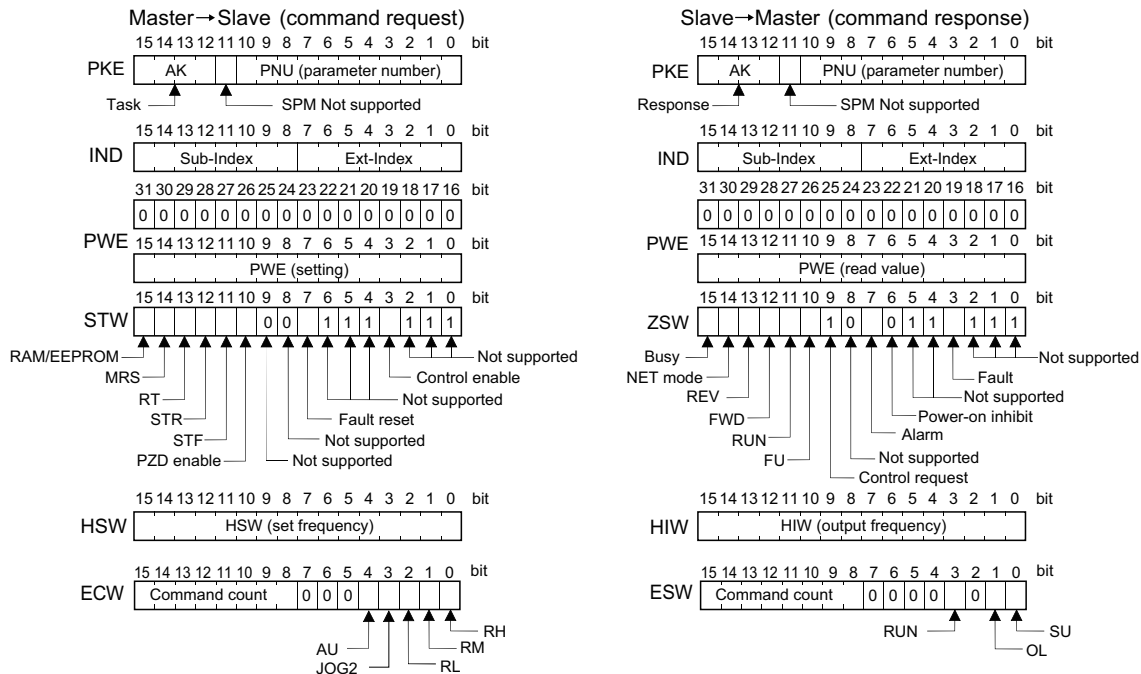

7.4 Buffer memory details

The following indicates the buffer memory details of the PROFIBUS profiles.

◆ PKW

Name		Bit	Definition
PKE	PNU	0 to 10	PNU number
	SPM	11	Not used (0 is set)
	AK	12 to 15	[Command request] 0: No task 1: Parameter value is requested (read request) 2: Parameter value (word) is changed (write request) 6: Parameter value (array) is requested (read request) 7: Parameter value (array word) is changed (write request) Other than the above: Not supported [Command response] 0: No response (Busy status) 1: Parameter value (word) is transferred. 4: Parameter value (array word) is transferred. 7: Command execution error (error number is stored into PWE) Other than the above: Not supported
IND		0 to 7	Ext-Index number When Bit 0 (extended parameter access) = "1" and AK = "1 or 2", the PNU value (parameter number) plus 1000 can be read or written.
		8 to 15	Sub-Index number At command request, set this number when AK ="6, 7".

Name	Bit	Definition
PWE	0 to 15	PNU read value/write value When command response AK ="7" (command execution error), PWE definition is as follows. 0: Invalid PNU 1: Parameter value unchangeable (This error also occurs when Pr.77 = "1") 2: Outside setting range 3: Invalid Sub-Index number 4: Without array 11: No parameter change right 18: Other error *1
	16 to 31	Not used (0 is set)

*1 Indicates outside AK number range, write data error, external operation error, without option error, instruction code error, with STF/STR error, with operation mode specification error, parameter calibration error (**Pr.900** or later), reset disabled error (with reset input specification of **Pr.75**), etc.

◆ PZD

	Name	Bit	Definition
STW	—	0 to 2	Not used (1 is set)
	Control enable	3	0: Inverter output shutoff, 1: Inverter output shutoff is cancelled
	—	4 to 6	Not used (1 is set)
	Fault reset (Reset)	7	[At inverter error] 0: No action 1: Fault reset (Reset). The operation depends on the Pr.349 setting. (Refer to page 35 .) [When inverter is normal] No action
	—	8	Not used (0 is set)
	—	9	Not used (0 is set)
	PZD enable	10	0: Command request of PZD is not processed.*1 1: Command request of PZD is processed. At power-on or inverter reset, set 1 once.
	STF signal	11	0: OFF, 1: ON (forward rotation command)
	STR signal	12	0: OFF, 1: ON (reverse rotation command)
	RT signal	13	Second function selection
	MRS signal	14	0: OFF, 1: ON (output is shut off)
	RAM/EEPROM	15	0: Set frequency (HSW) is written to RAM (Power-on reset returns the changed set frequency to the setting before it was written to RAM). 1: Set frequency (HSW) is written to EEPROM.

	Name	Bit	Definition
ZSW	—	0 to 2	Not used (1 is returned)
	Fault	3	0: Inverter normal 1: Inverter alarm occurrence
	—	4, 5	Not used (1 is returned)
	Power-on inhibit	6	0 is returned
	Alarm	7	0: Command execution normal 1: Command execution error
	—	8	Not used (0 is returned)
	Control request	9	1 is returned
	FU signal	10	0: OFF 1: ON (output frequency being detected) (Refer to Pr.42 and Pr.43 in the FR-E800 Instruction Manual (Function).)
	RUN signal	11	0: OFF 1: ON (inverter running)
	FWD	12	0: Other than forward running (during stop, reverse running) 1: Forward running
	REV	13	0: Other than reverse running (during stop, forward running) 1: Reverse running
	NET mode	14	0: Other than network operation mode 1: Network operation mode
BUSY	15	0: Ready status 1: Busy status *2	
HSW		0 to 15	Set frequency (0.01 Hz increments)
HIW		0 to 15	Output frequency (0.01 Hz increments)

Name		Bit	Definition
ECW	Terminal RH function	0	High speed operation command *3
	Terminal RM function	1	Middle-speed operation command *3
	Terminal RL function	2	Low-speed operation command *3
	JOG2 signal	3	0: OFF, 1: ON (JOG operation selection 2)
	AU signal	4	0: OFF, 1: ON (Terminal 4 input selection)
	—	5	Not used (0 is set)
	—	6, 7	Not used (0 is set)
	Command count	8 to 15	Used by the master to recognize the command response.
ESW	SU signal	0	0: OFF, 1: ON (up to frequency)
	OL signal	1	0: OFF, 1: ON (overload alarm)
	—	2	Not used (0 is set)
	Terminal RUN function	3	Inverter running *4
	—	4 to 7	Not used (0 is set)
	Command count	8 to 15	Echo back of the command request.

*1 PZD enable and command count request can be executed.

*2 If it takes time to perform slave side processing, slave side busy status is announced since reply to the master will be delayed. During busy status, other response data are unfixed values. When the slave side is busy, request from the master is invalid. Therefore, the same request must be sent again. The response data of the FR-A8NP during Busy status is as follows.

ID	During busy status and inverter reset	During busy status and other than inverter reset
PKW	0	All 0 when AK = "0" Reply data when AK ≠ "0"
PZD	ZSW Bit 15 (BUSY) = "1" Other error Bit = "0"	ZSW Bit 15 (BUSY) = "1" Other error Bit = inverter status data

*3 The signal initially assigned to the terminal. Using **Pr.180** to **Pr.182**, input signals assigned to the terminals can be changed. For the details of **Pr.180** to **Pr.182**, refer to the FR-E800 Instruction Manual (Function).

*4 The signal initially assigned to the terminal. Using **Pr.190**, output signal assigned to the terminal can be changed. For the details of **Pr.190**, refer to the FR-E800 Instruction Manual (Function).

 **NOTE**

Only when the contents of the command request (request for changing the inverter setting: PKW, HSW, STW/ECW) from the master changed, the inverter processes the request. If the contents of the command request are identical with those of the last request, the inverter does not process the request. (The received request is cleared.)

For instance, while the master keeps sending the "network operation mode enable" command, changing the mode to the PU operation mode with switchover function does not allow the "network operation mode enable" command to be executed due to the same contents as that sent last time. Therefore, the operation mode remains the PU operation mode without changing to the Network operation mode. In this case, send another command as "PU operation mode enable" from the master once, then send the "network operation mode enable" command again.

7.5 Outline of PNU

You can use the PNU to make inverter settings from the network.

The data used with the network is denoted PNU (P) to differentiate it from the parameter (Pr.) of the inverter.

This chapter explains the module type "PPO type 1" to "PPO type 5".

NOTE

- Parameter definitions differ according to the module type selected. When using "A5NP", refer to [page 71](#).

◆ PNU data definition

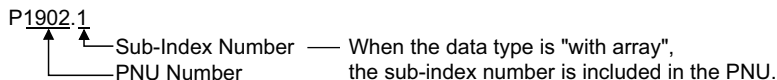

◆ PNU data type

The PNU has the data types of "Array Unsigned 16" and "Unsigned 16".

Data type	Array	Example
Array Unsigned 16 (AU16)	With	P1902.1 ↑ Sub-Index Number
Unsigned 16 (Us16)	Without	P1240

NOTE

- When the data type is "with array", include the sub-index number in the PNU.

7.6 PROFIBUS PNU

7.6.1 Real-time monitor

Different inverter data can be monitored using the master.

The data type for each monitor item is AUs16. The PNU number for the real-time monitor is 1.

The monitor item and the sub-index number are the same as those of the RS-485 communication dedicated monitor (monitor code 1) of the inverter.

For the details of the monitor items, refer to the monitor display section in the FR-E800 Instruction Manual (Function).

PNU	Item	Increments
P1.1	Output frequency	0.01 Hz
P1.2	Output current	0.01 A
P1.3	Output voltage	0.1 V
.	.	.
.	.	.
.	.	.

7.6.2 Parameter clear

Parameter clear can be performed from the master.

PNU	Item	Data definition	Data type
P2.2	Parameter clear	H965A	AUs16
P2.3	All parameter clear	H99AA	AUs16
P2.5	Parameter clear ^{*1}	H5A96	AUs16
P2.6	All parameter clear ^{*1}	HAA99	AUs16
P2.8	Fault history clear	H0000	AUs16

*1 The communication parameters are not cleared. For the communication parameters, refer to the FR-E800 Instruction Manual (Function).

7.6.3 Operation mode read/write

Read/write of the operation mode can be performed from the master.

PNU	Item	Data definition	Data type
P3	Operation mode read/write	External operation mode: H10 PU operation mode: H11 (For writing, when "6" is set in Pr.79) Network operation mode: H14	Us16

7.6.4 Set frequency read

The frequency set to the inverter can be read from the master.

PNU	Item	Data definition	Data type
P4.1	Set frequency (RAM) read	Set frequency (RAM) is read.	AUs16
P4.2	Set frequency (EEPROM) read	Set frequency (EEPROM) is read.	AUs16

7.6.5 Terminal input read

Analog input values of terminals 2, 4 can be read.

PNU	Item	Data definition	Data type
P5.1	Terminal 2 input value read	Terminal 2 input value (%) is read.	AUs16
P5.2	Terminal 4 input value read	Terminal 4 input value (%) is read.	AUs16

7.6.6 Inverter reset

The inverter can be reset from the master.

PNU	Item	Data definition	Data type
P6	Inverter reset	The inverter is reset after the data was written from the master.	Us16

- The inverter maintains the resetting status while reset is requested.
- When **Pr.75 Reset selection/disconnected PU detection/PU stop selection** = "1, 3, 15, 17, 10001, 10003, 10015, or 10017", reset is enabled only during an inverter error.

7.6.7 Node address read

The node address of the inverter can be read.

PNU	Item	Data definition	Data type
P918	Node address read	The node address settings of the inverter are read.	Us16

7.6.8 Fault history read

- Fault records of past eight faults occurred in the inverter can be read.

(For the data codes or details of fault records, refer to the FR-E800 Instruction Manual (Maintenance).)

PNU	Item	Data definition		Data type
P947.1 to P947.8	Latest fault	P947.1	Data code of the fault record	AUs16
		P947.2 to P947.8	All 0	
P947.9 to P947.16	Second latest fault	P947.9	Data code of the fault record	AUs16
		P947.10 to P947.16	All 0	
P947.17 to P947.24	Third latest fault	P947.17	Data code of the fault record	AUs16
		P947.18 to P947.24	All 0	
P947.25 to P947.32	Fourth latest fault	P947.25	Data code of the fault record	AUs16
		P947.26 to P947.32	All 0	
P947.33 to P947.40	Fifth latest fault	P947.33	Data code of the fault record	AUs16
		P947.34 to P947.40	All 0	
P947.41 to P947.48	Sixth latest fault	P947.41	Data code of the fault record	AUs16
		P947.42 to P947.48	All 0	
P947.49 to P947.56	Seventh latest fault	P947.49	Data code of the fault record	AUs16
		P947.50 to P947.56	All 0	
P947.57 to P947.64	Eighth latest fault	P947.57	Data code of the fault record	AUs16
		P947.58 to P947.64	All 0	

- Energization time (fault monitor) for past eight alarms at the inverter alarm occurrence can be read.

PNU	Item	Data definition		Data type
P948.1 to P948.8	Latest fault monitor energization time	P948.1	Energization time	AUs16
		P948.2 to P948.8	All 0	
P948.9 to P948.16	Energization time monitored when the second latest fault occurs	P948.9	Energization time	AUs16
		P948.10 to P948.16	All 0	
P948.17 to P948.24	Energization time monitored when the third latest fault occurs	P948.17	Energization time	AUs16
		P948.18 to P948.24	All 0	
P948.25 to P948.32	Energization time monitored when the fourth latest fault occurs	P948.25	Energization time	AUs16
		P948.26 to P948.32	All 0	
P948.33 to P948.40	Energization time monitored when the fifth latest fault occurs	P948.33	Energization time	AUs16
		P948.34 to P948.40	All 0	
P948.41 to P948.48	Energization time monitored when the sixth latest fault occurs	P948.41	Energization time	AUs16
		P948.42 to P948.48	All 0	
P948.49 to P948.56	Energization time monitored when the seventh latest fault occurs	P948.49	Energization time	AUs16
		P948.50 to P948.56	All 0	
P948.57 to P948.64	Energization time monitored when the eighth latest fault occurs	P948.57	Energization time	AUs16
		P948.58 to P948.64	All 0	

- Output frequency, output current and output voltage for past eight alarms at the inverter alarm occurrence can be read.

PNU	Item	Data definition		Data type
P949.1 to P949.8	Latest fault monitor frequency, current, and voltage	P949.1	Output frequency	AUs16
		P949.2	Output current	
		P949.3	Output voltage	
		P949.4 to P949.8	All 0	
P949.9 to P949.16	Frequency, current, and voltage monitored when the second latest fault occurs	P949.9	Output frequency	AUs16
		P949.10	Output current	
		P949.11	Output voltage	
		P949.12 to P949.16	All 0	
P949.17 to P949.24	Frequency, current, and voltage monitored when the third latest fault occurs	P949.17	Output frequency	AUs16
		P949.18	Output current	
		P949.19	Output voltage	
		P949.20 to P949.24	All 0	
P949.25 to P949.32	Frequency, current, and voltage monitored when the fourth latest fault occurs	P949.25	Output frequency	AUs16
		P949.26	Output current	
		P949.27	Output voltage	
		P949.28 to P949.32	All 0	
P949.33 to P949.40	Frequency, current, and voltage monitored when the fifth latest fault occurs	P949.33	Output frequency	AUs16
		P949.34	Output current	
		P949.35	Output voltage	
		P949.36 to P949.40	All 0	
P949.41 to P949.48	Frequency, current, and voltage monitored when the sixth latest fault occurs	P949.41	Output frequency	AUs16
		P949.42	Output current	
		P949.43	Output voltage	
		P949.44 to P949.48	All 0	

PNU	Item	Data definition		Data type
P949.49 to P949.56	Frequency, current, and voltage monitored when the seventh latest fault occurs	P949.49	Output frequency	AUs16
		P949.50	Output current	
		P949.51	Output voltage	
		P949.52 to P949.56	All 0	
P949.57 to P949.64	Frequency, current, and voltage monitored when the eighth latest fault occurs	P949.57	Output frequency	AUs16
		P949.58	Output current	
		P949.59	Output voltage	
		P949.60 to P949.64	All 0	

7.6.9 PNU list read

The usable PNU numbers can be read.

PNU	Item	Data definition	Data type
P980.1 to 116 P981.1 to 116 P982.1 to 116 P983.1 to 116 P984.1 to 116 P985.1 to 116 P986.1 to 116 P987.1 to 116 P988.1 to 116 P989.1 to 116	PNU list read	Usable PNU numbers are read in sorted status.	AUs16

- PNU list read example

PNU	Usable PNU number	Remarks
P980.1	1	Inverter command parameter
P980.2	2	
P980.3	3	
.	.	
P980.23	1000	Inverter standard parameter
P980.24	1001	
P980.25	1002	
.	.	
.	.	
.	0 ^{*1}	

*1 When 0 is stored, read is terminated.

7.7 Standard parameters

You can use the PNU to make parameter settings from the network.

The table below lists PNU numbers corresponding to parameter numbers.

Standard parameter examples are introduced below. Refer to the examples and make parameter settings.

For the parameter details, refer to the FR-E800 Instruction Manual (Function).

Representation of the PNU for standard parameters (Example: **Pr.902**)

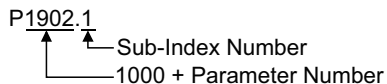

- Example of parameter list

PNU	Name		Data type
	Bit 0 of the ext-index number = "0"	Bit 0 of the ext-index number = "1"	
P1000	Pr.0 Torque boost	Pr.1000	Us16
P1001	Pr.1 Maximum frequency	Pr.1001	Us16
P1002	Pr.2 Minimum frequency	Pr.1002 Lq tuning target current adjustment coefficient	Us16
P1003	Pr.3 Base frequency	Pr.1003	Us16
P1004	Pr.4 Multi-speed setting (high speed)	Pr.1004	Us16
P1005	Pr.5 Multi-speed setting (middle speed)	Pr.1005	Us16
P1006	Pr.6 Multi-speed setting (low speed)	Pr.1006 Clock (year)	Us16
.	.	.	.
.	.	.	.
.	.	.	.

NOTE

- Write to **Pr.77 and Pr.79** is not allowed from the network with FR-A8NP. (Read is allowed.)
- To read or write parameter of **Pr.1000** or later, set Bit 0 of the ext-index number (extended parameter access) = "1". (Refer to [page 46](#).)

The following parameters require the sub-index number for the PNU.

Pr.	PNU	Name	Data Type
C0 (900)	P1900.1	FM terminal calibration [E800-1]	AUs16
C1 (901)	P1901.1	AM terminal calibration [E800-4][E800-5]	AUs16
C2 (902)	P1902.1	Terminal 2 frequency setting bias frequency	AUs16
C3 (902)	P1902.2	Terminal 2 frequency setting bias	AUs16
125 (903)	P1903.1	Terminal 2 frequency setting gain frequency	AUs16
C4 (903)	P1903.2	Terminal 2 frequency setting gain	AUs16
C5 (904)	P1904.1	Terminal 4 frequency setting bias frequency	AUs16
C6 (904)	P1904.2	Terminal 4 frequency setting bias	AUs16
126 (905)	P1905.1	Terminal 4 frequency setting gain frequency	AUs16
C7 (905)	P1905.2	Terminal 4 frequency setting gain	AUs16
C38 (932)	P1932.1	Terminal 4 bias command (torque/magnetic flux)	AUs16
C39 (932)	P1932.2	Terminal 4 bias (torque/magnetic flux)	AUs16
C40 (933)	P1933.1	Terminal 4 gain command (torque/magnetic flux)	AUs16
C41 (933)	P1933.2	Terminal 4 gain (torque/magnetic flux)	AUs16
C42 (934)	P1934.1	PID display bias coefficient	AUs16
C43 (934)	P1934.2	PID display bias analog value	AUs16
C44 (935)	P1935.1	PID display gain coefficient	AUs16
C45 (935)	P1935.2	PID display gain analog value	AUs16

7.8 PROFIBUS-DP communication function setting

7.8.1 Torque command / torque limit via PROFIBUS communication (Pr.804)

Setting **Pr.804 Torque command source selection** = "3 or 5" enables torque command / torque limit via PROFIBUS communication under torque control by Real sensorless vector control or under speed control.

Pr.	Name	Initial value	Setting range	Torque command (used under torque control)	Torque limit (used under speed control) ^{*2}
804	Torque command source selection	0	0	Torque command by terminal 4 analog input	Input via PROFIBUS communication is not available.
			1	Torque command by the parameter setting (Pr.805 or Pr.806) (-400% to 400%) ^{*1}	
			3	Torque command via PROFIBUS communication (FR-A8NP) Torque command by the parameter setting (Pr.805 or Pr.806) (-400% to 400%) ^{*1}	Input via PROFIBUS communication is available. (Regardless of the priority of the torque limit value input ^{*3})
			4	Not available.	
			5	Torque command via PROFIBUS communication (FR-A8NP) Torque command by the parameter setting (Pr.805 or Pr.806) (-327.68% to 327.67%) ^{*1}	Input via PROFIBUS communication is available. (Regardless of the priority of the torque limit value input ^{*3})
			6	Torque command by the parameter setting (Pr.805 or Pr.806) (-327.68% to 327.67%) ^{*1}	Input via PROFIBUS communication is not available.

*1 Can also be set from operation panel or parameter unit.

*2 When used as a torque limit value, the value is an absolute value.

*3 The priority of the torque limit value is as follows: TL signal > PROFIBUS communication > **Pr.810**.

7.8.2 Frequency command with sign (Pr.541)

By adding a sign to the frequency command value or the speed limit value, the start command (forward/reverse rotation) can be inverted to start operation.

Select whether or not to use a sign for the frequency command value / speed limit value.

Pr.	Name	Initial value	Setting range
541	Frequency command sign selection	0	0, 1

Pr.541 setting value	Sign	Setting range	Actual frequency command
0	Not used	0 to 59000	0 to 590.00 Hz
1	Used	-32768 to 32767 (complement of 2)	-327.68 to 327.67 Hz

- Relationship between the start command and sign (**Pr.541** = "1")

Start command	Sign of the frequency command	Actual operation command
Forward rotation	+	Forward rotation
	-	Reverse rotation
Reverse rotation	+	Reverse rotation
	-	Forward rotation

NOTE

- When **Pr.541** = "1" (with sign)

The set frequency cannot be written in EEPROM.

When power is turned ON (inverter reset), the initial setting status of the sign bit is "positive" and the set frequency is "0 Hz".
(The motor does not operate at the frequency set before turning OFF the power (inverter reset).)

8 PPO TYPE NON-SUPPORT SPECIFICATION

8.1 PROFIBUS profiles

The option unit operates as a "slave of the PROFIBUS DP master" or a "controller equivalent to PROFIBUS DP master class 1 on an RS-485 network".

The PROFIBUS profile (data buffer) can be selected from among six different types, "PPO type 1" to "PPO type 5", and "A5NP". (For the module type "PPO type 1" to "PPO type 5" profiles, refer to [page 43](#).)

Module type is changed with the slave module setting. For details, refer to the instruction manual of the Network Master Configuration Software.

NOTE

- The "A5NP" profile is compatible with the FR-A5NP profile.
Use "A5NP" profile when replacing the FR-A5NP with FR-A8NP, etc.

The configuration of the "A5NP" is as follows.

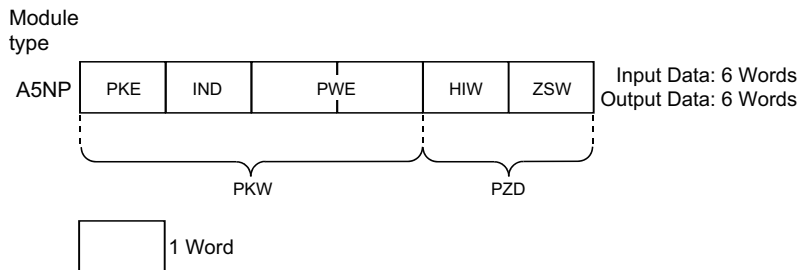

8.2 ID definitions

ID	Definition	
PKW (Refer to page 67.)	PKE	PNU number (PNU) and task or response Id (AK)
	IND	Index number
	PWE	Set 0 since high bits (Bits 16 to 31) are not used. Lower (Bits 0 to 15): Parameter value
PZD (Refer to page 69.)	ZSW	Bits 0 to 7: Inverter status (Command response) ^{*1} Bits 8 to 14: Command count (command request/response) ^{*1}
	HIW	Reserved area for extension

*1 Command request: Message from the master to the slave
Command response: Message from the slave to the master

8.3 Buffer memory configuration

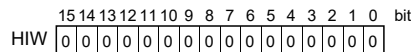
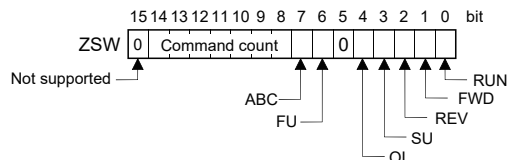
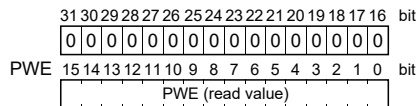
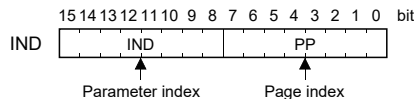
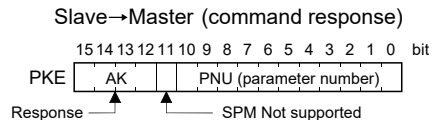
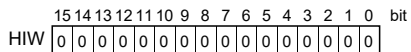
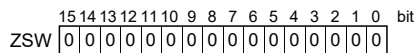
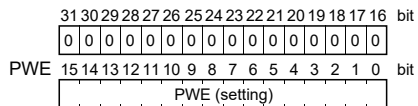
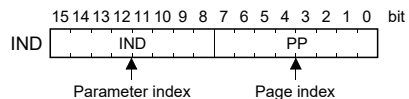
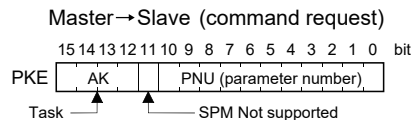

8.4 Buffer memory details

The following indicates the buffer memory details of the PROFIBUS profiles.

◆ PKW

	Name	Bit	Definition
PKE	PNU	0 to 10	PNU number (Together, the PNU and the IND define which data word is being accessed.)
	SPM	11	Not used (0 is set)
	AK	12 to 15	<p>[Command request]</p> <p>0: No task 1: Parameter value is requested (read request) 2: Parameter value (word) is changed (write request) Others: Not supported</p> <p>[Command response]</p> <p>0: No response (Busy status) 1: Inverter can accept data (Ready status) 7: Command execution error (error number is stored into PWE) (Refer to the next page) 8: No operation change rights (error number is stored into PWE) (Refer to the next page) Others: Not used</p>
IND	PP	0 to 7	<p>Page Index:</p> <ul style="list-style-type: none"> If IND = 1 (system environment variables (sev) area), the PP values specify different blocks of sev's: PP = 0: sev_I, block I PP = 1: sev_II, block II (alarm history) PP = 2: sev_III, block III (For details, refer to page 72.) If IND is other than 1, set PP to 0.
	IND	8 to 15	<p>Parameter Index:</p> <p>Specifies the area from which Parameter Number (PNU) is being accessed. (For details, refer to page 71.)</p> <p>IND = 0: real-time monitor area IND = 1: system environment variable (sev) area (3 blocks) IND = 2: normal parameter area IND = 3: Pr.900 to calibration parameter (frequency) area IND = 4: Pr.900 to calibration parameter (%) area</p>

Name	Bit	Definition
PWE	0 to 15	PNU read value/write value When command response AK = "7" (command execution error), PWE definition is as follows. [Error definition] H0: Without error H1: Unsupported task (includes writing) H2: Invalid parameter index (IND) H3: Invalid PNU H6: Invalid page index (PP) H41: Mode error H42: Instruction code error H43: Data setting range error
	16 to 31	Not used (0 is set)

◆ PZD

Name		Bit	Definition	
ZSW	RUN signal	0	0: OFF 1: ON (inverter running)	<ul style="list-style-type: none"> For master-to-slave messages (command request), bits 0 to 7 are not used and must be set to 0. The bit-wise data here do not reflect Pr.190 to Pr.196 (Output terminal function selection). At command response, signals are the same. Signals are not affected by settings of Pr.190 to Pr.196 (Output terminal function selection).
	FWD signal	1	0: OFF 1: ON (forward rotation operation being performed)	
	REV signal	2	0: OFF 1: ON (reverse rotation operation being performed)	
	SU signal	3	0: OFF 1: ON (up to frequency)	
	OL signal	4	0: OFF 1: ON (overload alarm)	
	—	5	Not used (0 is returned)	
	FU signal	6	0: OFF 1: ON (output frequency being detected)	
	ALM signal	7	0: Inverter normal 1: Inverter alarm occurrence	
Command count	8 to 14	Command count The command count is an optional feature maintained by the PROFIBUS master and can range from H00 to H7F. The option unit copies the command count from the command it receives to the same byte offset in the response it sends. The master may use this to synchronize commands and responses.		
—	15	Not used (0 is returned)		
HIW	0 to 15	Not used (0 is set)		

 **NOTE**

Only when the contents of the command request (request for changing the inverter setting: PKW) from the master changed, the inverter processes the request. If the contents of the command request are identical with those of the last request, the inverter does not process the request. (The received request is cleared.)

For instance, while the master keeps sending the "network operation mode enable" command, changing the mode to the PU operation mode with switchover function does not allow the "network operation mode enable" command to be executed due to the same contents as that sent last time. Therefore, the operation mode remains the PU operation mode without changing to the Network operation mode.

In this case, send another command as "PU operation mode enable" from the master once, then send the "network operation mode enable" command again.

8.5 Outline of PNU

You can use the PNU to make inverter settings from the network.

The data used with the network is denoted PNU (P) to differentiate it from the parameter (Pr.) of the inverter.

This chapter explains the module type "A5NP".



NOTE

- Parameter definitions differ according to the module type selected. When using "PPO type 1" to "PPO type 5", refer to [page 52](#).

8.6 PROFIBUS PNU (module type A5NP)

8.6.1 Real-time monitor area (IND = H0000 (IND = H00, PP = H00))

Different inverter data can be monitored using the master.

IND	PNU	Item	Increments
H0000	H0	Output frequency	0.01 Hz
H0000	H1	Output current	0.01 A
H0000	H2	Output voltage	0.1 V
.	.	.	.
.	.	.	.
.	.	.	.



NOTE

- The PNU number of each monitor item corresponds to the number of the inverter's RS-485 communication dedicated monitor (monitor code 1) that is one less than the PNU number in hexadecimal. For the details of the monitor items, refer to the monitor display section in the FR-E800 Instruction Manual (Function).

8.6.2 System environment variable (sev) area (IND = H01PP (IND = H01, PP = H00, H01))

◆ SEV Interface (IND = H01, PP = H00, SEV_I, Block I)

■ Parameter clear

Inverter reset and parameter clear can be performed from the master.

IND	PNU	Item	Data definition
H0100	H1	Inverter reset	H0000
H0100	H2	Parameter clear	H965A
H0100	H3	All parameter clear	H99AA
H0100	H5	Parameter clear *1	H5A96
H0100	H6	All parameter clear *1	HAA99

*1 The communication parameters are not cleared. For the communication parameters, refer to the FR-E800 Instruction Manual (Function).

■ Inverter status/operation command

The inverter status can be monitored and operation command can be given from the master.

IND	PNU	Item
H0100	HA	Inverter status For details, refer to ZSW on page 69 .
		Run command Bit 0: Not used (0 is set) Bit 1: STF signal (Forward rotation command) Bit 2: STR signal (Reverse rotation command) Bit 3: Terminal RH (High-speed operation command ^{*1}) Bit 4: Terminal RM (Middle-speed operation command ^{*1}) Bit 5: Terminal RL (Low-speed operation command ^{*1}) Bit 6: JOG2 signal (JOG operation selection 2) Bit 7: RT signal (Second function selection) Bit 8: AU signal (Terminal 4 input selection) Bit 9: Not used (0 is set) Bit 10: Terminal MRS (Inverter output shut off ^{*1}) Bit11: Not used (0 is set) Bit 12: Terminal RES ^{*2} Bit13 to 15: Not used (0 is set)

*1 The signal initially assigned to the terminal. Using **Pr.180 to Pr.183**, input signals assigned to the terminals can be changed. For the details of **Pr.180 to Pr.183**, refer to the FR-E800 Instruction Manual (Function).

*2 Inverter reset (**Pr.184** = "62") is disabled. Change the **Pr.184** setting value to assign a function other than the inverter reset. For the details of **Pr.184**, refer to the FR-E800 Instruction Manual (Function).

■ Operation mode read/write

Read/write of the operation mode can be performed from the master.

IND	PNU	Item	Data definition
H0100	HB	Operation mode	External operation mode: H10 PU operation mode: H11 (When Pr.79 = "6") Network operation mode: H14

■ Set frequency read/write

The frequency set to the inverter can be read/written from the master.

IND	PNU	Item	Data definition
H0100	HD	Set frequency (RAM) *1	Set frequency (RAM) is read or written.
H0100	HE	Set frequency (EEPROM) **2	Write set frequency to EEPROM.

*1 Writing to PNU = HD or PNU = HE can be read out from PNU = HD.

**2 To change the running frequency consecutively, always write data to the inverter RAM.

■ Terminal input read

The analog input values of terminals 2, 4 can be read.

IND	PNU	Item	Minimum setting increments
H0100	HF	Terminal 2 input value	0.1%
H0100	H10	Terminal 4 input value	0.1%

■ Fault History (IND = H01, PP = H01, SEV_II, Block II)

The past eight inverter fault records can be read.

(For the data codes or details of fault records, refer to the FR-E800 Instruction Manual (Maintenance).)

IND	PNU	Item
H0101	H0	Latest fault/Batch clearing of fault records *1
H0101	H1	Second latest fault
H0101	H2	Third latest fault
H0101	H3	Fourth latest fault
H0101	H4	Fifth latest fault
H0101	H5	Sixth latest fault
H0101	H6	Seventh latest fault
H0101	H7	Eighth latest fault

*1 Writing a value of H0000 to this parameter clear all fault history. All other parameters at this index are read only.

8.7 Standard parameters

8.7.1 Normal parameter area (IND = H0200 (IND = H02, PP = H00))

You can use the PNU to make parameter settings from the network.

The table below lists PNU numbers corresponding to parameter numbers.

Standard parameter examples are introduced below. Refer to the examples and make parameter settings.

For the parameter details, refer to the FR-E800 Instruction Manual (Function).

- Example of parameter list

IND	PNU	Pr.	Name
H0200	H0	0	Torque boost
	H1	1	Maximum frequency
	H2	2	Minimum frequency
	H3	3	Base frequency
	H4	4	Multi-speed setting (high speed)
	H5	5	Multi-speed setting (middle speed)
	H6	6	Multi-speed setting (low speed)
.	.	.	.
.	.	.	.

NOTE

- Write to **Pr.77 and Pr.79** is not allowed from the network with FR-A8NP. (Read is allowed.)

8.7.2 Pr.900 to calibration parameter (frequency) area (IND = H0300 (IND = H03, PP = H00))

The following parameters can be set with IND = H0300.

For the parameter details, refer to the FR-E800 Instruction Manual (Function).

IND	PNU	Pr.	Name
H0300	H0	C0 (900)	FM terminal calibration [E800-1]
H0300	H1	C1 (901)	AM terminal calibration [E800-4][E800-5]
H0300	H2	C2 (902)	Terminal 2 frequency setting bias frequency
H0300	H3	125 (903)	Terminal 2 frequency setting gain frequency
H0300	H4	C5 (904)	Terminal 4 frequency setting bias frequency
H0300	H5	126 (905)	Terminal 4 frequency setting gain frequency
H0300	H20	C38 (932)	Terminal 4 bias command (torque/magnetic flux)
H0300	H21	C40 (933)	Terminal 4 gain command (torque/magnetic flux)
H0300	H22	C42 (934)	PID display bias coefficient
H0300	H23	C44 (935)	PID display gain coefficient

8.7.3 Pr.900 to calibration parameter (%) area (IND = H0400 (IND = H04, PP = H00))

The following parameters can be set with IND = H0400.

For the parameter details, refer to the FR-E800 Instruction Manual (Function).

IND	PNU	Pr.	Name
H0400	H2	C3 (902)	Terminal 2 frequency setting bias
H0400	H3	C4 (903)	Terminal 2 frequency setting gain
H0400	H4	C6 (904)	Terminal 4 frequency setting bias
H0400	H5	C7 (905)	Terminal 4 frequency setting gain
H0400	H20	C39 (932)	Terminal 4 bias (torque/magnetic flux)
H0400	H21	C41 (933)	Terminal 4 gain (torque/magnetic flux)
H0400	H22	C43 (934)	PID display bias analog value
H0400	H23	C45 (935)	PID display gain analog value

9 TROUBLESHOOTING

When a fault occurs where the inverter trips itself and the option unit, check the inverter's operation panel, the LED on the option unit, and the following checkpoints to identify the cause, then take appropriate countermeasures. If the fault does not correspond to any of the following faults or if you have any other problem, please contact your sales representative.

Operation panel display on the inverter	LED on FR-A8NP	Possible cause		Checkpoint / troubleshooting
0.00	OFF	The option unit is not operating.	The option unit is not mounted properly.	Check that the option unit is mounted properly.
			PROFIBUS communication is not established with the master. (Incorrect node address setting)	Set the same node address with the master on the inverter (FR-A8NP) using the node address switches. (Turn OFF, then ON the power supply after changing the node address setting on the inverter (FR-A8NP).)
			PROFIBUS communication is not established with the master. (Incorrect GSD file has been registered.)	Register the correct GSD file with a configuration software, and set the network configuration to the master.
			PROFIBUS communication is not established with the master. (Incorrect wiring)	Check the wiring of the option unit. D+ PROFIBUS transmitting/receiving data+ (B line) D- PROFIBUS transmitting/receiving data- (A line)
			—	Reset the inverter. Perform all parameter clear to initialize all parameter settings, then turn ON the inverter power again.
		The network is unstable.	The network cables are not connected correctly.	Check that the network cables are connected properly between the nodes.
			The PROFIBUS communication is not established with the master. (Unstable bus line)	Connect a terminating resistor. If a terminating resistor has been already connected, check that it is connected properly.
			The network setting is incorrect.	Check the network setting with the PROFIBUS-DP network configuration software.

Operation panel display on the inverter	LED on FR-A8NP	Possible cause		Checkpoint / troubleshooting
0.00	OFF	The network is unstable.	The inverter is affected by the other nodes.	Check if any network error has occurred in the other nodes.
		No master is present in the network, or the master is not properly operating.		Check the connection and the operation of the PROFIBUS-DP master.
	Red (ON)	The PROFIBUS communication had been established (the green LED had been ON), but the master stopped transmitting data to the option unit during an inverter stop.		Check the master ladder, etc., and remove the causes that disconnect the data transmission between the master and the option unit.
E.OP1	Red (ON)	A communication cable break occurred after the PROFIBUS communication had been established (green LED had been ON).		Check the connection and the wiring of the communication cable.
		Communication errors occurred consecutively after the PROFIBUS communication had been established (green LED had been ON).		Connect a terminating resistor. If a terminating resistor has been already connected, check that it is connected properly.
		The PROFIBUS communication had been established (the green LED had been ON), but the master stopped transmitting data to the option unit during an inverter operation.		Check the master ladder, etc., and remove the causes that disconnect the data transmission between the master and the option unit.

APPENDIX

Appendix 1 Instructions for compliance with the EU Directives

The EU Directives are issued to standardize different national regulations of the EU Member States and to facilitate free movement of the equipment, whose safety is ensured, in the EU territory. Since 1996, compliance with the EMC Directive that is one of the EU Directives has been legally required. Since 1997, compliance with the Low Voltage Directive, another EU Directive, has been also legally required. When a manufacturer confirms its equipment to be compliant with the EMC Directive and the Low Voltage Directive, the manufacturer must declare the conformity and affix the CE marking.



- The authorized representative in the EU

The authorized representative in the EU is shown below.

Name: Mitsubishi Electric Europe B.V.

Address: Mitsubishi-Electric-Platz 1, 40882 Ratingen, Germany

◆ EMC Directive

We declare that this product conforms with the EMC Directive when installed in a compatible inverter, and affix the CE marking on the packaging plate.

- EMC Directive: 2014/30/EC
- Standard(s): EN 61800-3:2004+A1:2012 (Second environment / PDS Category "C3")

■ Note

- To install and wire the inverter, refer to the "Instructions for compliance with the EU Directives" in the Instruction Manual enclosed with the inverter.
- Confirm that the final integrated system with the inverter conforms with the EMC Directive.

◆ EU RoHS Directive

We declare that this product conforms with the EU RoHS Directive (2011/65/EU) when installed in a compatible inverter, and affix the CE marking on the packaging plate.

Appendix 2 Instructions for EAC

The product certified in compliance with the Eurasian Conformity has the EAC marking on the packaging plate.

Note: EAC marking

In 2010, three countries (Russia, Belarus, and Kazakhstan) established a Customs Union for the purposes of revitalizing the economy by forming a large economic bloc by abolishing or reducing tariffs and unifying regulatory procedures for the handling of articles.

Products to be distributed over these three countries of the Customs Union must comply with the Customs Union Technical Regulations (CU-TR), and the EAC marking must be affixed to the products.

For information on the country of origin, manufacture year and month, and authorized sales representative (importer) in the CU area of this product, refer to the following:

- Country of origin indication

Check the package of this product.

Example: MADE IN JAPAN

- Manufactured year and month

Check the SERIAL number indicated on this product.

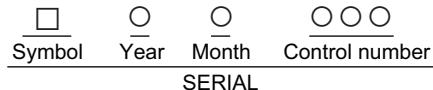

The SERIAL consists of one symbol, two characters indicating the production year and month, and three characters indicating the control number. The last digit of the production year is indicated as the Year, and the Month is indicated by 1 to 9, X (October), Y (November), or Z (December).

- Authorized sales representative (importer) in the CU area

The authorized sales representative (importer) in the CU area is shown below.

Name: Mitsubishi Electric (Russia) LLC

Address: 52, bld 1 Kosmodamianskaya Nab 115054, Moscow, Russia

Phone: +7 (495) 721-2070

Fax: +7 (495) 721-2071



SERIAL

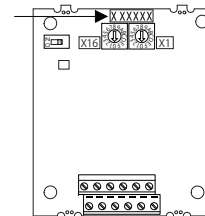

Appendix 3 Restricted Use of Hazardous Substances in Electronic and Electrical Products

The mark of restricted use of hazardous substances in electronic and electrical products is applied to the product as follows based on the "Management Methods for the Restriction of the Use of Hazardous Substances in Electrical and Electronic Products" of the People's Republic of China.

电器电子产品有害物质限制使用标识要求



本产品中所含有的有害物质的名称、含量、含有部件如下表所示。

- 产品中所含有害物质的名称及含量

部件名称 *2	有害物质 *1					
	铅 (Pb)	汞 (Hg)	镉 (Cd)	六价铬 (Cr (VI))	多溴联苯 (PBB)	多溴二苯醚 (PBDE)
电路板组件 (包括印刷电路板及其构成的零部件, 如电阻、电容、集成电路、连接器等)、电子部件	×	○	×	○	○	○
金属壳体、金属部件	×	○	○	○	○	○
树脂壳体、树脂部件	○	○	○	○	○	○
螺丝、电线	○	○	○	○	○	○

上表依据 SJ/T11364 的规定编制。

○：表示该有害物质在该部件所有均质材料中的含量均在 GB/T26572 规定的限量要求以下。

×：表示该有害物质在该部件的至少一种均质材料中的含量超出 GB/T26572 规定的限量要求。

*1 即使表中记载为 ×，根据产品型号，也可能会有有害物质的含量为限制值以下的情况。

*2 根据产品型号，一部分部件可能不包含在产品中。

Appendix 4 Referenced Standard (Requirement of Chinese standardized law)

This Product is designed and manufactured accordance with following Chinese standards.

EMC: GB/T 12668.3

Appendix 5 Compliance with the UK certification scheme

We declare that this product conforms with the related technical requirements under UK legislation when installed in a compatible inverter, and affix the UKCA (UK Conformity Assessed) marking on the packaging plate.

Approval conditions are the same as those for the EU Directives. (Refer to [page 80.](#))



UKCA marking:

The UKCA marking is used for products sold in the markets of Great Britain (England, Wales, and Scotland) from January 1, 2021 after the departure of the UK from the EU on January 31, 2020.

MEMO

REVISIONS

*The manual number is given on the bottom left of the back cover.

Revision Date	*Manual Number	Revision
Apr. 2020	IB(NA)-0600929ENG-A	First edition
Dec. 2021	IB(NA)-0600929ENG-B	Added Position control Compliance with the UK certification scheme

INVERTER

mitsubishi **MITSUBISHI ELECTRIC CORPORATION**

HEAD OFFICE: TOKYO BUILDING 2-7-3, MARUNOUCHI, CHIYODA-KU, TOKYO 100-8310, JAPAN