

**mitsubishi**

*Changes for the Better*

**FATEC**

---

INVERTER SCHOOL TEXT  
INVERTER BEGINNER COURSE

# ● SAFETY PRECAUTIONS ●

(Always read these instructions before the exercise.)

When designing a system, always read the relevant manuals and give sufficient consideration to safety.

During the exercise, pay full attention to the following points and handle the equipments correctly.

## [Precautions for Exercise]



### WARNING

- Do not touch the terminals while the power is on, to prevent an electric shock.
- When opening the safety cover, turn the power off or conduct a sufficient check of safety before operation.



### CAUTION

- Follow the instructor's directions during the exercise.
- Do not remove the units of a demonstration machine or change wirings without permission.  
Doing so may cause a failure, malfunction, injury and/or fire.
- Turn the power off before installing or removing a unit.  
Failure to do so may result in a malfunction of the unit or an electric shock.
- When an error occurs, notify the instructor immediately.

## Introduction

Thank you very much for joining the FATEC school today. Also, thank you very much for choosing the Mitsubishi products.

Before taking a course in this school, please read the following brief explanation on the contents and purpose of this school.

The targets of this "Inverter introduction course" are from those who have never used an inverter before to those who have some experience of using an inverter but want to know the basic principle, etc. This course especially describes the techniques, motor-related and power circuit-related contents that are common to inverters in an understandable way. This course also gives a simple account of the contents that are good to know for using an inverter including basic operations of an actual machine.

For the requests to know more details or to use selection software, the other schools are also available.

School name	Description	Period
Inverter practice course	Explains the inverter principle, the precautions for using an inverter, etc. in an understandable way. You can understand the functions, performance, etc. of an inverter by using an actual machine.	2 days

----- INDEX -----

1 BASICS OF MOTOR.....	1-1
1.1 Type of Motor .....	1-1
1.1.1 Overview .....	1-1
1.1.2 Classification of motor .....	1-2
1.2 Principle of Motor Operation .....	1-3
1.2.1 Overview .....	1-3
1.2.2 Three-phase motor (induction type) .....	1-4
1.2.3 IPM motor (synchronous type) .....	1-4
1.3 Performance of Motor .....	1-5
1.3.1 Heat-resistant classes and temperature rise .....	1-5
1.3.2 Rated torque .....	1-6
1.3.3 Relationship between motor speed and generated torque .....	1-7
1.3.4 Slip.....	1-8
1.4 Installation .....	1-9
1.4.1 Installation environment.....	1-9
1.4.2 Outer sheath form of motor.....	1-10
1.4.3 Mechanical specifications of main motors .....	1-11
1.4.4 Movement direction of motor load .....	1-12
2. BASICS OF INVERTER .....	2-1
2.1 Basic Configuration .....	2-1
2.1.1 Inverter.....	2-1
2.2 Principle of Converter Operation .....	2-2
2.2.1 Method to create DC from AC (commercial) power supply .....	2-2
2.2.2 Input current waveform when capacitor is used as load.....	2-3
2.2.3 Inrush current control circuit .....	2-3
2.2.4 Principle of smoothing circuit operation.....	2-4
2.3 Principle of Inverter Operation .....	2-5
2.3.1 Method to create AC from DC.....	2-5
2.3.2 Method to change frequency.....	2-6
2.3.3 Method to change voltage.....	2-6
2.3.4 Three-phase AC .....	2-7
2.3.5 Switch element.....	2-7
2.3.6 V/F pattern .....	2-8
2.4 Regenerative Brake .....	2-9
2.5 Control .....	2-10
2.5.1 Difference between general-purpose inverter and vector inverter .....	2-10

2.5.2 Control method.....	2-11
<b>3. DEMONSTRATION MACHINE OPERATION.....</b>	<b>3-1</b>
3.1 Inverter (FR-A720).....	3-1
3.1.1 Representative connection wiring diagram.....	3-1
3.1.2 Main parameter settings and setting method .....	3-3
3.1.3 Operating method.....	3-7
<b>4. PRECAUTIONS .....</b>	<b>4-1</b>
4.1 Environment .....	4-1
4.1.1 Power supply harmonics.....	4-1
4.1.2 Leakage current .....	4-3
4.1.3 Noise.....	4-4
4.1.4 Compliance to standards .....	4-6
4.2 Capacity Selection.....	4-8
4.2.1 Before selecting a capacity.....	4-8
4.2.2 Selecting a motor according to driving force.....	4-8
4.2.3 Selecting the most suitable capacity in consideration of acceleration/ deceleration .....	4-9
4.2.4 Software for capacity selection using a personal computer .....	4-13
4.2.5 Software for starting up an inverter .....	4-17
4.3 Application Examples .....	4-19
4.3.1 Inverter application examples .....	4-19
4.3.2 Vector inverter application examples .....	4-20
4.4 Maintenance and Inspection .....	4-21
4.4.1 Motor.....	4-21
4.4.2 Inverter.....	4-22
4.5 Troubleshooting.....	4-23
4.5.1 Alarm display.....	4-23
4.5.2 Wiring precautions and others .....	4-24
<b>APPENDICES.....</b>	<b>App-1</b>
Appendix 1. Glossary .....	App-1

# 1 BASICS OF MOTOR

## 1.1 Type of Motor

### 1.1.1 Overview

A motor is a device which converts the electrical energy to the rotating mechanical energy. Many motors are used for various industrial machines to home appliances or bicycle in daily use.

The types of motors can be classified by the performance, usage environmental condition, applications, etc. These are shown below.

The motor driven by the inverter is a mainly three-phase squirrel-cage motor, and the motor driven by the vector inverter is three-phase type motor with encoder which detects a position and speed. In addition, there is an energy-saving drive high-efficiency magnetic motor (IPM) for further energy saving.

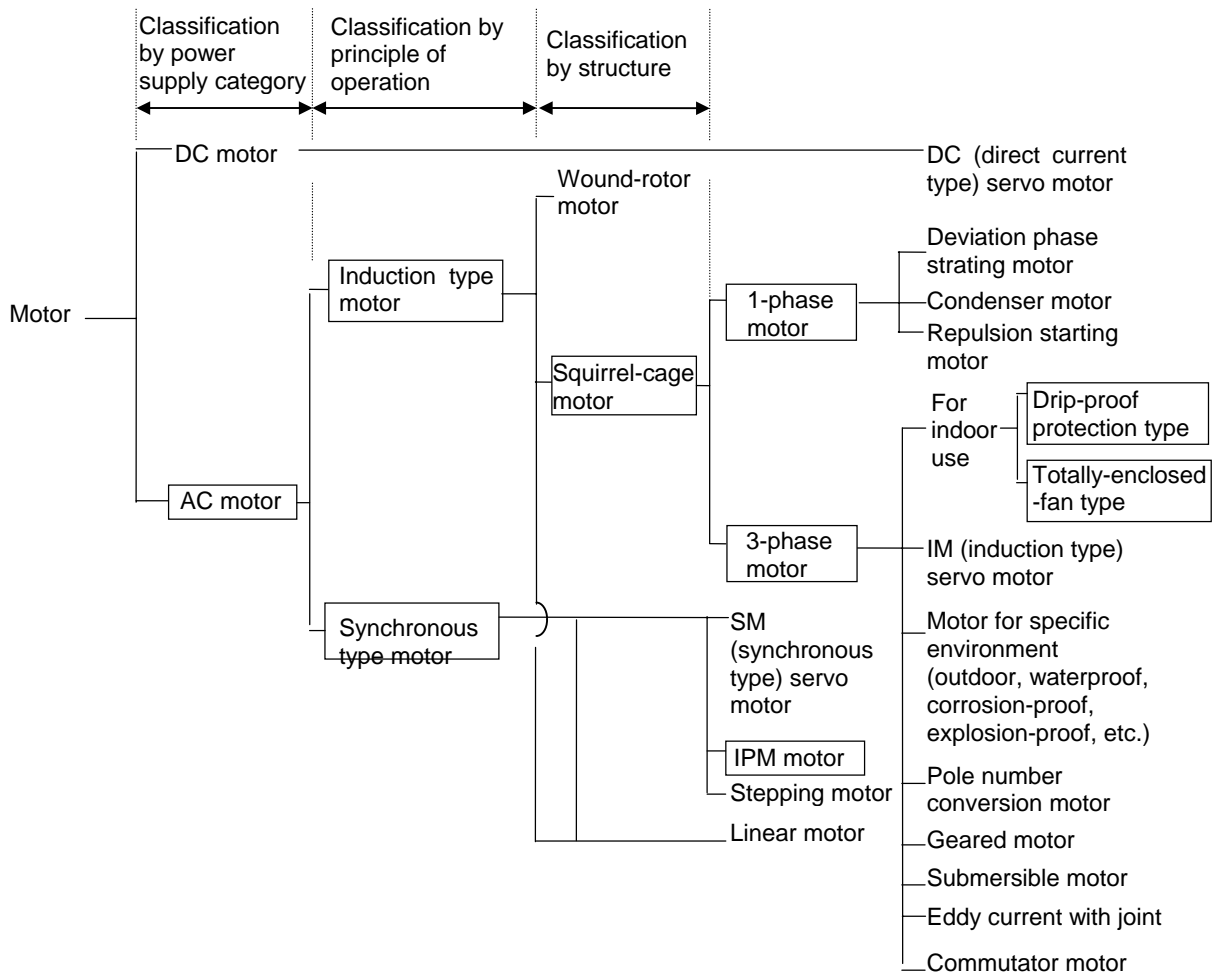

# 1 BASICS OF MOTOR

## 1.1.2 Classification of motor

The following table shows the values for when a motor is used in combination with a controller which can adjust the speed of a motor.

Motor types	Rated output range (kW)					Maximum motor speed (r/min)		Variable speed range (with inverter) 1:□			Encoder	Availability of torque control	Positioning accuracy (guide) (mm)				
	0.01	0.1	1	10	100	100	1000	10	100	1000			1/1000	1/100	1/10	1	10
General-purpose three-phase motor			↔				→	↔			Without	Not available*	Use the limit switch.			↔	
General-purpose three-phase motor with encoder			↔				→	↔			With	Not available*				↔	
Vector inverter dedicated motor			↔				→	↔			With	Available				↔	
IPM motor			↔				→	↔			Without	Not available	Use the limit switch.			↔	

\* Available for FREQROL-A700 series.

# 1 BASICS OF MOTOR

## 1.2 Principle of Motor Operation

### 1.2.1 Overview

The principle of operation is same for all motors regardless of the size, and a torque is occurred according to the "Fleming's left-hand rule" by which the current is applied to a conductor in a magnetic field and a force acts to the conductor.

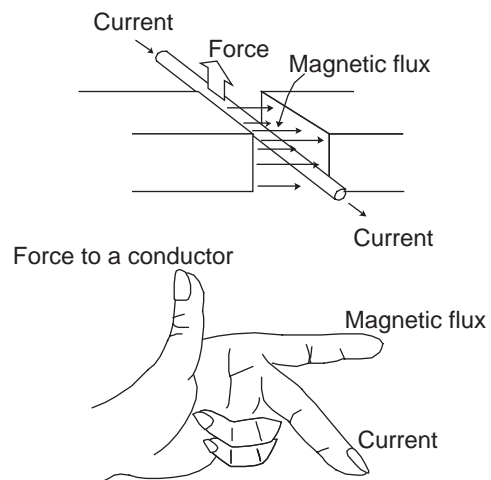

Fig. 1.1 Fleming's left-hand rule

The principle of induction motor operation is as below.

If the magnet is moved in the A direction when not touched with the disk, the disk also turns in the same direction.

At the same time as the movement of magnet, the electromotive force is induced in the disk, and the eddy current (induced current) is applied. The relationship between the eddy current induced in the disk and the magnetic flux by the magnet (Fleming's left-hand rule) causes an electromagnetic power, and the disk is turned in the arrow f direction.

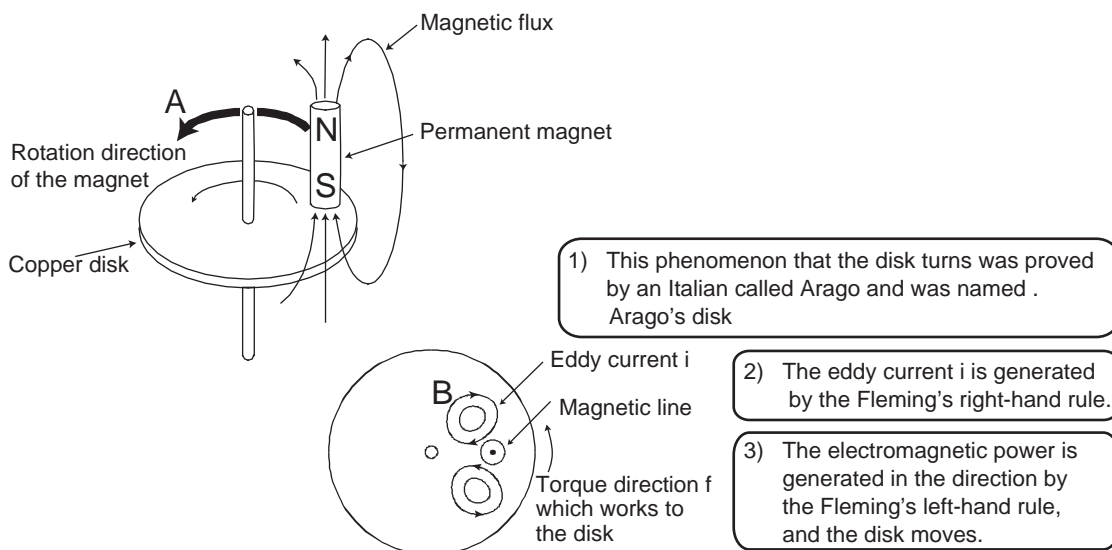

Fig. 1.2 Arago's disk

# 1 BASICS OF MOTOR

## 1.2.2 Three-phase motor (induction type)

The cross section view of the three-phase motor (induction type) is shown on the right.

It consists of stator core, stator winding, gap and rotor core.

The current is applied to the winding part, and the rotating magnetic field is generated. This rotating magnetic field is equivalent of Fig. 1.2. For this vector inverter dedicated motor used with the three-phase motor, the method, in which the current creating a magnetic field with the current applied to the stator winding (current for magnetic field) and the orthogonal current generating a torque (current for torque) are electrically controlled, is used. The control performance equivalent to a direct-current machine is ensured in principle. In addition, the vector inverter dedicated motor is widely used because of its constant torque control from low speed to high speed and good response.

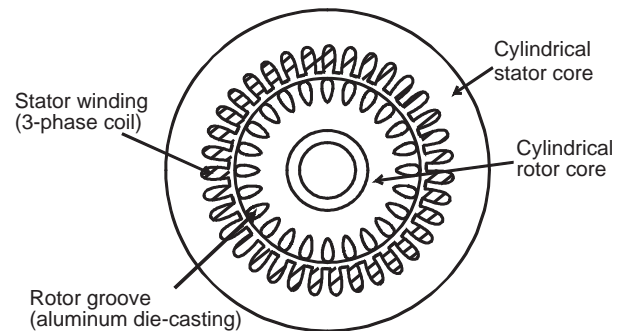

Fig. 1.3 Cross section of 3-phase motor (induction type)

## 1.2.3 IPM motor (synchronous type)

The rotor of the IPM motor (synchronous type) has permanent magnets embedded, and the stator consists of the winding which applies the current. The cross section view is shown in Fig. 1.4. The current according to the movement of the rotor is applied to the stator winding.

By detecting the magnet position at a start, the magnetic flux of these rotor magnets and the current applied to the stator winding are controlled at right angles to each other.

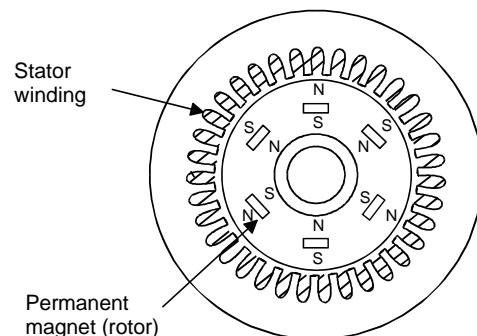

Fig. 1.4 Cross section of PM motor

# 1 BASICS OF MOTOR

---

## 1.3 Performance of Motor

### 1.3.1 Heat-resistant classes and temperature rise

Various insulants with high heat resistance are used for general-purpose motors due to the significant development of insulating materials to be used.

Currently, the motors have four types of heat-resistant class, E, B, F and H, and each maximum permissible temperature is as shown in Table 1.1. The rise of temperature severely shortens the life of motor.

It is necessary to set as (Ambient temperature + Motor temperature rise limit) < Maximum permissible temperature.

Motors are designed for the ambient temperature of 40°C.

For example, the motor temperature is designed to fit into the temperature rise limit standardized in Table 1.1 when the motor is operated with the rated torque in the rated voltage of 50Hz.

Table 1.1 Heat-resistant class, maximum permissible temperature and temperature rise limit

Heat-resistant class	Maximum permissible temperature	Temperature rise limit
E	120°C	75K
B	125°C	80K
F	155°C	105K
H	180°C	125K

Example In the case of E type

40°C(ambient temperature) + 75K (motor temperature rise limit)

< 120°C (maximum permissible temperature)

155°C < 120°C

\* The temperature rise of insulants is measured in a resistance method.

# 1 BASICS OF MOTOR

---

## 1.3.2 Rated torque

The values of guaranteed output limit and designated voltage, current (torque), motor speed, frequency, ambient temperature, etc. by the motor manufacturer are collectively called a rating. These data are called rated output, rated current (rated torque), rated motor speed and so on. For the rating of output, there are constant rating, short-time rating and repeat rating (duty rating).

The constant rating is a constant output which can output continuously for a long time.

For the short-time rating, one hour rating, for instance, is a constant output which continuously outputs only for one hour after a motor is cooled down.

The repeat rating (duty operation) indicates the output at the load if the load changes periodically.

$$\text{Rated torque } T_M = 9550 \times \frac{\text{Motor rated output } P \text{ [kW]}}{\text{Rated motor speed } N \text{ [r/min]}} \quad [\text{N} \cdot \text{m}]$$

..... (Formula 1.1)

These values are indicated on the name plates of motors or in test reports.

Example  
What is the rated torque of 3.7kW 4P rated motor speed 1730 [r/min]?

$$\text{Rated torque } T_M = 9550 \times \frac{3.7 \text{ [kW]}}{1730 \text{ [r/min]}} = 20.4 \quad [\text{N} \cdot \text{m}]$$

# 1 BASICS OF MOTOR

## 1.3.3 Relationship between motor speed and generated torque

The torque characteristics are shown in Fig. 1.5 and the current characteristics in Fig. 1.6 when a three-phase squirrel-cage motor is directly started.

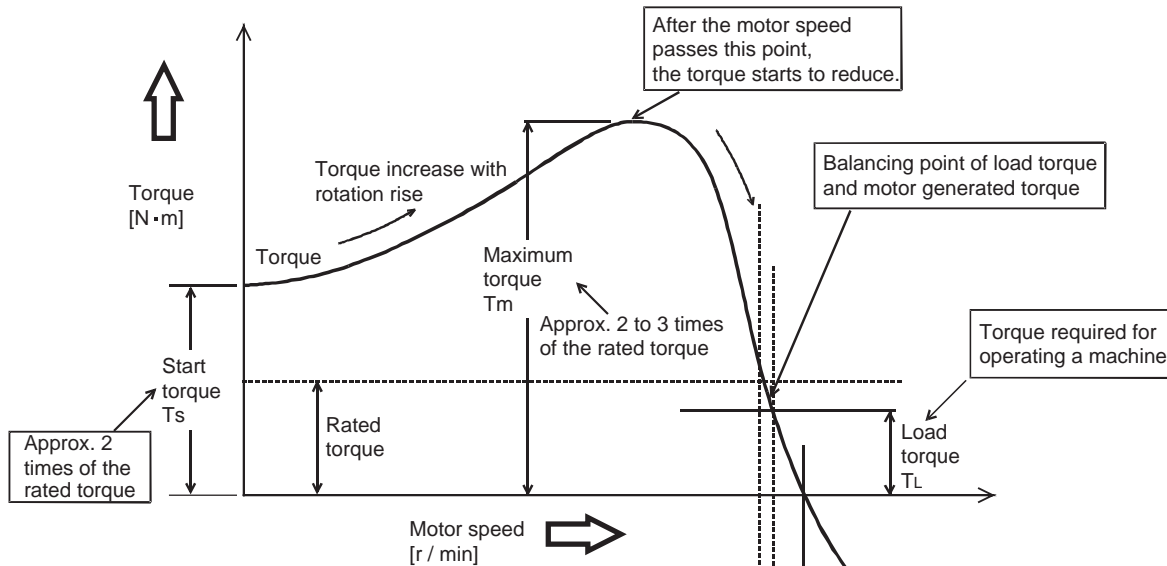

Fig. 1.5 Relationship of motor speed and torque

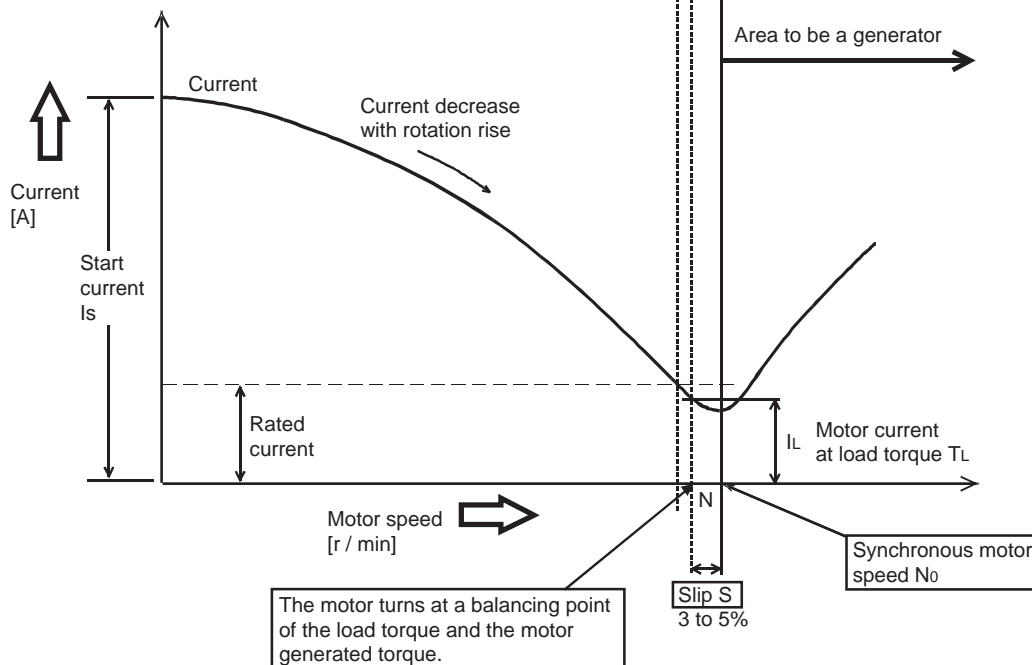

Fig. 1.6 Relationship of motor speed and current

# 1 BASICS OF MOTOR

---

Here, the motor speed is determined by the relationship between the load torque  $T_L$  and the motor generated torque according to the figure on the previous page, it can be expressed with the following formula.

$$\text{Motor speed} = \frac{120 \times \text{Frequency } f \text{ (Hz)}}{\text{Pole number } P} \times (1 - S) \text{ [r/min]} \quad \dots \dots \dots \text{ (Formula 1.2)}$$

Determined by the specification of the motor. This magnitude is called Synchronous speed  $N_0$ .

Determined by the magnitude of the load (load torque).

The control with an inverter is widely used in a method which changes this frequency  $f$  as a control of the motor speed.

## 1.3.4 Slip

The motor speed becomes a speed mismatched with the synchronous speed when the load is applied as shown in Fig. 1.5 and 1.6. The indicated degree of the gap with the synchronous speed is called "Slip".

The slip is derived by the following formula.

$$\text{Slip } S = \frac{\text{Synchronous motor speed } N_0 - \text{Motor speed } N}{\text{Motor speed } N_0} \quad \dots \dots \dots \text{ (Formula 1.3)}$$

At a start, the "slip" is 100% since the motor speed is 0.

When operating in the rated torque, the "slip" is generally 3 to 5%.

When the load torque increases, the motor speed slows down, the "slip" increases and the motor current also increases.

In the case of the rotation linked with outside, the motor speed becomes faster than the synchronous speed and the slip will be a minus value.

# 1 BASICS OF MOTOR



## 1.4 Installation

### 1.4.1 Installation environment

The motor driven with a general-purpose inverter is a general-purpose motor which does not generally operate a feedback control.

On the contrary, the motor driven with a vector inverter requires the feedback control and has a built-in encoder (sensor) behind the motor. For the encoder, a semiconductor and electronic components are installed.

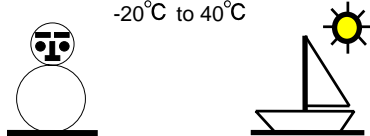
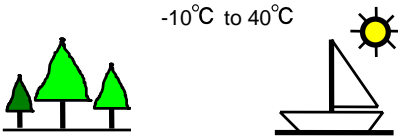
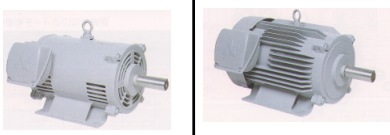
In addition, there are restrictions in the motor such as the environment and the lives of internal winding insulating material, bearing material, grease material inside the bearing and so on. The following environmental conditions are mainly defined.

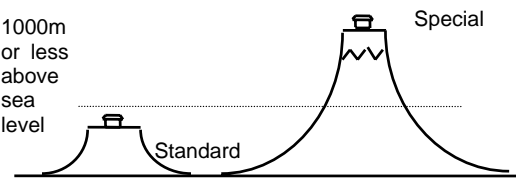
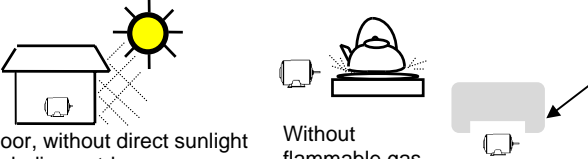
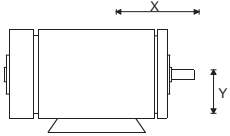
Environment	General-purpose inverter motor	Vector inverter dedicated motor
Ambient temperature	-20°C to 40°C 	-10°C to 40°C 
Ambient humidity	 Drip-proof protection type motor      Totally-enclosed-fan type motor Squirrel-cage induction motor 85% RH or less      95% RH or less No dripping to be generated      No dripping to be generated	 Totally-enclosed-fan type motor Squirrel-cage induction motor 90% RH or less No dripping to be generated
Elevation	1000m or less above sea level  Standard      Special	The installation height of a motor is 1000m or less above sea level. If the atmospheric pressure is low, the heat dissipation gets worse. The motor temperature, insulation, grease life, etc. during the operation cannot be guaranteed if the elevation is over 1000m, a special dealing is required.
Ambiance	 Indoor, without direct sunlight (excluding outdoor, totally-closed-fan motor)      Without flammable gas      Without	<ul style="list-style-type: none"> <li>▪ Oil mist</li> <li>▪ Corrosive gas</li> <li>▪ Dust and dirt</li> </ul>
Vibration resistance	Restrictions of the vibration passed on to the motor during the operation  Both X and Y directions 4.9m/S <sup>2</sup> (0.5G) or less	

- The motors are designed with reference to the above environmental conditions.

# 1 BASICS OF MOTOR

## 1.4.2 Outer sheath form of motor

An outer sheath form for motor must be selected according to the installation condition and environment. Selecting an inappropriate motor may cause a trouble or shorten the motor life. Although the outer sheath forms (protection forms) are commonly classified into the classification by JIS, the motors expressed in the classification by the international standard IEC are recently manufactured as well. The classifications by JIS and IEC are as below.

### (1) Classification by JIS

Symbols for the protection forms of motors are indicated by putting the first and second reference numbers corresponding to the following table after JP.

Example) JP **4****4**

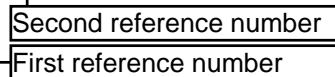

### (2) Classification by IEC

Symbols for the protection types of motors are indicated by putting the first and second reference numbers corresponding to the following table after IP.

Example) IP **6****5**

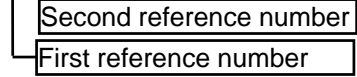

Upper: Classification by JIS  
Lower: Classification by IEC  
are indicated.

First reference number: Grade for the solid foreign matter entrance protection

<b>0</b>	Nonprotected type Unprotected	<b>3</b>	Protection to avoid the entrance of solid foreign matter of diameter 2.5mm or more such as an edge of tool or a wire	<b>6</b>	Absolute dust-proof structure, totally free from the entrance of powder dust
<b>1</b>	Half-protected type Protection to avoid the entrance of solid foreign matter of 50mm or more such as a hand	<b>4</b>	Totally-enclosed type Protection to avoid the entrance of solid foreign matter of diameter 1.0mm or more such as a cable or a flake		
<b>2</b>	Protected type Protection to avoid the entrance of solid foreign matter of diameter 12mm or more such as a one-yen coin	<b>5</b>	Dust-proof type Protection from powder dust, no entrance of the powder dust that disturbs a normal operation		

Upper: Classification by JIS  
Lower: Classification by IEC  
are indicated.

Second reference number: Grade for the water entrance related protection



<b>0</b>	Nonprotected type Unprotected	<b>3</b>	Rainproof type Protection against the water spray within the range of 60° from the perpendicular	<b>6</b>	Ocean waves protection type Protection against strong jet water as ocean waves, no water immersion which disturbs a normal operation
<b>1</b>	Protection against the dripping that vertically drops such as condensed water	<b>4</b>	Splash-proof type Protection against the splash from all directions	<b>7</b>	Immersion protection type No water immersion which disturbs a normal operation even if submerged in 150mm to 1m
<b>2</b>	Drip-proof type Protection against the dripping within the range of 15° from the perpendicular	<b>5</b>	Jetproof type Protection against the jet water from all directions	<b>8</b>	Underwater type Usable in water, usable for a long time below water

# 1 BASICS OF MOTOR

## 1.4.3 Mechanical specifications of main motors

Generally, for general-purpose inverters and vector inverter motors, leg installed type (with legs) motors are used in relatively large numbers.

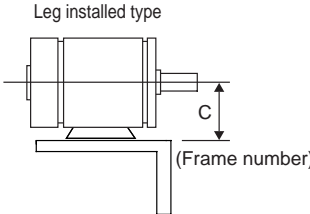
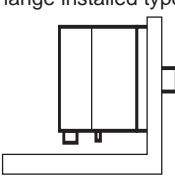
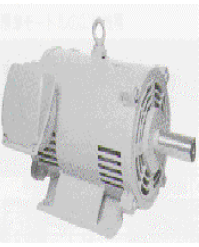
The following shows the point for the main mechanical specifications of these motors.

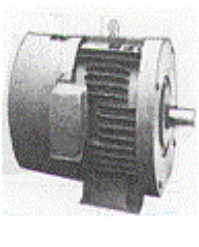
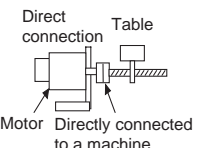
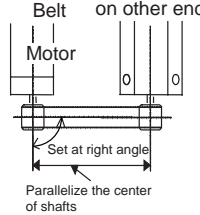
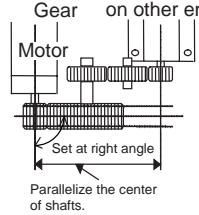
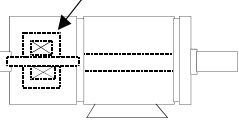
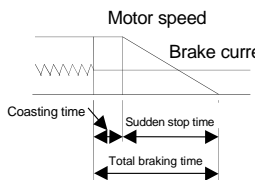
<p>Installation method</p> <ul style="list-style-type: none"> <li>Leg installed type</li> <li>Frame number</li> <li>Flange installed type</li> </ul>	<p>Leg installed type</p> 	<p>Flange installed type</p> 	
<p>Cooling method</p> <ul style="list-style-type: none"> <li>Open type</li> <li>Standard type</li> <li>Totally-enclosed type</li> <li>Suitable for adverse environment with dust, dirt, humidity, etc.</li> <li>Separate-cooling type</li> <li>Adopted with large capacity in a forced cooling system</li> </ul>	<p>Open type</p> 	<p>Totally-enclosed type</p> 	<p>Separate-cooling type</p> 
<p>Power transmission</p> <ul style="list-style-type: none"> <li>Direct connection driving</li> <li>Belt driving</li> <li>Gear driving</li> </ul>	<p>Direct connection</p>  <p>Motor Directly connected to a machine</p>	<p>Belt</p>  <p>Machine on other end</p> <p>Set at right angle</p> <p>Parallelize the center of shafts</p>	<p>Gear</p>  <p>Machine on other end</p> <p>Set at right angle</p> <p>Parallelize the center of shafts.</p>
<p>Brake</p> <ul style="list-style-type: none"> <li>Safety brake</li> <li>Excitation open brake</li> <li>Non-safety brake</li> <li>Excitation brake</li> </ul>	<p>Excitation open brake</p> <p>Brake installation position for the inverter motor</p>   <p>When turning the brake power off separately</p>		

# 1 BASICS OF MOTOR

## 1.4.4 Movement direction of motor load

There are many types of mechanical drive systems by motors, and they can be used depending on the purpose (such as desired accuracy, positioning accuracy, travel distance and details of machine operation at work). For classifying these drive system mechanical sections and considering the relationship with the motor, the following indicates the categories of the mechanical movement directions. "mm" is used for the linear motion as a command unit, and an angle or the number of partitions is used for the rotational motion.

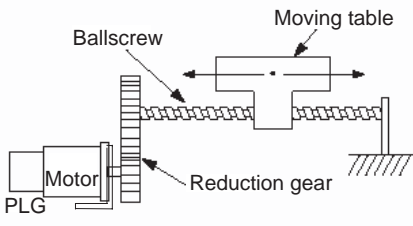
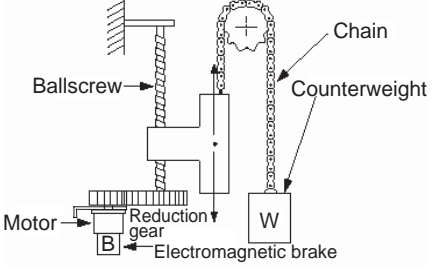
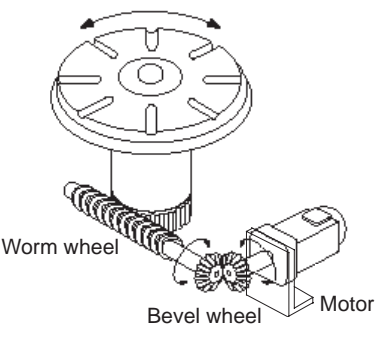
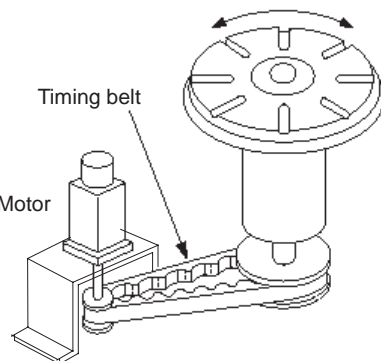
		Category of movement direction		
		Horizontal direction	Vertical direction (ascent and descent)	
Linear motion			<ul style="list-style-type: none"> <li>• Most common drive pattern which is used for a table feed of each machine or a transfer machine with a ballscrew, rack &amp; pinion, belt, etc.</li> </ul>	<ul style="list-style-type: none"> <li>• Drive pattern which is used for a lifting shaft of transfer machine or a robot up-and-down shaft. As shown in the figure, the counter weight for a load balance is often mounted, and the motor with the electromagnetic brake is used for avoiding a slip down at a power failure.</li> </ul>
	 <p>(Example 1. Connection with gear)</p>	 <p>(Example 2. Connection with belt)</p>	<ul style="list-style-type: none"> <li>• Drive pattern which is used for a rotary shaft of the index table, etc. The motor speed of load shaft (table rotary shaft) is generally slow and often used by being reduced the speed according to the teeth number ratio of a gear or pulley.</li> </ul>	

### Types of motor direction

# 2. BASICS OF INVERTER

## 2.1 Basic Configuration

### 2.1.1 Inverter

The basic configuration of an inverter is as follows.

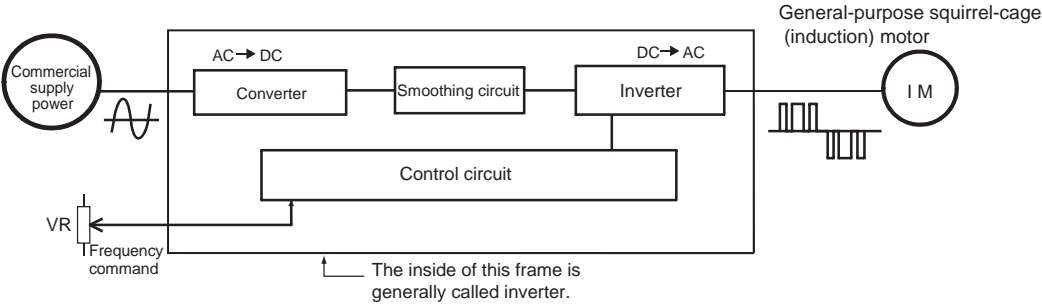

Fig. 2.1 Basic configuration of inverter

Each part of an inverter has the following function.

- Converter . . . . . Circuit to change the commercial power supply to the DC
- Smoothing circuit . . . . . Circuit to smooth the pulsation included in the DC
- Inverter . . . . . Circuit to change the DC to the AC with variable frequency
- Control circuit . . . . . Circuit to mainly control the inverter part

## 2. BASICS OF INVERTER

### 2.2 Principle of Converter Operation

The converter part consists of the following parts as Fig. 2.3 shows:

- 1) Converter
- 2) Inrush current control circuit
- 3) Smoothing circuit

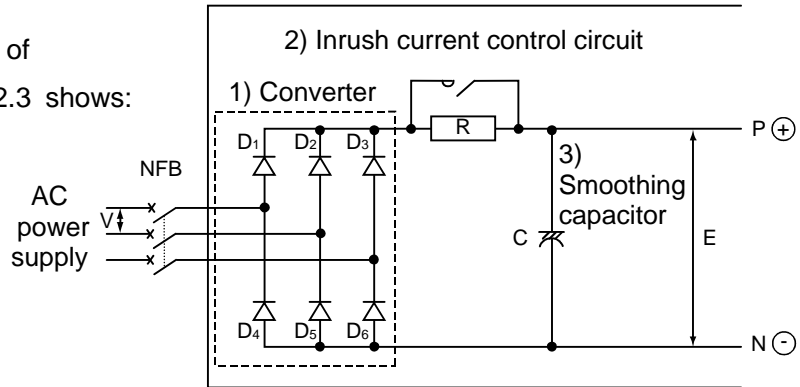

Fig. 2.3 Converter part

#### 2.2.1 Method to create DC from AC (commercial) power supply

A converter is a device to create the DC from the AC power supply. See the basic principle with the single-phase AC as the simplest example.

Fig. 2.5 shows the example of the method to convert the AC to the DC by utilizing a resistor for the load in place of a smoothing capacitor.

Diodes are used for the elements. These diodes let the current flow or not flow depending on the direction to which the voltage is applied as Fig. 2.4 shows.

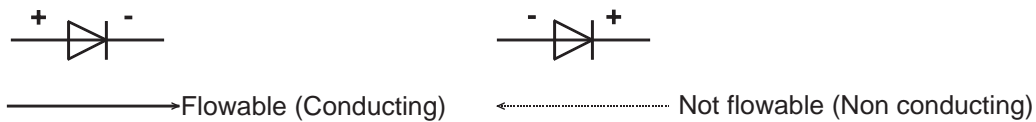

Fig. 2.4 Diode

This diode nature allows the following: When the AC voltage is applied between A and B of the circuit shown in Fig. 2.5, the voltage is always applied to the load in the same direction shown in Table 2.1.

That is to say, the AC is converted to the DC.

(To convert the AC to the DC is generally called rectification.)

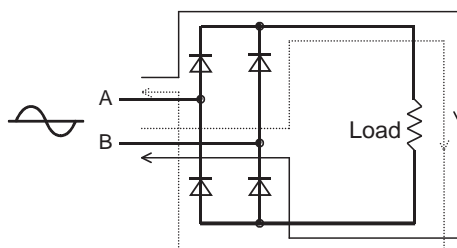

Fig. 2.5 Rectifying circuit

Table 2.1 Voltage applied to the load

AC voltage	AC flowing direction	Voltage applied to load
	Direction of solid line	
	Direction of dotted line	

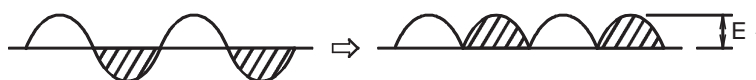

Fig. 2.6 (Continuous waveforms of the ones in Table 2.1)

## 2. BASICS OF INVERTER

For the three-phase AC input, combining six diodes to rectify all the waves of the AC power supply allows the output voltage as shown in Fig. 2.7.

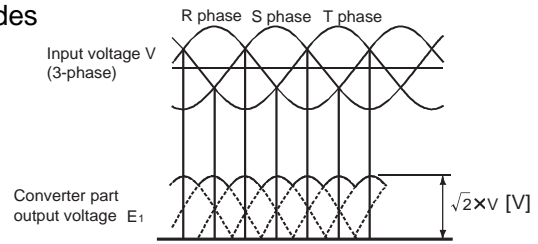
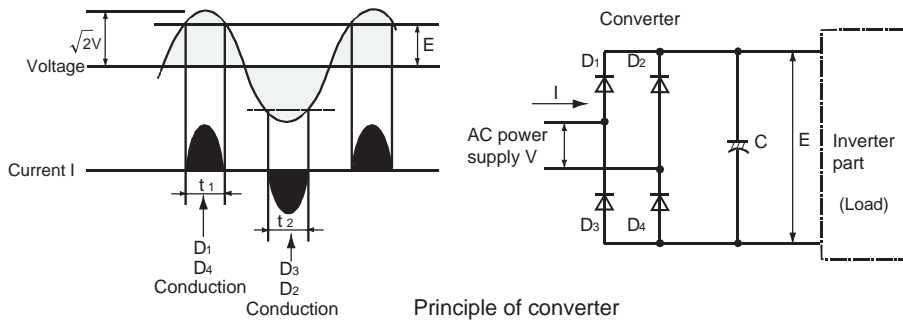

Fig. 2.7 Converter part waveform

### 2.2.2 Input current waveform when capacitor is used as load

The principle of rectification is explained with a resistor. However, a smoothing capacitor or is actually used for the load. If a smoothing capacitor is used, the input current waveforms become not sine waveforms but distorted waveforms shown in Fig. 2.8 since the AC voltage flows only when it surpasses the DC voltage.



### 2.2.3 Inrush current control circuit

The principle of rectification is explained with a resistor. However, a smoothing capacitor is actually used for the load. A capacitor has a nature to store electricity. At the moment when the voltage is applied, a large inrush current flows for charging a capacitor.

To prevent rectifying diodes from being damaged by this large inrush current, make a forcible series connection to capacitors for approximately 0.05 second from the power on to control the inrush current value. After that, short the both ends of these resistors with a magnetic switch to configure a resistor-bypassed circuit.

This circuit is called an inrush current control circuit.

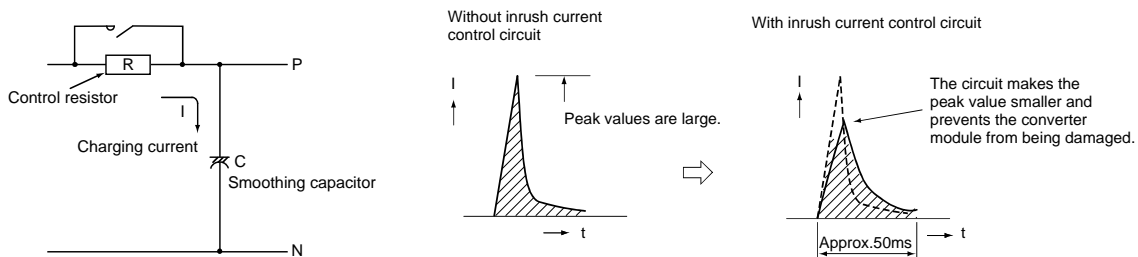

Fig. 2.9 Inrush current

# 2. BASICS OF INVERTER

---

## 2.2.4 Principle of smoothing circuit operation

The smoothing circuit creates the DC voltage  $E_2$  with little pulsation from the rectified DC voltage  $E_1$  using a smoothing capacitor.

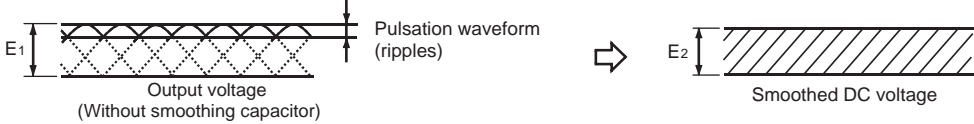

Fig. 2.10 DC smoothed waveform

# 2. BASICS OF INVERTER

## 2.3 Principle of Inverter Operation

### 2.3.1 Method to create AC from DC

An inverter is a device to create the AC from the DC power supply. See the basic principle with the single-phase DC as the simplest example.

Fig. 2.11 shows the example of the method to convert the DC to the AC by utilizing a lamp for the load in place of a motor.

When four switches, S1 to S4, are connected to the DC power supply, S1 and S4 and also S2 and S4 are respectively paired and the pairs are alternatively turned ON and OFF, the AC flows as shown in Fig 2.12.

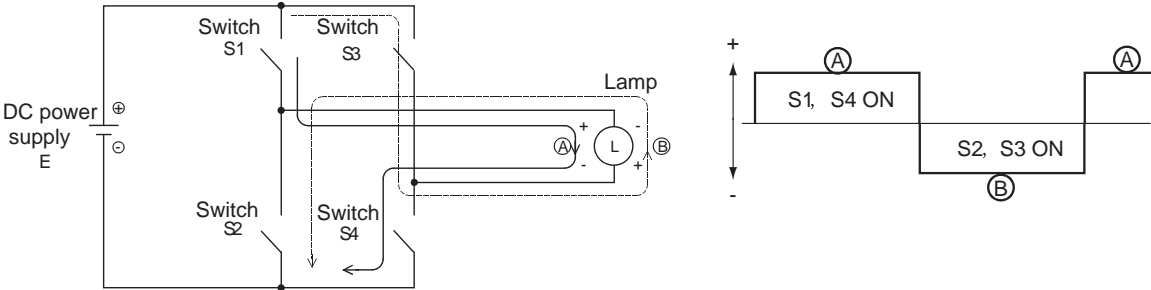

Fig. 2.11 Method to create AC

- When the switches S1 and S4 are turned ON, the current flows in the lamp in the direction of A.
- When the switches S2 and S3 are turned ON, the current flows in the lamp in the direction of B.

If these operations are repeated by a certain period, the AC is created since the direction of the current flowing in the lamp alters.

## 2. BASICS OF INVERTER

### 2.3.2 Method to change frequency

The frequency changes by changing the period to turn ON and OFF the switches S1 to S4.

For example, if the switches S1 and S4 are turned ON for 0.5 second and S2 and S3 for 0.5 second and this operation is repeated, the AC with one alternation per second, i.e., the AC with a frequency of 1[Hz] is created.

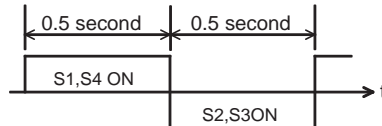

Figure 2.13 1Hz AC waveform

Generally, if S1/S4 and S2/S3 are respectively turned ON for the same period and the total time for one cycle is  $t_0$  second(s), the frequency  $f$  becomes  $f=1/t_0$  [Hz].

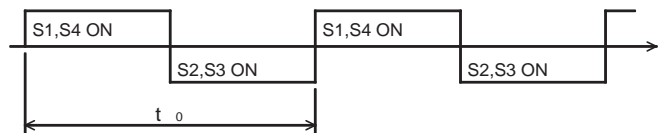

Fig. 2.14 Frequency

### 2.3.3 Method to change voltage

The voltage changes by turning ON and OFF the switches with a shorter period.

For example, if the switches S1 and S4 are turned ON for the half period, the output voltage is  $E/2$ , half of the DC voltage  $E$ .

To obtain a higher voltage, turn ON for the longer period. To obtain a lower voltage, turn ON for the shorter period.

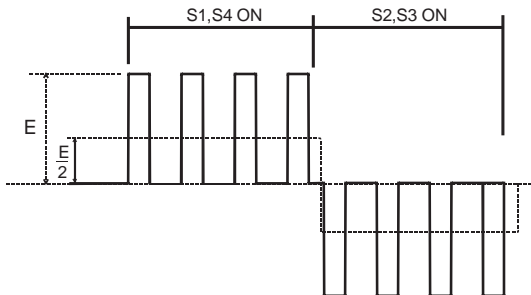

Figure 2.15 Voltage waveform of  $E/2$

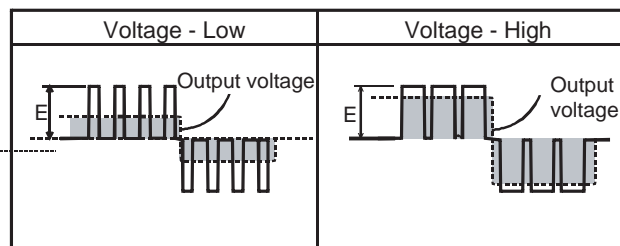

Fig. 2.16 Method to change voltage

This control method is generally used and called PWM (Pulse Width Modulation) since it controls pulse width. The frequency to be referenced to determine the time for pulse width is called a carrier frequency.

# 2. BASICS OF INVERTER

## 2.3.4 Three-phase AC

The basic circuit of the three-phase inverter and the method to create the three-phase AC are shown in Fig. 2.17 and 2.18.

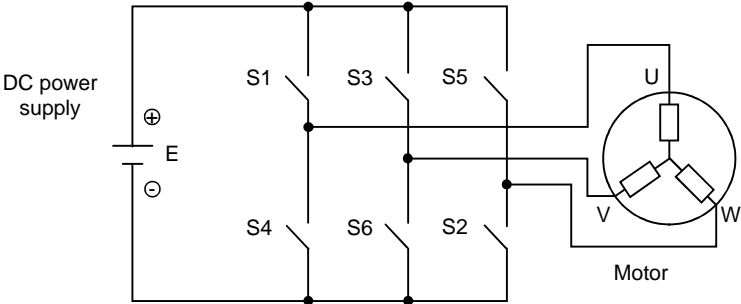

Fig 2.17 3-phase inverter basic circuit

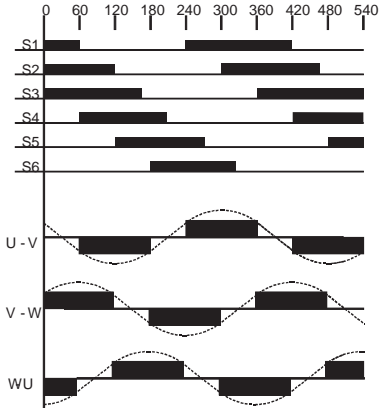

Fig. 2.18 Method to create 3-phase AC

To obtain the three-phase AC, connect the switches S1 to S6 to the circuit and simultaneously turn ON/OFF all the six switches at the timing shown in Fig. 2.18. If the order of turning ON/OFF six switches is changed, the phase order is changed between U-V, V-W and W-U and the rotation direction can be changed.

## 2.3.5 Switch element

For the switch element in the explanation above, a semiconductor called IGBT (Insulated Gate Bipolar Transistor) is used.

## 2. BASICS OF INVERTER

### 2.3.6 V/F pattern

Changing the motor speed is enabled by changing the frequency as shown in Formula 1.2. When the output frequency of an inverter is changed, the output voltage must be changed.

The output torque of a motor is expressed as the product of the magnetic flux inside the motor ( $\Phi$ ) multiplied by the current flowing in the coil ( $I$ ). (Refer to the principle of induction motor operation and the Fleming's left-hand rule.)

$$\text{Torque } T_M = K \times \Phi \times I = K \times \frac{V}{F} \times I$$

The relationship between the magnetic flux ( $\Phi$ ), the voltage applied to a motor ( $V$ ) and the frequency ( $F$ ), is expressed as  $\Phi = V/F$ . If the voltage is fixed (e.g. 200V) and only the frequency is decreased, the increased magnetic flux ( $\Phi$ ) causes the iron core to be magnetic saturation and then the increased current causes overheat and burnout.

Changing the voltage applied to a motor ( $V$ ) and the frequency ( $F$ ) with their relationship kept constant allows the motor output torque to be constant even if the motor speed is changed. For these two reasons, the output voltage must be controlled low when the inverter output frequency is low, and controlled high when the frequency is high.

This relationship between the output frequency and the output voltage is called V/F pattern.

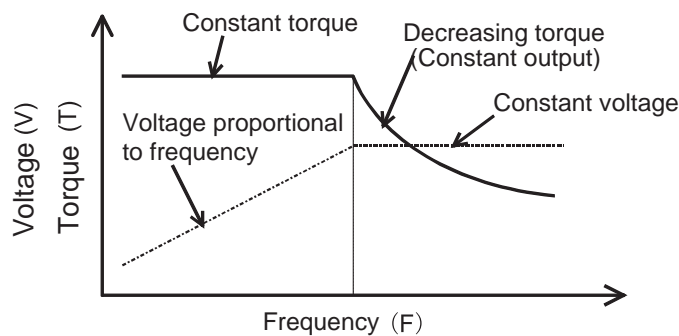

Fig. 2.19 V/F pattern and motor output torque

# 2. BASICS OF INVERTER

## 2.4 Regenerative Brake

When the motor speed surpasses the inverter output frequency (speed command from an inverter) such as the situation where an elevator goes down, a motor works as a generator and the generated electricity (energy) returns to an inverter. This status is called regeneration.

When the electricity returns to an inverter, the DC voltage of the inverter (Fig. 2.20 E1) increases. If this DC voltage surpasses a certain specified value (370VDC for 200V class), rectifying diodes or IGBT of the inverter part are damaged.

To prevent this, insert a resistor and a power capacitor for a switch element in series in the DC voltage circuit (between P and N) as shown in Fig. 2.20. This prevents the DC voltage increase by turning ON the power transistor to consume the current as heat when the DC voltage surpasses a certain specified value. See Fig. 2.21.

This resistor is called a regenerative brake resistor and this power capacitor a regenerative brake capacitor.

For a large capacity inverter that needs a large regenerative brake resistor, the power return system, which returns the regenerative energy to the power supply side, is adopted to prevent the heat influence to the ambience.

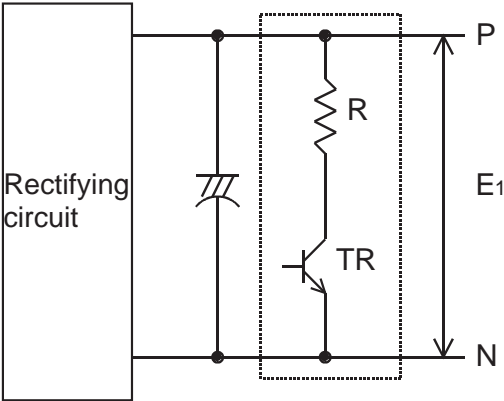

Fig. 2.20 Regenerative brake circuit

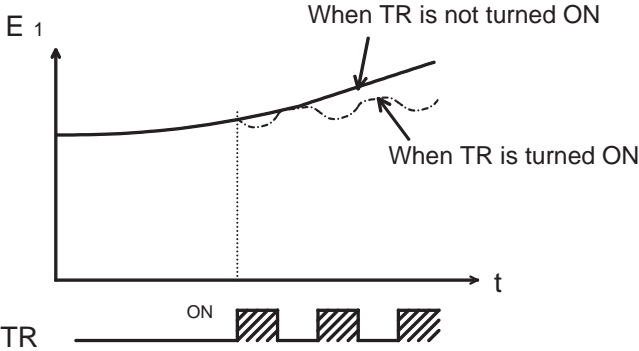

Fig. 2.21 DC voltage (between P and N)

## 2. BASICS OF INVERTER

### 2.5 Control

#### 2.5.1 Difference between general-purpose inverter and vector inverter

Although the same main circuit is used between a general-purpose inverter and a vector inverter, the following differences exist in outline according to the used control circuit or the presence/absence of an encoder, which depends on the applied motor.

Table 2.2 Difference between general-purpose inverter and vector inverter

Item	Type	General-purpose inverter	Vector inverter
Output		100W to 560kW	1.5 to 250kW
Transmission gear ratio (approx.)		1:10 to 1:20 to 200	1:1000 to 1:1500
Speed fluctuation percentage (%)		3 to 4% (1% or less for advanced magnetic flux vector control and real sensorless vector control)	0.03% (Load fluctuation between 0 to 100%)
Frequency response		Low 1 to 19Hz	30 to 125Hz
Guideline of start/stop frequency		Approx. 15 times/min.	Approx. 100 times/min.
Positioning accuracy		Approx. 1 to 5mm	Approx. 10μm to 100μm
Torque characteristics		Constant torque (Torque decreased for a base frequency or more)	Constant torque (0 to rated speed)
Applied motor		General-purpose motor (Induction motor)	Dedicated motor (Motor with encoder)
Remarks (Mitsubishi inverter main series)		Main series FR-E500 FR-A024 FR-A700 FR-A500 FR-F700 FR-F500 FR-S500	Main series FR-V500

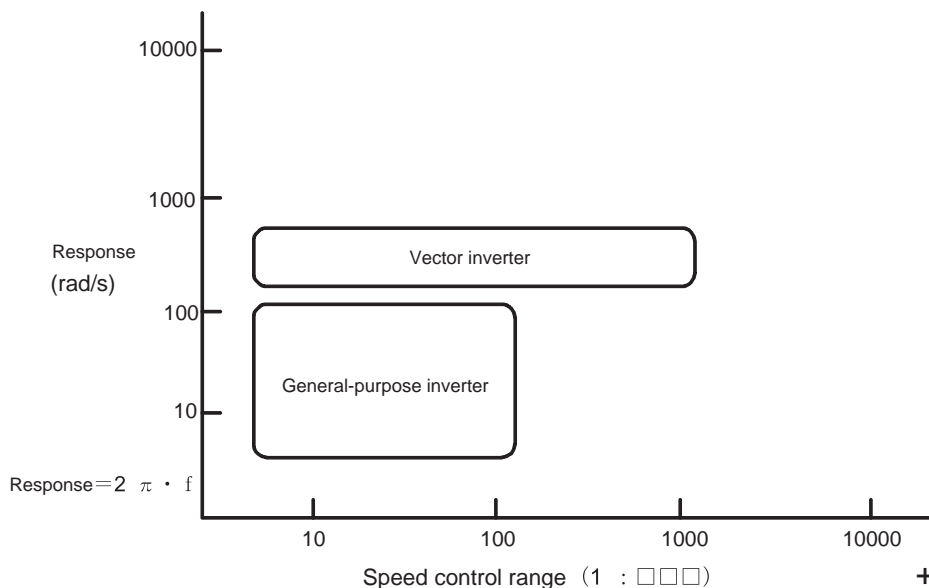

## 2. BASICS OF INVERTER

---

### 2.5.2 Control method

There are three methods to control an inverter: speed control to control the motor speed mainly with the analog voltage, position control to control the motor rotation amount with simple limit switches, a high accuracy encoder or others and torque control to control the current flowing into a motor for a constant torque value.

The detailed account is given below.

#### (1) Speed control

##### 1) Open loop control

This control method does not feed back the speed as general-purpose inverters adopt it.

The command system is analog voltage command, which is used for many applications such as the conveyor speed control, fan wind amount control, pump flow amount control, etc. The slip at the rated torque depends on the characteristics of a motor. Approximately 3 to 5% speed fluctuation occurs.

The recent inverters are resistant to temperature drifts for the digital control that allows setting the speed data internally and for the digital command (pulse train, parallel data and communication). In addition, the inverters of advanced magnetic flux vector control or real sensorless vector control are available with the speed fluctuation of 1% or less.

This speed control method is used for almost all general-purpose inverters.

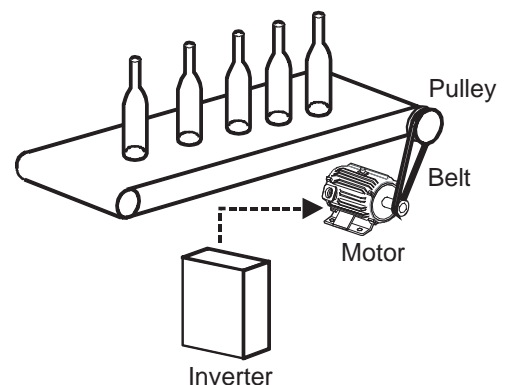

## 2. BASICS OF INVERTER

### 2) Closed loop control

To ensure the change of the motor speed, an encoder must be installed to detect the actual speed and feed it back to a control circuit. This method is called a closed loop control.

To detect the speed, TG (tachogenerator), encoder, etc. are used. Encoders are mostly used these days. For the closed loop control too, the analog voltage or current is used for the speed command. However, inputting pulse trains or using the digital input allows a high accuracy speed control for the draw operation or continuous speed control operation.

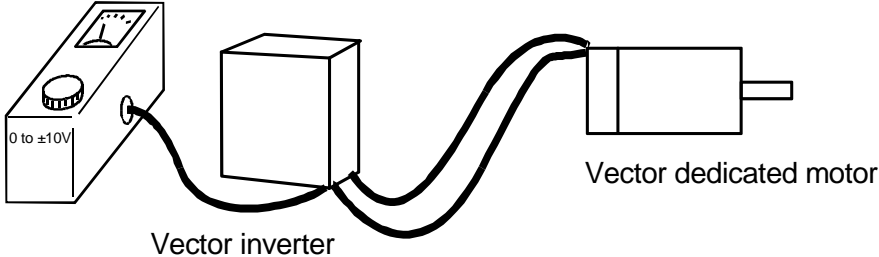

### (2) Position control

The position control allows not only the control of the motor speed but also the control to stop at the target stop position. There are many control methods from the simple method to stop at the target position by taking the external sensor signals into the stop signal, to the method to perform a high accuracy positioning with an encoder installed to the motor, and to the advanced method to perform a positioning to always-changing target stop positions by tracking or synchronization.

### 1) Open loop control

This control is used for the applications that do not need high accuracy for stop.

The motor decelerates to stop with signals from the limit switches installed before the target stop position for deceleration command. This is the simplest and most reasonable method although the fluctuation of the deceleration points affects the stop positions in accuracy.

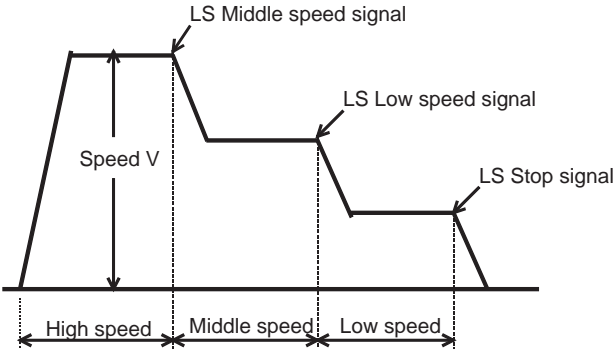

## 2. BASICS OF INVERTER

### 2) Semi-closed loop control

An encoder installed to a motor performs feedback. For example, a vector dedicated motor operates for the command input to a vector inverter when the feedback is looped back. At this moment, the speed command is calculated to zero the difference between the input command amount and the feedback amount for rotating the motor.

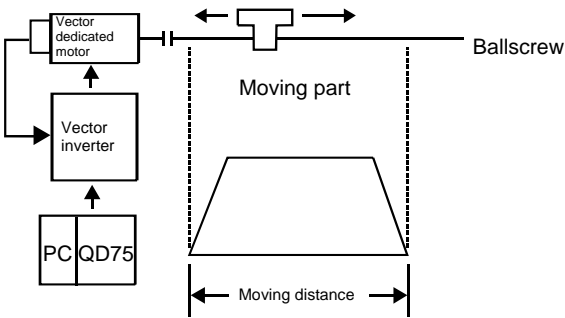

### 3) Full-closed loop control

This control is performed by the feedback from a linear scale or encoder installed to the machine side.

Installing a linear scale or encoder to the final machine edge allows a high accuracy positioning free from backlashes or mechanical system errors. Instead, it is required to heighten the machine rigidity. This control is sometimes used for machine tools part of which requires a high accuracy control.

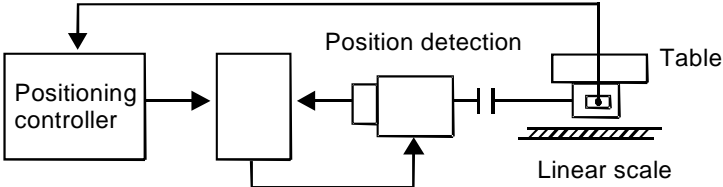

### (3) Torque control

The torque control indicates controlling the torque (current) output from a motor and it must be distinguished from the torque limit. However, both of them are available depending on the application. The most appropriate method should be selected. The torque control performs a control of the torque (current) against the torque command value. Therefore, the speed automatically increases when the load torque is smaller and decreases when larger. If the load torque is equal to the torque command value, both torque values are balanced and the speed becomes zero. That is to say, the motor stops. In short, the same principle as a tug of war is working.

On the other hand, the torque limit is used when a machine can be damaged for unnecessary torque to control the position or speed, when the stop is performed by pressing the machine, or when the mechanical lock is performed.

For the torque control, the current flowing in the motor must be detected and controlled. Therefore, the torque control can be supported by the vector inverter or the inverter of real sensorless vector control, which perform current detection.

# 2. BASICS OF INVERTER

## 1) Open loop control

This control is used for the applications that do not require high torque accuracy such as an unwinding or winding axis. The analog command is generally used for the torque command.

For this control, it must be taken into account that the torque accuracy (temperature drift) varies depending on the temperature and machines have losses.

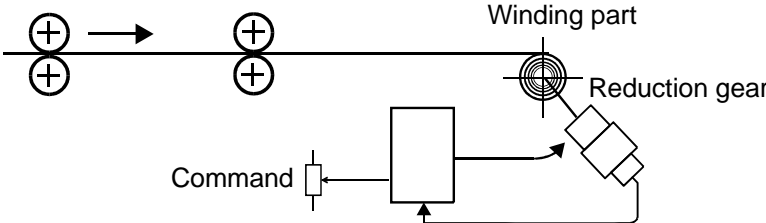

## 2) Closed loop control

This control is used for the applications that require high tension accuracy such as an unwinding or winding axis (for paper, film, etc.).

This control feeds back the tension applied to the actual products to a tension control device.

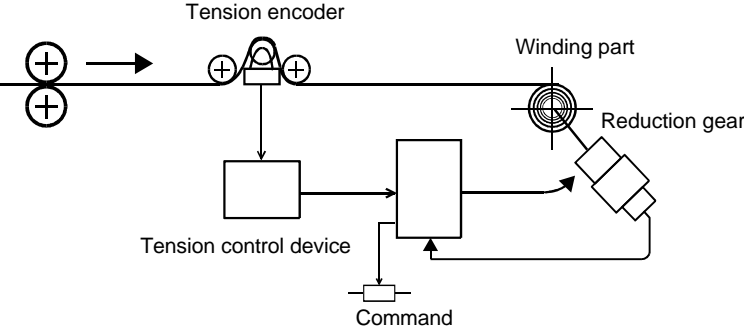

### 3. DEMONSTRATION MACHINE OPERATION

#### 3.1 Inverter (FR-A720)

##### 3.1.1 Representative connection wiring diagram

(1) The following shows a wiring connection example as a minimum requirement to operate the inverter FR-A720.

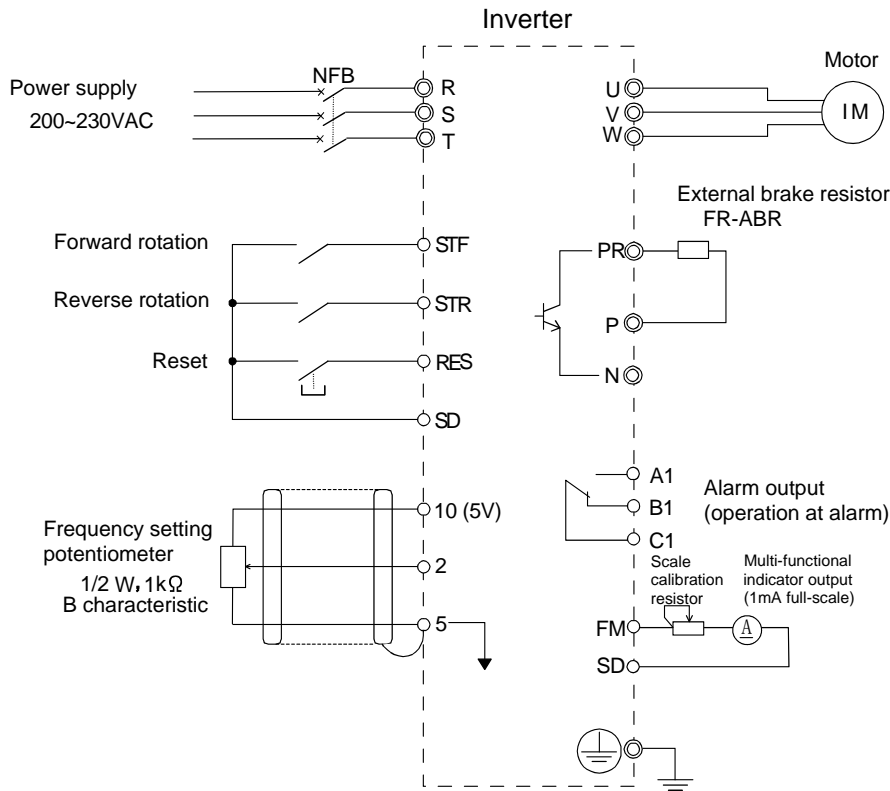

### 3. DEMONSTRATION MACHINE OPERATION

#### (2) Connection diagram of school demonstration machine

The following shows the connection diagram of the demonstration machine to be used in this school.

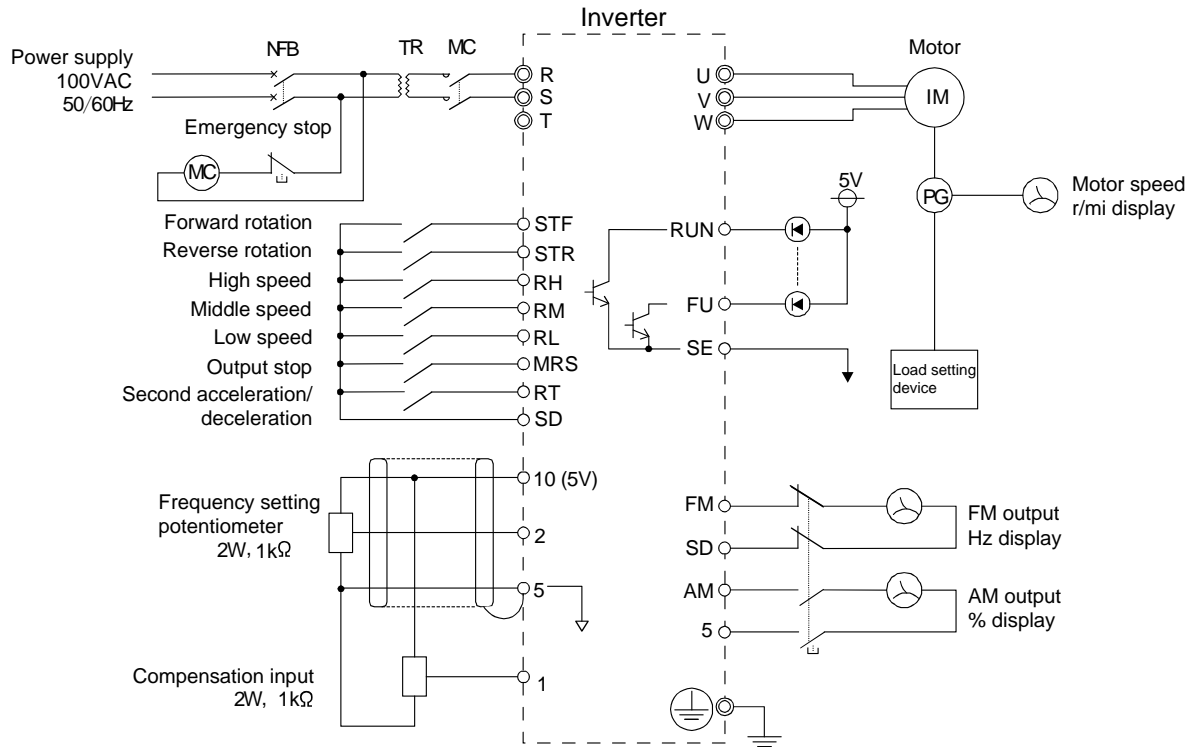

### 3. DEMONSTRATION MACHINE OPERATION

#### 3.1.2 Main parameter settings and setting method

##### (1) Parameters

An inverter has various settings for adjusting it to the operation conditions and machine specifications, which are called parameters.

The following shows the minimum required parameters to operate an inverter.

Parameter No.	Name	Description	Factory default value (7.5kW or less)
0	Manual torque boost	Heightens the motor torque at a start.	6/4/3 %
1	Maximum frequency	Sets the maximum value of the inverter output frequency.	120 Hz
2	Minimum frequency	Sets the minimum value of the inverter output frequency.	0 Hz
3	Base frequency	Sets the base frequency of the motor to be used.	60 Hz
4	3 speed setting (high speed)	Sets the frequency to operate the motor at high speed.	60 Hz
5	3 speed setting (middle speed)	Sets the frequency to operate the motor at middle speed.	30 Hz
6	3 speed setting (low speed)	Sets the frequency to operate the motor at low speed.	10 Hz
7	Acceleration time	Sets the time taken to accelerate the motor up to the reference frequency.	5 sec.
8	Deceleration time	Sets the time taken to decelerate the motor from the reference frequency to 0.	5 sec.
9	Electronic thermal O/L relay	Sets the permissible motor current value to protect the motor.	Rated current

The inverter can be operated with the factory default values for the above parameters. Set only the necessary parameters to the optimum value in accordance with the operation specifications of the machine.

(Note) Pr. is an abbreviation of Parameter.

##### 1) Pr 0 Manual torque boost

This parameter makes output voltage compensation in the low speed area under the V/F control and improves the decrease of the motor torque at low speed.

It is used with the increased setting value when the distance to the motor is long or the motor torque in the low speed area is insufficient. However, if the setting value is increased too much, an overcurrent trip occurs.

The factory default values differ depending on the inverter capacity.

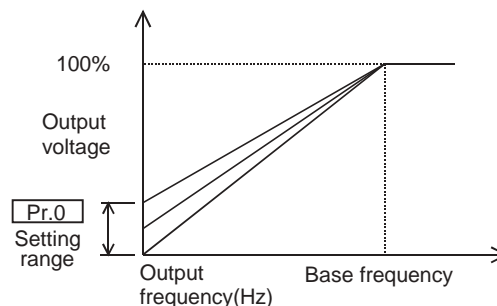

### 3. DEMONSTRATION MACHINE OPERATION

#### 2) Pr1 Maximum frequency, Pr2 Minimum frequency

These parameters determine the upper and lower limits of the inverter output frequency.

The inverter clamps to prevent the frequency from exceeding the upper limit and dropping below the lower limit.

Factory default value Pr1: 120Hz

Pr2: 0Hz

Inverters are normally used with the initial values.

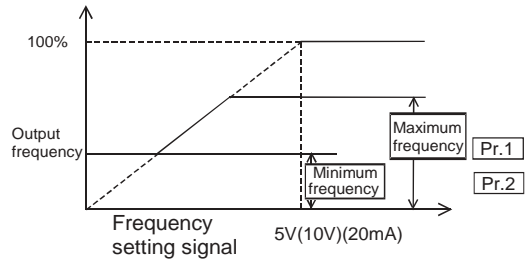

#### 3) Pr3 Base frequency

This parameter is used to adjust the reference frequency of the inverter to the rating of the motor.

Factory default value Pr3: 60Hz

When operating a standard three-phase motor, normally set this parameter to 60Hz.

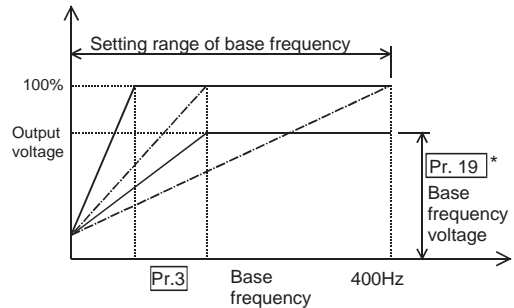

\* If Pr.19 is set to 9999 (factory default), the maximum output voltage will be the same as the power supply voltage.

#### 4) Pr4, Pr5, Pr6 Multi-speed settings

These parameters determine a frequency at each operation speed when the frequency at the operation with external signals is switched by three speed levels of high, middle and low.

Factory default value Pr4: 60Hz (High speed)

Pr5: 30Hz (Middle speed)

Pr6: 10Hz (Low speed)

Set these parameters depending on the specification of the machine operation.

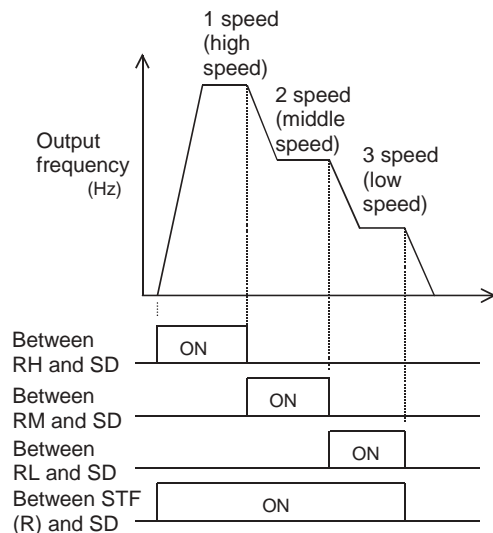

### 3. DEMONSTRATION MACHINE OPERATION

---

#### 5) Pr7 Acceleration time, Pr8 Deceleration time

These parameters determine the acceleration time and deceleration time when the motor is started and stopped.

Factory default value Pr7: 5 seconds

Pr8: 5 seconds

Set these parameters depending on the specification of the machine operation.

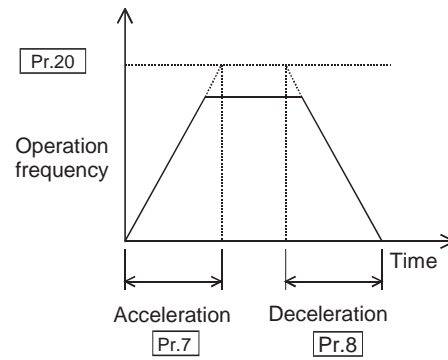

#### 6) Pr9 Electronic thermal

This parameter sets the electronic thermal for the motor protection.

Set the current value to protect the motor.

Normally set the rated current value of the connected motor at 50Hz.

### 3. DEMONSTRATION MACHINE OPERATION

#### (2) Parameter setting operation method

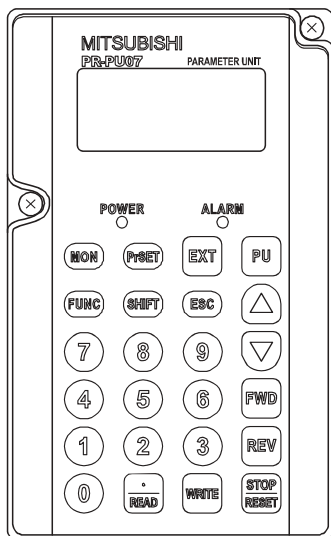

Parameter settings are performed by the operation of the parameter unit (PU) at an operation stop.

- 1) Press the **PU** key and select the PU operation mode.
- 2) Press the **PrSET** key to switch to the setting mode.

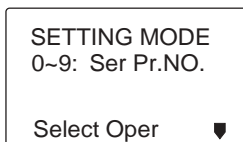

The display on the left appears.

- 3) Set the predetermined parameter number with the numeric keys.

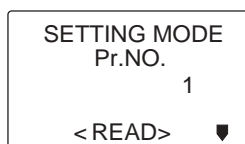

When setting the numerical key **1**.

- 4) Press the **READ** key to read the parameter settings of the selected parameter number.

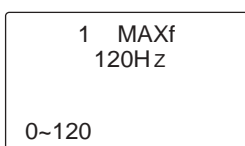

The current setting value is displayed.

- 5) Set the predetermined parameter value with the numeric keys.

When setting **60** with the numerical keys

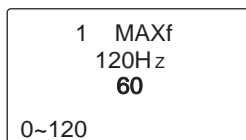

- 6) Press the **WRITE** key to write the set parameter.

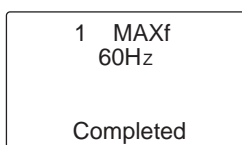

The parameter setting value is changed from 120 to 60 by the above operation.

### 3. DEMONSTRATION MACHINE OPERATION

---

#### 3.1.3 Operating method

There are two types of inverter operating method, parameter unit operation (PU operation) and external operation.

For the PU operation, an inverter can be easily operated only by the parameter unit operation when a machine is test-operated at a startup of the machine.

For the external operation, an inverter is operated with the control signal from outside the inverter according to the specification of the machine operation, and normally operated with a signal from a machine control panel or a PLC.

#### (1) Parameter unit operation (PU operation)

Operate an inverter with the key operation of the parameter unit.

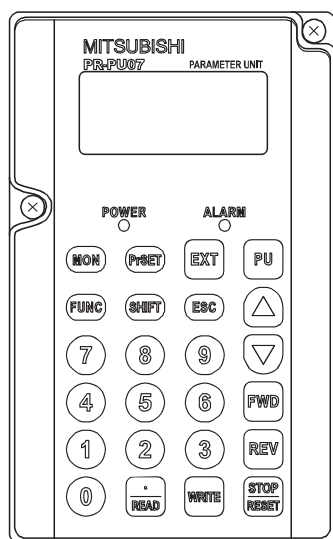

1) Press the **PU** key and select the PU operation.

2) Press the keys of **6,0** and **WRITE** in order and adjust the parameter unit display to the frequency to be operated.

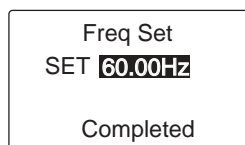

3) Press the **FWD** or **REV** key to start the motor.

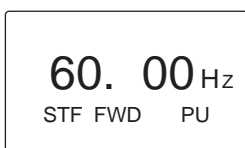

#### 4) When changing the operation frequency

Press **PU**, enter the operation frequency directly with the numeric keys, and press **WRITE**.

#### 5) Press the **STOP/RESET** key to stop the operation.

Confirm the change of the motor speed for the frequency setting by performing the PU operation above repeatedly.

### 3. DEMONSTRATION MACHINE OPERATION

---

#### (2) External operation

Operate an inverter with the operation switch of a demonstration machine.

1) Select the external operation with the parameter unit.



2) Set the frequency setting potentiometer to the predetermined frequency (60Hz) on the operation panel of a demonstration machine.

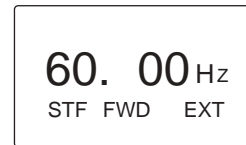

3) When the operation panel switch "正転 (Forward)" is turned ON, the motor starts to rotate in the forward direction.

When "正転 (Forward)" is turned OFF, the rotation stops.

4) Change the frequency as desired with operating the frequency setting potentiometer on the operation panel during the rotation and check that the motor rotation is freely changed by the inverter control.

5) The motor is rotated in the reverse direction with the operation panel switch "逆転 (Reverse)". Check the movement of the motor with the changed frequency (rotation) as described above.

6) By turning ON/OFF the operation switches, "高速 (High speed)", "中速 (Middle speed)" and "低速 (Low speed)", the multi-speed operation is performed at the frequency of the inverter parameter setting.

The frequency of the frequency setting potentiometer gives priority to that of the multi-speed selection.

7) Change the acceleration/deceleration time setting in parameter Pr7 and 8 to check the movement of the acceleration and deceleration.

# 4. PRECAUTIONS

## 4.1 Environment

### 4.1.1 Power supply harmonics

#### (1) Harmonics and its effects

##### (a) What is harmonics?

The sine wave of a commercial power supply provided from a power company is called a fundamental wave. The sine wave which has an integral multiple frequency of this fundamental wave is called harmonics. The power supply waveform becomes a distorted waveform when the harmonics are added to the fundamental wave. (Refer to the following figure.)

When a rectifying circuit and a smoothing circuit with a capacitor are provided in the circuit of equipment, the input current waveform becomes distorted and the harmonics are generated.

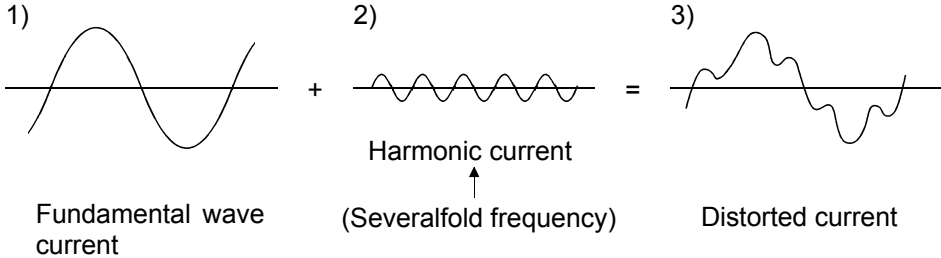

##### (b) Principle of harmonic generation

The AC input current supplied from the inverter power supply side is rectified with a bridge rectifier, smoothed with a capacitor, converted to the DC and then supplied to the inverter part. To charge this smoothing capacitor, the AC input current becomes a distorted waveform with the harmonics.

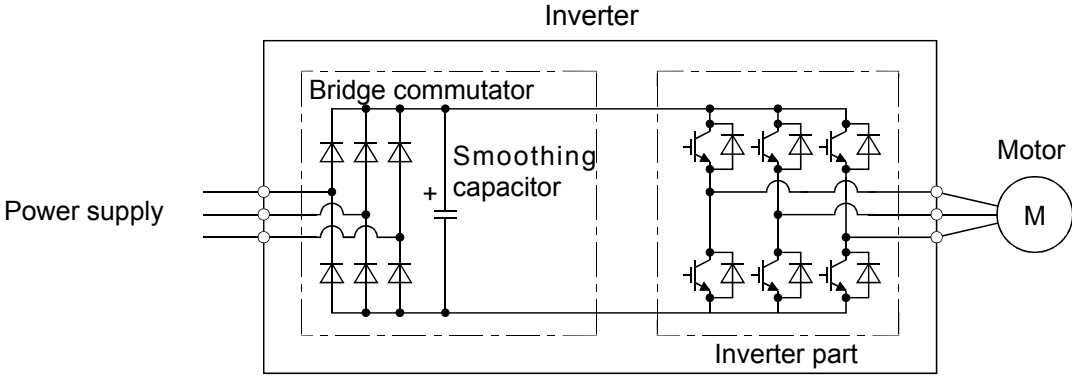

## 4. PRECAUTIONS

### (c) Effects of harmonics

The harmonics generated by equipment may give the following effects to the facilities or other equipments through cables.

- (1) Unusual noise, vibration, burnout, etc. caused by the influx of the harmonic current to equipments
- (2) Malfunction, etc. caused by the harmonic voltage applied to equipments.

### (2) Target models

Input power	Capacity of target motor	Measures
1-phase 100V	Full capacity	Make a judgment based on “Harmonic suppression guideline for customers who receive high voltage or special high voltage” issued by the Japanese Ministry of Economy, Trade and Industry (formerly Ministry of International Trade and Industry) in September 1994 and take measures if necessary. For calculation method of power supply harmonics, refer to materials below. Reference material (The Japan Electrical Manufacturers' Association (JEMA) ) · “Harmonic suppression related measure brochure” · “Calculation method of harmonic current of the general-purpose inverter used by specific consumers” · JEM-TR201 (revised in December, 2003)
1-phase 200V		
3-phase 200V		
3-phase 400V		

### (3) Harmonic current suppression measures

As a harmonic current suppression measure for inverters, connect a power factor improving reactor as shown in the figures below.

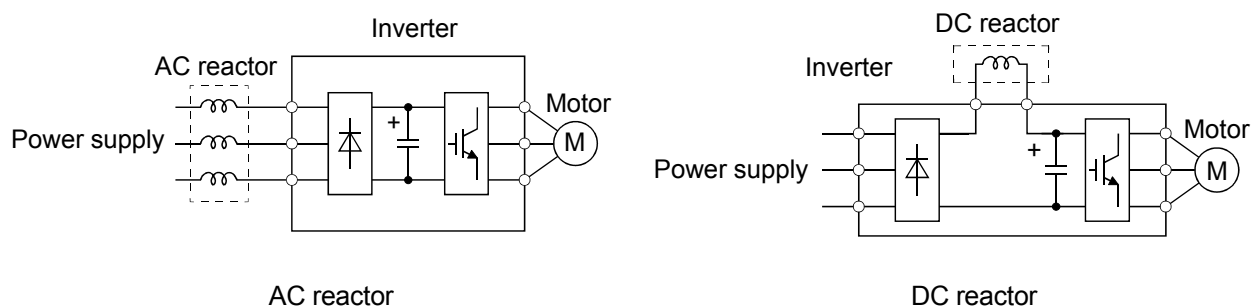

Even for consumers to whom the guideline is not applied, it is recommended to connect a power factor improving reactor in the same manner to avoid possible troubles due to the harmonic current.

## 4. PRECAUTIONS

---

### 4.1.2 Leakage current

In I/O cables and motors of an inverter, the stray capacitances  $C$  are present. High-speed switching in the main circuit lets the leakage current flow from the stray capacitances  $C$  to the ground. The amount of the leakage current differs depending on the stray capacitances  $C$ , carrier frequency, etc. Accordingly, the low-noise type inverters generate the larger leakage current.

#### (1) Effects of leakage current

- 1) The leakage breaker or leakage relay may operate unintentionally due to the leakage current between grounds.

The leakage current includes many high frequency components that have a relatively small influence on human body.

- 2) The external thermal relay may operate unintentionally due to the leakage current between cables.

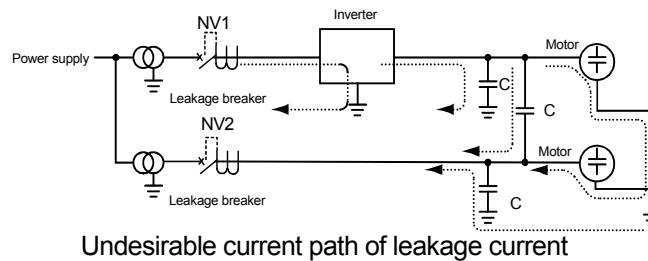

#### Measures

- Decrease the carrier frequency of the inverter.  
(Note that doing so causes a louder motor noise.)
- Install leakage breakers designed for the harmonics and surge suppression to the inverter's own system and other system.  
(Switching speed does not have to be decreased.)
- Decrease the stray capacitances between grounds.  
(Use cables or wires that are insulated with materials of low relative permittivity.)

#### (2) Selecting a leakage breaker

Select a leakage breaker designed for the harmonics and surge suppression.

## 4. PRECAUTIONS

### 4.1.3 Noise

Most inverters employ the PWM control method (refer to Section 2.3.3).

Inverters generate the AC by switching the main circuit elements.

This principle of operation can be referred to as the noise source.

(Note) The noise mentioned here and the harmonics mentioned previously are sometimes thought of as interchangeable. This is because both of them affect other electrical equipment. Generally, however, the harmonics commonly refer to waves with a frequency between 40th and 50th (2.4 to 3kHz) whereas noise commonly refers to waves with a frequency of tens of kilohertz or higher.

#### (1) Noise types and propagation paths

Noises generated from an inverter are broadly classified into the following types: those radiated from the cables connected to the inverter and inverter main circuits (I/O), those electromagnetically and electrostatically induced from the signal cables of the peripheral devices close to the main circuit power supply, and those transmitted through the power supply cables.

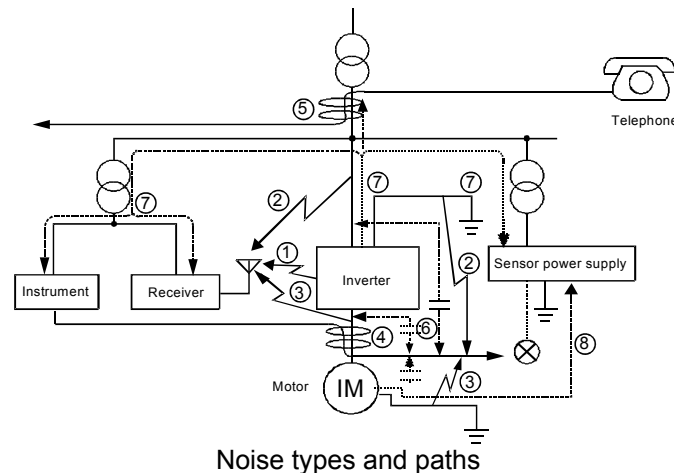

#### (a). Air-propagated noise (Paths 1) to 3))

This noise is generated by an inverter and radiated to the air. The paths of this noise can be classified into the following three types.

- 1) Radiated from inverter
- 2) Radiated from input cables
- 3) Radiated from motor connection cables

#### (b). Electromagnetic induction noise (Paths 4) and 5))

This noise is generated and transmitted when power cables or signal cables of peripheral devices cross a magnetic field generated by the current that is input to or output from an inverter.

#### (c). Electrostatic induction noise (Path 6))

This noise is combined capacitances that are generated by the principle of electrostatic induction and transmitted through I/O cables of an inverter.

## 4. PRECAUTIONS

### (d). Cable-propagated noise (Path 7))

This noise is a high-frequency noise that is generated inside the inverter and transmitted to peripheral devices through cables on the power supply side.

These noises tend to gain the lower noise level as the noise frequency band is higher. Generally, the noise level is low enough not to be problematic in frequencies of 30MHz or higher.

### (2) Measures against noise

Although there are many noise propagation paths, noise sources can broadly be classified into the following three types:

- 1) Propagation, induction or radiation from an input power supply cable
- 2) Induction or radiation from motor connection cables
- 3) Radiation from an inverter

#### (a) Reducing noises transmitted to the power supply cable

An effective method is to install a filter between an inverter and the power supply cable.

- 1) Radio noise filter FR-BIF (200V class), FR-BIF-H (400Vclass)
- 2) Line noise filter FR-BSF01, FR-BLF
- 3) Combination of FR-BIF(-H) and FR-BLF/FR-BSF01
- 4) Noise-cutting transformer

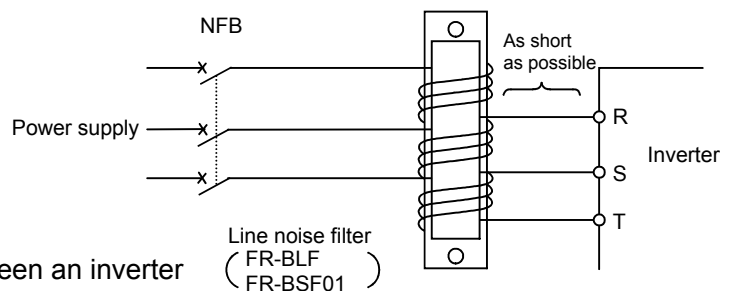

#### (b) Reducing noises radiated from cables between an inverter and motors

Installing the FR-BLF or FR-BSF01 line noise filter to the output side of the inverter is a method to reduce the radiated noises. Generally, however, a metal pipe is used.

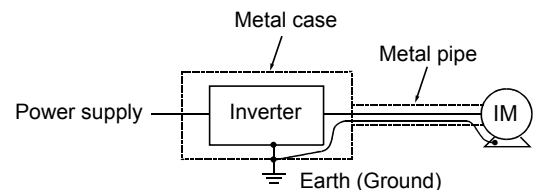

#### (c) Reducing noises radiated from an inverter

Noises generated from this inverter are relatively small and less problematic. However, when an inverter is installed close to devices easily affected by noises, it is required to house the inverter in a metal case and install a noise filter on the power supply side. Also, for the output side, connect a metal pipe to the case.

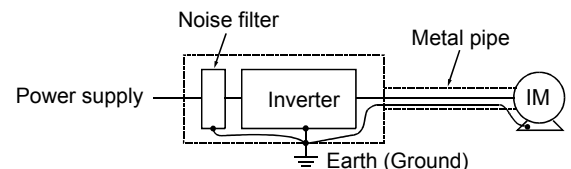

#### Good to know

For 55kW or less of the FREQROL-A700 and F700 series, functions equivalent to the line noise filter and radio noise filter on the input side are provided.

## 4. PRECAUTIONS

---

### 4.1.4 Compliance to standards

Inverters are compliant to non-Japanese standards that are UL standard, cUL standard and EN (European Norm).

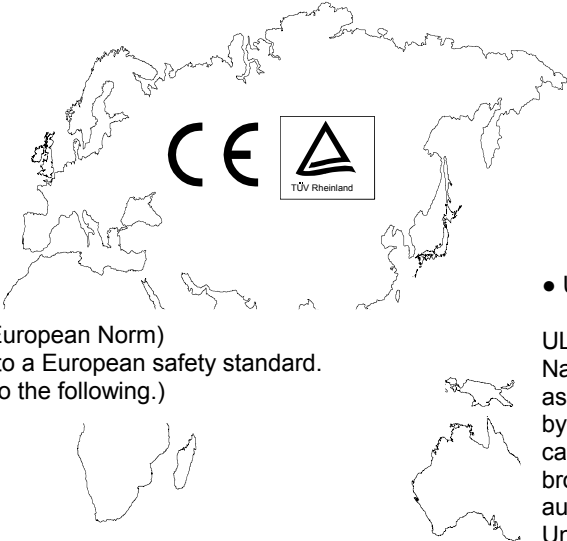
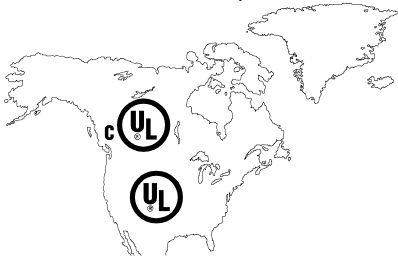
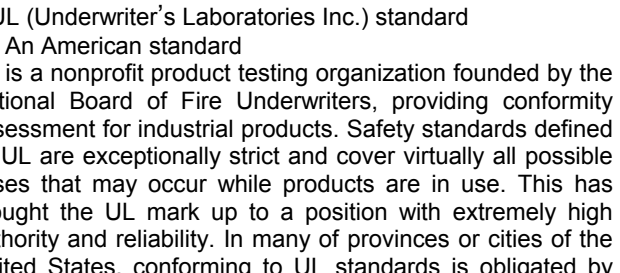
- EN (European Norm)  
Refers to a European safety standard.  
(Refer to the following.)  

- cUL standard  
Refers to an American standard equivalent to CSA, a Canadian standard. Products compliant to cUL standard are also compliant to CSA standard.  

- UL (Underwriter's Laboratories Inc.) standard  
: An American standard  
UL is a nonprofit product testing organization founded by the National Board of Fire Underwriters, providing conformity assessment for industrial products. Safety standards defined by UL are exceptionally strict and cover virtually all possible cases that may occur while products are in use. This has brought the UL mark up to a position with extremely high authority and reliability. In many of provinces or cities of the United States, conforming to UL standards is obligated by state laws or ordinances.  

In the process of uniting Europe, EC (the European Commission) has been making an effort to establish balanced rules that are adopted beyond countries. The intention of these rules is to realize borderless and free exchange of people, goods and services as well as free sales of goods and services. As one of these rules, EC proposed the integrated standard for technologies involving human health and safety as a form of 13 directives. The nations are currently seeking legislation based on these directives. The rules state that the-directive-targeted products must have the CE mark, which is the indication that approves exportation, free exchange and sales of the product across the Europe area. The directives involving driving products are the following three:

- (1) Directive of Machinery This directive defines safety requirements for machinery. This directive basically requires that the health and safety of both man and animals and the safety of any objects should not be endangered under the condition that proper installation, maintenance and operation are conducted.

# 4. PRECAUTIONS

---

(2) EMC Directive

This directive defines electromagnetic compatibility. This directive basically requires that an inverter should not adversely affect other equipment by electromagnetic interferences and that an inverter should have sufficient noise resistance. (EMC directive compliant filters are prepared for the requirement.)

(3) Low Voltage Directive

This directive defines safety requirements for electrical equipment. This directive basically requires that the health and safety of both man and animals and the safety of any objects should not be endangered under the condition that proper installation, maintenance and operation are conducted.

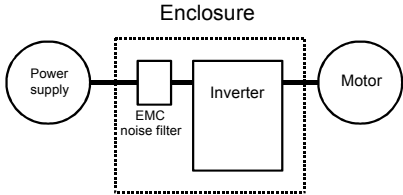

# 4. PRECAUTIONS

---

## 4.2 Capacity Selection

### 4.2.1 Before selecting a capacity

Before selecting a capacity, it is necessary to generally know the operating environment, the target work and if the performance and functions are satisfied. Based on this information, select a motor, and an inverter or a vector inverter to control the motor. In terms of the hardware basics, the same concept can be applied to both inverters and vector inverters.

### 4.2.2 Selecting a motor according to driving force

The formula to obtain the driving force differs depending on horizontal or vertical (up-down) movement.

#### (1) Horizontal movement

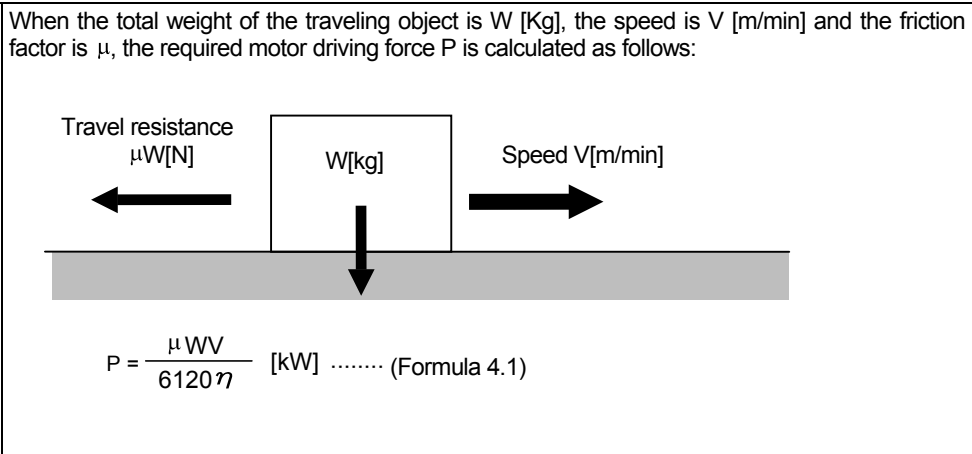

#### Example 1

Under the condition that the mass is 80kg, the object speed is 80m/min, the friction resistance is 0.2 and the machine efficiency is 0.8, the driving force required for the motor is:

$$P = 80 \times 0.2 \times 80 / (6120 \times 0.8) = 0.26 \text{ kW}$$

## 4. PRECAUTIONS

---

### (2) Vertical movement

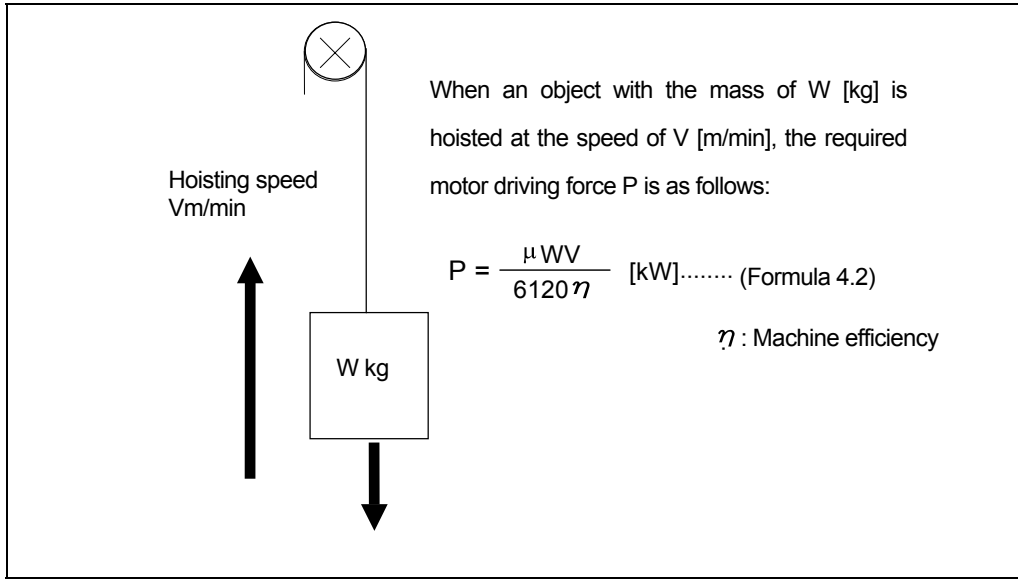

#### Example 2

Under the condition that the mass is 50kg, the object speed is 60m/min and the machine efficiency is 0.8, the driving force required for hoisting is:

$$P = 50 \times 60 / (6120 \times 0.8) \\ = 0.61 \text{ kW}$$

### 4.2.3 Selecting the most suitable capacity in consideration of acceleration/deceleration

Vector inverters frequently perform acceleration/deceleration. Select the most suitable capacity in accordance with the movement of the machine.

To make this selection, check data on the machine side and the operation pattern beforehand. The following shows the steps of the selection.

(1) Find the load torque of the machine.

Load torque: Force that is required to move a load.

(2) Find the inertia moment (J) of the machine.

J: Value that indicates how much difficult to move or stop an object.

It can be compared to a load on the back of a truck.

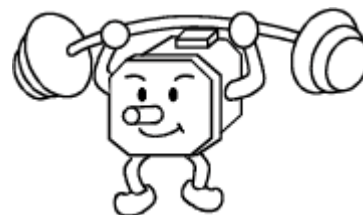

## 4. PRECAUTIONS

(3) Find the operation pattern of the machine.

Operation pattern: One cycle of machine operation status derived from travel time and stop time. The gray area below indicates travel amount.

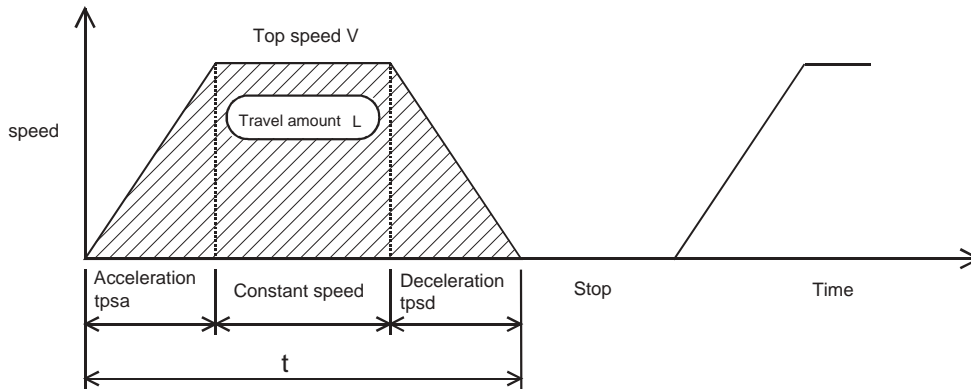

When the top speed is  $V$  [mm/s], travel time is  $t$  [s], acceleration and deceleration times are respectively  $tpsa$  [s] and  $tpsd$  [s], travel amount is  $L$  [mm], and  $tpsa=tpsd$ , their relation is as shown in the following formula.

$$L = V \text{ [mm/s]} \times (t - tpsa) \text{ [mm]} \dots\dots\dots \text{(Formula 4.3)}$$

(4) Tentatively select a motor.

Tentative selection: Selecting a motor that can be the most suitable in reference to the load torque and  $J$ .

- 1) The rated torque of the motor must be larger than the load torque.

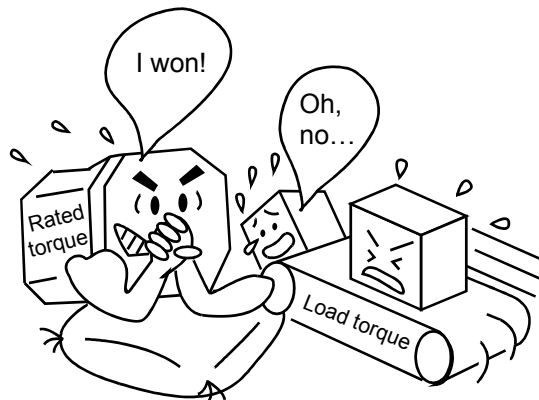

## 4. PRECAUTIONS

(5) Calculate a torque with the motor tentatively selected.

Torque calculation: Calculation that is basically made in accordance with the following four conditions. (Most typical pattern)

1) Torque required for accelerating to a constant speed from the start

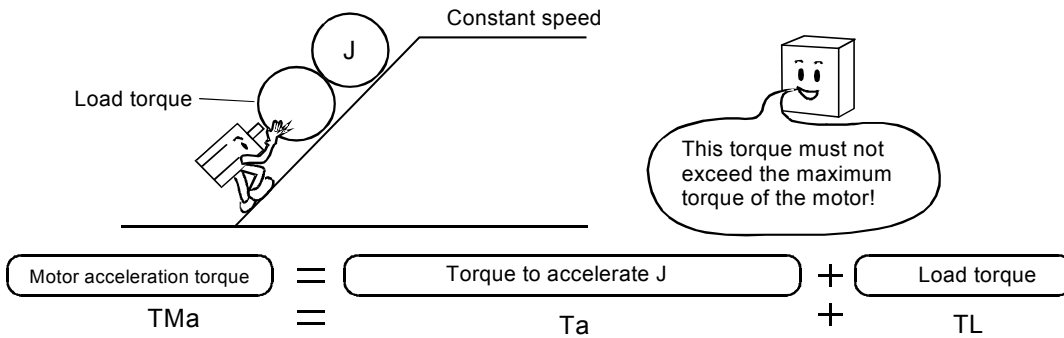

2) Torque required for keeping the load moving at a constant speed

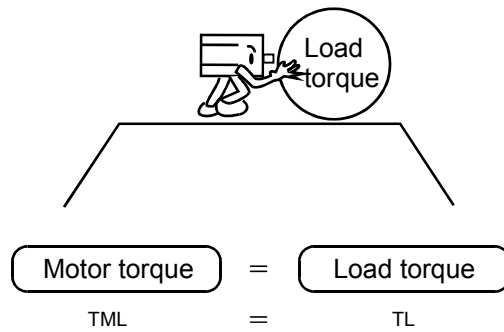

3) Torque required for decelerating to the stop

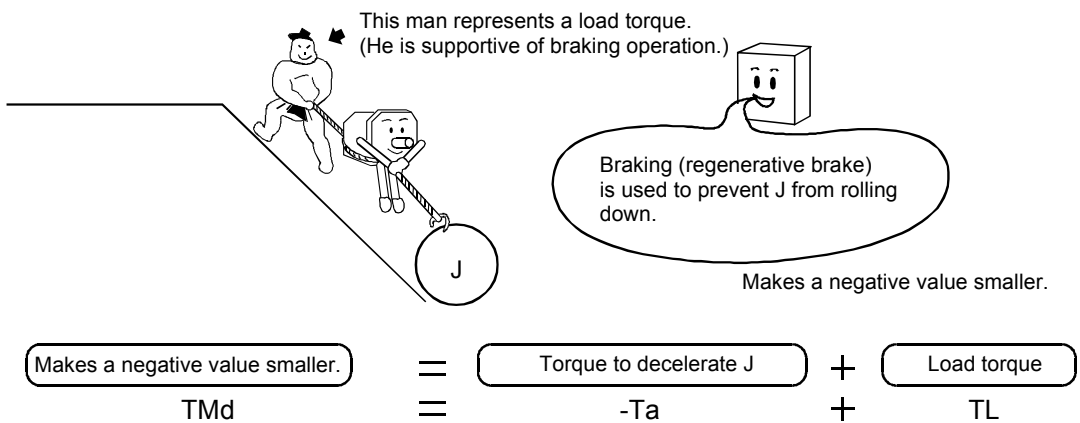

# 4. PRECAUTIONS

---

4) Judge the heat availability of the motor.

Using the motor current values obtained in 1) to 3) and the period of one cycle, obtain the equivalent current with the following formula to compare with the rated current. The selected motor must have the equivalent current that does not exceed the rated current.

$$\text{Motor equivalent current} = \sqrt{\frac{\sum (I_n^2 \times t_n)}{\sum (C_n \times t_n)}} \dots\dots\dots \text{(Formula 4.4)}$$

Cn: Cooling factor  
 Example. V/F control  
 $6\text{Hz} \leq f \leq 60\text{Hz}$

$$C = \left(\frac{f}{60}\right)^4$$

(Complement) When, as a feature of inverters, driving multiple motors with one inverter, select motors so that a value of “(total current of motors) multiplied by (approximately 1.05 to 1.1)” does not exceed the rated current of the inverter.

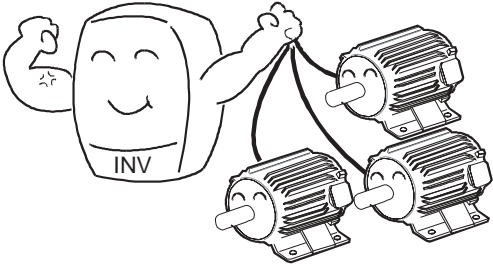

(6) Check the necessity of a brake resistor for the regenerative brake. Calculate the braking electric power from the energy generated by the use of the regenerative brake in a deceleration operation. Check if the calculated power is within the permissible range of the performance specifications. Install an external brake resistor (optional) if the power is outside the range

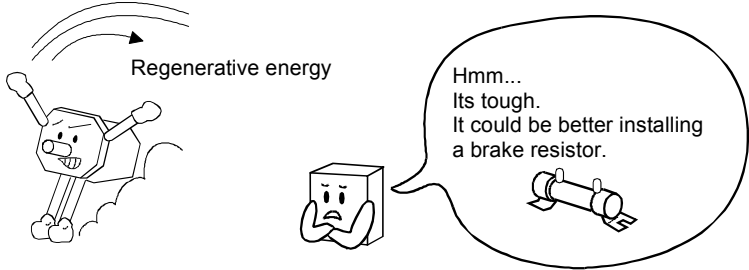

Clearing (1) to (6) completes the steps of a motor selection.

## 4. PRECAUTIONS

### 4.2.4 Software for capacity selection using a personal computer

The software is available, which automatically selects a capacity. The user's task is just to select a machine and input each data into the software. The software provides various efficient tool functions such as inertia calculation and unit conversion.

(1) For inverter use (FR-SW1-SEL-WJ)



#### 1) Specifications

Item		Specifications
Types of machine components		<ul style="list-style-type: none"> <li>· Ballscrew for horizontal use</li> <li>· Ballscrew for vertical use</li> <li>· Rack &amp; pinion</li> <li>· Rotating table</li> <li>· Cart</li> <li>· Elevator</li> <li>· Conveyor</li> <li>· Others (inertia direct input)</li> </ul>
Result output	Item	<ul style="list-style-type: none"> <li>· Selected inverter model name</li> <li>· Selected motor model name</li> <li>· Selected braking unit</li> <li>· Control method</li> </ul>
	Print	The following items are printed out: input data, operation pattern, calculation process, motor speed (feed speed), torque graph and selection result.
	Data save	The following data are saved in a named file: input data, operation pattern, selection result, and FAX form.
Inertia moment calculation function		<ul style="list-style-type: none"> <li>· Cylinder</li> <li>· Rectangular column with declination axis</li> <li>· Speed change</li> <li>· Linear motion</li> <li>· Suspension</li> <li>· Circular cone</li> <li>· Circular truncated cone</li> </ul>

#### 2) Input screen (with an example of a ballscrew for horizontal use)

## 4. PRECAUTIONS

**設定情報**

ボールねじ水平 | [ジョイントタイプ] [外付減速機]

インパルス: 選択インパルス: FF-A&D 自動選定  
制御方式: V/F制御 CD&D  
自動選定

モータ: 選択モータ: SF-JR 自動選定 4Pole  
減速機: なし

運転リターン: 容量計算

**データ設定**

ボールねじ質量	WT	200.000	kg
負荷質量	WL	200.000	kg
負荷慣性モーメント	Fc	20.000	N
ボールねじの最大許容力	Fg	6000	N
減速機 D/L 比率	L/r	1/2	
減速機ジョイント	JO	0.050	kg·m <sup>2</sup>
ボールねじの出力減速機ジョイント	JO	0.050	kg·m <sup>2</sup>
ボールねじの長さ	LB	10.000	mm
ボールねじの直径	DB	20.000	mm
ボールねじの長さ	LB	600.000	mm
減速機の効率	$\eta$	0.700	
減速機の減速比	$\alpha$	0.100	
最大慣性モーメント	Js	0.150	
減速機の減速比	ka	1.000	

ボールねじ質量 WT 200.000 kg

**容量確認結果**

確認結果

確認モータ

確認インパルス

制御方式

確認減速機ジョイント

容量確認ソフトウェアは、理論計算に基づいて計算を行うものです。容量確認結果を確認するものではありません。設計の信頼性を計算ソフトウェアで確認し、実際の運転に際しては、計算結果に必ず確認として最終的な容量決定は責任にておこないます。

[計算結果グラフ表示] [計算過程表示]

容量確認の準備が整いました。容量計算ボタンを押してOKし。

# 4. PRECAUTIONS

## 3) Examples of other input screens



Cart



Elevator



Conveyor



Others

# 4. PRECAUTIONS

## 4) Calculation example

The detailed results of calculations can be confirmed. The results also can be printed out.

\*\*\*\*\* サイクル運転 計算過程 [ ボールねじ水平 | テスト 1 | INIDT0.1na ] \*\*\*\*\*

<< 負荷・運転仕様 >>

1. モータ回転当たりの移動量  
 $dS = PB \times 1/n \times 1/nm$   
 $= 10.000 \times 1/3 \times 1.000$   
 $= 3.333333 \text{ [mm/rev]}$

2. 移動速度・モータ回転速度・運転周波数  
 $Vn = Nn \times dS / 1000 \text{ [m/min]} \text{ (移動速度)}$   
 $Nn = Vn / dS \times 1000 \text{ [r/min]} \text{ (回転速度)}$   
 $fn = Nn \times Pole / 120 \text{ [Hz]} \text{ (運転周波数)}$

運転モード	移動速度 [m/min]	回転速度 [r/min]	運転周波数 [Hz]
1	V1 = 0 ~ 6.000	N1 = 0 ~ 1800.000	f1 = 0 ~ 60.000
2	V2 = 6.000 ~ 6.000	N2 = 1800.000 ~ 1800.000	f2 = 60.000 ~ 60.000
3	V3 = 6.000 ~ 3.000	N3 = 1800.000 ~ 900.000	f3 = 60.000 ~ 30.000
4	V4 = 3.000 ~ 3.000	N4 = 900.000 ~ 900.000	f4 = 30.000 ~ 30.000
5	V5 = 3.000 ~ 0	N5 = 900.000 ~ 0	f5 = 30.000 ~ 0

3. 負荷所要動力・負荷トルク・イナーシャと負荷質量・負荷反抗力の関係

負荷質量 WL	負荷反抗力 Fc	負荷 所要動力	モータ軸換算 負荷トルク	始動時 負荷トルク	直線運動の 物体イナーシャ	モータ軸換算 負荷イナーシャ
無	無	PLR1	TLR1	TLS1	JF1	JL1
無	有	PLR2	TLR2	TLS2		
有	無	PLR3	TLR3	TLS3	JF2	JL2
有	有	PLR4	TLR4	TLS4		

4. 負荷所要動力  
 $PLR1 = (\mu \times (WT + FG / g) \times Vmax) / (6120 \times \eta) \text{ (WL無, Fc無)}$   
 $= (0.1 \times (250.000 + 1.000 / 9.80665) \times 6.000) / (6120 \times 0.9)$   
 $= 0.027244 \text{ [kW]}$   
 $PLR2 = (ABS(Fc / g + \mu \times (WT + FG / g)) \times Vmax) / (6120 \times \eta) \text{ (WL無, Fc有)}$   
 $= (ABS(350.000 / 9.80665 + 0.1 \times (250.000 + 1.000 / 9.80665)) \times 6.000) / (6120 \times 0.9)$   
 $= 0.066122 \text{ [kW]}$   
 $PLR3 = (\mu \times (WT + WL + FG / g) \times Vmax) / (6120 \times \eta) \text{ (WL有, Fc無)}$   
 $= (0.1 \times (250.000 + 20.000 + 1.000 / 9.80665) \times 6.000) / (6120 \times 0.9)$   
 $= 0.029423 \text{ [kW]}$   
 $PLR4 = (ABS(Fc / g + \mu \times (WT + WL + FG / g)) \times Vmax) / (6120 \times \eta) \text{ (WL有, Fc有)}$   
 $= (ABS(350.000 / 9.80665 + 0.1 \times (250.000 + 20.000 + 1.000 / 9.80665)) \times 6.000) / (6120 \times 0.9)$   
 $= 0.068301 \text{ [kW]}$

5. モータ換算負荷トルク  
 $TLR1 = (\mu \times (WT \times g + FG) \times Vmax) / (2 \times \pi \times Nmax \times \eta) \text{ (WL無, Fc無)}$   
 $= (0.1 \times (250.000 \times 9.80665 + 1.000) \times 6.000) / (2 \times 3.14159 \times 1800.000 \times 0.9)$   
 $= 0.144575 \text{ [N·m]}$   
 $TLR2 = ((Fc + \mu \times (WT \times g + FG)) \times Vmax) / (2 \times \pi \times Nmax \times \eta) \text{ (WL無, Fc有)}$   
 $= ((350.000 + 0.1 \times (250.000 \times 9.80665 + 1.000)) \times 6.000) / (2 \times 3.14159 \times 1800.000 \times 0.9)$   
 $= 0.350887 \text{ [N·m]}$   
 $TLR3 = (\mu \times (WT + WL) \times g + FG) \times Vmax) / (2 \times \pi \times Nmax \times \eta) \text{ (WL有, Fc無)}$   
 $= (0.1 \times ((250.000 + 20.000) \times 9.80665 + 1.000) \times 6.000) / (2 \times 3.14159 \times 1800.000 \times 0.9)$   
 $= 0.156137 \text{ [N·m]}$   
 $TLR4 = ((Fc + \mu \times (WT + WL) \times g + FG) \times Vmax) / (2 \times \pi \times Nmax \times \eta) \text{ (WL有, Fc有)}$   
 $= ((350.000 + 0.1 \times ((250.000 + 20.000) \times 9.80665 + 1.000)) \times 6.000) / (2 \times 3.14159 \times 1800.000 \times 0.9)$   
 $= 0.362449 \text{ [N·m]}$

## 4. PRECAUTIONS

---

### 4.2.5 Software for starting up an inverter

#### (1) FR Configurator (FR-SW2-SETUP-WJ)

The software is available, which supports starting up a Mitsubishi general-purpose inverter from the screen of a personal computer connected to the inverter.

Using this software allows the following: monitoring and diagnosing an inverter and also setting parameters on the personal computer screen; measuring frequency and current waveform of an inverter and then displaying them as a graph; and saving and diverting data.

In addition, the software automatically converts parameters of the conventional models (FREQROL-A500, V500/F500) to those of FREQROL-A700/F70 series.

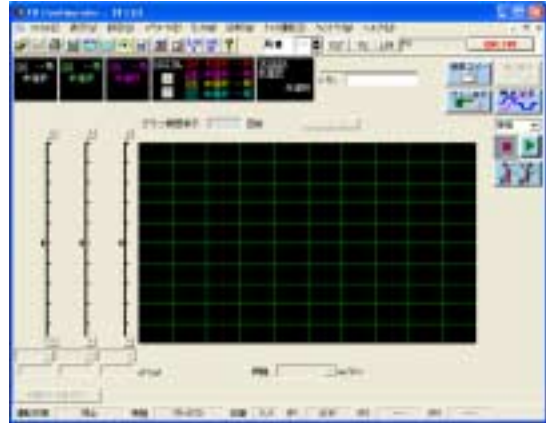

#### 1) Supported general-purpose inverter models

FREQROL-A700 series

FREQROL-F700 series

#### 2) Functions

- Monitor: Indicator needle display, waveform display, etc.
- Alarm: Alarm display, alarm history, etc.
- Diagnosis: Operation diagnosis, error diagnosis, service life diagnosis
- Parameter: Parameter setting, list display, converting function, etc.
- Test operation: Test operation, auto tuning, etc.
- File-related operation: Open, save, print

# 4. PRECAUTIONS

## 3) Connection

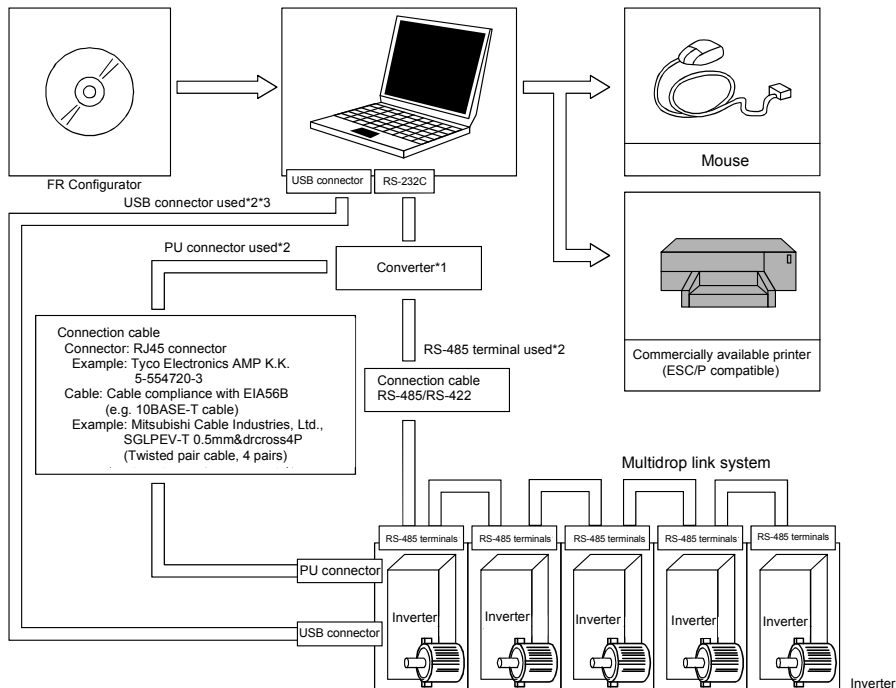

\*1: A commercially available converter is required when the personal computer uses the RS-232C port.  
 <Example of commercially available products> (As of April, 2004)  
 1) Model: FA-T-RS40? Converter (A model with connectors and a cable is also available.)  
 2) Model: DINV-CABV (with connectors and a cable)

\*2: The PU connector, RS-485 terminal or USB connector (FREQROL-A700 series only) can be used to make communication.

\*3: The communication using the USB connector (FREQROL-A700 series only) cannot connect two or more inverters. (A personal computer and an inverter are connected on a 1:1 basis)  
 The communication using a USB HUB cannot be made.

# 4. PRECAUTIONS

## 4.3 Application Examples

### 4.3.1 Inverter application examples

Inverters are used in various fields.

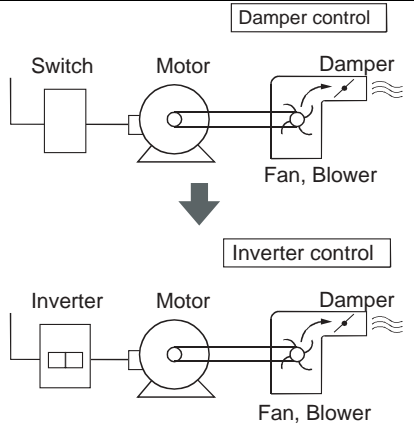
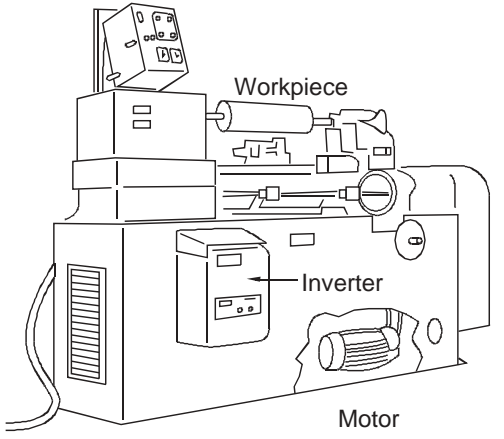
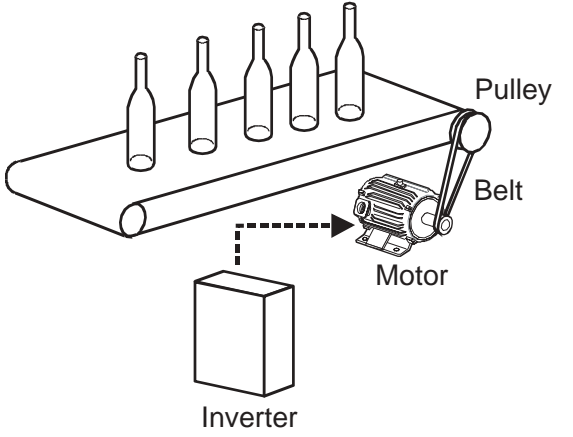
Features	Application examples
<p>Inverters realize energy saving and automation.</p> <ul style="list-style-type: none"> <li>• Useful for air flow control (flow amount control)</li> <li>• Automatic control over air flow (pressure or flow amount)</li> <li>• Necessary amount can be changed according to seasons and day/night.</li> </ul>	<ul style="list-style-type: none"> <li>• Pump</li> <li>• Fan, blower</li> <li>• Ventilation fan</li> <li>• Cooling tower</li> <li>• Drying machine (Furnace fan)</li> </ul> 
<p>Higher machine efficiency and downsizing of machines</p> <ul style="list-style-type: none"> <li>• Conventionally, the rotation speed of a main spindle was controlled by changing the speed of a pulley, etc., according to the size of a workpiece. Using inverters makes such speed change system simpler, allowing downsized machines.</li> <li>• The most suitable machining conditions are easily obtained.</li> </ul>	<ul style="list-style-type: none"> <li>• Drive for a main spindle of a machine tool</li> <li>• Table of a machine tool</li> <li>• Spindle stock feed</li> <li>• Drive for a cutter</li> <li>• Rice mill</li> </ul> 
<p>Higher machine efficiency, defined position stop, automatic operation</p> <ul style="list-style-type: none"> <li>• The operation efficiency can be improved and carts can be stopped at the defined position.</li> <li>• The conveyor speed can be changed to the most suitable value according to the workpiece.</li> <li>• The soft start and stop realizes preventing products from falling down and wobbling.</li> <li>• Shocks to machines are absorbed and the acceleration and deceleration without shocks are realized.</li> </ul>	<ul style="list-style-type: none"> <li>• Cart</li> <li>• Belt conveyor</li> <li>• Wood working machine</li> <li>• Weighing machine</li> <li>• Packaging machine</li> </ul> 

# 4. PRECAUTIONS

## 4.3.2 Vector inverter application examples

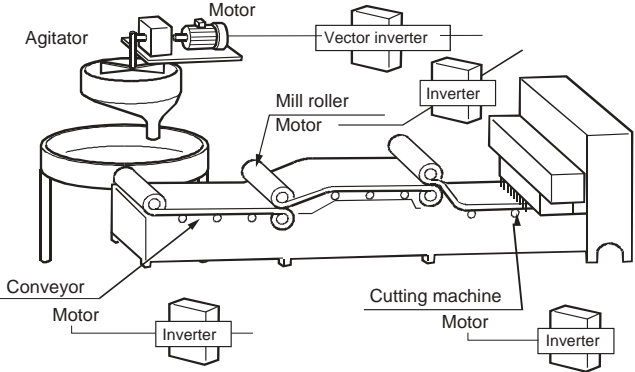
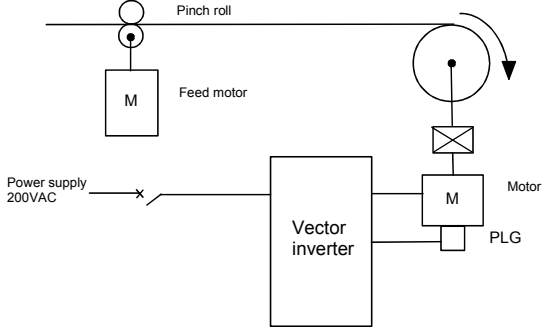
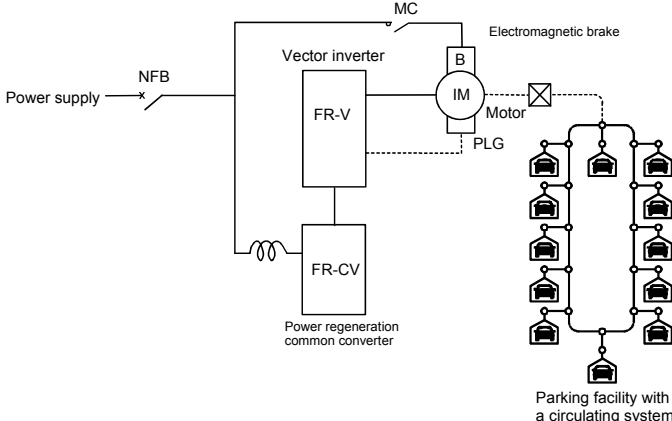
Features	Application examples
<p>High starting torque, small speed fluctuation</p> <ul style="list-style-type: none"> <li>• Accurate control over extrusion pressure according to the material extruded</li> <li>• Even for loads that change (increase) their viscosity as the speed decreases, operations continue without torque shortage.</li> </ul>	<ul style="list-style-type: none"> <li>• Extruder</li> <li>• Molding machine</li> <li>• Wiredrawing machine</li> <li>• Agitator</li> <li>• Roller driving</li> <li>• Testing machine</li> </ul> 
<p>Higher machine efficiency and accurate torque control</p> <ul style="list-style-type: none"> <li>• Accurate torque control over winding and unwinding</li> </ul>	<ul style="list-style-type: none"> <li>• Various winding</li> <li>• Unwinding line</li> </ul> 
<p>Higher machine efficiency, fixed position stop, automatic operation</p> <ul style="list-style-type: none"> <li>• Higher machine speed enables higher machine efficiency.</li> <li>• Carts can be stopped at the fixed position.</li> <li>• Multilevel car parking towers with a circulating system may need a large starting torque depending on the imbalance amount of the automobiles parked. The vector control is suitable for such application.</li> </ul> <p>A negative load may be generated depending on the number of automobiles parked, requiring a large brake torque. In such cases, use a vector inverter with the power regeneration common converter FR-CV (optional) to construct an efficient driving system.</p>	<ul style="list-style-type: none"> <li>• Multilevel car parking towers</li> <li>• Automated warehouse</li> <li>• Cargo elevator</li> <li>• Conveyor</li> </ul> 

## 4. PRECAUTIONS

---

### 4.4 Maintenance and Inspection

#### 4.4.1 Motor

General-purpose motors and vector inverter dedicated motors are three-phase induction motors. These motors mainly consist of a rotary shaft, bearings, stator winding and connection terminals. Vector inverter dedicated motors have an encoder at the rear of their rotary shaft. These components must be inspected periodically to prevent any fault from occurring due to the adverse effects from the operating environment, such as temperature, humidity, dust, dirt and vibration, changes in the parts with time, service life, and other factors.

#### (1) Inspection items for a motor

It is recommended to check the following items periodically.

- 1) Check if screws of the terminal block are securely tightened. Retighten if the screws are loosened.
- 2) Check if there is no unusual noise generated from the bearings or brake of motors.
- 3) Check if there are no damages or cracks in cables. Especially for operated motors, perform an inspection periodically in accordance with the operating environment.
- 4) Check if the load connecting shaft has its axis without declination.

#### (2) Service life

A service life of each part is as shown below. Note that the service lives shown below may differ depending on the operating conditions or environmental conditions. Replace faulty parts if found. For part replacement, contact a Mitsubishi service center or service station.

	Part Name	Standard replacement interval	Remarks
General-purpose motor	Bearing	20,000 to 30,000 hours	Standard replacement intervals are for reference. Replace faulty parts if found regardless of the standard replacement interval.
	Grease	20,000 to 30,000 hours	
	Forced cooling fan	10,000 to 30,000 hours (2 to 3 years)	
Vector inverter dedicated motor	Bearing	20,000 to 30,000 hours	
	Encoder	20,000 to 30,000 hours	
	Oil seal	5,000 hours	
	Forced cooling fan	10,000 to 30,000 hours (2 to 3 years)	

## 4. PRECAUTIONS

---

### 4.4.2 Inverter

An inverter is a static unit mainly consisting of semiconductor devices. Daily inspection must be performed to prevent any fault from occurring due to the adverse effects from the operating environment, such as temperature, humidity, dust, dirt and vibration, changes in the parts with time, service life, and other factors.

 **Caution** For some time after the power is switched off, a high voltage remains in the smoothing capacitor. When accessing the inside of an inverter for inspection, wait until the charge lamp is turned off, and then make sure that the voltage across the main circuit terminals P-N is not more than 30VDC using a tester, etc.

#### · Inverter

##### Inspection items

##### (1) Daily inspection

Basically, a daily inspection is to check for the following faults during operation.

- 1) Check if the motor operates properly as set.
- 2) Check for unusual vibration and noise.

##### (2) Periodic inspection

Check the areas inaccessible during operation and those which require periodic inspection.

- 1) Check if there are no abnormal signs in the cooling system ..... Clean the air filter, etc.
- 2) Tightening check and retightening ..... Screws and bolts may become loose due to vibration, temperature changes, etc. Check and retighten them.
- 3) Check the conductors and insulating materials for corrosion and damages.
- 4) Measure the insulation resistance.
- 5) Check and replace the cooling fan, smoothing capacitors and relays.

##### (3) Service life

A service life of each part is as shown below. Note that the service lives shown below may differ depending on the operating conditions or environmental conditions. Replace faulty parts if found. For part replacement, contact a Mitsubishi service center or service station.

##### FREQROL-A700, F700 series

Components	Standard Replacement Interval	Remarks
Cooling fan	10 years	Standard replacement intervals are for reference. Replace faulty parts if found regardless of the standard replacement interval.
Main circuit smoothing capacitor	10 years	
On-board smoothing capacitor	10 years	
Relays	-	

## 4. PRECAUTIONS

### 4.5 Troubleshooting

#### 4.5.1 Alarm display

An inverter provides various protective functions that prevent semiconductors (main circuit elements) from being damaged due to errors that may occur on the power supply side, load side of the inverter or external sequences.

- Inverter …… The protective functions of an inverter are largely classified into those to protect the inverter and those to protect a motor from overheat. In addition to the protective functions, an inverter is equipped with warning functions to inform that the operation status is abnormal.

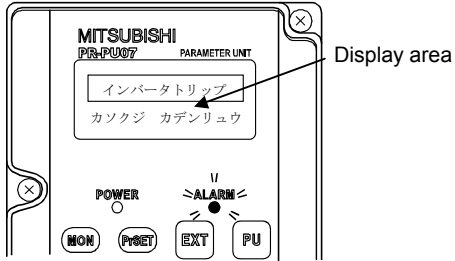
Item	Inverter
Description	<ul style="list-style-type: none"> <li>· When an alarm occurs, a code assigned to the alarm status is displayed on the operation panel (parameter unit), and the alarm output (contact signal) is turned on.</li> <li>· When the operation stops due to an alarm, refer to the displayed alarm code to identify the error source.</li> <li>· The inverter holds the error status until the alarm is canceled (reset).</li> </ul>
Display example	<p>Parameter unit</p>  <p>(Example of overcurrent shut-off)</p>
Protection	<ul style="list-style-type: none"> <li>· Overcurrent shut-off (during acceleration, low speed operation, deceleration)</li> <li>· Regenerative overvoltage shut-off</li> <li>· Instantaneous power failure protection</li> <li>· Overload shut-off (electronic thermal relay)</li> <li>· Undervoltage protection</li> <li>· Output side earth (ground) fault overcurrent etc.</li> </ul>
Useful software	<p>Installing the inverter setup software on a personal computer allows displaying alarms and warnings, setting various parameters, and monitoring the operation status.</p>

(Note) How alarms are displayed and what alarms display differ depending on the inverter series.

## 4. PRECAUTIONS

### 4.5.2 Wiring precautions and others

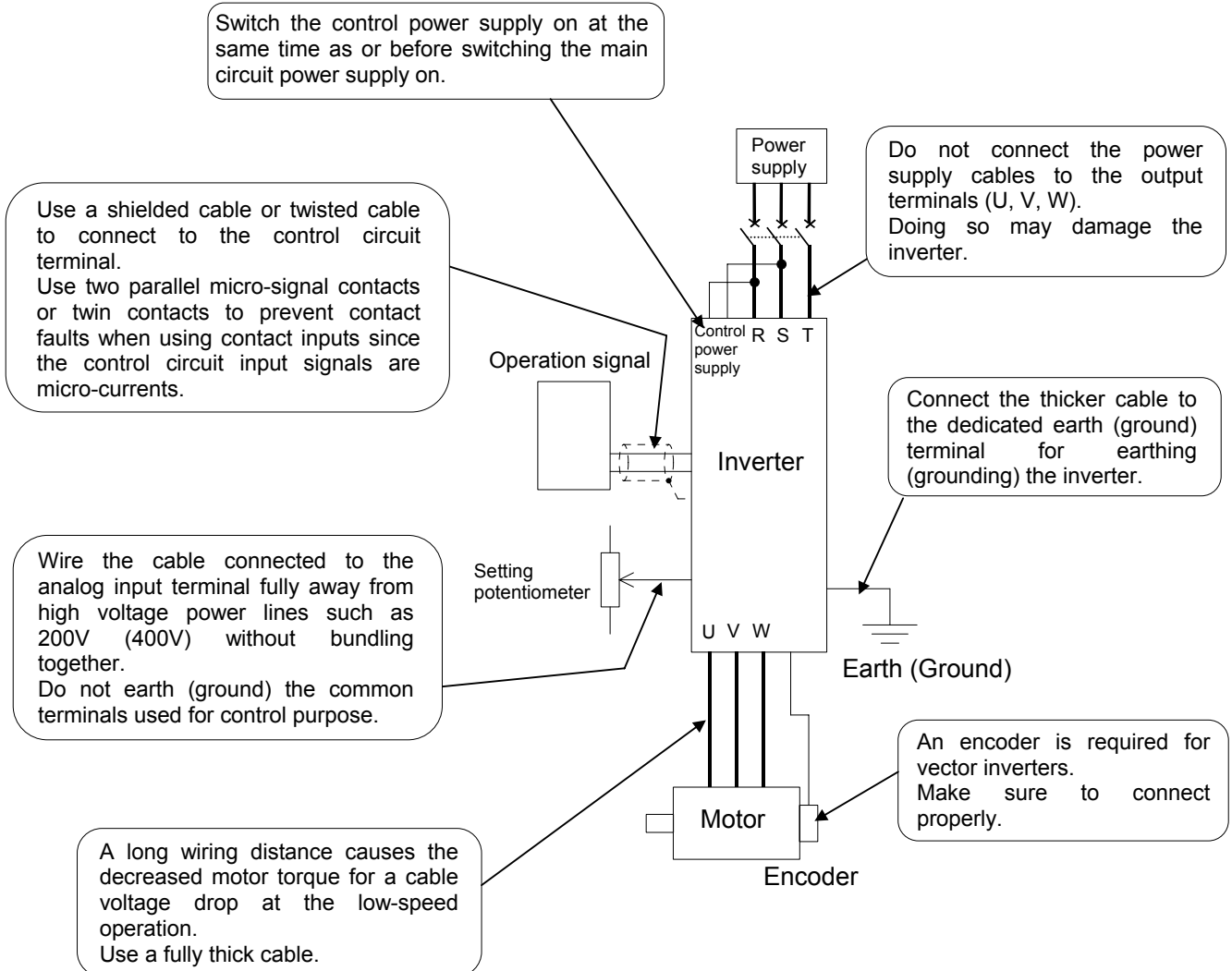

**Appendix 1. Glossary**

**- Absolute (absolute position) encoder <Antonym; Incremental encoder>**

This is an encoder which can output the angle data within one rotation of the encoder to the outside, and the one which can take out 360°C in 8 to 12-bit data is generally used.

If using the encoder as a servo motor encoder, the position within one revolution of the motor is identified. Therefore, this is used when the absolute positioning system is configured with a rotation amount counter.

The following figure shows the common structure of the absolute position encoder. In this case, the absolute position signal of 7 bits is output.

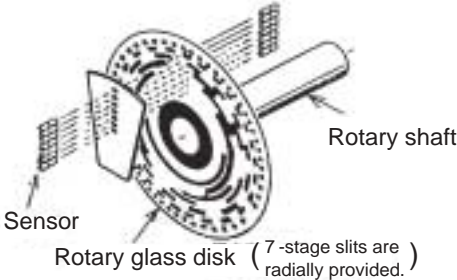

Structure example of absolute position encoder

**- Absolute (absolute position) positioning**

This is a positioning method in which the absolute coordinate based on the home position is set in the range of machine movement and specified in the positioning data.

**- Acceleration**

This is a change of the motor speed, which is expressed with ratio to the acceleration time, and is a slope to the time of motor speed change.

**- Acceleration time**

This is a time which is taken to reach from the current motor speed to the next motor speed when the motor speed is changed.

**- Acceleration time constant**

This is a time which is taken from start to end of the acceleration when the motor is accelerated from the stop status to the certain motor speed (rated motor speed, parameter limit speed, etc.).

For the acceleration pattern of the primary delay function, it indicates the time taken when the actual speed reaches to 63.5% of the target speed.

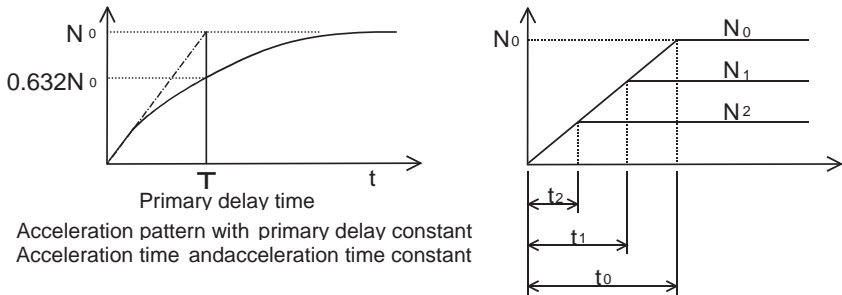

- t 0: Acceleration time up to the reference speed = Acceleration time constant
- t 1: Acceleration time up to the motor speed N<sub>1</sub>
- t 2: Acceleration time up to the motor speed N<sub>2</sub>

## APPENDICES

---

### **- All digital control (Digital control)**

This is a system which is controlled by a micro computer or a circuit configured with the peripheral LSI and logic IC.

### **- Analog control <Antonym; Digital control>**

This is a control system which is realized with a control circuit comprised of analog devices such as an operational amplifier.

### **- Angular frequency ( $\omega$ )**

The number of cycles per second is expressed in Hz (hertz) as a unit to express the continuous sine wave, and it is called angular frequency when expressed in angle (radian). It is converted to  $2\pi f$  [rad/sec] at frequency  $f$  [Hz].

### **- Auto tuning (Offline auto tuning/Online auto tuning)**

The offline auto tuning is a function with which an inverter itself measures and stores a necessary motor constant.

The online auto tuning is a function with which the status of the motor is quickly tuned at a start. Therefore, the high accuracy operation unaffected by the motor temperature and stable operation with high torque down to ultra low speed can be performed.

### **- Auto tuning (Real time auto tuning)**

The performance (especially response and stability) of a machine driven by the servo motor depends on the characteristics (inertial moment and rigidity) of the machine. Consequently, an adjustment operation is necessary to raise the machine performance to the best condition, and this operation is called tuning.

The auto tuning is a function with which automatically operates the tuning mentioned above and normally indicates a function with which automatically adjusts the speed and position loop gains to be set by a servo amplifier.

The real time auto tuning indicates a function with which a tuning is automatically performed by always tracking, especially when the machine characteristics are changed during operation.

### **- Capacitor regeneration**

This is a method to perform a regenerative operation by charging the regenerative energy in the capacitor of the main circuit.

Since the heat is not generated, the capacitor can be repeatedly used when the regenerative energy is smaller than the energy charged in the capacitor. However, the method is only applied to small capacity models since the energy, which can be charged in the capacitor, is small.

### **- Differential transmission system**

This is a system in which one signal is simultaneously transmitted in pair with a signal of reversed polarity. Since the logic of the signals can be evaluated at the same time on the receiving side, this system has superior noise resistance and is used for a signal

# APPENDICES

---

transmission at high speed such as the input and output of pulse trains. Generally, the sending side is called driver and the receiving side receiver, and a dedicated IC is used.

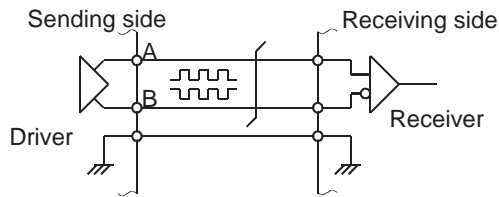

## **- Digital control <Antonym; Analog control>**

This is a control system which is realized with a control circuit comprised of digital devices. In these days, a system, in which an operation is processed with software using a micro computer or micro processor for the increase of the calculation amount, has become common.

The merits of the digital control system are that there is no temperature drift and the performance is stable and has a high-repeatability.

## **- Droop pulses and stop settling time**

Droop pulses represent the gap between the command pulses counted with the deviation counter of a servo amplifier and the feedback pulses of a position encoder.

A constant amount of the droop pulse exists in the deviation counter during the operation at a constant speed. As the speed varies, the number of the droop pulses also varies.

Since the servo motor rotates with a delay behind a command for the amount of the droop pulses of the servo amplifier, it stops a little bit behind the command completion. This delay time is called stop settling time.

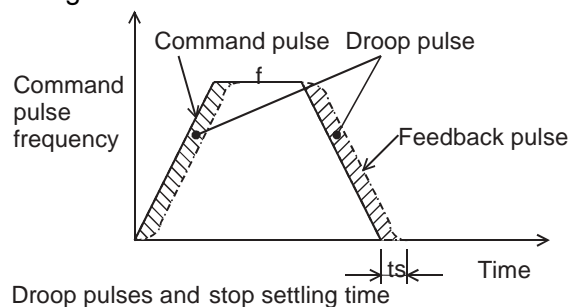

## **- Dynamic brake**

This is a break function to be used for stopping a machine rapidly at a power failure or a servo amplifier failure, and a large break torque is obtained from an electromagnetic brake. However, there is no holding torque during stop.

This function is not provided for the IM servo with an induction motor.

## **- Electronic gear**

This indicates that the feedback pulse ratio to a command pulse is changed. However, the position resolution is not changed since it is determined with an encoder. The ratio change can be made using fractions with parameters.

Unlike a mechanical gear, the motor torque is not increased even if the ratio magnification is

## APPENDICES

---

increased.

### **- Error excessive**

This means that droop pulses exceed the capacity of the deviation counter.

When an overflow occurs on the deviation counter in the positioning system, an accurate positioning cannot be made. In this condition, a servo amplifier or positioning module stops the machine with outputting the error excessive error.

### **- Feed forward control**

This is a control which outputs a speed command before droop pulses increase when a pulse command is input in the position loop control.

### **- Feedback control**

This is a control which detects a gap between a command and an actual speed with a closed loop and compensates the command value to reduce this gap.

### **- Frequency response (characteristic)**

This expresses the speed response quantitatively. The frequency to which the actual motor can respond is indicated in  $\omega c$  [rad/sec] or  $f_c$  [Hz] when the speed command is changed into a sine wave pattern as a extremely low-speed command of approximately 10r/min. This frequency response can be enhanced by increasing the speed loop gain. However, if it is increased too much, a vibration or stability easily occurs due to the rigidity of a mechanical system.

### **- Gain search**

A personal computer searches the value of the shortest settling time with little overshoot or vibration while automatically changing the gain.

This function exhibits the best performance when a high-level adjustment is required.

### **- Grounding**

This indicates a condition in which either a cable (P or N after a diode rectification) of the main power supply circuit of the servo amplifier or a power line (U, V or W) of the motor is short-circuited with the earth.

### **- IGBT(Insulated Gate Bipolar Transistor)**

Compared to the existing transistor, IGBT is available for high-speed switching and is better for the current, pressure resistance, etc.

### **- Impact drop**

This expresses the temporal response characteristic as a value indicating the fluctuation range of the output to the input command in the feed back control. The value is indicated with the size and duration time of the temporary movement amount for when the load is changed in a staircase pattern.

Especially, it will be effective when including an integral operation.

### **- Incremental (relative position) positioning**

This is a relative positioning in the machine movement. In the positioning data, the

## APPENDICES

---

positioning is executed by specifying the travel from the current position as a reference (home position). This positioning system is used for the fixed-feed of the roll feed, etc.

### **- Inertia (Inertia moment)**

Refer to “· Inertia moment” on App-4.

### **- Inertia moment (Inertia)**

This is the amount which indicates the rotation gravity of a rotator and is equivalent to the mass of the linear operation.

$$\text{Definitional equation } J = m \cdot r^2$$

Here, J: Inertia moment [kg · cm<sup>2</sup>]

M: Mass [kg]

r: Rotation radius [cm]

In addition, GD<sup>2</sup> is usually used as the amount to indicate the inertia moment. The r (radius) of the equation above is expressed in 2r (diameter), and there is a relationship as shown below.

$$GD^2 = m \cdot (2r)^2 = 4J$$

### **- Instantaneous power failure**

The servo amplifier and inverter keep the control when the power failure is very short (normally, 15msec or less). However, if the power failure is longer than 15msec, they stop the control with outputting an instantaneous power failure error.

If the power failure continues (normally, several 100msec or more), as in the case of power off, they are recovered to the same condition as at power on by power restoration.

The power failure, which is 15msec or more and several 100msec or less as described above, is normally called instantaneous power failure, and the instantaneous power failure error is hold.

### **- Machine analyzer**

By connecting to a servo motor, this automatically vibrates the servo motor and analyzes the frequency characteristic of the mechanical system.

Although this analysis varies depending on the performance of personal computer, it can be completed in approximately 30 seconds.

### **- Model adaptive control**

This is a control system which is used for the servo amplifiers of MR-H, MR-J2, MR-J2S, MR-J2-03A5, and MR-C series. It has an ideal servo amplifier and load (high rigidity and no backlash, etc.) as an ideal model on the software and exhibits the best performance at the actual load with always adapting the actual operation.

### **- Motor electromagnetic brake**

The electromagnetic brake, which is installed on the motor with the electromagnetic brake, is a no-excitation operation brake to be used in a up-and-down drive, etc. for preventing a drop at power failure or servo error occurrence or for keeping during a stop.

# APPENDICES

## - Motor frame number

The installation dimension, shaft diameter and shaft length, etc. of general-purpose motor are standardized by JIS standards as shown below.

The size of the electric motor can be checked with the frame number.

For the display method of the frame number, the C dimension is indicated in mm, and the size of the frame length is shown after that.

The additional letter such as S, M, L, and LL is applied.

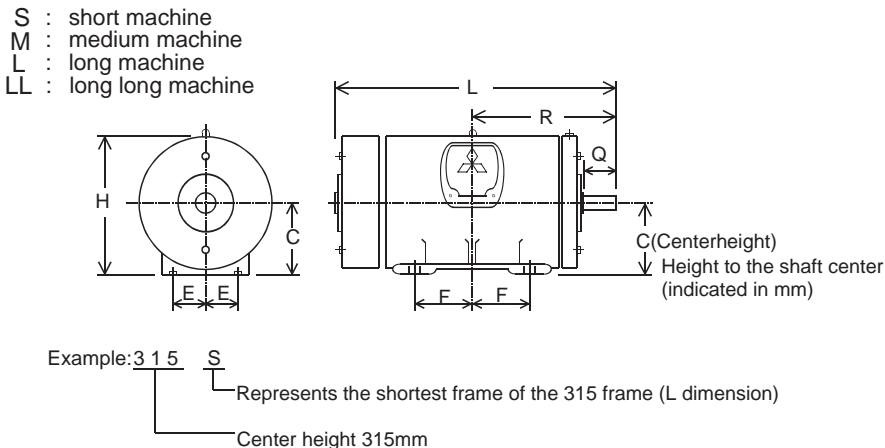

## - Open loop

This system is a positioning by the stepping motor, etc. Since this is a system which does not use an encoder, the control system is simple and reasonable. Therefore, it is often used for a relatively rough positioning or applications which do not really need a torque of small capacity at high speed.

## - Position loop gain

This indicates the response to a command in the position control. The following shows the block diagram of the position control indicating the speed control system as  $G_v(s)$ .

Here, the position loop gain is expressed as follows

$$\begin{aligned} \text{Position loop gain} &= K_p \cdot G_v(s) \\ &= K_p \end{aligned}$$

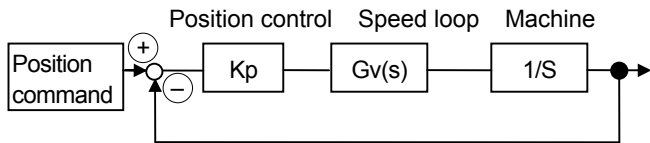

The speed control is assumed as  $G_v(s) = 1/s$  since the response to the position control is sufficiently high.

The position loop gain will be  $K_p = \omega_p [\text{rad/sec}]$  expressed as a position response.

## - Power rate

For the rated torque motor with the output rise ratio that can be output by the motor, this indicates the speed when the motor itself accelerates. The definition is expressed with the following formula.

## APPENDICES

---

$$Q = \frac{T_R^2}{J_M} \times 10 \quad [\text{kW/s}]$$

$T_R$  : Motor output torque [N · m]

$J_M$  : Motor inertia moment [kg · cm<sup>2</sup>]

### **- Power regeneration**

This is a system to return the regenerative energy to the power supply side via the bus of the amplifier. A dedicated unit for returning the regenerative energy to the power supply side is required. However, since there are merits that the heat generation is less than that in the resistance regenerative system and the installation dimension becomes smaller with the large regenerative energy, this system is mainly used for the operation to be a continuous generation such as large-capacity models and an up-and-down shaft.

### **- Primary delay time constant**

This is a time constant of exponential function, which is a time taken to reach 63% of the final value.

### **- Proportional control**

The proportional control is also called P control and expressed as  $Y = \varepsilon \times K_p$  since the operation amount  $Y$  is proportional to the deviation  $\varepsilon$ . After the positioning is completed, even if the mechanically locked motor is turned in the amount of one pulse, the large current flows into the motor, and an attempt is made to compensate the position declination. To prevent this, the proportional control is set to decrease the torque gain at the same time as the positioning completion, and then the current is suppressed. Also, the vibration during servo lock can be suppressed by setting to the proportional control. Here, the proportional control immediately starts to eliminate the deviation for a sudden disturbance. However, the deviation cannot be completely eliminated for a continuous disturbance. It is because the control system continues the operation to correct the deviation for the continuous disturbance. Therefore, some amount of the deviation has to exist.

### **- Regeneration**

This is a condition that the power flows from the motor side to the power supply (servo amplifier or inverter) side. For instance, when the motor speed is faster than the speed command, the difference of the rotation energy flows to the power supply side. The servo amplifier or inverter stores this energy in a capacitor or consumes it in a resistor if it is large.

### **- Regenerative brake**

Normally the power is supplied from an amplifier to a motor when a load is driven with the motor. This condition is called driving. On the contrary, the rotation energy of the motor and load flows to the amplifier when the load speed is decelerated at motor deceleration or descent load drive. This status is called regeneration.

The servo amplifier obtains the regenerative brake torque with consuming the regenerative energy in a capacitor and resistor.

The regenerative brake torque is automatically adjusted depending on the deceleration

# APPENDICES

---

pattern. However, the regenerative brake option is used when the regenerative frequency is high.

**- Regenerative overvoltage**

This is a condition that the converter bus voltage exceeds the permissible value due to the regenerative energy which flows to the servo amplifier or inverter during regenerative operation. In this case, since the breakdown of the capacitor, etc. may occur, the control function is stopped with the regenerative overvoltage error.

This condition may occur when the regenerative energy is extremely large or the capability of regenerative brake resistor is low.

**- Resistance regeneration**

This is a system in which a braking torque is obtained by applying the regenerative energy to the resistor connected to the bus of the amplifier and consuming it with heat.

**- Response**

The servo system has the position, speed and current loops. They indicate the trackability in response to each command and generally the speed response.

**- Speed fluctuation percentage**

This is a fluctuation percentage of the motor speed generated when an inverter is used as a speed servo, and the ratio to the rated motor speed of the fluctuated motor speed is indicated in percentage.

The speed fluctuation percentage by load fluctuation is shown in the following formula.

$$\text{Speed fluctuation percentage} = \frac{\text{Speed fluctuation}}{\text{Rated speed}} \times 100 \text{ [%]}$$

**- Speed loop gain**

This indicates the response to a command on the speed control. When the constant to be determined by a motor is assumed as K1,

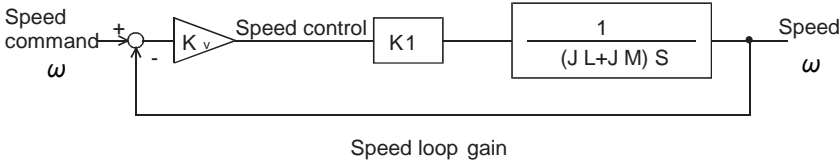

the speed loop gain is expressed with the following formula.

$$\text{Speed loop gain} = \frac{K1 \times Kv}{J_M + J_L}$$

Kv : Speed amplifier gain  
 J<sub>L</sub> : Load inertia  
 J<sub>M</sub> : Motor inertia

**- Stop settling time**

The servo motor moves holding a constant deviation to the position command. Therefore, there is a delay time from when a stop-time command is completed until the servomotor stops.

This delay time is called stop settling time, and approx 3 Tp is assumed in the time of t<sub>s</sub> in the figure of the droop pulses described above. (Tp: Position loop time constant)

## APPENDICES

---

When the operation pattern of the servo motor is examined, this stop settling time must be considered.

### **- Torque linearity**

This indicates the relationship of a torque command and the torque generated by a motor. Especially in the torque control, there is a dead band around the torque zero. In addition, the magnetic force of the magnet used for the motor is changed due to the temperature, and the torque linearity is affected as a result.

### **- Undervoltage**

When the power supply voltage becomes lower than a specified value in a servo amplifier or an inverter, the control is stopped for a device protection and an external error signal is output. This specified value is normally about 160V for a device used at 200V, and the voltage level at or below the specified value is called undervoltage level.

### **- Uneven rotation**

This is a fluctuation of instant motor speed to a command. The unevenness generally increases at low speed and decreases at high speed.

### **- V/F control**

This is a control system in which the ratio of frequency to the output voltage is constant when the frequency is changed.

In this system, if the voltage to be actually valid decreases due to a voltage drop in a wiring or the primary coil of a motor, enough amount of torque cannot be output (the slower the speed is, the more this phenomenon affects.). Therefore, the amount of voltage drop estimated in advance is set higher (torque boost) to cover the shortage of the torque at low speed.

### **- Vector control**

Detect a motor speed with an encoder and calculate a motor slip to identify the load magnitude.

This control is a system which divides the inverter output current into an excitation current (a current necessary to generate a magnetic flux) and a torque current (a current proportional to the load torque) by vector calculation and controls a frequency and voltage optimally to flow a necessary current individually according to this load magnitude.

# INVERTER SCHOOL TEXT

## INVERTER BEGINNER COURSE

MODEL	
MODEL CODE	1A2P20
SH(NA)-060011ENG-A(0609)MEE	



HEAD OFFICE : TOKYO BUILDING, 2-7-3 MARUNOUCHI, CHIYODA-KU, TOKYO 100-8310, JAPAN  
NAGOYA WORKS : 1-14, YADA-MINAMI 5-CHOME, HIGASHI-KU, NAGOYA, JAPAN

When exported from Japan, this manual does not require application to the Ministry of Economy, Trade and Industry for service transaction permission.

Specifications subject to change without notice.