



# Mitsubishi Programmable Controller

## CC-Link IE Field Network Ethernet Adapter Module User's Manual

---

-NZ2GF-ETB

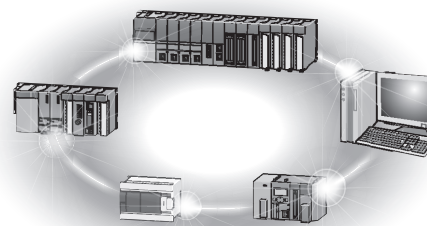



# ● SAFETY PRECAUTIONS ●

(Read these precautions before using this product.)

Before using this product, please read this manual and the relevant manuals carefully and pay full attention to safety to handle the product correctly.

In this manual, the safety precautions are classified into two levels: "⚠ WARNING" and "⚠ CAUTION".



Indicates that incorrect handling may cause hazardous conditions, resulting in death or severe injury.



Indicates that incorrect handling may cause hazardous conditions, resulting in minor or moderate injury or property damage.

Under some circumstances, failure to observe the precautions given under "⚠ CAUTION" may lead to serious consequences.

Observe the precautions of both levels because they are important for personal and system safety. Make sure that the end users read this manual and then keep the manual in a safe place for future reference.

## [Design Precautions]

### ⚠ WARNING

- Configure safety circuits external to the Ethernet adapter module to ensure that the entire system operates safely even when a fault occurs in the external power supply or the Ethernet adapter module. Failure to do so may result in an accident due to an incorrect output or malfunction. The Ethernet adapter module will stop its operation if it detects an error such as a watchdog timer error by the self-diagnostic function.
- When changing data from a peripheral device connected to the Ethernet adapter module during operation, configure an interlock circuit in the program of another station to ensure that the entire system will always operate safely. For other controls to a running programmable controller on another station (such as program modification or operating status change) or the operating status change of the Ethernet adapter module, read relevant manuals carefully and ensure the safety before the operation. Especially, in the case of a control from an external device to a remote programmable controller on another station, immediate action cannot be taken for a problem on the programmable controller due to a communication failure. To prevent this, configure an interlock circuit on the program on another station, and determine corrective actions to be taken between the external device and the programmable controller in case of a communication failure.
- Do not write any data to the "system area" and "write-protect area" (R) of the buffer memory in the Ethernet adapter module. Doing so may cause malfunction of the Ethernet adapter module.

## [Design Precautions]

### CAUTION

- Do not install the communication cables together with the main circuit lines or power cables. Keep a distance of 100mm or more between them. Failure to do so may result in malfunction due to noise.

## [Security Precautions]

### WARNING

- To maintain the security (confidentiality, integrity, and availability) of the programmable controller and the system against unauthorized access, denial-of-service (DoS) attacks, computer viruses, and other cyberattacks from external devices via the network, take appropriate measures such as firewalls, virtual private networks (VPNs), and antivirus solutions.

## [Installation Precautions]

### CAUTION

- Use the Ethernet adapter module in an environment that meets the general specifications in this manual. Failure to do so may result in electric shock, fire, malfunction, or damage to or deterioration of the product.
- Do not directly touch any conductive parts and electric components of the Ethernet adapter module. Doing so can cause malfunction or failure of the Ethernet adapter module.

## [Wiring Precautions]

### WARNING

- Shut off the external power supply (all phases) used in the system before wiring. Failure to do so may result in electric shock or cause the Ethernet adapter module to fail or malfunction.
- After wiring, attach the included terminal cover to the module before turning it on for operation. Failure to do so may result in electric shock.



## [Wiring Precautions]

### CAUTION

- Individually ground the FG and LG terminals of the programmable controller with a ground resistance of 100 ohms or less. Failure to do so may result in electric shock or malfunction.
- Use applicable solderless terminals and tighten them within the specified torque range. If any spade solderless terminal is used, it may be disconnected when a terminal block screw comes loose, resulting in failure.
- Check the rated voltage and terminal layout before wiring to the Ethernet adapter module, and connect the cables correctly. Connecting a power supply with a different voltage rating or incorrect wiring may cause a fire or failure.
- Securely connect the connector to the Ethernet adapter module.
- Do not install the communication cables together with the main circuit lines or power cables. Failure to do so may result in malfunction due to noise.
- Place the cables connected to the Ethernet adapter module in a duct or clamp them. If not, dangling cable may swing or inadvertently be pulled, resulting in damage to the Ethernet adapter module or cables or malfunction due to poor contact.
- Tighten the terminal block screws within the specified torque range. Undertightening can cause short circuit, fire, or malfunction. Overtightening can damage the screw and/or Ethernet adapter module, resulting in drop, short circuit, or malfunction.
- When disconnecting the cable from the Ethernet adapter module, do not pull the cable by the cable part. For the cable with connector, hold the connector part of the cable. Pulling the cable connected to the Ethernet adapter module may result in malfunction or damage to the module or cable.
- Prevent foreign matter such as dust or wire chips from entering the Ethernet adapter module. Such foreign matter can cause a fire, failure, or malfunction.
- A protective film is attached to the top of the Ethernet adapter module to prevent foreign matter, such as wire chips, from entering the module during wiring. Do not remove the film during wiring. Remove it for heat dissipation before system operation.
- The Ethernet adapter module must be installed in a control panel. Connect the main power supply through a relay terminal block. Wiring and replacement of the Ethernet adapter module must be performed by qualified maintenance personnel with knowledge of protection against electric shock. For wiring methods, refer to "Wiring" in this manual.

## [Startup and Maintenance Precautions]

### **WARNING**

- Do not touch any terminal while power is on. Doing so will cause electric shock or malfunction.
- Shut off the external power supply (all phases) used in the system before cleaning the module or retightening the terminal block screws. Failure to do so may result in electric shock.

## [Startup and Maintenance Precautions]

### **CAUTION**

- Before performing online operations (especially, program modification, forced output, and operating status change) for the running Ethernet adapter module or programmable controller module on another station from the peripheral device connected, read relevant manuals carefully and ensure the safety. Improper operation may damage machines or cause accidents.
- Do not disassemble or modify the Ethernet adapter module. Doing so may cause failure, malfunction, injury, or a fire.
- Use any radio communication device such as a cellular phone or PHS (Personal Handy-phone System) more than 25cm away in all directions from the Ethernet adapter module. Failure to do so may cause malfunction.
- Tighten the terminal block screws within the specified torque range. Undertightening can cause drop of the component or wire, short circuit, or malfunction. Overtightening can damage the screw and/or module, resulting in drop, short circuit, or malfunction.
- Before handling the Ethernet adapter module, touch a conducting object such as a grounded metal to discharge the static electricity from the human body. Failure to do so may cause the Ethernet adapter module to fail or malfunction.

## [Disposal Precautions]

### **CAUTION**

- When disposing of this product, treat it as industrial waste.

# ● CONDITIONS OF USE FOR THE PRODUCT ●

- (1) MELSEC programmable controller ("the PRODUCT") shall be used in conditions;
- i) where any problem, fault or failure occurring in the PRODUCT, if any, shall not lead to any major or serious accident; and
  - ii) where the backup and fail-safe function are systematically or automatically provided outside of the PRODUCT for the case of any problem, fault or failure occurring in the PRODUCT.
- (2) The PRODUCT has been designed and manufactured for the purpose of being used in general industries. MITSUBISHI ELECTRIC SHALL HAVE NO RESPONSIBILITY OR LIABILITY (INCLUDING, BUT NOT LIMITED TO ANY AND ALL RESPONSIBILITY OR LIABILITY BASED ON CONTRACT, WARRANTY, TORT, PRODUCT LIABILITY) FOR ANY INJURY OR DEATH TO PERSONS OR LOSS OR DAMAGE TO PROPERTY CAUSED BY the PRODUCT THAT ARE OPERATED OR USED IN APPLICATION NOT INTENDED OR EXCLUDED BY INSTRUCTIONS, PRECAUTIONS, OR WARNING CONTAINED IN MITSUBISHI ELECTRIC USER'S, INSTRUCTION AND/OR SAFETY MANUALS, TECHNICAL BULLETINS AND GUIDELINES FOR the PRODUCT.
- ("Prohibited Application")
- Prohibited Applications include, but not limited to, the use of the PRODUCT in;
- Nuclear Power Plants and any other power plants operated by Power companies, and/or any other cases in which the public could be affected if any problem or fault occurs in the PRODUCT.
  - Railway companies or Public service purposes, and/or any other cases in which establishment of a special quality assurance system is required by the Purchaser or End User.
  - Aircraft or Aerospace, Medical applications, Train equipment, transport equipment such as Elevator and Escalator, Incineration and Fuel devices, Vehicles, Manned transportation, Equipment for Recreation and Amusement, and Safety devices, handling of Nuclear or Hazardous Materials or Chemicals, Mining and Drilling, and/or other applications where there is a significant risk of injury to the public or property.
- Notwithstanding the above restrictions, Mitsubishi Electric may in its sole discretion, authorize use of the PRODUCT in one or more of the Prohibited Applications, provided that the usage of the PRODUCT is limited only for the specific applications agreed to by Mitsubishi Electric and provided further that no special quality assurance or fail-safe, redundant or other safety features which exceed the general specifications of the PRODUCTS are required. For details, please contact the Mitsubishi Electric representative in your region.
- (3) Mitsubishi Electric shall have no responsibility or liability for any problems involving programmable controller trouble and system trouble caused by DoS attacks, unauthorized access, computer viruses, and other cyberattacks.

# INTRODUCTION

---

Thank you for purchasing the CC-Link IE Field Network Ethernet adapter module (hereinafter abbreviated as the Ethernet adapter module).

This manual describes the operating procedure, system configuration, parameter setting, functions, and troubleshooting of the Ethernet adapter module.

Before using this product, please read this manual and the relevant manuals carefully and develop familiarity with the functions and performance of the Ethernet adapter module to handle it correctly.

When applying the program examples introduced in this manual to the actual system, ensure the applicability and confirm that it will not cause system control problems.

Please make sure that the end users read this manual.

# RELEVANT MANUALS

## (1) CC-Link IE Field Network (relevant) manuals

When using the CC-Link IE Field Network for the first time, refer to the CC-Link IE Field Network Master/Local Module User's Manual first. The following shows the structure of the CC-Link IE Field Network manuals.

Manual name <manual number (model code)>	Description
MELSEC-Q CC-Link IE Field Network Master/Local Module User's Manual <SH-080917ENG, 13JZ47>	Overview of CC-Link IE Field Network, and specifications, procedures before operation, system configuration, installation, wiring, settings, functions, programming, and troubleshooting of the MELSEC-Q series master/local module
MELSEC-L CC-Link IE Field Network Master/Local Module User's Manual <SH-080972ENG, 13JZ54>	Overview of CC-Link IE Field Network, and specifications, procedures before operation, system configuration, installation, wiring, settings, functions, programming, and troubleshooting of the MELSEC-L series master/local module
MELSEC-QS CC-Link IE Field Network Master/Local Module User's Manual <SH-080969ENG, 13JZ53>	Overview of CC-Link IE Field Network, and specifications, procedures before operation, system configuration, installation, wiring, settings, functions, programming, and troubleshooting of the MELSEC-QS series master/local module
CC-Link IE Field Network Interface Board User's Manual (For SW1DNC-CCIEF-B) <SH-080980ENG, 13JZ58>	Specifications, procedures before operation, system configuration, settings, functions, programming, and troubleshooting of the CC-Link IE Field Network interface board

## (2) Ethernet related manual

For communications using SLMP, refer to the following manual.

Manual name <manual number (model code)>	Description
SLMP Reference Manual <SH-080956ENG, 13JV23>	The protocol (SLMP) used for data reading or writing from an external device to the Ethernet adapter module

# CONTENTS

SAFETY PRECAUTIONS .....	1
CONDITIONS OF USE FOR THE PRODUCT .....	5
INTRODUCTION .....	6
RELEVANT MANUALS .....	7
MANUAL PAGE ORGANIZATION .....	12
TERMS .....	13
PACKING LIST .....	15
<hr/>	
<b>CHAPTER 1 ETHERNET ADAPTER MODULE</b> .....	<b>16</b>
<hr/>	
<b>CHAPTER 2 PART NAMES</b> .....	<b>22</b>
<hr/>	
2.1 Power Supply Part .....	23
2.2 CC-Link IE Field Network Part .....	24
2.3 Ethernet Part .....	28
<hr/>	
<b>CHAPTER 3 SPECIFICATIONS</b> .....	<b>29</b>
<hr/>	
3.1 General Specifications .....	29
3.2 Performance Specifications .....	30
3.2.1 Performance specifications of each part .....	31
3.3 List of the Functions .....	36
3.4 Buffer Memory List .....	37
3.5 SLMP .....	44
3.5.1 Available command list .....	44
3.5.2 Ranges of accessible devices and buffer memory .....	45
<hr/>	
<b>CHAPTER 4 PROCEDURE BEFORE THE OPERATION</b> .....	<b>46</b>
<hr/>	
4.1 Start-Up Procedure .....	46
<hr/>	
<b>CHAPTER 5 SYSTEM CONFIGURATION</b> .....	<b>48</b>
<hr/>	
5.1 Network Configuration .....	48
5.2 Network Components .....	49
5.2.1 CC-Link IE Field Network .....	49
5.2.2 Ethernet .....	49
5.3 Applicable Systems .....	51
5.3.1 Configuration tool .....	51
5.3.2 Software package .....	53
<hr/>	
<b>CHAPTER 6 INSTALLATION AND WIRING</b> .....	<b>54</b>
<hr/>	
6.1 Installation Environment .....	54
6.2 Installation .....	55
6.2.1 Installation precautions .....	55
6.2.2 Mounting the module to a control panel .....	55
6.2.3 Mounting the modules on a DIN rail .....	56
6.3 Testing the Module Before Wiring .....	59

6.4	Wiring	61
6.4.1	Wiring of the power supply part	61
6.4.2	Ethernet cable wiring	63
6.4.3	Grounding	66
6.4.4	Precautions	67

---

<b>CHAPTER 7 COMMUNICATION OF THE ETHERNET ADAPTER MODULE</b>	<b>68</b>
---	-----------

---

7.1	SLMP Communication and Cyclic Transmission	68
7.1.1	System configuration	68
7.1.2	Communication details	69
7.1.3	Network setting on the configuration computer	71
7.1.4	Connection to CC-Link IE Field Network	73
7.1.5	Connection to Ethernet	78
7.2	Communication Using the On-demand Function	90
7.2.1	System configuration	90
7.2.2	Specifications of send data using the on-demand function	90
7.2.3	Applicable range of on-demand data	91
7.2.4	How to send on-demand data	92
7.2.5	Buffer memories used for the on-demand function	93
7.2.6	On-demand data format	99
7.2.7	Example of on-demand data sending	103
7.3	IP Communications over CC-Link IE Field Network (IP Packet Transfer Function)	107
7.3.1	Deciding the IP address	108
7.3.2	System configuration	111
7.3.3	Network setting of the configuration computer	111
7.3.4	Connection to CC-Link IE Field Network	112
7.3.5	Connection to Ethernet	121
7.3.6	Checking communications (IP communication test)	124
7.3.7	Setting for when the network addresses are different	127
7.4	MELSOFT Connection	130
7.4.1	Setting for connection between the Ethernet adapter module and a GOT	131
7.4.2	Connection through a hub	133
7.4.3	Direct connection (simple connection)	137

---

<b>CHAPTER 8 MAINTENANCE AND INSPECTION</b>	<b>140</b>
---	------------

---

8.1	Daily Inspection	140
8.2	Periodic Inspection	141

---

<b>CHAPTER 9 TROUBLESHOOTING</b>	<b>142</b>
----------------------------------	------------

---

9.1	Troubleshooting Procedure	142
9.2	Checking the Error Code	144
9.2.1	Error history of CC-Link IE Field Network diagnostics	144
9.2.2	Ethernet Adapter Diagnostics	146
9.3	Checking the LEDs	147
9.3.1	The LED on the power supply part	147

9.3.2	The LEDs on the CC-Link IE Field Network part . . . . .	148
9.3.3	The LEDs on the Ethernet part . . . . .	152
9.4	Troubleshooting by Symptom . . . . .	154
9.4.1	Cyclic transmission cannot be performed . . . . .	154
9.4.2	Transient transmission cannot be performed . . . . .	154
9.4.3	Configuration tool does not start, or communication is not available . . . . .	155
9.4.4	Configuration tool is not displayed in English . . . . .	156
9.4.5	New function or improved function cannot be used . . . . .	157
9.4.6	Communication using SLMP cannot be performed . . . . .	158
9.4.7	Communications cannot be performed using the IP packet transfer function . . . . .	159
9.5	Error Code List . . . . .	161

---

<b>CHAPTER 10 CONFIGURATION TOOL</b>	<b>179</b>
--------------------------------------	------------

---

10.1	Starting Procedure . . . . .	179
10.1.1	Preparation before starting the tool . . . . .	179
10.1.2	Starting up the configuration tool . . . . .	184
10.2	Window Structure . . . . .	186
10.2.1	Main window structure . . . . .	186
10.2.2	Menu bar elements . . . . .	187
10.2.3	Toolbar elements . . . . .	187
10.3	Parameters . . . . .	188
10.3.1	System setting . . . . .	189
10.3.2	CC-Link IE Field Network . . . . .	190
10.3.3	Ethernet setting . . . . .	193
10.3.4	Precautions . . . . .	198
10.4	Destination Setting . . . . .	199
10.5	Parameter Writing/Reading . . . . .	200
10.5.1	Parameter writing . . . . .	200
10.5.2	Parameter reading . . . . .	200
10.6	Device/Buffer Memory Batch Monitor . . . . .	201
10.7	Ethernet Adapter Diagnostics . . . . .	203

---

<b>APPENDICES</b>	<b>205</b>
-------------------	------------

---

Appendix 1	Buffer Memory Details . . . . .	205
Appendix 1.1	Module operation area . . . . .	206
Appendix 1.2	Own station information . . . . .	208
Appendix 1.3	Ethernet port operation area . . . . .	209
Appendix 1.4	Ethernet port error log area . . . . .	215
Appendix 1.5	Ethernet port line status . . . . .	216
Appendix 1.6	Ethernet port connection status data area . . . . .	217
Appendix 1.7	On-demand function data sending area . . . . .	217
Appendix 2	Link Special Relay (SB) List . . . . .	218
Appendix 3	Link Special Register (SW) List . . . . .	219
Appendix 4	Special Relay (SM) List . . . . .	221
Appendix 5	Special Register (SD) List . . . . .	223



Appendix 6	Resetting Parameters to Factory Default Values	229
Appendix 7	Access Codes and an Attribute Code	230
Appendix 8	EMC and Low Voltage Directives	231
Appendix 8.1	Measures to comply with the EMC Directive	231
Appendix 8.2	Measures to comply with the Low Voltage Directive	236
Appendix 9	Processing Time	237
Appendix 9.1	Transmission from the external device to the Ethernet adapter module	237
Appendix 9.2	Transmission from the external device to a CPU module through the Ethernet adapter module	238
Appendix 10	New Function and Improved Function	240
Appendix 11	Checking the Serial Number and Function Version	241
Appendix 12	External Dimensions	243

---

<b>INDEX</b>	<b>245</b>
--------------	------------

---

REVISIONS	248
WARRANTY	249
TRADEMARKS	250

# MANUAL PAGE ORGANIZATION

In this manual, pages are organized and the symbols are used as shown below.

The following illustration is for explanation purpose only, and should not be referred to as an actual documentation.

Annotations on the left side of the page:

- "" is used for screen names and items.
- 1. shows operating procedures.
- ☞ shows mouse operations.\*1
- [ ] is used for items in the menu bar and the project window.
- Ex. shows setting or operating examples.
- 📖 shows reference manuals.
- 📄 shows reference pages.

Annotations on the right side of the page:

- The chapter of the current page is shown.
- The section of the current page is shown.
- Point shows notes that requires attention.
- Remark shows useful information.

Page content includes:

CHAPTER 7 VARIOUS SETTINGS

### 7.1.1 Setting method

(1) Setting parameters

(a) Operating procedure

1. Open the "PLC Parameter" dialog box.  
☞ Project window->[Parameter]-☞[PLC parameter]
2. Select the "IO Assignment" tab.

Item	Description	Reference
Type	Select the type of the connected module.	Page 74, Section 7.1.2
Model Name	Select the model name of the connected module.	Page 74, Section 7.1.3
Points	Select the number of points assigned to each slot.	Page 74, Section 7.1.4
Start XY	Specify a start I/O number for each slot.	Page 74, Section 7.1.5
[Switch Setting]	Configure the switch setting of the built-in I/O or intelligent function modules.	Page 74, Section 7.1.6
[Detailed Setting]	Set the following. - Error Time Output Mode - PLC Operation Mode at HW Error - I/O Response Time	Page 75, Section 7.1.7

Setting "Start X/Y" enables modification on the start I/O numbers assigned to connected modules.

Ex. When "1000" is specified in "Start X/Y" to the slot where a 16-point module is connected, the assignment range of an input module is changed to X1000 to X100F.

For details, refer to the following:  
MELSEC-L CPU Module User's Manual (Function Explanation, Program Fundamentals)

Point  
Set the type of the connected module in "Type". Setting a different type results in "SPUNIT LAY ERR". For the intelligent function module, the I/O points must also be the same in addition to the I/O assignment setting.  
☞ Page 30, Section 4.2.2)

Remark  
When an intelligent module is connected, I/O assignment can be omitted by selecting connected modules from "Intelligent Function Module" in the Project window.

73

\*1 The mouse operation example (for GX Works2) is provided below.

Annotations on the left side of the screenshot:

- Menu bar  
Ex. ☞ [Online] ☞ [Write to PLC...]  
Select [Online] on the menu bar, and then select [Write to PLC...].
- A window selected in the view selection area is displayed.  
Ex. ☞ Project window ☞ [Parameter] ☞ [PLC Parameter]  
Select [Project] from the view selection area to open the Project window. In the Project window, expand [Parameter] and select [PLC Parameter].
- View selection area

The screenshot shows the MELSOFT Series GX Works2 interface with the following elements:

- Menu bar: Project, Edit, Find/Replace, Compile, View, Online, Debug, Diagnostics
- Navigation pane: Project, Parameter, Intelligent Function Module, Global Device Comment, Program Setting, POU, Program, MAIN, Local Device Comment, Device Memory, Device Initial Value
- View selection area: Project, User Library, Connection Destination
- Main workspace: [PRG] MAIN

# TERMS

Unless otherwise specified, this manual uses the following terms.

Term	Description
Buffer memory	A memory in an Ethernet adapter module, where data (such as Ethernet port information, setting values, and monitoring values) are stored
CC-Link IE Field Network	A high-speed and large-capacity open field network that is based on Ethernet (1000BASE-T)
Configuration tool	A software package built in an Ethernet adapter module
Cyclic transmission	A function by which data are periodically exchanged among stations on the same network using link devices (RX, RY, RWw, and RWr)
Data link	A generic term for cyclic transmission and transient transmission
Dedicated instruction	An instruction that simplifies programming for using functions of intelligent function modules
Device	A device (X, Y, W, or others) in an Ethernet adapter module
Disconnection	A process of stopping data link if a data link error occurs
Ethernet adapter module	The abbreviation for the N22GF-ETB CC-Link IE Field Network Ethernet adapter module
External device	A generic term for devices that send SLMP request messages to an Ethernet adapter module
GX Works2	The product name of the software package for the MELSEC programmable controllers
Intelligent device station	A station that exchanges I/O signals (bit data) and I/O data (word data) with the master station by cyclic transmission. This station responds to a transient transmission request from another station and also issues a transient transmission request to another station.
Link device	A device (RX, RY, RWr, or RWw) in a module on CC-Link IE Field Network
Link special register (SW)	Word data that indicates the operating status and data link status of a module on CC-Link IE Field Network
Link special relay (SB)	Bit data that indicates the operating status and data link status of a module on CC-Link IE Field Network
Local station	A station that performs cyclic transmission and transient transmission with the master station and other local stations. The station is controlled by programs in the CPU module or other equivalent modules on the station.
Master station	A station that controls the entire network. This station can perform cyclic transmission and transient transmission with all stations. Only one master station can be used in a network.
Master/local module	A generic term for the CC-Link IE Field Network master/local modules: QJ71GF11-T2, QS0J71GF11-T2, and LJ71GF11-T2
Network module	A generic term for the following modules: <ul style="list-style-type: none"> <li>• Module on CC-Link IE Field Network</li> <li>• CC-Link IE Controller Network module</li> <li>• Ethernet interface module</li> <li>• MELSECNET/H module</li> <li>• MELSECNET/10 module</li> </ul>
Parameter memory	A flash ROM in an Ethernet adapter module, where the parameters of the Ethernet adapter module are stored
Relay station	A station that includes two or more network modules. Data are passed through this station to stations on other networks
Remote device station	A station that exchanges I/O signals (bit data) and I/O data (word data) with the master station by cyclic transmission. This station responds to a transient transmission request from another station.
Remote I/O station	A station that exchanges I/O signals (bit data) with the master station by cyclic transmission
Remote input (RX)	Bit data input from a slave station to the master station (For some areas in a local station, data are input in the opposite direction.)  User's manual for the master/local module used
Remote output (RY)	Bit data output from the master station to a slave station (For some areas in a local station, data are output in the opposite direction.)  User's manual for the master/local module used
Remote register (RWr)	Word data input from a slave station to the master station (For some areas in a local station, data are input in the opposite direction.)  User's manual for the master/local module used
Remote register (RWw)	Word data output from the master station to a slave station (For some areas in a local station, data are output in the opposite direction.)  User's manual for the master/local module used
Request message	An SLMP message sent from an external device to an Ethernet adapter module

Term	Description
Reserved station	A station reserved for future use. This station is not actually connected, but counted as a connected station
Response message	An SLMP message sent from an Ethernet adapter module to an external device
Return	A process of restarting data link when a station recovers from an error
RIRD	The abbreviation for JP.RIRD and GP.RIRD. This dedicated instruction is used in programs of the master/local module.
RIWT	The abbreviation for JP.RIWT and GP.RIWT. This dedicated instruction is used in programs of the master/local module.
Routing	A process of selecting paths for communication with other networks. CC-Link IE Field Network requires communication paths to be preset using routing parameters to communicate with stations on different networks. An Ethernet adapter module does not require routing parameters. Communications with other networks are performed according to the routing parameters set to the master station.
Slave station	A generic term for stations other than a master station: local station, remote I/O station, remote device station, and intelligent device station
SLMP	The abbreviation for Seamless Message Protocol. This protocol is used to access an SLMP-compatible device or a programmable controller connected to an SLMP-compatible device from an external device.
Transient transmission	A function of communication with another station, which is used when requested by a dedicated instruction or GX Works2

# PACKING LIST

The following items are included in the package of this product. Before use, check that all the items are included.

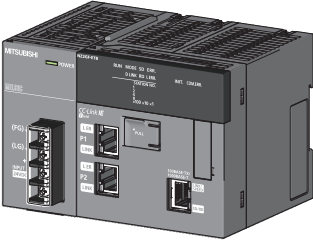
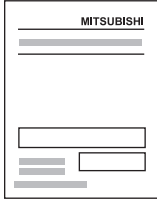
NZ2GF-ETB	
	
Ethernet adapter module	Safety Guidelines (IB-0800463)

# CHAPTER 1 ETHERNET ADAPTER MODULE

The Ethernet adapter module connects external devices on the Ethernet network to CC-Link IE Field Network.

For details on CC-Link IE Field Network, refer to the following.

 User's manual for the master/local module used

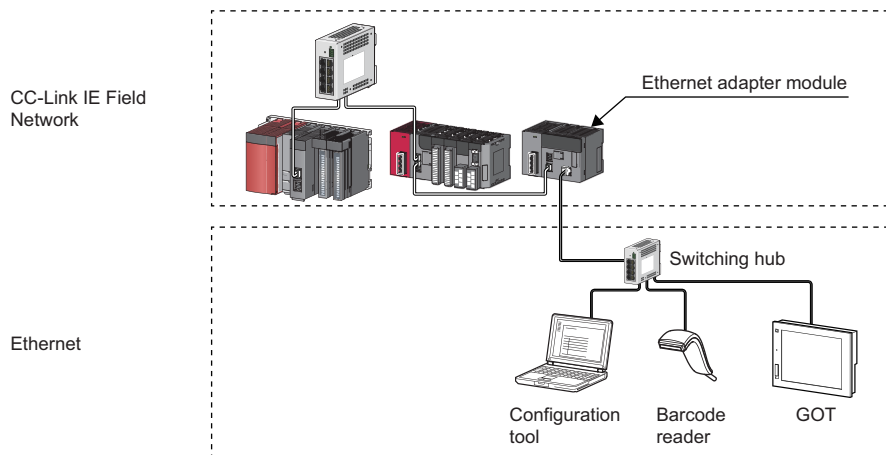

## (1) Communication using SLMP

### (a) Data of the programmable controller device can be read/written

Device data can be read or written from an external device to a module on the network where the Ethernet adapter module is connected. Data reading and writing is also available to the devices of the Ethernet adapter module. For details on SLMP, refer to the following.

 SLMP Reference Manual

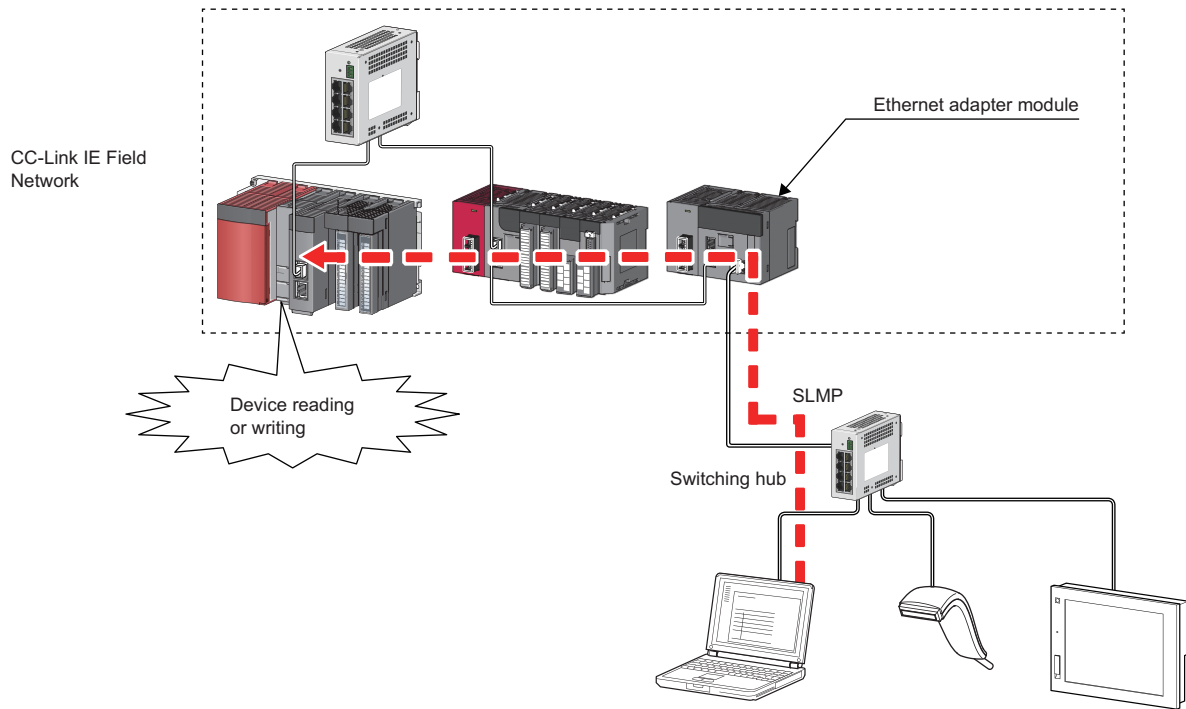

### (b) The on-demand function enables data to be sent from the programmable controller

Issuing a send request from the CPU module to the Ethernet adapter module allows data to be sent to the external device. ( Page 90, Section 7.2)

Events such as link start instruction and read instruction can be notified to an external device.

In addition, data can be simultaneously sent to all the external devices on Ethernet where the Ethernet adapter module is also connected (broadcast communications).

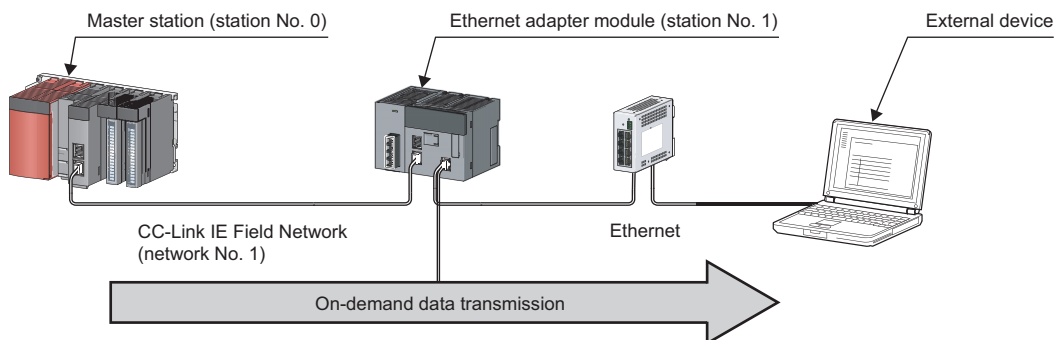

## (2) Connection of MC protocol devices

The message format of SLMP is the same as that of the QnA compatible 3E or 4E frame format of the MC protocol. Therefore, external devices that support the MC protocol can be connected to CC-Link IE Field Network.

## (3) Communications using the specified IP address over CC-Link IE Field Network (IP packet transfer function)

With this function, communications using the specified IP address can be performed over CC-Link IE Field Network. (☞ Page 107, Section 7.3)

For example, a personal computer can communicate with the FTP server. Two networks of CC-Link IE Field Network and Ethernet are not required, resulting in reduced wiring cost.

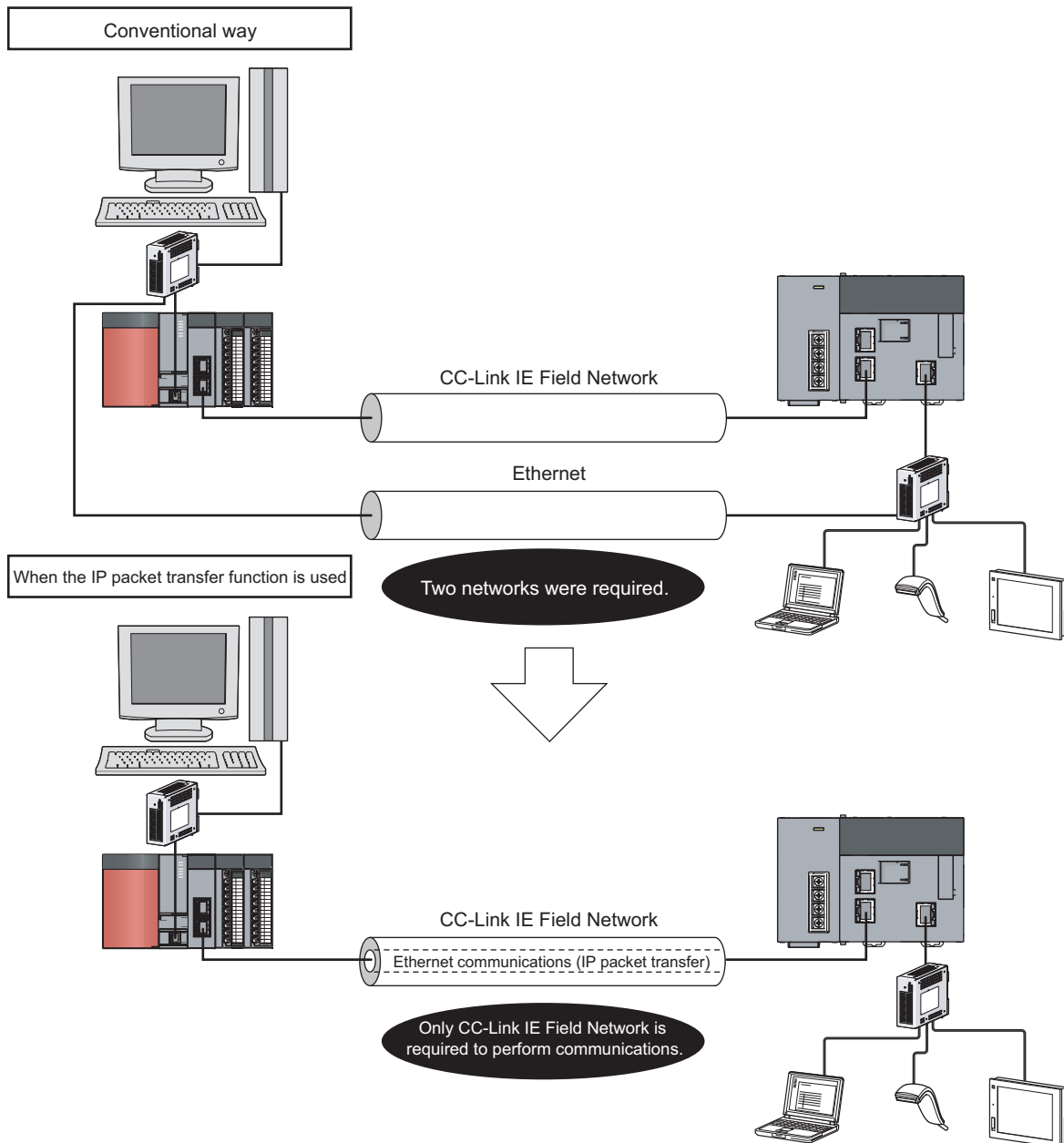



**Point**

The IP packet transfer function allows an IP packet to be transferred from an external device to a request destination. An Ethernet adapter module cannot be used as a request source or a request destination.

**(4) Connection to MELSOFT products or GOTs**

The Ethernet adapter module can be also connected to MELSOFT products or GOTs.

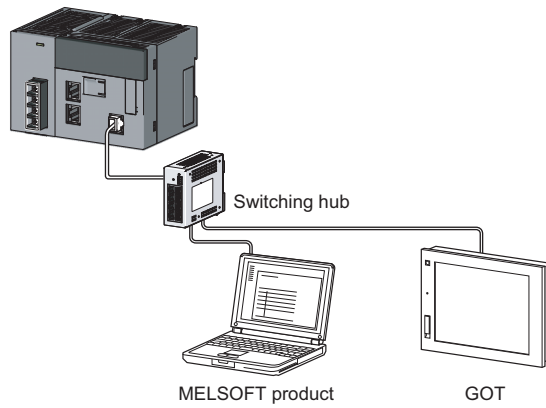

**(5) Cyclic transmission**

Data can be periodically exchanged with the master station through link devices (RX, RY, RWr, and RWw). (Page 33, Section 3.2.1 (2))

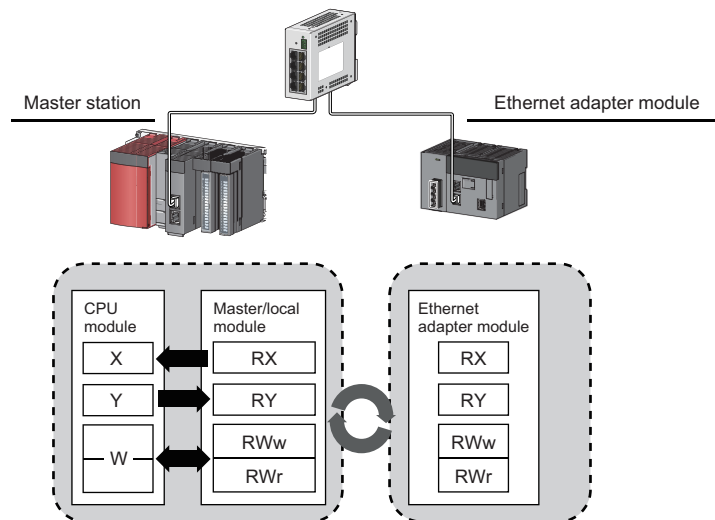

## (6) Transient transmission

Transient transmission allows direct access from a master or local station to the devices or buffer memory of the Ethernet adapter module.

Requests from the master or local station to the Ethernet adapter module are made with dedicated instructions.

(📖 User's manual for the master/local module used)

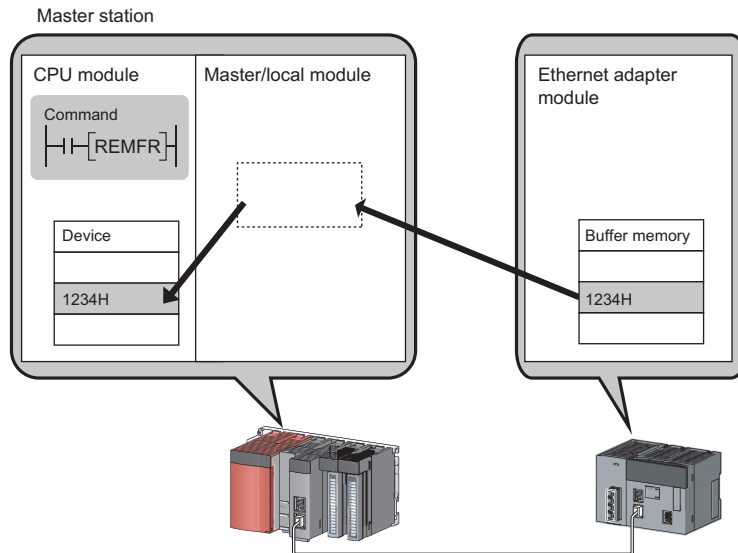

## (7) Parameter setting

Parameters can be set in the configuration tool incorporated in the Ethernet adapter module. (👉 Page 188, Section 10.3)

Therefore, there is no need to create any configuration programs. The configuration tool will be started from a Web browser.

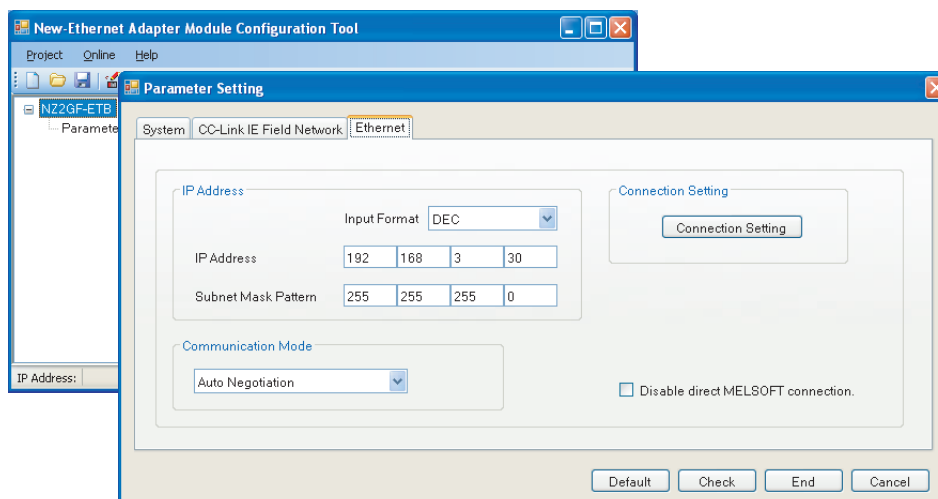

**(8) Diagnostics**

**(a) CC-Link IE Field Network diagnostics**

By connecting GX Works2 to a master/local module, the condition of the entire CC-Link IE Field Network can be viewed on the CC-Link IE Field Network diagnostics dialog box. (📖 User's manual for the master/local module used)

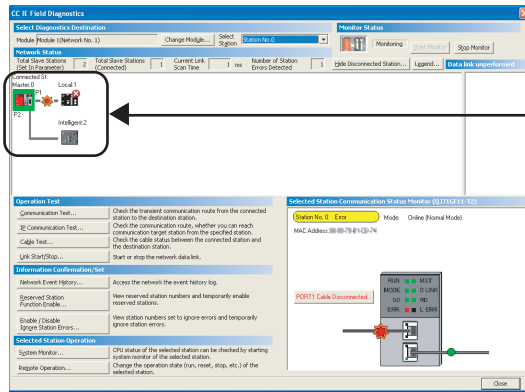

The status of the entire CC-Link IE Field Network can be monitored.

**(b) Ethernet adapter diagnostics**

In the Ethernet Adapter Diagnostics dialog box, the condition, such as an error occurred in communication with an external device, can be checked. (📖 Page 203, Section 10.7)

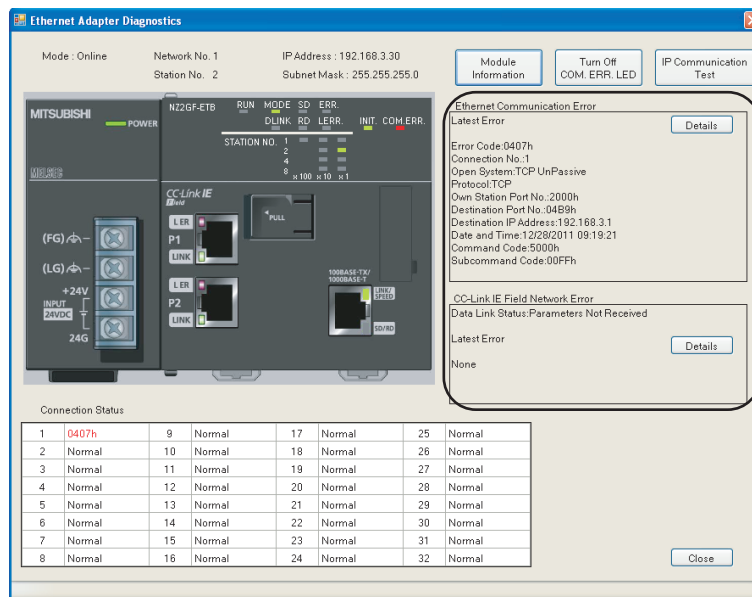

# CHAPTER 2 PART NAMES

This chapter describes the Ethernet adapter module parts and their names.

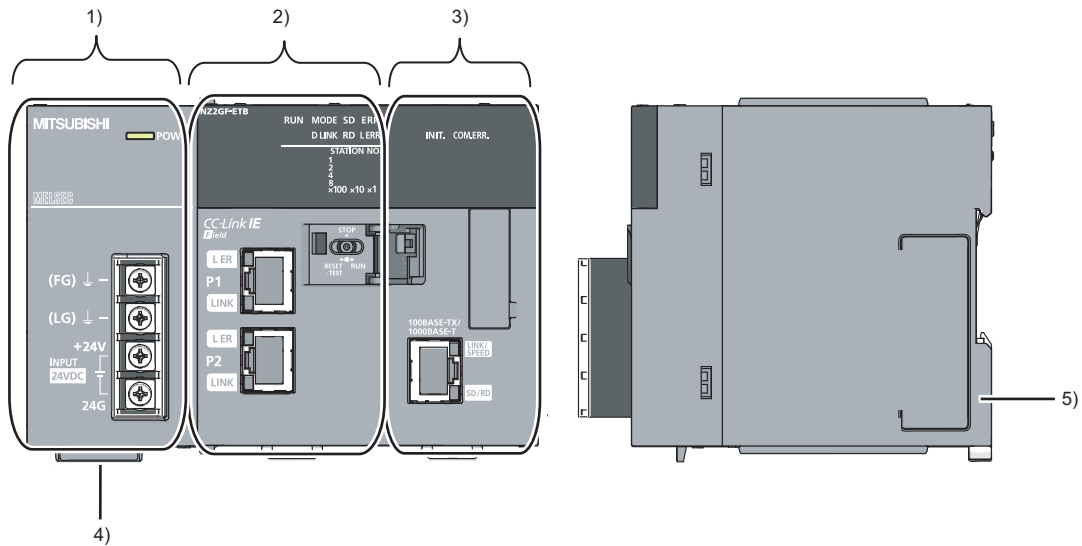

No.	Name	Description
1)	Power supply part	Power is supplied to the Ethernet adapter module through this part. (24VDC) (☞ Page 23, Section 2.1)
2)	CC-Link IE Field Network part	The Ethernet adapter module is connected to CC-Link IE Field Network at this part. <ul style="list-style-type: none"> <li>The communication status of CC-Link IE Field Network is indicated with the LEDs. (☞ Page 24, Section 2.2 (1))</li> <li>The switch on this part is used for controlling the operation of the Ethernet adapter module. (☞ Page 26, Section 2.2 (2))</li> </ul>
3)	Ethernet part	The Ethernet adapter module is connected to the Ethernet at this part. The communication status of the Ethernet is indicated with the LEDs. (☞ Page 28, Section 2.3)
4)	Serial number display	The serial number on the rating plate is indicated.
5)	DIN rail hook	This hook is used to mount the module to a DIN rail.

## 2.1 Power Supply Part

Respective names of the Ethernet adapter module's power supply part are shown below.

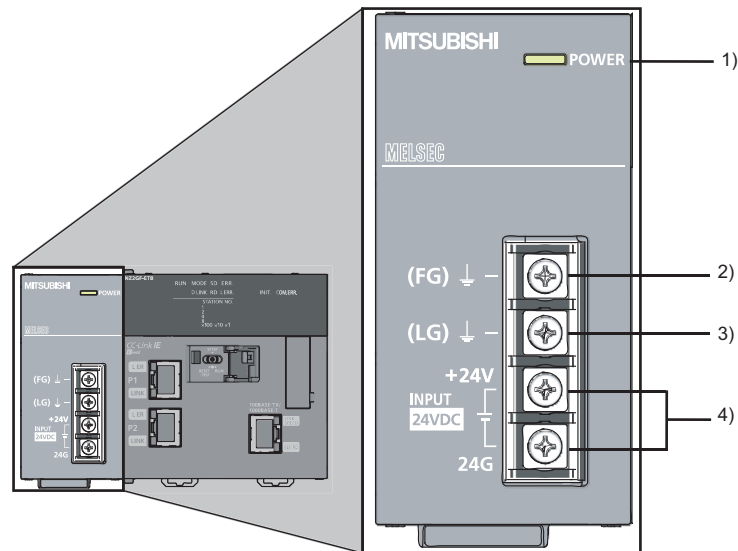

No.	Name	Part
1)	POWER LED	Indicates the operating status of the power supply part. <ul style="list-style-type: none"> <li>• On (green): Normally operating.</li> <li>• Off: No power input, power failure, or hardware failure</li> </ul>
2)	FG terminal	A ground terminal connected to the shield pattern on the printed circuit board (M3.5 screws)
3)	LG terminal	A terminal grounded to a power filter (M3.5 screws)
4)	Power input terminal	Terminals for power input. (M3.5 screws) For the specifications of the power supply to be connected, refer to "Performance specifications of each part." (☞ Page 31, Section 3.2.1 (1))

## 2.2 CC-Link IE Field Network Part

Respective names of the Ethernet adapter module's CC-Link IE Field Network part are shown below.

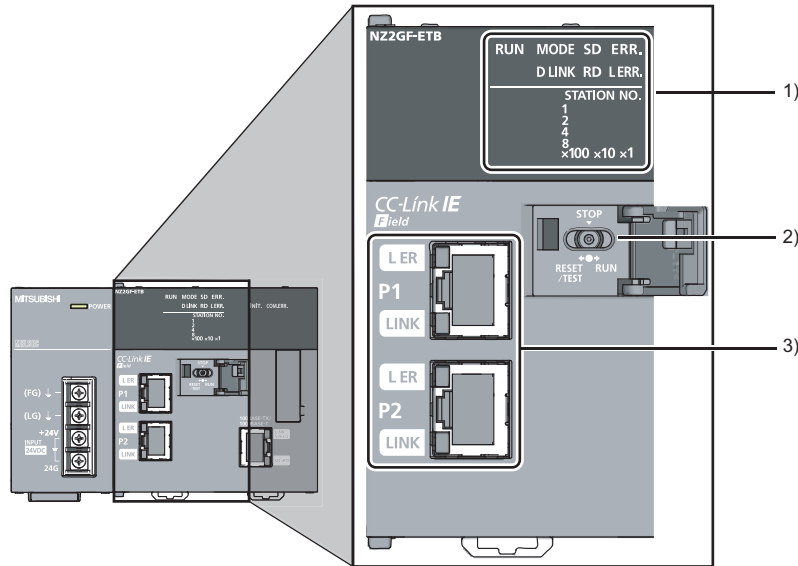

### (1) LEDs

Name	Description
RUN LED	<p>Indicates the operating status.</p> <p>On: Normally operating. (RUN status)</p> <p>Flashing: Normally operating. (STOP status)</p> <ul style="list-style-type: none"> <li>The Ethernet adapter module's switch is set to STOP. (Data transfer among the Ethernet adapter module devices is stopped.)</li> <li>The master station is in the STOP status. (Data transfer among the Ethernet adapter module devices is continued.)</li> <li>A remote STOP request is being received.</li> <li>The Ethernet adapter module stopped due to an error (except a watchdog timer error).</li> </ul> <p>Off: A hardware failure or a watchdog timer error has occurred.</p>
MODE LED	<p>Indicates the mode.</p> <p>On: Online mode</p> <p>Flashing: Test mode</p> <p>Off: Offline mode</p>
D LINK LED	<p>Indicates the data link status of CC-Link IE Field Network.</p> <p>On: Data link in operation (cyclic transmission in progress)</p> <p>Flashing: Data link in operation (cyclic transmission stopped)</p> <p>Off: Data link not in operation (disconnected) or the module is in offline mode.</p>
SD LED	<p>Indicates the data sending status on CC-Link IE Field Network.</p> <p>On: Data being sent</p> <p>Off: No data being sent</p>
RD LED	<p>Indicates the data receiving status on CC-Link IE Field Network.</p> <p>On: Data being received</p> <p>Off: No data being received</p>

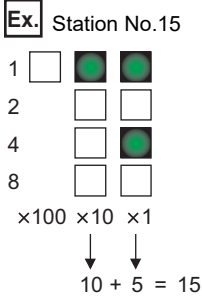
Name	Description
ERR. LED	<p>Indicates the error status of the Ethernet adapter module. The error details can be checked by the CC-Link IE Field Network diagnostics. (Page 144, Section 9.2.1)</p> <p>On: One of the following errors occurred in the Ethernet adapter module.</p> <ul style="list-style-type: none"> <li>Multiple modules with the same station number exist on CC-Link IE Field Network.</li> <li>Network parameters for CC-Link IE Field Network is corrupted. Or, there is an error in the reserved station setting, the number of connected stations, or the network number setting.</li> <li>There is an error in the network parameter settings for the Ethernet adapter module.</li> </ul> <p>Off: Normally operating.</p>
L ERR. LED	<p>Indicates the error status of the received data and the line. When this LED is on, check the L ER LED for "P1" or "P2" to see on which port the error was detected.</p> <p>The error details can be checked by the CC-Link IE Field Network diagnostics. (Page 144, Section 9.2.1)</p> <p>This LED automatically turns off when the module has received normal data and loopback is completed.</p> <p>On:</p> <ul style="list-style-type: none"> <li>The Ethernet adapter module has received abnormal data.</li> <li>The Ethernet adapter module is performing loopback (only the Ethernet adapter module with a serial number (first five digits) of "12102" or later).</li> </ul> <p>Off:</p> <ul style="list-style-type: none"> <li>The Ethernet adapter module has received normal data.</li> <li>The Ethernet adapter module does not perform loopback (only the Ethernet adapter module with a serial number (first five digits) of "12102" or later).</li> </ul>
STATION NO.	<p>Indicates the station number of the Ethernet adapter module.</p> <p>On: Indicates the station number.</p> <p><b>Ex.</b> Station No.15</p>  <p>Off: The station number has not been set.</p>

**Remark**

- LED indication during line test execution
  - While a line test is being performed from the master station, the following LEDs are flashing.
    - MODE LED
    - D LINK LED
    - x100 LED

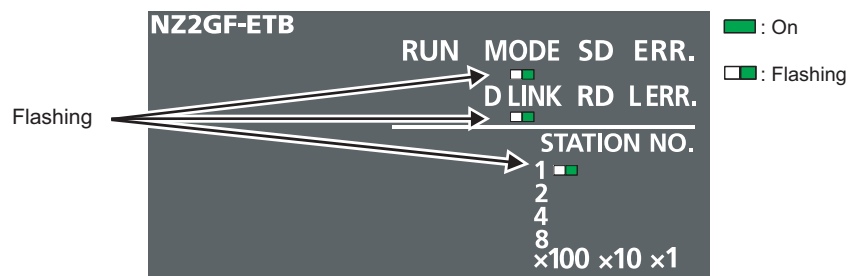

For execution of the line test, refer to the following.  
 User's manual for the master/local module used

## (2) Switch

With this switch, the operation of the Ethernet adapter module can be controlled.

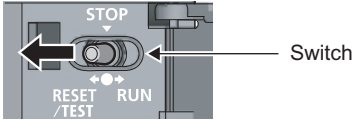
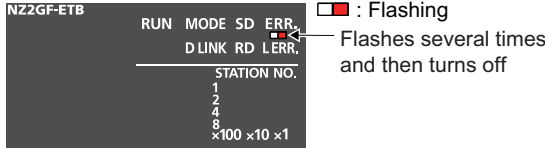
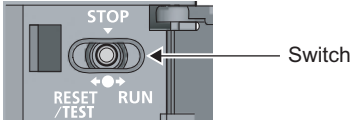
Name	Description
RESET/ TEST	<p>The Ethernet adapter module can be reset by the following method. Set the switch with your fingertip. Using a tool such as a screwdriver may damage the switch.</p> <ol style="list-style-type: none"> <li><b>Shift the switch to RESET/TEST for one second or longer.</b> Hold the switch and do not release it.</li> </ol>  <ol style="list-style-type: none"> <li><b>Confirm that the ERR. LED flashes several times and then turns off.</b></li> </ol>  <ol style="list-style-type: none"> <li><b>Set the switch back to the STOP position.</b> The switch will automatically return to the STOP position when released.</li> </ol>  <p>You can also switch the Ethernet adapter module to the test mode and reset the parameters to default values. For switching to the test mode, refer to "Testing the Module Before Wiring." (Page 59, Section 6.3) For resetting the parameters to default values, refer to "Resetting Parameters to Factory Default Values." (Page 229, Appendix 6)</p>
STOP*1	<p>Transfer between the link devices (cyclic data from the master station) and the devices of the Ethernet adapter module is stopped. (Transfer is stopped while cyclic transmission with the master station is continued.) This transfer stop can prevent the data exchanged between an external device and the Ethernet adapter module from being sent to the master and local stations. The STOP switch is used for a purpose, such as debugging between the Ethernet adapter module and external devices.</p> <p><b>Ex.</b> Debugging communication data with an external device using the STOP switch</p> <ol style="list-style-type: none"> <li>Set the switch to "STOP."</li> <li>Data transfer between the link devices and devices of the Ethernet adapter module is stopped, and the Ethernet adapter module is separated from the master station control.</li> <li>Check if communications are normally performed between the Ethernet adapter module and an external device. Because transfer is stopped, data exchanged between the Ethernet adapter module and the external device will not be sent to the master and local stations.</li> <li>After checking the above, write the parameters to the Ethernet adapter module and start the system operation.</li> </ol>
RUN	<p>Cyclic transmission starts between the Ethernet adapter module and the master station. (Data communication between the Ethernet adapter module and external devices is performed regardless of the switch status.)</p>

\*1 Even if the switch is set to "STOP", the Ethernet adapter module is shown to be in the cyclic transmission status at the master station.



**(3) Connectors**

Name		Description
P1	—	The PORT1 connector for connecting to CC-Link IE Field Network. (RJ45 connector) Connect an Ethernet cable to this. (☞ Page 63, Section 6.4.2) There are no restrictions on the connection order of the cables for the "P1" and "P2" connectors.
	L ER LED	On: • The Ethernet adapter module has received abnormal data. • The Ethernet adapter module is performing loopback (only the Ethernet adapter module with a serial number (first five digits) of "12102" or later). Off: • The Ethernet adapter module has received normal data. • The Ethernet adapter module does not perform loopback (only the Ethernet adapter module with a serial number (first five digits) of "12102" or later).
	LINK LED	On: Linkup in progress Off: Linkdown in progress
P2	—	The PORT2 connector for connecting to CC-Link IE Field Network. (RJ45 connector) Connect an Ethernet cable to this. (☞ Page 63, Section 6.4.2) There are no restrictions on the connection order of the cables for the "P1" and "P2" connectors.
	L ER LED	(Same as the "P1" connector)
	LINK LED	(Same as the "P1" connector)

## 2.3 Ethernet Part

This section describes the names of the Ethernet adapter module's Ethernet part.

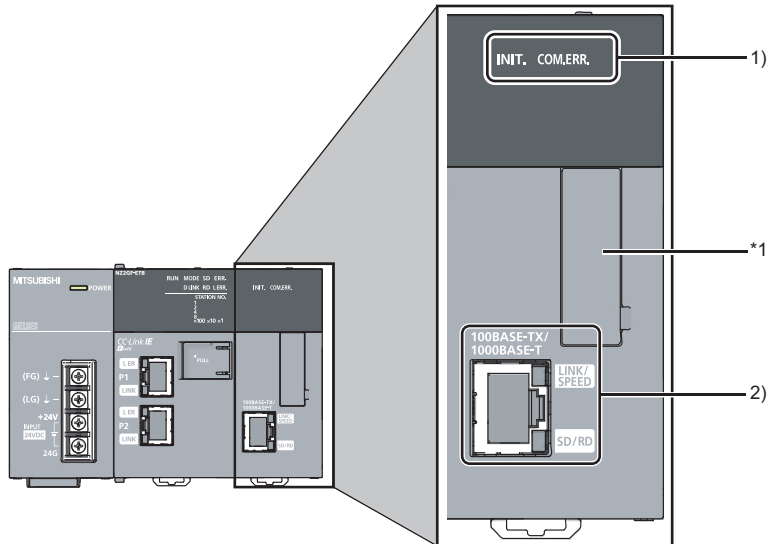

\*1 Do not remove this sticker since it is used for maintenance.

No.	Name	Description	
1)	INIT. LED	Indicates the initial processing status. On: Initial processing completed. Off: Initial processing not completed.	
	COM.ERR. LED	Indicates the Ethernet communication status. On: An error occurred in Ethernet communication. Off: Normal Ethernet communication	
2)	Ethernet port	—	Connector for Ethernet connection. (RJ45 connector) Connects an Ethernet cable. (Page 63, Section 6.4.2)
		LINK/SPEED	On (green): Linkup in progress at 1Gbps On (orange): Linkup in progress at 100Mbps Off: Linkdown in progress
		SD/RD	On: Data being sent or received in Ethernet communication Off: No data transfer in Ethernet communication

# CHAPTER 3 SPECIFICATIONS

This chapter describes the specifications of the Ethernet adapter module.

## 3.1 General Specifications

Item	Specification					
Operating ambient temperature	0 to 55°C					
Storage ambient temperature	-25 to 75°C					
Operating ambient humidity	5 to 95%RH, non-condensing					
Storage ambient humidity						
Vibration resistance	Compliant with JIS B 3502 and IEC 61131-2	Under intermittent vibration	Frequency	Constant acceleration	Half amplitude	Sweep count
			5 to 8.4Hz	—	3.5mm	10 times each in X, Y, and Z directions
		8.4 to 150Hz	9.8m/s <sup>2</sup>	—		
		Under continuous vibration	5 to 8.4Hz	—	1.75mm	—
8.4 to 150Hz	4.9m/s <sup>2</sup>	—				
Shock resistance	Compliant with JIS B 3502 and IEC 61131-2 (147m/s <sup>2</sup> , 3 times each in X, Y, and Z directions)					
Operating atmosphere	No corrosive gases					
Operating altitude*1	0 to 2000m					
Installation location	Inside a control panel					
Overvoltage category*2	II or lower					
Pollution degree*3	2 or lower					
Equipment class	Class I					

\*1 Do not use or store the Ethernet adapter module under pressure equivalent to the atmospheric pressure of an elevation of 0m or higher. Doing so may cause malfunction. When applying pressure to the module, please consult your local Mitsubishi representative.

\*2 This indicates the section of the power supply to which the equipment is assumed to be connected between the public power distribution network and the machinery within premises.  
Category II applies to equipment for which electric power is supplied from fixed facilities. The surge voltage withstand level for up to the rated voltage of 300V is 2500V.

\*3 This index indicates the degree to which conductive material is generated in terms of the environment in which the equipment is used.

At pollution level 2, only non-conductive pollution occurs. A temporary conductivity caused by condensing must be expected occasionally.



For compliance with the EMC directive, refer to "EMC and Low Voltage Directives" in this manual. (☞ Page 231, Appendix 8)

## 3.2 Performance Specifications

The following describes the performance specifications of the Ethernet adapter module.

Item		Specification
Number of device points	X	8192 points, 1KB (X0 to X1FFF are assigned to RX0 to RX1FFF.)
	Y	8192 points, 1KB (Y0 to Y1FFF are assigned to RY0 to RY1FFF.)
	W	8192 points, 16KB (1024 points of W0 to W3FF are assigned to RWw0 to RWw3FF. 1024 points of W1000 to W13FF are assigned to RWr0 to RWr3FF.)
	SB	8192 points, 1KB
	SW	8192 points, 16KB
	SM	2048 points, 256 bytes
	SD	2048 points, 4KB
Number of writes to the parameter memory		Up to 100000 times
Clock function (for display of data such as the date and time at which an error occurred)		Year, month, date, hour, minute, and second (with automatic leap year detection) When connected to a network, the clock is periodically synchronized with the clock in the CPU module on the master station via the network. (Initial value: 2000/1/1 00:00:00) If the Ethernet adapter module is powered off and then on, the clock will restart at the time the power was turned off. (The clock does not run while the power is off.) Therefore, the date and time of an error that occurred during initial processing may be different from the actual date and time.)
Internal current consumption (24VDC)		0.6A
External dimensions	H	90mm
	W	135mm
	D	109mm
Weight		0.7kg

## 3.2.1 Performance specifications of each part

The performance specifications of each part of the Ethernet adapter module are described below.

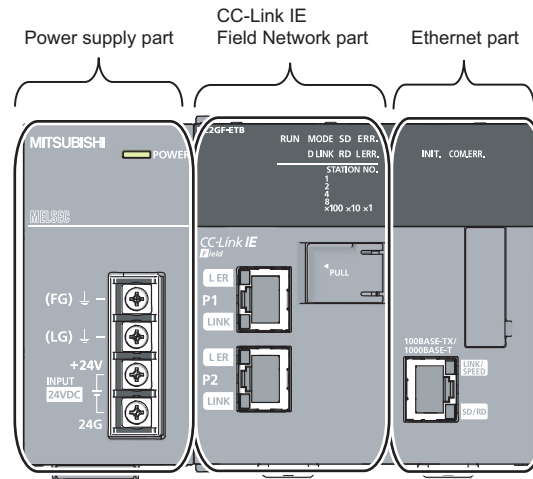

### (1) Power supply part

Item	Specification
Input voltage (☞ Page 32, Section 3.2.1 (1) (a))	24VDC (-35% to +30%)
Current consumption	0.6A
Inrush current (☞ Page 32, Section 3.2.1 (1) (b))	100A, 1ms or less
Allowable momentary power failure time (☞ Page 32, Section 3.2.1 (1) (c))	10ms or less
Withstand voltage	510V AC/min (Altitude: 0 to 2000m) Between the combined "line input/LG terminals" and the "FG terminal and output"
Insulation resistance	10MΩ or higher by 500VDC insulation resistance tester Between the combined "line input/LG terminals" and the "FG terminal and output", the line input and LG terminals, the output and FG terminals
Noise immunity	<ul style="list-style-type: none"> <li>By noise simulator of 500Vp-p noise voltage, 1μs noise width, and 25 to 60 Hz noise frequency</li> <li>Noise voltage IEC 61000-4-4, 2kV</li> </ul>
Operation status indicator	LEDs (Normal: On (green), Error: Off)
Fuse	Built-in (not replaceable)
Terminal screw size	M3.5
Applicable wire size	0.75 to 2 mm <sup>2</sup>
Applicable solderless terminal	RAV1.25-3.5, RAV2-3.5, 0.8mm or less in thickness, Two solderless terminals can be connected to one terminal.
Applicable tightening torque	0.66 to 0.89N·m

**(a) Input voltage**

Input voltage is a voltage at which the power supply part operates normally. If it is outside the specified range, the Ethernet adapter module may detect an error and stop its operation.

**(b) Inrush current**

Inrush current is a large current that instantaneously flows into a circuit immediately after power is applied.

Reapplying input power after power-off may cause an inrush current that exceeds the specified value.

Allow 5 seconds or more before reapplying input power.

Also, select appropriate fuses or breakers for external circuits, considering the possibility of meltdown, sensing property, and other items shown in this section.

**(c) Allowable momentary power failure time**

If a momentary power failure occurs, the system detects an input voltage failure and stops its operation.

Allowable momentary power failure time is the period of time that the system can continue its operation after power is restored.

If a momentary stop exceeding the allowable momentary power failure time occurs, the operation will be continued by the load of the power supply part, or will be initially started. When the operation is continued, the operational behavior is the same as that for the momentary stop within the allowable momentary power failure time.

**(2) CC-Link IE Field Network part**

Item		Specification
Maximum link points per network	RWw	8192 points, 16KB
	RWr	8192 points, 16KB
	RX	16384 points, 2KB
	RY	16384 points, 2KB
Maximum link points per station	RWw	1024 points, 2KB
	RWr	1024 points, 2KB
	RX	2048 points, 256 bytes
	RY	2048 points, 256 bytes
Station type	Intelligent device station	
Station No.	1 to 120	
Network No.	1 to 239	
Communication method	Token passing method	
Communication speed	1Gbps	
Transmission path	Line or star topology (Coexistence of line topology and star topology is possible.), ring topology	
Connection cable	An Ethernet cable that meets the 1000BASE-T standard: Category 5e or higher, (Double shielded/STP), Straight cable (☞ Page 49, Section 5.2.1)	
Maximum station-to-station distance	Up to 100m (compliant with ANSI/TIA/EIA-568-B (Category 5e)) (☞ Page 67, Section 6.4.4 (7))	
Overall cable distance	Line topology: 12000m (when connecting 1 master station and 120 slave stations) Star topology: Depends on the system configuration Ring topology: 12100m (when connecting 1 master station and 120 slave stations)	
Number of cascade connections	Up to 20	

### (3) Ethernet part

Item		Specification
Number of connections	For users	32
	For auto-open	1
	For MELSOFT connection	3 (TCP connection: 1* <sup>1</sup> , UDP connection: 1, Direct connection: 1)
Own Station Port No.		1025 to 4999, 5011 to 65534 (0401 <sub>H</sub> to 1387 <sub>H</sub> , 1393 <sub>H</sub> to FFFE <sub>H</sub> )
Number of simultaneously connectable modules		Up to 32
Communication speed		1Gbps or 100Mbps
Communication mode		Full- or Half-duplex
Transmission system		Base band
Connection cable	For 1Gbps	An Ethernet cable that meets the 1000BASE-T standard: Category 5e or higher, (Double shielded/STP), Straight cable (☞ Page 49, Section 5.2.2 (1))
	For 100Mbps* <sup>2</sup>	An Ethernet cable that meets the 100BASE-TX standard: Category 5 or higher, (STP), Straight cable (☞ Page 49, Section 5.2.2 (1))
Maximum distance between switching hub and node		Up to 100m
Number of cascade connections		Up to 20

\*1 To use two or more TCP connections for a MELSOFT Connection, user connections can be assigned to MELSOFT Connection. (☞ Page 195, Section 10.3.3 (2))

\*2 Use of double shielded cables is recommended in a high noise environment.

#### **Point**

- When connected to a switching hub, the Ethernet adapter module detects and sets 1000BASE-T or 100BASE-TX and full-or half- duplex communication mode according to the switching hub. When the connected switching hub does not support the auto-negotiation function, set the switching hub to the half-duplex communication mode.
- The operation of the following connections is not guaranteed. Check the operation at the user's discretion before use.
  - Connections using the Internet (public line) (Internet connection services by Internet service providers or telecommunications carriers)
  - Connections using firewall devices
  - Connections using broadband routers



## (4) Communication specifications for TCP connection

### (a) Number of resends and resend interval

If the Ethernet adapter module sent a message to an external device and after that did not receive an ACK from the external device, it will resend the message at the intervals shown below.

Item	Specification
Number of resends	Up to 3 times
Resend interval	Up to 64 seconds (Varies depending on the line status.) If the resend fails, the amount of time is doubled. (The maximum value is 64 seconds.)  <b>Ex.</b> When the interval for the first resend is 20 seconds; 1st: 20s, 2nd: 40s, 3rd: 64s

If the Ethernet adapter module fails to receive an ACK response from the external device even when it resends data as many times as the number of resends, it regards that there is no external device, causing disconnection.

When the connection is disconnected, send a connection establishment request from the external device, reestablish a connection, and resend a request message.

### (b) Alive check by KeepAlive

The Ethernet adapter module performs alive check by KeepAlive.

The Ethernet adapter module sends an alive check message in 5 seconds after receiving the last message from an external device. If no response is returned from the external device for 5 seconds, the module resends the alive check message. The module resends the message for 7 times at intervals of 5 seconds.

If no response is received for 45 seconds from the last message reception from the external device, the Ethernet adapter module will close the connection. Allow 45 seconds or longer before opening the same connection again.

When the external device does not support the TCP KeepAlive function, the connection may be closed.

### (c) Connection establishment request

When a connection establishment request is sent from an external device to the port of the Ethernet adapter module, where a connection has been already established, the Ethernet adapter module will not respond.

Therefore, if no response is returned even after a connection establishment request is sent to the Ethernet adapter module, check if the specified port number is correct.

## 3.3 List of the Functions

This section lists the functions of the Ethernet adapter module.

### (1) Communications with an external device

Function		Description	Refer to
Communications using SLMP	Communications from an external device	Device data can be read or written from an external device to a module on the network where the Ethernet adapter module is connected. Data also can be read or written from/to the Ethernet adapter module.	Page 68, Section 7.1
	Communications from a CPU module (on-demand function)	Issuing a send request from the CPU module to the Ethernet adapter module allows data to be sent to the external device. Events such as link start instruction and read instruction can be notified to an external device. In addition, data can be simultaneously sent to all the external devices on Ethernet where the Ethernet adapter module is also connected (broadcast communications).	Page 90, Section 7.2
Communication using the specified IP address over CC-Link IE Field Network (IP packet transfer function)		With this function, communications using the specified IP address can be performed over CC-Link IE Field Network. For example, a personal computer connected to the Ethernet part can communicate with another personal computer connected to a Built-in Ethernet port QCPU. Two networks of CC-Link IE Field Network and Ethernet are not required, resulting in reduced wiring cost.	Page 107, Section 7.3
Connection to MELSOFT products or GOTs		The Ethernet adapter module can be also connected to MELSOFT products or GOTs.	—

### (2) CC-Link IE Field Network communications

Function		Description	Refer to
Cyclic transmission		Data can be periodically exchanged with the master station through link devices (RX, RY, RWr, and RWw).	Page 68, Section 7.1
Transient transmission		The devices or buffer memory of the Ethernet adapter module can be directly accessed from the master or local station. Requests from the master or local station to the Ethernet adapter module are made with dedicated instructions.	—

### (3) Other functions

Function		Description	Refer to
Device/buffer memory batch monitor		The values in the devices and buffer memory of the Ethernet adapter module can be monitored.	Page 201, Section 10.6
Ethernet adapter diagnostics		Information such as the latest error that occurred in the Ethernet adapter module and the status of the communications with an external device can be checked.	Page 203, Section 10.7

## 3.4 Buffer Memory List

The buffer memory is used for exchanging data between the Ethernet adapter module and a master/local module or an external device.

The contents of the buffer memory return to the default state (initial values) when the system is powered off or reset.

Address (Decimal (Hexadecimal))	Name	Initial value	Read/Write	Refer to	
0 (0 <sub>H</sub> )	Module operation area	Module LED information	Read	Page 206, Appendix 1.1 (1)	
1 (1 <sub>H</sub> )		Station No. LED information	Read	Page 206, Appendix 1.1 (2)	
2 (2 <sub>H</sub> )		Ethernet port LED information		Page 207, Appendix 1.1 (3)	
3 to 15 (3 <sub>H</sub> to F <sub>H</sub> )	System area			—	
16 to 18 (10 <sub>H</sub> to 12 <sub>H</sub> )	Own station information (PORT1 and PORT2)	Own station MAC address	—	Read	Page 208, Appendix 1.2 (1)
19 (13 <sub>H</sub> )		System area			—
20 to 21 (14 <sub>H</sub> to 15 <sub>H</sub> )		Own station IP address	0	Read	Page 208, Appendix 1.2 (1)
22 to 25 (16 <sub>H</sub> to 19 <sub>H</sub> )	System area			—	
26 to 28 (1A <sub>H</sub> to 1C <sub>H</sub> )	Own station information (Ethernet port)	Own station MAC address	—	Read	Page 208, Appendix 1.2 (2)
29 (1D <sub>H</sub> )		System area			—
30 to 31 (1E <sub>H</sub> to 1F <sub>H</sub> )		Own station IP address	0	Read	Page 208, Appendix 1.2 (2)
32 to 33 (20 <sub>H</sub> to 21 <sub>H</sub> )		Own station subnet mask	0		
34 to 35 (22 <sub>H</sub> to 23 <sub>H</sub> )	System area			—	

Address (Decimal (Hexadecimal))	Name		Initial value	Read/Write	Refer to	
36 (24 <sub>H</sub> )	Own station information (Parameters)	Mode	0	Read	Page 208, Appendix 1.2 (3)	
37 (25 <sub>H</sub> )		Network No.	0	Read		
38 (26 <sub>H</sub> )		Station No.	0	Read		
39 to 47 (27 <sub>H</sub> to 2F <sub>H</sub> )		System area			—	
48 (30 <sub>H</sub> )		Function check area*1	0001 <sub>H</sub>	Read	Page 208, Appendix 1.2 (3)	
49 to 767 (31 <sub>H</sub> to 2FF <sub>H</sub> )	System area				—	
768 (300 <sub>H</sub> )	Ethernet port operation area (area for initial processing)	Initial processing error code	0	Read	Page 209, Appendix 1.3 (1)	
769 to 783 (301 <sub>H</sub> to 30F <sub>H</sub> )	System area				—	
784 (310 <sub>H</sub> )	Ethernet port operation area (Connection information area No.1)	Open system	1	Read	Page 209, Appendix 1.3 (2)	
785 (311 <sub>H</sub> )		Protocol	0			
786 (312 <sub>H</sub> )		Communication data code	1			
787 (313 <sub>H</sub> )		Own Station Port No.	0			
788 (314 <sub>H</sub> )		TCP connection system	0	Read	Page 209, Appendix 1.3 (2)	
789 (315 <sub>H</sub> )		Connection status	0			
790 to 791 (316 <sub>H</sub> to 317 <sub>H</sub> )		System area		—	—	—
792 (318 <sub>H</sub> )		Latest error code	0	Read	Page 209, Appendix 1.3 (2)	
793 (319 <sub>H</sub> )		Destination port No.	0	Read		
794 to 795 (31A <sub>H</sub> to 31B <sub>H</sub> )		Destination IP address	0	Read		
796 to 799 (31C <sub>H</sub> to 31F <sub>H</sub> )		System area		—	—	—
800 to 1295 (320 <sub>H</sub> to 50F <sub>H</sub> )		Ethernet port operation area (Connection information area No.2 to No.32)	Same as Connection information area No.1			Page 210, Appendix 1.3 (3)

Address (Decimal (Hexadecimal))	Name	Initial value	Read/Write	Refer to		
1296 (510 <sub>H</sub> )	Ethernet port operation area (Auto-open UDP port area)	Open system	Read	Page 210, Appendix 1.3 (4)		
1297 (511 <sub>H</sub> )		Protocol			1	
1298 (512 <sub>H</sub> )		Communication data code			0	
1299 (513 <sub>H</sub> )		Own Station Port No.			1388 <sub>H</sub>	
1300 (514 <sub>H</sub> )		System area	—		—	—
1301 (515 <sub>H</sub> )		Connection status	0		Read	Page 210, Appendix 1.3 (4)
1302 to 1303 (516 <sub>H</sub> to 517 <sub>H</sub> )		System area	—		—	—
1304 (518 <sub>H</sub> )		Latest error code	0		Read	Page 210, Appendix 1.3 (4)
1305 (519 <sub>H</sub> )		Destination port No.	0			
1306 to 1307 (51A <sub>H</sub> to 51B <sub>H</sub> )		Destination IP address	0			
1308 to 1311 (51C <sub>H</sub> to 51F <sub>H</sub> )	System area			—		
1312 (520 <sub>H</sub> )	System area			—		
1313 (521 <sub>H</sub> )	Ethernet port operation area (MELSOFT application communication port (UDP/IP) area for the system)	Protocol	Read	Page 211, Appendix 1.3 (5)		
1314 (522 <sub>H</sub> )		Communication data code			0	
1315 (523 <sub>H</sub> )		Own Station Port No.			1389 <sub>H</sub>	
1316 (524 <sub>H</sub> )		System area	—		—	—
1317 (525 <sub>H</sub> )		Connection status	0		Read	Page 211, Appendix 1.3 (5)
1318 to 1319 (526 <sub>H</sub> to 527 <sub>H</sub> )		System area	—		—	—
1320 (528 <sub>H</sub> )		Latest error code	0		Read	Page 211, Appendix 1.3 (5)
1321 (529 <sub>H</sub> )		Destination port No.	0			
1322 to 1323 (52A <sub>H</sub> to 52B <sub>H</sub> )		Destination IP address	0			
1324 to 1327 (52C <sub>H</sub> to 52F <sub>H</sub> )		System area			—	

Address (Decimal (Hexadecimal))	Name	Initial value	Read/Write	Refer to			
1328 (530 <sub>H</sub> )	Ethernet port operation area (MELSOFT application communication port (TCP/IP) area for the system)	Open system	0	Read	Page 212, Appendix 1.3 (6)		
1329 (531 <sub>H</sub> )		Protocol	0				
1330 (532 <sub>H</sub> )		Communication data code	0				
1331 (533 <sub>H</sub> )		Own Station Port No.	138A <sub>H</sub>				
1332 (534 <sub>H</sub> )		TCP connection system	0				
1333 (535 <sub>H</sub> )		Connection status	0				
1334 to 1335 (536 <sub>H</sub> to 537 <sub>H</sub> )		System area	—			—	—
1336 (538 <sub>H</sub> )		Latest error code	0			Read	Page 212, Appendix 1.3 (6)
1337 (539 <sub>H</sub> )		Destination port No.	0				
1338 to 1339 (53A <sub>H</sub> to 53B <sub>H</sub> )		Destination IP address	0				
1340 to 1343 (53C <sub>H</sub> to 53F <sub>H</sub> )	System area			—			
1344 (540 <sub>H</sub> )	Ethernet port operation area (Direct MELSOFT connection port)	Open system	3	Read	Page 213, Appendix 1.3 (7)		
1345 (541 <sub>H</sub> )		Protocol	1				
1346 (542 <sub>H</sub> )		Communication data code	0				
1347 (543 <sub>H</sub> )		Own Station Port No.	1390 <sub>H</sub>				
1348 (544 <sub>H</sub> )		System area	—			—	—
1349 (545 <sub>H</sub> )		Connection status	0			Read	Page 213, Appendix 1.3 (7)
1350 to 1351 (546 <sub>H</sub> to 547 <sub>H</sub> )		System area	—			—	—
1352 (548 <sub>H</sub> )		Latest error code	0			Read	Page 213, Appendix 1.3 (7)
1353 (549 <sub>H</sub> )		Destination port No.	0				
1354 to 1355 (54A <sub>H</sub> to 54B <sub>H</sub> )		Destination IP address	0				
1356 to 1359 (54C <sub>H</sub> to 54F <sub>H</sub> )	System area			—			

Address (Decimal (Hexadecimal))	Name	Initial value	Read/Write	Refer to	
1360 (550 <sub>H</sub> )	Ethernet port operation area (Connection port for the configuration tool)	Open system	Read	Page 214, Appendix 1.3 (8)	
1361 (551 <sub>H</sub> )		Protocol			
1362 (552 <sub>H</sub> )		Communication data code			
1363 (553 <sub>H</sub> )		Own Station Port No.			
1364 (554 <sub>H</sub> )		System area	—		—
1365 (555 <sub>H</sub> )		Connection status	0		Read
1366 to 1367 (556 <sub>H</sub> to 557 <sub>H</sub> )		System area	—		—
1368 (558 <sub>H</sub> )		Latest error code	0		Read
1369 (559 <sub>H</sub> )		Destination port No.	0		
1370 to 1371 (55A <sub>H</sub> to 55B <sub>H</sub> )		Destination IP address	0		
1372 to 2048 (55C <sub>H</sub> to 800 <sub>H</sub> )	System area			—	
2049 (801 <sub>H</sub> )	Ethernet port error log area	Error count	Read	Page 215, Appendix 1.4 (1)	
2050 (802 <sub>H</sub> )		Error log write pointer		0	Page 215, Appendix 1.4 (2)
2051 to 2063 (803 <sub>H</sub> to 80F <sub>H</sub> )	System area			—	

Address (Decimal (Hexadecimal))	Name		Initial value	Read/Write	Refer to
2064 (810 <sub>H</sub> )	Ethernet port error log area (Error log No.1)	Error code	0	Read	Page 215, Appendix 1.4 (3)
2065 (811 <sub>H</sub> )		Connection No.	0		
2066 (812 <sub>H</sub> )		Open system	0		
2067 (813 <sub>H</sub> )		Protocol	0		
2068 (814 <sub>H</sub> )		Own Station Port No.	0		
2069 (815 <sub>H</sub> )		Destination port No.	0		
2070 to 2071 (816 <sub>H</sub> to 817 <sub>H</sub> )		Destination IP address	0	Read	Page 215, Appendix 1.4 (3)
2072 to 2075 (818 <sub>H</sub> to 81B <sub>H</sub> )		Date and time	0		
2076 (81C <sub>H</sub> )		Command code	0		
2077 (81D <sub>H</sub> )		Subcommand code	0		
2078 to 2079 (81E <sub>H</sub> to 81F <sub>H</sub> )	System area	—	—	—	
2080 to 3087 (820 <sub>H</sub> to C0F <sub>H</sub> )	Ethernet port error log area (Error log No.2 to No.64)	Same as error log No.1			Page 216, Appendix 1.4 (4)
3088 to 3327 (C10 <sub>H</sub> to CFF <sub>H</sub> )	System area				—
3328 (D00 <sub>H</sub> )	Ethernet port line status	Communication status	0	Read	Page 216, Appendix 1.5 (1)
3329 to 5375 (D01 <sub>H</sub> to 14FF <sub>H</sub> )	System area				—
5376 to 5377 (1500 <sub>H</sub> to 1501 <sub>H</sub> )	Ethernet port connection status data area	Open completion signal	0	Read	Page 217, Appendix 1.6 (1)
5378 to 5631 (1502 <sub>H</sub> to 15FF <sub>H</sub> )	System area				—



Address (Decimal (Hexadecimal))	Name	Initial value	Read/Write	Refer to	
5632 (1600 <sub>H</sub> )	On-demand function data sending area (channel 1)* <sup>1</sup>	Send request flag	0	Read/Write	Page 93, Section 7.2.5 (1)
5633 (1601 <sub>H</sub> )		Send completed flag	0	Read	Page 93, Section 7.2.5 (2)
5634 (1602 <sub>H</sub> )		Completion code	0	Read	Page 93, Section 7.2.5 (3)
5635 to 5643 (1603 <sub>H</sub> to 160B <sub>H</sub> )		Control data	0	Read/Write	Page 94, Section 7.2.5 (4)
5644 to 6603 (160C <sub>H</sub> to 19CB <sub>H</sub> )		Send data	0	Read/Write	
6604 to 6655 (19CC <sub>H</sub> to 19FF <sub>H</sub> )		System area	—	—	—
6656 to 9727 (1A00 <sub>H</sub> to 25FF <sub>H</sub> )	On-demand function data sending area (channels 2 to 4)* <sup>1</sup>	Same as channel 1		Page 93, Section 7.2.5	
9728 to 29697 (2600 <sub>H</sub> to 7401 <sub>H</sub> )	System area			—	

\*1 Check the corresponding serial No. and software version. (☞ Page 240, Appendix 10)

### Point

Do not write data to "System area".  
Doing so may cause the Ethernet adapter module to malfunction.

## 3.5 SLMP

The Ethernet adapter module's devices can be read or written with command messages in the predefined format from an external device.

For details on SLMP, refer to the following.

 SLMP Reference Manual

### 3.5.1 Available command list

The following table lists the commands that can be executed from an external device to the Ethernet adapter module.

The □ part in the Subcommand column varies depending on the specified device. ( SLMP Reference Manual)

Item		Command	Subcommand	Description
Type	Operation			
Device	Read	0401	00□1	Reads values in 1-point units from bit devices (consecutive device numbers).
			00□0	<ul style="list-style-type: none"> <li>Reads values in 16-point units from bit devices (consecutive device numbers).</li> <li>Reads values in 1-word units from word devices (consecutive device numbers).</li> </ul>
	Write	1401	00□1	Writes values to bit devices (consecutive device numbers) in 1-point units.
			00□0	<ul style="list-style-type: none"> <li>Writes values to bit devices (consecutive device numbers) in 16-point units.</li> <li>Writes values to word devices (consecutive device numbers) in 1-word units.</li> </ul>
	Read Random	0403	00□0	Specifies a device number to read the device value. Discrete device numbers can be used. <ul style="list-style-type: none"> <li>Reads bit devices in 16- or 32-point units.</li> <li>Reads word devices in 1- or 2-word units.</li> </ul>
	Write Random	1402	00□1	Writes values in 1-point units to bit devices by specifying the device numbers. Discrete device numbers can be used.
			00□0	<ul style="list-style-type: none"> <li>Specifies a device number in 16- or 32-point units to write a value to a bit device. Discrete device numbers can be used for specification.</li> <li>Specifies a device number in word units to write a value to a word device. Discrete device numbers can be used for specification.</li> </ul>
	Entry Monitor Device	0801	00□0	Registers a device to be read by Execute Monitor (command: 0802).
	Execute Monitor	0802	0000	Reads the value of the device registered by Entry Monitor Device (command: 0801).
	Read Block	0406	00□0	Specifies n points (1 point: 16 bits) of word or bit devices as one block, and reads multiple blocks of data. Discrete device numbers can be used for specification.
Write Block	1406	00□0	Specifies n points (1 point: 16 bits) of word or bit devices as one block, and writes multiple blocks of data. Discrete device numbers can be used for specification.	
Memory	Read	0613	0000	Reads buffer memory data of the Ethernet adapter module.
	Write	1613	0000	Writes data to the buffer memory of the Ethernet adapter module.
Remote Control	Remote Run	1001	0000	Executes remote RUN to the Ethernet adapter module.
	Remote Stop	1002	0000	Executes remote STOP to the Ethernet adapter module.
	Remote Reset	1006	0000	Executes remote RESET to the Ethernet adapter module.
	Read Type Name	0101	0000	Reads the model name and code of the Ethernet adapter module.
Clear Error		1617	0000	Turns off the COM.ERR. LED on the Ethernet adapter module.
Ondemand		2101	0000	Issues a send request from the CPU module to the Ethernet adapter module and sends data to the external device.

## 3.5.2 Ranges of accessible devices and buffer memory

Within the following device and buffer memory ranges, external devices can access the Ethernet adapter module.

### (1) Devices

Device		Device No. range	Unit
Input	X	0000 to 1FFF	Hexadecimal
Output	Y	0000 to 1FFF	Hexadecimal
Link special relay	SB	0000 to 1FFF	Hexadecimal
Link special register	SW	0000 to 1FFF	Hexadecimal
Special relay	SM	0000 to 2047	Decimal
Special register	SD	0000 to 2047	Decimal
Link register	W	0000 to 1FFF	Hexadecimal

### (2) Buffer memory

For the access ranges and read and write availabilities, refer to "Buffer Memory List". (☞ Page 37, Section 3.4)

# CHAPTER 4 PROCEDURE BEFORE THE OPERATION

---

This chapter describes the procedure to be taken before operating the Ethernet adapter module.

## 4.1 Start-Up Procedure

---

The following shows how to start up the system where the Ethernet adapter module is used.

### 1. Setting on the master station

Set network parameters on the master station. For details, refer to the following.

 User's manual for the master/local module used

### 2. Installation

Mount the module to the DIN rail, and wire the power supply part. ( Page 54, Section 6.1, Page 55, Section 6.2, Page 61, Section 6.4.1)

### 3. Unit test

Check the Ethernet adapter module for hardware failure. ( Page 59, Section 6.3)

### 4. Ethernet cable connection

Connect Ethernet cables to the Ethernet adapter module. ( Page 63, Section 6.4.2)

### 5. Parameter setting

Set parameters for connection to CC-Link IE Field Network and Ethernet. ( Page 179, Section 10.1, Page 188, Section 10.3, Page 200, Section 10.5)



### 6. Data link start

Shift the switch on the Ethernet adapter module to RUN. ( Page 26, Section 2.2 (2))

### 7. CC-Link IE Field Network diagnostics



Check whether communication can be normally performed using the CC-Link IE Field Network diagnostics on the master station.

For details, refer to the following.

 User's manual for the master/local module used,  Page 144, Section 9.2.1

### 8. Communications with an external device

Send SLMP using an external device. ( Page 81, Section 7.1.5 (2))

- Using the on-demand function enables data to be sent from the Ethernet adapter module to an external device. ( Page 90, Section 7.2)
- IP communications can be performed between external devices over CC-Link IE Field Network. ( Page 107, Section 7.3)

### 9. Ethernet diagnostics

Check whether communication can be normally performed using the Ethernet adapter diagnostics. ( Page 203, Section 10.7)

# Memo

---

# CHAPTER 5 SYSTEM CONFIGURATION

This chapter describes a configuration of the system containing the Ethernet adapter module.

For the overall CC-Link IE Field Network configuration, refer to the following.

📖 User's manual for the master/local module used

## 5.1 Network Configuration

The following shows a network configuration for the Ethernet adapter module.

Through a switching hub, the Ethernet adapter module can communicate with up to 32 external devices at the same time. Direct connection is also available between the Ethernet adapter module and an external device.

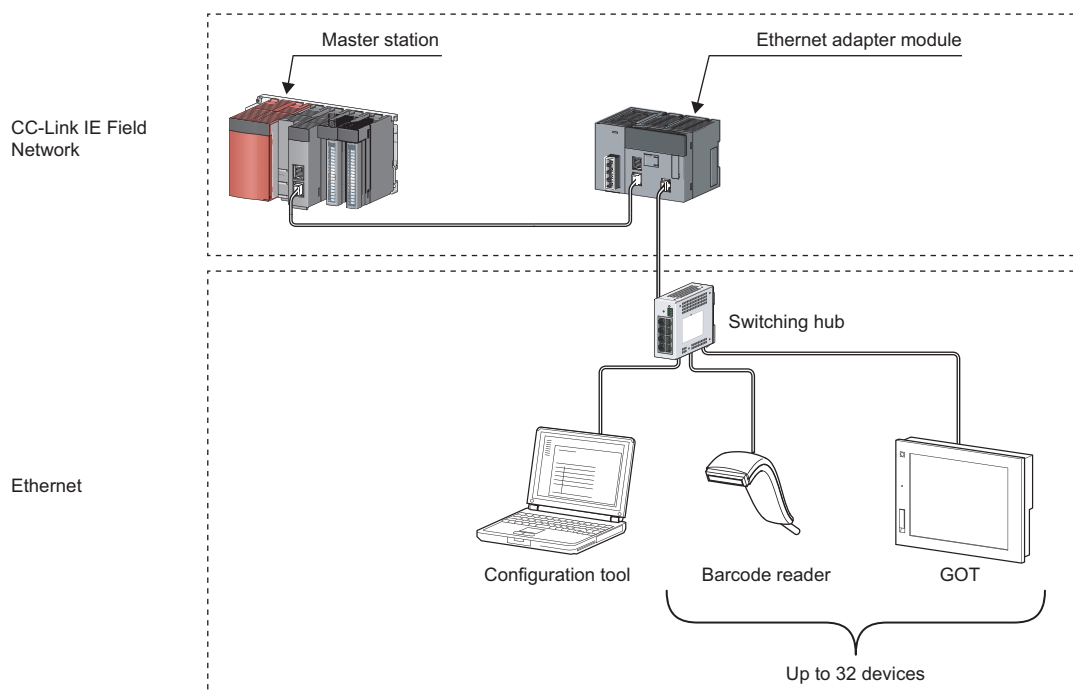

### Point

External devices must be on the same network as the Ethernet adapter module; therefore, those on different networks cannot be connected using devices such as a router.

## 5.2 Network Components

The following shows network components.

### 5.2.1 CC-Link IE Field Network

For network components of CC-Link IE Field Network, refer to the following.

 User's manual for the master/local module used

### 5.2.2 Ethernet

#### (1) Cables

Use the 1000BASE-T or 100BASE-TX compliant Ethernet cables.

Communication speed	Ethernet cable	Connector	Standard
1Gbps	Category 5e or higher, (STP) Straight cable	RJ45 connector	Cables that meet the following standards: <ul style="list-style-type: none"> <li>• IEEE802.3(1000BASE-T)</li> <li>• ANSI/TIA/EIA-568-B(Category 5e)</li> </ul>
100Mbps	Category 5 or higher, (STP) Straight cable	RJ45 connector	Cables that meet the following standards: <ul style="list-style-type: none"> <li>• IEEE802.3(1000BASE-T/100BASE-TX)</li> <li>• ANSI/TIA/EIA-568-B(Category 5)</li> </ul>

#### (a) Recommended products

Ethernet cables meeting the 1000BASE-T or 100BASE-TX standard are available from Mitsubishi Electric System & Service Co., Ltd. (Cable catalogs are also available.)

Connectors can be customized to the specified length. Please consult your local Mitsubishi service representative.

Type	Model (manufacturer)
Ethernet cable	SC-E5EW series (Mitsubishi Electric System & Service Co., Ltd.)

#### Remark

- Cable types

The following types are available depending on the operating environment.

- Standard type: Cables used in control panels or indoors
- L type: Cables for outdoor connections

Special cables, such as flame-retardant or water-tight cables, and relay adapters are also available. Please consult your local Mitsubishi Electric System & Service Co., Ltd.

- For order or inquiry on the cables: Mitsubishi Electric System & Service Co., Ltd.  
www.melco.jp/business

## (2) Hubs

Use hubs that meet the following conditions 1 to 4. If these conditions are not satisfied, the operation of the hub is not guaranteed.

- Compliant with the IEEE802.3(1000BASE-T/100BASE-TX) standard
- Supporting the auto MDI/MDI-X function
- Supporting the auto-negotiation function
- Switching hub (layer 2 switch)<sup>\*1</sup>

\*1 Repeater hubs cannot be used.

### (a) Mitsubishi Electric products

Type	Model	Data communication rate
Industrial switching hub	NZ2EHG-T8	1000Mbps/100Mbps/10Mbps
	NZ2EHF-T8	100Mbps/10Mbps



## 5.3 Applicable Systems

### 5.3.1 Configuration tool

#### (1) Operating environment

The following table lists the operating environment of the personal computer where the configuration tool is used.

##### (a) Computer requirements

Item		Description
Computer	—	Personal computer running any of the following operating systems
	CPU	Specifications recommended for the following operating systems
	Memory	
Web browser		Versions recommended for the following operating systems
Hard disk space		512MB or more
Display		Resolution: 1024 × 768 dots or more
Operating system		Microsoft® Windows®XP Professional Operating System (English version) SP2 or later <sup>*1</sup> Microsoft® Windows®XP Home Edition Operating System (English version) SP2 or later <sup>*1</sup> Microsoft® Windows Vista® Home Basic Operating System (English version) <sup>*1*2</sup> Microsoft® Windows Vista® Home Premium Operating System (English version) <sup>*1*2</sup> Microsoft® Windows Vista® Business Operating System (English version) <sup>*1*2</sup> Microsoft® Windows Vista® Ultimate Operating System (English version) <sup>*1*2</sup> Microsoft® Windows Vista® Enterprise Operating System (English version) <sup>*1*2</sup> Microsoft® Windows® 7 Home Premium Operating System (English version) <sup>*1*2</sup> Microsoft® Windows®7 Professional Operating System (English version) <sup>*1*2</sup> Microsoft® Windows®7 Enterprise Operating System (English version) <sup>*1*2</sup> Microsoft® Windows®7 Ultimate Operating System (English version) <sup>*1*2</sup> Microsoft® Windows®7 Starter Operating System (English version) <sup>*1*2</sup>
Interface		Ethernet port

\*1 Installation of .NET Framework 2.0 SP2 or later is required.

The .NET Framework 2.0 SP2 or later might have been installed with other software. In this case, the reinstallation of this package is not required.

\*2 Not available for logon users whom Parental Controls are set up.

**(b) Precautions on the operating systems**

- The 64-bit Windows® XP Professional, Windows Vista®, and Windows®7 cannot be used.
- When the logon user right is Guest, the operating systems cannot be used.
- When Windows® Firewall settings are enabled, direct connection may not function properly. Disable Windows® Firewall settings.
- The following functions are not available. If any of these is used, this product may not function properly.
  - Application start in Windows® Compatibility Mode
  - Fast User Switching
  - Remote Desktop
  - Big Fonts (in the Advanced Setting of Screen Properties)
  - Hibernate and Standby of Windows®

## 5.3.2 Software package

---

GX Works2 allows the status check of the Ethernet adapter module and access to other stations.

GX Developer cannot be used.

Software	Version
GX Works2	Version 1.40S

### (1) Precaution

If a GX Works2 version earlier than the above is used, the dialog box will not be displayed correctly.

# CHAPTER 6 INSTALLATION AND WIRING

---

This chapter explains installation of the Ethernet adapter module and the wiring method.

## 6.1 Installation Environment

---

Install the Ethernet adapter module in an environment that meets the general specifications. (☞ Page 29, Section 3.1)

Do not install the Ethernet adapter module in the place where:

- The ambient temperature is outside the range of 0°C to 55°C.
- The ambient humidity is outside the range of 5%RH to 95%RH.
- Condensation occurs due to a rapid temperature change.
- Corrosive or combustible gas is present.
- There is conductive powder such as dust and iron powder, oil mist, salinity, or organic solvent.
- The module is exposed to direct sunlight.
- A strong electric or magnetic field is generated.
- The module is directly subject to vibrations or shocks.

## 6.2 Installation

When installing the Ethernet adapter module to a control panel or any other place, consider the operability, maintainability, and environmental resistance.

### 6.2.1 Installation precautions

- (1) Do not directly touch any conductive parts and electronic components of the Ethernet adapter module. Doing so can cause malfunction or failure of the module.
- (2) Do not drop or apply strong shock to the Ethernet adapter module.
- (3) Do not remove the printed-circuit board of the Ethernet adapter module from the case. Doing so may cause failure.
- (4) Do not release the levers located at the top and bottom of the Ethernet adapter module. Doing so can cause malfunction or failure of the module.

### 6.2.2 Mounting the module to a control panel

To ensure good ventilation and to make replacement of the Ethernet adapter module easy, provide a distance between the top or bottom of the module and other structures or parts as shown below.

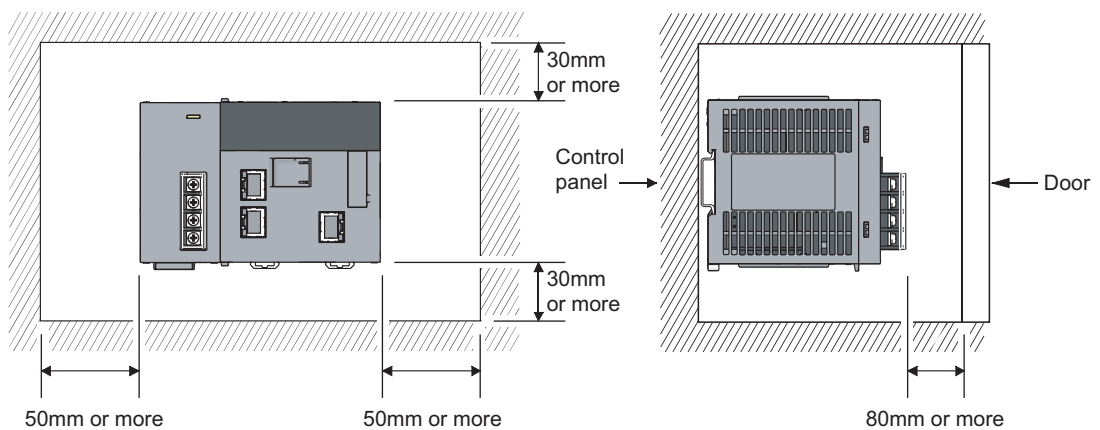

## 6.2.3 Mounting the modules on a DIN rail

The Ethernet adapter module must be mounted on a DIN rail.

The procedure for mounting the Ethernet adapter module on a DIN rail is shown below.

### (1) Mounting procedure

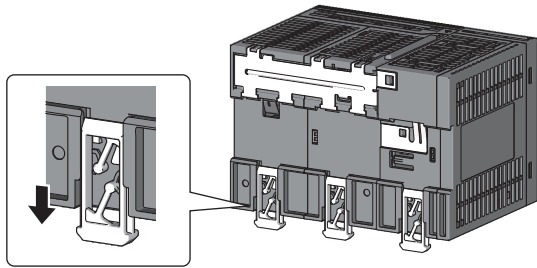

- 1. Pull down all of the DIN rail hooks on the back of the Ethernet adapter module.**

Pull it until a click sound is heard.

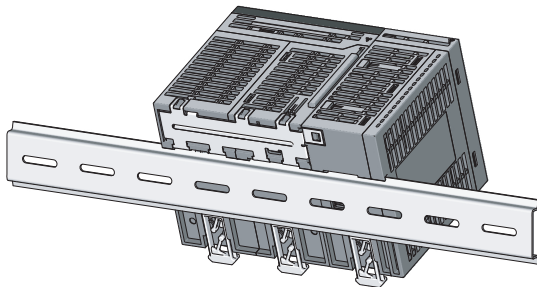

- 2. Hang the upper tabs of the Ethernet adapter module on the DIN rail, and push the module in position.**

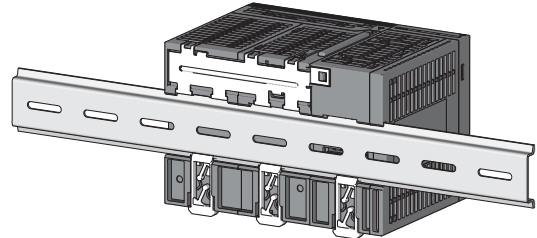

- 3. Lock the DIN rail hooks of the Ethernet adapter module to secure it in position.**

Push each hook until a click sound is heard.

If you cannot reach the hooks, use a tool such as a screwdriver.

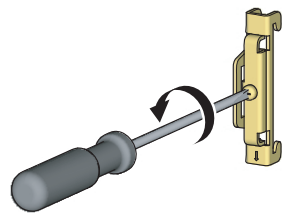

- 4. Loosen the screw on the DIN rail stopper.**

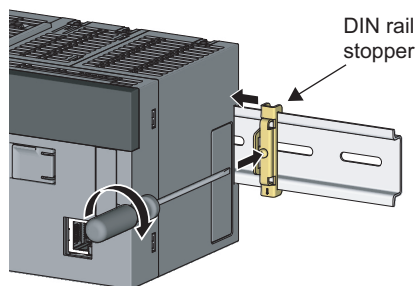
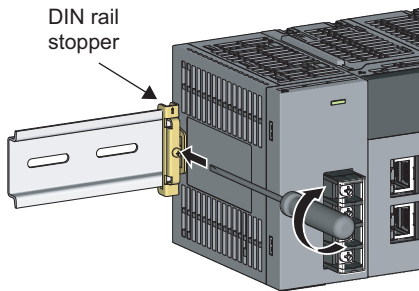
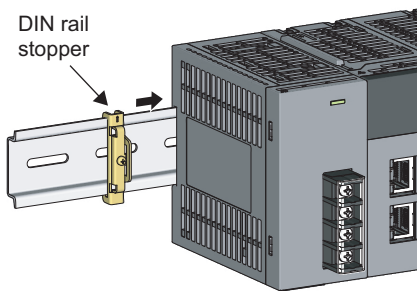
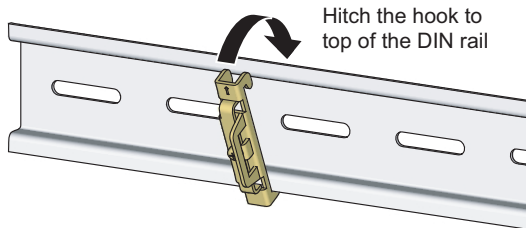
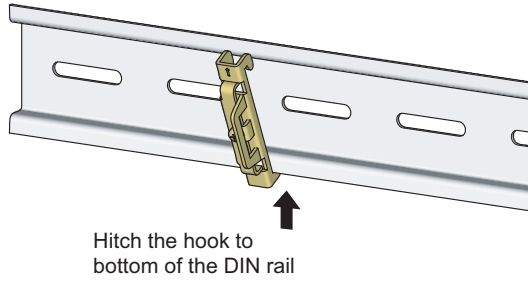

**5. Hitch the bottom hook of the DIN rail stopper to the bottom of the DIN rail.**

Hitch the hook according to the orientation of the arrow on the front of the stopper.

**6. Hitch the upper hook of the DIN rail stopper to the top of the DIN rail.**

**7. Slide the DIN rail stopper to the left end of the Ethernet adapter module.**

**8. Tighten the screw of the DIN rail stopper with a screwdriver.**

**9. Attach another DIN rail stopper on the right side of the Ethernet adapter module by the same procedure as the left side.**

## (2) Removal procedure

The Ethernet adapter module can be removed from the DIN rail in reverse order of the mounting procedure.

## (3) Applicable DIN rail models (IEC 60715)

- TH35-7.5Fe
- TH35-7.5Al
- TH35-15Fe

## (4) DIN rail stopper

Use stoppers that can be attached to the DIN rail.

## (5) Interval between DIN rail mounting screws

To ensure the strength of the DIN rail, tighten DIN rail mounting screws (sold separately) 30mm away from the both edges of the DIN rail and at intervals of 200mm or less.

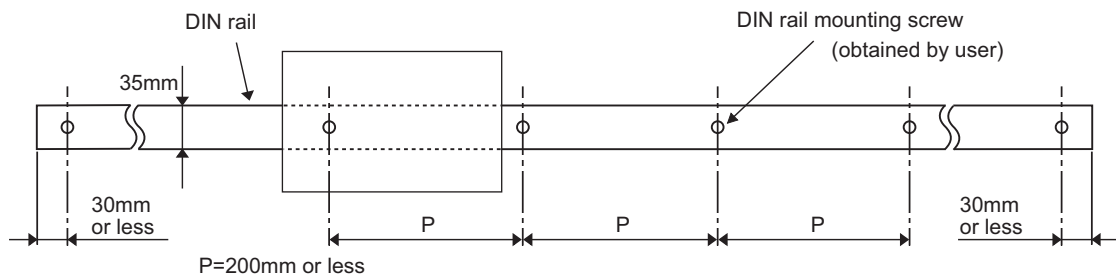



# 6.3 Testing the Module Before Wiring

## (1) Unit test

Perform a unit test to check the Ethernet adapter module for hardware failure.

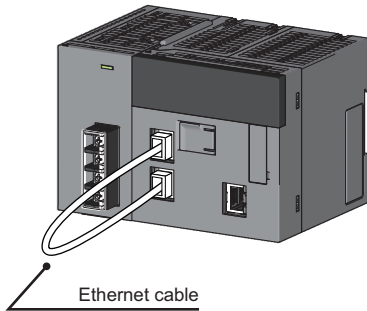

Repeat at intervals of less than 1s.

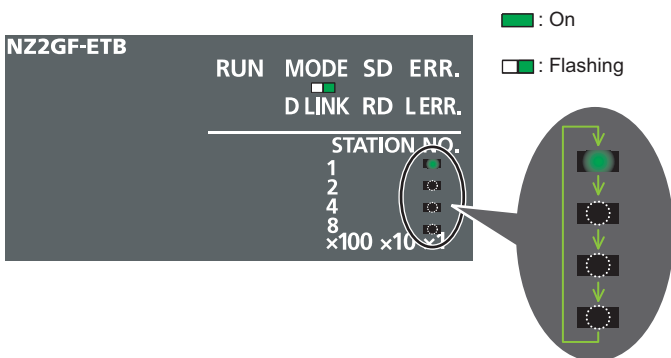
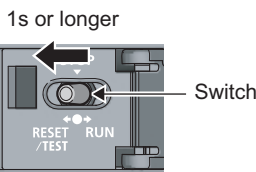
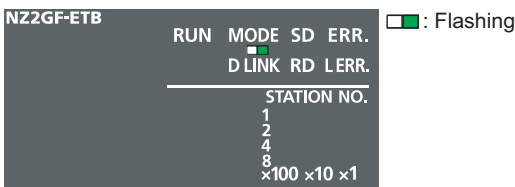
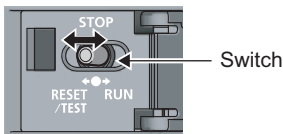

1. Turn off the power.
2. Connect PORT1 and PORT2 of the Ethernet adapter module with an Ethernet cable.
3. Turn on the power.
4. With the switch on the Ethernet adapter module, repeat 3 cycles of STOP → RESET/TEST → STOP, taking less than 1 second per cycle. (The MODE LED flashes after the third cycle.)

5. Hold the switch on the Ethernet adapter module in the RESET/TEST position for 1 second or more.

6. The unit test starts. The MODE LED starts flashing, and the ×1 and ×10 LEDs repeat turning and off in the sequence of 1→2→4→8→1... and so on.

6

6.3 Testing the Module Before Wiring

When completed

N22GF-ETB			
RUN	MODE	SD	ERR.
D LINK	RD	LERR.	
STATION NO.			
1			
2			
4			
8			
×100	×10	×1	

■ : On  
■ : Flashing

**7. When the unit test is completed, flashing of the ×1 and ×10 LEDs is stopped, and the D LINK LED turns on.**

- When completed: The D LINK LED turns on with the ERR. LED off.
- When failed: The following LEDs turn on.
  - Either of the ×1 and ×10 LEDs
  - ERR. LED
  - D LINK LED

If the unit test fails, replace the Ethernet cable and perform the test again. If it fails again, the Ethernet adapter module may have hardware failure. Please consult your local Mitsubishi representative, with a detailed explanation of the problem.

When failed

N22GF-ETB			
RUN	MODE	SD	ERR.
D LINK	RD	LERR.	
STATION NO.			
1			
2			
4			
8			
×100	×10	×1	

■ : On  
■ : Flashing

## 6.4 Wiring

### 6.4.1 Wiring of the power supply part

#### (1) Wiring method

The following figure shows an example of wiring to the power supply part.

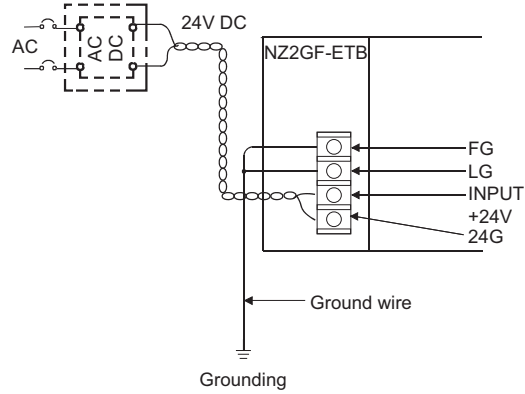

## (2) Precautions

Take the following precautions when wiring the power supply.

- Considering the rated current and inrush current of the power supply part, connect a circuit breaker having an appropriate sensing property or an external fuse causing proper blowout. (A 10A circuit breaker or external fuse is recommended.)
- To minimize a voltage drop, use thickest possible power cables (up to 2mm<sup>2</sup>), and connect them in the shortest distance by finely twisting them.
- Do not install the power cables together with the main circuit lines (high voltage and large current) and Ethernet cables. Keep a distance of 100mm or more between them.
- After wiring, always attach the included terminal cover to the power supply part, and do not touch any terminal while the power is on or the module is operating.
- Use a Class 2 power supply for the external power supply which inputs power to the power supply part.
- Use solderless terminals when wiring the terminal block of the power supply part. To prevent short-circuit that may occur when a screw become loose, use a solderless terminal with insulation sleeve, of which thickness is 0.8mm or less. Up to two solderless terminals can be connected to one terminal block.

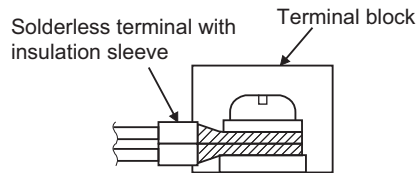

- Use UL-approved solderless terminals and, for processing, use a tool recommended by their manufacturer.
- Tighten the terminal screws on the power supply part within the applicable torque range of 0.66 to 0.89N·m.
- Use the following wires for connection to the power supply part.

Applicable wire size	Material	Temperature rating
0.75 to 2mm <sup>2</sup> (18 to 14AWG) (stranded wire)	Copper	75°C or higher

- An input of a signal of a different voltage level may cause malfunction or equipment failure.
- When supplying power to the power supply part, select a power supply having sufficient power capacity. (Double power capacity or more is recommended.)

### Point

For compliance with the EMC directive, refer to "EMC and Low Voltage Directives" in this manual. (  Page 231, Appendix 8)

## 6.4.2 Ethernet cable wiring

The following figure shows the respective ports connected to CC-Link IE Field Network and Ethernet.

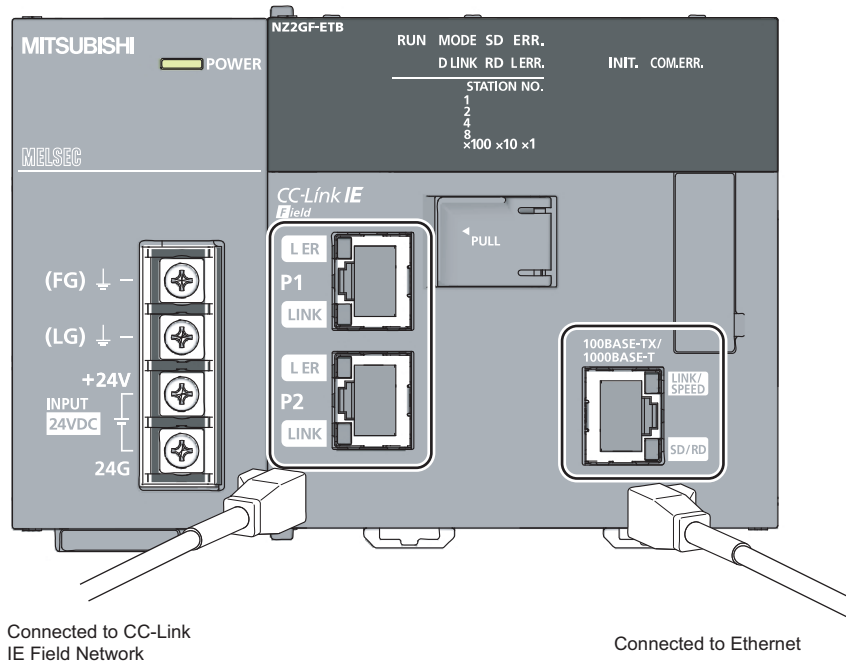

## (1) Connecting the Ethernet cable

For Ethernet cables, refer to "Network Components". (☞ Page 49, Section 5.2.2 (1))

### (a) Connection

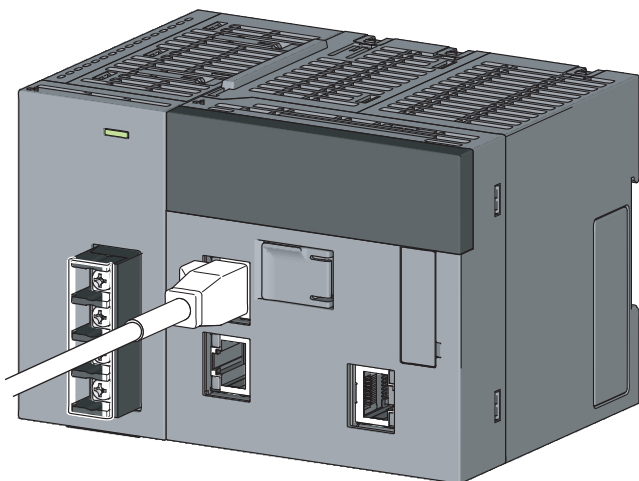

1. Turn off the power.
2. Insert the Ethernet cable connector into the port until a click sound is heard. Pay attention to the orientation of the connector.
3. Turn on the power.
4. Power on the external device connected to the port.
5. Check if the LED for the port of the connected Ethernet cable is on.

● Port for CC-Link IE Field Network connection

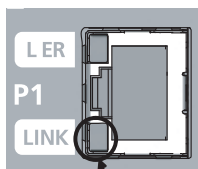

On

● Port for Ethernet connection

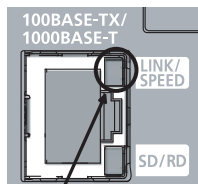

On

The time between the power-on and the LINK/SPEED LED turning on may vary. The LINK/SPEED LED usually turns on in a few seconds. Note, however, that the time may be extended further if the linkup process is repeated depending on the status of the device on the line.

If the LINK/SPEED LED does not turn on, refer to the troubleshooting section and take corrective actions.

(☞ Page 142, CHAPTER 9)

**(b) Disconnection**

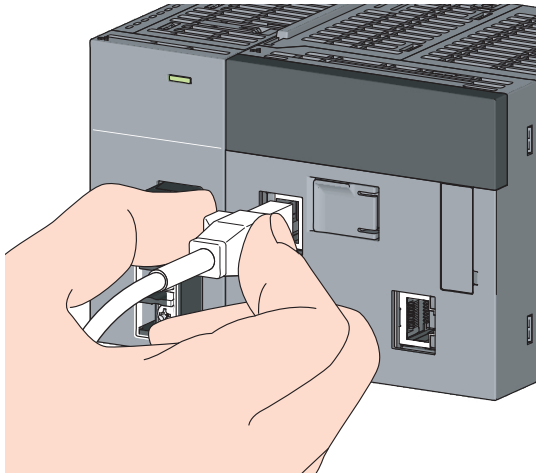

1. Turn off the power.
2. Pull out the Ethernet cable while pinching the retaining clip on the connector.

**Point**

There is no need to distinguish between PORT1 and PORT2.

- When using only one port in a star topology, either of PORT1 or PORT2 can be used.

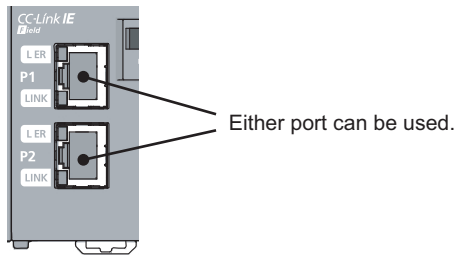

- When using the two ports in a line topology and a ring topology, there is no restriction on the order in which PORT1 and PORT2 are connected. For example, PORT1 can be connected to PORT1 or PORT2.

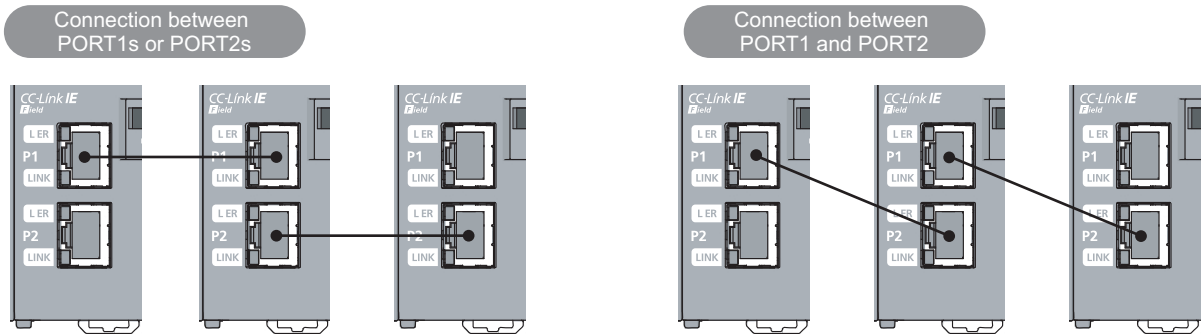

## 6.4.3 Grounding

Observe the following:

- Provide independent grounding when possible. Ground the FG and LG terminals to the protective ground conductor. (Grounding resistance:  $100\Omega$  or less)
- If independent grounding is not possible, employ shared grounding, making all of the ground wires to the same length.

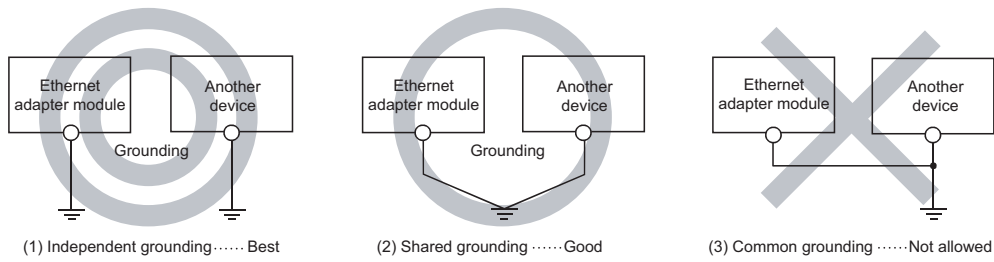

- Use the thickest possible ground wires (up to  $2\text{mm}^2$ ). Also, bring the grounding point close to the Ethernet adapter module as much as possible so that the ground wire can be shortened.



## 6.4.4 Precautions

This section provides precautions for wiring to CC-Link IE Field Network and Ethernet.

### (1) Ethernet cables

Use Ethernet cables that satisfy the 1000BASE-T or 100BASE-TX standard. (☞ Page 49, Section 5.2.2 (1))

### (2) Laying Ethernet cables

- Place the Ethernet cables in a duct or clamp them. If not, dangling cable may swing or inadvertently be pulled, resulting in damage to the Ethernet adapter module or cables or malfunction due to poor contact.
- Do not touch the core of the cable connector or the port, and protect it from dirt and dust. If oil from your hand, dirt, or dust sticks to the core, it can increase transmission loss, causing data link to fail.
- Check the Ethernet cables for:
  - Disconnection
  - Short circuit
  - Any connector connection problem

### (3) Connecting or disconnecting the Ethernet cable

When connecting or disconnecting the Ethernet cable, hold the connector part of the cable. Failure to do so may result in damage to the Ethernet adapter module or the cable or malfunction due to poor contact.

### (4) Bend radius of the Ethernet cable

There are restrictions on the bend radius of the Ethernet cable. Check the specifications of the Ethernet cable used.

### (5) If the retaining clip of the Ethernet cable is broken

Do not use any Ethernet cable that has a broken retaining clip. Doing so may cause cable disconnection or malfunction.

### (6) Unused Ethernet ports

To prevent dust from entering the module, attach the provided connector cover.

### (7) Maximum station-to-station distance (maximum Ethernet cable length)

The maximum station-to-station distance is 100m. However, it may be shorter depending on the environment. For details, contact the manufacturer of the cables used.

# CHAPTER 7 COMMUNICATION OF THE ETHERNET ADAPTER MODULE

## 7.1 SLMP Communication and Cyclic Transmission

Communication examples of SLMP communication and cyclic transmission are given below.

### 7.1.1 System configuration

The following system configuration is used as an example.

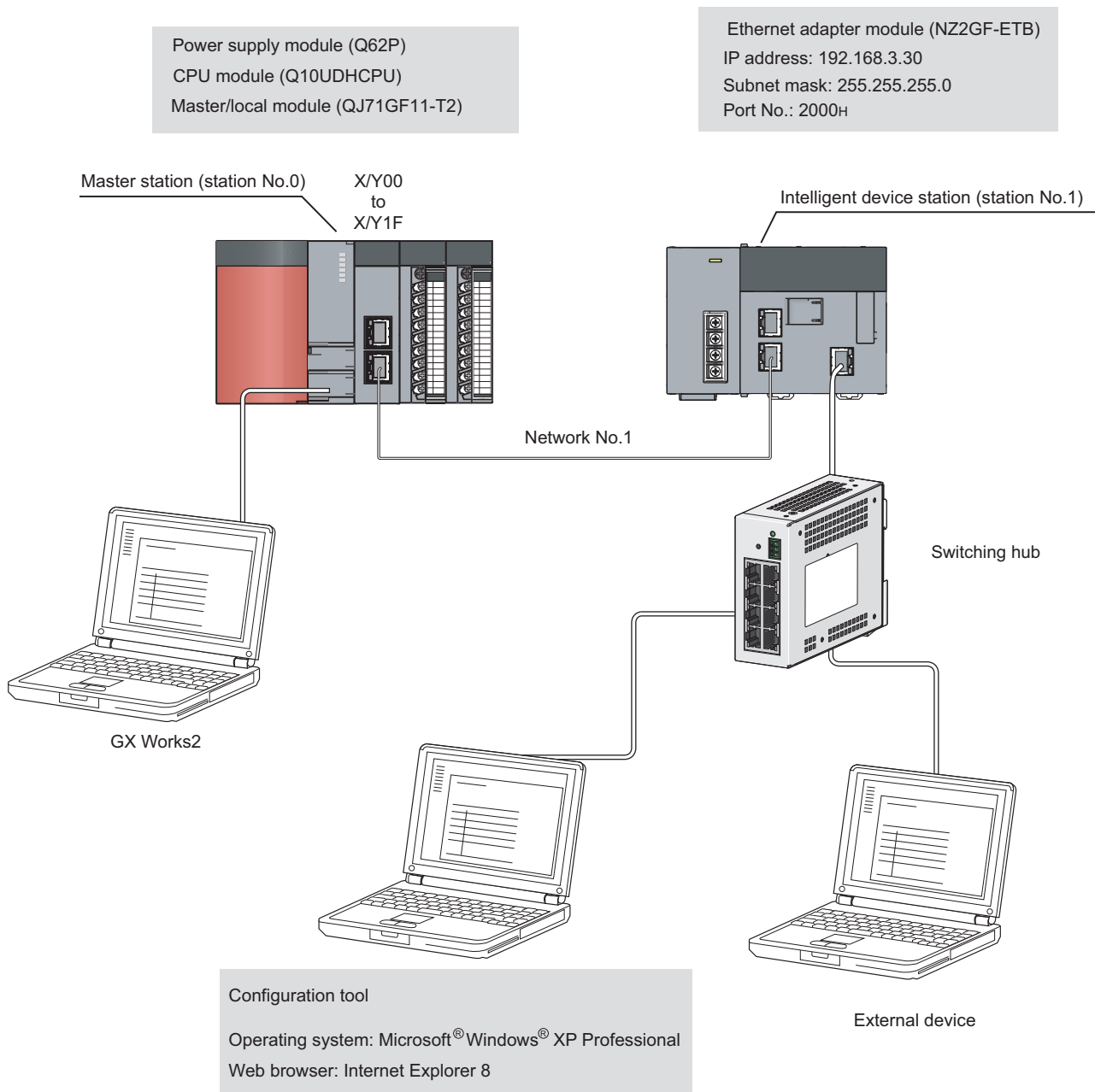

## 7.1.2 Communication details

The following SLMP message is sent from the external device to the Ethernet adapter module.

- By Read (command: 0401), 32-bit data in RY0000 to RY001F (Y0000 to Y001F) are read out.
- By Write (command: 1401), 2-word data (1234<sub>H</sub> and 5678<sub>H</sub>) are written to RWr0000 to RWr0001 (W1000 to W1001).

Through cyclic transmissions, data in link devices of the Ethernet adapter module are periodically exchanged with the CPU module's devices.

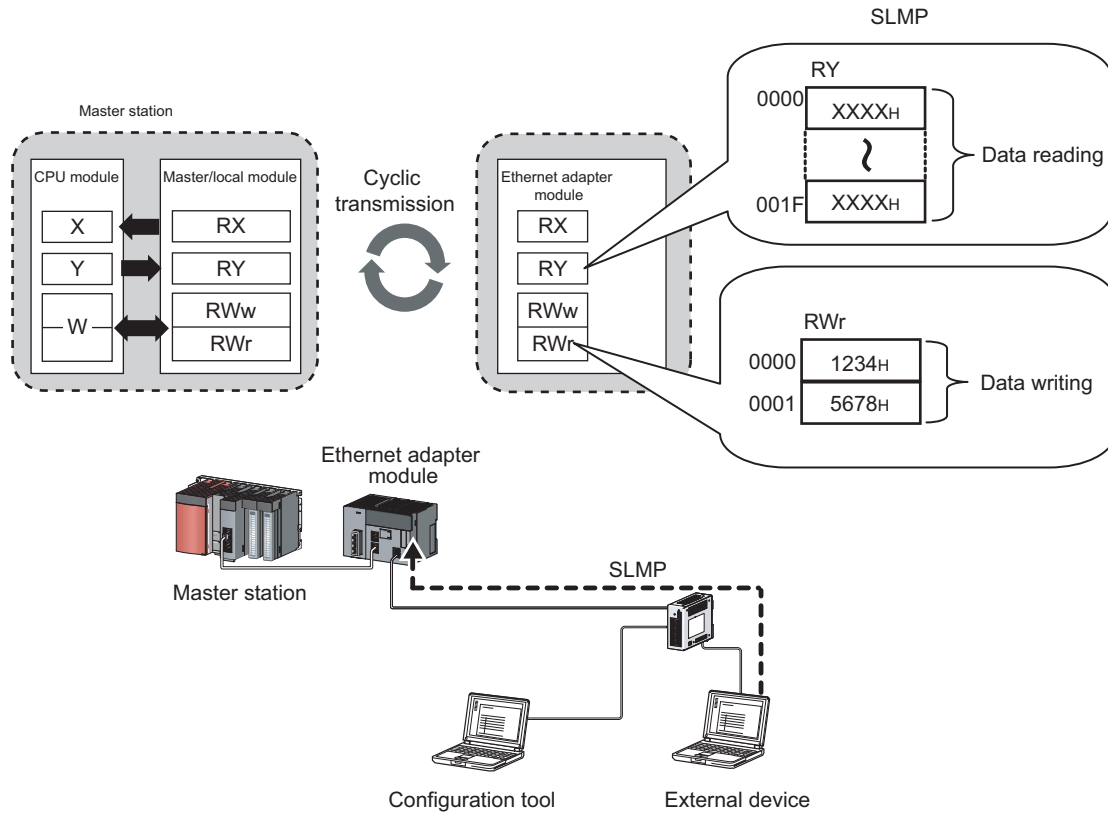

7

### (1) Communication settings

Item	Setting
Protocol	TCP/IP
TCP connection type	Unpassive
Communication data code	Binary code

### (2) SLMP commands

Item		Command	Subcommand	Description
Type	Operation			
Device	Read	0401	0000	Reads values from bit devices (of consecutive device numbers) in units of 16 points.
	Write	1401	0000	Writes values to word devices (of consecutive device numbers) in units of one point.

7.1 SLMP Communication and Cyclic Transmission

### (3) Link device assignment

#### (a) Assignment of RX and RY

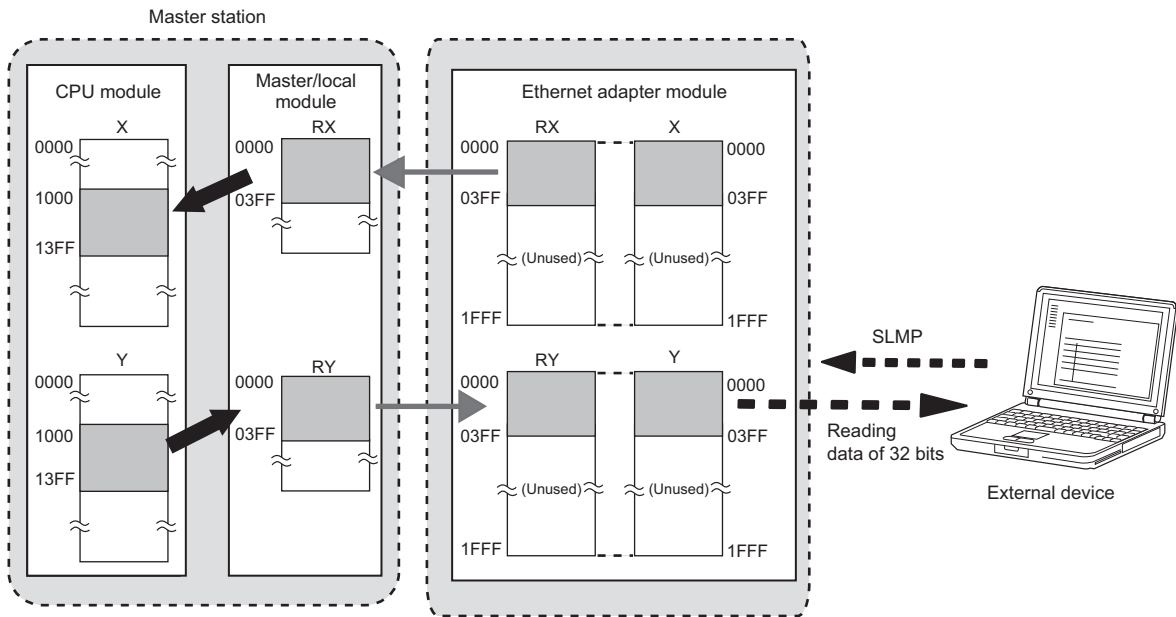

#### (b) Assignment of RWr and RWw

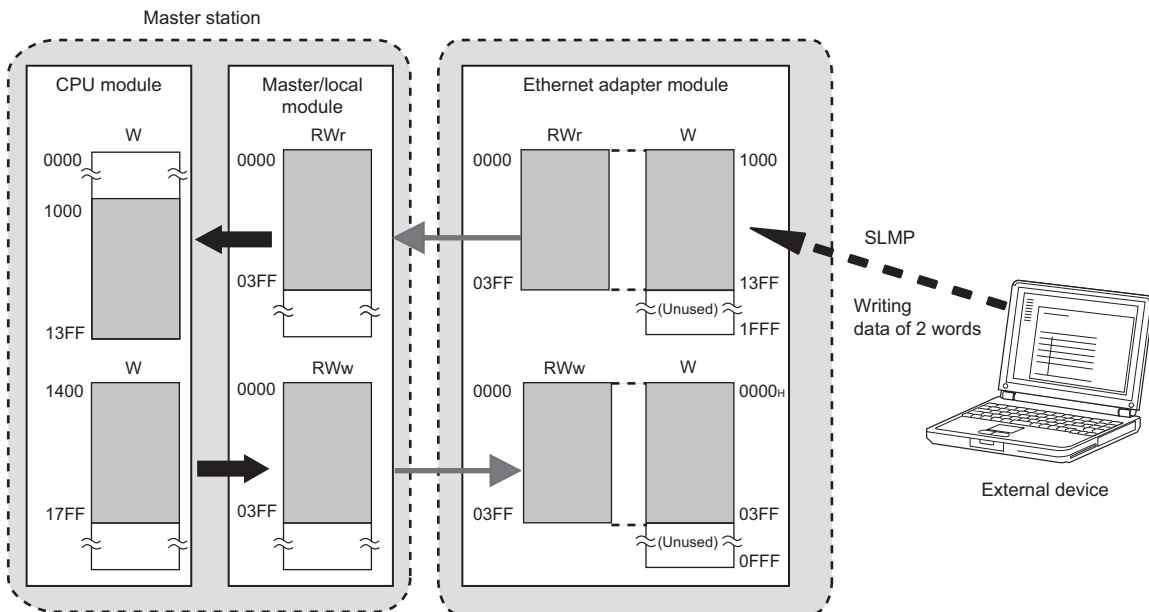

## 7.1.3 Network setting on the configuration computer

1. Open the "Internet Protocol (TCP/IP) Properties" dialog box on the personal computer, and configure the settings as shown below.

Control panel ⇒ "Network and Internet Connections" ⇒ "Network Connections" ⇒ "Local Area Connection" ⇒ "General" ⇒ [Properties] button ⇒ "Internet Protocol (TCP/IP)" ⇒ [Properties] button

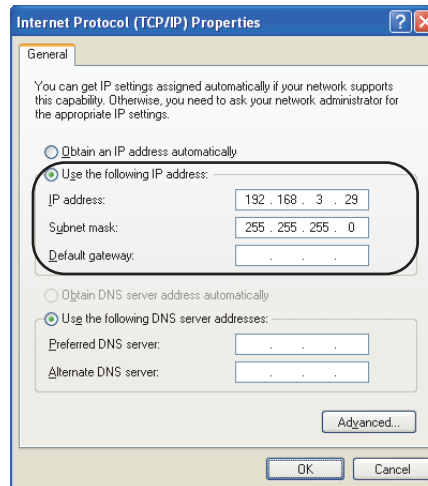

2. Open the "Local Area Network (LAN) Settings" dialog box from the Web browser, and configure the settings as shown below. If the same network settings are applied to the Ethernet adapter module and the proxy server, the following settings are not necessary.

Web browser ⇒ [Tools] ⇒ [Internet Options] ⇒ "Connections" ⇒ [LAN settings] button

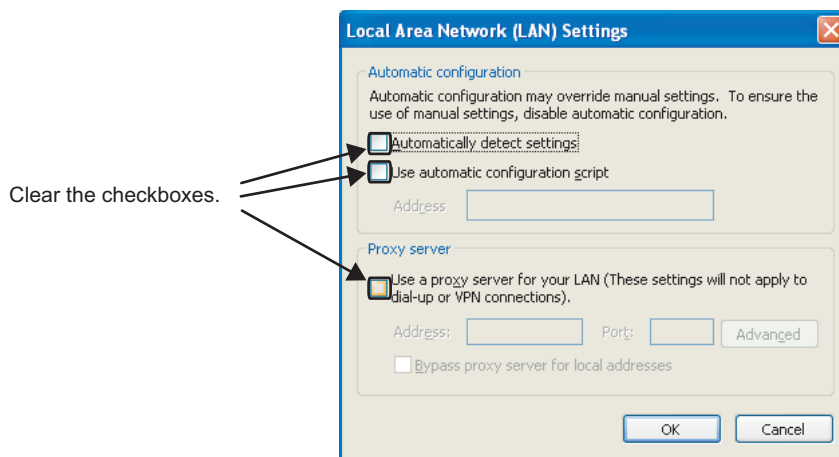

3. Open the "Internet Options" dialog box from the Web browser, and select "Local Intranet Zone" as shown below.

Web browser ⇒ [Tools] ⇒ [Internet Options] ⇒ "Security"

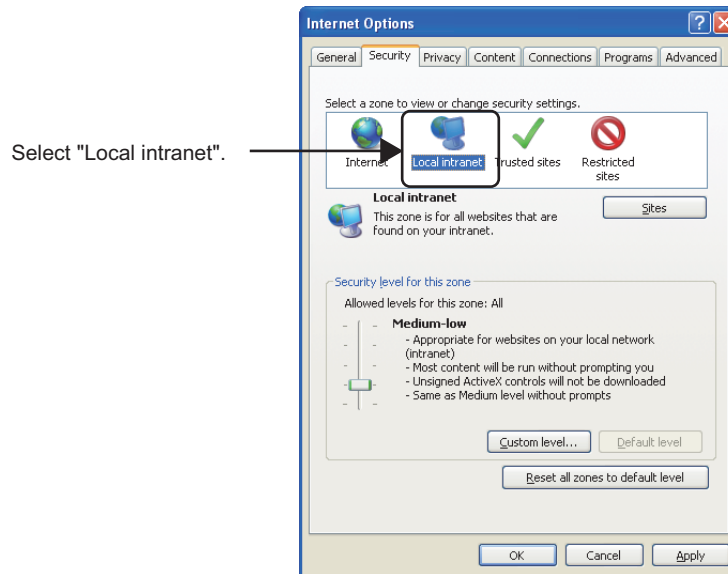

4. After that, click the [Custom level...] button and configure the settings as shown below.

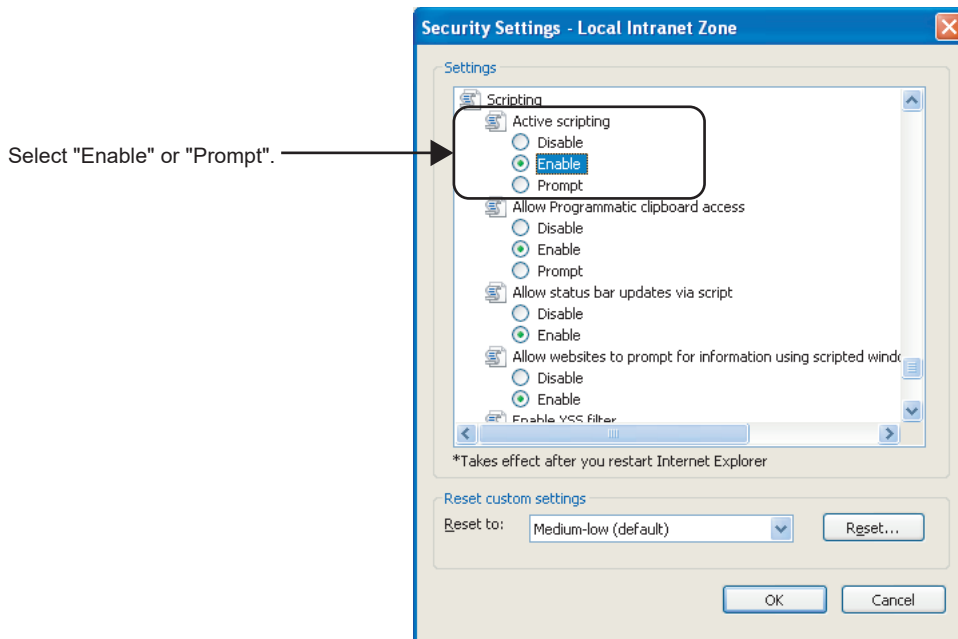

When "Prompt" is selected, the following dialog box may be displayed during the start-up of the configuration tool. If this occurs, click the [Yes] button.

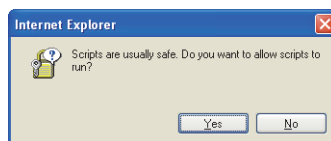

# 7.1.4 Connection to CC-Link IE Field Network

## (1) Setting in the master station

Use GX Works2 to set the parameters in the master station. Use the default settings for the parameters other than those set below.

### 1. Create a project on GX Works2.

Select "QCPU (Q mode)" for "PLC Series", and "Q10UDH" for "PLC Type".

 [Project] ⇒ [New...]

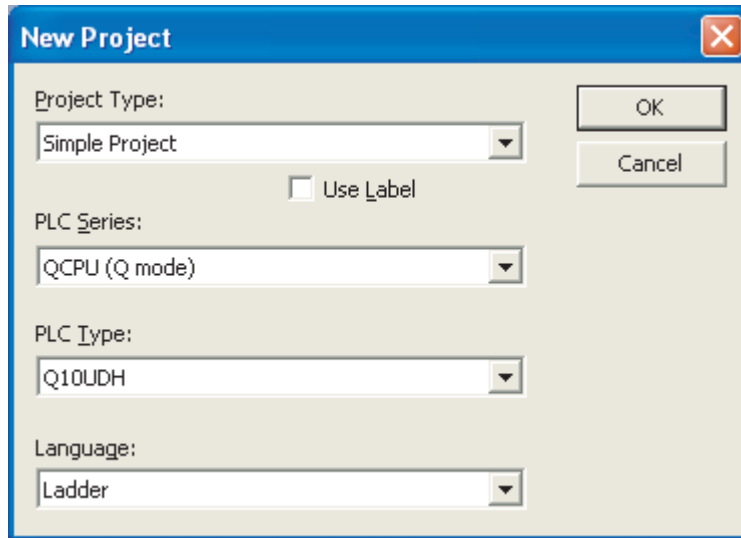

### 2. Open the "Network Parameter" setting window to set the parameters as follows.

 Project window ⇒ [Parameter] ⇒ [Network Parameter] ⇒ [Ethernet/CC IE/MELSECNET]

Setting

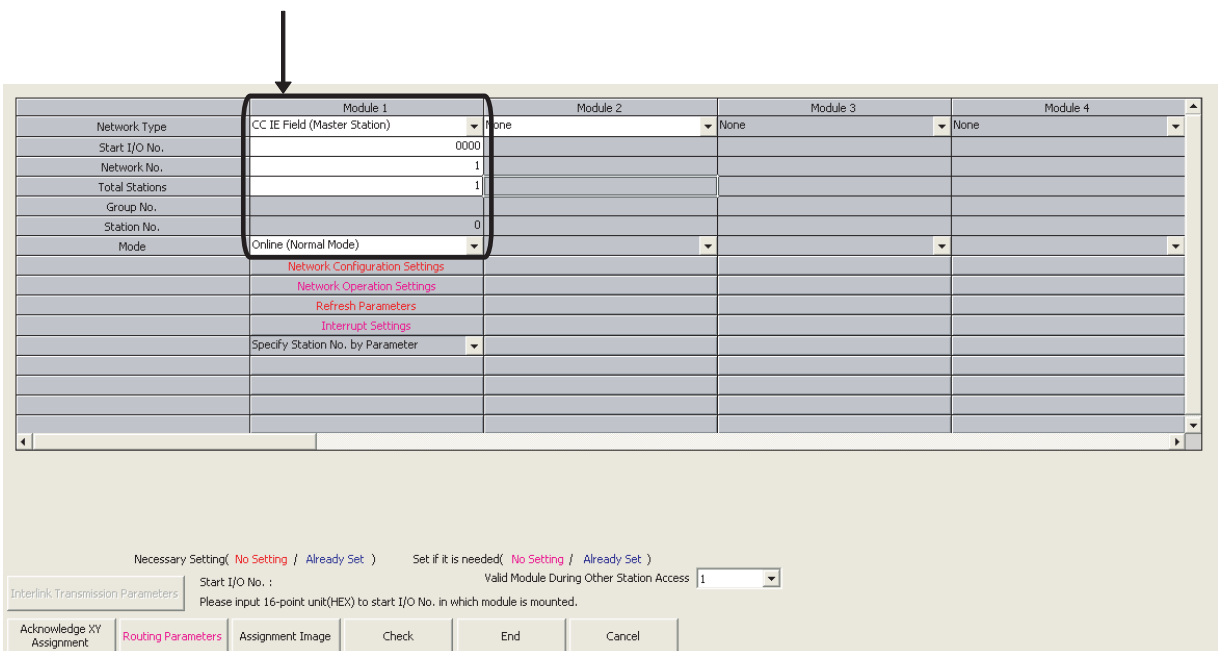

3. Click the [Network Configuration Settings] button to set the parameters as follows.

Set up Network configuration.

Assignment Method  
 Points/Start  
 Start/End

The column contents for refresh device will be changed corresponding to refresh parameter. Please reopen the window after completing refresh parameter setting when changing refresh parameter.

Number of PLCs	Station No.	Station Type	RX/RX Setting			RWw/RWr Setting		
			Points	Start	End	Points	Start	End
0	0	Master Station						
1	1	Intelligent Device Station	1024	0000	03FF	1024	0000	03FF

4. After setting, click the [End] button.
5. Click the [Refresh Parameters] button to open the refresh parameter setting window. Set the parameters as follows.

Assignment Method  
 Points/Start  
 Start/End

	Link Side					PLC Side			
	Dev. Name	Points	Start	End		Dev. Name	Points	Start	End
Transfer SB	SB	512	0000	01FF	↔	SB	512	0000	01FF
Transfer SW	SW	512	0000	01FF	↔	SW	512	0000	01FF
Transfer 1	RX	1024	0000	03FF	↔	X	1024	1000	13FF
Transfer 2	RY	1024	0000	03FF	↔	Y	1024	1000	13FF
Transfer 3	RWr	1024	0000	03FF	↔	W	1024	001000	0013FF
Transfer 4	RWw	1024	0000	03FF	↔	W	1024	001400	0017FF
Transfer 5					↔				
Transfer 6					↔				
Transfer 7					↔				
Transfer 8					↔				

Default Check End Cancel

6. After setting, click the [End] button.
7. In the network parameter setting window, click the [End] button.
8. Write the set parameters to the CPU module on the master station.  
 [Online] ⇒ [Write to PLC]
9. Reset the CPU module or power off and on the system.

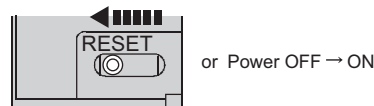



## (2) Setting for the Ethernet adapter module

Set the parameters to connect the Ethernet adapter module to CC-Link IE Field Network using the configuration tool.

1. Start up the configuration tool using a Web browser. (☞ Page 184, Section 10.1.2)
2. Open the "Parameter Setting" dialog box in the configuration tool to set the parameters as follows.

☞ Setting item tree ⇒ NZ2GF-ETB ⇒ [Parameter] ⇒ "CC-Link IE Field Network"

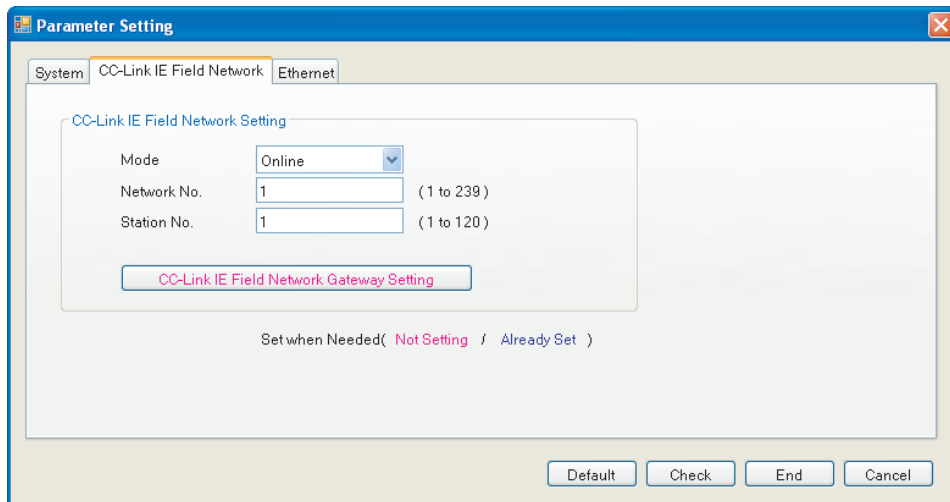

3. After setting, click the [End] button.
4. Set the IP address of the connected Ethernet adapter module. Open the "Destination Setting" dialog box in the configuration tool to enter the address as follows.

☞ [Online] ⇒ [Destination Setting]

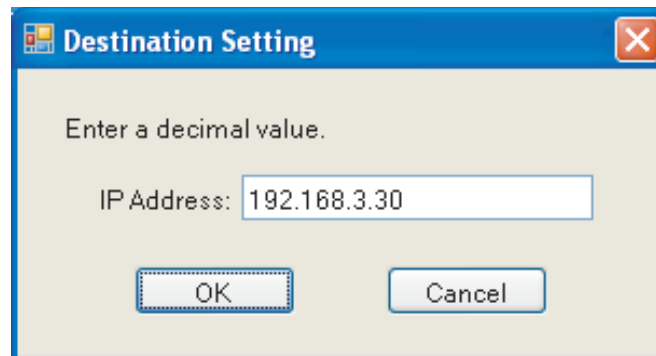

5. Write the set parameters to the Ethernet adapter module. (Set the switch on the Ethernet adapter module to STOP.)

 [Online] ⇒ [Write]

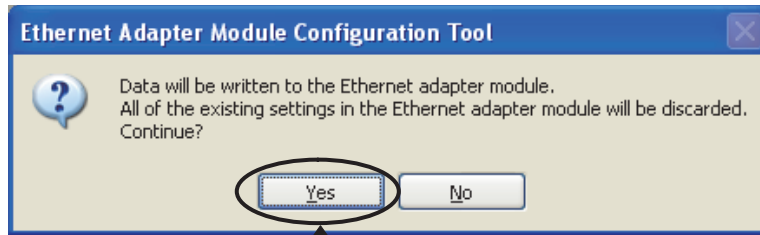

Click

6. The following dialog box appears.

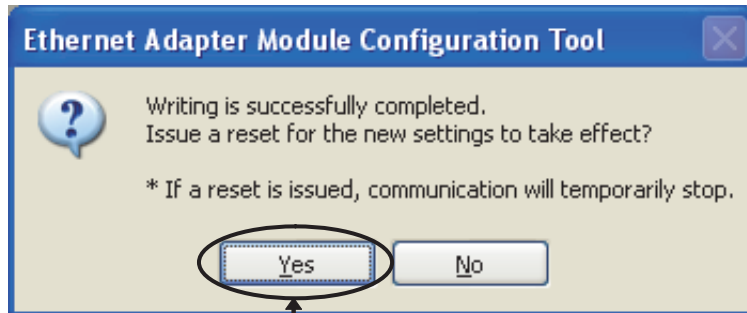

Click

7. Set the switch on the Ethernet adapter module to RUN.

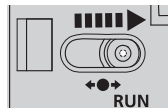

### (3) Checking the connection





After setting the parameters for the master station and the Ethernet adapter module, check if data link can be normally performed between them, by using the CC-Link IE Field Network diagnostics of GX Works2 connected to the master station.

1. From the menu of GX Works2, activate the CC-Link IE Field Network diagnostics.

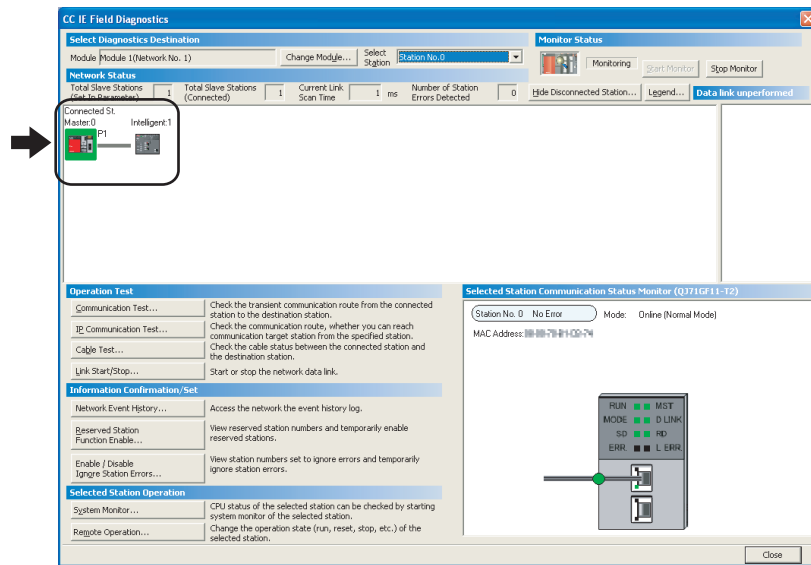
 [Diagnostics] ⇒ [CC IE Field Diagnostics]

The following shows the normal condition.



If a mark, such as , , and , is displayed in "Network Status", an error has occurred. Identify the cause of the error and take corrective action. ( User's manual for the master/local module used)

**Ex.** If an error occurred in the Ethernet adapter module, the dialog box appears as follows.

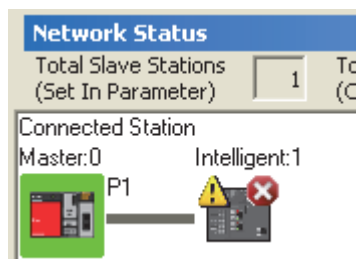

# 7.1.5 Connection to Ethernet

## (1) Configuring the Ethernet adapter module

Configure the parameters for communication between the Ethernet adapter module and external devices, using the configuration tool.

1. Start up the configuration tool using a Web browser. (👉 Page 184, Section 10.1.2)
2. Open the "Parameter Setting" dialog box in the configuration tool to set the parameters as follows.

🖱️ Setting item tree ⇒ NZ2GF-ETB ⇒ [Parameter] ⇒ "Ethernet"

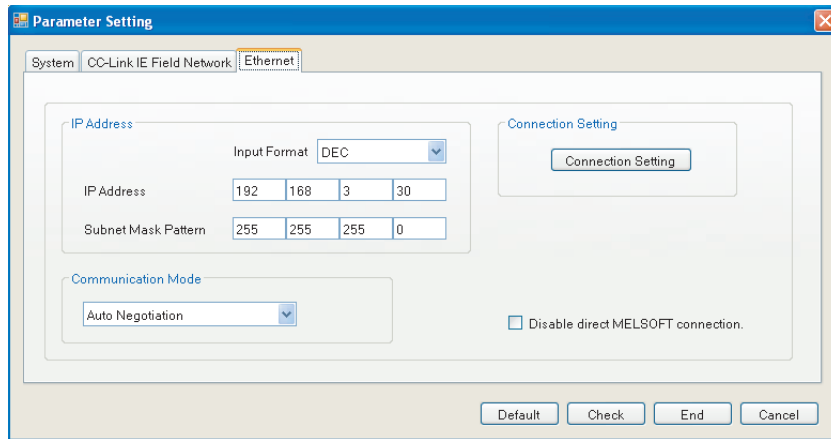

3. Click the [Connection Setting] button to display the "Ethernet Port Connection Setting" window. Set it up as shown below.

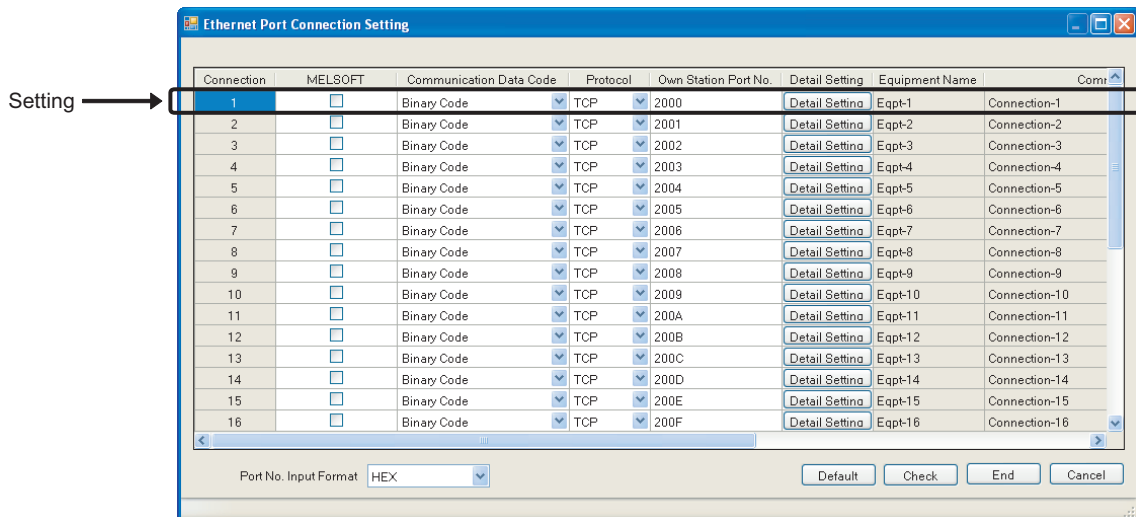

- Click the [Detail Setting] button to display the "Detail Setting" dialog box. Set the parameters as follows.

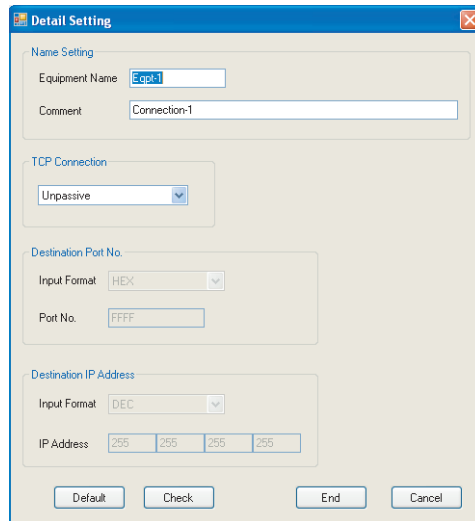

- Click the [End] button.
- In the "Ethernet Port Connection Setting" window, click the [End] button.
- In the "Parameter Setting" dialog box, click the [End] button.
- Set the IP address of the connected Ethernet adapter module. In the "Destination Setting" dialog box of the configuration tool, enter a value as shown below.

[Online] ⇒ [Destination Setting]

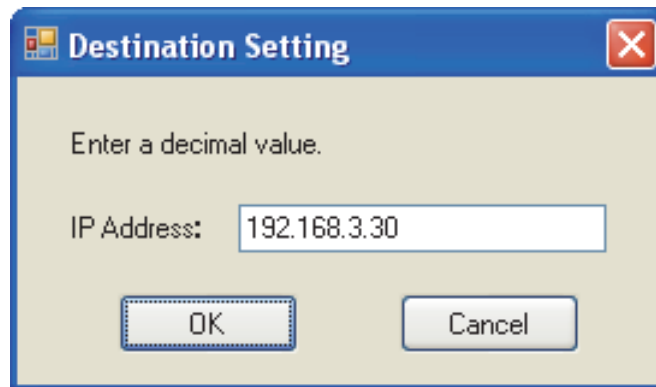

- Write the configured parameters to the Ethernet adapter module. (Set the switch on the Ethernet adapter module to STOP.)

[Online] ⇒ [Write]

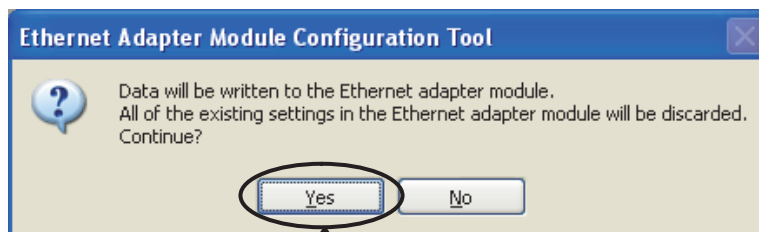

Click

**10.** The following dialog box is displayed.

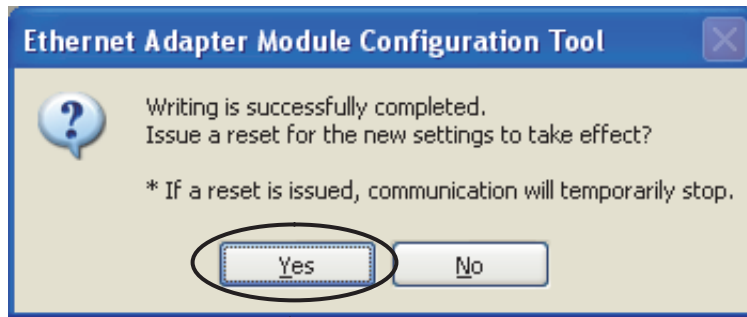

Click

**11.** Set the switch on the Ethernet adapter module to RUN.

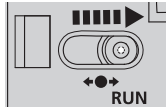

## (2) Creating a program

A program example is shown in this section. Programs should be executed from an external device.

### Point

- In the program example shown in this section, the minimum processing is described. When including any other processing such as error handling, add the corresponding program to it.
- If the Ethernet adapter module is powered off and then on, data written from the external device to the Ethernet adapter module using SLMP will be cleared. Therefore, create a program of communicating data while handshaking with the master station.

### (a) Programming environment

Development environment: Microsoft® Visual C++® 2005

Library that requires a link: ws2\_32.lib

### (b) Configuration of the Ethernet adapter module

Item	Setting
IP address	192.168.3.30
Subnet mask	255.255.255.0
Port No.	2000 <sub>H</sub>

### (c) Program example

```
//EthernetAD_test.cpp: Defines the entry point of the console application.
//

#include "stdafx.h"

/*****
**                                     **
** Sample program (program name: EthernetAD_test.cpp)                       **
**                                     **
** This is a sample program for testing a connection between                 **
** the Ethernet adapter module and the external device.                     **
** This program reads RY0000 to RY001F of the Ethernet adapter module       **
** and writes data to RWr0000 and RWr0001.                                  **
**                                     **
** Copyright(C) 2010 Mitsubishi Electric Corporation                       **
** All Rights Reserved                                                       **
**                                     **
*****/

#include <winsock2.h>

#define FLAG_OFF 0 // End flag OFF
#define FLAG_ON 1 // End flag ON
#define SOCK_OK 0 // Normal end
#define SOCK_NG -1 // Abnormal end
#define BUF_SIZE 4096 // Receive buffer size
#define ERROR_INITIAL 0 // Initial error
#define ERROR_SOCKET 1 // Socket creation error
#define ERROR_BIND 2 // Bind error
#define ERROR_CONNECT 3 // Connect error
#define ERROR_SEND 4 // Send error
#define ERROR_RECV 5 // Receive error
#define ERROR_SHUTDOWN 6 // Shutdown error
#define ERROR_CLOSE 7 // Line close error
```

```

// Definitions for checking the receiving data size
#define SEND_REQ_1 25 // The size of the request message to be sent for device writing (3E frame, binary)
#define RECV_ANS_1 11 // The size of the response message to be received for device writing (3E frame, binary)

#define SEND_REQ_2 21 // The size of the request message to be sent for device reading (3E frame, binary)
#define RECV_ANS_2 15 // The size of the response message to be received for device reading (3E frame, binary)

typedef struct sck_inf{
    struct
        unsigned short    in_addr my_addr;
        unsigned short    my_port;
    struct
        unsigned short    in_addr aj_addr;
        unsigned short    aj_port;
}sck_inf;

int nErrorStatus; // Error information stored in variable
int Dmykeyin; // Dummy key input
int Closeflag; // Connection end flag
int socketno;

int main()
{
    WORD wVersionRequested = MAKEWORD(1, 1); // Winsock Ver.1.1 request
    WSADATA wsaData;

    int j; // For command identification 1
    int k; // For command identification 2

    int i; // Counter for data display
    char disp[2]; // Workspace for data display

    char s_buf[BUF_SIZE]; // Send buffer
    char r_buf[BUF_SIZE]; // Receive buffer

    int length; // Receive data length
    int rbuf_idx; // Receive data storage head index
    int rcv_size; // Total number of receive data
    struct sck_inf sc;
    struct sockaddr_in hostdata; // External device side data
    struct sockaddr_in EthernetAD; // Ethernet adapter module side data
    void Sockerror(int); // Error handling function

    unsigned long ulCmdArg; // Non-blocking mode setting flag

    sc.my_addr.s_addr = htonl(INADDR_ANY); // External device's IP address
    sc.my_port = htons(0); // External device's port number
    sc.aj_addr.s_addr = inet_addr("192.168.3.30"); // Ethernet adapter module's IP address(C0A8031Eh)
    sc.aj_port = htons(0x2000); // Ethernet adapter module's port number

    Closeflag = FLAG_OFF; // Connection end flag off

    nErrorStatus = WSASStartup(wVersionRequested, &wsaData); // Winsock initial processing

    if(nErrorStatus != SOCK_OK) {
        Sockerror(ERROR_INITIAL); // Error handling
        return (SOCK_NG);
    }

    printf("Winsock Version is %1d.%1d\n", HIBYTE(wsaData.wVersion), LOBYTE(wsaData.wVersion));
    printf("EthernetAD_test Start\n\n");

    socketno = socket(AF_INET, SOCK_STREAM, 0); // Creating TCP/IP socket

    if(socketno == INVALID_SOCKET) {
        Sockerror(ERROR_SOCKET); // Error handling
    }

    return (SOCK_NG);
}

```



```

hostdata.sin_family = AF_INET;
hostdata.sin_port = sc.my_port;
hostdata.sin_addr.s_addr = sc.my_addr.s_addr;

if(bind(socketno, (LPSOCKADDR)&hostdata, sizeof(hostdata)) != SOCK_OK) { // Bind
    Sockerror(ERROR_BIND); // Error handling
    return (SOCK_NG);
}

EthernetAD.sin_family = AF_INET;
EthernetAD.sin_port = sc.aj_port;
EthernetAD.sin_addr.s_addr = sc.aj_addr.s_addr;

if(connect(socketno, (LPSOCKADDR)&EthernetAD, sizeof(EthernetAD)) != SOCK_OK) {
    // Connect (Active open)
    Sockerror(ERROR_CONNECT); // Error handling

    return (SOCK_NG);
}

Closeflag = FLAG_ON; // Connection end flag on
// Make non-blocking mode active.

ulCmdArg = 1;

ioctlsocket(socketno, FIONBIO, &ulCmdArg); // Set to non-blocking mode

k = 1;

while (k) {

    printf("For the Read command, enter 1.\n");
    printf("For the Write command, enter 2.\n");
    printf("For ending, enter a value other than 1 and 2.\n");
    printf(">");

    scanf_s("%d", &j);

    switch (j) {

    case 1:

        //Creates a frame requesting for reading RY0000 to RY001F devices (3E frame)
        s_buf[0] = 0x50; // Setting subheader
        s_buf[1] = 0x00;
        s_buf[2] = 0x00; // Setting network number
        s_buf[3] = 0xff; // Setting station number
        s_buf[4] = 0xff; // Setting request destination module I/O number
        s_buf[5] = 0x03;
        s_buf[6] = 0x00; // Setting request destination module station number
        s_buf[7] = 0x0c; // Setting request data length (12 bytes)
        s_buf[8] = 0x00;
        s_buf[9] = 0x10; // Setting CPU monitoring timer
        s_buf[10] = 0x00;
        s_buf[11] = 0x01; // Setting command (batch read of word data)
        s_buf[12] = 0x04;
        s_buf[13] = 0x00; // Setting subcommand
        s_buf[14] = 0x00;
        s_buf[15] = 0x00; // Setting device number 000000
        s_buf[16] = 0x00;
        s_buf[17] = 0x00;
        s_buf[18] = 0x9d; // Setting device code (Y)
        s_buf[19] = 0x02; // Setting device points (2 words)
        s_buf[20] = 0x00;

```

```

if(send(socketno, (char *)s_buf, SEND_REQ_2, 0) == SOCKET_ERROR) {
    // Data sending
    Sockerror(ERROR_SEND); // Error handling

    return (SOCK_NG);
}

// Receiving data with the size checked
rbuf_idx = 0; // Initializes the head index of the receive data storage
recv_size = 0; // Initializes the number of receive data

while(1) {
    length = recv(socketno, (char *)&r_buf[rbuf_idx], (BUF_SIZE - rbuf_idx), 0);
    // Receiving response data
    if(length == 0) { // Was the connection cut off?

        Sockerror(ERROR_RECIEVE); // Error handling

        return (SOCK_NG);
    }

    if(length == SOCKET_ERROR) {

        nErrorStatus = WSAGetLastError();

        if(nErrorStatus != WSAEWOULDBLOCK) {

            Sockerror(ERROR_RECIEVE); // Error handling

            return (SOCK_NG);
        } else {

            continue; // Repeat until data are received.
        }
    }
    else {
        rbuf_idx += length; // Updates the receive data storage location.
        recv_size += length; // Updates the number of receive data.
        if(recv_size >= RECV_ANS_2) // Received all response messages?
            break; // Stops the repetition as they were received.
    }
}

printf("\nRY read completed\n");

//Read value display
for (i = 0; i < 2; i++) {

    disp[0] = r_buf[11+(i*2)];
    disp[1] = r_buf[12+(i*2)];
    printf("RY00%d0 to RY00%dF read value: %4X\n", i, i, *(USHORT*)&disp);
}

printf("\n\n");

break;

```

case 2:

```

// Creates a frame requesting for writing to RWr0 and RWr1 devices (3E frame)
s_buf[0] = 0x50; // Setting subheader
s_buf[1] = 0x00;
s_buf[2] = 0x00; // Setting network number
s_buf[3] = 0xff; // Setting station number
s_buf[4] = 0xff; // Setting request destination module I/O number
s_buf[5] = 0x03;
s_buf[6] = 0x00; // Setting request destination module station number
s_buf[7] = 0x10; // Setting request data length (16 bytes)
s_buf[8] = 0x00;
s_buf[9] = 0x10; // Setting CPU monitoring timer
s_buf[10] = 0x00;
s_buf[11] = 0x01; // Setting command (batch write of word data)
s_buf[12] = 0x14;
s_buf[13] = 0x00; // Setting subcommand
s_buf[14] = 0x00;
s_buf[15] = 0x00; // Setting device number 001000
s_buf[16] = 0x10;
s_buf[17] = 0x00;
s_buf[18] = 0xb4; // Setting device code (W)
s_buf[19] = 0x02; // Setting device points (2 words)
s_buf[20] = 0x00;
s_buf[21] = 0x34; // Setting write data
s_buf[22] = 0x12;
s_buf[23] = 0x78;
s_buf[24] = 0x56;

if(send(socketno, (char *)s_buf, SEND_REQ_1, 0) == SOCKET_ERROR) {
    // Data sending
    Sockerror(ERROR_SEND); // Error handling

    return (SOCK_NG);
}

// Receiving data with the size checked
rbuf_idx = 0; // Initializes the head index of the receive data storage.
rcv_size = 0; // Initializes the number of receive data.

while(1) {
    length = recv(socketno, (char *)&r_buf[rbuf_idx], (BUF_SIZE - rbuf_idx), 0);
    // Receiving response data
    if(length == 0) { // Was the connection cut off?

        Sockerror(ERROR_RECIEVE); // Error handling

        return (SOCK_NG);
    }

    if(length == SOCKET_ERROR) {

        nErrorStatus = WSAGetLastError();

        if(nErrorStatus != WSAEWOULDBLOCK) {

            Sockerror(ERROR_RECIEVE); // Error handling

            return (SOCK_NG);
        } else {

            continue; // Repeat until data are received.
        }
    }
}
else {
    rbuf_idx += length; // Updates the receive data storage location.
    rcv_size += length; // Updates the number of received data.
    if(rcv_size >= RECV_ANS_1) // Received all response messages?
        break; // Stops the repetition as they were received.
}
}

```

```

printf("\nRWr write completed\n");

//Write value display
for (i = 0; i < 2; i++) {

    disp[0] = s_buf[21+(i*2)];
    disp[1] = s_buf[22+(i*2)];
    printf("RWr000%d written value: %4X\n", i, *(USHORT*)&disp);
}

printf("\n\n");

break;

default:

    k = 0;

    break;

}

}

if(shutdown(socketno, 2) != SOCK_OK) { // Send/receive disabled
    Sockerror(ERROR_SHUTDOWN); // Error handling
    return (SOCK_NG);
}

if(closesocket(socketno) != SOCK_OK) { // Close processing
    Sockerror(ERROR_CLOSE); // Error handling
    return (SOCK_NG);
}

Closeflag = FLAG_OFF; // Connection end flag off
WSACleanup(); // Winsock DLL freed
printf("\nEthernetAD_test End.\n\nCompleted.\n");
printf("Exiting the program. Press any key.\n");
Dmykeyin = getchar(); // Waiting for key input

return (SOCK_OK);
}

```

```

void Sockerror(int error_kind) // Error handling function
{
    if (error_kind == ERROR_INITIAL){
        printf("Initial processing is abnormal.");
    }

    else{
        nErrorStatus = WSAGetLastError();

        switch(error_kind){
        case ERROR_SOCKET:
            printf("Failed to create the socket.");
            break;

        case ERROR_BIND:
            printf("Failed to bind.");
            break;

        case ERROR_CONNECT:
            printf("Failed to establish the connection.");
            break;

        case ERROR_SEND:
            printf("Failed to send.");
            break;

        case ERROR_RECIEVE:
            printf("Failed to receive.");
            break;

        case ERROR_SHUTDOWN:
            printf("Failed to shut it down.");
            break;

        case ERROR_CLOSE:
            printf("Failed to properly close it.");
            break;

        }

        printf("Error code is %d.\n", nErrorStatus);

        if (Closeflag == FLAG_ON){
            nErrorStatus = shutdown(socketno, 2);           // Shutdown processing
            nErrorStatus = closesocket(socketno);          // Close processing
            Closeflag = FLAG_OFF;                          // Connection end flag off
        }

        printf("Exiting the program. Press any key.\n");
        Dmykeyin = getchar();                             // Waiting for key input
        WSACleanup();                                     // Winsock DLL freed

        return;
    }
}

```

### (3) Executing the program

#### (a) Sending the Read command

1. On the "Device/Buffer Memory Batch Monitor" window of GX Works2, set values for Y1000 to Y100F and Y1010 to Y101F of the CPU module as shown below.

 [Online] ⇒ [Monitor] ⇒ [Device/Buffer Memory Batch]

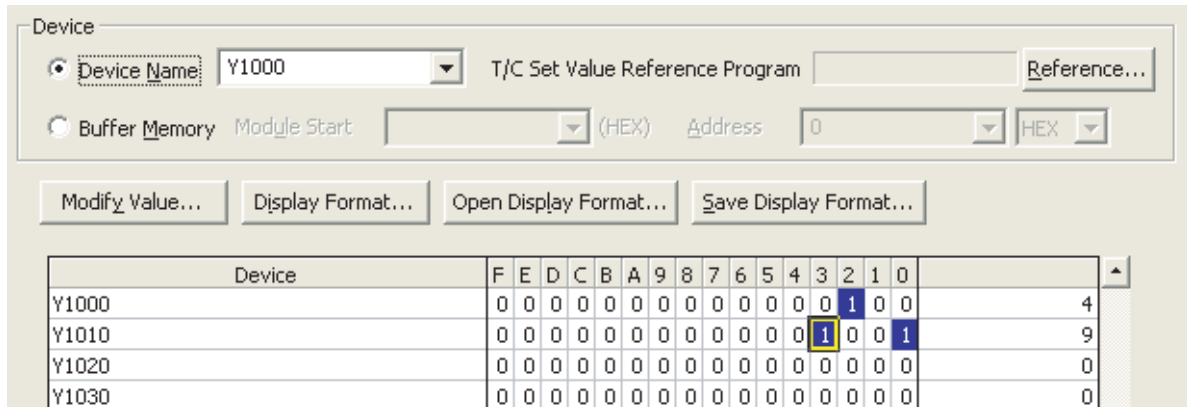

2. Run the executable file at the command prompt. In the following window, enter 1.

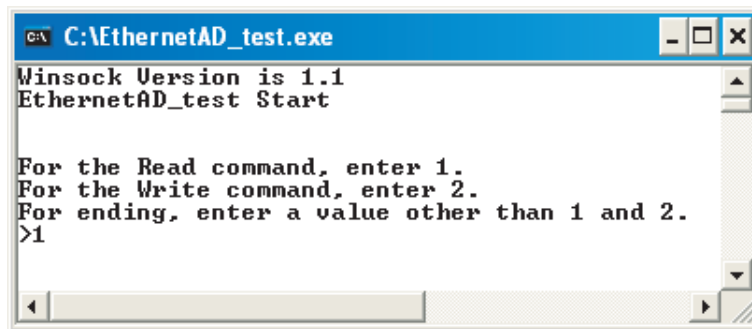

3. The following window message is displayed upon successful completion. If not, take action according to the troubleshooting instructions. (☞ Page 142, CHAPTER 9)

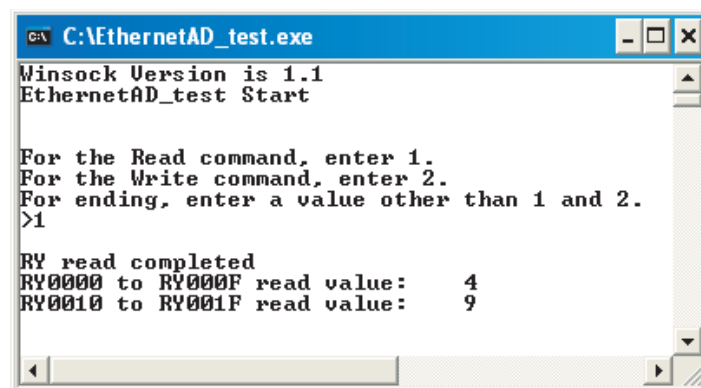

(b) Sending the Write command

1. Run the executable file at the command prompt. In the following window, enter 2. By the Write (command: 1401), a program of writing 2-word data (1234<sub>H</sub>, 5678<sub>H</sub>) to RWr0000 to RWr0001 (W1000 to W1001) will be executed.

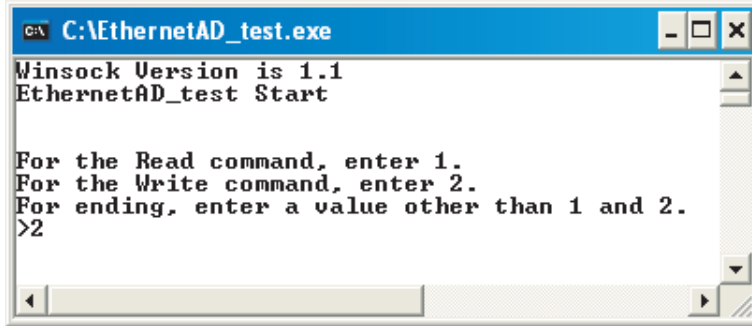

2. The following is displayed on the window. If not, take action according to the troubleshooting instructions. (👉 Page 142, CHAPTER 9)

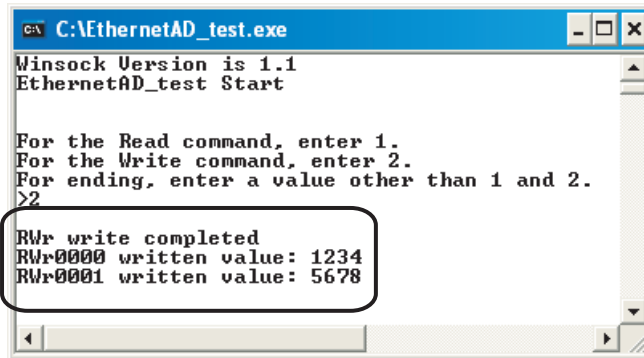

3. Activate "Device/Buffer Memory Batch Monitor" in GX Works2.

👉 [Online] ⇒ [Monitor] ⇒ [Device/Buffer Memory Batch]

4. If 1234<sub>H</sub> and 5678<sub>H</sub> were stored in W1000 and W1001 of the CPU module, it means successful completion. If not, take action according to the troubleshooting instructions. (👉 Page 142, CHAPTER 9)

Device	F	E	D	C	B	A	9	8	7	6	5	4	3	2	1	0	
W1000	0	0	0	1	0	0	1	0	0	0	1	1	0	1	0	0	1234
W1001	0	1	0	1	0	1	1	0	0	1	1	1	1	0	0	0	5678
W1002	0	0	0	0	0	0	0	0	0	0	0	0	0	0	0	0	0000
W1003	0	0	0	0	0	0	0	0	0	0	0	0	0	0	0	0	0000
W1004	0	0	0	0	0	0	0	0	0	0	0	0	0	0	0	0	0000
W1005	0	0	0	0	0	0	0	0	0	0	0	0	0	0	0	0	0000
W1006	0	0	0	0	0	0	0	0	0	0	0	0	0	0	0	0	0000
W1007	0	0	0	0	0	0	0	0	0	0	0	0	0	0	0	0	0000
W1008	0	0	0	0	0	0	0	0	0	0	0	0	0	0	0	0	0000
W1009	0	0	0	0	0	0	0	0	0	0	0	0	0	0	0	0	0000
W100A	0	0	0	0	0	0	0	0	0	0	0	0	0	0	0	0	0000

## 7.2 Communication Using the On-demand Function

---

This section provides an example of where a send request is issued from the CPU module to the Ethernet adapter module and data is sent to the external device.\*1

\*1 Check the corresponding serial No. and software version. (☞ Page 240, Appendix 10)

### **Point**

---

To perform the on-demand function, use the REMFR and REMTO instructions.

The on-demand function is supported by the master/local module with a serial number (first five digits) of "12072" or later.

---

### 7.2.1 System configuration

---

A communication example using the on-demand function is explained with the same system configuration as SLMP communication and cyclic transmission. (☞ Page 68, Section 7.1.1)

### 7.2.2 Specifications of send data using the on-demand function

---

The following table lists the specifications of items such as the number of on-demand data simultaneously used and communication data code.

Item	Specification
Number of channels simultaneously used	Up to 4 channels
Send data length	Up to 1920 bytes (up to 960 words)
Protocol	TCP, UDP
Available connection	<ul style="list-style-type: none"><li>• Connection for users (TCP only)</li><li>• Auto-open UDP port</li></ul>
Frame format	SLMP
Communication data code setting	<ul style="list-style-type: none"><li>• Binary code communication</li><li>• ASCII code communication</li></ul>



## 7.2.3 Applicable range of on-demand data

The on-demand function can send data only to the external devices on the same network (Ethernet) as the Ethernet adapter module. In addition, data can be simultaneously sent to all the external devices on Ethernet where the Ethernet adapter module is also connected (broadcast communications).

On-demand data cannot be sent to other stations via other MELSEC products (such as Ethernet adapter modules) on the same network (Ethernet) as the Ethernet adapter module.

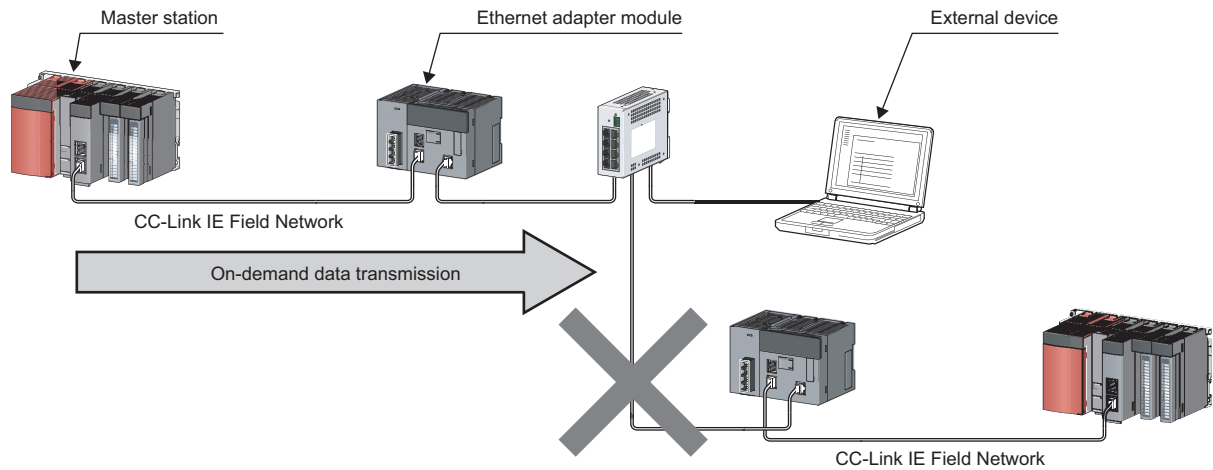

## 7.2.4 How to send on-demand data

On-demand data is sent to an external device after the buffer memory in the Ethernet adapter module receives/sends the data from/to the CPU module using the REMFR and REMTO instructions. The Ethernet adapter module converts the data sent to the buffer memory into SLMP and sends it to the external device.

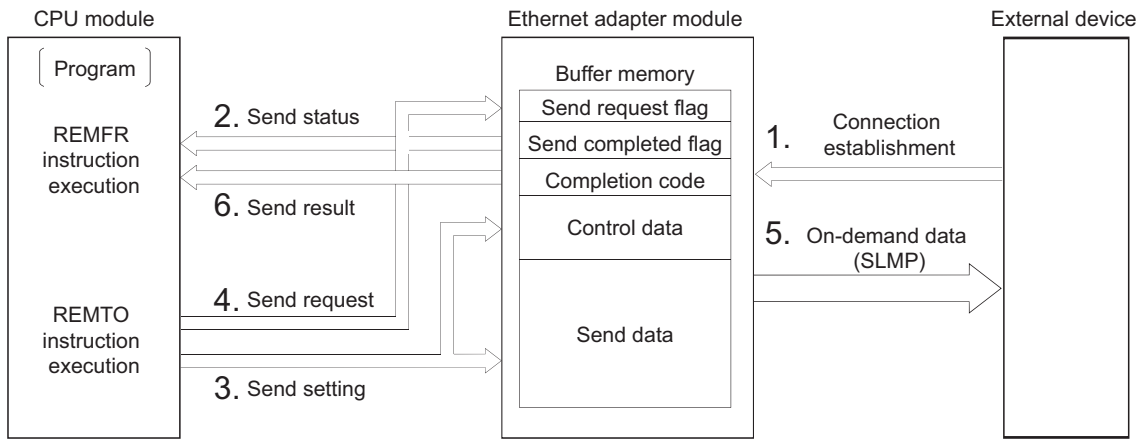

1. Establish connection between an external device and the Ethernet adapter module.
2. Check that the Ethernet adapter module is in a state where on-demand data can be sent.
3. Store control data and send data in the buffer memory in the Ethernet adapter module.
4. Turn on Send request flag.
5. On-demand data is sent from the Ethernet adapter module to the external device.
6. Check the result of the on-demand data sent from the Ethernet adapter module to the external device.

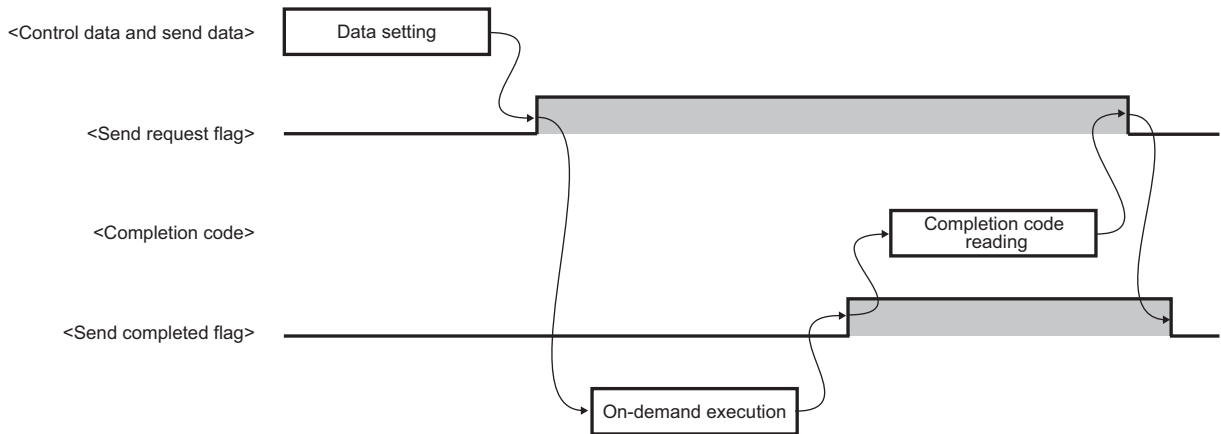

### Point

Turn on Send request flag after setting all the setting data (buffer memory address: 5635 to 6655 (1603<sub>H</sub> to 19FF<sub>H</sub>)).

When turning on Send request flag, complete the REMTO instruction that sets the setting data before executing the REMTO instruction that turns on Send request flag. Do not set the setting data and turn on Send request flag at the same time using one REMTO instruction.

## 7.2.5 Buffer memories used for the on-demand function

This section describes the buffer memories used for channel 1 in the on-demand function.

For channels 2 to 4, store information in the same way as channel 1. (☞ Page 37, Section 3.4)

### (1) Send request flag (buffer memory address: 5632 (1600<sub>H</sub>))

This flag requests on-demand data to be sent from the Ethernet adapter module to an external device.

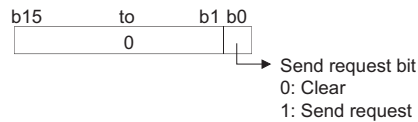

### (2) Send completed flag (buffer memory address: 5633 (1601<sub>H</sub>))

This flag checks if on-demand data has been sent from the Ethernet adapter module to an external device. \*1

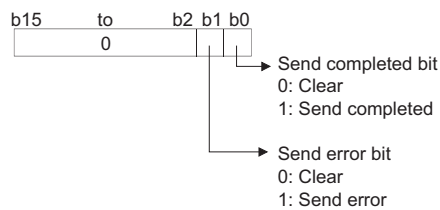

\*1 The on-demand function in the Ethernet adapter module does not check whether an external device has received on-demand data because Send completed flag turns on when the data has been sent. Even when the protocol is TCP, Send completed flag turns on before an ACK response is received from the external device.

### (3) Completion code (buffer memory address: 5634 (1602<sub>H</sub>))

The Ethernet adapter module stores the result of the on-demand data sent to an external device (error code).

(☞ Page 161, Section 9.5)

#### (4) Setting data (buffer memory address: 5635 to 6655 (1603<sub>H</sub> to 19FF<sub>H</sub>))

On-demand data can be sent using the connection for users and auto-open UDP port in the Ethernet adapter module.

##### (a) On-demand data sending using the connection for users (TCP only)

Send on-demand data using the connection of the connection setting in the configuration tool.

Buffer memory address		Name	Default value	Read/Write	Reference		
(Decimal)	(Hexadecimal)						
+0	+0 <sub>H</sub>	Setting data	0 <sub>H</sub>	Write	Page 95, Section 7.2.5 (5)		
+1	+1 <sub>H</sub>					Control data	Connection No. (setting value: 1 to 32)
+2	+2 <sub>H</sub>						Frame setting format
+3 to +6	+3 <sub>H</sub> to +6 <sub>H</sub>						Serial No.
+7	+7 <sub>H</sub>						System area
+8	+8 <sub>H</sub>						Send data format
+9 to +968	+9 <sub>H</sub> to +3C8 <sub>H</sub>						Send data length
+969 to +1020	+3C9 <sub>H</sub> to +3FC <sub>H</sub>					Send data	
						System area	

#### Point

On-demand data is sent using TCP only when the protocol setting for the connection for users is TCP and TCP connection is being established with an external device.

If the protocol setting is UDP or TCP connection is not established with an external device, a send error occurs.

##### (b) On-demand data sending using the auto-open UDP port

Send on-demand data using the auto-open UDP port in the Ethernet adapter module.

Using UDP enables data to be sent to an arbitrary external device set for the setting data.

Buffer memory address		Name	Default value	Read/Write	Reference			
(Decimal)	(Hexadecimal)							
+0	+0 <sub>H</sub>	Setting data	0 <sub>H</sub>	Write	Page 95, Section 7.2.5 (5)			
+1	+1 <sub>H</sub>					Control data	Connection No. (setting value: fixed to 0)	
+2	+2 <sub>H</sub>						Frame setting format	
+3	+3 <sub>H</sub>						Serial No.	
+4	+4 <sub>H</sub>						Communication data code specification	
+5	+5 <sub>H</sub>						Destination IP address	Lower
+6	+6 <sub>H</sub>							Upper
+7	+7 <sub>H</sub>						Destination port No.	
+8	+8 <sub>H</sub>						Send data format	
+9 to +968	+9 <sub>H</sub> to +3C8 <sub>H</sub>						Send data length	
+969 to +1020	+3C9 <sub>H</sub> to +3FC <sub>H</sub>	Send data						
		System area						
					—			

**(5) Setting data****(a) Connection No.**

Set the connection No. where on-demand data is sent from the Ethernet adapter module.

Connection	Setting value
Connection for users <sup>*1</sup>	1 to 32
Auto-open UDP port	0

If any number other than those described above is set, a connection No. error (error code: 420<sub>H</sub>) occurs. (Page 161, Section 9.5)

\*1 This corresponds to the connection No. in the connection setting in the configuration tool. (Page 195, Section 10.3.3 (2))

**(b) Frame setting format**

Specify whether a serial No. is added to on-demand data.

Frame setting format	Setting value
No serial No. added	0 <sub>H</sub>
Serial No. added	1 <sub>H</sub>

If any number other than those described above is set, a frame setting format error (error code: 421<sub>H</sub>) occurs. (Page 161, Section 9.5)

**(c) Serial No.**

Set the serial No. added to the subheader of on-demand data.

The serial No. is effective only when the frame setting format is set to the serial No. added (1<sub>H</sub>).

When the communication data code set in the connection setting is an ASCII code, the setting value is converted from the binary data to the ASCII code and sent.

**(d) Communication data code specification (when using the auto-open UDP port)**

Set the communication data code required when using the auto-open UDP port.

(When using TCP, follow the connection setting in the configuration tool.)

ASCII conversion specification	Setting value
Binary code communication	0 <sub>H</sub>
ASCII code communication	1 <sub>H</sub>

If any number other than those described above is set, a communication data code specification error (error code: 422<sub>H</sub>) occurs. (Page 161, Section 9.5)

### (e) Destination IP address (when using the auto-open UDP port)

Set the IP address of the external device where on-demand data is sent from the Ethernet adapter module.

The effective setting values are from 0.0.0.1 to 255.255.255.255.

When 255.255.255.255 is set, on-demand data is sent to all the external devices (all the hosts) with the same network address (broadcast communications).

If any number other than those described above is set, a destination IP address error (error code: 423<sub>H</sub>)

occurs. (☞ Page 161, Section 9.5)

**Ex.** When the IP address is 192.168.3.1:

	b15 to b8	b7 to b0
+4	3 (03 <sub>H</sub> )	1 (01 <sub>H</sub> )

	b15 to b8	b7 to b0
+5	192 (C0 <sub>H</sub> )	168 (A8 <sub>H</sub> )

### Point

- To perform broadcast communications, use the same network address and port number for all the external devices to receive on-demand data.
- When using broadcast communications, set 255.255.255.0 for the subnet mask pattern of the Ethernet adapter module (Ethernet part).

### (f) Destination port No. (when using the auto-open UDP port)

Set the port No. of the external device where on-demand data is sent from the Ethernet adapter module.

The effective setting values are from 1<sub>H</sub> to FFFF<sub>H</sub>.

If any number other than those described above is set, a destination port No. error (error code: 424<sub>H</sub>) occurs.

(☞ Page 161, Section 9.5)

### (g) Send data format/send data length

Specify the send data format and send data length.

Send data format			Send data length
Setting value	Unit specification	Data code	Setting value
0 <sub>H</sub>	Byte	Binary code	0 to 1920
1 <sub>H</sub>		ASCII code	
2 <sub>H</sub>	Word	Binary code	0 to 960
3 <sub>H</sub>		ASCII code	

If any number other than those described above is set, a send data format error (error code: 425<sub>H</sub>) or send data length error (error code: 426<sub>H</sub>) occurs. (☞ Page 161, Section 9.5)

**(h) Send data (buffer memory address: 5644 to 6603 (160C<sub>H</sub> to 19CB<sub>H</sub>))**

Set the data to be sent from the Ethernet adapter module to an external device.

The set data is sent to the external device based on the send data format of the control data.

Send data by send data format are as follows:

- When a send data format is 0<sub>H</sub> (byte unit and binary code selected): This send data is used to send binary data or character strings.

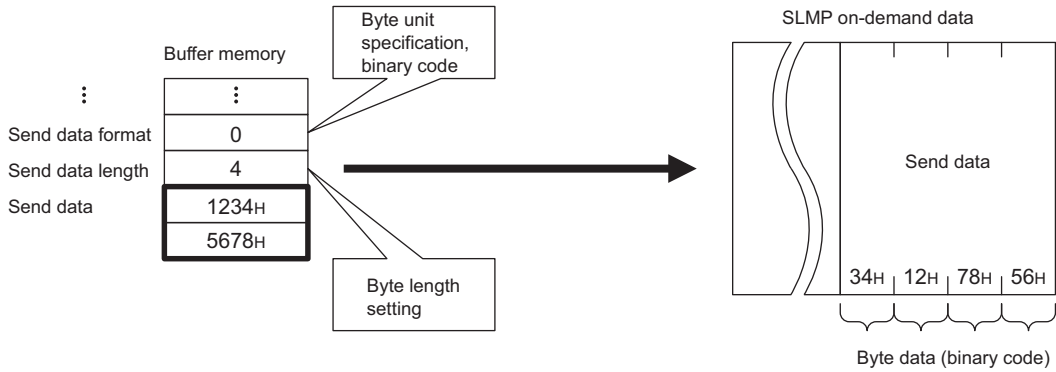

- When a send data format is 1<sub>H</sub> (byte unit and ASCII code selected): This send data is used to send ASCII data.

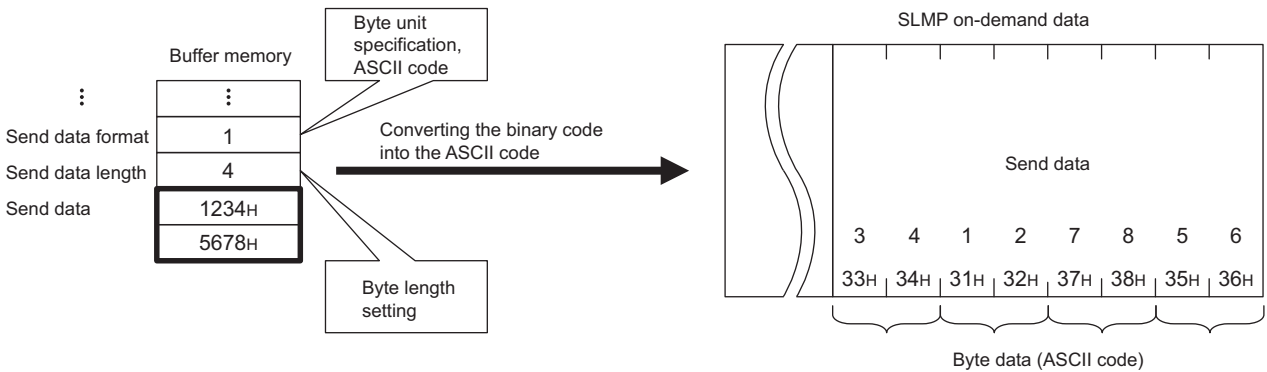

- When a send data format is 2<sub>H</sub> (word unit and binary code selected): This send data is used to send a device value using the binary code.

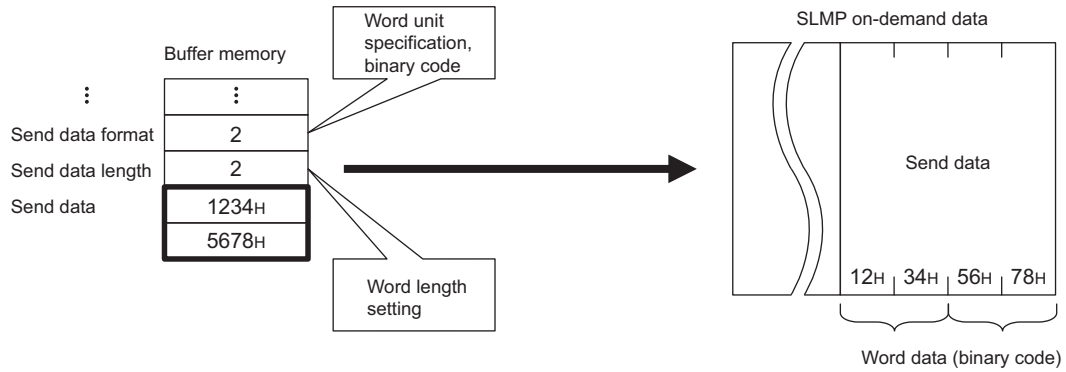

- When a send data format is 3<sub>H</sub> (word unit and ASCII code selected): This send data is used to send a device value using the ASCII code.

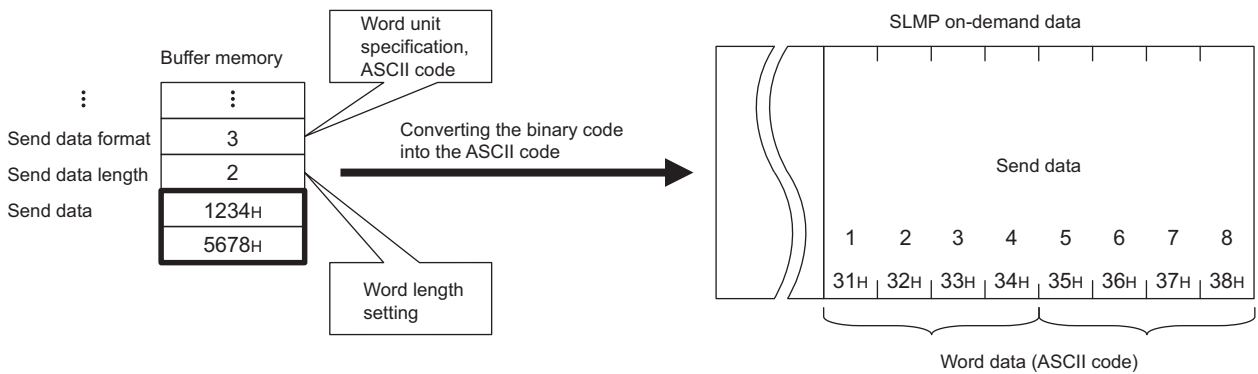



## 7.2.6 On-demand data format

This section explains about on-demand data sent from the Ethernet adapter module to an external device.

### (1) On-demand data

The following illustration shows the on-demand format.

Header	Subheader	Network number	Station number	Request destination module I/O number	For future extension	Request data length	Monitoring timer	Command	Subcommand	Send data
--------	-----------	----------------	----------------	---------------------------------------	----------------------	---------------------	------------------	---------	------------	-----------

#### (a) Subheader

Subheaders vary depending on whether a serial No. is added or not added to a request message.

- Set whether a serial No. is added in the frame setting format of control data.
- Set the serial No. of control data. (Page 95, Section 7.2.5 (5))

For applications and precautions of serial Nos., refer to the following:

SLMP Reference Manual

When adding a serial No.	When not adding a serial No.																																								
<p>(Fixed value) (Fixed value)</p> <p>ASCII code</p> <table border="1"> <tr> <td>5</td><td>4</td><td>0</td><td>0</td><td>1</td><td>2</td><td>3</td><td>4</td><td>0</td><td>0</td><td>0</td><td>0</td> </tr> <tr> <td>35<sub>H</sub></td><td>34<sub>H</sub></td><td>30<sub>H</sub></td><td>30<sub>H</sub></td><td>31<sub>H</sub></td><td>32<sub>H</sub></td><td>33<sub>H</sub></td><td>34<sub>H</sub></td><td>30<sub>H</sub></td><td>30<sub>H</sub></td><td>30<sub>H</sub></td><td>30<sub>H</sub></td> </tr> </table> <p>Serial number</p> <p>(Fixed value) (Fixed value)</p> <p>Binary code</p> <table border="1"> <tr> <td>54<sub>H</sub></td><td>00<sub>H</sub></td><td>34<sub>H</sub></td><td>12<sub>H</sub></td><td>00<sub>H</sub></td><td>00<sub>H</sub></td> </tr> </table> <p>Serial number</p>	5	4	0	0	1	2	3	4	0	0	0	0	35 <sub>H</sub>	34 <sub>H</sub>	30 <sub>H</sub>	30 <sub>H</sub>	31 <sub>H</sub>	32 <sub>H</sub>	33 <sub>H</sub>	34 <sub>H</sub>	30 <sub>H</sub>	30 <sub>H</sub>	30 <sub>H</sub>	30 <sub>H</sub>	54 <sub>H</sub>	00 <sub>H</sub>	34 <sub>H</sub>	12 <sub>H</sub>	00 <sub>H</sub>	00 <sub>H</sub>	<p>(Fixed value)</p> <p>ASCII code</p> <table border="1"> <tr> <td>5</td><td>0</td><td>0</td><td>0</td> </tr> <tr> <td>35<sub>H</sub></td><td>30<sub>H</sub></td><td>30<sub>H</sub></td><td>30<sub>H</sub></td> </tr> </table> <p>(Fixed value)</p> <p>Binary code</p> <table border="1"> <tr> <td>50<sub>H</sub></td><td>00<sub>H</sub></td> </tr> </table>	5	0	0	0	35 <sub>H</sub>	30 <sub>H</sub>	30 <sub>H</sub>	30 <sub>H</sub>	50 <sub>H</sub>	00 <sub>H</sub>
5	4	0	0	1	2	3	4	0	0	0	0																														
35 <sub>H</sub>	34 <sub>H</sub>	30 <sub>H</sub>	30 <sub>H</sub>	31 <sub>H</sub>	32 <sub>H</sub>	33 <sub>H</sub>	34 <sub>H</sub>	30 <sub>H</sub>	30 <sub>H</sub>	30 <sub>H</sub>	30 <sub>H</sub>																														
54 <sub>H</sub>	00 <sub>H</sub>	34 <sub>H</sub>	12 <sub>H</sub>	00 <sub>H</sub>	00 <sub>H</sub>																																				
5	0	0	0																																						
35 <sub>H</sub>	30 <sub>H</sub>	30 <sub>H</sub>	30 <sub>H</sub>																																						
50 <sub>H</sub>	00 <sub>H</sub>																																								

#### (b) Network No. and station No.

The third octet of the external device IP address is stored in the network No.

The fourth octet of the external device IP address is stored in the station No.

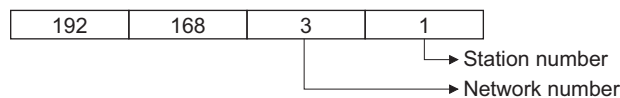

When 255.255.255.255 (broadcast communications) is selected for the IP address of the destination, the third and fourth octets are as follows:

- The third octet: The third octet of the IP address of the Ethernet adapter module (Ethernet part)
- The fourth octet: 255 (FF<sub>H</sub>)

**(c) Request destination module I/O No., request data length, monitoring timer, command, and subcommand**

The following values are stored for each item:

Setting item	Setting value
Request destination module I/O No.	03FF <sub>H</sub>
Request data length	The data length from the monitoring timer to the send data is stored in 4-digit hexadecimal format.
Monitoring timer	0000 <sub>H</sub>
Command	2101 <sub>H</sub>
Subcommand	0000 <sub>H</sub>

**(d) Send data**

The value stored in the buffer memory in the Ethernet adapter module is stored. (☞ Page 97, Section 7.2.5 (5) (h))

**(2) Precautions when setting on-demand data**

For the send data formats (binary code/ASCII code) of a message at the time of sending on-demand data, setting locations differ between the subheader to the subcommand and the send data.

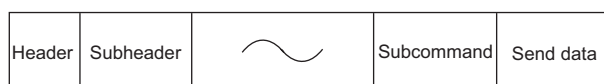

Protocol	Subheader to subcommand	Send data
Connection for users (TCP)	Setting in the configuration tool (☞ Page 195, Section 10.3.3 (2))	Setting in the buffer memory (☞ Page 97, Section 7.2.5 (5) (h))
Auto-open UDP port	Setting in the buffer memory (☞ Page 94, Section 7.2.5 (4) (b))	

**(3) Example of on-demand data**

**(a) On-demand data format in SLMP (no serial No.)**

- ASCII data

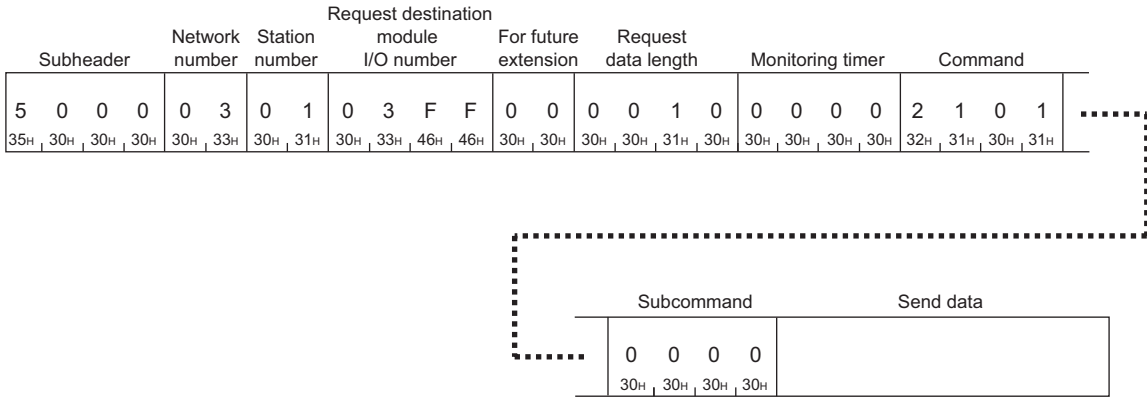

- Binary data

Subheader	Network number	Station number	Request destination module I/O number	For future extension	Request data length	Monitoring timer	Command	Subcommand	Send data
50H, 00H	03H	01H	FFH, 03H	00H	0AH, 00H	00H, 00H	01H, 21H	00H, 00H	

**(b) On-demand data format in SLMP (serial No. added)**

- ASCII data

Subheader				Serial number				Fixed value				Network number		Station number		Request destination module I/O number				For future extension		Request data length			
5	4	0	0	0	0	0	1	0	0	0	0	0	3	0	1	0	3	F	F	0	0	0	0	1	0
35H	34H	30H	30H	30H	30H	30H	31H	30H	30H	30H	30H	30H	33H	30H	31H	30H	33H	46H	46H	30H	30H	30H	30H	31H	30H

Monitoring timer				Command				Subcommand				Send data			
0	0	0	0	2	1	0	1	0	0	0	0				
30H	30H	30H	30H	32H	31H	30H	31H	30H	30H	30H	30H				

- Binary data

Subheader			Fixed value		Serial number		Fixed value		Network number		Station number		Request destination module I/O number		For future extension		Request data length		Monitoring timer		Command		Subcommand		Send data	
54H	00H	01H	00H	00H	00H	03H	01H	FFH	03H	00H	0AH	00H	00H	00H	00H	01H	21H	00H	00H							

## 7.2.7 Example of on-demand data sending

This section explains how to send on-demand data and provides a program example.

### (1) How to send data

Follow the instructions below to send on-demand data.

#### (a) Ethernet adapter module

1. **Connect the Ethernet adapter module to CC-Link IE Field Network and Ethernet.** (☞ Page 68, Section 7.1)

Before connecting to Ethernet, establish connection between an external device and the Ethernet adapter module.

#### (b) CPU module (for channel 1)

1. **Write parameters and a program to the CPU module and reset the CPU module.** (☞ Page 104, Section 7.2.7 (2))
2. **Run the CPU module.**
3. **Read Send completed flag (buffer memory address: 5633 (1601<sub>H</sub>)) in the Ethernet adapter module using the REMFR instruction.**  
When the 0th bit or 1st bit of Send completed flag is 1 (ON), set the 0th bit of Send request flag (buffer memory address: 5632 (1600<sub>H</sub>)) to 0 (OFF).
4. **Set Control data (buffer memory address: 5635 to 5643 (1603<sub>H</sub> to 160B<sub>H</sub>)) and Send data (buffer memory address: 5644 to 6603 (160C<sub>H</sub> to 19CB<sub>H</sub>)) in the Ethernet adapter module using the REMTO instruction.**
5. **Set Send request bit of Send request flag in the Ethernet adapter module to 1 (ON) using the REMTO instruction.**
6. **On-demand data is sent.**
7. **Read Send completed flag and Completion code (buffer memory address: 5634 (1602<sub>H</sub>)) in the Ethernet adapter module using the REMFR instruction.**  
If the 1st bit of Send completed flag is 1 (ON), check Completion code (error code) and remove the error cause. (☞ Page 161, Section 9.5)
8. **Set Send request flag and Send completed flag to 0 (OFF).**

#### (c) External device

1. **Receive on-demand data.**
2. **Find whether the received data is on-demand data or data received using a command.**  
When the command No. in the message is 2101, the data is on-demand data.
3. **Process the data.**

### Point

For details, refer to the buffer memories used for the on-demand function. (☞ Page 93, Section 7.2.5)

## (2) Program example

### (a) On-demand data setting

Item	Specification
Number of channels simultaneously used	1 channel
Send data length	4 bytes
Protocol	TCP
Available connection	Connection for users (connection No.1)
Frame format	SLMP (serial No. added)
Communication data code setting	ASCII code communication

### (b) Devices used for a program

Device	Description
M1	Start-up contact
M10	Device of control data and send data setting completed
M11, M12	Device of the REMFR instruction completed (Open completion signal of the connection obtained)
M100	Device of connection open completion check completed
M101, M102	Device of the REMFR instruction completed (Send completed flag reading)
M103	Device of Send completed flag reading completed
M110	Device of Send completed flag OFF check completed
M111, M112	Device of the REMTO instruction completed (send data setting)
M120	Device of send data setting completed
M121, M122	Device of the REMTO instruction completed (Send request flag ON)
M130	Device of Send request flag ON completed
M131, M132	Device of the REMFR instruction completed (Send completed flag and Completion code reading)
M133	Device of Send completed flag and Completion code reading completed
M140	Device of on-demand data sending completed
M141, M142	Device of the REMTO instruction completed (Send request flag OFF)
W10.0	Ethernet port connection status (connection No.1)
W100.0	Send request flag (Send request bit)
W101.0	Send completed flag (Send completed bit)
W101.1	Send completed flag (Send error bit)
W102	Completion flag
SB0047	Baton pass status of the own station
SW00A0.0	Baton pass status of each station (station No.1)
D200 to D208	Control data
D209, D210	Send data
Y20	Connection open not completed error output
Y21	REMFR instruction error output
Y22	REMTO instruction error output
Y23	Send completed flag error output
Y24	On-demand data send error output
Y2A	On-demand data send completed output

(c) On-demand data to be sent

Subheader				Serial number				Fixed value				Network number		Station number		Request destination module I/O number				For future extension		Request data length				
5	4	0	0	0	0	0	1	0	0	0	0	0	3	0	1	0	3	F	F	0	0	0	0	1	0	
35H	34H	30H	30H	30H	30H	30H	31H	30H	30H	30H	30H	30H	33H	30H	31H	30H	33H	46H	46H	30H	30H	30H	30H	30H	31H	30H

Monitoring timer				Command				Subcommand				Send data			
0	0	0	0	2	1	0	1	0	0	0	0				
30H	30H	30H	30H	32H	31H	30H	31H	30H	30H	30H	30H	34H	12H	78H	56H

(d) Program



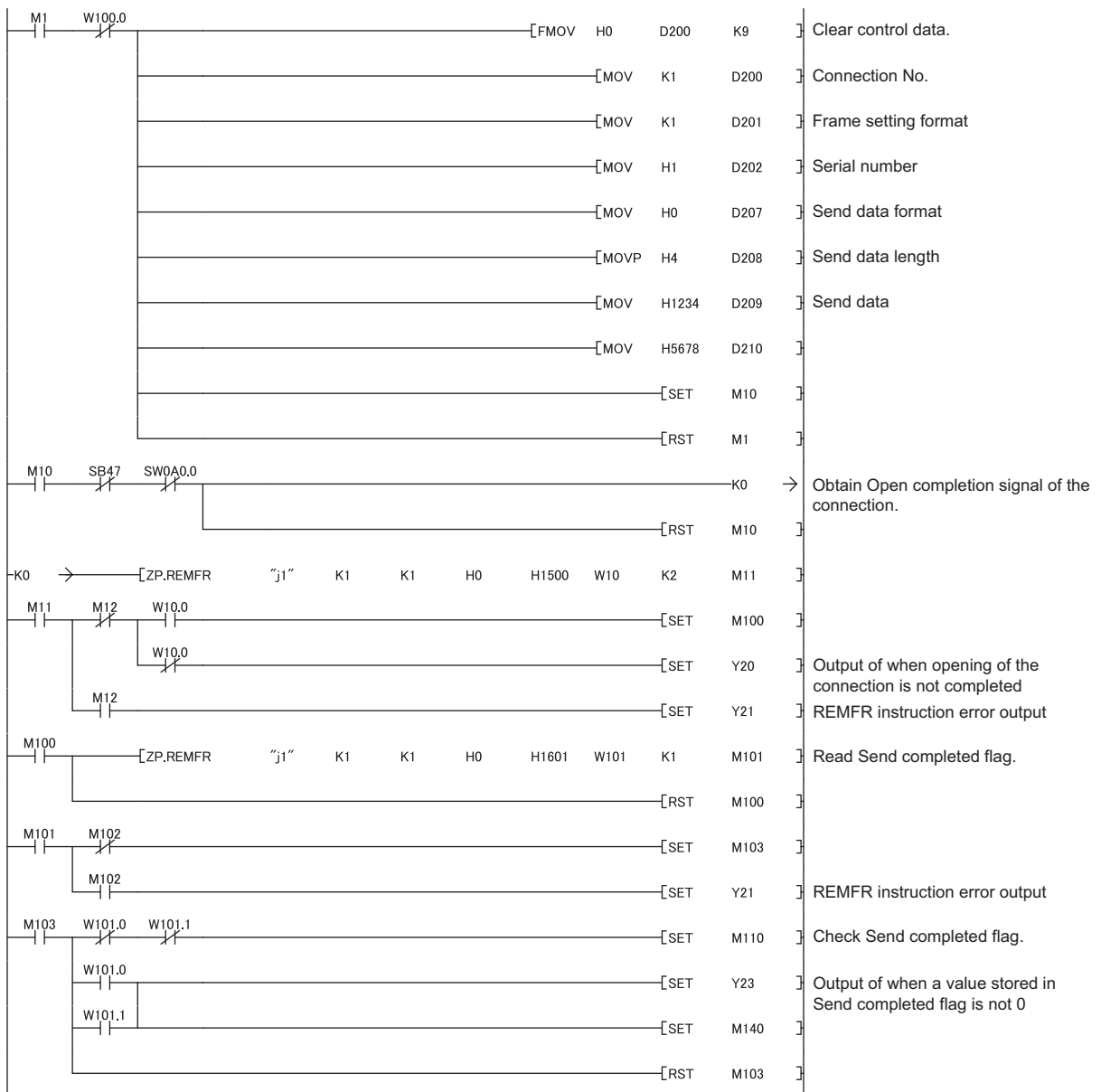

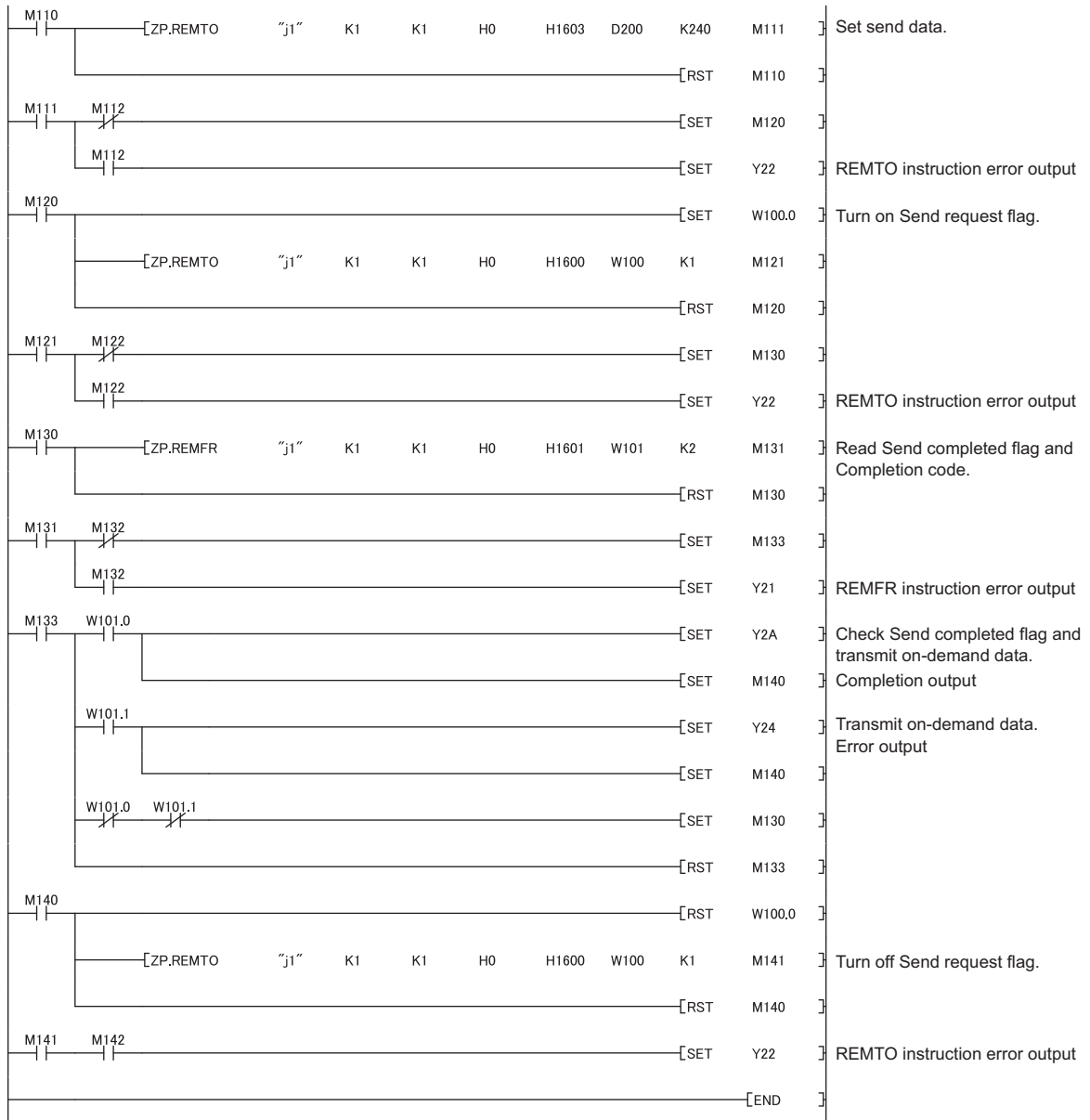

## 7.3 IP Communications over CC-Link IE Field Network (IP Packet Transfer Function)

This section describes an example of communications using the specified IP address between external devices over CC-Link IE Field Network.\*1

\*1 Check the corresponding serial No. and software version. (☞ Page 240, Appendix 10)

### Point

- The data that are communicated using the IP packet transfer function are communicated separately by the following process.
  - Service process by a sequence scan of a CPU module (when communications are transferred through the CPU module)
  - Link scan on CC-Link IE Field Network

Because of this, the speed of communications using the IP packet transfer function is slower than the speed of communications with the Ethernet line. The reference speed of communication using the IP packet transfer function is described in the manual for the master/local module used. (☞ User's manual for the master/local module used)

- To perform IP communications over CC-Link IE Field Network, the CPU module and the master/local module on the communication route must support the IP packet transfer function. To check whether the CPU module and the master/local module used support the IP packet transfer function, refer to the sections listing the functions and added functions in the user's manual for those modules.
- IP communications over CC-Link IE Field Network enable communications with an external device connected to the built-in Ethernet port of a CPU module. For the applicable system configuration, IP address setting rule, and accessible range, refer to the following.
  - ☞ User's manual for the master/local module used
- Using the UDP protocol may reduce the data reliability compared to TCP, causing a problem such as data missing and changed order of data receiving. If any problem occurs, change the protocol to TCP.
- IP communications over CC-Link IE Field Network cannot transfer communications of Broadcast and Multicast. Use Unicast (identifying a single request destination) instead.

## 7.3.1 Deciding the IP address

This section explains how to set an IP address to perform communications over CC-Link IE Field Network.

### (1) When the network addresses of the request source external device, request destination external device, and modules between them are the same

Communications can be performed with the minimum setting by setting the same network address of the IP address in the request source external device, request destination external device, and modules between them. The IP addresses of the request source external device, request destination external device, and modules between them must meet the rules below. Especially, pay attention to the setting ranges of the third and fourth octets.

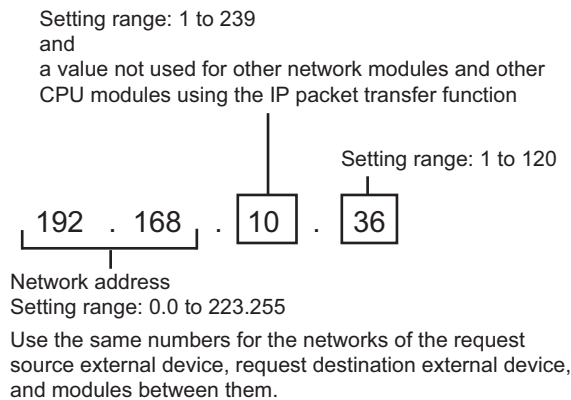

Device to be set	Setting range of the IP address		
	First and second octets	Third octet	Fourth octet
External device	0.0 to 223.255 <sup>*1</sup>	1 to 239 <sup>*1</sup>	
Ethernet adapter module (Ethernet part)	(Same numbers for the request source external device, request destination external device, and modules between them)	(Same number for the external device and the Ethernet adapter module (Ethernet part) connected to the external device)	1 to 120 <sup>*1</sup>
Ethernet adapter module (CC-Link IE Field Network part)	Automatically set (network address of the master station) 0.0 to 223.255 <sup>*1</sup>		Automatically set (station number of the own station) • 1 to 120
Master/local module	0.0 to 223.255 <sup>*1</sup> (Same numbers for the request source external device, request destination external device, and modules between them)	Automatically set (network number of the own station) 1 to 239	Automatically set (station number of the own station) • 1 to 120 • 125 (125 is always set in the master station)
CPU module connected to the external device	0.0 to 223.255 <sup>*1</sup> (Same numbers for the request source external device, request destination external device, and modules between them)	1 to 239 <sup>*1</sup> (Same number for the external device and the CPU module)	1 to 120 <sup>*1</sup>
Universal model QCPU on the communication route (not connected to the external device)	IP address setting not required		

- \*1 Set the numbers according to the range supported by the external device used.  
The range may not apply depending on the external device. Check the specifications of the external device used.

**Point** 

---

To transmit communications to the external device, the routing parameters are required. (  Page 112, Section 7.3.4 (1) )

---

## (2) When the network addresses are different

When the same network address cannot be set for the external device and CC-Link IE Field Network, decide the IP address within the ranges listed in the following table.

Device to be set	Setting range of the IP address		
	First and second octets	Third octet	Fourth octet
External device	0.0 to 223.255 <sup>*1</sup> (Same numbers for the external device and the Ethernet adapter module (Ethernet part) connected to the external device)	0 to 255 <sup>*1</sup> (Same numbers for the external device and the Ethernet adapter module (Ethernet part) connected to the external device)	1 to 254 <sup>*1</sup>
Ethernet adapter module (Ethernet part)			
Ethernet adapter module (CC-Link IE Field Network part)	Automatically set (network address of the master station) 0.0 to 255.255	Automatically set (network number of the own station) 1 to 239	Automatically set (station number of the own station) • 1 to 120
Master/local module	0.0 to 255.255		Automatically set (station number of the own station) • 1 to 120 • 125 (125 is always set in the master station)
Universal model QCPU on the communication route (not connected to the external device)	IP address setting not required		

\*1 Set the numbers according to the range supported by the external device used.  
The range may not apply depending on the external device. Check the specifications of the external device used.

### Point

- To transmit communications to an external device having a different network address, the CC-Link IE Field Network gateway setting and the routing parameters are required. (Page 127, Section 7.3.7)
- When the request source external device, request destination external device, and modules between them have the same network address, the CC-Link IE Field Network gateway setting is not required.
- To connect a request source or request destination to a module that does not support the CC-Link IE Field Network gateway setting, follow the rules described on Page 108, Section 7.3.1 (1). Even if the CC-Link IE Field Network gateway setting is configured in the Ethernet adapter module, communications cannot be performed.

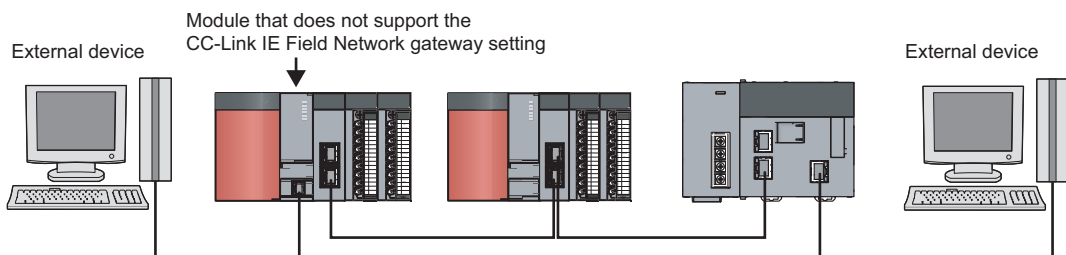

## 7.3.2 System configuration

For an example of when the request source external device, request destination external device, and modules between them have the same network address, refer to the following.

☞ Page 111, Section 7.3.2 to ☞ Page 124, Section 7.3.6

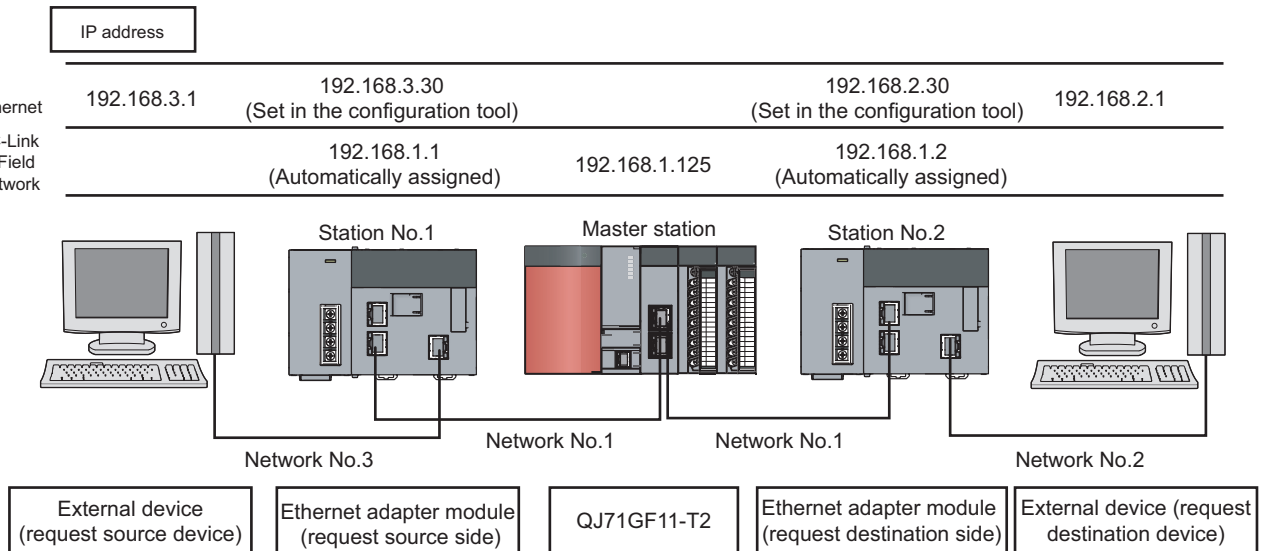

Configuration of the external device

Configuration tool: Version 1.05F or later  
 Basic software: Microsoft® Windows® XP Professional  
 Operating System  
 Web browser: Internet Explorer® 8.0

For an example of when the request source external device, request destination external device, and modules between them do not have the same network address, refer to the following.

☞ Page 127, Section 7.3.7

## 7.3.3 Network setting of the configuration computer

The configuration tool needs to be started on a Web browser to configure the setting in the Ethernet adapter module. To start up the configuration tool on a Web browser, the network setting of the configuration computer is required.

☞ Page 71, Section 7.1.3

## 7.3.4 Connection to CC-Link IE Field Network

Set the parameters in the master station for IP communications over CC-Link IE Field Network.

### (1) Setting in the master station

Use GX Works2 to set the parameters in the master station. Use the default settings for the parameters other than those set below.

#### 1. Create a project on GX Works2.

 [Project] ⇒ [New...]

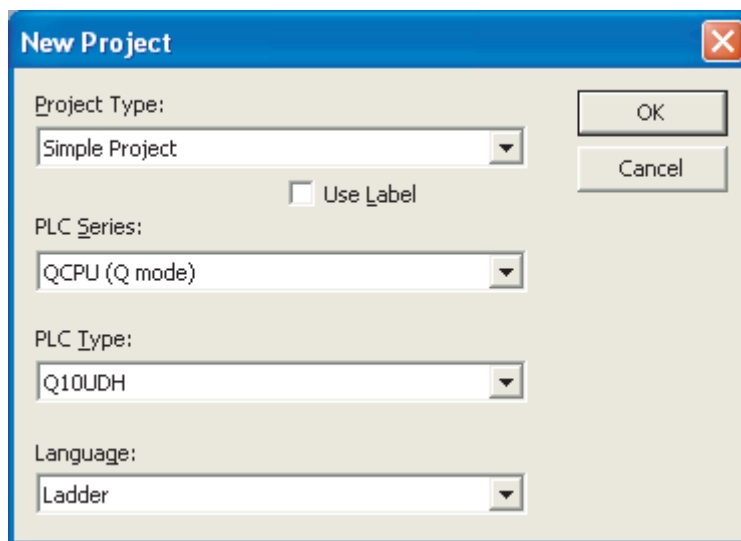

#### 2. Open the "Network Parameter" setting window to set the parameters as follows.

 Project window ⇒ [Parameter] ⇒ [Network Parameter] ⇒ [Ethernet/CC IE/MELSECNET]

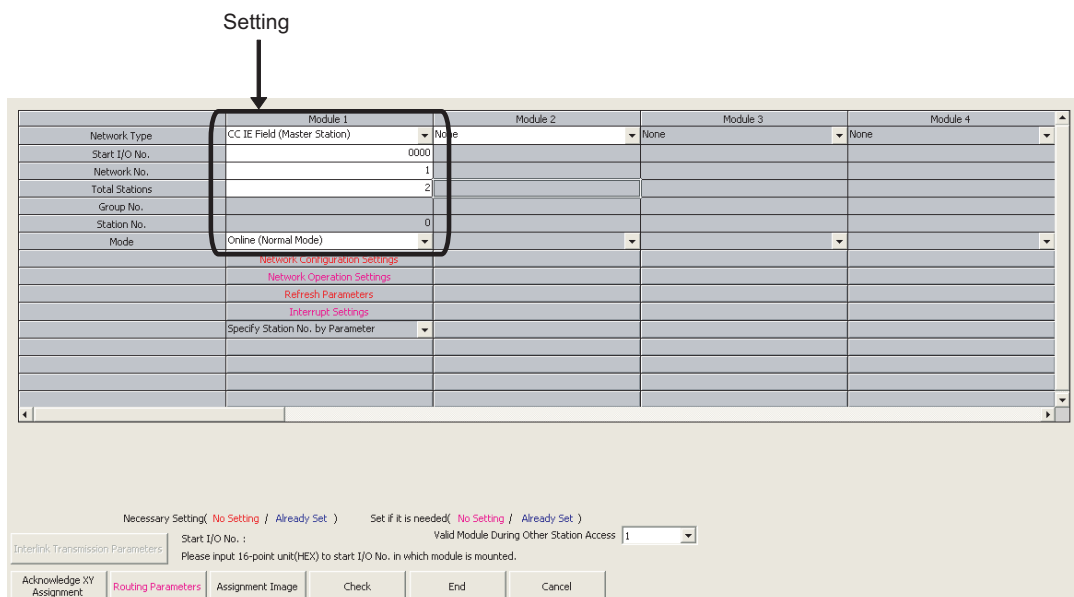

**3. Click the [Network Configuration Settings] button to set the parameters as follows.**

The following setting is an assignment example. (Communications using the IP packet transfer function do not affect assigned points.)

Change the points according to the system configuration used.

Set up Network configuration.

Assignment Method  
 Points/Start  
 Start/End

The column contents for refresh device will be changed corresponding to refresh parameter. Please reopen the window after completing refresh parameter setting when changing refresh device.

Number of PLCs	Station No.	Station Type	RX/Ry Setting			RWw/RWr Setting		
			Points	Start	End	Points	Start	End
0	0	Master Station						
1	1	Intelligent Device Station	256	0000	00FF	128	0000	007F
2	2	Intelligent Device Station	256	0100	01FF	128	0080	00FF

**4. Click the [Network Operation Settings] button to set the IP address of the master station.**

Network Operation Settings

Parameter Name: \_\_\_\_\_

Output Setting During CPU STOP  
 Hold  
 Clear (ALL OFF)

Data Link Faulty Station Setting  
 Turn OFF or 0 Clear Input Data (RX/Ry)  
 Hold Input Data (RX/Ry)

Set IP address  
 Input Format: DEC  
 IP Address: 192.168.1.125

\* Please set IP Address and Routing Parameters to use IP packet transfer function.

End Cancel

- Set the IP address of CC-Link IE Field Network in the master station and submaster station. When the IP address is set, the IP address is automatically assigned to the CC-Link IE Field Network part on the Ethernet adapter module. The IP address to be assigned is as follows.

IP address

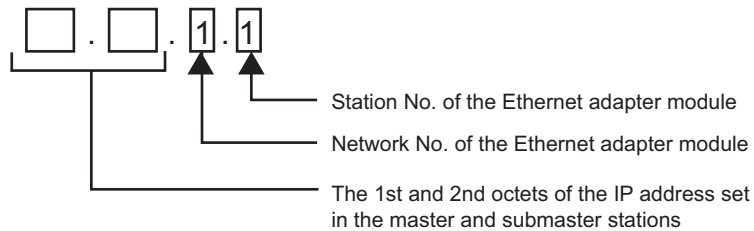

- The assigned IP address can be checked using the Ethernet adapter diagnostics of the configuration tool in the Ethernet adapter module.

 [Online] ⇒ [Diagnostics] ⇒ [Module Information] button

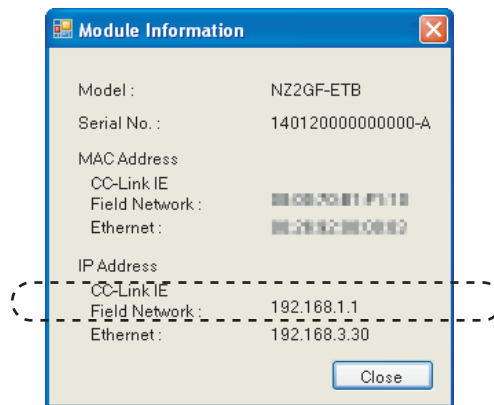

The IP address can be also checked using the CC-Link IE Field Network diagnostics of GX Works2. ( User's manual for the master/local module used)

- If the IP address is not displayed, check that the D LINK LED is on, and check Baton pass status (own station) (SW0047) to see whether baton pass can be performed.



**5. Click the [Routing Parameters] button to set the communication route.**

The communication route needs to be set so that communications reach the network of the Ethernet adapter module (Ethernet part). Because Ethernet adapter modules do not have routing parameters, set the routing parameters of the master station to perform communications.

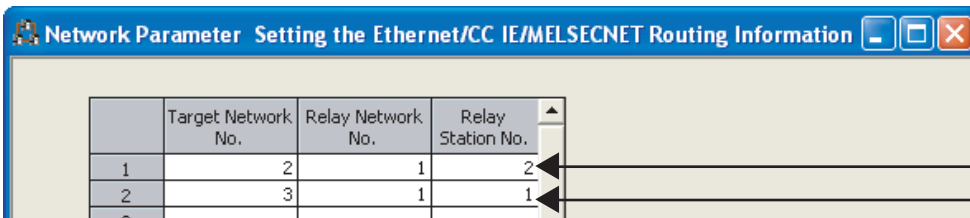
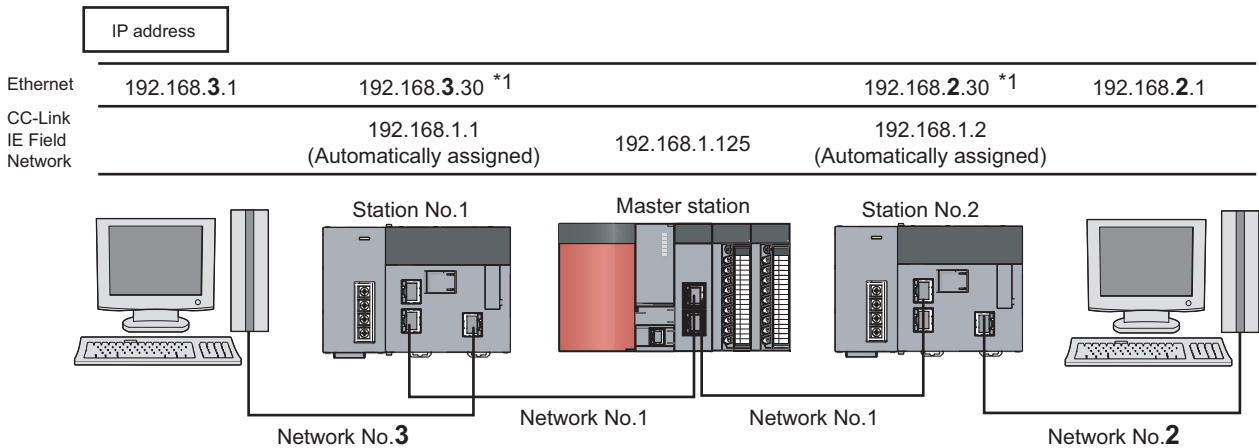

\*1 This IP address is set on "Ethernet" in the configuration tool. (Page 121, Section 7.3.5 (1))

Item	Description
Target Network No.	Set the network No. of the external device side to be communicated with. In this setting example, set the third octet of the IP address set in "Ethernet" of the Ethernet adapter module.
Relay Network No.	Set the network No. of the station where communications transmit through to reach the target network No. In this setting example, set the network No. set in "CC-Link IE Field Network" of the Ethernet adapter module.
Relay Station No.	Set the station No. of the station where communications transmit through to reach the target network No. In this setting example, set the station No. set in "CC-Link IE Field Network" of the Ethernet adapter module.

- Details on the routing parameters  
Refer to the user's manual for the master/local module used.
- When an external device is connected to an Ethernet adapter module  
Set the routing parameters so that communications transmit through the master station.  
Communications from an Ethernet adapter module automatically transmit through the master station. The communication routes must be the same for data sending and receiving; therefore, configure the setting so that communications transmit through the master station.

**Ex.** Proper setting

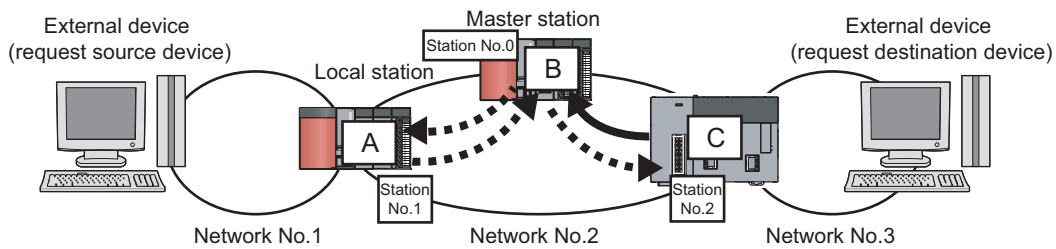

- - - - -> Communication routes set using the routing parameters  
 ———> Communication route automatically set (from the Ethernet adapter module to the master station)

Setting for **A**

Target Network No.	Relay Network No.	Relay Station No.
3	2	0

Setting for **B**

Target Network No.	Relay Network No.	Relay Station No.
1	2	1
3	2	2

Setting for **C**

The setting is not required because the Ethernet adapter module does not have the routing parameters.

Set this column to pass communications through the master station.

**Ex.** Improper setting

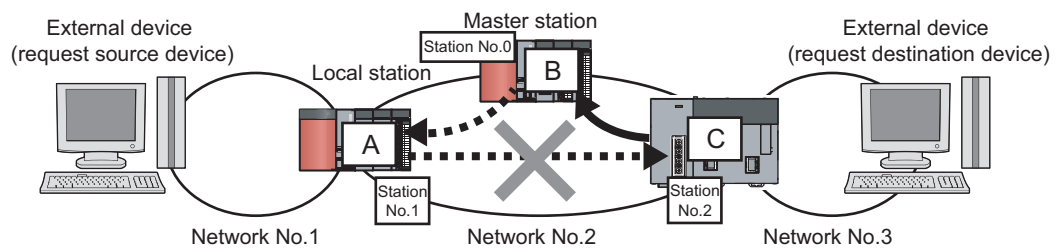

- - - - -> Communication routes set using the routing parameters  
 ———> Communication route automatically set (from the Ethernet adapter module to the master station)

Setting for **A**

Target Network No.	Relay Network No.	Relay Station No.
3	2	2

Setting for **B**

Target Network No.	Relay Network No.	Relay Station No.
1	2	1

Setting for **C**

The setting is not required because the Ethernet adapter module does not have the routing parameters.

Because the communication route for data sending is different from that for data receiving, an error occurs.\*2

\*2 An IP communication test related error (error code: 4A28<sub>H</sub>) occurs in the IP communication test.

6. After setting, click the [End] button. Write the set parameters to the CPU module on the master station.

 [Online] ⇒ [Write to PLC]

7. Reset the CPU module or power off and on the system.

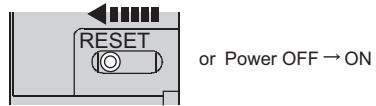

## (2) Setting in the Ethernet adapter module

Set the parameters to connect the Ethernet adapter module to CC-Link IE Field Network, using the configuration tool.

1. Start up the configuration tool using a Web browser. (👉 Page 184, Section 10.1.2)
2. Open the "Parameter Setting" dialog box in the configuration tool to set the parameters as follows.

🖱️ Setting item tree ⇒ NZ2GF-ETB ⇒ [Parameter] ⇒ "CC-Link IE Field Network"

- Setting on the request source

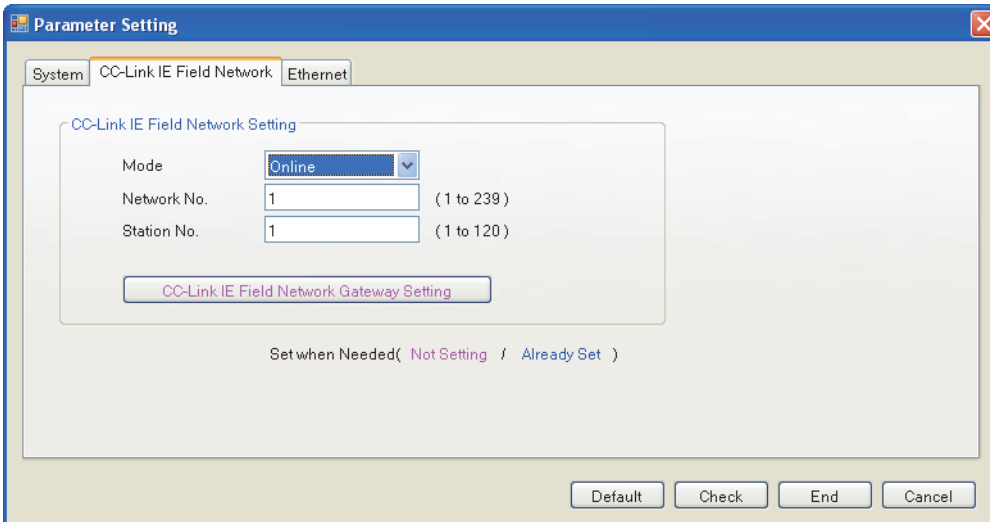

The screenshot shows the 'Parameter Setting' dialog box with the 'CC-Link IE Field Network' tab selected. The 'Mode' dropdown is set to 'Online'. The 'Network No.' is set to 1 (range 1 to 239) and the 'Station No.' is set to 1 (range 1 to 120). A 'CC-Link IE Field Network Gateway Setting' button is visible. At the bottom, the status is 'Set when Needed( Not Setting / Already Set )' and there are 'Default', 'Check', 'End', and 'Cancel' buttons.

- Setting on the request destination

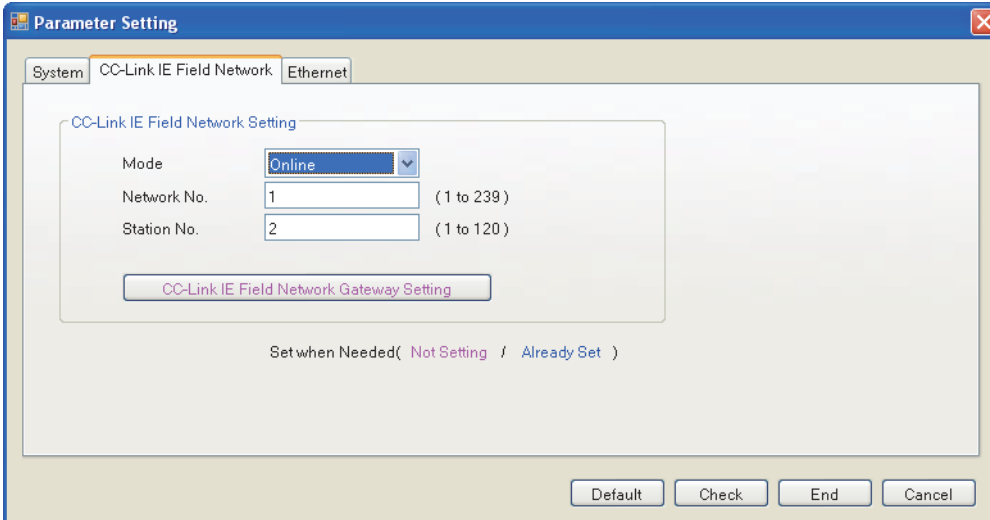

The screenshot shows the 'Parameter Setting' dialog box with the 'CC-Link IE Field Network' tab selected. The 'Mode' dropdown is set to 'Online'. The 'Network No.' is set to 1 (range 1 to 239) and the 'Station No.' is set to 2 (range 1 to 120). A 'CC-Link IE Field Network Gateway Setting' button is visible. At the bottom, the status is 'Set when Needed( Not Setting / Already Set )' and there are 'Default', 'Check', 'End', and 'Cancel' buttons.

### Point!

To communicate with an external device having a different network address, the CC-Link IE Field Network gateway setting is also required. (👉 Page 127, Section 7.3.7)

3. After the setting, click the [End] button.
4. Set the IP address of the connected Ethernet adapter module (Ethernet part). Open the "Destination Setting" dialog box in the configuration tool to enter the address as follows.

 [Online] ⇒ [Destination Setting]

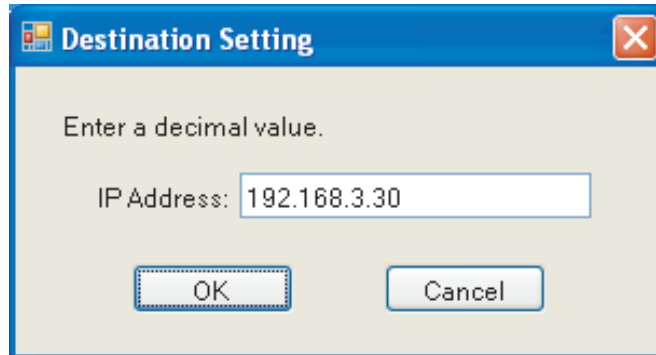

5. Write the set parameters to the Ethernet adapter module. (Set the switch on the Ethernet adapter module to STOP.)

 [Online] ⇒ [Write]

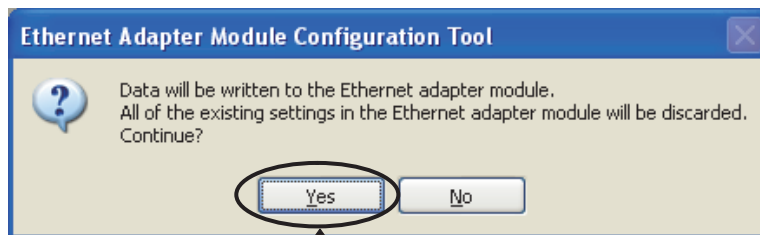

Click

6. The following dialog box appears.

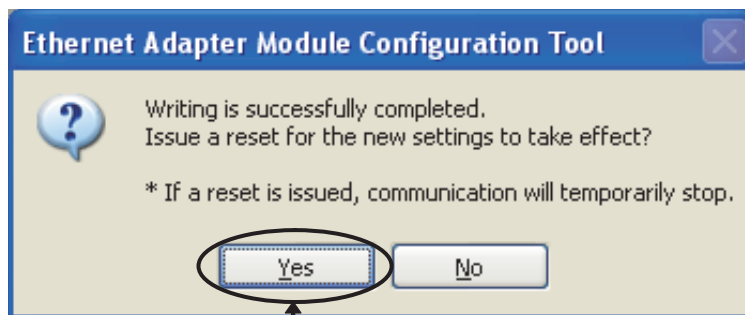

Click

7. Set the switch on the Ethernet adapter module to RUN.

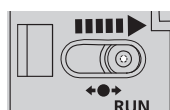

### (3) Checking the connection



After setting the parameters in the master station and Ethernet adapter module, check that data link can be normally performed in the master station and Ethernet adapter module. To check the connection, use the CC-Link IE Field Network diagnostics of GX Works2 connected to the master station.

1. In the menu on GX Works2, start up the CC-Link IE Field Network diagnostics.

[Diagnostics] ⇒ [CC IE Field Diagnostics]

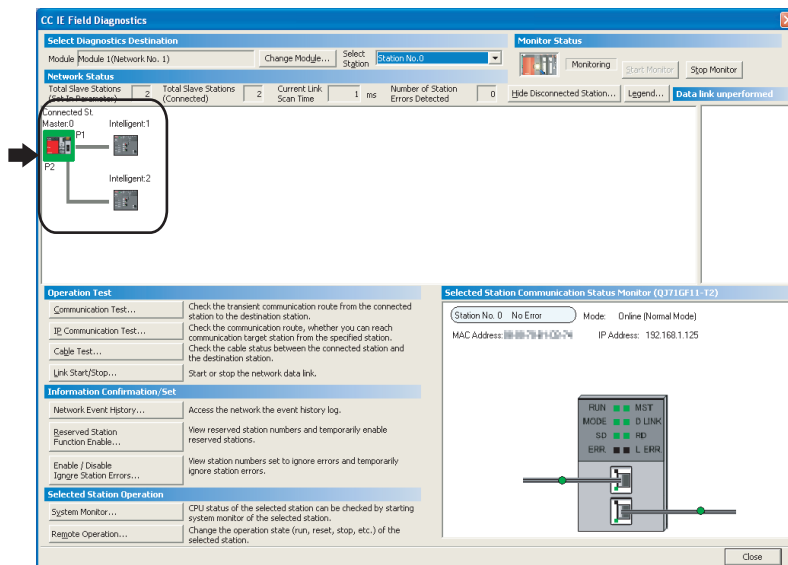
When the dialog box appears as follows, the connection is normal.



If a mark, such as , , and , is displayed in "Network Status", an error has occurred. Identify the cause of the error and take corrective action. (User's manual for the master/local module used)

**Ex.** If an error occurred in the Ethernet adapter module, the dialog box appears as follows.

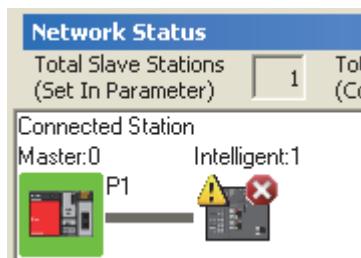

## 7.3.5 Connection to Ethernet

### (1) Setting in the Ethernet adapter module

Set the IP address of the Ethernet adapter module (Ethernet part) using the configuration tool.

1. Start up the configuration tool using a Web browser. (☞ Page 184, Section 10.1.2)
2. Open the "Parameter Setting" dialog box in the configuration tool to set the parameters as follows.

☞ Setting item tree ⇒ NZ2GF-ETB ⇒ [Parameter Setting] ⇒ "Ethernet"

- Setting on the request source: Set the IP address and subnet mask pattern of the Ethernet adapter module (Ethernet part).

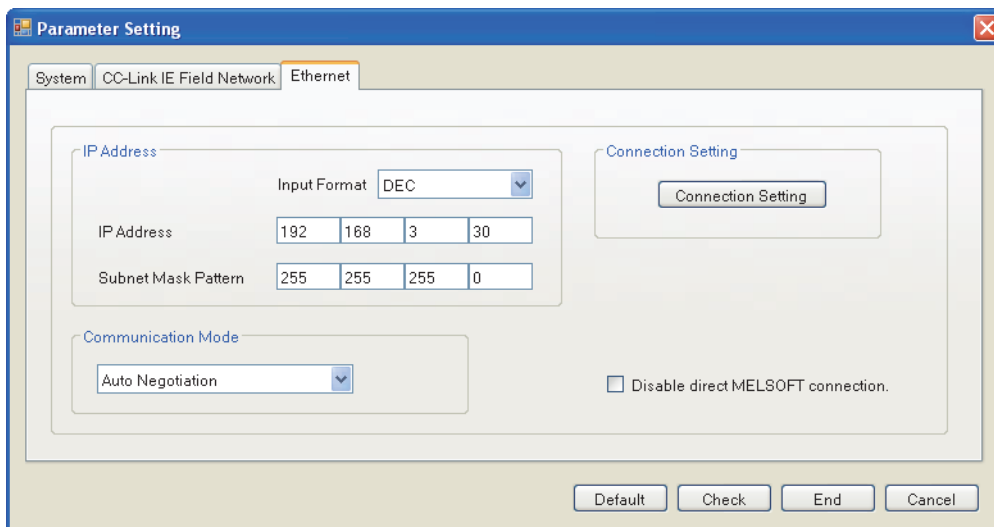

- Setting on the request destination: Set the IP address and subnet mask pattern of the Ethernet adapter module (Ethernet part).

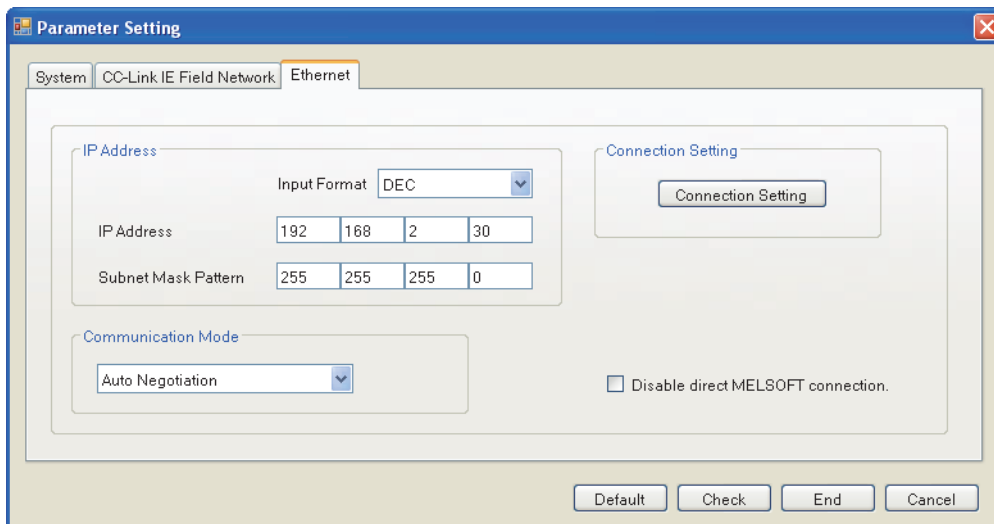

3. In the "Parameter Setting" dialog box, click the [End] button.
4. Write the set parameters to the Ethernet adapter module by the same procedure as parameter setting for connecting the module to CC-Link IE Field Network. (☞ Page 118, Section 7.3.4 (2))

## (2) Changing the IP address of the external device and gateway address setting

Change the IP address of the external device according to the system configuration. In addition, configure the gateway address setting in the external device so that IP communications from the external device transmit through the Ethernet adapter module.

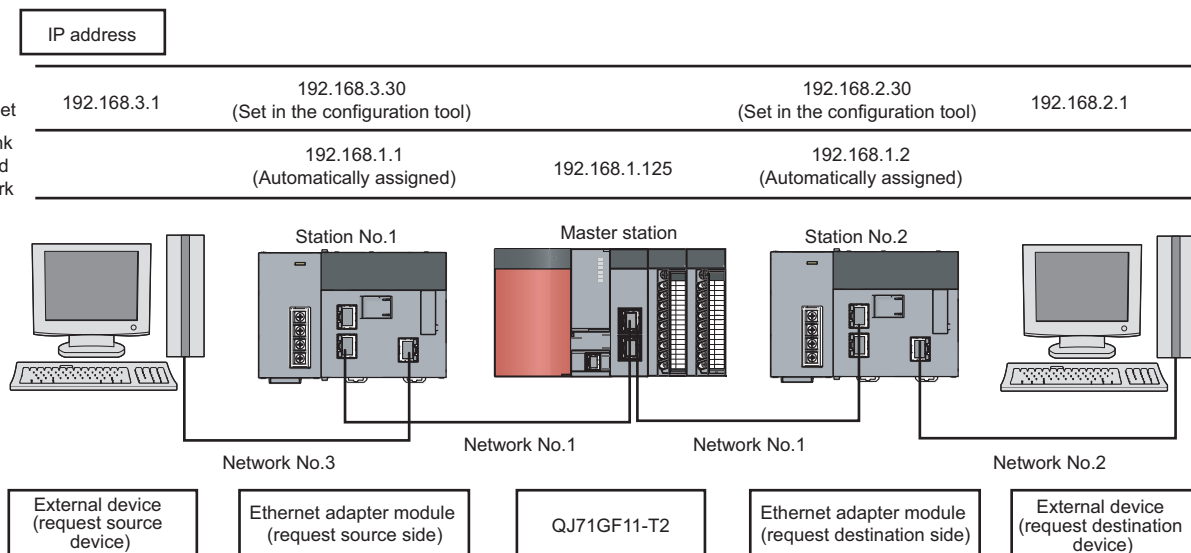

Configuration of the external device

Basic software: Microsoft® Windows® XP Professional Operating System

For the gateway address, set the IP address of the Ethernet adapter module (Ethernet part).

When the external device is a personal computer, set the IP address of the Ethernet adapter module (Ethernet part) in the default gateway. When the default gateway has been already set, use the route command to set the communication route where communications for the request destination transmit through the Ethernet adapter module.



**1. Open the "Internet Protocol (TCP/IP) Properties" dialog box and set the parameters as follows.**

- ☞ Control panel ⇒ "Network and Internet Connections" ⇒ "Network Connections" ⇒ "Local Area Connection" ⇒ "General" ⇒ [Properties] button ⇒ "Internet Protocol (TCP/IP)" ⇒ [Properties] button
- Setting in the external device (request source device)

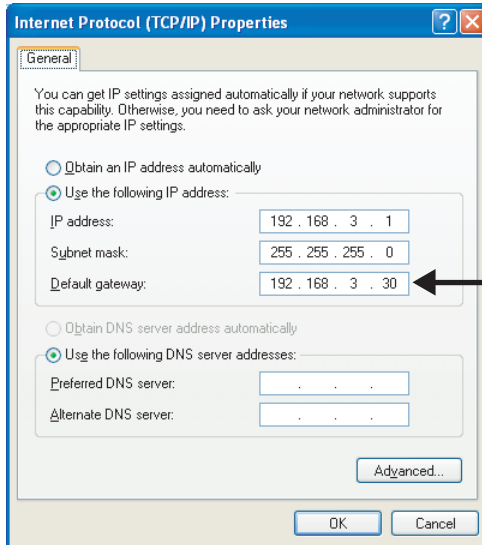

Set the IP address to the Ethernet part of the Ethernet adapter module (request source side).

- Setting in the external device (request destination device)

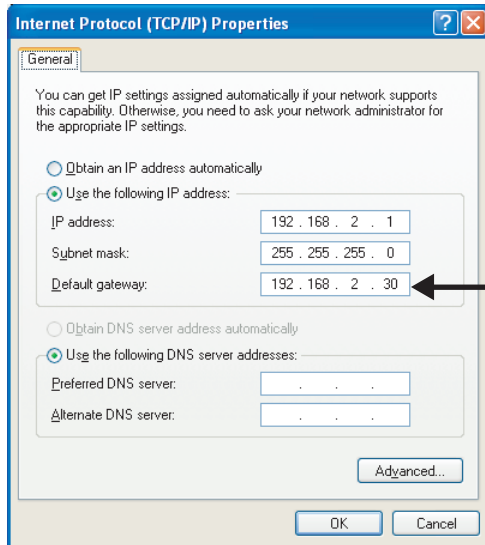

Set the IP address to the Ethernet part of the Ethernet adapter module (request destination side).

## 7.3.6 Checking communications (IP communication test)

---

After the following settings are completed, communications using the IP address can be performed between the external devices.

- Network setting of the configuration computer (☞ Page 111, Section 7.3.3)
- Connection to CC-Link IE Field Network (☞ Page 112, Section 7.3.4)
- Connection to Ethernet (☞ Page 121, Section 7.3.5)

Use the IP communication test of the configuration tool to check that communications can be performed. The following items can be checked:

- The cables on the communication route are properly connected.
- The parameter settings that are required for IP communications in an external device on the communication route, such as the IP address, routing parameters on the master and local stations, and CC-Link IE Field Network gateway setting on the Ethernet adapter module, are correct.
- Modules, such as a CPU module, master/local module, and Ethernet adapter module, that do not support the IP packet transfer function are connected or not on the communication route.

## (1) Test method

1. Open the "IP Communication Test" dialog box in the configuration tool.

 [Online] ⇒ [Diagnostics] ⇒ [IP Communication Test] button

2. Enter the IP address of the external device (request destination device) for "Communication Target".
3. Click the [Test] button.

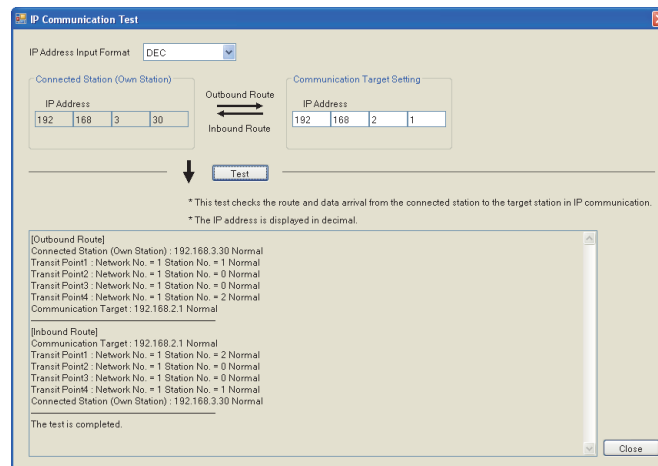

### Point

- In the IP communication test, whether IP communications can be performed between the Ethernet adapter module (request destination) and the external device (request source) set in "Communication Target" is checked using the Ping command. If the external device does not support the Ping command, the IP communication test ends abnormally.

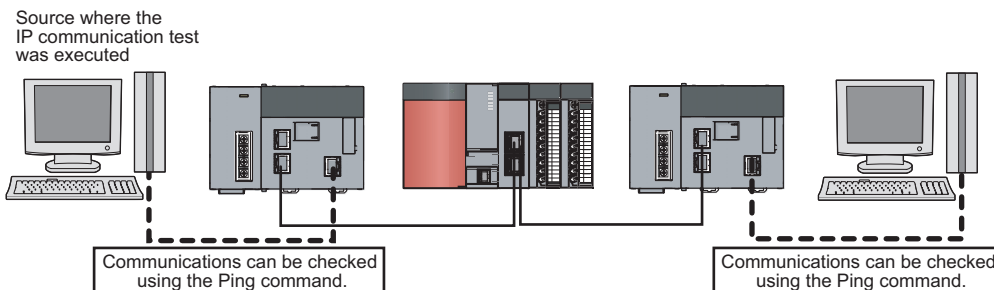

- Up to four IP communication tests can be executed at the same time.
- When the external device (request destination) is connected to a CPU module, the IP communication test cannot be executed for the external device (request destination). Set the IP address of the CPU module connected to the external device (request destination) in the "Communication Target" field on the "IP Communication Test" dialog box.

## (2) Corrective action upon abnormal end

### (a) If a network number, station number, and an error code are displayed

An error has occurred in the station with the network number and station number displayed. Check the error code and take corrective action.

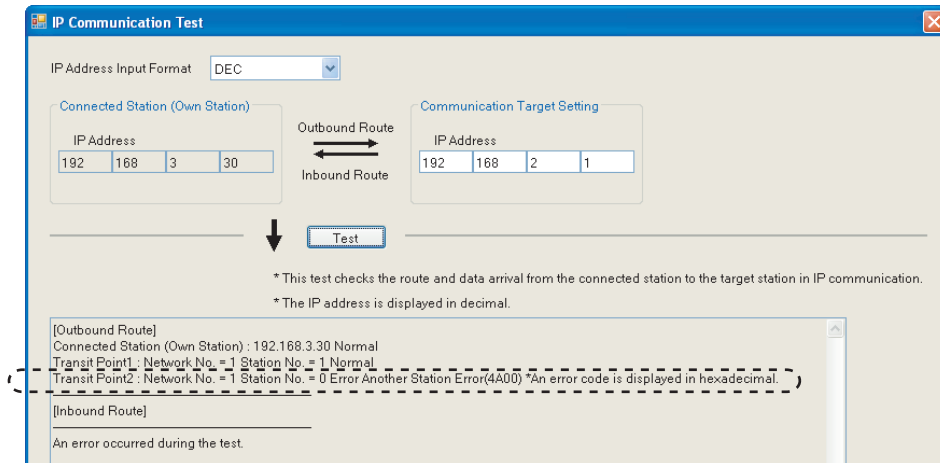

### (b) If the cause cannot be identified from symptoms such as a timeout error display

Enter the IP address in a module closest to the device where the IP communication test was executed. Repeat the test until the station that cannot receive communications is found.

In the following system configuration, execute the IP communication test in order of ① to ⑤.

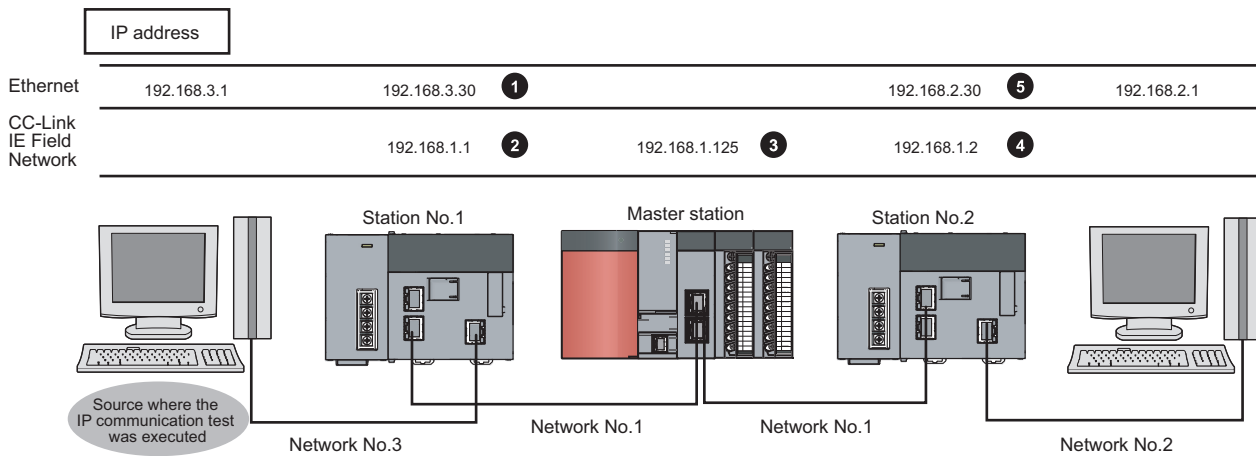

## 7.3.7 Setting for when the network addresses are different

When the same network address cannot be set for the external device and CC-Link IE Field Network, the following settings are required. (☞ Page 108, Section 7.3.1)

- Connection to CC-Link IE Field Network (☞ Page 112, Section 7.3.4)
- Routing parameters: A communication route to the Ethernet adapter module connected to the external device with a different network address (☞ Page 127, Section 7.3.7 (1))
- CC-Link IE Field Network gateway setting: A network number and station number of the Ethernet adapter module connected to the external device with a different network address (☞ Page 129, Section 7.3.7 (2))

### (1) Routing parameters

#### (a) A communication route to an external device with a different network address

Set the communication route to the Ethernet adapter module (CC-Link IE Field Network part) connected to an external device.

#### (b) A communication route to an external device with the same network address as that of the master station

Set the communication route to the Ethernet adapter module (Ethernet adapter part).

Ex.

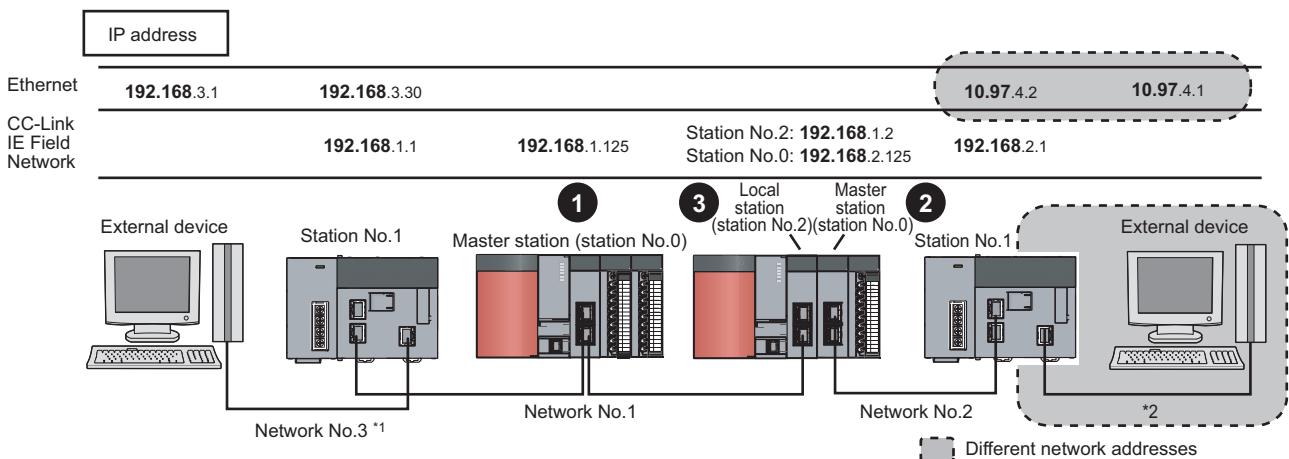

- \*1 When the network address of the external device and Ethernet adapter module (Ethernet part) is the same as that of the master station, the third octet of the IP address of the external device side is used as a network number. In the routing parameters of the CPU module, set the communication route to the network number 3.
- \*2 Because the network address of the external device is different from that of the master station, the Ethernet part does not have a network number. In the routing parameters, set the communication route to the network number 2.

☞ Project window on GX Works2 ⇒ [Parameter] ⇒ [Network Parameter] ⇒ [Ethernet/CC IE/MELSECNET] ⇒ [Routing Parameters] button

- Setting for ❶

	Target Network No.	Relay Network No.	Relay Station No.
1	2	1	2
2	3	1	1

- Setting for ❷

	Target Network No.	Relay Network No.	Relay Station No.
1	3	1	0

- Setting for ❸: This setting is not required for a local station.

**Point** 

---

Precautions when setting the routing parameters are the same as those described in the "Point" for when the request source and request destination have the same network address. (Page 112, Section 7.3.4 (1))

---

## (2) CC-Link IE Field Network gateway setting

For an external device having a different network address to receive communications, configure the setting in the station on CC-Link IE Field Network connected to the request destination. (☞ Page 191, Section 10.3.2 (1))

Ex.

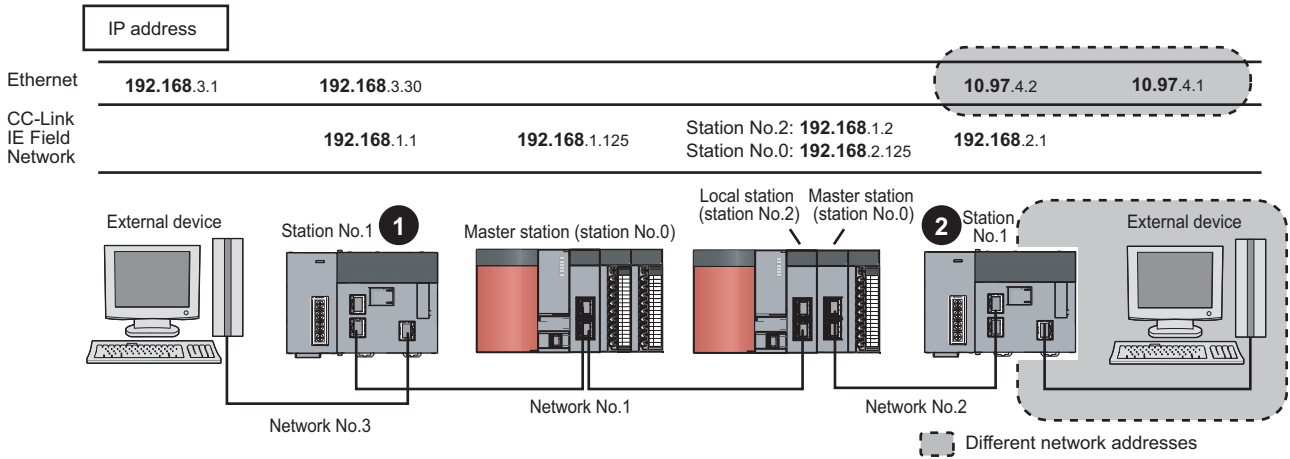

☞ Setting item tree ⇒ NZ2GF-ETB ⇒ [Parameter Setting] ⇒ "CC-Link IE Field Network" ⇒ button

- Setting for ❶

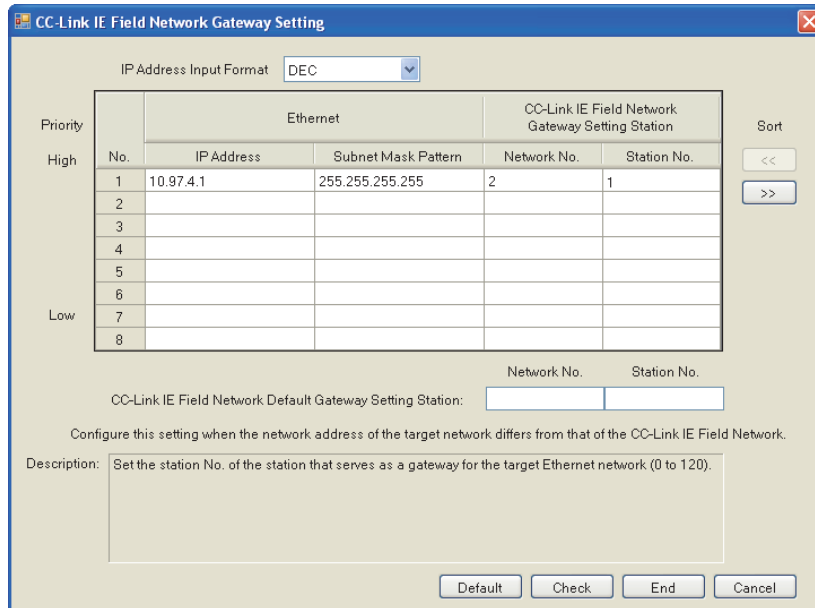

- Setting for ❷: Because the network address of ❶ is the same, communications reach the external device of ❶ using the routing parameters. Thus the CC-Link IE Field Network gateway setting is not required.

## 7.4 MELSOFT Connection

Through the Ethernet adapter module, access to a CPU module on another station is possible from GOT and GX Works2.

- Setting for connection between the Ethernet adapter module and a GOT (☞ Page 131, Section 7.4.1)
- Connection through a hub (☞ Page 133, Section 7.4.2)
- Direct connection (simple connection) (☞ Page 137, Section 7.4.3)

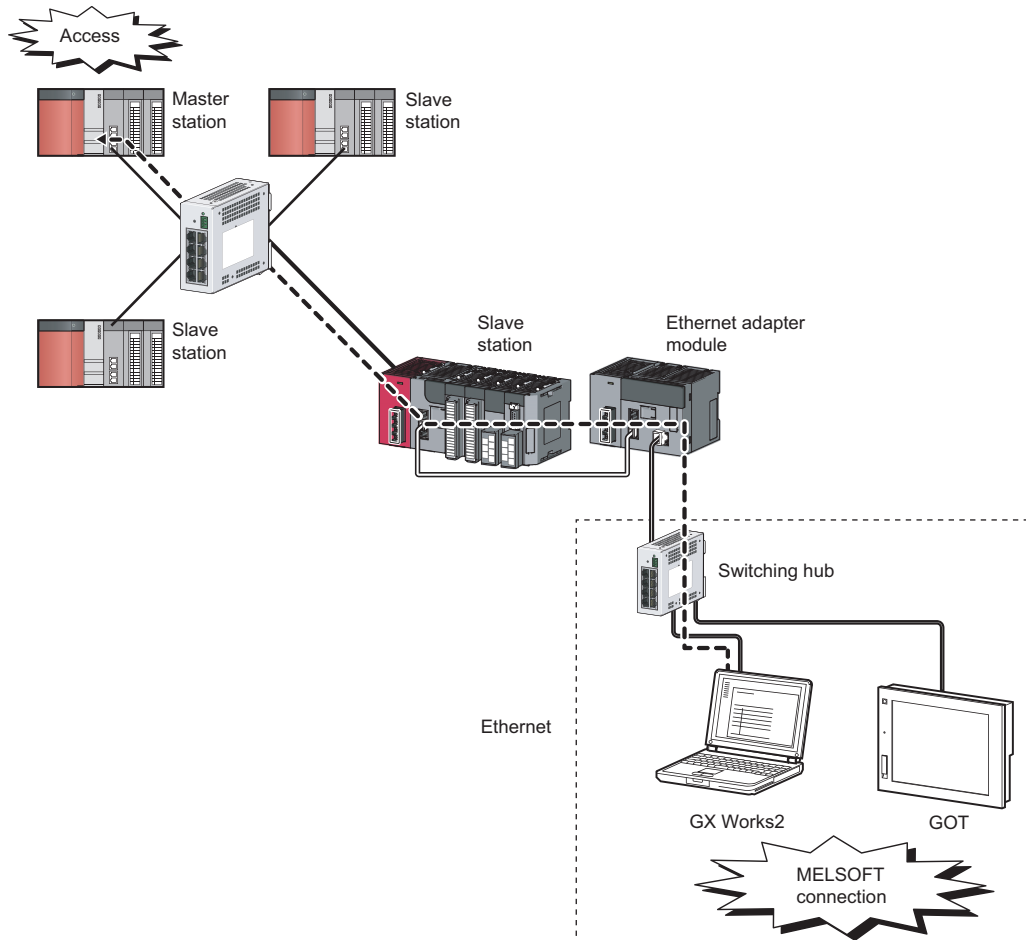



## 7.4.1 Setting for connection between the Ethernet adapter module and a GOT

The Ethernet adapter module can be connected to a GOT by "Ethernet connection".

### (1) Setting for the Ethernet adapter module

Set the third and fourth octets of the IP address within the following ranges.

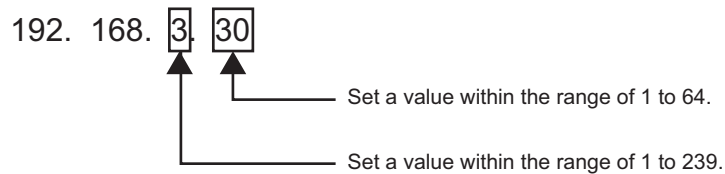

### (2) Setting on the GOT

#### (a) Access from the GOT to the Ethernet adapter module

Configure the same settings for the GOT as those for "Ethernet connection" of the QJ71E71, except for the following two items.

- Set "MELSEC-L" for "Type" in "Controller Setting."
- Set the following values for the network and station numbers of the connected Ethernet adapter module.  
 Network No.: The third octet value of the Ethernet adapter module's IP address
- Station No.: The fourth octet value of the Ethernet adapter module's IP address

**Ex.** The IP address of the connected Ethernet adapter module is 192.168.3.30.

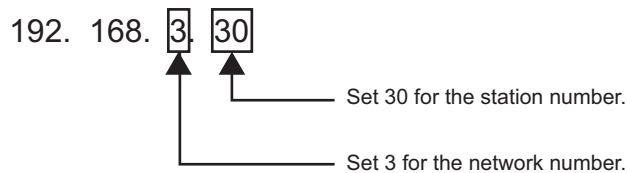

**(b) Access from the GOT to a CPU module on the master or local station through the Ethernet adapter module**

Configure the same settings on the GOT as those for "Ethernet Connection" on the QJ71E71, except the following two items.

- Set a "Type" appropriate to the connected CPU module in "Controller Setting".
- Set the following values for the relay network number and the relay station number in the routing parameter setting. Relay Network No.: The third octet value of the IP address of the Ethernet adapter module
- Relay Station No.: The forth octet value of the IP address of the Ethernet adapter module

**Ex.** The IP address of the relay Ethernet adapter module is 192.168.3.30.

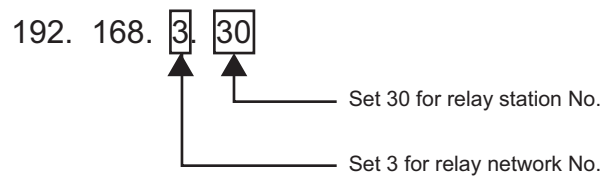

---

**Point**

For details on the GOT setting, refer to the following.

 GOT1000 Series Connection Manual (Mitsubishi Products)

---

## 7.4.2 Connection through a hub

Through a switching hub, the Ethernet adapter module can be connected to more than one GX Works2.

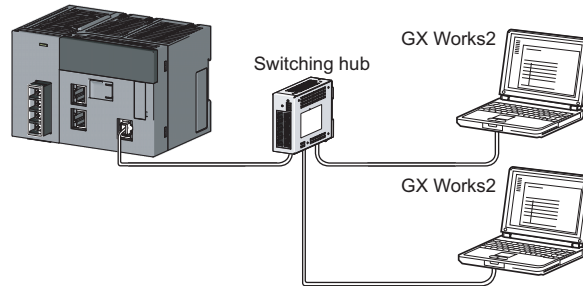

### (1) Setting for the Ethernet adapter module

By using the configuration tool, set parameters for the Ethernet adapter module. The setting is required for MELSOFT connection using two or more TCP connections. If MELSOFT connection is implemented under the following conditions, the setting is not necessary.

- UDP connection
- TCP connection using one connection

1. Start the configuration tool. (👉 Page 179, Section 10.1)
2. Set the network No. and station No. (👉 Page 190, Section 10.3.2)
3. Open the "Ethernet Port Connection Setting" window to set connections used for MELSOFT connection.

🖱️ Setting item tree ⇒ NZ2GF-ETB ⇒ [Parameter] ⇒ "Ethernet" ⇒ [Connection Setting] button

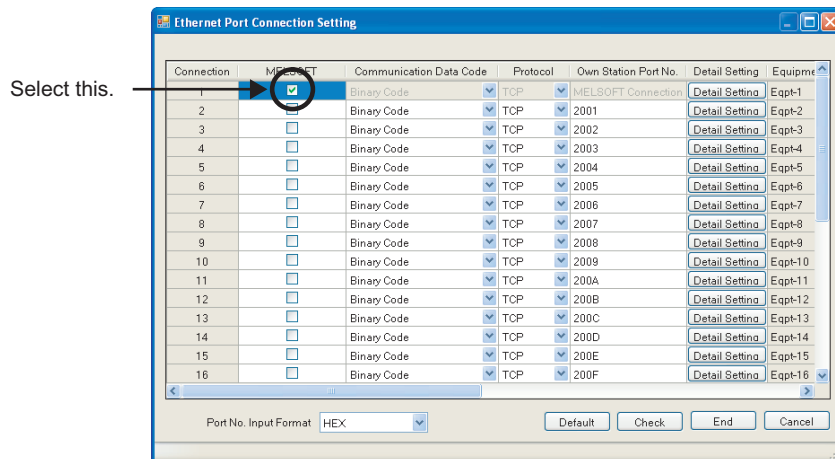

4. Click the [End] button.
5. Write the parameters to the Ethernet adapter module. (Set the switch on the Ethernet adapter module to STOP.)

🖱️ [Online] ⇒ [Write]

6. Reset the Ethernet adapter module.

## (2) Setting in GX Works2

Specify the connection destination in the "Transfer Setup" dialog box of GX Works2.

### (a) UDP connection or TCP connection using one connection

 Connection Destination window ⇒ [Connection1]

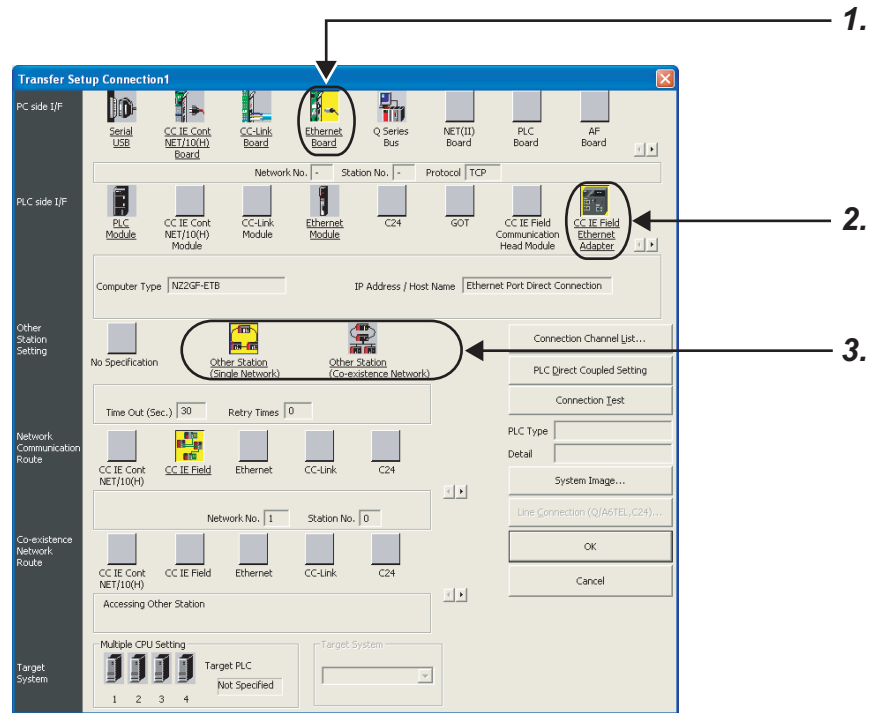

#### 1. Set "Ethernet Board" for PC side I/F.

In the "PC side I/F Ethernet Board Setting" dialog box, select "TCP" or "UDP" protocol. No setting is required for Network No. and Station No.

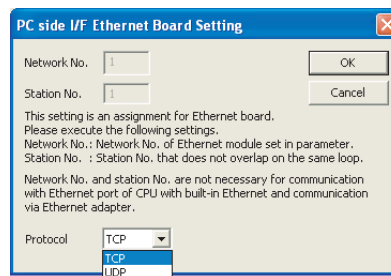

**2. Set "CC IE Field Ethernet Adapter" for PLC side I/F.**

In the "PLC side I/F Detailed Setting of CC IE Field Ethernet Adapter" dialog box, set the IP address of the Ethernet adapter module.

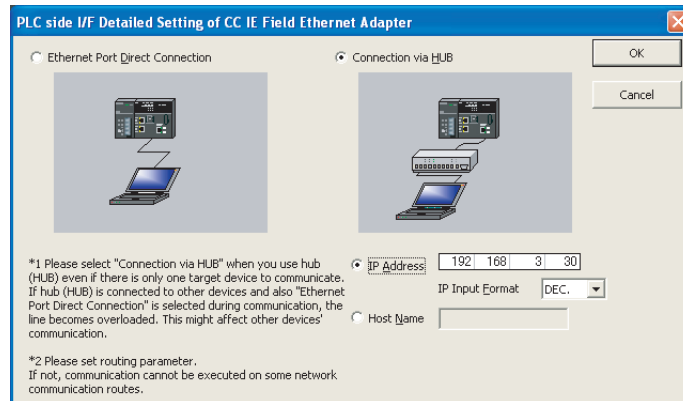

**3. Specify the other station.**

Set the destination CPU

For the setting method, refer to the following.

GX Works2 Version1 Operating Manual (Common)

**(b) Connection using two or more TCP connections**

Connection Destination window ⇒ [Connection1]

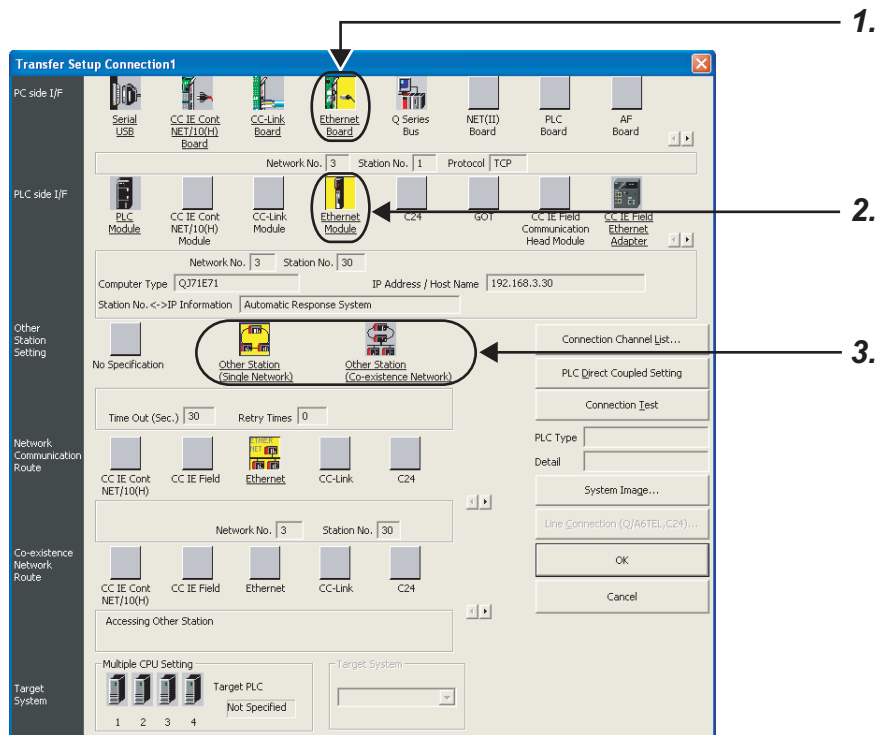

## 1. Set "Ethernet Board" for PC side I/F.

In the "PC side I/F Ethernet Board Setting", configure the settings as shown below.

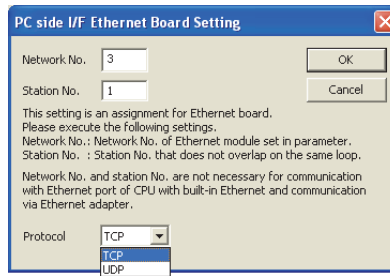

- Network No.: The third octet value of the Ethernet adapter module's IP address
- Station No.: Any value of 1 to 64
- Protocol: TCP

**Ex.** The IP address of the connected Ethernet adapter module is 192.168.3.30.

192. 168. 3. 30



Set 3 for the network number.

## 2. Set "Ethernet Module" for PLC side I/F.

In the "PLC side I/F Ethernet Module Setting", configure the settings as shown below.

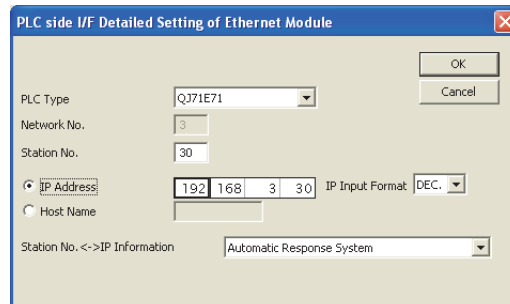

- Model name: QJ71E71
- Station No.: Any value of 1 to 64 that does not overlap the Station No. set in the "PC side I/F Ethernet Board Setting"
- IP address: Ethernet adapter module's IP address

## 3. Specify the other station.

Set the destination CPU.

For the setting method, refer to the following.

GX Works2 Version1 Operating Manual (Common)

## 7.4.3 Direct connection (simple connection)

The Ethernet adapter module can be directly connected to GX Works2 with an Ethernet cable, without using a hub. The IP address setting is not required in the destination setting for direct connection.

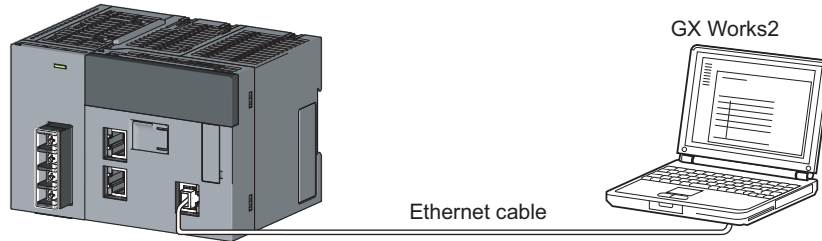

### Point

In the case of direct connection using an Ethernet cable, there is a risk of an illegal access. Selecting the following item in "Ethernet" in the "Parameter Setting" dialog box of the configuration tool will disable direct connection, preventing any illegal access.

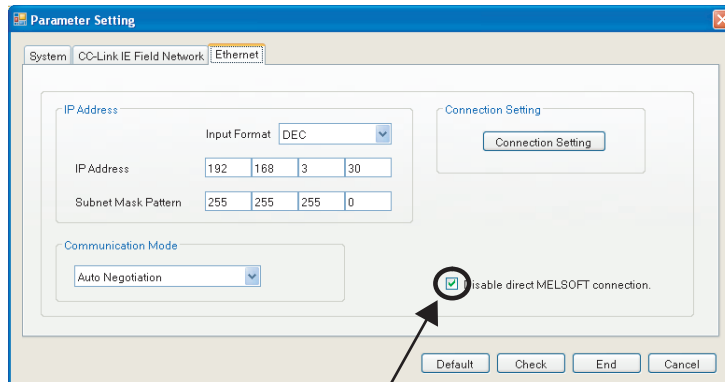

Select this.

## (1) Setting in GX Works2

Specify the connection destination in the "Transfer Setup" dialog box.

 Connection Destination window ⇒ [Connection1]

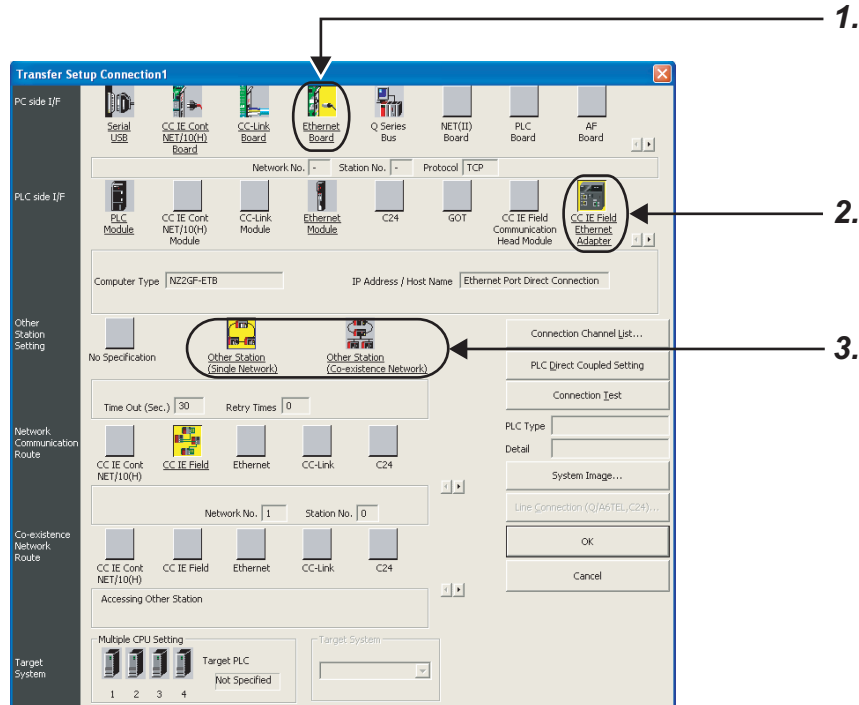

**1. Set "Ethernet Board" for PC side I/F.**

**2. Set "CC IE Field Ethernet Adapter" for PLC side I/F.**

In the "PLC side I/F Detailed Setting of CC IE Field Ethernet Adapter", select "Ethernet Port Direct Connection" as shown below.

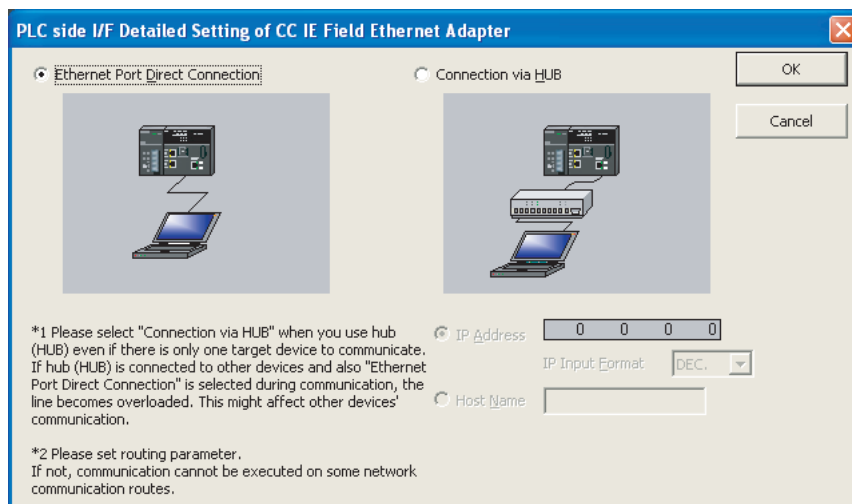

**3. Specify the other station.**

Set the destination CPU.

For the setting method, refer to the following.

 GX Works2 Version1 Operating Manual (Common)



**(2) Precautions: Connection not regarded as direct connection**

Connection between the Ethernet adapter module and GX Works2 through a switching hub is not regarded as direct connection. Do not configure the settings for direct connection.

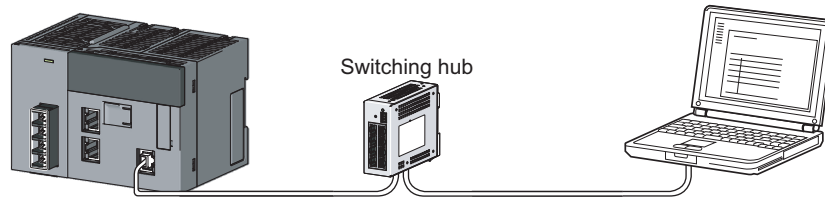
**(3) Precautions: Conditions under which communication is not possible through direct connection****(a) When two or more Ethernet ports are enabled in the network setting of the personal computer**

Communication is not possible in direct connection. Correct the setting on the personal computer so that only one Ethernet port will be enabled for direct connection and the others will be disabled.

**(b) IP address condition 1 of the Ethernet adapter module**

In the IP address bits of the Ethernet adapter module, if all of the bits corresponding to subnet mask 0 of the personal computer are on or off, communication may not possible through direct connection. Correct the settings of the Ethernet adapter module and/or personal computer.

**Ex.**

- IP address of the Ethernet adapter module: 64.64.255.255
- IP address of the personal computer: 64.64.1.1
- Subnet mask for the personal computer: 255.255.0.0

**(c) IP address condition 2 of the Ethernet adapter module**

In the IP address bits of the Ethernet adapter module, if all of the bits corresponding to the host address in each class of the personal computer IP address are on or off, communication may not possible through direct connection. Correct the settings of the Ethernet adapter module and/or personal computer.

**Ex.**

- IP address of the Ethernet adapter module: 64.64.255.255
- IP address of the personal computer: 192.168.0.1
- Subnet mask for the personal computer: 255.0.0.0

**Remark**

- The IP address for each class is as follows:  
Class A: 0.x.x.x to 127.x.x.x, Class B: 128.x.x.x to 191.x.x.x, Class C: 192.x.x.x to 223.x.x.x
- The host address for each class is the part of 0 as shown below.  
Class A: 255. 0. 0. 0, Class B: 255.255. 0, Class C: 255.255.255. 0

# CHAPTER 8 MAINTENANCE AND INSPECTION

---

This chapter describes check points in daily and periodic inspections for using the Ethernet adapter module in the optimum condition.

## 8.1 Daily Inspection

---

The following must be checked daily.

Check box

- The Ethernet adapter module is securely mounted to the DIN rail.
- The terminal screws of the power supply part are not loose.
- The terminal cover of the power supply part has not come off.
- Solderless terminals are physically out of contact and away from each other.
- The cable connectors are fully inserted.

## 8.2 Periodic Inspection

---

The following must be checked once or twice every six months or a year.

Also, perform this inspection when the system is relocated or modified, or when wiring layout is changed.

Check box

- The ambient temperature is within the range of 0 to 55°C.
- The ambient humidity is within the range of 5 to 95%RH.
- There is no corrosive gas.
- The voltage across 24VDC terminals is within the range of 15.6V to 31.2VDC.
- The Ethernet adapter module is mounted securely.
- No dust or foreign matter is present.
- No error has occurred.

# CHAPTER 9 TROUBLESHOOTING

This chapter describes errors that may occur in the Ethernet adapter module, and explains how to identify the causes of the errors and troubleshooting methods.

## 9.1 Troubleshooting Procedure

The procedure for identifying the cause of the problem and taking action is explained below.

### 1. Troubleshooting for the entire CC-Link IE Field Network

The network condition can be checked on the CC-Link IE Field Network diagnostics dialog box of GX Works2, which is connected to the master station. Identify the cause of the problem and take corrective action. (📖 User's manual for the master/local module used, 🖱️ Page 144, Section 9.2.1)

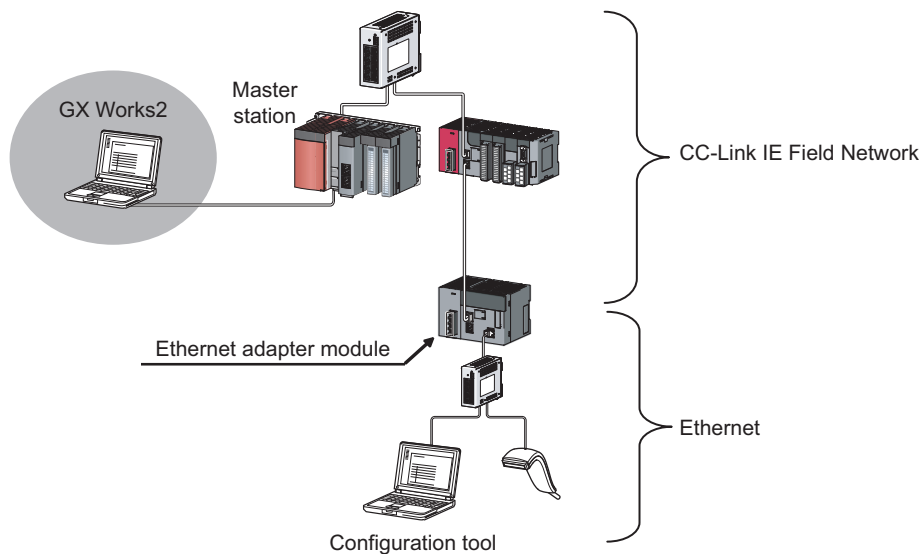

### 2. Troubleshooting of the error that has occurred in the Ethernet adapter module

By the Ethernet Adapter Diagnostics in the configuration tool, an error code can be obtained. Confirm the error and take corrective action. (🖱️ Page 146, Section 9.2.2)

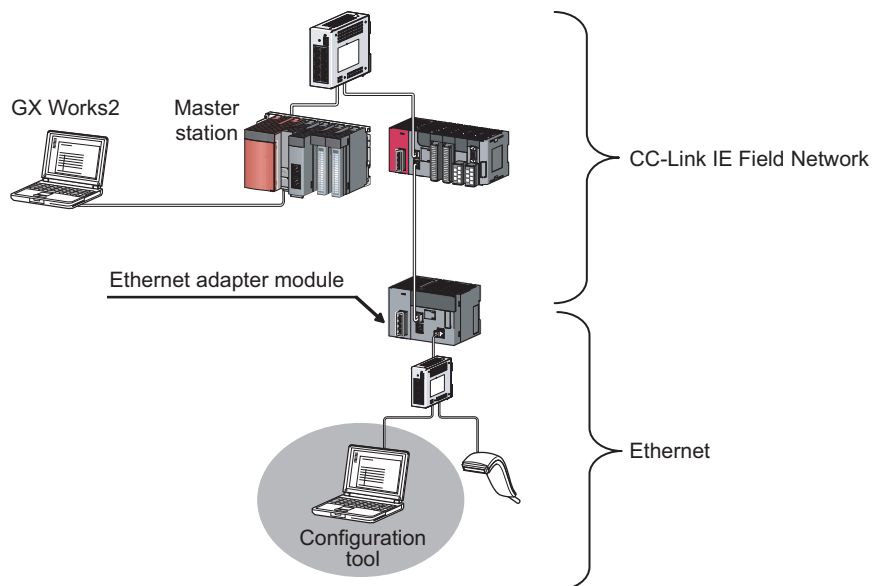

- 3. If communication is not possible even after taking the above troubleshooting measures, perform the following:**
- Checking the LEDs (☞ Page 147, Section 9.3)
  - Troubleshooting by symptom (☞ Page 154, Section 9.4)

## 9.2 Checking the Error Code

### 9.2.1 Error history of CC-Link IE Field Network diagnostics

By the CC-Link IE Field Network diagnostics in GX Works2, which is connected to the master station, an error code can be checked.

1. From the menu of GX Works2, activate the CC-Link IE Field Network diagnostics.

 [Diagnostics] ⇒ [CC IE Field Diagnostics]

2. Under "Network Status", double-click the icon that represents the Ethernet adapter module.

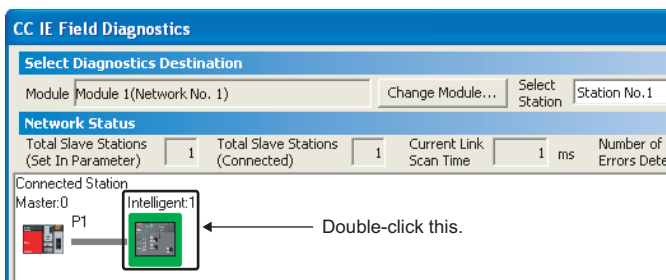

3. The "Error History" dialog box is displayed. The error history is displayed. check the error details and solution and troubleshoot the problem.

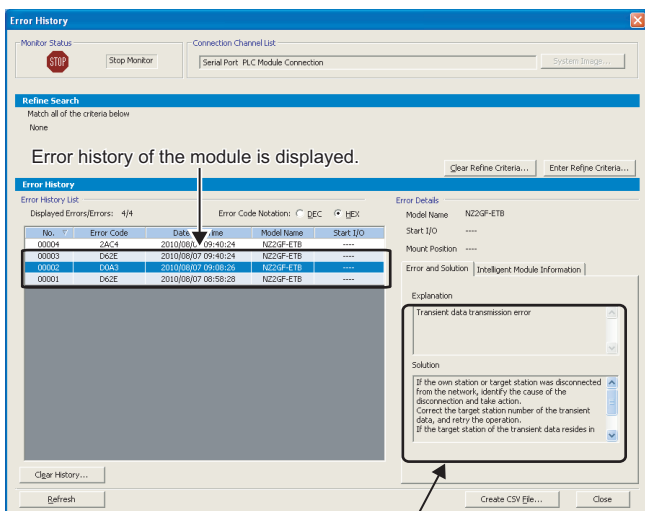

The details and solution of the error selected in "Error history list" is displayed.

**(1) Precautions****(a) The date and time of the error is not correctly displayed.**

- Check if the master station is connected to the Ethernet adapter module. The Ethernet adapter module periodically collects time information from the CPU module on the master station. If the Ethernet adapter module is not connected, the time and date information of errors will not be displayed correctly. (Initial value: 2000/01/01 00:00:00)
- After acquisition of clock information from the master station, if the Ethernet adapter module is powered off and then on, the clock will restart from the time of the power off. (The clock pauses during power off.) Because of this, the displayed time and date of the error occurred during initial processing may be different from the actual time and date.

**(b) The error code is not correctly displayed.**

If errors occurred frequently, "\*"HST.LOSS\*" may be displayed in the "Error Code" column, instead of an error code.



No. ▾	Error Code	Date and Time	Model Name	Start I/O
00005	*HST.LOSS*	2010/08/06 10:28:33	NZ2GF-ETB	----

## 9.2.2 Ethernet Adapter Diagnostics

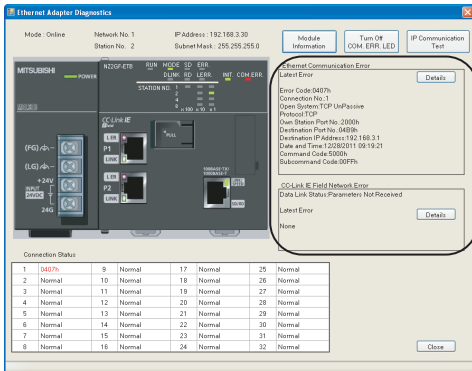
By the Ethernet Adapter Diagnostics in the configuration tool, an error that has occurred on the Ethernet can be checked.



Latest error information

1. Open the "Ethernet Adapter Diagnostics" window.  
 [Online] ⇒ [Diagnostics]
2. The latest error code is displayed. Refer to "Error Code List" and take corrective action. ( Page 161, Section 9.5)



## 9.3 Checking the LEDs

The following explains how to troubleshoot the problem by checking the LEDs. Use this troubleshooting method when communication cannot be performed even after taking corrective action according to the CC-Link IE Field diagnostics.

**Point** 

The state of the LEDs can be also checked from the Ethernet Adapter Diagnostics. (  Page 146, Section 9.2.2)

### 9.3.1 The LED on the power supply part

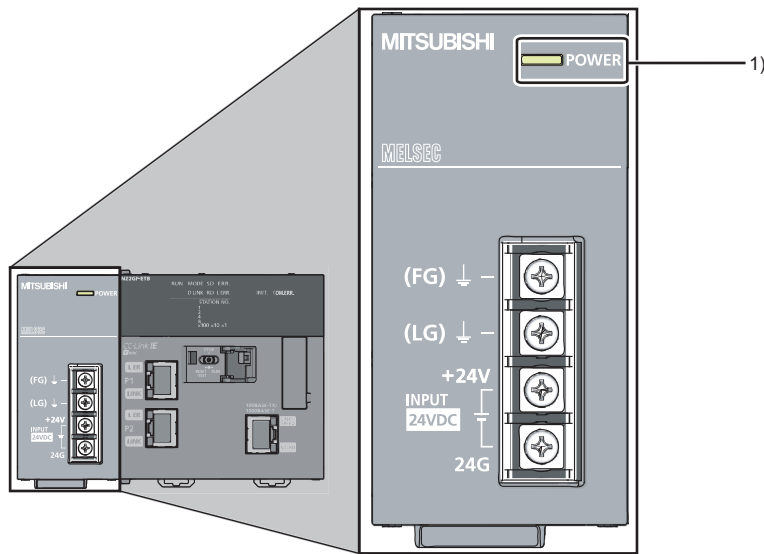

**(1) When the POWER LED is off**

Checking	Action
Is power being supplied?	Supply power. (  Page 61, Section 6.4.1)

9.3 Checking the LEDs

## 9.3.2 The LEDs on the CC-Link IE Field Network part

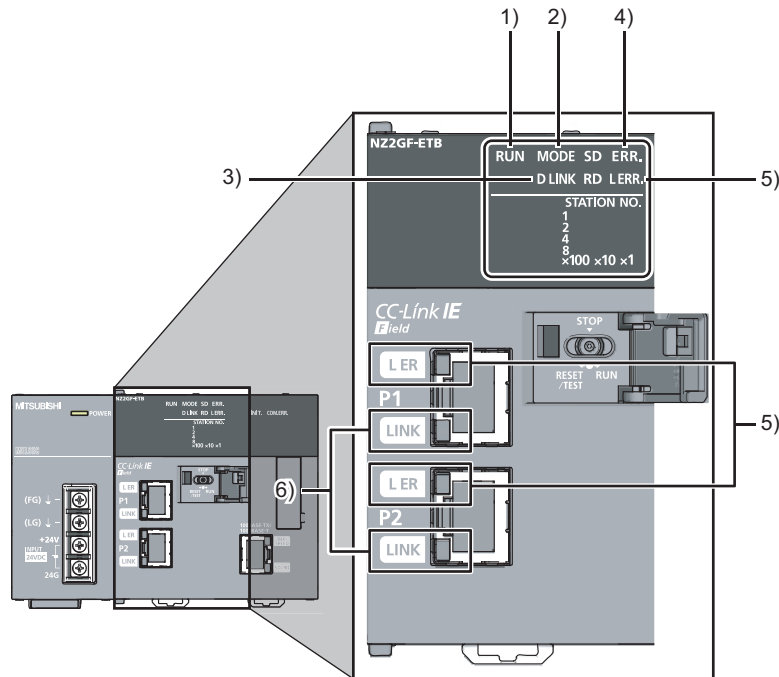

### (1) RUN LED

#### (a) When turned off

Checking	Action
Is the Ethernet adapter module in execution of a unit test?	If the MODE LED is flashing, a unit test is being performed. Reset the Ethernet adapter module, or turn off the power and then on.

If the above does not solve the problem, perform a unit test on the Ethernet adapter module to check for hardware failure. (📖 Page 59, Section 6.3)

#### (b) When flashing

Checking	Action
Is the switch of the Ethernet adapter module set to RUN?	Set the switch of the Ethernet adapter module to RUN to start data link.
Is the module in the remote STOP status?	Cancel the remote STOP and start data link.
Is the master station in the RUN status?	Place the master station into the RUN state. If the master station has stopped due to an error, troubleshoot it referring to the manual for the master station. (📖 User's manual for the master/local module used)
Was the Ethernet adapter module disconnected while the master station was in the STOP status?	<ul style="list-style-type: none"> <li>Place the master station into the RUN state, and reconnect the Ethernet adapter module to the network.</li> <li>Reset the Ethernet adapter module since it retains the STOP status data of the master station.</li> </ul>

If the above does not solve the problem, perform a unit test on the Ethernet adapter module to check for hardware failure. (📖 Page 59, Section 6.3)

**(2) MODE LED****(a) When turned off**

Checking	Action
Is the mode of the Ethernet adapter module set to Online?	Change the mode of the Ethernet adapter module to Online. (☞ Page 190, Section 10.3.2)

If the above does not solve the problem, perform a unit test on the Ethernet adapter module to check for hardware failure. (☞ Page 59, Section 6.3)

**(b) When flashing**

Checking	Action
Is the mode of the master station set to Online?	Change the mode of the master station to Online. (📖 User's manual for the master/local module used)
Is the Ethernet adapter module in preparation for a unit test?	If the switch on the Ethernet adapter module was repeatedly switched between STOP and RESET/TEST, reset the Ethernet adapter module and start the unit test.
Is the Ethernet adapter module in execution of a unit test? (The ×1 or ×10 LED is flashing.)	The Ethernet adapter module is in execution of the unit test. Upon termination of the test, the D LINK LED turns on. Take action according to the test result. (☞ Page 59, Section 6.3)

If the above does not solve the problem, perform a unit test on the Ethernet adapter module to check for hardware failure. (☞ Page 59, Section 6.3)

**(3) D LINK LED****(a) When turned off**

Checking	Action
Is the Ethernet cable connected to PORT1 or PORT2 normal?	<ul style="list-style-type: none"> <li>• Check if Ethernet cables are used.</li> <li>• Check if 1000BASE-T-compliant Ethernet cables are used. (☞ Page 49, Section 5.2.2 (1))</li> <li>• Check if the station-to-station distance is 100m or less. (☞ Page 67, Section 6.4.4 (7))</li> <li>• Check if the cable laying (bend radius) is within the specified range. (📖 Manual for the Ethernet cable used)</li> <li>• Check the Ethernet cables for disconnection.</li> </ul>
Are the other stations, where the Ethernet adapter module is connected, normal?	Check if the other stations are powered on.
Is the switching hub used in the system normal?	<ul style="list-style-type: none"> <li>• Check if the switching hub is powered on.</li> <li>• Check if a 1000BASE-T-compliant switching hub is used. (☞ Page 50, Section 5.2.2 (2))</li> </ul>
Does the network No. of the Ethernet adapter module match that of the connected network?	Change the network No. of the Ethernet adapter module to that of the connected network.

If the above does not solve the problem, perform the following tests on the Ethernet adapter module to check for failure.

- Unit test (☞ Page 59, Section 6.3)
- Cable test (📖 User's manual of the master/local module used)

## (b) When flashing

Checking	Action
Are the STATION NO. LEDs of the Ethernet adapter module correctly showing the station number specified in Network Configuration Setting of the master station?	<ul style="list-style-type: none"> <li>Have the station number of the actual Ethernet adapter module and the one specified in Network Configuration Setting of the master station matched.</li> </ul>

From the master station, perform the CC-Link IE Field Network diagnostics in GX Works2 to check the network status, and take action. (📖 User's manual for the master/local module used), (📄 Page 144, Section 9.2.1)

## (4) When the ERR. LED turned on

From the master station, perform the CC-Link IE Field Network diagnostics in GX Works2 to check the network status, and take action. (📖 User's manual for the master/local module used), (📄 Page 144, Section 9.2.1)

## (5) When the L ERR. LED or L ER LED turned on

Checking	Action
Is the Ethernet cable connected to PORT1 or PORT2 normal?	<ul style="list-style-type: none"> <li>Check if Ethernet cables are used.</li> <li>Check if 1000BASE-T-compliant Ethernet cables are used. (📄 Page 49, Section 5.2.2 (1))</li> <li>Check if the station-to-station distance is 100m or less. (📄 Page 67, Section 6.4.4 (7))</li> <li>Check if the cable laying (bend radius) is within the specified range. (📖 Manual for the Ethernet cable used)</li> </ul>
Is the switching hub used in the system normal?	<ul style="list-style-type: none"> <li>Check if a 1000BASE-T-compliant switching hub is used. (📄 Page 50, Section 5.2.2 (2))</li> <li>Check if the switching hub is powered on.</li> </ul>
Are the other stations, where the Ethernet adapter module is connected, normal?	Check if the other stations are powered on.
Is the mode of the master station set to Online?	Change the mode of the master station to Online. (📖 User's manual for the master/local module used)
Is there any noise affecting the system?	Check the wiring condition.
Is the loopback function enabled for the master station?	When the loopback function is enabled, check if the ring topology is correctly configured for the port where the L ERR. LED is on. (📖 User's manual for the master/local module used)

If the above does not solve the problem, perform the following tests on the Ethernet adapter module to check for failure.

- Unit test (📄 Page 59, Section 6.3)
- Cable test (📖 User's manual of the master/local module used)

**(6) When the LINK LED turned off**

Checking	Action
Is the Ethernet cable connected to PORT1 or PORT2 normal?	<ul style="list-style-type: none"> <li>• Check if Ethernet cables are used.</li> <li>• Check if 1000BASE-T-compliant Ethernet cables are used. (📖 Page 49, Section 5.2.2 (1))</li> <li>• Check if the station-to-station distance is 100m or less. (📖 Page 67, Section 6.4.4 (7))</li> <li>• Check if the cable laying (bend radius) is within the specified range. (📖 Manual for the Ethernet cable used)</li> <li>• Check the Ethernet cables for disconnection.</li> </ul>
Are the other stations, where the Ethernet adapter module is connected, normal?	Check if the other stations are powered on.
Is the switching hub used in the system normal?	<ul style="list-style-type: none"> <li>• Check if the switching hub is powered on.</li> <li>• Check if a 1000BASE-T-compliant switching hub is used. (📖 User's manual for the master/local module used)</li> </ul>

If the above does not solve the problem, perform the following tests on the Ethernet adapter module to check for failure.

- Unit test (📖 Page 59, Section 6.3)
- Cable test (📖 User's manual of the master/local module used)

## 9.3.3 The LEDs on the Ethernet part

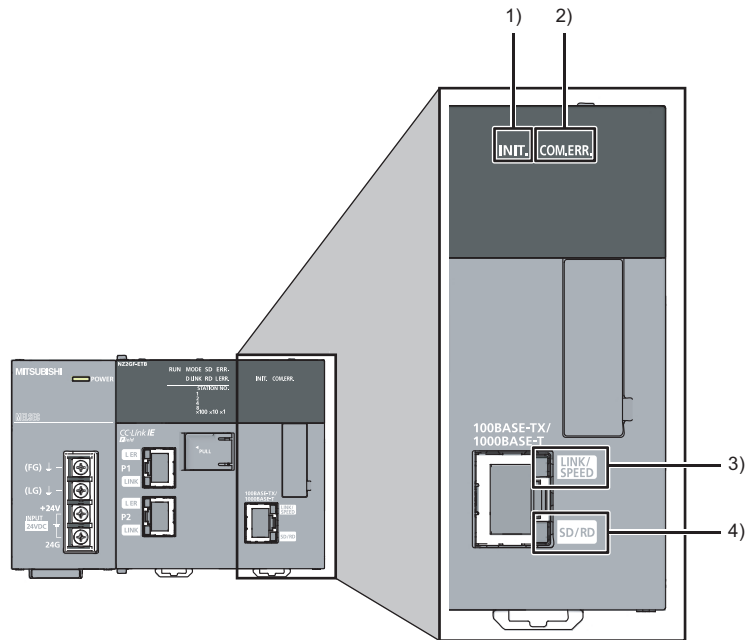

### (1) When the INIT. LED turned off

Checking	Action
Are the configured Ethernet adapter module parameters correct?	Check if the parameters set by the configuration tool are correct. (☞ Page 193, Section 10.3.3)

If the above does not solve the problem, perform a unit test on the Ethernet adapter module to check for failure. (☞ Page 59, Section 6.3)

### (2) When the COM.ERR. LED turned on

After removing the error cause according to the Ethernet Adapter Diagnostics, follow one of the instructions below to turn off the COM.ERR.LED.

- Send an SLMP message (Clear Error (command: 1617)) from the external device.
- Click the [Turn Off COM.ERR.] button on the "Ethernet Adapter Diagnostics" window in the configuration tool.

**(3) When the LINK/SPEED LED turned off**

Checking	Action
Is the Ethernet cable connected to the Ethernet port normal?	<ul style="list-style-type: none"> <li>• Check if Ethernet cables are used.</li> <li>• Check if 1000BASE-T- or 100BASE-TX-compliant Ethernet cables are used. (☞ Page 49, Section 5.2.2 (1))</li> <li>• Check if the station-to-station distance is 100m or less. (☞ Page 67, Section 6.4.4 (7))</li> <li>• Check if the cable laying (bend radius) is within the specified range. (📖 Manual for the Ethernet cable used)</li> <li>• Check the Ethernet cables for disconnection.</li> </ul>
After sending the Ping command from the personal computer connected to the Ethernet adapter module, is a normal response returned?	If a normal response is not returned, replace the Ethernet cable.
Are the other stations, where the Ethernet adapter module is connected, normal?	Check if the other stations are powered on.
Is the switching hub used in the system normal?	<ul style="list-style-type: none"> <li>• Check if the switching hub is powered on.</li> <li>• Check if a 1000BASE-T- or 100BASE-TX-compliant switching hub is used. (📖 User's manual for the master/local module used)</li> </ul>

If the above does not solve the problem, perform a unit test on the Ethernet adapter module to check for failure. (☞ Page 59, Section 6.3)

**(4) The SD/RD LED does not turn on**

Checking	Action
Is the Ethernet cable connected to the Ethernet port normal?	<ul style="list-style-type: none"> <li>• Check if Ethernet cables are used.</li> <li>• Check if 1000BASE-T- or 100BASE-TX-compliant Ethernet cables are used. (☞ Page 49, Section 5.2.2 (1))</li> <li>• Check if the station-to-station distance is 100m or less. (☞ Page 67, Section 6.4.4 (7))</li> <li>• Check if the cable laying (bend radius) is within the specified range. (📖 Manual for the Ethernet cable used)</li> </ul>
Are the switching hub and external devices, where the Ethernet adapter module is connected, normal?	Check if the switching hub and external devices are powered on.
Are the parameters configured for the Ethernet adapter module correct?	In "Ethernet" in the "Parameter Setting" dialog box of the configuration tool, correct the IP address and subnet mask pattern values. (☞ Page 193, Section 10.3.3)
Is the program running from the external device correct?	Modify the program that is running from the external device. (☞ Page 81, Section 7.1.5 (2))

If the above does not solve the problem, perform a unit test on the Ethernet adapter module to check for failure. (☞ Page 59, Section 6.3)

## 9.4 Troubleshooting by Symptom

This section describes troubleshooting methods by symptom.

### Point

- If the problem is not solved by troubleshooting by symptom  
Perform a unit test on the Ethernet adapter module to check for hardware failure. (☞ Page 59, Section 6.3)

### 9.4.1 Cyclic transmission cannot be performed

When cyclic data are not delivered to other stations or not received from the master station, troubleshoot the problem as shown below.

Checking	Action
Is the D LINK LED on the Ethernet adapter module on?	If the D LINK LED is flashing or off, troubleshoot the problem by checking the LEDs. (☞ Page 147, Section 9.3)
Is the switch of the Ethernet adapter module set to "RUN"?	Set the switch of the Ethernet adapter module to "RUN."
Is the RUN LED on the Ethernet adapter module on?	If the RUN LED is flashing or off, troubleshoot the problem by checking the LEDs. (☞ Page 147, Section 9.3)

If the above does not solve the problem, check the link device assignment of the master station or the refresh target devices set in the refresh parameter setting for any error. (📖 User's manual for the master/local module used)

### 9.4.2 Transient transmission cannot be performed

#### (1) Transmission from a master or local station to the Ethernet adapter module

If transient transmission to the target station is not available, check if the network number and station number of the Ethernet adapter module are correctly set. (☞ Page 190, Section 10.3.2)

If they are set on the Ethernet adapter module, troubleshoot the problem referring to the master/local module troubleshooting section. (📖 User's manual for the master/local module used)

#### (2) Transmission from GX Works2 and through the Ethernet adapter module

Troubleshoot the problem as shown below when MELSOFT connection from GX Works2 through the Ethernet adapter module is not possible.

Checking	Action
Is the D LINK LED on the Ethernet adapter module on or flashing?	If the D LINK LED is off, troubleshoot the problem by checking the LEDs. (☞ Page 147, Section 9.3)
Are the settings in "Transfer Setup" correct?	Correct the settings in "Transfer Setup" of GX Works2. (☞ Page 131, Section 7.4.1)
Does the network No. of the Ethernet adapter module match that of the connected network?	Change the network No. of the Ethernet adapter module to that of the connected network.



## 9.4.3 Configuration tool does not start, or communication is not available

Troubleshoot the problem as shown below if the configuration tool does not start or communication is not available.

Checking	Action
Is the Ethernet cable connected to the Ethernet port normal?	<ul style="list-style-type: none"> <li>• Check if Ethernet cables are used.</li> <li>• Check if 1000BASE-T- or 100BASE-TX-compliant Ethernet cables are used. (☞ Page 49, Section 5.2.2 (1))</li> <li>• Check if the station-to-station distance is 100m or less. (☞ Page 67, Section 6.4.4 (7))</li> <li>• Check if the cable laying (bend radius) is within the specified range. (📖 Manual for the Ethernet cable used)</li> </ul>
Are the external devices, where the Ethernet adapter module is connected, normal?	Check if the external devices are powered on.
Is the switching hub used in the system normal?	<ul style="list-style-type: none"> <li>• Check if the switching hub is powered on.</li> <li>• Check if a 1000BASE-T- or 100BASE-TX-compliant switching hub is used. (☞ Page 50, Section 5.2.2 (2))</li> </ul>
Is the IP address specified at startup of the configuration tool correct?	<p>Enter a correct IP address in the address box of the Web browser or in "Destination Setting" of the configuration tool. (☞ Page 184, Section 10.1.2)</p> <p>If the IP address set for the configuration tool is unknown, the settings of the Ethernet adapter module can be changed back to the factory default settings. (☞ Page 229, Appendix 6)</p>
Are the Web browser settings correct?	Configure the settings so that the proxy server is not used. (☞ Page 181, Section 10.1.1 (4))
Is the firewall enabled on the personal computer?	Disable the firewall on the personal computer and check whether communications can be performed. If communications are performed, check and correct the firewall settings.
Is the antivirus software on the personal computer blocking the communications?	<ul style="list-style-type: none"> <li>• Lower the security setting level of the antivirus software.</li> <li>• Disable the firewall of the antivirus software and check whether communications can be performed. If communications are performed, check and correct the firewall settings of the antivirus software.</li> <li>• Stop the operation of the antivirus software.</li> </ul>
Is the .NET Framework 2.0 SP2 or later installed yet?	Install the .NET Framework 2.0 SP2 or later.

## 9.4.4 Configuration tool is not displayed in English

Troubleshoot the problem as shown below if the configuration tool is not displayed in English.

Checking	Action
Is the version of the Web browser correct?	Check the version of the Web browser. (☞ Page 51, Section 5.3.1 (1))
Are the Web browser settings correct?	Configure the settings so that the JavaScript is enabled. (☞ Page 181, Section 10.1.1 (4))
Has the configuration tool of the Ethernet adapter module, with a serial number (first five digits) of "12101" or earlier, ever been started up)?	<ul style="list-style-type: none"><li>• Start the configuration tool from the Ethernet adapter module. (Do not start the configuration tool stored on the personal computer.)</li><li>• Delete temporary Internet files from the Web browser and start the configuration tool.</li></ul>

### (1) Deleting the temporary Internet files

Delete the files in the "Delete Browsing History" dialog box.

**Ex.** For the following computer environment

- Operating system: Microsoft® Windows® XP Professional Operating System
- Web browser: Internet Explorer® 8.0

#### 1. Open the "Delete Browsing History" dialog box.

☞ Web browser ⇒ [Tools] ⇒ [Internet Options] ⇒ "General" ⇒ [Delete] button

#### 2. Select "Temporary Internet files" and click the [Delete] button.

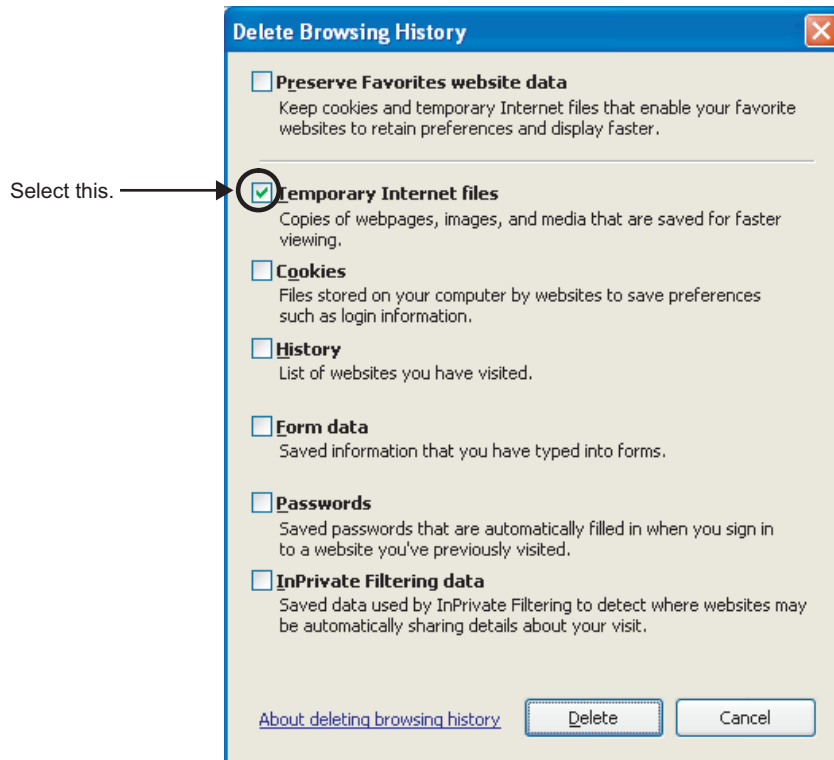

## 9.4.5 New function or improved function cannot be used

Troubleshoot the problem as shown below if the new function or the improved function of the Ethernet adapter module cannot be used.

Checking	Action
Has the configuration tool of the Ethernet adapter module, on which the new function or the improved function is not installed, ever been started up?	<ul style="list-style-type: none"><li>• Write the parameters again using the configuration tool started from the Ethernet adapter module. (Do not use the configuration tool stored on the personal computer.)</li><li>• Delete temporary Internet files from the Web browser, start the configuration tool, and write the parameters again.</li></ul>

## 9.4.6 Communication using SLMP cannot be performed



### (1) Communication from an external device to an Ethernet adapter module

If communication cannot be performed with an external device using SLMP, refer to the troubleshooting section in the following manual.

 SLMP Reference Manual

### (2) Communication from an Ethernet adapter module to an external device (on-demand function)

Refer to the following troubleshooting when communication cannot be performed using the on-demand function.

Checking	Action
Is the Ethernet adapter module supporting the on-demand function?	<ul style="list-style-type: none"> <li>• Check that bit 0 of Function check area of the own station (buffer memory address: 48 (30<sub>H</sub>)) is on.</li> <li>• Check that the first five digits of the serial No. of the Ethernet adapter module is 13012 or later. To perform broadcast communications, check that the first five digits of the serial No. is 14022 or later. ( Page 241, Appendix 11)</li> </ul>
Have the setting data, send data, and send request instruction been written in On-demand function data sending area (buffer memory address: 1600 <sub>H</sub> to 25FF <sub>H</sub> )?	Check Device of the REMTO instruction completed (D, (D + 1)) that writes data in On-demand function data sending area and Completion status ((S1)+ 0). If the REMTO instruction did not complete, find the error cause using the error code and take action to correct the problem. (  Page 161, Section 9.5)
Is connection being established with the SLMP compatible device when TCP/IP is used?	Request for connection from the external device. To send on-demand data, read Open completion signal (buffer memory address: 1500 <sub>H</sub> to 1501 <sub>H</sub> ) using the REMFR instruction and check if the open is completed. Then issue a send request.
Is Send error bit of Send completed flag (buffer memory address: 1601 <sub>H</sub> , 1A01 <sub>H</sub> , 1E01 <sub>H</sub> , 2201 <sub>H</sub> ) on?	Read Send completion flag and Completion code using the REMFR instruction. If Send error bit (bit 1) is on, find the error cause using the error code stored in Completion code (buffer memory address: 1602 <sub>H</sub> , 1A02 <sub>H</sub> , 1E02 <sub>H</sub> , 2202 <sub>H</sub> ) and take action to correct the problem.
When on-demand data was sent the last time, was Send request bit of Send request flag turned off?	After writing 1 (ON) to Send request bit of Send request flag (buffer memory address: 1600 <sub>H</sub> , 1A00 <sub>H</sub> , 1E00 <sub>H</sub> , 2200 <sub>H</sub> ) using the REMTO instruction, read the following areas: <ul style="list-style-type: none"> <li>• Send completed flag (buffer memory address: 1601<sub>H</sub>, 1A01<sub>H</sub>, 1E01<sub>H</sub>, 2201<sub>H</sub>)</li> <li>• Completion code (buffer memory address: 1602<sub>H</sub>, 1A02<sub>H</sub>, 1E02<sub>H</sub>, 2202<sub>H</sub>)</li> </ul> When Send completed bit or Send error bit of Send completed flag is turned on, write 0 (OFF) to Send request flag using the REMTO instruction.
Has the connection for users (1 to 32) been selected for Connection No. (buffer memory address: 1603 <sub>H</sub> , 1A03 <sub>H</sub> , 1E03 <sub>H</sub> , and 2203 <sub>H</sub> ) upon broadcast communications?	Set "Auto-open UDP Port" for Connection No. (buffer memory address: 1603 <sub>H</sub> , 1A03 <sub>H</sub> , 1E03 <sub>H</sub> , and 2203 <sub>H</sub> ) and issue a send request again. Broadcast communications can be used for UDP only.

## 9.4.7 Communications cannot be performed using the IP packet transfer function

Before troubleshooting the problem as listed below, execute the IP communication test and take corrective actions according to the error code. (☞ Page 124, Section 7.3.6)

If the problem cannot be solved using the IP communication test, execute the actions listed below.

Checking	Action																
Does the Ethernet adapter module support the IP packet transfer function?	<ul style="list-style-type: none"> <li>Check that bit 1 of Function check area of the own station (buffer memory address: 48 (30<sub>H</sub>)) is on.</li> <li>Check that the first five digits of the serial No. of the Ethernet adapter module is 14022 or later. (☞ Page 241, Appendix 11)</li> </ul>																
When the IP address of the Ethernet adapter module (Ethernet part) is the same as the network address of the master station, is the IP address (the third and fourth octets) of the external device and Ethernet adapter module (Ethernet part) within the setting range?	<ul style="list-style-type: none"> <li>Set the IP address that meets the rules in the external device and Ethernet adapter module (Ethernet part). (☞ Page 108, Section 7.3.1 (1))</li> <li>Change the IP address of CC-Link IE Field Network in the master station so that the IP address of the external device and Ethernet adapter module (Ethernet part) differs from the network address of the master station.</li> </ul>																
Is the IP address already in use?	<ul style="list-style-type: none"> <li>For the external device, set the IP address different from that of other devices on the network, such as a CPU module, master/local module, and Ethernet adapter module.</li> <li>Disconnect the external device from the line and execute the Ping command to the IP address of the disconnected external device. If a response is received even though the external device is disconnected, the IP address is already in use. Change the IP address.</li> </ul>																
Has a timeout error occurred in the IP communication test?	Check "Relay Network No." in the routing parameters of the master station and local stations.																
Have the routing parameters correctly been set in the master station and local stations?	<ul style="list-style-type: none"> <li>Check and correct the routing parameters of the master station and local stations.</li> <li>When the first and second octets of the IP address are the same for the request source external device, request destination external device, and modules between them, set the routing parameters so that the third octet of the IP address of the external device is used as "Target Network No."</li> <li>If a timeout error occurs in the IP communication test, enter the IP address in the order of station from the closest to the device where the IP communication test was executed. Repeat the test until which station can or cannot receive communications to identify the error. (☞ Page 126, Section 7.3.6 (2) (b)) If the station causing the error is found, check and correct the settings.</li> </ul>																
Is the network number of the external device side (the third octet of the IP address) the same as that of modules and another external device? (This applies only when the request source external device, request destination external device, and modules between them have the same first and second octets of the IP address.)	<p>Change the network number of the external device side (the third octet of the IP address) to the one different from that of modules and another external device.</p> <p>The diagram illustrates the IP address configuration for three stations: Station No. 1, Master station, and Station No. 2. It shows the IP addresses for Ethernet, CC-Link, and IE Field Network for each station. The IE Field Network addresses are automatically assigned. The network topology shows three networks (Network No. 1, 2, 3) connected to the stations.</p> <table border="1"> <thead> <tr> <th>IP address</th> <th>Station No. 1</th> <th>Master station</th> <th>Station No. 2</th> </tr> </thead> <tbody> <tr> <td>Ethernet</td> <td>192.168.3.1</td> <td>192.168.3.30</td> <td>192.168.2.30 192.168.2.1</td> </tr> <tr> <td>CC-Link</td> <td>192.168.1.1</td> <td>192.168.1.125</td> <td>192.168.1.2</td> </tr> <tr> <td>IE Field Network</td> <td>(Automatically assigned)</td> <td>(Automatically assigned)</td> <td>(Automatically assigned)</td> </tr> </tbody> </table> <p>Change the network numbers to those not used for other stations.</p>	IP address	Station No. 1	Master station	Station No. 2	Ethernet	192.168.3.1	192.168.3.30	192.168.2.30 192.168.2.1	CC-Link	192.168.1.1	192.168.1.125	192.168.1.2	IE Field Network	(Automatically assigned)	(Automatically assigned)	(Automatically assigned)
IP address	Station No. 1	Master station	Station No. 2														
Ethernet	192.168.3.1	192.168.3.30	192.168.2.30 192.168.2.1														
CC-Link	192.168.1.1	192.168.1.125	192.168.1.2														
IE Field Network	(Automatically assigned)	(Automatically assigned)	(Automatically assigned)														

Checking	Action
Is the CC-Link IE Field Network gateway setting correct? (This applies only when the request source external device, request destination external device, and modules between them do not have the same first and second octets of the IP address.)	<ul style="list-style-type: none"> <li>• Check and correct the CC-Link IE Field Network gateway setting.</li> <li>• Use the routing parameters of the master station and local stations to set the communication route to the CC-Link IE Field Network gateway setting station.</li> </ul>
Has the gateway setting been configured in the external device? (Even if the IP communication test is normally completed, IP communications cannot be performed without the gateway setting configured on the external device.)	<p>Execute one of the following actions to configure the gateway setting in the external device:</p> <ul style="list-style-type: none"> <li>• Set the IP address of the Ethernet adapter module (Ethernet part) in the gateway setting of the external device.</li> <li>• Set the communication route on the external device side using the route command so that communications can be transmitted to the external device through the Ethernet adapter module. (This applies only to external devices that have the route command, such as Microsoft®Windows®.)</li> </ul> <p>When the gateway setting is completed, execute the Ping command from the external device to check whether communications can be performed.</p>
Is the firewall enabled on the external device?	<p>Check and correct the firewall settings on the external device.</p> <p><b>Ex.</b></p> <p>Is a response to the Ping command (ICMP echo request) enabled?</p>
Is the antivirus software on the external device blocking the communications?	<p>Check and correct the antivirus software settings on the external device.</p> <p><b>Ex.</b></p> <ul style="list-style-type: none"> <li>• Is the security setting level of the antivirus software low?</li> <li>• Is a response to the Ping command (ICMP echo request) enabled in the firewall settings?</li> </ul>
When the external device has two or more Ethernet ports, have different default gateway settings been configured for each Ethernet port?	<ul style="list-style-type: none"> <li>• Set the same IP address in the default gateway of each Ethernet port.</li> <li>• Set the communication route on the external device side using the route command so that communications can be transmitted to the external device through the Ethernet adapter module. (This applies only to external devices that have the route command, such as Microsoft®Windows®.)</li> </ul> <p>When the gateway setting is completed, execute the Ping command from the external device to check whether communications can be performed.</p>
Is the switching hub normal?	<ul style="list-style-type: none"> <li>• If an error has occurred in the switching hub, remove the error.</li> <li>• If communications cannot be performed although no error has occurred in the switching hub, replace the switching hub.*1</li> </ul>
Has any device on the line, such as an external device, CPU module, Ethernet adapter module, and switching hub, been replaced? (This applies only when the device has been replaced by the one having the same IP address.)	<p>Reset the device on the line.*2</p>

\*1 When the device has been reconnected to the switching hub, or the switching hub has been replaced, it may take some time to read the MAC address. If so, retry communications from the external device again after a while or power on the switching hub again.

\*2 A device on Ethernet has a table of IP addresses and their corresponding MAC address, called "ARP cache". When a device on the line is replaced by the one having the same IP address, the MAC address in the ARP cache is different from that of the replaced device; therefore, communications may not be normally performed. The ARP cache is updated by resetting the device or after a while. The time varies depending on the device.

## 9.5 Error Code List

This section describes error message, error conditions, causes, and solutions for respective error codes of the Ethernet adapter module.

Error codes can be viewed in the CC-Link IE Field Network diagnostics of GX Works2. (☞ Page 144, Section 9.2.1)

Error codes, each of which is stored in the buffer memory of the Ethernet adapter module, are classified as shown below.

Error code	Classification	Reference
0000 <sub>H</sub> to 07FF <sub>H</sub>	<ul style="list-style-type: none"> <li>• Error codes that are generated in data communication with external devices</li> <li>• End codes that are returned to external devices in SLMP communication</li> </ul>	Page 162, Section 9.5 (1)
0800 <sub>H</sub> to 2AC4 <sub>H</sub>	Error codes of the Ethernet adapter module	Page 167, Section 9.5 (2)
4000 <sub>H</sub> to 4FFF <sub>H</sub>	Error codes that are generated in other modules during transient transmission	Page 170, Section 9.5 (3)
7000 <sub>H</sub> to 7FFF <sub>H</sub>		
B000 <sub>H</sub> to BFFF <sub>H</sub>		
C000 <sub>H</sub> to CFFF <sub>H</sub>		
D000 <sub>H</sub> to DFFF <sub>H</sub>	Error codes of the CC-Link IE Field Network	Page 171, Section 9.5 (4)
E000 <sub>H</sub> to EFFF <sub>H</sub>	Error codes that are generated in other modules during transient transmission	Page 178, Section 9.5 (5)
F000 <sub>H</sub> to FFFF <sub>H</sub>		

## (1) Error code list (0000<sub>H</sub> to 07FF<sub>H</sub>)

The following describes the error messages, error conditions, causes and actions of the error codes (0000<sub>H</sub> to 07FF<sub>H</sub>).



If an error occurred, after taking action, clear the error.

For the Ethernet adapter module, use an SLMP command, Clear Error (command: 1617).

End code or error code	Error and cause	Action
0100 <sub>H</sub>	System error	Please consult your local Mitsubishi representative.
0101 <sub>H</sub> to 0103 <sub>H</sub>	Network module failure	<ul style="list-style-type: none"> <li>Malfunction may have occurred due to noise. Check the wire and cable distances and grounding condition of each device, and take measures against noise.</li> <li>Perform a unit test. If the same error is displayed again, the hardware of the Ethernet adapter module may be faulty. Please consult your local Mitsubishi representative.</li> </ul>
0104 <sub>H</sub>	Receive queue full	<ul style="list-style-type: none"> <li>Reduce the frequency of transient transmission and then retry the operation.</li> <li>Check if the cables and switching hub are connected properly.</li> </ul>
0105 <sub>H</sub>	Network module failure	<ul style="list-style-type: none"> <li>Malfunction may have occurred due to noise. Check the wire and cable distances and grounding condition of each device, and take measures against noise.</li> <li>Perform a unit test. If the same error is displayed again, the hardware of the Ethernet adapter module may be faulty. Please consult your local Mitsubishi representative.</li> </ul>
0106 <sub>H</sub> to 0109 <sub>H</sub>	Parameter error	Write the parameters again. If the same error is displayed again, please consult your local Mitsubishi representative.
010A <sub>H</sub>	Parameter check result error	
010B <sub>H</sub> to 010C <sub>H</sub>	System error	<ul style="list-style-type: none"> <li>Malfunction may have occurred due to noise. Check the wire and cable distances and grounding condition of each device, and take measures against noise.</li> <li>Perform a unit test. If the same error is displayed again, the hardware of the Ethernet adapter module may be faulty. Please consult your local Mitsubishi representative.</li> </ul>
010D <sub>H</sub>	Ethernet adapter module failure	Restart the Ethernet adapter module. If the same error is displayed again, please consult your local Mitsubishi representative.
010E <sub>H</sub>	Ethernet adapter module stop error	<ul style="list-style-type: none"> <li>Check the description in "CC-Link IE Field Network Error" in the "Ethernet Adapter Diagnostics" window of the configuration tool, and take action.</li> <li>Perform the CC-Link IE Field Network diagnostics from the master station, identify the error and take action.</li> <li>Write the parameters again. If the same error is displayed again, please consult your local Mitsubishi representative.</li> </ul>
0180 <sub>H</sub>	Sum check code error	Write the parameters again. If the same error is displayed again, please consult your local Mitsubishi representative.
0181 <sub>H</sub>	Start block code error	
0182 <sub>H</sub>	End block code error	
0183 <sub>H</sub>	Operation setting parameter error	
0184 <sub>H</sub>	Initial setting parameter error	
0185 <sub>H</sub>	Connection setting parameter error	
0186 <sub>H</sub>	Account setting parameter error	
0187 <sub>H</sub>	CC-Link IE Field Network gateway setting error	



End code or error code	Error and cause	Action
0188 <sub>H</sub>	No IP address distribution	An IP address is not distributed to the Ethernet adapter module (CC-Link IE Field Network part). Take the following actions to distribute an IP address. <ul style="list-style-type: none"> <li>• Set an IP address to the master station.</li> <li>• Use a master station that supports the IP packet transfer function.</li> </ul> <p>After taking the actions above, check that baton pass becomes enabled. Then execute the IP communication test again. The baton pass status can be checked using Baton pass status (own station) (SB0047, SW0047).</p>
0189 <sub>H</sub>	No CC-Link IE Field Network gateway setting	<ul style="list-style-type: none"> <li>• Check that the CC-Link IE Field Network gateway setting is configured and is correct in the Ethernet adapter module.</li> <li>• Check the IP address of the master station.</li> </ul> <p>Take the actions above then execute the IP communication test again.</p>
018A <sub>H</sub>	CC-Link IE Field Network gateway setting error	The own station cannot be set for "CC-Link IE Field Network Gateway Setting Station" and "CC-Link IE Field Network Default Gateway Setting Station" in the CC-Link IE Field Network gateway setting. Set the station where IP packets arrive last on the CC-Link IE Field Network. (☞ Page 191, Section 10.3.2 (1))
018B <sub>H</sub>	IP communication test communication target setting error	The connected station (own station) cannot be set for "Communication Target" in the IP communication test. Change the setting configured in "Communication Target".
018C <sub>H</sub>	IP address out of range (Ethernet part of the Ethernet adapter module on the own station)	<p>When the IP address of the Ethernet adapter module (Ethernet part) is the same as the network address of the master station, set the IP address of the Ethernet adapter module (Ethernet part) within the following range.</p> <ul style="list-style-type: none"> <li>• Third octet: 1 to 239</li> <li>• Fourth octet: 1 to 120</li> </ul> <p>Change the IP address of the CC-Link IE Field Network in the master station so that the IP address of the Ethernet adapter module (Ethernet part) may differ from the network address of the master station.</p>
018D <sub>H</sub>	IP address out of range (external device on the destination)	<p>When the IP address of the external device on the destination is the same as the network address of the master station, set the IP address of the external device within the following range.</p> <ul style="list-style-type: none"> <li>• Third octet: 1 to 239</li> <li>• Fourth octet: 1 to 120, 125</li> </ul> <p>Change the IP address of the CC-Link IE Field Network in the master station so that the IP address of the external device may differ from the network address of the master station.</p>
0200 <sub>H</sub>	UDP send error	<ul style="list-style-type: none"> <li>• Check and correct the status of the cable connection and line.</li> <li>• When using the on-demand function, check that the IP address of the destination is correct.</li> <li>• When using the on-demand function, check that the connection No. for users for UDP has not been selected in the protocol setting.</li> </ul>
0201 <sub>H</sub>	TCP send error	<ul style="list-style-type: none"> <li>• Check and correct the status of the cable connection and line.</li> <li>• When using the on-demand function, check the open status of the connection.</li> </ul>
0202 <sub>H</sub>	UDP receive error	Check and correct the status of the cable connection and line.
0203 <sub>H</sub>	TCP receive error	
0204 <sub>H</sub>	TCP receive wait error	
0205 <sub>H</sub>	Parameter error (An error in connection parameters)	
0206 <sub>H</sub>	Socket creation error	Restart the Ethernet adapter module. If the same error is displayed again, please consult your local Mitsubishi representative.
0207 <sub>H</sub>	Incorrect option setting for freeing the memory in closing	
0208 <sub>H</sub>	Incorrect option setting for port reuse	
0209 <sub>H</sub>	Socket naming error	
020A <sub>H</sub>	Socket control error	
020B <sub>H</sub>	Socket wait setting error	
020C <sub>H</sub>	Socket deletion error	
020D <sub>H</sub>	Connected socket deletion error	

End code or error code	Error and cause	Action
020E <sub>H</sub>	List full	<ul style="list-style-type: none"> <li>Reduce the frequency of SLMP or transient transmission and then retry the operation.</li> <li>When the mode of the master station is "Online (High Speed Mode)", change it to "Online (Normal Mode)" and retry the operation.</li> <li>Check if the cables and switching hub are connected properly.</li> </ul>
020F <sub>H</sub>	System error	Restart the Ethernet adapter module. If the same error is displayed again, please consult your local Mitsubishi representative.
0210 <sub>H</sub>	System error	
0211 <sub>H</sub>	System error	
0212 <sub>H</sub>	System error	
0280 <sub>H</sub> to 0282 <sub>H</sub>	System error	
		Please consult your local Mitsubishi representative.
0300 <sub>H</sub>	Send buffer full	<ul style="list-style-type: none"> <li>Reduce the frequency of SLMP or transient transmission and then retry the operation.</li> <li>When the mode of the master station is "Online (High Speed Mode)", change it to "Online (Normal Mode)" and retry the operation.</li> <li>Check if the cables and switching hub are connected properly.</li> </ul>
0301 <sub>H</sub>	Address specification error	Correct the specified read or write address at the SLMP or transient request source, and retry the operation.
0302 <sub>H</sub>	Network No. error	Confirm the network number at the SLMP or transient request source, and retry the operation.
0303 <sub>H</sub>	Target station No. error	<ul style="list-style-type: none"> <li>Correct the target station number at the transient request source, and retry the operation.</li> <li>Correct the station number at the SLMP request source, and retry the operation.</li> </ul>
0304 <sub>H</sub>	Network No. error	Confirm the network number at the SLMP or transient request source, and retry the operation.
0305 <sub>H</sub>	Incorrect number of relays	<ul style="list-style-type: none"> <li>Correct the system configuration to reduce the number of relay stations to seven or less.</li> <li>Check if the routing parameters are correctly set, and take corrective action.</li> </ul>
0306 <sub>H</sub>	Network No. error	Confirm the network number at the SLMP or transient request source, and retry the operation.
0307 <sub>H</sub>	Target station No. error	<ul style="list-style-type: none"> <li>Correct the target station number at the transient request source, and retry the operation.</li> <li>Correct the station number at the SLMP request source, and retry the operation.</li> </ul>
0308 <sub>H</sub>	Target station No. error	Correct the target station number at the transient request source, and retry the operation.
0309 <sub>H</sub>	Transmission completion timeout error	<ul style="list-style-type: none"> <li>If an error was detected, identify the cause of the error and take action.</li> <li>Reduce the frequency of SLMP or transient transmission and then retry the operation.</li> <li>Check if the Ethernet port side cable and the switching hub are connected properly.</li> </ul>
030A <sub>H</sub>	Header information error	Retry the transient transmission.
030B <sub>H</sub>	Target station No. error	<ul style="list-style-type: none"> <li>Check the command at the transient request source to see if it is available for all stations, and retry the operation.</li> <li>Do not use group specification when making a request to the Ethernet adapter module.</li> </ul>
030C <sub>H</sub>	System error	Please consult your local Mitsubishi representative.
030D <sub>H</sub>	Transmission failed	<ul style="list-style-type: none"> <li>Check if the cable on the Ethernet part and the switching hub are connected properly.</li> <li>Reduce the frequency of transient transmission and then retry the operation.</li> <li>Restart the Ethernet adapter module. If the same error is displayed again, please consult your local Mitsubishi representative.</li> </ul>
030E <sub>H</sub>	Request message error	Correct the request command at the SLMP or transient request source, and retry the operation.
030F <sub>H</sub>	Request message error	Retry the transient transmission.

End code or error code	Error and cause	Action
0310 <sub>H</sub>	Data length error	<ul style="list-style-type: none"> <li>• Correct the read or write data length.</li> <li>• When the read or write data length is too long, divide it into parts for a command request.</li> </ul>
0311 <sub>H</sub>	Request message error	Retry the transient transmission.
0312 <sub>H</sub>	Target station No. error	
0313 <sub>H</sub>	Target station No. error	Correct the request command at the transient request source, and retry the operation.
0314 <sub>H</sub>	System error	Please consult your local Mitsubishi representative.
0315 <sub>H</sub>	IP communication test in progress	Retry the IP communication test after a while. (Up to four IP communication tests can be concurrently executed.)
0316 <sub>H</sub>	IP communication test execution error (no response to Ping)	<ul style="list-style-type: none"> <li>• Check "Communication Target" in the "IP Communication Test" dialog box.</li> <li>• Check and correct the status of the cable connection and line between the CC-Link IE Field Network gateway setting station and the communication destination.</li> <li>• Enable a response to the Ping command (ICMP echo request) in the firewall settings on the external device or antivirus software.</li> </ul>
0380 <sub>H</sub>	Request source ID error	Restart the Ethernet adapter module. If the same error is displayed again, please consult your local Mitsubishi representative.
0381 <sub>H</sub>	Receive error	When the receiving station encountered overloading of transient data, send the data from the source after a given time has elapsed.
0382 <sub>H</sub>	Receive queue full	
0383 <sub>H</sub>	Send error	Reduce the frequency of transient transmission and then retry the operation.
0384 <sub>H</sub>	System error	Please consult your local Mitsubishi representative.
0400 <sub>H</sub>	ASCII conversion error	<ul style="list-style-type: none"> <li>• Set "Binary Code" in the configuration tool, and restart the Ethernet adapter module to start communication.</li> <li>• Correct the data sent from the external device.</li> <li>• Correct the setting for the subcommand.</li> <li>• Check the device settings.</li> </ul>
0401 <sub>H</sub>	Word device read/write size error	Correct the number of read or write points, and send the data to the Ethernet adapter module again.
0402 <sub>H</sub>	Bit device read/write size error	
0403 <sub>H</sub>	Random read/write bit device size error	
0404 <sub>H</sub>	Random read/write word device size error	
0405 <sub>H</sub>	File size error	Correct the number of read or write points (or bytes), and send the data to the Ethernet adapter module again.
0406 <sub>H</sub>	Address range error	Correct the start address or the number of read or write points, and send the data to the Ethernet adapter module. (Do not exceed the maximum address number.)
0407 <sub>H</sub>	Unsupported command	Check and correct the request data.
0408 <sub>H</sub>	Device name error	Correct the device, and read or write the device again.
0409 <sub>H</sub>	Unsupported device specified	
040A <sub>H</sub>	Device access type error	Correct the request data (e.g. the subcommand), and send them to the Ethernet adapter module again.
040B <sub>H</sub>	Unregistered monitoring	Register the monitoring data before start monitoring.
040C <sub>H</sub>	Response monitoring timer timeout	<ul style="list-style-type: none"> <li>• Increase the monitoring timer value.</li> <li>• Check if the Ethernet adapter module is operating properly.</li> <li>• Correct the network or station number.</li> <li>• If a station with another network number is set as the destination, correct the routing parameter value.</li> <li>• If a station with another network number is set as the destination, check the network number for duplication.</li> <li>• Confirm the IP address. (☞ Page 193, Section 10.3.3)</li> </ul>
040D <sub>H</sub>	ACK error	<ul style="list-style-type: none"> <li>• Correct the network or station number.</li> <li>• Correct the I/O number of the target module.</li> <li>• Correct the read or write request data.</li> </ul>
040E <sub>H</sub>	Request data error	Correct the request data, and send them to the Ethernet adapter module again.

End code or error code	Error and cause	Action
040F <sub>H</sub>	Online change of Q series remote I/O disabled	To write data to a remote I/O station by MC protocol (QnA compatible 3E frame or 4E frame), set the online change function to "Enable" in the operation setting.
0410 <sub>H</sub>	Data length error	Check and correct the text or the request data length in the Qn header, and send the data to the Ethernet adapter module again.
0411 <sub>H</sub>	Block size error	Correct the specified number of blocks.
0412 <sub>H</sub>	Bit device specification error	Correct the subcommand value.
0413 <sub>H</sub>	File name size error	Change the number of characters for the file name to 255 or less.
0414 <sub>H</sub>	Device No. error	Correct the specified device No. value.
0415 <sub>H</sub>	File name size error	Change the number of characters for the file name to 255 or less.
0416 <sub>H</sub>	Online change error	Stop the Ethernet adapter module and write the data.
0417 <sub>H</sub> to 041C <sub>H</sub>	System error	Please consult your local Mitsubishi representative.
0420 <sub>H</sub>	Connection No. error	Correct the connection No. set in the on-demand function.
0421 <sub>H</sub>	Frame setting format error	Correct the frame setting format set in the on-demand function.
0422 <sub>H</sub>	Communication data code specification error	Correct the communication data code specification set in the on-demand function.
0423 <sub>H</sub>	Destination IP address error	Correct the destination IP address set in the on-demand function.
0424 <sub>H</sub>	Destination port No. error	Correct the destination port No. set in the on-demand function.
0425 <sub>H</sub>	Send data format error	Correct the send data format used in the on-demand function.
0426 <sub>H</sub>	Send data length error	Correct the send data length used in the on-demand function.
0600 <sub>H</sub> to 0601 <sub>H</sub>	System error	Please consult your local Mitsubishi representative.
0640 <sub>H</sub> to 0645 <sub>H</sub>		
0680 <sub>H</sub> to 0688 <sub>H</sub>		
0700 <sub>H</sub> to 0702 <sub>H</sub>		
0703 <sub>H</sub> to 0704 <sub>H</sub>	System error	Restart the Ethernet adapter module. If the same error is displayed again, please consult your local Mitsubishi representative.
0710 <sub>H</sub> to 0711 <sub>H</sub>		

## (2) Error code list (0800<sub>H</sub> to 2AC4<sub>H</sub>)

The following lists the error messages, error conditions, causes, and actions of the error codes (0800<sub>H</sub> to 17FF<sub>H</sub>).

The "■Supplementary information" in the "Error and cause" column can be confirmed by any of the following.

- Common error information (SD5 to SD15)
- Individual error information (SD16 to SD26)

Error code	Error and cause	Action	LED status
0800 <sub>H</sub>	<b>[ADAPTER UNIT DOWN]</b>		
0801 <sub>H</sub>	The Ethernet adapter module is running away or faulty.		
0802 <sub>H</sub>	<ul style="list-style-type: none"> <li>• Malfunction due to noise</li> <li>• Hardware failure</li> </ul>	Take action against noise, and reset the module.	
0803 <sub>H</sub>	<b>■Supplementary information</b>	If this error occurs again, the hardware of the Ethernet adapter module may be faulty. Please consult your local Mitsubishi representative.	RUN: Flashing ERR.: On
0804 <sub>H</sub>	<ul style="list-style-type: none"> <li>• Common information: -</li> <li>• Individual information: -</li> </ul>		
0805 <sub>H</sub>	<b>■Diagnostic timing</b>		
0806 <sub>H</sub>	<ul style="list-style-type: none"> <li>• Any time</li> </ul>		
0809 <sub>H</sub>	<b>[ADAPTER UNIT DOWN]</b> The power supply part or the Ethernet adapter module is faulty. <b>■Supplementary information</b> <ul style="list-style-type: none"> <li>• Common information: -</li> <li>• Individual information: -</li> </ul> <b>■Diagnostic timing</b> <ul style="list-style-type: none"> <li>• Any time</li> </ul>	Reset the Ethernet adapter module. If the same error is displayed again, the Ethernet adapter module may be faulty. Please consult your local Mitsubishi representative.	RUN: Flashing ERR.: On
0823 <sub>H</sub>	<b>[ADAPTER UNIT DOWN]</b> The Ethernet adapter module is running away or faulty. <ul style="list-style-type: none"> <li>• Malfunction due to noise</li> <li>• Hardware failure</li> </ul> <b>■Supplementary information</b> <ul style="list-style-type: none"> <li>• Common information: -</li> <li>• Individual information: -</li> </ul> <b>■Diagnostic timing</b> <ul style="list-style-type: none"> <li>• Any time</li> </ul>	Take action against noise, and reset the module. If this error occurs again, the hardware of the Ethernet adapter module may be faulty. Please consult your local Mitsubishi representative.	RUN: Flashing ERR.: On
085A <sub>H</sub>	<b>[ADAPTER UNIT DOWN]</b> The Ethernet adapter module is running away or faulty. <ul style="list-style-type: none"> <li>• Malfunction due to noise</li> <li>• Hardware failure</li> </ul> <b>■Supplementary information</b> <ul style="list-style-type: none"> <li>• Common information: -</li> <li>• Individual information: Breakdown information</li> </ul> <b>■Diagnostic timing</b> <ul style="list-style-type: none"> <li>• Any time</li> </ul>		
0865 <sub>H</sub>	<b>[RAM ERROR]</b> The RAM built in the Ethernet adapter module is faulty.		
0866 <sub>H</sub>	<b>■Supplementary information</b>		
0867 <sub>H</sub>	<ul style="list-style-type: none"> <li>• Common information: -</li> <li>• Individual information: -</li> </ul>		
0868 <sub>H</sub>	<b>■Diagnostic timing</b> <ul style="list-style-type: none"> <li>• When powered on or reset</li> </ul>	Take action against noise, and reset the module. If this error occurs again, the hardware of the Ethernet adapter module may be faulty. Please consult your local Mitsubishi representative.	RUN: Flashing ERR.: On
08A1 <sub>H</sub>	<b>[RAM ERROR]</b> The data in the device memory built in the Ethernet adapter module were overwritten. <b>■Supplementary information</b> <ul style="list-style-type: none"> <li>• Common information: -</li> <li>• Individual information: -</li> </ul> <b>■Diagnostic timing</b> <ul style="list-style-type: none"> <li>• Any time</li> </ul>		

Error code	Error and cause	Action	LED status
0991 <sub>H</sub>	<p><b>[ADAPTER UNIT DOWN]</b></p> <ul style="list-style-type: none"> <li>The buffer memory size of the Ethernet part is abnormal.</li> <li>No response is returned from the Ethernet part.</li> </ul> <p>■ <b>Supplementary information</b></p> <ul style="list-style-type: none"> <li>Common information: -</li> <li>Individual information: -</li> </ul> <p>■ <b>Diagnostic timing</b></p> <ul style="list-style-type: none"> <li>When powered on or reset</li> </ul>	The hardware of the Ethernet adapter module may be faulty. Please consult your local Mitsubishi representative.	RUN: Flashing ERR.: On
0993 <sub>H</sub>	<p><b>[ADAPTER UNIT DOWN]</b></p> <ul style="list-style-type: none"> <li>No response is returned from the Ethernet part.</li> <li>Failure of the Ethernet part was detected.</li> </ul> <p>■ <b>Supplementary information</b></p> <ul style="list-style-type: none"> <li>Common information: -</li> <li>Individual information: -</li> </ul> <p>■ <b>Diagnostic timing</b></p> <ul style="list-style-type: none"> <li>Any time</li> </ul>		
09F4 <sub>H</sub>	<p><b>[DC DOWN]</b></p> <ul style="list-style-type: none"> <li>Momentary supply power failure occurred.</li> <li>The supply power turned off.</li> </ul> <p>■ <b>Supplementary information</b></p> <ul style="list-style-type: none"> <li>Common information: -</li> <li>Individual information: -</li> </ul> <p>■ <b>Diagnostic timing</b></p> <ul style="list-style-type: none"> <li>Any time</li> </ul>	Check the supply power.	RUN: On ERR.: Off
0A62 <sub>H</sub>	<p><b>[FLASH ROM ERROR]</b></p> <p>The number of writes to the parameter memory exceeded 100,000 times. (Number of writes &gt; 100,000)</p> <p>■ <b>Supplementary information</b></p> <ul style="list-style-type: none"> <li>Common information: -</li> <li>Individual information: -</li> </ul> <p>■ <b>Diagnostic timing</b></p> <ul style="list-style-type: none"> <li>When writing data to ROM</li> </ul>	Replace the Ethernet adapter module.	RUN: On ERR.: On
0ABC <sub>H</sub>	<p><b>[BUS TIMEOUT ERR.]</b></p> <p>Failure of the system bus was detected.</p> <ul style="list-style-type: none"> <li>Self-diagnostic error of the system bus</li> <li>Self-diagnostic error of the Ethernet adapter module</li> </ul> <p>■ <b>Supplementary information</b></p> <ul style="list-style-type: none"> <li>Common information: -</li> <li>Individual information: -</li> </ul> <p>■ <b>Diagnostic timing</b></p> <ul style="list-style-type: none"> <li>Any time</li> </ul>	Reset the Ethernet adapter module. If this error occurs again, the hardware of the Ethernet adapter module may be faulty. Please consult your local Mitsubishi representative.	RUN: Flashing ERR.: On
0AC6 <sub>H</sub>	<p><b>[UNIT BUS ERROR]</b></p> <p>Failure of the system bus was detected.</p> <p>■ <b>Supplementary information</b></p> <ul style="list-style-type: none"> <li>Common information: -</li> <li>Individual information: -</li> </ul> <p>■ <b>Diagnostic timing</b></p> <ul style="list-style-type: none"> <li>Any time</li> </ul>		
0ADA <sub>H</sub>	<p><b>[SYSTEM RST ERR.]</b></p> <p>Failure of the system bus was detected.</p> <p>■ <b>Supplementary information</b></p> <ul style="list-style-type: none"> <li>Common information: -</li> <li>Individual information: -</li> </ul> <p>■ <b>Diagnostic timing</b></p> <ul style="list-style-type: none"> <li>When powered on or reset</li> </ul>	Reset the Ethernet adapter module. If this error occurs again, the hardware of the Ethernet adapter module may be faulty. Please consult your local Mitsubishi representative.	RUN: Flashing ERR.: On
0C10 <sub>H</sub>	<p><b>[UNIT HW ERROR]</b></p> <p>Hardware failure was detected.</p> <p>■ <b>Supplementary information</b></p> <ul style="list-style-type: none"> <li>Common information: -</li> <li>Individual information: -</li> </ul> <p>■ <b>Diagnostic timing</b></p> <ul style="list-style-type: none"> <li>Any time</li> </ul>	Reset the Ethernet adapter module. If this error occurs again, the hardware of the Ethernet adapter module may be faulty. Please consult your local Mitsubishi representative.	RUN: Flashing ERR.: On

Error code	Error and cause	Action	LED status
0C65 <sub>H</sub>	<p><b>[SP.UNIT LAY ERR.]</b> Hardware failure inside the Ethernet adapter module was detected.</p> <p>■ <b>Supplementary information</b></p> <ul style="list-style-type: none"> <li>• Common information: Module No. (slot No.)</li> <li>• Individual information: -</li> </ul> <p>■ <b>Diagnostic timing</b></p> <ul style="list-style-type: none"> <li>• When powered on or reset</li> </ul>	The hardware of the Ethernet adapter module may be faulty. Please consult your local Mitsubishi representative.	RUN: Flashing ERR.: On
0C92 <sub>H</sub>	<p><b>[SYSTEM LAY ERR.]</b> Hardware failure inside the Ethernet adapter module was detected.</p> <p>■ <b>Supplementary information</b></p> <ul style="list-style-type: none"> <li>• Common information: -</li> <li>• Individual information: -</li> </ul> <p>■ <b>Diagnostic timing</b></p> <ul style="list-style-type: none"> <li>• When powered on or reset</li> </ul>	The hardware of the Ethernet adapter module may be faulty. Please consult your local Mitsubishi representative.	RUN: Flashing ERR.: On
0FD1 <sub>H</sub>	<p><b>[PARAMETER ERROR]</b> Parameters are corrupted.</p> <p>■ <b>Supplementary information</b></p> <ul style="list-style-type: none"> <li>• Common information: File name</li> <li>• Individual information: Parameter No.</li> </ul> <p>■ <b>Diagnostic timing</b></p> <ul style="list-style-type: none"> <li>• When powered on or reset, or when parameters are written</li> </ul>	Write the parameters to the Ethernet adapter module again. If the same error is displayed again, the memory in the Ethernet adapter module is in failure. Please consult your local Mitsubishi representative.	RUN: Flashing ERR.: On
0FD4 <sub>H</sub>	<p><b>[PARAMETER ERROR]</b> The parameter file is incorrect. Or, the contents of the file are not parameters.</p> <p>■ <b>Supplementary information</b></p> <ul style="list-style-type: none"> <li>• Common information: File name</li> <li>• Individual information: Parameter No.</li> </ul> <p>■ <b>Diagnostic timing</b></p> <ul style="list-style-type: none"> <li>• When powered on or reset, or when parameters are written</li> </ul>	Check if the type of the parameter file is shown as "****.QPA" and if the file contains parameters.	RUN: Flashing ERR.: On
1038 <sub>H</sub>	<p><b>[LINK PARA. ERROR]</b> The network No. of the CC-Link IE Field Network is the same as the third octet value of the IP address. Or, parameters are corrupted.</p> <p>■ <b>Supplementary information</b></p> <ul style="list-style-type: none"> <li>• Common information: File name</li> <li>• Individual information: Parameter No.</li> </ul> <p>■ <b>Diagnostic timing</b></p> <ul style="list-style-type: none"> <li>• When powered on or reset</li> </ul>	Correct the parameters and write them to the Ethernet adapter module again. If this error occurs again, the hardware of the Ethernet adapter module may be faulty. Please consult your local Mitsubishi representative.	RUN: Flashing ERR.: On
17A0 <sub>H</sub>	<p><b>[WDT ERROR]</b> The watchdog timer timed out.</p> <p>■ <b>Supplementary information</b></p> <ul style="list-style-type: none"> <li>• Common information: Time (200ms)</li> <li>• Individual information: Time (value actually measured)</li> </ul>	Take measures on the power supply system to prevent momentary power failure, and reset the module. If this error occurs again, the hardware of the Ethernet adapter module may be faulty. Please consult your local Mitsubishi representative.	RUN: Off ERR.: On
17A1 <sub>H</sub>	<p>■ <b>Diagnostic timing</b></p> <ul style="list-style-type: none"> <li>• Any time</li> </ul>		
2AC4 <sub>H</sub>	<p><b>[NETWORK ERROR]</b> A CC-Link IE Field Network error has occurred.</p> <p>■ <b>Supplementary information</b></p> <ul style="list-style-type: none"> <li>• Common information: -</li> <li>• Individual information: -</li> </ul> <p>■ <b>Diagnostic timing</b></p> <ul style="list-style-type: none"> <li>• Any time</li> </ul>	<ul style="list-style-type: none"> <li>• Perform the CC-Link IE Field Network diagnostics from the master station to check the network status. Then take action to correct the problem.</li> <li>• Check the network's error code of the error that occurred at the same time using the error history of the CC-Link IE Field Network diagnostics from the master station.</li> </ul>	RUN: On ERR.: On

### (3) Error code list (4000<sub>H</sub> to 4FFF<sub>H</sub>, 7000<sub>H</sub> to 7FFF<sub>H</sub>, and B000<sub>H</sub> to CFFF<sub>H</sub>)

The following lists the error messages, error conditions, causes, and actions of the error codes (4000<sub>H</sub> to 4FFF<sub>H</sub>, 7000<sub>H</sub> to 7FFF<sub>H</sub>, and B000<sub>H</sub> to CFFF<sub>H</sub>).

Error code	Error	Action
4000 <sub>H</sub> to 4FFF <sub>H</sub>	Errors that may be detected by a CPU module	Refer to the User's Manual (Hardware Design, Maintenance and Inspection) for the CPU module used.
7000 <sub>H</sub> to 7FFF <sub>H</sub>	Errors that may be detected by a serial communication module	Refer to the user's manual of the serial communication module used.
B000 <sub>H</sub> to BFFF <sub>H</sub>	Errors that may be detected by a CC-Link module	Refer to the user's manual of the CC-Link system master/local module used.
C000 <sub>H</sub> to CFFF <sub>H</sub>	Errors that may be detected by an Ethernet module	Refer to the user's manual of the Ethernet interface module used.



**(4) Error code list (D000<sub>H</sub> to DFFF<sub>H</sub>)**

The following lists the error messages, error conditions, causes, and actions of the error codes (D000<sub>H</sub> to DFFF<sub>H</sub>).

Error code	Error	Action
D038 <sub>H</sub>	No corresponding station (IP communication test)	If the own station, target station, or relay station is disconnected from the network, identify the cause of the disconnection and take action.
D039 <sub>H</sub>	IP packet transfer function not supported (IP communication test)	Check the first five digits of the serial number of the module on the station on the route next to the faulty station. If the module does not support the used function, replace it with the module with the latest version.
D0A0 <sub>H</sub>	Transient data transmission response wait timeout	<ul style="list-style-type: none"> <li>• If the originating station or the target station is disconnected from the network, identify the cause of the disconnection and take action.</li> <li>• When the mode of the master station is "Online (High Speed Mode)", change it to "Online (Normal Mode)" and retry the operation.</li> <li>• When the receiving station encountered overloading of transient data, reduce the frequency of transient transmission and then retry the operation.</li> </ul>
D0A1 <sub>H</sub>	Transient data transmission completion wait timeout	<ul style="list-style-type: none"> <li>• Check if the cables and switching hub are connected properly.</li> <li>• Exchange the cables between PORT1 and PORT2 and retry the operation.</li> <li>• Reduce the frequency of transient transmission and then retry the operation.</li> <li>• Perform a unit test on the Ethernet adapter module. If the failure occurs again, the hardware of the Ethernet adapter module may be faulty. Please consult your local Mitsubishi representative.</li> </ul>
D0A2 <sub>H</sub>	Transient data transmission processing wait timeout	<ul style="list-style-type: none"> <li>• Reduce the frequency of transient transmission and then retry the operation.</li> <li>• Check if the cable of the request source and the switching hub are connected properly.</li> </ul>
D0A3 <sub>H</sub>	Transient data transmission error	<ul style="list-style-type: none"> <li>• If the originating station or the target station is disconnected from the network, identify the cause of the disconnection and take action.</li> <li>• Correct the target station number of the transient data, and retry the operation.</li> </ul>
D0A4 <sub>H</sub> to D0A6 <sub>H</sub>	Transient transmission failed	<ul style="list-style-type: none"> <li>• Check if the cables and the switching hub are connected properly.</li> <li>• Exchange the cables between PORT1 and PORT2 and retry the operation.</li> <li>• Reduce the frequency of transient transmission and then retry the operation.</li> </ul>
D0A7 <sub>H</sub>	Transient reception failed	<ul style="list-style-type: none"> <li>• Perform a unit test on the Ethernet adapter module. If the failure occurs again, the hardware of the Ethernet adapter module may be faulty. Please consult your local Mitsubishi representative.</li> </ul>
D0E0 <sub>H</sub>	Station type mismatch	In Network Configuration Setting of the master station, change the station type of the Ethernet adapter module to intelligent device station.
D0E1 <sub>H</sub>	Own station specified as reserved	<ul style="list-style-type: none"> <li>• In Network Configuration Setting of the master station, cancel the reserved station setting.</li> <li>• Change the station number of the Ethernet adapter module to a station number that is not reserved.</li> </ul>
D0E2 <sub>H</sub>	Station No. duplication (own station)	<ul style="list-style-type: none"> <li>• Change the station number so that it will not duplicated with any other station number.</li> <li>• After taking the above action, power off and then on all of the stations that detected the station number duplication error, or reset them.</li> </ul>
D0E3 <sub>H</sub>	Own station No. out of range	Add station information of the Ethernet adapter module to Network Configuration Setting of the master station.

Error code	Error	Action
D200 <sub>H</sub>	Double transient data received	<ul style="list-style-type: none"> <li>From the master station, check the network condition by CC-Link IE Field Network diagnostics of GX Works2, and take action.</li> <li>Check if the cables and the switching hub are connected properly.</li> <li>If the request source resides in another network, check if the routing parameters are correctly set, and take corrective action.</li> </ul>
D201 <sub>H</sub>	Header information error in transient data	Correct the header information at the transient request source, and retry the operation.
D202 <sub>H</sub>	Send buffer full	<ul style="list-style-type: none"> <li>Reduce the frequency of transient transmission and then retry the operation.</li> <li>When the mode of the master station is "Online (High Speed Mode)", change it to "Online (Normal Mode)" and retry the operation.</li> <li>Check if the cables and switching hub are connected properly.</li> </ul>
D203 <sub>H</sub>	Read/write address error in transient data	Correct the read or write address at the transient request source, and retry the operation.
D204 <sub>H</sub>	Network No. error in transient data	<ul style="list-style-type: none"> <li>Check and correct the network number at the transient request source, and retry the operation.</li> <li>If the request source resides in another network, check if the routing parameters are correctly set, and take corrective action.</li> </ul>
D205 <sub>H</sub>	Target station No. error in transient data	Correct the target station number at the transient request source, and retry the operation.
D206 <sub>H</sub>	Network No. error in transient data	<ul style="list-style-type: none"> <li>Check and correct the network number at the transient request source, and retry the operation.</li> <li>If the request source resides in another network, check if the routing parameters are correctly set, and take corrective action.</li> </ul>
D207 <sub>H</sub>	Incorrect number of relays specified in transient data	<ul style="list-style-type: none"> <li>Correct the system configuration to reduce the number of relay stations to seven or less.</li> <li>Check if the routing parameters are correctly set, and take corrective action.</li> </ul>
D208 <sub>H</sub>	Network No. error in transient data	<ul style="list-style-type: none"> <li>Check and correct the network number at the transient request source, and retry the operation.</li> <li>If the request source resides in another network, check if the routing parameters are correctly set, and take corrective action.</li> </ul>
D209 <sub>H</sub> to D20A <sub>H</sub>	Target station No. error in transient data	Check and correct the target station number at the transient request source, and retry the operation.
D20B <sub>H</sub>	Specified master station No. error in transient data	
D20C <sub>H</sub>	Current master station No. error in transient data	
D20D <sub>H</sub>	Transient data transmission completion wait timeout	<ul style="list-style-type: none"> <li>From the master station, check the network condition by CC-Link IE Field Network diagnostics of GX Works2, and take action.</li> <li>If the originating or target station has detected an error, identify the cause of the error and take action.</li> <li>Reduce the frequency of transient transmission and then retry the operation.</li> <li>When the mode of the master station is "Online (High Speed Mode)", change it to "Online (Normal Mode)" and retry the operation.</li> <li>Check if the cable of the request source and the switching hub are connected properly.</li> </ul>
D20E <sub>H</sub>	Header information error in transient data	Correct the header information at the transient request source, and retry the operation.
D20F <sub>H</sub>	Target station No. error in transient data	Check the command at the transient request source to see if it is available for all stations or a group, and retry the operation.
D210 <sub>H</sub>	Target station No. error in transient data	Correct the header information at the transient request source, and retry the operation.

Error code	Error	Action
D211 <sub>H</sub>	Own station No. undefined (dedicated instruction)	Set the station number in the parameter setting, and retry the operation.
D212 <sub>H</sub>	Transient transmission failed	<ul style="list-style-type: none"> <li>• Check if the cable of the request source and the switching hub are connected properly.</li> <li>• Exchange the cables between PORT1 and PORT2 and retry the operation.</li> <li>• Reduce the frequency of transient transmission and then retry the operation.</li> </ul>
D213 <sub>H</sub>	Transient data request error	Correct the request command at the transient request source, and retry the operation.
D214 <sub>H</sub>	Transient data request error	Correct the data size at the transient request source, and retry the operation.
D216 <sub>H</sub> to D217 <sub>H</sub>	Transient data request error	Correct the request command at the transient request source, and retry the operation.
D218 <sub>H</sub>	Transient data request error	Correct the size of the device read/write data at the transient request source, and retry the operation.
D219 <sub>H</sub>	Transient data request error	Correct the attribute code at the transient request source, and retry the operation.
D21A <sub>H</sub>	Transient data request error	Correct the access code at the transient request source, and retry the operation.
D21B <sub>H</sub> to D21C <sub>H</sub>	Ethernet adapter module request error	<ul style="list-style-type: none"> <li>• Malfunction may have occurred due to noise. Check the wire and cable distances and grounding condition of each device, and take measures against noise.</li> <li>• Perform a unit test on the Ethernet adapter module. If the failure occurs again, the hardware of the Ethernet adapter module may be faulty. Please consult your local Mitsubishi representative.</li> </ul>
D21D <sub>H</sub>	Network No. error in transient data	Transient data that are not executable for different networks were received. Correct the network number or the target station number at the transient request source, and retry the operation.
D21E <sub>H</sub>	Target station No. error in transient data	The received transient data of the application type cannot be handled by the own station. Correct the application type or the target station number at the transient request source, and retry the operation.
D21F <sub>H</sub>	Target station type error (dedicated instruction)	The SEND instruction is not executable for the Ethernet adapter module. Modify the master and local station programs so that the SEND instruction will not be used.
D222 <sub>H</sub>	Transient data request error	Correct the request command at the transient request source, and retry the operation.
D236 <sub>H</sub>	IP data TTL error	Correct the TTL at the IP request source and retry the operation.
D237 <sub>H</sub>	IP address setting error	Correct the IP address of the master station (submaster station) and retry the operation.
D247 <sub>H</sub>	Double dedicated instructions received	<ul style="list-style-type: none"> <li>• From the master station, check the network condition by CC-Link IE Field Network diagnostics of GX Works2, and take action.</li> <li>• Check if the cable of the request source and the switching hub are connected properly.</li> <li>• If the request source resides in another network, check if the routing parameters are correctly set, and take corrective action.</li> </ul>
D280 <sub>H</sub>	Transient data request error	Correct the request command at the transient request source, and retry the operation.
D281 <sub>H</sub>	Transient reception failed	<ul style="list-style-type: none"> <li>• From the master station, check the network condition by CC-Link IE Field Network diagnostics of GX Works2, and take action.</li> <li>• When the receiving station encountered overloading of transient data, send the data from the source after a given time has elapsed.</li> </ul>

Error code	Error	Action
D282 <sub>H</sub>	Receive queue full	<ul style="list-style-type: none"> <li>From the master station, check the network condition by CC-Link IE Field Network diagnostics of GX Works2, and take action.</li> <li>When the receiving station encountered overloading of transient data, send the data from the source after a given time has elapsed.</li> </ul>
D283 <sub>H</sub>	Transient transmission failed	<ul style="list-style-type: none"> <li>From the master station, check the network condition by CC-Link IE Field Network diagnostics of GX Works2, and take action.</li> <li>Exchange the cables between PORT1 and PORT2 at the request source and retry the operation.</li> <li>Reduce the frequency of transient transmission and then retry the operation.</li> </ul>
D2A0 <sub>H</sub>	Receive buffer full	<ul style="list-style-type: none"> <li>From the master station, check the network condition by CC-Link IE Field Network diagnostics of GX Works2, and take action.</li> <li>When the receiving station encountered overloading of transient data, send the data from the source after a given time has elapsed.</li> </ul>
D2A1 <sub>H</sub>	Send buffer full	<ul style="list-style-type: none"> <li>Reduce the frequency of transient transmission and then retry the operation.</li> <li>Check if the cable of the request source and the switching hub are connected properly.</li> </ul>
D2A2 <sub>H</sub>	Transmission completion wait timer timeout	<ul style="list-style-type: none"> <li>Reduce the frequency of transient transmission and then retry the operation.</li> <li>Check if the cable of the request source and the switching hub are connected properly.</li> </ul>
D2A3 <sub>H</sub>	Data length error in transient data	Correct the data size (frame length) at the transient request source, and retry the operation.
D2A4 <sub>H</sub>	Header information error in transient data	Correct the header information at the transient request source, and retry the operation.
D2A5 <sub>H</sub>	Target station No. error in transient data	Correct the target station number at the transient request source, and retry the operation.
D2A6 <sub>H</sub>	Transient data request source No. error	Correct the request source number at the transient request source, and retry the operation.
D2A7 <sub>H</sub> to D2A8 <sub>H</sub>	Header information error in transient data	Correct the header information at the transient request source, and retry the operation.
D2A9 <sub>H</sub>	Target network No. error in transient data	Correct the target network number at the transient request source, and retry the operation.
D2AA <sub>H</sub>	Target station No. error in transient data	Correct the target station number at the transient request source, and retry the operation.
D2AB <sub>H</sub>	Network No. error in transient data	Correct the request source network number at the transient request station, and retry the operation.
D2AC <sub>H</sub>	Transient data request source No. error	Correct the request source station number at the transient request station, and retry the operation.
D2AD <sub>H</sub>	Data length error in transient data	Correct the data size (frame length) at the transient request station, and retry the operation.
D2AE <sub>H</sub>	Target station No. error in transient data	<ul style="list-style-type: none"> <li>The Ethernet adapter module received transient data addressed to a different network. Check the network and target station numbers, and retry the operation.</li> <li>Check if the routing parameters are correctly set.</li> </ul>
D2AF <sub>H</sub>	Target station No. error in transient data	<ul style="list-style-type: none"> <li>Transient data addressed to the own station were sent. Check the network and target station numbers, and retry the operation.</li> <li>Check if the routing parameters are correctly set.</li> </ul>

Error code	Error	Action
D2B0 <sub>H</sub>	Transient transmission failed	<ul style="list-style-type: none"> <li>• Check if the cable of the request source and the switching hub are connected properly.</li> <li>• Exchange the cables between PORT1 and PORT2 at the request source and retry the operation.</li> <li>• Reduce the frequency of transient transmission and then retry the operation.</li> </ul>
D2E0 <sub>H</sub>	IP communication test in progress	Retry the IP communication test after a while. (Up to four IP communication tests can be concurrently executed.)
D2E1 <sub>H</sub>	IP communication test execution error (no response to Ping)	<ul style="list-style-type: none"> <li>• Check "Communication Target" in the "IP Communication Test" dialog box.</li> <li>• Check and correct the status of the cable connection and line between the CC-Link IE Field Network gateway setting station and the communication destination.</li> <li>• Enable a response to the Ping command (ICMP echo request) in the firewall settings on the external device or antivirus software.</li> </ul>
D2E2 <sub>H</sub>	No IP address distribution	<p>An IP address is not distributed to the destination Ethernet adapter module (CC-Link IE Field Network part). Take the following actions to distribute an IP address.</p> <ul style="list-style-type: none"> <li>• Set an IP address to the master station.</li> <li>• Use a master station that supports the IP packet transfer function.</li> </ul> <p>After taking the actions above, check that baton pass becomes enabled. Then execute the IP communication test again. The baton pass status can be checked using Baton pass status (own station) (SB0047, SW0047).</p>
D2E3 <sub>H</sub>	No CC-Link IE Field Network gateway setting	<ul style="list-style-type: none"> <li>• Check that the CC-Link IE Field Network gateway setting is configured and is correct in the destination Ethernet adapter module.</li> <li>• Check the IP address of the master station.</li> </ul> <p>Take the actions above then execute the IP communication test again.</p>
D2E4 <sub>H</sub>	IP address out of range (Ethernet part of the destination Ethernet adapter module)	<p>When the IP address of the destination Ethernet adapter module (Ethernet part) is the same as the network address of the master station, set the IP address within the following range.</p> <ul style="list-style-type: none"> <li>• Third octet: 1 to 239</li> <li>• Fourth octet: 1 to 120</li> </ul> <p>Change the IP address of the CC-Link IE Field Network in the master station so that the IP address of the Ethernet adapter module (Ethernet part) may differ from the network address of the master station.</p>
D501 <sub>H</sub>	Communication LSI failure	<ul style="list-style-type: none"> <li>• Malfunction may have occurred due to noise. Check the wire and cable distances and grounding condition of each device, and take measures against noise.</li> <li>• Perform a unit test on the Ethernet adapter module. If the failure occurs again, the hardware of the Ethernet adapter module may be faulty. Please consult your local Mitsubishi representative.</li> </ul>
D502 <sub>H</sub>	MAC address error	<ul style="list-style-type: none"> <li>• Malfunction may have occurred due to noise. Check the wire and cable distances and grounding condition of each device, and take measures against noise.</li> <li>• Perform a unit test on the Ethernet adapter module. If the failure occurs again, the hardware of the Ethernet adapter module may be faulty. Please consult your local Mitsubishi representative.</li> </ul>
D529 <sub>H</sub> to D52A <sub>H</sub>	RAM failure	<ul style="list-style-type: none"> <li>• Malfunction may have occurred due to noise. Check the wire and cable distances and grounding condition of each device, and take measures against noise.</li> <li>• Perform a unit test on the Ethernet adapter module. If the failure occurs again, the hardware of the Ethernet adapter module may be faulty. Please consult your local Mitsubishi representative.</li> </ul>

Error code	Error	Action
D52B <sub>H</sub> to D52C <sub>H</sub>	Communication LSI failure	<ul style="list-style-type: none"> <li>• Malfunction may have occurred due to noise. Check the wire and cable distances and grounding condition of each device, and take measures against noise.</li> <li>• Perform a unit test on the Ethernet adapter module. If the failure occurs again, the hardware of the Ethernet adapter module may be faulty. Please consult your local Mitsubishi representative.</li> </ul>
D62D <sub>H</sub>	Failed to start data link	<p>The system failed to start data link due to any of the following causes. Remove the cause of the problem, and retry the operation.</p> <ul style="list-style-type: none"> <li>• No station number setting</li> <li>• Ethernet adapter module failure</li> <li>• Master station duplication</li> <li>• Station type mismatch</li> <li>• Master station lost</li> <li>• Invalid station number of the own station</li> <li>• Duplication of the own station number</li> <li>• Own station specified as reserved station</li> <li>• Parameter error</li> <li>• Parameters being sent</li> <li>• Parameters not received (master station only: no slave stations exist.)</li> <li>• Link stop instruction</li> </ul>
D62E <sub>H</sub>	Master station lost	Communication with the master station was lost. Check the wiring for cable disconnection.
D721 <sub>H</sub>	Link start/stop retry error (to another station)	<ul style="list-style-type: none"> <li>• Link stop is not available because cyclic transmission has been stopped.</li> <li>• Link start is not available because cyclic transmission is in execution.</li> </ul>
D722 <sub>H</sub>	Link start/stop retry error (to own station)	<ul style="list-style-type: none"> <li>• Link stop is not available because cyclic transmission has been stopped.</li> <li>• Link start is not available because cyclic transmission is in execution.</li> </ul>
D725 <sub>H</sub>	Station type error (station executing data link start/stop to the entire system)	The Ethernet adapter module cannot execute link start/stop of all or multiple stations. Execute link start/stop of all or multiple stations from the master station.
D726 <sub>H</sub>	Transient data request error	Correct the request command at the transient request station, and retry the operation.
D727 <sub>H</sub>	Data link start/stop instructing station error	<ul style="list-style-type: none"> <li>• Link start was instructed from a station different from the station that instructed the link stop. The station instructing a link start must be the same as the station that instructed the link stop.</li> <li>• The method of the link start (data link start instruction in CC-Link IE Field Network diagnostics or by using the link special relay (SB) or link special register (SW) in the program) is different from that of the link stop. Instruct the link start by the same method as used for the link stop instruction.</li> <li>• Link start has failed in the past. Force the system to restart data link.</li> </ul>
D728 <sub>H</sub>	Data link start/stop instructing station error	Link start was instructed during execution of data link. Instruct link start after instruction of link stop.
D729 <sub>H</sub>	Station No. or network No. not set	Set the station or network number and write the parameters from the configuration tool.
D72A <sub>H</sub>	Out-of-range station No.	By online operation of the master station, change the network or station number of the Ethernet adapter module to a value within the following range. Network No.: 1 to 239 Station No.: 1 to 120
D783 <sub>H</sub> to D784 <sub>H</sub>	Transient data request error	Check the read request data at the transient request station, and retry the operation.
D800 <sub>H</sub>	Ethernet adapter module failure	<ul style="list-style-type: none"> <li>• Malfunction may have occurred due to noise. Check the wire and cable distances and grounding condition of each device, and take measures against noise.</li> <li>• Perform a unit test on the Ethernet adapter module. If the failure occurs again, the hardware of the Ethernet adapter module may be faulty. Please consult your local Mitsubishi representative.</li> </ul>

Error code	Error	Action
D806 <sub>H</sub>	Receive queue full	<ul style="list-style-type: none"> <li>Reduce the frequency of transient transmission and then retry the operation.</li> <li>Check if the cables and the switching hub are connected properly.</li> </ul>
D814 <sub>H</sub>	Ethernet adapter module failure	<ul style="list-style-type: none"> <li>Malfunction may have occurred due to noise. Check the wire and cable distances and grounding condition of each device, and take measures against noise.</li> <li>Perform a unit test on the Ethernet adapter module. If the failure occurs again, the hardware of the Ethernet adapter module may be faulty. Please consult your local Mitsubishi representative.</li> </ul>
D816 <sub>H</sub>	Ethernet adapter module failure	<ul style="list-style-type: none"> <li>Malfunction may have occurred due to noise. Check the wire and cable distances and grounding condition of each device, and take measures against noise.</li> <li>Perform a unit test on the Ethernet adapter module. If the failure occurs again, the hardware of the Ethernet adapter module may be faulty. Please consult your local Mitsubishi representative.</li> </ul>
D81A <sub>H</sub>	Ethernet adapter module stop error	Check the error in the Ethernet Adapter Diagnostics of the configuration tool for the Ethernet adapter module, and take corrective action. From the master station, check the network condition by CC-Link IE Field Network diagnostics of GX Works2, and take action.
D827 <sub>H</sub>	Communication RAM failure	<ul style="list-style-type: none"> <li>Malfunction may have occurred due to noise. Check the wire and cable distances and grounding condition of each device, and take measures against noise.</li> <li>Perform a unit test on the Ethernet adapter module. If the failure occurs again, the hardware of the Ethernet adapter module may be faulty. Please consult your local Mitsubishi representative.</li> </ul>
D82E <sub>H</sub>	IP packet transfer function not supported (IP communication test)	Check the first five digits of the serial number of the CPU module. If the module does not support the used function, replace it with the CPU module with the latest version.
D902 <sub>H</sub>	Incorrect online test data	<ul style="list-style-type: none"> <li>Check the data at the station that initiated the online test, and retry the test.</li> <li>If this error persists, please consult your local Mitsubishi representative.</li> </ul>
D903 <sub>H</sub>	Communication test retry error	After completion of the communication test, retry it.
D905 <sub>H</sub>	Communication monitoring time in communication test timed out	<ul style="list-style-type: none"> <li>Check the network condition by CC-Link IE Field Network diagnostics, take action, and retry the operation.</li> <li>Check if the routing parameters are correctly set.</li> </ul>
D906 <sub>H</sub>	Transmission completion wait time in communication test timed out	<ul style="list-style-type: none"> <li>Check the network condition by CC-Link IE Field Network diagnostics, take action, and retry the operation.</li> <li>Check if the routing parameters are correctly set.</li> </ul>
D909 <sub>H</sub>	Header information error in transient data	Correct the header information at the transient request source, and retry the operation.
D90A <sub>H</sub>	Double communication test data received	After completion of the communication test, retry it.
D90B <sub>H</sub>	Incorrect number of stations	<ul style="list-style-type: none"> <li>Check the network condition by CC-Link IE Field Network diagnostics of GX Works2, and take action.</li> <li>If the number of slave stations per network is more than 120, reduce it to 120 or less.</li> </ul>
D90C <sub>H</sub>	Communication test target station specification error	Check "Communication Destination Setting" of the communication test, and retry the operation.
D90D <sub>H</sub>	Cable test retry error	After completion of the cable test, retry it.
D90E <sub>H</sub>	IP packet transfer function not supported	The transfer destination of the IP data does not support the IP packet transfer function.
D90F <sub>H</sub>	IP communication test in progress	Retry the operation after a while.
D910 <sub>H</sub>	IP address not set (own station)	Check the destination IP address of the IP communication test.

Error code	Error	Action
D911 <sub>H</sub>	Destination IP address error	Check the destination IP address of the IP communication test.
DA00 <sub>H</sub> to DA01 <sub>H</sub>	Ethernet adapter module failure	<ul style="list-style-type: none"> <li>Malfunction may have occurred due to noise. Check the wire and cable distances and grounding condition of each device, and take measures against noise.</li> <li>Perform a unit test on the Ethernet adapter module. If the failure occurs again, the hardware of the Ethernet adapter module may be faulty. Please consult your local Mitsubishi representative.</li> </ul>
DA10 <sub>H</sub> to DA18 <sub>H</sub>	Ethernet adapter module failure	<ul style="list-style-type: none"> <li>Malfunction may have occurred due to noise. Check the wire and cable distances and grounding condition of each device, and take measures against noise.</li> <li>Perform a unit test on the Ethernet adapter module. If the failure occurs again, the hardware of the Ethernet adapter module may be faulty. Please consult your local Mitsubishi representative.</li> </ul>
DAF2 <sub>H</sub>	Failed to write to flash ROM	<ul style="list-style-type: none"> <li>If the number of times that data were written to the flash ROM exceeded 100,000, set the system not to hold the error history by power-off/reset in "PLC System" in the parameter setting.</li> <li>Check the wire and cable distances and grounding condition of each device, and take measures against noise.</li> <li>Perform a unit test on the Ethernet adapter module. If the failure occurs again, the hardware of the Ethernet adapter module may be faulty. Please consult your local Mitsubishi representative.</li> </ul>
DAF3 <sub>H</sub>	MAC address read error	<ul style="list-style-type: none"> <li>The RAM may malfunction due to noise. Check the wire and cable distances and grounding condition of each device, and take measures against noise.</li> <li>Perform a unit test on the Ethernet adapter module. If the failure occurs again, the hardware of the Ethernet adapter module may be faulty. Please consult your local Mitsubishi representative.</li> </ul>

### (5) Error code list (E000<sub>H</sub> to FFFF<sub>H</sub>)

The following lists the error messages, error conditions, causes, and actions of the error codes (E000<sub>H</sub> to FFFF<sub>H</sub>).

Error code	Error	Action
E000 <sub>H</sub> to EFFF <sub>H</sub>	Errors that may be detected by the CC-Link IE Controller Network	Refer to the CC-Link IE Controller Network reference manual.
F000 <sub>H</sub> to FFFF <sub>H</sub>	Errors that may be detected by the MELSECNET/H or MELSECNET/10 network system	Refer to the MELSECNET/H or MELSECNET/10 network system reference manual.



# CHAPTER 10 CONFIGURATION TOOL

This chapter describes the starting procedure, window structures, and functions of the configuration tool.

## 10.1 Starting Procedure

10

### 10.1.1 Preparation before starting the tool

#### (1) Connecting the Ethernet adapter module and a configuration computer

They can be connected via a switching hub or directly. (☞ Page 48, Section 5.1)

#### (2) Checking the operating environment of the personal computer

Check the operating environment of the personal computer. (☞ Page 51, Section 5.3.1)

Install the .NET Framework 2.0 SP2 or later if it is not installed.

#### (3) Configuring the personal computer

Set the same value for each network part of the IP addresses of the Ethernet adapter module and the personal computer. For the host part of the IP address, the Ethernet adapter module must have a different value from that of the personal computer.

The following IP address and subnet mask values are set for the Ethernet adapter module by default.

- IP address: 192.168.3.30
- Subnet mask: 255.255.255.0

When starting up the configuration tool the first time, configure network settings of the personal computer according to the IP address and subnet mask values shown above.

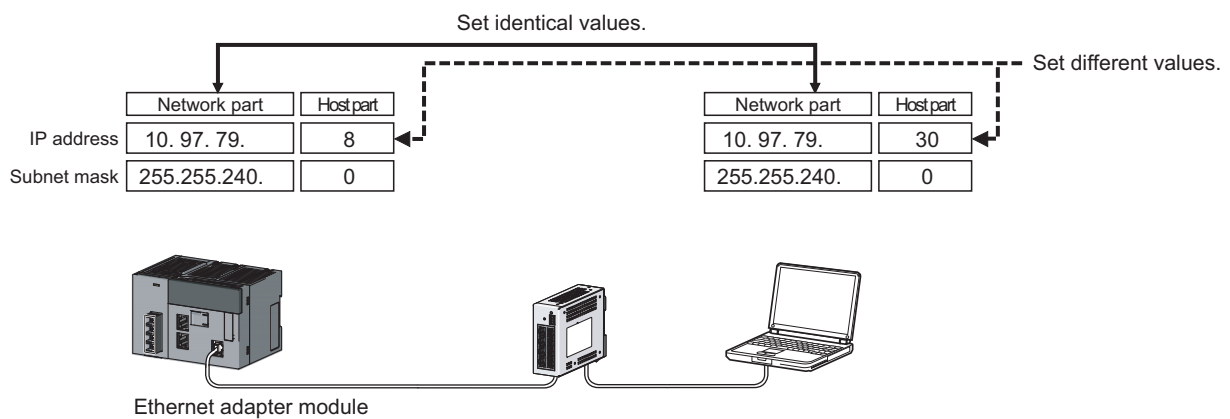

Configure the network settings for the personal computer in the "Internet Protocol (TCP/IP) Properties" dialog box.

**Ex.** When computer environment is in the following case

- Operating system: Microsoft® Windows® XP Professional Operating System

☞ Control Panel ⇒ "Network and Internet Connections" ⇒ "Network Connections" ⇒ "Local Area Connection" ⇒ "General" ⇒ [Properties] button ⇒ "Internet Protocol (TCP/IP)"

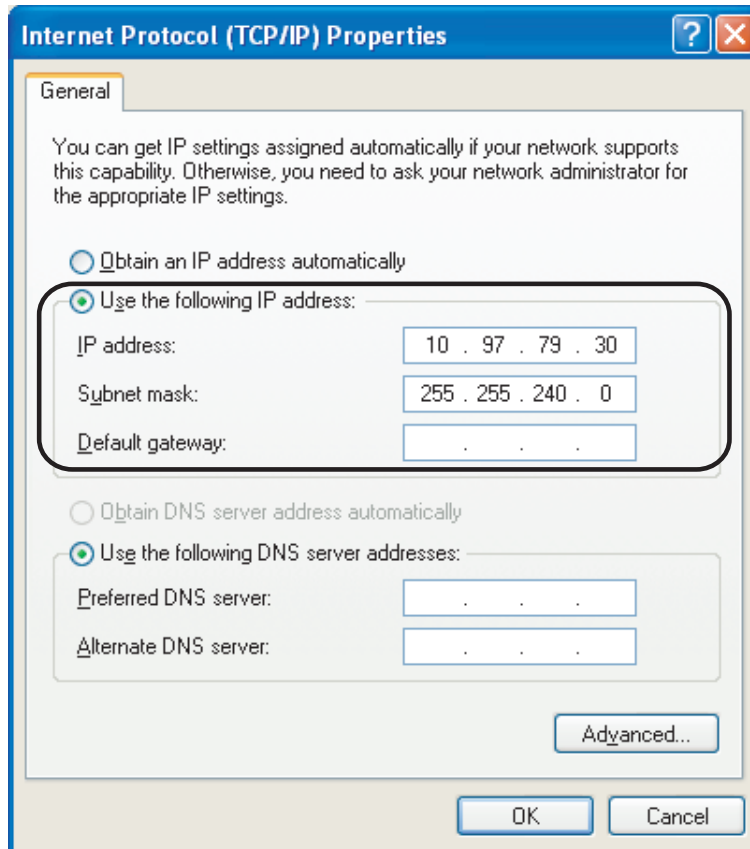

## (4) Setting the Web browser

Configure the settings for the proxy server or the JavaScript from the Web browser.

### (a) Proxy server settings

Perform the Web browser settings in the "Local Area Network (LAN) Settings" dialog box.

If the same value is set for the network part of the Ethernet Adapter Module and the proxy server, the following setting is not required.

**Ex.** When computer environment is in the following case

- Operating system: Microsoft® Windows® XP Professional Operating System
- Web browser: Internet Explorer® 8.0

 Web browser ⇒ [Tools] ⇒ [Internet Options] ⇒ "Connections" ⇒ [LAN settings] button

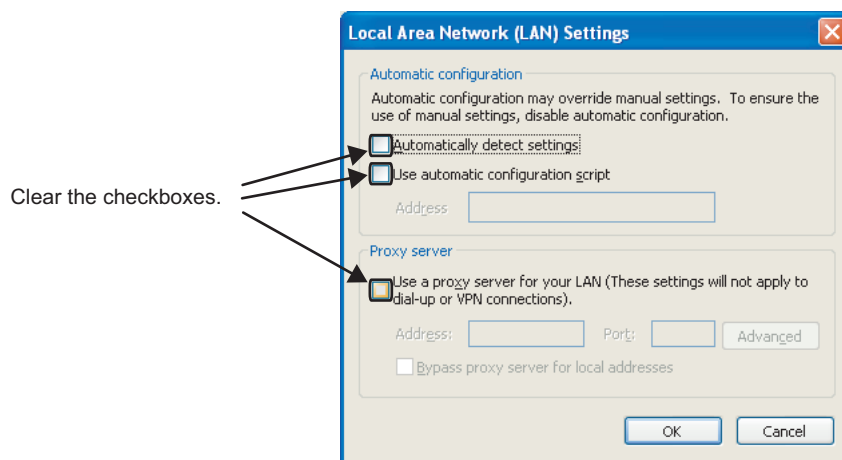

## (b) JavaScript settings

Perform the JavaScript settings in the "Security Settings" dialog box.

**Ex.** When computer environment is in the following case

- Operating system: Microsoft® Windows® XP Professional Operating System
- Web browser: Internet Explorer® 8.0

### 1. Select "Local Intranet Zone".

☞ Web browser ⇒ [Tools] ⇒ [Internet Options] ⇒ "Security"

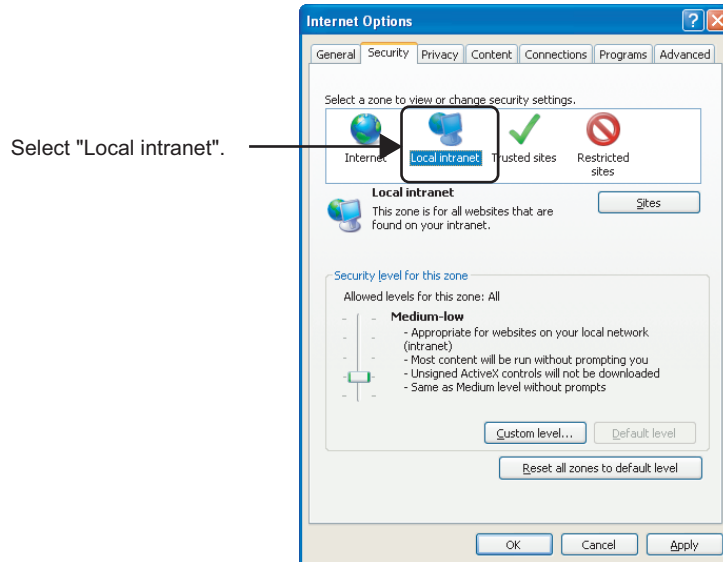

2. After that, click the [Custom level] button and configure the settings as shown below.

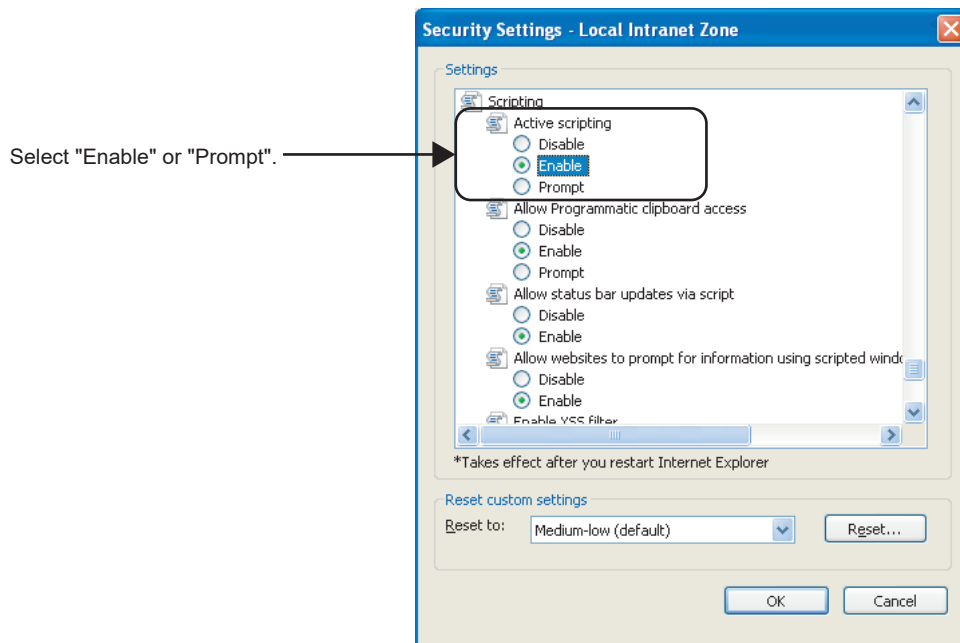

When "Prompt" is selected, the following dialog box may be displayed during the start-up of the configuration tool. If this occurs, click the [Yes] button.

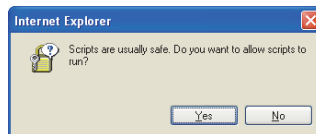

# 10.1.2 Starting up the configuration tool

The configuration tool can be started by either of the following methods.

- Starting from the Web browser (↩ Page 184, Section 10.1.2 (1))
- Starting from GX Works2 (↩ Page 185, Section 10.1.2 (2))

## (1) Starting from a Web browser



1. Start a Web browser from the personal computer.
2. Enter the IP address of the Ethernet adapter module in the Address space, click the Enter key. The IP address shown in the left is a default value.
3. Click "Start up the configuration tool."

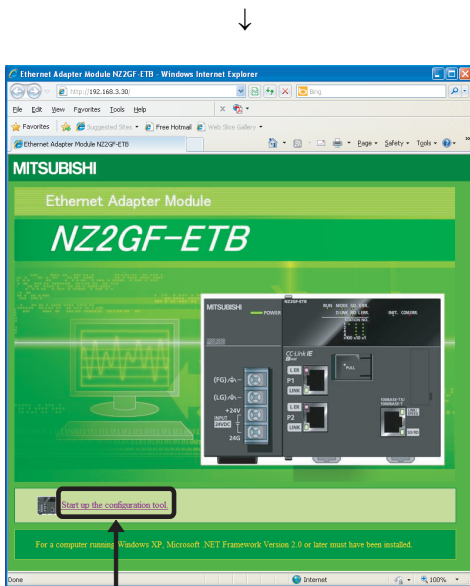

Click

Starting up the configuration tool directly from the Ethernet Adapter Module

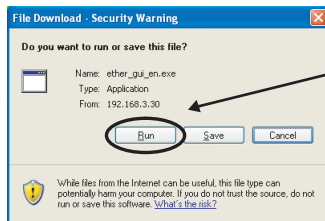

Click.

Saving the configuration tool to the personal computer

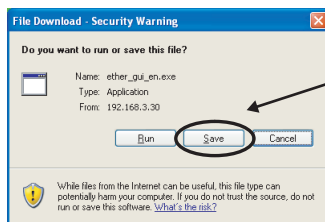

The executable file of the configuration tool is saved to the personal computer by clicking. Run the executable file.

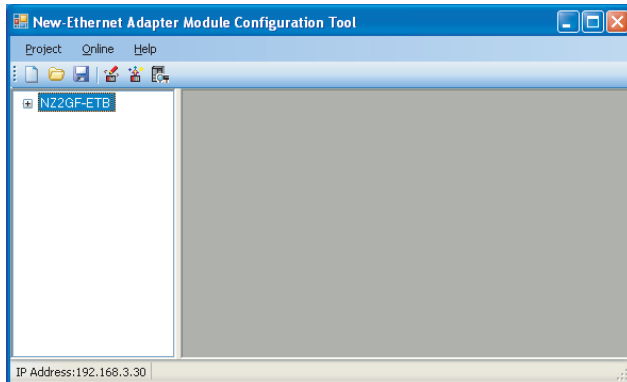
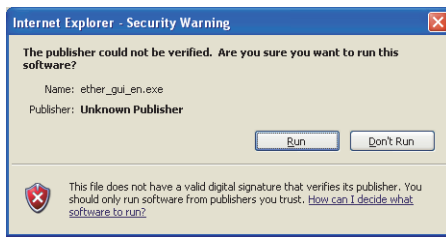

## (2) Starting from GX Works2

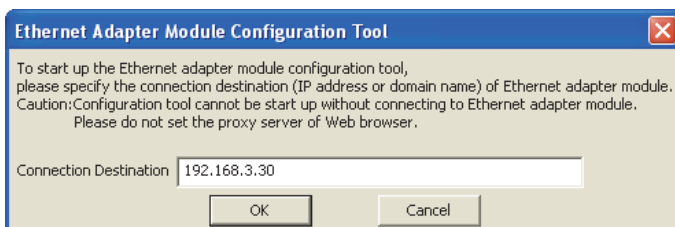

4. When the dialog box on the left is displayed, click the [Run] button.

5. The configuration tool is activated. If the configuration tool is not activated, refer to the troubleshooting method for the cases that the configuration tool does not start or that communication is not available, and then take action. (☞ Page 155, Section 9.4.3)

1. From GX Works2, start the configuration tool.

☞ [Tool] ⇒ [Ethernet Adapter Module Configuration Tool]

2. Enter the IP address of the Ethernet adapter module, and click the [OK] button. The IP address shown in the left is a default value.

3. The procedure after the step is the same as the one shown in step 3 or later of "Starting from a Web browser". (☞ Page 184, Section 10.1.2 (1))

# 10.2 Window Structure

## 10.2.1 Main window structure

The main window structure of the configuration tool is as illustrated below.

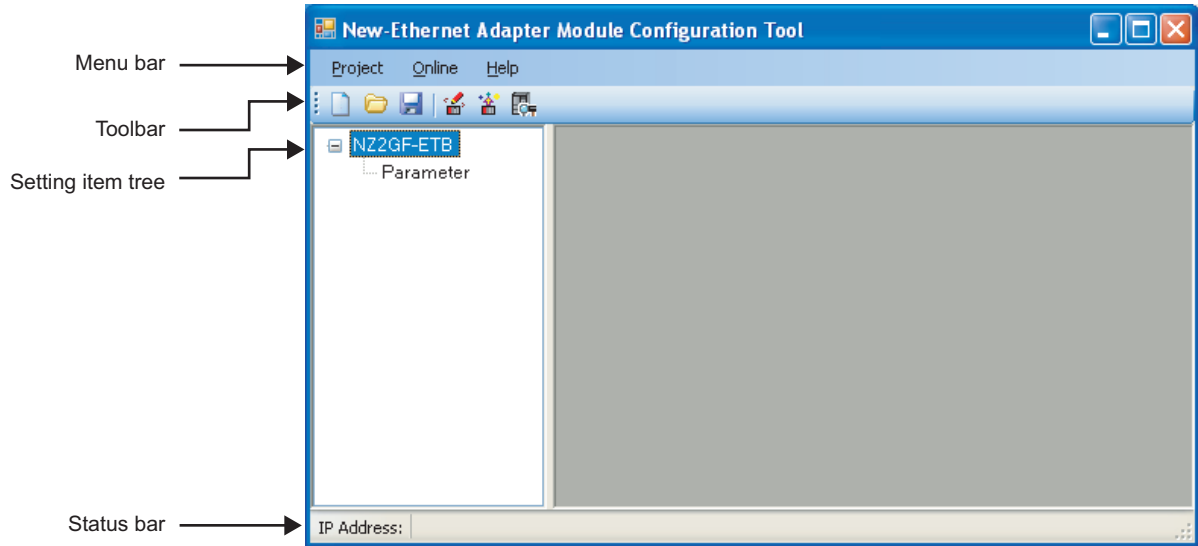

Name	Description	Reference
Menu bar	Menus which provide access to respective functions are displayed.	Page 187, Section 10.2.2
Toolbar	Tool buttons used for execution of respective functions are displayed.	Page 187, Section 10.2.3
Setting item tree	Selecting one of the tree items will display the corresponding configuration dialog box.	Page 188, Section 10.3
Status bar	The IP address of the connected Ethernet adapter module is displayed.	—









## 10.2.2 Menu bar elements

The following are the menu bar elements of the configuration tool.

Project		
New	Creates a new project.	
Open	Opens a project file that has been saved to the local disk. When a project is saved in the configuration tool of other languages, opening the file may cause garbled characters.	
Save	Saves the current project file.	
Save As	Saves the current project with a different file name. The extension of the project file is ".eap".	
Exit	Terminates the configuration tool.	
Online		Reference
Read	Reads parameters from the Ethernet adapter module.	Page 200, Section 10.5.2
Write	Writes parameters to the Ethernet adapter module.	Page 200, Section 10.5.1
Diagnostics	Performs diagnostics on the Ethernet adapter module.	Page 203, Section 10.7
Monitor	Monitors the device/buffer memories in the Ethernet adapter module.	Page 201, Section 10.6
Destination Setting	Specifies the IP address of the connected Ethernet adapter module.	Page 199, Section 10.4
Help		
About	Displays the version of the configuration tool.	

## 10.2.3 Toolbar elements

The following are the toolbar elements of the configuration tool.

Toolbar icon	Corresponding menus	Description
	[Project] ⇒ [New]	Creates a new project.
	[Project] ⇒ [Open]	Opens a project file that has been saved to the local disk.
	[Project] ⇒ [Save]	Saves the current project file.
	[Online] ⇒ [Write]	Writes parameters to the Ethernet adapter module.
	[Online] ⇒ [Read]	Reads settings from the Ethernet adapter module.
	[Online] ⇒ [Diagnostics]	Performs diagnostics on the Ethernet adapter module.

# 10.3 Parameters

This section describes the parameters of the Ethernet Adapter Module. The setting dialog box can be displayed by the following operation.

 Setting item tree ⇒ NZ2GF-ETB ⇒ [Parameter]

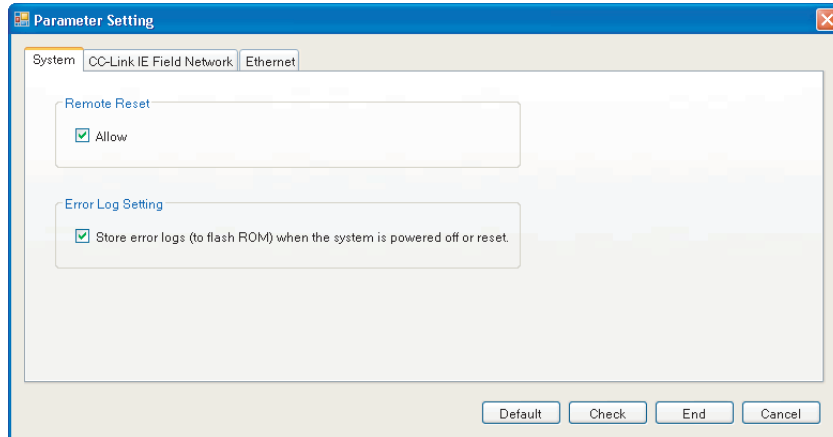

The Parameter Setting dialog box contains the following three kinds of settings, and each of them can be displayed by selecting the tab.

Item	Description	Parameter No. <sup>*1</sup>	Reference
System	For the Ethernet Adapter Module, specify whether or not to: <ul style="list-style-type: none"> <li>• Allow remote reset.</li> <li>• Hold error logs when the system is powered off or reset.</li> </ul>	1002 <sub>H</sub> , 01F0 <sub>H</sub>	Page 189, Section 10.3.1
CC-Link IE Field Network	Configure the settings for connecting the Ethernet Adapter Module to CC-Link IE Field Network.	01F0 <sub>H</sub>	Page 190, Section 10.3.2
Ethernet	Configure the settings for connecting the Ethernet Adapter Module to Ethernet.	9181 <sub>H</sub>	Page 193, Section 10.3.3

\*1 The parameter numbers are used to identify an invalid parameter when a parameter error has occurred.

## (1) Buttons

The buttons displayed in the Parameter Setting dialog box are explained below.

Button	Description
[Default] button	Sets default values for all of the setting items on the current dialog box.
[Check] button	Checks if the parameters set on the current dialog box are correct.
[End] button	Ends the setting.
[Cancel] button	Cancels the setting.

## 10.3.1 System setting

Configure the system settings required for use of the Ethernet Adapter Module.

 Setting item tree ⇒ NZ2GF-ETB ⇒ [Parameter] ⇒ "System"

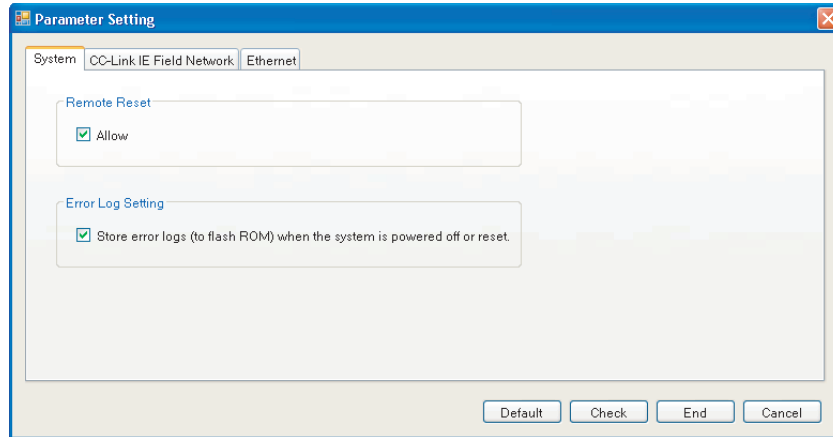

The following table lists the setting items on the dialog box.

Item		Description	Setting range
Remote Reset	Allow	Specify whether to enable remote reset of the Ethernet Adapter Module.	Allow/not allow (Default: Allow)
Error Log Setting	Store error logs (to flash ROM) when the system is powered off or reset.	Set whether to hold error logs after the system is powered off or reset.	Hold/not hold (Default: Hold)

## 10.3.2 CC-Link IE Field Network

Configure the settings for connecting the Ethernet Adapter Module to CC-Link IE Field Network.

Setting item tree ⇒ NZ2GF-ETB ⇒ [Parameter] ⇒ "CC-Link IE Field Network"

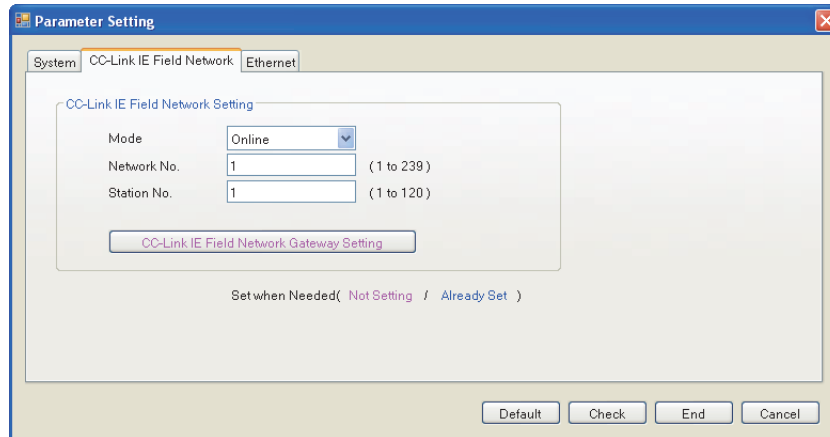

The following table lists the setting items on the dialog box.

Item		Description	Setting range
CC-Link IE Field Network	Mode	Set the mode of the Ethernet Adapter Module.	Online/Offline (Default: Online)
	Network No.	Set the network number of the Ethernet Adapter Module.	1 to 239 (Default: None)
	Station No.	Set the station number of the Ethernet Adapter Module.	1 to 120 (Default: None)
	CC-Link IE Field Network Gateway Setting	Set the communication route of when the IP packet transfer function is used. (☞ Page 191, Section 10.3.2 (1))	—

## (1) CC-Link IE Field Network gateway setting

When the network address (the first and second octets of the IP address) of the external device is different from that of the master station, set the communication route where communications reach the request destination external device.

This setting is not required when the request source external device, request destination external device, and modules between them have the same network address.

Configure the CC-Link IE Field Network gateway setting to perform IP communications via CC-Link IE Field Network (IP packet transfer function). (☞ Page 107, Section 7.3)

192 . 168 . 3 . 1  
 |  
 Network address

### Point

If the setting is configured although the network address of the external device is the same as that of the master station, the Ethernet adapter module ignores the setting.

### (a) Setting details

☞ Setting item tree ⇒ NZ2GF-ETB ⇒ [Parameter] ⇒ "CC-Link IE Field Network Gateway Setting" ⇒ [CC-Link IE Field Network Gateway Setting] button

IP Address Input Format: DEC

Priority	Ethernet			CC-Link IE Field Network Gateway Setting Station		Sort
	No.	IP Address	Subnet Mask Pattern	Network No.	Station No.	
High	1	10.97.10.0	255.255.255.255	10	0	<< >>
	2					
	3					
	4					
	5					
	6					
Low	7					
	8					

Network No.    Station No.

CC-Link IE Field Network Default Gateway Setting Station:

Configure this setting when the network address of the target network differs from that of the CC-Link IE Field Network.

Description: Set the station No. of the station that serves as a gateway for the target Ethernet network (0 to 120).

Default    Check    End    Cancel

The following table lists the setting items on the dialog box.

Item	Description	Setting range																		
IP Address Input Format	Set the input type for the IP address and subnet mask pattern.	DEC/HEX (Default: DEC)																		
Ethernet	IP Address	<ul style="list-style-type: none"> <li>• Decimal input 0.0.0.1 to 223.255.255.254 (Default: none)</li> <li>• Hexadecimal input 0.0.0.1 to DF.FF.FF.FE (Default: none)</li> </ul>																		
	Subnet Mask Pattern	<ul style="list-style-type: none"> <li>• Decimal input 192.0.0.0 to 255.255.255.255 (Default: none)</li> <li>• Hexadecimal input C0.0.0.0 to FF.FF.FF.FF (Default: none)</li> </ul>																		
CC-Link IE Field Network Gateway Setting Station	Network No.	<p>To transmit communications to the request destination★, the IP packet passes through the station with the network address No.▲ and station No.■.</p> <table border="1"> <thead> <tr> <th colspan="3">Ethernet</th> <th colspan="2">CC-Link IE Field Network Gateway Setting Station</th> </tr> <tr> <th>No.</th> <th>IP Address</th> <th>Subnet Mask Pattern</th> <th>Network No.</th> <th>Station No.</th> </tr> </thead> <tbody> <tr> <td>1</td> <td></td> <td></td> <td>▲</td> <td>■</td> </tr> </tbody> </table> <p>Station where the IP packet passes through last (Network No.▲, station No.■)</p> <p>1 to 239 (Default: none)</p>	Ethernet			CC-Link IE Field Network Gateway Setting Station		No.	IP Address	Subnet Mask Pattern	Network No.	Station No.	1			▲	■			
	Ethernet			CC-Link IE Field Network Gateway Setting Station																
No.	IP Address	Subnet Mask Pattern	Network No.	Station No.																
1			▲	■																
Station No.	<p><b>Ex.</b></p> <ul style="list-style-type: none"> <li>• When setting the communication route to all the IP addresses starting with 192.160.10</li> </ul> <table border="1"> <thead> <tr> <th colspan="3">Ethernet</th> </tr> <tr> <th>No.</th> <th>IP Address</th> <th>Subnet Mask Pattern</th> </tr> </thead> <tbody> <tr> <td>1</td> <td>192.160.10.0</td> <td>255.255.255.0</td> </tr> </tbody> </table> <p>Enter a number in the 4th octet.      Enter 0 in the 4th octet.</p> <ul style="list-style-type: none"> <li>• When setting the communication route to the IP address of 192.160.10.21</li> </ul> <table border="1"> <thead> <tr> <th colspan="3">Ethernet</th> </tr> <tr> <th>No.</th> <th>IP Address</th> <th>Subnet Mask Pattern</th> </tr> </thead> <tbody> <tr> <td>1</td> <td>192.160.10.21</td> <td>255.255.255.255</td> </tr> </tbody> </table>	Ethernet			No.	IP Address	Subnet Mask Pattern	1	192.160.10.0	255.255.255.0	Ethernet			No.	IP Address	Subnet Mask Pattern	1	192.160.10.21	255.255.255.255	0 to 120 (Default: none)
Ethernet																				
No.	IP Address	Subnet Mask Pattern																		
1	192.160.10.0	255.255.255.0																		
Ethernet																				
No.	IP Address	Subnet Mask Pattern																		
1	192.160.10.21	255.255.255.255																		
[▲] [▼] button	These buttons are used to change the priority for communication routes set in "Ethernet" and "CC-Link IE Field Gateway Setting Station".	—																		
CC-Link IE Field Network Default Gateway Setting	Network No.	Set the station on CC-Link IE Field Network, where communications transmit through to reach the request destination. (Default: none)																		
	Station No.	This setting is used to communicate with an external device that does not exist in "Ethernet" or "CC-Link IE Gateway Setting Station". (Default: none)																		

**Point**

Set the CC-Link IE Field Network gateway setting in the request source that accesses a different network address. (Page 129, Section 7.3.7 (2))





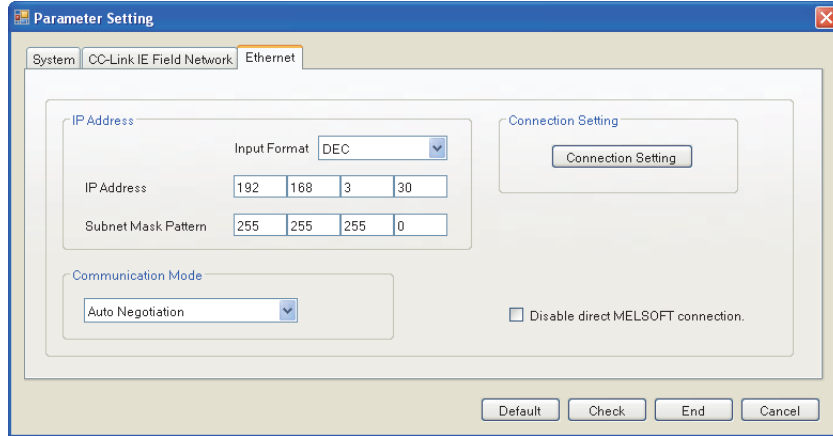

## 10.3.3 Ethernet setting

Configure the settings for connecting the Ethernet Adapter Module to the Ethernet.

 Setting item tree ⇒ NZ2GF-ETB ⇒ [Parameter] ⇒ "Ethernet"



The following table lists the setting items on the dialog box.

	Item	Description	Setting range
IP Address	Input Format	Select an input format for the IP address and subnet mask pattern.	DEC/HEX (Default: DEC)
	IP Address	Set the IP address of the Ethernet Adapter Module. (  Page 194, Section 10.3.3 (1)) If the IP address was changed, configure the network settings again. (  Page 179, Section 10.1.1 (3))	<ul style="list-style-type: none"> <li>Decimal input 0.0.0.1 to 223.255.255.254 (Default: 192.168.3.30)</li> <li>Hexadecimal input 0.0.0.1 to DF.FF.FF.FE (Default: C0.A8.03.1E)</li> </ul> <b>■There are restrictions on the setting range. (  Page 194, Section 10.3.3 (1))</b>
	Subnet Mask Pattern	Set the subnet mask of the Ethernet Adapter Module. If the subnet mask was changed, configure the network settings again. (  Page 179, Section 10.1.1 (3))	<ul style="list-style-type: none"> <li>Decimal input 192.0.0.0 to 255.255.255.252 (Default: 255.255.255.0)</li> <li>Hexadecimal input C0.0.0.0 to FF.FF.FF.FC (Default: FF.FF.FF.00)</li> </ul> <b>■There are restrictions on the setting range. (  Page 194, Section 10.3.3 (1))</b>
Communication Mode	Set the communication mode.	Auto Negotiation 100Mbps/Half Duplex 100Mbps/Full Duplex (Default: Auto Negotiation)	
Connection Setting	Set connections. (  Page 195, Section 10.3.3 (2))	—	
Disable direct MELSOFT connection.	Specify whether to disable direct connections to MELSOFT.	Disable/not disable (Default: Not disable)	

## (1) Restrictions of the IP address setting range

Restrictions apply to IP addresses that can be set to perform the communications described on the next page. Build the system so that the IP address within each setting range described on the next page can be set.

- When accessing to the master station with SLMP

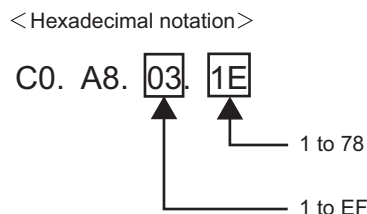
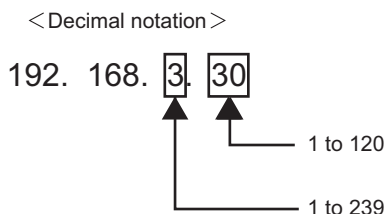

- When connecting to MELSOFT from GX Works2

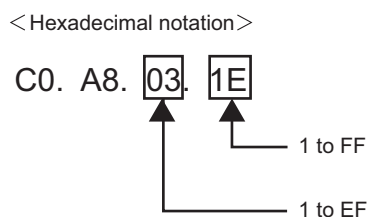
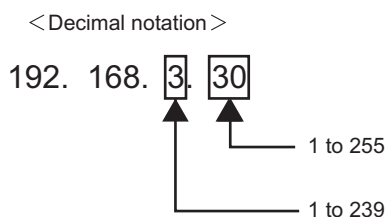

- When connecting to MELSOFT from a GOT

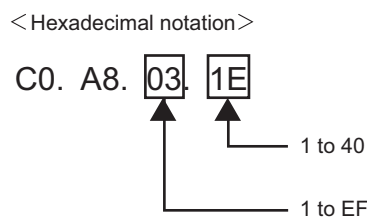
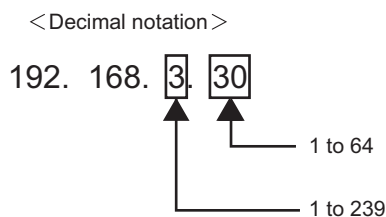

- When communicating with an external device over CC-Link IE Field Network (IP packet transfer function)

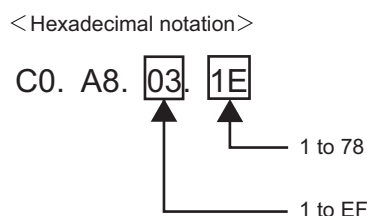
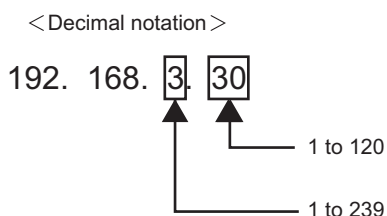

### Point

- For the third octet of the IP address, do not set the same value as the network number of CC-Link IE Field Network.
- To perform IP communications over CC-Link IE Field Network (IP packet transfer function), set the same first and second octets of the IP address as those of the master station and submaster station. When these numbers are different, configure the CC-Link IE Field Network gateway setting. (Page 107, Section 7.3, Page 191, Section 10.3.2 (1))



## (2) Connection Setting

Configure the Ethernet Connection settings. Up to 32 Connections can be set.

 Setting item tree ⇒ NZ2GF-ETB ⇒ [Parameter] ⇒ "Ethernet" ⇒ [Connection Setting] button

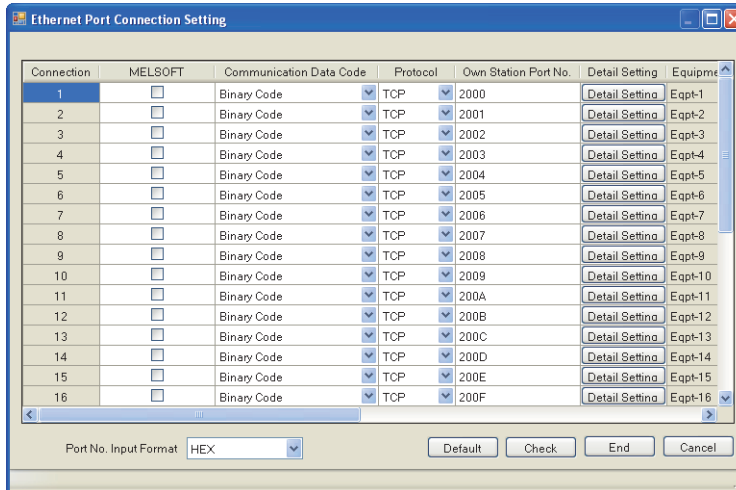

The following table lists the setting items on the window.

Item	Description	Setting range
MELSOFT	Select the checkbox when using the connection for MELSOFT connection. When the checkbox is selected, items after "Connection Data Code" are automatically set.	Selected/Not selected (Default: Not selected)
Communication Data Code	Set a communication data code.	Binary Code/ASCII Code (Default: Binary Code)
Protocol	Set a communication protocol.	TCP/UDP (Default: TCP)
Own Station Port No.	Set the Own Station Port No. Set a unique number for each Connection. #DELTE# If Connection is selected to be used for MELSOFT in "MELSOFT", "MELSOFT Connection" is displayed for the connection.	<ul style="list-style-type: none"> <li>Decimal input 1025 to 4999, 5011 to 65534 (Default: 8192 to 8223)</li> <li>Hexadecimal input 0401<sub>H</sub> to 1387<sub>H</sub>, 1393<sub>H</sub> to FFFE<sub>H</sub> (Default: 2000<sub>H</sub> to 201F<sub>H</sub>)</li> </ul>
Detail Setting	Set the Connection details. (  Page 196, Section 10.3.3 (2) (a) )	—
Port No. Input Format	Select a port number input format.	HEX/DEC (Default: HEX)

### Point

If the [Default] button is clicked on the "Ethernet Port Connection Setting" window, the parameters set in the "Detail Setting" dialog box are also set to default values.

**(a) Detail Setting**

**Detail Setting**

Name Setting

Equipment Name

Comment

TCP Connection

Destination Port No.

Input Format

Port No.

Destination IP Address

Input Format

IP Address

The following table lists the setting items on the dialog box.

Item		Description	Setting range
Name Setting	Equipment Name	Enter an equipment name.	8 characters or less (Default: Eqpt-1-Connection No.)
	Comment	Enter a comment.	32 characters or less (Default: Connection-Connection No.)
TCP Connection		Select a TCP connection type. Set this item only when "TCP" is selected for "Protocol" in the "Ethernet Port Connection Setting" window. There are two TCP connection types: Unpassive* <sup>1</sup> and Fullpassive* <sup>2</sup> .	Unpassive/Fullpassive (Default: Unpassive)
Destination Port No.* <sup>3</sup>	Input Format	Select a format used for entering the port number of the external communication-target device.	DEC/HEX (Default: HEX)
	Port No.	Enter the port number of the external device with which communications are made.	• Decimal input 1 to 65535 (Default: 65535) • Hexadecimal input 1 <sub>H</sub> to FFFF <sub>H</sub> (Default: FFFF <sub>H</sub> )
Destination IP Address* <sup>3</sup>	Input Format	Select a format used for entering the IP address of the external communication-target device.	DEC/HEX (Default: DEC)
	IP Address	Enter the IP address of the external device with which communications are made.	• Decimal input 0.0.0.1 to 255.255.255.255 (Default: 255.255.255.255) • Hexadecimal input 0.0.0.01 to FF.FF.FF.FF (Default: FF.FF.FF.FF)

\*1 Unpassive: Allows connections with no restrictions on the IP address and port number of the destination.

\*2 Fullpassive: Allows connections only when the IP address and port number of the destination meet the specified ones. If an external device with any other IP address and/or port number tries to open a connection, the line will be automatically disconnected.

However, if the destination port number and destination IP address are set to default values, connections are allowed with no restrictions on the IP address and port number of the destination.

\*3 No setting is required when "Unpassive" is set for "TCP Connection".

## 10.3.4 Precautions

---

### (1) Parameters for the entire CC-Link IE Field Network

Parameters for the entire CC-Link IE Field Network (e.g. number of slave stations, link device assignment, reserved station and error invalid station settings) must be set on the master station. For details, refer to the following.

 User's manual for the master/local module used

### (2) Routing parameters used for communication with another network

Routing parameters used for communication with another network must be set on the master station. No setting is required on the Ethernet Adapter Module.

## 10.4 Destination Setting

---

Set the IP address of the connected Ethernet adapter module before execution of parameter writing or reading or diagnostics.

 [Online] ⇒ [Destination Setting]

## 10.5 Parameter Writing/Reading

---

Parameters can be written and read.

### 10.5.1 Parameter writing

---

1. Write the set parameters to the Ethernet adapter module. (Set the switch on the Ethernet adapter module to STOP.)

 [Online] ⇨ [Write]

2. After completion of the writing, reset the Ethernet adapter module if necessary.

### 10.5.2 Parameter reading

---

Read parameters from the Ethernet adapter module.

 [Online] ⇨ [Read]

## 10.6 Device/Buffer Memory Batch Monitor

The devices and buffer memories can be specified to be checked.\*1

\*1 Check the corresponding serial No. and software version. (☞ Page 240, Appendix 10)

☞ [Online] ⇒ [Monitor] ⇒ [Device/Buffer Memory Batch Monitor]

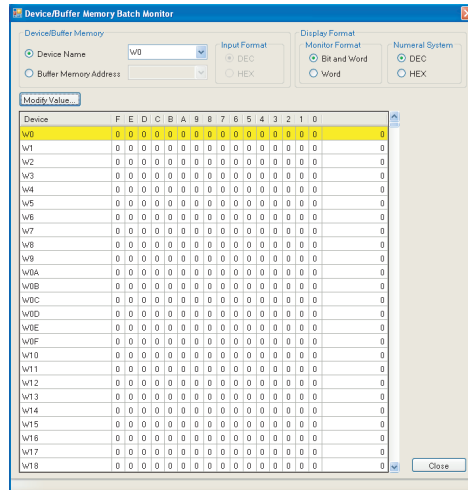

The following table lists the setting items on the dialog box.

Item		Description	
Device/Buffer Memory	Device Name	Set the device name to be monitored.	
	Buffer Memory Address	Enter the buffer memory address to be monitored.	
	Input Format	DEC HEX	Specify the input format for the buffer memory address.
Display Format	Monitor Format	Bit and Word Word	Specify the monitor format.
	Numeral System	DEC HEX	Specify how numbers are displayed.

### (1) Devices that can be monitored and accessible range

The following table lists the devices that can be monitored and their accessible range.

Device	Accessible range	Bit specification	Word specification
X	0000 <sub>H</sub> to 1FFF <sub>H</sub>	○	○*1
Y	0000 <sub>H</sub> to 1FFF <sub>H</sub>	○	○*1
W	0000 <sub>H</sub> to 1FFF <sub>H</sub>	×	○
SB	0000 <sub>H</sub> to 1FFF <sub>H</sub>	○	○*1
SW	0000 <sub>H</sub> to 1FFF <sub>H</sub>	×	○
SM	0000 to 2047	○	○*1
SD	0000 to 2047	×	○
Buffer memory	0000 <sub>H</sub> to 7FFF <sub>H</sub>	×	○

○: Can be specified, ×: Cannot be specified

\*1 Words can be also specified for a bit device (e.g. K4X0)

## (2) Changing the current value

Select the device or buffer memory to change the current value.

 [Online] ⇒ [Monitor] ⇒ [Device/Buffer Memory Batch Monitor] ⇒ [Modify Value] button

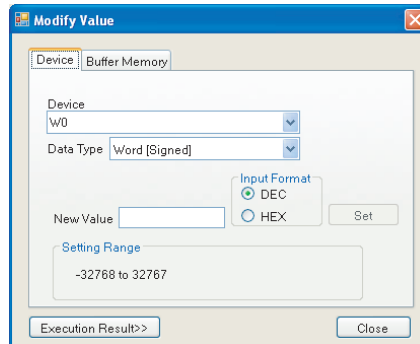

The following table lists the setting items on the dialog box.

Item		Description
Device (Address)		Enter the device or buffer memory address to be changed.
Data Type	Bit	Select the data type of the device to be changed.
	Word [Signed]	
	Double Word [Signed]	
Input Format	DEC	Specify the input format of the device, buffer memory address, or value.
	HEX	
New Value		Enter the value to be changed.

The current value is changed to the specified value by entering the device or device of the buffer memory address and the value and clicking [Set] button.

Clicking [Execution Result▼] button on the dialog box displays the execution result window.



# 10.7 Ethernet Adapter Diagnostics

The latest error occurred in the Ethernet adapter module or the status of communication with external devices can be checked.

[Online] ⇒ [Diagnostics]

### Point

Set the IP address of the connected Ethernet adapter module in the "Destination Setting" dialog box before execution of the Ethernet adapter diagnostics.

[Online] ⇒ [Destination Setting]

The screenshot shows the 'Ethernet Adapter Diagnostics' window. Callout 1 points to the status bar (Mode: Online, Network No. 1, Station No. 2, IP Address: 192.168.3.30, Subnet Mask: 255.255.255.0). Callout 2 points to the Mitsubishi N22GF-ETB hardware image. Callout 3 points to the Ethernet Communication Error details (Error Code: 0407h, Connection No.: 1, Open System: TCP/UnPassive Protocol/TCP, Own Station Port No.: 2000h, Destination IP Address: 192.168.3.1, Date and Time: 12/28/2011 09:19:21, Command Code: 5000h, Subcommand Code: 00FFh). Callout 4 points to the CC-Link IE Field Network Error details (Data Link Status: Parameters Not Received, Latest Error: None). Callout 5 points to the Connection Status table. Callout 6 points to the 'Module Information' button. Callout 7 points to the 'Turn Off COM, ERR, LED' button. Callout 8 points to the 'IP Communication Test' button.

Connection Status					
1	0407h	9	Normal	17	Normal
2	Normal	10	Normal	18	Normal
3	Normal	11	Normal	19	Normal
4	Normal	12	Normal	20	Normal
5	Normal	13	Normal	21	Normal
6	Normal	14	Normal	22	Normal
7	Normal	15	Normal	23	Normal
8	Normal	16	Normal	24	Normal

The following table lists the setting items on the dialog box.

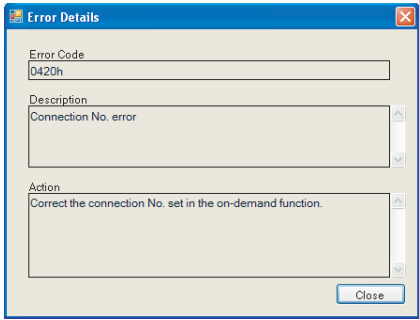
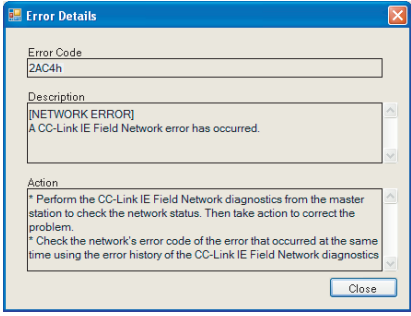
No.	Item	Description	
1)	Mode	Displays the mode of the own station.	
	Network No.	Displays the network number of the own station.	
	Station No.	Displays the station number of the own station.	
	IP Address	Displays the IP address of the own station.	
	Subnet Mask	Displays the subnet mask of the own station.	
2)	LEDs	Displays the status of the LEDs. (☞ Page 22, CHAPTER 2) When the Ethernet adapter module is in the offline mode, the display of the SD LED and RD LED is not changed.	
3)	Latest Error	Error Code	Displays an error code of the Ethernet part. (☞ Page 161, Section 9.5)
		Connection No.	Displays the number of the Connection where the error occurred.
		Open System	Displays how the Connection is opened.
		Protocol	Displays the protocol for the Connection.
		Own Station Port No.	Displays the own station's port number at the time of the error.
		Destination Port No.	Displays the port number of the target external device.
		Destination IP Address	Displays the IP address of the target external device.
		Date and Time	Displays the date and time of the error occurrence.
		Command Code	Displays a command code of the message that was detected as an error.
	Subcommand Code	Displays a subcommand code of the message that was detected as an error.	
[Details] button* <sup>1</sup>	Displays the error details and countermeasure.		
4)	Data Link Status* <sup>1</sup>	Displays the current data link status.	
	Latest Error* <sup>1</sup>	Error Code	Displays an error code of the CC-Link IE Field Network part. (☞ Page 161, Section 9.5)
		Date and Time	Displays the date and time of the error occurrence.
[Details] button* <sup>1</sup>	Displays the error details and countermeasure.		
5)	Connection Status	Displays the latest error code of each Connection (No.1 to No.32). Normal: No error Other than normal: Latest error code	
6)	[Module Information] button* <sup>1</sup>	Displays the information about the Ethernet adapter module. (☞ Page 242, Appendix 11 (3))	
7)	[Turn Off COM.ERR.LED] button* <sup>1</sup>	Clears the communication error and turns off the COM.ERR.LED.	
8)	[IP Communication Test] button* <sup>1</sup>	Checks whether the communication route between external devices is correctly set and whether IP communications over CC-Link IE Field Network (IP packet transfer function) can be performed. (☞ Page 124, Section 7.3.6)	

\*1 Check the corresponding serial number and software version. (☞ Page 240, Appendix 10)

# APPENDICES

## Appendix 1 Buffer Memory Details

This section describes the buffer memory of the Ethernet adapter module.

### (1) Reading from or writing to the buffer memory

#### (a) Access from the master/local module on CC-Link IE Field Network

When the master/local module is a Mitsubishi product, execute the following dedicated instructions.

- Reading: REMFR instruction
- Writing: REMTO instruction

For the "I/O number of an intelligent function module that is on an intelligent device station", specify "00" in the setting data of the dedicated instruction. For details, refer to the following.

 User's manual of the master/local module used

#### (b) Access from the external device on the Ethernet network

By SLMP, send the following command messages.

- Reading

Item		Command	Subcommand
Type	Operation		
Memory	Read	0613	0000

- Writing

Item		Command	Subcommand
Type	Operation		
Memory	Write	1613	0000

For details on SLMP, refer to the following.

 SLMP Reference Manual



**(3) Ethernet port LED information (buffer memory address: 2 (2<sub>H</sub>))**

Information on the LEDs of the Ethernet part is stored in the following bit pattern.

0: Off

1: On

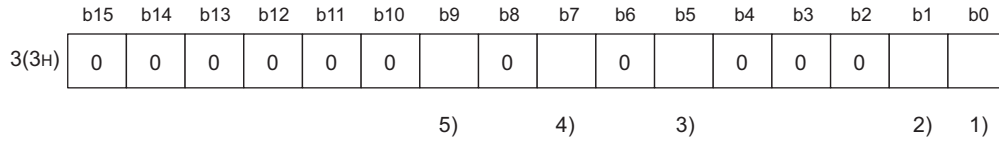

- 1) LINK/SPEED 100Mbps
- 2) LINK/SPEED 1Gbps
- 3) INT LED
- 4) COM.ERR. LED
- 5) SD/RD LED

## Appendix 1.2 Own station information

### (1) PORT1 and PORT2 (buffer memory address: 16 to 21 (10<sub>H</sub> to 15<sub>H</sub>))

Address	Name	Description
16 to 18 (10 <sub>H</sub> to 12 <sub>H</sub> )	Own station MAC address	The MAC address of the own station is stored.
19 (13 <sub>H</sub> )	System area	—
20 to 21 (14 <sub>H</sub> to 15 <sub>H</sub> )	Own station IP address	The IP address assigned from the master station is stored (when the IP packet transfer function is used).

### (2) Ethernet port (buffer memory address: 26 to 33 (1A<sub>H</sub> to 21<sub>H</sub>))

Address	Name	Description
26 to 28 (1A <sub>H</sub> to 1C <sub>H</sub> )	Own station MAC address	The MAC address of the own station is stored.
29 (1D <sub>H</sub> )	System area	—
30 to 31 (1E <sub>H</sub> to 1F <sub>H</sub> )	Own station IP address	The IP address of the own station is stored.
32 to 33 (20 <sub>H</sub> to 21 <sub>H</sub> )	Own station subnet mask	The subnet mask of the own station is stored.

### (3) Parameters (buffer memory address: 36 to 38 (24<sub>H</sub> to 26<sub>H</sub>))

Address	Name	Description
36 (24 <sub>H</sub> )	Mode	The mode of the own station is stored. 0: Online 1: Offline
37 (25 <sub>H</sub> )	Network No.	The network number of the own station is stored.
38 (26 <sub>H</sub> )	Station No.	The station number of the own station is stored.

### (4) Function check area (buffer memory address: 48 (30<sub>H</sub>))

Address	Name	Description																																
48 (30 <sub>H</sub> )	Function check area	<p>The status of each supported function is indicated. 0: Not supported 1: Supported</p> <table border="1" style="margin-left: 40px;"> <tr> <td>b15</td><td>b14</td><td>b13</td><td>b12</td><td>b11</td><td>b10</td><td>b9</td><td>b8</td><td>b7</td><td>b6</td><td>b5</td><td>b4</td><td>b3</td><td>b2</td><td>b1</td><td>b0</td> </tr> <tr> <td>0</td><td>0</td><td>0</td><td>0</td><td>0</td><td>0</td><td>0</td><td>0</td><td>0</td><td>0</td><td>0</td><td>0</td><td>0</td><td>0</td><td>0</td><td>0</td> </tr> </table> <p style="text-align: right; margin-right: 40px;">2) 1)</p> <p>1) On-demand function 2) IP packet transfer function</p>	b15	b14	b13	b12	b11	b10	b9	b8	b7	b6	b5	b4	b3	b2	b1	b0	0	0	0	0	0	0	0	0	0	0	0	0	0	0	0	0
b15	b14	b13	b12	b11	b10	b9	b8	b7	b6	b5	b4	b3	b2	b1	b0																			
0	0	0	0	0	0	0	0	0	0	0	0	0	0	0	0																			

## Appendix 1.3 Ethernet port operation area

A

### (1) Initial processing error code (buffer memory address: 768 (300<sub>H</sub>))

The initial processing result is stored.

0: Completed

Other than 0: Failed: Refer to the troubleshooting page describing the case where the INIT.LED turned off, and take action. (☞ Page 152, Section 9.3.3 (1))

### (2) Connection information area No.1 (buffer memory address: 784 to 799 (310<sub>H</sub> to 31F<sub>H</sub>))

Address	Name	Description
784 (310 <sub>H</sub> )	Open system	The specified open system is stored. 0: TCP Unpassive 1: TCP Fullpassive 3: UDP
785 (311 <sub>H</sub> )	Protocol	The specified protocol is stored. 0: TCP 1: UDP
786 (312 <sub>H</sub> )	Communication data code	The specified communication data code is stored. 0: Binary code 1: ASCII code
787 (313 <sub>H</sub> )	Own Station Port No.	The port number specified for the own station is stored. 0000 <sub>H</sub> : No setting 0401 <sub>H</sub> to 1387 <sub>H</sub> , 1393 <sub>H</sub> to FFFE <sub>H</sub> : Own station's port
788 (314 <sub>H</sub> )	TCP connection system	The specified TCP connection system is stored. Valid only when the protocol is TCP. 0: Unpassive 1: Fullpassive
789 (315 <sub>H</sub> )	Connection status	The current status is stored. • When the protocol is TCP: 0000 <sub>H</sub> : Disconnected (Connection disrupted) 0001 <sub>H</sub> : Communicating (Connection established) • When the protocol is UDP: 0000 <sub>H</sub> : Error 0001 <sub>H</sub> : Normal
790 to 791 (316 <sub>H</sub> to 317 <sub>H</sub> )	System area	—
792 (318 <sub>H</sub> )	Latest error code	The latest error code is stored. 0: No error Other than 0: Latest error code
793 (319 <sub>H</sub> )	Destination port No.	The port number of the external device on the other end is stored. • When the protocol is TCP: 0000 <sub>H</sub> : No setting, or disconnected (Connection disrupted) Other than 0000 <sub>H</sub> : Port No. of the external device with which the module is currently communicating • When the protocol is UDP: 0000 <sub>H</sub> : No setting, or no communication log in the past Other than 0000 <sub>H</sub> : Port number of an external device, with which the latest communication was made

Address	Name	Description
794 to 795 (31A <sub>H</sub> to 31B <sub>H</sub> )	Destination IP address	The IP address of the communication target is stored. <ul style="list-style-type: none"> <li>When the protocol is TCP: 00000000<sub>H</sub>: No setting, or disconnected (Connection disrupted) Other than 00000000<sub>H</sub>: IP address of the communication destination</li> <li>When the protocol is UDP: 00000000<sub>H</sub>: No setting, or no communication log in the past Other than 00000000<sub>H</sub>: IP address of a device, with which the latest communication was made</li> </ul>
796 to 799 (31C <sub>H</sub> to 31F <sub>H</sub> )	System area	—

### (3) Connection information area No.2 to No.32 (buffer memory address: 800 to 1295 (320<sub>H</sub> to 50F<sub>H</sub>))

In the same sequence as Connection information No.1, information is stored in Connection information area No.2 to No.32.

### (4) Auto-open UDP port area (buffer memory address: 1296 to 1307 (510<sub>H</sub> to 51B<sub>H</sub>))

Address	Name	Description
1296 (510 <sub>H</sub> )	Open system	Data of the open system is stored. 3: UDP (fixed)
1297 (511 <sub>H</sub> )	Protocol	Data of the protocol is stored. 1: UDP (fixed)
1298 (512 <sub>H</sub> )	Communication data code	A communication data code is stored. 0: Binary code (fixed)
1299 (513 <sub>H</sub> )	Own Station Port No.	The port number of the own station is stored. 1388 <sub>H</sub> : Own station's port (fixed)
1300 (514 <sub>H</sub> )	System area	—
1301 (515 <sub>H</sub> )	Connection status	The current status is stored. 0000 <sub>H</sub> : Error 0001 <sub>H</sub> : Normal
1302 to 1303 (516 <sub>H</sub> to 517 <sub>H</sub> )	System area	—
1304 (518 <sub>H</sub> )	Latest error code	The latest error code is stored. 0: No error Other than 0: Latest error code
1305 (519 <sub>H</sub> )	Destination port No.	The port number of the communication target is stored. 0000 <sub>H</sub> : No setting, or no communication log in the past Other than 0000 <sub>H</sub> : Port number of a device, with which the latest communication was made
1306 to 1307 (51A <sub>H</sub> to 51B <sub>H</sub> )	Destination IP address	The IP address of the communication target is stored. 00000000 <sub>H</sub> : No setting, or no communication log in the past Other than 00000000 <sub>H</sub> : IP address of a device, with which the latest communication was made



**(5) MELSOFT application communication port (UDP/IP) area for the system (buffer memory address: 1313 to 1323 (521<sub>H</sub> to 52B<sub>H</sub>))**

Address	Name	Description
1312 (520 <sub>H</sub> )	System area	—
1313 (521 <sub>H</sub> )	Protocol	Data of the protocol is stored. 1: UDP (fixed)
1314 (522 <sub>H</sub> )	Communication data code	A communication data code is stored. 0: Binary code (fixed)
1315 (523 <sub>H</sub> )	Own Station Port No.	The port number of the own station is stored. 1389 <sub>H</sub> : Own station's port (fixed)
1316 (524 <sub>H</sub> )	System area	—
1317 (525 <sub>H</sub> )	Connection status	The current status is stored. 0000 <sub>H</sub> : Error 0001 <sub>H</sub> : Normal
1318 to 1319 (526 <sub>H</sub> to 527 <sub>H</sub> )	System area	—
1320 (528 <sub>H</sub> )	Latest error code	The latest error code is stored. 0: No error Other than 0: Latest error code
1321 (529 <sub>H</sub> )	Destination port No.	The port number of the communication target is stored. 0000 <sub>H</sub> : No setting, or no communication log in the past Other than 0000 <sub>H</sub> : Port number of a device, with which the latest communication was made
1322 to 1323 (52A <sub>H</sub> to 52B <sub>H</sub> )	Destination IP address	The IP address of the communication target is stored. 00000000 <sub>H</sub> : No setting, or no communication log in the past Other than 00000000 <sub>H</sub> : IP address of a device, with which the latest communication was made

**(6) MELSOFT application communication port (TCP/IP) area for the system (buffer memory address: 1328 to 1339 (530<sub>H</sub> to 53B<sub>H</sub>))**

Address	Name	Description
1328 (530 <sub>H</sub> )	Open system	Data of the open system is stored. 0: TCP Unpassive (fixed)
1329 (531 <sub>H</sub> )	Protocol	Data of the protocol is stored. 0: TCP (fixed)
1330 (532 <sub>H</sub> )	Communication data code	A communication data code is stored. 0: Binary code (fixed)
1331 (533 <sub>H</sub> )	Own Station Port No.	The port number of the own station is stored. 138A <sub>H</sub> : Own station's port (fixed)
1332 (534 <sub>H</sub> )	TCP connection system	A TCP connection system is stored. 0: Unpassive (fixed)
1333 (535 <sub>H</sub> )	Connection status	The current status is stored. 0000 <sub>H</sub> : Disconnected (Connection disrupted) 0001 <sub>H</sub> : Communicating (Connection established)
1334 to 1335 (536 <sub>H</sub> to 537 <sub>H</sub> )	System area	—
1336 (538 <sub>H</sub> )	Latest error code	The latest error code is stored. 0: No error Other than 0: Latest error code
1337 (539 <sub>H</sub> )	Destination port No.	The port number of the communication target is stored. 0000 <sub>H</sub> : No setting, or disconnected (Connection disrupted) Other than 0000 <sub>H</sub> : Port number of a device, with which the latest communication was made
1338 to 1339 (53A <sub>H</sub> to 53B <sub>H</sub> )	Destination IP address	The IP address of the communication target is stored. 00000000 <sub>H</sub> : No setting, or disconnected (Connection disrupted) Other than 00000000 <sub>H</sub> : IP address of a device with which the module is communicating

**(7) Direct MELSOFT connection port (buffer memory address: 1344 to 1355 (540<sub>H</sub> to 54B<sub>H</sub>))**

Address	Name	Description
1344 (540 <sub>H</sub> )	Open system	Data of the open system is stored. 3: UDP (fixed)
1345 (541 <sub>H</sub> )	Protocol	Data of the protocol is stored. 1: UDP (fixed)
1346 (542 <sub>H</sub> )	Communication data code	A communication data code is stored. 0: Binary code (fixed)
1347 (543 <sub>H</sub> )	Own Station Port No.	The port number of the own station is stored. 1390 <sub>H</sub> : Own station's port (fixed)
1348 (544 <sub>H</sub> )	System area	—
1349 (545 <sub>H</sub> )	Connection status	The current status is stored. 0000 <sub>H</sub> : Error 0001 <sub>H</sub> : Normal
1350 to 1351 (546 <sub>H</sub> to 547 <sub>H</sub> )	System area	—
1352 (548 <sub>H</sub> )	Latest error code	The latest error code is stored. 0: No error Other than 0: Latest error code
1353 (549 <sub>H</sub> )	Destination port No.	The port number of the communication target is stored. 0000 <sub>H</sub> : No setting, or no communication log in the past Other than 0000 <sub>H</sub> : Port number of a device, with which the latest communication was made
1354 to 1355 (54A <sub>H</sub> to 54B <sub>H</sub> )	Destination IP address	The IP address of the communication target is stored. 00000000 <sub>H</sub> : No setting, or no communication log in the past Other than 00000000 <sub>H</sub> : IP address of a device, with which the latest communication was made

**(8) Connection port for the configuration tool (buffer memory address: 1360 to 1371 (550<sub>H</sub> to 55B<sub>H</sub>))**

Address	Name	Description
1360 (550 <sub>H</sub> )	Open system	Data of the open system is stored. 3: UDP (fixed)
1361 (551 <sub>H</sub> )	Protocol	Data of the protocol is stored. 1: UDP (fixed)
1362 (552 <sub>H</sub> )	Communication data code	A communication data code is stored. 0: Binary code (fixed)
1363 (553 <sub>H</sub> )	Own Station Port No.	The port number of the own station is stored. 1392 <sub>H</sub> : Own station's port (fixed)
1364 (554 <sub>H</sub> )	System area	—
1365 (555 <sub>H</sub> )	Connection status	The current status is stored. 0000 <sub>H</sub> : Error 0001 <sub>H</sub> : Normal
1366 to 1367 (556 <sub>H</sub> to 557 <sub>H</sub> )	System area	—
1368 (558 <sub>H</sub> )	Latest error code	The latest error code is stored. 0: No error Other than 0: Latest error code
1369 (559 <sub>H</sub> )	Destination port No.	The port number of the communication target is stored. 0000 <sub>H</sub> : No setting, or no communication log in the past Other than 0000 <sub>H</sub> : Port number of a device, with which the latest communication was made
1370 to 1371 (55A <sub>H</sub> to 55B <sub>H</sub> )	Destination IP address	The IP address of the communication target is stored. 00000000 <sub>H</sub> : No setting, or no communication log in the past Other than 00000000 <sub>H</sub> : IP address of a device, with which the latest communication was made

## Appendix 1.4 Ethernet port error log area

A

### (1) Error count (buffer memory address: 2049 (801<sub>H</sub>))

The number of errors occurred is stored.

0: No error

1 to 65535: Number of errors occurred

Even if errors occurred 65536 times or more, the count will stop at 65535.

### (2) Error log write pointer (buffer memory address: 2050 (802<sub>H</sub>))

Error log number of the latest error is stored.

0: No error (No error log)

1 to 64: Error log number of the latest error

If the 65th or more error occurs, it will return to error log No.1 and start registration again.

### (3) Error log No.1 (buffer memory address: 2064 to 2079 (810<sub>H</sub> to 81F<sub>H</sub>))

Address	Name	Description
2064 (810 <sub>H</sub> )	Error code	An error code is stored. 0: No error Other than 0: Error code
2065 (811 <sub>H</sub> )	Connection No.	The number of the Connection where the error occurred is stored. 0: Error independent of connection 1 to 32: No. of the Connection where the error occurred 33: Auto-Open UDP Port 34: MELSOFT application communication port (UDP/IP) 35: MELSOFT application communication port (TCP/IP) 36: Direct MELSOFT Connection Port 37: Connection Port for the Configuration Tool 38: System Connection 39: System Connection
2066 (812 <sub>H</sub> )	Open system	The open system of the Connection is stored. 0: TCP Unpassive 1: TCP Fullpassive 3: UDP
2067 (813 <sub>H</sub> )	Protocol	The protocol of the Connection is stored. 0: TCP 1: UDP
2068 (814 <sub>H</sub> )	Own Station Port No.	The own station's port number at the time of the error is stored. 0000 <sub>H</sub> : No error (default), or an error lower than the TCP or UDP level 0401 <sub>H</sub> to FFFE <sub>H</sub> : Own Station Port No.
2069 (815 <sub>H</sub> )	Destination port No.	The port number of the communication target is stored. 0000 <sub>H</sub> : No error (default), or an error lower than the TCP or UDP level 0001 <sub>H</sub> to FFFF <sub>H</sub> : Port number of the communication target
2070 to 2071 (816 <sub>H</sub> to 817 <sub>H</sub> )	Destination IP address	The IP address of the communication target is stored. 00000000 <sub>H</sub> : No error (default) or an error lower than the IP level 00000001 <sub>H</sub> to DFFFFFFF <sub>H</sub> : IP address of the communication target FFFFFFF <sub>H</sub> : Broadcast data received

Address	Name	Description																														
2072 to 2075 (818 <sub>H</sub> to 81B <sub>H</sub> )	Date and time	The date and time of the error is stored in the following BCD code. <table border="1" style="margin-left: auto; margin-right: auto;"> <tr> <td style="text-align: center;">b15</td> <td style="text-align: center;">~</td> <td style="text-align: center;">b8</td> <td style="text-align: center;">b7</td> <td style="text-align: center;">~</td> <td style="text-align: center;">b0</td> </tr> <tr> <td style="text-align: center;">2072(818<sub>H</sub>)</td> <td style="text-align: center;">Month (01<sub>H</sub> to 12<sub>H</sub>)</td> <td colspan="4" style="text-align: center;">Year (00<sub>H</sub> to 99<sub>H</sub>), last 2 digits</td> </tr> <tr> <td style="text-align: center;">2073(819<sub>H</sub>)</td> <td style="text-align: center;">Hour (00<sub>H</sub> to 23<sub>H</sub>)</td> <td colspan="4" style="text-align: center;">Day (01<sub>H</sub> to 31<sub>H</sub>)</td> </tr> <tr> <td style="text-align: center;">2074(81A<sub>H</sub>)</td> <td style="text-align: center;">Second (00<sub>H</sub> to 59<sub>H</sub>)</td> <td colspan="4" style="text-align: center;">Minute (00<sub>H</sub> to 59<sub>H</sub>)</td> </tr> <tr> <td style="text-align: center;">2075(81B<sub>H</sub>)</td> <td colspan="2" style="text-align: center;">Year (00<sub>H</sub> to 99<sub>H</sub>), first 2 digits</td> <td colspan="3" style="text-align: center;">Day of week (00<sub>H</sub> to 06<sub>H</sub>) 00<sub>H</sub> (Sun.) to 06<sub>H</sub> (Sat.)</td> </tr> </table>	b15	~	b8	b7	~	b0	2072(818 <sub>H</sub> )	Month (01 <sub>H</sub> to 12 <sub>H</sub> )	Year (00 <sub>H</sub> to 99 <sub>H</sub> ), last 2 digits				2073(819 <sub>H</sub> )	Hour (00 <sub>H</sub> to 23 <sub>H</sub> )	Day (01 <sub>H</sub> to 31 <sub>H</sub> )				2074(81A <sub>H</sub> )	Second (00 <sub>H</sub> to 59 <sub>H</sub> )	Minute (00 <sub>H</sub> to 59 <sub>H</sub> )				2075(81B <sub>H</sub> )	Year (00 <sub>H</sub> to 99 <sub>H</sub> ), first 2 digits		Day of week (00 <sub>H</sub> to 06 <sub>H</sub> ) 00 <sub>H</sub> (Sun.) to 06 <sub>H</sub> (Sat.)		
b15	~	b8	b7	~	b0																											
2072(818 <sub>H</sub> )	Month (01 <sub>H</sub> to 12 <sub>H</sub> )	Year (00 <sub>H</sub> to 99 <sub>H</sub> ), last 2 digits																														
2073(819 <sub>H</sub> )	Hour (00 <sub>H</sub> to 23 <sub>H</sub> )	Day (01 <sub>H</sub> to 31 <sub>H</sub> )																														
2074(81A <sub>H</sub> )	Second (00 <sub>H</sub> to 59 <sub>H</sub> )	Minute (00 <sub>H</sub> to 59 <sub>H</sub> )																														
2075(81B <sub>H</sub> )	Year (00 <sub>H</sub> to 99 <sub>H</sub> ), first 2 digits		Day of week (00 <sub>H</sub> to 06 <sub>H</sub> ) 00 <sub>H</sub> (Sun.) to 06 <sub>H</sub> (Sat.)																													
2076 (81C <sub>H</sub> )	Command code	A command code for the message of the error is stored. A value is stored only when the error occurred in SLMP communication. 0: No error (default) or an error lower than the TCP or UDP level Other than 0: Command code																														
2077 (81D <sub>H</sub> )	Subcommand code	A subcommand code for the message of the error is stored. A value is stored only when the error occurred in SLMP communication. 0: No error (default) or an error lower than the TCP or UDP level Other than 0: Subcommand code																														
2078 to 2079 (81E <sub>H</sub> to 81F <sub>H</sub> )	System area	—																														

#### (4) Error log No.2 to No.64 (buffer memory address: 2080 to 3087 (820<sub>H</sub> to C0F<sub>H</sub>))

In the same sequence as error log No.1, information on error log No.2 to No.64 is stored.

## Appendix 1.5 Ethernet port line status

#### (1) Communication status (buffer memory address: 3328 (D00<sub>H</sub>))

The communication status data of the Ethernet port is stored in the following bit pattern.

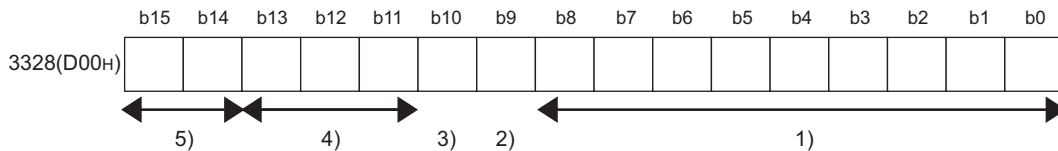

- 1) Empty
- 2) Communication mode
  - 0: Half-duplex
  - 1: Full-duplex
- 3) Connection status
  - 0: Hub or external device not connected or disconnected
  - 1: Hub or external device connected
- 4) Empty
- 5) Data transmission speed
  - 00: Empty
  - 01: Operating at 100BASE-TX
  - 10: Operating at 1000BASE-T
  - 11: Empty

## Appendix 1.6 Ethernet port connection status data area

A

### (1) Open completion signal (buffer memory address: 5376 to 5377 (1500<sub>H</sub> to 1501<sub>H</sub>))

The open status of each Connection is stored in the following bit pattern.

In the case of UDP protocol, when the Ethernet adapter module becomes ready for operation, Open completed (1) is set.

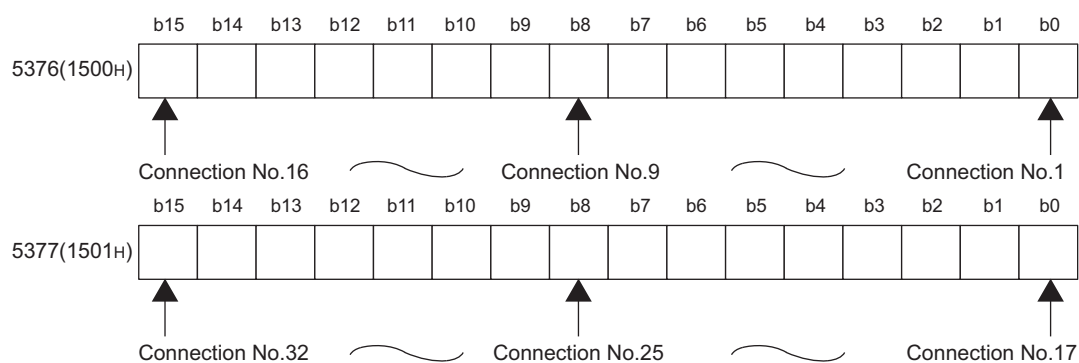

OFF: Open not completed, ON: Open completed

## Appendix 1.7 On-demand function data sending area

For the buffer memories used for the on-demand function, refer to the following. (☞ Page 90, Section 7.2)

## Appendix 2 Link Special Relay (SB) List

The link special relay (SB) is turned on or off depending on various factors generated during data link. The data link error status can be confirmed by using it in the program.



Do not turn on or off any link special relay (SB) since the system uses all of the area. Doing so may result in malfunction of the system.

Number	Name	Description
SB0047	Baton pass status of the own station	The baton pass status of the own station (transient transmission can be performed) is stored. OFF: Normal ON: Abnormal When an error occurs, the cause can be identified in Baton pass status of the own station (SW0047) and Cause of baton pass interruption (SW0048).
SB004F	Operating station No. status	Information on which values are used for operation, the network No. and station No. values set in "CC-Link IE Field Network" of PLC Parameter or those set in the CC-Link IE Field Network diagnostics, is stored. OFF: Values set in "CC-Link IE Field Network" of PLC Parameter ON: Values set in the CC-Link IE Field Network diagnostics When no parameter is set for the Ethernet adapter module, this area is turned on.
SB006A	PORT1 linkup status (own station)	The linkup status of PORT1 (own station) is stored. OFF: Linkup ON: Linkdown The time between the power-on and linkup after the Ethernet cable is connected may vary. It usually takes a few seconds. Note, however, that the time may be extended further if the linkup process is repeated depending on the status of the device on the line.
SB006B	PORT2 linkup status (own station)	The linkup status of PORT2 (own station) is stored. OFF: Linkup ON: Linkdown The time between the power-on and linkup after the Ethernet cable is connected may vary. It usually takes a few seconds. Note, however, that the time may be extended further if the linkup process is repeated depending on the status of the device on the line.
SB007F	IP address setting status	The status of whether the IP address was sent or not from the master station is stored. OFF: Not received ON: Received



## Appendix 3 Link Special Register (SW) List

In the link special registers (SW), data link information is stored as numerical values. By using them in programs, the location and cause of failure can be checked.

### Point

Do not write data to any link special register (SW) since the system uses all of the area. Doing so may result in malfunction of the system.

Number	Name	Description
SW0040	Network No.	The network number of the own station is stored. Range: 1 to 239
SW0042	Station No.	The station number of the own station is stored. Range: 1 to 120 (slave station), FFFF <sub>H</sub> (station number not set)
SW0043	Mode status	The mode of the own station is stored. 0: Online 2: Offline 9: Unit test
SW0047	Baton pass status (own station)	The communication status of the own station is stored. 0: Data link in progress 2: Data link stopped, baton pass in progress 3: Baton pass stopped 5: Offline
SW0048	Cause of baton pass interruption	The cause of communication (baton pass) interruption of the own station is stored. 00 <sub>H</sub> : Normal communication or at power-on 30 <sub>H</sub> : Cable disconnection 33 <sub>H</sub> : Being disconnected from or reconnected to the network 40 <sub>H</sub> : Offline mode
SW0049	Cause of data link stop	The cause of the data link stop (own station) is stored. 00 <sub>H</sub> : Normal communication or at power-on 01 <sub>H</sub> : Stop command 02 <sub>H</sub> : Monitoring timeout 10 <sub>H</sub> : Parameters not received 11 <sub>H</sub> : Station No. (own station) out of range 12 <sub>H</sub> : Own station specified as reserved station 13 <sub>H</sub> : Station No. duplication (own station) 16 <sub>H</sub> : No station No. setting 18 <sub>H</sub> : Parameter error 19 <sub>H</sub> : Parameter transfer in progress 1A <sub>H</sub> : Station type mismatch 20 <sub>H</sub> : Error detected
SW004B	Module status (own station)	The own station status is stored. 01 <sub>H</sub> : STOP (normal) 02 <sub>H</sub> : STOP (stop error) 03 <sub>H</sub> : STOP (continuation error) 04 <sub>H</sub> : RUN (normal) 05 <sub>H</sub> : RUN (continuation error) 0F <sub>H</sub> : Offline or initial processing

Number	Name	Description
SW0064	Connection status (own station)	<p>The connection status of the own station is stored.</p> <p>00<sub>H</sub>: Normal</p> <p>01<sub>H</sub>: Normal (communicating on PORT1, cable disconnected on PORT2)</p> <p>04<sub>H</sub>: Normal (loopback communicating on PORT1, cable disconnected on PORT2)</p> <p>10<sub>H</sub>: Normal (cable disconnected on PORT1, communicating on PORT2)</p> <p>11<sub>H</sub>: Disconnected (cables disconnected on PORT1 and PORT2)</p> <p>12<sub>H</sub>: Disconnected (cable disconnected on PORT1, PORT2 line being established)</p> <p>21<sub>H</sub>: Disconnected (PORT1 line being established, cable disconnected on PORT2)</p> <p>22<sub>H</sub>: Disconnected (PORT1 and PORT2 lines being established)</p> <p>40<sub>H</sub>: Normal (cable disconnected on PORT1, loopback communicating on PORT2)</p>

## Appendix 4 Special Relay (SM) List

A

The special relays (SM) are internal relays whose applications are predetermined in the Ethernet adapter module. However, they can be turned on or off as necessary for control of the Ethernet adapter module.

The following table shows how to read the special relay list.

Item	Description
No.	Special relay (SM) number
Name	Special relay (SM) name
Description	Content of the special relay (SM)
Details	Detailed description of the special relay (SM)
Set by (Set timing)	Setting side and, in the case of system setting, the timing <b>■&lt;Set by&gt;</b> <ul style="list-style-type: none"> <li>• S: Set by the system</li> <li>• U: Set by the user (by a dedicated instruction, SLMP, etc.)</li> <li>• S/U: Set by both the system and user</li> </ul> <b>■&lt;Set timing&gt;</b> Only in the case of system setting, the timing is indicated. <ul style="list-style-type: none"> <li>• Initial: Set during initial processing (after power-on or reset)</li> <li>• Status change: Set when the operating status is changed.</li> <li>• Error: Set when an error occurred.</li> <li>• Write: Set when data are written.</li> </ul>

### Point

Do not change any system-set special relay by using a dedicated instruction or SLMP. Doing so may result in a system down or a communication failure.

## (1) Diagnostic information

Number	Name	Description	Details	Set by (Set timing)
SM0	Diagnostic error	OFF: No error ON: Error	Turns on if an error is detected by the diagnostics. Stays on even if it returns to normal.	S (Error)
SM1	Self-diagnostic error	OFF: No self-diagnostic error ON: Self-diagnostic error	Turns on if an error is detected by the self-diagnostics. Stays on even if it returns to normal.	
SM5	Common error information	OFF: No common error information ON: Common error information	Turns on if there is any common error information when SM0 turns on.	
SM16	Individual error information	OFF: No individual error information ON: Individual error information	Turns on if there is any individual error information when SM0 turns on.	
SM50	Error clear	OFF→ON: Error clear	Clears an error.	U
SM53	DC DOWN detection	OFF: No DC DOWN ON: DC DOWN detected	Turns on if a momentary power failure of 10ms or less occurs. The status is reset when power is turned on from off.	S (Error)

## (2) Drive information

Number	Name	Description	Details	Set by (Set timing)
SM681	Parameter memory writing flag	ON: Writing OFF: Not writing	Turns on while writing parameters to a flash ROM, and turns off when the writing is completed.	S (Write)
SM682	Parameter memory rewrite count error flag	ON: Rewrite count reached 100000 OFF: Rewrite count less than 100000	Turns on when the count of rewriting parameters to a flash ROM reaches 100000. (The Ethernet adapter module needs to be replaced.)	

## Appendix 5 Special Register (SD) List

A

The special registers (SD) are internal registers whose applications are predetermined in the Ethernet adapter module. However, data can be written as necessary for control of the Ethernet adapter module. Data are stored in the special registers as binary values unless otherwise specified.

The following table shows how to read the special register list.

Item	Description
No.	Special register (SD) number
Name	Special register (SD) name
Description	Content of the special register (SD)
Details	Detailed description of the special register (SD)
Set by (Set timing)	Setting side and, in the case of system setting, the timing <b>■Set by</b> <ul style="list-style-type: none"> <li>• S: Set by the system</li> <li>• U: Set by the user (by a dedicated instruction, SLMP, etc.)</li> <li>• S/U: Set by both the system and user</li> </ul> <b>■Set timing</b> Only in the case of system setting, the timing is indicated. <ul style="list-style-type: none"> <li>• Initial: Set during initial processing (after power-on or reset)</li> <li>• Status change: Set when the operating status is changed.</li> <li>• Error: Set when an error occurred.</li> <li>• Switch change: Set when the switch is changed.</li> <li>• Write: Set when data are written.</li> </ul>

### Point

Do not change any system-set special register by using a dedicated instruction or SLMP. Doing so may result in a system down or a communication failure.

## (1) Diagnostic information

Number	Name	Description	Details	Set by (Set timing)						
SD0	Diagnostic error	Diagnostic error code	When an error is detected in the diagnostics, an error code is stored. The data is the same as the latest information in the error history and system error history.							
SD1	Clock time of diagnostic error	Clock time of diagnostic error	Data of the year (last two digits) and month (2-digit BCD code) when SD0 data were updated are stored. <table border="1" style="margin-left: auto; margin-right: auto;"> <tr> <td>b15 to b8</td> <td>b7 to b0</td> <td>(Example) January, 2010</td> </tr> <tr> <td>Year (0 to 99)</td> <td>Month (1 to 12)</td> <td>1001H</td> </tr> </table> <p>The clock of the Ethernet adapter module synchronizes the clock of the master station. (Page 30, Section 3.2)</p>	b15 to b8	b7 to b0	(Example) January, 2010	Year (0 to 99)	Month (1 to 12)	1001H	S (Error)
b15 to b8			b7 to b0	(Example) January, 2010						
Year (0 to 99)			Month (1 to 12)	1001H						
SD2	Data of the day and hour (2-digit BCD code) when SD0 data were updated are stored. <table border="1" style="margin-left: auto; margin-right: auto;"> <tr> <td>b15 to b8</td> <td>b7 to b0</td> <td>(Example) 10 a.m. on 25th</td> </tr> <tr> <td>Day (1 to 31)</td> <td>Hour (0 to 23)</td> <td>2510H</td> </tr> </table> <p>The clock of the Ethernet adapter module synchronizes the clock of the master station. (Page 30, Section 3.2)</p>	b15 to b8	b7 to b0	(Example) 10 a.m. on 25th	Day (1 to 31)	Hour (0 to 23)	2510H			
b15 to b8	b7 to b0	(Example) 10 a.m. on 25th								
Day (1 to 31)	Hour (0 to 23)	2510H								
SD3	Data of the minute and second (2-digit BCD code) when SD0 data were updated are stored. <table border="1" style="margin-left: auto; margin-right: auto;"> <tr> <td>b15 to b8</td> <td>b7 to b0</td> <td>(Example) 35 min. 48 sec.</td> </tr> <tr> <td>Minutes (0 to 59)</td> <td>Seconds (0 to 59)</td> <td>3548H</td> </tr> </table> <p>The clock of the Ethernet adapter module synchronizes the clock of the master station. (Page 30, Section 3.2)</p>	b15 to b8	b7 to b0	(Example) 35 min. 48 sec.	Minutes (0 to 59)	Seconds (0 to 59)	3548H			
b15 to b8	b7 to b0	(Example) 35 min. 48 sec.								
Minutes (0 to 59)	Seconds (0 to 59)	3548H								
SD4	Error information category	Error information category code	<p>Data are stored in the common information (SD5 to SD15) or individual information (SD16 to SD26) areas respectively. A category code that determines what type of error information is stored.</p> <table border="1" style="margin-left: auto; margin-right: auto;"> <tr> <td>b15 to b8</td> <td>b7 to b0</td> </tr> <tr> <td>Individual information category codes</td> <td>Common information category codes</td> </tr> </table> <p>Any of the following are stored in the common information category codes area.            0: None            1: Module No. (slot No.)            2: File name            3: Time (set value)</p> <p>Any of the following are stored in the individual information category codes area.            0: None            1: (Empty)            2: None            3: Time (measured value)            4: None            5: Parameter No.            6: None            7: None            8: None            9: Failure information            12: None            13: None</p>	b15 to b8	b7 to b0	Individual information category codes	Common information category codes	S (Error)		
b15 to b8	b7 to b0									
Individual information category codes	Common information category codes									



Number	Name	Description	Details	Set by (Set timing)																																																							
SD5	Common error information	Common error information	<p>Three types of error common information on the error code (SD0) are stored.</p> <p>By common information category codes in SD4, the type of the common error information can be recognized.</p> <p>1) Module No. (slot No.) → Unused (fixed to 0)</p> <p>2) File name</p> <table border="1" style="margin-left: 40px;"> <thead> <tr> <th>Number</th> <th>Meaning</th> </tr> </thead> <tbody> <tr> <td>SD5</td> <td>(Empty)</td> </tr> <tr> <td>SD6</td> <td rowspan="4">File name (ASCII code: 8 characters)</td> </tr> <tr> <td>SD7</td> </tr> <tr> <td>SD8</td> </tr> <tr> <td>SD9</td> </tr> <tr> <td>SD10</td> <td>Extension *1   2EH(.)</td> </tr> <tr> <td>SD11</td> <td>(ASCII code: 3 characters)</td> </tr> <tr> <td>SD12</td> <td rowspan="4">(Empty)</td> </tr> <tr> <td>SD13</td> </tr> <tr> <td>SD14</td> </tr> <tr> <td>SD15</td> </tr> </tbody> </table> <p>(Example) File name =                      ABCDEFGH. IJK                      b15 to b8 b7 to b0                      42H(B) 41H(A)                      44H(D) 43H(C)                      46H(F) 45H(E)                      48H(H) 47H(G)                      49H(I) 2EH(.)                      4BH(K) 4AH(J)</p> <p>3) Time (set value)</p> <table border="1" style="margin-left: 40px;"> <thead> <tr> <th>Number</th> <th>Meaning</th> </tr> </thead> <tbody> <tr> <td>SD5</td> <td>Time : 1μs units (0 to 999μs)</td> </tr> <tr> <td>SD6</td> <td>Time : 1ms units (0 to 65535ms)</td> </tr> <tr> <td>SD7</td> <td rowspan="10">(Empty)</td> </tr> <tr> <td>SD8</td> </tr> <tr> <td>SD9</td> </tr> <tr> <td>SD10</td> </tr> <tr> <td>SD11</td> </tr> <tr> <td>SD12</td> </tr> <tr> <td>SD13</td> </tr> <tr> <td>SD14</td> </tr> <tr> <td>SD15</td> </tr> </tbody> </table>	Number	Meaning	SD5	(Empty)	SD6	File name (ASCII code: 8 characters)	SD7	SD8	SD9	SD10	Extension *1   2EH(.)	SD11	(ASCII code: 3 characters)	SD12	(Empty)	SD13	SD14	SD15	Number	Meaning	SD5	Time : 1μs units (0 to 999μs)	SD6	Time : 1ms units (0 to 65535ms)	SD7	(Empty)	SD8	SD9	SD10	SD11	SD12	SD13	SD14	SD15	S (Error)																					
Number			Meaning																																																								
SD5			(Empty)																																																								
SD6			File name (ASCII code: 8 characters)																																																								
SD7																																																											
SD8																																																											
SD9																																																											
SD10			Extension *1   2EH(.)																																																								
SD11			(ASCII code: 3 characters)																																																								
SD12			(Empty)																																																								
SD13																																																											
SD14																																																											
SD15																																																											
Number			Meaning																																																								
SD5			Time : 1μs units (0 to 999μs)																																																								
SD6	Time : 1ms units (0 to 65535ms)																																																										
SD7	(Empty)																																																										
SD8																																																											
SD9																																																											
SD10																																																											
SD11																																																											
SD12																																																											
SD13																																																											
SD14																																																											
SD15																																																											
SD16		Individual error information	Individual error information	<p>Four types of individual information on the error code (SD0) are stored.</p> <p>By individual information category code in SD4, the type of the individual error information can be recognized.</p> <p>1: (Empty)</p> <p>3: Time (measured value)</p> <table border="1" style="margin-left: 40px;"> <thead> <tr> <th>Number</th> <th>Meaning</th> </tr> </thead> <tbody> <tr> <td>SD16</td> <td>Time : 1μs units (0 to 999μs)</td> </tr> <tr> <td>SD17</td> <td>Time : 1ms units (0 to 65535ms)</td> </tr> <tr> <td>SD18</td> <td rowspan="10">(Empty)</td> </tr> <tr> <td>SD19</td> </tr> <tr> <td>SD20</td> </tr> <tr> <td>SD21</td> </tr> <tr> <td>SD22</td> </tr> <tr> <td>SD23</td> </tr> <tr> <td>SD24</td> </tr> <tr> <td>SD25</td> </tr> <tr> <td>SD26</td> </tr> </tbody> </table> <p>5: Parameter No.</p> <table border="1" style="margin-left: 40px;"> <thead> <tr> <th>Number</th> <th>Meaning</th> </tr> </thead> <tbody> <tr> <td>SD16</td> <td>Parameter No.</td> </tr> <tr> <td>SD17</td> <td rowspan="10">(Empty)</td> </tr> <tr> <td>SD18</td> </tr> <tr> <td>SD19</td> </tr> <tr> <td>SD20</td> </tr> <tr> <td>SD21</td> </tr> <tr> <td>SD22</td> </tr> <tr> <td>SD23</td> </tr> <tr> <td>SD24</td> </tr> <tr> <td>SD25</td> </tr> <tr> <td>SD26</td> </tr> </tbody> </table> <p>9: Failure information</p> <table border="1" style="margin-left: 40px;"> <thead> <tr> <th>Number</th> <th>Meaning</th> </tr> </thead> <tbody> <tr> <td>SD16</td> <td>Failure information 1</td> </tr> <tr> <td>SD17</td> <td>Failure information 2</td> </tr> <tr> <td>SD18</td> <td>Failure information 3</td> </tr> <tr> <td>SD19</td> <td>Failure information 4</td> </tr> <tr> <td>SD20</td> <td>Failure information 5</td> </tr> <tr> <td>SD21</td> <td>Failure information 6</td> </tr> <tr> <td>SD22</td> <td>Failure information 7</td> </tr> <tr> <td>SD23</td> <td>Failure information 8</td> </tr> <tr> <td>SD24</td> <td>Failure information 9</td> </tr> <tr> <td>SD25</td> <td>Failure information 10</td> </tr> <tr> <td>SD26</td> <td>Failure information 11</td> </tr> </tbody> </table>	Number	Meaning	SD16	Time : 1μs units (0 to 999μs)	SD17	Time : 1ms units (0 to 65535ms)	SD18	(Empty)	SD19	SD20	SD21	SD22	SD23	SD24	SD25	SD26	Number	Meaning	SD16	Parameter No.	SD17	(Empty)	SD18	SD19	SD20	SD21	SD22	SD23	SD24	SD25	SD26	Number	Meaning	SD16	Failure information 1	SD17	Failure information 2	SD18	Failure information 3	SD19	Failure information 4	SD20	Failure information 5	SD21	Failure information 6	SD22	Failure information 7	SD23	Failure information 8	SD24	Failure information 9	SD25	Failure information 10	SD26	Failure information 11
Number	Meaning																																																										
SD16	Time : 1μs units (0 to 999μs)																																																										
SD17	Time : 1ms units (0 to 65535ms)																																																										
SD18	(Empty)																																																										
SD19																																																											
SD20																																																											
SD21																																																											
SD22																																																											
SD23																																																											
SD24																																																											
SD25																																																											
SD26																																																											
Number		Meaning																																																									
SD16	Parameter No.																																																										
SD17	(Empty)																																																										
SD18																																																											
SD19																																																											
SD20																																																											
SD21																																																											
SD22																																																											
SD23																																																											
SD24																																																											
SD25																																																											
SD26																																																											
Number	Meaning																																																										
SD16	Failure information 1																																																										
SD17	Failure information 2																																																										
SD18	Failure information 3																																																										
SD19	Failure information 4																																																										
SD20	Failure information 5																																																										
SD21	Failure information 6																																																										
SD22	Failure information 7																																																										
SD23	Failure information 8																																																										
SD24	Failure information 9																																																										
SD25	Failure information 10																																																										
SD26	Failure information 11																																																										
SD17	SD26																																																										
SD18																																																											
SD19																																																											
SD20																																																											
SD21																																																											
SD22																																																											
SD23																																																											
SD24																																																											
SD25																																																											
SD26																																																											

Number	Name	Description	Details	Set by (Set timing)
SD50	Error clear	Error code to be cleared	The error code to be cleared is stored.	U
SD53	DC DOWN detection	DC DOWN detection count	Every time the input voltage of the Ethernet adapter module drops to 65% of the rated voltage (DC power), the stored value is incremented by one. The counter repeats cycles of 0 → 32767 → -32768 → 0.	S (Error)

\*1 The extension name is listed below.

SD <sub>n</sub> Upper 8 bits	SD <sub>n+1</sub>		Extension name	File type
	Lower 8 bits	Upper 8 bits		
51 <sub>H</sub>	50 <sub>H</sub>	41 <sub>H</sub>	QPA	Parameter

## (2) System information

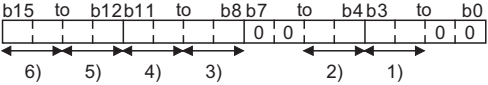
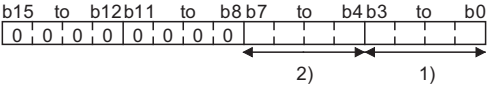
Number	Name	Description	Details	Set by (Set timing)
SD200	Switch status	Ethernet adapter module switch status	The switch status of the Ethernet adapter module is stored. 0: RUN 1: STOP/RESET	S (Switch change)
SD201	LED status	LED status	The LED status of the Ethernet adapter module is stored. 0: Off 1: On 2: Flashing   1) ERR. 2) D LINK 3) RD 4) SD 5) MODE 6) RUN (In the offline mode, RD and SD are always off.)	S (Status change)
SD203	Operating status	Operating status	The operating status of the Ethernet adapter module is stored.   1) Operating status 0: RUN 2: STOP 2) Cause of STOP The latest cause of the change in the operation status is stored. 0: STOP switch 1: Master station STOP 2: Remote operation from GX Works2, etc. 4: Error	S (Status change)



**A**

Number	Name	Description	Details	Set by (Set timing)
SD290	Device assignment 1	Number of points assigned to X	The number of X points is stored (fixed to 8192).	S (Initial)
SD291		Number of points assigned to Y	The number of Y points is stored (fixed to 8192).	
SD296		Number of points assigned to SB	The number of SB points is stored (fixed to 8192).	
SD303		Number of points assigned to W	The number of W points is stored (fixed to 8192).	
SD304		Number of points assigned to SW	The number of SW points is stored (fixed to 8192).	

Appendix 5 Special Register (SD) List

### (3) Drive information

Number	Name	Description	Details	Set by (Set timing)
SD681	Parameter memory write (transfer) status	Write (transfer) status indication (%)	The progress of writing (transfer) to the parameter memory (flash ROM) is stored as percentage (0 to 100%). Upon instruction of write (transfer), 0 is set.	S (Write)
SD682	Parameter memory write count index	Current write count index	A current index value for write count to the parameter memory (flash ROM) is stored as a 32-bit binary value. If the index value exceeds 100000, "FLASH ROM ERROR" (error code: A62 <sub>H</sub> ) will be detected. (The index value will be continued to be counted even after it exceeds 100000.)	
SD683			The write count is not equal to the index value. (Since the system has increased the write life of the parameter memory, the value increments by 1 for every two write operations.)	

# Appendix 6 Resetting Parameters to Factory Default Values

A

This section explains how to reset the parameters of the Ethernet adapter module to factory default values. Perform the following when an IP address set in the configuration tool is unknown.

## Point

Parameters other than IP addresses will be also reset to factory default values.

Repeat at intervals of less than 1s.

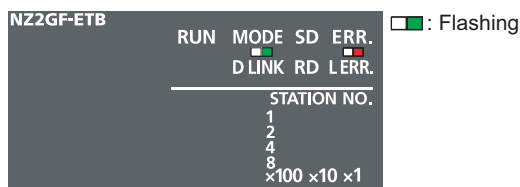
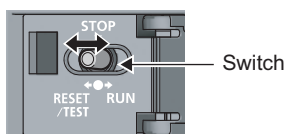

1. Power on the module.
2. Move the switch on the Ethernet adapter module from STOP → RESET/TEST → STOP in less than 1 second, and repeat this cycle ten times. (Then the MODE and ERR. LEDs start flashing.)

When canceling the reset operation, shift the switch to RUN.

1s or longer

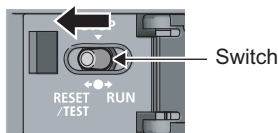

3. Move the switch to RESET/TEST and hold it for 1 second.

## Appendix 7 Access Codes and an Attribute Code

The following shows the access codes and an attribute code that are set for accessing the Ethernet adapter module with the RIRD or RIWT instruction from the master/local module.

Device *1	Name	Device type		Unit	Access code	Attribute code
		Bit	Word			
X	Input	○	—	Hexadecimal	01 <sub>H</sub>	05 <sub>H</sub>
Y	Output	○	—	Hexadecimal	02 <sub>H</sub>	
W	Link register	—	○	Hexadecimal	24 <sub>H</sub>	
SB	Link special relay	○	—	Hexadecimal	63 <sub>H</sub>	
SW	Link special register	—	○	Hexadecimal	64 <sub>H</sub>	
SM	Special relay	○	—	Decimal	43 <sub>H</sub>	
SD	Special register	—	○	Decimal	44 <sub>H</sub>	

\*1 Devices other than the above are not accessible.  
To access a bit device, specify 0 or a multiple of 16.

# Appendix 8 EMC and Low Voltage Directives

A

In each country, laws and regulations concerning electromagnetic compatibility (EMC) and electrical safety are enacted. For the products sold in the European countries, compliance with the EU's EMC Directive has been a legal obligation as EMC regulation since 1996, as well as the EU's Low Voltage Directive as electrical safety regulation since 1997.

Manufacturers who recognize their products are compliant with the EMC and Low Voltage Directives are required to attach a "CE marking" on their products in European countries.

In some other countries and regions, manufacturers are required to make their products compliant with applicable laws or regulations and attach a certification mark on the products as well (such as UK Conformity Assessed (UKCA) marking in the UK, and Korea Certification (KC) marking in South Korea).

Each country works to make their regulatory requirements consistent across countries based on international standards. When the requirements are consistent, measures to comply with the EMC and electrical safety regulations become common across countries.

The UK and South Korea have enacted EMC regulations whose requirements are consistent with those of the EMC Directive.

The UK has also enacted electrical safety regulations whose requirements are consistent with those of the Low Voltage Directive. In this section, the requirements of the EMC and Low Voltage Directives are described as examples of those of the EMC and electrical safety regulations.

## Appendix 8.1 Measures to comply with the EMC Directive

The EMC Directive specifies that "products placed on the market must be so constructed that they do not cause excessive electromagnetic interference (emissions) and are not unduly affected by electromagnetic interference (immunity)".

This section summarizes the precautions on compliance with the EMC Directive of the machinery constructed with the Ethernet adapter module.

These precautions are based on the requirements and the standards of the regulation, however, it does not guarantee that the entire machinery constructed according to the descriptions will comply with the above-mentioned directives.

Machine manufacturers are required to determine the method and judgment for complying with the EMC Directive at their discretion.

### (1) EMC Directive related standards

#### (a) Emission requirements

Specification	Test item	Test details	Standard value
EN61131-2: 2007	CISPR16-2-3 Radiated emission <sup>*2</sup>	Radio waves from the product are measured.	<ul style="list-style-type: none"> <li>• 30M-230MHz QP: 40dB<math>\mu</math>V/m (10m in measurement range)<sup>*1</sup></li> <li>• 230M-1000MHz QP: 47dB<math>\mu</math>V/m (10m in measurement range)</li> </ul>
	CISPR16-2-1, CISPR16-1-2 Conducted emission <sup>*2</sup>	Noise from the product to the power line is measured.	<ul style="list-style-type: none"> <li>• 150k-500kHz QP: 79dB, Mean: 66dB<sup>*1</sup></li> <li>• 500k-30MHz QP: 73dB, Mean: 60dB</li> </ul>

\*1 QP: Quasi-peak value, Mean: Average value

\*2 The Ethernet adapter module is an open-type device (a device designed to be housed inside other equipment) and must be installed inside a conductive control panel. The corresponding tests were conducted with the Ethernet adapter module installed inside a control panel.

### (b) Immunity requirements

Specification	Test item	Test details	Standard value
EN61131-2: 2007	EN61000-4-2 Electrostatic discharge immunity* <sup>1</sup>	Immunity test in which electrostatic is applied to the cabinet of the equipment.	<ul style="list-style-type: none"> <li>• 8kV Air discharge</li> <li>• 4kV Contact discharge</li> </ul>
	EN61000-4-3 Radiated, radio-frequency, electromagnetic field immunity* <sup>1</sup>	Immunity test in which electric fields are irradiated to the product.	80% AM modulation @1kHz <ul style="list-style-type: none"> <li>• 80M-1000MHz: 10V/m</li> <li>• 1.4G-2.0GHz: 3V/m</li> <li>• 2.0G-2.7GHz: 1V/m</li> </ul>
	EN61000-4-4 Electrical fast transient/burst immunity* <sup>1</sup>	Immunity test in which burst noise is applied to the power line and signal line.	<ul style="list-style-type: none"> <li>• AC/DC main power, I/O power, AC I/O (unshielded): 2kV</li> <li>• DC I/O, analog, communication: 1kV</li> </ul>
	EN61000-4-5 Surge immunity* <sup>1</sup>	Immunity test in which lightning surge is applied to the power line and signal line.	<ul style="list-style-type: none"> <li>• AC power line, AC I/O power, AC I/O (unshielded): 2kV CM, 1kV DM</li> <li>• DC power line, DC I/O power: 0.5kV CM, DM</li> <li>• DC I/O, AC I/O (shielded), analog*<sup>2</sup>, communication: 1kV CM</li> </ul>
	EN61000-4-6 Immunity to conducted disturbances, induced by radio-frequency fields* <sup>1</sup>	Immunity test in which high frequency noise is applied to the power line and signal line	0.15M-80MHz, 80% AM modulation @1kHz, 10Vrms
	EN61000-4-8 Power-frequency magnetic field immunity* <sup>1</sup>	Immunity test in which the product is installed in inductive magnetic field	50Hz/60Hz, 30A/m
	EN61000-4-11 Voltage dips and interruption immunity* <sup>1</sup>	Immunity test in which power supply voltage is momentarily interrupted	<ul style="list-style-type: none"> <li>• Apply at 0%, 0.5 cycles and zero-cross point</li> <li>• 0%, 250/300 cycles (50/60Hz)</li> <li>• 40%, 10/12 cycles (50/60Hz)</li> <li>• 70%, 25/30 cycles (50/60Hz)</li> </ul>

\*1 The Ethernet adapter module is an open-type device (a device designed to be housed inside other equipment) and must be installed inside a conductive control panel. The corresponding tests were conducted with the Ethernet adapter module installed inside a control panel.

\*2 The accuracy of an analog-digital converter module may temporary vary within  $\pm 10\%$ .

## (2) Installation in a control panel

Ethernet adapter modules are open type devices and must be installed inside a control panel.

This ensures safety as well as effective shielding of electromagnetic noise that is generated from the Ethernet adapter module.

### (a) Control panel

- Use a conductive control panel.
- When securing the top or bottom plate using bolts, cover the grounding part on the control panel so that the part will not be painted.
- To ensure electrical contact between the inner plate and control panel, take measures such as covering the bolts so that conductivity can be ensured in the largest possible area.
- Ground the control panel with a thick ground cable so that low impedance can be ensured even at high frequencies.
- Holes in the control panel must be 10cm diameter or less. If the holes are larger than 10cm, radio wave may be emitted. In addition, because radio waves leak through a clearance between the control panel and its door, reduce the clearance as much as possible. The leakage of radio waves can be suppressed by the direct application of an EMI gasket on the paint surface.

Our tests have been carried out on a panel having the attenuation characteristics of 37 dB (max.) and 30 dB (mean) (measured by 3m method, 30 to 300MHz).

### (b) Wiring power and ground cables

- Provide a ground point near the power supply module. Ground the LG and FG terminals of the power supply part with the thickest and shortest ground cable (30cm or shorter) possible.

### (3) Cables

Use shielded cables for the cables which are connected to the Ethernet adapter module and run out from the control panel. If a shielded cable is not used or not grounded correctly, the noise immunity will not meet the specified value.

#### (a) Grounding a twisted pair cable

- Always use shielded twisted pair cables for connection to 10BASE-T and 100BASE-TX connectors. For the shielded twisted pair cable, strip a part of the jacket as shown below and ground the exposed shield section to the ground as much as possible.

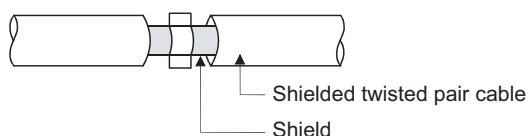

#### (b) CC-Link IE Field Network cables

The precautions for using CC-Link IE Field Network cables are described below.

- Be sure to use the cables for CC-Link IE Field Network (manufactured by Mitsubishi Electric System & Service Co., Ltd.: SCE5EW-S□M).
- Shielded cables should be used for CC-Link IE Field Network. Strip a part of the jacket as shown below and ground the exposed shield in the largest possible area.

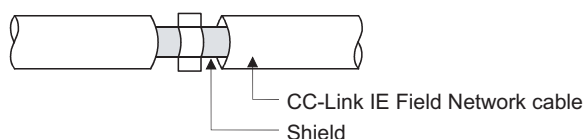

#### (c) Grounding cables with a cable clamp

Use shielded cables for external wiring and ground the shields of the external wiring cables to the control panel with the AD75CK-type cable clamping (Mitsubishi). (Ground the shield section 20 to 30cm away from the Ethernet adapter module.)

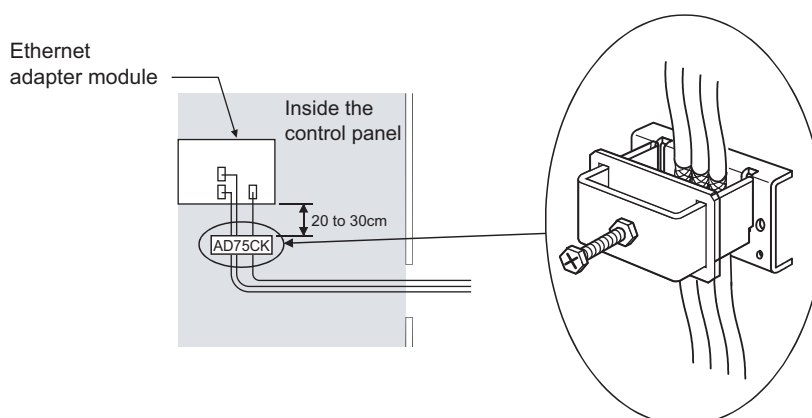

For details of the AD75CK, refer to the following.

 AD75CK-type Cable Clamping Instruction Manual



#### (4) External power supply

Use a CE-marked product for an external power supply and always ground the FG terminal.

(External power supply used for the tests conducted by Mitsubishi: TDK-Lambda DLP-120-24-1, IDEC PS5R-SF24)

#### (5) Power supply part

Always ground the LG and FG terminals after shunting them.

#### (6) Other measures

##### (a) Ferrite core

A ferrite core has the effect of reducing radiated noise in the 30MHz to 100MHz band.

It is recommended to attach ferrite cores if shield cables coming out from pulled out of the control panel do not provide sufficient shielding effects.

Note that the ferrite cores must be attached at the position closest to the cable hole inside the control panel. If attached at an improper position, the ferrite core will not produce any effect.

Attach a ferrite core to each power line as illustrated below.

- Example

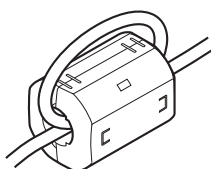

##### (b) Noise filter (power supply line filter)

A noise filter is a component which has an effect on conducted noise. Attaching the filter can suppress more noise. (The noise filter has the effect of reducing conducted noise of 10MHz or less.)

The precautions for attaching a noise filter are described below.

- Do not bundle the cables on the input side and output side of the noise filter. If bundled, the output side noise will be induced into the input side cables from which the noise was filtered.

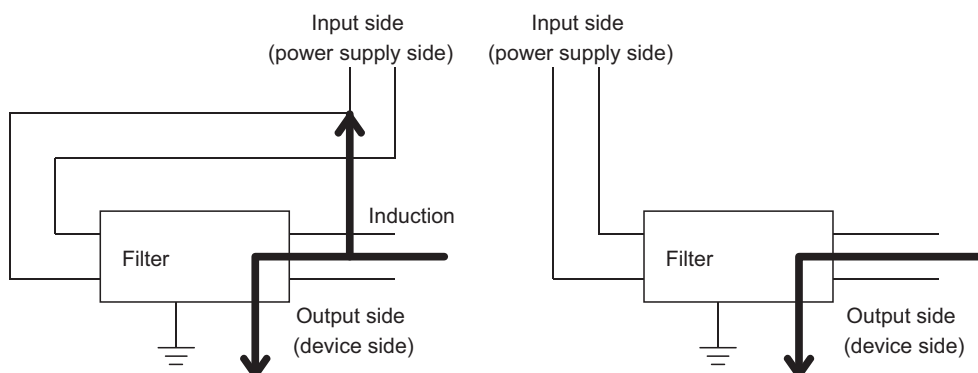

Noise will be induced when the input and output wires are bundled.

Separately install the input and output wires.

- Ground the noise filter grounding terminal to the control panel with the shortest cable possible (approx. 10cm).

## **Appendix 8.2**    **Measures to comply with the Low Voltage Directive**

---

The Ethernet adapter module operates at the rated voltage of 24VDC. The Low Voltage Directive is not applied to the modules that operate at the rated voltage of less than 50VAC and 75VDC.

# Appendix 9 Processing Time

A

This section describes processing time from the start of SLMP communication to the end of it. The processing time values given below are the values calculated under the assumption that the Read (command: 0401) and Write (command: 1401) are used.

## Point

The calculation formulas are provided for the case where the Ethernet adapter module communicates with an external device through a connection. The processing time may increase due to any of the following factors.

- Network load (line congestion)
- Window size of the external device connected to the Ethernet adapter module
- Number of connections concurrently used, and the system configuration

## Appendix 9.1 Transmission from the external device to the Ethernet adapter module

### (1) Calculation formula

$Tsf = Ke + (Kdt \times Df) + \text{ACK processing time of external device [ms]}$

- Tsf: The elapsed time between when the Ethernet adapter module receives request data from the external device and when until the requested processing is completed
- Ke, Kdt: Constant
- Df: Number of words in request message (excluding the header) + Number of words in response message (excluding the header)

Item		Command	Subcommand	Communication data code	TCP		UDP	
Type	Operation				Ke	Kdt	Ke	Kdt
Device	Read	0401	00 □ 1, 00 □ 0	Binary code	6	0.0028	6	0.0028
				ASCII code	6	0.0045	6	0.0040
	Write	1401	00 □ 1, 00 □ 0	Binary code	6	0.0030	6	0.0030
				ASCII code	6	0.0051	6	0.0044

### (2) Processing timing

Processing timing of the Ethernet adapter module is shown below.

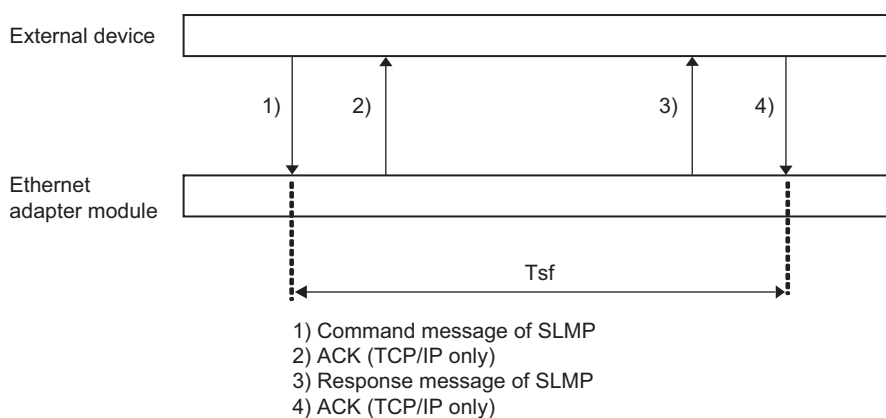

## Appendix 9.2 Transmission from the external device to a CPU module through the Ethernet adapter module

### (1) Calculation formula

$T_{sf} = K_e + (K_{dt} \times D_f) + 2 \times LS + Scr \times \text{Number of CPU module's sequence scans required for processing of the message} + \text{ACK processing time of external device [ms]}$

- $T_{sf}$ : The elapsed time between when the Ethernet adapter module receives request data from the external device and when until the requested processing is completed
- $K_e, K_{dt}$ : Constant
- $D_f$ : Number of words in request message (excluding the header) + Number of words in response message (excluding the header)
- $LS^{*1}$ : Link scan time of CC-Link IE Field Network
- $Scr^{*2}$ : Sequence scan time of CPU module

\*1 For processing time on CC-Link IE Field Network, refer to the following.

 User's manual for the master/local module used

\*2 For sequence scan time of the CPU module, refer to the following.

 User's manual of the CPU module used (Function Explanation, Program Fundamentals)

Item		Command	Subcommand	Communication data code	TCP		UDP	
Type	Operation				Ke	Kdt	Ke	Kdt
Device	Read	0401	00 □ 1, 00 □ 0	Binary code	6	0.0028	6	0.0028
				ASCII code	6	0.0045	6	0.0040
	Write	1401	00 □ 1, 00 □ 0	Binary code	6	0.0030	6	0.0030
				ASCII code	6	0.0051	6	0.0044

## (2) Processing timing

Processing timing of the Ethernet adapter module is shown below.

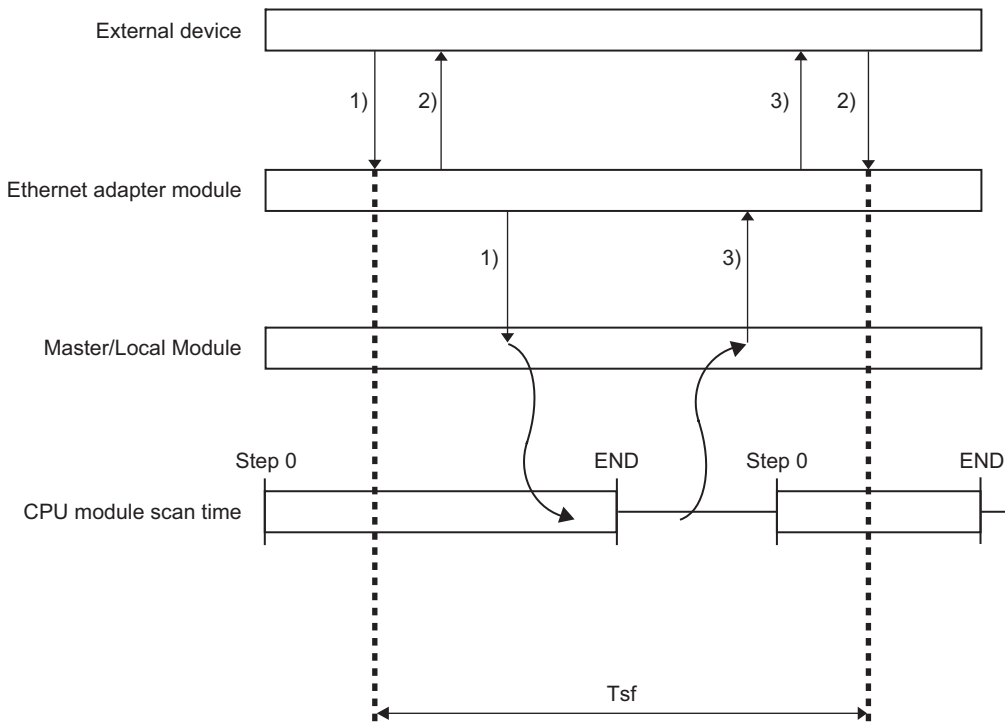

- 1) Command message of SLMP
- 2) ACK (TCP/IP only)
- 3) Response message of SLMP

# Appendix 10 New Function and Improved Function

The following table lists the new and improved functions.

New function and improved function	Module supporting the function (first five digits of the serial number)	Configuration tool supporting the function
Support the English version of the configuration tool* <sup>1</sup>	"12102" or later	Version 1.02C or later
L ERR. LED or L ER LED is on while the Ethernet adapter module is performing loopback. (☞ Page 24, Section 2.2)	"12102" or later	—
On-demand function (☞ Page 90, Section 7.2)	"13012" or later	—
The configuration tool is compatible with Windows®7		Version 1.04E or later
Configuration tool functions added (☞ Page 179, CHAPTER 10) <ul style="list-style-type: none"> <li>• Device/buffer memory batch monitor</li> <li>• Module information display</li> <li>• Error details display</li> <li>• Turning off the COM.ERR.LED on the configuration tool</li> </ul>		
Support of the access that specifies the master and submaster stations (When 7D <sub>H</sub> (specified control station/master station) is selected for the station number of the request message of SLMP, the master station can be always accessed.* <sup>2</sup> )	"14022" or later	—
Support of broadcast communications of the on-demand function (☞ Page 96, Section 7.2.5 (5) (e))	"14022" or later	—
Support of IP communications over CC-Link IE Field Network (IP packet transfer function) (☞ Page 107, Section 7.3)	"14022" or later	Version 1.05F or later
Configuration tool functions added (☞ Page 179, CHAPTER 10) <ul style="list-style-type: none"> <li>• IP communication test</li> <li>• Monitoring of the SD LED and RD LED</li> </ul>	"14022" or later	Version 1.05F or later

\*1 The English version of the configuration tool starts up under the operating systems of English version.

\*2 External devices with a serial number (first five digits) of "14021" or earlier access a station operating as a master station (master operating station). When the submaster station starts to take in control instead of the master station, the access destination also changes to the submaster station. (Each time stations in control change, the access destination also changes.)  
Changing the station number to 7E<sub>H</sub> (current control station/master station) allows external devices with a serial number (first five digits) of "14022" or later to access a station operating as a master station (master operating station).

# Appendix 11 Checking the Serial Number and Function Version

A

The serial number and function version of the Ethernet adapter module can be checked on any of the following.

- Rating plate
- Front of the module
- Configuration tool

## (1) Checking on the rating plate

The rating plate is located on the side face of the Ethernet adapter module.

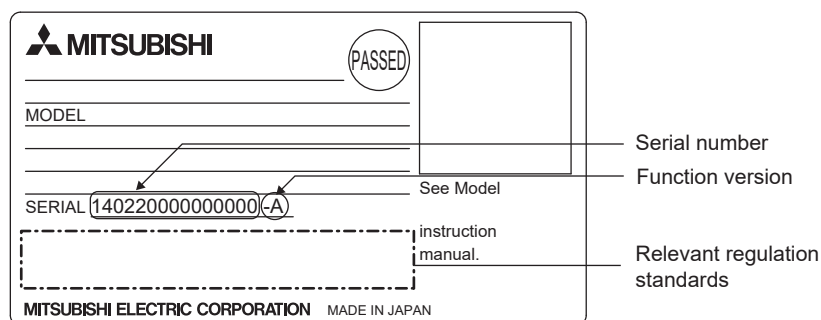

## (2) Checking on the front of the module

The serial number on the rating plate is also printed on the front (at the bottom) of the module.

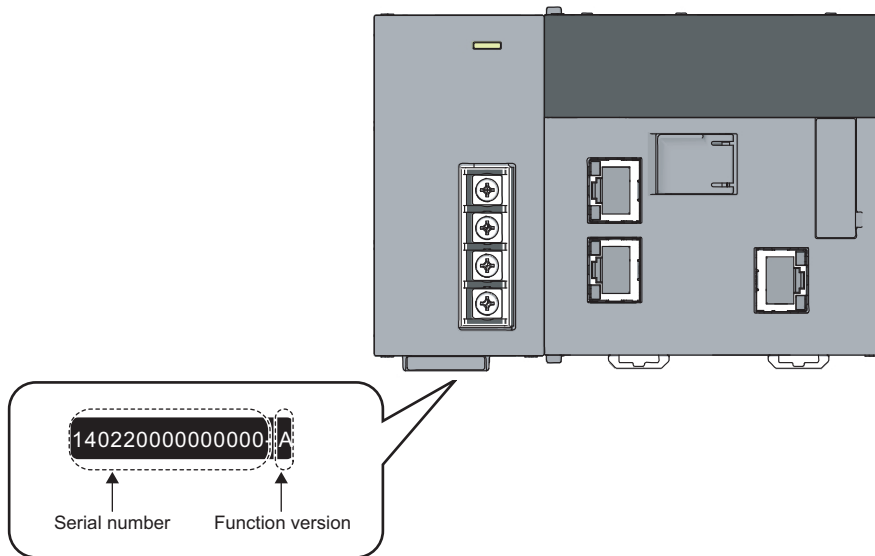

## (3) Checking using the configuration tool

The serial number and function version can be checked on the "Ethernet Adapter Diagnostics" window in the configuration tool. \*1

 [Online] ⇒ [Diagnostics] ⇒ [Module Information]

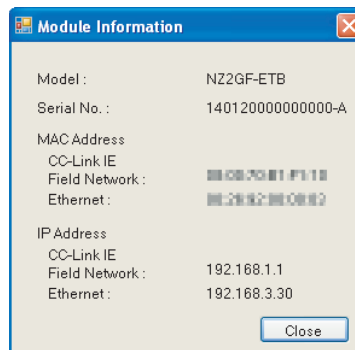

\*1 Check the corresponding serial No. and software version. (  Page 240, Appendix 10)



# Appendix 12 External Dimensions

A

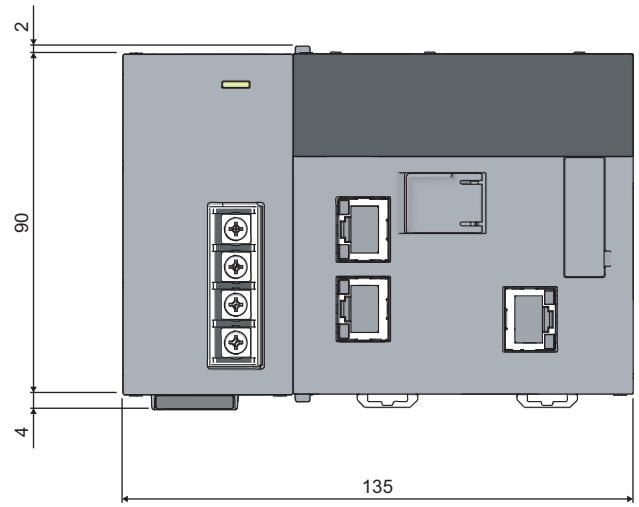
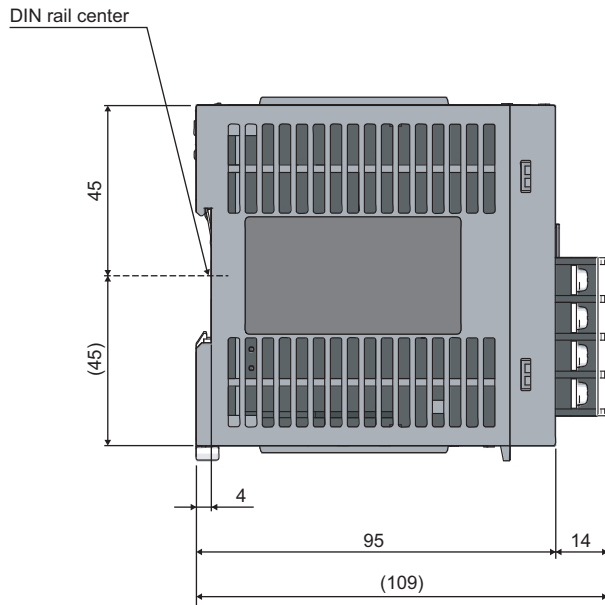

(Unit: mm)

# Memo

---

# INDEX

## A

Access code . . . . .	230
Allowable momentary power failure time . . . . .	31,32
Applicable DIN rail models (IEC 60715) . . . . .	58
Applicable solderless terminal . . . . .	31
Applicable wire size . . . . .	31,62
Attribute code . . . . .	230
Auto-open UDP port area . . . . .	210

## B

Broadcast communications . . . . .	158
Buffer memory . . . . .	13
Buffer memory list . . . . .	37

## C

Cable . . . . .	49
CC-Link IE Field Network . . . . .	13,190
CC-Link IE Field Network diagnostics . . . . .	21,77,144
CC-Link IE Field Network gateway setting . . . . .	129,191
CC-Link IE Field Network part . . . . .	24
Checking the LEDs . . . . .	147
Checking the serial number and function version . . . . .	241
Clock function . . . . .	30
COM.ERR. LED . . . . .	28,152
Command list . . . . .	44
Communication examples of the Ethernet adapter module . . . . .	68
Communication is not available . . . . .	155
Communication status . . . . .	216
Communication using SLMP . . . . .	68
Communication using SLMP cannot be performed . . . . .	158
Configuration tool . . . . .	13,51,179
Configuration tool does not start . . . . .	155
Configuration tool is not displayed in English . . . . .	156
Configuring the master station . . . . .	73
Configuring the personal computer . . . . .	179
Connectibility of MC protocol devices . . . . .	18
Connecting the Ethernet cable . . . . .	64
Connection information area No.1 . . . . .	209
Connection information area No.2 to No.32 . . . . .	210
Connection port for the configuration tool . . . . .	214
Connection sting . . . . .	195
Connection through a hub . . . . .	131,133
Connection to Ethernet . . . . .	78
Creating a program . . . . .	81
Current consumption . . . . .	31
Cyclic transmission . . . . .	13,19
Cyclic transmission cannot be performed . . . . .	154

## D

D LINK LED . . . . .	24,149
Data link . . . . .	13
Date and time of the error . . . . .	145
Dedicated instruction . . . . .	13

Delete browsing history . . . . .	156
Destination setting . . . . .	75,79,199
Detail setting . . . . .	79,196
Device . . . . .	13,45
DIN rail hook . . . . .	22
Direct connection (simple connection) . . . . .	137
Direct MELSOFT connection port . . . . .	213
Disconnection . . . . .	13

## E

ERR. LED . . . . .	25,150
Error code . . . . .	161
Error count . . . . .	215
Error history . . . . .	144
Error log No.1 . . . . .	215
Error log No.2 to No.64 . . . . .	216
Error log write pointer . . . . .	215
Ethernet adapter diagnostics . . . . .	146,203
Ethernet adapter module . . . . .	13
Ethernet port . . . . .	208
Ethernet port connection setting . . . . .	78,195
Ethernet port LED information . . . . .	207
Ethernet setting . . . . .	78,193
External device . . . . .	13
External dimensions . . . . .	30,243

## F

FG terminal . . . . .	23
Fuse . . . . .	31

## G

GX Works2 . . . . .	13,53
---------------------	-------

## H

HST.LOSS . . . . .	145
Hub . . . . .	50

## I

INIT. LED . . . . .	28,152
Initial processing error code . . . . .	209
Input voltage . . . . .	31,32
Inrush current . . . . .	31,32
Installation . . . . .	55
Installation and wiring . . . . .	54
Installation environment . . . . .	54
Insulation resistance . . . . .	31
Intelligent device station . . . . .	13
Internal current consumption (24VDC) . . . . .	30
Internet options . . . . .	72
Internet protocol (TCP/IP) properties . . . . .	71,180
IP address . . . . .	179
IP communication test . . . . .	124
IP packet transfer function . . . . .	107

<b>L</b>	
<hr/>	
L ERR. LED . . . . .	25
L ERR. LED, L ER LED . . . . .	150
LED indication during line test execution. . . . .	25
LG terminal . . . . .	23
Link device . . . . .	13
Link device assignment . . . . .	70
LINK LED . . . . .	27,151
Link special register (SW) . . . . .	13
Link special register (SW) list . . . . .	219
Link special relay (SB) . . . . .	13
Link special relay (SB) list. . . . .	218
LINK/SPEED . . . . .	28
LINK/SPEED LED . . . . .	153
Local area network (LAN) setting . . . . .	71
Local area network (LAN) settings . . . . .	181
Local station . . . . .	13
<b>M</b>	
<hr/>	
Master station . . . . .	13
Master/local module . . . . .	13
Maximum link points per network . . . . .	33
Maximum link points per station . . . . .	33
Maximum station-to-station distance . . . . .	33
MELSOFT application communication port (TCP/IP) area for the system . . . . .	212
MELSOFT application communication port (UDP/IP) area for the system. . . . .	211
MELSOFT connection . . . . .	130
Menu bar . . . . .	187
MODE LED . . . . .	24,149
Module LED information . . . . .	206
Mounting the module to a control panel . . . . .	55
Mounting the modules on a DIN rail . . . . .	56
<b>N</b>	
<hr/>	
Network components . . . . .	49
Network configuration . . . . .	48
Network configuration setting . . . . .	74
Network module. . . . .	13
Network parameter setting . . . . .	73
Network status. . . . .	77
New function or improved function cannot be used. . . . .	157
Noise immunity . . . . .	31
Number of cascade connections . . . . .	33,34
Number of device points . . . . .	30
Number of simultaneously connectable modules . . . . .	34
<b>O</b>	
<hr/>	
Open completion signal . . . . .	217
Operating environment . . . . .	51
Overall cable distance . . . . .	33
<b>P</b>	
<hr/>	
P1 . . . . .	27
P2 . . . . .	27
Parameter memory . . . . .	13
Parameter setting . . . . .	20,75,78,137
Parameter writing/reading. . . . .	200
Parameters . . . . .	208
Part names . . . . .	22
PC side I/F Ethernet board setting . . . . .	134,136
Performance specifications . . . . .	30
PLC side I/F detailed setting of CC IE Field Ethernet adapter . . . . .	135,138
PLC side I/F Ethernet module setting . . . . .	136
PORT1 and PORT2. . . . .	208
PORT1 connector . . . . .	27
PORT2 connector . . . . .	27
Power input terminal . . . . .	23
POWER LED . . . . .	23,147
Power supply part . . . . .	23,31
Preparation before starting the tool . . . . .	179
Procedure before the operation . . . . .	46
Processing time. . . . .	237
Program example . . . . .	81
<b>R</b>	
<hr/>	
RD LED . . . . .	24
Refresh parameter setting . . . . .	74
Relay station . . . . .	13
Remote device station . . . . .	13
Remote I/O station. . . . .	13
Remote input (RX) . . . . .	13
Remote output (RY) . . . . .	13
Remote register (RW <sub>r</sub> ) . . . . .	13
Remote register (RW <sub>w</sub> ) . . . . .	13
Reserved station . . . . .	14
RESET/TEST . . . . .	26
Resetting parameters to factory default values . . . . .	229
Return . . . . .	14
RIRD . . . . .	14
RIWT . . . . .	14
Routing. . . . .	14
RUN. . . . .	26
RUN LED . . . . .	24,148
<b>S</b>	
<hr/>	
SD LED . . . . .	24
SD/RD . . . . .	28
SD/RD LED . . . . .	153
Security settings . . . . .	182
Serial number display. . . . .	22
Setting in GX Works2. . . . .	134,138
Setting item tree . . . . .	186
Setting on the GOT . . . . .	131
Setting the Web browser . . . . .	181
Slave station . . . . .	14
SLMP. . . . .	14,17,44
Software package . . . . .	53
Special register (SD) list. . . . .	223
Special relay (SM) list . . . . .	221
Starting from a Web browser. . . . .	184
Starting from GX Works2 . . . . .	185
Starting up the configuration tool . . . . .	184
STATION NO. . . . .	25
Station No. LED information . . . . .	206
Status bar . . . . .	186
STOP . . . . .	26

Subnet mask . . . . .	179
System . . . . .	189
System configuration . . . . .	48

## **T**

---

Terminal screw size . . . . .	31
Tightening torque . . . . .	31
Toolbar . . . . .	187
Transfer setup . . . . .	134,138
Transient transmission . . . . .	14,20
Transient transmission cannot be performed . . . . .	154
Troubleshooting . . . . .	142
Troubleshooting by symptom . . . . .	154

## **U**

---

Unit test . . . . .	59
---------------------	----

## **W**

---

Weight . . . . .	30
Wiring . . . . .	61
Wiring of the power supply part . . . . .	61
Withstand voltage . . . . .	31



# REVISIONS

\*The manual number is given on the bottom left of the back cover.

Print date	*Manual number	Revision
October 2010	SH(NA)-080939ENG-A	First edition
September 2011	SH(NA)-080939ENG-B	[Partial correction] RELEVANT MANUALS, TERMS, Chapter 1, Section 3.1, 3.2.1, 3.3, 3.4.1, 4.1, 5.1, 5.3.1, 7.1.4, 9.2.2, 9.3.3, 9.4.4, 9.4.6, 9.5, 10.2.2, 10.3.2, 10.7, Appendix 1.2, 1.4, 3, 9, 10 [Addition] Section 7.2, 10.6, Appendix 1.7 [Change] Section 7.2 → Section 7.3, Section 10.6 → Section 10.7
March 2012	SH(NA)-080939ENG-C	[Partial correction] TERMS, Chapter 1, Section 3.1, 3.4, 4.1, 6.4.2, 7.2.3, 7.2.5, 7.3.6, 7.4.1, 9.4.3, 9.4.6, 9.5, 10.3.2, 10.3.3, 10.7, Appendix 1.1, 1.2, 2, 10 [Addition] Section 3.3, 7.3, 9.4.7, Appendix 8 [Change] EMC and Low Voltage Directives → Appendix 8, Section 3.3 to 3.4 → Section 3.4 to 3.5, Appendix 8 to 11 → Appendix 9 to 12
April 2013	SH(NA)-080939ENG-D	[Partial correction] Section 3.2.1, 7.3.4, 9.5, 10.7
January 2016	SH(NA)-080939ENG-E	[Partial correction] Section 7.4, 10.3.3
November 2022	SH(NA)-080939ENG-F	[Partial correction] SAFETY PRECAUTIONS, CONDITIONS OF USE FOR THE PRODUCT, Appendix 8

Japanese manual number: SH-080930-H

This manual confers no industrial property rights or any rights of any other kind, nor does it confer any patent licenses. Mitsubishi Electric Corporation cannot be held responsible for any problems involving industrial property rights which may occur as a result of using the contents noted in this manual.

© 2010 MITSUBISHI ELECTRIC CORPORATION

# WARRANTY

Please confirm the following product warranty details before using this product.

## **1. Gratis Warranty Term and Gratis Warranty Range**

If any faults or defects (hereinafter "Failure") found to be the responsibility of Mitsubishi occurs during use of the product within the gratis warranty term, the product shall be repaired at no cost via the sales representative or Mitsubishi Service Company.

However, if repairs are required onsite at domestic or overseas location, expenses to send an engineer will be solely at the customer's discretion. Mitsubishi shall not be held responsible for any re-commissioning, maintenance, or testing on-site that involves replacement of the failed module.

[Gratis Warranty Term]

The gratis warranty term of the product shall be for one year after the date of purchase or delivery to a designated place. Note that after manufacture and shipment from Mitsubishi, the maximum distribution period shall be six (6) months, and the longest gratis warranty term after manufacturing shall be eighteen (18) months. The gratis warranty term of repair parts shall not exceed the gratis warranty term before repairs.

[Gratis Warranty Range]

- (1) The range shall be limited to normal use within the usage state, usage methods and usage environment, etc., which follow the conditions and precautions, etc., given in the instruction manual, user's manual and caution labels on the product.
- (2) Even within the gratis warranty term, repairs shall be charged for in the following cases.
  1. Failure occurring from inappropriate storage or handling, carelessness or negligence by the user. Failure caused by the user's hardware or software design.
  2. Failure caused by unapproved modifications, etc., to the product by the user.
  3. When the Mitsubishi product is assembled into a user's device, Failure that could have been avoided if functions or structures, judged as necessary in the legal safety measures the user's device is subject to or as necessary by industry standards, had been provided.
  4. Failure that could have been avoided if consumable parts (battery, backlight, fuse, etc.) designated in the instruction manual had been correctly serviced or replaced.
  5. Failure caused by external irresistible forces such as fires or abnormal voltages, and Failure caused by force majeure such as earthquakes, lightning, wind and water damage.
  6. Failure caused by reasons unpredictable by scientific technology standards at time of shipment from Mitsubishi.
  7. Any other failure found not to be the responsibility of Mitsubishi or that admitted not to be so by the user.

## **2. Onerous repair term after discontinuation of production**

- (1) Mitsubishi shall accept onerous product repairs for seven (7) years after production of the product is discontinued. Discontinuation of production shall be notified with Mitsubishi Technical Bulletins, etc.
- (2) Product supply (including repair parts) is not available after production is discontinued.

## **3. Overseas service**

Overseas, repairs shall be accepted by Mitsubishi's local overseas FA Center. Note that the repair conditions at each FA Center may differ.

## **4. Exclusion of loss in opportunity and secondary loss from warranty liability**

Regardless of the gratis warranty term, Mitsubishi shall not be liable for compensation to:

- (1) Damages caused by any cause found not to be the responsibility of Mitsubishi.
- (2) Loss in opportunity, lost profits incurred to the user by Failures of Mitsubishi products.
- (3) Special damages and secondary damages whether foreseeable or not, compensation for accidents, and compensation for damages to products other than Mitsubishi products.
- (4) Replacement by the user, maintenance of on-site equipment, start-up test run and other tasks.

## **5. Changes in product specifications**

The specifications given in the catalogs, manuals or technical documents are subject to change without prior notice.

# TRADEMARKS

---

Microsoft and Windows are either registered trademarks or trademarks of Microsoft Corporation in the United States and/or other countries.

The company names, system names and product names mentioned in this manual are either registered trademarks or trademarks of their respective companies.

In some cases, trademark symbols such as <sup>™</sup> or <sup>®</sup> are not specified in this manual.





SH(NA)-080939ENG-F(2211)MEE

MODEL: NZ2GF-ETB-U-E

MODEL CODE: 13JZ50

## **MITSUBISHI ELECTRIC CORPORATION**

HEAD OFFICE : TOKYO BUILDING, 2-7-3 MARUNOUCHI, CHIYODA-KU, TOKYO 100-8310, JAPAN  
NAGOYA WORKS : 1-14, YADA-MINAMI 5-CHOME, HIGASHI-KU, NAGOYA, JAPAN

When exported from Japan, this manual does not require application to the Ministry of Economy, Trade and Industry for service transaction permission.

Specifications subject to change without notice.