

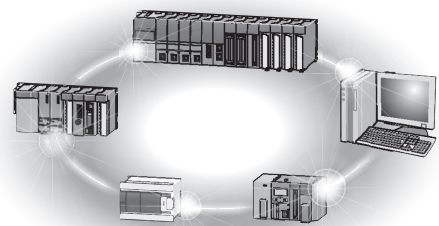

Mitsubishi Programmable Controller

CC-Link IE Field Network-CC-Link Bridge Module User's Manual

-NZ2GF-CCB



● SAFETY PRECAUTIONS ●

(Read these precautions before using this product.)

Before using this product, please read this manual and the relevant manuals carefully and pay full attention to safety to handle the product correctly.

The precautions given in this manual are concerned with this product only. For the safety precautions of the programmable controller system, refer to the user's manual for the CPU module used.

In this manual, the safety precautions are classified into two levels: "⚠ WARNING" and "⚠ CAUTION".



Indicates that incorrect handling may cause hazardous conditions, resulting in death or severe injury.



Indicates that incorrect handling may cause hazardous conditions, resulting in minor or moderate injury or property damage.

Under some circumstances, failure to observe the precautions given under "⚠ CAUTION" may lead to serious consequences.

Observe the precautions of both levels because they are important for personal and system safety. Make sure that the end users read this manual and then keep the manual in a safe place for future reference.

[Design Precautions]

⚠ WARNING

- In the case of a communication failure in CC-Link IE Field Network, the status of the error station will be as follows:
 - (1) All inputs from remote I/O stations connected to CC-Link are turned off.
 - (2) All outputs from remote I/O stations connected to CC-Link are turned off.Check Data link status (each station) (SW00B0 to SW00B7) and configure an interlock circuit in the program to ensure that the entire system will operate safely. Incorrect output or malfunction due to a communication failure may result in an accident.
- Outputs may remain on or off due to a failure of a bridge module. Configure an external circuit for monitoring output signals that could cause a serious accident.
- Do not use any "use prohibited" signals as a remote I/O signal since they are used by the system. Do not write any data to the "use prohibited" areas in the remote register. If these operations are performed, correct operation of the module cannot be guaranteed.

[Design Precautions]

⚠ CAUTION

- Do not install the control lines or communication cables together with the main circuit lines or power cables. Keep a distance of 100mm or more between them. Failure to do so may result in malfunction due to noise.

[Security Precautions]

WARNING

- To maintain the security (confidentiality, integrity, and availability) of the programmable controller and the system against unauthorized access, denial-of-service (DoS) attacks, computer viruses, and other cyberattacks from external devices via the network, take appropriate measures such as firewalls, virtual private networks (VPNs), and antivirus solutions.

[Installation Precautions]

WARNING

- Shut off the external power supply (all phases) used in the system before mounting or removing a module. Failure to do so may result in electric shock or cause the module to fail or malfunction.

[Installation Precautions]

CAUTION

- Use the module in an environment that meets the general specifications in this manual. Failure to do so may result in electric shock, fire, malfunction, or damage to or deterioration of the product.
- Do not directly touch any conductive parts and electronic components of the module. Doing so can cause malfunction or failure of the module.
- Securely fix the module with a DIN rail.
- Securely connect the cable connectors. Poor contact may cause malfunction.

[Wiring Precautions]

WARNING

- Shut off the external power supply (all phases) used in the system before wiring. Failure to do so may result in electric shock or cause the module to fail or malfunction.

[Wiring Precautions]

CAUTION

- Tighten any unused terminal screws within the specified torque range. Undertightening can cause a short circuit due to contact with a solderless terminal.
- Use applicable solderless terminals and tighten them within the specified torque range. If any spade solderless terminal is used, it may be disconnected when a terminal block screw comes loose, resulting in failure.
- Check the rated voltage and terminal layout before wiring to the module, and connect the cables correctly. Connecting a power supply with a different voltage rating or incorrect wiring may cause a fire or failure.
- Tighten the terminal block screws within the specified torque range. Undertightening can cause short circuit, fire, or malfunction. Overtightening can damage the screw and/or module, resulting in drop, short circuit, fire, or malfunction.

[Wiring Precautions]

CAUTION

- Prevent foreign matter such as dust or wire chips from entering the module. Such foreign matter can cause a fire, failure, or malfunction.
- Place the cables in a duct or clamp them. If not, dangling cable may swing or inadvertently be pulled, resulting in damage to the module or cables or malfunction due to poor contact.
- Do not install the control lines or communication cables together with the main circuit lines or power cables. Keep a distance of 100mm or more between them. Failure to do so may result in malfunction due to noise.
- When disconnecting the cable from the module, do not pull the cable by the cable part. For the cable with connector, hold the connector part of the cable. For the cable connected to the terminal block, loosen the terminal screw. Pulling the cable connected to the module may result in malfunction or damage to the module or cable.
- When an overcurrent caused by an error of an external device or a failure of the programmable controller flows for a long time, it may cause smoke and fire. To prevent this, configure an external safety circuit, such as a fuse.

[Startup and Maintenance Precautions]

WARNING

- Do not touch any terminal while power is on. Doing so will cause electric shock or malfunction.
- Shut off the external power supply (all phases) used in the system before cleaning the module or retightening the terminal block screws. Failure to do so may result in electric shock.

[Startup and Maintenance Precautions]

CAUTION

- Do not disassemble or modify the module. Doing so may cause failure, malfunction, injury, or a fire.
- Do not drop or apply strong shock to the module. Doing so may damage the module.
- Shut off the external power supply (all phases) used in the system before mounting or removing a module. Failure to do so may cause the module to fail or malfunction.
- After the first use of the product, do not connect/disconnect the terminal block more than 50 times (in accordance with IEC 61131-2). Exceeding the limit may cause malfunction.
- Before handling the module, touch a conducting object such as a grounded metal to discharge the static electricity from the human body. Failure to do so may cause the module to fail or malfunction.

[Disposal Precautions]

CAUTION

- When disposing of this product, treat it as industrial waste.

● CONDITIONS OF USE FOR THE PRODUCT ●

- (1) MELSEC programmable controller ("the PRODUCT") shall be used in conditions;
- i) where any problem, fault or failure occurring in the PRODUCT, if any, shall not lead to any major or serious accident; and
 - ii) where the backup and fail-safe function are systematically or automatically provided outside of the PRODUCT for the case of any problem, fault or failure occurring in the PRODUCT.
- (2) The PRODUCT has been designed and manufactured for the purpose of being used in general industries. MITSUBISHI ELECTRIC SHALL HAVE NO RESPONSIBILITY OR LIABILITY (INCLUDING, BUT NOT LIMITED TO ANY AND ALL RESPONSIBILITY OR LIABILITY BASED ON CONTRACT, WARRANTY, TORT, PRODUCT LIABILITY) FOR ANY INJURY OR DEATH TO PERSONS OR LOSS OR DAMAGE TO PROPERTY CAUSED BY the PRODUCT THAT ARE OPERATED OR USED IN APPLICATION NOT INTENDED OR EXCLUDED BY INSTRUCTIONS, PRECAUTIONS, OR WARNING CONTAINED IN MITSUBISHI ELECTRIC USER'S, INSTRUCTION AND/OR SAFETY MANUALS, TECHNICAL BULLETINS AND GUIDELINES FOR the PRODUCT.
- ("Prohibited Application")
- Prohibited Applications include, but not limited to, the use of the PRODUCT in;
- Nuclear Power Plants and any other power plants operated by Power companies, and/or any other cases in which the public could be affected if any problem or fault occurs in the PRODUCT.
 - Railway companies or Public service purposes, and/or any other cases in which establishment of a special quality assurance system is required by the Purchaser or End User.
 - Aircraft or Aerospace, Medical applications, Train equipment, transport equipment such as Elevator and Escalator, Incineration and Fuel devices, Vehicles, Manned transportation, Equipment for Recreation and Amusement, and Safety devices, handling of Nuclear or Hazardous Materials or Chemicals, Mining and Drilling, and/or other applications where there is a significant risk of injury to the public or property.
- Notwithstanding the above restrictions, Mitsubishi Electric may in its sole discretion, authorize use of the PRODUCT in one or more of the Prohibited Applications, provided that the usage of the PRODUCT is limited only for the specific applications agreed to by Mitsubishi Electric and provided further that no special quality assurance or fail-safe, redundant or other safety features which exceed the general specifications of the PRODUCTS are required. For details, please contact the Mitsubishi Electric representative in your region.
- (3) Mitsubishi Electric shall have no responsibility or liability for any problems involving programmable controller trouble and system trouble caused by DoS attacks, unauthorized access, computer viruses, and other cyberattacks.

INTRODUCTION

Thank you for purchasing the CC-Link IE Field Network—CC-Link bridge module (hereafter abbreviated as bridge module).

This manual describes the procedures, system configuration, parameter settings, functions, and troubleshooting of a bridge module.

Before using this product, please read this manual and the relevant manuals carefully and develop familiarity with the functions and performance of the bridge module to handle the product correctly.

When applying the program examples introduced in this manual to an actual system, ensure the applicability and confirm that it will not cause system control problems.

Remark

Unless otherwise specified, this manual describes the program example in which the station number of the bridge module is set to 1.

For details on station numbers, refer to the following.

 User's manual for the master/local module used

.....

RELEVANT MANUALS

(1) CC-Link IE Field Network (relevant) manuals

When using the CC-Link IE Field Network for the first time, refer to the CC-Link IE Field Network Master/Local Module User's Manual first. The following shows the structure of the CC-Link IE Field Network manuals.

Manual name <manual number (model code)>	Description
MELSEC-Q CC-Link IE Field Network Master/Local Module User's Manual <SH-080917ENG, 13JZ47>	Overview of CC-Link IE Field Network, and specifications, procedures before operation, system configuration, installation, wiring, settings, functions, programming, and troubleshooting of the QJ71GF11-T2
MELSEC-L CC-Link IE Field Network Master/Local Module User's Manual <SH-080972ENG, 13JZ54>	Overview of CC-Link IE Field Network, and specifications, procedures before operation, system configuration, installation, wiring, settings, functions, programming, and troubleshooting of the LJ71GF11-T2
MELSEC iQ-R Ethernet/CC-Link IE User's Manual (Startup) <SH-081256ENG, 13JX09>	Specifications, procedures before operation, system configuration, wiring, and communication examples of Ethernet, CC-Link IE Controller Network, and CC-Link IE Field Network
MELSEC iQ-R CC-Link IE Field Network User's Manual (Application) <SH-081259ENG, 13JX18>	Functions, parameter settings, programming, troubleshooting, I/O signals, and buffer memory of CC-Link IE Field Network

(2) Operating manual

Manual name <manual number (model code)>	Description
GX Works2 Version 1 Operating Manual (Common) <SH-080779ENG, 13JU63>	System configuration, parameter settings, and online operations of GX Works2, which are common to Simple projects and Structured projects
GX Works3 Operating Manual <SH-081215ENG>	System configuration, parameter settings, and online operations of GX Works3

Memo

CONTENTS

SAFETY PRECAUTIONS	1
CONDITIONS OF USE FOR THE PRODUCT	4
INTRODUCTION	5
RELEVANT MANUALS	6
MANUAL PAGE ORGANIZATION	11
TERMS	12
PACKING LIST	14
<hr/>	
CHAPTER 1 BRIDGE MODULE	15
<hr/>	
1.1 Application	15
1.2 Features	15
<hr/>	
CHAPTER 2 PART NAMES	17
<hr/>	
CHAPTER 3 SPECIFICATIONS	20
<hr/>	
3.1 General Specifications	20
3.2 Performance Specifications	21
3.3 Function List	23
3.4 Flow of Data during Communications	24
3.5 List of Remote I/O Signals	26
3.6 List of Remote Register	27
3.7 Example of Link Device Assignment	29
3.8 List of Remote Buffer Memory Areas	31
<hr/>	
CHAPTER 4 THE PROCEDURE BEFORE OPERATION	32
<hr/>	
CHAPTER 5 SYSTEM CONFIGURATON	34
<hr/>	
5.1 Network Configuration	34
5.2 Applicable Systems	35
5.3 Precautions	36
<hr/>	
CHAPTER 6 INSTALLATION AND WIRING	37
<hr/>	
6.1 Station Number Setting	37
6.1.1 Station number setting of the bridge module	37
6.1.2 Station number setting of a CC-Link remote station	38
6.2 Installation Environment and Installation Position	39
6.2.1 Installation environment	39
6.2.2 Installation position	39
6.2.3 Installation direction	40
6.3 Installation	41
6.3.1 Mounting a module on a DIN rail	41
6.4 Wiring	44
6.4.1 Wiring with a terminal block for module power supply and FG	44
6.4.2 Wiring of an Ethernet cable	46

6.4.3	Wiring of a CC-Link dedicated cable	49
-------	-------------------------------------	----

CHAPTER 7 VARIOUS SETTINGS	53
-----------------------------------	-----------

7.1	Parameter Settings for CC-Link IE Field Network	53
7.2	Parameter Settings for CC-Link	55
7.2.1	Setting with the switch	55
7.2.2	Setting using the engineering tool	59
7.2.3	Checking the status of communications (line test)	64

CHAPTER 8 PROGRAMMING	65
------------------------------	-----------

8.1	Precautions for Programming	65
8.2	Example of Communications with CC-Link Remote Stations	68
8.2.1	System configuration example	68
8.2.2	Setting of CC-Link IE Field Network	70
8.2.3	Setting of CC-Link	72
8.2.4	Program example	73

CHAPTER 9 TROUBLESHOOTING	75
----------------------------------	-----------

9.1	Operation Upon Error	75
9.2	Troubleshooting Procedure	77
9.3	CC-Link IE Field Network Diagnostics	78
9.4	How to Check Error Codes and Warning Codes	81
9.5	List of Error Codes and Warning Codes	83
9.5.1	Errors that occur in the bridge module	83
9.5.2	Errors that occur in CC-Link IE Field Network	85
9.5.3	Errors that occur in CC-Link	86
9.5.4	Other errors	88
9.6	Checking the LEDs	89
9.6.1	POWER LED	89
9.6.2	LEDs of CC-Link IE Field Network	89
9.6.3	CC-Link LEDs	92
9.7	Troubleshooting by Symptom	94
9.7.1	CC-Link IE Field Network	94
9.7.2	CC-Link	94
9.7.3	Bridge module	100
9.8	Unit Test	101

APPENDICES	103
-------------------	------------

Appendix 1	Details of Remote Registers	103
Appendix 2	Details of Remote Buffer Memory	107
Appendix 3	Data Link Processing Time	125
Appendix 3.1	Device transfer time	126
Appendix 3.2	Processing time of CC-Link	127
Appendix 3.3	Transmission delay time	128

Appendix 4 Added and Enhanced Functions	132
Appendix 5 EMC and Low Voltage Directives	133
Appendix 5.1 Measures to comply with the EMC Directive	133
Appendix 5.2 Requirements to compliance with the Low Voltage Directive	139
Appendix 6 Checking the Serial Number and Function Version	140
Appendix 7 External Dimensions	141

INDEX	142
REVISIONS	144
WARRANTY	145
TRADEMARKS	146

MANUAL PAGE ORGANIZATION

In this manual, pages are organized and the symbols are used as shown below.

The following illustration is for explanation purpose only, and should not be referred to as an actual documentation.

"" is used for window names and items.

1. shows operating procedures.

shows mouse operations.*1

[] is used for items in the menu bar and the project window.

shows setting or operating examples.

shows reference manuals.

shows reference pages.

shows notes that require attention.

shows useful information.

The chapter of the current page is shown.

The section of the current page is shown.

73

*1 The mouse operation example (for GX Works2) is provided below.

Menu bar

[Online] ⇒ [Write to PLC...]
Select [Online] on the menu bar, and then select [Write to PLC...].



A window selected in the view selection area is displayed.

Project window ⇒ [Parameter]
⇒ [PLC Parameter]
Select [Project] from the view selection area to open the Project window. In the Project window, expand [Parameter] and select [PLC Parameter].

View selection area

TERMS

Unless otherwise specified, this manual uses the following terms.

Term	Description
Bridge module	The abbreviation for the NZ2GF-CCB CC-Link IE Field Network — CC-Link bridge module
Buffer memory	A memory in a bridge module, where data (such as setting values and monitoring values) are stored
CC-Link	A field network system where data processing for control and information can be simultaneously performed at high speed.
CC-Link dedicated cable	The abbreviation for the Ver.1.10-compatible CC-Link dedicated cable
CC-Link IE Field Network	A high-speed and large-capacity open field network that is based on Ethernet (100BASE-T)
CC-Link remote station	A generic term for CC-Link remote I/O stations and remote device stations
Cyclic transmission	A function by which data are periodically exchanged among stations on the same network using link devices (RX, RY, RWw, and RWr)
Data link	A generic term for cyclic transmission and transient transmission
Dedicated instruction	An instruction that simplifies programming for using functions of intelligent function modules
Device	A device (X, Y, M, D, or others) in a CPU module
Disconnection	A process of stopping data link if a data link error occurs
Engineering tool	A generic term for GX Works2 and GX Works3
GX Works2	The product name of the software package for the MELSEC programmable controllers
GX Works3	
Intelligent device station	A station that exchanges I/O signals (bit data) and I/O data (word data) with the master station by cyclic transmission. This station responds to a transient transmission request from another station.
Link device	A device (RX, RY, RWr, or RWw) in a module on CC-Link IE Field Network and CC-Link
Link scan (link scan time)	Time required for all stations in a system to transmit data. The link scan time depends on data volume and the number of transient transmission requests.
Link special register (SW)	Word data that indicates the module operating status and data link status of CC-Link IE Field Network and CC-Link
Link special relay (SB)	Bit data that indicates the module operating status and data link status of CC-Link IE Field Network and CC-Link
Local station	A station that performs cyclic transmission and transient transmission with the master station and other local stations. The station is controlled by programs in the CPU module or other equivalent modules on the station.
Master station	A station that controls the entire network. This station can perform cyclic transmission and transient transmission with all stations. Only one master station can be used in a network. ("Master station" after Chapter 1 in this manual is a CC-Link IE Field Network master station. A master station on CC-Link is described as "CC-Link master station".)
Master/local module	A generic term for CC-Link IE Field Network master/local modules
Relay station	A station that includes two or more network modules. Data are passed through this station to stations on other networks.
Remote buffer memory	Buffer memory in a remote device station
Remote device station	A station that exchanges I/O signals (bit data) and I/O data (word data) with the master station by cyclic transmission. This station responds to a transient transmission request from another station.
Remote I/O station	A station that exchanges I/O signals (bit data) with the master station by cyclic transmission
Remote input (RX)	Bit data input from a slave station to the master station (For some areas in a local station, data are input in the opposite direction.)  User's manual for the master/local module used
Remote output (RY)	Bit data output from the master station to a slave station (For some areas in a local station, data are output in the opposite direction.)  User's manual for the master/local module used
Remote register (RWr)	Word data input from a slave station to the master station (For some areas in a local station, data are input in the opposite direction.)  User's manual for the master/local module used
Remote register (RWw)	Word data output from the master station to a slave station (For some areas in a local station, data are output in the opposite direction.)  User's manual for the master/local module used
Reserved station	A station reserved for future use. This station is not actually connected, but counted as a connected station
Return	A process of restarting data link when a station recovers from an error

Term	Description
Slave station	A generic term for stations other than a master station: local station, remote I/O station, remote device station, and intelligent device station
Transient transmission	A function of communication with another station, which is used when requested by a dedicated instruction or the engineering tool

PACKING LIST

The following items are included in the package of this product. Before use, check that all the items are included.

NZ2GF-CCB

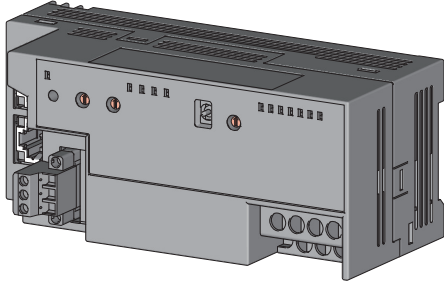

Bridge module

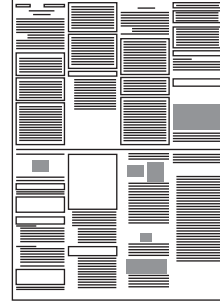

Safety Guidelines

A set of terminating resistors for CC-Link

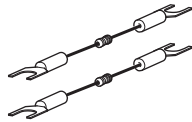

Terminating resistor 110 Ω 1/2W \times 2
(brown-brown-brown, gold)



Notes about
the terminating resistors

CHAPTER 1 BRIDGE MODULE

This chapter describes the application and features of the bridge module.

1.1 Application

A bridge module is a module to connect a CC-Link remote station to CC-Link IE Field Network.

A bridge module allows a CC-Link Ver.1-compatible CC-Link remote station to connect to CC-Link IE Field Network.

For the functions of CC-Link IE Field Network, refer to the following.

 User's manual for the master/local module used

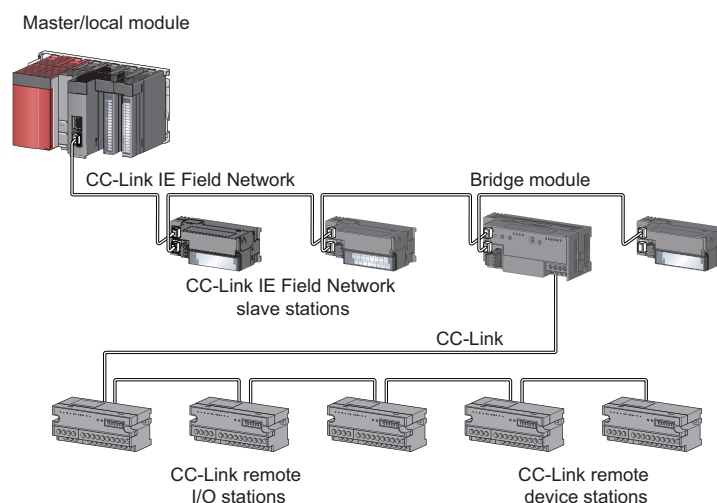

1.2 Features

(1) No need to set CC-Link parameters

A bridge module allows CC-Link parameters to be set by switch operation alone. ( Page 55, Section 7.2)
In addition, a CC-Link remote station can be added easily into the system by switch operation on the bridge module.

(2) Easy to control a CC-Link remote station

Link devices assigned to bridge modules are directly assigned to the link devices of a CC-Link remote station in the order of the station numbers.

This allows the master station to control a CC-Link remote station in the same way as the slave stations on CC-Link IE Field Network.

(3) Independent cyclic transmission

Cyclic transmission of CC-Link is independent from CC-Link IE Field Network.

In addition, the cyclic transmission of CC-Link IE Field Network is not affected even when the communication status of CC-Link changes.

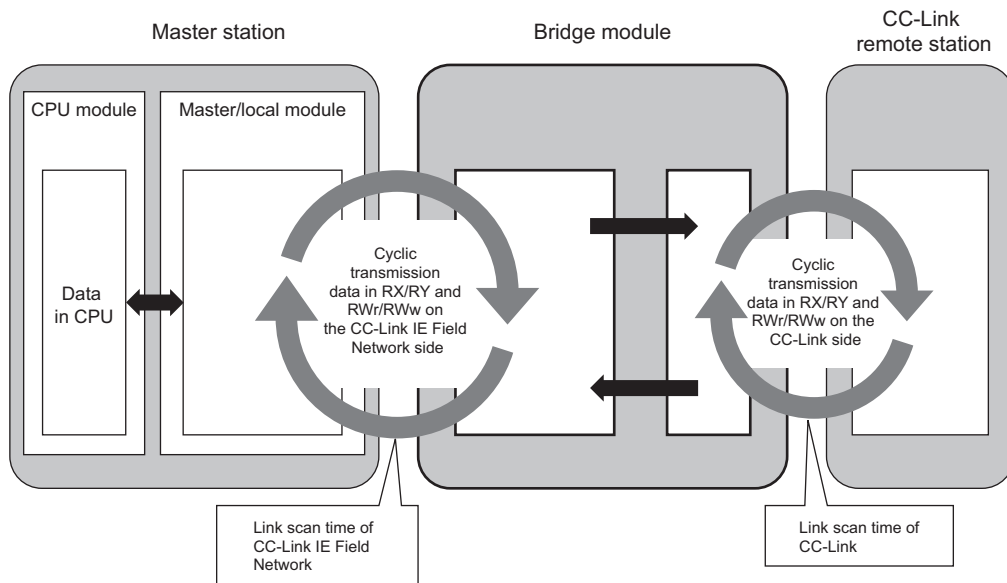

CHAPTER 2 PART NAMES

This chapter describes the part names of a bridge module.

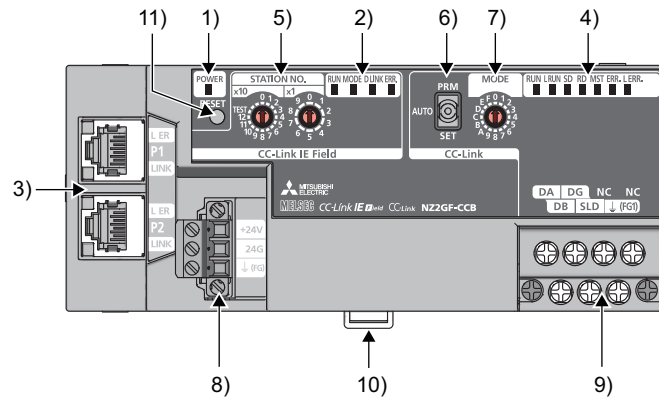

No.	Name	Description	
1)	POWER LED (green)	Indicates the power supply status of the bridge module. ON: Power supply on OFF: Power supply off	
2)	CC-Link IE Field Network LED	—	Indicates the status of CC-Link IE Field Network.
		RUN LED (green)	Indicates the operating status of the bridge module. ON: Operating normally OFF: A serious error has occurred.
		MODE LED (green)	Indicates the mode of the bridge module. ON: In the online mode Flashing: In the unit test mode OFF: Unit test completed
		D LINK LED (green)	Indicates the data link status. ON: Performing data link (cyclic transmission in progress) Flashing: Performing data link (cyclic transmission stopped) OFF: Not performing data link (disconnected)
		ERR. LED (red)	Indicates the error status of CC-Link IE Field Network of the bridge module. ON: A moderate error or serious error has occurred. Flashing: A warning has occurred. OFF: Operating normally
3)	P1	—	PORT1 connector for connecting CC-Link IE Field Network. (RJ45 connector) Connect an Ethernet cable. (Page 46, Section 6.4.2) There are no restrictions on the connecting order of the "P1" connector and "P2" connector.
		L ER LED (red)	ON: • The module has received abnormal data. • The module is performing loopback. OFF: • The module has received normal data. • The module has not performed loopback.
		LINK LED (green)	ON: Linkup in progress. OFF: Linkdown in progress.
	P2	—	PORT2 connector for connecting CC-Link IE Field Network. (RJ45 connector) Connect an Ethernet cable. (Page 46, Section 6.4.2) There are no restrictions on the connecting order of the "P1" connector and "P2" connector.
		L ER LED (red)	(Same as the LEDs of the "P1" connector)
		LINK LED (green)	(Same as the LEDs of the "P1" connector)

No.	Name	Description	
4)	CC-Link LED	—	Indicates the status of CC-Link.
		RUN LED (green)	Indicates the operating status of the bridge module. ON: Operating normally OFF: A hardware failure or watchdog timer error has occurred.
		L RUN LED (green)	Indicates the data link status. ON: Performing data link OFF: Not performing data link
		SD LED (green)	Indicates whether the module is sending data. ON: Sending data OFF: Not sending data
		RD LED (green)	Indicates whether the module is receiving data. ON: Receiving data OFF: Not receiving data
		MST LED (green)	Indicates whether the bridge module is operating as a CC-Link master station. ON: Operating as a CC-Link master station. Flashing: Line test or unit test is being executed.
		ERR. LED (red)	Indicates the error status of CC-Link of the bridge module. ON: Any of the following errors has occurred. <ul style="list-style-type: none"> An error has been detected in all the stations. The transmission speed/mode setting switch of the bridge module is out of the setting range. Two or more CC-Link master stations are connected on the same line. The CC-Link parameters have not been set correctly. The cable is disconnected. Or the transmission path has been affected by noise or other factors. Flashing: A faulty station has been detected in the data link. Or the same station number is used for multiple CC-Link remote stations. OFF: Operating normally
L ERR. LED (red)	Indicates the data link error of CC-Link of the bridge module. ON: A data link error has occurred at the own station. Flashing at regular intervals: The setting of the transmission speed/mode setting switch was changed when the power of the module was on. (Note that the change of the switch may not be detected when all stations are faulty.) Flashing at irregular intervals: The communications are unstable due to the following reasons. <ul style="list-style-type: none"> A terminating resistor is not connected. The bridge module or CC-Link dedicated cable has been affected by noise. OFF: Operating normally		
5)	Station number setting switch	A rotary switch used for the following setting and test. <ul style="list-style-type: none"> Station number setting (☞ Page 37, Section 6.1.1) Unit test (☞ Page 101, Section 9.8) To set the station number setting switch, use a flathead screwdriver having a tipped width of 3.5mm or less.	
6)	Startup mode switch	—	Sets how to read the CC-Link parameters at the startup. (☞ Page 55, Section 7.2)
		AUTO	Starts up CC-Link by the automatic CC-Link startup, and starts the data refresh after the module is powered on or reset. When the switch is changed from PRM to AUTO, CC-Link also starts up by the automatic CC-Link startup.
		SET	Generates CC-Link parameters from the station information of the connected CC-Link remote station and stores the data in the flash ROM. Writing to the flash ROM is not executed if a parameter-related error has occurred. When the switch is changed from SET to AUTO, the data refresh starts by the automatic CC-Link startup.
		PRM	Reads the CC-Link parameters from the flash ROM to start up CC-Link and starts the data refresh when the module is powered on or the switch is changed from AUTO to PRM. When CC-Link parameter setting using the engineering tool is used, set the switch to PRM. (☞ Page 59, Section 7.2.2)

No.	Name	Description		
7)	Transmission speed/mode setting switch	Sets the transmission speed and mode of CC-Link. (Default: 0) Set the same value of the transmission speed for all stations.		
		Mode	Transmission speed setting	Switch number
		Online	Transmission speed 156kbps	0
			Transmission speed 625kbps	1
			Transmission speed 2.5Mbps	2
			Transmission speed 5Mbps	3
			Transmission speed 10Mbps	4
		Line test (☞ Page 64, Section 7.2.3)	Transmission speed 156kbps	5
			Transmission speed 625kbps	6
			Transmission speed 2.5Mbps	7
			Transmission speed 5Mbps	8
Transmission speed 10Mbps	9			
Setting not allowed	—	A to F		
8)	Terminal block for module power supply and FG	A terminal block to connect the module power supply (24VDC) and FG.		
9)	Terminal block for CC-Link	For connecting the Ver.1.10-compatible CC-Link dedicated cable. (☞ Page 49, Section 6.4.3) The SLD terminal and FG terminal are connected inside the module. The module can be replaced without disconnecting the signal line connected to the terminal block because the terminal block has the two-piece structure. Before connecting or removing the terminal block, power off the module.		
10)	DIN rail hook	A hook for mounting a module on a DIN rail.		
11)	RESET switch	Resets the hardware and initializes the module when the station number setting of CC-Link IE Field Network or the transmission speed or mode setting of CC-Link is changed.		

CHAPTER 3 SPECIFICATIONS

This chapter describes the specifications of the bridge module.

3.1 General Specifications

The following table lists the general specifications of the bridge module.

Item	Specifications					
Operating ambient temperature	0 to 55°C					
Storage ambient temperature	-25 to 75°C					
Operating ambient humidity	5 to 95%RH, non-condensing					
Storage ambient humidity						
Vibration resistance	Compliant with JIS B 3502 and IEC 61131-2	Under intermittent vibration	Frequency	Constant acceleration	Half amplitude	Number of sweeps
			5 to 8.4Hz	—	3.5mm	
		Under continuous vibration	8.4 to 150Hz	9.8m/s ²	—	10 times each in X, Y, and Z directions
			5 to 8.4Hz	—	1.75mm	
		8.4 to 150Hz	4.9m/s ²	—	—	
Shock resistance	Compliant with JIS B 3502 and IEC 61131-2 (147m/s ² , three times each in X, Y, and Z directions)					
Operating atmosphere	No corrosive gases					
Operating altitude* ¹	0 to 2000m					
Installation location	Inside a control panel					
Overvoltage category* ²	II or less					
Pollution degree* ³	2 or less					
Equipment class	Class I					

- *1 Do not use or store the bridge module under pressure higher than the atmospheric pressure of altitude 0m. Doing so may cause malfunction. When using the bridge module under pressure, please consult your local Mitsubishi representative.
- *2 This indicates the section of the power supply to which the equipment is assumed to be connected between the public electrical power distribution network and the machinery within premises. Category II applies to equipment for which electrical power is supplied from fixed facilities. The surge voltage withstand level for the equipment with the rated voltage of 300V or less is 2500V.
- *3 This index indicates the degree to which conductive material is generated in terms of the environment in which the equipment is used. Pollution degree 2 is when only non-conductive pollution occurs. A temporary conductivity caused by condensing must be expected occasionally.

Point

To make the bridge module comply with the EMC Directive, refer to "EMC and Low Voltage Directives" in this manual. ( Page 133, Appendix 5)

3.2 Performance Specifications

The following table lists the performance specifications of the bridge module.

(1) Hardware specifications

Item		Specifications
Protection code		IP2X
External connection system	CC-Link IE Field Network	RJ45 connector
	Module power supply	Terminal block for module power supply and FG
	CC-Link	Terminal block for CC-Link (two-piece, M3 screw)
Applicable DIN rail		TH35-7.5Fe, TH35-7.5Al (compliant with IEC 60715)
Applicable wire size	Terminal block for module power supply and FG	Core: 0.5 to 1.5mm ² (20 to 16 AWG)
	Terminal block for CC-Link	Core: 0.3 to 1.5mm ² (22 to 16 AWG)
Applicable solderless terminal	Terminal block for module power supply and FG ^{*1}	TE 0.5-10 (Nichifu Co. Ltd.) [Applicable wire size: 0.5mm ²] TE 0.75-10 (Nichifu Co. Ltd.) [Applicable wire size: 0.75mm ²] TE 1.0-10 (Nichifu Co. Ltd.) [Applicable wire size: 0.9 to 1.0mm ²] TE 1.5-10 (Nichifu Co. Ltd.) [Applicable wire size: 1.25 to 1.5mm ²] Al 0.5-10WH (Phoenix Contact Co. Ltd.) [Applicable wire size: 0.5mm ²] Al 0.75-10GY (Phoenix Contact Co. Ltd.) [Applicable wire size: 0.75mm ²] Al 1-10RD (Phoenix Contact Co. Ltd.) [Applicable wire size: 1.0mm ²] Al 1.5-10BK (Phoenix Contact Co. Ltd.) [Applicable wire size: 1.5mm ²]
	Terminal block for CC-Link	RAV1.25-3 (compliant with JIS C 2805) [Applicable wire size: 0.3 to 1.25mm ²]
External dimensions	H	69.5mm
	W	160mm
	D	68mm
External power supply		24VDC (20.4 to 28.8VDC) Current consumption: 0.29A
Weight		0.38kg

*1 Do not connect two or more wires to the terminal.

(2) CC-Link IE Field Network specifications

For the specifications of the entire CC-Link IE Field Network, refer to the user's manual for the master/local module used.

Item		Specifications
Station type		Intelligent device station
Cyclic transmission	Number of RX/Ry points	Up to 2048 points
	Number of RWr/RWw points	Up to 272 points

(3) CC-Link specifications

Item		Specifications		
Compatible CC-Link version		Ver.1.10		
Control specifications	Number of connected modules	Condition 1	$\{(1 \times a) + (2 \times b) + (3 \times c) + (4 \times d)\} \leq 64$ <p>a: Number of modules occupying 1 station b: Number of modules occupying 2 stations c: Number of modules occupying 3 stations d: Number of modules occupying 4 stations</p>	
		Condition 2	$(16 \times A) + (54 \times B) \leq 2304$ <p>A: Number of remote I/O stations ≤ 64 B: Number of remote device stations ≤ 42</p>	
	Maximum number of link points	Remote input (RX)	2048 points	
		Remote output (RY)	2048 points	
		Remote register (RWw)	256 points (256 words)	
		Remote register (RWr)	256 points (256 words)	
	Number of link points per remote station	Remote input (RX)	32 points	
		Remote output (RY)	32 points	
		Remote register (RWw)	4 points (4 words)	
		Remote register (RWr)	4 points (4 words)	
Maximum number of occupied stations per remote station		4 stations (Ver.1.10)		
Communication specifications	Transmission speed		Selectable among 156kbps/625kbps/2.5Mbps/5Mbps/10Mbps	
	Communication method		Broadcast polling method	
	Synchronization method		Frame synchronization method	
	Encoding method		NRZI method	
	Network topology		Bus topology (RS-485)	
	Transmission format		HDLC compliant	
	Error control system		CRC ($X^{16} + X^{12} + X^5 + 1$)	
	Connection cable		Ver.1.10-compatible CC-Link dedicated cable	
	Station-to-station distance		20cm or more	
	Maximum station-to-station distance (Maximum transmission distance)		Varies according to the transmission speed	
Transmission speed			Maximum station-to-station distance	
156kbps			1200m	
625kbps			900m	
2.5Mbps			400m	
5Mbps			160m	
10Mbps	100m			

3.3 Function List

The following table lists the functions of the bridge module.

(1) Functions of CC-Link IE Field Network

Function	Description	Reference
CC-Link IE Field Network diagnostic function	Checks for a network error from the engineering tool connected to the master station using the CC-Link IE Field Network diagnostic function.	Page 78, Section 9.3
Module error collection function	Checks the error history of the bridge module from GX Works2 connected to the master station using the CC-Link IE Field Network diagnostic function.	Page 81, Section 9.4 (1)
Remote resetting function ^{*1}	Resets the bridge module from the master station.	Page 80, Section 9.3 (2)

*1 When the bridge module is reset with the remote resetting function, the CC-Link communication also stops.

(2) CC-Link functions

Function	Description	Reference
Slave station cutoff function	Disconnects the CC-Link remote station where data link cannot be performed due to power-off or other factors, and continues data link in normal CC-Link remote stations. This function prevents the entire system from going down caused by faulty one station.	—
Automatic return function	Restarts data link when the CC-Link remote station disconnected from data link due to power-off or other factors returns to normal. This function shortens the time to recover from an error.	—
Automatic CC-Link startup function	Performs CC-Link data link simply by powering on the module.	Page 55, Section 7.2.1
Slave station information saving function	Saves the slave station information performing data link by the automatic CC-Link startup.	
Temporary error invalid station setting function	Excludes the CC-Link where an error has occurred during data link from being detected as a faulty station. This function is used when the CC-Link remote station is replaced during data link for maintenance or other purposes.	Page 115, Appendix 2 (6) (a)
CC-Link data link stop/restart	Stops or restarts CC-Link data link using the remote buffer memory. This function is used when data link is stopped temporarily for maintenance or other purposes.	Page 116, Appendix 2 (6) (b)
Line test function	Checks whether a CC-Link dedicated cable is connected correctly and the module is ready to perform data link with the CC-Link remote station.	Page 55, Section 7.2

(3) Hardware functions

Function	Description	Reference
Unit test function	Checks the hardware inside the bridge module.	Page 101, Section 9.8

3.4 Flow of Data during Communications

The bridge module communicates with a master station and a CC-Link remote station using link devices (RX/RX/RWw/RWw).

This section describes the flow of the link devices between the bridge module and the master station or a CC-Link remote station.

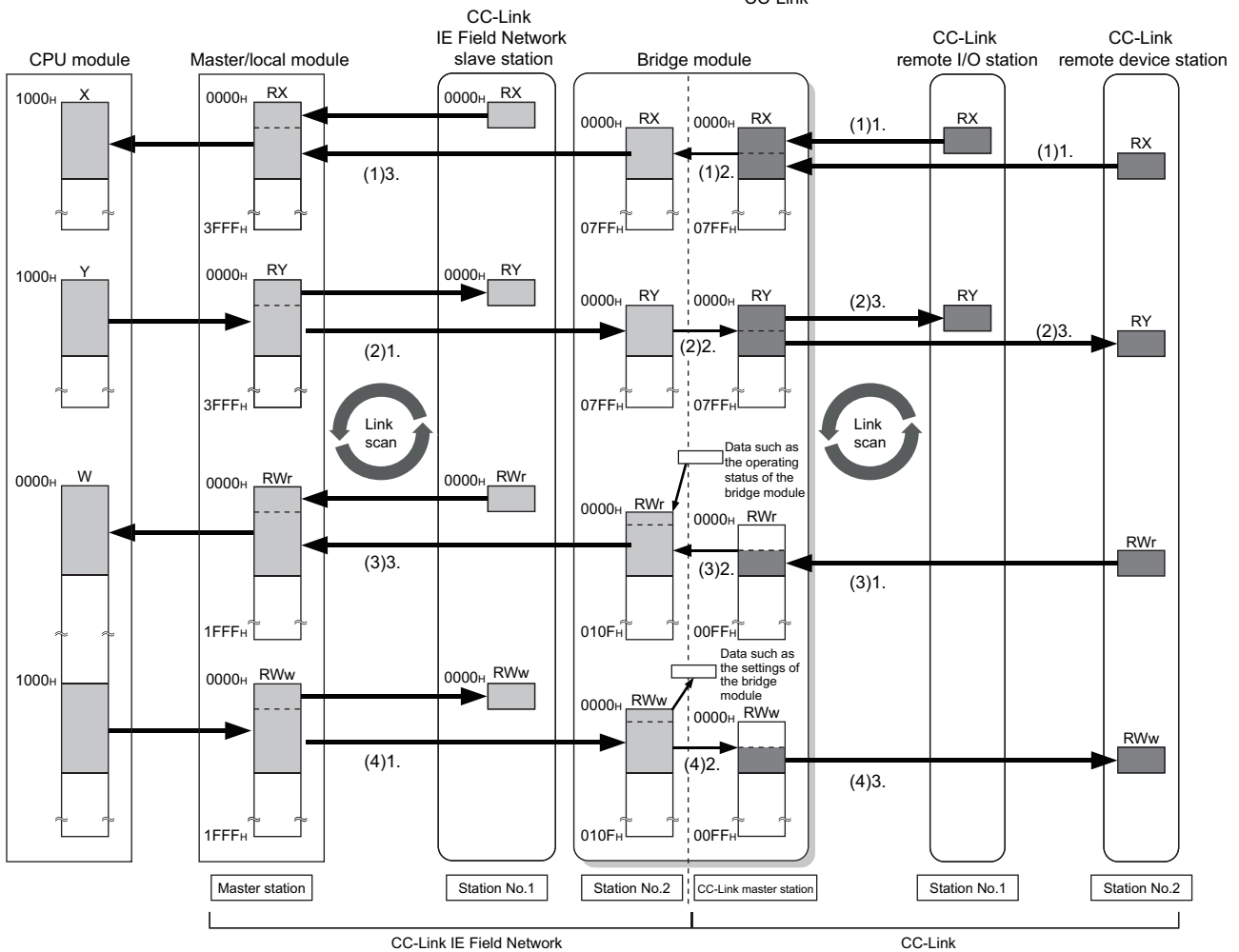
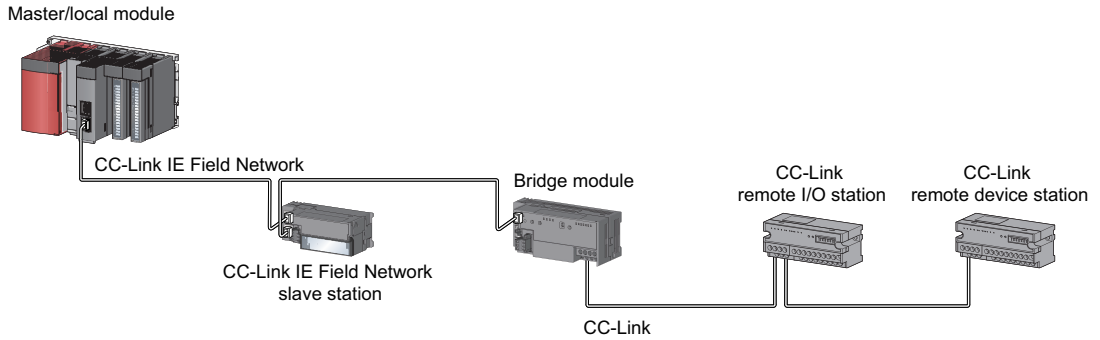

(1) Remote input (RX)

1. The data in the RX of the CC-Link remote station is stored in the RX of the bridge module by the link scan of CC-Link.
2. The bridge module transfers the data from CC-Link to CC-Link IE Field Network.
3. The data in the RX of the bridge module is stored in the RX of the master station by the link scan of CC-Link IE Field Network.

(2) Remote output (RY)

1. The data in the RY of the master station is stored in the RY of the bridge module by the link scan of CC-Link IE Field Network.
2. The bridge module transfers the data from CC-Link IE Field Network to CC-Link.
3. The data in the RY of the bridge module is stored in the RY of the CC-Link remote station by the link scan of CC-Link.

(3) Remote register (RW_r)

1. Data in the RW_r of the CC-Link remote device station is stored in the RW_r of the bridge module by the link scan of CC-Link.
2. The bridge module transfers the data from CC-Link to CC-Link IE Field Network.
3. The data in the RW_r of the bridge module is stored in the RW_r of the master station by the link scan of CC-Link IE Field Network.

(4) Remote register (RW_w)

1. The data in the RW_w of the master station is stored in the RW_w of the bridge module by the link scan of CC-Link IE Field Network.
2. The bridge module transfers the data from CC-Link IE Field Network to CC-Link.
3. The data in the RW_w of the bridge module is stored in the RW_w of the CC-Link remote device station by the link scan of CC-Link.

3.5 List of Remote I/O Signals

The following table lists the remote I/O signal (RX/RX) assignment of the bridge module.

- Assignment example (☞ Page 29, Section 3.7)

(1) Remote input (RX)

Bridge module to master station (RX)		
Address	Description	
RX n+0 _H	RX0 of CC-Link	RX0 of the station number 1
RX n+1 _H	RX1 of CC-Link	RX1 of the station number 1
⋮	⋮	⋮
RX n+1F _H	RX1F of CC-Link	RX1F of the station number 1
RX n+20 _H	RX20 of CC-Link	RX0 of the station number 2
⋮	⋮	⋮
RX n+3F _H	RX3F of CC-Link	RX1F of the station number 2
⋮	⋮	⋮
RX n+k+0 _H	RX k+0 _H of CC-Link	RX0 of the station number m
⋮	⋮	⋮
RX n+k+1F _H	RX k+1F _H of CC-Link	RX1F of the station number m

n: The start address assigned to the bridge module by the station number setting in CC-Link IE Field Network

m: The last station number in CC-Link

k: The start address assigned to the CC-Link remote input of the last connected station number in CC-Link

(2) Remote output (RY)

Master station to bridge module (RY)		
Address	Description	
RY n+0 _H	RY0 of CC-Link	RY0 of the station number 1
RY n+1 _H	RY1 of CC-Link	RY1 of the station number 1
⋮	⋮	⋮
RY n+1F _H	RY1F of CC-Link	RY1F of the station number 1
RY n+20 _H	RY20 of CC-Link	RY0 of the station number 2
⋮	⋮	⋮
RY n+3F _H	RY3F of CC-Link	RY1F of the station number 2
⋮	⋮	⋮
RY n+k+0 _H	RY k+0 _H of CC-Link	RY0 of the station number m
⋮	⋮	⋮
RY n+k+1F _H	RY k+1F _H of CC-Link	RY1F of the station number m

n: The start address assigned to the bridge module by the station number setting in CC-Link IE Field Network

m: The last station number in CC-Link

k: The start address assigned to the CC-Link remote input of the last connected station number in CC-Link

3.6 List of Remote Register

The following table lists the functions and assignment of the remote register (RWr/RWw) of the bridge module.

- Details of remote registers (☞ Page 103, Appendix 1)
- Assignment example (☞ Page 29, Section 3.7)

(1) Remote register (RWr)

Bridge module to master station (RWr)		
Address	Description	
RWr n+0 _H	Bridge module operating status	
RWr n+1 _H	Error code	
RWr n+2 _H	Warning code	
RWr n+3 _H	Use prohibited	
RWr n+4 _H	CC-Link operating status	
RWr n+5 _H		
RWr n+6 _H to RWr n+7 _H	Use prohibited	
RWr n+8 _H	Data link status of other stations on CC-Link	
RWr n+9 _H		
RWr n+A _H		
RWr n+B _H		
RWr n+C _H to RWr n+F _H	Use prohibited	
RWr n+10 _H	RWr0 of CC-Link	RWr0 of the station number 1
RWr n+11 _H	RWr1 of CC-Link	RWr1 of the station number 1
RWr n+12 _H	RWr2 of CC-Link	RWr2 of the station number 1
RWr n+13 _H	RWr3 of CC-Link	RWr3 of the station number 1
RWr n+14 _H	RWr4 of CC-Link	RWr0 of the station number 2
RWr n+15 _H	RWr5 of CC-Link	RWr1 of the station number 2
RWr n+16 _H	RWr6 of CC-Link	RWr2 of the station number 2
RWr n+17 _H	RWr7 of CC-Link	RWr3 of the station number 2
⋮	⋮	⋮
RWr n+k+10 _H	RWr k+0 _H of CC-Link	RWr0 of the station number m
RWr n+k+11 _H	RWr k+1 _H of CC-Link	RWr1 of the station number m
RWr n+k+12 _H	RWr k+2 _H of CC-Link	RWr2 of the station number m
RWr n+k+13 _H	RWr k+3 _H of CC-Link	RWr3 of the station number m

n: The start address assigned to the bridge module by the station number setting in CC-Link IE Field Network

m: The last station number in CC-Link

k: The start address assigned to the CC-Link remote input of the last connected station number in CC-Link

Point

Do not read or write the data from/to any "Use prohibited" remote registers. If the data is read or written from/to any of the registers, correct operation of the module cannot be guaranteed.

(2) Remote register (RWw)

Master station to bridge module (RWw)		
Address	Description	
RWw n+0 _H	Bridge module setting	
RWw n+1 _H to RWw n+F _H	Use prohibited	
RWw n+10 _H	RWw0 of CC-Link	RWw0 of the station number 1
RWw n+11 _H	RWw1 of CC-Link	RWw1 of the station number 1
RWw n+12 _H	RWw2 of CC-Link	RWw2 of the station number 1
RWw n+13 _H	RWw3 of CC-Link	RWw3 of the station number 1
RWw n+14 _H	RWw4 of CC-Link	RWw0 of the station number 2
RWw n+15 _H	RWw5 of CC-Link	RWw1 of the station number 2
RWw n+16 _H	RWw6 of CC-Link	RWw2 of the station number 2
RWw n+17 _H	RWw7 of CC-Link	RWw3 of the station number 2
⋮	⋮	⋮
RWw n+k+10 _H	RWw k+0 _H of CC-Link	RWw0 of the station number m
RWw n+k+11 _H	RWw k+1 _H of CC-Link	RWw1 of the station number m
RWw n+k+12 _H	RWw k+2 _H of CC-Link	RWw2 of the station number m
RWw n+k+13 _H	RWw k+3 _H of CC-Link	RWw3 of the station number m

n: The start address assigned to the bridge module by the station number setting in CC-Link IE Field Network

m: The last station number in CC-Link

k: The start address assigned to the CC-Link remote input of the last connected station number in CC-Link

Point

Do not read or write the data from/to any "Use prohibited" remote registers. If the data is read or written from/to any of the registers, correct operation of the module cannot be guaranteed.

3.7 Example of Link Device Assignment

The following table lists an example of the assignment of remote I/O signals and remote registers.

Ex. Example of assignment in the following system configuration
Refresh parameter

Link side				CPU side			
Device name	Number of points	Start	Last	Device name	Number of points	Start	Last
RX	128	0 _H	7F _H	X	128	1000 _H	107F _H
RY	128	0 _H	7F _H	Y	128	1000 _H	107F _H
RWw	32	0 _H	1F _H	W	32	1000 _H	101F _H
RWr	32	0 _H	1F _H	W	32	0 _H	1F _H

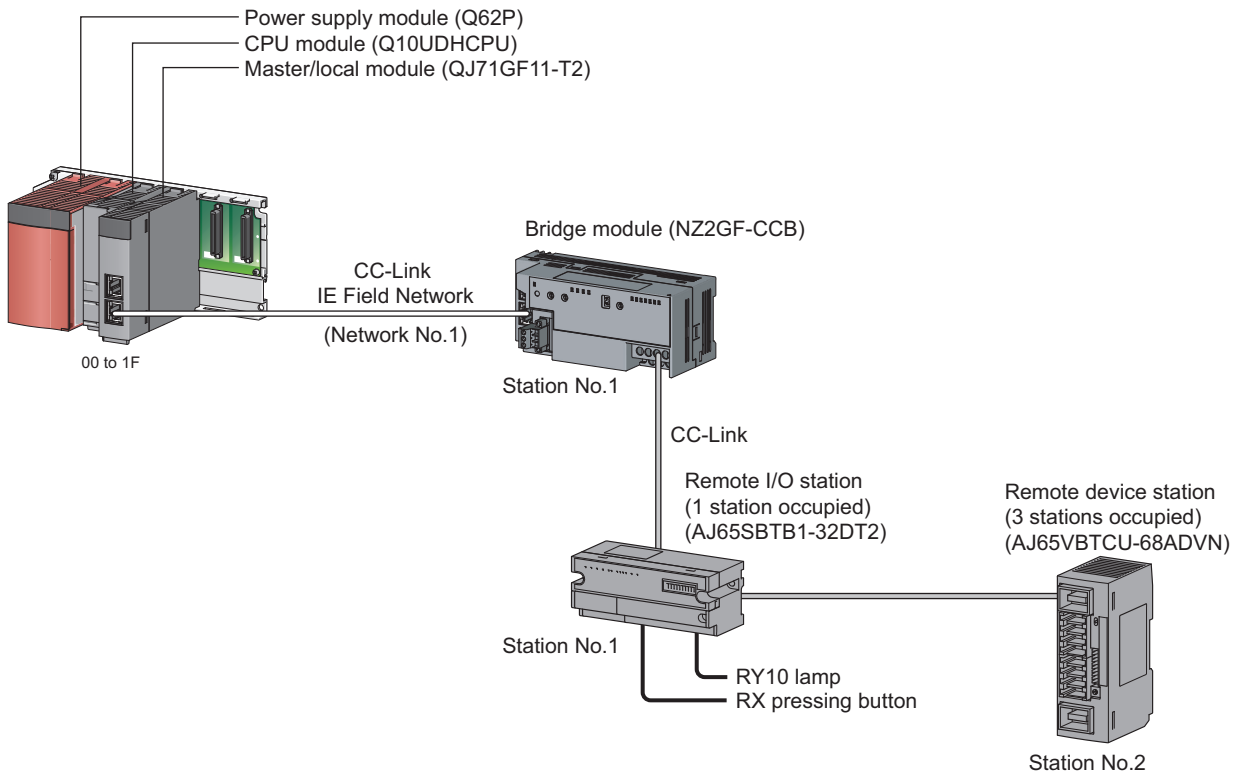

3

3.7 Example of Link Device Assignment

When the setting is configured with the assignment in the system, the start numbers of the link devices of each module are as follows.

CPU module	Master/local module	Bridge module	Remote I/O station	Remote device station
X1000	RX0	RX0	RX0	—
X1020	RX20	RX20	—	RX0
Y1000	RY0	RY0	RY0	—
Y1020	RY20	RY20	—	RY0
W0	RWr0	RWr0 ^{*1}	—	—
W10	Rwr10	RWr10	— ^{*2}	—
W14	RWr14	RWr14	—	RWr0
W1000	RWw0	RWw0 ^{*1}	—	—
W1010	RWw10	RWw10	— ^{*2}	—
W1014	RWw14	RWw14	—	RWw0

*1 The first 16 points of the link device are used as the area for the bridge module.

*2 This device is an unused area because a remote I/O station does not use a remote register.

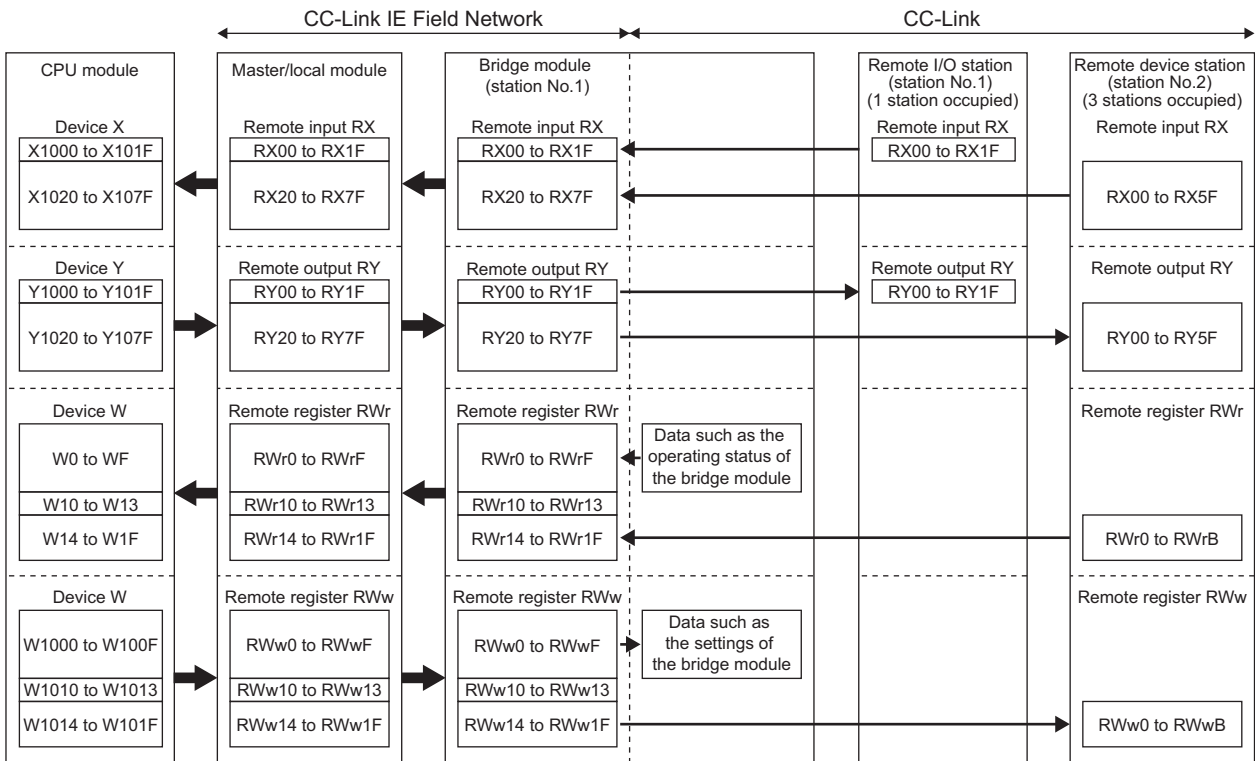

3.8 List of Remote Buffer Memory Areas

This section lists the remote buffer memory areas of the bridge module. The data in the remote buffer memory is read and written with the REMFR and REMTO instructions of a program. For the REMFR and REMTO instructions, refer to the user's manual for the master/local module used.

When the power supply of the module is turned off then on or reset, the data in the remote buffer memory returns to the default (initial value).

Address		Name	Description	Read/Write *1	Reference
Decimal	Hexadecimal				
0 to 127	0 to 7F _H	CC-Link parameter information area	Stores the information (parameter) on the bridge module to perform the data link with the CC-Link remote I/O station and remote device station.	R	Page 107, Appendix 2 (1)
128 to 223	80 _H to DF _H	System area	—	—	—
224 to 351	E0 _H to 15F _H	CC-Link remote input (RX)	Stores the input status from the CC-Link remote station.	R	Page 108, Appendix 2 (2)
352 to 479	160 _H to 1DF _H	CC-Link remote output (RY)	Stores the output status of the CC-Link remote station.	W	Page 109, Appendix 2 (3)
480 to 735	1E0 _H to 2DF _H	CC-Link remote register (RWw)	Stores the transmitted data to the CC-Link remote station.	W	Page 110, Appendix 2 (4)
736 to 991	2E0 _H to 3DF _H	CC-Link remote register (RWr)	Stores the received data from the CC-Link remote station.	R	Page 111, Appendix 2 (5)
992 to 1503	3E0 _H to 5DF _H	System area	—	—	—
1504 to 1535	5E0 _H to 5FF _H	CC-Link link special relay	Stores the status of the data link of CC-Link.	R/W (only the first 32 points can be written)	Page 112, Appendix 2 (6)
1536 to 2047	600 _H to 7FF _H	CC-Link link special register	Stores the status of the data link of CC-Link.		Page 117, Appendix 2 (7)
2048 to 32767	800 _H to 7FFF _H	System area	—	—	—
32768 to 33023	8000 _H to 80FF _H	Module monitor/control area	Stores the remote READY, an error code, and a warning code of the bridge module. The areas are also used for a error clear request.	R/W	Page 123, Appendix 2 (8)
33024 to 35327	8100 _H to 89FF _H	System area	—	—	—

*1 Shows whether the data can be read or written from/to the program.
R: Readable
W: Writable

CHAPTER 4 THE PROCEDURE BEFORE OPERATION

This chapter describes the procedure before operation.

1. Station number setting

Set the station numbers of the bridge module. (☞ Page 37, Section 6.1)

Set the station numbers of the CC-Link remote station. (📖 Manual for the CC-Link remote station)

2. Installation

Install the bridge module on a DIN rail. (☞ Page 41, Section 6.3)

3. Wiring

Connect a power supply, Ethernet cable, and CC-Link dedicated cable to the bridge module. (☞ Page 44, Section 6.4)

Connect a power supply, CC-Link dedicated cable, and external device to the CC-Link remote station. (📖 Manual for the CC-Link remote station)

4. Parameter setting for CC-Link IE Field Network

Connect the master station to the engineering tool to set the parameters of CC-Link IE Field Network. (☞ Page 53, Section 7.1)

5. Parameter setting for CC-Link

Set the parameters of CC-Link with the switch of the bridge module or using the engineering tool. (☞ Page 55, Section 7.2)

6. Programming

Create a program. (☞ Page 65, CHAPTER 8)

Point

To change the system, follow the procedure described below.

- Power off the system.
 - Delete or add the CC-Link remote station and perform the procedure above from "Station number setting" to "Programming".
-

Memo

CHAPTER 5 SYSTEM CONFIGURATON

5.1 Network Configuration

The following diagram shows the network configuration using a bridge module.

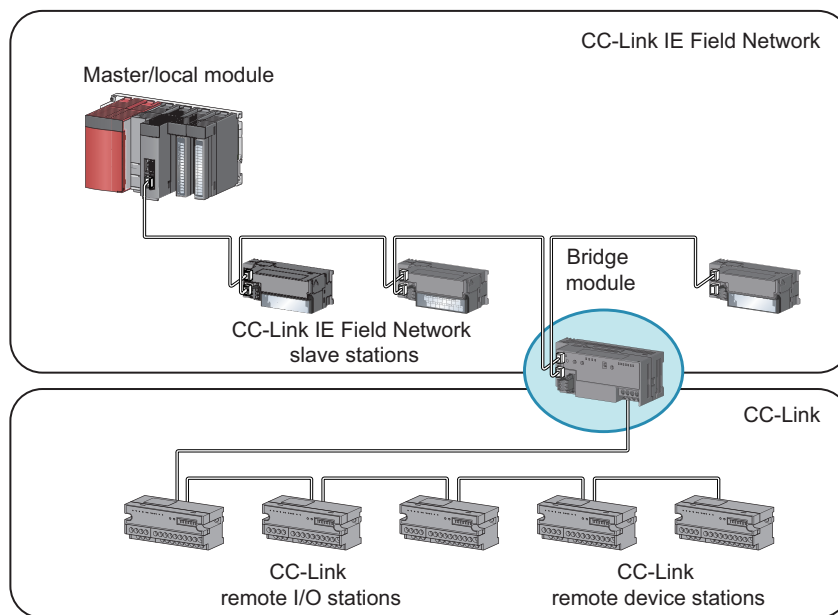

5.2 Applicable Systems

(1) Applicable master station

Master stations that can be used are listed on the website of CC-Link Partner Association (CLPA).

Refer to the following.

www.cc-link.org

Remark

Check the specifications of the master stations of each manufacturer before use.

(2) Applicable CC-Link module

The connectable stations are as follows:

- CC-Link Ver.1-compatible remote I/O station
- CC-Link Ver.1-compatible remote device station

The stations other than listed above cannot be connected.

(3) Ethernet cable

For the specifications of the Ethernet cable, refer to the following.

 User's manual for the master/local module used

(4) CC-Link dedicated cable

Use a Ver.1.10-compatible CC-Link dedicated cable.

Performance of CC-Link cannot be guaranteed when cables other than a Ver.1.10-compatible CC-Link dedicated cable are used.

For the specifications of a Ver.1.10-compatible CC-Link dedicated cable and contact information, refer to the following website.

www.cc-link.org

Remark

Refer to "CC-Link Cable Wiring Manual" issued by CC-Link Partner Association.

(5) Supported software package

GX Works2 or GX Works3 is required for setting and diagnosing a bridge module.

Software	Version
GX Works2	Version 1.98C or later
GX Works3 ^{*1}	Version 1.000A or later

*1 The system error history is not supported.

Point

When the latest profile of the bridge module is necessary, please consult your local Mitsubishi representative.
For the profile registration, refer to the following.

 GX Works2 Version 1 Operating Manual (Common)

 GX Works3 Operating Manual

5.3 Precautions

This section describes the precautions for the system configuration.

(1) CC-Link diagnostics

The CC-Link remote station connected to a bridge module cannot be diagnosed.

To check the status of CC-Link, use the remote buffer memory of the bridge module.

Point

To acquire the remote buffer memory of the bridge module, a sequence program for accessing the remote buffer memory of the bridge module is required.

(2) CC-Link parameter setting using the engineering tool

If the parameter processing of slave station is performed to the bridge module not supporting this function, an error message "Cannot communicate with the PLC because the SLMP function is not supported." is displayed and this function is not executed. Check whether the bridge module has a version supporting this function. (
Page 132, Appendix 4)

CHAPTER 6 INSTALLATION AND WIRING

This chapter describes the installation and wiring of the bridge module.

6.1 Station Number Setting

6.1.1 Station number setting of the bridge module

(1) Setting method

Set the station number with the rotary switch on the front of the module. The setting value of the station number becomes effective when the module is powered on. Thus, set the station number while the module is powered off.

- The hundreds and tens places of the station number are set with $\times 10$.
- The ones place of the station number is set with $\times 1$.

Ex. To set the station number to 115, set the switch as shown below.

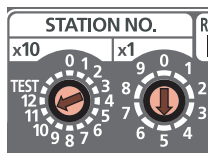

(2) Setting range

Set the station number from 1 to 120. When a value outside the range of 1 to 120 is set, an error occurs and the D LINK LED on the CC-Link IE Field Network side will not turn on.

6.1.2 Station number setting of a CC-Link remote station

(1) Setting method

For details on the station number setting of a CC-Link remote station, refer to the manual for each module.

(2) Detection of a station number in use error

A station number in use error of a bridge module is detected for a station number other than a start station number.

If a station number in use error is detected, the ERR.LED on the CC-Link side flashes and the status is stored in Station number in use status (address: 698_H to 69B_H).

Even if there is an error, data link is performed with normal stations.

After correcting the station number setting, turn off then on or reset the power supply of the bridge module to turn off the ERR.LED on the CC-Link side and clear the data stored in Station number in use status (address: 698_H to 69B_H).

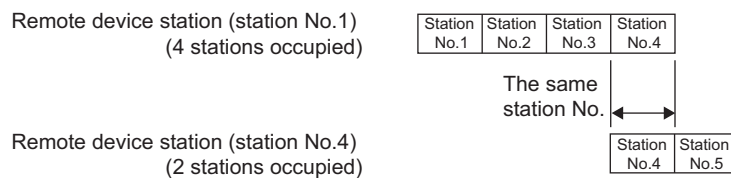

If the start station numbers are the same, a station number in use error is not detected.

Check if the station number of the station with a data link error is used for another station with Other stations data link status (address: 680_H to 683_H).

Ex. Between a remote device station (station number 1 with 4 stations occupied) and a remote device station (station number 1 with 2 stations occupied)

A station number in use error is not detected in the following case.

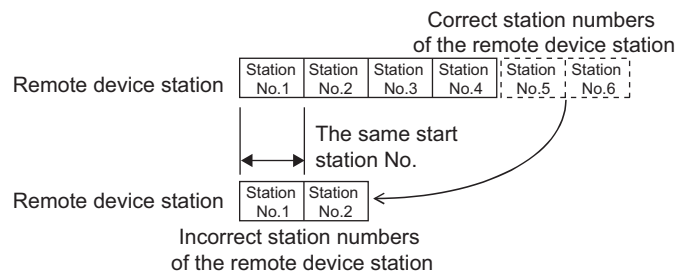

6.2 Installation Environment and Installation Position

6.2.1 Installation environment

(1) Installation location

Do not install the bridge module to the place where:

- Ambient temperature is outside the range of 0 to 55°C;
- Ambient humidity is outside the range of 5 to 95% RH;
- Condensation occurs due to rapid temperature change;
- Corrosive gas or combustible gas is present;
- Conductive powder such as dust and iron powder, oil mist, salinity, or organic solvent is filled;
- The bridge module is exposed to direct sunlight;
- A strong electric field or strong magnetic field is generated; and
- The bridge module is subject to vibration and shock.

(2) Installation surface

Install the bridge module on a flat surface. When the installation surface is uneven, excessive force is applied to the printed-circuit board, causing a failure.

6.2.2 Installation position

When installing the bridge module in a control panel, provide clearance of 60mm or longer between the module and the sides of the control panel or neighboring modules to ensure good ventilation and to facilitate a module change.

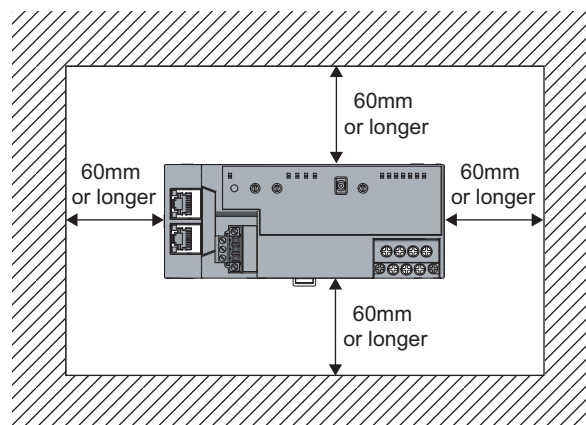

6.2.3 Installation direction

A bridge module can be installed in six directions.
Use a DIN rail to install the module.

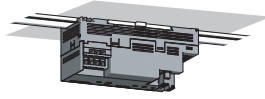

Downward installation

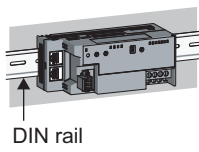

DIN rail
Horizontal installation
(basic)

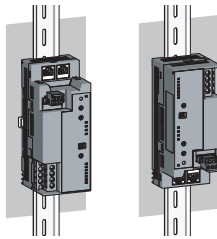

Vertical installation

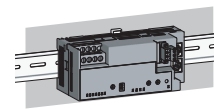

Horizontal installation
(upside down)

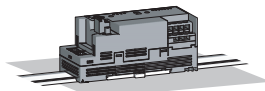

Upward installation

6.3 Installation

6.3.1 Mounting a module on a DIN rail

Point

An example of the use of the DIN rail stopper is described in the following procedure. Fix the module according to the manual of the DIN rail stopper used.

(1) Mounting procedure

This section describes how to mount the bridge module on a DIN rail.

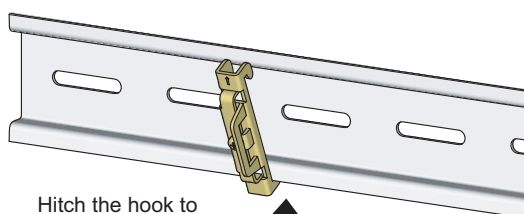
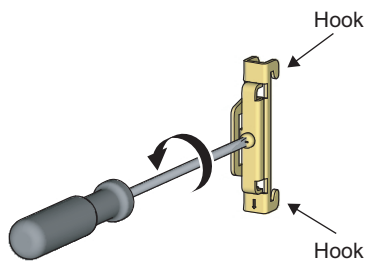
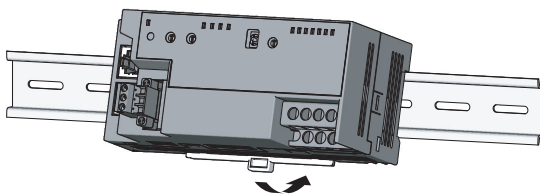
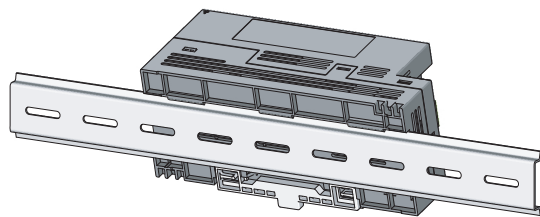

1. Hitch the upper hook of the module to the top of the DIN rail.

2. Push in the DIN rail hook of the module until it clicks.

3. Loosen the screw on the DIN rail stopper.

4. Hitch the bottom hook of the DIN rail stopper to the bottom of the DIN rail.

Hitch the hook according to the orientation of the arrow on the front of the stopper.

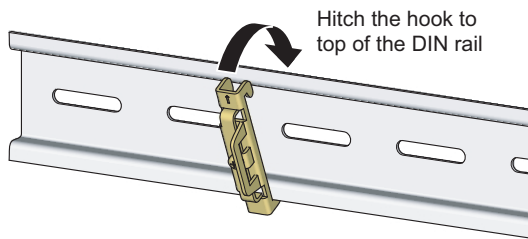

5. Hitch the upper hook of the DIN rail stopper to the top of the DIN rail.

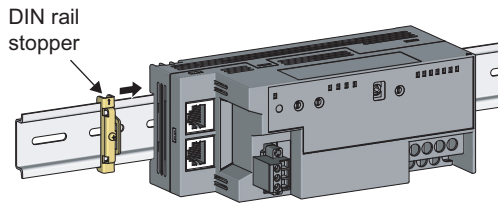

6. Slide the DIN rail stopper up to the left edge of the module.

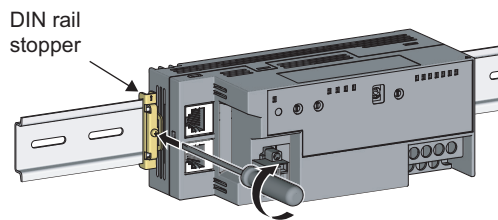

7. Hold the DIN rail stopper in the orientation opposite to the arrow inscribed on the stopper and tighten the screw with a driver.

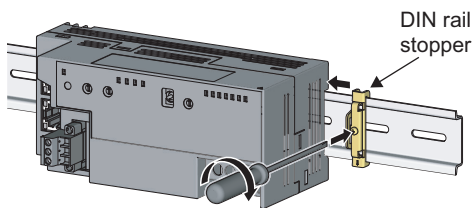

8. Install the DIN rail stopper on the right side of the module in the same procedure. Install the stopper upside down on the right side.

Point!

Do not slide the module from the edge of the DIN rail. Doing so may damage the metal part located on the back of the module.

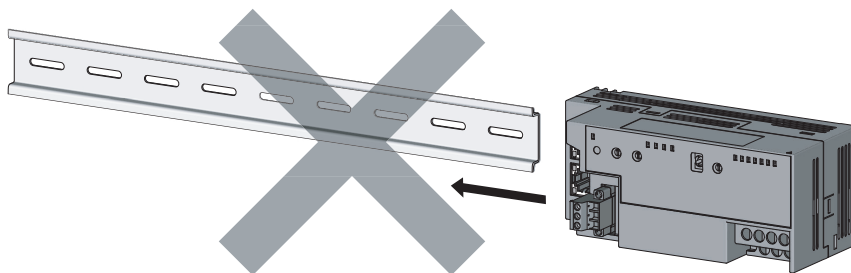

(2) Removal procedure

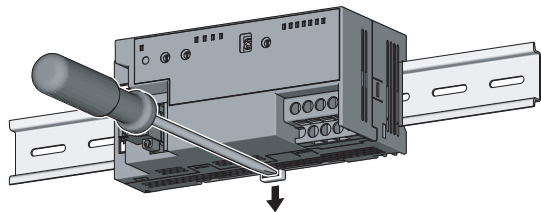

1. Remove the DIN rail stopper.

Remove the module in the reverse manner of (1).

2. Remove the module from the DIN rail by pulling the lower part of the module closer while pushing down the DIN rail hook with a slotted screwdriver.

(3) Applicable DIN rail model (compliant with IEC 60715)

- TH35-7.5Fe
- TH35-7.5Al

(4) Interval between DIN rail mounting screws

Tighten the screws at intervals of 200mm or less.

(5) DIN rail stopper

Use a stopper that is attachable to a DIN rail.

6.4 Wiring

6.4.1 Wiring with a terminal block for module power supply and FG

(1) Tightening torque

Tighten the terminal block screws within the following specified torque range.

Overtightening can damage the module case.

Screw type	Tightening torque range
Terminal block mounting screw (M2.5 screw)	0.2 to 0.3N·m
Terminal screw (M2.5 screw)	0.5 to 0.6N·m

(2) Wire to be used

The following table lists the wire to be connected to the terminal block for module power supply and FG.

Diameter	Type	Material	Temperature rating
20 to 16 AWG	Stranded	Copper	75°C or more

For applicable solderless terminals, refer to the following.

- Performance Specifications (☞ Page 21, Section 3.2)

(3) Installing and removing the terminal block

To remove the terminal block, loosen the terminal block mounting screw with a slotted screwdriver.

To install the terminal block, tighten the terminal block mounting screw.

Failure to secure the terminal block may cause drop, short-circuit, or malfunction.

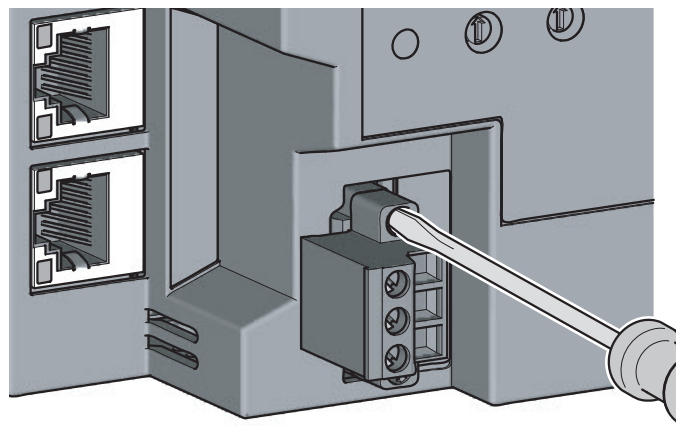

(4) Connecting and disconnecting the cable

To connect the cable, insert it with the cable fixing screw loosened and tighten the terminal screw.
 To disconnect the cable, pull it out with the terminal screw loosened using a slotted screwdriver.

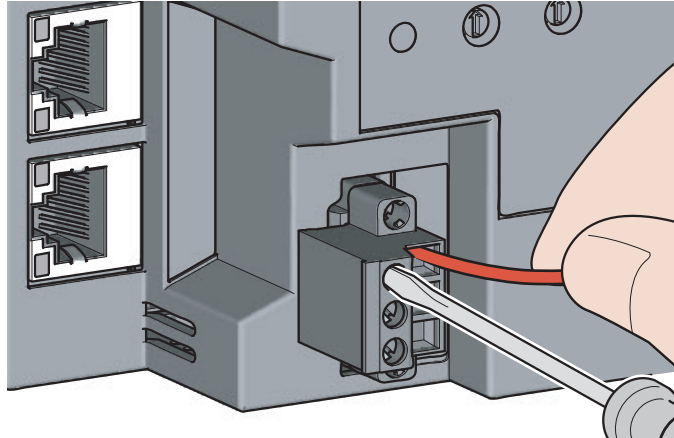

(5) Processing method of the cable terminal

Strip the cable about 10mm from the edge.
 To use a bar solderless terminal, connect it to the stripped part.

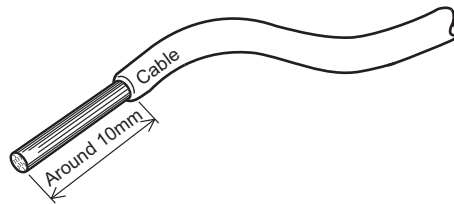

(6) List of bar solderless terminals

The following table lists recommended bar solderless terminals.

Product name	Model name	Applicable wire size	Bar solderless terminal tool	Contact
Bar solderless terminal	TE 0.5-10	0.5mm ²	NH79	NICHIFU Co., Ltd.
	TE 0.75-10	0.75mm ²		
	TE 1.0-10	0.9 to 1.0mm ²		
	TE 1.5-10	1.25 to 1.5mm ²		
	AI 0.5-10WH	0.5mm ²	CRIMPFOX6	PHOENIX CONTACT GmbH & Co. KG
	AI 0.75-10GY	0.75mm ²		
	AI 1-10RD	1.0mm ²		
	AI 1.5-10BK	1.5mm ²		

6.4.2 Wiring of an Ethernet cable

(1) Connecting the Ethernet cable

(a) Connecting

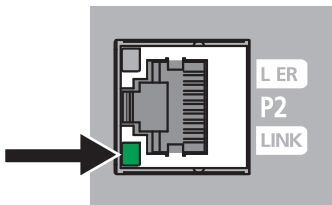
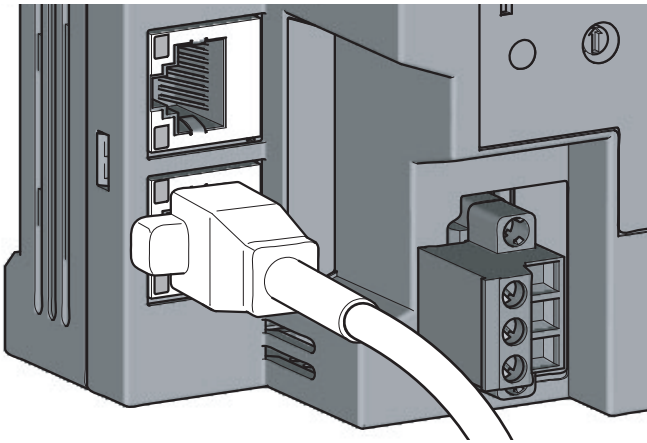

1. Power off the bridge module and the devices connected to the bridge module.
2. Push the Ethernet cable connector into the bridge module until it clicks. Pay attention to the orientation of the connector.
3. Power on the bridge module.
4. Power on the devices connected to the bridge module.
5. Check that the LINK LED on the port into which the Ethernet cable is connected is on. It may take a few seconds for the LINK LED to turn on after the module is powered on. Normally, it turns on in a few seconds. If the LINK LED does not turn on, refer to the troubleshooting section and take a corrective action. (👉 Page 91, Section 9.6.2 (7))

Point

- PORT1 and PORT2 connectors need not to be distinguished. When only one connector is used in the star topology, either PORT1 or PORT2 can be used.

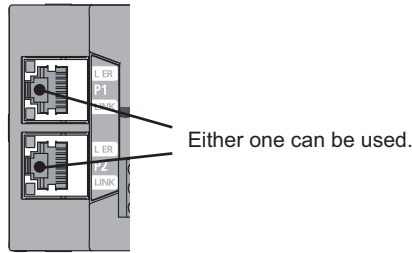

- When two connectors are used in the line topology or ring topology, an Ethernet cable can be connected to the PORT1 and PORT2 connectors in any combination. For example, a cable can be connected between PORT1s or between PORT1 and PORT2.

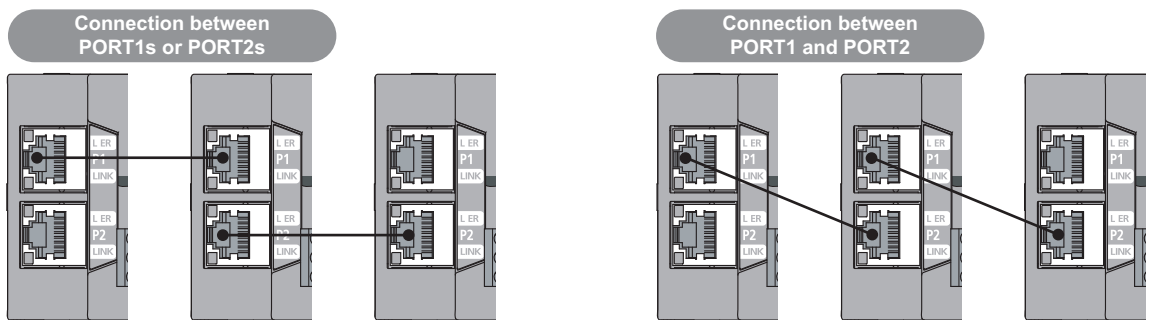

6

(b) Disconnecting

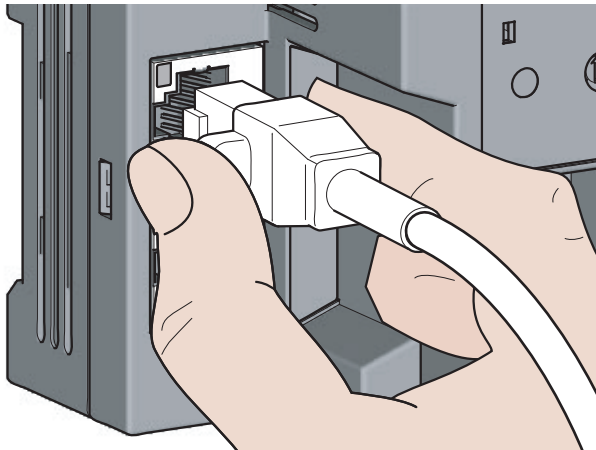

1. Power off the module.
2. Unplug the Ethernet cable while pinching the latch of the cable.

6.4 Wiring

(2) Precautions

This section describes precautions on the wiring for CC-Link IE Field Network.

(a) Laying Ethernet cables

- Place the Ethernet cable in a duct or fix the cable by clamping it. If not, dangling cable may swing or inadvertently be pulled, resulting in damage to the module or cables or malfunction due to poor contact.
- Do not touch the core of the connector of the cable or the module, and protect it from dirt and dust. If any oil from hands or any dirt or dust sticks to the core, it can increase transmission loss, causing data link to fail.
- Check the following:
 - Is any Ethernet cable disconnected?
 - Is any Ethernet cable shorted?
 - Are the connectors securely connected?

(b) Broken cable latch of the Ethernet cable

Do not use an Ethernet cable with broken latches. Doing so may cause the cable disconnection or malfunction.

(c) Connecting and disconnecting the Ethernet cable

Hold the connector part when connecting and disconnecting the Ethernet cable. Pulling the cable with connected to the module may result in damage to the module or cable or malfunction due to poor contact.

(d) Connectors without Ethernet cables connected

To prevent dust from entering the module, attach the included connector cover.

(e) Maximum station-to-station distance of the Ethernet cable (maximum cable length)

The maximum station-to-station distance is 100m. However, the distance may become shorter depending on the operating environment of the cable. For details, contact the manufacturer of the cable used.

(f) Bend radius of the Ethernet cable

There are restrictions on the bend radius of the Ethernet cable. Check the bend radius in the specifications of the Ethernet cable used.

6.4.3 Wiring of a CC-Link dedicated cable

This section describes the wiring of the terminal block for CC-Link.

(1) Preparation before wiring

(a) Available cable

For the bridge module, use a Ver.1.10-compatible CC-Link dedicated cable.

If cables other than a Ver.1.10-compatible CC-Link dedicated cable are used, normal data transmission is not guaranteed.

(b) Connection order

Cables do not need to be connected in order of station number.

(c) Terminating resistor to be used

Always connect included terminating resistors (110Ω , $1/2W$ (brown, brown, brown)) to the modules at both ends of the CC-Link system.

(2) Wiring method

(a) Wiring diagram

There are no restrictions on the connection location of the bridge module. (Cables do not need to be connected in order of station number.)

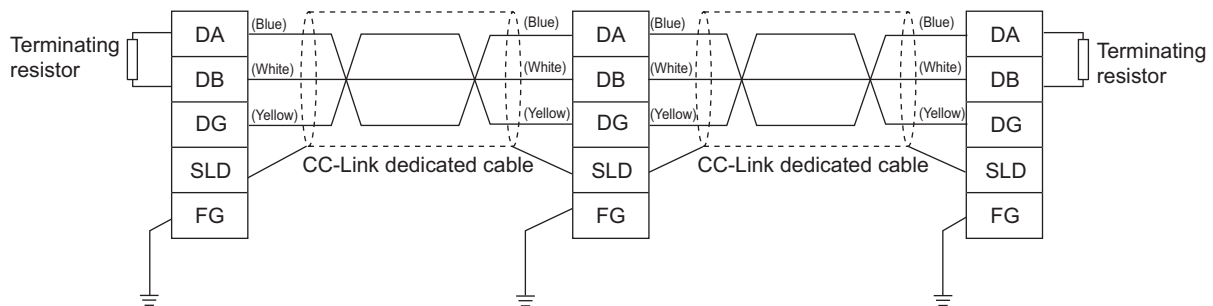

(b) Actual wiring

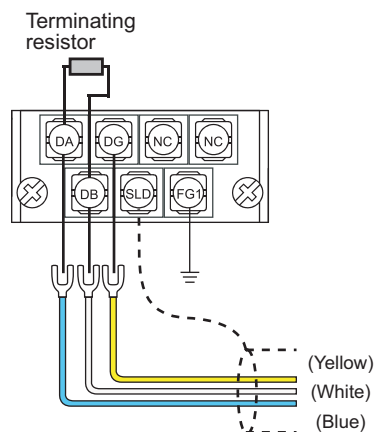

Point

- Connect a terminating resistor between DA and DB.
- Connect the shielded wire of a CC-Link dedicated cable to SLD of each module and ground both ends via FG with a ground resistance of 100Ω or less. SLD and FG are connected inside the module.
- Star topology cannot be used. However, T-branch connection can be used. (Page 51, Section 6.4.3 (5))

(3) Terminal block for CC-Link

(a) Solderless terminal

For wiring, use the applicable solderless terminal and wire specified in the following table and attach them in an applicable tightening torque. Use UL-listed solderless terminals. For processing, use a tool recommended by manufacturers of solderless terminals.

Sleeved solderless terminals cannot be used.

Solderless terminal		Wire			
Model	Applicable tightening torque	Diameter	Type	Material	Temperature rating
1.25 to -3	0.42 to 0.58N·m	22 to 16 AWG	Stranded	Copper	60°C or more

(b) Screw and tightening torque

Tighten the terminal block screws within the following specified torque.

Overtightening can damage the module case.

Screw type	Tightening torque
Terminal block screw (M3 screw)	0.43 to 0.57N·m
Terminal block mounting screw (M3.5 screw)	0.68 to 0.92N·m

Point

- Prevent oil from adhering on the terminals and screws. Failure to do so may damage the screws.
- When inserting two solderless terminals, insert them back-to-back. Otherwise the screw cannot be tightened and it may damage the screw.
- Tighten the terminal screws with an appropriate driver. Otherwise it may damage the screw.

(4) Wiring check

After wiring the master station, the bridge module, and the CC-Link remote station, check that the CC-Link remote station is turned on/off by turning on/off the device of the master station.

(5) T-branch connection

This section describes the method to configure the T-branch connection of the CC-Link system.

(a) T-branch system configuration

The following figure shows the system configuration for the T-branch connection.

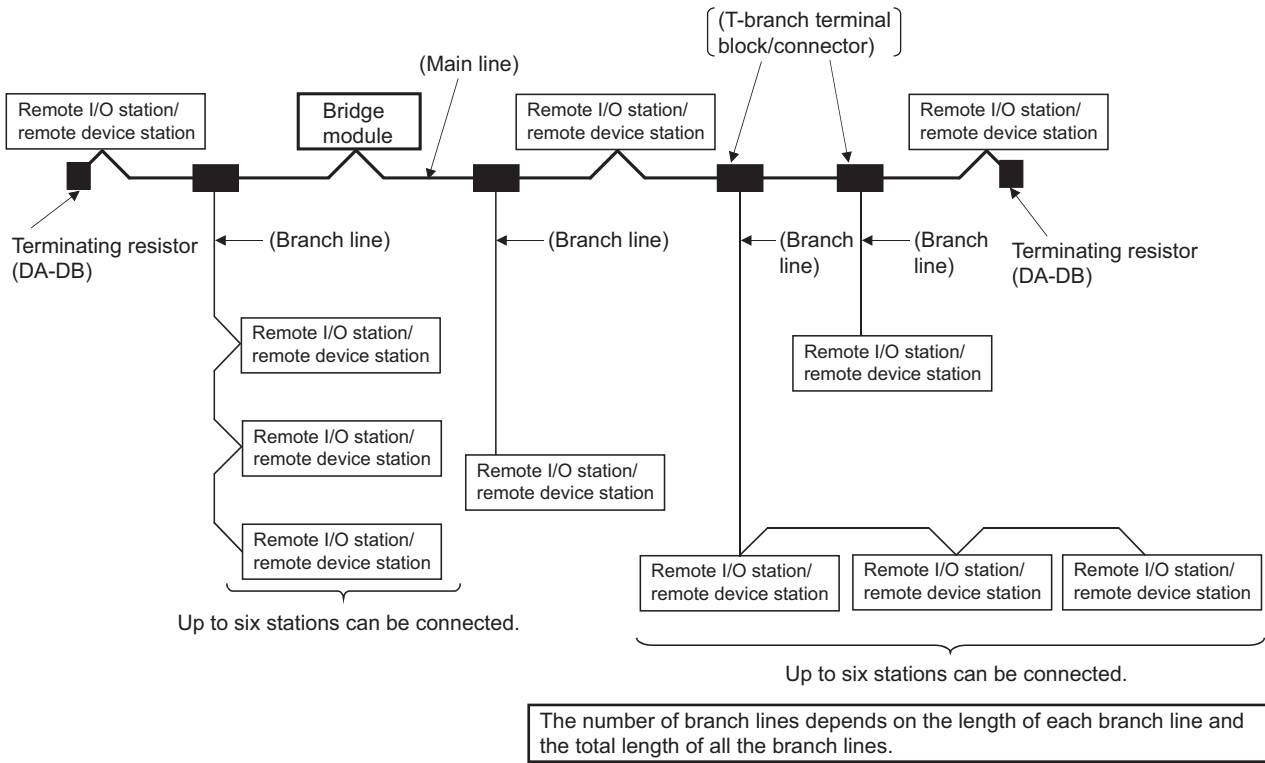

(b) Communication specifications list of T-branch connection

The following table lists the communication specifications for the T-branch connection.

For the communication specifications not listed in the following table, refer to the performance specifications.

(☞ Page 21, Section 3.2)

Item	Specifications		Remarks	
Transmission speed	625kbps	156kbps	10M/5M/2.5Mbps cannot be used.	
Maximum length of the main line	100m	500m	Cable length between the terminating resistors. The cable length of T-branch (length of the branch line) is not included.	
Maximum length of the branch line	8m		Total cable length per branch	
Overall branch line length	50m	200m	Total length of all branch cables	
Maximum number of modules on the branch line	6 modules/branch		Total number of connected modules is in accordance with the CC-Link specifications.	
Connection cable	Ver.1.10-compatible CC-Link dedicated cable		Ver.1.10-compatible CC-Link dedicated cables made by different manufacturers can be used in combination.	
T-branch terminal block/connector	<ul style="list-style-type: none"> Terminal block Commercially available terminal block <ul style="list-style-type: none"> Connector FA sensor connector NECA4202 (IEC947-5-2) or equivalent is recommended. (NECA: Nippon Electric Control Equipment Industries Association Standards)		Avoid peeling the sheath of the cable on the main line side whenever possible.	
Maximum length of the main line, length between two T-branch lines, and station-to-station distance	Ver.1.10-compatible CC-Link dedicated cable (Terminating resistors of 110Ω are used.)			
	Transmission speed	Maximum length of the main line	Length between two T-branch lines	Distance between remote I/O stations or remote device stations
	625kbps	100m	No limitation	30cm or more
156kbps	500m			

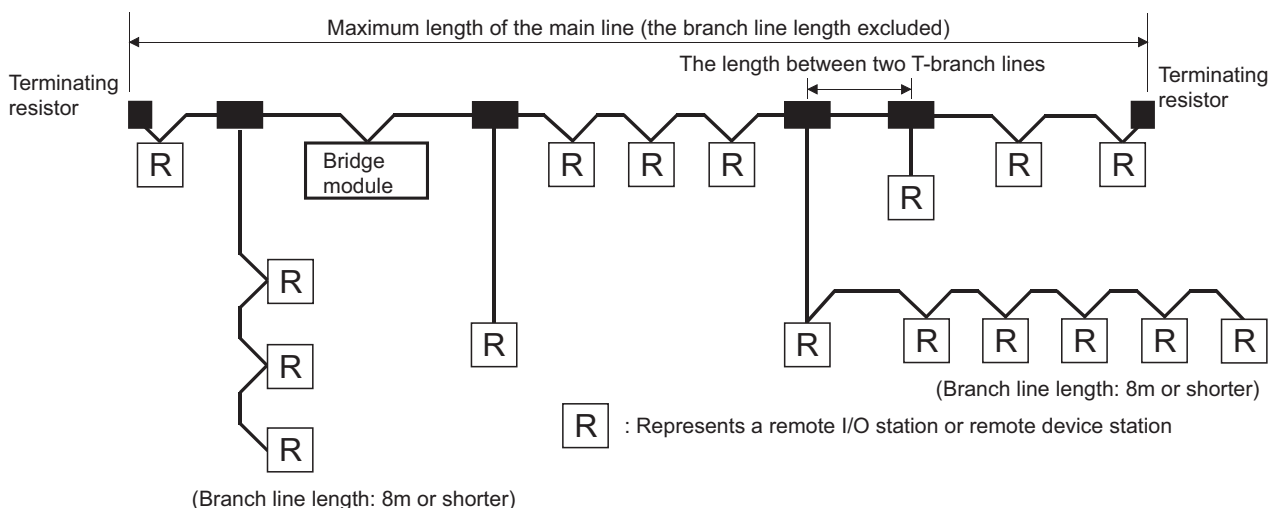

CHAPTER 7 VARIOUS SETTINGS

This chapter describes the various setting methods of the bridge module.

7.1 Parameter Settings for CC-Link IE Field Network

To use the bridge module, set the number of points and assignment of the link device in the CPU module of the master station.

This manual describes the settings of the bridge module. For the settings of network and refresh parameters, refer to the user's manual for the master/local module used.

Remark

Check "Set the network configuration setting in CC IE Field configuration window" on the "MELSECNET/CC IE/Ethernet Module Configuration" window in advance.

(1) Setting procedure

1. Open the "CC IE Field Configuration" window.

- An example of when the master/local module is the QJ71GF11-T2

Project window ⇒ [Parameter] ⇒ [Network Parameter] ⇒ [Ethernet/CC IE/MELSECNET] ⇒ [CC IE Field Configuration Setting] button

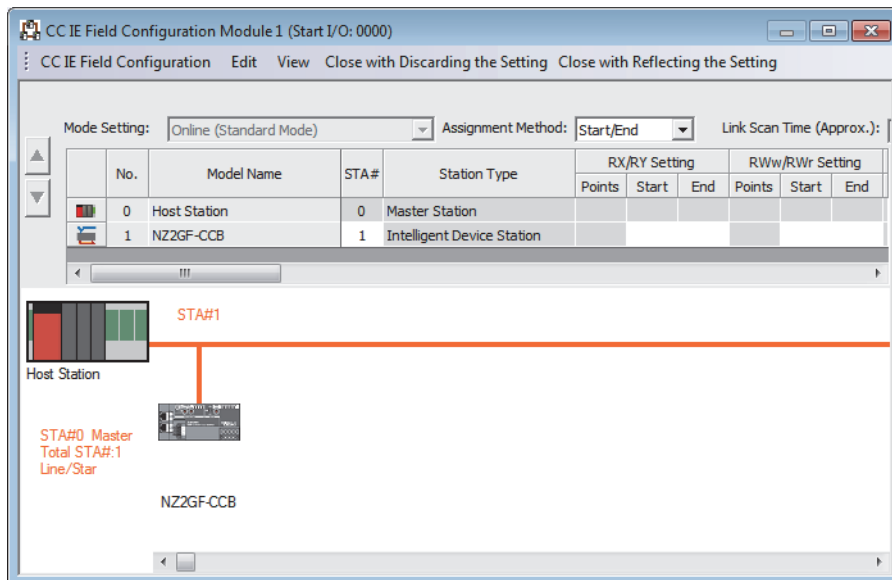

2. Enter the setting for the bridge module.

Enter the following values for the setting of the bridge module.

Setting item		Description
Station number		Set the station number for the bridge module.
RX/RX setting	Number of points	$32 \text{ points} \times \text{last station number on the CC-Link side (including the number of occupied stations)}$
RWr/RWw setting	Number of points	$4 \text{ points} \times \text{last station number on the CC-Link side (including the number of occupied stations)} + 16 \text{ points}$

3. Click the [Close with Reflecting the Setting] button.

7.2 Parameter Settings for CC-Link

This section describes the settings for CC-Link.

The following two methods are available for the settings for CC-Link.

- Setting with the switch
- Setting using the engineering tool

7.2.1 Setting with the switch

Follow the procedures below to set CC-Link.

1. Detecting the CC-Link remote stations

Execute the automatic CC-Link startup so that the bridge module detects the CC-Link remote station.

(☞ Page 55, Section 7.2.1 (1))

2. Saving the parameters

Save the information of the CC-Link remote station as parameters into the bridge module. Then restart CC-Link. (☞ Page 57, Section 7.2.1 (2))

(☞ Page 57, Section 7.2.1 (2))

3. Checking the status of communications

Execute a line test in CC-Link to check the communication status. (☞ Page 64, Section 7.2.3)

(1) Detecting the CC-Link remote stations

The automatic CC-Link startup enables the bridge module to recognize the CC-Link remote stations and start CC-Link only by powering on the module.

After executing the automatic CC-Link startup, set the parameters with the slave station information saving. (☞ Page 57, Section 7.2.1 (2))

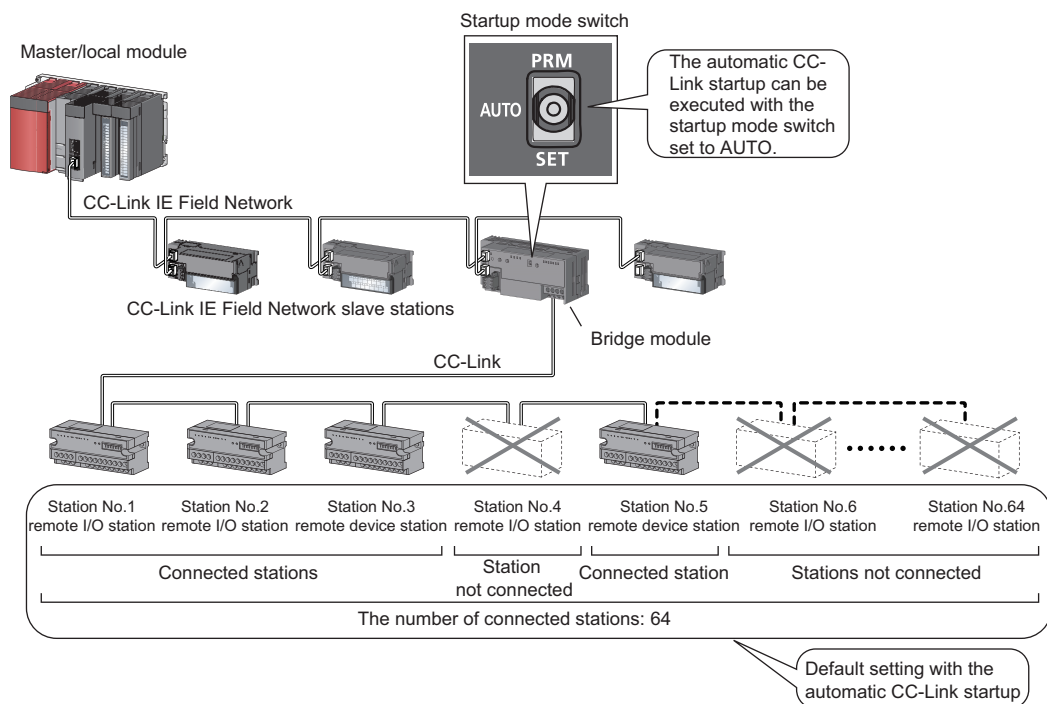

(a) Operating procedure

This section describes the procedures for the automatic CC-Link startup.
Execute this function after completing all the wiring.



1. Set the startup mode switch of the bridge module to AUTO.
2. Power on the module of the CC-Link remote station.
3. Power on the bridge module.
4. The RUN LED and L RUN LED on the CC-Link side turn on.
5. Power on the master station.
6. CC-Link is started and the data is refreshed.

Point

- Always power on the CC-Link remote station module first. If the bridge module is powered on first, the CC-Link remote station is not recognized in the automatic CC-Link startup.
- If the station is not connected to the CC-Link remote station or not recognized upon automatic CC-Link startup, such station number is recognized as an unconnected station. Accordingly, when 64 CC-Link remote stations are not connected, the ERR.LED on the CC-Link side flashes. To check whether a connecting station is performing data link, use Data link status of other stations on CC-Link (RWr8 to RWrB).
- Always perform the line test to all the stations whenever the system is changed due to the module replacement or other reasons after performing the automatic CC-Link startup. If a station with the start station number used for another station is returned, a station already performing data link (only a station having a station number in use error) may be disconnected.

(b) Precautions

- If the automatic CC-Link startup is executed in the following conditions of the CC-Link remote station, the bridge module cannot recognize the CC-Link remote station, resulting in a data link failure.

Item	Description	Action
Transmission speed mismatch	The transmission speed set for the bridge module is different from that for the CC-Link remote station.	Set the transmission speed of the bridge module and the CC-Link remote station properly. ( Page 17, CHAPTER 2)
Error in number of connected modules	The total number of CC-Link remote stations or connected modules is outside of the specifications range.	Adjust the number of CC-Link remote stations and connected modules within the range of the specifications. ( Page 22, Section 3.2 (3))
Station number in use error	The same station number is used for multiple CC-Link remote stations.	Set the appropriate station number for the CC-Link remote station.
Cable error	The CC-Link dedicated cable has an error.	<ul style="list-style-type: none">• Check the cable for disconnection, short circuit, incorrect wiring, poor contact, and usage not meeting the specifications (transmission distance, station-to-station distance, coexistence of different types of cables, and FG connection).• Check if a transmission cable other than a CC-Link dedicated cable is used.

- Temporary error invalid stations cannot be used with data link established through the automatic CC-Link startup. Start CC-Link with the slave station information saving function.

(2) Saving parameters

The information of a slave station performing data link through the automatic CC-Link startup is stored in the flash ROM inside a bridge module using the slave station information saving function.

If the startup mode switch of a bridge module is set to PRM with the slave station information saved, the parameters are set based on the saved data. Then CC-Link is started, and data link is performed.

(a) Operating procedure

The following is a procedure for saving slave station information.

1. Start CC-Link using the automatic CC-Link startup function. (☞ Page 56, Section 7.2.1 (1) (a))
2. Hold the startup mode switch in the SET position until the CC-Link RUN LED of the bridge module turns off (about five seconds).
Slave station information is saved in the flash ROM inside the bridge module.
3. The bridge module is reset and data link is started by executing the automatic CC-Link startup again.
4. Set the startup mode switch of the bridge module to PRM.
5. The bridge module is reset and the parameters are set based on the saved slave station information.
6. The RUN LED and L RUN LED on the CC-Link side turn on.
7. CC-Link is started.

If the startup mode switch of the bridge module is set to PRM when the power supply of the module is turned off then on, the parameters are set based on the saved slave station information and CC-Link is started.

Point



- When the slave station information saving function is executed, the remote station having the largest station number among connected stations is recognized as the last station. The unconnected stations having a smaller station number than the last station are set as reserved stations in the parameter when the slave station information is saved.

(b) Parameters

The network parameters of CC-Link are set as listed below.

Item	Description	Setting value
Mode	Set the mode for the bridge module.	Remote Net (Ver.1 Mode)
Total Module Connected	Set the number of CC-Link remote stations connected.	Based on the actual connection
Retry Count	Set the number of retries to be performed upon a communication error.	3 times
Automatic Reconnection Station Count	Set the number of CC-Link remote stations that can be returned to the network with one link scan from the disconnection due to a communication error or other factors.	1 station
PLC Down Select	Specify whether to stop or continue data link when a stop error occurs in the CPU module of the master station.	Stop
Data Link Faulty Station Setting	Specify whether to clear or hold the input data from the data link faulty station.	Clear the input data
Case of CPU STOP Setting	Specify whether to refresh or compulsorily clear the data output (transmitted) to the CC-Link remote stations when the CPU module of the master station is stopped.	Refresh

Point

- Only when CC-Link is started using the slave station information saving function, a temporary error invalid station can be set using the remote buffer memory. ( Page 115, Appendix 2 (6) (a))
 - Error invalid stations cannot be set using the automatic CC-Link startup function. To set error invalid stations, use the CC-Link parameter setting using the engineering tool. ( Page 59, Section 7.2.2)
-

7.2.2 Setting using the engineering tool

Follow the procedures below to set CC-Link.

1. Writing the parameters of CC-Link remote stations using the engineering tool

Set the parameters of CC-Link remote stations by CC-Link parameter setting using the engineering tool.

(☞ Page 59, Section 7.2.2 (1))

2. Checking the status of communications

Execute a line test in CC-Link to check the communication status. (☞ Page 64, Section 7.2.3)

Point

- There are restrictions on the version of the bridge module to use CC-Link parameter setting using the engineering tool. (☞ Page 132, Appendix 4)
- Do not power off or reset the power supply of the bridge module during parameter writing. Doing so may delete the parameters set in the bridge module.
- During parameter writing, the transmission delay time may extend (3s maximum) or data link may stop.

(1) Writing the parameters of CC-Link remote stations

The parameters of the CC-Link remote station can be set from the engineering tool by connecting the engineering tool to the master station connected to the bridge module.

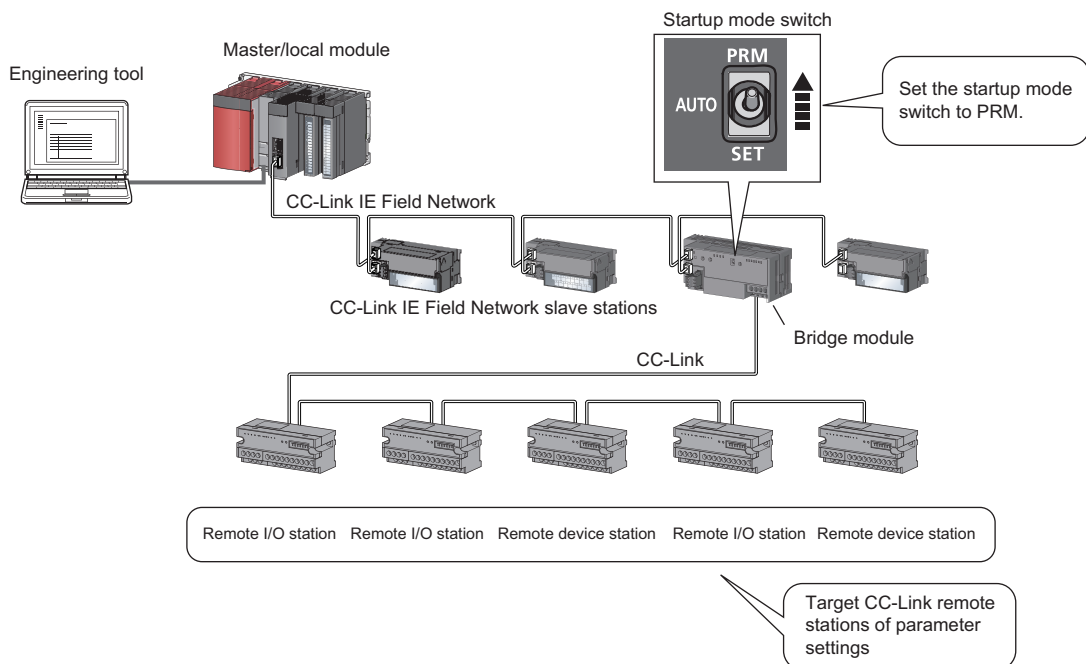

(a) Operating procedure

The following is a procedure of CC-Link parameter setting using the engineering tool.

1. Set the startup mode switch of the bridge module to PRM.

2. Open the "CC IE Field Configuration" window.

- An example of when the master/local module is the QJ71GF11-T2

 Project window ⇒ [Parameter] ⇒ [Network Parameter] ⇒ [Ethernet/CC IE/MELSECNET] ⇒ [CC IE Field Configuration Setting] button

3. Select the bridge module in "List of stations" on the "CC IE Field Configuration" window.

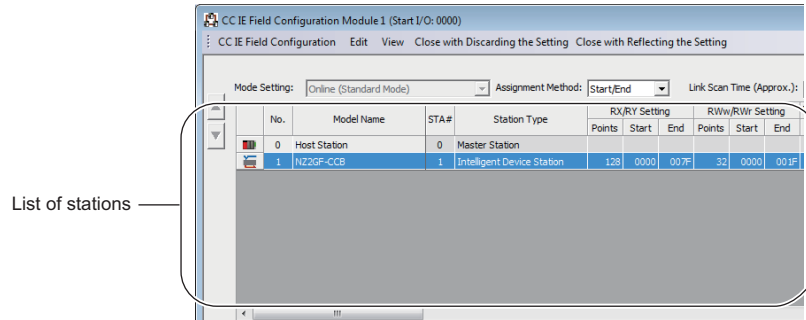

4. Open the "Parameter Processing of Slave Station" window.

 [CC IE Field Configuration] ⇒ [Online] ⇒ [Parameter Processing of Slave Station].

5. Set "Method selection" to "Parameter read".

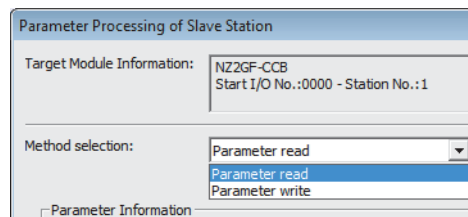

6. Click the [Execute] button and the following window is displayed.

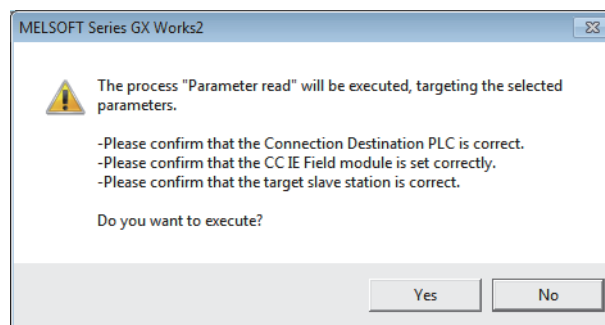

7. Click the [Yes] button.

8. The parameters of the CC-Link remote station are read from the bridge module.

	Name	Initial Value	Unit	Read Value	Unit	Write Value
<input checked="" type="checkbox"/>	Total module connected	64		64		
<input checked="" type="checkbox"/>	Retry count	3		3		
<input checked="" type="checkbox"/>	Automatic reconnection stati...	1		1		
Station information						
<input checked="" type="checkbox"/>	<input type="checkbox"/> 1st station					
	Station number	1		1		
	Number of occupied statio...	1: 1 station ...		1: 1 station ...		
	Station type	0: Remote I/...		0: Remote I/...		
<input checked="" type="checkbox"/>	<input type="checkbox"/> 2nd station					
	Station number	2		2		
	Number of occupied stati...	1: 1 station ...		1: 1 station ...		

9. Set "Method selection" to "Parameter write".

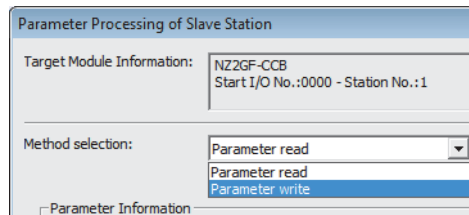

10. Set "Write Value". The following are the procedure.

- Click the title cell of "Read Value" to select all the items and copy them.
- Click the title cell of "Write Value" to select all the items and paste the copy.
- Select the items to be changed, and set new values.

Parameter Processing of Slave Station

Target Module Information: NZ2GF-CCB
Start I/O No.:0000 - Station No.:1

Method selection: Parameter write

The parameters are written to the target module.

Parameter Information

Checked parameters are the targets of selected processes.

	Name	Initial Value	Unit	Read Value	Unit	Write Value	Unit	Setting Range	Description
<input checked="" type="checkbox"/>	Total module connected	64		64		64		1 to 64	Set the number of slave s
<input checked="" type="checkbox"/>	Retry count	3		3		3		1 to 7	Set the number of retries s
<input checked="" type="checkbox"/>	Automatic reconnection stati...	1		1		1		1 to 10	Set the number of slave s
Station information									
<input checked="" type="checkbox"/>	<input type="checkbox"/> 1st station								
	Station number	1		1		1		1 to 64	Set the station number, th
	Number of occupied statio...	1: 1 station ...		1: 1 station ...		1: 1 station ...			Set the number of occupie
	Station type	0: Remote I/...		0: Remote I/...		0: Remote I/...			Set the station type.
<input checked="" type="checkbox"/>	<input type="checkbox"/> 2nd station								Set the station number, th
	Station number	2		2		2		1 to 64	Set the station number, th
	Number of occupied stati...	1: 1 station ...		1: 1 station ...		1: 1 station ...			Set the number of occupie

Process Option

There is no option in the selected process.

The refreshed device values of remote I/O or remote registers may be overwritten.
-Accesses the PLC CPU by using the current connection destination. Please check if there is any problem with the connection destination.
-Process is executed according to the parameters written in the PLC CPU.
-For information on items not displayed on the screen, please refer to the Operating Manual.

Execute

Import... Export... Close

Item		Description	Range
Total module connected		Set the number of CC-Link remote stations connected.	1 to 64 (Default: 64)
Retry count		Set the number of retries to be performed upon a communication error.	1 to 7 (Default: 3)
Automatic reconnection station count		Set the number of CC-Link remote stations that can be returned to the network with one link scan from the disconnection due to a communication error or other factors.	1 to 10 (Default: 1)
1st to 64th station	Station number	Set the station number of the slave station.	1 to 64 (Default: 1)
	Number of occupied stations	Set the number of occupied stations of the slave station.	<ul style="list-style-type: none"> • 1: 1 station occupied • 2: 2 stations occupied • 3: 3 stations occupied • 4: 4 stations occupied (Default: 1)
	Station type	Set the station type of the slave station.	<ul style="list-style-type: none"> • 0: Remote I/O station • 1: Remote device station (Default: 0)
Reserved station specification		Specify the slave station as a reserved station.	<ul style="list-style-type: none"> • 0: Not specified • 1: Specified (Default: 0)
Error invalid station specification		Specify the slave station as an error invalid station.	<ul style="list-style-type: none"> • 0: Not specified • 1: Specified (Default: 0)

Point

- By "Parameter read", the parameters of the CC-Link remote station can be read regardless of parameter setting method.
- The parameters of the CC-Link remote stations specified for the number of station exceeding the value specified in "Total module connected" are invalid.
- Set all parameter items. If there is any vacant item, the parameters cannot be written to the bridge module.
- For the following parameters, the same values as for when setting with the switch are set. (Page 57, Section 7.2.1 (2) (b))
 - Mode
 - PLC Down Select
 - Data Link Faulty Station Setting
 - Case of CPU STOP Setting

11. Click the [Execute] button and the following window is displayed.

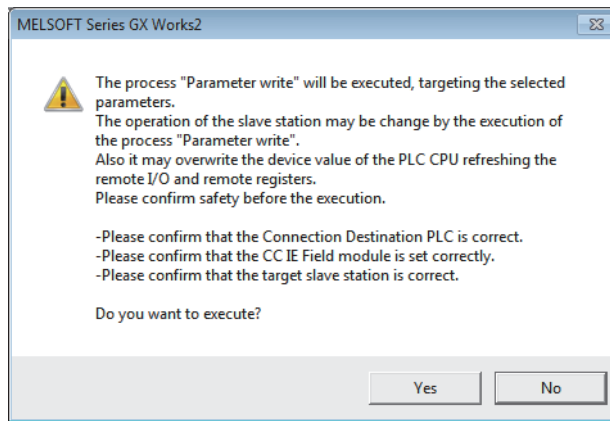

12. Click the [Yes] button.

13. The parameters of the CC-Link remote station are written to the bridge module.

The parameter setting of the CC-Link remote station is completed.

14. Power off and on or reset the power supply of the bridge module.



7.2.3 Checking the status of communications (line test)

This section describes the line test of CC-Link.

For the line test of CC-Link IE Field Network, refer to the following.

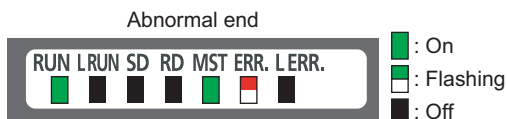
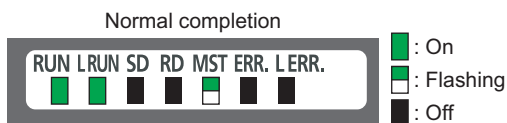
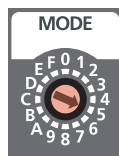
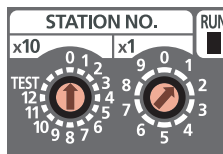
 User's manual for the master/local module used



1. **Check the following before executing the line test.**
 - Check that the startup mode switch of the bridge module is set to AUTO or PRM.
 - Check that all the CC-Link remote stations are connected using CC-Link dedicated cables.
 - Check that the module is connected with the master station.
2. **Set the station number setting switch of the bridge module according to the network parameter of CC-Link IE Field Network.**
3. **Set the transmission speed/mode setting switch of the bridge module to the range of 5 to 9.**
When setting the switch to 5 to 9, set the same transmission speed as that of the system operation. ( Page 17, CHAPTER 2)
4. **Turn the power supply off then on in the order of the CC-Link remote station, the bridge module, and the master station.**
5. **The line test starts.**
The MST LED flashes during the line test.
6. **The L RUN LED or the MST LED turns on when the line test is completed.**
 - Test completed: The L RUN LED turns on and the MST LED flashes. The station number which performs data link successfully with the CC-Link remote station is stored in Line test 1 result (address: 6B4_H to 6B7_H).
 - Test not completed (all stations failed): The MST LED turns on and the ERR. LED on the CC-Link side flashes. The error code is stored in Line test result (address: 6B8_H). ( Page 83, Section 9.5)

Point

To obtain Line test 1 result (address: 6B4_H to 6B7_H) or Line test result (address: 6B8_H), a sequence program for accessing the remote buffer memory of the bridge module is required.

CHAPTER 8 PROGRAMMING

This chapter describes the programming of the bridge module.

The program of the bridge module is written to the CPU module of the master station.

8.1 Precautions for Programming

(1) Cyclic transmission program

For a cyclic transmission program, interlock the link special relay (SB) and the link special register (SW) of the master/local module with the remote register (RWr) of the bridge module.

- Data link status (own station) (SB0049)
- Data link status (each station) (SW00B0 to SW00B7)
- CC-Link operating status (RWr4 to RWr5) (☞ Page 105, Appendix 1 (4))
- Data link status of other stations on CC-Link (RWr8 to RWrB) (☞ Page 106, Appendix 1 (5))

For the link special relay (SB) and link special register (SW) of CC-Link IE Field Network, refer to the following.

📖 User's manual for the master/local module used

(a) Interlock program example

This section describes an interlock program example when the link devices are set as follows.

CC-Link IE Field Network side/ CC-Link side	Link device RWr in which the remote buffer memory is stored	CPU device assigned with the refresh parameter
CC-Link side	RWr4	W4
	RWr8 to RWrB	W8 to WB

The following table lists the devices used by a user in the program example.

Device	Description
SB0049	Data link status of the own station on the CC-Link IE Field Network side
SW00B0.0	Data link status of each station on the CC-Link IE Field Network side (station number 1)
W4.0	CC-Link error
W4.1	Data link status of the own station on the CC-Link side
W4.F	CC-Link ready
W8.0	Data link status of other stations on the CC-Link side (station number 1)

Ex. Interlock example

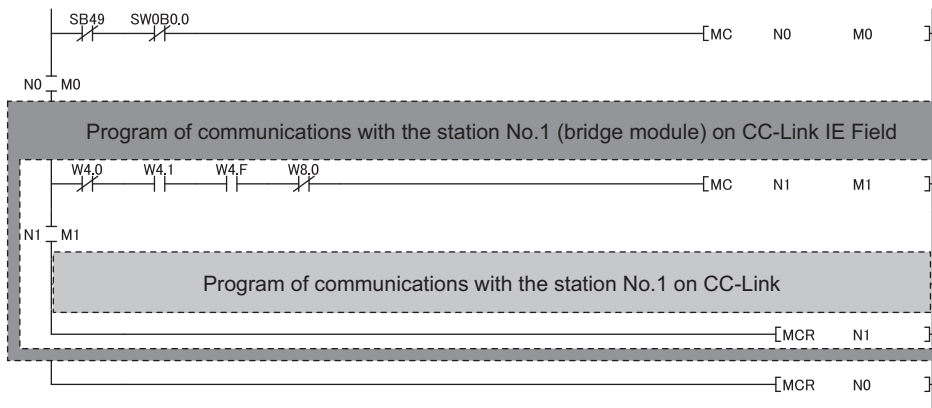

(2) Transient transmission program

For a transient transmission program, interlock the link special relay (SB) with the link special register (SW) of the master/local module.

- Baton pass status (own station) (SB0047)
- Baton pass status (each station) (SW00A0 to SW00A7)

For the link special relay (SB) and link special register (SW) of CC-Link IE Field Network, refer to the following.

 User's manual for the master/local module used

(a) Interlock program example

The following table lists the devices that are used by a user in the program example.

Device	Description
SB0047	Baton pass status of the own station on the CC-Link IE Field Network side
SW00A0.0	Baton pass status of each station on the CC-Link IE Field Network side (station number 1)

Interlock example



8.2 Example of Communications with CC-Link Remote Stations

This section describes an example of communications with CC-Link remote stations using the following system configuration.

8.2.1 System configuration example

(1) System configuration

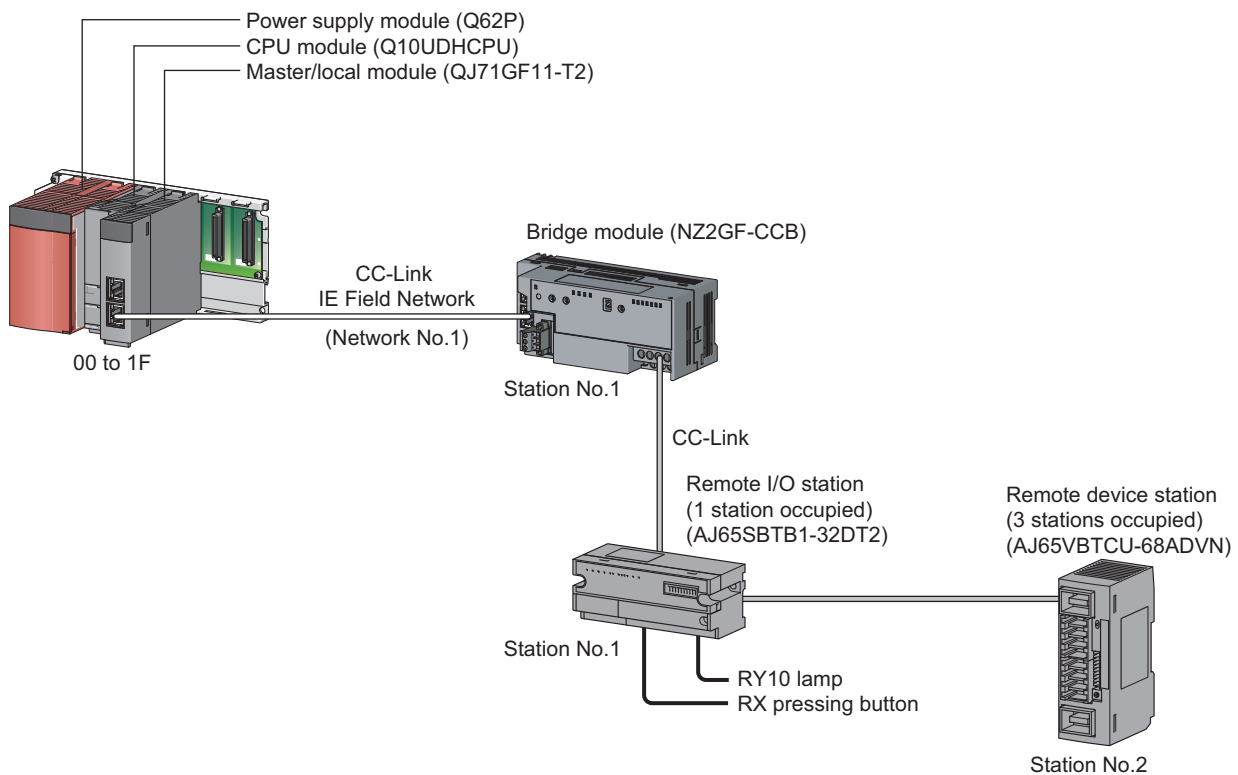

(2) Link device assignment

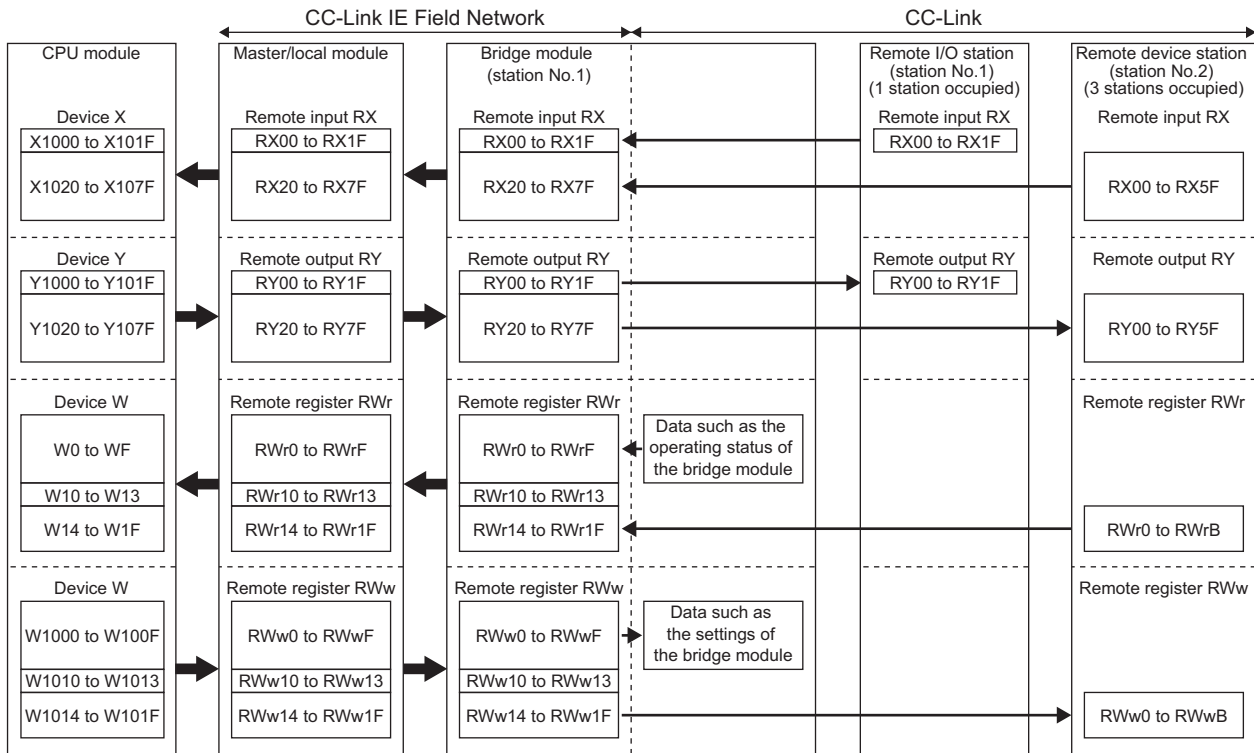

8.2.2 Setting of CC-Link IE Field Network

Connect GX Works2 to the master station and set parameters for CC-Link IE Field Network.

1. Create a project of GX Works2.

For "Series", select "QCPU (Q mode)" and for "Type", select "Q10UDH".

 [Project] ⇒ [New]

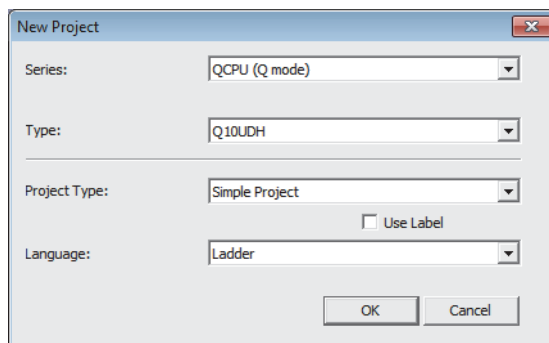

The "New Project" dialog box is shown with the following settings:

- Series: QCPU (Q mode)
- Type: Q10UDH
- Project Type: Simple Project
- Use Label:
- Language: Ladder

Buttons: OK, Cancel

2. Display the network parameter setting window and configure the setting as follows.

 Project window ⇒ [Parameter] ⇒ [Network Parameter] ⇒
[Ethernet/CC IE/MELSECNET]

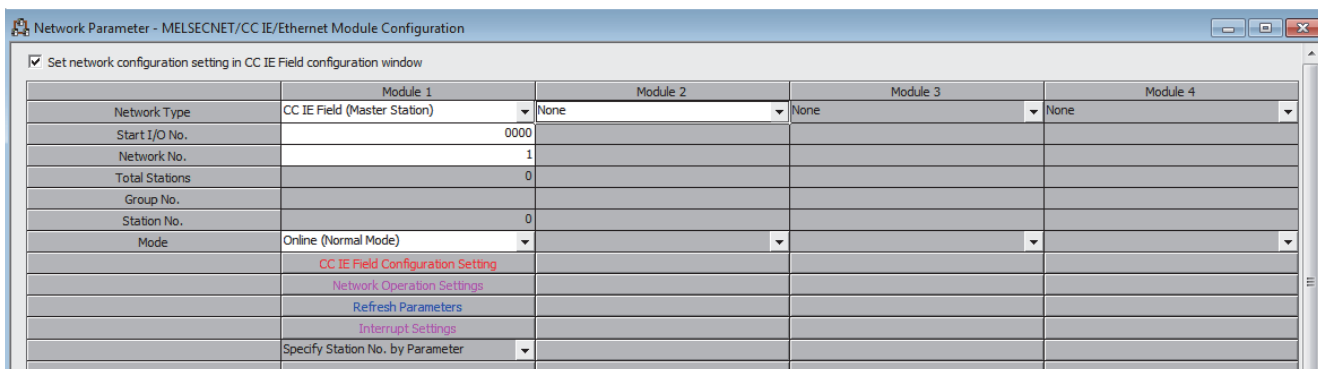

The "Network Parameter - MELSECNET/CC IE/Ethernet Module Configuration" window is shown with the following settings:

	Module 1	Module 2	Module 3	Module 4
Network Type	CC IE Field (Master Station)	None	None	None
Start I/O No.	0000			
Network No.	1			
Total Stations	0			
Group No.				
Station No.	0			
Mode	Online (Normal Mode)			
	CC IE Field Configuration Setting			
	Network Operation Settings			
	Refresh Parameters			
	Interrupt Settings			
	Specify Station No. by Parameter			

3. Display the "CC IE Field Configuration" window and configure the setting as follows.

 [CC IE Field Configuration Setting] button

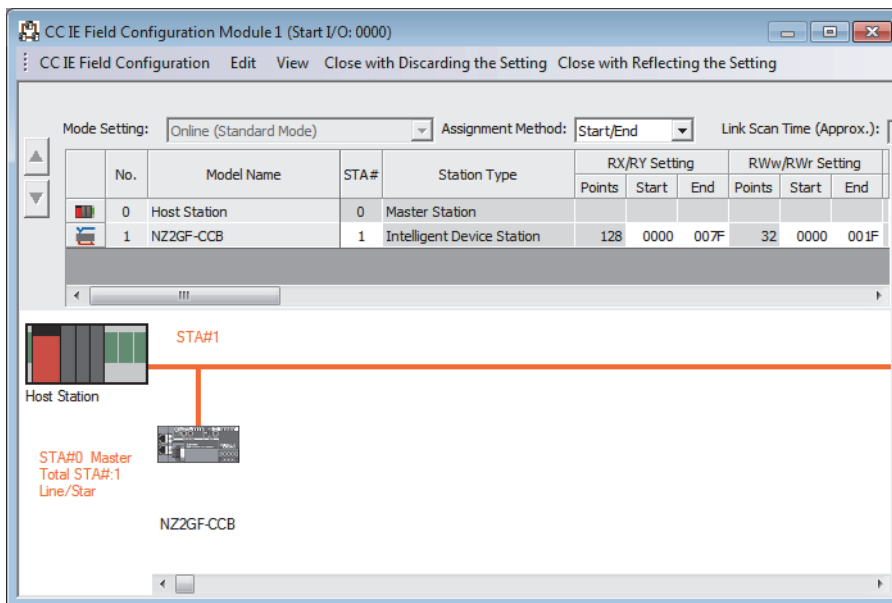

4. Display the refresh parameter setting window and configure the setting as follows.

 [Refresh Parameters] button

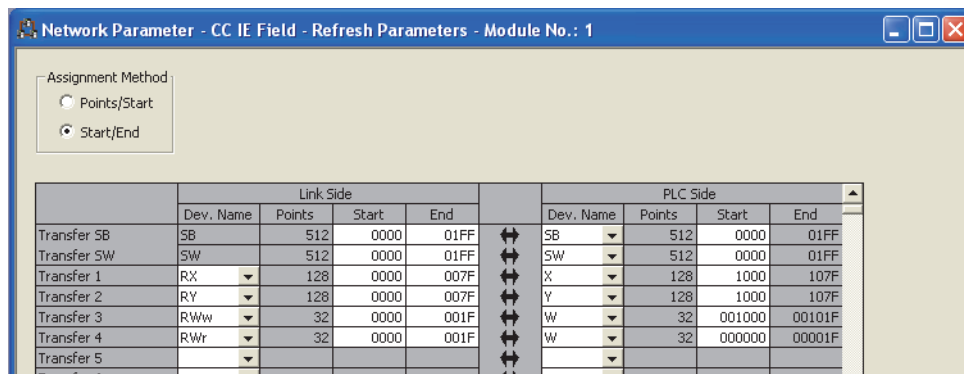

5. Write the set parameters to the CPU module of the master station and reset or power off then on the CPU module.

 [Online] ⇄ [Write to PLC...]

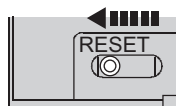

or Power OFF → ON

Point

Use the default values for parameters other than those shown in the program example above. For parameters, refer to the following.

 User's manual for the master/local module used

8.2.3 Setting of CC-Link

To start CC-Link, use the automatic CC-Link startup function and the slave station information saving function.

1. Power on the module of the CC-Link remote station.
2. Set the startup mode switch of the bridge module to AUTO.



3. Power on the bridge module.
4. Hold the startup mode switch in the SET position until the CC-Link RUN LED of the bridge module turns off (about five seconds).

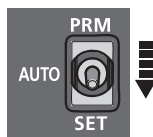

5. Set the startup mode switch of the bridge module to PRM.



8.2.4 Program example

This section describes a program example. Write a program to the CPU module of the master station.

(1) Devices used in the program

(a) Link special relay (SB) and link special register (SW)

Device	Description	Device	Description
SB0049	Data link status of the own station on the CC-Link IE Field Network side	SW00B0.0	Data link status of each station on the CC-Link IE Field Network side (station number 1)

(b) Devices used by a user

Device	Description
X1000	X0 input signal from the CC-Link side (station number 1)
X1020	Remote input RX0 (CH1 A/D conversion completed flag) on the CC-Link side (station number 2)
X1038	Remote input RX18 (Initial data processing request flag) on the CC-Link side (station number 2)
X1039	Remote input RX19 (Initial data setting completion flag) on the CC-Link side (station number 2)
X103A	Remote input RX1A (Error flag) on the CC-Link side (station number 2)
X103B	Remote input RX1B (Remote READY) on the CC-Link side (station number 2)
Y1010	Y10 output signal to the CC-Link side (station number 1)
Y1038	Remote input RX1B (Remote READY) on the CC-Link side (station number 2)
Y1039	Remote output RY19 (Initial data setting request flag) on the CC-Link side (station number 2)
Y103A	Remote output RY1A (Error reset request flag) on the CC-Link side (station number 2)
N0	Nesting on the CC-Link IE Field Network side
N1	Nesting on the CC-Link side (station number 1)
N2	Nesting on the CC-Link side (station number 2)
M0	Communication condition satisfied flag on the CC-Link IE Field Network side
M1	Communication condition satisfied flag on the CC-Link side (station number 1)
M2	Communication condition satisfied flag on the CC-Link side (station number 2)
M100	Initial settings change flag on the CC-Link side (station number 2)
M101	Error clear flag on the CC-Link side (station number 2)
W4.0	CC-Link error
W4.1	Data link status of the own station on the CC-Link side
W4.F	CC-Link ready
W8.0	Data link status of other stations on the CC-Link side (station number 1)
W8.1	Data link status of other stations on the CC-Link side (station number 2)
W14	Remote register RWr0 (CH1 Digital output value) on the CC-Link side (station number 2)
W1C	Remote register RWr8 (Error code) on the CC-Link side (station number 2)
W1014	Remote register RWw0 (A/D conversion enable/disable setting) on the CC-Link side (station number 2)
W1015	Remote register RWw1 (CH1 to CH4 Input range setting) on the CC-Link side (station number 2)
W1017	Remote register RWw3 (Averaging processing specification) on the CC-Link side (station number 2)
W1019	Remote register RWw5 (CH2 Time average/count average setting) on the CC-Link side (station number 2)
D500	CH1 Digital output value storage
D508	Error code storage

(2) Program example

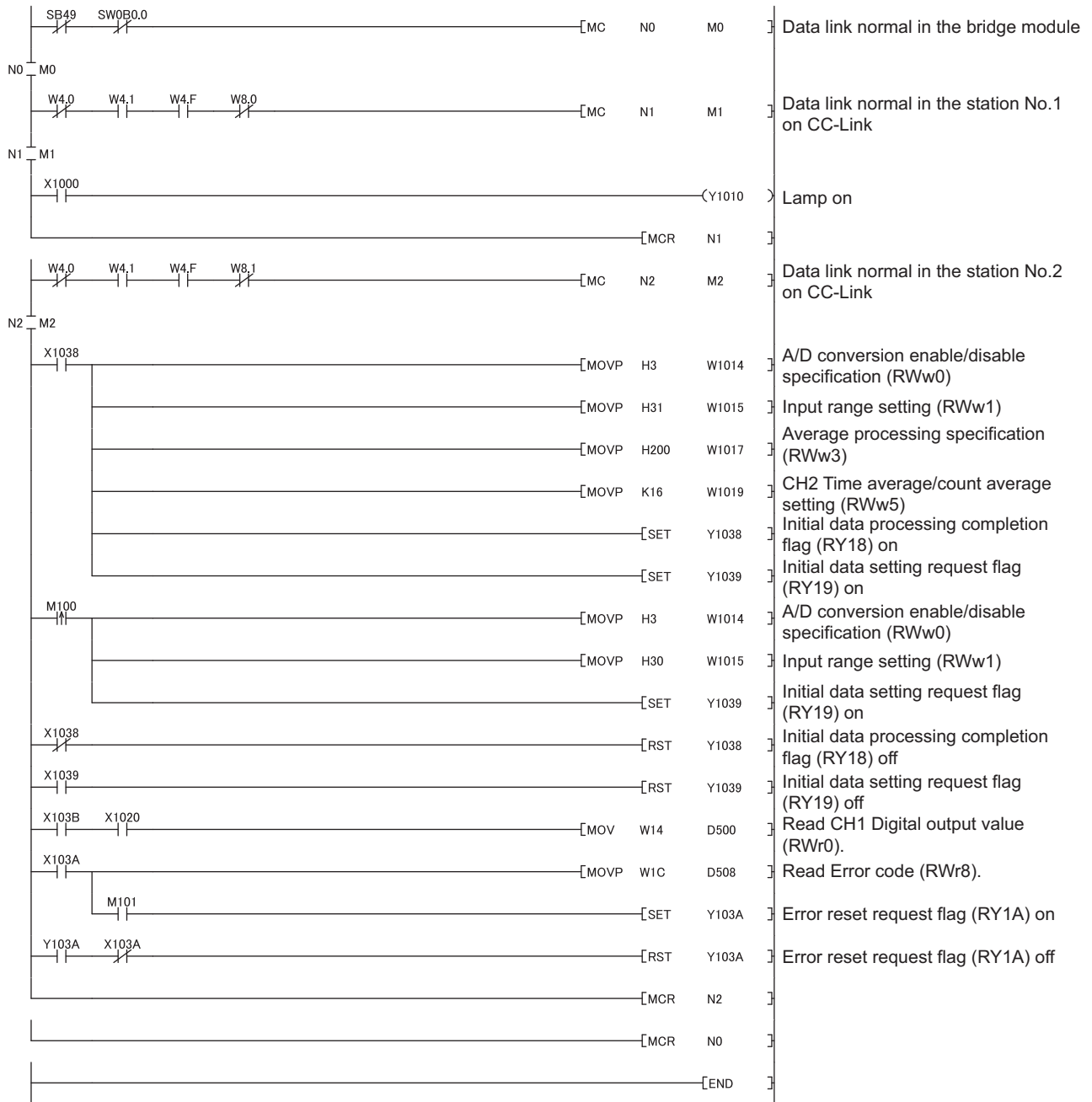

If the bridge module does not respond to the master station for several link scans, such station is judged as a cyclic transmission faulty station. Then the bit of the corresponding station turns on in Data link status (each station) (SW00B0 to SW00B7).

CHAPTER 9 TROUBLESHOOTING

9.1 Operation Upon Error

This section describes the status of a link device if a communication error occurs in the master station or the CC-Link remote station during data link.

(1) When the status of the CPU module of the master station becomes STOP due to an error (with data link continued)

Module	Remote input (RX)	Remote output (RY)	Remote register (RWw)	Remote register (RWr)
CPU module of the master station	Continue	Depends on the engineering tool setting	Continue	Hold
Bridge module	Continue	Clear	Continue	Hold
CC-Link remote I/O station	Continue	Clear	—	—
CC-Link remote device station	Continue	Clear	Continue	Continue

(2) When data link on CC-Link IE Field Network stops

Module	Remote input (RX)	Remote output (RY)	Remote register (RWw)	Remote register (RWr)
CPU module of the master station	Depends on the engineering tool setting	Not output	Continue	Hold
Bridge module	Depends on the engineering tool setting	Not output	Continue	Hold
CC-Link remote I/O station	Depends on the external signal	All points turn off.	—	—
CC-Link remote device station	*1	All points turn off.	*1	*1

*1 Error status defined by the CC-Link remote device station

(3) When the bridge module stops due to an error

Module	Remote input (RX)	Remote output (RY)	Remote register (RWw)	Remote register (RWr)
CPU module of the master station	<ul style="list-style-type: none"> The receiving area for the remote I/O station having a communication error is cleared. The areas for remote I/O stations having no communication error are continued. 	Continue	The areas for remote I/O stations having no communication error are continued.	The areas for remote I/O stations having no communication error are continued.
Bridge module	—	—	—	—
CC-Link remote I/O station	Depends on the external signal	All points turn off.	—	—
CC-Link remote device station	Continue	Continue	Continue	Continue

(4) When a communication error (such as power-off) occurs in a CC-Link remote I/O station

Module	Remote input (RX)	Remote output (RY)	Remote register (RWw)	Remote register (RWr)
CPU module of the master station	<ul style="list-style-type: none"> The receiving area for the remote I/O station having a communication error is cleared. The areas for remote I/O stations having no communication error are continued. 	Continue	The areas for remote I/O stations having no communication error are continued.	The areas for remote I/O stations having no communication error are continued.
Bridge module	<ul style="list-style-type: none"> The receiving area for the remote I/O station having a communication error is cleared. The areas for remote I/O stations having no communication error are continued. 	Continue	The areas for remote I/O stations having no communication error are continued.	The areas for remote I/O stations having no communication error are continued.
CC-Link remote I/O station	Depends on the external signal	All points turn off.	—	—
CC-Link remote device station	Continue	Continue	Continue	Continue

(5) When a communication error (such as power-off) occurs in a CC-Link remote device station

Module	Remote input (RX)	Remote output (RY)	Remote register (RWw)	Remote register (RWr)
CPU module of the master station	<ul style="list-style-type: none"> The receiving area for the remote device station having a communication error is cleared. The areas for remote device stations having no communication error are continued. 	Continue	Continue	<ul style="list-style-type: none"> The receiving area for the remote device station having a communication error is held. The areas for remote device stations having no communication error are continued.
Bridge module	<ul style="list-style-type: none"> The receiving area for a remote device station having a communication error is cleared. The areas for remote device stations having no communication error are continued. 	Continue	Continue	<ul style="list-style-type: none"> The receiving area for the remote device station having a communication error is held. The areas for remote device stations having no communication error are continued.
CC-Link remote I/O station	Continue*2	Continue*2	—	—
CC-Link remote device station	*1	*1	*1	*1

*1 Error status defined by the CC-Link remote device station

*2 Continued regardless of the communication status of the CC-Link remote device station

9.2 Troubleshooting Procedure

This section describes a procedure from identifying the cause of an error to taking a corrective action.

1. Troubleshooting for CC-Link IE Field Network

Errors can be checked with the CC-Link IE Field Network diagnostics of the engineering tool connected to the master station.

Identify the cause of an error and take a corrective action. (☞ Page 78, Section 9.3)

2. Troubleshooting for errors occurring in the bridge module (☞ Page 81, Section 9.4)

3. If data link cannot be performed even after the troubleshooting above is performed, follow the troubleshooting procedures below.

- Checking the LEDs (☞ Page 89, Section 9.6)
- Troubleshooting by Symptom (☞ Page 94, Section 9.7)

9.3 CC-Link IE Field Network Diagnostics

With this function, whether a network error has occurred can be checked on the engineering tool connected to the master station.

This section describes the function of when GX Works2 is used as the engineering tool.

(1) How to use

1. Connect GX Works2 to the master station.
2. Start the CC IE Field Network diagnostics from the menu of GX Works2.

 [Diagnostics] ⇒ [CC-Link IE Field Diagnostics]

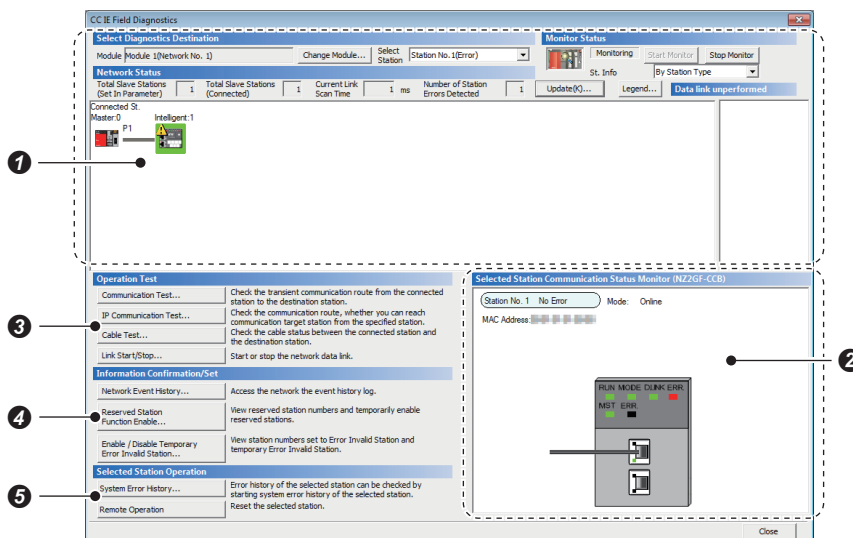

Diagnostics item	Description	Reference	
① Display of the network map and error status	The status of CC-Link IE Field Network can be checked. If an error or warning occurs in the bridge module, an icon appears.	User's manual for the master/local module used	
② Display of the status of the selected station and error details	The communication status of the station selected in "Networks Status" can be checked. The LEDs in the upper row of the module diagram shows LEDs on the CC-Link IE Field Network side and those in the lower row are LEDs on the CC-Link side.		
③	Communication Test		The route and establishment of transient communications from the connected station to the destination station can be checked.
	IP Communication Test		This function cannot be used for the bridge module.
	Cable Test		The cable connection status between the tested station and the device connected to the port of the tested station can be checked.
	Link Start/Stop		Data link can be started or stopped.
④	Network Event History		The history of various events that occurred on the network can be checked.
	Reserved Station Function Enable		A reservation for a station can be temporarily cancelled, and the cancellation can be disabled. In addition, the station numbers of stations set as reserved stations can be checked on a list.
	Enable/Disable Ignore Station Errors		A temporary error invalid station can be set or canceled. In addition, the station numbers of stations set as (temporary) error invalid stations can be checked on a list.

	Diagnostics item	Description	Reference
5	System Error History ^{*1}	The history of errors that occurred in the bridge module can be checked.	Page 81, Section 9.4
	Remote Operation	The selected station can be reset through the remote operation.	Page 80, Section 9.3 (2)

*1 Only GX Works2 supports this item.

(2) Remote operation

Remotely reset the bridge module from GX Works2 connected to the master station.

1. Select a slave station to be reset and click the [Remote Operation] button.

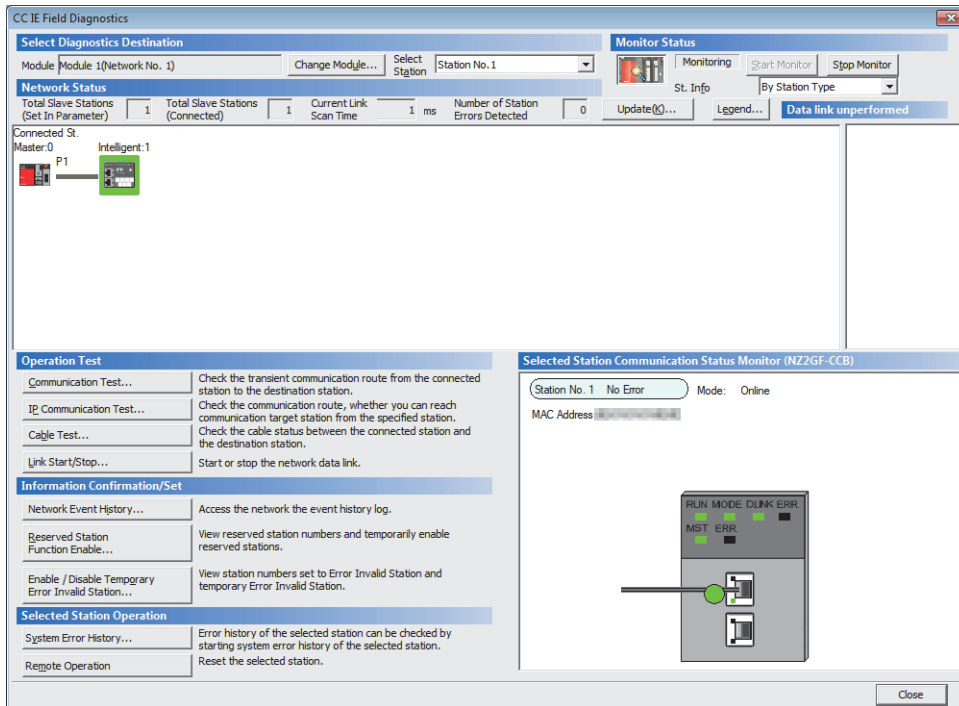

2. Clicking the [Yes] button on the following window starts the remote reset operation.

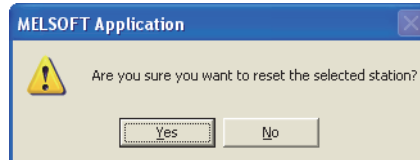

3. Click the [OK] button on the following window.

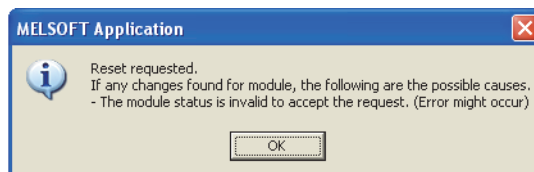

When using the remote reset function, use a master/local module with a serial number (first five digits) of 14102 or later as the master station.

9.4 How to Check Error Codes and Warning Codes

Error codes and warning codes can be checked by any of the following methods:

- Check by the CC-Link IE Field Network diagnostics (Page 81, Section 9.4 (1))
- Check by the remote register (error code (RWr1) and warning code (RWr2)) (Page 82, Section 9.4 (2))

(1) Check by the CC-Link IE Field Network diagnostics

Check the error codes and warning codes by the CC-Link IE Field Network diagnostics.

 [Diagnostics] ⇒ [CC-Link IE Field Diagnostics]

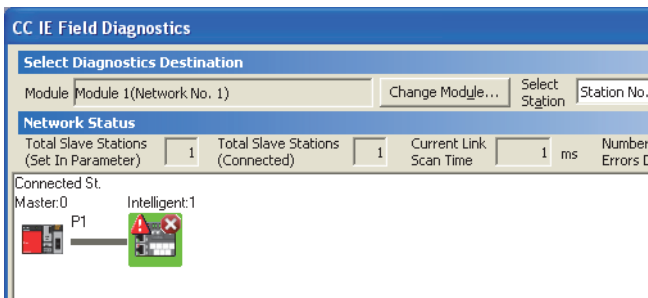

1. Double-click the icon of the bridge module displayed in "Network Status" to display the "Error History" window.

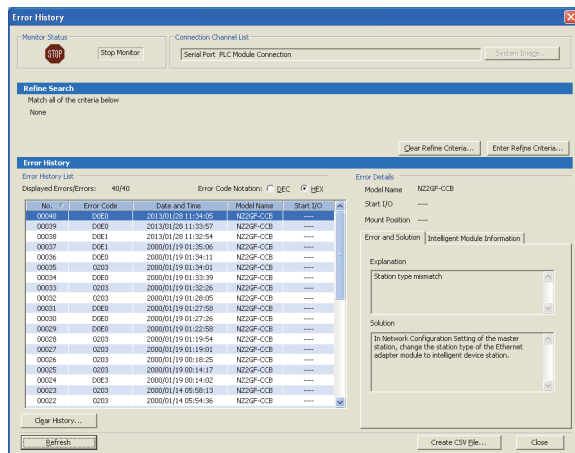

2. The error history appears. Check the error details and corrective action, and perform the troubleshooting.

Point

- The error history can be checked only with GX Works2.
- Up to 40 error histories are saved in the bridge module. When the number of histories exceeds 40, the old error is deleted in chronological order.
- If the same error has occurred continuously, only the error that has occurred first is stored to the error history.
- The occurrence date of the error that has occurred during the initial processing or before data link on CC-Link IE Field Network starts is recorded in the module error history as "0000/00/0000:00:00". An error recorded as "0000/00/0000:00:00" is not displayed on the error history list in the order of the actual date of the error occurrence.

(a) Precautions

When an error occurrence date is not displayed normally, check the communication status between the bridge module and the master station. The bridge module acquires the clock information regularly from the CPU module of the master station. If an error has occurred with no data link performed with the master station, the date of the error occurrence is not recorded because there is no clock information to be referred to in the bridge module. ("—" is displayed on the error history list.)

(2) Check by the remote register

Check the remote register of the master/local module.

 [Online] ⇒ [Monitor] ⇒ [Device/Buffer Memory Batch]

Ex. When the refresh target device of the error code (RWr1) is W1

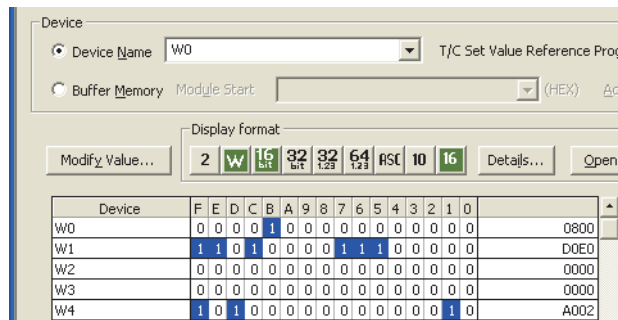

Device	F	E	D	C	B	A	9	8	7	6	5	4	3	2	1	0	
W0	0	0	0	0	1	0	0	0	0	0	0	0	0	0	0	0	0800
W1	1	1	0	1	0	0	0	0	1	1	1	0	0	0	0	0	D0E0
W2	0	0	0	0	0	0	0	0	0	0	0	0	0	0	0	0	0000
W3	0	0	0	0	0	0	0	0	0	0	0	0	0	0	0	0	0000
W4	1	0	1	0	0	0	0	0	0	0	0	0	0	0	1	0	A002

9.5 List of Error Codes and Warning Codes

This section describes error codes and warning codes.

9.5.1 Errors that occur in the bridge module

(1) Error codes

Error code (hexadecimal)	Classification	Error description	Action
0001 _H	Major error	Bridge module failure	Take noise reduction measures and reset the master station and the bridge module. If the same error occurs again, the hardware of the bridge module is in failure. Please consult your local Mitsubishi representative.
0002 _H			
0003 _H			
0004 _H		CC-Link H/W error	
0006 _H		Data write error	
0007 _H			
0101 _H	Moderate error	Data read error	Reset the bridge module. If the same error occurs again, the hardware of the bridge module is in failure. Please consult your local Mitsubishi representative.
0104 _H		Date data out of range	An error may have occurred due to noise or the hardware may be in failure. If the same error occurs again even after measures have been taken against noise, please consult your local Mitsubishi representative.
0107 _H		Station number switch out of range	Set a station number within the setting range.
0108 _H		Data write error	Write the parameters again. If the same error occurs again, the hardware of the bridge module is in failure. Please consult your local Mitsubishi representative.
0109 _H		Data read error	Reset the bridge module. If the same error occurs again, the hardware of the bridge module is in failure. Please consult your local Mitsubishi representative.
0511 _H		Parameter not set	Set the startup mode switch to AUTO and set the switch to SET while the CC-Link system is operating normally. Then set CC-Link parameters.
0512 _H		Invalid parameter	Check if the same station numbers are used at the same time or the connected CC-Link remote station supports only CC-Link Ver.2.

(2) Warning codes

Error code (hexadecimal)	Classification	Error description	Action	
0201 _H	Minor error	Data read error (error history)	<ul style="list-style-type: none"> The error is automatically corrected immediately after it has occurred. However, the history of errors that have occurred before this error is lost. Take noise reduction measures such as using a shielded cable for connection. If the same error occurs again, the module may be in failure. Please consult your local Mitsubishi representative. 	
0203 _H		Station number switch changing error	Reset the switch to the station number that was set when the module was powered on.	
0204 _H		Momentary power failure occurrence	Check the power supply to the bridge module.	
0205 _H		Startup mode switch out of range	Set the startup mode switch to PRM.	
0601 _H		Invalid parameter		Write the parameters again using the parameter processing of slave station. If the same error occurs, register the latest profile of the bridge module to the engineering tool and write the parameters again. If the same error occurs again, the hardware of the bridge module is in failure. Please consult your local Mitsubishi representative.
0602 _H				
0603 _H				
0604 _H				
0605 _H				
0606 _H				
0607 _H		Station information setting error	In parameter processing of slave station, set "Station information" so that it meets the following condition: $(16 \times A) + (54 \times B) \leq 2304$ <ul style="list-style-type: none"> A: Number of remote I/O stations B: Number of remote device stations 	
0608 _H		Remote device station setting error	In parameter processing of slave station, set the parameters so that the number of stations in which "Station type" of "Station information" is set to the remote device station is 42 or less.	
0609 _H		Invalid station specification error	In parameter processing of slave station, specify only the station numbers set in "Station number" of "Station information" as the error invalid stations.	
060A _H		Station number setting error	In parameter processing of slave station, set the parameters so that the sum of the number set in "Station number" and "Number of occupied stations" of "Station information" is 64 or less.	
060B _H		Invalid parameter	Write the parameters again using the parameter processing of slave station. If the same error occurs, register the latest profile of the bridge module to the engineering tool and write the parameters again. If the same error occurs again, the hardware of the bridge module is in failure. Please consult your local Mitsubishi representative.	
060C _H		Reserved station specification error	<ul style="list-style-type: none"> In parameter processing of slave station, specify only the station numbers set in "Station number" of "Station information" as the reserved stations. In parameter processing of slave station, check if all the station numbers set in "Station number" of "Station information" are set as the reserved stations. 	
060D _H	Station number already in use error	In parameter processing of slave station, set the parameters so that there is no duplication in "Station number" of "Station information".		
060E _H	No parameter input error	In parameter processing of slave station, any of "Total module connected", "Retry count", "Automatic reconnection station count", or "Station information" has not yet been written. Write the parameters.		

9.5.2 Errors that occur in CC-Link IE Field Network

(1) Error codes

Error code (hexadecimal)	Classification	Error description	Action
D010 _H	Moderate error	Parameter error (RX size over)	Correct the points assigned to the RX devices.
D011 _H		Parameter error (RY size over)	Correct the points assigned to the RY devices.
D012 _H		Parameter error (RWw size over)	Correct the points assigned to the RWw devices.
D013 _H		Parameter error (RWr size over)	Correct the points assigned to the RWr devices.
D0E0 _H		Station type mismatch	Change the station type of the module to the intelligent device station in the network configuration setting of the master station (submaster station).
D0E1 _H		Own station reserved	<ul style="list-style-type: none"> In the network configuration settings of the master station (submaster station), cancel the reserved station setting. Change the station number of the module to a station number that is not reserved.
D0E2 _H		Station No. already in use (own station)	<ul style="list-style-type: none"> Set a unique station number. After taking the corrective action above, power off then on or reset all the stations where a station number in use error was detected.
D0E3 _H		Own station No. out of range	Add the station information of the module to the network configuration setting of the master station (submaster station).
D529 _H	Major error	Communication error 1	<ul style="list-style-type: none"> A malfunction due to noise may have occurred. Take noise reduction measures after checking the length of wires or cables and the grounding of the devices.
D52B _H		Communication error 2	<ul style="list-style-type: none"> Execute a unit test for the module. If the same error occurs again, the hardware of the bridge module is in failure. Please consult your local Mitsubishi representative.

(2) Warning codes

Error code (hexadecimal)	Classification	Error description	Action
D0AA _H	Minor error	Transient divided reception error	Set the transient data size within the range that can be handled by the module. Then send the transient data that is not divided.
D217 _H		Transient data request error	Correct the request command at the request source, and retry the operation.
D2A0 _H		Receive buffer full	<ul style="list-style-type: none"> Check the network status with the CC-Link IE Field Network diagnostics of the programming tool and correct the error. When the target station or relay station is overloaded and cannot receive transient data, send the data to the station after a while.
D2A3 _H		Transient data length error	Correct the number of data (frame length) at the request source, and retry the operation.







9.5.3 Errors that occur in CC-Link

Error code (hexadecimal)	Error description	Error cause (detailed)	Action							
B115 _H	Link error	A line error has occurred.	Check the line.							
B116 _H	Packet error	A line error has occurred.	Check the line.							
B301 _H	Processing request error during link stop	A line test request was issued during link stop.	Execute a line test while data link is being performed.							
B302 _H	Specified station number setting error	The destination station number of the temporary error invalid request or temporary error invalid canceling request has exceeded the maximum station number that can communicate.	Specify a station number smaller than or equal to the maximum station number.							
B303 _H	No station number setting error	Although the temporary error invalid request or temporary error invalid canceling request was issued, the target station number has not been set.	Set the station number. (Address: 603 _H and 604 _H to 607 _H)							
B304 _H	Detection of a faulty station in a line test	When a line test was executed, an error has been detected in a CC-Link remote station.	Check that the CC-Link remote station has been started, and that the cables are not disconnected.							
B306 _H	Specified station number setting error	A station number other than the start station number has been specified in the temporary error invalid request or temporary error invalid canceling request.	Specify the start station number.							
B307 _H	Data link error in all stations	When one of the following requests is issued, a data link error has occurred in all stations. • Data link restart (address: 5E0 _H .b0) • Data link stop (address: 5E0 _H .b2)	Make sure that the data link returns to normal then issue the request again.							
B308 _H	Station number setting error (installation status)	A slave station number is outside of 1 to 64.	Set the number within 1 to 64.							
B309 _H	Station number already in use error	The station number of the connected module is already in use (including the station numbers of occupied stations and excluding the start station number).	Check the station number of the corresponding modules.							
B30A _H	Mismatch between the connected module status and parameter setting	The station type differs between the connected modules and parameter settings. (Example) <table border="1" style="margin-left: auto; margin-right: auto;"> <thead> <tr> <th>Connected module</th> <th>Parameter setting</th> </tr> </thead> <tbody> <tr> <td>Remote device</td> <td>Remote I/O</td> </tr> <tr> <td rowspan="2">Intelligent device</td> <td>Remote I/O</td> </tr> <tr> <td>Remote device</td> </tr> </tbody> </table>	Connected module	Parameter setting	Remote device	Remote I/O	Intelligent device	Remote I/O	Remote device	Start CC-Link with the automatic CC-Link startup and save the parameters again.
Connected module	Parameter setting									
Remote device	Remote I/O									
Intelligent device	Remote I/O									
	Remote device									
B30B _H	Mismatch between the connected module status and parameter setting	The network parameter setting does not match with the connected module status.	Match them.							

Error code (hexadecimal)	Error description	Error cause (detailed)	Action
B30D _H	Initial status	A request, such as the temporary error invalid station specification, line test request, or data link stop/restart request, was issued before data link is started.	Start the data link then issue the request.
B30F _H	Temporary error invalid station specification error	A temporary error invalid station was specified while data link was being performed upon automatic CC-Link startup.	Do not use the temporary error invalid station setting in the automatic CC-Link startup.
B310 _H	Data link restart error	Data link restart (address: 5E0 _H .b0) was executed to the station that was performing data link.	Execute Data link restart (address: 5E0 _H .b0) to the stations where data link has stopped using Data link stop (address: 5E0 _H .b2).
B311 _H	Data link stop error	Data link stop (address: 5E0 _H .b2) was executed to the station where data link had been stopped.	Execute Data link stop (address: 5E0 _H .b2) to the station performing data link.
B31A _H	Data link in progress	An instruction for clearing a multiple master stations error was executed after data link has been started.	Do not execute the instruction during data link.
B31B _H	Transmission speed test execution error	The transmission speed test was executed during data link.	Turn on Data link stop (address: 5E0 _H .b2) then Transmission speed test request (address: 5E0 _H .b11).
B384 _H	Flash ROM failure	Parameters saved in the flash ROM are damaged.	<ul style="list-style-type: none"> • Start CC-Link with the automatic CC-Link startup and save the parameters again. • If the same error occurs again, the hardware of the bridge module is in failure. Please consult your local Mitsubishi representative.
B385 _H			
B386 _H			
B387 _H			
B388 _H			
BA19 _H	Corresponding station error	The target station of the line test cannot be communicated.	Check the cables and the target station.
BA1B _H	Error in all stations	A communication failure has occurred in all stations during execution of the line test.	Check the cables.
BBC5 _H	Multiple master stations error	Multiple CC-Link master stations exist on the same line. Or noise has been detected on the line at power-on.	Use only one CC-Link master station on the same line.

9.5.4 Other errors

For details on errors detected in other modules, refer to the following.

Error code (hexadecimal)	Error description	Reference
4000 _H to 4FFF _H	Error detected in a CPU module	 User's manual for the CPU module used
7000 _H to 7FFF _H	Error detected in a module such as a serial communication module	 User's manual for the serial communication module used.
C000 _H to CFFF _H	Error detected in an Ethernet interface module	<ul style="list-style-type: none"> User's manual for the Ethernet interface module used QnUCPU User's Manual (Communication via Built-in Ethernet Port) MELSEC-L CPU Module User's Manual (Built-In Ethernet Function)
E000 _H to EFFF _H	Error detected in CC-Link IE Controller Network	 Manual for the CC-Link IE Controller Network used
F000 _H to FFFF _H	Error detected in the MELSECNET/H and MELSECNET/10 network system	 Reference manual for the MELSECNET/H and MELSECNET/10 network system

9.6 Checking the LEDs

This section describes how to troubleshoot the system with the LEDs. Perform troubleshooting with the LEDs when communication is disabled even after the CC-Link IE Field Network diagnostics has been carried out.

9.6.1 POWER LED

(1) When the POWER LED does not turn on

Check item	Corrective action
Is any LED other than the POWER LED on?	If any LED other than the POWER LED turns on, the possible cause is a hardware failure. Please consult your local Mitsubishi representative.
Is the module power supply (24VDC) wired?	Wire the module power supply (24VDC).
Is the module power supply (24VDC) turned on?	Turn on the module power supply (24VDC).
Is the voltage of the module power supply (24VDC) within the specified range?	Set the voltage value within the range of performance specifications.

9.6.2 LEDs of CC-Link IE Field Network

(1) When the RUN LED does not turn on

Check item	Corrective action
Does the voltage of the module power supplied externally reach the voltage of the performance specifications?	If the RUN LED does not turn on even after the module power supply is tuned off then on, the possible cause is a hardware failure. Please consult your local Mitsubishi representative.
Has any hardware failure or watchdog timer error occurred?	
Is the startup mode switch still in the SET position?	Reset the startup mode switch from SET to the normal position.

(2) When the MODE LED flashes

Check item	Corrective action
Is the bridge module under the unit test?	When the bridge module is under the unit test, completion of the unit test turns on the D LINK LED on the CC-Link IE Field Network side. Take a corrective action according to the result of the unit test. (☞ Page 101, Section 9.8)

(3) When the MODE LED turns off

Check item	Corrective action
Has any hardware failure occurred?	If the MODE LED does not turn on even after the module power supply is turned off then on, the possible cause is a hardware failure. Please consult your local Mitsubishi representative.

(4) When the D LINK LED flashes

Check item	Corrective action
Does the bridge module station number match the station number of the bridge module specified in the network configuration settings of the master station?	Match the bridge module station number and the station number specified in the network configuration settings of the master station.
Is the station type an intelligent device station?	Change the station type of the module to an intelligent device station in the network configuration settings of the master station.
Is the station type a reserved station?	Change the setting of reserved/ignored error station to other than the reserved station in the network configuration settings of the master station.
Has data link been found stopped through the CC-Link IE Field Network diagnostics?	Check the link status through the CC-Link IE Field Network diagnostics and start link if it is stopped.
Is the station number setting switch set to other than 1 to 120?	The setting range for the station number setting switch is 1 to 120. Set the number between 1 to 120.

(5) When the D LINK LED turns off

Check item	Corrective action
Does the own station on the network operate normally?	Connect the engineering tool to the master station, and check that the master station is performing data link with the CC-Link IE Field Network diagnostics. (📖 User's manual for the master/local module used)
Are 1000BASE-T-compliant Ethernet cables used?	Replace the cable with a 1000BASE-T-compliant Ethernet cable. (📖 User's manual for the master/local module used)
Is the distance between stations connected to each other with an Ethernet cable 100m or less?	Change the length of the Ethernet cable between stations to 100m or less.
Does the cabling condition (bend radius) meet the specifications?	Refer to the manual for the Ethernet cable used, and correct the bend radius.
Is any Ethernet cable disconnected?	Replace the Ethernet cable.
Do other stations connected to the bridge module operate normally?	Check that other stations have been powered on.
Does the switching hub operate normally?	<ul style="list-style-type: none"> • Check that a 1000BASE-T-compliant switching hub is used. (📖 User's manual for the master/local module used) • Check that the switching hub has been powered on.
Is the station number of the bridge module same as that of another station?	The same station number is used for two or more stations. Change the setting so that all the stations have their unique numbers.

(6) When the L ER LED turns on

Check item	Corrective action
Are Ethernet cables normal?	<ul style="list-style-type: none"> • Check that 1000BASE-T-compliant Ethernet cables are used. (📖 User's manual for the master/local module used) • Check that the station-to-station distance is 100m or less. • Check if the Ethernet cables are not disconnected.
Does the switching hub in the system normally operate?	<ul style="list-style-type: none"> • Check that a 1000BASE-T-compliant switching hub is used. (📖 User's manual for the master/local module used) • Check that the switching hub has been powered on.
Do other stations connected to the bridge module operate normally?	Check that other stations have been powered on.
Is the mode of the master station set to other than online?	Change the mode of the master station to online.
Is there any noise affecting the system?	Check the wiring condition of the Ethernet cables.
Is the loopback function enabled for the master station?	When the loopback function is enabled, check that the ring topology has been correctly configured for the port where the L ER LED is on. (📖 User's manual for the master/local module used)

(7) When the LINK LED turns off

Check item	Corrective action
Are Ethernet cables normal?	<ul style="list-style-type: none"> • Check that 1000BASE-T-compliant Ethernet cables are used. (📖 User's manual for the master/local module used) • Check that the station-to-station distance is 100m or less. • Check if the Ethernet cables are not disconnected.
Do the switching hub and other stations in the system normally operate?	<ul style="list-style-type: none"> • Check that a 1000BASE-T-compliant switching hub is used. • Check that the switching hub and other stations are turned on.

(8) When the ERR. LED turns on or flashes

Check item	Corrective action
Was the station number setting switch changed while the module was turned on?	Reset the station number setting switch to the previous setting.
Has any error occurred?	Identify the cause of the error using the engineering tool and take a corrective action. (📖 Page 78, Section 9.3)

9.6.3 CC-Link LEDs

(1) When the RUN LED does not turn on

Check item	Corrective action
Has any hardware failure or watchdog timer error occurred?	If the RUN LED does not turn on even after the module power supply is turned off then on, the possible cause is a hardware failure. Please consult your local Mitsubishi representative.
Is the startup mode switch still in the SET position (key resetting)?	Reset the startup mode switch from SET to the normal position.

(2) When the L RUN LED does not turn on

Check item	Corrective action
Is the mode on the CC-Link IE Field Network side of the bridge module online?	Change the mode on the CC-Link IE Field Network side of the bridge module to online.
Is the mode on the CC-Link side of the bridge module online?	Change the mode on the CC-Link side of the bridge module to online.
Has any error occurred in the CPU module of the master station?	If an error has occurred in the CPU module of the master station, remove the cause of the CPU module error. (📖 User's manual for the CPU module used)

(3) When the SD/RD LED does not turn on

Check item	Corrective action
Has any error occurred in the CPU module of the master station?	If an error has occurred in the CPU module of the master station, remove the cause of the CPU module error. (📖 User's manual for the CPU module used)
Is the mode of the CC-Link remote station online?	Change the mode of the CC-Link remote station to online.
Is the CC-Link dedicated cable normal?	<ul style="list-style-type: none"> • Check the cable for disconnection, short circuit, incorrect wiring, poor contact, and usage not meeting the specifications (transmission distance, station-to-station distance, coexistence of different types of cables, and FG connection). • Check if a transmission cable other than a CC-Link dedicated cable is used.

(4) When the MST LED flashes or turns off

Check item	Corrective action
Is the bridge module under the unit test?	When the bridge module is under the unit test, completion of the unit test turns on the D LINK LED on the CC-Link IE Field Network side. Take a corrective action according to the result of the unit test. (📖 Page 101, Section 9.8)
Is the bridge module under the CC-Link line test?	When the bridge module is under the CC-Link line test, completion of the CC-Link line test turns on the L RUN LED or the MST LED on the CC-Link side. Take a corrective action according to the result of the line test. (📖 Page 64, Section 7.2 (1))

(5) When the ERR. LED turns on or flashes

Check item	Corrective action
Is the transmission speed/mode setting switch set within the setting range?	Set the transmission speed/mode setting switch within the setting range.
Are there multiple CC-Link master stations on the same line?	Change the configuration so that only one CC-Link master station is connected on one line.
Is the CC-Link cable normal?	<ul style="list-style-type: none"> • Check the cable for disconnection, short circuit, incorrect wiring, poor contact, and usage not meeting the specifications (transmission distance, station-to-station distance, coexistence of different types of cables, and FG connection). • Check if a transmission cable other than a CC-Link dedicated cable is used. • Check that a terminating resistor is connected.
Is there any noise affecting the system?	Check the wiring condition.
Is the same station number used for multiple CC-Link stations?	Set a unique station number for each CC-Link remote station.

If the ERR. LED still turns on or flashes even after the above items have been checked, connect the engineering tool to the master station. Then identify the cause of the error using the CC-Link IE Field Network diagnostics, and take a corrective action. (📖 Page 78, Section 9.3)

(6) When the L ERR. LED turns on or flashes

Check item	Corrective action
Is the CC-Link cable normal?	<ul style="list-style-type: none"> • Check the cable for disconnection, short circuit, incorrect wiring, poor contact, and usage not meeting the specifications (transmission distance, station-to-station distance, coexistence of different types of cables, and FG connection). • Check if a transmission cable other than a CC-Link dedicated cable is used. • Check that a terminating resistor is connected.
Is there any noise affecting the system?	Check the wiring condition.
Has the setting for the transmission speed/mode setting switch been changed while the module is on?	After setting the transmission speed/mode setting switch, turn on the module.

9.7 Troubleshooting by Symptom

9.7.1 CC-Link IE Field Network

For details on the troubleshooting for each symptom observed on CC-Link IE Field Network, refer to the user's manual for the master/local module used.

9.7.2 CC-Link

(1) Trouble caused due to disconnection of a slave station when a CC-Link system has been newly built or the existing system has been changed

Trouble description	Item to check	Point to check	Check method	Corrective action
The entire system cannot be data-linked.	Transmission speed	Is the transmission speed out of the setting range or is the transmission speed of the bridge module is different from that of CC-Link remote stations?	Check the setting for the transmission speed of each station.	Set the transmission speed correctly.
	Mode	Is the mode of the bridge module other than online?	Check the mode setting of the bridge module.	Change the mode of the bridge module to online.
	Cables and other devices	<ul style="list-style-type: none"> Check the cable and other tools for disconnection, short circuit, incorrect wiring, poor contact, and usage not meeting the specifications (transmission distance, station-to-station distance, coexistence of different types of cables, and FG connection). Check if a transmission cable other than a CC-Link dedicated cable is used. 	Check if there are any failures, such as cable disconnection between the bridge module and slave stations.	Connect the cable correctly.
		Is a terminating resistor connected?	Check that terminating resistors are connected to the farthest ends of the CC-Link system.	Connect terminating resistors to the farthest ends of the CC-Link system.
	Link start	Is the CPU module of the master station in the RESET position?	Check if the RESET switch of the CPU module of the master station is in the RESET position.	Disable the RESET status.
	Bridge module check	Has any error occurred in the bridge module?	Check the error codes of the bridge module.	Correct the error of the bridge module. (☞ Page 81, Section 9.4)

Trouble description	Item to check	Point to check	Check method	Corrective action
The entire system cannot be data-linked.	Noise	Is there any noise on the transmission cable?	Is the transmission cable located near the power cable?	Wire the transmission cable and the power cable as far as possible from each other. (It is recommended that they be wired with a distance of 100mm or more between them.)
			Is the FG separated from the power-cable GND?	Separate the FG from the power-cable GND.
			Decrease the transmission speed and check the frequency of noise occurrence.	Take measures against noise. Decrease the transmission speed.
	Bridge module failure	Is the bridge module broken?	Replace the bridge module and check if it operates normally.	Repair the bridge module or replace it.
Some stations cannot be data-linked.	Station number	Is the station number of the faulty station wrong?	Check the setting for the station number of the faulty station.	Set the station number correctly.
	Transmission speed	Is the transmission speed of the faulty station wrong?	Check the setting for the transmission speed of the faulty station.	Adjust the transmission speed to a specified one.
	Online status (Slave station)	Check if the faulty station is in the online status.	Check the status of the faulty station.	Change the status of the faulty station to online.
	Cables and other devices	<ul style="list-style-type: none"> • Check the cable and other tools for disconnection, short circuit, incorrect wiring, poor contact, and usage not meeting the specifications (transmission distance, station-to-station distance, coexistence of different types of cables, and FG connection). • Check if a transmission cable other than a CC-Link dedicated cable is used. 	Check if the SD LED and the RD LED of the faulty station are flashing.	Connect the cable correctly.
			When multiple faulty stations exist successively up to the end of the transmission path, check the cable of the stations close to the bridge module (multiple stations).	Connect the cable correctly.
	Supplied power (for communication)	Check if the power is disconnected or the voltage is out of a specified range.	Are the faulty stations on?	Turn on the power supply.
			Is the supply voltage within a specified range?	Adjust the supply voltage so that it is within the specified range.
	Noise	Is there any noise on the transmission cable?	Is the transmission cable located near the power cable?	Wire the transmission cable and the power cable as far as possible from each other. (It is recommended that they be wired with a distance of 100mm or more between them.)
Is the FG separated from the power-cable GND?			Separate the FG from the power-cable GND.	
Decrease the transmission speed and check the frequency of noise occurrence.			Take measures against noise. Decrease the transmission speed.	
Slave station failure	Is any slave station broken?	Does the system operate normally after the faulty slave station has been replaced?	Repair or replace the faulty slave station.	

Trouble description	Item to check	Point to check	Check method	Corrective action
The entire system cannot be data-linked occasionally.	Cables and other devices	Check if there is any cable/connector poor contact or usage not meeting the specifications.	Check the cable between the bridge module and the CC-Link remote stations.	Connect the cable correctly.
	Supplied power (for communication)	Check if the power is disconnected or the voltage is out of the specified range.	Check the power supply of the bridge module and those of all slave stations.	Adjust the supply voltage so that it is within the specified range.
	Noise	Is there any noise on the transmission cable?	Is the transmission cable located near the power cable?	Wire the transmission cable and the power cable as far as possible from each other. (It is recommended that they be wired with a distance of 100mm or more between them.)
			Is the FG separated from the power-cable GND?	Separate the FG from the power-cable GND.
			Decrease the transmission speed and check the frequency of noise occurrence.	Take measures against noise. Decrease the transmission speed.
	Bridge module failure	Is the bridge module broken?	Replace the bridge module and check if it operates normally.	Repair the bridge module or replace it.
Link stop	Has the data link stop instruction been executed wrongly?	Is Data link stop (address: 5E0 _H .b2) on?	Do not turn on Data link stop (address: 5E0 _H .b2). Do not use a device that has read Data link stop (address: 5E0 _H .b2) multiple times.	

Trouble description	Item to check	Point to check	Check method	Corrective action
Some stations cannot be data-linked occasionally.	Cables and other devices	<ul style="list-style-type: none"> Check the cable and other tools for disconnection, short circuit, incorrect wiring, poor contact, and usage not meeting the specifications (transmission distance, station-to-station distance, coexistence of different types of cables, and FG connection). Check if a transmission cable other than a CC-Link dedicated cable is used. 	<p>Check the cable used for the faulty station.</p> <p>When multiple faulty stations exist successively up to the end of the transmission path, check the cable of the stations close to the bridge module (multiple stations).</p>	Connect the cable correctly.
	Supplied power (for communication)	Check if the power is disconnected or the voltage is out of the specified range.	Check the power supply of the faulty station.	Adjust the supply voltage so that it is within the specified range.
	Noise	Is there any noise on the transmission cable?	Is the transmission cable located near the power cable?	Wire the transmission cable and the power cable as far as possible from each other. (It is recommended that they be wired with a distance of 100mm or more between them.)
			Is the FG separated from the power-cable GND?	Separate the FG from the power-cable GND.
			Decrease the transmission speed and check the frequency of noise occurrence.	Take measures against noise. Decrease the transmission speed.
	Start-up	Have the stations been started up in correct order?	Start up the faulty stations in different order, and check the system.	Start the faulty stations in the order according to the manual for each station.
Slave station failure	Is any slave station broken?	Does the system operate normally after the faulty slave station has been replaced?	Repair or replace the faulty slave station.	

Point

To turn on/off Data link stop (address: 5E0_H.b2), a sequence program for accessing the remote buffer memory of the bridge module is required.

(2) Trouble caused due to disconnection of a slave station in a CC-Link system that has actually operated

Trouble description	Item to check	Point to check	Check method	Corrective action
The entire system cannot be data-linked.	Bridge module check	Has any error occurred in the bridge module?	Check the error codes of the bridge module.	Correct the error of the bridge module. (☞ Page 81, Section 9.4)
	Supplied power (for communication)	Check if the voltage is too low.	Check the power supply of the bridge module and those of all slave stations.	Adjust the supply voltage so that it is within the specified range.
	Cables and other devices	Check if there are any failures, such as cable disconnection, short circuit, and poor contact.	Check if there are any failures, such as disconnection of cables between the bridge module and slave stations.	Connect the cable correctly.
	Noise	Is there any noise on the transmission cable?	Is the transmission cable located near the power cable?	Wire the transmission cable and the power cable as far as possible from each other. (It is recommended that they be wired with a distance of 100mm or more between them.)
			Is the FG separated from the power-cable GND?	Separate the FG from the power-cable GND.
			Decrease the transmission speed and check the frequency of noise occurrence.	Take measures against noise. Decrease the transmission speed.
	Bridge module failure	Is the bridge module broken?	Replace the bridge module and check if it operates normally.	Repair the bridge module or replace it.
Link stop	Has the data link stop instruction been executed wrongly?	Is Data link stop (address: 5E0 _H .b2) on?	Do not turn on Data link stop (address: 5E0 _H .b2). Do not use a device that has read Data link stop (address: 5E0 _H .b2) multiple times.	

Trouble description	Item to check	Point to check	Check method	Corrective action
Some stations cannot be data-linked occasionally.	Supplied power (for communication)	Check if the voltage is too low.	Check the power supply of the faulty station.	Adjust the supply voltage so that it is within the specified range.
	Cables and other devices	Check if there is any cable/connector poor contact or usage not meeting the specifications.	Check the connection cable used for the faulty station.	Connect the cable correctly.
			When multiple faulty stations exit successively up to the end of the transmission path, check the cable of the stations close to the bridge module.	
	Noise	Is there any noise on the transmission cable?	Is the transmission cable located near the power cable?	Wire the transmission cable and the power cable as far as possible from each other. (It is recommended that they be wired with a distance of 100mm or more between them.)
			Is the FG separated from the power-cable GND?	Separate the FG from the power-cable GND.
Decrease the transmission speed and check the frequency of noise occurrence.			Take measures against noise. Decrease the transmission speed.	
Slave station failure	Is any slave station broken?	Does the system operate normally after the faulty slave station has been replaced?	Repair or replace the faulty slave station.	

Point

To turn on/off Data link stop (address: 5E0_H.b2), a sequence program for accessing the remote buffer memory of the bridge module is required.

9.7.3 Bridge module

Trouble description	Item to check	Point to check	Check method	Corrective action
Data link cannot be stopped or restarted.	Data link stop	Is Data link stop (address: 5E0 _H .b2) turned on?	Check the program.	Turn on Data link stop (address: 5E0 _H .b2).
		Has any error occurred?	Check the Data link stop result (address: 645 _H).	Take a corrective action according to the error code.
	Data link restart	Is Data link restart (address: 5E0 _H .b0) turned on?	Check the program.	Turn on Data link restart (Address: 5E0 _H .b0).
		Has any error occurred?	Check the Data link restart result (address: 641 _H).	Take a corrective action according to the error code.
		Check if relevant stations are disconnected.	Check the cable condition visually or by carrying out the line test using the programming tool.	Check the cables of and the settings for relevant stations and start the data link normally.
A faulty station cannot be detected.	Check if the station has been set as an error invalid station.	Check if the station has been set as an error invalid station.	Check Temporary error invalid status (address: 67C _H to 67F _H).	Set Temporary error invalid station specification (address: 604 _H to 607 _H) and turn on Temporary error invalid setting cancel request (address: 5E0 _H .b5).
	Check if the same station number is used for multiple stations.	Check if the same station number is used for multiple stations.	Check the station number setting.	Set the station number correctly.
Faulty stations are generated at some transmission speeds.	Check if faulty stations can be identified using Other stations data link status (address: 680 _H to 683 _H). Check whether normal communications can be performed when the transmission speed is decreased to 156kbps.	Check if faulty stations can be identified using Other stations data link status (address: 680 _H to 683 _H). Check whether normal communications can be performed when the transmission speed is decreased to 156kbps.	Check the switch setting of the faulty station.	Adjust the transmission speed setting to that of the bridge module.
			Check that the cable is wired correctly.	Wire the cable correctly.
			Check that the shield of the cable is grounded.	Ground the shield.
			Check that terminating resistors are connected to the farthest ends of the CC-Link system.	Connect terminating resistors to the farthest ends of the CC-Link system.

Point

To turn on/off Data link restart (address: 5E0_H.b0), a sequence program for accessing the remote buffer memory of the bridge module is required.

9.8 Unit Test

Carry out the unit test to check if there is any hardware failure in the bridge module.

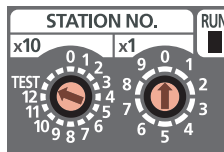
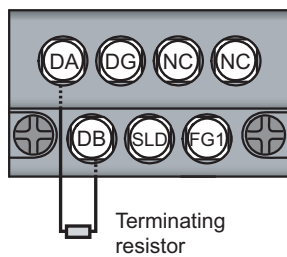
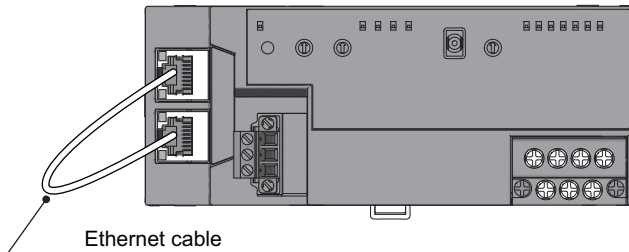

CC-Link IE Field Network
side



1. Power off the module.
2. Connect the PORT1 and PORT2 connectors of the bridge module with an Ethernet cable.
3. Connect the included terminating resistor between the terminals (DA and DB).
4. Set the station number setting switches of the bridge module as follows.
 - x10: TEST
 - x1: 0
5. Check the following before turning on the module.
 - Check the voltage input from the power supply.
 - Check that the startup mode switch of the bridge module has been set to AUTO or PRM.
6. Power on the module.
7. The unit test on the CC-Link IE Field Network side starts.

The MODE LED flashes during the unit test.

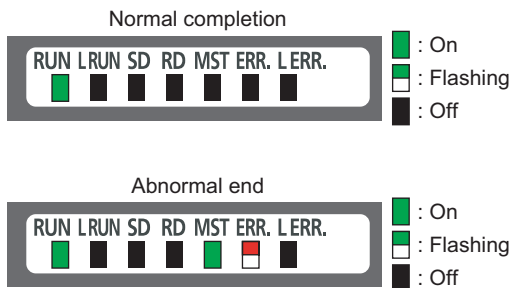
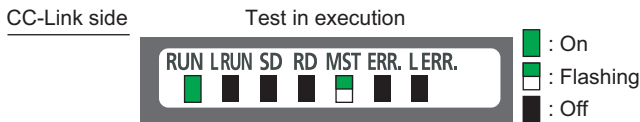
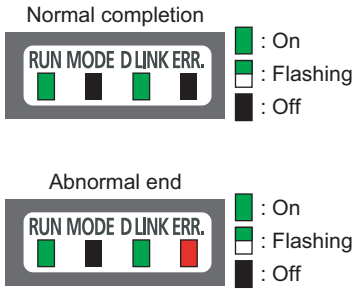

8. The MODE LED turns off when the unit test is completed.

- When the unit test is completed normally: The ERR. LED on the CC-Link IE Field Network side stays off and does not turn on.
- When ended abnormally: The ERR. LED on the CC-Link IE Field Network side turns on. (The D LINK LED on the CC-Link IE Field Network side turns on, flashes, or turns off.)

If the unit test has been ended abnormally, replace the Ethernet cable with a new one and carry out the test again. If the test fails again, the possible cause of the failure is the hardware. Please consult your local Mitsubishi representative.

9. The unit test on the CC-Link side starts. The MST LED flashes during the test.

10. The MST LED turns on or off when the unit test is completed.

- When the unit test is completed normally: The MST LED stays off and does not turn on.
- When ended abnormally: The MST LED turns on and the ERR. LED on the CC-Link side flashes.

If the test has been ended abnormally, check that the terminating resistor included with the bridge module is connected between DA and DB. If the test fails again with the terminating resistor connected between them, the possible cause of the failure is the hardware. Please consult your local Mitsubishi representative.

APPENDICES

Appendix 1 Details of Remote Registers

This section describes the details of remote registers for the master/local module.

The assignment of each device number is for when the start numbers of the remote registers of the bridge module are RWr0 and RWw0.

(1) Bridge module operating status (RWr0)

In Bridge module operating status (RWr0), information in Module monitor area (read) of the module monitor/control area (address: 8000_H) is stored.

Device	Description	
RWr0	b0 to b9	Use prohibited
	b10	Error status flag
	b11	Remote READY
	b12	Warning status flag
	b13 to b15	Use prohibited

(a) Error flag (RWr0.b10)

If a moderate or major error (excluding a watchdog timer error) occurs, Error status flag (RWr0.b10) turns on. When Error clear request flag (RWw0.b10) is turned on after the cause of the error is removed, Error code (RWr1) becomes 0 and Error status flag (RWr0.b10) turns off.

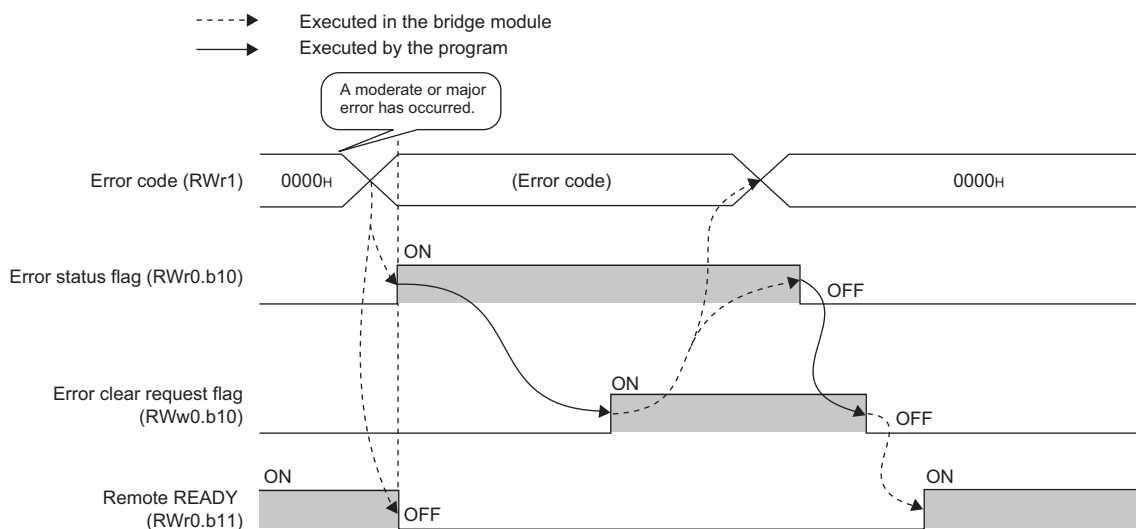

(b) Remote READY (RWr0.b11)

This signal is used as an interlock condition when the master station reads/writes data.

After the bridge module is turned on, Remote READY (RWr0.b11) turns on.

If a moderate or major error (excluding a watchdog timer error) occurs, Remote READY (RWr0.b11) turns off.

(c) Warning status flag (RWr0.b12)

If a minor error occurs, Warning status flag (RWr0.b12) turns on.

When the cause of the error is removed, Warning code (RWr2) becomes 0 and Warning status flag (RWr0.b12) turns off.

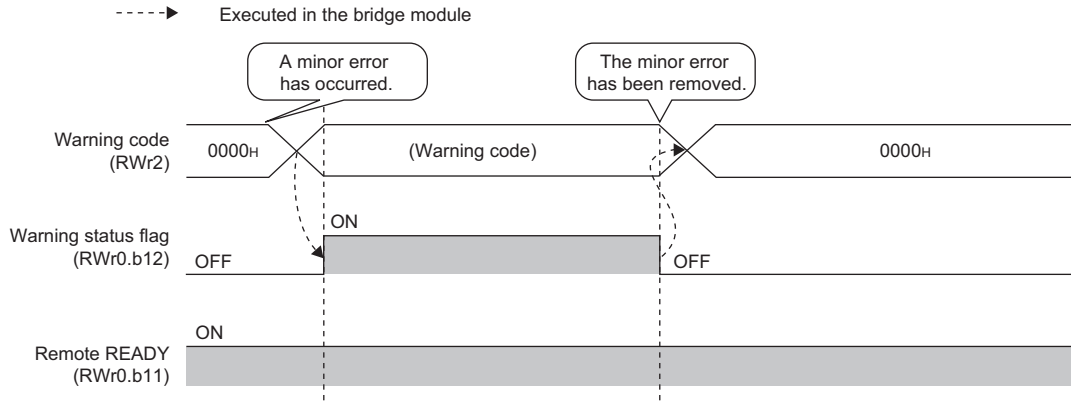

(2) Error code (RWr1)

In Error code (RWr1), information in Error code (address: 8001_H) of the module monitor/control area is stored.

(Page 83, Section 9.5)

(3) Warning code (RWr2)

In Warning code (RWr2), information in Warning code (address: 8002_H) of the module monitor/control area is stored.

(Page 83, Section 9.5)

(4) CC-Link operating status (RWr4 and RWr5)

In CC-Link operating status (RWr4 and RWr5), the following information is stored.

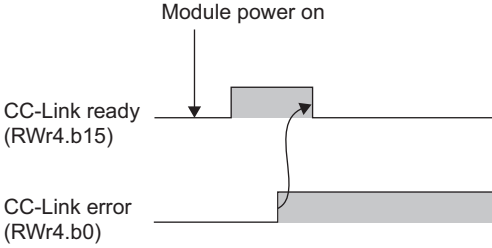
Device	Description	Details
RWr4	b0	CC-Link error This signal shows the normal/abnormal status of CC-Link. OFF: The module is normal. ON: The module is abnormal.
	b1	Own station data link status This signal shows the data link status of the own station. OFF: Data link stopped ON: Data link in operation
	b2	Use prohibited —
	b3	Other stations data link status This signal shows the data link statuses of other stations (CC-Link remote stations). A signal status that is the same as Other stations data link status (address: 5E8 _H .b0) of the remote buffer memory is stored. OFF: All the stations are normal. ON: Some stations are faulty. (The statuses of faulty stations are stored in Other stations data link status (address: 680 _H to 683 _H .)
	b4 to b14	Use prohibited —
	b15	CC-Link ready This signal shows whether CC-Link can operate. When CC-Link becomes operable, the signal turns on automatically. It turns off under one of the following conditions: <ul style="list-style-type: none"> • the switches of CC-Link are set incorrectly • CC-Link error signal (RWr4.b0) turns on 
RWr5	b0 to b15 Use prohibited —	

Point

It takes a maximum of six seconds for Other stations data link status (RWr4.b3) to turn on after some slave stations become faulty.

The time it takes until the signal turns on differs, depending on the adopted system configuration or the status of a faulty station.

When using Other stations data link status (RWr4.b3) on a program, consider the time until the signal turns on.

(5) Data link status of other stations on CC-Link (RWr8 to RWrB)

In Data link status of other stations on CC-Link (RWr8 to RWrB), information in Other stations data link status (address: 680_H to 683_H) of the remote buffer memory is stored.

0: Normal

1: Data link error

	b15	b14	b13	b12	b11	b10	b9	b8	b7	b6	b5	b4	b3	b2	b1	b0
RWr8	16	15	14	13	12	11	10	9	8	7	6	5	4	3	2	1
RWr9	32	31	30	29	28	27	26	25	24	23	22	21	20	19	18	17
RWrA	48	47	46	45	44	43	42	41	40	39	38	37	36	35	34	33
RWrB	64	63	62	61	60	59	58	57	56	55	54	53	52	51	50	49

The numbers 1 to 64 in the table are station numbers.

(6) Bridge module setting (RWw0)

Bridge module setting (RWw0) is stored in Module control area (write) (address: 8080_H) of the module monitor/control area.

Device	Description ^{*1}	
RWw0	b0	Use prohibited
	b1	
	b2	
	b3	
	b4	
	b5	
	b6	
	b7	
	b8	
	b9	
	b10	Error clear request flag ^{*1}
	b11	Use prohibited
	b12	
	b13	
	b14	
	b15	

*1 For details, refer to the error status flag. (☞ Page 103, Appendix 1 (1) (a))

Appendix 2 Details of Remote Buffer Memory

This section describes the remote buffer memory of the bridge module.

(1) CC-Link parameter information area (address: 0 to 7F_H)

Do not write any data to the parameter information areas. Writing data may cause an error.

Address		Name	Description
Hexadecimal	Decimal		
0 _H	0	Use prohibited	—
1 _H	1	Total number of connected stations	The number of slave stations connected to the bridge module is stored (including reserved stations). Default value: 64 (stations) Storage range: 1 to 64 (stations)
2 _H	2	Number of retries	The number of retries to a communication faulty station is stored. Stored value: 3 (times)
3 _H	3	Number of automatic return stations	The number of slave stations that can return to the data link with one link scan is stored. Stored value: 1 (station)
4 _H	4	Use prohibited	—
5 _H	5	Use prohibited	—
6 _H	6	CPU down operation specification	The specified status of Data link status when the master station programmable controller CPU has an error is stored. Stored value: 0 (stop)
7 _H	7	Scan mode setting	The specified status of the synchronization or asynchronization of the link scan with the sequence scan is stored. Stored value: 0 (asynchronized)
8 _H	8	Delay time setting	Delay time is stored. Stored value: 0
9 _H to 13 _H	9 to 19	Use prohibited	—
14 _H to 17 _H	20 to 23	Error invalid station specification	The specified status of an error invalid station is stored. Stored value: 0 (no setting)
18 _H to 1F _H	24 to 31	Use prohibited	—
20 _H (1st station) to 5F _H (64th station)	32 (1st station) to 95 (64th station)	Station information	<p>The station types of connected slave stations and the setting status of the number of occupied stations are stored. Default value: 0101_H (Ver.1-compatible remote I/O station, 1 station occupied, station number 1) to 0140_H (Ver.1-compatible remote I/O station, 1 station occupied, station number 64)</p> <p>Station type The number of occupied stations Station number</p> <p>1 to 64 (01H to 40H)</p> <p>1H: 1 station occupied 2H: 2 stations occupied 3H: 3 stations occupied 4H: 4 stations occupied 0H: Ver.1-compatible remote I/O station 1H: Ver.1-compatible remote device station</p>
60 _H to 7F _H	96 to 127	Use prohibited/reserved	—

(2) CC-Link remote input (RX) (address: E0_H to 15F_H)

The CC-Link remote input (RX) is stored.

Station No.	Address	Station No.	Address	Station No.	Address	Station No.	Address	Station No.	Address
1	E0 _H to E1 _H (224 to 225)	14	FA _H to FB _H (250 to 251)	27	114 _H to 115 _H (276 to 277)	40	12E _H to 12F _H (302 to 303)	53	148 _H to 149 _H (328 to 329)
2	E2 _H to E3 _H (226 to 227)	15	FC _H to FD _H (252 to 253)	28	116 _H to 117 _H (278 to 279)	41	130 _H to 131 _H (304 to 305)	54	14A _H to 14B _H (330 to 331)
3	E4 _H to E5 _H (228 to 229)	16	FE _H to FF _H (254 to 255)	29	118 _H to 119 _H (280 to 281)	42	132 _H to 133 _H (306 to 307)	55	14C _H to 14D _H (332 to 333)
4	E6 _H to E7 _H (230 to 231)	17	100 _H to 101 _H (256 to 257)	30	11A _H to 11B _H (282 to 283)	43	134 _H to 135 _H (308 to 309)	56	14E _H to 14F _H (334 to 335)
5	E8 _H to E9 _H (232 to 233)	18	102 _H to 103 _H (258 to 259)	31	11C _H to 11D _H (284 to 285)	44	136 _H to 137 _H (310 to 311)	57	150 _H to 151 _H (336 to 337)
6	EA _H to EB _H (234 to 235)	19	104 _H to 105 _H (260 to 261)	32	11E _H to 11F _H (286 to 287)	45	138 _H to 139 _H (312 to 313)	58	152 _H to 153 _H (338 to 339)
7	EC _H to ED _H (236 to 237)	20	106 _H to 107 _H (262 to 263)	33	120 _H to 121 _H (288 to 289)	46	13A _H to 13B _H (314 to 315)	59	154 _H to 155 _H (340 to 341)
8	EE _H to EF _H (238 to 239)	21	108 _H to 109 _H (264 to 265)	34	122 _H to 123 _H (290 to 291)	47	13C _H to 13D _H (316 to 317)	60	156 _H to 157 _H (342 to 343)
9	F0 _H to F1 _H (240 to 241)	22	10A _H to 10B _H (266 to 267)	35	124 _H to 125 _H (292 to 293)	48	13E _H to 13F _H (318 to 319)	61	158 _H to 159 _H (344 to 345)
10	F2 _H to F3 _H (242 to 243)	23	10C _H to 10D _H (268 to 269)	36	126 _H to 127 _H (294 to 295)	49	140 _H to 141 _H (320 to 321)	62	15A _H to 15B _H (346 to 347)
11	F4 _H to F5 _H (244 to 245)	24	10E _H to 10F _H (270 to 271)	37	128 _H to 129 _H (296 to 297)	50	142 _H to 143 _H (322 to 323)	63	15C _H to 15D _H (348 to 349)
12	F6 _H to F7 _H (246 to 247)	25	110 _H to 111 _H (272 to 273)	38	12A _H to 12B _H (298 to 299)	51	144 _H to 145 _H (324 to 325)	64	15E _H to 15F _H (350 to 351)
13	F8 _H to F9 _H (248 to 249)	26	112 _H to 113 _H (274 to 275)	39	12C _H to 12D _H (300 to 301)	52	146 _H to 147 _H (326 to 327)	—	—

(3) CC-Link remote output (RY) (address: 160_H to 1DF_H)

The CC-Link remote output (RY) is stored.

Station No.	Address	Station No.	Address	Station No.	Address	Station No.	Address	Station No.	Address
1	160 _H to 161 _H (352 to 353)	14	17A _H to 17B _H (378 to 379)	27	194 _H to 195 _H (404 to 405)	40	1AE _H to 1AF _H (430 to 431)	53	1C8 _H to 1C9 _H (456 to 457)
2	162 _H to 163 _H (354 to 355)	15	17C _H to 17D _H (380 to 381)	28	196 _H to 197 _H (406 to 407)	41	1B0 _H to 1B1 _H (432 to 433)	54	1CA _H to 1CB _H (458 to 459)
3	164 _H to 165 _H (356 to 357)	16	17E _H to 17F _H (382 to 383)	29	198 _H to 199 _H (408 to 409)	42	1B2 _H to 1B3 _H (434 to 435)	55	1CC _H to 1CD _H (460 to 461)
4	166 _H to 167 _H (358 to 359)	17	180 _H to 181 _H (384 to 385)	30	19A _H to 19B _H (410 to 411)	43	1B4 _H to 1B5 _H (436 to 437)	56	1CE _H to 1CF _H (462 to 463)
5	168 _H to 169 _H (360 to 361)	18	182 _H to 183 _H (386 to 387)	31	19C _H to 19D _H (412 to 413)	44	1B6 _H to 1B7 _H (438 to 439)	57	1D0 _H to 1D1 _H (464 to 465)
6	16A _H to 16B _H (362 to 363)	19	184 _H to 185 _H (388 to 389)	32	19E _H to 19F _H (414 to 415)	45	1B8 _H to 1B9 _H (440 to 441)	58	1D2 _H to 1D3 _H (466 to 467)
7	16C _H to 16D _H (364 to 365)	20	186 _H to 187 _H (390 to 391)	33	1A0 _H to 1A1 _H (416 to 417)	46	1BA _H to 1BB _H (442 to 443)	59	1D4 _H to 1D5 _H (468 to 469)
8	16E _H to 16F _H (366 to 367)	21	188 _H to 189 _H (392 to 393)	34	1A2 _H to 1A3 _H (418 to 419)	47	1BC _H to 1BD _H (444 to 445)	60	1D6 _H to 1D7 _H (470 to 471)
9	170 _H to 171 _H (368 to 369)	22	18A _H to 18B _H (394 to 395)	35	1A4 _H to 1A5 _H (420 to 421)	48	1BE _H to 1BF _H (446 to 447)	61	1D8 _H to 1D9 _H (472 to 473)
10	172 _H to 173 _H (370 to 371)	23	18C _H to 18D _H (396 to 397)	36	1A6 _H to 1A7 _H (422 to 423)	49	1C0 _H to 1C1 _H (448 to 449)	62	1DA _H to 1DB _H (474 to 475)
11	174 _H to 175 _H (372 to 373)	24	18E _H to 18F _H (398 to 399)	37	1A8 _H to 1A9 _H (424 to 425)	50	1C2 _H to 1C3 _H (450 to 451)	63	1DC _H to 1DD _H (476 to 477)
12	176 _H to 177 _H (374 to 375)	25	190 _H to 191 _H (400 to 401)	38	1AA _H to 1AB _H (426 to 427)	51	1C4 _H to 1C5 _H (452 to 453)	64	1DE _H to 1DF _H (478 to 479)
13	178 _H to 179 _H (376 to 377)	26	192 _H to 193 _H (402 to 403)	39	1AC _H to 1AD _H (428 to 429)	52	1C6 _H to 1C7 _H (454 to 455)	—	—

(4) CC-Link remote register (RWw) (address: 1E0_H to 2DF_H)

The CC-Link remote register (RWw) is stored.

Station No.	Address	Station No.	Address	Station No.	Address	Station No.	Address	Station No.	Address
1	1E0 _H to 1E3 _H (480 to 483)	14	214 _H to 217 _H (532 to 535)	27	248 _H to 24B _H (584 to 587)	40	27C _H to 27F _H (636 to 639)	53	2B0 _H to 2B3 _H (688 to 691)
2	1E4 _H to 1E7 _H (484 to 487)	15	218 _H to 21B _H (536 to 539)	28	24C _H to 24F _H (588 to 591)	41	280 _H to 283 _H (640 to 643)	54	2B4 _H to 2B7 _H (692 to 695)
3	1E8 _H to 1EB _H (488 to 491)	16	21C _H to 21F _H (540 to 543)	29	250 _H to 253 _H (592 to 595)	42	284 _H to 287 _H (644 to 647)	55	2B8 _H to 2BB _H (696 to 699)
4	1EC _H to 1EF _H (492 to 495)	17	220 _H to 223 _H (544 to 547)	30	254 _H to 257 _H (596 to 599)	43	288 _H to 28B _H (648 to 651)	56	2BC _H to 2BF _H (700 to 703)
5	1F0 _H to 1F3 _H (496 to 499)	18	224 _H to 227 _H (548 to 551)	31	258 _H to 25B _H (600 to 603)	44	28C _H to 28F _H (652 to 655)	57	2C0 _H to 2C3 _H (704 to 707)
6	1F4 _H to 1F7 _H (500 to 503)	19	228 _H to 22B _H (552 to 555)	32	25C _H to 25F _H (604 to 607)	45	290 _H to 293 _H (656 to 659)	58	2C4 _H to 2C7 _H (708 to 711)
7	1F8 _H to 1FB _H (504 to 507)	20	22C _H to 22F _H (556 to 559)	33	260 _H to 263 _H (608 to 611)	46	294 _H to 297 _H (660 to 663)	59	2C8 _H to 2CB _H (712 to 715)
8	1FC _H to 1FF _H (508 to 511)	21	230 _H to 233 _H (560 to 563)	34	264 _H to 267 _H (612 to 615)	47	298 _H to 29B _H (664 to 667)	60	2CC _H to 2CF _H (716 to 719)
9	200 _H to 203 _H (512 to 515)	22	234 _H to 237 _H (564 to 567)	35	268 _H to 26B _H (616 to 619)	48	29C _H to 29F _H (668 to 671)	61	2D0 _H to 2D3 _H (720 to 723)
10	204 _H to 207 _H (516 to 519)	23	238 _H to 23B _H (568 to 571)	36	26C _H to 26F _H (620 to 623)	49	2A0 _H to 2A3 _H (672 to 675)	62	2D4 _H to 2D7 _H (724 to 727)
11	208 _H to 20B _H (520 to 523)	24	23C _H to 23F _H (572 to 575)	37	270 _H to 273 _H (624 to 627)	50	2A4 _H to 2A7 _H (676 to 679)	63	2D8 _H to 2DB _H (728 to 731)
12	20C _H to 20F _H (524 to 527)	25	240 _H to 243 _H (576 to 579)	38	274 _H to 277 _H (628 to 631)	51	2A8 _H to 2AB _H (680 to 683)	64	2DC _H to 2DF _H (732 to 735)
13	210 _H to 213 _H (528 to 531)	26	244 _H to 247 _H (580 to 583)	39	278 _H to 27B _H (632 to 635)	52	2AC _H to 2AF _H (684 to 687)	—	—

(5) CC-Link remote register (RWr) (address: 2E0_H to 3DF_H)

The CC-Link remote register (RWr) is stored.

Station No.	Address	Station No.	Address	Station No.	Address	Station No.	Address	Station No.	Address
1	2E0 _H to 2E3 _H (736 to 739)	14	314 _H to 317 _H (788 to 791)	27	348 _H to 34B _H (840 to 843)	40	37C _H to 37F _H (892 to 895)	53	3B0 _H to 3B3 _H (944 to 947)
2	2E4 _H to 2E7 _H (740 to 743)	15	318 _H to 31B _H (792 to 795)	28	34C _H to 34F _H (844 to 847)	41	380 _H to 383 _H (896 to 899)	54	3B4 _H to 3B7 _H (948 to 951)
3	2E8 _H to 2EB _H (744 to 747)	16	31C _H to 31F _H (796 to 799)	29	350 _H to 353 _H (848 to 851)	42	384 _H to 387 _H (900 to 903)	55	3B8 _H to 3BB _H (952 to 955)
4	2EC _H to 2EF _H (748 to 751)	17	320 _H to 323 _H (800 to 803)	30	354 _H to 357 _H (852 to 855)	43	388 _H to 38B _H (904 to 907)	56	3BC _H to 3BF _H (956 to 959)
5	2F0 _H to 2F3 _H (752 to 755)	18	324 _H to 327 _H (804 to 807)	31	358 _H to 35B _H (856 to 859)	44	38C _H to 38F _H (908 to 911)	57	3C0 _H to 3C3 _H (960 to 963)
6	2F4 _H to 2F7 _H (756 to 759)	19	328 _H to 32B _H (808 to 811)	32	35C _H to 35F _H (860 to 863)	45	390 _H to 393 _H (912 to 915)	58	3C4 _H to 3C7 _H (964 to 967)
7	2F8 _H to 2FB _H (760 to 763)	20	32C _H to 32F _H (812 to 815)	33	360 _H to 363 _H (864 to 867)	46	394 _H to 397 _H (916 to 919)	59	3C8 _H to 3CB _H (968 to 971)
8	2FC _H to 2FF _H (764 to 767)	21	330 _H to 333 _H (816 to 819)	34	364 _H to 367 _H (868 to 871)	47	398 _H to 39B _H (920 to 923)	60	3CC _H to 3CF _H (972 to 975)
9	300 _H to 303 _H (768 to 771)	22	334 _H to 337 _H (820 to 823)	35	368 _H to 36B _H (872 to 875)	48	39C _H to 39F _H (924 to 927)	61	3D0 _H to 3D3 _H (976 to 979)
10	304 _H to 307 _H (772 to 775)	23	338 _H to 33B _H (824 to 827)	36	36C _H to 36F _H (876 to 879)	49	3A0 _H to 3A3 _H (928 to 931)	62	3D4 _H to 3D7 _H (980 to 983)
11	308 _H to 30B _H (776 to 779)	24	33C _H to 33F _H (828 to 831)	37	370 _H to 373 _H (880 to 883)	50	3A4 _H to 3A7 _H (932 to 935)	63	3D8 _H to 3DB _H (984 to 987)
12	30C _H to 30F _H (780 to 783)	25	340 _H to 343 _H (832 to 835)	38	374 _H to 377 _H (884 to 887)	51	3A8 _H to 3AB _H (936 to 939)	64	3DC _H to 3DF _H (988 to 991)
13	310 _H to 313 _H (784 to 787)	26	344 _H to 347 _H (836 to 839)	39	378 _H to 37B _H (888 to 891)	52	3AC _H to 3AF _H (940 to 943)	—	—

(6) CC-Link link special relay (address: 5E0_H to 5FF_H)

The operating status of CC-Link can be checked with bit information.

5E0_H to 5E1_H are turned on/off by the program and 5E2_H to 5FF_H are turned on/off automatically.

Address	Name	Description
5E0 _H .b0	Data link restart	Restart the data link that has been stopped with Data link stop (address: 5E0 _H .b2). OFF: Not instructed ON: Instructed
5E0 _H .b2	Data link stop	Stop the data link of the own station. Note that if this relay is instructed to the bridge module, the entire system will stop. OFF: Not instructed ON: Instructed
5E0 _H .b4	Temporary error invalid request	Determine the stations specified with Multiple temporary error invalid station specification (address: 603 _H) or Temporary error invalid station specification (address: 604 _H to 607 _H) as a temporary error invalid station. OFF: Not requested ON: Requested
5E0 _H .b5	Temporary error invalid setting cancel request	Cancel the temporary error invalid station setting configured for the stations specified with Multiple temporary error invalid station specification (address: 603 _H) or Temporary error invalid station specification (address: 604 _H to 607 _H). OFF: Not requested ON: Requested
5E0 _H .b8	Line test request	Execute a line test to the station specified with Line test station setting (address: 608 _H). OFF: Not requested ON: Requested
5E0 _H .b9	Parameter information read request	Read the parameter setting information of the actual system configuration (CC-Link Ver.1-compatible remote station only). OFF: Not requested ON: Requested
5E0 _H .b11	Transmission speed test request	Execute a transmission speed test. OFF: Not requested ON: Requested
5E4 _H .b0	Data link restart acceptance	Whether the data link restart instruction has been accepted is stored. OFF: Not accepted ON: Accepted
5E4 _H .b1	Data link restart completion	Whether the data link restart instruction has been completed is stored. OFF: Not completed ON: Started
5E4 _H .b4	Data link stop acceptance	Whether the data link stop instruction has been accepted is stored. OFF: Not accepted ON: Accepted
5E4 _H .b5	Data link stop completion	Whether the data link stop instruction has been completed is stored. OFF: Not completed ON: Stopped
5E4 _H .b8	Temporary error invalid acceptance status	Whether the temporary error invalid instruction has been accepted is stored. OFF: Not executed ON: Accepted
5E4 _H .b9	Temporary error invalid setting completion status	Whether the temporary error invalid instruction has been completed is stored. OFF: Not executed ON: A temporary error invalid station determined/specified station number invalid

Address	Name	Description
5E4 _H .b10	Temporary error invalid setting cancel acceptance status	Whether the temporary error invalid cancel instruction has been accepted is stored. OFF: Not executed ON: Accepted
5E4 _H .b11	Temporary error invalid setting cancel completion status	Whether the temporary error invalid cancel instruction has been completed is stored. OFF: Not executed ON: Temporary error invalid station setting canceled
5E4 _H .b12	Line test acceptance status	Whether a line test request has been accepted is stored. OFF: Not executed ON: Accepted
5E4 _H .b13	Line test completion status	Whether a line test has been completed is stored. OFF: Not executed ON: Completed
5E4 _H .b14	Parameter information read acceptance status	Whether a parameter information read request has been accepted is stored. OFF: Not executed ON: Accepted
5E4 _H .b15	Parameter information read completion status	Whether parameter information has been read is stored. OFF: Not read ON: Read
5E5 _H .b0	Offline test status	Whether an offline test is being executed is stored. OFF: Not executed ON: In process
5E6 _H .b0	Own station mode	The setting status of the transmission speed/mode setting switch on the own station is stored. OFF: Online ON: Mode other than online
5E6 _H .b5	Input data status of data link faulty station (own station)	The setting status of the data link faulty station setting of the own station is stored. OFF: Clear ON: Hold
5E6 _H .b10	Switch setting status	Whether the switch has been correctly set is stored. OFF: Correct ON: Setting incorrect (An error code is stored in Switch setting status (address: 66A _H).)
5E6 _H .b13	Parameter setting status	Whether the parameters have been correctly set is stored. OFF: Correct ON: Setting incorrect (An error code is stored in Parameter status (own station) (address: 668 _H).)
5E6 _H .b14	Own station operation status	Whether data link with other stations is being performed is stored. OFF: In process ON: Not performed
5E6 _H .b15	Station-based block cyclic data assurance setting status	Whether the block guarantee of cyclic data per station has been set to the own station is stored. OFF: Not set ON: Set
5E7 _H .b2	Scan mode setting information	The setting status of the scan mode is stored. OFF: Asynchronous mode ON: Synchronous mode
5E7 _H .b3	CPU down operation specification status	The parameter setting status of the operation specification when CPU is down is stored. OFF: Stopped ON: Continued

Address	Name	Description
5E7 _H .b6	Temporary error invalid station setting information	Whether a temporary error invalid station has been set is stored. OFF: Not set ON: Set (The set station number is stored in Temporary error invalid status (address: 67C _H to 67F _H).) There may be difference of several sequence scans between Temporary error invalid status (address: 67C _H to 67F _H) and its updated status, depending on the device transfer time and link scan time of the bridge module.
5E7 _H .b8	Own station switch change detection	Whether the setting of setting switches of the own station during data link has been changed is detected. OFF: No change ON: Changed
5E7 _H .b12	Slave station refresh/compulsory clear specification status in the programmable controller CPU STOP mode	The parameter setting status of the slave station refresh/compulsory clear setting in case of programmable controller CPU STOP is stored. OFF: Refreshed ON: Forcibly cleared
5E8 _H .b0	Other stations data link status	The status of communication with CC-Link remote stations is stored. OFF: All the stations are normal. ON: Some stations are faulty. (The information on faulty stations is stored in Other stations data link status (address: 680 _H to 683 _H).) It takes a maximum of six seconds for Other stations data link status (address: 5E8 _H .b0) to turn on after a CC-Link remote station connected to the bridge module becomes faulty.
5E8 _H .b1	Watchdog timer error status (another station)	Whether a watchdog timer error has occurred in other stations is stored. OFF: No error ON: Error (The error information is stored in Watchdog timer error occurrence status (another station) (address: 684 _H to 687 _H).) There may be difference of several sequence scans between Watchdog timer error occurrence status (another station)(address: 684 _H to 687 _H) and its updated status depending on the device transfer time and link scan time of the bridge module.
5E8 _H .b2	Blown fuse status of another station	Whether a fuse blown error has occurred in other stations is stored. OFF: No error ON: Error (The error information is stored in Blown fuse status of another station (address: 688 _H to 68B _H).) There may be difference of several sequence scans between Blown fuse status of another station (address: 688 _H to 68B _H) and its updated status depending on the device transfer time and link scan time of the bridge module.
5E8 _H .b3	Other stations switch change status	Whether the setting of setting switches of other stations during data link has been changed is detected. OFF: No change ON: Changed (The information is stored in Other stations switch change status (address: 68C _H to 68F _H).) There may be difference of several sequence scans between Other stations switch change status (address: 68C _H to 68F _H) and its updated status depending on the device transfer time and link scan time of the bridge module.
5F8 _H .b5	Transmission speed test acceptance status	Whether Transmission speed test request (address: 5E0 _H .b11) has been accepted is stored. OFF: No request accepted ON: Request accepted
5F8 _H .b6	Transmission speed test completion status	Whether the transmission speed test has been completed is stored. OFF: Test not carried out ON: Test completed

(a) Temporary error invalid station setting

A temporary error invalid station can be set only when CC-Link is started with the slave station information saving function.

When a CC-Link remote station is set as a temporary error invalid station, the CC-Link remote station is not detected as a faulty station even if a data link error occurs.

This function is used for maintenance, such as replacement of CC-Link remote stations during data link.

Point

- If an error occurs in all the CC-Link remote stations set as a temporary error invalid station, the ERR. LED on the CC-Link side turns on.
- All the cyclic transmission data of a station set as a temporary error invalid station is refreshed. If a station set as a temporary error invalid station becomes faulty, data input in the station is held and its output is turned off.

Set a temporary error invalid station with remote buffer memory.

The following table lists the remote buffer memory areas used for the temporary error invalid station setting and cancel.

Item	Address of a remote buffer memory area to be used
Temporary error invalid station specification	<ul style="list-style-type: none"> • Temporary error invalid request (5E0_H.b4) • Temporary error invalid acceptance status (5E4_H.b8) • Temporary error invalid setting completion status (5E4_H.b9) • Temporary error invalid station setting information (5E7_H.b6) • Multiple temporary error invalid station specification (603_H) • Temporary error invalid station specification (604_H to 607_H) • Temporary error invalid station specification result (649_H) • Temporary error invalid status (67C_H to 67F_H)
Temporary error invalid station specification cancel	<ul style="list-style-type: none"> • Temporary error invalid setting cancel request (5E0_H.b5) • Temporary error invalid setting cancel acceptance status (5E4_H.b10) • Temporary error invalid setting cancel completion status (5E4_H.b11) • Temporary error invalid station setting information (5E7_H.b6) • Multiple temporary error invalid station specification (603_H) • Temporary error invalid station specification (604_H to 607_H) • Temporary error invalid station specification cancel result (64B_H) • Temporary error invalid status (67C_H to 67F_H)

(b) CC-Link data link stop/restart

CC-Link data link of the own station can be stopped or restarted using a programming tool or the remote buffer memory. This function can be used to stop data link temporarily or for other maintenance purposes.

CC-Link data link can be stopped or restarted with remote buffer memory.

The following table lists the remote buffer memory areas used for CC-Link data link stop/restart.





Item	Address of a remote buffer memory area to be used
Data link stop	<ul style="list-style-type: none">• Data link stop (5E0_H.b2)• Data link stop acceptance (5E4_H.b4)• Data link stop completion (5E4_H.b5)• Data link stop result (645_H)
Data link restart	<ul style="list-style-type: none">• Data link restart (5E0_H.b0)• Data link restart acceptance (5E4_H.b0)• Data link restart completion (5E4_H.b1)• Data link restart result (641_H)

(7) CC-Link link special register (address: 600_H to 7FF_H)

The CC-Link operating status can be checked with word information.

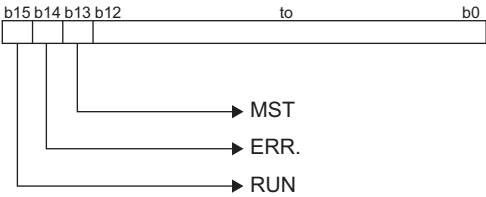
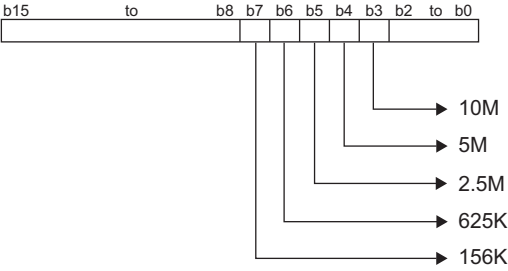
600_H to 61F_H are stored by the program and 620_H to 7FF_H are stored automatically.

Address	Name	Description																																																		
603 _H	Multiple temporary error invalid station specification	Select whether to specify multiple temporary error invalid stations. 00: Multiple stations set in Temporary error invalid station specification (address: 604 _H to 607 _H) specified 01 to 64: A single station specified from 1 to 64 (The number represents the station number to be set as a temporary error invalid station.)																																																		
604 _H 605 _H 606 _H 607 _H	Temporary error invalid station specification	Specify a temporary error invalid station. 0: Temporary error invalid station not specified 1: Temporary error invalid station specified <table border="1" style="margin-left: auto; margin-right: auto;"> <thead> <tr> <th></th> <th>b15</th> <th>b14</th> <th>b13</th> <th>b12</th> <th>to</th> <th>b3</th> <th>b2</th> <th>b1</th> <th>b0</th> </tr> </thead> <tbody> <tr> <td>604_H</td> <td>16</td> <td>15</td> <td>14</td> <td>13</td> <td>to</td> <td>4</td> <td>3</td> <td>2</td> <td>1</td> </tr> <tr> <td>605_H</td> <td>32</td> <td>31</td> <td>30</td> <td>29</td> <td>to</td> <td>20</td> <td>19</td> <td>18</td> <td>17</td> </tr> <tr> <td>606_H</td> <td>48</td> <td>47</td> <td>46</td> <td>45</td> <td>to</td> <td>36</td> <td>35</td> <td>34</td> <td>33</td> </tr> <tr> <td>607_H</td> <td>64</td> <td>63</td> <td>62</td> <td>61</td> <td>to</td> <td>52</td> <td>51</td> <td>50</td> <td>49</td> </tr> </tbody> </table> <p style="text-align: center;">The numbers 1 to 64 in the table are station numbers.</p> <p>The stations need not be set by the number of occupied stations. Error invalid stations, reserved stations, station with the last station number, and stations later than that are excepted.</p>		b15	b14	b13	b12	to	b3	b2	b1	b0	604 _H	16	15	14	13	to	4	3	2	1	605 _H	32	31	30	29	to	20	19	18	17	606 _H	48	47	46	45	to	36	35	34	33	607 _H	64	63	62	61	to	52	51	50	49
	b15	b14	b13	b12	to	b3	b2	b1	b0																																											
604 _H	16	15	14	13	to	4	3	2	1																																											
605 _H	32	31	30	29	to	20	19	18	17																																											
606 _H	48	47	46	45	to	36	35	34	33																																											
607 _H	64	63	62	61	to	52	51	50	49																																											
608 _H	Line test station setting	Set a station number where the line test is executed. 00: Entire system (executed to all stations) 01 to 64: Target station number																																																		
641 _H	Data link restart result	Whether the data link restart instruction using Data link restart (address: 5E0 _H .b0) has been normally completed is stored. 0: Normal completion Values other than 0: Error code (☞ Page 83, Section 9.5)																																																		
645 _H	Data link stop result	Whether the data link stop instruction using Data link stop (address: 5E0 _H .b2) has been normally completed is stored. 0: Normal completion Values other than 0: Error code (☞ Page 83, Section 9.5)																																																		
649 _H	Temporary error invalid station specification result	Whether the temporary error invalid station specification has been normally completed is stored. 0: Normal completion Values other than 0: Error code (☞ Page 83, Section 9.5)																																																		
64B _H	Temporary error invalid station specification cancel result	Whether the temporary error invalid station setting has been normally canceled is stored. 0: Normal completion Values other than 0: Error code (☞ Page 83, Section 9.5)																																																		
64D _H	Line test result	The result of a line test is stored. 0: Normal completion Values other than 0: Error code (☞ Page 83, Section 9.5)																																																		
64F _H	Parameter information read request result	The result of a parameter information read request is stored. 0: Normal Values other than 0: Error code (☞ Page 83, Section 9.5)																																																		
652 _H	Automatic CC-Link startup execution result	The result of system configuration check when a station has been added to a system and the system has started using the automatic CC-Link startup is stored. 0: Normal Values other than 0: Error code (☞ Page 83, Section 9.5)																																																		

Address	Name	Description
658 _H	Detailed LED indication status	<p>The details of the LED indication status of the module is stored.</p> <p>0: Off 1: On</p> 
659 _H	Transmission speed setting	<p>Transmission speed setting status is stored.</p> <p>0: Not set 1: Set</p> 
660 _H	Mode setting status	<p>Mode setting status is stored.</p> <p>0: Online 3: Line test 1 6: Hardware test</p>
664 _H	No. of retries information	<p>The set number of retries upon an error response is stored.</p> <p>1 to 7 (times)</p>
665 _H	No. of automatic return stations	<p>The set number of automatic return stations in one link scan is stored.</p> <p>1 to 10 (stations)</p>
666 _H	Delay timer information	<p>The set delay time is stored.</p>
667 _H	Parameter information	<p>The parameter setting used is stored.</p> <p>0_H: Slave station information saving startup D_H: Automatic CC-Link startup</p>
668 _H	Parameter status (own station)	<p>Whether the parameters have been correctly set is stored.</p> <p>0: Correct Values other than 0: Error code ( Page 83, Section 9.5)</p>
669 _H	Mounted status	<p>Whether unique station numbers have been assigned for modules and whether parameter settings match with connected module status are stored.</p> <p>0: Normal Values other than 0: Error code ( Page 83, Section 9.5)</p> <p>Error details are stored in Station number in use status (address: 698_H to 69B_H) and Actual installation/parameter consistency status (address: 69C_H to 69F_H).</p> <p>This item is checked, and the result is stored only upon link start.</p>
66A _H	Switch setting status	<p>Whether the switch has been correctly set is stored.</p> <p>0: Correct Values other than 0: Error code ( Page 83, Section 9.5)</p>
66D _H	Maximum link scan time	<p>The maximum link scan time is stored (unit: 1ms). The maximum value while the power supply of the module is on is stored.</p>
66E _H	Current link scan time	<p>The current link scan time is stored (unit: 1ms).</p>
66F _H	Minimum link scan time	<p>The minimum link scan time is stored (unit: 1ms). The minimum value while the power supply of the module is on is stored.</p>

Address	Name	Description																																																		
670 _H	Total number of stations	The last station number set using the parameter is stored. 1 to 64 (stations)																																																		
671 _H	Maximum station number among the station numbers of communicating stations	The maximum station number during data link (station number set using the station number switches) is stored. 1 to 64 (stations) Reserved stations are excepted.																																																		
672 _H	Number of connected modules	The number of modules performing data link is stored. Reserved stations are excepted.																																																		
67C _H 67D _H 67E _H 67F _H	Temporary error invalid status	<p>Whether a station is in the temporary error invalid status is stored. 0: Normal 1: Temporary error invalid status</p> <table border="1"> <thead> <tr> <th></th> <th>b15</th> <th>b14</th> <th>b13</th> <th>b12</th> <th>to</th> <th>b3</th> <th>b2</th> <th>b1</th> <th>b0</th> </tr> </thead> <tbody> <tr> <td>67C_H</td> <td>16</td> <td>15</td> <td>14</td> <td>13</td> <td>to</td> <td>4</td> <td>3</td> <td>2</td> <td>1</td> </tr> <tr> <td>67D_H</td> <td>32</td> <td>31</td> <td>30</td> <td>29</td> <td>to</td> <td>20</td> <td>19</td> <td>18</td> <td>17</td> </tr> <tr> <td>67E_H</td> <td>48</td> <td>47</td> <td>46</td> <td>45</td> <td>to</td> <td>36</td> <td>35</td> <td>34</td> <td>33</td> </tr> <tr> <td>67F_H</td> <td>64</td> <td>63</td> <td>62</td> <td>61</td> <td>to</td> <td>52</td> <td>51</td> <td>50</td> <td>49</td> </tr> </tbody> </table> <p>The numbers 1 to 64 in the table are station numbers.</p> <ul style="list-style-type: none"> The bits for the station number of the start station and the number of occupied stations are turned on. Error invalid stations, reserved stations, station with the last station number, and stations later than that are excepted. 		b15	b14	b13	b12	to	b3	b2	b1	b0	67C _H	16	15	14	13	to	4	3	2	1	67D _H	32	31	30	29	to	20	19	18	17	67E _H	48	47	46	45	to	36	35	34	33	67F _H	64	63	62	61	to	52	51	50	49
	b15	b14	b13	b12	to	b3	b2	b1	b0																																											
67C _H	16	15	14	13	to	4	3	2	1																																											
67D _H	32	31	30	29	to	20	19	18	17																																											
67E _H	48	47	46	45	to	36	35	34	33																																											
67F _H	64	63	62	61	to	52	51	50	49																																											
680 _H 681 _H 682 _H 683 _H	Other stations data link status	<p>The data link status of each station is stored. 0: Normal 1: Data link error</p> <table border="1"> <thead> <tr> <th></th> <th>b15</th> <th>b14</th> <th>b13</th> <th>b12</th> <th>to</th> <th>b3</th> <th>b2</th> <th>b1</th> <th>b0</th> </tr> </thead> <tbody> <tr> <td>680_H</td> <td>16</td> <td>15</td> <td>14</td> <td>13</td> <td>to</td> <td>4</td> <td>3</td> <td>2</td> <td>1</td> </tr> <tr> <td>681_H</td> <td>32</td> <td>31</td> <td>30</td> <td>29</td> <td>to</td> <td>20</td> <td>19</td> <td>18</td> <td>17</td> </tr> <tr> <td>682_H</td> <td>48</td> <td>47</td> <td>46</td> <td>45</td> <td>to</td> <td>36</td> <td>35</td> <td>34</td> <td>33</td> </tr> <tr> <td>683_H</td> <td>64</td> <td>63</td> <td>62</td> <td>61</td> <td>to</td> <td>52</td> <td>51</td> <td>50</td> <td>49</td> </tr> </tbody> </table> <p>The numbers 1 to 64 in the table are station numbers.</p> <ul style="list-style-type: none"> The bits for the station number of the start station and the number of occupied stations are turned on. It takes a maximum of six seconds for this register to turn on after a CC-Link remote station connected to the bridge module becomes faulty. The time until this register turns on differs depending on the system configuration and error status. Temporary error invalid stations, error invalid stations, reserved stations, station with the last station number, and stations later than that are excepted. 		b15	b14	b13	b12	to	b3	b2	b1	b0	680 _H	16	15	14	13	to	4	3	2	1	681 _H	32	31	30	29	to	20	19	18	17	682 _H	48	47	46	45	to	36	35	34	33	683 _H	64	63	62	61	to	52	51	50	49
	b15	b14	b13	b12	to	b3	b2	b1	b0																																											
680 _H	16	15	14	13	to	4	3	2	1																																											
681 _H	32	31	30	29	to	20	19	18	17																																											
682 _H	48	47	46	45	to	36	35	34	33																																											
683 _H	64	63	62	61	to	52	51	50	49																																											
684 _H 685 _H 686 _H 687 _H	Watchdog timer error occurrence status (another station)	<p>Whether a watchdog timer error has occurred is stored. 0: No watchdog timer error 1: Watchdog timer error</p> <table border="1"> <thead> <tr> <th></th> <th>b15</th> <th>b14</th> <th>b13</th> <th>b12</th> <th>to</th> <th>b3</th> <th>b2</th> <th>b1</th> <th>b0</th> </tr> </thead> <tbody> <tr> <td>684_H</td> <td>16</td> <td>15</td> <td>14</td> <td>13</td> <td>to</td> <td>4</td> <td>3</td> <td>2</td> <td>1</td> </tr> <tr> <td>685_H</td> <td>32</td> <td>31</td> <td>30</td> <td>29</td> <td>to</td> <td>20</td> <td>19</td> <td>18</td> <td>17</td> </tr> <tr> <td>686_H</td> <td>48</td> <td>47</td> <td>46</td> <td>45</td> <td>to</td> <td>36</td> <td>35</td> <td>34</td> <td>33</td> </tr> <tr> <td>687_H</td> <td>64</td> <td>63</td> <td>62</td> <td>61</td> <td>to</td> <td>52</td> <td>51</td> <td>50</td> <td>49</td> </tr> </tbody> </table> <p>The numbers 1 to 64 in the table are station numbers.</p> <ul style="list-style-type: none"> The bits for the station number of the start station and the number of occupied stations are turned on. Reserved stations, station with the last station number, and stations later than that are excepted. 		b15	b14	b13	b12	to	b3	b2	b1	b0	684 _H	16	15	14	13	to	4	3	2	1	685 _H	32	31	30	29	to	20	19	18	17	686 _H	48	47	46	45	to	36	35	34	33	687 _H	64	63	62	61	to	52	51	50	49
	b15	b14	b13	b12	to	b3	b2	b1	b0																																											
684 _H	16	15	14	13	to	4	3	2	1																																											
685 _H	32	31	30	29	to	20	19	18	17																																											
686 _H	48	47	46	45	to	36	35	34	33																																											
687 _H	64	63	62	61	to	52	51	50	49																																											

Address	Name	Description																																																		
688 _H 689 _H 68A _H 68B _H	Blown fuse status of another station	<p>Whether a fuse blown error has occurred is stored.</p> <p>0: Normal 1: Error</p> <table border="1"> <thead> <tr> <th></th> <th>b15</th> <th>b14</th> <th>b13</th> <th>b12</th> <th>to</th> <th>b3</th> <th>b2</th> <th>b1</th> <th>b0</th> </tr> </thead> <tbody> <tr> <td>688H</td> <td>16</td> <td>15</td> <td>14</td> <td>13</td> <td>to</td> <td>4</td> <td>3</td> <td>2</td> <td>1</td> </tr> <tr> <td>689H</td> <td>32</td> <td>31</td> <td>30</td> <td>29</td> <td>to</td> <td>20</td> <td>19</td> <td>18</td> <td>17</td> </tr> <tr> <td>68AH</td> <td>48</td> <td>47</td> <td>46</td> <td>45</td> <td>to</td> <td>36</td> <td>35</td> <td>34</td> <td>33</td> </tr> <tr> <td>68BH</td> <td>64</td> <td>63</td> <td>62</td> <td>61</td> <td>to</td> <td>52</td> <td>51</td> <td>50</td> <td>49</td> </tr> </tbody> </table> <p>The numbers 1 to 64 in the table are station numbers.</p> <ul style="list-style-type: none"> • The bits for the station number of the start station and the number of occupied stations are turned on. • Reserved stations, station with the last station number, and stations later than that are excepted. 		b15	b14	b13	b12	to	b3	b2	b1	b0	688H	16	15	14	13	to	4	3	2	1	689H	32	31	30	29	to	20	19	18	17	68AH	48	47	46	45	to	36	35	34	33	68BH	64	63	62	61	to	52	51	50	49
	b15	b14	b13	b12	to	b3	b2	b1	b0																																											
688H	16	15	14	13	to	4	3	2	1																																											
689H	32	31	30	29	to	20	19	18	17																																											
68AH	48	47	46	45	to	36	35	34	33																																											
68BH	64	63	62	61	to	52	51	50	49																																											
68C _H 68D _H 68E _H 68F _H	Other stations switch change status	<p>Whether the setting of switches of other stations during data link has been changed is stored.</p> <p>0: No change 1: Changed</p> <table border="1"> <thead> <tr> <th></th> <th>b15</th> <th>b14</th> <th>b13</th> <th>b12</th> <th>to</th> <th>b3</th> <th>b2</th> <th>b1</th> <th>b0</th> </tr> </thead> <tbody> <tr> <td>68CH</td> <td>16</td> <td>15</td> <td>14</td> <td>13</td> <td>to</td> <td>4</td> <td>3</td> <td>2</td> <td>1</td> </tr> <tr> <td>68DH</td> <td>32</td> <td>31</td> <td>30</td> <td>29</td> <td>to</td> <td>20</td> <td>19</td> <td>18</td> <td>17</td> </tr> <tr> <td>68EH</td> <td>48</td> <td>47</td> <td>46</td> <td>45</td> <td>to</td> <td>36</td> <td>35</td> <td>34</td> <td>33</td> </tr> <tr> <td>68FH</td> <td>64</td> <td>63</td> <td>62</td> <td>61</td> <td>to</td> <td>52</td> <td>51</td> <td>50</td> <td>49</td> </tr> </tbody> </table> <p>The numbers 1 to 64 in the table are station numbers.</p> <ul style="list-style-type: none"> • The bits for the station number of the start station and the number of occupied stations are turned on. • Reserved stations, station with the last station number, and stations later than that are excepted. 		b15	b14	b13	b12	to	b3	b2	b1	b0	68CH	16	15	14	13	to	4	3	2	1	68DH	32	31	30	29	to	20	19	18	17	68EH	48	47	46	45	to	36	35	34	33	68FH	64	63	62	61	to	52	51	50	49
	b15	b14	b13	b12	to	b3	b2	b1	b0																																											
68CH	16	15	14	13	to	4	3	2	1																																											
68DH	32	31	30	29	to	20	19	18	17																																											
68EH	48	47	46	45	to	36	35	34	33																																											
68FH	64	63	62	61	to	52	51	50	49																																											
690 _H	Line status	<p>Line status is stored.</p> <p>0: Normal 1: Data link disabled (disconnected)</p>																																																		
698 _H 699 _H 69A _H 69B _H	Station number in use status	<p>Whether station numbers are unique when the start station numbers of modules are different is stored.</p> <p>0: Normal 1: Station number in use (start station number only)</p> <table border="1"> <thead> <tr> <th></th> <th>b15</th> <th>b14</th> <th>b13</th> <th>b12</th> <th>to</th> <th>b3</th> <th>b2</th> <th>b1</th> <th>b0</th> </tr> </thead> <tbody> <tr> <td>698H</td> <td>16</td> <td>15</td> <td>14</td> <td>13</td> <td>to</td> <td>4</td> <td>3</td> <td>2</td> <td>1</td> </tr> <tr> <td>699H</td> <td>32</td> <td>31</td> <td>30</td> <td>29</td> <td>to</td> <td>20</td> <td>19</td> <td>18</td> <td>17</td> </tr> <tr> <td>69AH</td> <td>48</td> <td>47</td> <td>46</td> <td>45</td> <td>to</td> <td>36</td> <td>35</td> <td>34</td> <td>33</td> </tr> <tr> <td>69BH</td> <td>64</td> <td>63</td> <td>62</td> <td>61</td> <td>to</td> <td>52</td> <td>51</td> <td>50</td> <td>49</td> </tr> </tbody> </table> <p>The numbers 1 to 64 in the table are station numbers.</p> <ul style="list-style-type: none"> • Reserved stations, station with the last station number, and stations later than that are excepted. • Only the bit corresponding to the start station number turns on. This item is checked, and the result is stored only upon data link start and the update of a parameter. • For a CC-Link remote station with the transmission speed auto-tracking setting, whether the station number is already used for other stations may not be detected. 		b15	b14	b13	b12	to	b3	b2	b1	b0	698H	16	15	14	13	to	4	3	2	1	699H	32	31	30	29	to	20	19	18	17	69AH	48	47	46	45	to	36	35	34	33	69BH	64	63	62	61	to	52	51	50	49
	b15	b14	b13	b12	to	b3	b2	b1	b0																																											
698H	16	15	14	13	to	4	3	2	1																																											
699H	32	31	30	29	to	20	19	18	17																																											
69AH	48	47	46	45	to	36	35	34	33																																											
69BH	64	63	62	61	to	52	51	50	49																																											

Address	Name	Description																																																										
69C _H 69D _H 69E _H 69F _H	Actual installation/parameter consistency status	<p>Whether the connected module status matches with parameter settings is stored. A mismatch error will occur in the following cases.</p> <ul style="list-style-type: none"> The station types do not match.*¹ The number of occupied stations do not match. The expanded cyclic settings do not match.*¹ The CC-Link compatible versions do not match. <p>*¹ When the number of connected modules is smaller than or equal to the number of modules set using the parameter, a mismatch error will not occur. (When a remote I/O station is actually connected and a remote device station has been set using the parameter, for example, a mismatch error will not occur.)</p> <p>0: Normal 1: Mismatch error</p> <p>Example of a mismatch error</p> <table border="1"> <tr> <td>Installation</td> <td>Parameter</td> </tr> <tr> <td>Remote device station</td> <td>Remote I/O station</td> </tr> <tr> <td>Intelligent device station</td> <td>Remote I/O station</td> </tr> <tr> <td>Intelligent device station</td> <td>Remote device station</td> </tr> </table> <table border="1"> <thead> <tr> <th></th> <th>b15</th> <th>b14</th> <th>b13</th> <th>b12</th> <th>to</th> <th>b3</th> <th>b2</th> <th>b1</th> <th>b0</th> </tr> </thead> <tbody> <tr> <td>69C_H</td> <td>16</td> <td>15</td> <td>14</td> <td>13</td> <td>to</td> <td>4</td> <td>3</td> <td>2</td> <td>1</td> </tr> <tr> <td>69D_H</td> <td>32</td> <td>31</td> <td>30</td> <td>29</td> <td>to</td> <td>20</td> <td>19</td> <td>18</td> <td>17</td> </tr> <tr> <td>69E_H</td> <td>48</td> <td>47</td> <td>46</td> <td>45</td> <td>to</td> <td>36</td> <td>35</td> <td>34</td> <td>33</td> </tr> <tr> <td>69F_H</td> <td>64</td> <td>63</td> <td>62</td> <td>61</td> <td>to</td> <td>52</td> <td>51</td> <td>50</td> <td>49</td> </tr> </tbody> </table> <p>The numbers 1 to 64 in the table are station numbers.</p> <ul style="list-style-type: none"> Reserved stations, station with the last station number, and stations later than that are excepted. Only the bit corresponding to the start station number turns on. This item is checked, and the result is stored only upon data link start and the update of a parameter. 	Installation	Parameter	Remote device station	Remote I/O station	Intelligent device station	Remote I/O station	Intelligent device station	Remote device station		b15	b14	b13	b12	to	b3	b2	b1	b0	69C _H	16	15	14	13	to	4	3	2	1	69D _H	32	31	30	29	to	20	19	18	17	69E _H	48	47	46	45	to	36	35	34	33	69F _H	64	63	62	61	to	52	51	50	49
Installation	Parameter																																																											
Remote device station	Remote I/O station																																																											
Intelligent device station	Remote I/O station																																																											
Intelligent device station	Remote device station																																																											
	b15	b14	b13	b12	to	b3	b2	b1	b0																																																			
69C _H	16	15	14	13	to	4	3	2	1																																																			
69D _H	32	31	30	29	to	20	19	18	17																																																			
69E _H	48	47	46	45	to	36	35	34	33																																																			
69F _H	64	63	62	61	to	52	51	50	49																																																			
6B4 _H 6B5 _H 6B6 _H 6B7 _H	Line test 1 result	<p>The result of the line test 1 is stored.</p> <p>0: Normal 1: Error</p> <table border="1"> <thead> <tr> <th></th> <th>b15</th> <th>b14</th> <th>b13</th> <th>b12</th> <th>to</th> <th>b3</th> <th>b2</th> <th>b1</th> <th>b0</th> </tr> </thead> <tbody> <tr> <td>6B4_H</td> <td>16</td> <td>15</td> <td>14</td> <td>13</td> <td>to</td> <td>4</td> <td>3</td> <td>2</td> <td>1</td> </tr> <tr> <td>6B5_H</td> <td>32</td> <td>31</td> <td>30</td> <td>29</td> <td>to</td> <td>20</td> <td>19</td> <td>18</td> <td>17</td> </tr> <tr> <td>6B6_H</td> <td>48</td> <td>47</td> <td>46</td> <td>45</td> <td>to</td> <td>36</td> <td>35</td> <td>34</td> <td>33</td> </tr> <tr> <td>6B7_H</td> <td>64</td> <td>63</td> <td>62</td> <td>61</td> <td>to</td> <td>52</td> <td>51</td> <td>50</td> <td>49</td> </tr> </tbody> </table> <p>The numbers 1 to 64 in the table are station numbers.</p> <p>The bits for the station number of the start station and the number of occupied stations are turned on.</p>		b15	b14	b13	b12	to	b3	b2	b1	b0	6B4 _H	16	15	14	13	to	4	3	2	1	6B5 _H	32	31	30	29	to	20	19	18	17	6B6 _H	48	47	46	45	to	36	35	34	33	6B7 _H	64	63	62	61	to	52	51	50	49								
	b15	b14	b13	b12	to	b3	b2	b1	b0																																																			
6B4 _H	16	15	14	13	to	4	3	2	1																																																			
6B5 _H	32	31	30	29	to	20	19	18	17																																																			
6B6 _H	48	47	46	45	to	36	35	34	33																																																			
6B7 _H	64	63	62	61	to	52	51	50	49																																																			
6B8 _H	Line test result	<p>The result of a line test is stored.</p> <p>0: Normal Values other than 0: Error code (☞ Page 83, Section 9.5)</p>																																																										
783 _H	Transmission speed test result	<p>The result of a transmission speed test is stored.</p> <p>0: Normal Values other than 0: Error code (☞ Page 83, Section 9.5)</p>																																																										

Address	Name	Description																																																		
784 _H 785 _H 786 _H 787 _H	Transmission speed test result for each station	<p>The result of the transmission speed test for each station is stored. 0: Normal (same transmission speed as the bridge module) or no response from the module 1: Error (different transmission speed from the bridge module)</p> <table border="1"> <thead> <tr> <th></th> <th>b15</th> <th>b14</th> <th>b13</th> <th>b12</th> <th>to</th> <th>b3</th> <th>b2</th> <th>b1</th> <th>b0</th> </tr> </thead> <tbody> <tr> <td>784_H</td> <td>16</td> <td>15</td> <td>14</td> <td>13</td> <td>to</td> <td>4</td> <td>3</td> <td>2</td> <td>1</td> </tr> <tr> <td>785_H</td> <td>32</td> <td>31</td> <td>30</td> <td>29</td> <td>to</td> <td>20</td> <td>19</td> <td>18</td> <td>17</td> </tr> <tr> <td>786_H</td> <td>48</td> <td>47</td> <td>46</td> <td>45</td> <td>to</td> <td>36</td> <td>35</td> <td>34</td> <td>33</td> </tr> <tr> <td>787_H</td> <td>64</td> <td>63</td> <td>62</td> <td>61</td> <td>to</td> <td>52</td> <td>51</td> <td>50</td> <td>49</td> </tr> </tbody> </table> <p>The numbers 1 to 64 in the table are station numbers.</p> <p>The bits for the station number of the start station and the number of occupied stations are turned on.</p>		b15	b14	b13	b12	to	b3	b2	b1	b0	784 _H	16	15	14	13	to	4	3	2	1	785 _H	32	31	30	29	to	20	19	18	17	786 _H	48	47	46	45	to	36	35	34	33	787 _H	64	63	62	61	to	52	51	50	49
	b15	b14	b13	b12	to	b3	b2	b1	b0																																											
784 _H	16	15	14	13	to	4	3	2	1																																											
785 _H	32	31	30	29	to	20	19	18	17																																											
786 _H	48	47	46	45	to	36	35	34	33																																											
787 _H	64	63	62	61	to	52	51	50	49																																											

(8) Module monitor/control area (address: 8000_H to 80FF_H)

Communication direction	Address	Description	Default value
Bridge module to master station	8000 _H	Module monitor area (read)	0100 _H
	8001 _H	Error code	0000 _H
	8002 _H	Warning code	0000 _H
	8003 _H ⋮ 807F _H	Use prohibited	—
Master station to bridge module	8080 _H	Module control area (write)	—
	8081 _H ⋮ 80FF _H	Use prohibited	—

Point

Do not read/write data from/to use prohibited remote buffer memory areas.
Doing so does not guarantee the functions of the bridge module.

(a) Module monitor/control area (address: 8000_H and 8080_H)

Module monitor area (read) (address: 8000 _H)		Module control area (write) (address: 8080 _H)	
b0 to b9	Use prohibited	b0 to b9	Use prohibited
b10	Error status flag	b10	Error clear request flag
b11	Remote READY	b11 to b15	Use prohibited
b12	Warning status flag		
b13 to b15	Use prohibited		

The status of Module monitor area (address: 8000_H) is transferred to Bridge module operating status (RWr0) of the remote register.

The status of Module control area (address: 8080_H) is transferred to Bridge module setting (RWW0) of the remote register.

- Details of remote registers (☞ Page 103, Appendix 1)

Point

Do not read/write data from/to use prohibited remote buffer memory areas.
Doing so does not guarantee the functions of the bridge module.

(b) Error code (address: 8001_H)

When a moderate or major error occurs (excluding a watchdog timer error), its error code is stored.

When Error clear request flag (address: 8080_H.b10) is turned on after the cause of the error is removed, the error code is cleared.

Errors that occurred in the past can be checked with the error history. (☞ Page 81, Section 9.4)

The status of Error code (address: 8001_H) is transferred to Error code (RWr1) of the remote register.

(c) Warning code (address: 8002_H)

When a minor error occurs, its warning code is stored.

When the cause of the minor error is removed, Warning code (address: 8002_H) is cleared.

Warnings that occurred in the past can be checked with the error history. (☞ Page 81, Section 9.4)

The status of Warning code (address: 8002_H) is transferred to Warning code (RWr2) of the remote register.

Appendix 3 Data Link Processing Time

A

The processing time when a bridge module is used is as follows.

(1) Transmission delay time

The transmission delay time is the total of the following periods of time.

- 1) Sequence scan (📖 User's manual for the CPU module used)
- 2) Link refresh time of CC-Link IE Field Network (📖 User's manual for the master/local module used)
- 3) Link scan time of CC-Link IE Field Network (📖 User's manual for the master/local module used)
- 4) Device transfer time (👉 Page 126, Appendix 3.1)
- 5) Link scan time of CC-Link (👉 Page 127, Appendix 3.2)
- 6) Processing time of a CC-Link remote station (📖 Manual for the CC-Link remote station used)

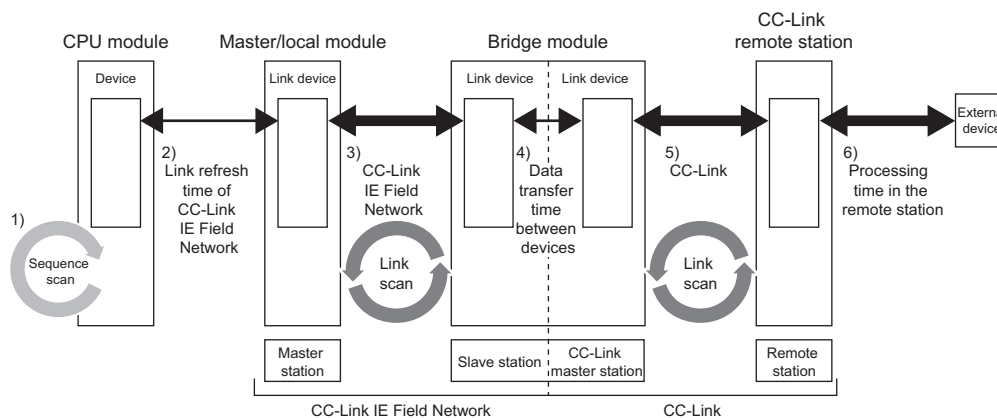

Appendix 3.1 Device transfer time

This section describes the time it takes for data to be transferred between CC-Link IE Field Network and CC-Link.

Data transfer time	Value in normal operation	Maximum value
β_T : Time for data transfer from CC-Link IE Field Network to CC-Link	$LSc \times n3[\text{ms}]$	$LSf + LSc \times n3[\text{ms}]$
β_R : Time for data transfer from CC-Link to CC-Link IE Field Network	$TRb[\text{ms}]$	$LSf + TRb[\text{ms}]$

LSf: Link scan time of CC-Link IE Field Network

LSc: Link scan time of CC-Link

n3: Value obtained by rounding up the decimal places of $(TRb \div LSc)$

TRb: Data processing time of the bridge module = 3ms

Appendix 3.2 Processing time of CC-Link

A

This section describes the link scan time of CC-Link.

Calculation formula

$$LSc = BT \times \{27 + (NI \times 4.8) + (NW \times 9.6) + (N \times 30) + (ni \times 4.8) + (nw \times 9.6)\} + ST + RT + F[\mu s]$$

BT: Constant (transmission speed)

Transmission speed	156kbps	625kbps	2.5Mbps	5Mbps	10Mbps
BT	51.2	12.8	3.2	1.6	0.8

NI: Last station number of A and B (The number of occupied stations is included and reserved stations are excluded. The number needs to be a multiple of 8.)

- A: Last station number of remote I/O stations
- B: Last station number of remote device stations (including the number of occupied stations)

NW: Last station number of remote device stations (The number of occupied stations is included and reserved stations are excluded. The number needs to be a multiple of 8.)

Last station number	1 to 8	9 to 16	17 to 24	25 to 32	33 to 40	41 to 48	49 to 56	57 to 64
NI, NW	8	16	24	32	40	48	56	64

N: Number of connected stations (excluding reserved stations)

ni: a + b (excluding reserved stations)

nw: b

- a: Total number of occupied remote I/O stations
- b: Total number of occupied remote device stations

ST: Constant (The constant is the larger of the following two values: 1) and 2). However, when B is equal to 0, ignore the value of 2.)

- 1) $800 + (A \times 15)$
- 2) $900 + (B \times 50)$

RT: Retry processing time (Only the time for the link scan that has found data-linked slave stations to be faulty is added.)

$\alpha + \beta \times (\text{number of stations in which a communication error has been detected} - 1)$

α : Retry processing time for the first station

- $BT \times (200 + R) \times \text{Retry count set value} + 178.5$
- $R: 13.2 + (NI \times 4.8) + (NW \times 9.6)$

β : Retry processing time for the second and succeeding stations

- $BT \times \{(200 + P) \times \text{Retry count set value} + 178.5\}$
- $P: 10.8$

F: Return processing time (This is added only when there are communication faulty stations.)

$BT \times \{243.1 + 210.8 \times (\text{number of automatic return stations} - 1)\} + ST$

Appendix 3.3 Transmission delay time

This section describes transmission delay time between the CPU module of the master station and a remote station of CC-Link when a bridge module is used.

(1) Between the master station and a CC-Link remote I/O station

(a) From a CC-Link remote I/O station to the master station (RX) (input)

The following shows the time it takes for a CPU module device of the master station to turn on (off) after a signal is input to a CC-Link remote I/O station.

For CC-Link, station-based block data assurance is disabled and the asynchronous mode is used.

- CC-Link IE Field Network station-based block data assurance is available.

Calculated value	Calculation formula for asynchronous mode	Calculation formula for synchronous mode
Normal value	$(SM \times 1) + (LSf \times n1) + \beta_R + (LSc \times 1) + Rio$	$(SM \times 1) + (LSf \times 1) + \beta_R + (LSc \times 1) + Rio$
Maximum value	$(SM \times 1) + \{LSf \times (n1 + 1)\} + \beta_R + (LSc \times 2) + Rio$	$(SM \times 1) + (LSf \times 2) + \beta_R + (LSc \times 2) + Rio$

- CC-Link IE Field Network station-based block data assurance is not available.

Calculated value	Calculation formula for asynchronous mode	Calculation formula for synchronous mode
Normal value	$(SM \times 1) + (LSf \times 1) + \beta_R + (LSc \times 1) + Rio$	$(SM \times 1) + (LSf \times 1) + \beta_R + (LSc \times 1) + Rio$
Maximum value	$(SM \times 1) + (LSf \times 2) + \beta_R + (LSc \times 2) + Rio$	$(SM \times 1) + (LSf \times 2) + \beta_R + (LSc \times 2) + Rio$

SM: Sequence scan time of the master station (including the link refresh time of the receiving side)

LSf: Link scan time of CC-Link IE Field Network

n1: Value obtained by rounding up the decimal places of $(SM \div LSf)$

β_R : Time for data transfer from CC-Link to CC-Link IE Field Network

LSc: Link scan time of CC-Link

Rio: Processing time of a CC-Link remote I/O station ( Manual for the CC-Link remote I/O station used)

(b) From the master station (RY) to a CC-Link remote I/O station (output)

The following shows the time it takes for the output of a CC-Link remote I/O station to turn on (off) after a CPU module device of the master station turns on (off).

For CC-Link, station-based block data assurance is disabled and the asynchronous mode is used.

- CC-Link IE Field Network station-based block data assurance is available.

Calculated value	Calculation formula for asynchronous mode	Calculation formula for synchronous mode
Normal value	$(SM \times n2) + (LSf \times 1) + \beta_T + (LSc \times 1) + Rio$	$(SM \times 1) + (LSf \times 1) + \beta_T + (LSc \times 1) + Rio$
Maximum value	$(SM \times n2) + (LSf \times 2) + \beta_T + (LSc \times 2) + Rio$	$(SM \times n2) + (LSf \times 1) + \beta_T + (LSc \times 2) + Rio$

- CC-Link IE Field Network station-based block data assurance is not available.

Calculated value	Calculation formula for asynchronous mode	Calculation formula for synchronous mode
Normal value	$(SM \times 1) + (LSf \times 1) + \beta_T + (LSc \times 1) + Rio$	$(SM \times 1) + (LSf \times 1) + \beta_T + (LSc \times 1) + Rio$
Maximum value	$(SM \times 2) + (LSf \times 2) + \beta_T + (LSc \times 2) + Rio$	$(SM \times n2) + (LSf \times 1) + \beta_T + (LSc \times 2) + Rio$

SM: Sequence scan time of the master station (including the link refresh time of the sending side)

LSf: Link scan time of CC-Link IE Field Network

n2: Value obtained by rounding up the decimal places of $(LSf \div SM)$

β_T : Time for data transfer from CC-Link to CC-Link IE Field Network

LSc: Link scan time of CC-Link

Rio: Processing time of a CC-Link remote I/O station (Manual for the CC-Link remote I/O station used)

(2) Between the master station and a CC-Link remote device station

(a) From a CC-Link remote device station to the master station (RX/RWr) (input)

The following shows the time it takes for a CPU module device of the master station to turn on (off) after a signal is input to a CC-Link remote device station or the time it takes until the data of a CPU module device is changed.

For CC-Link, station-based block data assurance is disabled and the asynchronous mode is used.

- CC-Link IE Field Network station-based block data assurance is available.

Calculated value	Calculation formula for asynchronous mode	Calculation formula for synchronous mode
Normal value	$(SM \times 1) + (LSf \times n1) + \beta_R + (LSc \times 1) + Rd$	$(SM \times 1) + (LSf \times 1) + \beta_R + (LSc \times 1) + Rd$
Maximum value	$(SM \times 1) + \{LSf \times (n1 + 1)\} + \beta_R + (LSc \times 2) + Rd$	$(SM \times 1) + (LSf \times 2) + \beta_R + (LSc \times 2) + Rd$

- CC-Link IE Field Network station-based block data assurance is not available.

Calculated value	Calculation formula for asynchronous mode	Calculation formula for synchronous mode
Normal value	$(SM \times 1) + (LSf \times 1) + \beta_R + (LSc \times 1) + Rd$	$(SM \times 1) + (LSf \times 1) + \beta_R + (LSc \times 1) + Rd$
Maximum value	$(SM \times 1) + (LSf \times 2) + \beta_R + (LSc \times 2) + Rd$	$(SM \times 1) + (LSf \times 2) + \beta_R + (LSc \times 2) + Rd$

SM: Sequence scan time of the master station (including the link refresh time of the receiving side)

LSf: Link scan time of CC-Link IE Field Network

n1: Value obtained by rounding up the decimal places of $(SM \div LSf)$

β_R : Time for data transfer from CC-Link to CC-Link IE Field Network

LSc: Link scan time of CC-Link

Rd: Processing time of a CC-Link remote device station ( Manual for the CC-Link remote device station used)

(b) From the master station (RY/RWw) to a CC-Link remote device station (output)

The following shows the time it takes for a CC-Link remote device station to turn on (off) after a CPU module device of the master station turns on (off) or the time it takes until the data of a CC-Link remote device station is changed after the data is set on a CPU module device.

For CC-Link, station-based block data assurance is disabled and the asynchronous mode is used.

- CC-Link IE Field Network station-based block data assurance is available.

Calculated value	Calculation formula for asynchronous mode	Calculation formula for synchronous mode
Normal value	$(SM \times n2) + (LSf \times 1) + \beta_T + (LSc \times 1) + Rd$	$(SM \times 1) + (LSf \times 1) + \beta_T + (LSc \times 1) + Rd$
Maximum value	$(SM \times n2) + (LSf \times 2) + \beta_T + (LSc \times 2) + Rd$	$(SM \times n2) + (LSf \times 1) + \beta_T + (LSc \times 2) + Rd$

- CC-Link IE Field Network station-based block data assurance is not available.

Calculated value	Calculation formula for asynchronous mode	Calculation formula for synchronous mode
Normal value	$(SM \times 1) + (LSf \times 1) + \beta_T + (LSc \times 1) + Rd$	$(SM \times 1) + (LSf \times 1) + \beta_T + (LSc \times 1) + Rd$
Maximum value	$(SM \times 2) + (LSf \times 2) + \beta_T + (LSc \times 2) + Rd$	$(SM \times n2) + (LSf \times 1) + \beta_T + (LSc \times 2) + Rd$

SM: Sequence scan time of the master station (including the link refresh time of the sending side)

LSf: Link scan time of CC-Link IE Field Network

n2: Value obtained by rounding up the decimal places of $(LSf \div SM)$

β_T : Time for data transfer from CC-Link to CC-Link IE Field Network

LSc: Link scan time of CC-Link

Rd: Processing time of a CC-Link remote device station (Manual for the CC-Link remote device station used)

Appendix 4 Added and Enhanced Functions

The following table lists the added and enhanced functions in the bridge module.

Added and enhanced function	Serial No. (first 5 digits) of the bridge module	GX Works2 version	GX Works3 version	Reference
CC-Link parameter setting using the engineering tool	18072 or later	Version 1.98C or later	Version 1.000A or later	Page 59, Section 7.2.2

Appendix 5 EMC and Low Voltage Directives

A

In each country, laws and regulations concerning electromagnetic compatibility (EMC) and electrical safety are enacted. For the products sold in the European countries, compliance with the EU's EMC Directive has been a legal obligation as EMC regulation since 1996, as well as the EU's Low Voltage Directive as electrical safety regulation since 1997.

Manufacturers who recognize their products are compliant with the EMC and Low Voltage Directives are required to attach a "CE marking" on their products in European countries.

In some other countries and regions, manufacturers are required to make their products compliant with applicable laws or regulations and attach a certification mark on the products as well (such as UK Conformity Assessed (UKCA) marking in the UK, and Korea Certification (KC) marking in South Korea).

Each country works to make their regulatory requirements consistent across countries based on international standards. When the requirements are consistent, measures to comply with the EMC and electrical safety regulations become common across countries.

The UK and South Korea have enacted EMC regulations whose requirements are consistent with those of the EMC Directive.

The UK has also enacted electrical safety regulations whose requirements are consistent with those of the Low Voltage Directive. In this section, the requirements of the EMC and Low Voltage Directives are described as examples of those of the EMC and electrical safety regulations.

Appendix 5.1 Measures to comply with the EMC Directive

The EMC Directive sets two requirements for compliance: emission (conducted and radiated electromagnetic energy emitted by a product) and immunity (the ability of a product to not be influenced by externally generated electromagnetic energy).

This section summarizes the precautions for machinery constructed with the bridge module to comply with the EMC Directive.

These precautions are based on the requirements of the EMC Directive and the harmonized standards. However, they do not guarantee that the entire machinery constructed according to the descriptions complies with the EMC Directive. The manufacturer of the machinery must determine the testing method for compliance and declare conformity to the EMC Directive.

(1) EMC Directive related standards

(a) Emission requirements

Standard	Test item	Test description	Value specified in standard
EN61131-2: 2007	CISPR16-2-3 Radiated emission ^{*2}	The electromagnetic wave which the product emits to the external space is measured.	<ul style="list-style-type: none"> • 30 to 230MHz, QP: 40dBμV/m (measured at 10m distance)^{*1} • 230 to 1000MHz, QP: 47dBμV/m (measured at 10m distance)
	CISPR16-2-1, CISPR16-1-2 Conducted emission ^{*2}	The noise level which the product emits to the power line is measured.	<ul style="list-style-type: none"> • 0.15 to 0.5MHz, QP: 79dB, Mean: 66dB^{*1} • 0.5 to 30MHz, QP: 73dB, Mean: 60dB

*1 QP: Quasi-Peak value, Mean: Average value

*2 The bridge module is an open type device (a device designed to be housed in other equipment) and must be installed inside a conductive control panel.

(b) Immunity requirements

Standard	Test item	Test description	Value specified in standard
EN61131-2: 2007	EN61000-4-2 Electrostatic discharge immunity ^{*1}	An electrostatic discharge is applied to the enclosure of the equipment.	<ul style="list-style-type: none"> • 8kV Air discharge • 4kV Contact discharge
	EN61000-4-3 Radiated, radio-frequency, electromagnetic field immunity ^{*1}	An electric field is radiated to the product.	80% AM modulation @1kHz <ul style="list-style-type: none"> • 80 to 1000MHz: 10Vm • 1.4 to 2.0GHz: 3Vm • 2.0 to 2.7GHz: 1Vm
	EN61000-4-4 Fast transient burst immunity ^{*1}	Burst noise is applied to power lines and signal lines.	<ul style="list-style-type: none"> • AC/DC power, I/O power, and AC I/O (unshielded) lines: 2kV • DC I/O, analog, and communication lines: 1kV
	EN61000-4-5 Surge immunity ^{*1}	Lightning surge is applied to power lines and signal lines.	<ul style="list-style-type: none"> • AC power, AC I/O power, and AC I/O (unshielded) lines: 2kV CM, 1kV DM • DC power and DC I/O power lines: 0.5kV CM, 0.5kV DM • DC I/O, AC I/O (shielded), analog^{*2}, and communication lines: 1kV CM
	EN61000-4-6 Conducted RF immunity ^{*1}	High-frequency noise is applied to power lines and signal lines.	0.15 to 80MHz, 80% AM modulation @1kHz, 10Vrms
	EN61000-4-8 Power-frequency magnetic field immunity ^{*1}	The product is immersed in the magnetic field of an induction coil.	50/60Hz, 30A/m
	EN61000-4-11 Voltage dips and interruption immunity ^{*1}	Power voltage is momentarily interrupted.	<ul style="list-style-type: none"> • 0%, 0.5 period, starting at zerocrossing • 0%, 250/300 period (50/60Hz) • 40%, 10/12 period (50/60Hz) • 70%, 25/30 period (50/60Hz)

*1 The bridge module is an open type device (a device designed to be housed in other equipment) and must be installed inside a conductive control panel. The tests were conducted with the programmable controller installed in a control panel.

*2 The accuracy of an analog-digital converter module may temporary vary within $\pm 10\%$.

(2) Installation in a control panel

The bridge module is an open type device and must be installed inside a control panel. ^{*1}

This ensures safety as well as effective shielding of the bridge module-emitted electromagnetic noise.

*1 Modules on the remote station in each network must be also installed inside the control panel. However, the waterproof type remote station can be installed outside the control panel.

(a) Control panel

- Use a conductive control panel.
- Mask off the area used for grounding when securing the top or bottom plate to the control panel using bolts.
- To ensure electrical contact between the inner plate and the control panel, mask off the bolt installation areas of an inner plate so that conductivity can be ensured in the largest possible area.
- Ground the control panel with a thick ground cable so that low impedance can be ensured even at high frequencies.

- Keep the diameter of the holes on the control panel to 10cm or less. If the diameter is larger than 10cm, electromagnetic wave may be emitted. In addition, because electromagnetic wave leaks through a clearance between the control panel and its door, reduce the clearance as much as possible. Use of EMI gaskets (sealing the clearance) can suppress undesired radiated emissions.
- The tests by Mitsubishi were conducted using a control panel having the damping characteristics of 37dB (maximum) and 30dB (average) (measured at 3m distance, 30 to 300MHz).

(b) Wiring power cables

Provide a ground point to the control panel near the power supply module. Ground the FG (frame ground) terminal of the power supply module to the ground point with the thickest and shortest ground cable possible (30cm or shorter).

(3) Cables

Use a shielded cable for the cable connected to the bridge module and may be extended out of the control panel. If a shielded cable is not used or not grounded correctly, the noise immunity will not meet the required value.

(a) CC-Link IE Field Network cable

The precautions for using CC-Link IE Field Network cables are described below.

- For CC-Link IE Field Network module, use CC-Link IE Field Network cables (SC-E5EW-S□M, manufactured by Mitsubishi Electric System & Service Co., Ltd.).
- A CC-Link IE Field Network cable is a shielded cable. Remove a part of the shield as shown below and ground the largest possible exposed section to the ground.

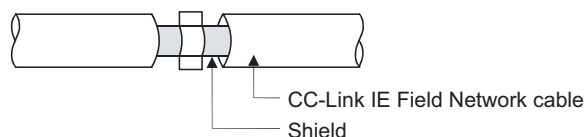

(b) Grounding a Ver.1.10-compatible CC-Link dedicated cable

Ground the shield of a cable connected to the CC-Link module or any of the CC-Link stations which is the farthest from the input power inside the control panel within 30cm from the module or station.

Ver.1.10-compatible CC-Link dedicated cable is a shielded cable. Strip a part of the jacket of the cable as shown below and ground the exposed shield to the ground as much as possible.

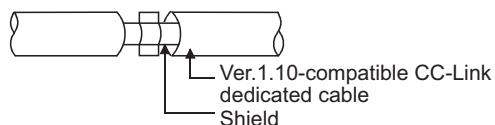

Use the specified Ver.1.10-compatible CC-Link dedicated cable.

Use the FG terminals of the CC-Link module and CC-Link stations as shown below to connect to the FG line inside the control panel.

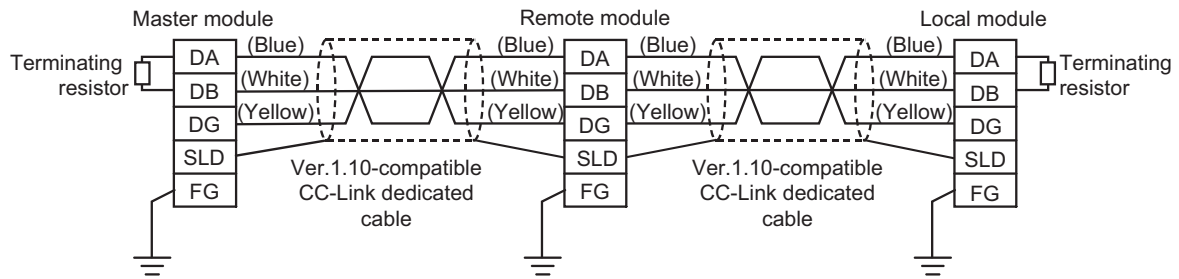

(c) Grounding cables with a cable clamp

Use a shielded cable for external wiring and ground the shield of the shielded cable to the control panel with the AD75CK cable clamp (Mitsubishi). (Ground the shield within 20 to 30cm from the module.)

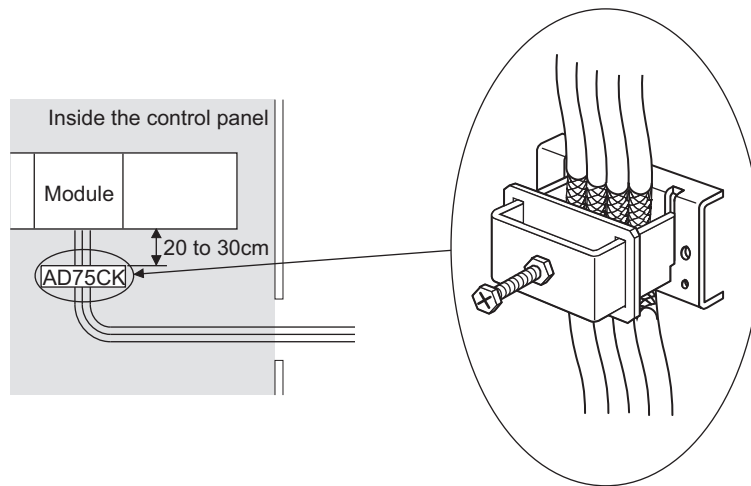

For details on the AD75CK, refer to the following.

AD75CK-type Cable Clamping Instruction Manual

(4) External power supply

Use a CE-marked external power supply and ground the FG terminal.

(External power supply used for the tests conducted by Mitsubishi: TDK-Lambda DLP-120-24-1, IDEC PS5RSF24)

(5) CC-Link module

- To ground the Ver.1.10-compatible CC-Link dedicated cable, refer to Page 135, Appendix 5.1 (3) (b).
- Each power line connecting to the external power supply terminal or module power supply terminal must be 30m or less.
- Install a noise filter to the external power supply. Use the noise filter having an attenuation characteristic, MA1206 (TDKLambda) or equivalent. Note that a noise filter is not required if the module is used in Zone A defined in EN61131-2.
- Keep the length of signal cables connected to the analog input terminals of the following modules to 30m or less. Wire cables connected to the external power supply and module power supply terminal in the control panel where the module is installed.
 - AJ65BT-64RD3
 - AJ65BT-64RD4
 - AJ65BT-68TD
- For the cable connected to the power supply terminal of the AJ65SBT-RPS, AJ65SBT-RPG or AJ65BT-68TD, attach a ferrite core with attenuation characteristic equivalent to that of the ZCAT3035-1330 from TDK Corporation. Twist the cable around the ferrite core by one as shown below.

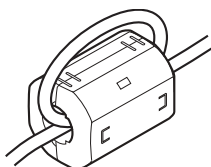

- To supply the module power supply terminal of the AJ65BTB2-16R/16DR, AJ65SBTB2N-8A/8R/8S/16A/16R/16S with power using the AC/DC power supply, follow as shown below.
 - Install the AC/DC power supply in the control panel where the module is installed.
 - Use a CE-marked AC/DC power supply and ground the FG terminals. (The AC/DC power supply used for the tests conducted by Mitsubishi: TDK-Lambda Corporation: DLP-120-24-1)
 - For the cable connected to the AC input terminal and DC output terminals of the AC/DC power supply, attach a ferrite core. Twist the cable around the ferrite core by one as shown below. (Ferrite core used for the tests conducted by Mitsubishi: NEC TOKIN Corporation: ESD-SR-250)

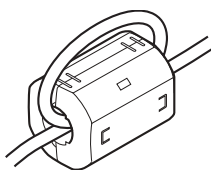

(6) Other measures

(a) Ferrite core

Ferrite core is effective for reducing radiated noise in the 30MHz to 100MHz frequency band. It is recommended to install a ferrite core if a shield cable extended out of the control panel does not provide sufficient shielding effects. Install a ferrite core to the cable in the position immediately before the cable is extended out of the control panel. If the installation position is not appropriate, the ferrite core will not produce any effect.

Install a ferrite core to each power cable as shown below.

(Ferrite core used for the tests conducted by Mitsubishi: NEC TOKIN ESD-SR-250)

- Example

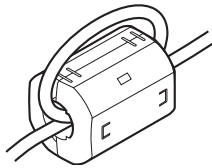

(b) Noise filter (power supply line filter)

Noise filter is effective for reducing conducted noise in the 10MHz or less frequency. (Use of a noise filter can suppress noise.)

The installation precautions are described below.

- Do not bundle the cables on the input side and output side of the noise filter. If bundled, the output side noise will be induced into the filtered cable on the input side.

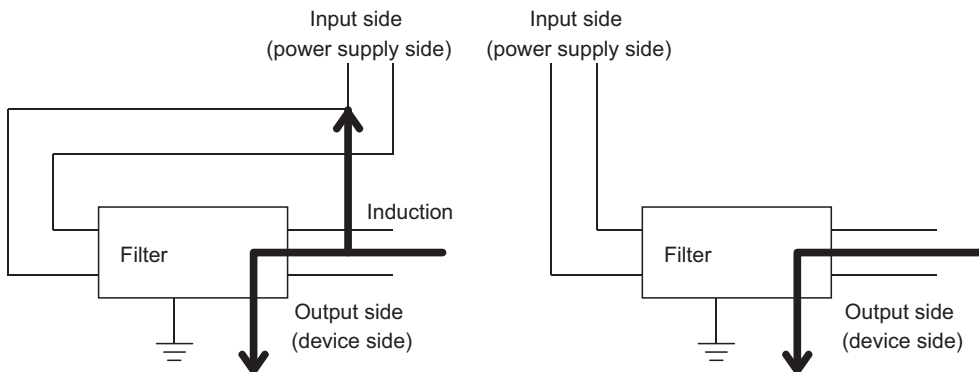

Noise will be induced when the input and output cables are bundled.

Separately install the input and output cables.

- Ground the ground terminal of the noise filter to the ground point of the control panel with the shortest ground wire possible (approximately 10cm).

Appendix 5.2 Requirements to compliance with the Low Voltage Directive

A

The bridge module operates at the rated voltage of 24VDC.

The Low Voltage Directive is not applied to the modules that operate at the rated voltage of less than 50VAC and 75VDC.

Appendix 6 Checking the Serial Number and Function Version

The serial number and function version of the bridge module can be checked on the rating plate.

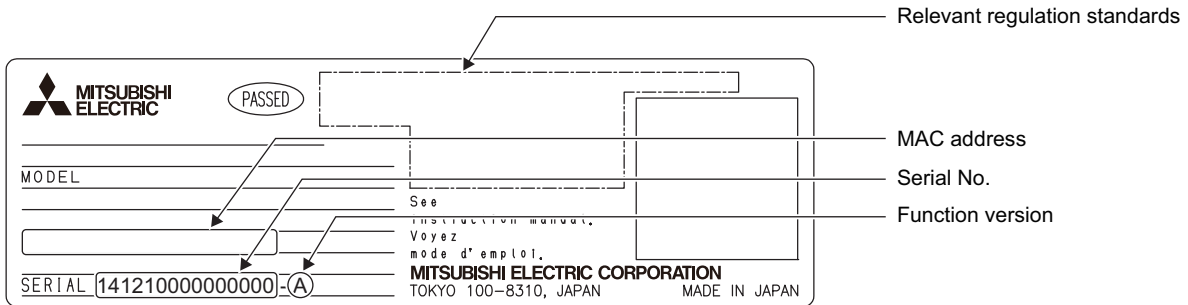

Appendix 7 External Dimensions

A

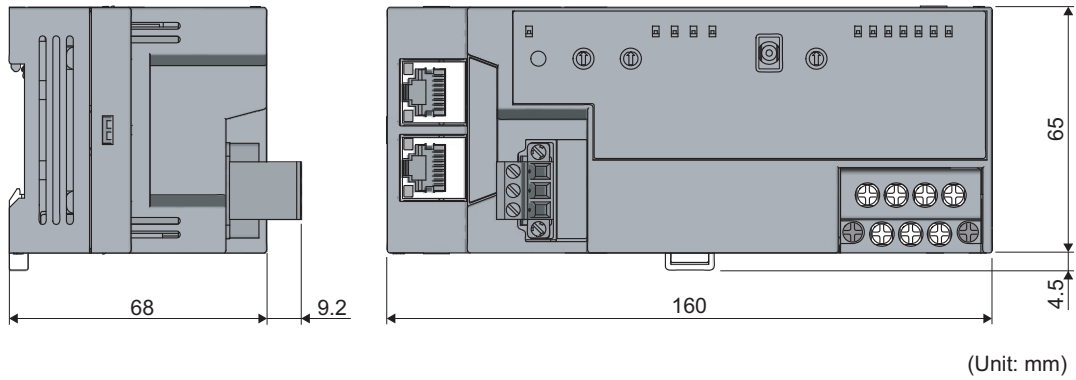

INDEX

A	
Automatic CC-Link startup function	55
B	
Bridge module	12
C	
CC-Link	12
CC-Link dedicated cable	12
CC-Link IE Field Network	12
CC-Link IE Field Network LED	17
CC-Link LED	18
CC-Link remote station	12
CE marking	133
Cyclic transmission	12
D	
D LINK LED (CC-Link IE Field Network part)	17
Data link	12
Dedicated instruction	12
Device	12
Disconnection	12
E	
Emission	133
Engineering tool	12
ERR. LED (CC-Link IE Field Network part)	17
ERR. LED (CC-Link part)	18
F	
Ferrite core	138
G	
GX Works2	12
GX Works3	12
I	
Immunity	134
Intelligent device station	12
L	
L ER LED	17
L ERR. LED (CC-Link part)	18
L RUN LED (CC-Link part)	18
Line test	64
Link device	12
LINK LED	17
Link scan	12
Link scan time	12
Link special register (SW)	12
Link special relay (SB)	12
Local station	12
Low Voltage Directive	133,139
M	
Master station	12
Master/local module	12
MODE LED (CC-Link IE Field Network part)	17
MST LED (CC-Link part)	18
N	
Noise filter	138
P	
P1	17
P2	17
POWER LED	17
R	
RD LED (CC-Link part)	18
Relay station	12
Remote buffer memory	12
Remote device station	12
Remote I/O station	12
Remote input (RX)	12
Remote output (RY)	12
Remote register (RW _r)	12,111
Remote register (RW _w)	12,110
Reserved station	12
Return	12
RUN LED (CC-Link IE Field Network part)	17
RUN LED (CC-Link part)	18
S	
SD LED (CC-Link part)	18
Slave station	13
Slave station information saving function	57
System Error History	79
T	
Transient transmission	13

Memo



REVISIONS

*The manual number is given on the bottom left of the back cover.

Print date	*Manual number	Revision
February 2013	SH(NA)-081121ENG-A	First edition
January 2016	SH(NA)-081121ENG-B	[Added or modified part] Appendix 4.1
July 2016	SH(NA)-081121ENG-C	[Added or modified part] SAFETY PRECAUTIONS, CONDITIONS OF USE FOR THE PRODUCT, RELEVANT MANUALS, TERMS, PACKING LIST, Chapter 2, Section 3.3, Chapter 4, Section 5.2, 5.3, 7.1, 7.2, Chapter 8, Section 10.1, 10.2, 10.3, 10.4, 10.5.1, 10.5.3, 10.5.4, 10.6.2, 10.6.3, Appendix 4, 5.1, 6
November 2022	SH(NA)-081121ENG-D	[Added or modified part] SAFETY PRECAUTIONS, CONDITIONS OF USE FOR THE PRODUCT, Appendix 5

Japanese manual number: SH-081122-D

This manual confers no industrial property rights or any rights of any other kind, nor does it confer any patent licenses. Mitsubishi Electric Corporation cannot be held responsible for any problems involving industrial property rights which may occur as a result of using the contents noted in this manual.

© 2013 MITSUBISHI ELECTRIC CORPORATION

WARRANTY

Please confirm the following product warranty details before using this product.

1. Gratis Warranty Term and Gratis Warranty Range

If any faults or defects (hereinafter "Failure") found to be the responsibility of Mitsubishi occurs during use of the product within the gratis warranty term, the product shall be repaired at no cost via the sales representative or Mitsubishi Service Company.

However, if repairs are required onsite at domestic or overseas location, expenses to send an engineer will be solely at the customer's discretion. Mitsubishi shall not be held responsible for any re-commissioning, maintenance, or testing on-site that involves replacement of the failed module.

[Gratis Warranty Term]

The gratis warranty term of the product shall be for one year after the date of purchase or delivery to a designated place. Note that after manufacture and shipment from Mitsubishi, the maximum distribution period shall be six (6) months, and the longest gratis warranty term after manufacturing shall be eighteen (18) months. The gratis warranty term of repair parts shall not exceed the gratis warranty term before repairs.

[Gratis Warranty Range]

- (1) The range shall be limited to normal use within the usage state, usage methods and usage environment, etc., which follow the conditions and precautions, etc., given in the instruction manual, user's manual and caution labels on the product.
- (2) Even within the gratis warranty term, repairs shall be charged for in the following cases.
 1. Failure occurring from inappropriate storage or handling, carelessness or negligence by the user. Failure caused by the user's hardware or software design.
 2. Failure caused by unapproved modifications, etc., to the product by the user.
 3. When the Mitsubishi product is assembled into a user's device, Failure that could have been avoided if functions or structures, judged as necessary in the legal safety measures the user's device is subject to or as necessary by industry standards, had been provided.
 4. Failure that could have been avoided if consumable parts (battery, backlight, fuse, etc.) designated in the instruction manual had been correctly serviced or replaced.
 5. Failure caused by external irresistible forces such as fires or abnormal voltages, and Failure caused by force majeure such as earthquakes, lightning, wind and water damage.
 6. Failure caused by reasons unpredictable by scientific technology standards at time of shipment from Mitsubishi.
 7. Any other failure found not to be the responsibility of Mitsubishi or that admitted not to be so by the user.

2. Onerous repair term after discontinuation of production

- (1) Mitsubishi shall accept onerous product repairs for seven (7) years after production of the product is discontinued. Discontinuation of production shall be notified with Mitsubishi Technical Bulletins, etc.
- (2) Product supply (including repair parts) is not available after production is discontinued.

3. Overseas service

Overseas, repairs shall be accepted by Mitsubishi's local overseas FA Center. Note that the repair conditions at each FA Center may differ.

4. Exclusion of loss in opportunity and secondary loss from warranty liability

Regardless of the gratis warranty term, Mitsubishi shall not be liable for compensation to:

- (1) Damages caused by any cause found not to be the responsibility of Mitsubishi.
- (2) Loss in opportunity, lost profits incurred to the user by Failures of Mitsubishi products.
- (3) Special damages and secondary damages whether foreseeable or not, compensation for accidents, and compensation for damages to products other than Mitsubishi products.
- (4) Replacement by the user, maintenance of on-site equipment, start-up test run and other tasks.

5. Changes in product specifications

The specifications given in the catalogs, manuals or technical documents are subject to change without prior notice.

TRADEMARKS

The company names, system names and product names mentioned in this manual are either registered trademarks or trademarks of their respective companies.

In some cases, trademark symbols such as '™' or '®' are not specified in this manual.

SH(NA)-081121ENG-D(2211)MEE

MODEL: NZ2GF-CCB-U-E

MODEL CODE: 13JZ84

MITSUBISHI ELECTRIC CORPORATION

HEAD OFFICE : TOKYO BUILDING, 2-7-3 MARUNOUCHI, CHIYODA-KU, TOKYO 100-8310, JAPAN
NAGOYA WORKS : 1-14, YADA-MINAMI 5-CHOME, HIGASHI-KU, NAGOYA, JAPAN

When exported from Japan, this manual does not require application to the
Ministry of Economy, Trade and Industry for service transaction permission.

Specifications subject to change without notice.