



Programmable Controller

CC-Link IE TSN Digital-Analog Converter Module
User's Manual
(CC-Link IE Field Network Communication Mode)

-NZ2GN2S-60DA4
-NZ2GN2B-60DA4

SAFETY PRECAUTIONS

(Read these precautions before using this product.)

Before using this product, please read this manual and the relevant manuals carefully and pay full attention to safety to handle the product correctly.

The precautions given in this manual are concerned with this product only. For the safety precautions of the programmable controller system, refer to the user's manual for the CPU module used.

In this manual, the safety precautions are classified into two levels: "⚠️ WARNING" and "⚠️ CAUTION".

WARNING

Indicates that incorrect handling may cause hazardous conditions, resulting in death or severe injury.

CAUTION

Indicates that incorrect handling may cause hazardous conditions, resulting in minor or moderate injury or property damage.

Under some circumstances, failure to observe the precautions given under "⚠️ CAUTION" may lead to serious consequences.

Observe the precautions of both levels because they are important for personal and system safety.

Make sure that the end users read this manual and then keep the manual in a safe place for future reference.

[Design Precautions]

WARNING

- In the case of a communication failure in the network, data of the master station are held. Check Data link status (each station) (SW00B0 to SW00B7) and configure an interlock circuit in the program to ensure that the entire system will operate safely.
 - Do not use any "use prohibited" signals as a remote input or output signal. These signals are reserved for system use. Do not write any data to the "use prohibited" areas in the remote register. If these operations are performed, an accident may occur due to an incorrect output or malfunction.
 - Configure safety circuits external to the programmable controller to ensure that the entire system operates safely even when a fault occurs in the external power supply or the programmable controller. Failure to do so may result in an accident due to an incorrect output or malfunction.
 - (1) The status of analog output depends on the setting of various functions that control the analog output. Set those functions carefully. For details of analog output status, refer to Page 53 Analog Output HOLD/CLEAR Setting Function.
 - (2) Due to failure of the output element or internal circuit, output may not be performed correctly. Configure an external circuit for monitoring output signals that could cause a serious accident.
-

[Design Precautions]

CAUTION

- Do not install the control lines or communication cables together with the main circuit lines or power cables. Keep a distance of 100mm or more between them. Failure to do so may result in malfunction due to noise.
 - At power-on/off, a voltage may occur or a current may flow between output terminals for a moment. In this case, start the control after analog outputs become stable.
-

[Security Precautions]

WARNING

- To maintain the security (confidentiality, integrity, and availability) of the programmable controller and the system against unauthorized access, denial-of-service (DoS) attacks, computer viruses, and other cyberattacks from external devices via the network, take appropriate measures such as firewalls, virtual private networks (VPNs), and antivirus solutions.
-

[Installation Precautions]

WARNING

- Shut off the external power supply (all phases) used in the system before mounting or removing a module. Failure to do so may result in electric shock or cause the module to fail or malfunction.
-

[Installation Precautions]

CAUTION

- Use the module in an environment that meets the general specifications in this manual. Failure to do so may result in electric shock, fire, malfunction, or damage to or deterioration of the product.
 - Do not directly touch any conductive parts and electronic components of the module. Doing so can cause malfunction or failure of the module.
 - Securely connect the cable connectors. Poor contact may cause malfunction.
-

[Wiring Precautions]

WARNING

- Shut off the external power supply (all phases) used in the system before wiring. Failure to do so may result in electric shock or cause the module to fail or malfunction.
-

[Wiring Precautions]

CAUTION

- Individually ground the FG terminal of the programmable controller with a ground resistance of 100 ohms or less. Failure to do so may result in electric shock or malfunction.
 - Tighten any unused terminal screws within the specified torque range. Undertightening may cause a short circuit due to contact with a solderless terminal.
 - Use applicable solderless terminals and tighten them within the specified torque range. If any spade solderless terminal is used, it may be disconnected when a terminal block screw comes loose, resulting in failure.
 - Check the rated voltage and terminal layout before wiring to the module, and connect the cables correctly. Connecting a power supply with a different voltage rating or incorrect wiring may cause a fire or failure.
 - Tighten the terminal block screws within the specified torque range. Undertightening can cause short circuit, fire, or malfunction. Overtightening can damage the screw and/or module, resulting in drop, short circuit, fire, or malfunction.
 - Prevent foreign matter such as dust or wire chips from entering the module. Such foreign matter can cause a fire, failure, or malfunction.
 - Place the cables in a duct or clamp them. If not, dangling cables may swing or inadvertently be pulled, resulting in malfunction or damage to modules or cables. In addition, the weight of the cables may put stress on modules in an environment of strong vibrations and shocks.
 - Do not install the control lines or communication cables together with the main circuit lines or power cables. Keep a distance of 100mm or more between them. Failure to do so may result in malfunction due to noise.
 - When disconnecting the cable from the module, do not pull the cable by the cable part. For the cable with connector, hold the connector part of the cable. For the cable connected to the terminal block, loosen the terminal screw. Pulling the cable connected to the module may result in malfunction or damage to the module or cable.
 - When an overcurrent caused by an error of an external device or a failure of the programmable controller flows for a long time, it may cause smoke and fire. To prevent this, configure an external safety circuit, such as a fuse.
 - Mitsubishi Electric programmable controllers must be installed in control panels. Wiring and replacement of a module must be performed by qualified maintenance personnel with knowledge of protection against electric shock. For wiring methods, refer to "INSTALLATION AND WIRING" in this manual.
-

[Startup and Maintenance Precautions]

WARNING

- Do not touch any terminal while power is on. Doing so will cause electric shock or malfunction.
 - Shut off the external power supply (all phases) used in the system before cleaning the module or retightening the terminal block screws and connector screws. Failure to do so may cause the module to fail or malfunction.
-

[Startup and Maintenance Precautions]

CAUTION

- Do not disassemble or modify the module. Doing so may cause failure, malfunction, injury, or a fire.
 - Do not drop or apply strong shock to the module. Doing so may damage the module.
 - Use any radio communication device such as a cellular phone or PHS (Personal Handy-phone System) 25cm or more away in all directions from the programmable controller. Failure to do so may cause malfunction.
 - Shut off the external power supply (all phases) used in the system before mounting or removing a module. Failure to do so may cause the module to fail or malfunction.
 - After the first use of the product, do not mount/remove the terminal block to/from the module more than 50 times (IEC 61131-2/JIS B 3502 compliant). Exceeding the limit may cause malfunction.
 - Before handling the module or connection cables, touch a conducting object such as a grounded metal to discharge the static electricity from the human body. Failure to do so may cause the module to fail or malfunction.
 - Startup and maintenance of a control panel must be performed by qualified maintenance personnel with knowledge of protection against electric shock. Lock the control panel so that only qualified maintenance personnel can operate it.
-

[Disposal Precautions]

CAUTION

- When disposing of this product, treat it as industrial waste.
-

CONDITIONS OF USE FOR THE PRODUCT

- (1) Mitsubishi programmable controller ("the PRODUCT") shall be used in conditions;
- i) where any problem, fault or failure occurring in the PRODUCT, if any, shall not lead to any major or serious accident; and
 - ii) where the backup and fail-safe function are systematically or automatically provided outside of the PRODUCT for the case of any problem, fault or failure occurring in the PRODUCT.
- (2) The PRODUCT has been designed and manufactured for the purpose of being used in general industries. MITSUBISHI SHALL HAVE NO RESPONSIBILITY OR LIABILITY (INCLUDING, BUT NOT LIMITED TO ANY AND ALL RESPONSIBILITY OR LIABILITY BASED ON CONTRACT, WARRANTY, TORT, PRODUCT LIABILITY) FOR ANY INJURY OR DEATH TO PERSONS OR LOSS OR DAMAGE TO PROPERTY CAUSED BY the PRODUCT THAT ARE OPERATED OR USED IN APPLICATION NOT INTENDED OR EXCLUDED BY INSTRUCTIONS, PRECAUTIONS, OR WARNING CONTAINED IN MITSUBISHI'S USER, INSTRUCTION AND/OR SAFETY MANUALS, TECHNICAL BULLETINS AND GUIDELINES FOR the PRODUCT.
- ("Prohibited Application")
- Prohibited Applications include, but not limited to, the use of the PRODUCT in;
- Nuclear Power Plants and any other power plants operated by Power companies, and/or any other cases in which the public could be affected if any problem or fault occurs in the PRODUCT.
 - Railway companies or Public service purposes, and/or any other cases in which establishment of a special quality assurance system is required by the Purchaser or End User.
 - Aircraft or Aerospace, Medical applications, Train equipment, transport equipment such as Elevator and Escalator, Incineration and Fuel devices, Vehicles, Manned transportation, Equipment for Recreation and Amusement, and Safety devices, handling of Nuclear or Hazardous Materials or Chemicals, Mining and Drilling, and/or other applications where there is a significant risk of injury to the public or property.
- Notwithstanding the above restrictions, Mitsubishi may in its sole discretion, authorize use of the PRODUCT in one or more of the Prohibited Applications, provided that the usage of the PRODUCT is limited only for the specific applications agreed to by Mitsubishi and provided further that no special quality assurance or fail-safe, redundant or other safety features which exceed the general specifications of the PRODUCTS are required. For details, please contact the Mitsubishi representative in your region.
- (3) Mitsubishi shall have no responsibility or liability for any problems involving programmable controller trouble and system trouble caused by DoS attacks, unauthorized access, computer viruses, and other cyberattacks.

INTRODUCTION

Thank you for purchasing the CC-Link IE TSN digital-analog converter module (hereafter abbreviated as D/A converter module).

This manual describes the procedures, system configuration, parameter settings, functions, and troubleshooting required to use the D/A converter module in CC-Link IE Field Network communication mode.

Before using this product, please read this manual and the relevant manuals carefully and develop familiarity with the functions and performance of the D/A converter module to handle the product correctly.

When applying the program examples introduced in this manual to an actual system, ensure the applicability and confirm that it will not cause system control problems.

CC-Link IE Field Network communication mode

The CC-Link IE Field Network communication mode allows a D/A converter module to be used as a remote device station in CC-Link IE Field Network.

When operating the D/A converter module in CC-Link IE Field Network communication mode, turn on the function setting switch 1. (👉 Page 23 Function setting switch setting)

Restriction

The CC-Link IE Field Network communication mode is available for a D/A converter module with firmware version "02" or later.

For other applicable systems, refer to the following.

👉 Page 19 SYSTEM CONFIGURATION

Relevant products

NZ2GN2S-60DA4, NZ2GN2B-60DA4

Point

Unless otherwise specified, this manual describes the program examples in which the remote I/O signals and remote registers are assigned for a D/A converter module as follows.

- Remote input signals: RX0 to RX2F
- Remote output signals: RY0 to RY2F
- Remote register: RWr0 to RWr1F
- Remote register: RWw0 to RWw1F

For the assignment of remote I/O signals and remote registers, refer to the following.

👉 Page 68 PROGRAMMING

CONTENTS

SAFETY PRECAUTIONS	1
CONDITIONS OF USE FOR THE PRODUCT	5
INTRODUCTION	6
RELEVANT MANUALS	9
TERMS	10
GENERIC TERMS AND ABBREVIATIONS	10
CHAPTER 1 PART NAMES	11
CHAPTER 2 SPECIFICATIONS	13
2.1 General Specifications	13
2.2 Performance Specifications	14
2.3 Function List	16
CHAPTER 3 PROCEDURES BEFORE OPERATION	17
CHAPTER 4 SYSTEM CONFIGURATION	19
4.1 Applicable Systems	19
CHAPTER 5 INSTALLATION AND WIRING	21
5.1 Setting Switch	21
Setting the IP address/station number setting switches	21
Function setting switch setting	23
5.2 Installation Environment and Installation Position	26
Installation environment	26
Installation position	26
Installation direction	27
5.3 Installation	28
How to mount a module on a DIN rail	28
5.4 Wiring to Terminal Block for Module Power Supply and FG	29
5.5 Wiring of Ethernet Cable	32
5.6 Wiring to Analog Output Terminal Block	34
Wiring of spring clamp terminal block	34
Wiring of screw terminal block	37
5.7 External Wiring	39
CHAPTER 6 VARIOUS SETTINGS	40
6.1 Network Configuration Setting	40
6.2 Parameter Setting	42
Device station parameter processing	44
CHAPTER 7 FUNCTIONS	48
7.1 Operation Mode Shift at Power-On	48
7.2 D/A Conversion Enable/Disable Setting Function	49
7.3 D/A Output Enable/Disable Function	50
7.4 Conversion Speed and Conversion Cycle	51
7.5 Range Switching Function	52
7.6 Analog Output HOLD/CLEAR Setting Function	53

7.7	Scaling Function	54
7.8	Shift Function	57
7.9	Digital Value Range Check Function	61
7.10	Warning Output Function	63
7.11	SLMP Communication Function	65
7.12	Firmware Update Function	66
7.13	Module Power Supply Voltage Drop Detection Function	67
CHAPTER 8 PROGRAMMING		68
8.1	Precautions for Programming	68
8.2	When Function Setting Switch 2 Is Not Used	69
8.3	When Function Setting Switch 2 Is Used	76
CHAPTER 9 MAINTENANCE AND INSPECTION		83
CHAPTER 10 TROUBLESHOOTING		85
10.1	CC-Link IE TSN/CC-Link IE Field Diagnostics	85
10.2	Checking the LEDs	88
10.3	Unit Test	91
10.4	Troubleshooting by Symptom	92
10.5	How to Check Error Codes and Alarm Codes	94
10.6	Error Code List	101
10.7	Alarm Code List	105
10.8	Error Log Display Specifications	106
APPENDICES		107
Appendix 1 Remote I/O Signal		107
	List of remote I/O signals	107
	Details of remote input signals	108
	Details of remote output signals	113
Appendix 2 Remote Register		115
	List of remote register areas	115
	Details of remote register areas	116
Appendix 3 Remote Buffer Memory		119
	List of remote buffer memory areas	119
	Details of remote buffer memory areas	123
Appendix 4 I/O Conversion Characteristics of D/A Conversion		131
Appendix 5 Accuracy of D/A Conversion		133
Appendix 6 CC-Link IE Field Network Processing Time		134
Appendix 7 EMC and Low Voltage Directives		135
	Measures to comply with the EMC Directive	135
	Requirements to compliance with the Low Voltage Directive	139
Appendix 8 How to Check Production Information and Firmware Version		140
Appendix 9 Added Functions		141
Appendix 10 External Dimensions		142
INDEX		144
REVISIONS		146
WARRANTY		147
TRADEMARKS		148

RELEVANT MANUALS

Manual name [manual number]	Description	Available form
CC-Link IE TSN Digital-Analog Converter Module User's Manual (CC-Link IE Field Network Communication Mode) [SH-082238ENG] (this manual)	Part names, specifications, procedures before operation, system configuration, installation, wiring, parameter settings, functions, programming, troubleshooting, I/O signals, and remote buffer memory of the D/A converter module to be used in CC-Link IE Field Network communication mode	Print book e-Manual PDF
CC-Link IE TSN Digital-Analog Converter Module User's Manual (CC-Link IE TSN Communication Mode) [SH-082133ENG]	Part names, specifications, procedures before operation, system configuration, installation, wiring, parameter settings, functions, programming, troubleshooting, I/O signals, and remote buffer memory of the D/A converter module to be used in CC-Link IE TSN communication mode	Print book e-Manual PDF
MELSEC iQ-R Ethernet/CC-Link IE User's Manual (Startup) [SH-081256ENG]	Specifications, procedures before operation, system configuration, wiring, and communication examples of Ethernet, CC-Link IE Controller Network, and CC-Link IE Field Network	Print book e-Manual PDF
MELSEC iQ-R CC-Link IE Field Network User's Manual (Application) [SH-081259ENG]	Functions, parameter settings, programming, troubleshooting, I/O signals, and buffer memory of CC-Link IE Field Network	Print book e-Manual PDF
MELSEC-L CC-Link IE Field Network Master/Local Module User's Manual [SH-080972ENG]	Specifications, procedures before operation, system configuration, installation, wiring, settings, functions, programming, and troubleshooting of CC-Link IE Field Network and LJ71GF11-T2	Print book e-Manual PDF
MELSEC-Q CC-Link IE Field Network Master/Local Module User's Manual [SH-080917ENG]	Specifications, procedures before operation, system configuration, installation, wiring, settings, functions, programming, and troubleshooting of CC-Link IE Field Network and QJ71GF11-T2	Print book e-Manual PDF
MELSEC iQ-R Simple Motion Module User's Manual (Network) [IB-0300307ENG]	Functions, parameter settings, troubleshooting, and buffer memory of CC-Link IE Field Network	Print book e-Manual PDF
MELSEC iQ-R Simple Motion Module User's Manual (Application) [IB-0300247ENG]	Functions, parameter settings, I/O signals, buffer memory, programming, and troubleshooting of the Simple Motion module	Print book e-Manual PDF
MELSEC-Q QD77GF Simple Motion Module User's Manual (Positioning Control) [IB-0300202]	Specifications of the QD77GF and information on how to establish a system, maintenance and inspection, and troubleshooting. Functions, programming and buffer memory for the positioning control of the QD77GF	Print book e-Manual PDF
MELSEC-Q QD77GF Simple Motion Module User's Manual (Network) [IB-0300203]	Functions, programming, and troubleshooting for CC-Link IE Field Network of the QD77GF	Print book e-Manual PDF
GX Works3 Operating Manual [SH-081215ENG]	System configuration, parameter settings, and online operations of GX Works3	e-Manual PDF
GX Works2 Version 1 Operating Manual (Common) [SH-080779ENG]	Functions common to Simple and Structured projects such as the system configuration, parameter settings, and online function operation methods of GX Works2	Print book e-Manual PDF
SLMP Reference Manual [SH-080956ENG]	A protocol used to access an SLMP-compatible device from an external device (such as a personal computer or HMI (Human Machine Interface)) or an SLMP-compatible module (such as the Ethernet-equipped module or modules on CC-Link IE TSN).	Print book e-Manual PDF



e-Manual refers to the Mitsubishi Electric FA electronic book manuals that can be browsed using a dedicated tool.

e-Manual has the following features:

- Required information can be cross-searched in multiple manuals.
- Other manuals can be accessed from the links in the manual.
- The hardware specifications of each part can be found from the product figures.
- Pages that users often browse can be bookmarked.
- Sample programs can be copied to an engineering tool.

TERMS

Unless otherwise specified, this manual uses the following terms.

Term	Description
Cyclic transmission	A function by which data are periodically exchanged among stations on the same network using link devices
Data link	Communications that are performed by cyclic transmission and transient transmission
Dedicated instruction	An instruction that simplifies programming for using functions of intelligent function modules
Device station	Stations other than a master station: local station, remote I/O station, remote device station, and intelligent device station
Engineering tool	A tool used for setting up programmable controllers, programming, debugging, and maintenance
Link device	A device (RX, RY, RWr, RWw, SB, and SW) in a module or board on CC-Link IE Field Network
Link scan (link scan time)	Time required for all the stations on the network to transmit data. The link scan time depends on data volume and the number of transient transmission requests.
Master station	A station that controls the entire network. This station can perform cyclic transmission and transient transmission with all stations. Only one master station can be used in a network.
Remote buffer memory	Buffer memory in a remote device station and an intelligent device station
Remote device station	A station that exchanges I/O signals (bit data) and I/O data (word data) with the master station by cyclic transmission. This station responds to a transient transmission (request) from another station.
Reserved station	A station reserved for future use. This station is not actually connected, but counted as a connected station.
Transient transmission	A function of communications with other stations, which is used when requested by a dedicated instruction or engineering tool

GENERIC TERMS AND ABBREVIATIONS

Unless otherwise specified, this manual uses the following generic terms and abbreviations.

Generic term and abbreviation	Description
A/D converter module	An abbreviation for the CC-Link IE TSN analog-digital converter module
CC-Link IE TSN remote module	A generic term for an A/D converter module, a D/A converter module, an I/O module
D/A converter module	An abbreviation for the CC-Link IE TSN digital-analog converter module
REMFR	An abbreviation for ZP.REMFR
REMFRD	An abbreviation for JP.REMFRD
REMTO	An abbreviation for ZP.REMTO
REMTOD	An abbreviation for JP.REMTOD
RWr	An abbreviation for remote register of link devices. RWr refers to word data input from a device station to the master station (For some areas in a local station, data are input in the opposite direction.)
RWw	An abbreviation for remote register of link devices. RWw refers to word data output from the master station to a device station (For some areas in a local station, data are output in the opposite direction.)
RX	An abbreviation for remote input of link devices. Bit data input from a device station to the master station (For some areas in a local station, data are input in the opposite direction.)
RY	An abbreviation for remote output of link devices. Bit data output from the master station to a device station (For some areas in a local station, data are output in the opposite direction.)
SLMPREQ	A generic term for the J.SLMPREQ, JP.SLMPREQ, G.SLMPREQ, GP.SLMPREQ
I/O module	An abbreviation for the CC-Link IE TSN remote I/O module

1 PART NAMES

This section describes part names of the D/A converter module.

- Spring clamp terminal block type

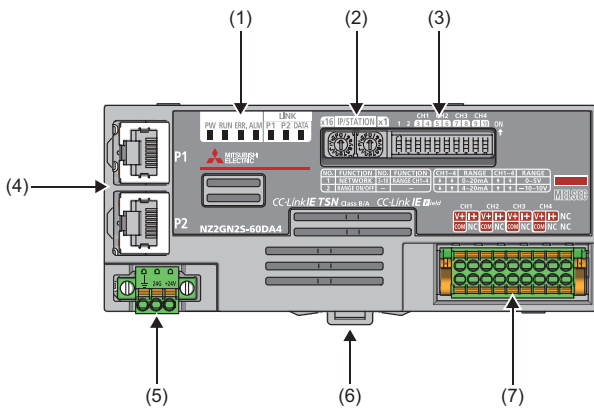

- Screw terminal block type

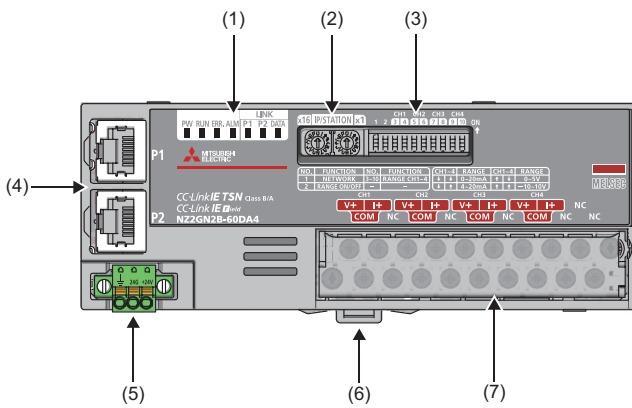

No.	Name	Application
(1)	PW LED	Indicates the power supply status of the D/A converter module. <ul style="list-style-type: none"> • On: Power-on • Off: Power-off
	RUN LED	Indicates the operating status of the D/A converter module. <ul style="list-style-type: none"> • On: In normal operation • Flashing: In unit test mode • Off: Major error occurred
	ERR. LED	Indicates the error status of the D/A converter module. <ul style="list-style-type: none"> • On: Moderate error or major error occurred • Flashing: Minor error occurred • Off: Operating normally
	ALM LED	Indicates the warning status of the D/A converter module. <ul style="list-style-type: none"> • On: Warning issued • Off: Operating normally
	P1 LINK LED	Indicates the link status for P1. <ul style="list-style-type: none"> • On: Link-up • Off: Link-down
	P2 LINK LED	Indicates the link status for P2. <ul style="list-style-type: none"> • On: Link-up • Off: Link-down
	DATA LINK LED	Indicates the data link status of the D/A converter module. <ul style="list-style-type: none"> • On: Cyclic transmission being performed • Flashing: Cyclic transmission stopped • Off: Own station disconnected
(2)	IP address/station number setting switch	Sets the station number. ☞ Page 21 Setting the IP address/station number setting switches

No.	Name	Application
(3)	Function setting switch	Sets the operation mode and the output range. ☞ Page 23 Function setting switch setting
(4)	P1	A port for the connection to CC-Link IE Field Network (RJ45 connector) Connect an Ethernet cable. (☞ Page 32 Wiring of Ethernet Cable) There are no restrictions on the connection order of the cables for P1 and P2.
	P2	Same as P1
(5)	Terminal block for module power supply and FG	A terminal block for the connection to module power supply (24VDC) and FG.
(6)	DIN rail hook	A hook to mount a D/A converter module on a DIN rail
(7)	Analog output terminal block	A terminal block for the connection to external devices

D/A converter module status and LED status

The following table shows how the D/A converter module status and LED status correspond each other.

D/A converter module status		LED status				
		PW LED	RUN LED	DATA LINK LED	ERR. LED	ALM LED
Data link in operation		On	On	On	*2	*3
Disconnecting		On	On	Off	*2	*3
Reserved station being set		On	On	Flashing	*2	*3
Link stop		On	On	Flashing	*2	*3
Communication system error occurring		On	On	*1	*2	*3
Error	Major error	On	Off	*1	On	*3
	Moderate error	On	On	*1	On	*3
	Minor error	On	On	*1	Flashing	*3
Alarm	Warning issued	On	On	*1	*2	On
Unit test	In progress	On	Flashing	Off	Off	Off
	Completed successfully	On	On	Off	Off	Off
	Completed with an error	On	On	Off	On	Off

- *1 On: Cyclic transmission being performed
Flashing: Cyclic transmission stopped
Off: Own station disconnected
- *2 On: Moderate error or major error occurred
Flashing: Minor error occurred
Off: Operating normally
- *3 On: Warning issued
Off: Operating normally

2 SPECIFICATIONS

This chapter describes the specifications of the D/A converter module.

2.1 General Specifications

Item	Specifications					
Operating ambient temperature	0 to 55°C					
Storage ambient temperature	-25 to 75°C					
Operating ambient humidity	5 to 95%RH, non-condensing					
Storage ambient humidity						
Vibration resistance	Compliant with JIS B 3502 and IEC 61131-2	—	Frequency	Constant acceleration	Half amplitude	Sweep count
		Under intermittent vibration	5 to 8.4Hz	—	3.5mm	10 times each in X, Y, and Z directions
			8.4 to 150Hz	9.8m/s ²	—	
		Under continuous vibration	5 to 8.4Hz	—	1.75mm	—
8.4 to 150Hz	4.9m/s ²		—			
Shock resistance	Compliant with JIS B 3502 and IEC 61131-2 (147m/s ² , 3 times each in X, Y, and Z directions)					
Operating atmosphere	No corrosive gases					
Operating altitude	0 to 2000m					
Installation location	Inside a control panel					
Overvoltage category* ¹	II or less					
Pollution degree* ²	2 or less					
Equipment class	Class I					

*1 This indicates the section of the power supply to which the equipment is assumed to be connected between the public electrical power distribution network and the machinery within premises.

Category II applies to equipment for which electrical power is supplied from fixed facilities. The surge voltage withstand level for up to the rated voltage of 300V is 2500V.

*2 This index indicates the degree to which conductive material is generated in terms of the environment in which the equipment is used. Pollution degree 2 is when only non-conductive pollution occurs. A temporary conductivity caused by condensing must be expected occasionally.

Point 

For compliance with the EMC Directive, refer to the following:

 Page 135 EMC and Low Voltage Directives

2.2 Performance Specifications

NZ2GN2S-60DA4

Item		NZ2GN2S-60DA4				
Station type		Remote device station				
Network topology		Line topology, star topology, star topology and line topology co-existing, and ring topology				
Number of analog output channels		4 channels/module				
Digital input		16-bit signed binary value (-16384 to 16383)				
Analog output	Voltage	-10 to 10VDC (external load resistance value: 1kΩ to 1MΩ)				
	Current	0 to 20mADC (external load resistance value: 0Ω to 600Ω)				
I/O characteristics, maximum resolution*1		Output	Output range	Digital input value	Maximum resolution	
		Voltage	-10 to 10V	-16000 to 16000	0 to 16000	0.625mV
			0 to 10V			0.625mV
			0 to 5V			0.3125mV
			1 to 5V			0.25mV
		Current	0 to 20mA	0 to 16000	1.25μA	
4 to 20mA	1μA					
Conversion accuracy*2	Ambient temperature (25±5°C)	±0.2%				
	Ambient temperature (0 to 55°C)	±0.3%				
Conversion speed		200μs/channel				
Absolute maximum output		Voltage: ±15V, Current: ±21mA				
Isolation method		Between communication system terminal and all analog output terminals: Digital isolator isolation Between power supply system terminal and all analog output terminals: Transformer isolation Between output channels: Non-isolation				
Withstand voltage		Between all power supply and communication system terminals and all analog output terminals 500VDC for 1 minute				
Noise immunity		Noise voltage 500Vp-p, noise width 1μs, noise frequency 25 to 60Hz (noise simulator condition)				
External interface	Communication part	RJ45 connector				
	Module power supply part	Terminal block for module power supply and FG (2-piece spring clamp terminal block)				
	I/O part	18-point spring clamp terminal block				
Applicable wire size	For power supply	Stranded wire: 0.3 to 1.5mm ² (22 to 16 AWG), terminal slot size: 2.4mm × 1.5mm				
	For I/O	Stranded wire: 0.3 to 1.5mm ² (22 to 16 AWG)*3				
Applicable solderless terminal	Terminal block for module power supply and FG	☞ Page 29 Applicable solderless terminal				
	Analog output terminal block	☞ Page 34 Applicable solderless terminal				
External power supply		24VDC (Allowable voltage range: 20.4 to 28.8VDC, ripple ratio within 5%) Current consumption: 250mA Inrush current: 41.0A, 0.73ms or lower				
Weight		0.15kg				

*1 For details on the I/O conversion characteristics, refer to the following.

☞ Page 131 I/O Conversion Characteristics of D/A Conversion

*2 Except for the conditions under noise influence.

*3 When using a solderless terminal with an insulation sleeve, the wire size must be 0.75mm² or smaller.

NZ2GN2B-60DA4

Item		NZ2GN2B-60DA4				
Station type		Remote device station				
Network topology		Line topology, star topology, star topology and line topology co-existing, and ring topology				
Number of analog output channels		4 channels/module				
Digital input		16-bit signed binary value (-16384 to 16383)				
Analog output	Voltage	-10 to 10VDC (external load resistance value: 1kΩ to 1MΩ)				
	Current	0 to 20mADC (external load resistance value: 0Ω to 600Ω)				
I/O characteristics, maximum resolution*1		Output	Output range	Digital input value	Maximum resolution	
		Voltage	-10 to 10V	-16000 to 16000	0 to 16000	0.625mV
			0 to 10V			0.625mV
			0 to 5V			0.3125mV
			1 to 5V			0.25mV
		Current	0 to 20mA	0 to 16000	1.25μA	
4 to 20mA	1μA					
Conversion accuracy*2	Ambient temperature (25±5°C)	±0.2%				
	Ambient temperature (0 to 55°C)	±0.3%				
Conversion speed		200μs/channel				
Absolute maximum output		Voltage: ±15V, Current: ±21mA				
Isolation method		Between communication system terminal and all analog output terminals: Digital isolator isolation Between power supply system terminal and all analog output terminals: Transformer isolation Between output channels: Non-isolation				
Withstand voltage		Between all power supply and communication system terminals and all analog output terminals 500VDC for 1 minute				
Noise immunity		Noise voltage 500Vp-p, noise width 1μs, noise frequency 25 to 60Hz (noise simulator condition)				
External interface	Communication part	RJ45 connector				
	Module power supply part	Terminal block for module power supply and FG (2-piece spring clamp terminal block)				
	I/O part	18-point 2-piece terminal block (M3 screw)				
Applicable wire size	For power supply	Stranded wire: 0.3 to 1.5mm ² (22 to 16 AWG), terminal slot size: 2.4mm × 1.5mm				
	For I/O	Stranded wire: 0.3 to 2.0mm ² (22 to 14 AWG)				
Applicable solderless terminal	Terminal block for module power supply and FG	☞ Page 29 Applicable solderless terminal				
	Analog output terminal block	☞ Page 37 Applicable solderless terminal				
External power supply		24VDC (Allowable voltage range: 20.4 to 28.8VDC, ripple ratio within 5%) Current consumption: 250mA Inrush current: 41.0A, 0.73ms or lower				
Weight		0.20kg				

*1 For details on the I/O conversion characteristics, refer to the following.

☞ Page 131 I/O Conversion Characteristics of D/A Conversion

*2 Except for the conditions under noise influence.

2.3 Function List

This section lists the functions of the D/A converter module.

Item	Description	Reference
D/A conversion enable/disable setting function	Allows D/A conversion to be enabled or disabled for each channel. Disabling the D/A conversion for unused channels reduces the conversion cycles.	☞ Page 49 D/A Conversion Enable/Disable Setting Function
D/A output enable/disable function	Sets whether to output the D/A conversion value or the offset value for each channel.	☞ Page 50 D/A Output Enable/Disable Function
Range switching function	Sets the output range for each channel.	☞ Page 52 Range Switching Function
Analog output HOLD/CLEAR setting function	Sets whether to hold or clear the analog value output when the CPU module is in the following operating status: RUN, STOP, PAUSE, or a stop error.	☞ Page 53 Analog Output HOLD/CLEAR Setting Function
Scaling function	Performs scale conversion on a digital value to the set range of the scaling upper limit value and the scaling lower limit value. This function reduces the time and effort to create a program of the scale conversion.	☞ Page 54 Scaling Function
Shift function	Performs analog output, with the addition of the set shift value to a digital value. This function facilitates fine adjustment at the system start-up.	☞ Page 57 Shift Function
Digital value range check function	Outputs an error when the digital value is out of the digital input range for the output range.	☞ Page 61 Digital Value Range Check Function
Warning output function	Outputs a warning when a digital value falls within the warning output range set in advance.	☞ Page 63 Warning Output Function
iQ Sensor Solution data backup/restoration function	This function backs up data, such as device station setting data, to an SD memory card for the CPU module of the master station. The function also restores data, such as the setting data backed up to an SD memory card for the CPU module of the master station, to a device station.	☞ iQ Sensor Solution Reference Manual
SLMP communication function	Allows communications with the D/A converter module using SLMP.	☞ Page 65 SLMP Communication Function
Firmware update function	Updates firmware of a D/A converter module via CC-Link IE TSN.	☞ Page 66 Firmware Update Function
Module power supply voltage drop detection function	Detects voltage drop of the module power supply. This function makes troubleshooting easy when the voltage of the power supplied to the D/A converter module drops, or when poor connection in the wiring occurs. Note that the voltage to be monitored for a module power supply voltage drop is 20.4V.	☞ Page 67 Module Power Supply Voltage Drop Detection Function

3 PROCEDURES BEFORE OPERATION

This chapter describes the procedures before operation.

1. Setting the IP address/station number setting switches

Set the station number for the D/A converter module.

☞ Page 21 Setting the IP address/station number setting switches

2. Function setting switch setting

Set the network setting function, output range switch enable/disable setting, and range switching function.

☞ Page 23 Function setting switch setting

3. Mounting

Mount the D/A converter module to the DIN rail.

☞ Page 28 How to mount a module on a DIN rail

4. Wiring

Connect a power supply, an Ethernet cable, and external devices to the D/A converter module.

☞ Page 29 Wiring to Terminal Block for Module Power Supply and FG

☞ Page 32 Wiring of Ethernet Cable

☞ Page 34 Wiring to Analog Output Terminal Block

5. Network parameter setting

Set the network parameters.

📖 User's manual for the master/local module used

6. Parameter setting

Set parameters in the following case.

- When the function setting switch 2 is disabled

☞ Page 42 Parameter Setting

7. Programming

Create a program.

☞ Page 68 PROGRAMMING

Point

To replace the D/A converter module, follow the procedure described below.

- When the function setting switch 2 is disabled, the parameter setting is exported.
- Turn off the D/A converter module power supply and remove the D/A converter module.
- Prepare a new D/A converter module, and perform the procedure from step 1 to step 6. (When the function setting switch 2 is disabled, import the parameter setting.)

Restriction

Restrictions are applied when the function setting switch 2 is enabled. Check the restrictions before setting.

(☞ Page 23 Function setting switch setting)

MEMO

4 SYSTEM CONFIGURATION

This chapter describes how to configure the system using D/A converter modules.

For CC-Link IE Field Network configuration, refer to the following.

 User's manual for the master/local module used

4.1 Applicable Systems

Supported master station

For the use of a D/A converter module, select a product for the master station from the following list.

Model name	First five digits of serial number
RJ71GF11-T2	No restriction
RJ71EN71	
RnENCPU	
RD77GF32, RD77GF16, RD77GF8, RD77GF4	
QJ71GF11-T2	14102 or later
LJ71GF11-T2	
QD77GF8, QD77GF4	17101 or later
QD77GF16	14111 or later

The above information of "Supported master station" is information at the time of this manual's issuance.

For latest information, please visit the website of CC-Link Partner Association.

www.cc-link.org

Compatible software version

For the compatible software version, always keep the engineering tool of the master station up to date.

The compatible engineering tool is GX Works3 or GX Works2.

When the latest software is necessary, please consult your local Mitsubishi representative.

Compatible software package

Diagnosing the D/A converter module requires GX Works3 or GX Works2.

Install GX Works3 or GX Works2 with the following version in accordance with the D/A converter module used.

Model name	Software version	
	GX Works3	GX Works2
NZ2GN2S-60DA4, NZ2GN2B-60DA4	1.060N or later	1.590Q or later

Applicable profile

A profile is required to use the D/A converter module in the "CC IE Field Configuration" window.

The following table shows the applicable profile versions.

Model name	Firmware version	Profile version
NZ2GN2S-60DA4, NZ2GN2B-60DA4	"02" or later	"00" or later

When the latest profile of the D/A converter module is necessary, please consult your local Mitsubishi representative.

The profile is a setting file that stores information required for the start-up, operation, and maintenance of devices supporting the CC-Link family.

A module is added to "Module List" of the "CC IE Field Configuration" window by profile registration to the configuration tool of the master station.

For the profile registration, refer to the following.

 GX Works3 Operating Manual

 GX Works2 Version 1 Operating Manual (Common)

Ethernet cables

For the specifications of the Ethernet cable, refer to the following.

 User's manual for the master/local module used

Hub

For compatible hubs, refer to the following.

 User's manual for the master/local module used

5 INSTALLATION AND WIRING

This chapter describes the installation and wiring of the D/A converter module.

5.1 Setting Switch

Setting the IP address/station number setting switches

Set the station number using the IP address/station number setting switches on the front of D/A converter module. The setting of IP address/station number setting switches is enabled when the D/A converter module is powered on. Therefore, set this function when the module is powered off.

Point 

When operating the IP address/station number setting switches, use a flathead screwdriver with a tip width of 2.5mm or less.

Setting method

Set the station number using the IP address/station number setting switches x1 and x16 (hexadecimal). Combinations of x1 and x16 are as follows.

		x1															
		0	1	2	3	4	5	6	7	8	9	A	B	C	D	E	F
x16	0	0	1	2	3	4	5	6	7	8	9	10	11	12	13	14	15
	1	16	17	18	19	20	21	22	23	24	25	26	27	28	29	30	31
	2	32	33	34	35	36	37	38	39	40	41	42	43	44	45	46	47
	3	48	49	50	51	52	53	54	55	56	57	58	59	60	61	62	63
	4	64	65	66	67	68	69	70	71	72	73	74	75	76	77	78	79
	5	80	81	82	83	84	85	86	87	88	89	90	91	92	93	94	95
	6	96	97	98	99	100	101	102	103	104	105	106	107	108	109	110	111
	7	112	113	114	115	116	117	118	119	120	121	122	123	124	125	126	127
	8	128	129	130	131	132	133	134	135	136	137	138	139	140	141	142	143
	9	144	145	146	147	148	149	150	151	152	153	154	155	156	157	158	159
	A	160	161	162	163	164	165	166	167	168	169	170	171	172	173	174	175
	B	176	177	178	179	180	181	182	183	184	185	186	187	188	189	190	191
	C	192	193	194	195	196	197	198	199	200	201	202	203	204	205	206	207
	D	208	209	210	211	212	213	214	215	216	217	218	219	220	221	222	223
	E	224	225	226	227	228	229	230	231	232	233	234	235	236	237	238	239
	F	240	241	242	243	244	245	246	247	248	249	250	251	252	253	254	255

Ex.

To set to 30:

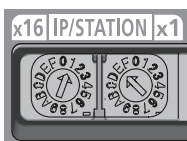

Setting range

Set a value in the range of 1 to 120.

When a value outside the range of 1 to 120 is set, the IP address/station number setting switch out of range error (station number) (error code: 2E10H) occurs, and the DATA LINK LED flashes.

Point

- Do not change the IP address/station number setting switches while the D/A converter module is powered on. If the IP address/station number setting switches are changed while the D/A converter module is powered on, IP address/station number setting switch changed error (error code: 1030H) occurs, and the ERR. LED flashes. After setting the IP address/station number setting switches back to the previous setting, turn off and on Error clear request flag (RYA) to clear the error state and turn off the ERR. LED.
- Do not set a station number duplicated with other station numbers. If a station number is duplicated, a communication error occurs and the DATA LINK LED does not turn on.

Function setting switch setting

Use the function setting switches on the front of the D/A converter module to set the network setting function, output range switch enable/disable setting, and range switching function.

The setting of the function setting switch is enabled when the D/A converter module is powered on. Therefore, set each function when the module is powered off.



When operating the function setting switch, use a flathead screwdriver with a tip width of 1.2mm or less.

Setting method

Set each function with function setting switch 1 to function setting switch 10.

Enabling function setting switch 2 before setting function setting switch 3 to function setting switch 10 makes the parameter setting unnecessary and shortens the start-up time.

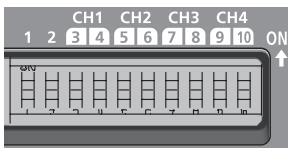

Switch name	Function name	Setting details
Function setting switch 1	NETWORK	Network setting function Set the operation mode. ☞ Page 48 Operation Mode Shift at Power-On
Function setting switch 2	RANGE ON/OFF	Output range switch enable/disable setting Enable/disable the output range switch. • Off: Disable • On: Enable
Function setting switch 3*1 Function setting switch 4*1	RANGE CH1	Range switching function Set the CH1 output range. ☞ Page 24 Setting function setting switch 3 to function setting switch 10
Function setting switch 5*1 Function setting switch 6*1	RANGE CH2	Set the CH2 output range. ☞ Page 24 Setting function setting switch 3 to function setting switch 10
Function setting switch 7*1 Function setting switch 8*1	RANGE CH3	Set the CH3 output range. ☞ Page 24 Setting function setting switch 3 to function setting switch 10
Function setting switch 9*1 Function setting switch 10*1	RANGE CH4	Set the CH4 output range. ☞ Page 24 Setting function setting switch 3 to function setting switch 10

*1 Set this switch when the function setting switch 2 is enabled. The setting is ignored when the function setting switch 2 is disabled.

■Setting function setting switch 3 to function setting switch 10

The following table lists the settings of function setting switch 3 to function setting switch 10.

Function setting switch 3 to function setting switch 10		Setting
3, 5, 7, 9	4, 6, 8, 10	
OFF	OFF	0 to 20mA
OFF	ON	4 to 20mA
ON	OFF	0 to 5V
ON	ON	-10 to 10V

Point

- Do not change any function setting switch while the D/A converter module is powered on. If the function setting switch is changed while the D/A converter module is powered on, any of the errors from Function setting switch 1 changed error (error code: 1041H) to Function setting switch 10 changed error (error code: 104AH) occurs and the ERR. LED flashes. After setting the function setting switch back to the previous setting, turn on Error clear request flag (RYA) to clear the error state and turn off the ERR. LED. When the setting of the function setting switch is changed, turn off and on the D/A converter module to apply the change.
- The status of the output range switch enable/disable setting can also be checked with Output range switch enable/disable setting status flag (RXC).

Restriction

The output range cannot be set to 1 to 5V or 0 to 10V. Use the parameter or program to set this range.

Operation

The following table list the parameter settings when the function setting switch 2 is enabled.



Setting item	Setting value
CH□ D/A conversion enable/disable setting	Enable
CH□ Range setting	Values set by function setting switch 3 to function setting switch 10
CH□ Analog output HOLD/CLEAR setting	CLEAR
CH□ Warning output setting	Disable
CH□ Warning output upper limit value	0
CH□ Warning output lower limit value	0
CH□ Scaling enable/disable setting	Disable
CH□ Scaling upper limit value	0
CH□ Scaling lower limit value	0

Point

- To output a D/A-converted value, turn on CH□ D/A conversion output enable/disable flag (RY10 to RY13).
- Parameters are not saved in the non-volatile memory when the function setting switch 2 is enabled.

Restrictions

The following table lists the restrictions applied when the function setting switch 2 is enabled.

Item	Description
Shift function	The shift function cannot be used. A value for CH□ Shifting set value (RWw10 to RWw13) is ignored.
Initial data setting request flag (RY9)	When Initial data setting request flag (RY9) is turned on, an operating condition setting change disable error (error code: 3610H) occurs and the operating condition is not changed.
Parameter writing	When parameter writing is performed from the engineering tool, an operating condition setting change disable error (error code: 3610H) occurs and the operating condition is not changed.
Parameter area initialization	When module parameter initialization is performed by using Parameter area initialization command (address: 1002H), an operating condition setting change disable error (error code: 3610H) occurs and the operating condition is not changed. The values in the parameter area of the remote buffer memory are also not changed.
Data backup/restoration	The following are operations of data backup/restoration. <ul style="list-style-type: none"> • For backup Backup operation is not performed, and an error (error code: BAD6H) occurs. For details, refer to the following.  iQ Sensor Solution Reference Manual • For restoration Restoration operation is not performed, and an error (error code: BAD6H) occurs. For details, refer to the following.  iQ Sensor Solution Reference Manual

Precautions

Slide one function setting switch at a time horizontally. Do not hold the screwdriver at an angle or pivot it off the edge of the case while working a function setting switch, since damage or deformation may result.

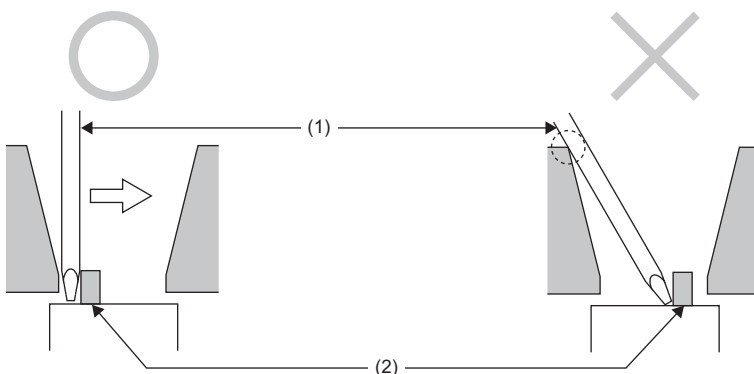

- (1) Flathead screwdriver
- (2) Function setting switch

5.2 Installation Environment and Installation Position

Installation environment

Installation location

Do not install the D/A converter module in places where:

- Ambient temperature is outside the range of 0 to 55°C;
- Ambient humidity is outside the range of 5 to 95% RH;
- Condensation occurs due to rapid temperature change;
- Corrosive gas or combustible gas is present;
- There are a high level of conductive powder such as dust and iron powder, oil mist, salinity, or organic solvent;
- It is exposed to direct sunlight;
- A strong electric field or strong magnetic field is generated; and
- The module is subject to vibration and shock.

Installation surface

Install the D/A converter module on a flat surface. Unevenness on the installation surface causes application of an excessive force to the printed-circuit board, which may lead to a malfunction.

Installation position

When installing the D/A converter module in a control panel, provide a clearance of 60mm or more (1) between the D/A converter module and the sides of the control panel or other parts to ensure good ventilation and facilitate D/A converter module change.

When installing two or more CC-Link IE TSN remote modules next to each other, they can be installed in contact with each other.

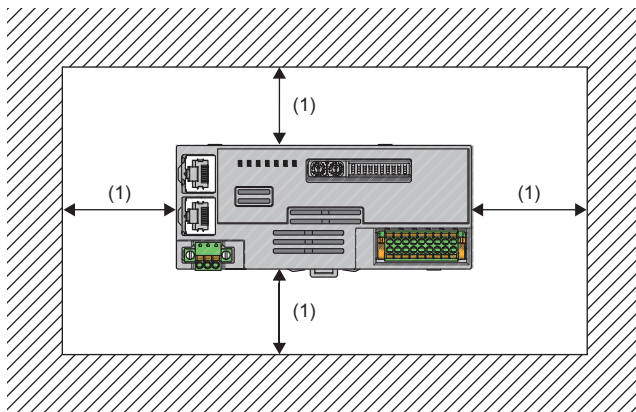

Installation direction

The D/A converter module can be installed in six directions.
Use a DIN rail (1) to install the D/A converter module.

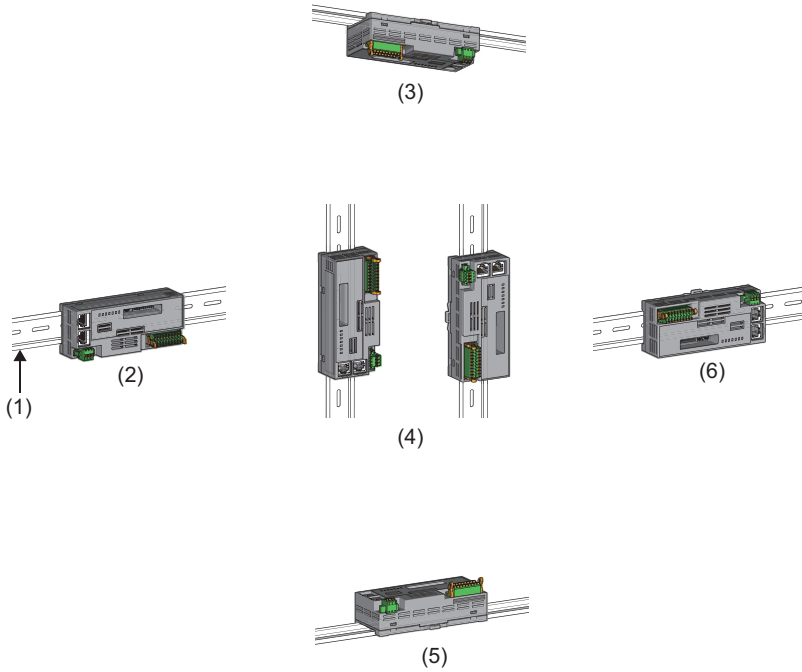

- (1) DIN rail
- (2) Horizontal installation
- (3) Downward installation
- (4) Vertical installation
- (5) Upward installation
- (6) Horizontal installation (upside down)

5.3 Installation

How to mount a module on a DIN rail

Installation procedure

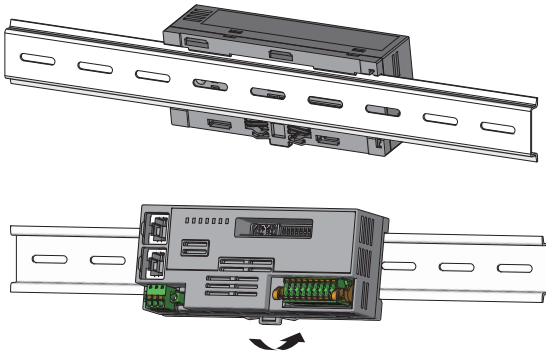

1. Hang the upper tabs of the D/A converter module on the top of the DIN rail.
2. Push in the DIN rail hooks of the D/A converter module until they click.

Point

Do not slide a module from the edge of the DIN rail when mounting it. Otherwise, the D/A converter module may be damaged.

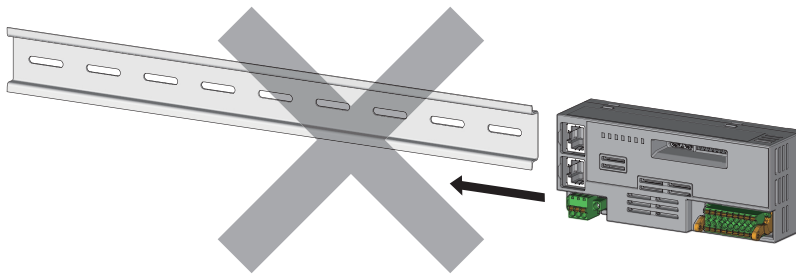

Removal procedure

Remove the modules from the DIN rail by reversing the above procedure.

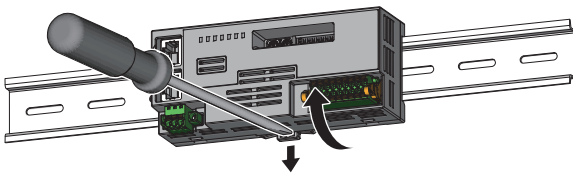

1. While pushing down the DIN rail hook with a flathead screwdriver, pull the bottom part of the D/A converter module to remove it from the DIN rail.

Applicable DIN rail models

Use the following DIN rails that are compliant with JIS C 2812 and IEC 60715.

- TH35-7.5Fe
- TH35-7.5Al

Space between DIN rail mounting screws

When installing a DIN rail, tighten the screws at a pitch of 200mm or less.

5.4 Wiring to Terminal Block for Module Power Supply and FG

Tightening torque

Tighten the terminal block mounting screws within the following tightening torque range.
Tightening the screws too much may damage the D/A converter module case.

Screw type	Tightening torque range
Terminal block mounting screw (M2.5 screw)	0.2 to 0.3N·m

Wire to be used

The following table describes the wire to be connected to the terminal block for module power supply and FG.

Wire diameter	Type	Material	Temperature rating
AWG22 to 16	Stranded	Copper	75°C or higher

5

Applicable solderless terminal

The following table lists the applicable solderless terminal.

Product name	Terminal shape	Model name	Applicable wire size	Bar solderless terminal tool	Contact
Bar solderless terminal	Ferrule (with insulation sleeve)	TE0.5-8, TE0.5-10	0.3 to 0.5mm ²	NH-79A	NICHIFU Co., Ltd.
		TE0.75-8, TE0.75-10	0.75mm ²		
		A10.34-10TQ	0.34mm ²	CRIMPFOX6	
		A10.5-10WH	0.5mm ²		
		A10.75-10GY	0.75mm ²		
	Ferrule (without insulation sleeve)	A0.5-10	0.5mm ²		PHOENIX CONTACT GmbH & Co. KG
		A0.75-10	0.75mm ²		
		A1.0-10	1.0mm ²		
		A1.5-10	1.5mm ²		

Installing and removing the terminal block

To remove the terminal block, loosen the terminal block mounting screws with a flathead screwdriver.
To install the terminal block, tighten the terminal block mounting screws with a flathead screwdriver.
Failure to secure the terminal block may cause drop, short circuit, or malfunction.

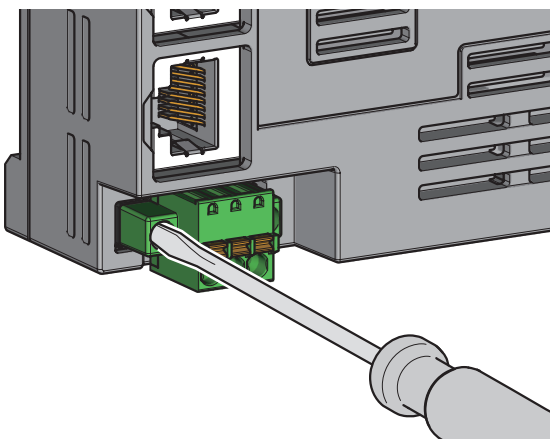

Connecting and disconnecting the cable

To connect the cable, fully insert a wire with a bar solderless terminal into a wire insertion opening.
After inserting the wire, pull it lightly to check that it is securely clamped.

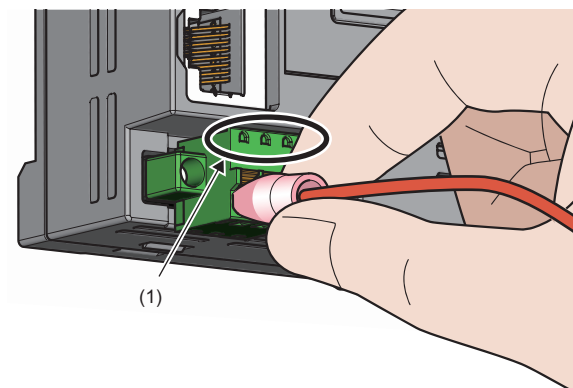

Point

Continuity can be checked with test terminal (1).

Use the following test plug to check continuity.

- PHOENIX CONTACT GmbH & Co. KG test plug ($\phi 1.0\text{mm}$): MPS-MT 1-S4-B RD, MPS-MT 1-S

To disconnect the cable, push in the open/close button with a flathead screwdriver.

With the button pushed in, pull out the wire having a bar solderless terminal.

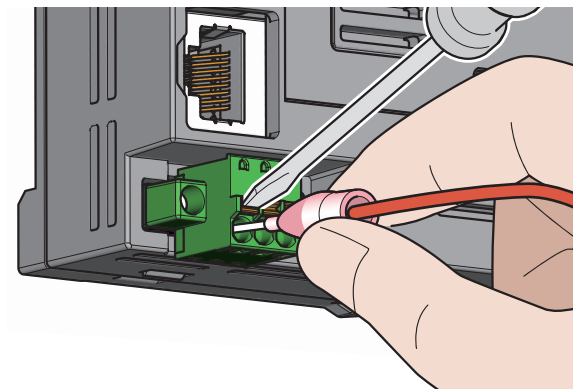

Precautions

- Use a bar solderless terminal for the wiring to the push-in type spring clamp terminal block. If a stripped wire is inserted into a wire insertion opening, the wire cannot be securely clamped.
- For how long the wire should be stripped, follow the specifications of the bar solderless terminal used. To attach a bar solderless terminal to a wire, use a crimping tool.
- Before inserting a bar solderless terminal into a wire insertion opening (1), check the shape of the opening and the shape of the terminal, and insert the terminal paying attention to the orientation. If a bar solderless terminal larger than the wire insertion opening (1) is inserted, the terminal block may be damaged.

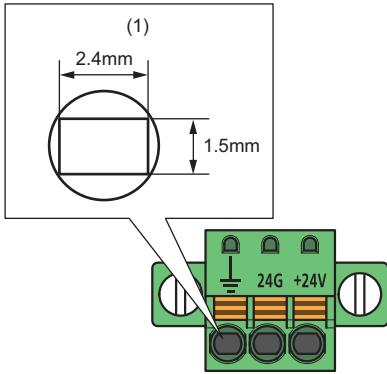

5.5 Wiring of Ethernet Cable

Wiring method

■Installation method

1. Turn off the power supply of the D/A converter module and the power supply of the external device.
2. With attention to the orientation of the cable, push the Ethernet cable connector into the D/A converter module until it clicks.
3. Power on the power supply of the D/A converter module.
4. Power on the external device.
5. Check if P1 LINK LED/P2 LINK LED on the port into which the Ethernet cable is connected is on.*1

*1 The time taken for P1 LINK LED/P2 LINK LED to turn on after connection of the cable may vary. The LINK LED normally turns on in a few second. However, if link-up processing is repeated due to a condition of a device on the line, the longer time may be required. If P1 LINK LED/P2 LINK LED does not turn on, refer to the following and take corrective action.

☞ Page 89 When the P1 LINK LED or P2 LINK LED turns off

Point

Both P1 and P2 connectors can be used.

- To use only one of them for star topology, either P1 or P2 can be connected.
- To use both of them for line topology and ring topology, P1-P1, P2-P2, and P1-P2 connections are possible.

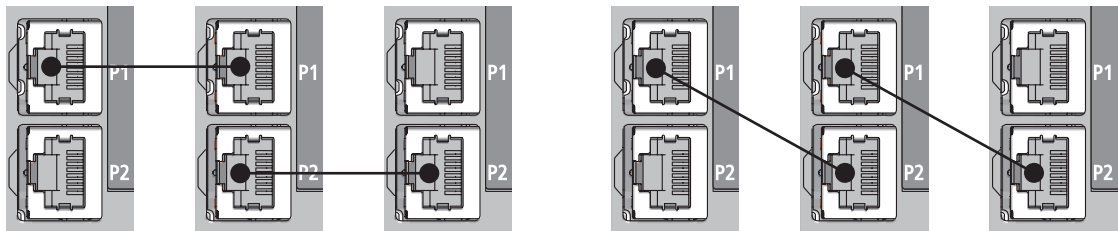

■How to disconnect

1. Turn off the power supply of the D/A converter module.
2. With the latch of the Ethernet cable pressed, unplug the cable.

Precautions

■Laying Ethernet cables

- The Ethernet cables must be placed in the duct or fixed by clamp. If not, dangling cable may swing or inadvertently be pulled, resulting in damage to the module or cables or malfunction due to poor contact.
- Do not touch the core of the connector of the cable or the module, and protect it from dirt and dust. If any oil from your hand, or any dirt or dust sticks to the core, it can increase transmission loss, causing data link to fail.
- For the Ethernet cables to be used, check that they are not disconnected or short-circuited and that there is no problem with connector connection.

■Broken cable latch

Do not use Ethernet cables with broken latches. Doing so may cause the cable to unplug or malfunction.

■Connecting and disconnecting an Ethernet cable

Hold the connector part when connecting and disconnecting the Ethernet cable. Pulling the cable connected to the module may result in damage to the module or cable or malfunction due to poor contact.

■Connector to which an Ethernet cable is not connected

Attach a connector cover to prevent dirt and dust from entering the D/A converter module and prevent D/A converter module failure and malfunction caused by static electricity.

■Maximum segment length for the Ethernet cable (Maximum cable length)

The maximum segment length is 100m. However, the distance may be shorter depending on the operating environment of the cable. For details, contact the manufacturer of the cables used.

■Bending radius of an Ethernet cable

There are restrictions on the bending radius of the Ethernet cable. Check the bending radius in the specifications of the Ethernet cables used.

5.6 Wiring to Analog Output Terminal Block

Wiring of spring clamp terminal block

Wire to be used

The following table describes the wire to be connected to the spring clamp terminal block.

Wire diameter	Type	Material	Temperature rating
AWG22 to 16	Stranded	Copper	75°C or higher

Applicable solderless terminal

The following table lists the applicable solderless terminal.

Product name	Terminal shape	Model name	Applicable wire size *1	Bar solderless terminal tool	Contact
Bar solderless terminal	Ferrule (with insulation sleeve)	A10.34-10TQ	0.34mm ²	CRIMPFOX6	PHOENIX CONTACT GmbH & Co. KG
		A10.5-10WH	0.5mm ²		
		A10.75-10GY	0.75mm ²		
	Ferrule (without insulation sleeve)	A0.5-10	0.5mm ²		
		A0.75-10	0.75mm ²		
		A1.0-10	1.0mm ²		
		A1.5-10	1.5mm ²		

*1 When using a solderless terminal with an insulation sleeve, select the terminal whose applicable wire size is 0.75mm² or smaller.

Installing and removing the terminal block

The following procedures show how to install and remove the terminal block.

■ Lock and release lever positions

To make it easy to install and remove the terminal block, a three-stage positioning stopper is attached so that the lever does not freely turn around.

When installing or removing the terminal block, turn the lever to the lock or release lever position.

View of right side of D/A converter module: When pulling out the terminal block **1.** Release lever position

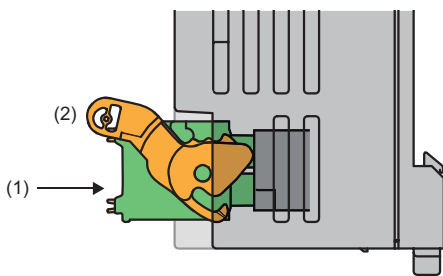

This lever position shows the state in which the terminal block (1) has been completely pulled out from the D/A conversion module. Turn from the lock lever position to the release lever position (2) and lift the terminal block from the D/A converter module.

View of right side of the D/A converter module: When insertion of the terminal block is complete

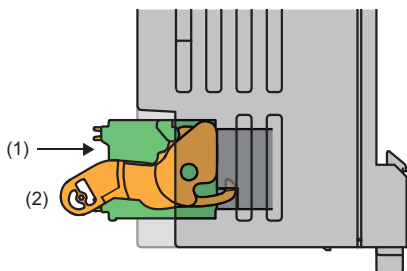

2. Lock lever position

This position shows the state in which the terminal block (1) completely fits the D/A converter module. Check the lock lever position (2) and pull the terminal block lightly to check that the D/A converter module completely fits the terminal block.

■ Removal procedure

Turn the lever to the release lever position and remove the terminal block from the D/A converter module.

■ Installation procedure

Move the lever to the lock lever position and push the terminal block. When the terminal block is fully pushed in, the hook of the lever hangs on the module and fits the terminal block.

Point

The terminal block can be inserted with the lever in positions other than the lock lever position.
After insertion, check that the lever is in the lock lever position.

Signal name

The following table lists the signal names of the terminal block.

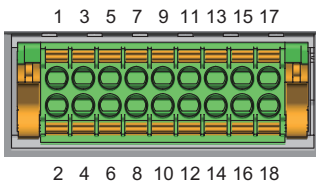

Item	CH1		CH2		CH3		CH4		—
Terminal number	1	3	5	7	9	11	13	15	17
Signal name	V+	I+	V+	I+	V+	I+	V+	I+	NC
Signal name	COM	NC	COM	NC	COM	NC	COM	NC	NC
Terminal number	2	4	6	8	10	12	14	16	18

Point

Do not wire the NC terminals. Incorrect wiring may cause malfunction or failure of the D/A converter module.

Connecting and disconnecting the cable

■Connecting the cable

Strip the cable as follows.

- The strip length of wire: 10mm

Insert a wire whose tip was processed into a wire insertion opening (2) and push it all the way in to the back.

If the wire cannot be inserted by this method, insert the wire all the way in to the back while pressing the release button (1) using a flathead screwdriver with a tip width of 2.0mm to 2.5mm. Once the wire is inserted all the way in to the back, remove the flathead screwdriver.

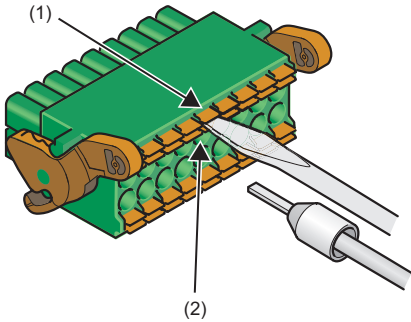

Point

Pull the wire or bar solderless terminal lightly to check that it is securely clamped.

■Disconnecting the cable

Pull the wire while pressing the release button using a flathead screwdriver with a tip width of 2.0mm to 2.5mm.

Precautions

- Use a bar solderless terminal for wiring to the terminal block. If a stripped wire is inserted to a wire insertion opening, the wire cannot be clamped securely.
- Use a crimping tool to connect a bar solderless terminal to a wire. (☞ Page 34 Applicable solderless terminal)
- When inserting a bar solderless terminal, check that the size of the terminal and its insertion direction are correct to prevent the terminal from getting stuck in or damage to the terminal block. When using a bar solderless terminal other than the applicable solderless terminals, check that for its size, the cross-sectional shape of the terminal after processing is smaller than the size mentioned below, even including an error in processing. For the correct terminal insertion direction, refer to the figure below.

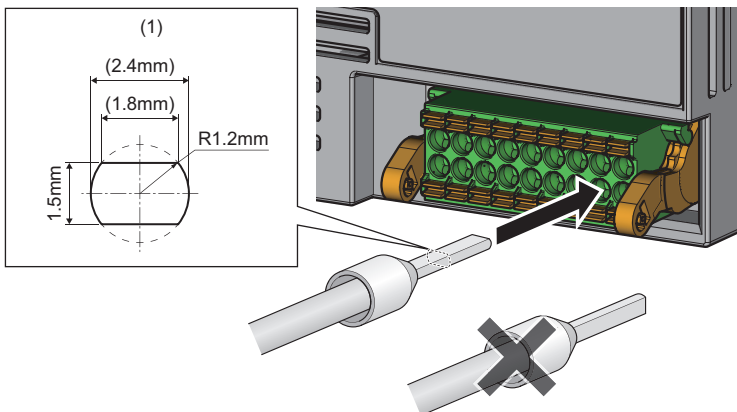

Point

For details on the finish shape of a bar solderless terminal including an error in processing, contact the manufacturers of the bar solderless terminal and the bar solderless terminal tool.

Wiring of screw terminal block

Tightening torque

Tighten the terminal screws within the following tightening torque range.

Tightening the screws too much may damage the D/A converter module case.

Screw type	Tightening torque range
Terminal screw (M3×5.2 screw)	0.43 to 0.57N·m
Terminal block mounting screw (M3.5 screw)	0.68 to 0.92N·m

Wire to be used

The following table describes the wire to be connected to the screw terminal block.

Wire diameter	Type	Material	Temperature rating
AWG22 to 14	Stranded	Copper	75°C or higher

5

Applicable solderless terminal

The following table lists the applicable solderless terminal.

Model name	Applicable wire size	Contact
RAA1.25-3 (compliant with JIS C 2805)	0.3 to 1.25mm ²	—
V2-MS3	1.25 to 2.0mm ²	JST Mfg. Co., Ltd.
TGV2-3N	1.25 to 2.0mm ²	NICHIFU Co., Ltd.

Installing and removing the terminal block

■Removal procedure

1. Open the terminal cover, and loosen the terminal block mounting screws with a cross-head screwdriver.
2. When the terminal block mounting screws are loosened, the terminal block can be removed.

■Installation procedure

1. Open the terminal cover, and mount the terminal block.
2. Tighten the terminal block mounting screws with a cross-head screwdriver.

Failure to secure the terminal block may cause drop, short circuit, or malfunction.

Signal name

The following table lists the signal names of the terminal block.

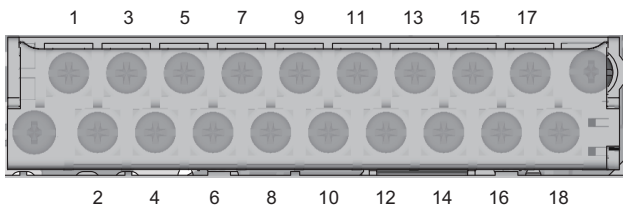

Item	CH1		CH2		CH3		CH4		—
Terminal number	1	3	5	7	9	11	13	15	17
Signal name	V+	I+	V+	I+	V+	I+	V+	I+	NC
Signal name	COM	NC	COM	NC	COM	NC	COM	NC	NC
Terminal number	2	4	6	8	10	12	14	16	18

Point

Do not wire the NC terminals. Incorrect wiring may cause malfunction or failure of the D/A converter module.

Wiring method

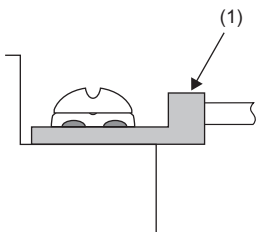

1. Loosen the terminal screw. Connect the round solderless terminal (1) as it is.

Point

- Do not put oil on the terminal or screw. Doing so may damage the screw.
- The number of the applicable solderless terminals must be two or less. When inserting two applicable solderless terminals, insert them back-to-back. Otherwise, the screw cannot be tightened and it may damage the screw.
- Tighten the terminal screw with an applicable driver. Tightening with an inapplicable driver may damage the screw.
- When operating terminal screws in the lower row, prevent the screwdriver from contacting the upper row. If the screwdriver contacts the upper row, it may damage the terminal block.
- Install the terminal block so it is level. If the terminal block skews when installed, it may damage the contacts of the terminal block.

5.7 External Wiring

Using a voltage output

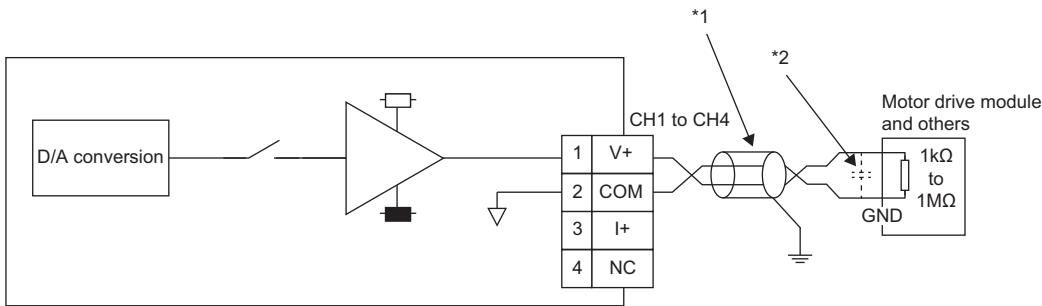

*1 For the cable, use the 2-core shielded twisted pair cable.

*2 If there is noise or ripples in the external wiring, connect a 0.1 to 0.47 μ F capacitor (25V or higher voltage-resistant product) to the input terminal of the external device.

Using a current output

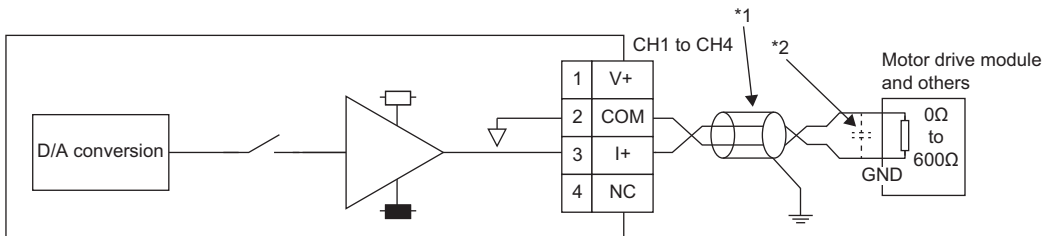

*1 For the cable, use the 2-core shielded twisted pair cable.

*2 If there is noise or ripples in the external wiring, connect a 0.1 to 0.47 μ F capacitor (25V or higher voltage-resistant product) to the input terminal of the external device.

Precautions

To obtain the maximum performance from the functions of the D/A converter module and improve the system reliability, external wiring that is noise resistant is required. Precautions for external wiring are as follows.

- Use separate cables for the AC control circuit and the external input signals of the D/A converter module to avoid the influence of the AC side surges or induction.
- Do not install cables near or bundle cables with any main circuit lines, high voltage lines, or load cables for equipment other than the programmable controller. Noise, surges, or induction may affect the system.
- Ground shielded wires or shielded cables based on single-point ground. However, depending on the external noise conditions, it may be better to ground them externally.

6 VARIOUS SETTINGS

This chapter uses GX Works3 for explanations.

6.1 Network Configuration Setting

Set the parameters of the D/A converter module with the network parameters written to the CPU module of the master station. For the setting procedure for the master station, refer to the following.

 User's manual for the master/local module used

Also when changing the network configuration, the network parameters must be changed and written to the CPU module.

Point

- When points less than the ones of the D/A converter module are set for the remote I/O signal and remote register, no error occurs. The cyclic transmission is performed for the data of the points set from the start.
- In "Module List" of the "CC IE Field Configuration" window, select "NZ2GN2B-60DA4" or "NZ2GN2S-60DA4".

Precautions

■ Before setting the parameters

Check that the start I/O No. in the network parameters of the master station matches the start I/O No. of the D/A converter module parameters. If they do not match, the parameter settings cannot be written or read.

■ When setting the parameters

- If using the D/A converter module when setting the parameters, always set the station-based block data assurance to "Enable". When it is set to "Disable", correct operation of the D/A converter module cannot be guaranteed.

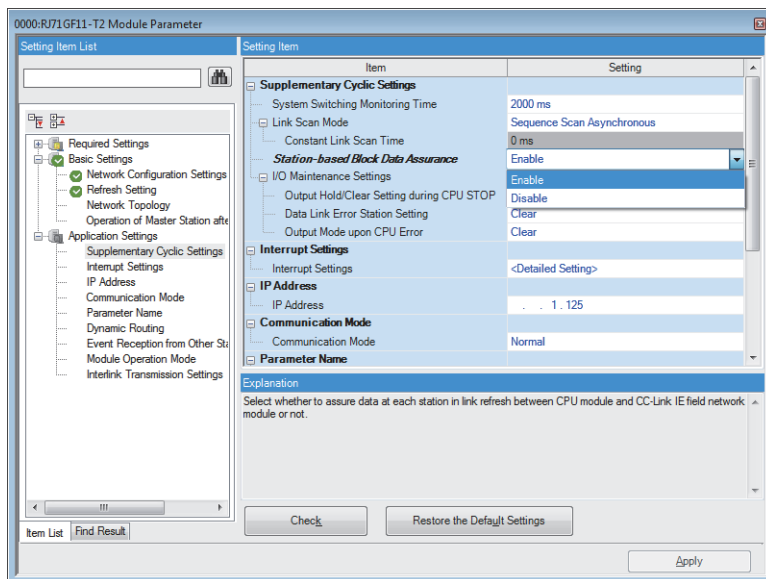

- Do not set the parameter using the CCPASET instruction in the master station. Correct operation of the D/A converter module cannot be guaranteed because the module operates with the station-based block data assurance disabled when the CCPASET instruction is executed.

Window

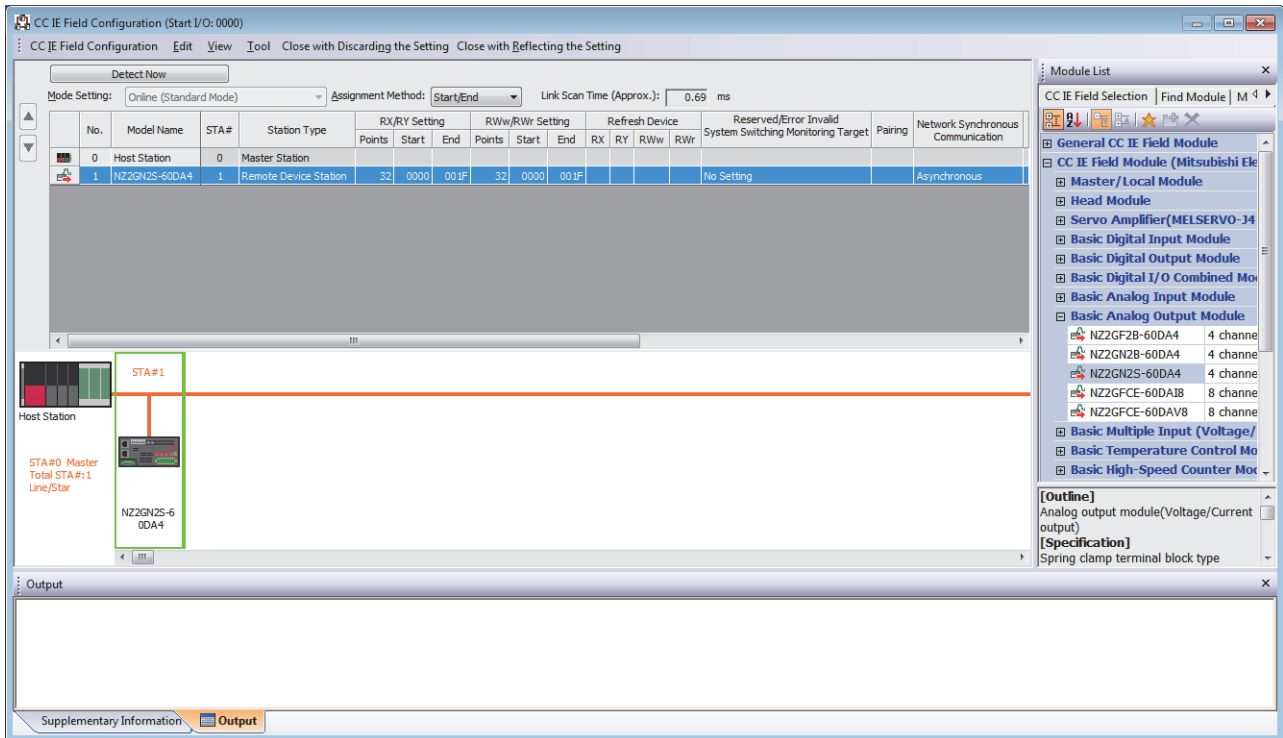

6

Displayed items

Item		Setting details	Setting range
RX/Ry Setting	Points	Set the assignment of RX/Ry points.	0 to 128 (Default value: 32)
	Start	The RX/Ry start number is displayed.	—
	End	The RX/Ry end number is displayed.	—
RWw/RWw Setting	Points	Set the assignment of RWw/RWw points.	0 to 128 (Default value: 32)
	Start	The RWw/RWw start number is displayed.	—
	End	The RWw/RWw end number is displayed.	—
Network Synchronous Communication		Set "Asynchronous" for the D/A converter module.	<ul style="list-style-type: none"> Asynchronous (Default value) Synchronous

6.2 Parameter Setting

Set module parameters for the D/A converter module from the "CC IE Field Configuration" window of the engineering tool. The following describes the parameter setting for the NZ2GN2S-60DA4.



Point

When the module parameter setting is performed, the module parameters are saved to the non-volatile memory of the D/A converter module. However, note that the save destination area differs between the CC-Link IE TSN communication mode and the CC-Link IE Field Network communication mode. For that reason, when the communication mode is switched, the module parameters that were set in the communication mode before it was switched are not transferred. When the communication mode is switched, set the module parameters again.

Window

Displayed items

Setting item		Description	Setting range	Reference
D/A conversion enable/disable setting	CH□ D/A conversion enable/disable setting	Specify whether to enable or disable the D/A conversion.	<ul style="list-style-type: none"> • Enable • Disable (Default value) 	☞ Page 49 D/A Conversion Enable/Disable Setting Function
Range setting	CH□ Range setting	Set the output range.	<ul style="list-style-type: none"> • 4 to 20mA (Default value) • 0 to 20mA • 1 to 5V • 0 to 5V • -10 to 10V • 0 to 10V 	☞ Page 52 Range Switching Function
Analog output HOLD/CLEAR setting	CH□ Analog output HOLD/CLEAR setting	Set output HOLD/CLEAR.	<ul style="list-style-type: none"> • CLEAR (Default value) • HOLD 	☞ Page 53 Analog Output HOLD/CLEAR Setting Function

Setting item		Description	Setting range	Reference
Warning output function	CH <input type="checkbox"/> Warning output setting	Set whether to enable or disable warning output.	<ul style="list-style-type: none"> • Enable • Disable (Default value) 	 Page 63 Warning Output Function
	CH <input type="checkbox"/> Warning output upper limit value	Set the upper limit of the digital input value for warning output. The upper limit value must be greater than the lower limit value.	-32768 to 32767 (Default value: 0)	
	CH <input type="checkbox"/> Warning output lower limit value	Set the lower limit of the digital input value for warning output. The upper limit value must be greater than the lower limit value.	-32768 to 32767 (Default value: 0)	
Scaling function	CH <input type="checkbox"/> Scaling enable/disable setting	Set whether to enable or disable the scaling.	<ul style="list-style-type: none"> • Enable • Disable (Default value) 	 Page 54 Scaling Function
	CH <input type="checkbox"/> Scaling upper limit value	Set the upper limit value of scale conversion. The upper limit value must be greater than the lower limit value.	-32000 to 32000 (Default value: 0)	
	CH <input type="checkbox"/> Scaling lower limit value	Set the lower limit value of scale conversion. The upper limit value must be greater than the lower limit value.	-32000 to 32000 (Default value: 0)	

Device station parameter processing

The device station parameter processing writes the D/A converter module parameters to the D/A converter module.

Parameter setting

Operating procedure

1. Open the "CC IE Field Configuration" window.

[Navigation window] ⇒ [Parameter] ⇒ [Module Information] ⇒ Model ⇒ [Basic Settings] ⇒ [Network Configuration Settings]

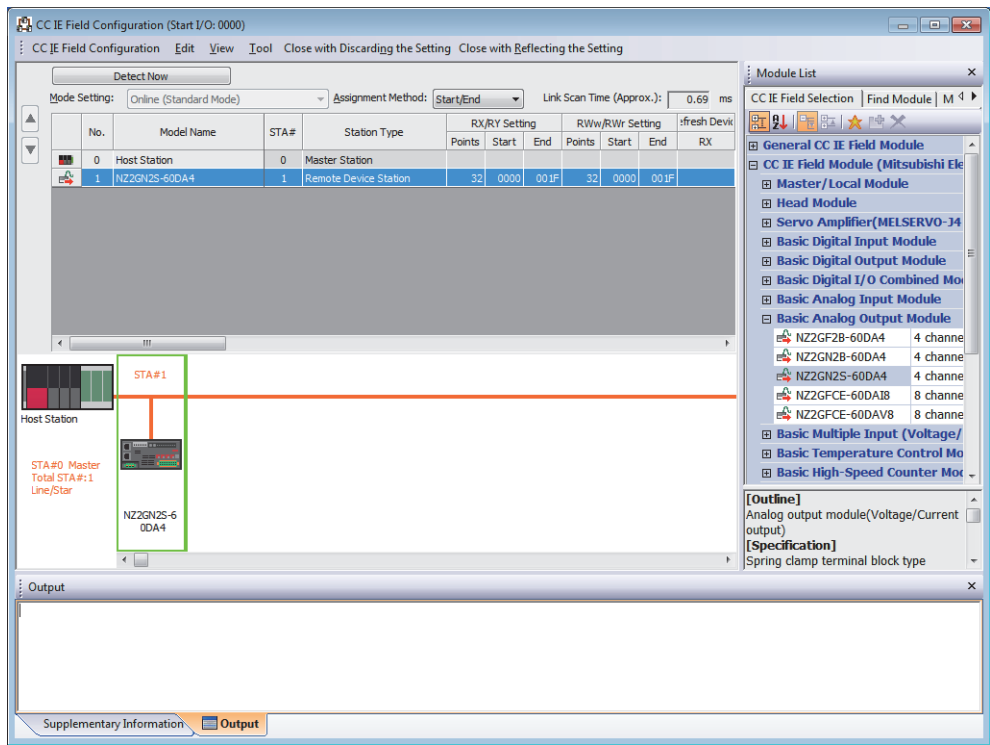

2. Open the "Parameter Processing of Device Station" window.

Select a D/A converter module from the station list, right-click, and select [Parameter Processing of Device Station].

3. Set "Method selection" to "Parameter write".

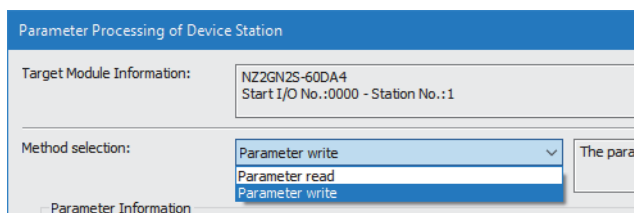

4. Double-click the item to be set, and enter the setting value.
 - Items to input from the drop-down list: Double-click the item to set, to display the drop-down list. Select the item.
 - Items to input from the text box: Double-click the item to set, and input the numerical value.
- To save the parameter setting values in a CSV file, click the [Export...] button.
 To read the parameter setting values from a CSV file, click the [Import] button.

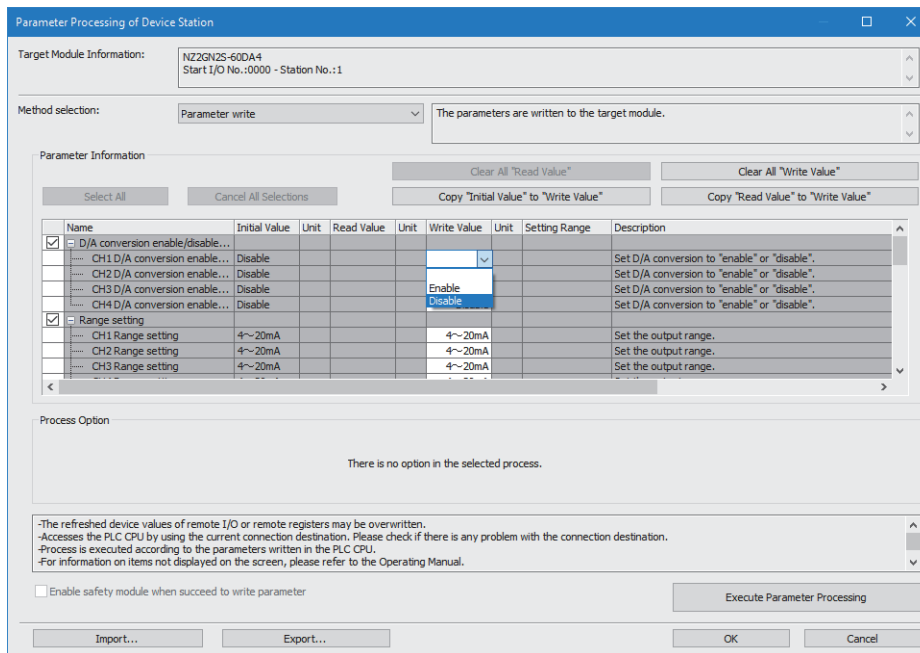

5. Click the [Execute Parameter Processing] button.
6. Follow the on-screen instructions and click the [Yes] button.
7. The parameters are written to the D/A converter module.
8. Click the [OK] button to close the "Parameter Processing of Device Station" window.
9. Click the [Close with Reflecting the Setting] button to end the CC IE Field configuration.

Precautions

Set all the items for the parameter. If any blank exists, the parameters cannot be written to the D/A converter module.

When changing the parameters

Operating procedure

1. Open the "CC IE Field Configuration" window.
① [Navigation window] ⇒ [Parameter] ⇒ [Module Information] ⇒ Model ⇒ [Basic Settings] ⇒ [Network Configuration Settings]
2. Open the "Parameter Processing of Device Station" window.
① Select a D/A converter module from the station list, right-click, and select [Parameter Processing of Device Station].
3. Set "Method selection" to "Parameter read".

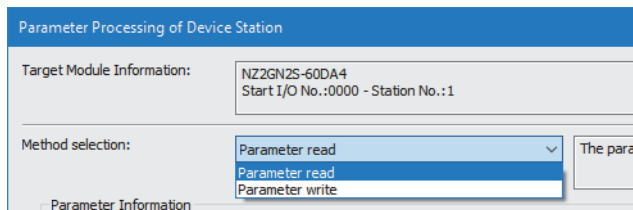

4. Click the [Execute Parameter Processing] button.
5. Click the [Yes] button.
6. The parameters are read from the D/A converter module.

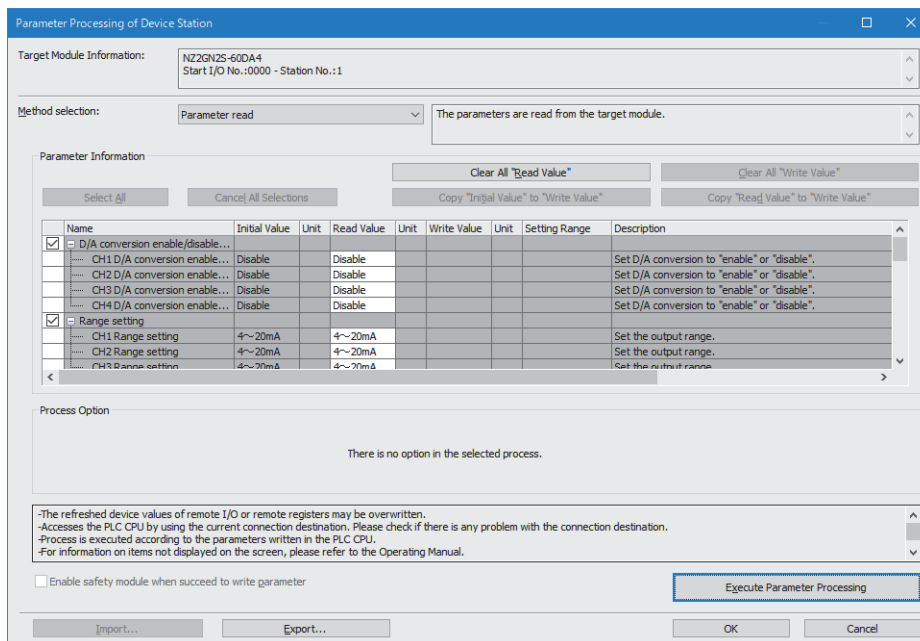

7. Set "Method selection" to "Parameter write".

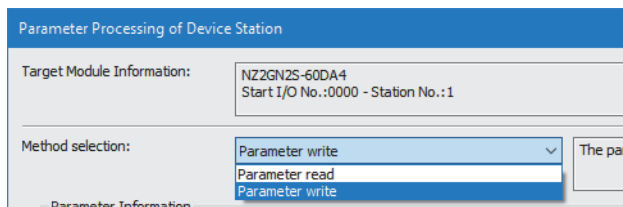

8. Select the items to be changed, and set new values.
 - Click [Copy "Read Value" to "Write Value"] button and paste the value.
 - Select the items to be changed, and set new values.

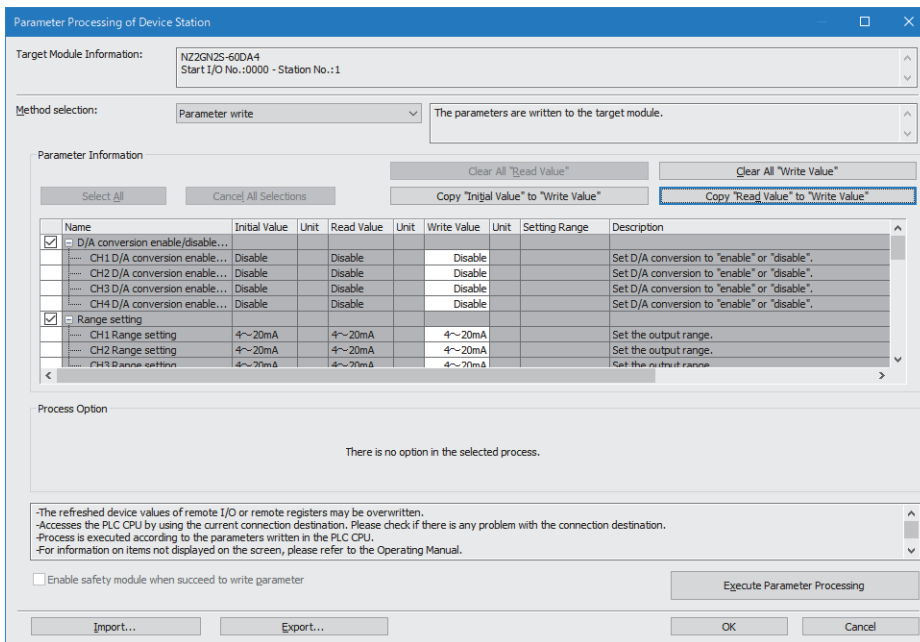

9. Click the [Execute Parameter Processing] button.
 10. Follow the on-screen instructions and click the [Yes] button.
 11. The parameters are written to the D/A converter module.
- Setting the module parameters of the device station is complete.

7 FUNCTIONS

This chapter describes the details of the functions available in the D/A converter module, and the setting methods for those functions.

For details on remote I/O signals, remote registers, and remote buffer memory, refer to the following:

☞ Page 107 Remote I/O Signal

☞ Page 115 Remote Register

☞ Page 119 Remote Buffer Memory

Setting method

Each function can be set by using the parameter setting. (☞ Page 42 Parameter Setting)

For items to be set for each function, check with the details of each function.

7.1 Operation Mode Shift at Power-On

When using the D/A converter module in CC-Link IE Field Network communication mode, the operation mode shifts to either of the following modes at power-on.

- Normal mode
- Unit test mode

When using the D/A converter module in CC-Link IE TSN communication mode, refer to the following.

📖 CC-Link IE TSN Digital-Analog Converter Module User's Manual(CC-Link IE TSN Communication Mode)

Normal mode

When the IP address/station number setting switches and function setting switch 1 are set as follows, the mode shifts to normal mode.

- IP address/station number setting switch (x1): Any position
- IP address/station number setting switch (x16): 0 to 7
- Function setting switch 1: ON
- Function setting switch 2 to function setting switch 10: Any position

For details, refer to the following.

☞ Page 21 Setting the IP address/station number setting switches

☞ Page 23 Function setting switch setting

Unit test mode

When the IP address/station number setting switches and function setting switch 1 are set as follows, the mode shifts to unit test mode.

- IP address/station number setting switch (x1): Any position
- IP address/station number setting switch (x16): F
- Function setting switch 1: ON
- Function setting switch 2 to function setting switch 10: Any position

For details, refer to the following.

☞ Page 91 Unit Test

7.2 D/A Conversion Enable/Disable Setting Function

This function allows D/A conversion to be enabled or disabled for each channel.
Disabling the D/A conversion for unused channels reduces the conversion cycles.

Setting procedure

Operating procedure

1. Use "CH□ D/A conversion enable/disable setting" in "D/A conversion enable/disable setting".

7.3 D/A Output Enable/Disable Function

This function allows the selection of whether to output the D/A conversion value or the offset value for each channel.

Setting procedure

Operating procedure

1. Set CH□ Output enable/disable flag (RY10 to RY13).

7.4 Conversion Speed and Conversion Cycle

Conversion speed

Conversion speed is the rate at which the D/A converter module converts and outputs digital values. The conversion speed is 200 μ s/channel.

Conversion cycle

The conversion cycle is the period for D/A conversion in a channel.

The conversion cycle changes according to the number of conversion enabled channels and conversion speed.

Conversion cycle [μ s] = Number of conversion enabled channels \times Conversion speed (200 μ s/channel)

7.5 Range Switching Function

Set the output range for each channel.

An output range can be selected from the following.

- Voltage: 1 to 5V, 0 to 5V, -10 to 10V, 0 to 10V
- Current: 4 to 20mA, 0 to 20mA

Setting procedure

Operating procedure

1. Set "CH□ D/A conversion enable/disable setting" to "Enable".
2. Set " CH□ Range setting".

7.6 Analog Output HOLD/CLEAR Setting Function

This function sets whether to hold or clear the analog value output when the CPU module is in the following operating status: RUN, STOP, PAUSE, or a stop error.

Combination of analog output status

The following table shows how the analog output status changes, depending on the combination of settings for D/A conversion enable/disable setting and CH□ Output enable/disable flag (RY10 to RY13).

D/A conversion enable/disable setting	Enable		Disable	
CH□ Output enable/disable flag (RY10 to RY13).	Enable		Disable	Enable or disable
Analog output HOLD/CLEAR setting	HOLD	CLEAR	HOLD or CLEAR	HOLD or CLEAR
Analog output status while the CPU module is in RUN	The analog value D/A-converted from the digital value is output.		Offset value	0V/0mA
Analog output status while the CPU module is in STOP	Hold	Offset value	Offset value	0V/0mA
Analog output status while the CPU module is in PAUSE	The analog value D/A-converted from the digital value is output.		Offset value	0V/0mA
Analog output status while the CPU module is in stop error	Hold	Offset value	Offset value	0V/0mA
Analog output status while the DATA LINK LED is off.	Hold	Offset value	Offset value	0V/0mA
Analog output status when the data link stop instruction is issued from the master station	Hold	Offset value	Offset value	0V/0mA
Analog output status when the setting is changed from master station to reserved station	Hold	Offset value	Offset value	0V/0mA
Analog output status of when the out-of-range digital value error occurs	The upper limit value or lower limit value of analog value is output.		Offset value	0V/0mA
Analog output status of when the out-of-range setting error occurs	0V/0mA	0V/0mA	0V/0mA	0V/0mA
Analog output status of when a hardware error ^{*1} occurs	0V/0mA	0V/0mA	0V/0mA	0V/0mA

*1 Indicates the case that the operation of a program is not completed within the expected time in the CPU module due to a hardware failure in the D/A converter module or other factors. In this case, Remote READY (RXB) turns off and the RUN LED of the D/A converter module turns off.

Setting procedure

Operating procedure

1. Set "CH□ D/A conversion enable/disable setting" to "Enable".
2. Set "CH□ Analog output HOLD/CLEAR setting".

7.7 Scaling Function

The D/A converter module performs scale conversion on a digital value to the set range of the scaling upper limit value and scaling lower limit value. This function reduces the time and effort to create a program of the scale conversion.

How to interpret the scaling setting

Set a value corresponding to the upper limit value of the analog output value in the range setting for the scaling upper limit value.

Set a value corresponding to the lower limit value of the analog output value in the range setting for the scaling lower limit value.

Calculation of the scaling value

Scale conversion is performed on the digital values using the following formula: (Values after the decimal point are rounded down during scale conversion.)

- When the output range is -10 to 10V

$$D_Y = \frac{32000}{S_H - S_L} \times (D_X - S_L) - 16000$$

- When the output range is 4 to 20mA, 0 to 20mA, 1 to 5V, 0 to 5V, and 0 to 10V

$$D_Y = \frac{16000}{S_H - S_L} \times (D_X - S_L)$$

Item	Description
D _Y	Digital value used for D/A conversion
D _X	Digital value
S _H	Scaling upper limit value
S _L	Scaling lower limit value

Setting procedure

Operating procedure

1. Set "CH□ D/A conversion enable/disable setting" to "Enable".
2. Set "CH□ Scaling enable/disable setting" to "Enable".
3. Set values in "CH□ Scaling lower limit value" and "CH□ Scaling upper limit value".

Point

- Even if the scaling upper limit value and the scaling lower limit value are set so that the change is larger than the maximum resolution described in the performance specifications, the resolution will not increase.
- The settings must satisfy the condition: Scaling upper limit value > Scaling lower limit value.

Example of the scaling setting

Ex.

When the following settings are made for channel 1 with the output range 0 to 5V set to it

- "CH1 Scaling enable/disable setting": "Enable"
- "CH1 Scaling upper limit value": 10000
- "CH1 Scaling lower limit value": 2000

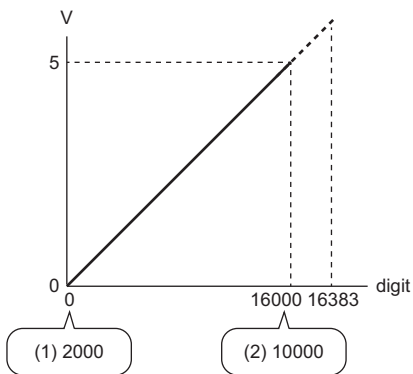

digit: Digital value

V: Analog output voltage (V)

(1) Scaling lower limit value

(2) Scaling upper limit value

Digital value	Digital value after scale conversion	Analog output voltage
2000	0	0V
3600	3200	1V
5200	6400	2V
6800	9600	3V
8400	12800	4V
10000	16000	5V

Ex.

When the following settings are made for channel 1 with the output range -10 to 10V set to it

- "CH1 Scaling enable/disable setting": "Enable"
- "CH1 Scaling upper limit value": 12000
- "CH1 Scaling lower limit value": 4000

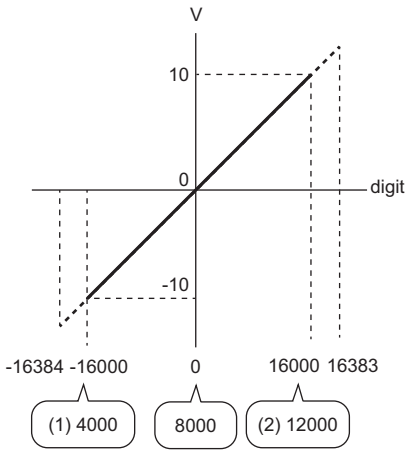

digit: Digital value

V: Analog output voltage (V)

(1) Scaling lower limit value

(2) Scaling upper limit value

Digital value	Digital value after scale conversion	Analog output voltage
4000	-16000	-10V
6000	-8000	-5V
8000	0	0
10000	8000	5V
12000	16000	10V

Point

- When using the scaling function, the digital value before scaling can be set to a value out of the range of the scaling upper and lower limit values (dotted line area in the I/O characteristics). However, use the scaling function within the range of the analog output practical range (solid line area in the I/O characteristics). If the value is out of the analog output practical range, the maximum resolution and accuracy may not fall within the range of performance specifications.
- The default digital value 0 may not be appropriate depending on the scaling function setting. Especially in the above examples, a CH□ Out-of-range digital value error (error code: 190□H) occurs if CH□ Output enable/disable flag (RY10 to RY13) is turned on with the digital value being 0. Therefore, set an appropriate digital value within the scaling range before turning on CH□ Output enable/disable flag (RY10 to RY13).

7.8 Shift Function

The D/A converter module outputs the converted digital value with the set shift value added, in analog. This function facilitates fine adjustment at the system start-up.

Operation

The shifting set value is added to a digital value, and the added digital value is output in analog.

When the scaling function is used, the scale conversion is executed after the addition by the shift function.

If some value is set to the shifting set value, the shifting set value is added regardless of the status change (OFF→ON→OFF) of Initial data setting request flag (RY9).

Setting procedure

Operating procedure

1. Set "CH□ D/A conversion enable/disable setting" to "Enable".
2. Set a value in CH□ Shifting set value (RWw10 to RWw13).

Point

If the digital value exceeds the range from -32768 to 32767 as a result of shift-and-add operation, the digital operation value is fixed to the lower limit value (-32768) or the upper limit value (32767).

Setting example

Ex.

For channel 1 to which the input range 0 to 5V is set, when a conversion value shift amount of 10 is added to a D/A converter module with the following I/O characteristics

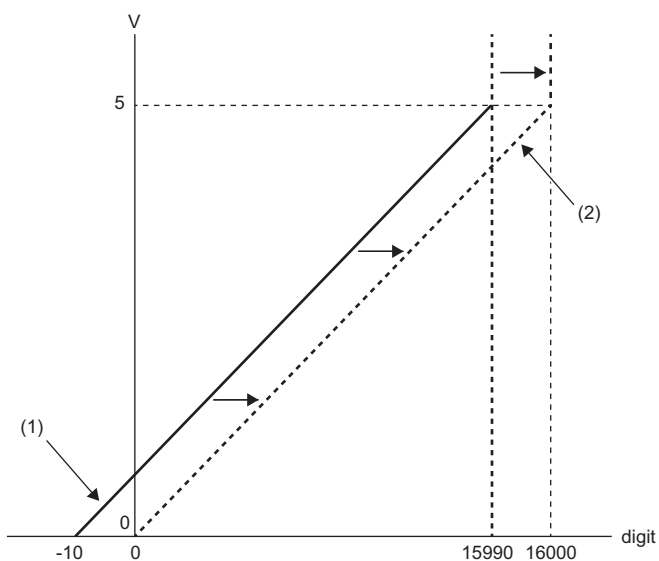

digit: Digital value

V: Analog output voltage (V)

(1) CH1 Digital value (RWw2)

(2) Digital value after shift-and-add operation

Digital value	Digital value after shift-and-add operation	Analog output voltage
-10	0	0V
3190	3200	1V
6390	6400	2V
9590	9600	3V
12790	12800	4V
15990	16000	5V

Ex.

When the shifting set value of 250 is added to channel 1 set with the output range -10 to 10V

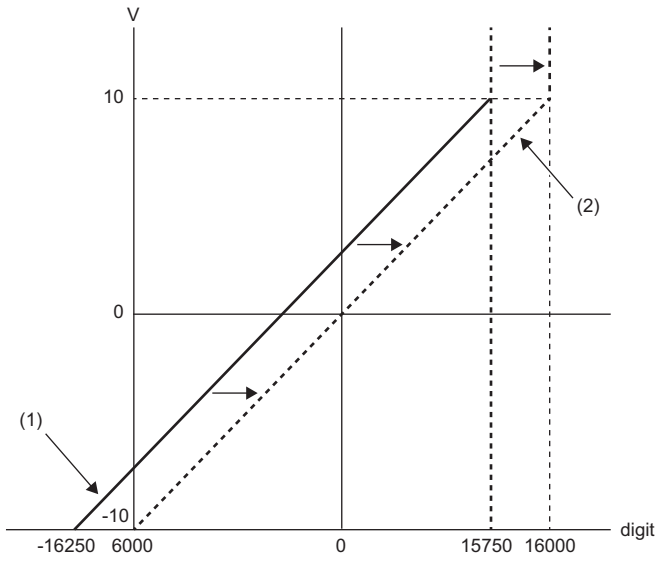

digit: Digital value

V: Analog output voltage (V)

(1) CH1 Digital value (RWw2)

(2) Digital value after shift-and-add operation

Digital value	Digital value after shift-and-add operation	Analog output voltage
-16250	-16000	-10V
-8250	-8000	-5V
-250	0	0
7750	8000	5V
15750	16000	10V

Example of combined use of scaling function and shift function

Ex.

When the following settings are made for channel 1 with the output range 0 to 5V set to it

- "CH1 Scaling enable/disable setting": "Enable"
- "CH1 Scaling upper limit value": 9000
- "CH1 Scaling lower limit value": 3000
- CH1 Shifting set value (RWw10): -25

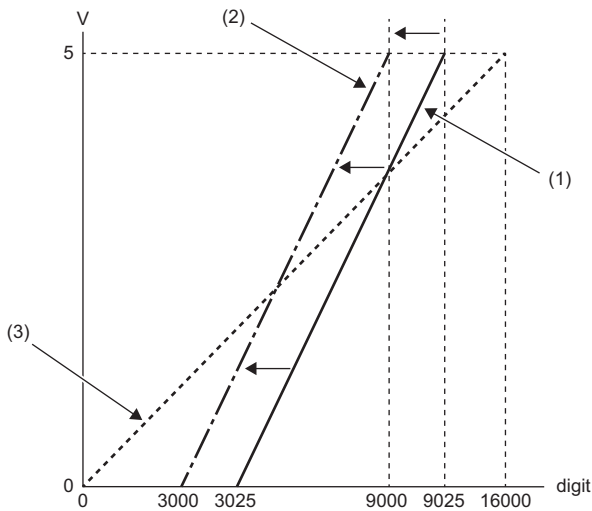

digit: Digital value

V: Analog output voltage (V)

(1) CH1 Digital value (RWw2)

(2) Digital value after shift-and-add operation

(3) Digital value after scale conversion

Digital value	Digital value after shift-and-add operation	Digital value after scale conversion	Analog output voltage
3025	3000	0	0V
4225	4200	3200	1V
5425	5400	6400	2V
6625	6600	9600	3V
7825	7800	12800	4V
9025	9000	16000	5V

Operating procedure

1. Set "CH1 D/A conversion enable/disable setting" to "Enable".
2. Set "CH1 Scaling enable/disable setting" to "Enable".
3. Set values in "CH1 Scaling lower limit value" and "CH1 Scaling upper limit value".
4. Set -25 to CH1 Shifting set value (RWw10).

7.9 Digital Value Range Check Function

This function outputs an error when the digital value is out of the digital input range for the output range.

Notification

When the digital value is greater than the upper limit of the setting range or smaller than the lower limit of the setting range, the out-of-range state is notified with the following operation.

- The check code is stored in CH□ Set value check code (RWr2 to RWr5). (Page 116 Set value check code)
- CH□ Out-of-range digital value (error code: 190□H) is stored in Latest error code (RWr0).
- The ERR. LED flashes.

Operation

When the digital value is greater than the upper limit of the setting range or smaller than the lower limit of the setting range, analog output is as follows.

- When the digital value is greater than the upper limit of the setting range, the analog value is output with the upper limit of the setting range.
- When the digital value is smaller than the lower limit of the setting range, the analog value is output with the lower limit of the setting range.

The analog output value returns to the normal value when the digital value falls within the setting range. However, the indicated notification remains as follows:

- Once a check code is stored, it is not reset automatically.
- The ERR. LED remains flashing.

Resetting a check code

After rewriting a digital value with a value in the settable range, there are two methods for resetting a check code.

- Turning on and off Error clear request flag (RYA)
- Turning on and off Initial data setting request flag (RY9)

When the scaling function is enabled

When "Scaling enable/disable setting" is set to "Enable", the scale-converted digital value is the target for check code detection.

Point

When the scale-converted digital value is out of the setting range, a slight inaccuracy may be contained in the target digital value for the check code when the check code is stored due to an operational error in the scale conversion.

When the shift function is enabled

When a value is set for CH□ Shifting set value (RWw10 to RWw13), the value with the shifting set value added is the target for the check code.

Operation example of the check code detection

Ex.

When the following settings are made for channel 1 with the output range -10 to 10V set to it

- "CH1 Scaling enable/disable setting": "Enable"
- "CH1 Scaling upper limit value": 24000
- "CH1 Scaling lower limit value": -24000
- CH1 Shifting set value (RWw10): -200

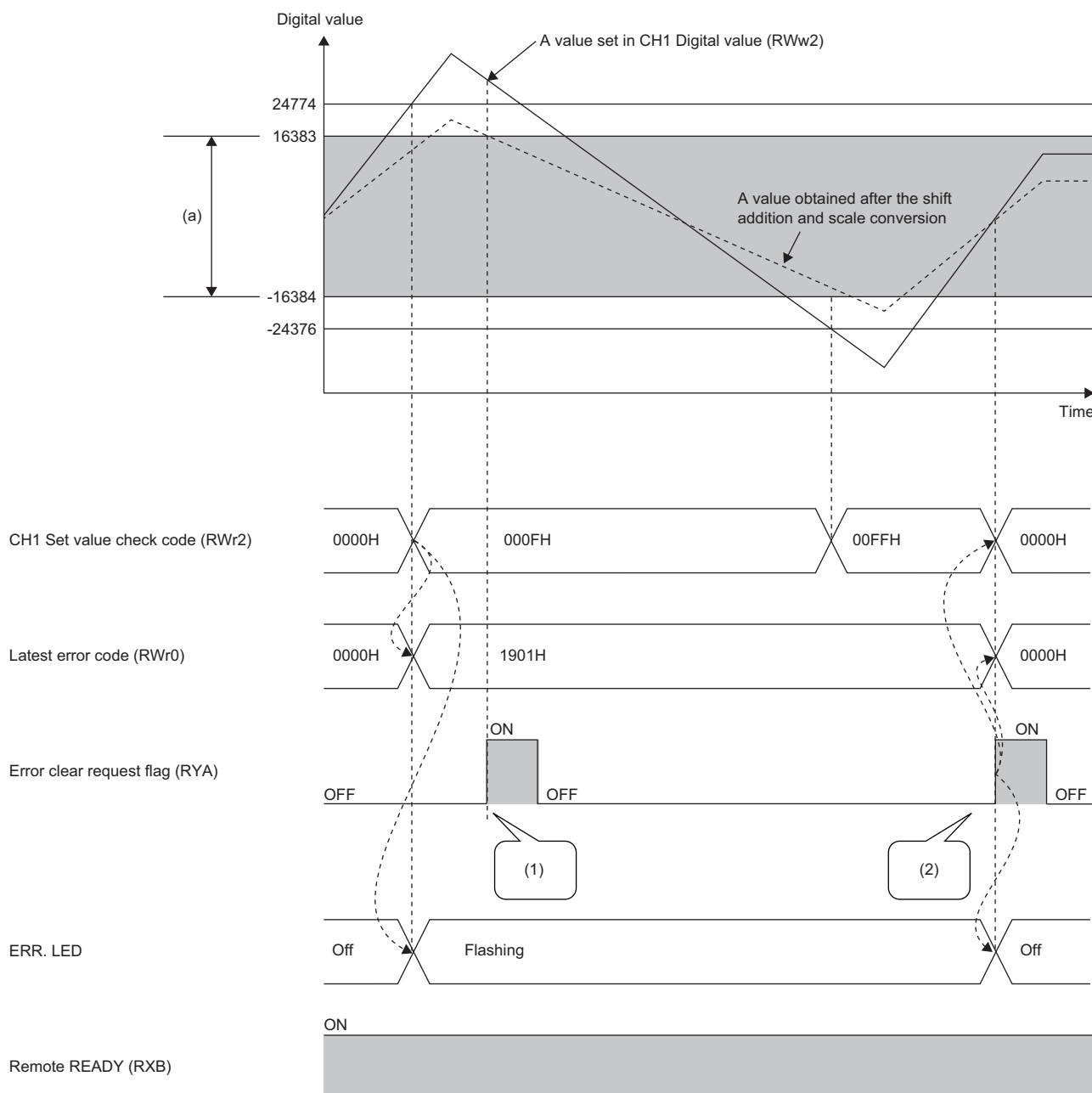

(a) Setting range after shift-and-add operation, scale conversion

(1) For a value outside the setting range, the check code is not reset.

(2) For a value within the setting range, the check code is reset.

7.10 Warning Output Function

This function outputs a warning when a digital value falls within the warning output range set in advance. The following figure schematically shows how the warning output behaves in the D/A converter module.

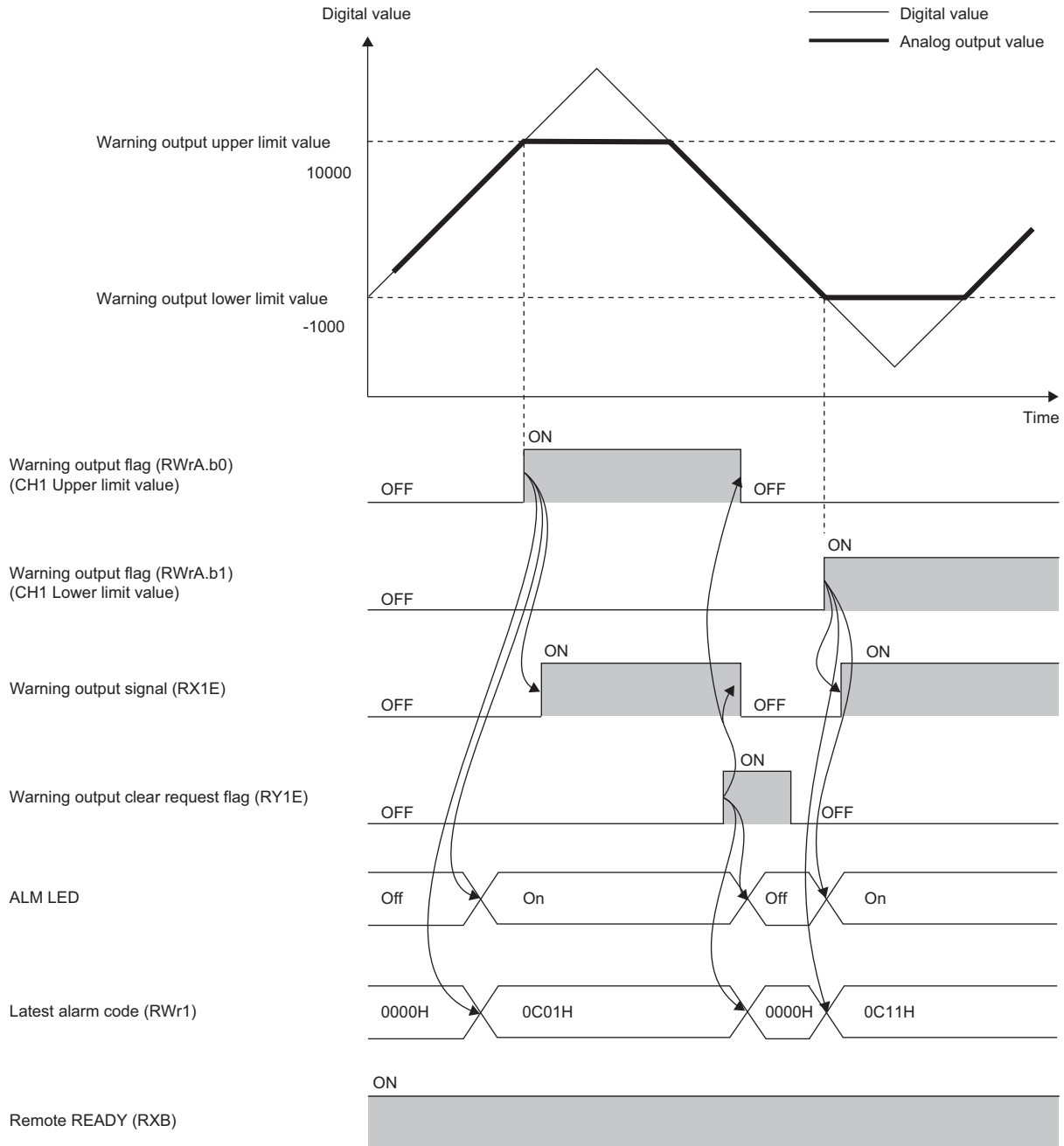

Notification

When the digital value is greater than the warning output upper limit value or smaller than the warning output lower limit value, the warning is notified by the following.

- Warning output flag (RW_rA): Bit corresponding to the warning content turns on (☞ Page 117 Warning output flag).
- Warning output signal (RX1E): ON
- ALM LED: On

CH \square Warning (upper limit) occurrence (alarm code: 0C0 \square H) or CH \square Warning (lower limit) occurrence (alarm code: 0C1 \square H) is stored in Latest alarm code (RW_r1).

Operation

When the digital value exceeds the warning output upper limit value or is below the warning output lower limit value, a warning is output and the analog output value becomes any of the following:

- When the digital value exceeds the warning output upper limit value: An analog value converted from the digital value of the warning output upper limit value is output.
- When the digital value is below the warning output lower limit value: An analog value converted from the digital value of the warning output lower limit value is output.

After a warning occurs, the analog output value returns to the normal value by changing the digital value to a value within the setting range. However, Warning output flag (RW_rA) and Warning output signal (RX1E) are not cleared. (ALM LED remains turned on.)

Clearing the warning output

The warning output can be cleared by either of the following two methods.

- Turning on and off Warning output clear request flag (RY1E)
- Turning on and off Initial data setting request flag (RY9)

When the warning output is cleared, the D/A converter module results in the following state:

- Warning output flag (RW_rA): OFF
- Warning output signal (RX1E): OFF
- ALM LED: Off
- CH \square Warning (upper limit) occurrence (alarm code: 0C0 \square H) or CH \square Warning (lower limit) occurrence (alarm code: 0C1 \square H) is cleared from Latest alarm code (RW_r1).

When the scaling function is enabled

When "Scaling enable/disable setting" is set to "Enable", the scale-converted digital value is the target for warning detection. Be sure to set a value considering the scaling range.

When the shift function is enabled

When a value is set to CH \square Shifting set value (RW_w10 to RW_w13), the value with the shifting set value added is the target for the warning.

Be sure to set a value considering the scaling range.

Setting procedure

Operating procedure

1. Set "CH \square D/A conversion enable/disable setting" to "Enable".
2. Set "CH \square Warning output setting" to "Enable".
3. Set the values in "CH \square Warning output upper limit value" and "CH \square Warning output lower limit value".

7.11 SLMP Communication Function

This function allows communications with the D/A converter module using SLMP.

For details on SLMP, refer to the following.

 SLMP Reference Manual

Applicable version

This function is available for a D/A converter module with firmware version "06" or later.

 Page 141 Added functions

Available commands

SLMP command*1				Application
Type	Operation	Command	Subcommand	
Remote Control	Remote Reset	1006H	0000H	Remotely resets the D/A converter module.
Memory	Read	0613H	0000H	Reads data from the remote buffer memory.*2
	Write	1613H	0000H	Writes data to the remote buffer memory.*2

*1 The SLMP commands are compatible with 4E frame.

*2 The maximum word length that the D/A converter module can use is 240 words.

Point

For a single D/A converter module, do not execute multiple SLMP commands at the same time. If multiple SLMP commands are executed at the same time, the D/A converter module may not be able to receive the SLMP commands, and the SLMP commands may time out.

7

How to communicate

Use the SLMPREQ instruction to send SLMP commands to the D/A converter module from the CPU module.

For the SLMPREQ instruction, refer to the following.

 MELSEC iQ-R Programming Manual (Module Dedicated Instructions)

Precautions

If D0A0H is stored in the completion status of the SLMPREQ instruction, any of the following error codes is stored in the error history. Take an action corresponding to the error code stored in the error history.

- Transient data request command error (error code: D217H)
- Receive buffer full (error code: D2A0H)
- Transient data length error (error code: D2A3H)
- Transient data divided error (error code: DF01H)

For details on the error codes, refer to the following.

 Page 101 Error Code List

7.12 Firmware Update Function

This function updates firmware of a D/A converter module via CC-Link IE TSN.

For details on the firmware update function, refer to the following.

 CC-Link IE TSN Digital-Analog Converter Module User's Manual(CC-Link IE TSN Communication Mode)

Precautions

- The firmware cannot be updated when the D/A converter module is operating in CC-Link IE Field Network communication mode. Operate the D/A converter module in CC-Link IE TSN communication mode to update the firmware.
- The firmware is updated for both the CC-Link IE TSN communication mode and the CC-Link IE Field Network communication mode.

7.13 Module Power Supply Voltage Drop Detection Function

This function detects a voltage drop of the module power supply.

This function makes troubleshooting easy when the voltage of the power supplied to the D/A converter module drops, or when poor connection in the wiring occurs. Note that the voltage to be monitored for a module power supply voltage drop is 20.4V.

Operation

When a drop of the module power supply voltage is detected, the module results in the following state and an error is notified.

- Module power supply voltage drop error (error code: 1080H) is stored in Latest error code (RWr0).
- Error flag (RXA) turns on.

Point

- When an error is detected, since the power supply environment is out of specification range, the operation is not guaranteed.
 - A power supply voltage drop is not detected in the event of a sudden power failure or when power-off operation is performed.
 - The voltage to be monitored varies depending on the environment.
-

8 PROGRAMMING

This chapter describes the programming of the D/A converter module.

8.1 Precautions for Programming

This section describes precautions to create CC-Link IE Field Network programs.

Program for cyclic transmission

For a program for cyclic transmission, provide interlock between the following link special relay (SB) and the link special register (SW).

- Own station data link error status (master station) (SB0049)
- Data link status (each station) (SW00B0 to SW00B7)

 User's manual for the master/local module used

Ex.

Interlock example

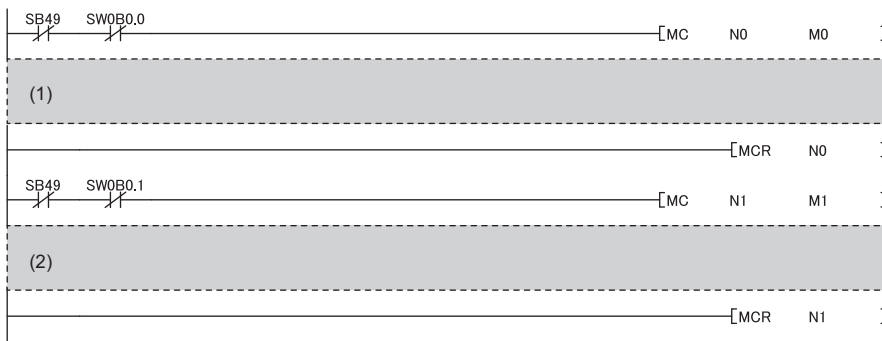

- (1) Program for communications with station No.1
 (2) Program for communications with station No.2

Program for transient transmission

For a program for transient transmission, provide interlock between the following link special relay (SB) and the link special register (SW).

- Baton pass status of the own station (master station) (SB0047)
- Baton pass status of each station (SW00A0 to SW00A7)

 User's manual for the master/local module used

Ex.

Interlock example

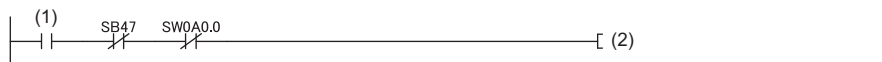

- (1) Start contact
 (2) Dedicated instruction to station No.1

8.2 When Function Setting Switch 2 Is Not Used

System configuration

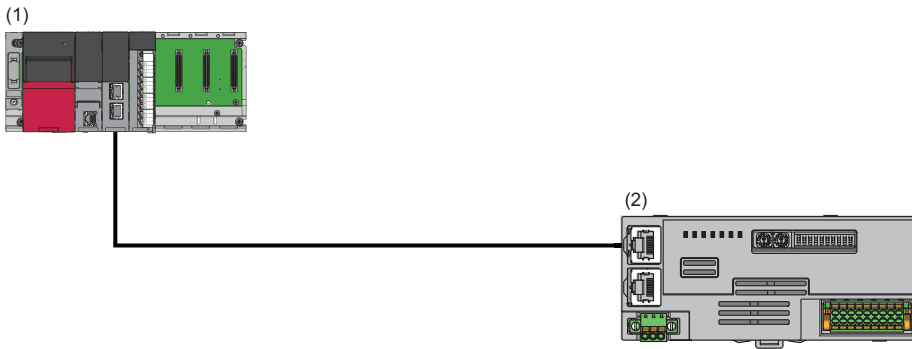

- (1) Master station
 - Power supply module: R62P
 - CPU module: R120CPU
 - Master/local module: RJ71GF11-T2 (Start I/O number: 0000H to 001FH)
 - Input module: RX40C7 (Start I/O number: 0020H to 002FH)
- (2) Remote device station (IP address/station number setting switches: 1)
 - D/A converter module: NZ2GN2S-60DA4 (analog output: CH1, CH2)

Assignment of link devices

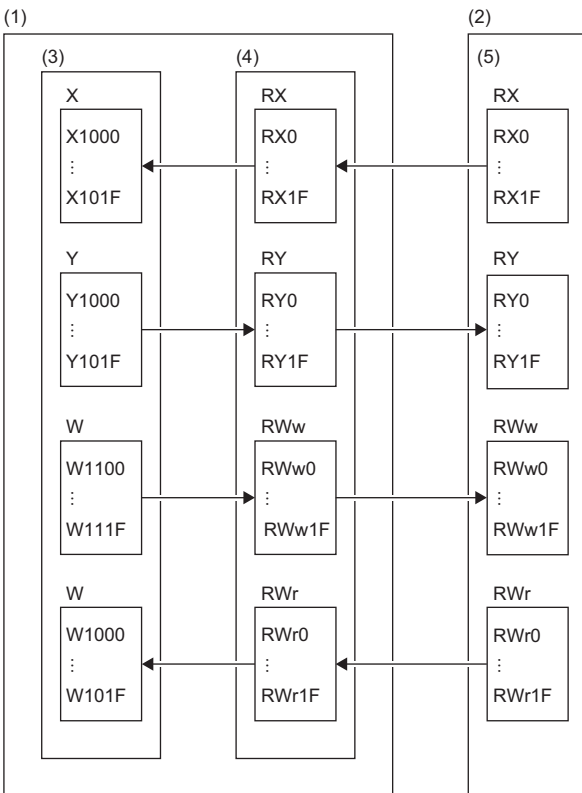

- (1) Master station
- (2) Remote device station
- (3) CPU module
- (4) Master/local module
- (5) D/A converter module

Programming conditions

D/A conversion in CH1 and CH2 of the D/A converter module is enabled and the written digital values are output as analog data. Scaling conversion is performed in CH1 and warning output is performed in CH2.

Initial setting description

Setting item		Setting value
D/A conversion enable/disable setting	CH1 D/A conversion enable/disable setting	Enable
	CH2 D/A conversion enable/disable setting	Enable
Analog output HOLD/CLEAR setting	CH1 Analog output HOLD/CLEAR setting	HOLD
Warning output function	CH2 Warning output setting	Enable
	CH2 Warning output upper limit value	10000
	CH2 Warning output lower limit value	3000
Scaling function	CH1 Scaling enable/disable setting	Enable
	CH1 Scaling upper limit value	32000
	CH1 Scaling lower limit value	0

For the parameters other than the above, use the initial value.

Devices to be used

Device	Description		
X20	Digital value write command	RX40C7 (X20 to X2F)	
X22	Batch analog output enable command		
X24	Warning output clear command		
X26	Error clear command		
X1009	Initial data setting completion flag	NZ2GN2S-60DA4 (RX0 to RX1F)	
X100A	Error flag		
X100B	Remote READY		
X101E	Warning output signal		
Y100A	Error clear request flag	NZ2GN2S-60DA4 (RY0 to RY1F)	
Y1010	CH1 Output enable/disable flag		
Y1011	CH2 Output enable/disable flag		
Y101E	Warning output clear request flag		
W1102	CH1 Digital value	Remote register RWw	
W1103	CH2 Digital value		
W1000	Latest error code	Remote register RWr	
W1001	Latest alarm code		
W1002	CH1 Set value check code		
W1003	CH2 Set value check code		
W100A	Warning output flag		
D2002	CH1 Digital value		Device for storage
D2003	CH2 Digital value		
D2100	Latest error code		
D2110	Warning output flag		
D2120	Latest alarm code		
D2130	CH1 Set value check code		
D2131	CH2 Set value check code		
F0	CH2 Upper limit warning occurrence		
F1	CH2 Lower limit warning occurrence		
SM400	Always ON		
SB49	Data link status of the own station (master station)		
SW0B0.0	Data link status of each station (station No.1)		
M0	Communication ready flag (station No.1)		
N0	Nesting (station No.1)		

Setting procedure

Operating procedure

1. Create a project.

[Project] ⇒ [New...]

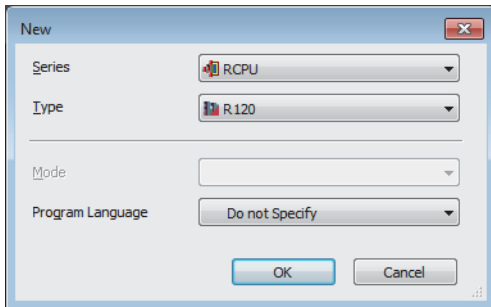

2. Set the master/local module in the following window.

[Navigation window] ⇒ [Parameter] ⇒ [Module Information] ⇒ Right-click ⇒ [Add New Module]

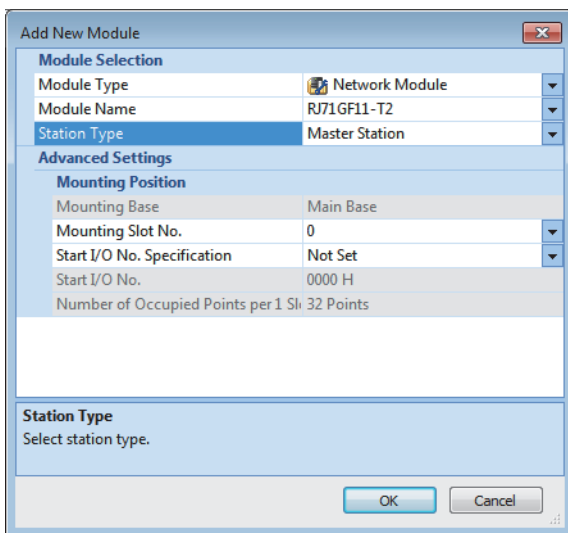

3. Open the "CC IE Field Configuration" window and set items as follows.

[Navigation window] ⇒ [Parameter] ⇒ [Module Information] ⇒ Model ⇒ [Basic Settings] ⇒ [Network Configuration Settings]

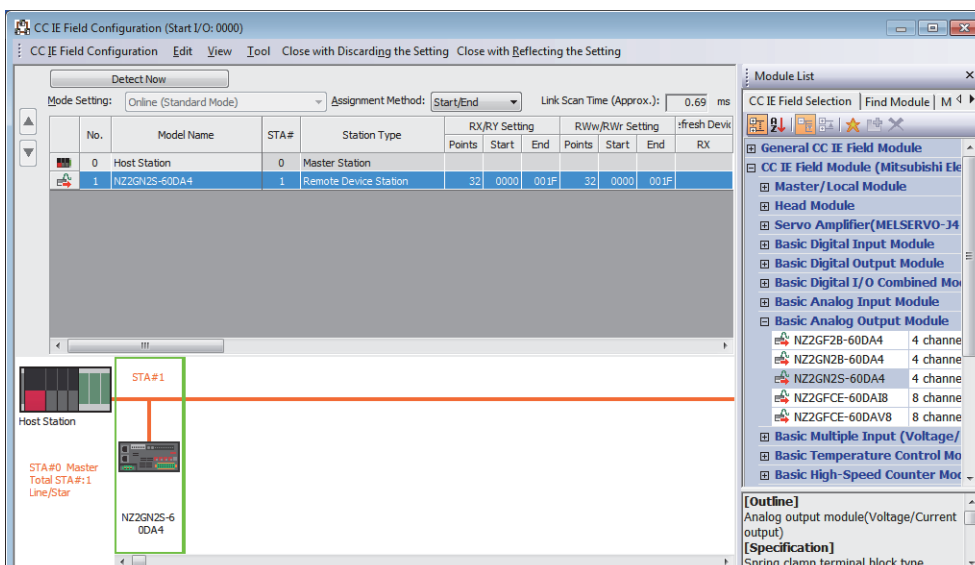

4. Click the [Close with Reflecting the Setting] button to close the "CC IE Field Configuration" window.

5. Open the refresh parameter setting window and set items as follows.

 [Navigation window] ⇒ [Parameter] ⇒ [Module Information] ⇒ Model ⇒ [Basic Settings] ⇒ [Refresh Settings]

No.	Link Side					CPU Side				
	Device Name	Points	Start	End		Target	Device Name	Points	Start	End
-	SB	512	00000	001FF	↔	Specify Device	SB	512	00000	001FF
-	SW	512	00000	001FF	↔	Specify Device	SW	512	00000	001FF
1	RX	32	00000	0001F	↔	Specify Device	X	32	00000	0001F
2	RY	32	00000	0001F	↔	Specify Device	Y	32	00000	0001F
3	RWr	32	00000	0001F	↔	Specify Device	W	32	01000	0101F
4	RWw	32	00000	0001F	↔	Specify Device	W	32	01100	0111F

6. Check that the station-based block data assurance is set to "Enable" for the master/local module.

 [Navigation window] ⇒ [Parameter] ⇒ [Module Information] ⇒ Model ⇒ [Application Settings] ⇒ [Supplementary Cyclic Settings]

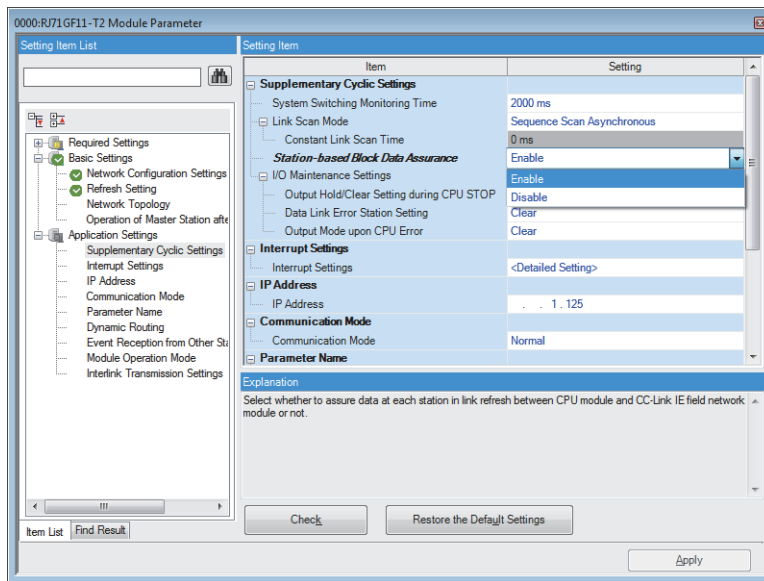

7. Click the [Apply] button.

8. Write the set parameters to the CPU module of the master station and reset the CPU module of the master station, or turn off and on the power supply of the programmable controller.

 [Online] ⇒ [Write to PLC]

9. Open the "CC IE Field Configuration" window.

[Navigation window] ⇒ [Parameter] ⇒ [Module Information] ⇒ Model ⇒ [Basic Settings] ⇒ [Network Configuration Settings]

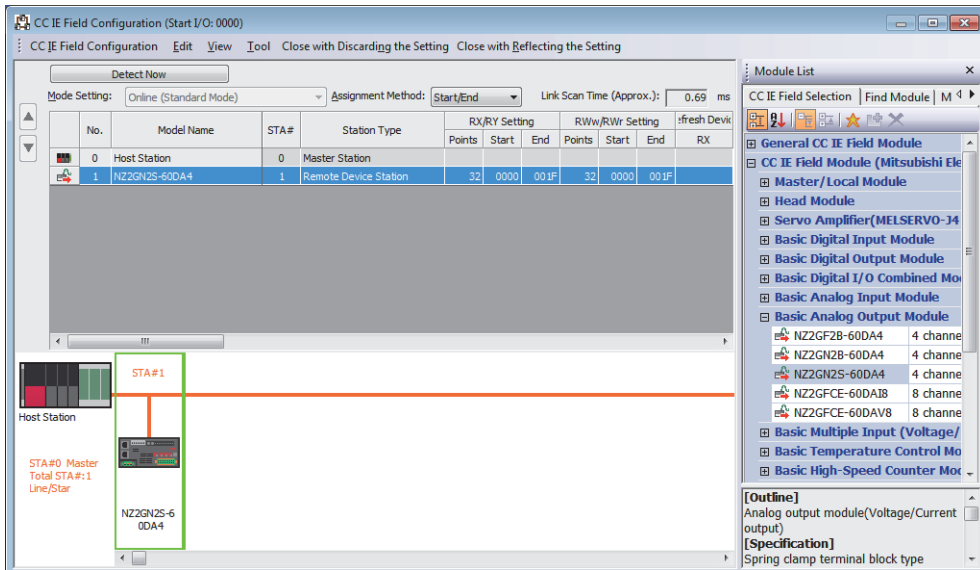

10. In the "Parameter Processing of Device Station" window, set the items as described in Initial settings.

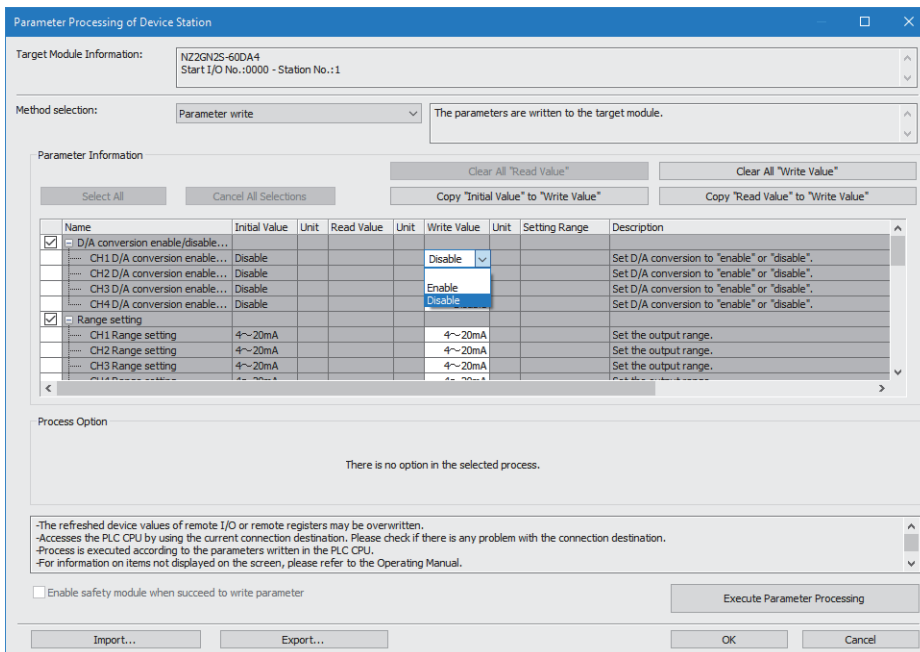

11. Click the [OK] button to close the "Parameter Processing of Device Station" window.

12. Set the CPU module of the master station to RUN, and check that the DATA LINK LED of the D/A converter module is turned on.

Program example

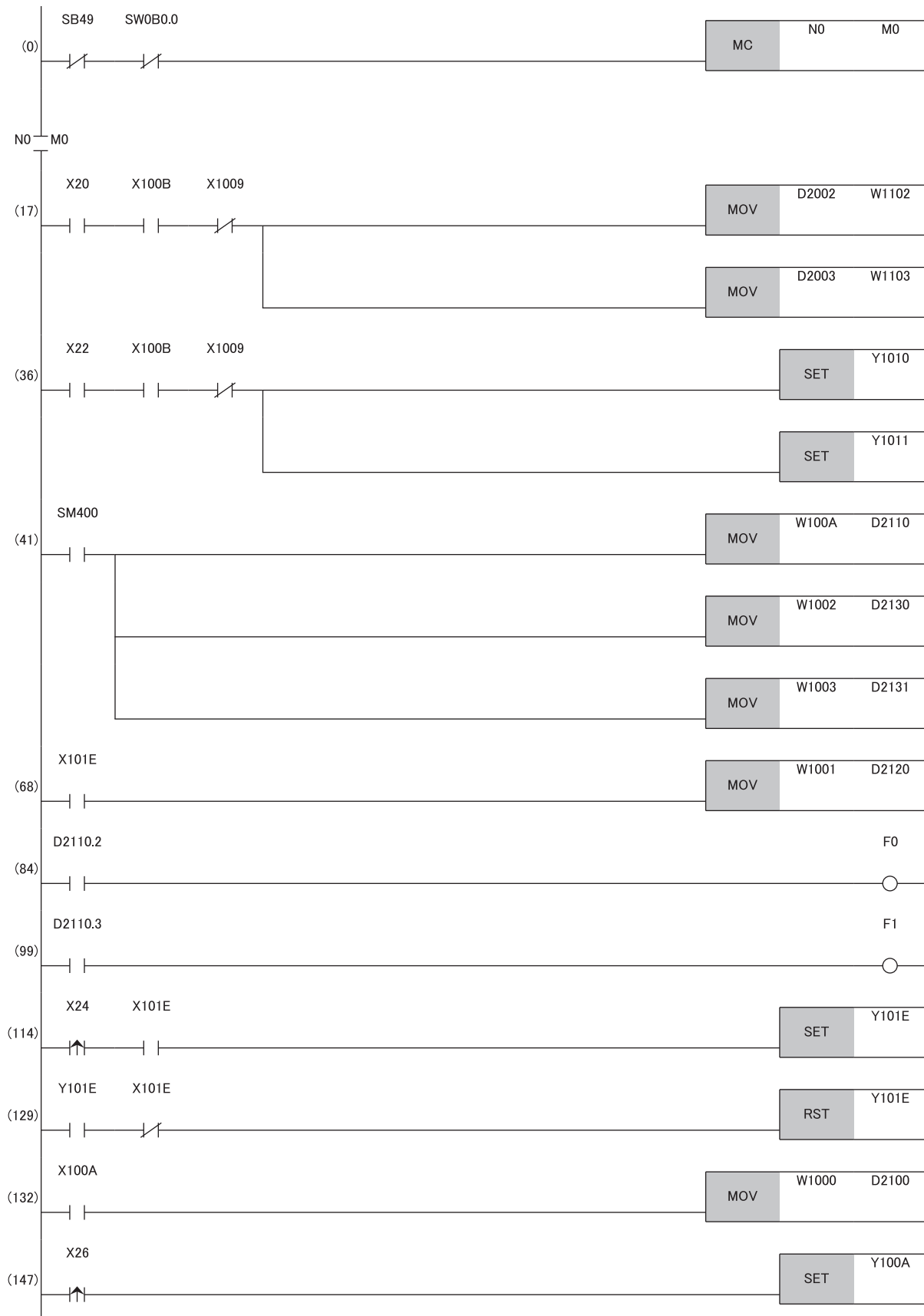

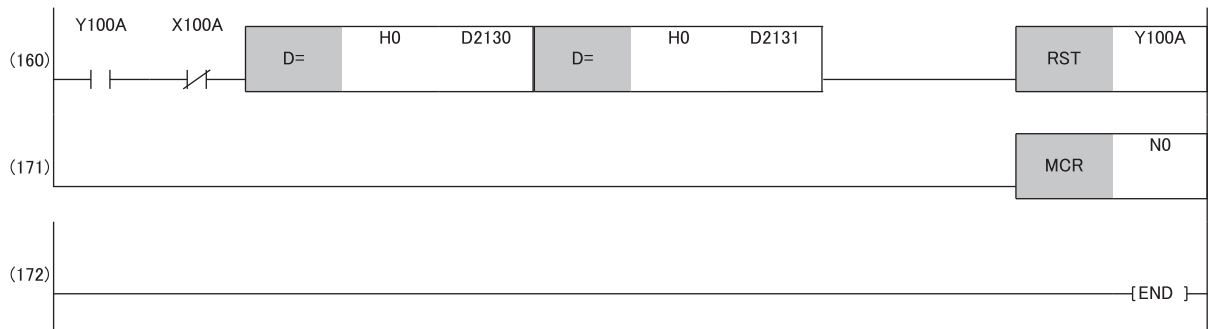

- (17), (36) Write a digital value.
- (41) Detect the warning output flag and check code.
- (68) Read the latest alarm code.
- (84), (99) Perform the processing to be performed when a CH2 warning occurs.
- (114), (129) Clear the alarm code.
- (132) Read the latest error code.
- (147), (160) Clear the error code.

8.3 When Function Setting Switch 2 Is Used

System configuration

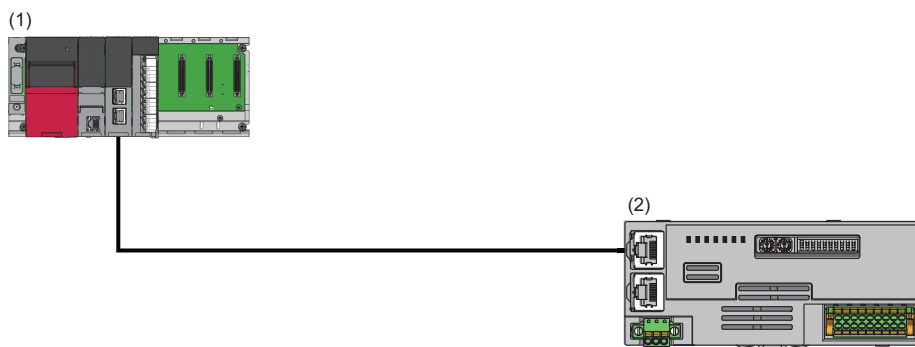

(1) Master station

- Power supply module: R62P
- CPU module: R120CPU
- Master/local module: RJ71GF11-T2 (Start I/O number: 0000H to 001FH)
- Input module: RX40C7 (Start I/O number: 0020H to 002FH)

(2) Remote device station (IP address/station number setting switches: 1)

- D/A converter module: NZ2GN2S-60DA4 (analog output: CH1, CH2, CH3, CH4)

Programming conditions

D/A conversion in CH1, CH2, CH3, and CH4 of the D/A converter module is enabled and the written digital values are output as analog data.

Initial setting description

Set the function setting switches as follows. Set the range to 4 to 20mA for all channels.

Switch name	Setting details
Function setting switch 1	ON
Function setting switch 2	ON
Function setting switch 3	OFF
Function setting switch 4	ON
Function setting switch 5	OFF
Function setting switch 6	ON
Function setting switch 7	OFF
Function setting switch 8	ON
Function setting switch 9	OFF
Function setting switch 10	ON

Devices to be used

Device	Description	
X20	Digital value write command	RX40C7 (X20 to X2F)
X22	Batch analog output enable command	
X26	Error clear command	
X1009	Initial data setting completion flag	NZ2GN2S-60DA4 (RX0 to RX1F)
X100A	Error flag	
X100B	Remote READY	

Device	Description	
Y100A	Error clear request flag	NZ2GN2S-60DA4 (RY0 to RY1F)
Y1010	CH1 Output enable/disable flag	
Y1011	CH2 Output enable/disable flag	
Y1012	CH3 Output enable/disable flag	
Y1013	CH4 Output enable/disable flag	
W1102	CH1 Digital value	Remote register RWw
W1103	CH2 Digital value	
W1104	CH3 Digital value	
W1105	CH4 Digital value	
W1000	Latest error code	Remote register RWr
W1002	CH1 Set value check code	
W1003	CH2 Set value check code	
W1004	CH3 Set value check code	
W1005	CH4 Set value check code	
D2002	CH1 Digital value	Device for storage
D2003	CH2 Digital value	
D2004	CH3 Digital value	
D2005	CH4 Digital value	
D2100	Latest error code	
D2130	CH1 Set value check code	
D2131	CH2 Set value check code	
D2132	CH3 Set value check code	
D2133	CH4 Set value check code	
SM400	Always ON	
SB49	Data link status of the own station (master station)	
SW0B0.0	Data link status of each station (station No.1)	
M0	Communication ready flag (station No.1)	
N0	Nesting (station No.1)	

Setting procedure

Operating procedure

1. Create a project.

[Project] ⇒ [New...]

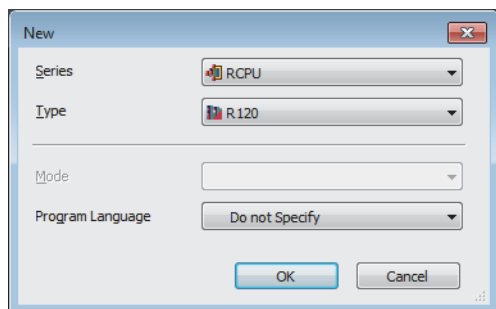

2. Set the master/local module in the following window.

[Navigation window] ⇒ [Parameter] ⇒ [Module Information] ⇒ Right-click ⇒ [Add New Module]

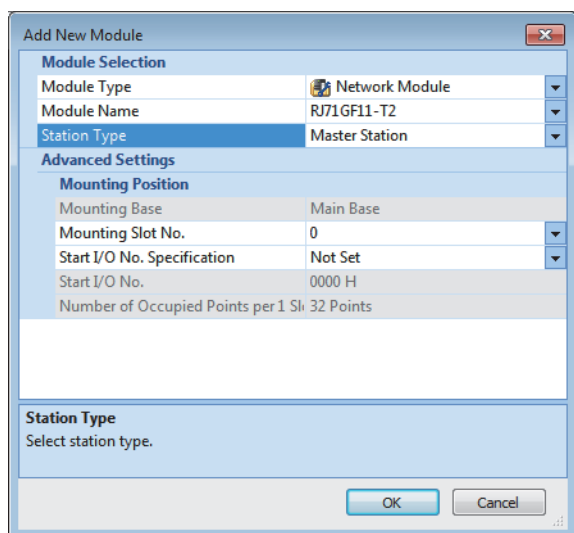

3. Open the "CC IE Field Configuration" window and set items as follows.

[Navigation window] ⇒ [Parameter] ⇒ [Module Information] ⇒ Model ⇒ [Basic Settings] ⇒ [Network Configuration Settings]

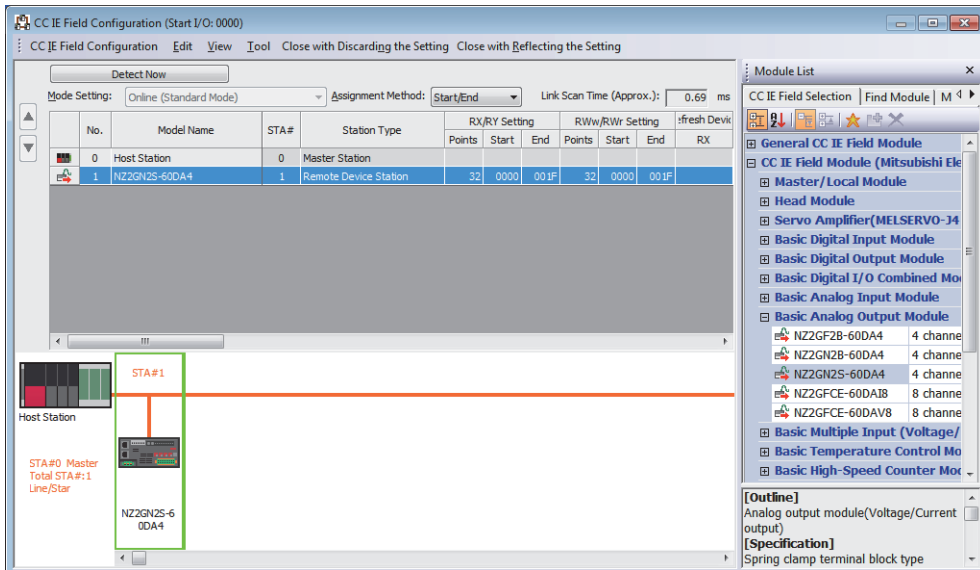

4. Click the [Close with Reflecting the Setting] button to close the "CC IE Field Configuration" window.

5. Open the refresh parameter setting window and set items as follows.

[Navigation window] ⇒ [Parameter] ⇒ [Module Information] ⇒ Model ⇒ [Basic Settings] ⇒ [Refresh Settings]

No.	Link Side					CPU Side				
	Device Name	Points	Start	End		Target	Device Name	Points	Start	End
-	SB	512	00000	001FF	↔	Specify Device	SB	512	00000	001FF
-	SW	512	00000	001FF	↔	Specify Device	SW	512	00000	001FF
1	RX	32	00000	0001F	↔	Specify Device	X	32	00000	0001F
2	RY	32	00000	0001F	↔	Specify Device	Y	32	00000	0001F
3	RWr	32	00000	0001F	↔	Specify Device	W	32	01000	0101F
4	RWw	32	00000	0001F	↔	Specify Device	W	32	01100	0111F

6. Click the [Apply] button.

7. Check that the station-based block data assurance is set as "Enable" for the master/local module.

[Navigation window] ⇒ [Parameter] ⇒ [Module Information] ⇒ Model ⇒ [Application Settings] ⇒ [Supplementary Cyclic Settings]

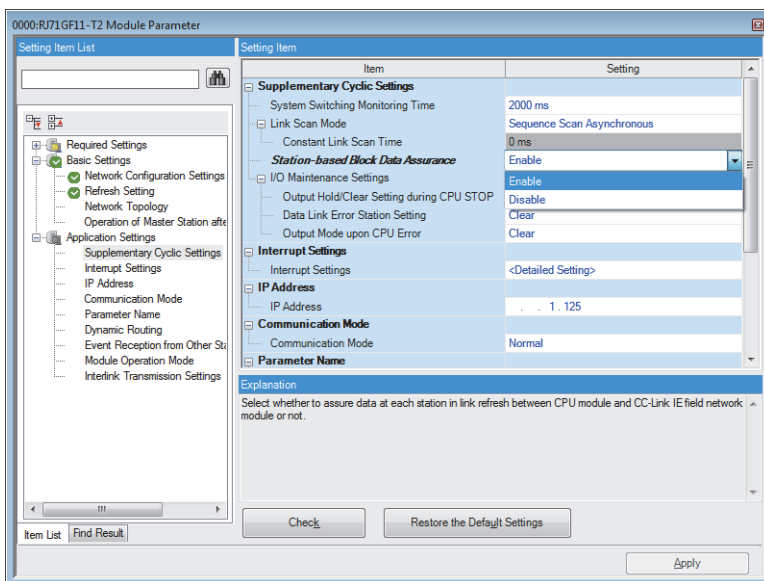

8. Write to the CPU module of the master station and reset the CPU module of the master station, or turn off and on the power supply of the programmable controller.

 [Online] ⇄ [Write to PLC]

9. Set the CPU module of the master station to RUN, and check that the DATA LINK LED of the D/A converter module is turned on.

Program example

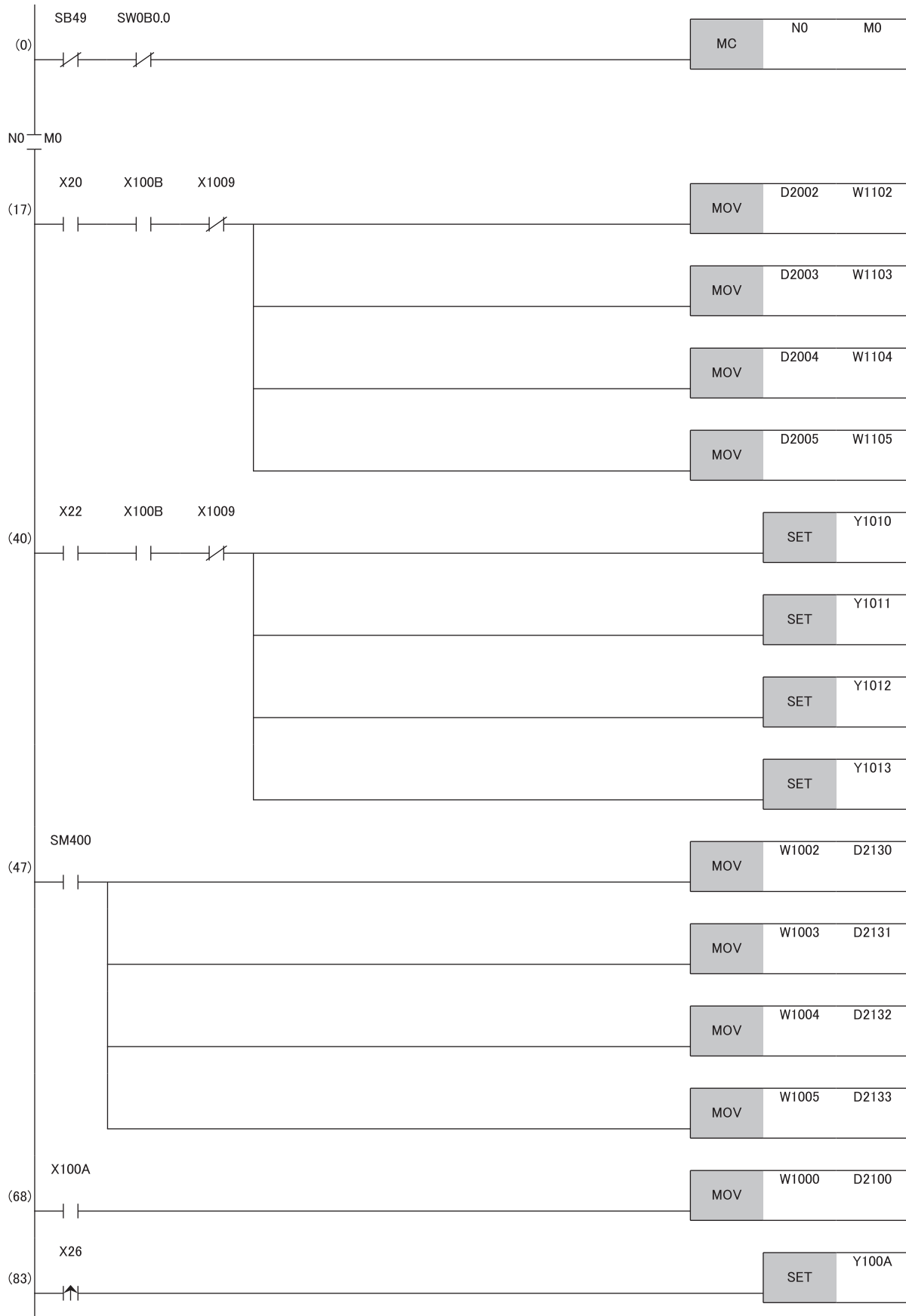

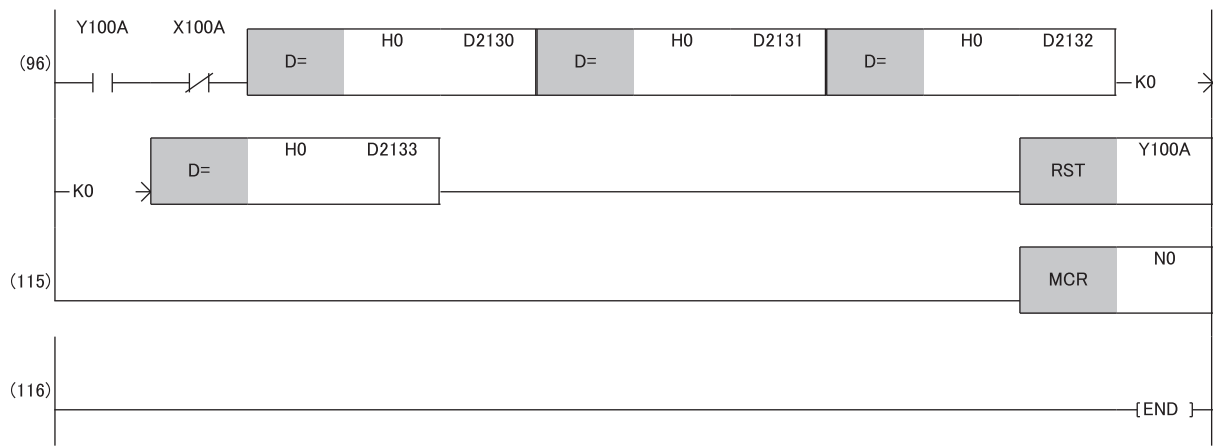



- (17), (40) Write a digital value.
- (47) Detect the check code.
- (68) Read the latest error code.
- (83), (96) Clear the error code.

9 MAINTENANCE AND INSPECTION

The D/A converter module has no special item to be inspected. However, to maintain the best condition of the system, perform the inspection in accordance with the items described in either of the following manuals, depending on the system configuration of the master station used.

- MELSEC iQ-R series:  MELSEC iQ-R Module Configuration Manual
- Except for MELSEC iQ-R series:  User's manual for the CPU module used

MEMO

10 TROUBLESHOOTING

This chapter describes errors that may occur while the D/A converter module is used, and their troubleshooting. This chapter uses GX Works3 for explanations.

10

10.1 CC-Link IE TSN/CC-Link IE Field Diagnostics

For CC-Link IE Field Network, monitor the status and conduct an operation test.
For details on CC-Link IE TSN/CC-Link IE Field diagnostics, refer to the following.
 User's manual for the master/local module used

How to use

1. Connect GX Works3 to the CPU module.
2. Start CC-Link IE Field Network diagnostics from the menu of GX Works3.

 [Diagnostics] ⇒ [CC-Link IE TSN/CC-Link IE Field Diagnostics]

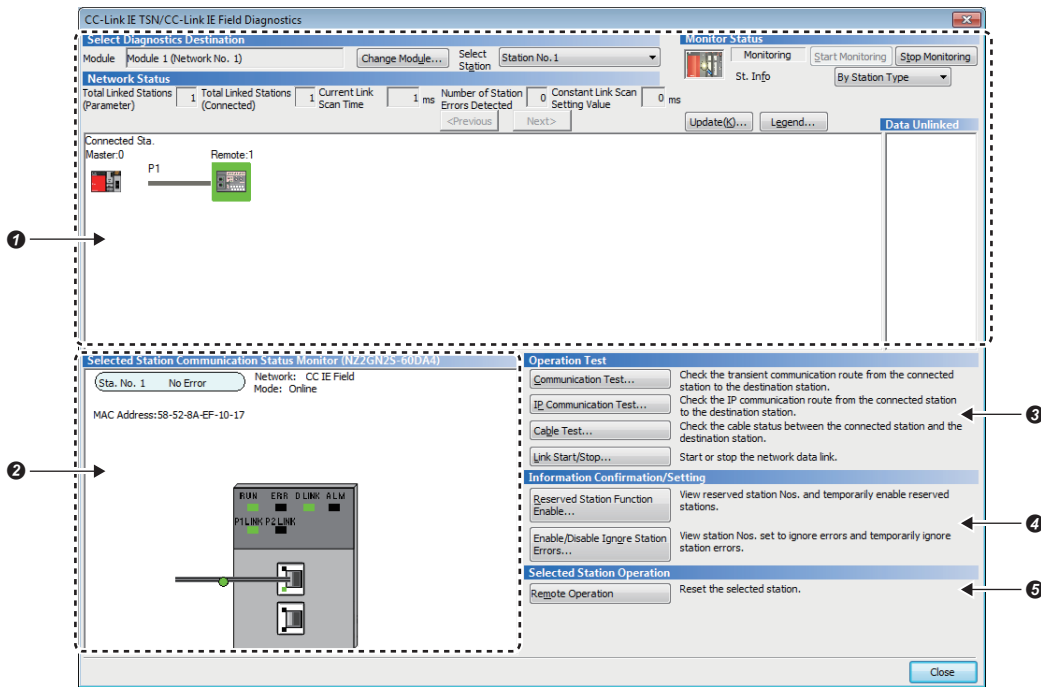

Item to be diagnosed	Description	Reference
① Network configuration diagram and error status	The status of CC-Link IE Field Network can be checked. When an error occurs in the D/A converter module, the icon of the module shows the error status of the station.	Manual for the master/local module used
② Selected-station status and error details	The communication status of the station selected in "Networks Status" can be checked.*1	
③ Communication Test	Communication Test	The transient communication route and whether the communication is established from the connected station to the destination station can be checked.
	IP Communication Test	This item cannot be performed in the A/D converter module in CC-Link IE Field Network communication mode.
	Cable Test	The cable status between the connected station and the destination station can be checked.
	Link Start/Stop	The network data link can be started or stopped.
④ Reserved Station Function Enable	Reserved Station Function Enable	A reservation for a station can be temporarily cancelled, and the cancellation can be disabled. Also, the station numbers for the modules set as reserved stations can be checked on a list.
	Enable/Disable Ignore Station Errors	A station not set as an error invalid station can be temporarily set as an error invalid station, and the error invalid station setting can be disabled. Also, the station numbers for the modules set as (temporarily) error invalid stations can be checked on a list.
⑤ Remote Operation	The remote operation of the selected station can be started and the module status can be changed. The remote reset can be performed for the D/A converter module.	Page 87 Remote reset

*1 At the lower left of the window, the "Selected Station Communication Status Monitor" shows the communication status of the D/A converter module. For how to check errors of the D/A converter module, refer to the following.

Page 94 How to Check Error Codes and Alarm Codes

Point

Some of items cannot be diagnosed depending on the master/local module used.

For details, refer to the following.

User's manual for the master/local module used

Remote reset

To remote reset a selected D/A converter module, follow the procedure below.

Operating procedure

1. Select a device station to be reset and click the [Remote Operation] button.

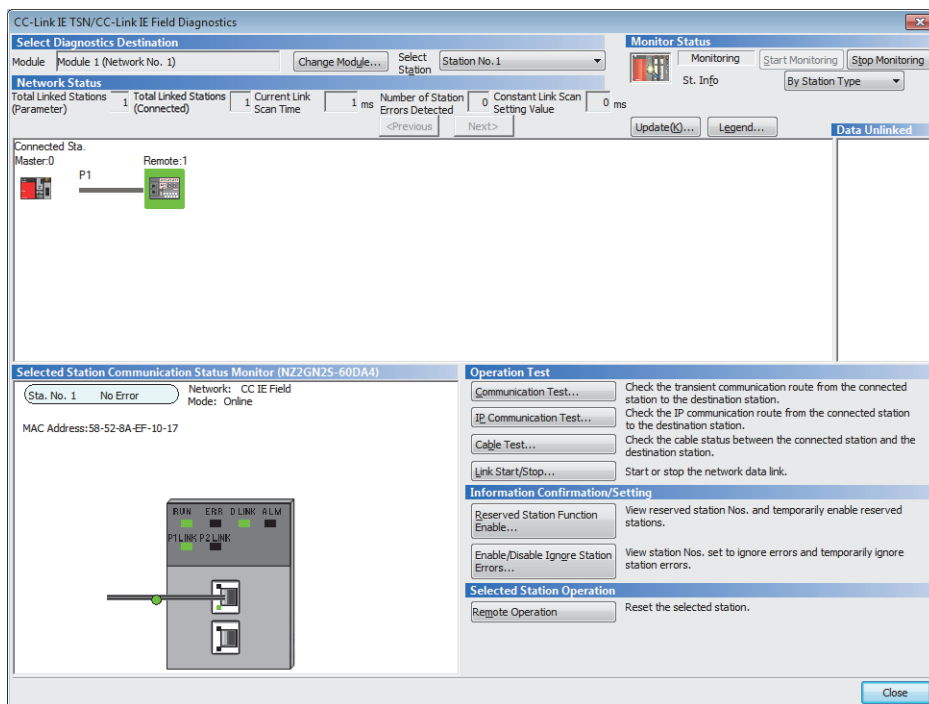

2. Follow the on-screen instructions and click the [Yes] button.
3. Follow the on-screen instructions and click the [OK] button.



When remote reset is performed, if the setting of function setting switch 1 is different from the setting at power-on, remote reset disable error (error code: 1090H) occurs, and the D/A converter module is not reset.

10.2 Checking the LEDs

This section describes how to troubleshoot the system by the LEDs.

When the PW LED does not turn on

When the PW LED does not turn on, check the following items.

Check item	Action
Is any LED other than the PW LED turned on?	When any LED other than the PW LED turns on, the possible cause is a hardware failure. Please consult your local Mitsubishi representative.
Is the module power supply (24VDC) wired?	Wire the module power supply (24VDC).
Is the module power supply (24VDC) turned on?	Turn on the module power supply (24VDC).
Does the voltage of the module power supply (24VDC) conform to the specified range?	Adjust the voltage value to conform to the range of performance specifications.

When the RUN LED does not turn on

When the RUN LED does not turn on, check the following item.

Check item	Action
Has a hardware error occurred?	Turn off and on the module power supply. If the RUN LED does not turn on even after the module power supply is turned off and on, the failure of the module is a possible cause. Please consult your local Mitsubishi representative.

When the RUN LED flashes

When the RUN LED flashes, check the following item.

Check item	Action
Is the D/A converter module in the unit test?	When the D/A converter module is in the unit test, the RUN LED turns on after the unit test is completed. Take corrective action according to the result of the unit test.  Page 91 Unit Test When a unit test is not conducted, set the IP address/station number setting switches to an appropriate value, and set function setting switch 1 to ON.

When the ERR. LED turns on or flashes

When the ERR. LED turns on or flashes, check the following item.

Check item	Action
Does any error occur?	Identify the error factor of the D/A converter module with the engineering tool to take corrective action.  Page 94 How to Check Error Codes and Alarm Codes

When the ALM LED turns on

When the ALM LED turns on, check the following item.

Check item	Action
Has a warning been output in the D/A converter module?	Check Warning output flag (RWrA).

When the P1 LINK LED or P2 LINK LED turns off

When the P1 LINK LED or P2 LINK LED turns off, check the following items.

Check item	Action
Is the Ethernet cable used compliant with the relevant standard?	Replace the cable with an Ethernet cable compliant with the relevant standard. ☞ User's manual for the master/local module used
Is the segment length 100m or less?	Change the segment length to 100m or less.
Does the cabling condition (bending radius) meet the specifications?	Refer to the manual for the Ethernet cable used, and correct the bend radius.
Is any Ethernet cable disconnected?	Replace the Ethernet cable.
Do the hub and other stations used in the system operate normally?	<ul style="list-style-type: none"> • Check that the hub and the power supplies of the other stations are turned on. • Check that the hub compliant with the specifications of the master module in use is used. (www.cc-link.org) • Disconnect Ethernet cables, and then reconnect them. • Turn off and on the hub power supply.

Point

If link-up processing is repeated due to a condition of a device on the line, it may take longer for the P1 LINK LED/P2 LINK LED to turn on. This phenomenon may be eliminated by changing the connector of the relevant module to which the Ethernet cable is connected (example: P1 → P2).

For the wiring of Ethernet cable, refer to the following.

☞ Page 32 Wiring of Ethernet Cable

When the DATA LINK LED turns off

When the DATA LINK LED turns off, check the following items.

Check item	Action
Is the Ethernet cable used compliant with the relevant standard?	Replace the cable with an Ethernet cable compliant with the relevant standard. ☞ User's manual for the master/local module used
Is the segment length 100m or less?	Change the segment length to 100m or less.
Does the cabling condition (bending radius) meet the specifications?	Refer to the manual for the Ethernet cable used, and correct the bend radius.
Is any Ethernet cable disconnected?	Replace the Ethernet cable.
Do the hub and other stations used operate normally?	<ul style="list-style-type: none"> • Check that the hub and the power supplies of the other stations are turned on. • Check that the hub compliant with the specifications of the master module in use is used. (www.cc-link.org) • Disconnect Ethernet cables, and then reconnect them. • Turn off and on the hub power supply.
Does the master station connected to the network operate normally?	<ul style="list-style-type: none"> • If an error occurs in the master station, clear the error in the master station. • Check that the master station in use is a supported master station. (☞ Page 19 Supported master station)
Is the station number of the D/A converter module duplicated with that of any other stations?	If two or more stations are set with the same station number, change the settings so that their station numbers are different from each other.
Is another device that operates using a network other than CC-Link IE Field Network connected between the master station and the D/A converter module?	Remove the device that operates using the network other than CC-Link IE Field Network. If the operating network can be switched on the device, use CC-Link IE Field Network.
Are the IP address/station number setting switches set to a value other than 1 to 120?	For the station number setting, the effective range is 1 to 120. Change the setting within the range from 1 to 120.
Is function setting switch 1 turned on?	Turn on function setting switch 1 if it is turned off, and turn off and on the module power supply.

When the DATA LINK LED flashes

When the DATA LINK LED flashes, check the following items.

Check item	Action
Does the station number setting of the D/A converter module match the station number of the D/A converter module set in the network configuration settings of the master station or in the CC IE Field Configuration settings?	Match the station number of the D/A converter module with the station number set in the network configuration settings of the master station or in the CC IE Field Configuration settings.
Does the station type match?	Match the station type of the D/A converter module with the station type that is set in the network configuration settings of the master station.
Is the D/A converter module a reserved station?	Change the setting of reserved/invalid error station to other than the reserved station in the network configuration settings of the master station.
Is link stop displayed in the "CC-Link IE TSN/CC-Link IE Field Diagnostics" window?	Check the link status in the "CC-Link IE TSN/CC-Link IE Field Diagnostics" window, and start the link if the link is stopped.
Are the IP address/station number setting switches set to a value other than 1 to 120?	For the station number setting, the effective range is 1 to 120. Change the setting within the range from 1 to 120.
Has the connection been changed from the connected master/local station to a master/local module with a different network number?	<ul style="list-style-type: none">• Reconnect to the previous master/local module.• To communicate with a master/local module with a different network number, power off and on the D/A converter module.

10.3 Unit Test

The purpose of a unit test is to check if there is any abnormality in the D/A converter module.

- 1.** Turn off the power supply of the D/A converter module.
- 2.** Connect P1 and P2 of the D/A converter module with an Ethernet cable.
- 3.** Set the IP address/station number setting switches and the function setting switches as follows.
 - IP address/station number setting switch (x1): Any position
 - IP address/station number setting switch (x16): F
 - Function setting switch 1: ON
 - Function setting switch 2 to function setting switch 10: Any position
- 4.** Power on the power supply of the D/A converter module.
- 5.** Unit test begins.

The RUN LED flashes during the unit test.

- 6.** The RUN LED turns on when the unit test is completed.
 - When completed normally, the ERR. LED does not turn on, remaining off.
 - When completed with an error, the ERR. LED turns on. If the test is completed with an error, replace the Ethernet cable and run the test again. If the test is completed with an error again, it may be due to a hardware failure in the D/A converter module. Please consult your local Mitsubishi representative.

10.4 Troubleshooting by Symptom

Troubleshooting by symptom is suitable for the case where modules fail to operate normally even though no error has occurred in the D/A converter module. If an error occurs in the D/A converter module, identify the cause of the error using the engineering tool.

When the analog output value is not read

When the analog output value is not read, check the following items.

Check item	Action
Is there any problem with the wiring, such as looseness or disconnection of analog signal lines?	Check the faulty area by checking signal line visually or conductively.
Does the voltage of the module power supplied externally reach to the voltage of the performance specifications?	Verify that the voltage of the module power supply lies in the range of performance specifications.  Page 14 Performance Specifications
Is the CPU module in the STOP status?	Change the status of the CPU module to RUN.
Is the output range setting correct?	<ul style="list-style-type: none"> • Check Output range switch enable/disable setting status flag (RXC) for the output range switch enable/disable setting. • If Output range switch enable/disable setting status flag (RXC) is enabled, check the setting of the function setting switch 3 to 10. Change any incorrect settings, and turn off and on the module power supply. • If Output range switch enable/disable setting status flag (RXC) is disabled, check the range setting (address: 0103H) using the engineering tool or dedicated instruction. If the output range setting is incorrect, correct it by the program or the parameter settings.
Is D/A conversion disabled for the channels where the analog value is to be output?	Check D/A conversion enable/disable setting (address: 0102H) by using the engineering tool or the dedicated instruction. Then, set D/A conversion enabled by program or parameter setting.
Is Initial data setting request flag (RY9) executed?	Check that the analog value is output properly after turning on and off Initial data setting request flag (RY9) using the engineering tool. If the analog output is performed properly, check the program again.
Is CH□ Output enable/disable flag (RY10 to RY13) set to OFF for the channels where the analog value is to be output?	Check the setting for CH□ Output enable/disable flag (RY10 to RY13) on the monitor of the engineering tool. When CH□ Output enable/disable flag (RY10 to RY13) is turned off, check the program again.
Is a digital value written to the channel where the analog value is to be output?	Check the setting for CH□ Digital value (RWw2 to RWw5) on the monitor of the engineering tool.

Point

If the analog output value cannot be read even after the above actions are taken, the failure of the D/A converter module is a possible cause.

Please consult your local Mitsubishi representative.

When the analog output value is not held

When the analog output value is not held, check the following items.

Check item	Action
Is the setting for the analog output HOLD/CLEAR setting function correct?	Set HOLD for the analog output HOLD/CLEAR setting function using the engineering tool. Also check the setting value of Analog output HOLD/CLEAR setting (address: 0105H).

10

When parameter read/write or CC-Link IE Field Network diagnostics fail

When parameter read/write or CC-Link IE Field Network diagnostics cannot be performed, check the following items.

Check item	Action
Is the DATA LINK LED of the D/A converter module on?	Check the DATA LINK LED of the D/A converter module and if it is not on, perform troubleshooting by referring to the following. ☞ Page 89 When the DATA LINK LED turns off ☞ Page 90 When the DATA LINK LED flashes Check for other LEDs by referring to the following. ☞ Page 88 Checking the LEDs
Is the version of the engineering tool supported?	Check the version of the engineering tool, and if it is older than the supported versions, upgrade it.
Are network parameter settings same as the settings of the CPU module?	Perform "Verify with PLC" and check that network parameter settings match the settings of the CPU module. If they differ, match the settings by performing "Read from PLC" and "Write to PLC", and write the parameters to modules on device stations.

Point

If parameter read/write or CC-Link IE Field Network diagnostics read cannot be performed even after the above actions are taken, failure of the D/A converter module is a possible cause.
Please consult your local Mitsubishi representative.

10.5 How to Check Error Codes and Alarm Codes

Error and alarm codes can be checked with the following methods.

- Checking by using CC-Link IE TSN/CC-Link IE Field diagnostics
- Checking by Latest error code (RWr0)
- Checking by Latest alarm code (RWr1)
- Checking by using CC IE Field configuration

Checking by using CC-Link IE TSN/CC-Link IE Field diagnostics

The error history held in the D/A converter module can be read. Errors that occurred before powering-off can be checked as well.

Point

- The error history records a maximum of 15 errors in reverse chronological order of occurrence. If 16 or more errors occur, errors are deleted from the oldest.
- If the same error occurs continuously, only the error that occurred first is stored to the error history.
- The error history is stored in the flash memory in the D/A converter module, and it remains even when the power is cut off. However, when the upper limit for the number of writes to the flash memory is reached, the error history cannot be stored in the flash memory.
- "Occurrence Date" information in the error history is recorded after clock information is distributed from the master station. When an error occurs before clock information is distributed from the master station, occurrence date information is not recorded.

Operating procedure

1. Connect the engineering tool to the CPU module.
2. Start CC-Link IE TSN/CC-Link IE Field diagnostics from the menu.
🔗 [Diagnostics] ⇒ [CC-Link IE TSN/CC-Link IE Field Diagnostics]
3. Right-click the device station whose error history is to be checked, and select "Error History".
4. Follow the on-screen instructions and click the [Yes] button.
5. The error history is displayed.

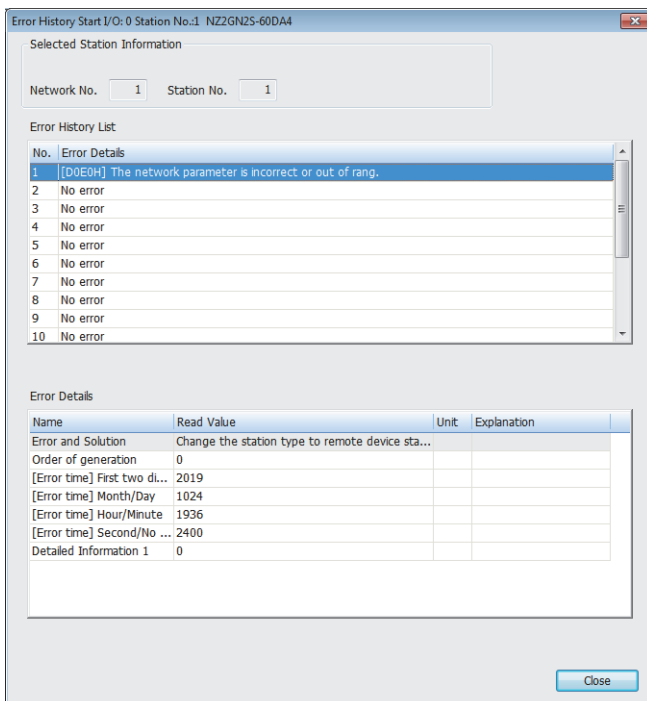

Checking by Latest error code (RWr0)

Check the latest error code with the remote register of the master/local module.

Operating procedure

 [Online] ⇒ [Monitor] ⇒ [Device/Buffer Memory Batch Monitor]

Ex.

When the refresh target device for Latest error code (RWr0) is W1100

<input checked="" type="radio"/> Device Name W1100 Detailed Cond		
<input type="radio"/> Buffer Memory Unit: (HEX) Address:		
Device Name	F E D C B A 9 8 7 6 5 4 3 2 1 0	Current Value
W1100	0 0 0 1 0 0 0 0 0 0 0 1 1 0 0 0	1030
W1101	0 0 0 0 0 0 0 0 0 0 0 0 0 0 0 0	0000

How to clear an error

How to clear an error depends on the error type.

Error type	How to clear an error
Major error	An error cannot be cleared.
Moderate error	Eliminate the error cause, and power off and on the D/A converter module. Or turn on and off Error clear request flag (RYA).
Minor error	Eliminate the error cause, and power off and on the D/A converter module. Or turn on and off Error clear request flag (RYA).
Communication system error	Eliminate the error cause. Clearing the error is not necessary.

Point

A communication system error is not stored in the latest error code (RWr0), but is stored only in the error history.

■How to clear an error using the command execution of device station

Follow the procedure below to clear an error using the command execution of device station.

Operating procedure

1. Select a D/A converter module from the station list on the "CC IE Field Configuration" window.
2. Open the "Command Execution of Device Station" window.

Right-click on the target D/A converter module ⇒ [Online] ⇒ [Command Execution of Device Station]

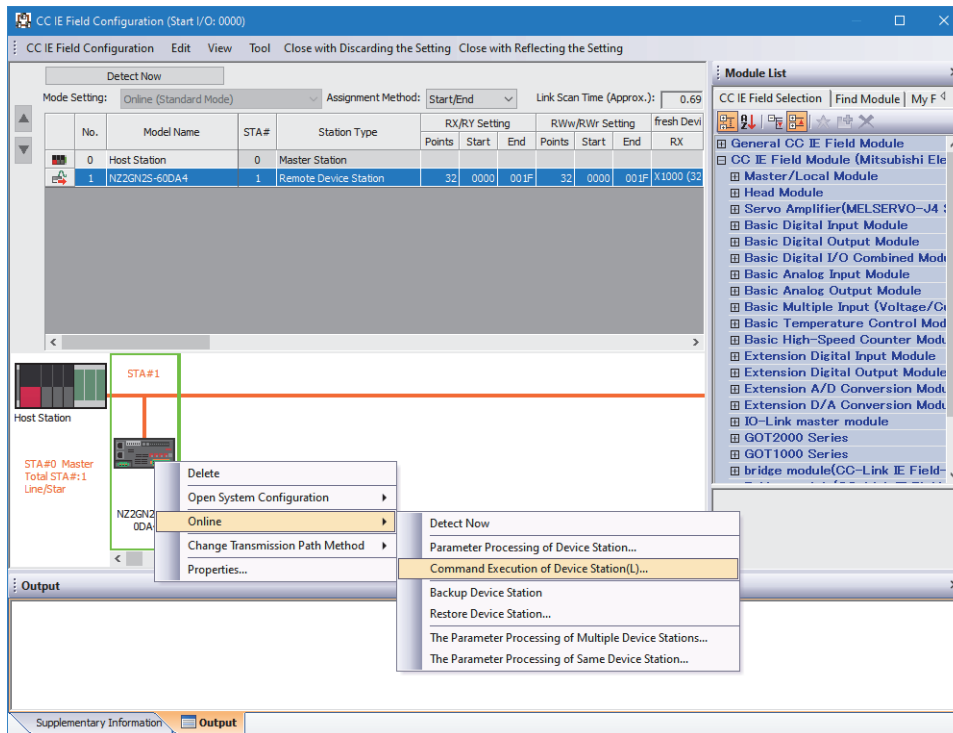

3. Set "Method selection" to "Error clear request", and click the [Execute] button.

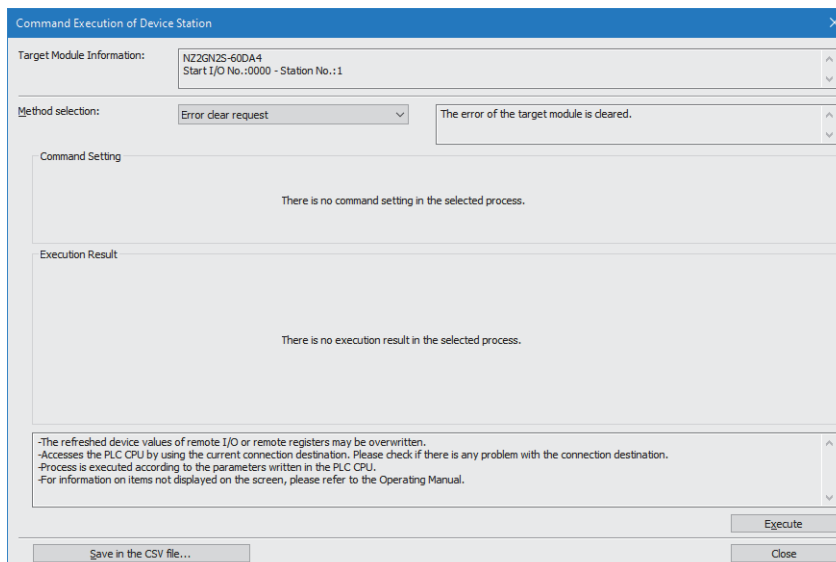

4. When the following window appears, click the [Yes] button.

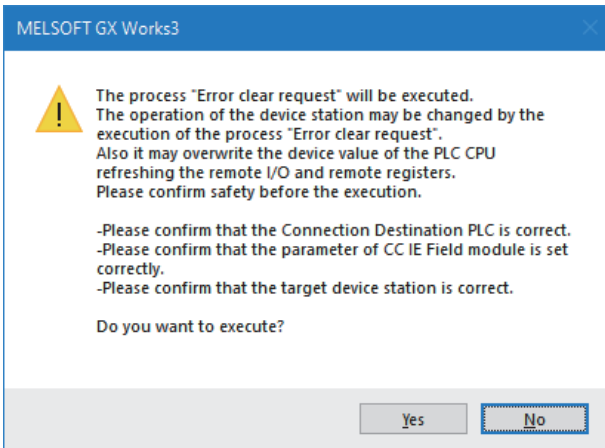
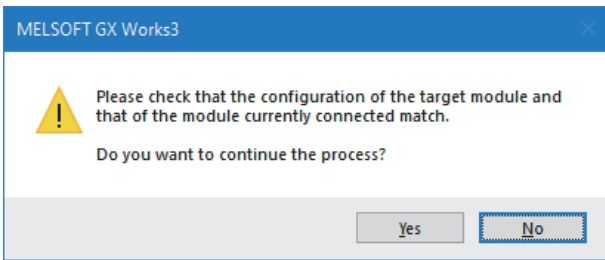

5. When the following window appears, click the [OK] button.

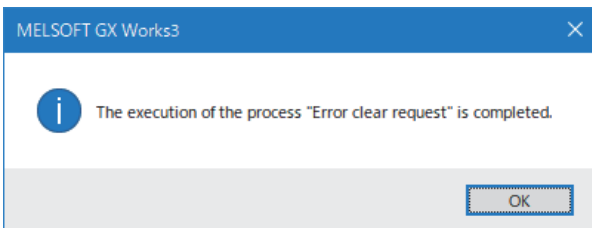

6. An error on the D/A converter module is cleared.

Checking by Latest alarm code (RWr1)

Check the latest alarm code with the remote register of the master/local module.

Operating procedure

[Online] ⇒ [Monitor] ⇒ [Device/Buffer Memory Batch Monitor]

Ex.

When the refresh target device for Latest alarm code (RWr1) is W1101

Device Name	F	E	D	C	B	A	9	8	7	6	5	4	3	2	1	0	Current Value
W1100	0	0	0	0	0	0	0	0	0	0	0	0	0	0	0	0	0000
W1101	0	0	0	0	1	1	0	0	0	0	0	0	0	0	0	1	0001

Checking by using CC IE Field configuration

■ How to check an error using the command execution of device station

Follow the procedure below to check an error using the command execution of device station.

Operating procedure

1. Select a D/A converter module from the station list on the "CC IE Field Configuration" window.
2. Open the "Command Execution of Device Station" window.

Right-click on the target D/A converter module ⇒ [Online] ⇒ [Command Execution of Device Station]

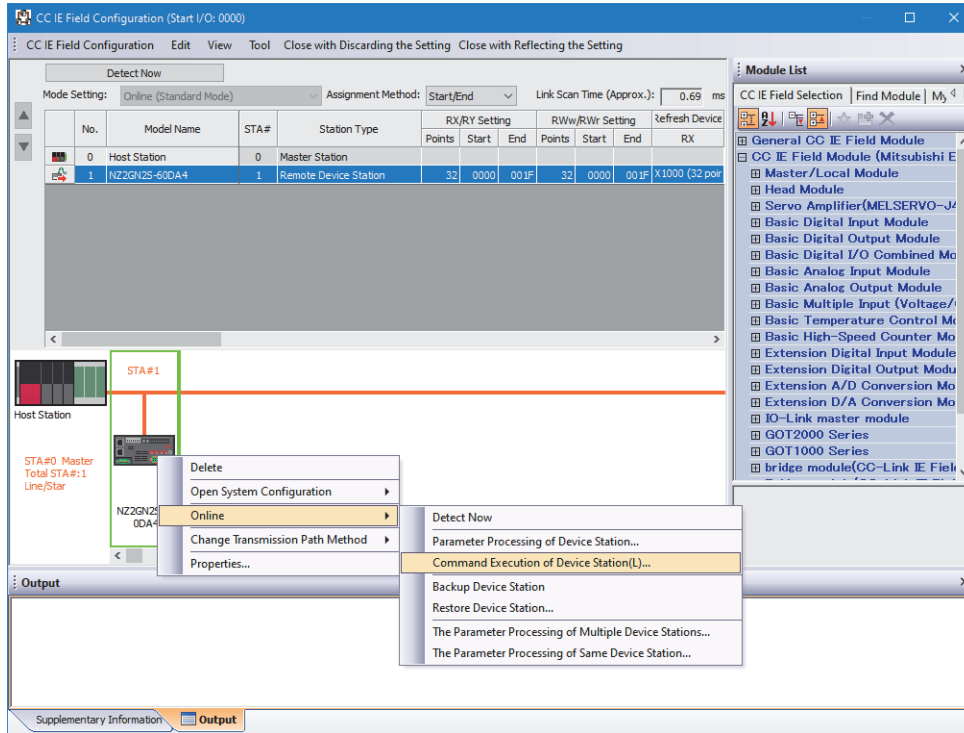

3. Set "Method selection" to "Error history read" and click the [Execute] button.

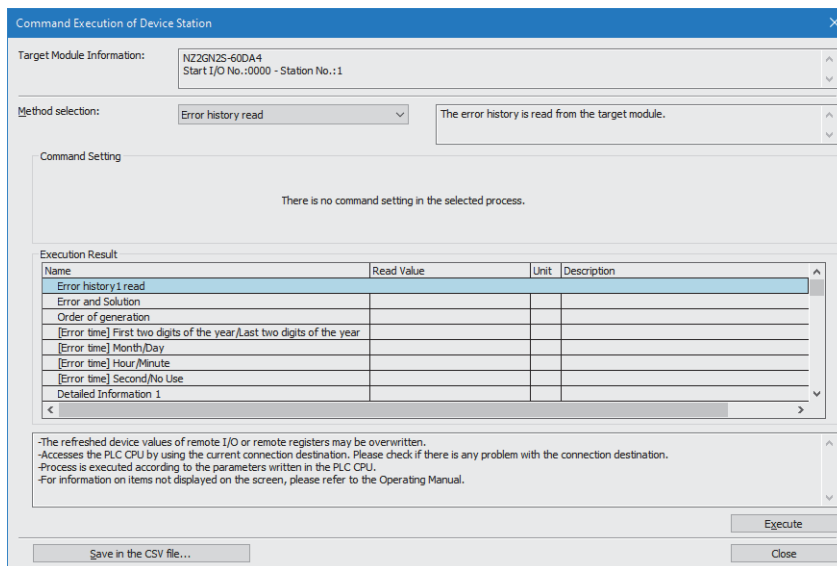

4. When the following window appears, click the [Yes] button.

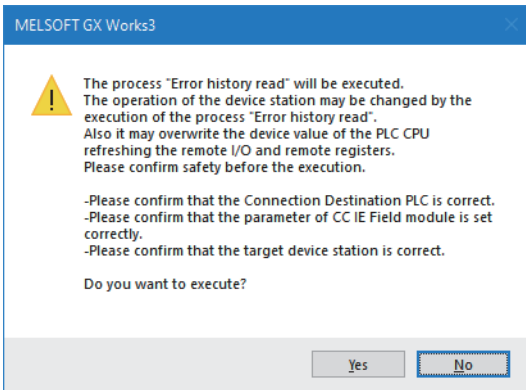
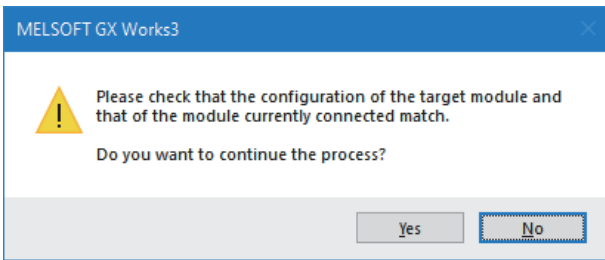

5. When the following window appears, click the [OK] button.

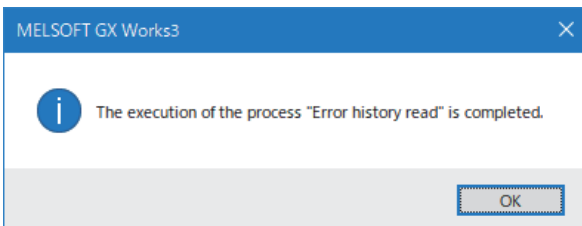

6. The error history of the D/A converter module is displayed in "Execution Result".

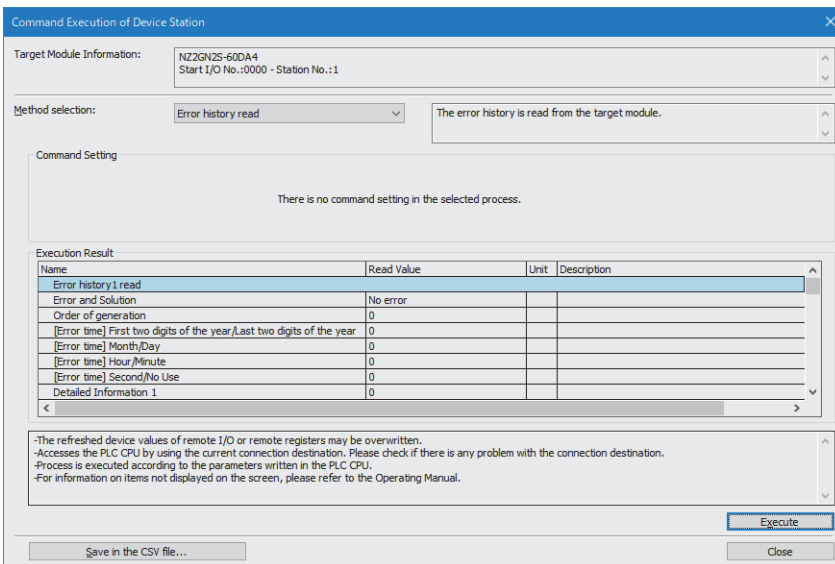

To initialize the error history, set "Method selection" to "Error history clear request" on the "Command Execution of Device Station" window and click the [Execute] button.

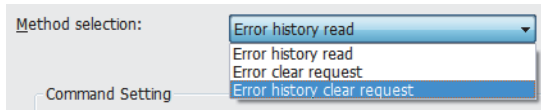

10.6 Error Code List

The error codes are classified into the following three types.

Classification	Description
Major error	This error is a sign that recovery is impossible, with the RUN LED turning off.
Moderate error	This error is a sign that the module cannot continue to operate, with the ERR. LED turning on.
Minor error	This error is a sign that the module can continue to operate, with the ERR. LED flashing.

If any of these errors occurs, check that the DATA LINK LED lights up, and take the corrective actions corresponding to the error code with the list below.

□ indicates the channel number where the error occurred.

(Address: 01××H) indicates the address where the error occurred.

Error code (hexadecimal)	Classification	Error name	Description and cause	Action
1020H ^{*1}	Minor error	Remote buffer memory access error	A buffer memory area other than the remote buffer memory areas has been accessed using the REMFR/REMTO instruction.	Correct the setting data of the REMFR/REMTO instruction to access the remote buffer memory.
1030H ^{*1}	Minor error	IP address/station number setting switch changed error	An IP address/station number setting switch has been changed with the module power supply on.	Return the IP address/station number setting switch to the setting it had when the module was powered on.
1041H ^{*1}	Minor error	Function setting switch 1 changed error	The function setting switch 1 has been changed with the module power supply on.	Return the function setting switch 1 to the setting when the module power supply was on.
1042H ^{*1}	Minor error	Function setting switch 2 changed error	The function setting switch 2 has been changed with the module power supply on.	Return the function setting switch 2 to the setting when the module power supply was on.
1043H ^{*1}	Minor error	Function setting switch 3 changed error	The function setting switch 3 has been changed with the module power supply on.	Return the function setting switch 3 to the setting when the module power supply was on.
1044H ^{*1}	Minor error	Function setting switch 4 changed error	The function setting switch 4 has been changed with the module power supply on.	Return the function setting switch 4 to the setting when the module power supply was on.
1045H ^{*1}	Minor error	Function setting switch 5 changed error	The function setting switch 5 has been changed with the module power supply on.	Return the function setting switch 5 to the setting when the module power supply was on.
1046H ^{*1}	Minor error	Function setting switch 6 changed error	The function setting switch 6 has been changed with the module power supply on.	Return the function setting switch 6 to the setting when the module power supply was on.
1047H ^{*1}	Minor error	Function setting switch 7 changed error	The function setting switch 7 has been changed with the module power supply on.	Return the function setting switch 7 to the setting when the module power supply was on.
1048H ^{*1}	Minor error	Function setting switch 8 changed error	The function setting switch 8 has been changed with the module power supply on.	Return the function setting switch 8 to the setting when the module power supply was on.
1049H ^{*1}	Minor error	Function setting switch 9 changed error	The function setting switch 9 has been changed with the module power supply on.	Return the function setting switch 9 to the setting when the module power supply was on.
104AH ^{*1}	Minor error	Function setting switch 10 changed error	The function setting switch 10 has been changed with the module power supply on.	Return the function setting switch 10 to the setting when the module power supply was on.
1050H ^{*1}	Minor error	Error history save limit error	The upper limit for the number of times an error is saved in the error history is reached.	No more errors can be saved in the error history. Check the error by the latest error code.
1052H ^{*1}	Minor error	Module parameter save limit error	The upper limit for the number of times a module parameter is saved is reached.	A module parameter change made when and after this error occurred is not saved into the non-volatile memory.

Error code (hexadecimal)	Classification	Error name	Description and cause	Action
1060H ¹	Minor error	Non-volatile memory access error (error history)	The error cannot be saved because an error in access to the non-volatile memory was detected.	<ul style="list-style-type: none"> An error that occurred at the time of or before this error may not be saved in the non-volatile memory. Take measures to reduce noise, such as using a shielded cable for connection. If this error persists, the failure of the module is a possible cause. Please consult your local Mitsubishi representative.
1062H ¹	Minor error	Non-volatile memory access error (module parameter)	The module parameters cannot be saved because an error in access to the non-volatile memory was detected.	<ul style="list-style-type: none"> The module parameters are not saved in the non-volatile memory. Take measures to reduce noise, such as using a shielded cable for connection. If this error persists, the failure of the module is a possible cause. Please consult your local Mitsubishi representative.
1080H ¹	Minor error	Module power supply voltage drop error	The module power supply voltage is dropped.	<ul style="list-style-type: none"> Check the state of the module power supply. Check if the power supply voltage satisfies the specifications for the module.
1090H ¹	Minor error	Remote reset disable error	Remote reset could not be performed because the setting of function setting switch 1 is different from the setting it had when the module was powered on.	Return function setting switch 1 to the setting it had when the module was powered on, and then perform remote reset again.
190□H ¹	Minor error	CH□ Out-of-range digital value	The value in CH□ Digital value (RWw2 to RWw5) is out of the range.	Set the value in CH□ Digital value (RWw2 to RWw5) within the allowable range.
2010H ²	Moderate error	Non-volatile memory data error (parameter)	The parameter data stored in the non-volatile memory are abnormal.	<ul style="list-style-type: none"> To set the parameters of the non-volatile memory back to their default, change Parameter area initialization command (address: 1002H) as follows: Not commanded (0)→Commanded (1)→Not commanded (0), and turn off and on the module power supply. After that, set the parameters again. Take measures to reduce noise, such as using a shielded cable for connection. If this error persists, the failure of the module is a possible cause. Please consult your local Mitsubishi representative.
2E10H ²	Moderate error	IP address/station number setting switch out of range error (station number)	The IP address/station number setting switches are set to a value other than 1 to 120.	Turn on the power supply with the IP address/station number setting switches set to a value in the range 1 to 120.
310□H ¹	Moderate error	CH□ Range setting out-of-range	The value set in CH□ Range setting (address: 0103H) is out of the setting range.	Set the value of CH□ Range setting (address: 0103H) within the allowable range.
330□H ¹	Moderate error	CH□ Warning output upper/lower limit value inversion	CH□ Warning output upper limit value (address: 01××H) and CH□ Warning output lower limit value (address: 01××H) are set such that the lower limit value is equal to or greater than the upper limit value.	Set CH□ Warning output upper limit value (address: 01××H) and CH□ Warning output lower limit value (address: 01××H) such that the lower limit value is smaller than the upper limit value.
350□H ¹	Moderate error	CH□ Scaling setting out-of-range	CH□ Scaling lower limit value (address: 01××H) and CH□ Scaling upper limit value (address: 01××H) are set to values out of the range from -32000 to 32000.	Set CH□ Scaling lower limit value (address: 01××H) and CH□ Scaling upper limit value (address: 01××H) to values that fall within the range from -32000 to 32000.

Error code (hexadecimal)	Classification	Error name	Description and cause	Action
351□H ^{*1}	Moderate error	CH□ Scaling setting upper/lower limit inversion	CH□ Scaling lower limit value (address: 01××H) and CH□ Scaling upper limit value (address: 01××H) are set such that the scaling lower limit value is equal to or greater than the scaling upper limit value.	Set CH□ Scaling lower limit value (address: 01××H) and CH□ Scaling upper limit value (address: 01××H) such that the scaling lower limit value is smaller than the scaling upper limit value.
3610H ^{*3}	Moderate error	Operating condition setting change disable error	While the output range switch enable/disable setting is enabled, Initial data setting request flag (RY9) is turned on, parameters are written from the engineering tool, or module parameter initialization is executed by Parameter area initialization command (address: 1002H).	Set the output range switch enable/disable setting to disable when turning on Initial data setting request flag (RY9), writing parameters from the engineering tool, or executing Parameter area initialization command (address: 1002H).
3C00H	Major error	Hardware error	Module hardware error	<ul style="list-style-type: none"> • Turn off and on the module power supply. • If this error persists, the failure of the module is a possible cause. Please consult your local Mitsubishi representative.

*1 The error can be cleared by turning on and off Error clear request flag (RYA), or turning on and off Initial data setting request flag (RY9).

*2 The error cannot be cleared by turning on and off Error clear request flag (RYA), or turning on and off Initial data setting request flag (RY9). After clearing the error, turn off and on the power supply or perform a remote reset.

*3 The error can be cleared by turning on and off Error clear request flag (RYA).

Point

When multiple errors occur, only the latest error code is stored in Latest error code (RWr0).

Communication system error codes

■Communication system error with the DATA LINK LED flashing or turned off

Communication system error with the DATA LINK LED flashing or turned off when the error occurs. Perform troubleshooting using CC-Link IE TSN/CC-Link IE Field diagnostics in the engineering tool.

Error code (hexadecimal)	Classification	Error name	Description and cause	Action
D0E0H	Communication system error	Station type mismatch	The network parameter is incorrect or outside the range.	In the network configuration settings of the master station, change the station type for the module to remote device station.
D0E1H	Communication system error	Own station reserved	The network parameter is incorrect or outside the range.	In the network configuration settings of the master station, cancel the reserved station specification. Change the station number of the module to a station number that is not reserved.
D0E2H	Communication system error	Station number in use (own station)	The station number setting is incorrect.	Set a unique station number. After taking the above action, turn off and on the module power supply for all the stations where the station number in use error was detected.
D0E3H	Communication system error	Own station No. out of range	The network parameter is incorrect or outside the range.	Add the station information of the module in the network configuration settings of the master station.

■Communication system error with the DATA LINK LED not changing

Communication system error with the DATA LINK LED not changing when the error occurs. This error is automatically resolved after its occurrence, and it is not displayed in CC-Link IE TSN/CC-Link IE Field diagnostics of the engineering tool. Therefore, perform troubleshooting using the error history read process from the CC IE Field Configuration settings of the engineering tool.

Error code (hexadecimal)	Classification	Error name	Description and cause	Action
D217H	Communication system error	Transient data request command error	The transient data request command is incorrect.	Correct the request command at the transient request source, and retry the operation.
D2A0H	Communication system error	Receive buffer full	The target station is overloaded and cannot receive transient data communication.	Check the network status using the CC-Link IE TSN/CC-Link IE Field diagnostics of the engineering tool, and take corrective action. When the target station is overloaded and cannot receive transient data communication, send the data from the send source after some time has passed.
D2A3H	Communication system error	Transient data length error	The received transient data is incorrect.	Correct the amount of data (frame length) at the transient request source, and retry the operation.
DF01H	Communication system error	Transient data divided error	Divided transient data has been received.	Set the transient data size to a value that can be handled by the module, correct the data to be undivided transient data, and send the data again.

10.7 Alarm Code List

Here is the list of alarm codes:

□ indicates the number of the channel where an alarm has occurred.

Alarm code (hexadecimal)	Classification	Alarm name	Description and cause	Action
0C0□H	Minor error	CH□ Warning (upper limit) occurrence	CH□ Warning (upper limit) has occurred.	Reset CH□ Digital value (RWw2 to RWw5) to a value within the setting range, and turn on and off Warning output clear request flag (RY1E).
0C1□H	Minor error	CH□ Warning (lower limit) occurrence	CH□ Warning (lower limit) has occurred.	Reset CH□ Digital value (RWw2 to RWw5) to a value within the setting range, and turn on and off Warning output clear request flag (RY1E).

10



When multiple alarms occur, only the latest alarm code is stored in Latest alarm code (RWr1).

10.8 Error Log Display Specifications

Histories of error and alarm occurrences related to the D/A converter module are registered to the error log of the D/A converter module. For details, refer to the following.

 Page 121 Error history area

The following table lists the error code details for the error log.

□ indicates the number of the channel where an alarm/error has occurred.

Error code/alarm code	Error name	Description
1020H	Remote buffer memory access error	— (No detailed information)
1030H	IP address/station number setting switch changed error	— (No detailed information)
1041H	Function setting switch 1 changed error	— (No detailed information)
1042H	Function setting switch 2 changed error	— (No detailed information)
1043H	Function setting switch 3 changed error	— (No detailed information)
1044H	Function setting switch 4 changed error	— (No detailed information)
1045H	Function setting switch 5 changed error	— (No detailed information)
1046H	Function setting switch 6 changed error	— (No detailed information)
1047H	Function setting switch 7 changed error	— (No detailed information)
1048H	Function setting switch 8 changed error	— (No detailed information)
1049H	Function setting switch 9 changed error	— (No detailed information)
104AH	Function setting switch 10 changed error	— (No detailed information)
1050H	Error history save limit error	— (No detailed information)
1052H	Module parameter save limit error	— (No detailed information)
1060H	Non-volatile memory access error (error history)	— (No detailed information)
1062H	Non-volatile memory access error (module parameter)	— (No detailed information)
1080H	Module power supply voltage drop error	— (No detailed information)
1090H	Remote reset disable error	— (No detailed information)
109□H	CH□ Out-of-range digital value	Detailed information 1: Digital value
2010H	Non-volatile memory data error (parameter)	— (No detailed information)
2E10H	IP address/station number setting switch out of range error (station number)	— (No detailed information)
310□H	CH□ Range setting out-of-range	— (No detailed information)
330□H	CH□ Warning output upper/lower limit value inversion	— (No detailed information)
350□H	CH□ Scaling setting out-of-range	— (No detailed information)
351□H	CH□ Scaling setting upper/lower limit inversion	— (No detailed information)
3610H	Operating condition setting change disable error	— (No detailed information)
3C00H	Hardware error	— (No detailed information)
0C0□H	CH□ Warning (upper limit) occurrence	Detailed information 1: Digital value
0C1□H	CH□ Warning (lower limit) occurrence	Detailed information 1: Digital value
D0E0H	Station type mismatch	— (No detailed information)
D0E1H	Own station reserved	— (No detailed information)
D0E2H	Station number in use (own station)	— (No detailed information)
D0E3H	Own station No. out of range	— (No detailed information)
D217H	Transient data request command error	— (No detailed information)
D2A0H	Receive buffer full	— (No detailed information)
D2A3H	Transient data length error	— (No detailed information)
DF01H	Transient data divided error	— (No detailed information)

Point

- For the digital value in Detailed information 1, set the digital value when the warning occurrence was detected.
- When the description for Detailed information is "— (No detailed information)", Detailed information 1 is fixed to 0.

APPENDICES

Appendix 1 Remote I/O Signal

List of remote I/O signals

This section lists I/O signals for a master/local module.

The I/O signals assignment shown assumes that the remote I/O signals of the D/A converter module are assigned to RX0 to RX2F and RY0 to RY2F.

Remote input (RX) indicates an input signal from the D/A converter module to the master/local module.

Remote output (RY) indicates the output signal from the master/local module to the D/A converter module.

Point

Do not use any "Use prohibited" remote I/O signals. Doing so may result in an accident due to an incorrect output or malfunction.

Remote input signals

Device number	Name
RX0 to RX8	Use prohibited
RX9	Initial data setting completion flag
RXA	Error flag
RXB	Remote READY
RXC	Output range switch enable/disable setting status flag
RXD to RX1D	Use prohibited
RX1E	Warning output signal
RX1F to RX2F	Use prohibited

Remote output signals

Device number	Name
RY0 to RY8	Use prohibited
RY9	Initial data setting request flag
RYA	Error clear request flag
RYB to RYF	Use prohibited
RY10	CH1 Output enable/disable flag
RY11	CH2 Output enable/disable flag
RY12	CH3 Output enable/disable flag
RY13	CH4 Output enable/disable flag
RY14 to RY1D	Use prohibited
RY1E	Warning output clear request flag
RY1F to RY2F	Use prohibited

A

Details of remote input signals

Initial data setting completion flag

■Device number

Name	Device number
Initial data setting completion flag	RX9

■Description

This flag turns on when the following is performed and the operation conditions are changed.

1. Write the parameter data to a remote buffer memory area using the REMTO instruction.
2. Turn on Initial data setting request flag (RY9).

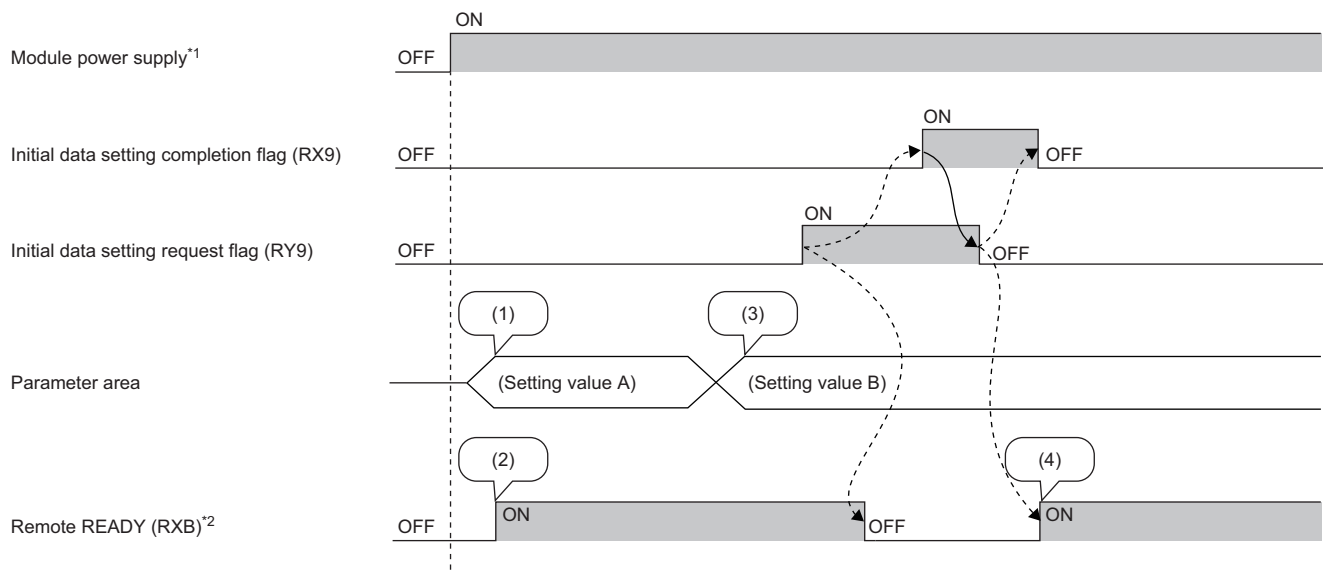

-----> Executed by the D/A converter module

—————> Executed by the program

(1) The setting is read from the non-volatile memory.

(2) With Setting value A, action starts.

(3) The setting value is changed by the user.

(4) Action with Parameter setting value B starts in this timing.

*1 For data link to be made at the power-on of the module power supply

*2 When turning on and off Initial data setting request flag (RY9), check that Remote READY (RXB) turns on before starting the control. Use Initial data setting completion flag as an interlock condition for turning on and off Initial data setting request flag (RY9) when changing the following settings.

- D/A conversion enable/disable setting (address: 0102H)
- Range setting (address: 0103H)
- Analog output HOLD/CLEAR setting (address: 0105H)
- Warning output setting (address: 0107H)
- CH1 Warning output upper limit value (address: 0108H) to CH4 Warning output lower limit value (address: 010FH)
- Scaling enable/disable setting (address: 0118H)
- CH1 Scaling lower limit value (address: 0119H) to CH4 Scaling upper limit value (address: 0120H)

Error flag

■ Device number

Name	Device number
Error flag	RXA

■ Description

Error flag (RXA) turns on when an error occurs.

To clear Latest error code (RWr0), turn on and off Error clear request flag (RYA).

- Minor error

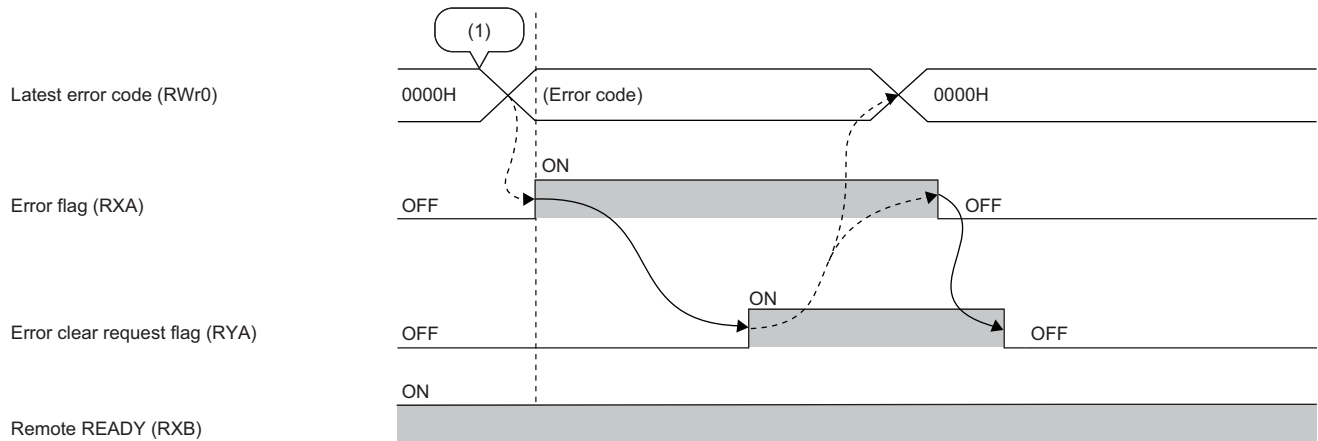

-----> Executed by the D/A converter module

—————> Executed by the program

(1) An error occurs.

- Moderate error

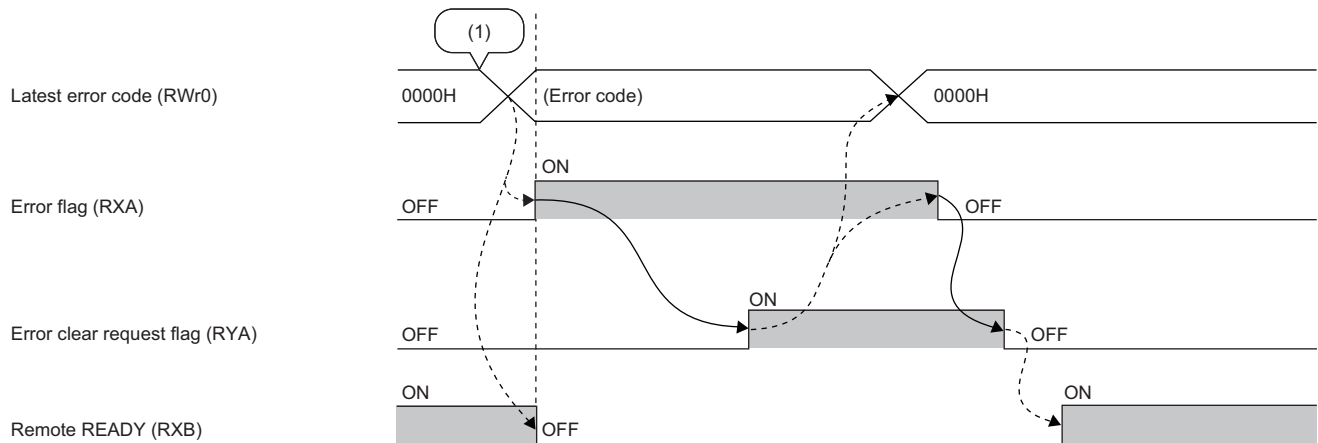

-----> Executed by the D/A converter module

—————> Executed by the program

(1) An error occurs.

- Major error

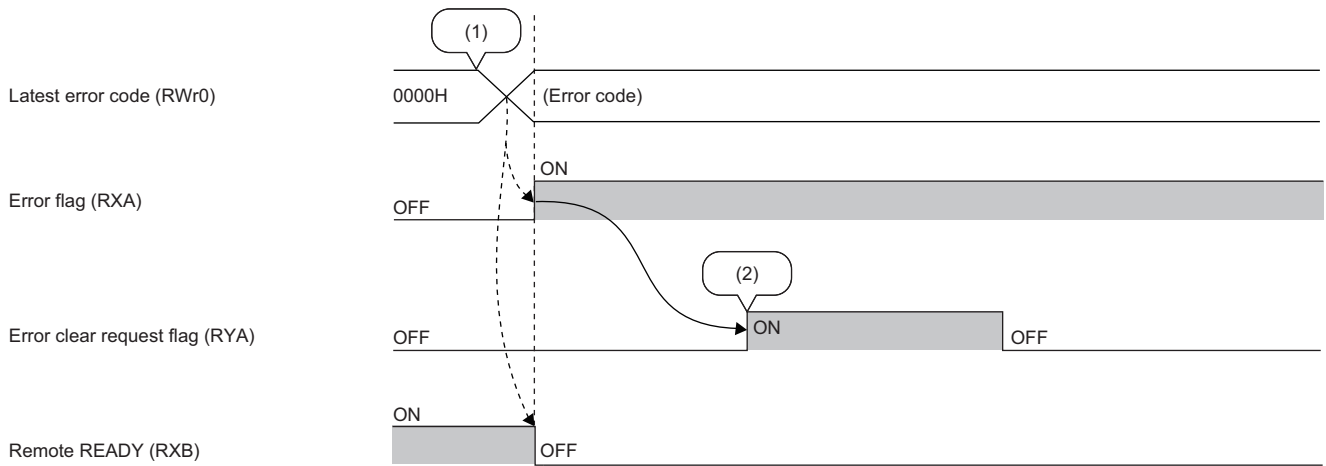

-----> Executed by the D/A converter module
 -----> Executed by the program

- (1) An error occurs.
- (2) When a major error occurs, it is not cleared even by executing an error clear request.

Remote READY

■Device number

Name	Device number
Remote READY	RXB

■Description

This signal turns on when the module power supply is turned on.

This signal is used as an interlock condition when the master station reads/writes data from/to the remote register or remote buffer memory areas of the D/A converter module.

Remote READY (RXB) turns off when a moderate error or major error occurs.

Output range switch enable/disable setting status flag

■Device number

Name	Device number
Output range switch enable/disable setting status flag	RXC

■Description

This flag can be used to check the output range switch enable/disable setting status.

- Enable: ON
- Disable: OFF

The output range switch enable/disable setting status is set with the function setting switch. (☞ Page 23 Function setting switch setting)

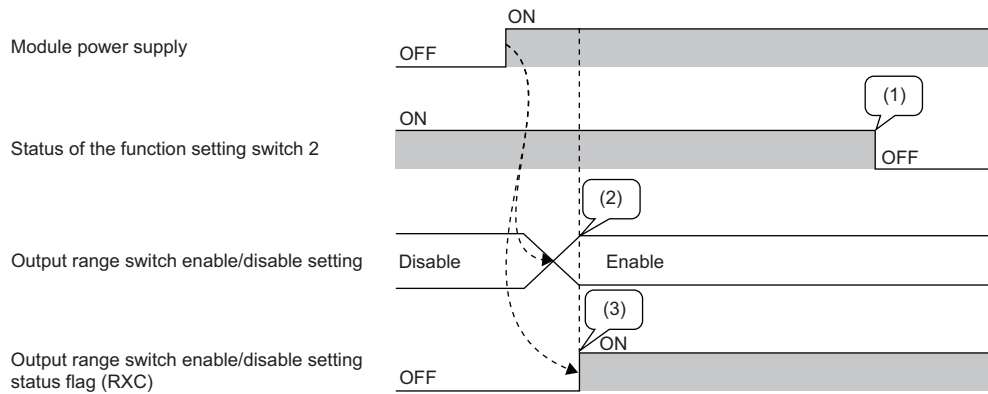

-----> Executed by the D/A converter module

-----> Executed by the program

(1) The output range switch enable/disable setting status is not changed even if the function setting switch 2 is changed while the module is being powered on.

(2) The status of the function setting switch 2 when the module is powered on determines the output range switch enable/disable setting status.

(3) The flag indicates the output range switch enable/disable setting status, not the status of the function setting switch 2.

A

Warning output signal

■Device number

Name	Device number
Warning output signal	RX1E

■Description

This signal turns on if a digital value falls into any of the following conditions even in one channel out of all the channels where D/A conversion is enabled.

- Digital value > Warning output upper limit value
- Digital value < Warning output lower limit value

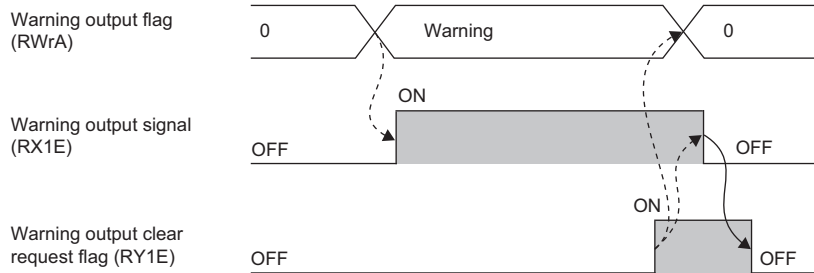

-----> Executed by the D/A converter module

■How to turn off the warning output signal

Turn off the signal by either of the following methods:

- Turning on and off Warning output clear request flag (RY1E)
- Turning on and off Initial data setting request flag (RY9)

An alarm code, if stored in Latest alarm code (RWr1), is cleared.

Details of remote output signals

Initial data setting request flag

■Device number

Name	Device number
Initial data setting request flag	RY9

■Description

Turn on this flag after writing parameter data to the remote buffer memory.

Upon completion of the change of operating conditions, Initial data setting completion flag (RX9) turns on.

For the timing of turning the flag on and off, refer to the following.

☞ Page 108 Initial data setting completion flag

Error clear request flag

■Device number

Name	Device number
Error clear request flag	RYA

■Description

This flag is used to clear Error flag (RXA) and Latest error code (RWr0).

The error history is not cleared even when this flag is turned on.

To clear the error history, use the error history clear command. For details, refer to the following.

☞ Page 128 Error history clear command

■When a minor error or moderate error occurs

Eliminating the cause of the error and turning on Error clear request flag (RYA) allow the error status to be cleared, resulting in Error flag (RXA) turning off.

Before Error flag (RXA) turns off, turning off Error clear request flag (RYA) does not allow Error flag (RXA) to turn off.

For the timing of turning the flag on and off, refer to the following.

☞ Page 109 Error flag

■When a major error occurs

Error flag (RXA) does not turn off even by turning on and off Error clear request flag (RYA).

For the timing of turning the flag on and off, refer to the following.

☞ Page 109 Error flag

Output enable/disable flag

■Device number

Name	Device number			
	CH1	CH2	CH3	CH4
CH□ Output enable/disable flag	RY10	RY11	RY12	RY13

■Description

CH□ Output enable/disable flag (RY10 to RY13) sets whether to output the D/A conversion value or the offset value for each channel.

- On: D/A conversion value
- Off: Offset value

Warning output clear request flag

■ Device number

Name	Device number
Warning output clear request flag	RY1E

■ Description

Turn on and off this flag to clear the warning output.

For the timing of when to turn on and off, refer to the following:

☞ Page 112 Warning output signal

An alarm code, if stored in Latest alarm code (RWr1), is cleared.

Appendix 2 Remote Register

List of remote register areas

This section lists remote register areas for a master/local module.

The remote register area assignment shown assumes that the remote register areas of the D/A converter module are assigned to RWr0 to RWr1F and RWw0 to RWw1F.

Remote register (RWr) is the information input from the D/A converter module to the master/local module.

Remote register (RWw) is the information output from the master/local module to the D/A converter module.

Point

- Do not read or write data from/to any "Use prohibited" remote register areas. Otherwise, an accident may occur due to an incorrect output or malfunction.
- Remote register areas are reset to the initial state when the D/A converter module is powered off and on because the content of remote register areas are not saved in the non-volatile memory of the D/A converter module.

Remote register areas (RWr)

Device number	Name
RWr0	Latest error code
RWr1	Latest alarm code
RWr2	CH1 Set value check code
RWr3	CH2 Set value check code
RWr4	CH3 Set value check code
RWr5	CH4 Set value check code
RWr6 to RWr9	Use prohibited
RWrA	Warning output flag
RWrB to RWr1F	Use prohibited

Remote register areas (RWw)

Device number	Name
RWw0, RWw1	Use prohibited
RWw2	CH1 Digital value
RWw3	CH2 Digital value
RWw4	CH3 Digital value
RWw5	CH4 Digital value
RWw6 to RWwF	Use prohibited
RWw10	CH1 Shifting set value
RWw11	CH2 Shifting set value
RWw12	CH3 Shifting set value
RWw13	CH4 Shifting set value
RWw14 to RWw1F	Use prohibited

A

Details of remote register areas

Latest error code

■Device number

Name	Device number
Latest error code	RWr0

■Description

The error code is stored when an error occurs.

Turning on Error clear request flag (RYA) after eliminating the cause of the error clears the error code.

The errors that have occurred in the past can be checked from the engineering tool. (☞ Page 94 Checking by using CC-Link IE TSN/CC-Link IE Field diagnostics)

Latest alarm code

■Device number

Name	Device number
Latest alarm code	RWr1

■Description

The alarm code is stored when an alarm occurs.

Turning on Warning output request flag (RY1E) after eliminating the cause of the alarm clears the alarm code.

The alarms that have occurred in the past can be checked from the engineering tool. (☞ Page 94 Checking by using CC-Link IE TSN/CC-Link IE Field diagnostics)

Set value check code

■Device number

Name	Device number			
	CH1	CH2	CH3	CH4
CH□ Set value check code	RWr2	RWr3	RWr4	RWr5

■Description

If the set digital value is out of the setting range, the check code is stored.

The following table lists the check codes.

Check code	Description
000FH	A digital value exceeding the setting range is written.
00F0H	A digital value less than the setting range is written.
00FFH	Digital values greater and less than the setting range are written. For example, the check code 00FFH is stored when a digital value less than the setting range is written after a digital value greater than the setting range is written and the check code is not reset.

For all channels, 0000H (within setting range) is stored as the default value.

The stored check code is not cleared even if the digital value falls within the setting range.

■Resetting a check code

After rewriting a digital value with a value in the settable range, there are two methods for resetting a check code.

- Turn on and off Error clear request flag (RYA).
- Turn on and off Initial data setting request flag (RY9).

Warning output flag

■Device number

Name	Device number
Warning output flag	RWrA

■Description

Whether the warning upper limit or warning lower limit is reached can be checked for each channel.

b15	b14	b13	b12	b11	b10	b9	b8	b7	b6	b5	b4	b3	b2	b1	b0
Fixed as 0								CH4		CH3		CH2		CH1	
								(2)	(1)	(2)	(1)	(2)	(1)	(2)	(1)

(1) Upper limit (0: Normal (Default value), 1: Warning occurrence)

(2) Lower limit (0: Normal (Default value), 1: Warning occurrence)

For details on the warning output function, refer to the following:

 Page 63 Warning Output Function

■The state of Warning output flag

On any of the following conditions, Warning (1) is stored to Warning output flag corresponding to each channel.

- Digital value > Warning output upper limit value
- Digital value < Warning output lower limit value

Of the channels where D/A conversion is enabled and warning output is enabled, if a warning is detected even in one channel, Warning output signal (RX1E) turns on.

■Clearing Warning output flag

Warning output flag (RWrA) is cleared by either of the following two methods.

- Turning on and off Warning output clear request flag (RY1E)
- Turning on and off Initial data setting request flag (RY9)

Digital value

■Device number

Name	Device number			
	CH1	CH2	CH3	CH4
CH□ Digital value	RWw2	RWw3	RWw4	RWw5

■Description

This area is where the digital value for D/A conversion from the CPU module is written in 16-bit signed binary data.

Output range setting	Setting range (Actual range)	When a value out of the setting range is written
4 to 20mA	-384 to 16383 (Actual range: 0 to 16000)	16384 or more: 16383 -385 or less: -384
0 to 20mA		
1 to 5V		
0 to 5V		
-10 to 10V	-16384 to 16383 (Actual range: -16000 to 16000)	16384 or more: 16383 -16385 or less: -16384
0 to 10V	-384 to 16383 (Actual range: 0 to 16000)	16384 or more: 16383 -385 or less: -384

For all channels, 0 is stored as the default value.

■When a value out of the setting range is written

D/A conversion is performed with the upper and lower limit value of the setting range. Simultaneously, the following status notifies that the setting is out of the range.

- The check code is stored in CH□ Set value check code (RWw2 to RWw5). (☞ Page 116 Set value check code)
- CH□ Out-of-range digital value (error code: 190□H) is stored in Latest error code (RWw0).
- The ERR. LED flashes.

Shifting set value

■Device number

Name	Device number			
	CH1	CH2	CH3	CH4
CH□ Shifting set value	RWw10	RWw11	RWw12	RWw13

■Description

Set the shifting set value that is to be used for the shift function in 16-bit signed binary data. The digital value with shift addition is D/A converted.

For details on the shift function, refer to the following:

☞ Page 57 Shift Function

■Setting range

-32768 to 32767 (Default value: 0)

■Enabling the setting

Once a value is set, the shifting set value is valid regardless of turning on and off Initial data setting request flag (RY9).

Appendix 3 Remote Buffer Memory

This section describes the remote buffer memory.

The remote buffer memory consists of addresses for the parameter area, monitor area, and module control data area.

Data can be read or written from/to remote buffer memory areas by using SLMP commands or dedicated instructions.

For SLMP commands, refer to the following.

 Page 65 SLMP Communication Function

Point

Do not read or write data from/to any "Use prohibited" remote buffer memory areas. Otherwise, an accident may occur due to an incorrect output or malfunction.

List of remote buffer memory areas

This section lists the remote buffer memory areas of the D/A converter module.

The remote buffer memory areas of the D/A conversion module are assigned as shown below.

○: Access permitted, ×: Access not permitted

Remote buffer memory address		Area name	Target	Access method		
Decimal	Hexadecimal			CC IE Field configuration of the engineering tool	Dedicated instruction *1	SLMP command
0 to 255	0000H to 00FFH	Parameter area	Use prohibited	—	—	—
256 to 511	0100H to 01FFH		Module-based parameter data	○*2	○	○
512 to 1279	0200H to 04FFH	Use prohibited		—	—	—
1280 to 1535	0500H to 05FFH	Monitor area	Use prohibited	—	—	—
1536 to 1791	0600H to 06FFH		Module-based monitor data	×	○	○
1792 to 2559	0700H to 09FFH	Use prohibited		—	—	—
2560 to 2799	0A00H to 0AEFH	Error history area	Station-based error history data	○	○	○
2800 to 4095	0AF0H to 0FFFH		Use prohibited	—	—	—
4096 to 4351	1000H to 10FFH	Module control data area	Station-based control data	×	○	○
4352 to 4607	1100H to 11FFH		Use prohibited	—	—	—
4608 to 5375	1200H to 14FFH	Use prohibited		—	—	—

*1 Data can be read or written from/to remote buffer memory areas by using the following dedicated instructions.

REMFRR, REMFRD, REMTO, and REMTOD instructions

( User's manual for the master/local module used)

*2 For details on the access method, refer to the following.

Parameter area ( Page 40 VARIOUS SETTINGS)

Point

For a single D/A converter module, do not execute multiple dedicated instructions at the same time. If multiple dedicated instructions are executed at the same time, the D/A converter module may be unable to receive the dedicated instructions and the dedicated instructions may time out.

Parameter area

■ Module-based parameter data

○: Applicable, ×: Not applicable

Address		Name	Default value	Read	Write
Decimal	Hexadecimal				
256, 257	0100H, 0101H	Use prohibited	—	×	×
258	0102H	D/A conversion enable/disable setting	000FH	○	○
259	0103H	Range setting	0000H	○	○
260	0104H	Use prohibited	—	×	×
261	0105H	Analog output HOLD/CLEAR setting	0000H	○	○
262	0106H	Use prohibited	—	×	×
263	0107H	Warning output setting	000FH	○	○
264	0108H	CH1 Warning output upper limit value	0	○	○
265	0109H	CH1 Warning output lower limit value	0	○	○
266	010AH	CH2 Warning output upper limit value	0	○	○
267	010BH	CH2 Warning output lower limit value	0	○	○
268	010CH	CH3 Warning output upper limit value	0	○	○
269	010DH	CH3 Warning output lower limit value	0	○	○
270	010EH	CH4 Warning output upper limit value	0	○	○
271	010FH	CH4 Warning output lower limit value	0	○	○
272 to 279	0110H to 0117H	Use prohibited	—	×	×
280	0118H	Scaling enable/disable setting	000FH	○	○
281	0119H	CH1 Scaling lower limit value	0	○	○
282	011AH	CH1 Scaling upper limit value	0	○	○
283	011BH	CH2 Scaling lower limit value	0	○	○
284	011CH	CH2 Scaling upper limit value	0	○	○
285	011DH	CH3 Scaling lower limit value	0	○	○
286	011EH	CH3 Scaling upper limit value	0	○	○
287	011FH	CH4 Scaling lower limit value	0	○	○
288	0120H	CH4 Scaling upper limit value	0	○	○
289 to 511	0121H to 01FFH	Use prohibited	—	×	×



To enable the parameter data, turn on Initial data setting request flag (RY9). Parameter data is not enabled simply by having it written to the parameter area.

Monitor area

■Module-based monitor data

○: Applicable, ×: Not applicable

Address		Name	Default value	Read	Write
Decimal	Hexadecimal				
1536	0600H	Setting range monitor	0000H	○	×
1537 to 1791	0601H to 06FFH	Use prohibited	—	×	×

Error history area

■Station-based error history data

○: Applicable, ×: Not applicable

Address		Name	Default value	Read	Write	
Decimal	Hexadecimal					
2560	0A00H	Error history data 1	Error code	0000H	○	×
2561	0A01H		Order of occurrence	0000H	○	×
2562	0A02H		[Error time] Western calendar year	0000H	○	×
2563	0A03H		[Error time] Month/Day	0000H	○	×
2564	0A04H		[Error time] Hour/Minute	0000H	○	×
2565	0A05H		[Error time] Second/00H (fixed)	0000H	○	×
2566	0A06H		Error code details 1	0000H	○	×
2567 to 2575	0A07H to 0A0FH		Use prohibited	—	—	—
2576 to 2591	0A10H to 0A1FH	Error history data 2	Same as Error history data 1	0000H	○	×
2592 to 2607	0A20H to 0A2FH	Error history data 3	Same as Error history data 1	0000H	○	×
2608 to 2623	0A30H to 0A3FH	Error history data 4	Same as Error history data 1	0000H	○	×
2624 to 2639	0A40H to 0A4FH	Error history data 5	Same as Error history data 1	0000H	○	×
2640 to 2655	0A50H to 0A5FH	Error history data 6	Same as Error history data 1	0000H	○	×
2656 to 2671	0A60H to 0A6FH	Error history data 7	Same as Error history data 1	0000H	○	×
2672 to 2687	0A70H to 0A7FH	Error history data 8	Same as Error history data 1	0000H	○	×
2688 to 2703	0A80H to 0A8FH	Error history data 9	Same as Error history data 1	0000H	○	×
2704 to 2719	0A90H to 0A9FH	Error history data 10	Same as Error history data 1	0000H	○	×
2720 to 2735	0AA0H to 0AAFH	Error history data 11	Same as Error history data 1	0000H	○	×
2736 to 2751	0AB0H to 0ABFH	Error history data 12	Same as Error history data 1	0000H	○	×
2752 to 2767	0AC0H to 0ACFH	Error history data 13	Same as Error history data 1	0000H	○	×
2768 to 2783	0AD0H to 0ADFH	Error history data 14	Same as Error history data 1	0000H	○	×
2784 to 2799	0AE0H to 0AEFH	Error history data 15	Same as Error history data 1	0000H	○	×
2800 to 4095	0AF0H to 0FFFH	Use prohibited	—	—	—	

Module control data area

■ Station-based control data

○: Applicable, ×: Not applicable

Address		Name	Default value	Read	Write
Decimal	Hexadecimal				
4096	1000H	Error history clear command	0	○	○
4097	1001H	Error history clear completed	0	○	×
4098	1002H	Parameter area initialization command	0	○	○
4099	1003H	Parameter area initialization completed	0	○	×
4100 to 4351	1004H to 10FFH	Use prohibited	—	×	×

Details of remote buffer memory areas

This section describes the remote buffer memory areas of the D/A converter module.

D/A conversion enable/disable setting

■Address

Name	Address
D/A conversion enable/disable setting	0102H

■Description

This function allows D/A conversion to be enabled or disabled for each channel.

b15	b14	b13	b12	b11	b10	b9	b8	b7	b6	b5	b4	b3	b2	b1	b0
Fixed as 0												CH4	CH3	CH2	CH1

0: D/A conversion enabled

1: D/A conversion disabled (default value)



If a value other than the above is set, the setting values of lower 4 bits are used for operation.

■Enabling the setting

Turn on and off Initial data setting request flag (RY9) to enable the setting.

Range setting

■Address

Name	Address
Range setting	0103H

■Description

The output range can be set for each channel.

b15	b14	b13	b12	b11	b10	b9	b8	b7	b6	b5	b4	b3	b2	b1	b0
CH4				CH3				CH2				CH1			

■Setting value

The following table shows the set values.

Output range	Setting value
4 to 20mA	0H (default value)
0 to 20mA	1H
1 to 5V	2H
0 to 5V	3H
-10 to 10V	4H
0 to 10V	5H



If a value other than the above is set, CH□ Range setting out-of-range (error code: 310□H) is stored in Latest error code (RWR0), Error flag (RXA) turns on, and the ERR. LED turns on. For channels for which data other than the above values has been set, the operation is the same as that with D/A conversion disabled and 0V/0mA is output.

■Enabling the setting

Turn on and off Initial data setting request flag (RY9) to enable the setting.

Analog output HOLD/CLEAR setting

■Address

Name	Address
Analog output HOLD/CLEAR setting	0105H

■Description

For each channel, set whether the analog value output when the CPU module was in RUN state is held or cleared when the module is in STOP state or when an error occurs.

b15	b14	b13	b12	b11	b10	b9	b8	b7	b6	b5	b4	b3	b2	b1	b0
CH4				CH3				CH2				CH1			

■Setting value

Analog output HOLD/CLEAR setting	Setting value
CLEAR	0H (default value)
HOLD	1H to FH

■Enabling the setting

Turn on and off Initial data setting request flag (RY9) to enable the setting.

Warning output setting

■Address

Name	Address
Warning output setting	0107H

■Description

This function allows warning output to be enabled or disabled for each channel.

b15	b14	b13	b12	b11	b10	b9	b8	b7	b6	b5	b4	b3	b2	b1	b0
Fixed as 0												CH4	CH3	CH2	CH1

0: Enable

1: Disable (default value)



If a value other than the above is set, the setting values of lower 4 bits are used for operation.

■Enabling the setting

Turn on and off Initial data setting request flag (RY9) to enable the setting.

Warning output

■Address

Name	Address			
	CH1	CH2	CH3	CH4
CH□ Warning output upper limit value	0108H	010AH	010CH	010EH
CH□ Warning output lower limit value	0109H	010BH	010DH	010FH

■Description

This function sets the upper limit value and lower limit value of the warning output range.

For details on the warning output function, refer to the following:

📖 Page 63 Warning Output Function

Point

- The settings must satisfy the condition: Warning output upper limit value > Warning output lower limit value. An error occurs in a channel that does not satisfy the condition, CH□ Warning output upper/lower limit value inversion (330□H) is stored in Latest error code (RWr0), Error flag (RXA) turns on, and the ERR. LED turns on.
- As 0 is set as a default value, change the setting value when using the warning output function.
- When the scaling function or shift function is used, the digital value that reflects the operation of each function is the target for warning. The set digital value should allow for the operation results of each function.
- When Warning output setting (address: 0107H) is set to Disabled, the settings of CH1 Warning output upper limit value (address: 0108H) to CH4 Warning output lower limit value (address: 010FH) are ignored.

■Setting range

-32768 to 32767 (Default value: 0)

■Enabling the setting

Turn on and off Initial data setting request flag (RY9) to enable the setting.

Scaling enable/disable setting

■Address

Name	Address
Scaling enable/disable setting	0118H

■Description

This function is used to set whether to enable or disable scaling for each channel.

b15	b14	b13	b12	b11	b10	b9	b8	b7	b6	b5	b4	b3	b2	b1	b0
Fixed as 0												CH4	CH3	CH2	CH1

0: Enable

1: Disable (default value)

Point

If a value other than the above is set, the setting values of lower 4 bits are used for operation.

■Enabling the setting

Turn on and off Initial data setting request flag (RY9) to enable the setting.

Scaling

■Address

Name	Address			
	CH1	CH2	CH3	CH4
CH□ Scaling lower limit value	0119H	011BH	011DH	011FH
CH□ Scaling upper limit value	011AH	011CH	011EH	0120H

■Description

This function is used to set the lower limit value and upper limit value of the scale conversion range.

For details on the scaling function, refer to the following.

📖 Page 54 Scaling Function

■Setting range

-32000 to 32000 (Default value: 0)

Point

- An error occurs in a channel where a value not within the above range is set, CH□ Scaling setting out-of-range (error code: 350□H) is stored in Latest error code (RWr0), Error flag (RXA) turns on, and the ERR. LED turns on.
- The settings must satisfy the condition: Scaling upper limit value > Scaling lower limit value. An error occurs in a channel that does not satisfy the condition, CH□ Scaling setting upper/lower limit inversion (error code: 351□H) is stored in Latest error code (RWr0), Error flag (RXA) turns on, and the ERR. LED turns on.
- If Scaling enable/disable setting (address: 0118H) is set to Disabled, the settings of CH1 Scaling lower limit value (address: 0119H) to CH4 Scaling upper limit value (address: 0120H) are ignored.

■Enabling the setting

Turn on and off Initial data setting request flag (RY9) to enable the setting.

Setting range monitor

■Address

Name	Address
Setting range monitor	0600H

■Description

This function allows the set output range value to be checked.

b15	b14	b13	b12	b11	b10	b9	b8	b7	b6	b5	b4	b3	b2	b1	b0
CH4				CH3				CH2				CH1			

For channels whose D/A conversion enable/disable setting (address: 0102H) is set to D/A conversion disabled, the value of Setting range monitor (address: 0600H) is not updated.

■Monitored value

The following table shows the monitored values.

Output range	Monitored value
4 to 20mA	0H
0 to 20mA	1H
1 to 5V	2H
0 to 5V	3H
-10 to 10V	4H
0 to 10V	5H

Error history data

■Address

Name	Address
Error history data □	0A00H to 0AEFH

■Description

Up to 15 errors generated in the module are recorded.

The following tables show the stored content for Error history data 1 (address: 0A00H to 0A0FH).

Address	b15	b14	b13	b12	b11	b10	b9	b8	b7	b6	b5	b4	b3	b2	b1	b0
0A00H	Error code															
0A01H	Order of occurrence															
0A02H	First two digits of the year								Last two digits of the year							
0A03H	Month								Day							
0A04H	Hour								Minute							
0A05H	Second								00H (fixed)							
0A06H	Error code details 1															
0A07H to 0A0FH	Use prohibited															

Item	Contents	Storage example ^{*1}
Error code	The error code for the error that occurred is stored.	—
Order of occurrence	The order of error occurrence is stored. (A value between 0 and 65535 is stored.) When the value exceeds 65535, counting starts from zero.	0001H
First two digits of the year/Last two digits of the year ^{*2}	The date and time of error occurrence is stored in BCD code.	2019H
Month/Day ^{*2}		0829H
Hour/Minute ^{*2}		1035H
Second ^{*2}		4000H
Error code details 1	Error information details at the occurrence of an error are stored.	—

*1 Values for when the second error occurs at 10:35:40, August 29, 2019

*2 The clock information of the error that occurred is based on the clock information acquired from the CPU module of the master station.
When an error has occurred before the clock information is acquired from the CPU module, the error time is not recorded.

Error history data 2 to Error history data 15 (address: 0A10H to 0AEFH) are stored in the same format as that of Error history data 1 (address: 0A00H to 0A0FH).

For error codes, refer to the following.

 Page 101 Error Code List

■Storage order of the error history

The latest error is stored in Error history data 1 (address: 0A00H to 0A0FH).

Errors that occurred in the past are stored in Error history data 2 to Error history data 15 (address: 0A10H to 0AEFH) in reverse chronological order.

Error history clear command

■Address

Name	Address
Error history clear command	1000H

■Description

The error history stored in the module is cleared.

b15	b14	b13	b12	b11	b10	b9	b8	b7	b6	b5	b4	b3	b2	b1	b0
Fixed as 0															0: Not commanded 1: Commanded

Immediately before the maximum number of times that error history can be saved is reached (maximum number of times - 1) or when the maximum number of times is reached (the upper limit), even if the error history clear command is turned on, the error history clear process is not performed. When the error history clear command is turned on, Error history clear completed is turned on, but the error history is not cleared.

When the upper limit for the number of times error history is saved is reached, because an "Error history save limit error" occurs, it can be checked using the error log.

■Operation of error history clear

When Error history clear command (address: 1000H) is set to Commanded (1), the error history is cleared.

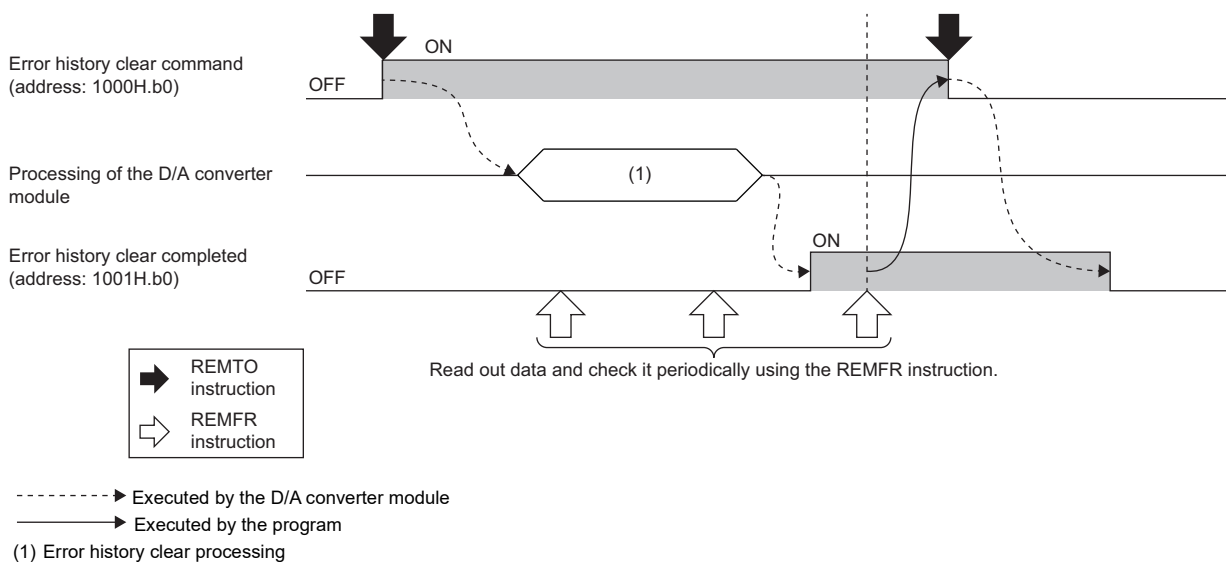

■Default value

The default value is Not commanded (0).

Precautions

When the error history clear command is turned on, the numbers for order of occurrence in the module (values from 0 to 65535 that show the order in which errors occurred) are also cleared.

Error history clear completed

■Address

Name	Address
Error history clear completed	1001H

■Description

This remote buffer memory area shows whether the error history stored in the module is cleared or not.

b15	b14	b13	b12	b11	b10	b9	b8	b7	b6	b5	b4	b3	b2	b1	b0
Fixed as 0															0: Not performed 1: Completed

■Operation of error history clear

When the error history clear is completed, Error history clear completed (address: 1001H) is turned to Completed (1).

For the timing of turning the bit to Not performed (0) → Completed (1) → Not performed (0), refer to the following.

☞ Page 128 Error history clear command

■Default value

The default value is Not performed (0).

Parameter area initialization command

■Address

Name	Address
Parameter area initialization command	1002H

■Description

This function sets parameters in remote buffer memory areas and non-volatile memory as default values.

The D/A converter module can be restored when a non-volatile memory data error (parameter) (error code: 2010H) occurs.

b15	b14	b13	b12	b11	b10	b9	b8	b7	b6	b5	b4	b3	b2	b1	b0
Fixed as 0															(1)

(1) 0: Not commanded (default value), 1: Commanded

Point

If a value other than the above is set, the setting value of lower 1 bit is used for operation.

■Behavior of parameter area initialization

Setting Parameter area initialization command (address: 1002H) to Commanded sets the parameters in the non-volatile memory back to default values.

Point

After the execution of Parameter area initialization command (address: 1002H), turning off and on the module power supply enables the module to operate normally.

Parameter area initialization completed

■Address

Name	Address
Parameter area initialization completed	1003H

■Description

This area indicates the initialization completion status of parameters stored in the non-volatile memory.

b15	b14	b13	b12	b11	b10	b9	b8	b7	b6	b5	b4	b3	b2	b1	b0
Fixed as 0															(1)

(1) 0: Not performed (default value), 1: Completed

■Behavior of parameter area initialization

Parameter area initialization completed (address: 1003H) is set to Completed when parameters stored in the non-volatile memory are set to the default values.

Appendix 4 I/O Conversion Characteristics of D/A Conversion

The I/O conversion characteristics of D/A conversion are expressed by the slope of the straight line connecting the offset value and the gain value, both of which are used when a digital value written from the CPU module is converted to the corresponding analog output value (voltage or current).

Offset value

This value is an analog output value (voltage or current) when the digital value is 0.

Gain value

This value is an analog output value (voltage or current) when the digital value is 16000.

Voltage output characteristics

The following graph shows the voltage output characteristics.

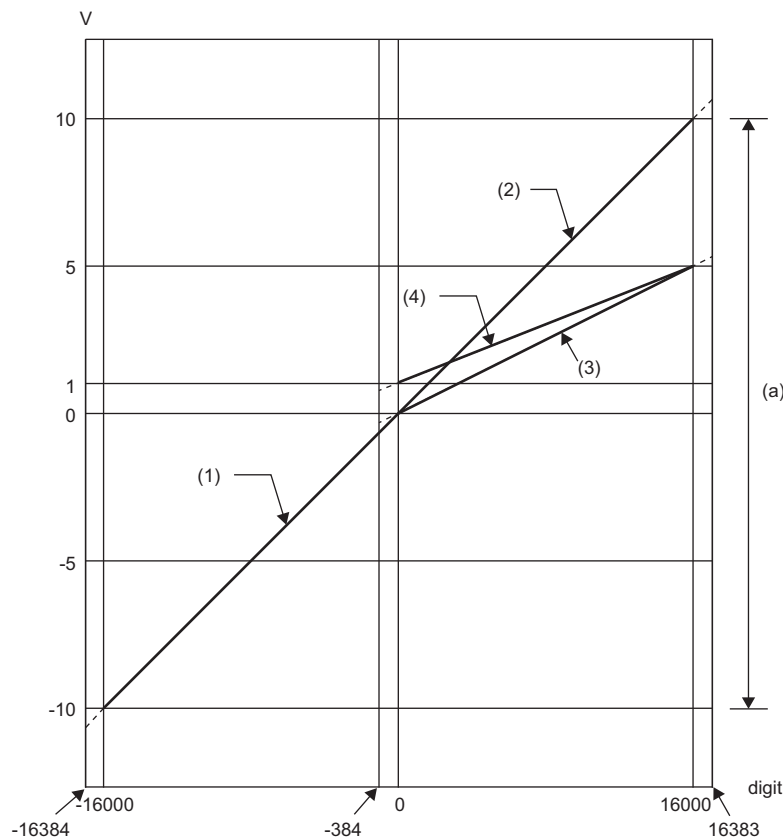

digit: Digital input value
 V: Analog output value (V)
 (a) Analog output practical range

No.	Range setting	Offset value	Gain value	Digital value	Maximum resolution
(1)	-10 to 10V	0V	10V	-16000 to 16000	0.625mV
(2)	0 to 10V	0V	10V	0 to 16000	0.625mV
(3)	0 to 5V	0V	5V		0.3125mV
(4)	1 to 5V	1V	5V		0.25mV

Point

Use a value within the practical analog output range for each output range. If a value is out of the range, the maximum resolution and accuracy may not fall within the range of performance specifications. (Do not use a value in the dotted line region in the graph of voltage output characteristics.)



Current output characteristics

The following graph shows the current output characteristics.

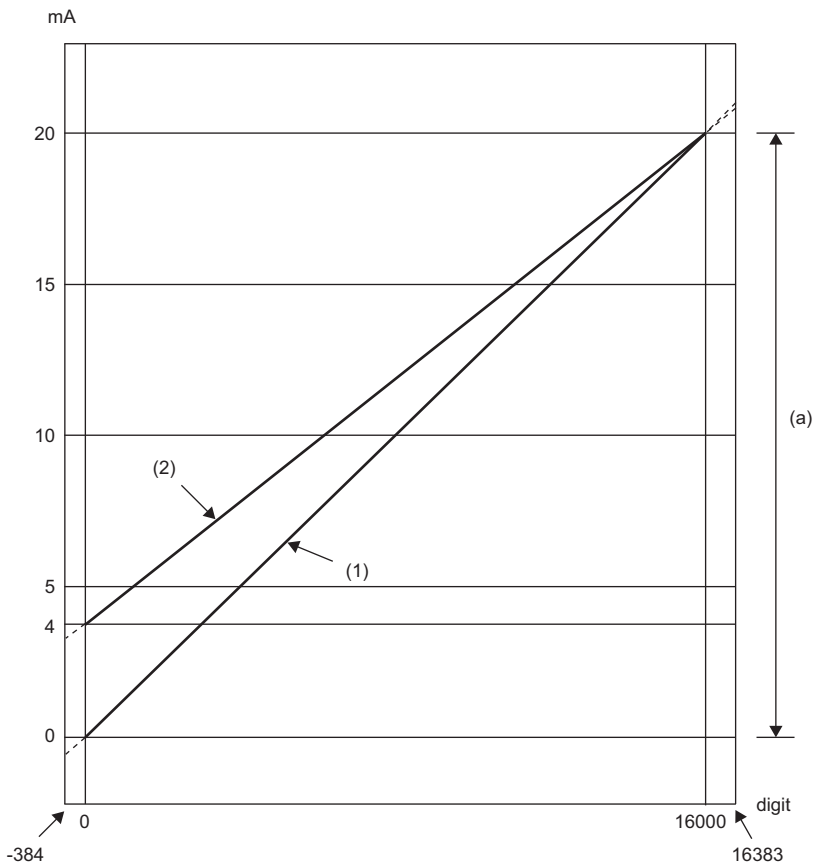

digit: Digital input value
 mA: Analog output current (mA)
 (a) Analog output practical range

No.	Range setting	Offset value	Gain value	Digital output value	Maximum resolution
(1)	0 to 20mA	0mA	20mA	0 to 16000	1.25 μ A
(2)	4 to 20mA	4mA	20mA		1 μ A

Point

Use a value within the practical analog output range for each output range. If a value is out of the range, the maximum resolution and accuracy may not fall within the range of performance specifications. (Do not use a value in the dotted line region in the above graph.)

Appendix 5 Accuracy of D/A Conversion

Accuracy of D/A conversion is the accuracy for the maximum value of analog output value.

An output characteristic change caused by changing the output range does not sacrifice the accuracy, which is maintained within the described range of the performance specifications.

The following figure shows the fluctuation range of accuracy with the range of -10 to 10V selected.

An analog value is output with an accuracy of $\pm 0.2\%$ when the ambient temperature is $25 \pm 5^\circ\text{C}$ or with an accuracy of $\pm 0.3\%$ when the ambient temperature is 0 to 55°C . (Except for the conditions under noise influence.)

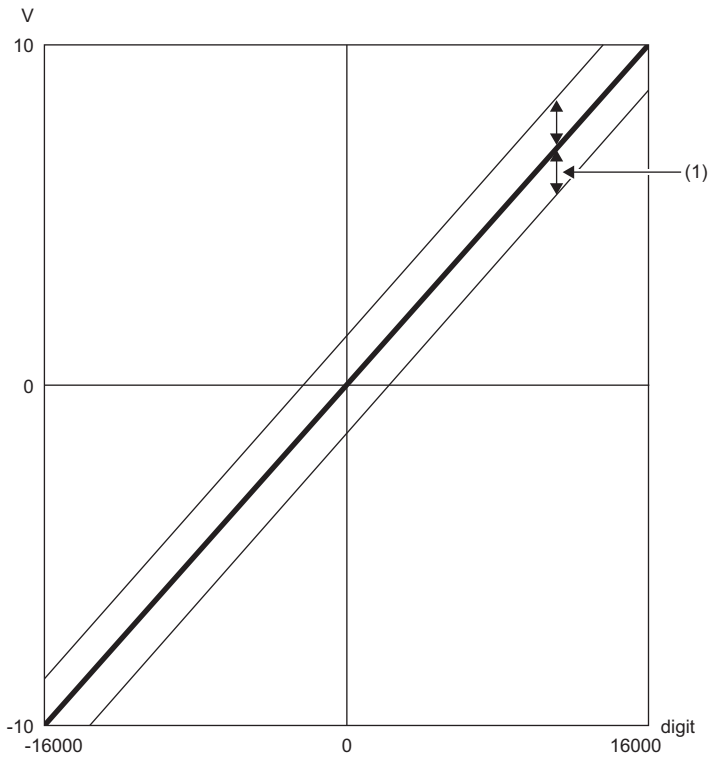

digit: Digital input value
V: Analog output value (V)
(1) Fluctuation range



Appendix 6 CC-Link IE Field Network Processing Time

The CC-Link IE Field Network processing time is the time it takes for the D/A converter module to perform D/A conversion on a digital value written with the CPU module of the master station, and output the actual analog output value.

The CC-Link IE Field Network processing time is determined by the following processing time.

Data link processing time = SM + LS + Remote device station processing time

- SM: Sequence scan time of the master station
- LS: Link scan time
- Remote device station processing time: Conversion speed (200 μ s/channel) \times Number of conversion enabled channels

For details on processing time, refer to the following.

 User's manual for the master/local module used

Appendix 7 EMC and Low Voltage Directives

Compliance to the EMC Directive, which is one of the EU Directives, has been a legal obligation for the products sold in European countries since 1996 as well as the Low Voltage Directive since 1997.

For products compliant to the EMC and Low Voltage Directives, their manufacturers are required to declare compliance and affix the CE marking.

Sales representative in EU member states

The sales representative in EU member states is:

Company: MITSUBISHI ELECTRIC EUROPE B.V.

Address: Mitsubishi-Electric-Platz 1, 40882 Ratingen, Germany

Measures to comply with the EMC Directive

The EMC Directive specifies that "products placed on the market must be so constructed that they do not cause excessive electromagnetic interference (emissions) and are not unduly affected by electromagnetic interference (immunity)".

This section describes the precautions for machinery constructed with modules to comply with the EMC Directive.

These precautions are based on the requirements of the EMC Directive and the harmonized standards. However, they do not guarantee that the entire machinery constructed according to the descriptions complies with the EMC Directive.

The manufacturer of the machinery must determine the testing method for compliance and declare conformity to the EMC Directive.

EMC Directive related standards

■ Emission requirements

Standard	Test item	Test description	Standard value
EN61131-2: 2007	CISPR16-2-3 Radiated emission*2	Radio waves from the product are measured.	<ul style="list-style-type: none">• 30M to 230MHz QP: 40dBμV/m (measured over 10m)*1• 230M to 1000MHz QP: 47dBμV/m (measured over 10m)
	CISPR16-2-1, CISPR16-1-2 Conducted emission*2	Noise from the product to the power line is measured.	<ul style="list-style-type: none">• 150k to 500kHz QP: 79dB, Mean: 66dB*1• 500k to 30MHz QP: 73dB, Mean: 60dB

*1 QP (Quasi-peak): quasi-peak value, Mean: mean value

*2 The module is an open-type device (a device designed to be housed in other equipment) and must be installed inside a conductive control panel. The tests were conducted with the programmable controller installed in a control panel.

■ Immunity requirements

Specifications	Test item	Test description	Standard value
EN61131-2: 2017	EN61000-4-2 Electrostatic discharge immunity* ¹	Static electricity is applied to the cabinet of the equipment.	<ul style="list-style-type: none"> • 30M to 230MHz QP: 40dBμV/m (measured over 10m)¹ • 230M to 1000MHz QP: 47dBμV/m (measured over 10m)
	EN61000-4-3 Radiated, radio-frequency, electromagnetic field immunity* ¹	Electric fields are radiated to the product.	<ul style="list-style-type: none"> • 150k to 500kHz QP: 79dB, Mean: 66dB¹ • 500k to 30MHz QP: 73dB, Mean: 60dB
	EN61000-4-4 Electrical fast transient/burst immunity* ¹	Burst noise is applied to the power line and signal line.	<ul style="list-style-type: none"> • AC/DC main power supply, I/O power supply, AC I/O (unshielded): 2kV • DC I/O, analog, communication cable: 1kV
	EN61000-4-5 Surge immunity* ¹	A lightning surge is applied to the power line and signal line.	<ul style="list-style-type: none"> • AC power line, AC I/O power supply, AC I/O (unshielded): 2kV CM, 1kV DM • DC power line, DC I/O power supply: 0.5kV CM, DM • DC I/O, AC I/O (shielded), analog², communication: 1kV CM
	EN61000-4-6 Conducted RF immunity* ¹	High frequency noise is applied to the power line and signal line.	0.15M to 80MHz, 80% AM modulation @1kHz, 10Vrms
	EN61000-4-8 Power-frequency magnetic field immunity* ¹	The product is installed in an inductive magnetic field.	50Hz/60Hz, 30A/m
	EN61000-4-11 Voltage dips and interruptions immunity* ¹	A momentary power failure is caused to the power supply voltage.	<ul style="list-style-type: none"> • Apply at 0%, 0.5 cycles and zero-cross point • 0%, 250/300 cycles (50/60Hz) • 40%, 10/12 cycles (50/60Hz) • 70%, 25/30 cycles (50/60Hz)

*1 The module is an open-type device (a device designed to be housed in other equipment) and must be installed inside a conductive control panel. The tests were conducted with the programmable controller installed in a control panel.

*2 The accuracy of a digital-analog converter module may temporarily vary within $\pm 10\%$.

Installation in a control panel

The module is an open-type device and must be installed inside a control panel.

This ensures safety as well as effective shielding of programmable controller-generated electromagnetic noise.

■ Control panel

- Use a conductive control panel.
- When securing the top or bottom plate using bolts, cover the grounding part on the control panel so that the part will not be painted.
- To ensure electrical contact between the inner plate and control panel, take measures such as covering the bolts so that conductivity can be ensured in the largest possible area.
- Ground the control panel with a thick ground cable so that low impedance can be ensured even at high frequencies.
- Holes in the control panel must be 10cm diameter or less. If the holes are larger than 10cm in diameter, radio waves may leak. In addition, because radio waves leak through a clearance between the control panel and its door, reduce the clearance as much as possible. The leakage of radio waves can be suppressed by the direct application of an EMI gasket on the paint surface.

Our tests have been carried out on a control panel having the damping characteristics of 37dB (max.) and 30dB (mean) (measured by 3m method, 30 to 300MHz).

■ Wiring of power cables and ground cables

Near the power supply part, provide a grounding point to the control panel. Ground the FG terminal with the thickest and shortest possible ground cable (30cm or shorter).

Cables

Use shielded cables for the cables which are connected to the module and run out from the control panel. If a shielded cable is not used or not grounded correctly, the noise immunity will not meet the specified value.

■Network cable

A shielded cable is used for the network cable. Strip a part of the jacket as shown below and ground the exposed shield in the largest possible area.

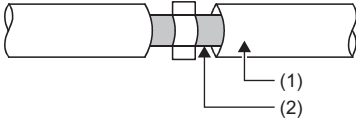

- (1) Network cable
- (2) Shield

■Grounding the cable clamp

Use shielded cables for external wiring and ground the shields of the external wiring cables to the control panel with the AD75CK cable clamp (manufactured by Mitsubishi Electric Corporation). (Ground the shield section 20 to 30cm away from the module.)

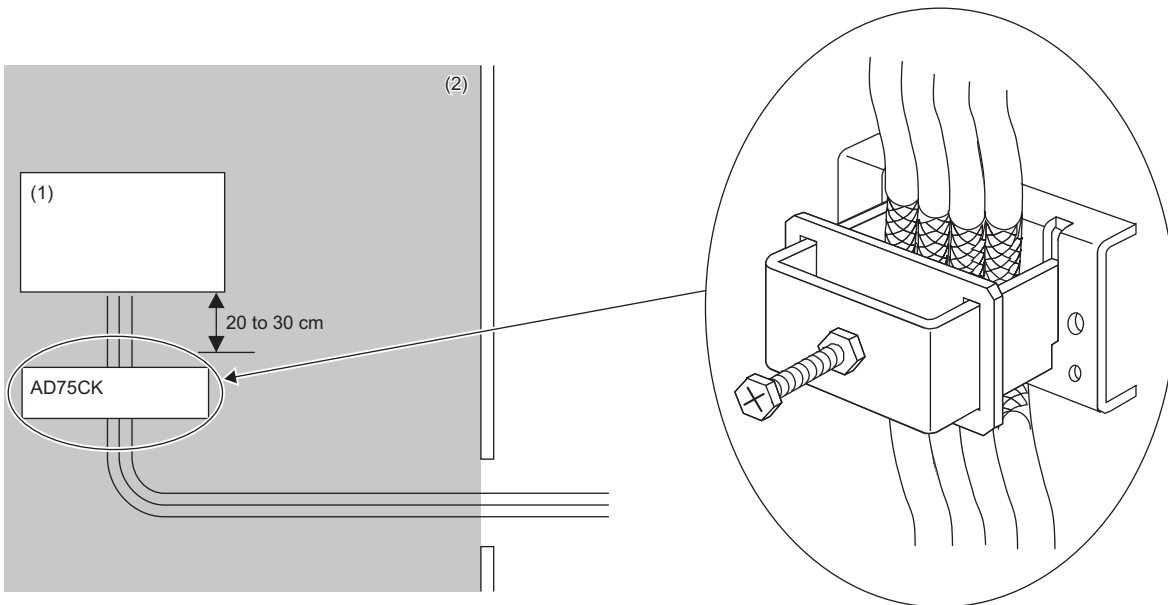

- (1) Module
- (2) Inside a control panel

For details on AD75CK, refer to the following.

 AD75CK-type Cable Clamping Instruction Manual

■Analog I/O signal line

Use a signal line of 30m or shorter when connecting it to the analog I/O terminals of the module.

External power supply

- Use a CE-marked product for an external power supply and always ground the FG terminal. (External power supply used for the tests conducted by Mitsubishi: DRJ100-24-1 and DRJ240-24-1 manufactured by TDK-Lambda Corporation)
- Use a power cable of 30m or shorter when connecting it to the module power supply terminal.

A

Others

■ Ferrite core

A ferrite core has the effect of reducing radiation noise in the 30MHz to 100MHz band.

It is recommended to attach ferrite cores if shielded cables coming out of the control panel do not provide sufficient shielding effects.

Note that the ferrite cores must be attached at the position closest to the cable hole inside the control panel. If attached at an improper position, the ferrite core will not produce any effect.

For the FG terminal on a D/A converter module that is connected to the external power supply, attach a ferrite core 4cm away from the module. (Ferrite core used for the tests conducted by Mitsubishi: ESD-SR-250 manufactured by TOKIN Corporation, and ZCAT3035-1330 manufactured by TDK Corporation)

Ex.

Example

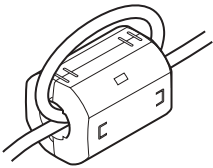

■ Noise filter (power supply line filter)

A noise filter is a component which has an effect on conducted noise. Attaching the filter can suppress more noise. (The noise filter has the effect of reducing conducted noise of 10MHz or less.)

Connect a noise filter to the external power supply of the D/A converter module. Use a noise filter with the damping characteristics equivalent to those of RSEN-2006 (manufactured by TDK-Lambda Corporation). Note that a noise filter is not required if the module is used in Zone A defined in EN61131-2.

The precautions for attaching a noise filter are described below.

- Do not bundle the cables on the input side and output side of the noise filter. If bundled, the output side noise will be induced into the input side cables from which the noise was filtered.

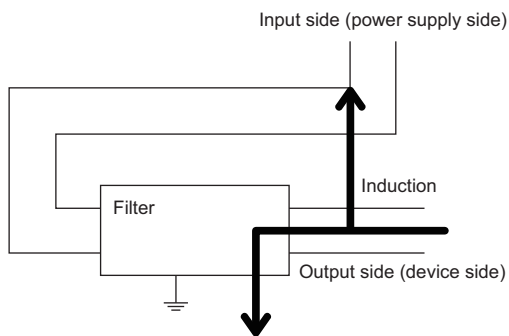

• Problem example

Noise is caused if wires for input and wires for output are bundled together.

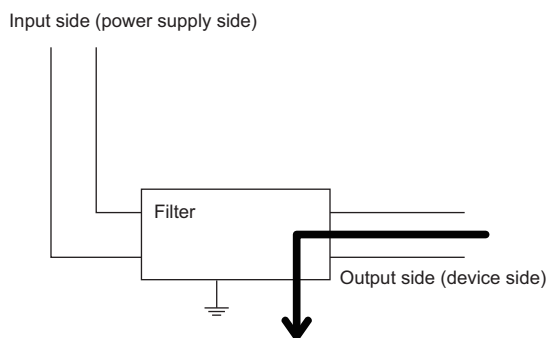

• Improvement example

Lay wires for input away from wires for output.

- Ground the noise filter grounding terminal to the control panel with the shortest cable possible (approx. 10cm).
- Install a noise filter within 3m from the module. (Distance between the external power supply and module is 30m.)

Requirements to compliance with the Low Voltage Directive

The module operates at the rated voltage of 24VDC.

The Low Voltage Directive is not applied to the modules that operate at the rated voltage of less than 50VAC and 75VDC.

Appendix 8 How to Check Production Information and Firmware Version

The production information and the firmware version of the D/A converter module can be checked with the following.

- Rating plate
- CC-Link IE TSN/CC-Link IE Field diagnostics

Point

When updating firmware for D/A converter modules, check the updated firmware version in CC-Link IE TSN communication mode.

 CC-Link IE TSN Digital-Analog Converter Module User's Manual (CC-Link IE TSN Communication Mode)

Checking on the rating plate

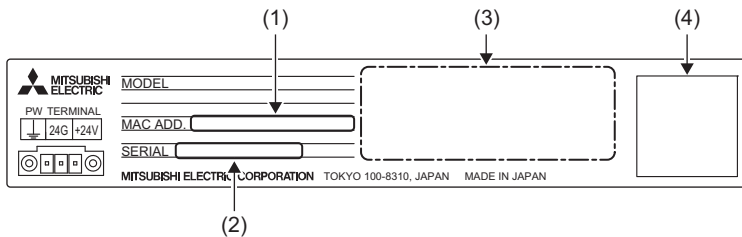

- (1) MAC address
- (2) Production information (The first two digits indicate the firmware version.)
- (3) Relevant standard symbol
- (4) QR code

Checking by using CC-Link IE TSN/CC-Link IE Field diagnostics

Operating procedure

1. Connect the engineering tool to the CPU module.
2. Start CC-Link IE TSN/CC-Link IE Field diagnostics from the menu.
 [Diagnostics] ⇒ [CC-Link IE TSN/CC-Link IE Field Diagnostics]
3. Right-click the device station and then select "Production Information" to display the production information.
4. The production information is displayed. (The first two digits indicate the firmware version.)

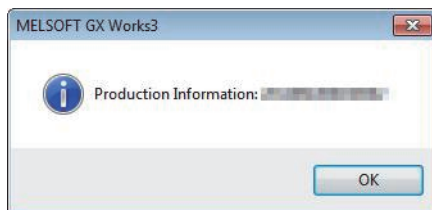

Appendix 9 Added Functions

The functions added to the D/A converter module are shown.

Added functions

The following table shows the functions that were added to the D/A converter module and the versions supporting these functions.

Added function	Firmware version	Profile version	Reference
SLMP communication function	"06" or later	— ^{*1}	 Page 65 SLMP Communication Function

*1 The function can be used regardless of the version.

Appendix 10 External Dimensions

The following shows the external dimensions of the D/A converter module.

- Spring clamp terminal block type

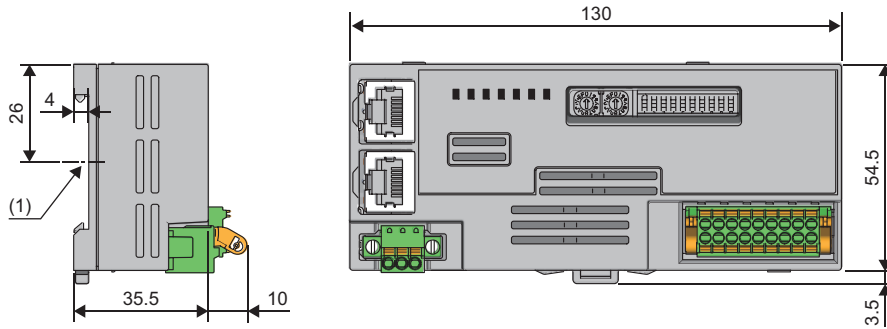

(1) Center of DIN rail
(Unit: mm)

- Screw terminal block type

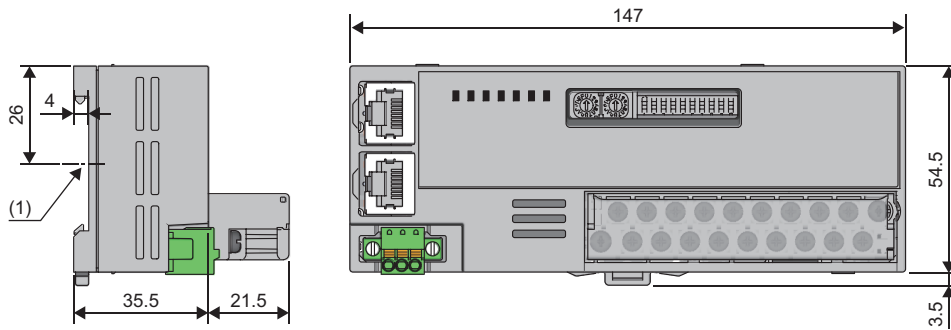

(1) Center of DIN rail
(Unit: mm)

MEMO

A

INDEX

A

ALM LED	11
Analog output HOLD/CLEAR setting	124
Analog output terminal block	12

C

Current output characteristics	132
--	-----

D

D/A conversion enable/disable setting	123
DATA LINK LED	11
Digital value	118
DIN rail hook	12

E

ERR. LED	11
Error clear request flag	113
Error flag	109
Error history area	121

G

Gain value	131
----------------------	-----

I

Initial data setting completion flag	108
Initial data setting request flag	113

L

Latest alarm code	116
Latest error code	116

M

Module control data area	122
Monitor area	121

O

Offset value	131
Output enable/disable flag	113
Output range switch enable/disable setting status flag	111

P

P1 LINK LED	11
P2 LINK LED	11
Parameter area	120
Parameter area initialization command	129
Parameter area initialization completed	130
PW LED	11

R

Range setting	123
Remote input signal	107
Remote output signal	107
Remote READY	110
Remote register areas (RW _r)	115
Remote register areas (RW _w)	115
RUN LED	11

S

Scaling	126
Scaling enable/disable setting	125
Set value check code	116
Setting range monitor	126
Shifting set value	118

T

Terminal block for module power supply and FG	12
---	----

V

Voltage output characteristics	131
--	-----

W

Warning output	125
Warning output clear request flag	114
Warning output flag	117
Warning output setting	124
Warning output signal	112

MEMO

REVISIONS

*The manual number is given on the bottom left of the back cover.

Revision date	*Manual number	Description
November 2019	SH(NA)-082238ENG-A	First edition
May 2020	SH(NA)-082238ENG-B	■Added or modified parts INTRODUCTION, RELEVANT MANUALS, TERMS, GENERIC TERMS AND ABBREVIATIONS, Section 2.2, 5.2, 10.1, 10.2, Appendix 8
July 2020	SH(NA)-082238ENG-C	■Added or modified parts SAFETY PRECAUTIONS, CONDITIONS OF USE FOR THE PRODUCT
May 2021	SH(NA)-082238ENG-D	■Added or modified parts Chapter 1, 9
May 2022	SH(NA)-082238ENG-E	■Added function SLMP communication function ■Added or modified parts RELEVANT MANUALS, GENERIC TERMS AND ABBREVIATIONS, Section 2.3, 7.11, Appendix 3, 9
October 2023	SH(NA)-082238ENG-F	■Added or modified parts SAFETY PRECAUTIONS, TERMS, GENERIC TERMS AND ABBREVIATIONS, Section 2.3, 6.2, 8.2, 10.1, 10.4, 10.5, Appendix 8

Japanese manual number: SH-082237-F

This manual confers no industrial property rights or any rights of any other kind, nor does it confer any patent licenses. Mitsubishi Electric Corporation cannot be held responsible for any problems involving industrial property rights which may occur as a result of using the contents noted in this manual.

© 2019 MITSUBISHI ELECTRIC CORPORATION

WARRANTY

Please confirm the following product warranty details before using this product.

1. Gratis Warranty Term and Gratis Warranty Range

If any faults or defects (hereinafter "Failure") found to be the responsibility of Mitsubishi occurs during use of the product within the gratis warranty term, the product shall be repaired at no cost via the sales representative or Mitsubishi Service Company.

However, if repairs are required onsite at domestic or overseas location, expenses to send an engineer will be solely at the customer's discretion. Mitsubishi shall not be held responsible for any re-commissioning, maintenance, or testing on-site that involves replacement of the failed module.

[Gratis Warranty Term]

The gratis warranty term of the product shall be for one year after the date of purchase or delivery to a designated place. Note that after manufacture and shipment from Mitsubishi, the maximum distribution period shall be six (6) months, and the longest gratis warranty term after manufacturing shall be eighteen (18) months. The gratis warranty term of repair parts shall not exceed the gratis warranty term before repairs.

[Gratis Warranty Range]

- (1) The range shall be limited to normal use within the usage state, usage methods and usage environment, etc., which follow the conditions and precautions, etc., given in the instruction manual, user's manual and caution labels on the product.
- (2) Even within the gratis warranty term, repairs shall be charged for in the following cases.
 1. Failure occurring from inappropriate storage or handling, carelessness or negligence by the user. Failure caused by the user's hardware or software design.
 2. Failure caused by unapproved modifications, etc., to the product by the user.
 3. When the Mitsubishi product is assembled into a user's device, Failure that could have been avoided if functions or structures, judged as necessary in the legal safety measures the user's device is subject to or as necessary by industry standards, had been provided.
 4. Failure that could have been avoided if consumable parts (battery, backlight, fuse, etc.) designated in the instruction manual had been correctly serviced or replaced.
 5. Failure caused by external irresistible forces such as fires or abnormal voltages, and Failure caused by force majeure such as earthquakes, lightning, wind and water damage.
 6. Failure caused by reasons unpredictable by scientific technology standards at time of shipment from Mitsubishi.
 7. Any other failure found not to be the responsibility of Mitsubishi or that admitted not to be so by the user.

2. Onerous repair term after discontinuation of production

- (1) Mitsubishi shall accept onerous product repairs for seven (7) years after production of the product is discontinued. Discontinuation of production shall be notified with Mitsubishi Technical Bulletins, etc.
- (2) Product supply (including repair parts) is not available after production is discontinued.

3. Overseas service

Overseas, repairs shall be accepted by Mitsubishi's local overseas FA Center. Note that the repair conditions at each FA Center may differ.

4. Exclusion of loss in opportunity and secondary loss from warranty liability

Regardless of the gratis warranty term, Mitsubishi shall not be liable for compensation to:

- (1) Damages caused by any cause found not to be the responsibility of Mitsubishi.
- (2) Loss in opportunity, lost profits incurred to the user by Failures of Mitsubishi products.
- (3) Special damages and secondary damages whether foreseeable or not, compensation for accidents, and compensation for damages to products other than Mitsubishi products.
- (4) Replacement by the user, maintenance of on-site equipment, start-up test run and other tasks.

5. Changes in product specifications

The specifications given in the catalogs, manuals or technical documents are subject to change without prior notice.

TRADEMARKS

QR Code is either a registered trademark or a trademark of DENSO WAVE INCORPORATED in the United States, Japan, and/or other countries.

The company names, system names and product names mentioned in this manual are either registered trademarks or trademarks of their respective companies.

In some cases, trademark symbols such as [™] or [®] are not specified in this manual.

SH(NA)-082238ENG-F(2310)MEE

MODEL: CCIETSNIEF-DA-U-E

MODEL CODE: 13JX2E

mitsubishi electric corporation

HEAD OFFICE : TOKYO BUILDING, 2-7-3 MARUNOUCHI, CHIYODA-KU, TOKYO 100-8310, JAPAN
NAGOYA WORKS : 1-14, YADA-MINAMI 5-CHOME, HIGASHI-KU, NAGOYA, JAPAN

When exported from Japan, this manual does not require application to the
Ministry of Economy, Trade and Industry for service transaction permission.

Specifications subject to change without notice.