



Programmable Controller

CC-Link IE TSN Waterproof/Dustproof Remote I/O Module (With Safety Functions) User's Manual

-NZ2GNS12A2-16DTE



SAFETY PRECAUTIONS

(Read these precautions before using this product.)

Before using this product, please read this manual and the relevant manuals carefully and pay full attention to safety to handle the product correctly.

The precautions given in this manual are concerned with this product only. For the safety precautions of the programmable controller system, refer to the user's manual for the CPU module used.

In this manual, the safety precautions are classified into two levels: "⚠ WARNING" and "⚠ CAUTION".

 WARNING	Indicates that incorrect handling may cause hazardous conditions, resulting in death or severe injury.
 CAUTION	Indicates that incorrect handling may cause hazardous conditions, resulting in minor or moderate injury or property damage.

Under some circumstances, failure to observe the precautions given under "⚠ CAUTION" may lead to serious consequences.

Observe the precautions of both levels because they are important for personal and system safety.

Make sure that the end users read this manual and then keep the manual in a safe place for future reference.

[Design Precautions]

WARNING

- When the safety remote I/O module detects an error in an external power supply or a failure in the module, it turns off the outputs. Configure an external circuit to ensure that the power source of a hazard is shut off by turning off the outputs. Failure to do so may result in an accident due to an incorrect output or malfunction.
 - When a load current exceeding the rated current or an overcurrent caused by a load short-circuit flows, the safety remote I/O module defines it as a fault and turns off the outputs. Note that if the overcurrent state continues for a long time, it may cause smoke and fire. To prevent this, configure an external safety circuit, such as a fuse.
 - At the start-up of the system, if the external power supply is short-circuited by the output wiring of the safety remote I/O module, or if the external power supply is connected with a wrong polarity, a load may turn on just after the power-on. Configure an interlock circuit to ensure that the entire system will always operate safely.
 - When a communication failure occurs in the network, the failed station becomes the following status. Check the communication status information and configure an interlock circuit in the program to ensure that the entire system will operate safely. Failure to do so may result in an accident due to an incorrect output or malfunction.
 - (1) All data that are output from remote stations are turned off.
 - (2) All data that are sent from remote stations to the CPU module are turned off.
 - Do not use any "use prohibited" signals as a remote input or output signal. These signals are reserved for system use. Do not write any data to the "use prohibited" areas in the remote register. If any of the "use prohibited" signals are used (turned on or off), or any data is written to the "use prohibited" areas, the correct operation of the module cannot be guaranteed. For the system areas, "use prohibited" areas, and "use prohibited" signals, refer to "APPENDICES" in this manual. For areas used for safety communications, they are protected from being written by users, and thus safety communications failure caused by data writing does not occur.
 - When the fast logic interlock is disabled, it is customer's responsibility to build the interlock circuit externally so that the entire system always operates safely. Be sure to connect an interlock mechanism to the output of this I/O module.
 - If the measure to prevent the restart cannot be taken, take other measures and ensure that operators are safe and machine parts are not damaged even if a device has restarted with the fast logic interlock disabled.
 - To satisfy SIL3, Category 4 PL.e, use input devices with normally closed contacts. Inputs using the devices with normally open contacts do not satisfy SIL3, Category 4 PL.e.
 - Use a SELV power supply for the devices to be connected to the input part of the safety remote I/O module. If not, SIL3, Category 4 PL.e is not satisfied.
-

[Design Precautions]

CAUTION

- Do not install the cables connected to external devices or the communication cables together with the main circuit lines or power cables. Keep a distance of 100mm or more between them. Failure to do so may result in malfunction due to noise.
 - Select the external devices to be connected to the module by referring to the performance specifications in this manual and considering the maximum inrush current. Connecting a device exceeding the maximum inrush current may cause malfunction or failure of the module.
-

[Security Precautions]

WARNING

- To maintain the security (confidentiality, integrity, and availability) of the programmable controller and the system against unauthorized access, denial-of-service (DoS) attacks, computer viruses, and other cyberattacks from external devices via the network, take appropriate measures such as firewalls, virtual private networks (VPNs), and antivirus solutions.
-

[Installation Precautions]

WARNING

- Shut off the external power supply (all phases) used in the system before mounting or removing a module. Failure to do so may result in electric shock or cause the module to fail or malfunction.
-

[Installation Precautions]

CAUTION

- Use the module in an environment that meets the general specifications in this manual. Failure to do so may result in electric shock, fire, malfunction, or damage to or deterioration of the product.
 - Do not directly touch any conductive parts and electronic components of the module. Doing so can cause malfunction or failure of the module.
 - After the first use of the product, do not connect/remove the connectors more than 50 times (IEC 61131-2/JIS B 3502 compliant). Exceeding the limit may cause malfunction.
 - Connect each connection cable to the connector securely. Poor contact may cause malfunction.
 - Securely fix the safety remote I/O module with the mounting screws. If not, the module will be greatly affected by vibration, causing failure of the module.
-

[Wiring Precautions]

WARNING

- Shut off the external power supply (all phases) used in the system before wiring. Failure to do so may result in electric shock or cause the module to fail or malfunction.
-

[Wiring Precautions]

CAUTION

- Individually ground the FG terminal of the programmable controller with a ground resistance of 100 ohms or less. Failure to do so may result in electric shock or malfunction.
 - Check the rated voltage and terminal layout before wiring to the module, and connect the cables correctly. Connecting a power supply with a different voltage rating or incorrect wiring may cause fire or failure.
 - Prevent foreign matter such as dust or wire chips from entering the module. Such foreign matter can cause a fire, failure, or malfunction.
 - Place the cables in a duct or clamp them. If not, dangling cables may swing or inadvertently be pulled, resulting in malfunction or damage to modules or cables. In addition, the weight of the cables may put stress on modules in an environment of strong vibrations and shocks.
 - When disconnecting the cable from the module, do not pull the cable by the cable part. For the cable with connector, hold the connector part of the cable. Pulling the cable connected to the module may result in malfunction or damage to the module or cable.
 - Do not install the control lines or communication cables together with the main circuit lines or power cables. Keep a distance of 100mm or more between them. Failure to do so may result in malfunction due to noise.
 - When an overcurrent caused by an error of an external device or a failure of the module flows for a long time, it may cause smoke and fire. To prevent this, configure an external safety circuit, such as a fuse.
 - Mitsubishi programmable controllers must be installed in control panels. Wiring and replacement of a module must be performed by qualified maintenance personnel with knowledge of protection against electric shock. For wiring methods, refer to "INSTALLATION AND WIRING" in this manual.
 - When attaching waterproof caps to the safety remote I/O module, tighten the caps within the specified torque range. Undertightening can cause short circuit, fire, or malfunction. Overtightening can damage the cap, resulting in short circuit or malfunction.
 - The safety remote I/O module is compliant with IP67 only when all necessary waterproof connectors and caps have been installed and the cover for the IP address/station number setting switches and the function setting switches has been properly tightened with screws.
 - For waterproof cables used for the safety remote I/O module, use UL listed cables in the categories "CYJV" and "PVVA", with the suitable voltage, current, and temperature rating (the operating temperature rating of the cables: 75°C or higher).
 - For the safety remote I/O module, prevent foreign matter such as dust or wire chips from attaching to the gasket to keep waterproofing of the cover. Remove the foreign matter if it is attached to the gasket.
 - Do not replace or wire the safety remote I/O module immediately after powering off the system because the connector parts of the module can get really hot depending on the load conditions.
-

[Startup and Maintenance Precautions]

WARNING

- Do not touch any terminal while power is on. Doing so will cause electric shock or malfunction.
 - Shut off the external power supply (all phases) used in the system before cleaning the module, retightening screws or connectors, or operating the IP address/station number setting switches. Failure to do so may cause the module to fail or malfunction.
-

[Startup and Maintenance Precautions]

CAUTION

- Do not disassemble or modify the modules. Doing so may cause failure, malfunction, injury, or a fire.
 - Use any radio communication device such as a cellular phone or PHS (Personal Handy-phone System) 25cm or more away from wiring as well as away in all directions from the module. Failure to do so may cause malfunction.
 - Shut off the external power supply (all phases) used in the system before mounting or removing a module. Failure to do so may cause the module to fail or malfunction.
 - Before handling the module, touch a conducting object such as a grounded metal to discharge the static electricity from the human body. Wearing an anti-static wrist strap (grounded) is also recommended. Not discharging the static electricity may cause the module to fail or malfunction.
 - Do not drop or apply strong shock to the module. Doing so may damage the module.
 - Shut off the external power supply (all phases) used in the system before installing or removing a module in/from the control panel. Failure to do so may cause the module to fail or malfunction.
 - Check the module once a day, by turning on output signals and confirming that no error occurs.
 - When loads are connected with double wiring, operate each load separately to check for a failure.
 - Startup and maintenance of a control panel must be performed by qualified maintenance personnel with knowledge of protection against electric shock. Lock the control panel so that only qualified maintenance personnel can operate it.
-

[Disposal Precautions]

CAUTION

- When disposing of this product, treat it as industrial waste.
-

[Precautions for Using Products]

WARNING

- Although MELCO has obtained the certification for Product's compliance to the international safety standards IEC 61508 and ISO 13849-1 from TUV Rheinland, this fact does not guarantee that Product will be free from any malfunction or failure.
 - With very small probability shown in PFDavg / PFH, the safety remote I/O module has residual risk that input and output may turn on or off in unintended way. When using this product, perform risk assessment on target equipment, and select appropriate SIL and PL, as well as reduce the risk.
 - This product complies with following requirements of international safety standards: SIL3 (IEC 61508: 2010), PL.e (EN ISO 13849-1: 2015).
-

[Transportation Precautions]

CAUTION

- For shipping, always use the original packaging.
-

CONDITIONS OF USE FOR THE PRODUCT

- (1) Although MELCO has obtained the certification for Product's compliance to the international safety standards IEC61508, ISO13849-1 from TUV Rheinland, this fact does not guarantee that Product will be free from any malfunction or failure. The user of this Product shall comply with any and all applicable safety standard, regulation or law and take appropriate safety measures for the system in which the Product is installed or used and shall take the second or third safety measures other than the Product. MELCO is not liable for damages that could have been prevented by compliance with any applicable safety standard, regulation or law.
- (2) MELCO prohibits the use of Products with or in any application involving, and MELCO shall not be liable for a default, a liability for defect warranty, a quality assurance, negligence or other tort and a product liability in these applications.
 - (a) power plants,
 - (b) trains, railway systems, airplanes, airline operations, other transportation systems,
 - (c) hospitals, medical care, dialysis and life support facilities or equipment,
 - (d) amusement equipments,
 - (e) incineration and fuel devices,
 - (f) handling of nuclear or hazardous materials or chemicals,
 - (g) mining and drilling,
 - (h) and other applications where the level of risk to human life, health or property are elevated.
- (3) Mitsubishi shall have no responsibility or liability for any problems involving programmable controller trouble and system trouble caused by DoS attacks, unauthorized access, computer viruses, and other cyberattacks.

INTRODUCTION

Thank you for purchasing the CC-Link IE TSN waterproof/dustproof remote I/O module (with safety functions) (hereinafter referred to as safety remote I/O module).

This manual describes the procedures, system configuration, parameter settings, functions, and troubleshooting of the relevant products listed below.

Before using this product, please read this manual and the relevant manuals carefully and develop familiarity with the functions and performance of the safety remote I/O module to handle the product correctly.

When applying the program examples introduced in this manual to an actual system, ensure the applicability and confirm that it will not cause system control problems.

Note that the menu names and operating procedures may differ depending on an operating system in use and its version.

When reading this manual, replace the names and procedures with the applicable ones as necessary.

Relevant products

NZ2GNS12A2-16DTE

Point

Unless otherwise specified, this manual describes the examples in which the safety remote I/O signals, remote control/monitor signals, and remote registers are assigned for a safety remote I/O module as follows.

- Safety remote inputs: SA\X0 to SA\X1F
- Safety remote outputs: SA\Y0 to SA\Y1F
- Remote control/monitor signals: RX0 to RXF, RY0 to RYF
- Remote register: RWr0 to RWr13, RWw0 to RWw13

For how to assign safety remote I/O signals, refer to the following.

 Page 61 Safety Communication Setting

For how to assign remote control/monitor signals and remote registers, refer to the following.

 Page 53 Parameter Setting

CONTENTS

SAFETY PRECAUTIONS	1
CONDITIONS OF USE FOR THE PRODUCT	7
INTRODUCTION	8
RELEVANT MANUALS	12
TERMS	13
GENERIC TERMS AND ABBREVIATIONS	14
CHAPTER 1 PRODUCT LINEUP	15
CHAPTER 2 PART NAMES	17
CHAPTER 3 SPECIFICATIONS	20
3.1 General Specifications	20
3.2 Performance Specifications	21
Safety remote I/O module safety response time	25
3.3 Function List	26
CHAPTER 4 PROCEDURES BEFORE OPERATION	28
CHAPTER 5 SYSTEM CONFIGURATION	30
5.1 Applicable Systems	30
5.2 Safety Standards	32
CHAPTER 6 INSTALLATION AND WIRING	33
6.1 Indicator Cover	33
6.2 Setting the IP Address/Station Number Setting Switches	34
6.3 Setting the Function Setting Switches	36
6.4 Installation Environment and Installation Position	38
Installation environment	38
Installation position	38
Installation direction	39
6.5 Installation	40
Fixing the safety remote I/O module	40
6.6 Wiring the Power Supply of the Safety Remote I/O Module	41
6.7 Wiring of Ethernet Cable	42
6.8 Wiring the External Device and I/O Connector	44
Precautions for wiring the safety remote I/O module to safety devices	45
6.9 List of Recommended Cables/Connectors for the Safety Remote I/O Module	46
CHAPTER 7 SETTINGS	49
7.1 Network Configuration Settings	49
7.2 Parameter Setting	53
Device station parameter automatic setting	55
Parameter processing of device station	58
7.3 Safety Communication Setting	61

CHAPTER 8	FUNCTIONS	67
8.1	Safety Input	67
	Safety input wiring selection function	67
8.2	Input Response Time Setting Function	70
8.3	Safety Output	71
	Safety output wiring selection function	71
	Fast logic function	74
8.4	Input Diagnostic	85
	Double input discrepancy detection function	85
	Input dark test function	89
	Internal input dark test function	91
8.5	Output Diagnostic	92
	Output dark test function	92
	Output read-back function	94
8.6	Diagnostics Visualization Function	95
8.7	Protection Functions	98
8.8	User Authentication Function	99
8.9	SLMP Communication Function	100
8.10	Communication Speed Setting Function	102
CHAPTER 9	MAINTENANCE AND INSPECTION	103
9.1	Daily Inspection	103
9.2	Periodic Inspection	104
CHAPTER 10	TROUBLESHOOTING	105
10.1	CC-Link IE TSN/CC-Link IE Field Diagnostics	105
10.2	Checking the LEDs	107
10.3	Unit Test	112
10.4	Troubleshooting by Symptom	113
10.5	Fault Examples with the Safety Remote I/O Module	115
	Troubleshooting for input circuit	115
	Troubleshooting for output circuit	117
10.6	Method for Checking Error Codes	118
10.7	List of Error Codes	120
	Error classification by error number	120
	Error codes related to the safety remote I/O module	120
	Error codes related to CC-Link IE TSN	126
	Error codes related to CC-Link IE TSN safety communications	128
APPENDICES		129
Appendix 1	Safety Remote I/O Signals	129
	List of safety remote I/O signals	130
	Details of safety remote input signals	131
	Details of safety remote output signals	133
Appendix 2	Remote Control/Monitor Signals	134
	List of remote control/monitor signals	134
	Details of remote control/monitor signals	134
Appendix 3	Remote Register	136
	List of remote registers	136
	Details of remote registers	136

Appendix 4 Remote Buffer Memory	140
Remote buffer memory list	140
Details of remote buffer memory areas	144
Appendix 5 EMC and Low Voltage Directives	150
Measures to comply with the EMC Directive	150
Requirements for Low Voltage Directive compliance	155
Measures to comply with the Machinery Directive	156
Appendix 6 How to Check Production Information and Firmware Version	158
Checking the production information	158
Checking the firmware version	159
Appendix 7 External Dimensions	160
INDEX	161
<hr/>	
REVISIONS	163
WARRANTY	164
TRADEMARKS	166

RELEVANT MANUALS

Manual name [manual number]	Description	Available form
CC-Link IE TSN Waterproof/Dustproof Remote I/O Module (With Safety Functions) User's Manual [SH-082466ENG] (this manual)	Part names, specifications, procedures before operation, system configuration, installation, wiring, parameter settings, functions, and troubleshooting of the safety remote I/O module	Print book e-Manual PDF
MELSEC iQ-R CC-Link IE TSN User's Manual (Startup) [SH-082127ENG]	Specifications, procedures before operation, system configuration, wiring, and communication examples of CC-Link IE TSN	Print book e-Manual PDF
MELSEC iQ-R CC-Link IE TSN User's Manual (Application) [SH-082129ENG]	Functions, parameter settings, troubleshooting, I/O signals, and buffer memory of CC-Link IE TSN	Print book e-Manual PDF
GX Works3 Operating Manual [SH-081215ENG]	System configuration, parameter settings, and online operations of GX Works3	e-Manual PDF



e-Manual refers to the Mitsubishi Electric FA electronic book manuals that can be browsed using a dedicated tool.

e-Manual has the following features:

- Required information can be cross-searched in multiple manuals.
- Other manuals can be accessed from the links in the manual.
- The hardware specifications of each part can be found from the product figures.
- Pages that users often browse can be bookmarked.
- Sample programs can be copied to an engineering tool.

TERMS

Unless otherwise specified, this manual uses the following terms.

Term	Description
CC-Link IE TSN Class ^{*1}	A group of devices and switching hubs compatible with CC-Link IE TSN, ranked according to the functions and performance by the CC-Link Partner Association. For CC-Link IE TSN Class, refer to the CC-Link IE TSN Installation Manual (BAP-C3007ENG-001) published by the CC-Link Partner Association.
Cyclic transmission	A function by which data are periodically exchanged among stations on the same network using link devices
Data link	Communications performed by cyclic transmission and transient transmission
Device station	A station other than a master station: a local station, a remote station
Engineering tool	A tool used for setting up programmable controllers, programming, debugging, and maintenance
Link device	A device (RX, RY, RWr, RWw, LB, and LW) in a module on CC-Link IE TSN
Local station	This station serves as a safety station or a standard station. This station can perform cyclic transmission and transient transmission with the master station and other local stations. When set as a safety station, the station can perform safety communication with another safety station on the same network. The station is controlled by programs in the CPU module or other equivalent modules on the station.
Master station	A station that controls the entire network. Only one master station can be used in a network. This station serves as a safety station or a standard station. The station can perform cyclic transmission and transient transmission with all stations. When set as a safety station, the station can perform safety communication with another safety station on the same network.
Multicast filter	A filter function that selects whether or not the own station sends cyclic data of multicast to the subsequent stations after receiving them. Since the master station sets the multicast filter according to the system configuration, parameter settings for this filter function are not required.
Multicast mode	Cyclic data are sent to multiple stations in this communication mode.
Remote station	A station that exchanges I/O signals (bit data) and I/O data (word data) with another station by cyclic transmission. This station can perform transient transmission.
Reserved station	A station reserved for future use. This station is not actually connected, but counted as a connected station.
Safety communications	A function for exchanging safety data between safety stations on the same network
Safety remote input (SAIX)	A safety device (safety input) that can be used in safety programs
Safety remote output (SAIY)	A safety device (safety output) that can be used in safety programs
Safety remote station	A remote station to perform safety communications
Transient transmission	A function of communication with another station, which is used when requested by a dedicated instruction or an engineering tool

*1 The term has been changed for standardization among manuals and software applications related to CC-Link IE TSN. However, the term used in some CC-Link IE TSN related software windows may remain unchanged and may be different from the term used in this manual.

In case of inconsistency, refer to the following.

Term in the windows	Replacement term
Authentication Class	CC-Link IE TSN Class

GENERIC TERMS AND ABBREVIATIONS

Unless otherwise specified, this manual uses the following generic terms and abbreviations.

Generic term and abbreviation	Description
REMFR	A generic term for the JP.REMFR and ZP.REMFR
REMFRIIP	An abbreviation for the GP.REMFRIIP
REMTO	A generic term for the JP.REMTO and ZP.REMTO
REMTOIP	An abbreviation for the GP.REMTOIP
RWr	An abbreviation for the remote register of link device. RWr refers to word data input from a device station to the master station. (For some areas in a local station, data are input in the opposite direction.)
RWw	An abbreviation for the remote register of link device. RWw refers to word data output from the master station to a device station. (For some areas in a local station, data are output in the opposite direction.)
RX	An abbreviation for remote input of link device. RX refers to bit data input from a device station to the master station. (For some areas in a local station, data are input in the opposite direction.)
RY	An abbreviation for remote output of link device. RY refers to bit data output from the master station to a device station. (For some areas in a local station, data are output in the opposite direction.)
Safety remote I/O module	An abbreviation for the CC-Link IE TSN waterproof/dustproof remote I/O module (with safety functions)
SLMPSND	A generic term for the J.SLMPSND, JP.SLMPSND, G.SLMPSND, and GP.SLMPSND

1 PRODUCT LINEUP

Module name		Input specifications	Output specifications	Module power supply current	Weight	Model	Reference
DC input/transistor output module	<ul style="list-style-type: none"> • Input part: Negative common type • Output part: Source/source type 	Waterproof connector 24VDC, 12 points	Waterproof connector 24VDC, 2.0A/1 point, 4 points	260mA	0.52kg	NZ2GNS12A2-16DTE	 Page 21 NZ2GNS12A2-16DTE DC input/transistor output module

MEMO

2 PART NAMES

The part names of the safety remote I/O module are listed below.

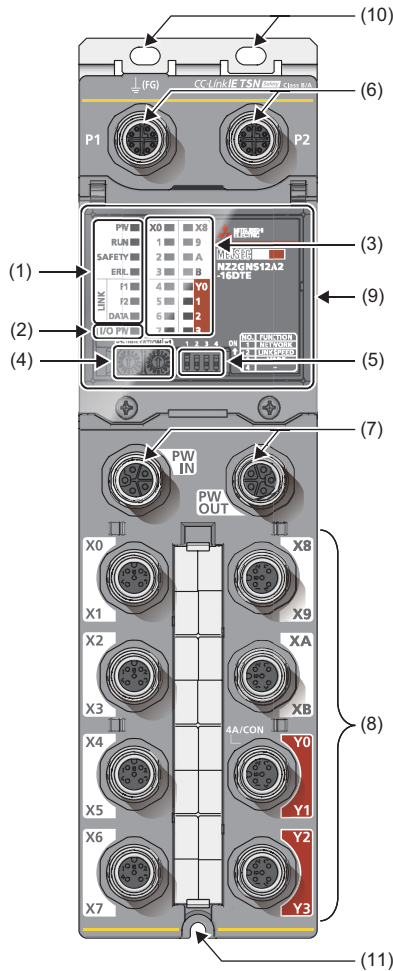

No.	Name	Description
(1)	PW LED	Indicates the power supply status of the safety remote I/O module. On: Power supply ON Off: Power supply OFF
	RUN LED	Indicates the operating status of the safety remote I/O module. On: Operating normally, in initial processing Flashing: Operating in unit test mode Off: A major error has occurred.
	SAFETY LED	Indicates the safety communications status of the safety remote I/O module. On: In safety communication connection, in initial processing Flashing: Checking the position of the setting target module Off: Safety communication being disconnected
	ERR. LED	Indicates the error status of the safety remote I/O module. On: A moderate error or major error has occurred, in initial processing Flashing: A minor error has occurred.*2 Off: Operating normally
	P1 LINK LED	Indicates the link status for P1. On: Link-up Off: Link-down
	P2 LINK LED	Indicates the link status for P2. On: Link-up Off: Link-down
	DATA LINK LED	Indicates the data link status of the safety remote I/O module. On: Cyclic transmission being performed, in initial processing Flashing: Cyclic transmission stopped*1 Off: Disconnected

No.	Name	Description
(2)	I/O PW LED	Indicates the status of the power supply from the external power supply. On: External power supply ON Off: External power supply OFF
(3)	X0 LED to XB LED Y0 LED to Y3 LED	When error points are not indicated Indicates the ON/OFF status of I/O. On: ON status of input or output* ³ Off: OFF status of input or output
		When error points are indicated Flashes the error points. On: ON status of input or output* ³ Flashing: An error has occurred.* ⁴ Off: OFF status of input or output
(4)	IP address/station number setting switch	Sets the fourth octet of the IP address. (☞ Page 34 Setting the IP Address/Station Number Setting Switches)
(5)	Function setting switch	Sets the functions of the safety remote I/O module. (☞ Page 36 Setting the Function Setting Switches)
(6)	P1	A port for the connection to CC-Link IE TSN (M12 waterproof connector) Connects an Ethernet cable. (☞ Page 42 Wiring of Ethernet Cable) There are no restrictions on the connection order of the cables for P1 and P2.
	P2	Same as P1
(7)	Power supply connector	A connector for the module power supply (24VDC) and FG
(8)	Connector for I/O	A connector for the I/O power supply and I/O signal connections
(9)	Indicator cover	A protective cover for LEDs and switches
(10)	FG metal fitting/mounting bracket	A metal bracket for FG connection and mounting the module
(11)	Module mounting hole	A hole for a module mounting screw

*1 When cyclic transmission is stopped only for the master station, the safety remote I/O module maintains the cyclic transmission. Thus, the DATA LINK LED remains on.

*2 After a minor error has been eliminated, the LED flashes for 5 seconds or longer and turns off.

*3 In the safety drive mode, the status of actual input signals that are externally input is indicated on the LEDs regardless of the setting of the input response time setting function.

For details on the safety drive mode, refer to the following.

☞ Page 27 Operation mode and state transition

*4 When the LED is flashing, the minor error state is applied to the safety remote I/O module.

For I/O LED indication setting at error occurrence, refer to the following.

☞ Page 144 I/O LED indication setting at error occurrence

Safety remote I/O module status and LED status

The correspondence between the safety remote I/O module status and the LED status is described below.

For the status of the safety remote I/O module, refer to the following.

☞ Page 27 Operation mode and state transition

For details on each error, refer to the following.

☞ Page 120 Error codes related to the safety remote I/O module

Safety remote I/O module status		Data link status	LED status				
			PW LED	RUN LED	SAFETY LED	ERR. LED	DATA LINK LED
Initial processing state ^{*1}		Disconnection	On	On	On	On	On
Initial processing state (wait for supply of module power supply voltage) ^{*2}		Disconnection	On	Off	Off	Flashing	Off
Standby mode	Disconnected	Disconnection	On	On	Off	Off	Off
	Data link in operation	Data link in operation	On	On	Off	Off	On
	Reserved station setting in progress	Cyclic stop	On	On	Off	Off	Flashing
	Link stop	Cyclic stop	On	On	Off	Off	Flashing
	Checking the position of the setting target module	Data link in operation/cyclic stop	On	On	Flashing	Off	^{*3}
Safety drive mode		Data link in operation	On	On	On	Off	On
Unit test mode	In progress	—	On	Flashing	Off	Off	Off
	Completed successfully	—	On	On	Off	Off	Off
	Completed with an error	—	On	On	Off	On	Off
Communication error		Cyclic stop	On	On	Off	Off	Flashing
Error	Major error	—	On	Off	^{*6}	On ^{*4}	^{*5}
	Moderate error	—	On	On	^{*6}	On	^{*5}
	Minor error	—	On	On	^{*5}	Flashing	^{*5}

^{*1} At the initial processing, the LEDs (RUN LED, SAFETY LED, ERR. LED, DATA LINK LED, I/O LED) turn on for a moment to check if the LEDs turn on.

^{*2} When the module power supply voltage does not reach the allowable voltage range at the initial processing, the initial processing is suspended and the module enters the standby state until the module power supply voltage reaches the allowable voltage range. If this state continues for two minutes or longer, a module power supply voltage error (error code: 0109H) occurs and the safety remote I/O module stops the operation. To recover the module, power off and on the module power supply. When the module power supply voltage reaches the allowable voltage range within two minutes after this state occurs, the initial processing is continued.

^{*3} Either of On or Flashing.

^{*4} When the safety remote I/O module fails, the LED may not turn on.

^{*5} Any of On, Flashing, or Off.

^{*6} Either of Flashing or Off.

3 SPECIFICATIONS

This chapter describes the specifications of the safety remote I/O module.

3.1 General Specifications

Item	Specifications					
Operating ambient temperature	0 to 55°C					
Storage ambient temperature	-25 to 75°C					
Operating ambient humidity	Compliant with IP67*1					
Storage ambient humidity	5 to 95%RH, non-condensing					
Vibration resistance	Compliant with JIS B 3502 and IEC 61131-2	—	Frequency	Constant acceleration	Half amplitude	Number of sweeps
		Under intermittent vibration	5 to 8.4Hz	—	3.5mm	10 times each in X, Y, and Z directions
			8.4 to 150Hz	9.8m/s ²	—	
		Under continuous vibration	5 to 8.4Hz	—	1.75mm	—
8.4 to 150Hz	4.9m/s ²		—			
Shock resistance	Compliant with JIS B 3502 and IEC 61131-2 (147m/s ² , 3 times each in X, Y, and Z directions)					
Operating atmosphere	No corrosive gases, flammable gases, less conductive dust					
Operating altitude*2	0 to 2000m					
Installation location	Inside a control panel*3					
Overvoltage category*4	II or less					
Pollution degree*5	2 or less					
Equipment class	ClassIII					

*1 Only when all necessary waterproof connectors and caps have been installed and the indicator cover for the IP address/station number setting switches and the function setting switches has been properly tightened with screws, the module is compliant with IP67. For the tightening torque range of the cover screws for the switches, refer to the following.

☞ Page 34 Setting the IP Address/Station Number Setting Switches, ☞ Page 36 Setting the Function Setting Switches

- *2 Do not use or store the safety remote I/O module under pressure higher than the atmospheric pressure of altitude 0m. Doing so may cause malfunction.
- *3 If the environment satisfies the operating ambient temperature, operating ambient humidity, and other conditions, the module can be used even outside the control panel.
- *4 This indicates the section of the power supply to which the equipment is assumed to be connected between the public electrical power distribution network and the machinery within premises. Category II applies to equipment for which electrical power is supplied from fixed facilities. The surge voltage withstand level for the equipment with up to the rated voltage of 300V is 2500V.
- *5 This index indicates the degree to which conductive material is generated in terms of the environment in which the equipment is used. Pollution degree 2 is when only non-conductive pollution occurs. A temporary conductivity caused by incidental condensation must be expected occasionally.

3.2 Performance Specifications

NZ2GNS12A2-16DTE DC input/transistor output module

Item		NZ2GNS12A2-16DTE
Station type		Remote station
CC-Link IE TSN Class		CC-Link IE TSN Class B/A
Network topology		Line topology, star topology, mixture of star topology and line topology, ring topology ⁵
Number of input points		Single wiring: 12 points, double wiring: 6 points
Rated input voltage		24VDC (ripple ratio: 5% or less) (allowable voltage range: 20.4 to 28.8VDC)
Rated input current		6.8mA TYP. (at 24VDC)
Maximum number of simultaneous input points		100%
ON voltage/ON current		11VDC or more/4mA or more
OFF voltage/OFF current		5VDC or less/1.5mA or less
Input resistance		3.2kΩ
Input circuit response time	Off → On	0.4ms or less (24VDC)
	On → Off	0.4ms or less (24VDC)
Safety remote station safety cycle time		2.0ms
Communication path response time		0.3ms
Safety remote station refresh response processing time		Safety remote station safety cycle time + Communication path response time
Safety remote station input response time		Input circuit response time + Input response time (1ms, 1.5ms, 5ms, 10ms, 20ms, 50ms, 70ms)
Load power supply and external power supply for output part ^{1*3}	Voltage	24VDC (ripple ratio: 5% or less) (allowable voltage range: 20.4 to 28.8VDC)
	Current	60mA
	Protection function	External power supply overvoltage protection function
Power supply current for input device ⁴		0.4A/terminal
Input type		Negative common type
Withstand voltage		500VAC for 1 minute between all DC external terminals and the ground
Insulation resistance		10MΩ or higher between all DC external terminals and ground (500VDC insulation resistance tester)
Noise immunity		Noise voltage 500Vp-p, noise width 1μs, noise frequency 25 to 60Hz (DC type noise simulator condition)
Protection degree		IP67
Wiring method for common		Input 12 points/common
Number of output points		Single wiring: 4 points, double wiring: 2 points
Rated load voltage		24VDC (ripple ratio: 5% or less) (allowable voltage range: 20.4 to 28.8VDC)
Maximum load current		4A/point (Y0-Y1) ⁶ , 2A/point (Y2-Y3) 8A/common
Maximum inrush current		Current is limited by the overload protection function.
Leakage current at OFF ⁷		0.1mA or less
Max. voltage drop at ON		1.0VDC or lower
Output circuit response time	Off → On	0.4ms or less (24VDC)
	On → Off	0.4ms or less (24VDC)
Safety remote station output response time		Output circuit response time
Surge suppressor		Zener diode
Double output type		Source + Source type
Wiring method for common		Output 4 points/common
Protection function		Limited current when detecting overcurrent: 4.4 to 5.2A/point
External interface	Communication part	M12 waterproof connector, 8 pins, female, X-code
	Module power supply part	M12 waterproof connector, 5 pins, male, female, L-code
	I/O part	M12 waterproof connector, 5 pins, female, A-code
Applicable waterproof connector	For communications	☞ Page 46 List of Recommended Cables/Connectors for the Safety Remote I/O Module
	For power supply	
	For I/O	
	Y-branch connector for I/O	

Item		NZ2GNS12A2-16DTE
CC-Link IE TSN protocol version		Class B: ver. 1.0/2.0 Class A: ver. 2.0
Maximum response time for time-managed polling (for CC-Link IE TSN Class A)		512μs
Multicast filter		Available
Cyclic transmission	RX/RY points	16 points
	RWr/RWw points	20 points
	SAIX / SAIY points	SAIX: 32 points, SAIY: 32 points* ²
Module-and-sensor power supply* ^{1,3}	Voltage	24VDC (ripple ratio: 5% or less) (allowable voltage range: 20.4 to 28.8VDC)
	Current	260mA
	Protection functions	Module power supply overvoltage protection function, module power supply overcurrent protection function
	Fuse	1.6A (user-unchangeable), 7A (user-unchangeable)
Safety element		Type B, HFT = 1, SC 3
Weight		0.52kg

- *1 For a power supply to be connected to the safety remote I/O module (such as the load power supply and external power supply for output part or the module-and-sensor power supply), use the power supply that meets the following conditions.
- SELV (Safety Extra Low Voltage): Product with reinforced insulation from the hazardous potential part (60VDC or higher)
 - LVD applicable product
 - Output voltage specifications: 20.4 to 28.8VDC (ripple ratio: 5% or less)
- *2 SAIX and SAIY are safety devices that store safety I/O data.
- *3 To connect to the module, use a power supply whose output hold time is 10ms or longer.
- *4 When using the test pulse output for the power supply for input device, use double insulation cables depending on applications used and the safety category (SIL/CAT) required.
- *5 Ring topology can be used only when CC-Link IE TSN Class B is selected for the CC-Link IE TSN Class setting. If a safety remote I/O module with CC-Link IE TSN Class A is connected in ring topology, data link cannot be performed.
- *6 Make sure that the total amount of output current that flows through one connector is 4A or less.
- *7 For the voltage at OFF, calculate it using the following formula: Resistance value of the load connected × Leakage current at OFF.

Derating chart

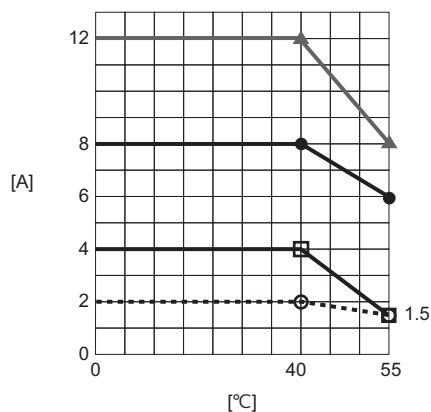

- ▲: Current of the load power supply and external power supply for output part
- : Module-and-sensor power supply current
- : Y0, Y1
- : Y2, Y3
- A: Current
- °C: Ambient temperature

External wiring

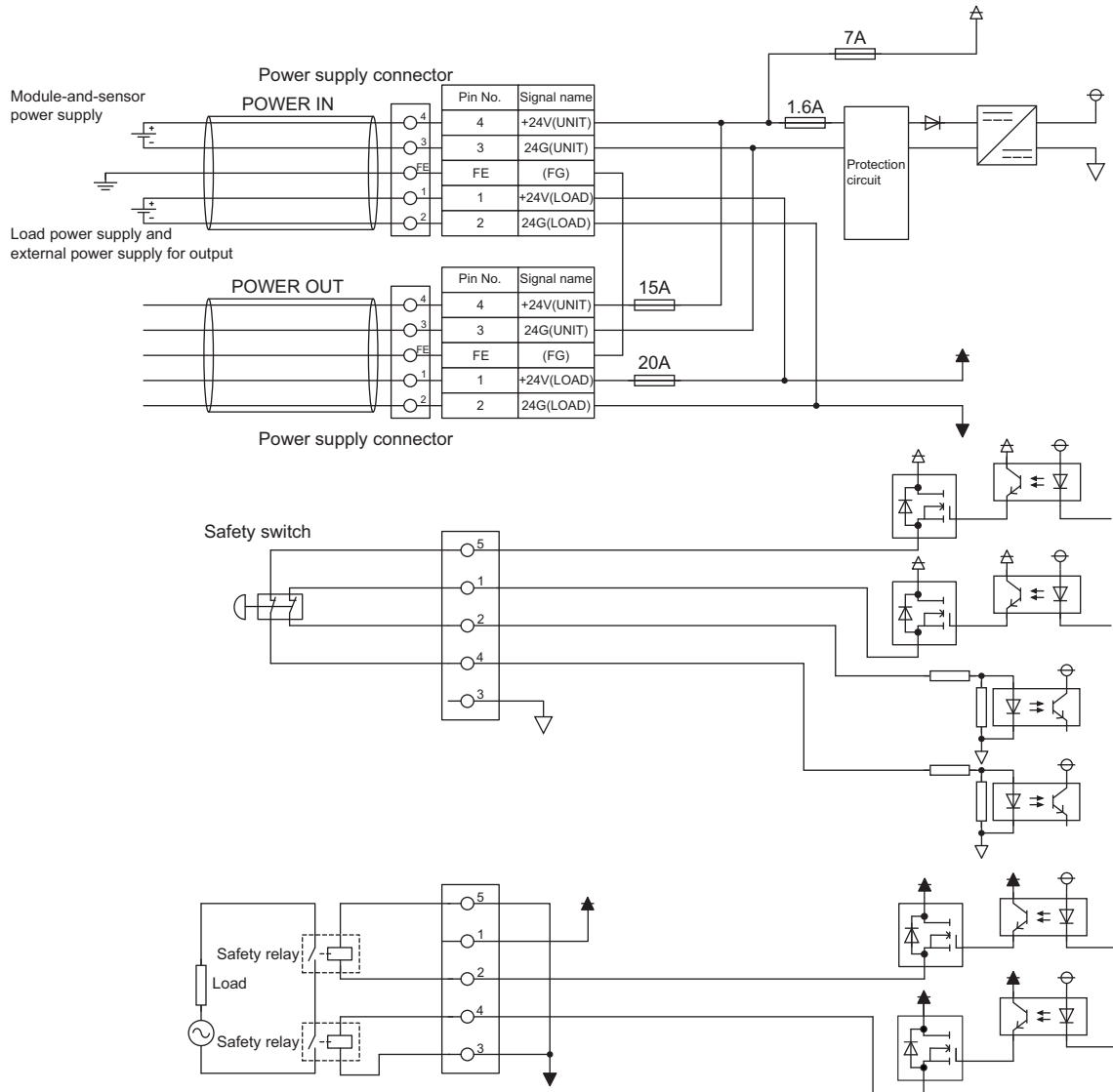

■ Power supply connectors

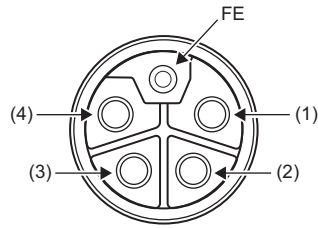
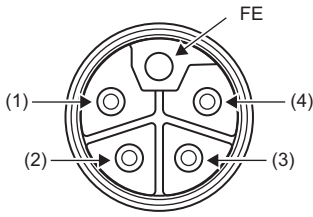

Pin number		Signal name	Pin number		Signal name
M12 connector, male (IN)	(1)	+24V (LOAD)	M12 connector, female (OUT)	(1)	+24V (LOAD)
	(2)	24G (LOAD)		(2)	24G (LOAD)
	(3)	24G (UNIT)		(3)	24G (UNIT)
	(4)	+24V (UNIT)		(4)	+24V (UNIT)
	FE	FG		FE	FG

■ Connector for I/O

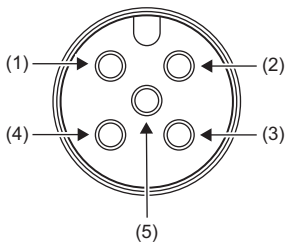

Pin number		Signal name	Pin number		Signal name
X0 X1	(1)	T1	X8 X9	(1)	T9
	(2)	X1		(2)	X9
	(3)	24G (UNIT)		(3)	24G (UNIT)
	(4)	X0		(4)	X8
	(5)	T0		(5)	T8
X2 X3	(1)	T3	XA XB	(1)	TB
	(2)	X3		(2)	XB
	(3)	24G (UNIT)		(3)	24G (UNIT)
	(4)	X2		(4)	XA
	(5)	T2		(5)	TA
X4 X5	(1)	T5	Y0 Y1	(1)	Empty
	(2)	X5		(2)	Y1
	(3)	24G (UNIT)		(3)	24G (LOAD)
	(4)	X4		(4)	Y0
	(5)	T4		(5)	24G (LOAD)
X6 X7	(1)	T7	Y2 Y3	(1)	Empty
	(2)	X7		(2)	Y3
	(3)	24G (UNIT)		(3)	24G (LOAD)
	(4)	X6		(4)	Y2
	(5)	T6		(5)	24G (LOAD)

Safety remote I/O module safety response time

The safety response time of the safety remote I/O module is shown below.

For the response time including the transmission delay time, refer to the following.

 Mitsubishi Electric Safety Programmable Controller MELSEC iQ-R Series Machinery Directive (2006/42/EC) Compliance

Input

Transmission interval monitoring time \times 2 + Safety remote station input response time

Output

Transmission interval monitoring time \times 2 + Safety remote station output response time

Point

For the transmission interval monitoring time, refer to the "Processing Time" of the following manual.

 User's manual for the master station used

3.3 Function List

The following table lists the functions of the safety remote I/O module.

Item		Description	Reference
Safety input	Safety input wiring selection function	The double wiring function or single wiring function can be selected for input wiring.	Page 67 Safety input wiring selection function
Input response time setting function		This function is used to set the filter time to reduce incorrect inputs caused by noise in input signals.	Page 70 Input Response Time Setting Function
Safety output	Safety output wiring selection function	The double wiring function or single wiring function can be selected for output wiring.	Page 71 Safety output wiring selection function
	Fast logic function	Output control according to the input status is performed inside the safety remote I/O module without going through the master station.	Page 74 Fast logic function
Input diagnostics ^{*1}	Double input discrepancy detection function	Discriminates failures by monitoring the discrepancy state of doubled safety remote inputs (SAIX).	Page 85 Double input discrepancy detection function
	Input dark test function	Outputs test pulses to turn off the external input signals (X0 to XB) that are on and diagnoses contacts including external devices for failure.	Page 89 Input dark test function
	Internal input dark test function	Outputs test pulses to the internal input circuit of the safety remote I/O module to detect a circuit-fixing failure. The test pulses turn off the external input signals (X0 to XB) that are on to detect the failure.	Page 91 Internal input dark test function
Output diagnostics ^{*2}	Output dark test function	Outputs test pulses to turn off the external output signals (Y0 to Y3) that are on and diagnoses the internal circuit for failure.	Page 92 Output dark test function
	Output read-back function	Reads back output results and diagnoses whether the external output signals (Y0 to Y3) are correctly output.	Page 94 Output read-back function
Diagnostics visualization function		Displays information about pulse width detected by the module performing the input dark test or output dark test.	Page 95 Diagnostics Visualization Function
Protection function		Prevents effects due to overvoltage and overcurrent from spreading to other modules of the safety system.	Page 98 Protection Functions
User authentication function		Limits the users (persons and personal computers) that can access the CPU module or safety remote I/O module.	Page 99 User Authentication Function
SLMP communication function		Allows communications with safety remote I/O modules using SLMP.	Page 100 SLMP Communication Function
Communication speed setting function		Sets the communication speed.	Page 102 Communication Speed Setting Function

*1 This function is used only for safety input.

*2 This function is used only for safety output.

Operation mode and state transition

The following describes the state transition and transition conditions of the safety remote I/O module.

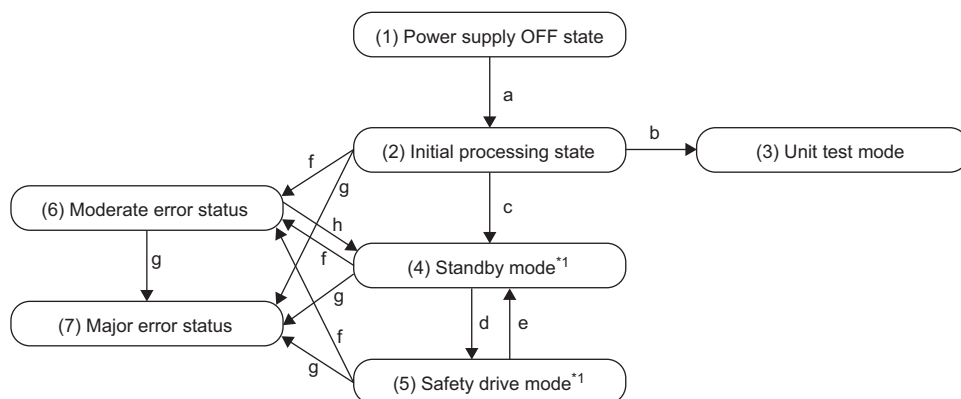

*1 When a moderate error or major error has occurred, the state is changed into an error state.

■ Operation mode/state

No.	Mode/state	Description
(1)	Power supply OFF state	The power supply is not turned on. Change the IP address using the IP address/station number setting switches or wire the module in this state. (☞ Page 33 INSTALLATION AND WIRING)
(2)	Initial processing state	The initial processing is performed at this state. When the mode is changed to this mode, the PW LED turns on, and the RUN LED, SAFETY LED, ERR. LED, DATA LINK LED, and I/O PW LED turn on for a moment.
(3)	Unit test mode	The unit test is performed in this mode. (☞ Page 112 Unit Test)
(4)	Standby mode	The safety functions of the safety remote I/O module do not operate in this mode. Set parameters in this mode. (☞ Page 53 Parameter Setting)
(5)	Safety drive mode	The safety functions of the safety remote I/O module operate in this mode.
(6)	Moderate error state	A moderate error has occurred.
(7)	Major error state	A major error has occurred.

■ Transition condition

Symbol	Transition condition
a	When the module is powered on
b	When the IP address/station number setting switch x16 is set to F and the function setting switch 1 is on in the power supply OFF state
c	When the initial processing is completed successfully
d	When Safety module enabled flag (RWr0.b0) is on and the safety communication with the master station is established. For Safety module enabled flag (RWr0.b0), refer to the following. ☞ Page 136 Safety module enabled flag (RWr0.b0)
e	When the safety communication is disconnected
f	When a moderate error has occurred
g	When a major error has occurred
h	When a parameter data error is eliminated. For parameter data errors, refer to the following. ☞ Page 120 List of Error Codes

Point

To switch the operation mode/state from the unit test mode, moderate error state, or major error state, power off and on the module.

4 PROCEDURES BEFORE OPERATION

This chapter describes the procedures before operation.

Consideration of system configuration

1. Determine a safety category required for configuring the safety system.
2. Determine function wiring required for configuring the safety system.

Safety remote I/O module installation, wiring, and parameter setting

1. Setting the IP address/station number setting switches

Set the fourth octet of IP address of the safety remote I/O module.

 Page 34 Setting the IP Address/Station Number Setting Switches

2. Function setting switch setting

Set the communication speed and CC-Link IE TSN Class for the safety remote I/O module.

In the factory default switch status, the I/O module operates in the following settings. Change the switch status as necessary.

- Communication speed setting: 1Gbps
- CC-Link IE TSN Class setting: CC-Link IE TSN Class B

 Page 36 Setting the Function Setting Switches

3. Attaching

Fix the safety remote I/O module.

 Page 40 Fixing the safety remote I/O module

4. Wiring

Connect the power supply, Ethernet cables, and external devices to the safety remote I/O module.

 Page 41 Wiring the Power Supply of the Safety Remote I/O Module

 Page 42 Wiring of Ethernet Cable

 Page 44 Wiring the External Device and I/O Connector

5. Network parameter setting

Set the network parameters.

 User's manual for the master station used

6. Parameter setting

Set the module parameters of the safety remote I/O module.

 Page 53 Parameter Setting

7. Safety module validation

Enable the module parameters of the safety remote I/O module.

 Page 61 Safety Communication Setting

Point

To replace the safety remote I/O module, follow the procedure described below:

- Export the parameter settings. Exporting is not necessary when device station parameter automatic setting is enabled.
- Power off the safety remote I/O module and remove it.
- Prepare a new safety remote I/O module and perform the procedure from step 1 to step 7. At that time, import the parameter settings. The setting of the IP address/station number setting switch must be the same as that of the safety remote I/O module before it was replaced. Step 6 is not necessary when device station parameter automatic setting is enabled.

5 SYSTEM CONFIGURATION

This chapter describes the safety system configuration using a safety remote I/O module.
For details on the CC-Link IE TSN configuration, refer to the following.

 User's manual for the master station used

5.1 Applicable Systems

Applicable products

When using a safety remote I/O module, use the following products.

Model	Firmware version
Safety CPU (R08SF CPU, R16SF CPU, R32SF CPU, R120SF CPU)	"20" or later
Safety function module (R6SFM)	"20" or later
Master station (RJ71GN11-T2)	"10" or later
Master station (RD78GHV, RD78GHW, RD78G64, RD78G32, RD78G16, RD78G8, RD78G4)	"08" or later

The above information on "master station" is the one at the time of this manual's issuance.

For the latest information, refer to the CC-Link Partner Association's website.

www.cc-link.org



CPU modules other than Safety CPUs cannot be used with the safety remote I/O module.

Compatible software version

For the compatible software version, always keep the engineering tool of the master station up to date.

Only GX Works3 is a compatible engineering tool.

When the latest software is necessary, please consult your local Mitsubishi representative.

Compatible software package

Settings or diagnostics of the safety remote I/O module require the following engineering tool.

Product name	Software version
GX Works3	Version 1.085P or later

Applicable profile

A profile is required to use the safety remote I/O module in the CC-Link IE TSN configuration setting.

When the latest profile of the safety remote I/O module is necessary, please consult your local Mitsubishi representative.

The profile is a setting file that stores information required for the start-up, operation, and maintenance of devices supporting the CC-Link family.

A module is added to the "Module List" of the "CC-Link IE TSN Configuration" window by profile registration to the engineering tool of the master station.

For the profile registration, refer to the following.

 GX Works3 Operating Manual

Ethernet cable

For the specifications of the Ethernet cable, refer to the following.

 User's manual for the master station used

Switching hub

For the models of compatible switching hubs and the usage methods, check them on the CC-Link Partner Association website (www.cc-link.org).

5.2 Safety Standards

Observe the following safety standards.

Region	Standard
Global	IEC 61508 (SIL3), IEC 62061 (SIL3), ISO 13849-1 (Category 4 PL.e) IEC 61131-2 IEC 61000-6-2, IEC 61000-6-4 IEC 61784-3 IEC 60204-1
Europe	EN ISO 13849-1 (Category 4 PL.e) EN 61131-2 EN 61000-6-2, EN 61000-6-4
North America	UL 61010-1, UL 61010-2-201

For records which safety standards the safety remote I/O module complies with, check EC-Type-Examination Certificate of the product.

6 INSTALLATION AND WIRING

This chapter describes the installation and wiring of the safety remote I/O module.

6.1 Indicator Cover

To operate the IP address/station number setting switch or function setting switch of the safety remote I/O module, loosen the screws for the indicator cover with the screwdriver and open the cover. After operating the IP address/station number setting switch and function setting switch, be sure to close the indicator cover and tighten the screws. When the cover is open or the screws have not been tightened properly, waterproof performance is lost.

Point

Prevent foreign matter such as dust or wire chips from attaching to the gasket. Remove the foreign matter if it is attached to the gasket.

Tightening torque

Tighten the screws for the indicator covers of the IP address/station number setting switch and function setting switch within the following tightening torque range.

Screw type	Tightening torque range
Indicator cover screw (M3 screw)	0.43 to 0.57N·m

Point

- Do not put oil on the screws. Doing so may damage the screws.
- Tighten the screws with an applicable screwdriver. Tightening with an inapplicable screwdriver may damage the screws.

6.2 Setting the IP Address/Station Number Setting Switches

Set the fourth octet of IP address using the IP address/station number setting switches on the front of the safety remote I/O module.

The setting of the IP address/station number setting switches is enabled when the safety remote I/O module is powered on. Therefore, set this function while the module is off.

Setting method

Set the fourth octet (decimal) of the IP address using the IP address/station number setting switches x1 and x16 (hexadecimal).

Combinations of x1 and x16 are as follows.

		x1															
		0	1	2	3	4	5	6	7	8	9	A	B	C	D	E	F
x16	0	0	1	2	3	4	5	6	7	8	9	10	11	12	13	14	15
	1	16	17	18	19	20	21	22	23	24	25	26	27	28	29	30	31
	2	32	33	34	35	36	37	38	39	40	41	42	43	44	45	46	47
	3	48	49	50	51	52	53	54	55	56	57	58	59	60	61	62	63
	4	64	65	66	67	68	69	70	71	72	73	74	75	76	77	78	79
	5	80	81	82	83	84	85	86	87	88	89	90	91	92	93	94	95
	6	96	97	98	99	100	101	102	103	104	105	106	107	108	109	110	111
	7	112	113	114	115	116	117	118	119	120	121	122	123	124	125	126	127
	8	128	129	130	131	132	133	134	135	136	137	138	139	140	141	142	143
	9	144	145	146	147	148	149	150	151	152	153	154	155	156	157	158	159
	A	160	161	162	163	164	165	166	167	168	169	170	171	172	173	174	175
	B	176	177	178	179	180	181	182	183	184	185	186	187	188	189	190	191
	C	192	193	194	195	196	197	198	199	200	201	202	203	204	205	206	207
	D	208	209	210	211	212	213	214	215	216	217	218	219	220	221	222	223
	E	224	225	226	227	228	229	230	231	232	233	234	235	236	237	238	239
	F	240	241	242	243	244	245	246	247	248	249	250	251	252	253	254	255

Ex.

To set to 30:

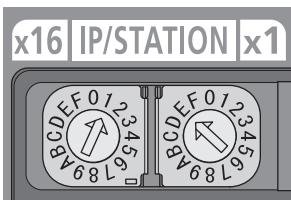

Setting range

The setting value must be in the range between 1 and 254.

When a value in the range between 1 and 254 is set, the IP address and subnet mask are as follows.

- The first three octets of the IP address: Octets one, two, and three from the IP address of the master station are used for operation.
- Subnet mask: The subnet mask of the master station is used for operation.

Do not set 0 and 255.

Point

- Do not change the IP address/station number setting switches while the power of the safety remote I/O module is on. If the IP address/station number setting switches are changed while the module is on, an IP address/station number setting switch changed error (error code: 0202H) occurs, and the ERR. LED flashes. After the IP address/station number setting switch is returned to the original setting, the error is automatically eliminated five seconds later, and the ERR. LED turns off.
- When the power is turned on with the IP address/station number setting switches set to a value in the range 1 to 254, the safety remote I/O module automatically sets the IP address. Moreover, the IP address and subnet mask are saved in the non-volatile memory at the time a data link with the master station is established.
- Do not set an IP address with duplicated fourth octet in the access range of CC-Link IE TSN. Duplicated fourth octet causes the duplicated IP address due to the automatic setting of the first to third octet, resulting in failure of data link establishment.
- If the value for the IP address/station number setting switches is set to 255, the state of the IP address becomes unset, and an IP address/station number setting switch out of range error (error code: 010AH) occurs.

Restriction

The following IP addresses cannot be used for the safety remote I/O module.

- IP addresses whose host addresses are all 0 or 255
- IP addresses whose third and fourth octets are all 255
- IP addresses outside the range 0.0.0.1 to 223.255.255.254

6.3 Setting the Function Setting Switches

Set the following functions using the function setting switches on the front of the safety remote I/O module.

- Network setting function
- Communication speed setting function
- CC-Link IE TSN Class setting function

The settings of the function setting switches are enabled when the safety remote I/O module is powered on. Therefore, set these functions while the module is off.

Point

When operating a function setting switch, use a flathead screwdriver with 1.2mm or less width of the tip.

Setting method

Set each function with function setting switch 1 to function setting switch 3.

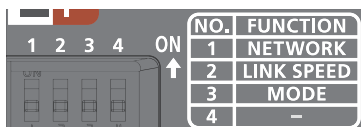

Switch name	Function name	Description
Function setting switch 1	NETWORK	Network setting function Set this switch to OFF in normal operation.
Function setting switch 2	LINK SPEED	Communication speed setting function This function sets the communication speed. • Off: 1Gbps (Factory default) • On: 100Mbps
Function setting switch 3	Class A/B	CC-Link IE TSN Class setting function This function sets CC-Link IE TSN Class. • Off: CC-Link IE TSN Class B (Factory default) • On: CC-Link IE TSN Class A
Function setting switch 4	—	Use prohibited Set this switch to OFF in normal operation.

Point

- Do not change the function setting switches while the power of the safety remote I/O module is on. If the setting of a function setting switch is changed while the safety remote I/O module is on, one of the errors from Function setting switch 1 changed error (error code: 0209H) to Function setting switch 3 changed error (error code: 020BH) occurs, and the ERR. LED flashes. After the function setting switch is returned to the original setting, the error is automatically eliminated five seconds later, and the ERR. LED turns off.
- When operating the safety remote I/O module with CC-Link IE TSN Class A, use the master station that can operate with the CC-Link IE TSN protocol version 2.0.

Precautions

Slide one function setting switch at a time horizontally. Do not hold the screwdriver at an angle or pivot it off the edge of the case while working a function setting switch, since damage or deformation may result.

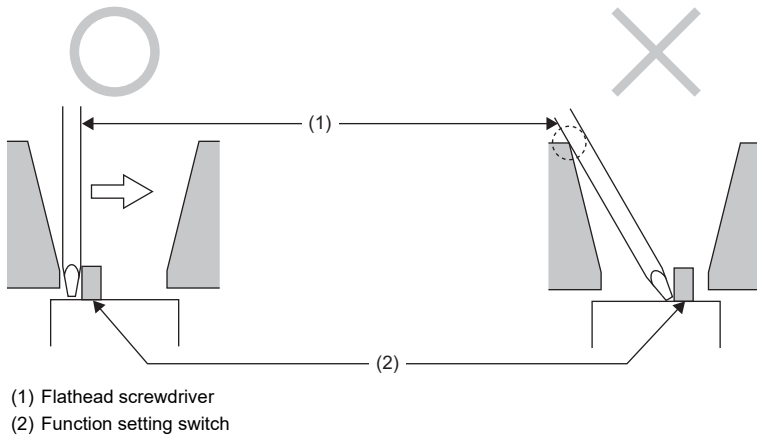

6.4 Installation Environment and Installation Position

Installation environment

Installation location

Do not install the safety remote I/O module in a location where:

- Ambient temperature is outside the range of 0 to 55°C;
- IP67 is not satisfied;
- Condensation occurs due to rapid temperature change;
- Corrosive gas or combustible gas is present;
- There is a lot of conductive powder such as dust and iron powder, oil mist, salinity, or organic solvent;
- The safety remote I/O module is exposed to direct sunlight;
- A strong electric field or strong magnetic field is generated (☞ Page 151 Immunity requirements); and
- The safety remote I/O module is subject to vibration and shocks (☞ Page 20 General Specifications).

Installation surface

Install the safety remote I/O module on the flat surface. When the installation surface is uneven, excessive force is applied to the printed-circuit board and may cause a defect.

Installation position

When installing the safety remote I/O module on a control panel, provide clearance of 50mm or more (1) between the safety remote I/O module and any neighboring structures or parts to ensure good ventilation and avoid interference. When installing two or more safety remote I/O modules next to each other, they can be installed in contact with each other. When using a right-angle or Y-branch type waterproof connector, however, provide enough clearance so that the cable bending radius does not become too short. For the cable bending radius, check the specifications of the cables used.

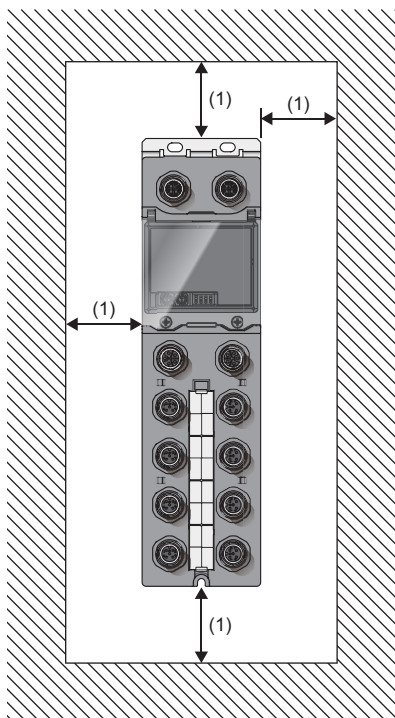

Installation direction

The safety remote I/O module can be installed in the following directions.

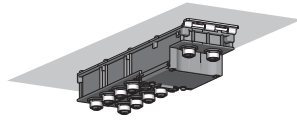

(2)

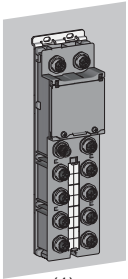

(1)

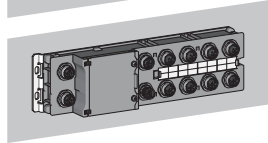
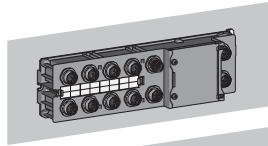

(3)

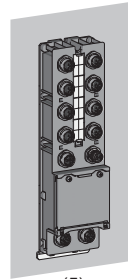

(5)

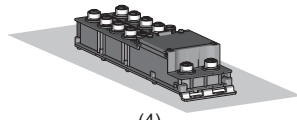

(4)

- (1) Vertical installation
- (2) Downward installation
- (3) Horizontal installation
- (4) Upward installation
- (5) Vertical installation (upside down)

6.5 Installation

Fixing the safety remote I/O module

When fixing the safety remote I/O module, tighten all of three screws.

If any of the screws is loose, the module will be greatly affected by vibration, causing failure of the module.

When installing the module, tighten screws within the following torque range.

Screw type	Tightening torque range
Screw for an FG metal fitting/mounting bracket (M4 screw)	0.83 to 1.11N·m

Point

- Do not put oil on the screws. Doing so may damage the screws.
- Tighten the screws with an applicable screwdriver. Tightening with an inapplicable screwdriver may damage the screws.

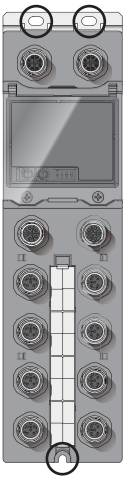

6.6 Wiring the Power Supply of the Safety Remote I/O Module

When wiring the power supply, connect it to the POWER IN terminal of the power supply connector of the safety remote I/O module.

Transition wiring of the power supply

When installing multiple safety remote I/O modules, the power can be supplied to the modules through transition wiring. For transition wiring of the power supply, connect cables between the POWER OUT terminal of the module (power supplier) and the POWER IN terminal of another module (power supply destination).

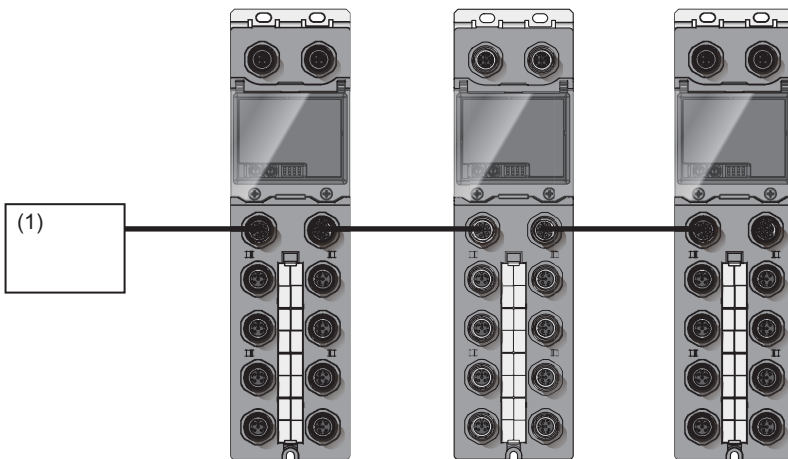

(1) Power supply

Point

- For transition wiring of the power supply, check the current consumption of each of the wired safety remote I/O modules. For the current consumption of a safety remote I/O module, refer to the performance specifications. (➔ Page 21 Performance Specifications)
- If the external power supply is off when the module power supply is turned on, an external power supply voltage error (error code: 0102H) occurs. Power on the external power supply at the same timing of power-on of the module power supply.

Precautions

The largest current flows from the power supplier to the power supply connector of the first safety remote I/O module. Ensure that the current does not exceed the following current capacity of the power supply connector.

- Module-and-sensor power supply: 8A per pin
- Load power supply and external power supply for output part: 12A per pin

For a power supply to supply 24VDC, use a power supply (SELV power supply) that does not exceed 30VAC (effective value), 42.4V (peak value), or 60VDC. Also, use a power supply which is compliant with "limited-energy circuit" defined in IEC 61010-1.

6.7 Wiring of Ethernet Cable

Wiring method

■Installation method

1. Power off the module power supply of the safety remote I/O module and the power supply of the external device.
2. Insert the Ethernet cable connector into the safety remote I/O module, paying attention to the connector's direction.
3. Tighten the screw of the Ethernet cable.
4. Power on the module power supply of the safety remote I/O module.
5. Power on the power supply of the external device.
6. Check if the LINK LED on the port into which the Ethernet cable is connected is on.^{*1*2}

*1 The time taken for the LINK LED to turn on after connection of the Ethernet cable may vary. The LINK LED normally turns on in a few second. However, if link-up processing is repeated due to a condition of a device on the line, the longer time may be required. If the LINK LED does not turn on, refer to the following and take a corrective action.

☞ Page 111 When the LINK LED turns off

*2 When the communication speed of both the safety remote I/O module and a device to be connected to P1 or P2 of safety remote I/O module is 100Mbps, enable the auto-negotiation of the device.

Point

Both P1 and P2 connectors can be used.

- When using only one of them in star topology, either P1 or P2 can be connected.
- When using both connectors in line topology or ring topology, P1-P1, P2-P2, and P1-P2 connections are possible.

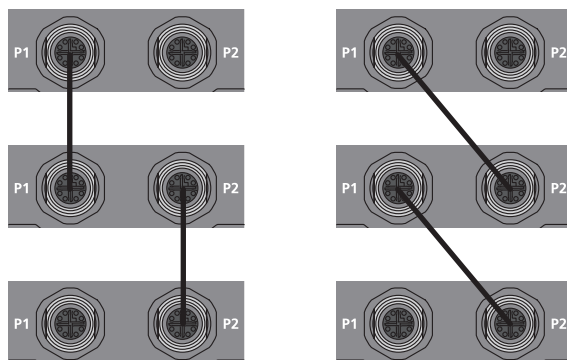

■How to disconnect

1. Power off the module power supply of the safety remote I/O module.
2. Loosen the screw of the Ethernet cable and remove the Ethernet cable.

Precautions

■Laying Ethernet cables

- Place the Ethernet cable in a duct or clamp it. If not, dangling cable may swing or inadvertently be pulled, resulting in damage to the safety remote I/O modules or cables or malfunction due to poor contact.
- Do not touch the core of the connector of the cable or the module, and protect it from dirt and dust. If any skin oil, or any dirt or dust sticks to the core, it can increase transmission loss, causing data link to fail.
- Check that the Ethernet cables are not disconnected or short and the connector is properly connected.

■Broken cable latch

Do not use Ethernet cables with broken latches. Doing so may cause the cable to unplug or malfunction.

■Connecting and disconnecting the Ethernet cable

Hold the connector part when connecting and disconnecting the Ethernet cable. Pulling the cable connected to the safety remote I/O module may result in damage to the safety remote I/O module or cable, or malfunction due to poor contact of the cable.

■Connectors without Ethernet cable

Attach connector covers or waterproof caps to prevent dirt and dust from entering the I/O module and prevent safety remote I/O module failure and malfunction caused by static electricity.

■Maximum segment length for the Ethernet cable (Maximum cable length)

The maximum segment length for the Ethernet cable is 100m. However, the distance may be shorter depending on the operating environment of the cable. For details, contact the manufacturer of the cables used.

■Bending radius of the Ethernet cable

There are restrictions on the bending radius of the Ethernet cable. Check the bending radius in the specifications of the Ethernet cables used.

6.8 Wiring the External Device and I/O Connector

Applicable connectors and cables

For connectors and cables that can be used for the safety remote I/O module, refer to the following.

 Page 46 List of Recommended Cables/Connectors for the Safety Remote I/O Module

Signal names and wiring

For the signal names of the connectors and wiring of the external device, refer to the specifications of each module. ()

Page 21 Performance Specifications)

Incorrect wiring can cause malfunction of or damage on the module.

Installation procedure

1. Insert the I/O cable connector into the safety remote I/O module. Pay attention to the connector's orientation.
2. Tighten the screw of the I/O cable connector.

Disconnecting

1. Loosen the screw of the I/O cable connector and remove the connector.

Point

- If the I/O cable is damp, the resin part of the connector of the product may get wet from the moisture on the cable at its removal. Dry or wipe up the water from the resin part before re-connecting the I/O cable. At the removal of I/O cable or waterproof cap, an O-ring attached to the connector of the safety remote I/O module may also come off with the cable or cap. In such a case, re-attach that O-ring to the connector of the module.
- Tighten the screw of the cable connector within the specified torque range. Although a threaded portion of the cable connector is still visible even if it is properly tightened, this does not affect the waterproof property. When assembling cables, use dedicated tools. ( Page 48 Tools for assembling waterproof cables)

Precautions for wiring the safety remote I/O module to safety devices

When wiring the input part

■Combination of input terminals for double input

For double input, the input terminals can be used only in the combinations shown below.

Combination of input terminals for double input					
X0, X1	X2, X3	X4, X5	X6, X7	X8, X9	XA, XB

■Test pulse output terminal and input terminal combination for double input

For double input, the test pulse output terminals and input terminals can be used only in the combinations shown below.

Combination of input terminals and test pulse output terminals	
Test pulse output terminal	Input terminal
T0	X0
T1	X1
T2	X2
T3	X3
T4	X4
T5	X5
T6	X6
T7	X7
T8	X8
T9	X9
TA	XA
TB	XB

When wiring the output part

■Combination of output terminals for double output

For double output, the output terminals can be used only in the combinations shown below.

Combination of output terminals for double output	
Y0, Y1	Y2, Y3

6.9 List of Recommended Cables/Connectors for the Safety Remote I/O Module

The following tables list applicable waterproof cables/connectors.

For details on applicable waterproof connectors, refer to the website of each manufacturer.

For power supply

The waterproof cables for power supply are listed below.

□, □ of a model represents the length of the cable.

Connector		Model	Connection cable diameter	Manufacturer
M12 5 pins (4 + FE) Male, female	L code	SC-M12PWL5MF-□, □MU	—	Mitsubishi Electric System & Service Co., Ltd.
M12 5 pins (4 + FE) Female, discrete wire		SC-M12PWL5F-□, □MU		

For I/O

The waterproof connectors/cables for I/O are listed below.

□, □ of a model represents the length of the cable.

Connector		Model	Connection cable diameter	Manufacturer
M12 5 pins Male, discrete wire	A code	SC-M12SNA5M-□, □MU	—	Mitsubishi Electric System & Service Co., Ltd.
M12 5 pins Male, discrete wire (shielded)		SC-M12SNA5SM-□, □MU		
M12	—	SACC-M12MS-5CON-PG 7-M	φ4.0 to 6.0mm	PHOENIX CONTACT GmbH & Co. KG
		SACC-M12MS-5CON-PG 9-M	φ6.0 to 8.0mm	

Y-branch connector for I/O

The waterproof connector is listed below.

Connector		Model	Connection cable diameter	Manufacturer
M12 5 pins Male	A code	SAC-5P-M12Y/2XM12FS VP	—	PHOENIX CONTACT GmbH & Co. KG

For communications

The waterproof connectors/cables for communications are listed below.

□, □ of a model represents the length of the cable.

Connector		Model	Connection cable diameter	Manufacturer
M12 8 pins Male	X code-X code	SC-E5EW-X□, □M	—	Mitsubishi Electric System & Service Co., Ltd.
		SC-E5EW-X□, □M-MV		
		SC-E5EW-X□, □M-L		
M12 8 pins Male	X code-RJ45	SC-E5EW-SX□, □M		
		SC-E5EW-SX□, □M-MV		
		SC-E5EW-SX□, □M-L		
M12 8 pins Male	X code-X code	NBC-M12MSX/□, □-94F/M12MSX	—	PHOENIX CONTACT GmbH & Co. KG
		NBC-M12MSX-M12MSX-10G/94F/□, □		
M12 8 pins Male	X code-RJ45	NBC-M12MSX/□, □-94F/R4AC		
		NBC-M12MSX-R4AC-10G/94F/□, □		
M12 8 pins Male	—	J80026A0100	φ5.5 to 9.0mm	Telegartner Karl Gartner GmbH
— (cable only)		SC-E5EW-□, □M	—	Mitsubishi Electric System & Service Co., Ltd.

Waterproof cap

The waterproof caps are listed below.

Type	Model	Manufacturer
Connector for I/O, connector for communication	PROT-M12	PHOENIX CONTACT GmbH & Co. KG
Connector for power supply (male)	PROT-M12 FS	
Connector for power supply (female)	PROT-M12 MS PWR	
Gasket (O-ring)	SACC-SEAL-M12-8X1,3 GREEN	

■Attaching waterproof caps

Tighten the waterproof caps within the following torque range.

Screw type	Tightening torque range
Waterproof cap	0.36 to 0.44N·m

Tools for assembling waterproof cables

The tools are listed below.

Type		Model	Cable	Tightening torque	Manufacturer
Torque screwdriver	Preset torque value: 0.4N·m	TSD 04 SAC	—	—	PHOENIX CONTACT GmbH & Co. KG
	Adjustable from 0.3 to 1.2N·m	TSD-M1.2NM	—	—	
Adapter bit		TSD-M SAC-BIT ADAPTER	—	—	
Nut for assembling cables with a connector, knurl diameter: 15 mm		SAC BIT M12-D15	I/O cable manufactured by Mitsubishi Electric System & Service Co., Ltd.	0.4N·m	
			Communication cable manufactured by PHOENIX CONTACT GmbH & Co. KG	0.4N·m	
Nut for assembling cables with a connector, knurl diameter: 16 mm		SAC BIT M12-D16	I/O cable manufactured by Mitsubishi Electric System & Service Co., Ltd.	0.4N·m	
Nut for assembling cables with a connector, knurl diameter: 20 mm		SACC BIT M12-D20	I/O cable manufactured by Mitsubishi Electric System & Service Co., Ltd.	0.6N·m	

7 SETTINGS

7.1 Network Configuration Settings

Set the parameters of the safety remote I/O module with the network parameters written to the CPU module of the master station.

For the setting procedure for the master station, refer to the following.

 User's manual for the master station used

Communication cycle interval setting

When using the safety remote I/O module, set values listed in the tables below for "Communication Period Interval Setting" of "Basic Period Setting" of "Communication Period Setting" of "Basic Settings" of the network parameters.

■When the CC-Link IE TSN Class setting for the safety remote I/O module is CC-Link IE TSN Class B

Communication speed		Value that can be set
Master station	Safety remote I/O module	
1Gbps	1Gbps	126.00 to 10000.00μs
	100Mbps ^{*1}	126.00μs to 625.00μs
100Mbps	1Gbps	126.00 to 10000.00μs
	100Mbps ^{*2}	500.00μs, to 10000.00μs, and divisible by 2μs

*1 To use the safety remote I/O module in this combination, set "Low-Speed" of "Multiple Period Setting" to "×16" for the master station, and set "Communication Period Setting" to "Low-Speed" for the safety remote I/O module.

*2 To use the safety remote I/O module in this combination, do not set "Communication Period Setting" to "Low-Speed" for the safety remote I/O module.

■When the CC-Link IE TSN Class setting for the safety remote I/O module is CC-Link IE TSN Class A

Communication speed		Value that can be set ^{*2}
Master station	Safety remote I/O module	
1Gbps	1Gbps	126.00 to 10000.00μs
	100Mbps ^{*1}	126.00 to 10000.00μs
100Mbps	1Gbps	126.00 to 10000.00μs
	100Mbps	The range changes depending on the communication period setting of the safety remote I/O module. <ul style="list-style-type: none"> • For Basic Period: 1000.00μs to 10000.00μs • For Normal-Speed/Low-Speed: 372.00μs to 10000.00μs

*1 To use the safety remote I/O module in this combination, set "Low-Speed" of "Multiple Period Setting" to "×16" for the master station, and set "Communication Period Setting" to "Low-Speed" for the safety remote I/O module.

*2 For "Communication Period Setting" is "Low-Speed", refer to the following.

 Page 50 Communication cycle setting value

■Communication cycle setting value

Set the communication cycle values that satisfy all of the following conditions. (Unit: ms)

- $LS \leq 500 - SCmst$
- $LS \leq 500 - SRref$
- $LS \leq 250 + a / 2$
- $LS \leq 250 + c / 2$

SRref: Safety refresh response processing time

SCmst: Safety cycle time of the master station (MELSEC iQ-R CPU Module User's Manual (Application))

LS: Communication cycle interval (MELSEC iQ-R CC-Link IE TSN User's Manual (Application))

a: This value is valid only when the station set to Active is the RJ71GN11-T2. In the other cases, the value is 0.

• $a = 1000ms - b$

b: A value obtained by rounding up 500ms to a multiple of safety cycle time

c: This value is valid only when the station set to Passive is the RJ71GN11-T2 or the NZ2GNS12A2-16DTE. In the other cases, the value is 0.

• $c = 1000ms - d$

d: A value obtained by rounding up 500ms to a multiple of safety cycle time (safety refresh response processing time)

If "Communication Period Setting" of the communication destination is set to other than "Basic Period" in "Network Configuration Settings" in "Basic setting" of the master station, multiply LS: Communication cycle interval by the multiple specified in "Multiple Period Setting" in "Communication Period Setting" in "Basic Setting". (MELSEC iQ-R CC-Link IE TSN User's Manual (Application))

Window

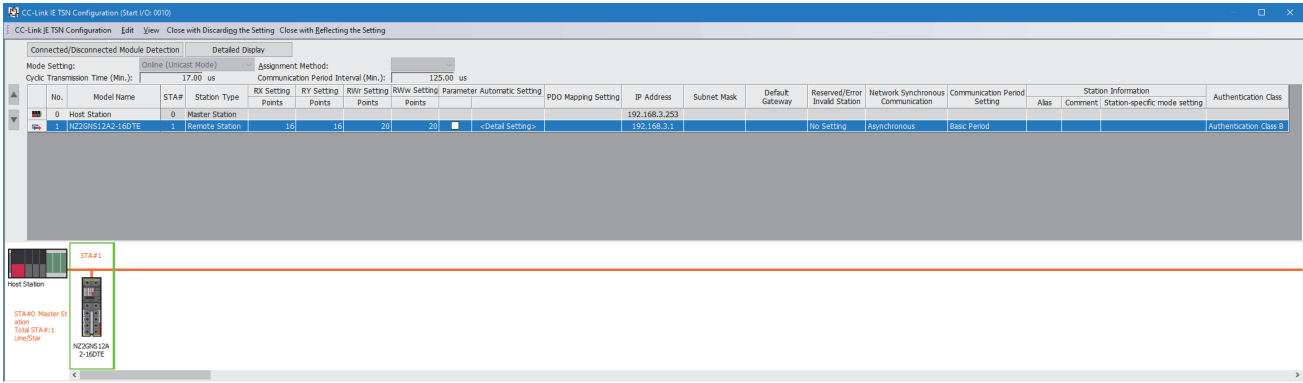

In this manual, "Authentication Class" is described as "CC-Link IE TSN Class".

Network topology setting

When using the safety remote I/O module, set the network topology setting as follows.

CC-Link IE TSN Class for the safety remote I/O module	Setting item
CC-Link IE TSN Class B	<ul style="list-style-type: none"> Line topology, star topology, or mixture of star topology and line topology Ring topology
CC-Link IE TSN Class A	Line topology, star topology, or mixture of star topology and line topology

7

Point

Ring topology can be used only when CC-Link IE TSN Class B is selected for the CC-Link IE TSN Class setting. If a safety remote I/O module with CC-Link IE TSN Class A is connected in ring topology, data link cannot be performed.

Communication mode

When "Communication Mode" of the master station is set to "Multicast", cyclic frames of multicast are not relayed via an Ethernet device (or a remote station of CC-Link IE TSN Class A) connected to a safety remote I/O module.

Setting item list

Item	Setting details	Setting range
RX Setting, RY Setting	Points	Set the assignment of RX/Ry points. 0 to 16 (Default value: 16)
	Start	The RX/Ry start number is displayed. —
	End	The RX/Ry end number is displayed. —
RWr Setting, RWw Setting	Points	Set the assignment of RWr/RWw points. 0 to 20 (Default value: 20)
	Start	The RWr/RWw start number is displayed. —
	End	The RWr/RWw end number is displayed. —
Network Synchronous Communication	Set "Asynchronous" for the safety remote I/O module.	<ul style="list-style-type: none"> Asynchronous (Default value) Synchronous
Communication Period Setting	Set the cycle of the safety remote I/O module when setting multiple communication cycles. When the communication speed differs between the master station and the safety remote I/O module, the setting range is limited. (☞ Page 49 Communication cycle interval setting)	<ul style="list-style-type: none"> Basic Period Normal-Speed Low-Speed
CC-Link IE TSN Class	Set the CC-Link IE TSN Class for the safety remote I/O module. Set the same Class as the Class set on the safety remote I/O module. (☞ Page 36 Setting the Function Setting Switches)	<ul style="list-style-type: none"> CC-Link IE TSN Class B CC-Link IE TSN Class A

Point

- When using the safety remote I/O module, always enable "Station-based Block Data Assurance" of the master station. When it is disabled, correct operation of the safety remote I/O module cannot be guaranteed. For "Station-based Block Data Assurance", refer to the user's manual for the master station in use.
- Set the number of points of the RX/Ry setting and the number of points of the RWr/RWw setting within their setting ranges. If a value out of range is set, Number of RX/Ry points error (error code: D021H) or Number of RWr/RWw points error (error code: D022H) occurs.
- If different values are set for the setting of Function setting switch 3 on the safety remote I/O module and for the CC-Link IE TSN Class setting in the network configuration setting, a data link is not established with the safety remote I/O module. The event code of 00C81 is registered with event history of the master station.

7.2 Parameter Setting

Parameter setting of the safety remote I/O module can be done with the following methods.

- Device station parameter automatic setting ( Page 55 Device station parameter automatic setting)
- Parameter processing of device station ( Page 58 Parameter processing of device station)

Even if the safety remote I/O module is replaced due to a failure of the safety remote I/O module when parameters are set with device station parameter automatic setting, the parameters of the safety remote I/O module are automatically set via the master station.

This saves one the trouble of having to newly set parameters.

Window

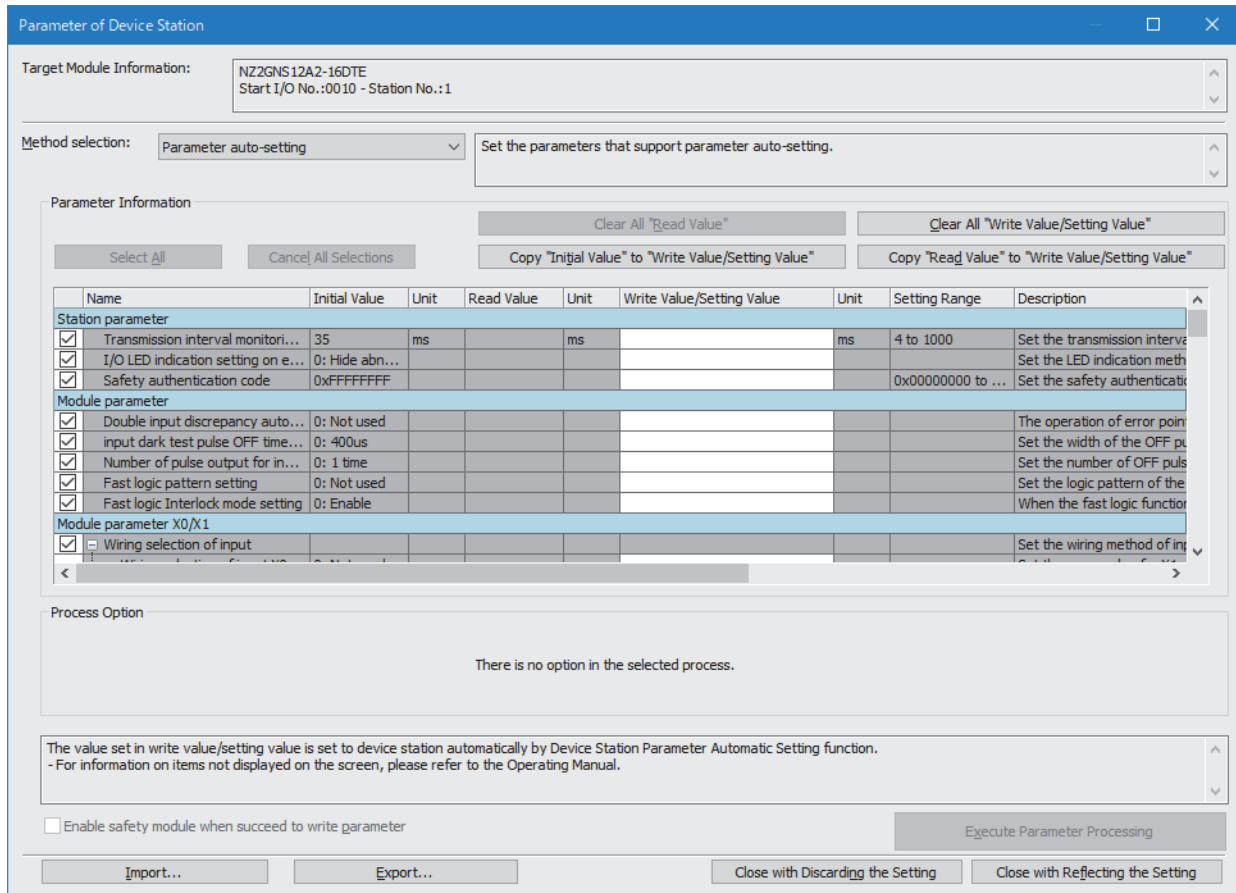

Setting item list

Item	Setting details	Setting range	Reference	
Station parameter	Transmission interval monitoring time	Set the transmission interval monitoring time for safety data.	4 to 1000 (ms)	Page 144 Transmission interval monitoring time
	I/O LED indication setting at error occurrence	Set whether the input and output points where an error is detected is indicated with an LED.	0: No indication of error point 1: Indication of error point	Page 144 I/O LED indication setting at error occurrence
	Safety approval code	Set a safety approval code that identifies the individual safety remote I/O module.	0x00000000 to 0xFFFFFFFF	Page 145 Safety approval code

Item		Setting details	Setting range	Reference
Module parameter	Double input discrepancy auto recovery setting	When double input discrepancy occurs, set whether to keep the abnormal point in the stop state, or to automatically return when the error is resolved.	0: Not used 1: Used	Page 147 Double input discrepancy auto recovery setting
	Input dark test pulse OFF time setting	Set the width of the OFF pulses that the terminals T0 to TB output, on a module-by-module basis.	0: 400 μ s 1: 1ms 2: 2ms	Page 148 Input dark test pulse OFF time setting
	Number of pulse output for input dark test	Set the number of OFF pulses for input dark test diagnostic on a module-by-module basis.	0: 1 time 1: 2 times 2: 3 times	Page 148 Number of pulse output for input dark test
	Fast logic pattern setting	Set the logic patterns for the fast logic function.	0: Not used 1: Pattern 1 2: Pattern 2 3: Pattern 3 4: Pattern 4	Page 149 Fast logic pattern setting
	Fast logic interlock mode setting	When the fast logic function is enabled, set whether to perform output point interlock when the output is turned off.	0: Enable 1: Disable	Page 149 Fast logic interlock mode setting
Module parameter (X0 to XB)	Wiring selection of input X0 to XB	Set the input wiring method.	0: Not used 1: Double wiring (NC/NC) 2: Single	Page 146 Wiring selection of input
	Input response time X0 to XB	To prevent malfunction of the input signal, set the sensitivity to react to the input signal in units of 1 point.	0: 1.0ms 1: 1.5ms 2: 5ms 3: 10ms 4: 20ms 5: 50ms 6: 70ms	Page 146 Input response time
	Double input discrepancy detection setting (X0, X1) to (XA, XB)	Set whether to detect double input discrepancy in units of 2 points.	0: Detect 1: Do not detect	Page 146 Double input discrepancy detection setting
	Double input discrepancy detection time (X0, X1) to (XA, XB)	Set the double input discrepancy allowed time in units of 2 points.	1 to 6000 (\times 10ms)	Page 147 Double input discrepancy detection time
	Input dark test execution setting X0 to XB	Set whether to perform the input dark test function of the diagnostic function in the safety remote I/O module in units of 1 point.	0: Perform 1: Do not perform	Page 147 Input dark test execution setting
Module parameter (Y0 to Y3)	Wiring selection of output Y0 to Y3	Set the wiring selection of output in units of 1 point.	0: Not used 1: Double wiring (Source/Source) 2: Single	Page 148 Wiring selection of output
	Output dark test execution setting Y0 to Y3	Set whether to perform the output dark test function of the diagnostic function in the safety remote I/O module in units of 1 point.	0: Perform 1: Do not perform	Page 148 Output dark test execution setting
	Output dark test pulse OFF time setting Y0 to Y3	Set the width of OFF pulses used for an output dark test in units of 1 point.	0: 400 μ s 1: 1ms 2: 2ms	Page 149 Output dark test pulse OFF time setting
	Number of pulse output for output dark test Y0 to Y3	Set the number of OFF pulses for output dark test diagnostic in units of 1 point.	0: 1 time 1: 2 times 2: 3 times	Page 149 Number of pulse output for output dark test

Device station parameter automatic setting

Device station parameter automatic setting writes the parameters of the safety remote I/O module to the CPU module.

The parameters of the safety remote I/O module are saved in the CPU internal memory.

When the safety remote I/O module enters or returns to the network, the parameters of the safety remote I/O module are automatically set via the master station. The parameters are written to the non-volatile memory of the safety remote I/O module.

The safety remote I/O module starts data link with the master station after parameter automatic setting.

The status of parameter automatic setting can be checked with the remote register. (☞ Page 138 Parameter automatic setting status monitor area)

Point

- When the user authentication function of the CPU module is enabled, perform the logon of the user authentication function in advance. (☞ Page 99 User Authentication Function)
- The parameters of the safety remote I/O module are not saved on the SD memory card.

Parameter setting

Operating procedure

1. Open the "CC-Link IE TSN Configuration" window.

[Navigation window] ⇒ [Parameter] ⇒ [Module Information] ⇒ Model ⇒ [Basic Settings] ⇒ [Network Configuration Settings]

2. Select the safety remote I/O module in "Module List" and drag and drop it to the list of stations (1) or the network map (2). "Station Type", "RX/Ry Setting", and "RWw/RWr Setting" are automatically input. Change a value as necessary.

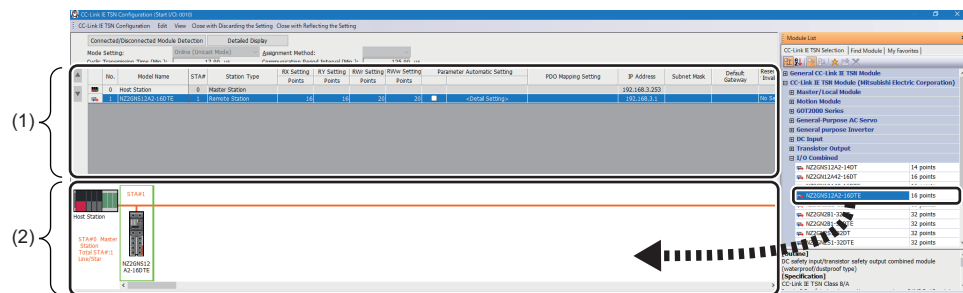

3. Select the "Parameter Automatic Setting" check box.

No.	Model Name	STA#	Station Type	RX Setting	RY Setting	RWw Setting	RWw Setting	Parameter Automatic Setting
				Points	Points	Points	Points	
0	Host Station	0	Master Station					
1	NZ2GNS12A2-16DTE	1	Remote Station	16	16	20	20	<input checked="" type="checkbox"/> <Detail Setting>

- Right-click the safety remote I/O module and select "Parameter of Device Station" to display the "Parameter of Device Station" window.

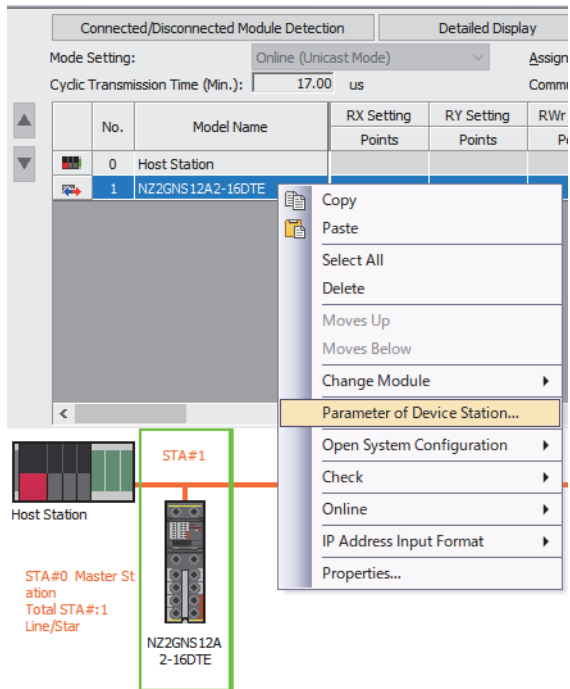

- Set each parameter on the "Parameter of Device Station" window.

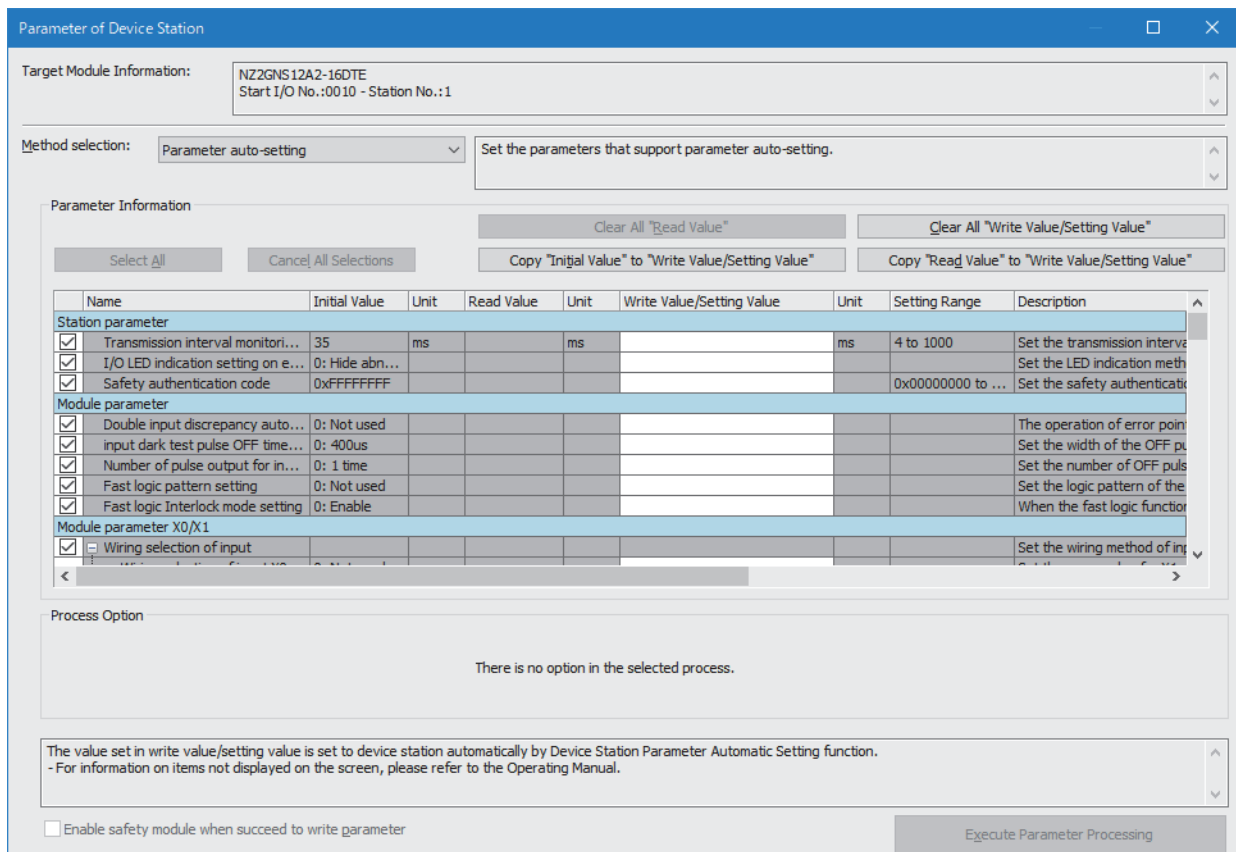







Point

For "Safety authentication code", set a value that does not overlap with those of other safety remote I/O modules, such as a MAC address. When setting a MAC address, set the lower eight digits of the MAC address.

6. Select [Close with Reflecting the Setting] and close the "Parameter of Device Station" window.
7. Select [Close with Reflecting the Setting] and close the "CC-Link IE TSN Configuration" window.
8. Display the refresh parameter setting window and configure the setting as follows.

 [Navigation window] ⇒ [Parameter] ⇒ [Module Information] ⇒ Model ⇒ [Basic Settings] ⇒ [Refresh Settings]

No.	Link Side					CPU Side				
	Device Name	Points	Start	End		Target	Device Name	Points	Start	End
-	SB	512	00000	001FF		Specify Device	SB	512	00000	001FF
-	SW	512	00000	001FF		Specify Device	SW	512	00000	001FF
1	RX	16	00000	0000F		Specify Device	X	16	01000	0100F
2	RY	16	00000	0000F		Specify Device	Y	16	01000	0100F
3	RWr	20	00000	00013		Specify Device	W	20	00100	00113
4	RWw	20	00000	00013		Specify Device	W	20	00200	00213

9. Click the [Apply] button.
10. Write the set parameters to the CPU module of the master station and reset the CPU module of the master station, or turn off and on the power supply of the programmable controller.

 [Online] ⇒ [Write to PLC]

11. Set the CPU module of the master station to RUN, and check that the DATA LINK LED of the safety remote I/O module is turned on.

Parameter processing of device station

The following describes the procedure for setting module parameters of the safety remote I/O module from the "Network Configuration Settings" window.

Parameter setting

Operating procedure

1. Open the "CC-Link IE TSN Configuration" window.
 - [Navigation window] ⇒ [Parameter] ⇒ [Module Information] ⇒ Model ⇒ [Basic Settings] ⇒ [Network Configuration Settings]
2. Select the safety remote I/O module in "Module List" and drag and drop it to the list of stations (1) or the network map (2). "Station Type", "RX/Ry Setting", and "RWw/RW_r Setting" are automatically input. Change a value as necessary.

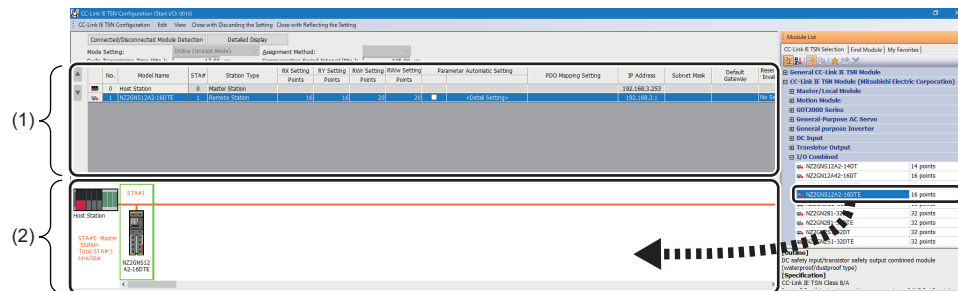

3. Right-click the safety remote I/O module and select "Parameter of Device Station" to display the "Parameter of Device Station" window.

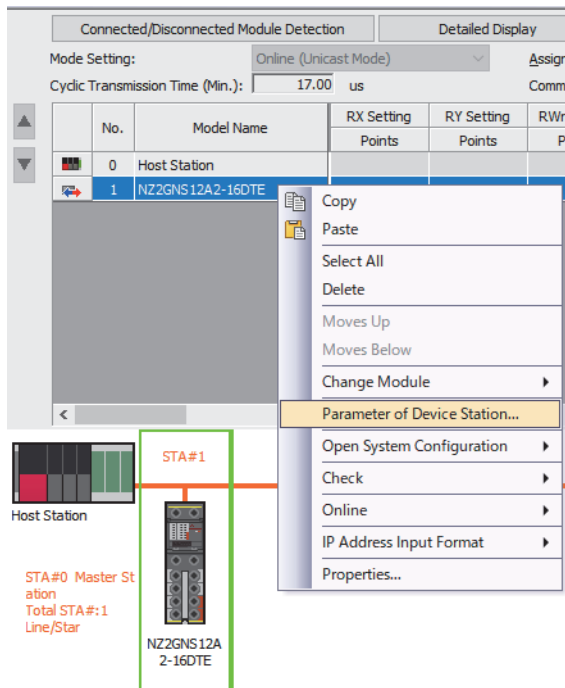

4. Set "Method selection" to "Parameter write" so that setting values can be set in the items of "Write Value/Setting Value". Set values in all the items of "Write Value/Setting Value". If an item where a value is not set exists, "Parameter write" cannot be executed.

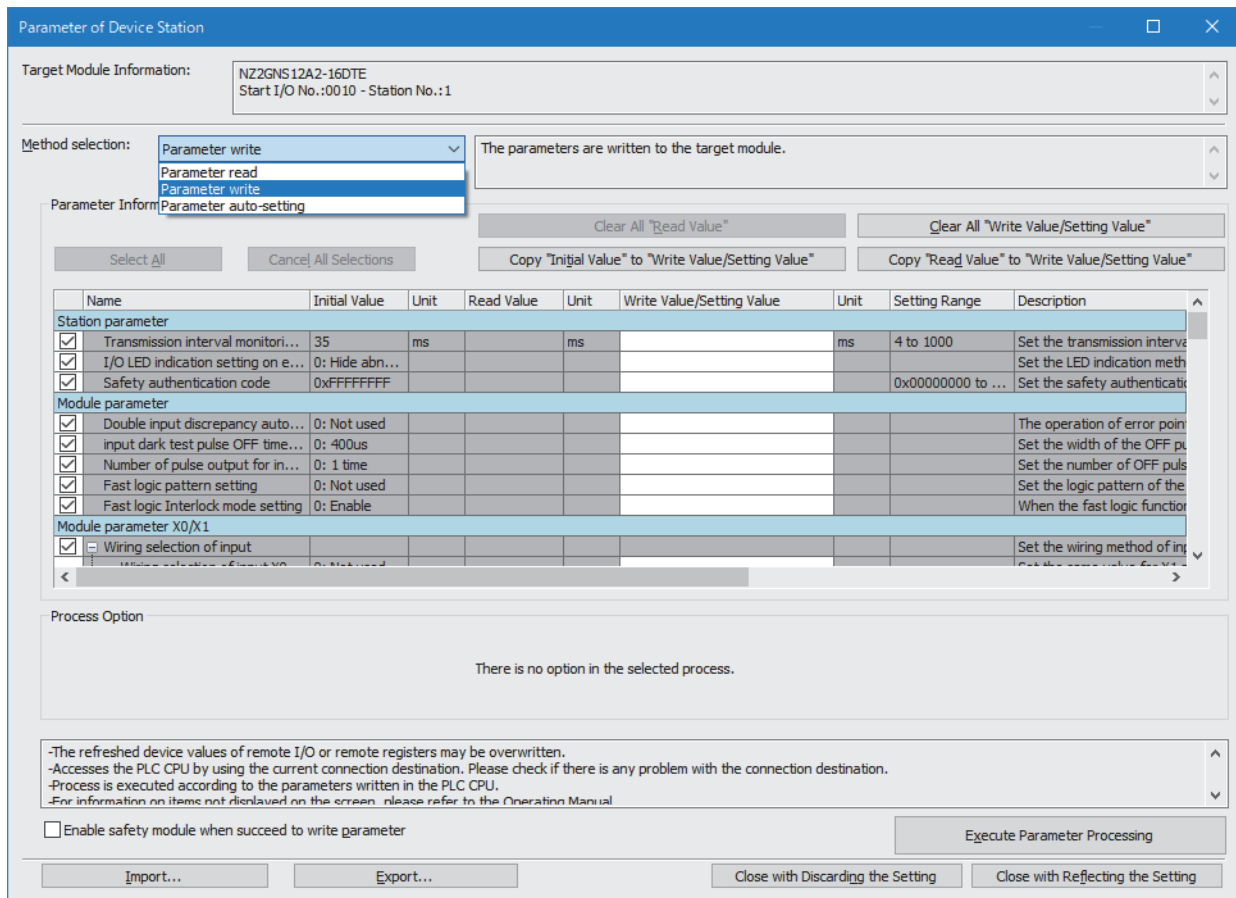

Point

- For "Safety authentication code", set a value that does not overlap with those of other safety remote I/O modules, such as a MAC address. When setting a MAC address, set the lower eight digits of the MAC address.
- When "Parameter write" has failed, the following window is displayed.

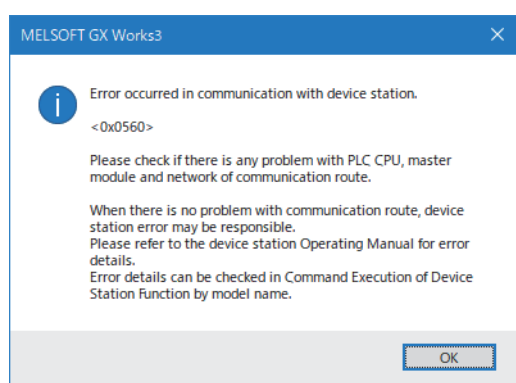

For error codes, refer to the following and take corrective actions.
 ➔ Page 120 List of Error Codes

5. Clicking the [Execute Parameter Processing] button displays a confirmation window. Check the contents and click the [Yes] button to execute "Parameter write".

6. After "Parameter write" is complete, the following window is displayed.

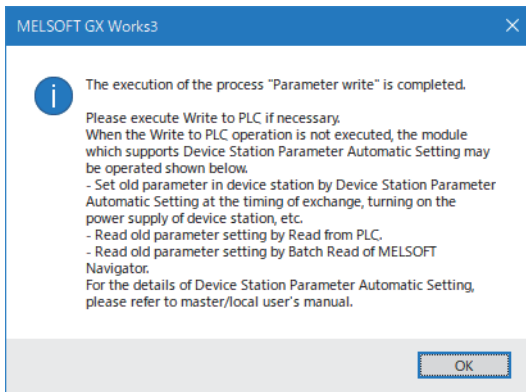

7. Select [Close with Reflecting the Setting] and close the "Parameter of Device Station" window.

8. Select [Close with Reflecting the Setting] and close the "CC-Link IE TSN Configuration" window.

9. Display the refresh parameter setting window and configure the setting as follows.

[Navigation window] ⇒ [Parameter] ⇒ [Module Information] ⇒ Model ⇒ [Basic Settings] ⇒ [Refresh Settings]

No.	Link Side					CPU Side				
	Device Name	Points	Start	End		Target	Device Name	Points	Start	End
-	SB	512	00000	001FF		Specify Device	SB	512	00000	001FF
-	SW	512	00000	001FF		Specify Device	SW	512	00000	001FF
1	RX	16	00000	0000F		Specify Device	X	16	01000	0100F
2	RY	16	00000	0000F		Specify Device	Y	16	01000	0100F
3	RWr	20	00000	00013		Specify Device	W	20	00100	00113
4	RWw	20	00000	00013		Specify Device	W	20	00200	00213

10. Click the [Apply] button.

11. Write the set parameters to the CPU module of the master station and reset the CPU module of the master station, or turn off and on the power supply of the programmable controller.

[Online] ⇒ [Write to PLC]

12. Set the CPU module of the master station to RUN, and check that the DATA LINK LED of the safety remote I/O module is turned on.

7.3 Safety Communication Setting

Write the safety communication setting of the master station to the CPU module.

Make the following settings before configuring the safety communication setting. Check that the safety remote I/O module and master/local module can perform cyclic transmission (the DATA LINK LED is lit).

☞ Page 49 Network Configuration Settings

☞ Page 53 Parameter Setting

Operating procedure

1. Set the module parameter of the master station "To Use or Not to Use the Safety Communication Setting" to "Use".

☞ [Navigation window] ⇒ [Parameter] ⇒ [Module Information] ⇒ Model ⇒ [Basic Settings] ⇒ [Safety Communication Setting] ⇒ [To Use or Not to Use the Safety Communication Setting]

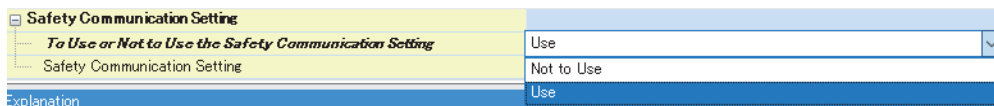

2. Select "Detailed Setting" of the module parameter of the master station "Safety Communication Setting", and the "Safety Communication Setting" window is displayed.

☞ [Navigation window] ⇒ [Parameter] ⇒ [Module Information] ⇒ Model ⇒ [Basic Settings] ⇒ [Safety Communication Setting] ⇒ [Safety Communication Setting]

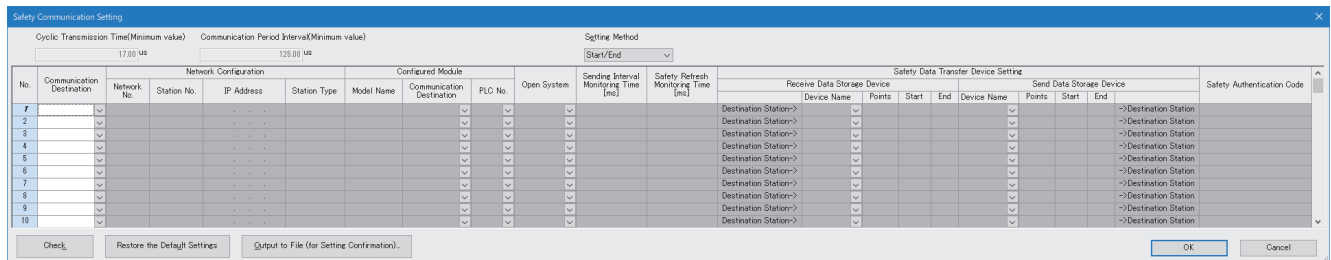

3. Select "Local Network" in "Communication Destination", and the "Select the target module for the Safety Communication Setting" window is displayed. Select the target safety remote I/O module and click the [Add] button.

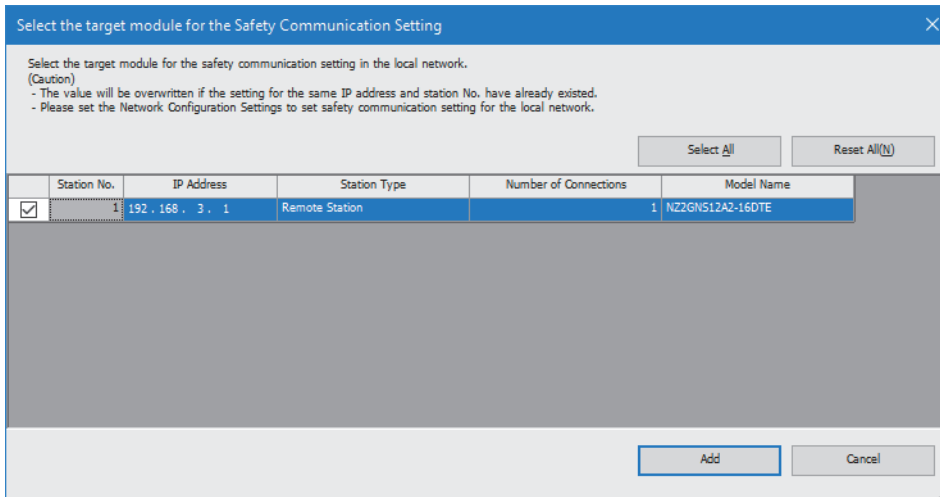

4. The parameters of the safety remote I/O module selected on the "Select the target module for the Safety Communication Setting" window are imported into the safety communication setting. Set "Sending Interval Monitoring Time", "Safety Refresh Monitoring Time", and "Safety Data Transfer Device Setting" and click the [OK] button.

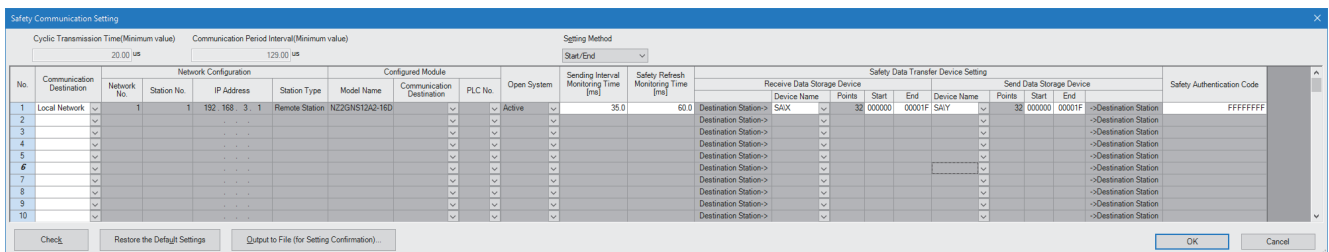

- For the setting values of "Transmission Interval Monitoring Time" and "Safety Refresh Monitoring Time", refer to the following.
 - 👉 Page 144 Parameter data per station
 - 📖 User's manual for the master station used
- For "Safety authentication code", set the same value as the "Safety authentication code" set in the parameters of the safety remote I/O module.
- No restrictions are provided on the access level for writing parameters to the safety remote I/O module. However, when the access level is "Users", even if parameters have been set to the safety remote I/O module, safety communications are disabled because the safety communication setting cannot be set in the CPU module. To perform the safety communications, set "Developers" or a higher access level. For details on the access levels, refer to the following.
 - 📖 GX Works3 Operating Manual

5. After applying the module parameter setting of the master station, perform "Write to PLC".

For the module parameter setting of the master station, refer to the following.

User's manual for the master station used

6. When "Write to PLC" is completed, right-click the target safety remote I/O module in the "Network Configuration Settings" and display the "Command Execution of Device Station" window.

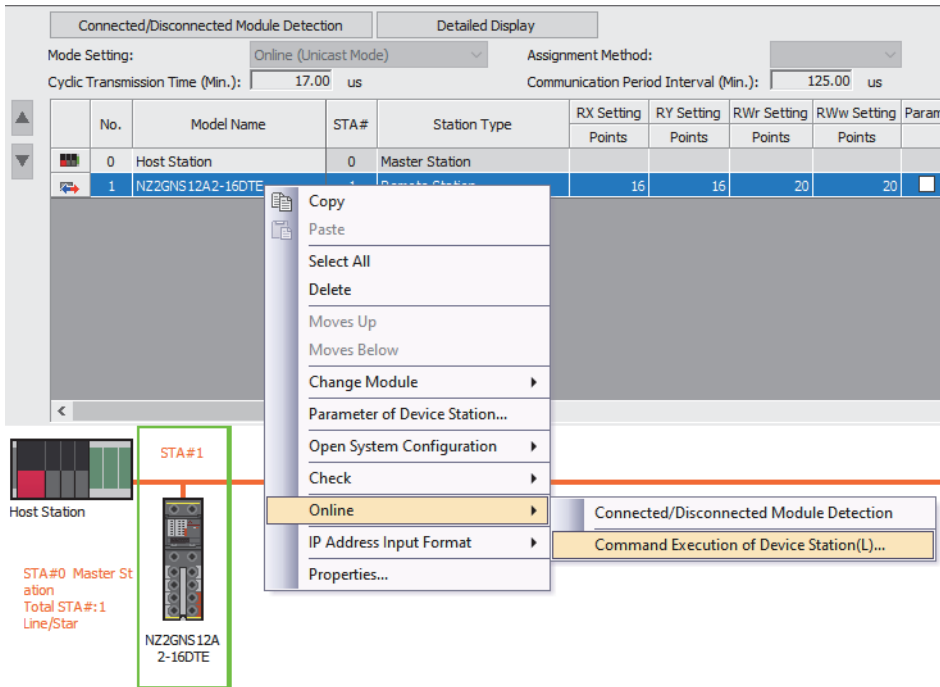

7. Select "Start of checking the module position" in "Method selection" and click the [Execute] button.

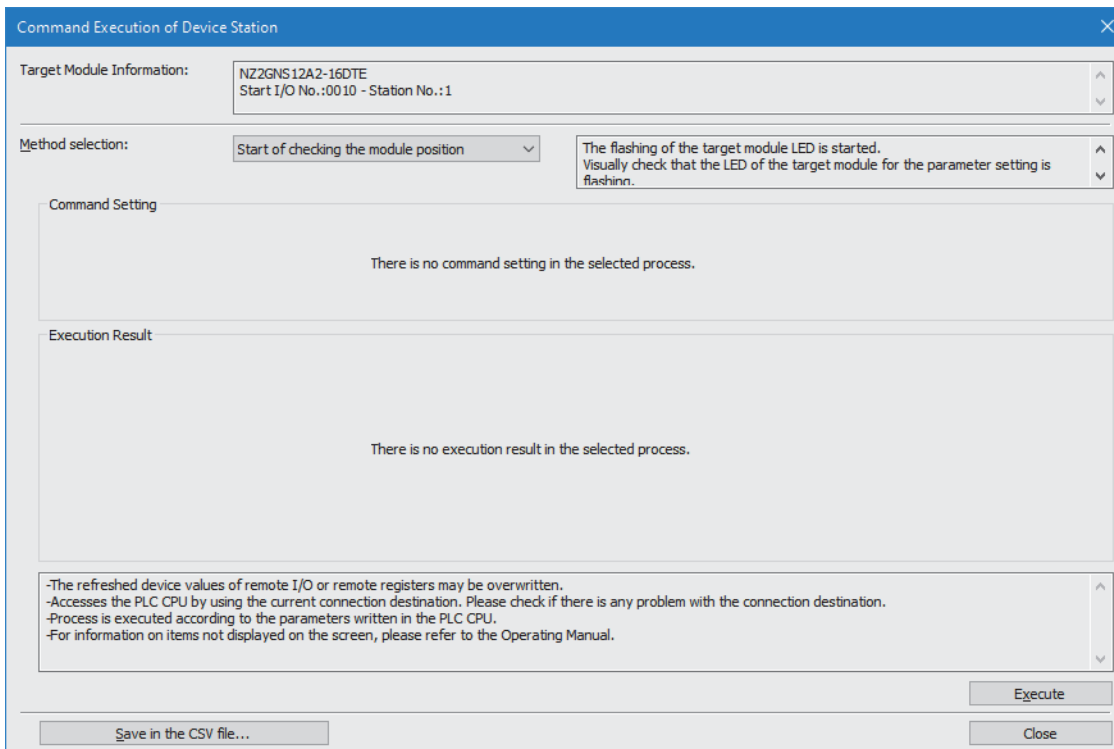

8. Clicking the [Execute] button displays a confirmation window. Check the contents and click the [Yes] button. The SAFETY LED of the selected safety remote I/O module starts flashing. Visually check that the safety remote I/O module on which the SAFETY LED is flashing is installed on the desired position. At the same time, visually check that the SAFETY LEDs of other safety remote I/O modules not targeted for the position checking are not flashing.
9. After checking the safety remote I/O module position is completed, select "Stop of checking the module position" in "Method selection" on the "Command Execution of Device Station" window and click the [Execute] button.

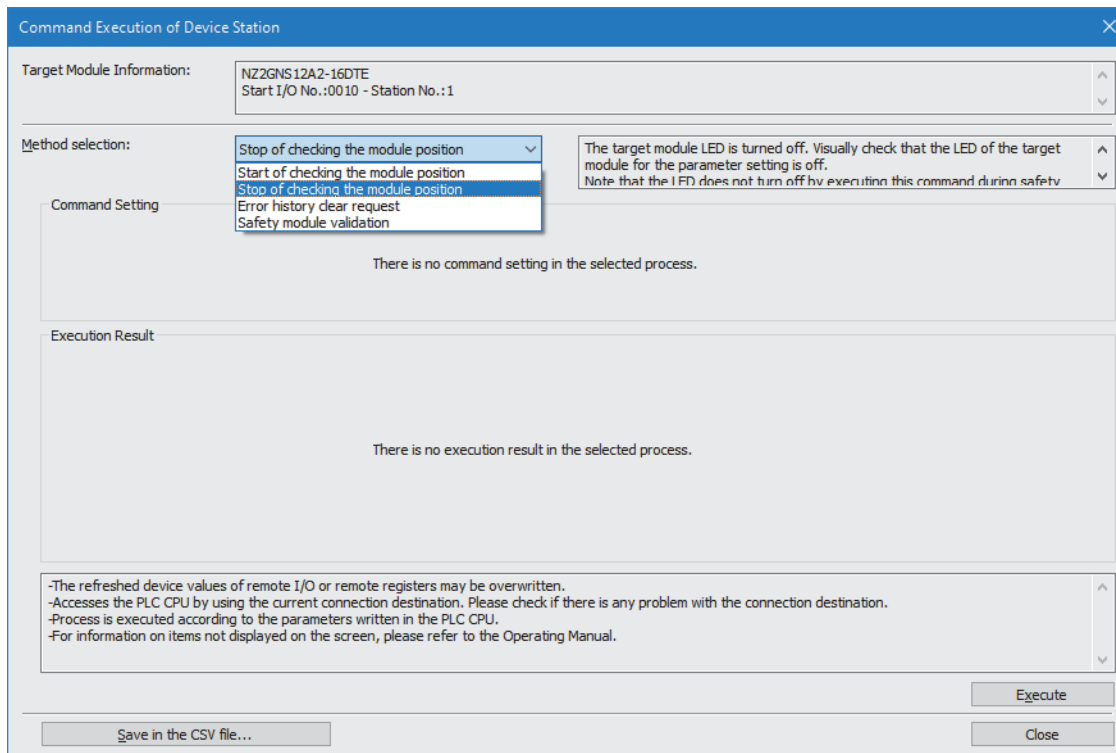

10. Clicking the [Execute] button displays a confirmation window. Check the contents and click the [Yes] button. The SAFETY LED of the safety remote I/O module turns off.
11. Perform the operations from "Start of checking the module position" to "Stop of checking the module position" for all safety remote I/O modules connected.

12. Select "Safety module validation" in "Method selection" and click the [Execute] button.

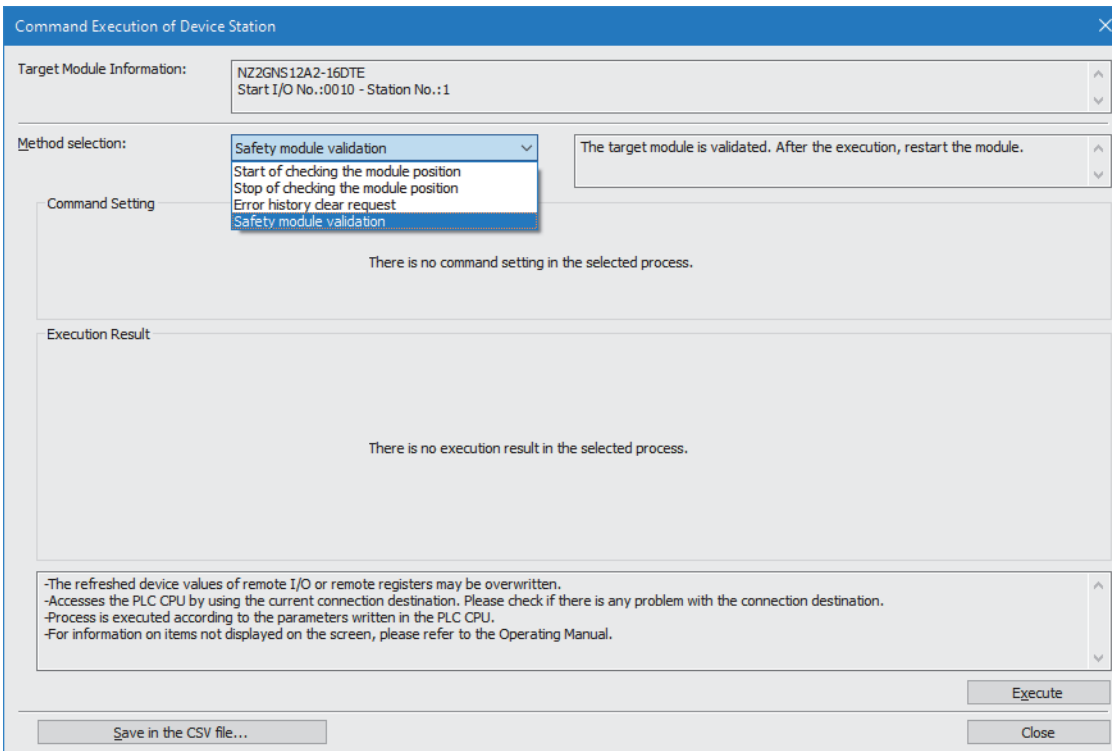

13. Clicking the [Execute] button displays the following confirmation window. Check the contents, and if the operations mentioned on the window are completed, click the [Yes] button. When the operations are not completed, click the [No] button. After performing the operations of "Confirm 1" and "Confirm 2", perform "Safety module validation" again.

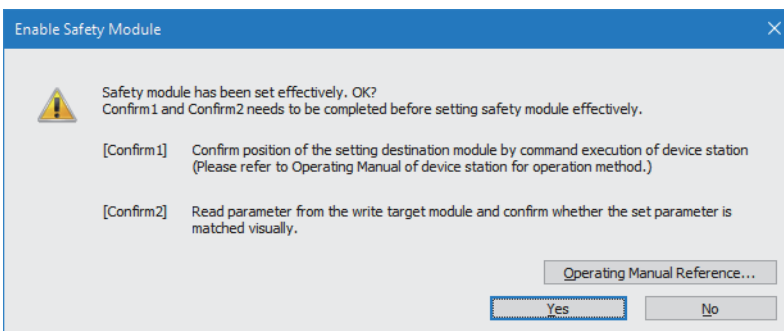

14. Clicking the [Yes] button displays a confirmation window. Check the contents and click the [Yes] button to validate the parameters set to the safety remote I/O module.

Point

- If "Safety module validation" has not been implemented, execute "Safety module validation" within 10 minutes after the safety remote I/O module is powered on. If it cannot be implemented, Safety module validation not performed (error code: 0206H) occurs.
- If "Parameter write" is performed after "Safety module validation" is performed, the safety module enabled flag (RWr0.b0) turns off. If the safety module enabled flag (RWr0.b0) remains off for 10 minutes, Safety module validation not performed (error code: 0206H) occurs, so perform "Safety module validation" within 10 minutes.
- "Safety module validation" cannot be performed while a moderate error caused by parameter settings persists. If "Safety module validation" is performed, a safety module validation failure (error code: 0205H) occurs.

- 15.** Restart the safety remote I/O module. The SAFETY LED turns on and the mode shifts to the safety drive mode.
- 16.** Perform the operations from "Safety module validation" to the restart of the safety remote I/O module for all safety remote I/O modules connected.

8 FUNCTIONS

This chapter describes the functions available in the safety remote I/O module, and the setting procedures for those functions. For details on safety remote I/O signals, remote control/monitor signals, and remote buffer memory, refer to the following.

☞ Page 129 Safety Remote I/O Signals

☞ Page 134 Remote Control/Monitor Signals

☞ Page 140 Remote Buffer Memory

8.1 Safety Input

This function safely inputs external signals. This function cannot be used in any modes other than the safety drive mode. All the safety remote inputs (SAX) are off in any modes other than the safety drive mode.

Safety input wiring selection function

The double wiring function or single wiring function can be selected for input wiring.

Double wiring function

The double wiring function supports double input wiring.

By verifying input signals of double wiring, safety inputs can be turned off even if one of the signals has an error.

In the safety drive mode, 24V output of the T0 to TB terminals are enabled.

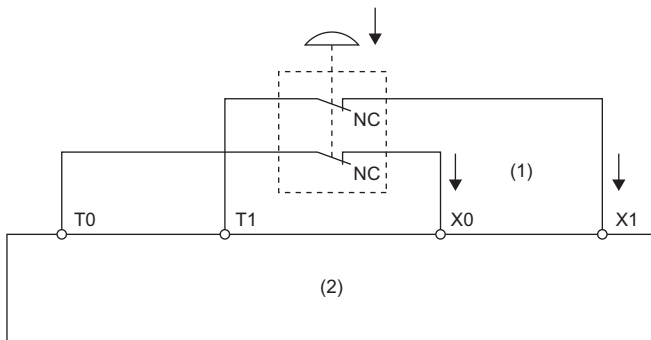

(1) 2 inputs

(2) Safety remote I/O module

■Combination for double wiring

Use the following combinations of input terminals for double wiring to the safety remote I/O module.

Combination of input terminals					
X0, X1	X2, X3	X4, X5	X6, X7	X8, X9	XA, XB

Single wiring function

This function can connect input devices with single wiring.

When the single wiring function is used, the input signal is set to safety remote input (SAIX0 to SAIXB) and external input signal (X0 to XB).

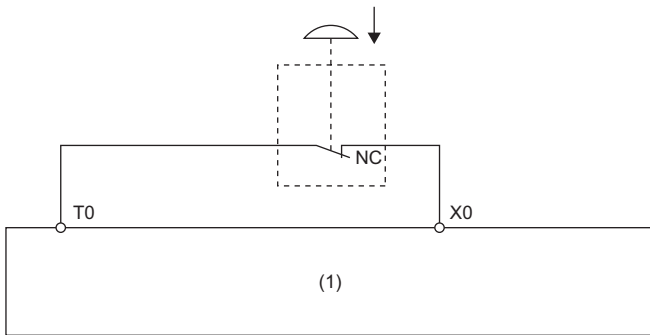

(1) Safety remote I/O module

Point

- To satisfy SIL3, Category 4 PL.e, use the double wiring function.
- Systems using single wiring do not comply with SIL3 or Category 4 PL.e, although the wiring is used for input using safety devices.

Diagnostic functions to detect input errors

Input errors can be detected by using the following diagnostic functions.

Diagnostic function	Description	Reference
Double input discrepancy detection function	Detects the discrepancy of double input signals.	Page 85 Double input discrepancy detection function
Input dark test function	Outputs test pulses to turn off the inputs that are on and diagnoses contacts including external devices for failure.	Page 89 Input dark test function

Combination of double inputs

The safety remote I/O module evaluates the logic of input signals and reflects the results to safety remote inputs (SAIX). When the double input signals differ, the double input discrepancy detection state is applied. The following table lists the correspondence between each double input signal state and safety remote input (SAIX).

Input terminal state		Safety remote input (SAIX)		Evaluation result of double inputs
Xn^{*1}	$Xn+1^{*1}$	$SAIXm^{*2}$	$SAIXm+1^{*2}$	
Off	Off	Off	Off	Off (Normal)
Off	On	Off	Off	Off (Discrepancy)
On	Off	Off	Off	Off (Discrepancy)
On	On	On	On	On (Normal)

*1 n: Even number from 0 to A

*2 m: Safety device address (even number from 0 to A) assigned to the master station

States of safety remote inputs (SAIX0, SAIX1) for X0 and X1 (double wiring)

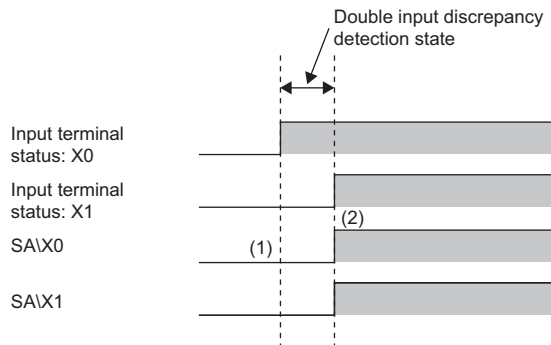

(1) Even when the input terminal X0 turns on, SAIX0 does not turn on because X1 is off.

(2) When the double inputs are on (X0 and X1 are on), safety remote inputs (SAIX0 and SAIX1) turn on.

External input signal monitor function

The state of input terminals can be monitored. This function facilitates the investigation for the cause of a double input discrepancy error. For details, refer to the following.

📖 Page 138 External input monitor area

Point

The signals of the external input signal monitor are used to investigate the cause of a double input discrepancy error. Do not use these signals in a safety program.

Setting method

Set the input wiring selection in "Wiring selection of input" from the "Parameter of Device Station" window of the engineering tool.

Set safety input to either "1: Double wiring (NC/NC)" or "2: Single".

Item	Setting range
Wiring selection of input Xn	0: Not used 1: Double wiring (NC/NC) 2: Single

Point

- When "Wiring selection of input" Xn is set to "0: Not used", input data is always off.
- When "Wiring selection of input" Xn (n: even number) is set to "1: Double wiring (NC/NC)", Xn+1, the partner of Xn, is automatically set to "1: Double wiring (NC/NC)", and no other settings are possible.
- When "Wiring selection of input" Xn (n: even number) is set to anything other than "1: Double wiring (NC/NC)", do not set "1: Double wiring (NC/NC)" for Xn+1, the partner of Xn. When "1: Double wiring (NC/NC)" is set, a parameter data error (Wiring selection of input) (error code: 0560H) occurs when the parameters of the device station are written to the programmable controller.

8.2 Input Response Time Setting Function

This function is used to set the filter time to reduce incorrect inputs caused by noise in input signals.

The longer the input response time is, the higher tolerance for chattering and noise the module has. But the response to input signals becomes slower.

The shorter the input response time is, the quicker the response to input signals is. But the tolerance for chattering and noise is reduced.

To set the input response time, consider fully the operating environment.

Ex.

When Input response time is set to "0: 1.0ms"

Without any noise effects, the time set in input response time and the time taken from when an external input (1) turns on or off until when the corresponding X input signal (2) in the safety remote I/O module turns on or off are equal.

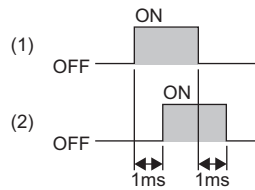

Point

The minimum value of input response time is set to 1ms for the safety remote I/O module, with the internal circuit diagnostic taken into account. When connecting the safety remote I/O module to an external device that generates OFF pulses, set Input response time to the following value: Minimum value of input response time + Pulse OFF time of the external device or longer.

When the set input response time does not include the pulse OFF time of the external device, an OFF pulse of the external device may be detected as an OFF signal.

Setting method

Set the input response time in "Input response time" from the "Parameter of Device Station" window of the engineering tool.

Item	Setting range
Input response time Xn	0: 1.0ms 1: 1.5ms 2: 5ms 3: 10ms 4: 20ms 5: 50ms 6: 70ms

Point

When "Wiring selection of input" Xn is set to "1: Double wiring (NC/NC)", only the same value as the value for Xn can be set for Xn+1, the partner of "Input response time" Xn (n: even number). If a different value is set, a parameter data error (input response time) (error code: 0564H) occurs.

Relation of the parameters for the input response time and input dark test

Set the input response time to satisfy the following condition.

Input response time > Input dark test pulse output time^{*1}

*1 Pulse output time for the input dark test = Pulse OFF time for the input dark test × ((Number of pulse outputs for the input dark test × 2) - 1)

For details on the input dark test, refer to the following.

☞ Page 89 Input dark test function

8.3 Safety Output

This function safely outputs signals. This function cannot be used in any modes other than the safety drive mode. All the safety remote outputs (SA\Y) are off in any modes other than the safety drive mode.

Safety output wiring selection function

The double wiring function or single wiring function can be selected for output wiring.

Double wiring function

The double wiring function supports double outputs.

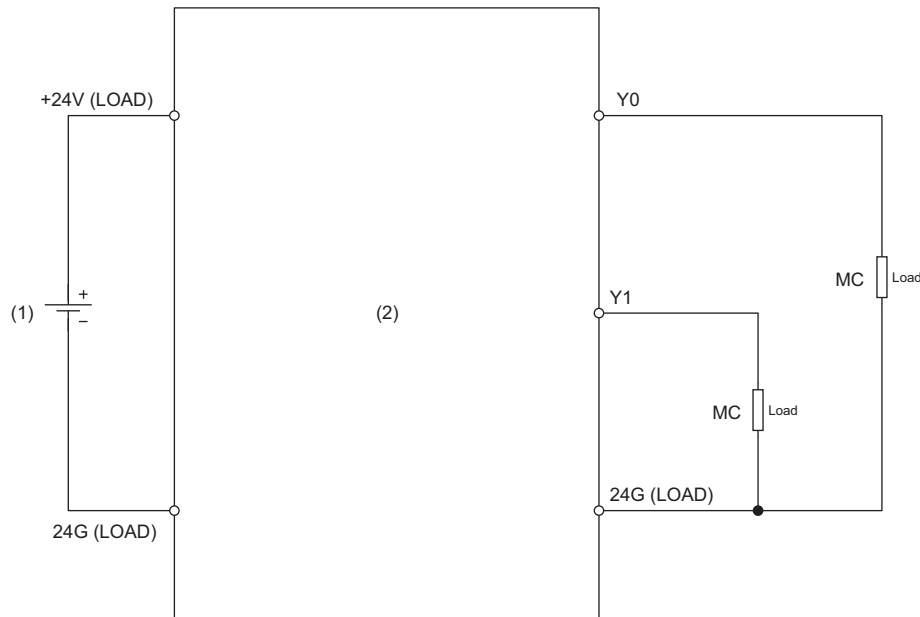

- (1) Load power supply and external power supply for output part
- (2) Safety remote I/O module

■Combination for double wiring

Use the following combinations of output terminals for double wiring to the safety remote I/O module.

Combination of output terminals	
Y0, Y1	Y2, Y3

Single wiring function

This function can connect output devices with single wiring.

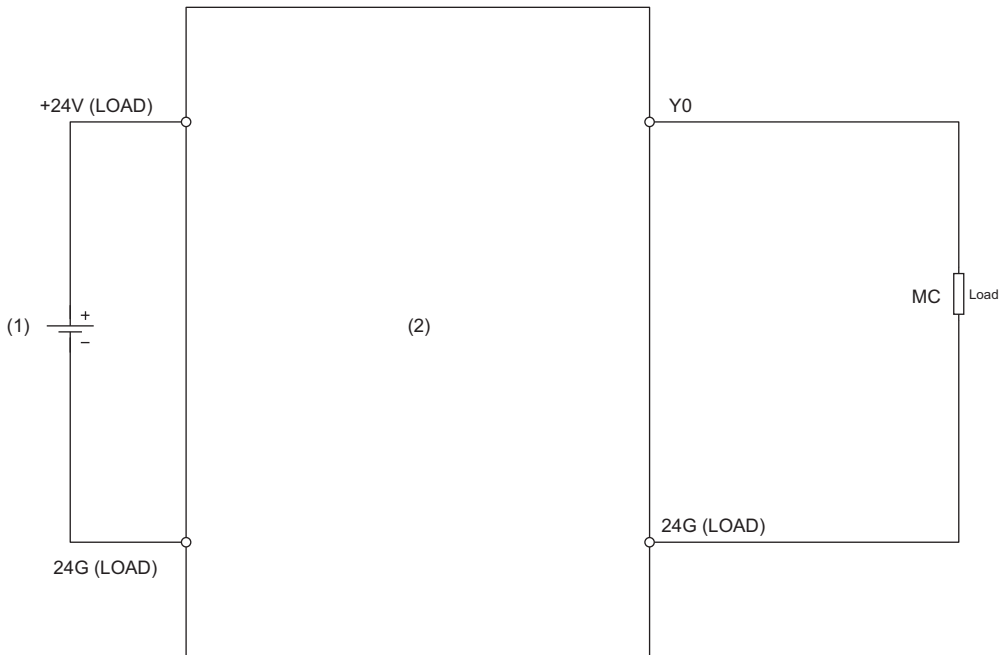

- (1) Load power supply and external power supply for output part
 (2) Safety remote I/O module

Diagnostic functions to detect output errors

Output errors can be detected by using the following diagnostic functions.

Diagnostic function	Description	Reference
Output dark test function	Outputs test pulses to turn off the outputs that are on and diagnoses contacts for failure.	☞ Page 92 Output dark test function
Output read-back function	Reads back output results and diagnoses whether the external output signals (Y0 to Y3) are correctly on or off.	☞ Page 94 Output read-back function

Combination of double outputs

Both terminals of double outputs are turned on only when both safety remote outputs (SAIY) are on. The safety remote I/O module evaluates the logic of safety remote outputs (SAIY) and determines the state of the output terminals. The following table lists the correspondence between each state of safety remote output (SAIY) and output terminal for double outputs.

Safety remote output (SAIY)		Output terminal state		Evaluation result of double outputs
SAIY ^{m*1}	SAIY ^{m+1*1}	Y ^{n*2}	Y ^{n+1*2}	
Off	Off	Off	Off	Off (Normal)
Off	On	Off	Off	Off (Discrepancy)
On	Off	Off	Off	Off (Discrepancy)
On	On	On	On	On (Normal)

*1 m: Safety device address (0, 2) assigned to the master station

*2 n: 0, 2

Point

Even if the double outputs do not match, the safety remote I/O module does not detect an error.

States of safety remote outputs (SAIY0, SAIY1) for Y0 and Y1 (double wiring)

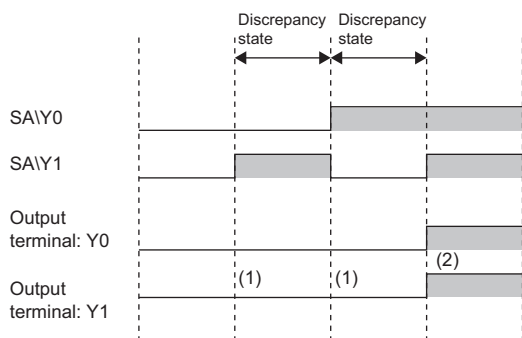

(1) When double outputs (source/source) are in the discrepancy state (safety remote outputs (SAIY0 and SAIY1) are different), Y0 and Y1 are off.

(2) When double outputs (source/source) are on (safety remote outputs (SAIY0 and SAIY1) are on), Y0 and Y1 are on.

Setting method

Set the safety output wiring selection in "Wiring selection of output" from the "Parameter of Device Station" window of the engineering tool.

To perform safety output, set either "1: Double wiring (Source/Source)" or "2: Single".

Item	Setting range
Wiring selection of output Yn	0: Not used 1: Double wiring (Source/Source) 2: Single

Point

- When "Wiring selection of output" Yn is set to "0: Not used", output data is always off.
- When "Wiring selection of output" Yn (n: even number) is set to "1: Double wiring (Source/Source)", set Y_{n+1}, the partner of Y_n, to "1: Double wiring (Source/Source)".
- When "Wiring selection of output" Yn (n: even number) is set to anything other than "1: Double wiring (Source/Source)", do not set Y_{n+1}, the partner of Y_n, to "1: Double wiring (Source/Source)".

Fast logic function

Output control according to the input status is performed inside the safety remote I/O module without going through the master station. Because the output status can be changed without CPU module processing such as programs, high-speed output control is possible.

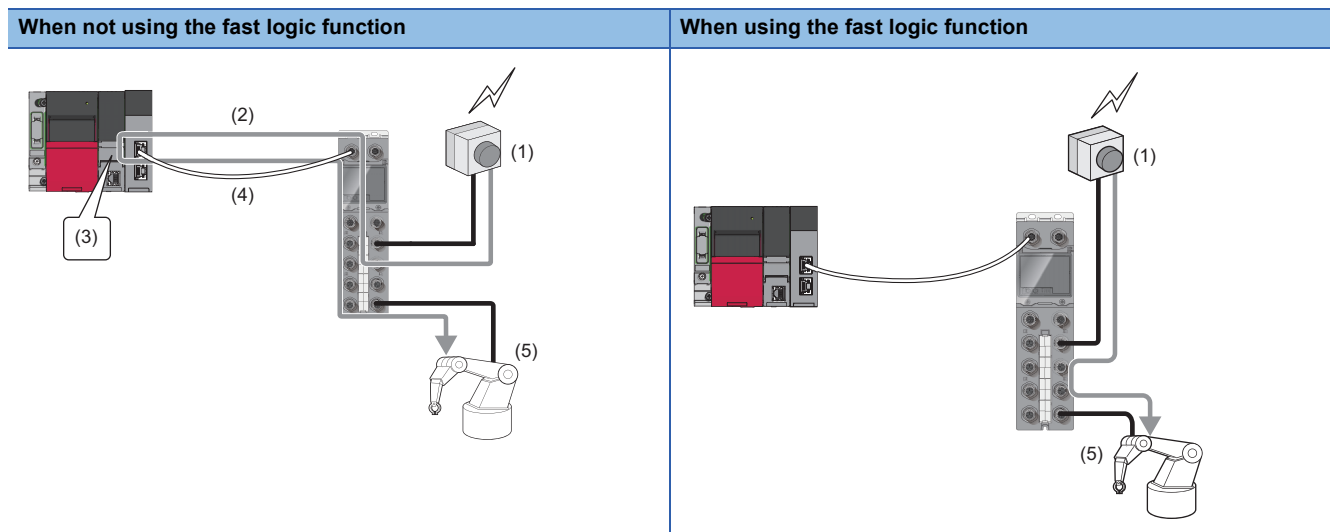

- (1) Emergency stop button push
- (2) Input status transmission
- (3) CPU module processing (program)
- (4) Output instruction reception
- (5) Robot stop

- The fast logic function performs logic operations based on the safety input and reflects the result to the safety output.
- When using the fast logic function, the I/O wiring selection is fixed, and the "Wiring selection of input" and "Wiring selection of output" parameters are ignored. Other parameters are valid.
- I/O points not used by the fast logic function are turned off. The operation is the same as when "0: Not used" is set for "Wiring selection of input" and "Wiring selection of output".

Logic patterns of fast logic function

The logic patterns of the fast logic function can be selected from the following four patterns.

No.	Fast logic pattern setting	Logical operation circuit of fast logic
1	Pattern 1 Four double wiring inputs (without reset signal)	
2	Pattern 2 Three double wiring inputs (with reset signal)	
3	Pattern 3 Three double wiring inputs (with reset signal)	
4	Pattern 4 Single wiring (with reset signal)	

(1) Input signals

(2) Logical operation circuit

(3) Output signals (fast logic output)

*1 The logical products of the safety output enable signals (SA\Y0, SA\Y1) and the fast logic output signals (Y0, Y1) are output as the output signals (Y0, Y1).

*2 The logical products of the safety output enable signal (SA\Y0) and the fast logic output signal (Y0) are output as the output signal (Y0).

Point

- In Pattern 2 to Pattern 4, a reset signal from external and a start signal can be input. In this case, the reset signal is input to X7 and the start signal is input to X6.
- When using the fast logic function, the safety output signals (SA\Y0, SA\Y1) are used as the safety output enable signals for the fast logic output. Other safety output signals are ignored even if they are operated from a program or engineering tool.
- Do not use Pattern 4 in a safety system.

Fast logic interlock

When the output is turned off by the fast logic function, the output is interlocked. When the fast logic interlock state is entered, the output signals (Y0, Y1) do not turn ON again unless there is a restart instruction, reset signal, or start signal input from the CPU module. This prevents unintended fast logic restarts. For applications that do not require interlock, fast logic interlock can be disabled.

■Fast logic interlock state conditions

Under the following conditions, the output signals (Y0, Y1) of the fast logic function are turned OFF and the fast logic interlock state is set.

- When the safety remote I/O module is disconnected from safety communications
- When the safety output enable signals (SA\Y0, SA\Y1) are turned off
- When the output conditions of the set logic pattern of the fast logic function are not satisfied

■Resumption of output from fast logic interlock state

The method of restarting output from the fast logic interlock state differs depending on the conditions that caused the output signals (Y0, Y1) of the fast logic function to turn off. For details, refer to the following.

☞ Page 79 Operation when fast logic output is off

☞ Page 81 Operation when safety output enable signal is off

Precautions

- When the fast logic interlock is disabled, it is customer's responsibility to build the interlock circuit externally so that the entire system always operates safely. Be sure to connect an interlock mechanism to the output of this I/O module.
- If the measure to prevent the restart cannot be taken, take other measures and ensure that operators are safe and machine parts are not damaged even if a device has restarted with the fast logic interlock disabled.

Operation at fast logic start

The fast logic function operates in the safe operation mode, and operation is stopped (output OFF) except in the fast logic interlock state and the safe operation mode.

The operation when the fast logic pattern setting is Pattern 2 is shown below.

Operating procedure

1. Turn on the safety output enable signals (SAIY0, SAIY1).
2. Turn on and off the fast logic initial request flag (SAIY8).
3. Check whether the fast logic initial completion flag (SAIX13) is on, and then turn on and off the fast logic start flag (SAIY9).
4. Turn on the input signals that satisfy the conditions of the logic pattern.
5. The output signals (Y0, Y1) turn on.

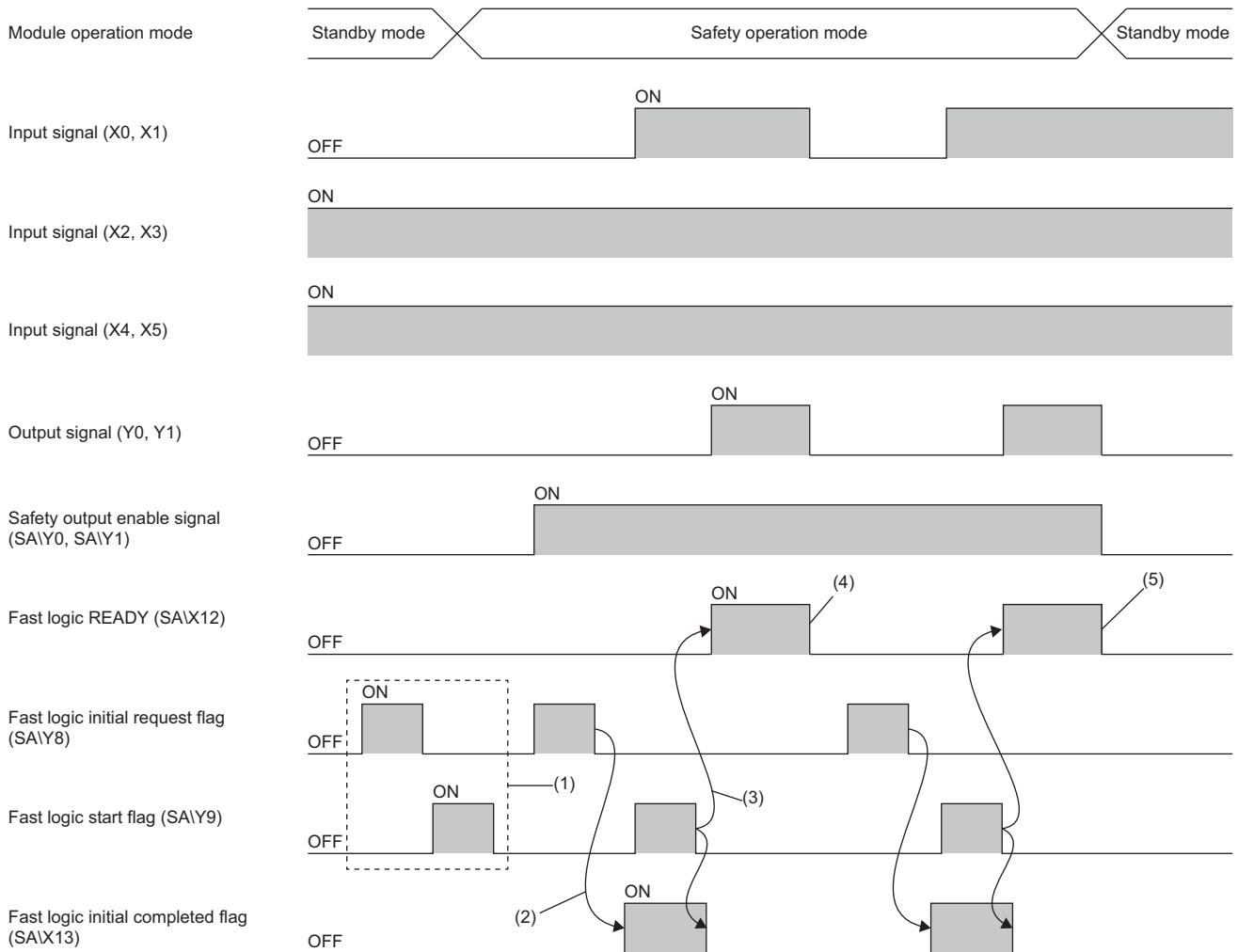

—————▶ Executed by the program

- (1) Even when the fast logic initial request flag (SAIY8) and fast logic start flag (SAIY9) are operated in other than the safe operation mode, the fast logic function is not enabled.
- (2) Turning on and off the fast logic initial request flag (SAIY8) in the safety drive mode causes fast logic initial processing to be performed. When initial processing is completed, the fast logic initial completion flag (SAIX13) turns on.
- (3) When the fast logic initial completion flag (SAIX13) is on, if the fast logic start flag (SAIY9) is turned on, the fast logic READY (SAIX12) turns on, the fast logic initial completion flag (SAIX13) turns off, and the fast logic function becomes enabled.
- (4) If the fast logic is interlocked, fast logic READY (SAIX12) turns off, and the fast logic function stops.
- (5) When a mode other than safety drive mode is entered, fast logic READY (SAIX12) turns off, and the fast logic function stops.

-
- The fast logic function turns off the output signals (Y0, Y1) and stops operation when the safety remote I/O module enters major or moderate error status.
 - If the input point is turned off due to a minor error, remove the cause of the error and then operate the fast logic initial request flag (SA\Y8) and fast logic start flag (SA\Y9) to start operation of the fast logic function.
 - To prevent unintended start of the fast logic function when the safety communications change from disconnected to connected, turn on and off both the fast logic initial request flag (SA\Y8) and the fast logic start flag (SA\Y9). When the fast logic initial completion flag (SA\X13) is turned off and fast logic READY (SA\X12) turns on, the operation starts.
 - Even if the fast logic interlock mode setting is disabled, perform the operation at the start of the fast logic function first.
 - Perform the operation so that the width of the pulse output from on to off for the fast logic initial request flag (SA\Y8) and the fast logic start flag (SA\Y9) is in the range of 200ms to 4s.
 - To restart the fast logic function, operate the fast logic initial request flag (SA\Y8) and fast logic start flag (SA\Y9) with the reset signal (X7) and start signal (X6) turned off.
-

Operation when fast logic output is off

■When fast logic interlock is enabled

When all the corresponding output signal points are turned off by the fast logic function, the fast logic READY (SAIX12) is turned off, the fast logic function stops operating, and the fast logic interlock state is entered.

When restarting the fast logic function, turning on the fast logic initial request flag (SAIY8) and fast logic start flag (SAIY9), or operating the reset signal X7 and start signal X6 causes fast logic READY (SAIX12) to turn on and the operation to resume.

The operation when the fast logic pattern setting is Pattern 2 is shown below.

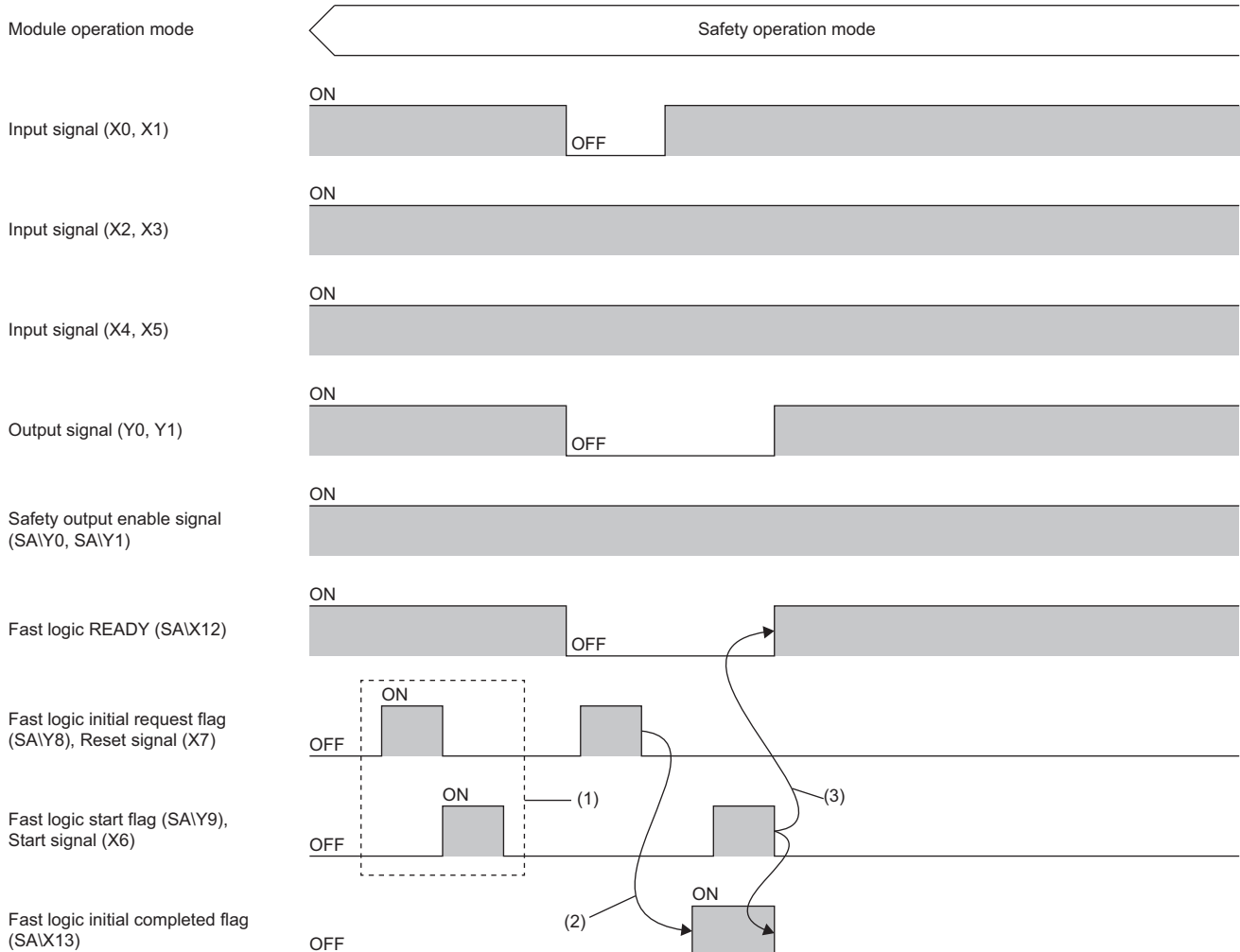

→ Executed by the program

- (1) When the fast logic output is not off, even if the fast logic initial request flag (SAIY8) and fast logic start flag (SAIY9) are operated, the fast logic initial completion flag (SAIX13) does not change.
- (2) Turning on the fast logic initial request flag (SAIY8) as a pulse output when fast logic output is off causes fast logic initial processing to be performed. When initial processing is completed, the fast logic initial completion flag (SAIX13) turns on.
- (3) When the fast logic initial completion flag (SAIX13) is on, if the fast logic start flag (SAIY9) is turned on as a pulse output, the fast logic READY (SAIX12) turns on, the fast logic initial completion flag (SAIX13) turns off, and the fast logic function becomes enabled.

Point

The operation of the fast logic function can be resumed by operating reset signal X7 and start signal X6 only when the fast logic function stops operating during safety communications return (fast logic interlock state). After safety communications changes from disconnected to connected, operate the fast logic initial request flag (SAIY8) and fast logic start flag (SAIY9) to restart the fast logic function.

■When fast logic interlock is disabled

Even when the output is turned off by the fast logic function, fast logic READY (SA\X12) remains on and the fast logic function does not stop. Operations of the fast logic initial request flag (SA\Y8) and fast logic start flag (SA\Y9), or operations of the reset signal X7 and start signal X6 will be ignored.

Since fast logic interlock is disabled, output resumes when an input signal that satisfies the logic pattern conditions is turned on again.

The operation when the fast logic pattern setting is Pattern 2 is shown below.

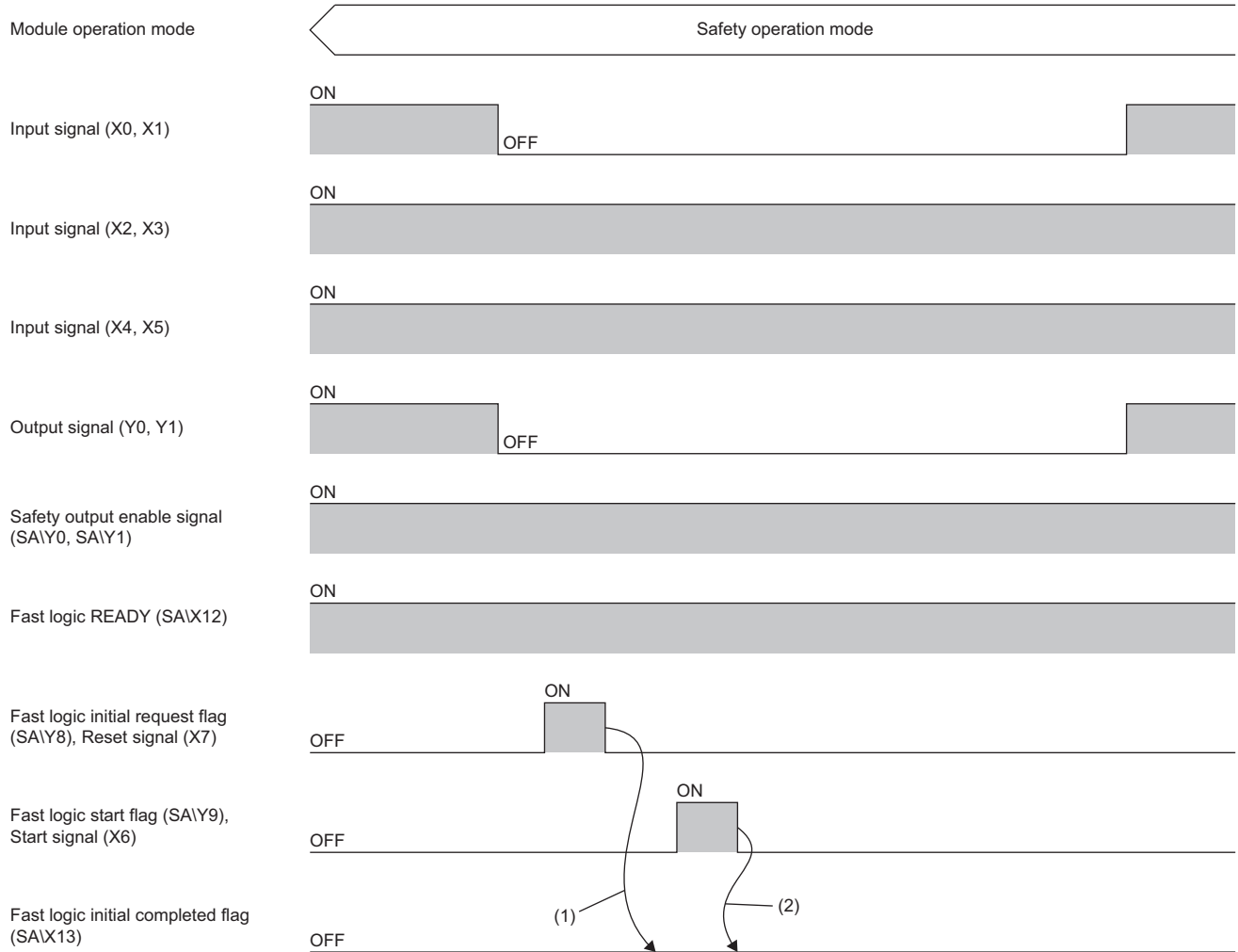

—————▶ Executed by the program

- (1) Even if the fast logic initial request flag (SA\Y8) is turned on as a pulse output, the fast logic initial completion flag (SA\X13) does not change.
- (2) Even if the fast logic start flag (SA\Y9) is turned on as a pulse output, the fast logic initial completion flag (SA\X13) does not change.

Operation when safety output enable signal is off

■When fast logic interlock is enabled

When the safety output enable signals (SAIY0, SAIY1) are turned off while the output signals (Y0, Y1) are on, all output signal points are turned off, fast logic READY (SAIX12) turns off, the fast logic function stops operation, and the fast logic interlock state is entered. The operation when the fast logic pattern setting is Pattern 2 is shown below. When the safety output enable signals (SAIY0, SAIY1) are turned off while the output signals (Y0, Y1) are off, the fast logic READY (SAIX12) remains on, and the fast logic interlock state is not entered.

The operation when the fast logic pattern setting is Pattern 2 is shown below.

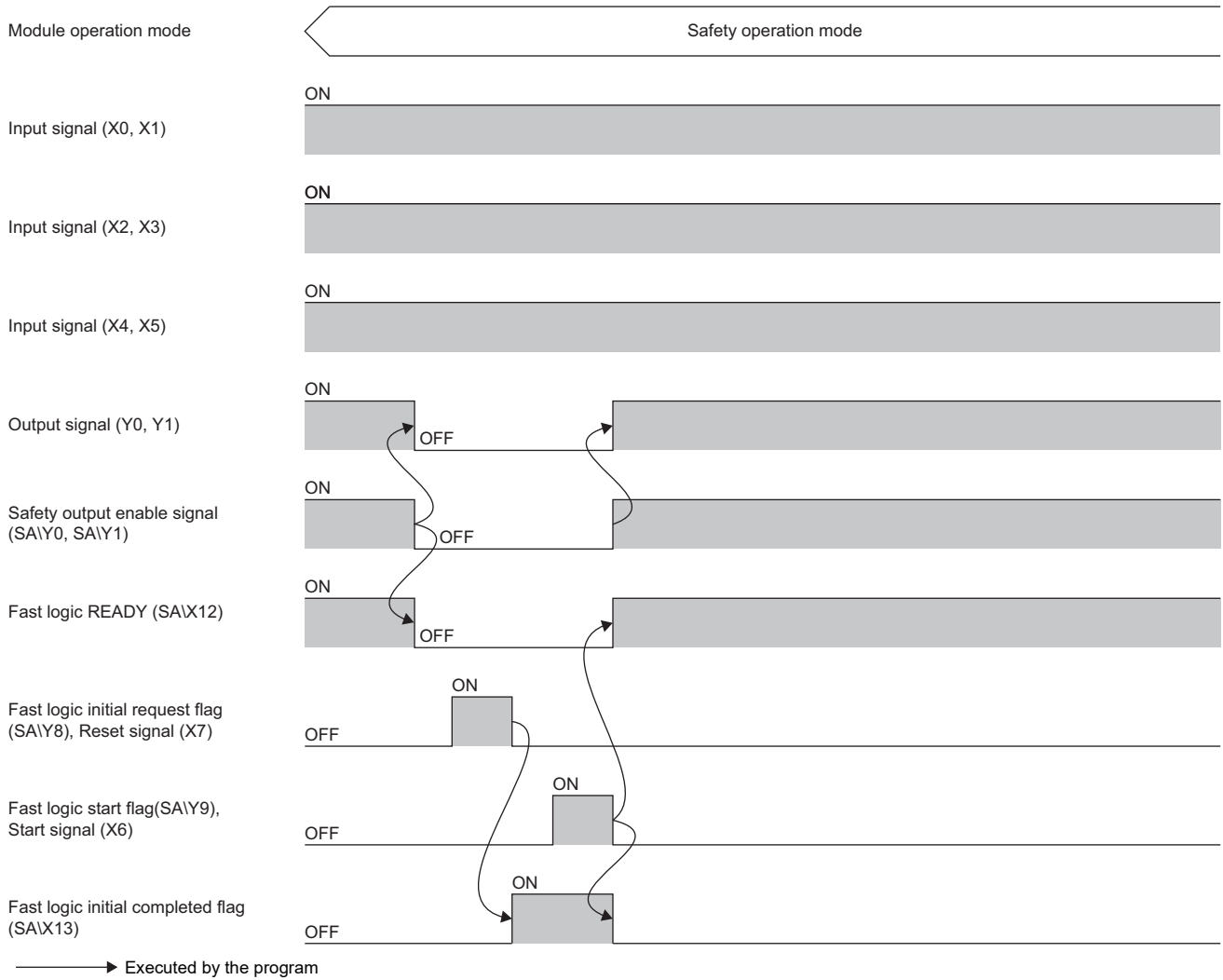

■When fast logic interlock is disabled

Turning off the safety output enable signals (SAIY0, SAIY1) turns off all the output signal points.

Since fast logic interlock is disabled, output resumes when the safety output enable signals (SAIY0, SAIY1) are turned on.

The operation when the fast logic pattern setting is Pattern 2 is shown below.

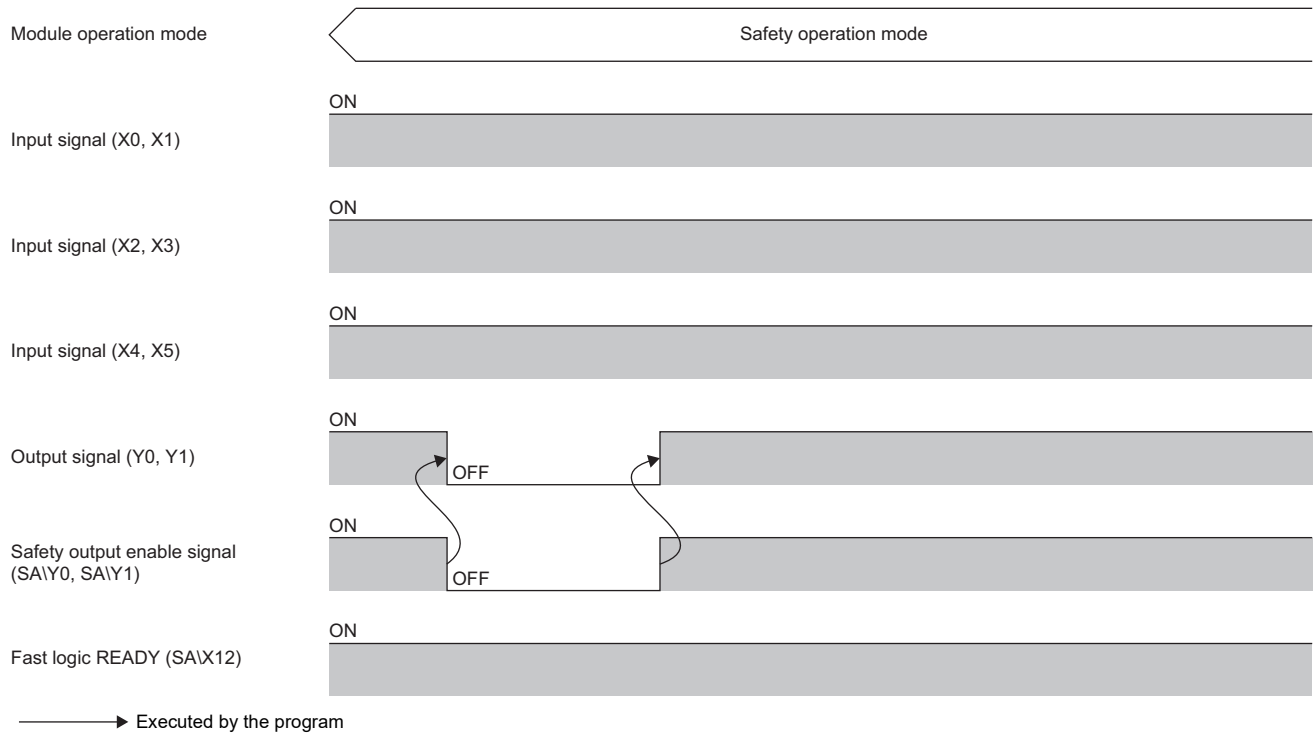

Total response time when using fast logic function

The total response time from input to output when using the fast logic function is shown below.

Safety remote station input response time + Fast logic function response time (4ms) + Safety remote station output response time

For details on the safety remote station input response time and safety remote station output response time, refer to the following.

📖 Page 21 Performance Specifications

Fast logic function parameter setting method

Fast logic pattern setting

Enable/disable the fast logic function and set the logic pattern.

Fast logic pattern setting is done with "Fast logic pattern setting" from the "Parameter of Device Station" window of the engineering tool.

Item	Setting range
Fast logic pattern setting	0: Not used 1: Pattern 1 2: Pattern 2 3: Pattern 3 4: Pattern 4

For details on the logic patterns, refer to the following.

 Page 75 Logic patterns of fast logic function

Precautions

When "Fast logic pattern setting" is other than "0: Not used", the parameter settings of "Wiring selection of input" and "Wiring selection of output" in the safety remote I/O module are automatically replaced with the following setting values. The replaced setting values cannot be checked on the "Parameter of Device Station" window.

No.	Fast logic pattern setting	Wiring selection of input/output	Setting value		
1	Pattern 1 Four double wiring inputs (without reset signal)	Wiring selection of input	X0	Double wiring (NC/NC)	
			X1		
			X2	Double wiring (NC/NC)	
			X3		
			X4	Double wiring (NC/NC)	
			X5		
			X6	Double wiring (NC/NC)	
			X7		
		X8	Not used		
		X9			
		XA			
		XB			
		Wiring selection of output		Y0	Double wiring (Source/Source)
				Y1	
Y2	Not used				
Y3					
2	Pattern 2 Three double wiring inputs (with reset signal)	Wiring selection of input	X0	Double wiring (NC/NC)	
			X1		
			X2	Double wiring (NC/NC)	
			X3		
			X4	Double wiring (NC/NC)	
			X5		
			X6	Single ^{*1}	
			X7	Single ^{*2}	
		X8	Not used		
		X9			
		XA			
		XB			
		Wiring selection of output		Y0	Double wiring (Source/Source)
				Y1	
Y2	Not used				
Y3					

No.	Fast logic pattern setting	Wiring selection of input/output		Setting value
3	Pattern 3 Three double wiring inputs (with reset signal)	Wiring selection of input	X0	Double wiring (NC/NC)
			X1	
			X2	Double wiring (NC/NC)
			X3	
			X4	Double wiring (NC/NC)
			X5	
			X6	Single ^{*1}
			X7	Single ^{*2}
			X8	Not used
			X9	
		XA		
		XB		
		Wiring selection of output	Y0	Double wiring (Source/Source)
			Y1	
Y2	Not used			
Y3				
4	Pattern 4 Single wiring (with reset signal)	Wiring selection of input	X0	Single
			X1	
			X2	
			X3	
			X4	Not used
			X5	
			X6	Single ^{*1}
			X7	Single ^{*2}
			X8	Not used
			X9	
		XA		
		XB		
		Wiring selection of output	Y0	Single
			Y1	Not used
Y2				
Y3				

*1 Start signal

*2 Reset signal

■Fast logic interlock mode setting

Fast logic interlock mode setting is done with "Fast logic Interlock mode setting" on the "Parameter of Device Station" window of the engineering tool.

Item	Setting range
Fast logic interlock mode setting	0: Enable 1: Disable

For details on the fast logic interlock, refer to the following.

 Page 79 Resumption of output from fast logic interlock state

8.4 Input Diagnostic

The input diagnostic function is a safety function for determining failure of input signals using the safety input function.

Double input discrepancy detection function

Discriminates failures by monitoring the discrepancy state of doubled safety remote inputs (SAIX).

Double input discrepancy detection

If "Double input discrepancy detection setting" is set to "0: Detect" from the "Parameter of Device Station" window, a double input discrepancy detection error is generated as an input error when the discrepancy state of double inputs continues for the set time or longer. For the double input discrepancy detection time, refer to the following.

☞ Page 87 Double input discrepancy detection time

The following figure shows the operation overview of the double input discrepancy detection for double wiring inputs X0 and X1.

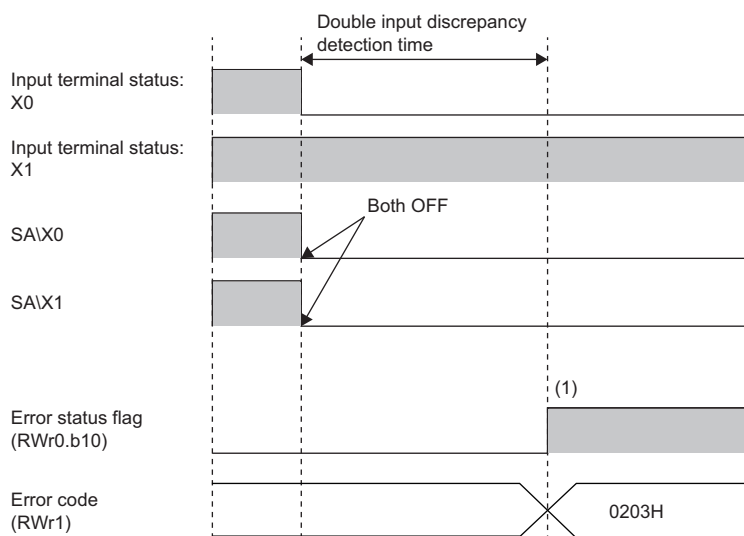

(1) After the double input discrepancy detection time elapses, a double input discrepancy detection error occurs.

■ Operation at error detection

When the discrepancy state of double inputs continues for the set time or longer, the double input discrepancy detection error (error code: 0203H) state is applied to the safety remote I/O module, and the corresponding input point is turned off. For the error state, refer to the following.

 Page 120 Error codes related to the safety remote I/O module

Point

When an error occurs for all the input points due to the input dark test error (error code: 0204H) or double input discrepancy detection error (error code: 0203H) and the input function cannot be performed anymore, an I/O data error (error code: 0108H) results. However, when a double input discrepancy detection error (error code: 0203H) occurs while "1: Used" is set for "Double input discrepancy auto recovery setting", the input function may be recovered. Thus, an I/O data error (error code: 0108H) does not occur even if the error occurs for all the input points.

■ Setting method

Set the double input discrepancy detection setting in "Double input discrepancy detection setting" from the "Parameter of Device Station" window of the engineering tool.

Item	Setting range
Double input discrepancy detection setting Xn, Xn+1*1	0: Detect 1: Do not detect

*1 n: Even number from 0 to A

Point

- When an item other than "1: Double wiring (NC/NC)" is selected in "Wiring selection of input", the "Double input discrepancy detection setting" parameter is ignored.
- When double input discrepancy errors do not need to be detected during equipment maintenance including system start-up and inspection, select "1: Do not detect".

Double input discrepancy detection time

When the double input discrepancy detection time is set, an error does not occur during the set detection time even if double input discrepancy occurs. The following table lists the relation of each double input evaluation result and the double input discrepancy detection time.

Input terminal state		Time passed after the discrepancy state is applied	Safety remote input		Evaluation result of double inputs
Xn*1	Xn+1*1		SA\Xm*2	SA\Xm+1*2	
Off	Off	—	Off	Off	Off (Normal)
Off	On	< Double input discrepancy detection time	Off	Off	Off (Discrepancy)
Off	On	≥ Double input discrepancy detection time	Off	Off	Double input discrepancy detection error
On	Off	< Double input discrepancy detection time	Off	Off	Off (Discrepancy)
On	Off	≥ Double input discrepancy detection time	Off	Off	Double input discrepancy detection error
On	On	—	On	On	On (Normal)

*1 n: Even number from 0 to A

*2 m: Safety device address (even number from 0 to A) assigned to the master station

Setting method

Set the double input discrepancy detection time in "Double input discrepancy detection time" from the "Parameter of Device Station" window of the engineering tool.

Item	Setting range
Double input discrepancy detection time Xn, Xn+1*1	1 to 6000 (×10ms)

*1 n: Even number from 0 to A

Point

A double input discrepancy error is detected in signals after the input response time has elapsed. Therefore, the time taken from when actual signals are in the discrepancy state until when a double input discrepancy detection error (error code: 0203H) occurs is equal to the input response time + double input discrepancy detection time.

Reference for the double input discrepancy detection time

- For mechanical switches and sensor inputs

Set the time based on the following values: 100ms for mechanical switches and 20ms for sensor inputs.

- When the synchronous time for double inputs can be defined

For the input devices whose synchronous time specifications is open to the public, set the double input discrepancy detection time considering the safety factor for the false detection.

Use the safety factor of 2 times or higher and set the double input discrepancy detection time to prevent false detection depending on the input devices used.

Ex.

When the synchronous time is 1s, 2s shall be set as the double input discrepancy detection time considering the safety factor of 2 times.

- When the synchronous time for double inputs cannot be defined

When the synchronous time cannot be defined for the application, such as usage of a door switches that are opened or closed manually, set the maximum time or set "1: Do not detect" in "Double input discrepancy detection setting". Even when "1: Do not detect" is set, the system stops when one of the input signals turns off. Therefore, safety is ensured by inspecting the safety remote I/O module periodically at a sufficiently short interval.

Double input discrepancy auto recovery function

When a double input discrepancy detection error has occurred, removing the error factor recovers the module into the normal state automatically.

By enabling this function, the reset operation of the safety remote I/O module to reset errors is not required.

When this function is enabled and a double input discrepancy is detected, the minor error state is applied to the safety remote I/O module. For details on the error state, refer to the following.

☞ Page 120 Error codes related to the safety remote I/O module

Auto recovery timing

To clear a double input discrepancy detection error, turning off both of the actual input signals is required. The following figure shows the timing of when the module is automatically recovered from a double input discrepancy detection error.

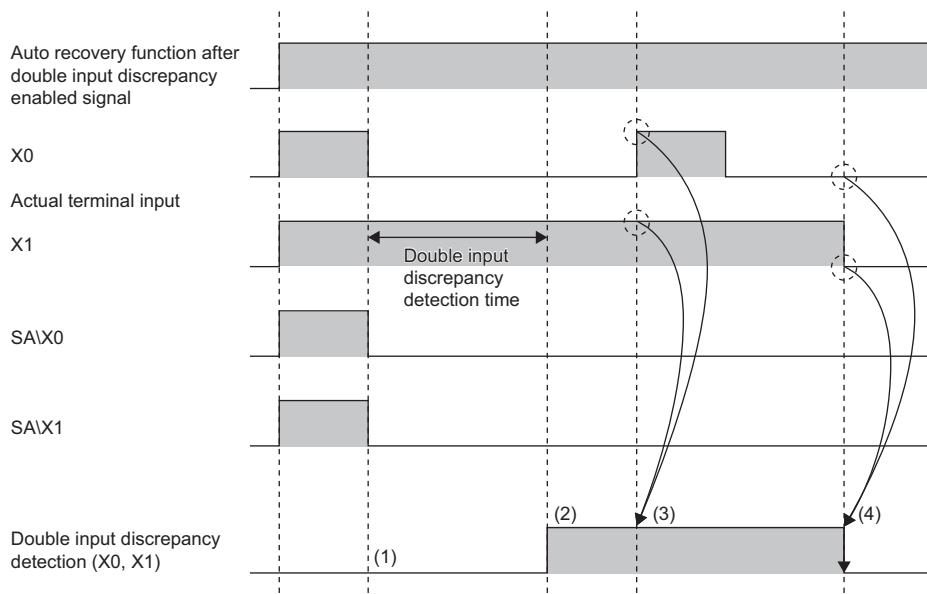

- (1) Both SAIX0 and SAIX1 turn off when discrepancy is detected.
- (2) A double input discrepancy detection error occurs.
- (3) The auto recovery is not performed even though both X0 and X1 turn on.
- (4) The auto recovery is performed when both X0 and X1 turn off.

Double input discrepancy detection state

The double input discrepancy detection state can be monitored with the safety remote inputs (SAIXC to SAIX11).

Point

Do not use the double input discrepancy detection state in a safety program.

Setting method

Set the double input discrepancy auto recovery function in "Double input discrepancy auto recovery setting" from the "Parameter of Device Station" window of the engineering tool.

Item	Setting range
Double input discrepancy auto recovery setting	0: Not used 1: Used

Point

The double input discrepancy auto recovery setting function is valid only for the input signals for which "0: Detect" is set in "Double input discrepancy detection setting".

Input dark test function

This function outputs test pulses to turn off the external input signals (X0 to XB) that are on and diagnoses contacts including external devices for failure. Failures including circuit fixing and short-circuit faults can be detected.

An input dark test can detect a short-circuit between any two Xn terminals because different test pulses are input for each Xn. The OFF time of test pulses and the number of pulse outputs used in one diagnostic can be set depending on the usage environment.

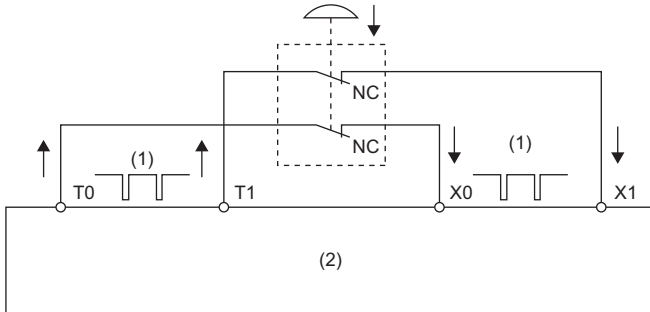

(1) Test pulse
(2) Safety remote I/O module

To use the input dark test function, use the test pulse output terminals (T0 to TB) and connect input devices. Use the input terminals and test pulse output terminals (T0 to TB) of the safety remote I/O module in the following combinations. An incorrect combination results in an error.

Test pulse output terminal	Input terminal
T0	X0
T1	X1
T2	X2
T3	X3
T4	X4
T5	X5
T6	X6
T7	X7
T8	X8
T9	X9
TA	XA
TB	XB

Operation at error detection

When an error is detected in a diagnostic of the input dark test, the input dark test error (error code: 0204H) state is applied. For details on the error state, refer to the following.

📖 Page 120 Error codes related to the safety remote I/O module

Point

When an error occurs for all the input points due to the input dark test error or double input discrepancy detection error and the input function cannot be performed anymore, an I/O data error (error code: 0108H) results. However, when a double input discrepancy detection error (error code: 0203H) occurs while "1: Used" is set for the parameter "Double input discrepancy auto recovery setting", the input function may be recovered. Thus, an I/O data error (error code: 0108H) does not occur even if the error occurs for all the input points.

Setting method

Set the following parameters for the input dark test function.

Point

There is a mutual relation of the parameter values of the input response time and input dark test. When setting parameters, set values that meet the mutual relation. For details, refer to the following.

 Page 70 Relation of the parameters for the input response time and input dark test

■ Input dark test execution setting

Set whether to perform the input dark test or not in "Input dark test execution setting" from the "Parameter of Device Station" window of the engineering tool.

Item	Setting range
Input dark test execution setting X0 to XB	0: Perform 1: Do not perform

■ Input dark test pulse OFF time setting

Set the input dark test pulse OFF time in "Input dark test pulse OFF time setting" from the "Parameter of Device Station" window of the engineering tool.

Item	Setting range
Input dark test pulse OFF time setting	0: 400 μ s 1: 1ms 2: 2ms

Point

Adjust the input dark test pulse OFF time depending on the installation environment or wiring length.

■ Number of pulse output for input dark test

Set the number of input dark test pulse outputs in "Number of pulse output for input dark test" from the "Parameter of Device Station" window of the engineering tool.

Item	Setting range
Number of pulse output for input dark test	0: 1 time 1: 2 times 2: 3 times

Point

Adjust the number of input dark test pulse outputs depending on the installation environment or wiring length.

Internal input dark test function

This function outputs test pulses to the internal input circuit of the safety remote I/O module to detect a circuit-fixing failure. The test pulses turn off the external input signals (X0 to XB) that are on to detect the failure.

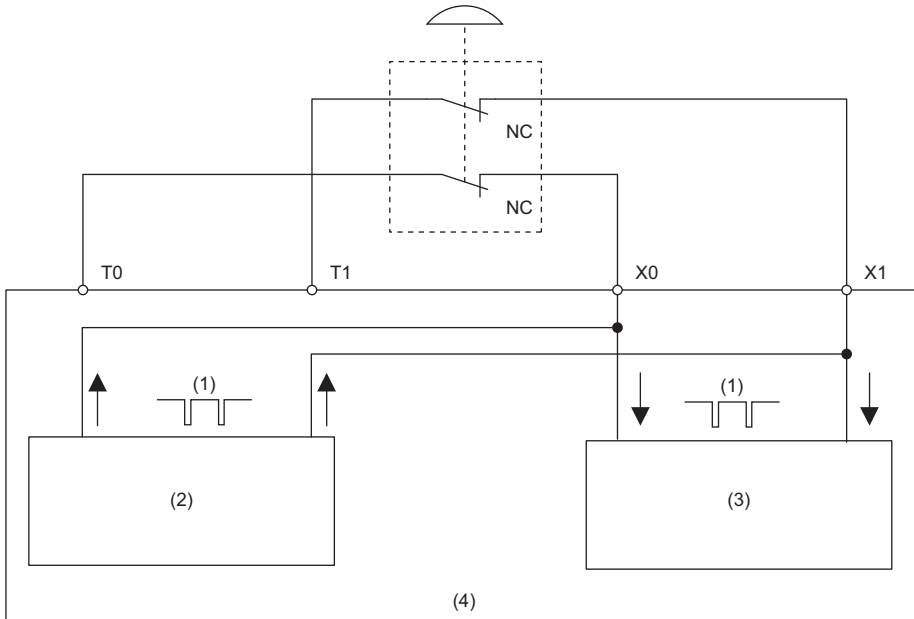

- (1) Test pulse
- (2) Test pulse output circuit
- (3) Input circuit
- (4) Safety remote I/O module

The test using this function is conducted to all input signals except for the signals where "Wiring selection of input" is set to "0: Not used".

Operation at error detection

When the safety remote I/O module detects an error in a diagnostic of the internal input dark test, an I/O data error (error code: 0108H) arises, and all input and output points are turned off. For details on the error state, refer to the following.

📖 Page 120 Error codes related to the safety remote I/O module

8.5 Output Diagnostic

The output diagnostic function is a safety function for determining failure of output signals using the safety output function.

Output dark test function

This function outputs test pulses to turn off the external output signals (Y0 to Y3) that are on and diagnoses the internal circuit for failure.

The read-back circuit checks the test pulse and output circuit fixing can be detected. The OFF time of test pulses and the number of pulse outputs used in one diagnostic can be set depending on the usage environment.

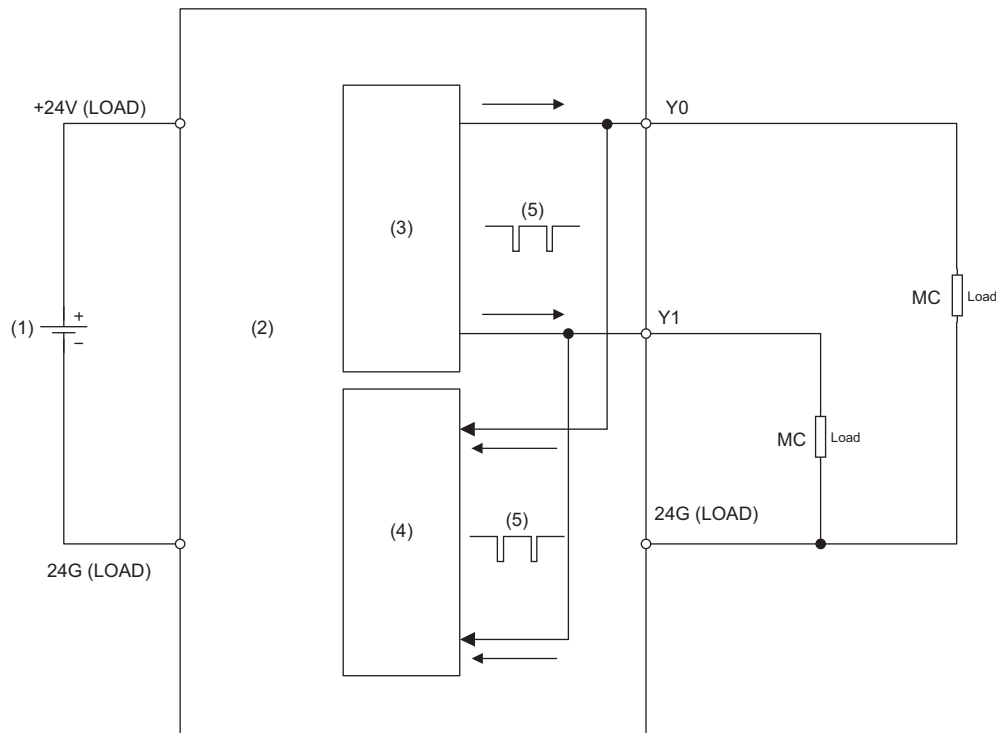

- (1) Load power supply and external power supply for output part
- (2) Safety remote I/O module
- (3) Output circuit
- (4) Read-back circuit
- (5) Test pulse

Operation at error detection

When the safety remote I/O module detects an error in a diagnostic of the output dark test, the output dark test error (error code: 0107H) state is applied and all output points are turned off. For details on the error state, refer to the following.

📖 Page 120 Error codes related to the safety remote I/O module

Setting method

Set the following parameters for the output dark test function.

■Output dark test execution setting

Set whether to perform the output dark test in "Output dark test execution setting" from the "Parameter of Device Station" window of the engineering tool.

Item	Setting range
Output dark test execution setting Y0 to Y3	0: Perform 1: Do not perform

■Output dark test pulse OFF time setting

Set the output dark test pulse OFF time (OFF pulse width) in "Output dark test pulse OFF time setting" from the "Parameter of Device Station" window of the engineering tool.

Item	Setting range
Output dark test pulse OFF time setting Y0 to Y3	0: 400 μ s 1: 1ms 2: 2ms

Point

Adjust the output dark test pulse OFF time depending on the installation environment or wiring length.

■Number of pulse output for output dark test

Set the number of output dark test pulse outputs in "Number of pulse output for output dark test" from the "Parameter of Device Station" window of the engineering tool.

Item	Setting range
Number of pulse output for output dark test Y0 to Y3	0: 1 time 1: 2 times 2: 3 times

Point

Adjust the number of output dark test pulse outputs depending on the installation environment or wiring length.

Output read-back function

This function reads back output results and diagnoses whether the external output signals (Y0 to Y3) are correctly output. By diagnosing whether the output terminal status matches the output data of the safety device, the output read-back function detects output operation errors of the safety remote I/O module.

To use this function, setting parameters is not required.

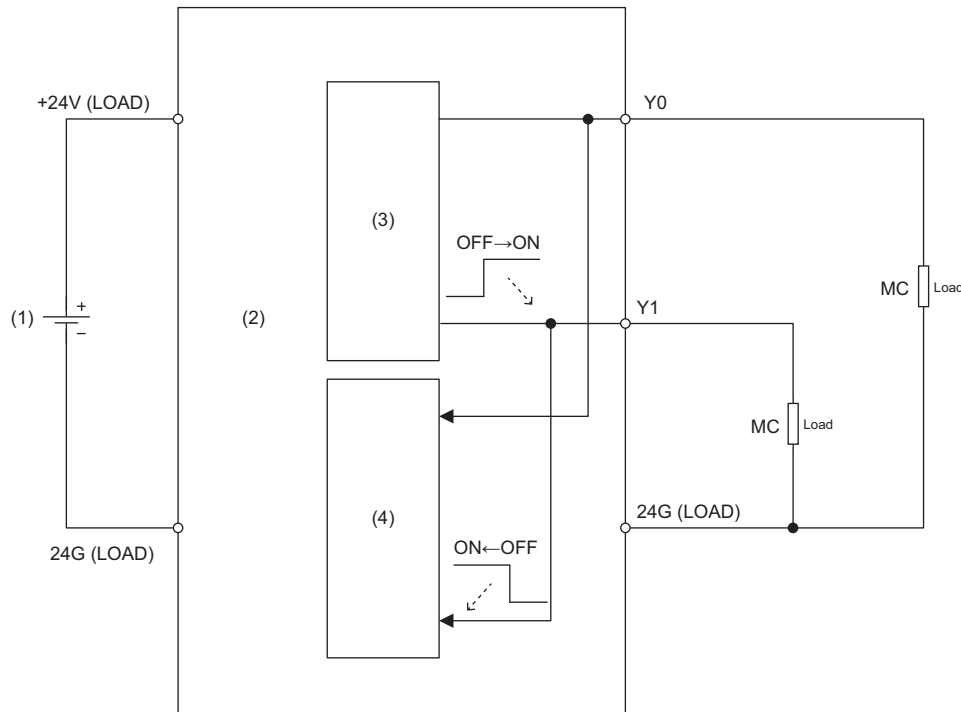

- (1) Load power supply and external power supply for output part
- (2) Safety remote I/O module
- (3) Output circuit
- (4) Read-back circuit

Operation at error detection

When the safety remote I/O module detects an error with the output read-back function, the output read-back error (error code: 0106H) state is applied and all output points are turned off. For details on the error state, refer to the following.

📖 Page 120 Error codes related to the safety remote I/O module

Point

The maximum output voltage in the output OFF state is 1.2V. However, even if the voltage exceeds 1.2V due to a short circuit or failure of the hardware, no error is detected until the voltage exceeds 7V. Thus, connected devices may turn on even when the output of the safety remote I/O module is in the OFF state.

8.6 Diagnostics Visualization Function

This function uses the remote register to notify the master station of the actual pulse width of test pulses that are output by the input dark test function and output dark test function. The master station is notified of the pulse width that is counted with the sampling cycle of 100µs as one.

The pulse width can be checked using the program or the data logging function.

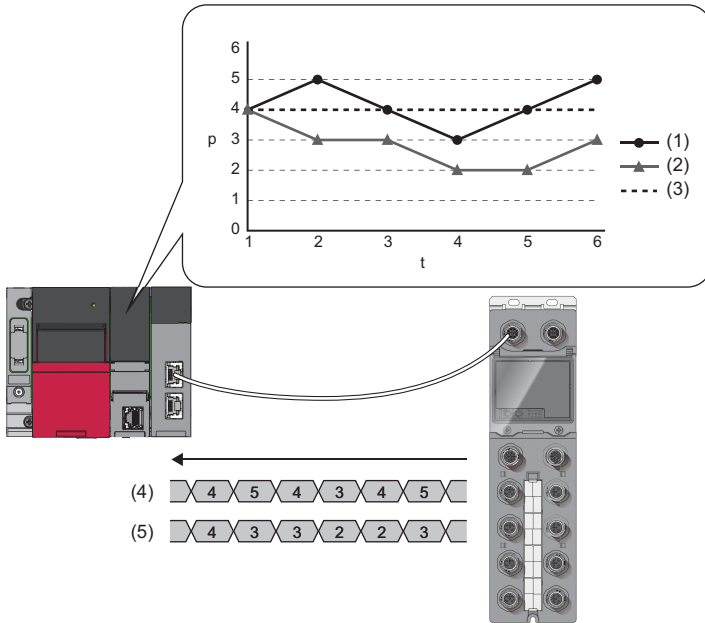

p: Pulse width

t: Time

(1) RWr4

(2) RWr10

(3) Pulse width at normal state

(4) Input dark test information area X0 (RWr4)

(5) Output dark test information area Y0 (RWr10)

The length of OFF pulse, from OFF edge (ON → OFF) to ON edge (OFF → ON), is measured as the test pulse width. The length is counted with the sampling cycle of 100µs as one.

Ex.

The test pulse widths to be sent to the master station become 4, 5, 3 with the following conditions: the parameters set for the test pulse OFF time and the number of test pulse outputs are 400 μ s and 1 respectively; the widths of actual read-back signals are 400 μ s, 500 μ s, and 300 μ s.

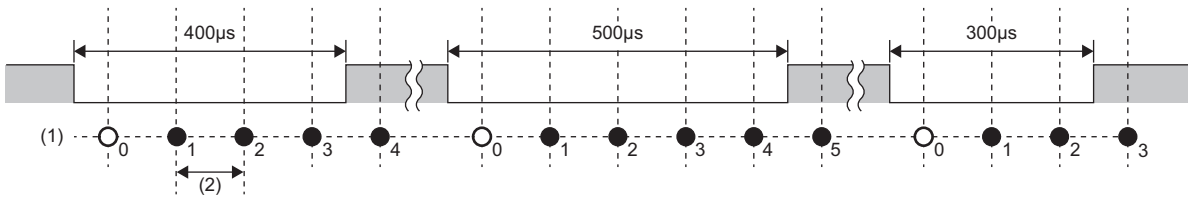

- (1) Test pulse width
- (2) Sampling cycle of 100 μ s

When the pulse width is consistently small

Pulses cannot be received satisfactorily due to the influence of external devices or wiring. Set the parameter to extend the pulse width of test pulses.

When the pulse width is temporarily small

At times, pulses cannot be received satisfactorily due to the influence of noise. Check if a load is being operated at the same time (such as an electromagnetic contactor or drive unit) and take measures to reduce noise, such as connecting a surge suppressor and separating wiring.

Normal values for pulse width

If the obtained pulse width is not a normal value, the possible causes are the following: In that case, correct the device and wiring conditions.

- Fault in the connected devices and wiring
- Influence of noise
- Hardware failure

The following table lists the normal values for pulse width.

Item	Setting value	Normal values for pulse width	
Input dark test pulse OFF time setting	0: 400 μ s	3 to 5	
	1: 1ms	9 to 11	
	2: 2ms	19 to 21	
Output dark test pulse OFF time setting	For source output	0: 400 μ s	1 to 5
		1: 1ms	7 to 11
		2: 2ms	17 to 21

When a value other than "0: 1 time" is set for "Number of pulse output for input dark test" and "Number of pulse output for output dark test", measure the test pulse width for the number of times specified, and treat the longest width as the test pulse width.

When the test pulse width is 0

In any of the following cases, the test pulse width for the relevant I/O points is 0.

- The input and output terminals are turned off.
- "1: Do not perform" is set for "Input dark test execution setting" Xn.
- "0: Not used" is set for "Wiring selection of input" Xn.
- "1: Do not perform" is set for "Output dark test execution setting" Yn.
- "0: Not used" is set for "Wiring selection of output" Yn.
- Input dark test error (error code: 0204H) has occurred.

In addition, when the module status is any of the following states, the test pulse width for all I/O points is 0.

- Safety communication connection is not being performed. (SAFETY LED is turned off.)

Even when the safety remote I/O module is not being affected by external devices, wiring, or noise, if the input or the output turns off while test pulses are being output, the test pulse width becomes 0. For that reason, if the input or output turns on and off repeatedly in a short cycle, the test pulse width becomes 0 frequently, making it impossible to accurately identify the pulse width.

8.7 Protection Functions

Prevents effects due to overvoltage and overcurrent from spreading to other modules of the safety system.

The following table lists the protection functions.

Function name	Purpose	Description
Module power supply overvoltage protection	Prevents ignition or burnouts from/of the safety remote I/O module due to overvoltage on the primary side.	This function operates when the module power supply is in the primary side overvoltage state.
Module power supply overcurrent protection	Prevents ignition or burnouts from/of the safety remote I/O module due to overcurrent on the primary side.	This function operates when the module power supply is in the primary side overcurrent state.
External power supply overvoltage protection	Prevents ignition or burnouts from/of the safety remote I/O module and load circuits due to overvoltage.	This function operates when the external power supply circuit is in the primary side overvoltage state.
External power supply overcurrent protection	Prevents ignition or burnouts from/of the safety remote I/O module and load circuits due to overcurrent.	This function operates when the external power supply circuit is in the primary side overcurrent state.

Point

The protection functions are intended to protect the internal circuit of a safety remote I/O module, not to protect external devices.

8.8 User Authentication Function

Limits the users (persons and personal computers) that can access the CPU module or safety remote I/O module.

Using this function permits only the specified users to access the CPU module.

This function is implemented in the CPU module used. For details on the user authentication function, refer to the following.

 GX Works3 Operating Manual

Online operations that require user authentication

The following table lists the online operations that require user authentication. No limitation is applied to the access levels of the user authentication function. With any access level of "Administrators", "Developers", "AssistantDevelopers", and "Users", the operations can be performed after the user authentication.

Operation name	Necessity of user authentication	Online operation
"Parameter read"	Required	"Parameter Processing of Device Station"
"Parameter write"	Required	
"Error History"	Not required	"CC-Link IE TSN/CC-Link IE Field Diagnostics"
"Start of checking the module position"	Required	"Command Execution of Device Station"
"Stop of checking the module position"	Required	
"Error history clear request"	Required	
"Delete Error History"	Not required	"CC-Link IE TSN/CC-Link IE Field Diagnostics"
"Safety module validation"	Required	"Command Execution of Device Station"
"CC-Link IE TSN/CC-Link IE Field Diagnostics"	Not required	"CC-Link IE TSN/CC-Link IE Field Diagnostics"
"Remote Operation"	Not required	



8.9 SLMP Communication Function

This function allows communications with the safety remote I/O modules using SLMP.

For details on SLMP, refer to the following.

 SLMP Reference Manual

Available commands

Item		Command	Subcommand	Description
Type	Operation			
Remote Control	Remote Reset	1006H	0000H	Executes remote RESET (function) for the safety remote I/O module.
Memory	Read	0613H	0000H	Reads data from the remote buffer memory. ( Page 140 Remote Buffer Memory) Depending on the combination of an address specified after the subcommand and the number of words to be read, if an attempt is made to read data from inaccessible remote buffer memory, the response to the SLMP command becomes an abnormal response, and C059H is stored as the end code.
	Write	1613H	0000H	Writes data to the remote buffer memory. ( Page 140 Remote Buffer Memory) Depending on the combination of an address specified after the subcommand and the number of words to be written, if an attempt is made to write data to inaccessible remote buffer memory, the response to the SLMP command becomes an abnormal response, and C059H is stored as the end code.

Point

For a single safety remote I/O module, do not execute multiple SLMP commands at the same time. If multiple SLMP commands are executed at the same time, the safety remote I/O module may be unable to receive the SLMP commands, and the SLMP commands may time out.

Available frames

The SLMP commands listed in the available commands table support the following frames.

- 3E frame
- 4E frame
- 6E frame

Communication settings

To communicate with the safety remote I/O modules using SLMP, set as follows.

- TCP/UDP: UDP
- Port: 45239
- Code: Binary code

How to communicate

Use the SLMPSND instruction to send SLMP commands to the safety remote I/O module from the CPU module.

For the SLMPSND instruction, refer to the following.

 MELSEC iQ-R Programming Manual (Module Dedicated Instructions)

Point

When a safety remote I/O module detects an SLMP command error, it returns an abnormal response, but the safety remote I/O module does not enter an error status. Because the error code is stored as the end code of the abnormal response data, check the error details and take action by referring to the following.

 Page 101 End codes for SLMP communications

End codes for SLMP communications

The following table lists the codes to be stored as end codes when a safety remote I/O module returns an abnormal response.

End code	Error definition and cause	Action
C059H	The command or subcommand is not specified correctly.	Correct the command or subcommand and send the SLMP command again.
C05CH	The request content is not specified correctly.	Correct the request content and send the SLMP command again.
C061H	The request data length and the number of data points do not match.	Correct the request data content or the request data length, and send the SLMP command again.
CF44H	The request destination cannot support divided data.	The safety remote I/O module cannot support divided data. Send a request message without dividing it.

8.10 Communication Speed Setting Function

This function sets the communication speed.

Setting method

Set with function setting switch 2. For details, refer to the following.

☞ Page 36 Setting the Function Setting Switches

Operating status

A communication speed at which the safety remote I/O module is operating can be checked with the remote register. For details, refer to the following.

☞ Page 137 Communication speed (RWr0.b1)

Precautions

Depending on the communication speed, the communication cycle range that can be set changes. For details, refer to the following.

☞ Page 49 Communication cycle interval setting

9 MAINTENANCE AND INSPECTION



This chapter describes the maintenance and inspection of the safety remote I/O module.

Point 

Read [Startup and Maintenance Precautions] in the safety precautions carefully before performing the inspection, and observe the precautions.

9.1 Daily Inspection

The following table lists the items that must be inspected on a daily basis.

Item	Inspection item	Inspection method	Judgment criterion	Corrective action	
1	Connection status	Check for the looseness of connecting plugs.	The connecting plugs must not be loose.	Ensure that the connecting plugs are securely connected.	
2	LED status at power-on or reset	PW LED	Check that the LED is on.	On	Refer to the following and take corrective actions.  Page 107 Checking the LEDs Replace the safety remote I/O module. (When an LED fails)
		RUN LED	Check that the LED is on.	On	
		SAFETY LED	Check that the LED is on.	On	
		ERR. LED	Check that the LED is on.	On	
		DATA LINK LED	Check that the LED is on.	On	
	I/O PW LED	Check that the LED is on.	The LED must be on when the external power supply is applied.*1		
3	LED status in operation	PW LED	Check that the LED is on.	On	Refer to the following and take corrective actions.  Page 107 Checking the LEDs
		RUN LED	Check that the LED is on.	On	
		SAFETY LED	Check that the LED is on.	On	
		ERR. LED	Check that the LED is off.	Off	
		DATA LINK LED	Check that the LED is on.	On	
		I/O PW LED	Check that the LED is on.	On	
		Input status indicator LED	Check that the LED is on, flashing, or off.	The LED must be on when an input is on. The LED must be off when an input is off. Flashing indicates the error point.*2	
		Output status indicator LED	Check that the LED is on, flashing, or off.	The LED must be on when an output is on. The LED must be off when an output is off. Flashing indicates the error point.*2	

*1 If the LED is off with the power applied from the external power supply, it indicates an error.

*2 For when the I/O LED indication at error occurrence is set to "1: Indication of error point"

9.2 Periodic Inspection

This section describes items that must be inspected one or two times every six months to one year. When the equipment has been relocated or modified, or cable laying has been changed, inspect the module for the items.

Item	Inspection item		Inspection method	Judgment criterion	Corrective action
1	Environment	Ambient temperature	Measure the temperature by using a thermometer.	0 to 55°C	Create the environment that satisfies the judgment criterion.
		Ambient humidity	Measure the humidity by using a hygrometer.	5 to 95%RH	
		Atmosphere	Measure corrosive gases.	No corrosive gases	
2	Power supply voltage check		Measure the voltage across 24VDC terminals.	20.4 to 28.8VDC	Change the supply power.
3	Installation	Looseness and rattling	Try to move the safety remote I/O module.	The module must be installed securely.	Retighten screws securely.
4	Connection status	Looseness of connecting plugs	Check for looseness by shaking connecting plugs lightly.	The connecting plugs must not be loose.	Ensure that the plugs are securely connected.

10 TROUBLESHOOTING

This chapter describes the errors that may occur while the safety remote I/O module is used and their troubleshooting.

10.1 CC-Link IE TSN/CC-Link IE Field Diagnostics

10

For CC-Link IE TSN, monitor the status and conduct an operation test.

For details on CC-Link IE TSN/CC-Link IE Field diagnostics, refer to the following.

 User's manual for the master station used

Remote reset

The safety remote I/O module can be remotely reset.

Operating procedure

1. Select a device station to be reset and click the [Remote Operation] button.

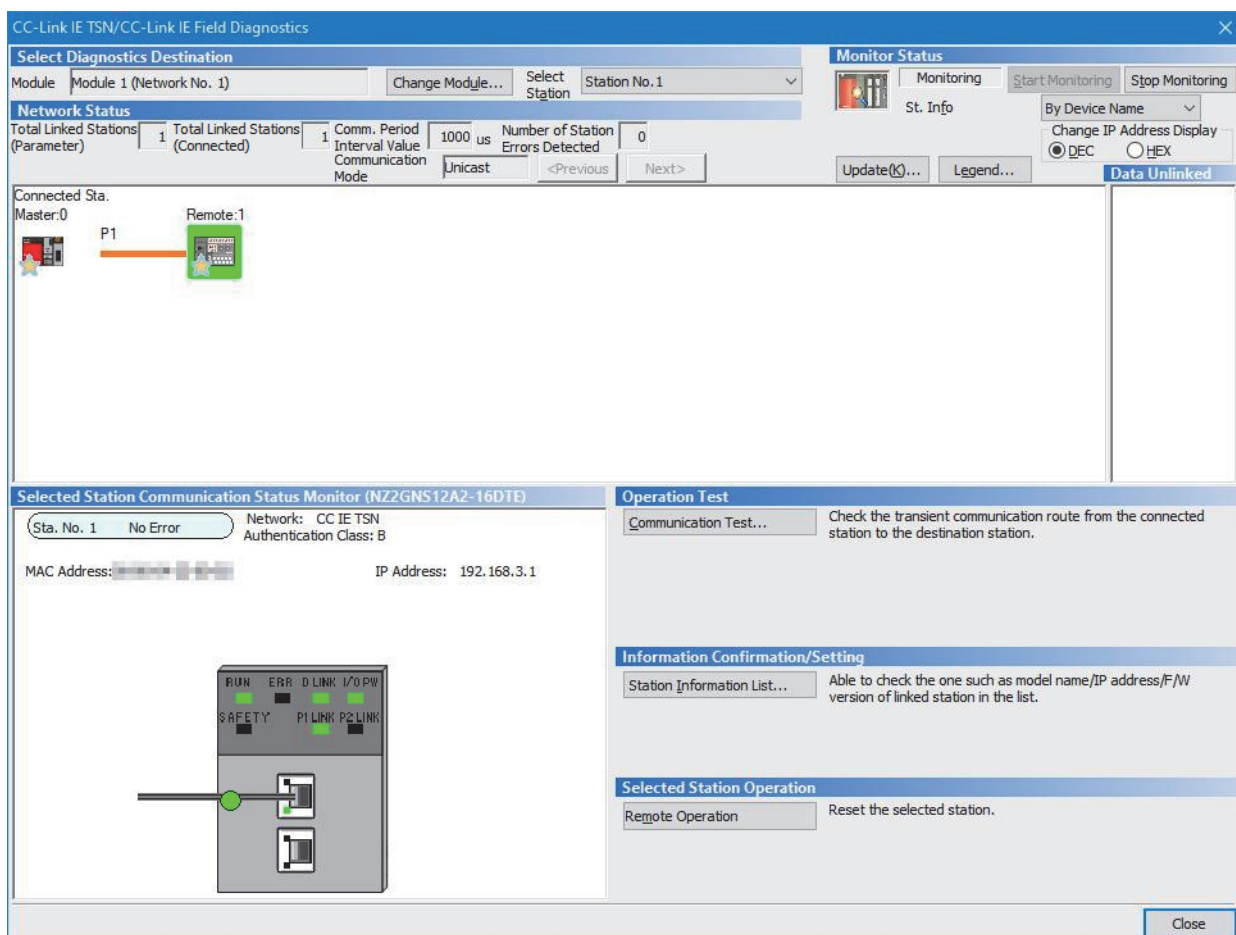

In this manual, "Authentication Class" is described as "CC-Link IE TSN Class".

2. Follow the on-screen instructions and click the [Yes] button.
3. Follow the on-screen instructions and click the [OK] button.

Precautions

Remote reset of a safety remote I/O module may cause the following.

- Another station is disconnected.
- If the function setting switch 1 and function setting switch 2 are different from the setting at power-on of the module power supply, a remote reset disable error (error code: 0271H) occurs, and the safety remote I/O module is not reset.

Checking station information

Information on safety remote I/O modules where data link is established are displayed in the "Station Information List" window. Information on each safety remote I/O module, such as the production information and firmware version, can be checked by clicking the [Station Information List] button in the "CC-Link IE TSN/CC-Link IE Field Diagnostics" window.

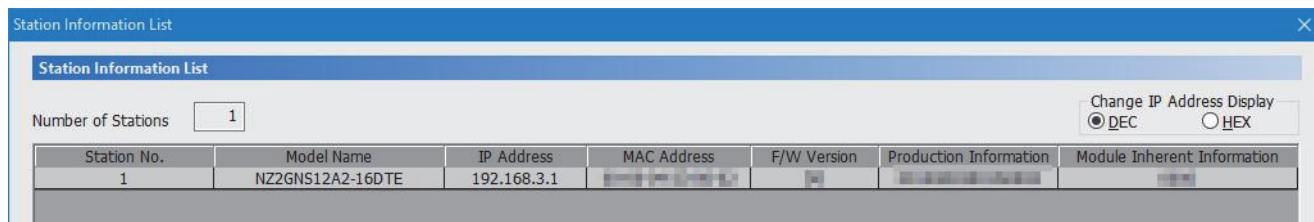

Point

- When checking the station information of each safety remote I/O module in the "Station Information List" window, check the versions of safety remote I/O modules that support the "Station Information List" window display function. (Page 160 External Dimensions)
- For items displayed in the "Station Information List" window, refer to the following.
 User's manual for the master station used

10.2 Checking the LEDs

This section describes how to troubleshoot the system by the LEDs.

When the PW LED does not turn on

When the PW LED does not turn on, check the following items.

Check item	Action
Is any LED other than the PW LED on?	When any LED other than the PW LED is on, the possible cause is a hardware failure. Please consult your local Mitsubishi representative.
Is the module power supply (24VDC) wired?	Wire the module power supply (24VDC).
Is the module power supply (24VDC) turned on?	Turn on the module power supply (24VDC).
Is the voltage of the module power supply (24VDC) within the specified range?	<ul style="list-style-type: none"> Set the module power supply voltage (24VDC) within the range of performance specifications. (☞ Page 21 Performance Specifications) After performing the above action, power off and on the module power supply (24VDC). If the PW LED does not turn on even after the module power supply (24VDC) is powered off and on, the possible cause is a safety remote I/O module failure or the activation of the overvoltage protection function. Please consult your local Mitsubishi representative.

When the RUN LED does not turn on

When the RUN LED does not turn on, check the following items.

Check item	Action
Has the voltage of the module power supplied externally reached the voltage of the specifications?	<ul style="list-style-type: none"> Check that module power supply voltage is within the range of performance specifications. (☞ Page 21 Performance Specifications) After performing the above action, power off and on the module power supply (24VDC). If the RUN LED does not turn on even after the module power supply (24VDC) is powered off and on, the possible cause is a safety remote I/O module failure. Please consult your local Mitsubishi representative.
Has any hardware failure occurred?	Power off and on the module power supply (24VDC). If the RUN LED does not turn on even after the module power supply (24VDC) is powered off and on, the possible cause is a safety remote I/O module failure. Please consult your local Mitsubishi representative.

When the RUN LED flashes

When the RUN LED flashes, check the following items.

Check item	Action
Is the safety remote I/O module in execution of the unit test?	<p>When the safety remote I/O module is in execution of the unit test, the RUN LED turns on after the unit test is completed. Take corrective action according to the result of the unit test.</p> <p>When a unit test is not conducted, set the IP address/station number setting switches to appropriate values. (☞ Page 112 Unit Test)</p>

When the DATA LINK LED turns off

When the DATA LINK LED turns off, check the following items.

Check item	Action
Is the safety remote I/O module on the network operating normally?	Connect the engineering tool to the master station, and check that the safety remote I/O module is data-linked using the CC-Link IE TSN/CC-Link IE Field diagnostics. ☞ User's manual for the master station used
Are Ethernet cables used compliant with the relevant standard?	Replace the cable with an Ethernet cable compliant with the relevant standard. ☞ User's manual for the master station used
Is the station-to-station distance 100m or less?	Change the station-to-station distance to 100m or less.
Does the cabling condition (bending radius) meet the specifications?	Refer to the manual for the Ethernet cable used, and correct the bending radius.
Is any Ethernet cable disconnected?	Replace the Ethernet cable.
Does the switching hub in use normally operate?	<ul style="list-style-type: none"> • Check that the power supply of the switching hub is turned on. • Check that the switching hub compliant with the specifications of the master module in use is used. (☞ User's manual for the master station used) • Disconnect the Ethernet cables and then reconnect them. • Power off and on the switching hub.
Are other stations connected to the safety remote I/O module normally operating?	<ul style="list-style-type: none"> • Check that the power supplies of the other stations are turned on. • Disconnect the Ethernet cables and then reconnect them. • Power off and on the switching hub.
Is the IP address of the safety remote I/O module duplicated with any of other stations within the access range of CC-Link IE TSN?	Change the IP address so that no IP address duplication occurs in the access range of CC-Link IE TSN.
Does another station between the master station and the safety remote I/O module link up at the desired communication speed?	Change the communication speed of another station or the switching hub to satisfy the communication speed conditions.
Is a device that is operating as a network other than CC-Link IE TSN connected between the master station and the safety remote I/O module?	Disconnect a device that is not operating as CC-Link IE TSN from the system. For a device that can be set to operate on CC-Link IE TSN, make sure that it is operating as CC-Link IE TSN.

When the DATA LINK LED flashes

When the DATA LINK LED flashes, check the following items.

Check item	Action
Does the IP address setting of the safety remote I/O module match the IP address of the safety remote I/O module specified in the network configuration settings of the master station?	Match the IP address of the safety remote I/O module with the IP address specified in the network configuration settings of the master station or the CC-Link IE TSN configuration settings.
Is the station type remote station?	In the network configuration settings of the master station, change "Station type" for the safety remote I/O module to "Remote station".
Is the module set to a reserved station?	Change the setting of "Reserved/Error Invalid Station" to "No Setting" in the network configuration settings of the master station.
Is the IP address of the safety remote I/O module duplicated with other stations?	If two or more duplicate IP addresses exist, change the setting so that they are different from each other.
In the network configuration settings of the master station, are the third or fourth octets of the IP address duplicated with those of other stations?	Set the IP address so that there is no duplication in the third and fourth octets of the IP address for all the stations.
In the network configuration settings of the master station, does each network address (the subnet mask part of IP address) match that of the master station?	Set each IP address and subnet mask so that the network addresses of all the stations are the same.
Is a station in which a communication error has occurred connected between the master station and the safety remote I/O module?	A safety remote I/O module cannot establish data link if there is no path available with which the safety remote I/O module can communicate with the master station without relaying data via a station with a communication error. If a communication error has occurred in two or more stations, clear the error one by one, starting from the station closest to the master station on the communication path.
Has another station been reset or powered off?	Disconnection temporarily occurs due to reset or power-off of another station. Wait until communication restarts.
Does a station on the network link up at the desired communication speed?	Change the communication speed of another station or the switching hub to satisfy the communication speed conditions.
Does the time synchronization source station operate normally?	<ul style="list-style-type: none"> • If an error occurs in the time synchronization source station, clear the error. • When the time synchronization source station is reset or powered off, disconnection temporarily occurs due to switching of time synchronization sources. Wait until communication restarts.
Is a time synchronization source station with a higher priority newly connected to the network?	Disconnection temporarily occurs due to switching of time synchronization sources. Wait until communication restarts.
Does the master station connected to the network operate normally?	If an error occurs in the master station, clear the error in the master station.
Is the system configured with ring topology?	When the CC-Link IE TSN Class setting for the safety remote I/O module is CC-Link IE TSN Class A, set the setting to CC-Link IE TSN Class B. Or, use a line topology, star topology, or mixture of star topology and line topology.
Does the model name of the device station set in the network configuration settings of the master station match the model name of the actual device?	Change the network configuration settings so that the model name of the device station set in the network configuration settings of the master station matches the model name of the actual device. Or, in the network configuration settings, set the safety remote I/O module as a general remote station.
Is a value out of the setting range set for the communication cycle interval setting of the master station?	Set a value within the setting range for the communication cycle interval setting of the master station. (Page 49 Communication cycle interval setting)
Is "Network Synchronous Communication" of the safety remote I/O module set to "Synchronous"?	Set "Network Synchronous Communication" of the safety remote I/O module to "Asynchronous".
Are RX/Ry with a number of points that cannot be handled by the safety remote I/O module set?	Set 16 for the number of points for RX and RY in the network configuration setting.
Are RWr/RWw with a number of points that cannot be handled by the safety remote I/O module set?	Set 20 or less for the number of points for RWr and RWw in the network configuration setting.
Has any error occurred in the safety remote I/O module?	<ul style="list-style-type: none"> • Change the network configuration settings so that the model name of the device station set in the network configuration settings of the master station matches the model name of the actual device. • Power off and on the module power supply (24VDC).
When device station parameter automatic setting is enabled, is device station parameter automatic setting completed with an error?	Check the device station parameter automatic setting execution result details (SW0194) and the event history of the master/local module, and take appropriate action according to the stored error code.
Are the IP address/station number setting switches incorrectly set to 0 or 255?	The effective range for the IP address setting is 1 to 254. Set the IP address within the range of 1 to 254.
Is the CC-Link IE TSN Class setting for the safety remote I/O module set to CC-Link IE TSN Class A?	When the setting is CC-Link IE TSN Class A, check the version of master station. When the version does not support CC-Link IE TSN protocol version 2.0, update the master station to the version supporting the protocol version 2.0.

Check item	Action
Is the event code of 00C81 related to the safety remote I/O module registered with event history of the master station?	Change the CC-Link IE TSN Class setting in the network configuration settings so that the CC-Link IE TSN Class setting set in the network configuration settings matches the CC-Link IE TSN Class setting for the safety remote I/O module. Or change the CC-Link IE TSN Class setting for the safety remote I/O module.

When the SAFETY LED turns off

When the SAFETY LED turns off, check the following items.

Check item	Action
Have parameters been set to the safety remote I/O module?	Set parameters to the safety remote I/O module. (☞ Page 53 Parameter Setting) If the parameters are changed, configure the safety communication setting and safety module validation again.
Has the safety communication setting been configured?	Configure the safety communication setting. After configuring the setting, perform "Write to PLC". For details on the safety communication setting, refer to the following. ☞ User's manual for the master station used
Has the safety module validation been performed?	Perform the safety module validation using the engineering tool. (☞ Page 61 Safety Communication Setting)
Has the safety station interlock of the CPU module been canceled?	Fully check wiring and connection, and cancel the safety station interlock of the CPU module. For the safety station interlock, refer to the following. ☞ User's manual for the master station used
Has any error occurred?	Identify the error factor of the safety remote I/O module with the engineering tool and take corrective actions. (☞ Page 118 Method for Checking Error Codes)

When the ERR. LED turns on or flashes

When the ERR. LED turns on or flashes, check the following items.

Check item	Action
Has any error occurred?	Identify the error factor of the safety remote I/O module with the engineering tool and take corrective actions. (☞ Page 118 Method for Checking Error Codes)

When the LINK LED turns off

When the LINK LED turns off, check the following items.

Check item	Action
Are Ethernet cables used compliant with the relevant standard?	Replace the cable with an Ethernet cable compliant with the relevant standard. ☞ User's manual for the master station used
Is the station-to-station distance 100m or less?	Change the station-to-station distance to 100m or less.
Does the cabling condition (bending radius) meet the specifications?	Refer to the manual for the Ethernet cable used, and correct the bending radius.
Is any Ethernet cable disconnected?	Replace the Ethernet cable.
Does the switching hub in use normally operate?	<ul style="list-style-type: none"> • Check that the power supply of the switching hub is turned on. • Check that the switching hub compliant with the specifications of the master module in use is used. (☞ User's manual for the master station used) • Disconnect the Ethernet cables and then reconnect them. • Power off and on the switching hub.
Are other stations connected to the safety remote I/O module normally operating?	<ul style="list-style-type: none"> • Check that the power supplies of the other stations are turned on. • Disconnect the Ethernet cables and then reconnect them. • Power off and on the switching hub.
Is a device connected to the PORT able to operate with the communication speed of the safety remote I/O module?	Connect a device that can communicate at the communication speed set in the safety remote I/O module.
When the communication speed of the safety remote I/O module is set to 100Mbps, is auto-negotiation of the connected device enabled?	Enable auto-negotiation of the connected device. Alternatively, connect a device with auto-negotiation enabled.

When the I/O LED flashes

When the I/O LED flashes, check the following items.

Check item	Action
Has any error related to safety I/O occurred when "I/O LED indication at error occurrence" is "1: Indication of error point"?	Identify the error factor of the safety remote I/O module with the engineering tool and take corrective actions. (☞ Page 105 CC-Link IE TSN/CC-Link IE Field Diagnostics)

When the I/O PW LED does not turn on

When the I/O PW LED does not turn on, check the following items.

Check item	Action
Is the external power supply turned on?	<ul style="list-style-type: none"> • Keep the external power supply voltage within the range of performance specifications. (☞ Page 21 Performance Specifications) • After performing the above action, power off and on the module power supply (24VDC). If the I/O PW LED does not turn on even after the module power supply (24VDC) is powered off and on, the possible cause is a safety remote I/O module failure. Please consult your local Mitsubishi representative.

10.3 Unit Test

Run a unit test to check if there is any hardware failure in the safety remote I/O module.

1. Power off the power supply of the safety remote I/O module.
2. Connect P1 and P2 of the safety remote I/O module with an Ethernet cable.
3. Set the IP address/station number setting switches and the function setting switches as follows.
 - IP address/station number setting switch (x16): F
 - Function setting switch 1: ON
4. Power on the power supply of the safety remote I/O module.
5. Unit test begins.

The RUN LED flashes during the unit test.

6. The RUN LED turns on when the unit test is completed.
 - If the test is completed normally, the ERR. LED does not turn on, but remains off.
 - If the test is completed with an error, the ERR. LED turns on. If the test is completed with an error, replace the Ethernet cable and run the test again. If the test fails again, it may be due to a hardware failure in the safety remote I/O module. Please consult your local Mitsubishi representative.

Precautions

If the I/O module is connected to the CC-Link IE TSN while the IP address/station number setting switch (x16) is set to F and the function setting switch 1 is set to ON, data link may not be properly performed on safety remote I/O modules of other stations.

Set appropriate values both for the IP address/station number setting switch (x16) and the function setting switch 1, and connect the I/O module to the CC-Link IE TSN.

10.4 Troubleshooting by Symptom

Perform the troubleshooting by symptom when the safety remote I/O module does not operate properly with no error. If an error occurs in the safety remote I/O module, identify the cause of the error using the engineering tool.

When the ON/OFF status of a safety input cannot be read

When the ON/OFF status of a safety input cannot be read, check the following items.

Check item	Action
Is the SAFETY LED on?	When the SAFETY LED is not on, "Safety module validation" has not been performed or the CPU module is in the safety station interlock status. Take the following actions. <ul style="list-style-type: none"> • Perform "Safety module validation". For details on "Safety module validation", refer to the following. <ul style="list-style-type: none"> ☞ Page 61 Safety Communication Setting • Fully check wiring and connection, and cancel the safety station interlock of the CPU module. For the safety station interlock, refer to the following. <ul style="list-style-type: none"> 📖 User's manual for the master station used
Is the corresponding LED (X0 LED to XB LED) of the safety remote I/O module on when a safety input device is on?	If the LED is not on, there is a problem with the input wiring. Check the wiring confirming that the input wiring is not disconnected or short-circuited, or the voltage of the input signal is correct. For the rated input voltage, check the rated input voltage of each module. <ul style="list-style-type: none"> ☞ Page 21 Performance Specifications Refer to the following as well. <ul style="list-style-type: none"> ☞ Page 115 Troubleshooting for input circuit
Is the setting of the refresh device (SAIX/SAIY) correct?	Check and correct the device setting of the safety communication setting so that the setting of the refresh device (SAIX/SAIY) matches the setting in the program. For details on the device setting of the safety communication setting, refer to the following. <ul style="list-style-type: none"> 📖 User's manual for the master station used
Is there any incorrect setting in the wiring selection of input?	Review the settings in the wiring selection of input. (☞ Page 67 Safety input wiring selection function)

When safety output cannot be turned on

When a safety output cannot be turned on, check the following items.

Check item	Action
Is the SAFETY LED on?	When the SAFETY LED is not on, "Safety module validation" has not been performed or the CPU module is in the safety station interlock status. Take the following actions. <ul style="list-style-type: none"> • Perform "Safety module validation". For details on "Safety module validation", refer to the following. <ul style="list-style-type: none"> ☞ Page 61 Safety Communication Setting • Fully check wiring and connection, and cancel the safety station interlock of the CPU module. For the safety station interlock, refer to the following. <ul style="list-style-type: none"> 📖 User's manual for the master station used
Is the setting of the refresh device (SAIX/SAIY) correct?	Check and correct the device setting of the safety communication setting so that the setting of the refresh device (SAIX/SAIY) matches the setting in the program. For details on the device setting of the safety communication setting, refer to the following. <ul style="list-style-type: none"> 📖 User's manual for the master station used
Is there any incorrect setting in the wiring selection of output?	Review the settings in the wiring selection of output. (☞ Page 71 Safety output wiring selection function)
Is the fast logic function being used by mistake?	When the fast logic function is enabled, the Y output is turned on/off according to the calculation result inside the safety remote I/O module, not the remote output signal (SAIY) received from the master station. Disable the fast logic function or review the output conditions. For details on the fast logic function, refer to the following. <ul style="list-style-type: none"> ☞ Page 74 Fast logic function

When safety output ON signal intermittently turns off

When a safety output ON signal turns off intermittently, check the following items.

Check item	Action
Is an output dark test being executed?	Check the specifications of the safety devices used, and review the setting of the output dark test pulse OFF time. (☞ Page 92 Output dark test function)

When the safety remote I/O module cannot be accessed with the engineering tool

When the safety remote I/O module cannot be accessed with the engineering tool, check the following items.

Check item	Action
Is the DATA LINK LED on?	Check the DATA LINK LED. When the LED is not on, refer to the following to perform troubleshooting. ☞ Page 108 When the DATA LINK LED turns off ☞ Page 109 When the DATA LINK LED flashes Refer to the following to check other LEDs. ☞ Page 107 Checking the LEDs
Is the version of the module on the master station correct?	Check the firmware version of the module on the master station, and if the version is not the applicable one, replace the module with a module of the applicable version or later. For the applicable version, refer to the following. ☞ Page 30 Applicable products
Is the version of the engineering tool supported?	Check the version of the engineering tool, and if it is prior to the compatible versions, update it. For the applicable version, refer to the following. ☞ Page 30 Compatible software version
Do the module parameter settings of the master station and those of the CPU module match?	Perform "Verify With PLC" to check whether the CPU module and module parameters match. If they do not match, execute "Write to PLC".

10.5 Fault Examples with the Safety Remote I/O Module

Troubleshooting for input circuit

This section describes the troubleshooting for input circuit.

An input signal does not turn off

■Cause

Drive by a switch with LED indicator

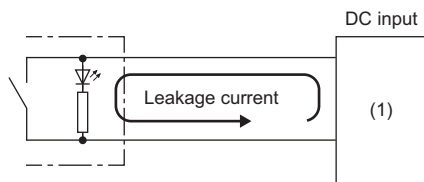

(1) Safety remote I/O module

■Action

Connect an appropriate resistor as shown below so that a current through the input module may become lower than the OFF current.

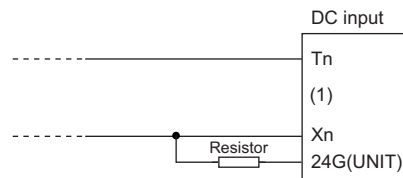

(1) Safety remote I/O module

For the calculation example of a resistor to be connected, refer to the following.

■Calculation example

When the 24VDC external power supply of the safety remote I/O module is on and an LED indicator switch that has a leakage current of 3mA at a maximum is connected



(1) Safety remote I/O module

1. The OFF current through the safety remote I/O module is more than 1.5mA. Therefore, connect a resistor as shown below.

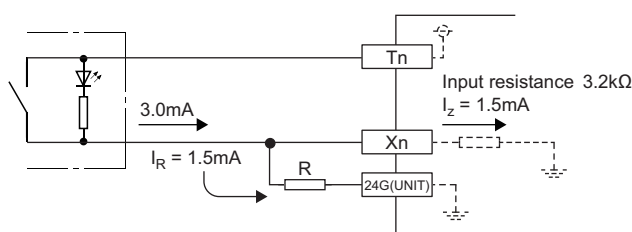

2. To satisfy the condition that the OFF current of the input module is 1.5mA or lower, the current through the connected resistor should be 1.5mA or higher. From the formula below, the connected resistor (R) is lower than or equal to 3.2kΩ.

$$I_R : I_z = Z (\text{Input resistance}) : R$$

$$R \leq \frac{I_z \times Z (\text{Input resistance})}{I_R} = \frac{1.5 \times 3.2}{1.5} = 3.2 \text{ [k}\Omega\text{]}$$

3. When the resistor (R) is 3.0kΩ, for example, the power capacity (W) of the resistor (R) becomes 0.28W.

$$W = (\text{Input voltage})^2 \div R = 28.8^2 \div 3000 = 0.28 \text{ [W]}$$

4. Because the resistor requires a power capacity that is 3 to 5 times larger than the actual current consumption, the resistor connected to the terminal should be 3.0kΩ; and 1.0 to 1.5W.

A signal incorrectly inputs data

■Cause

Noise is taken as input data.

■Action

- To prevent excessive noise, avoid installing power cables together with I/O cables.
- Set a longer input response time. (☞ Page 146 Input response time)
- Take noise reduction measures such as connecting surge absorbers to noise-generating devices such as relays and contactors using the same power supply.
- To prevent noise from being taken in, take measures to reduce noise for the I/O cable by using a part such as a ferrite core.
- To prevent radiation noise to the I/O cable, take measures to reduce noise by using a shielded cable.

Troubleshooting for output circuit

This section describes the troubleshooting for output circuit.

A load momentarily turns on from off when the system is powered off

■Cause

When an inductive load is connected, the load [2] in the off state may turn on due to a sneak current from the back EMF at the shutoff [1].

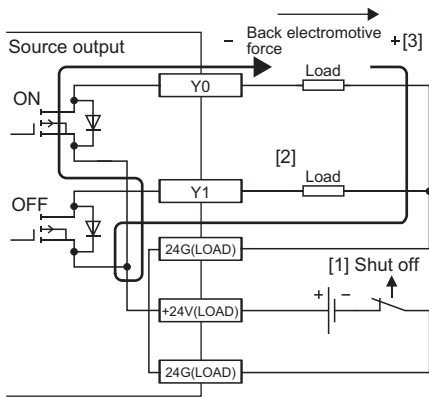

■Action

Take one of the two actions shown below.

- To suppress the back EMF, connect a diode in parallel with the load under the back EMF influence [3].

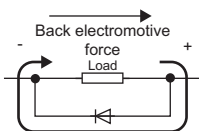

- Configure another current path by connecting a diode across positive and negative of the external power supply.

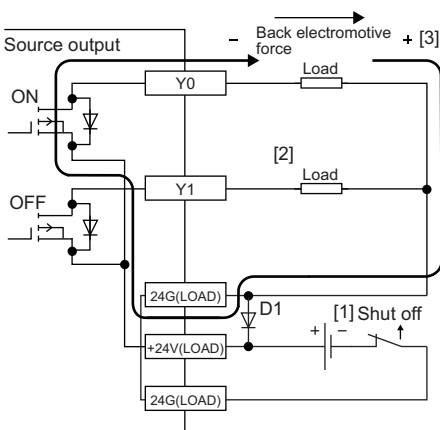

D1 indicates the following.

Reverse voltage VR (VRM)^{*1}

Forward current IF (IFM)^{*2}

*1 Approximately 10 times the rated load voltage in the specifications

Example: 24VDC → Approx. 200VDC

*2 Twice the maximum load current (common) in the performance specifications or more

Example: 4A/1 common → 8A or more

10.6 Method for Checking Error Codes

Error codes can be checked by any of the following methods:

- Checking with the engineering tool
- Checking by Error code (RWr1)

Checking with the engineering tool

The error history held in the safety remote I/O module can be read. Errors that occurred before powering-off can be checked as well.

The error history can be checked by using "CC-Link IE TSN/CC-Link IE Field Diagnostics".

Point

- The error history records a maximum of 16 errors in reverse chronological order of occurrence. If more than 16 errors occur, errors are deleted from the oldest.
- "Occurrence Date" information in the error history is recorded after clock information is distributed from the master station. When an error occurs before clock information is distributed from the master station, "Occurrence Date" information is not recorded.
- If the same error occurs successively, only the latest error is stored to the error history.
- Even after the module power supply is powered off and on, the error history remains.
- To initialize the error history, set "Method selection" to "Error history clear request" on the "Command Execution of Device Station" window and click the [Execute] button.
- For "Error Code", "Error details", and "Solution Methods", refer to the following.

 Page 120 List of Error Codes

- For detailed information, refer to the following.

 Page 124 Detailed information

■Checking by using CC-Link IE TSN/CC-Link IE Field diagnostics

Operating procedure

1. Connect the engineering tool to the CPU module.
2. Start "CC-Link IE TSN/CC-Link IE Field Diagnostics" from the menu.
 [Diagnostics] ⇒ [CC-Link IE TSN/CC-Link IE Field Diagnostics]
3. Right-click the device station whose error history to check, and select "Error History".
4. Follow the on-screen instructions and click the [Yes] button.
5. The error history appears.

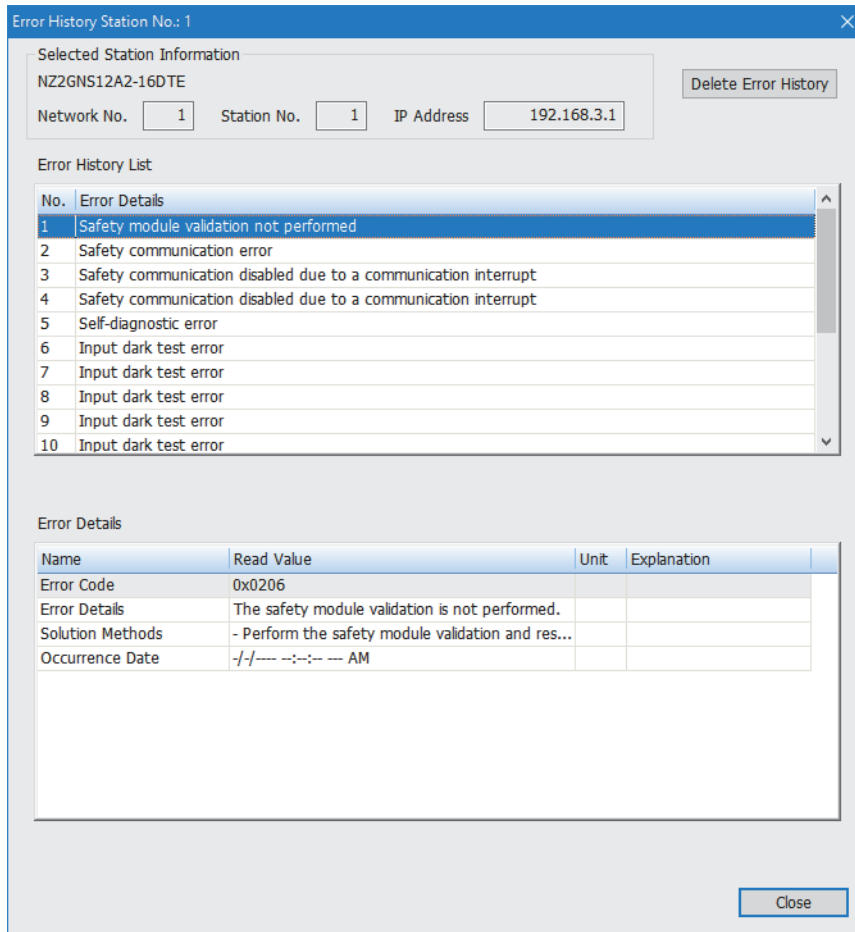

Checking by Error code (RWr1)

Check the latest error code with the remote register of the master/local module.

Operating procedure

 [Online] ⇒ [Monitor] ⇒ [Device/Buffer Memory Batch Monitor]

Ex.

When the refresh target device for Error code (RWr1) is W101

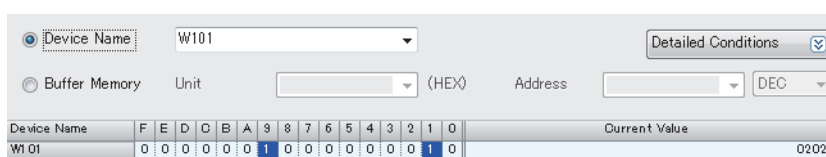

10.7 List of Error Codes

Error classification by error number

Error codes are classified by error number as follows.

Error code	Classification	Reference
0000H to 3FFFH	Safety remote I/O module error	Page 120 Error codes related to the safety remote I/O module
D000H to DFFFH	CC-Link IE TSN error	Page 126 Error codes related to CC-Link IE TSN
8400H to 84FFH	CC-Link IE TSN safety communications error	Page 128 Error codes related to CC-Link IE TSN safety communications

Error codes related to the safety remote I/O module

Errors of the safety remote I/O module are classified into the following four types.

Error status	Description
Major error	Error because of which the module stops, such as hardware failure. The safety functions (safety I/O, safety diagnostics, and safety communications) stop.
Moderate error	Error because of which the module stops, such as a parameter error related to module operation. The safety functions (safety I/O, safety diagnostics, and safety communications) stop.
Minor error	Error after which the module continues its operation, such as double input discrepancy detection. The safety functions keep operating.
Communication error	A CC-Link IE TSN safety communications error that causes the module to continue operating. The safety functions (safety I/O, safety diagnostics, and safety communications) stop.

List of error codes

Error code (hexadecimal)	Classification	Error name	Description and cause	Action
0001H	Major error	Hardware failure	A hardware error was detected.	<ul style="list-style-type: none"> Review the connected devices, wiring, and voltage. When the connected devices, wiring, and voltage have no errors, there may be an influence from noise or a hardware failure. Take measures to reduce noise. If the same error occurs again even after measures have been taken against noise, the module may be in failure. Please consult your local Mitsubishi representative.
0101H	Moderate error	Self-diagnostic error	An error was detected by the self-diagnostics.	
0102H ^{*1}	Moderate error	External power supply voltage error	An external power supply error was detected.	<ul style="list-style-type: none"> Review the connected devices, wiring, and voltage. Power on the external power supply at the same timing of power-on of the module power supply. There may be an influence from noise of external wiring (such as power supply part and I/O signal part). Take measures to reduce noise. If the same error occurs again, the module may be in failure. Please consult your local Mitsubishi representative.
0103H	Moderate error	Non-volatile memory data error (IP address information)	The IP address and subnet mask stored in the non-volatile memory are abnormal.	<ul style="list-style-type: none"> The module will be automatically recovered immediately after the error occurs. However, the stored IP address and subnet mask are lost, and operation is performed assuming that the following are stored. IP address: 192.168.3.250 Subnet mask: 255.255.255.0 Take measures against noise with a shielded cable for connection. If the same error occurs again, the module may be in failure. Please consult your local Mitsubishi representative.

Error code (hexadecimal)	Classification	Error name	Description and cause	Action
0104H	Moderate error	Restart not performed after safety module validation	The module has not been restarted after the safety module validation.	<ul style="list-style-type: none"> Restart the safety remote I/O module. After performing safety module validation, safety communications can be performed by restarting the module. If the same error occurs again, the module may be in failure. Please consult your local Mitsubishi representative.
0105H	Moderate error	Non-volatile memory data error (parameter)	An error of the parameter data stored in the non-volatile memory has been detected.	<ul style="list-style-type: none"> Restart the safety remote I/O module. The parameters are initialized and the module is recovered. In such a case, parameters are required to be set again by users. If the same error occurs again, the module may be in failure. Please consult your local Mitsubishi representative.
0106H ¹	Moderate error	Output read-back error	A discrepancy of an output read-back value and an output value was detected.	<ul style="list-style-type: none"> Review the connected devices and wiring. Check that 24V is supplied to the external power supply using a tester. Check that the external connection is not overloaded. When the connected devices and wiring have no errors, there may be an influence from noise or a hardware failure. Take measures to reduce noise. Power on the external power supply at the same timing of power-on of the module power supply. If the same error occurs again, the module may be in failure. Please consult your local Mitsubishi representative.
0107H ¹	Moderate error	Output dark test error	During an output dark test, test pulses were not detected.	<ul style="list-style-type: none"> Review the connected devices and wiring. Check that 24V is supplied to the external power supply using a tester. Check that the external connection is not overloaded. Correct the parameter settings of "Output dark test pulse OFF time" and "Number of pulse output for output dark test". When the connected devices and wiring have no errors, there may be an influence from noise or a hardware failure. Take measures to reduce noise. Power on the external power supply at the same timing of power-on of the module power supply. If the same error occurs again, the module may be in failure. Please consult your local Mitsubishi representative.
0108H ¹	Moderate error	I/O data error	An error was detected by the input diagnostic.	<ul style="list-style-type: none"> Review the connected devices and wiring. When the connected devices and wiring have no errors, there may be an influence from noise or a hardware failure. Take measures to reduce noise. Power on the external power supply at the same timing of power-on of the module power supply. If the same error occurs again, the module may be in failure. Please consult your local Mitsubishi representative.
0109H	Moderate error	Module power supply voltage error	A module power supply error was detected.	<ul style="list-style-type: none"> Review the connected devices, wiring, and voltage. If the same error occurs again, the module may be in failure. Please consult your local Mitsubishi representative.
010AH	Moderate error	IP address/station number setting switch out of range error	The IP address/station number setting switches are set to 255.	Turn on the power supply with the IP address/station number setting switches set to a value in the range 0 to 254.
0201H ¹	Minor error	Remote buffer memory access error	An area outside the range of the remote buffer memory areas has been accessed using a dedicated instruction.	<ul style="list-style-type: none"> The module will automatically recover immediately after the error occurs. Correct the setting data of the dedicated instruction to access within the range of remote buffer memory areas.

Error code (hexadecimal)	Classification	Error name	Description and cause	Action
0202H	Minor error	IP address/station number setting switch changed error	An IP address/station number setting switch has been changed with the module power supply on.	The module will recover from this error by setting the switches to the previous IP address that was set when the module power supply was powered on.
0203H ^{*1}	Minor error	Double input discrepancy detection error	A double input discrepancy was detected in a pair of inputs (X0 and X1, X2 and X3, ...).	<ul style="list-style-type: none"> Power on the external power supply at the same timing of power-on of the module power supply. Correct the parameter settings of "Double input discrepancy detection time". Review the connected devices and wiring. When the connected devices and wiring have no errors, there may be an influence from noise. Take measures to reduce noise. If the same error occurs again, the module may be in failure. Please consult your local Mitsubishi representative. When "Double input discrepancy auto recovery setting" is set to "1: Used", the module will recover from this error after the double input discrepancy is eliminated.
0204H ^{*1}	Minor error	Input dark test error	During an input dark test, test pulses were not detected.	<ul style="list-style-type: none"> Power on the external power supply at the same timing of power-on of the module power supply. Correct the parameter settings of "Input dark test pulse OFF time" and "Number of pulse output for input dark test". Review the connected devices and wiring. When the connected devices and wiring have no errors, there may be an influence from noise. Take measures to reduce noise. If the same error occurs again, the module may be in failure. Please consult your local Mitsubishi representative.
0205H	Minor error	Safety module validation failure	The safety module validation failed.	<ul style="list-style-type: none"> The module will automatically recover immediately after the error occurs. Check the module's ERR. LED and error history to see if a moderate error due to parameter settings has occurred in the module. If an error has occurred, eliminate the cause. If the same error occurs again even after "Safety module validation" is executed in no error state, the module may be in failure. Please consult your local Mitsubishi representative.
0206H	Minor error	Safety module validation not performed	The safety module validation has not been performed.	<ul style="list-style-type: none"> Perform "Safety module validation". After performing safety module validation, safety communications can be performed by restarting the module. If the same error occurs again, the module may be in failure. Please consult your local Mitsubishi representative.
0209H	Minor error ^{*2}	Function setting switch 1 changed error	The function setting switch 1 has been changed with the module power supply on.	Return the function setting switch 1 to the setting when the module power supply was powered on.
020AH	Minor error ^{*2}	Function setting switch 2 changed error	The function setting switch 2 has been changed with the module power supply on.	Return the function setting switch 2 to the setting when the module power supply was powered on.
020BH	Minor error ^{*2}	Function setting switch 3 changed error	The function setting switch 3 has been changed with the module power supply on.	Return the function setting switch 3 to the setting when the module power supply was powered on.
020DH	Minor error	Non-volatile memory data error (communication type switching information)	An error of the communication type switching information stored in a non-volatile memory was detected.	<ul style="list-style-type: none"> Take measures against noise with a shielded cable for connection. If the same error occurs again, the module may be in failure. Please consult your local Mitsubishi representative.
0271H	Minor error ^{*2}	Remote reset disable error (function setting switch)	Remote reset could not be performed because the setting of the NETWORK switch or the LINK SPEED switch is different from the setting it had when the module was powered on.	Return the NETWORK switch and LINK SPEED switch to the settings they had when the module was powered on, and then perform remote reset again.

Error code (hexadecimal)	Classification	Error name	Description and cause	Action
0500H ^{*1}	Moderate error	Parameter data error	An incorrect value or parameter data out of the range is set.	<ul style="list-style-type: none"> • Correct the module parameter settings and module configuration. • When the parameters are set again and the parameter setting has succeeded, the module will recover from this error.
0560H ^{*1}	Moderate error	Parameter data error (wiring selection of input)	An incorrect value or parameter (wiring selection of input) out of the range is set.	<ul style="list-style-type: none"> • Correct the module parameter settings (wiring selection of input) and module configuration. • When "0: Not used" or "2: Single" is set to Xn (n: even number) in "Wiring selection of input", set a value other than "1: Double wiring (NC/NC)" for Xn+1. • When the parameters are set again and the parameter setting has succeeded, the module will recover from this error.
0564H ^{*1}	Moderate error	Parameter data error (input response time)	An incorrect value or parameter data out of the range is set.	<ul style="list-style-type: none"> • Correct the module parameter settings (input response time) and module configuration. • Set the input response time so that it is longer than the input dark test pulse output time. Pulse output time for the input dark test = Pulse OFF time for the input dark test × ((Number of pulse outputs for the input dark test × 2) - 1) • When the parameters are set again and the parameter setting has succeeded, the module will recover from this error.
0580H ^{*1}	Moderate error	Parameter data error (wiring selection of output)	An incorrect value or parameter (wiring selection of output) out of the range is set.	<ul style="list-style-type: none"> • Correct the module parameter settings (wiring selection of output) and module configuration. • When "0: Not used" or "2: Single" is set to Yn (n: even number) in "Wiring selection of output", set a value other than "1: Double wiring (Source/Source)" for Yn+1. • When the parameters are set again and the parameter setting has succeeded, the module will recover from this error.

*1 Detailed information of the error is stored in Detailed Information in Error history data. For detailed information, refer to the following.

 Page 124 Detailed information

*2 Recovery is possible.

Point 

When multiple errors have occurred, only the latest error code is stored in Error code (RWr1). The errors that occurred before can be checked by executing "Error History" of the "CC-Link IE TSN/CC-Link IE Field Diagnostics" in the engineering tool. For the error history, refer to the following.

 Page 119 Checking by using CC-Link IE TSN/CC-Link IE Field diagnostics

However, when a moderate error occurs during a major error occurrence, the error code of the major error will remain in Error code.

Moreover, when a minor error occurs during a moderate error occurrence, the error code of the moderate error will remain in Error code.

Detailed information

External power supply voltage error (error code: 0102H)

An external power supply status (normal or error) is stored in Detailed information 1.

- 0H: Normal
- 1H: Error

Output read-back error (error code: 0106H)

Output read-back error detection point information is stored in Detailed information 1.

- Detailed information 1

b15	b14	b13	b12	b11	b10	b9	b8	b7	b6	b5	b4	b3	b2	b1	b0
0 (fixed)												Y3	Y2	Y1	Y0
0: Normal 1: Error															

Output dark test error (error code: 0107H)

The diagnostic result of an output dark test (normal or error) is stored in Detailed information 1.

- Detailed information 1

b15	b14	b13	b12	b11	b10	b9	b8	b7	b6	b5	b4	b3	b2	b1	b0
0 (fixed)												Y3	Y2	Y1	Y0
0: Normal 1: Error															

I/O data error (error code: 0108H)

The cause of an I/O data error is stored in Detailed information 1.

- 1H: All input points error
- 2H, 3H: Input internal dark test error

Error detection point information is stored in Detailed information 2.

- Detailed information 2

b15	b14	b13	b12	b11	b10	b9	b8	b7	b6	b5	b4	b3	b2	b1	b0
0 (fixed)				XB	XA	X9	X8	X7	X6	X5	X4	X3	X2	X1	X0
0: Normal 1: Error															

The following content is stored depending on the information stored in Detailed information 1.

- 1H: All input points error, all points become 0.
- 2H, 3H: Input internal dark test error, the diagnostic result of an internal input dark test (normal or error) is stored.

Point

The action to be taken when an I/O data error has occurred depends on the information stored in Detailed information 1. For details, refer to the following.

- 1H: All input points error: When an error occurs for all the input points due to the input dark test error (error code: 0204H) or double input discrepancy detection error (error code: 0203H) and the I/O function of the module cannot be performed anymore, an I/O data error (error code: 0108H) results. In such a case, take an action for the error that occurred immediately before this error.
- 2H, 3H: Input internal dark test error: When an error was detected by the internal input dark test, correct the wiring on the error detection points indicated in Detailed information 2.

Remote buffer memory access error (error code: 0201H)

The start address of a remote buffer memory area that was accessed using the REMFR instruction, REMFRIP instruction, REMTO instruction, REMTOIP instruction, or SLMPSEND instruction is stored in Detailed information 1 and Detailed information 2. The lower 16 bits are stored in Detailed information 1 and the upper 16 bits are stored in Detailed information 2. For details on the remote buffer memory addresses, refer to the following.

 Page 140 Remote buffer memory list

■ Double input discrepancy detection error (error code: 0203H)

Occurrence of a double input discrepancy error is stored in Detailed information 1. The input signal status after the input response time has passed is stored in Detailed information 3.

- Detailed information 1

b15	b14	b13	b12	b11	b10	b9	b8	b7	b6	b5	b4	b3	b2	b1	b0
0 (fixed)										XA	X8	X6	X4	X2	X0
										XB	X9	X7	X5	X3	X1
										0: Match 1: Mismatch					

- Detailed information 3

b15	b14	b13	b12	b11	b10	b9	b8	b7	b6	b5	b4	b3	b2	b1	b0
0 (fixed)				XB	XA	X9	X8	X7	X6	X5	X4	X3	X2	X1	X0
				0: OFF 1: ON											

■ Input dark test error (error code: 0204H)

The diagnostic result of an input dark test (normal or error) is stored in Detailed information 1.

- Detailed information 1

b15	b14	b13	b12	b11	b10	b9	b8	b7	b6	b5	b4	b3	b2	b1	b0
0 (fixed)				XB	XA	X9	X8	X7	X6	X5	X4	X3	X2	X1	X0
				0: Normal 1: Error											

■ Parameter data error (error code: 05□□H)

The start address (16 bits) of the remote buffer memory of the parameter where the error was detected is stored in Detailed information 1.

The value (16 bits) written in the corresponding address is stored in Detailed information 2.

If the set value is a 32-bit parameter, the lower 16 bits of the value written to the corresponding address are stored in Detailed information 2, and the upper 16 bits are stored in Detailed information 3.

For details on the remote buffer memory addresses, refer to the following.

 Page 144 Details of remote buffer memory areas

Error codes related to CC-Link IE TSN

The CC-Link IE TSN error codes are shown below.

List of error codes

Error code (hexadecimal)	Classification	Error name	Description and cause	Action
D000H ^{*1*2}	Minor error	Communication setting error 1	Invalid network settings are received.	Power off and on the module power supply. If the same error occurs again, the module may be in failure. Please consult your local Mitsubishi representative.
D001H ^{*1*2}	Minor error	Communication setting error 2	Network settings that cannot be handled by the safety remote I/O module are received.	Check that the model name of the device station set in the network configuration settings matches the model name of the actual device. If this error occurs even when the model names match, the possible cause is a module failure. Please consult your local Mitsubishi representative.
D010H ^{*1}	Minor error	IP address duplication detection	An IP address duplication is detected.	Change the IP address so that no IP address duplication occurs in the access range of CC-Link IE TSN. After change, power off and on the module power supply.
D011H ^{*1*2}	Moderate error	IP address setting error	Values the safety remote I/O module cannot use were set for the IP address and subnet mask settings.	<ul style="list-style-type: none"> Without using the set IP address and subnet mask, the module is operated based on the previous IP address and subnet mask. The set IP address and subnet mask will not be saved in non-volatile memory. Check the IP address and subnet mask again, and change the settings to values the safety remote I/O module can use. After change, power off and on the module power supply.
D020H ^{*1*2}	Minor error	Network synchronous communication setting error	The network synchronous communication setting of the safety remote I/O module is set to synchronous.	Set the network synchronous communication setting of the safety remote I/O module to asynchronous.
D021H ^{*1*2}	Minor error	Number of RX/Ry points error	RX/Ry with a number of points that cannot be handled by the safety remote I/O module are set.	Set 16 for the number of points for RX and Ry in the network configuration setting.
D022H ^{*1*2}	Minor error	RWr/RWw number of points error	RWr/RWw with a number of points that cannot be handled by the safety remote I/O module are set.	Set 20 or less for the number of points for RWr and RWw in the network configuration setting.
D023H ^{*1*2}	Minor error	Safety PDU number of points error	A safety PDU with a number of points that cannot be handled by the safety remote I/O module was received.	Power off and on the module power supply. If the same error occurs again, the module may be in failure. Please consult your local Mitsubishi representative.
D024H ^{*1*2}	Minor error	Communication period setting error (CC-Link IE TSN Class B/1Gbps)	When the safety remote I/O module was operating with CC-Link IE TSN Class B and at a communication speed of 1Gbps, a communication cycle the safety remote I/O module did not support was set.	For the communication period setting, set a value supported by the safety remote I/O module.
D025H ^{*1*2}	Minor error	Communication period setting error (CC-Link IE TSN Class B/100Mbps)	When the safety remote I/O module was operating with CC-Link IE TSN Class B and at a communication speed of 100Mbps, a communication cycle the safety remote I/O module did not support was set.	For the communication period setting, set a value supported by the safety remote I/O module.
D027H ^{*1*2}	Minor error	Communication period setting error (CC-Link IE TSN Class A)	When the safety remote I/O module was operating with CC-Link IE TSN Class A, a communication cycle the safety remote I/O module did not support was set.	For the communication period setting, set a value supported by the safety remote I/O module.

*1 This error occurs only once when an abnormality is detected.

*2 For these types of errors, more than one error may not occur at the same time. If errors occur, eliminate the cause of one error after another until a data link is established.

Point 

When multiple errors have occurred, only the latest error code is stored in Error code (RWr1). The errors that occurred before can be checked by executing "Error History" of the "CC-Link IE TSN/CC-Link IE Field Diagnostics" in the engineering tool. For the error history, refer to the following. However, when a moderate error occurs during a major error occurrence, the error code of the major error will remain in Error code. ( Page 119 Checking by using CC-Link IE TSN/CC-Link IE Field diagnostics)

Error codes related to CC-Link IE TSN safety communications

The CC-Link IE TSN safety communications error codes are shown below.

The ERR. LED does not turn on when an error related to CC-Link IE TSN safety communications occurs, the same as when a CC-Link IE TSN communication error occurs.

When a CC-Link IE TSN safety communications error occurs, the SAFETY LED turns off and the DATA LINK LED does not change.

List of error codes

Error code (hexadecimal)	Classification	Error name	Description and cause	Action
8400H	Communication error	Safety communication error	An error was detected in the safety communication with the master station.	<ul style="list-style-type: none"> Set module parameters and perform the safety module validation according to the parameter setting procedure. (☞ Page 61 Safety Communication Setting) When the parameter setting has no errors, there may be an influence from noise or a hardware failure. If the same error occurs again even after measures have been taken against noise, the module may be in failure. Please consult your local Mitsubishi representative.
8401H	Communication error	Safety communication disabled due to a communication interrupt	A communication interrupt has occurred on CC-Link IE TSN and safety communications stopped.	<ul style="list-style-type: none"> Check the network status using the CC-Link IE TSN/ CC-Link IE Field diagnostics of the engineering tool for errors. When no error has occurred on the network, there may be an influence from noise or a hardware failure. If the same error occurs again even after measures have been taken against noise, the module may be in failure. Please consult your local Mitsubishi representative.
8402H	Communication error	Safety communication connection being established Response monitoring timeout	Response monitoring timeout was detected while the safety connection was being established in the safety communication with the master station.	<ul style="list-style-type: none"> Correct "Transmission Interval Monitoring Time" of the module parameter as well as "Safety Communication Setting" of the master station. After that, refer to the following and set module parameters and perform the safety module validation according to the parameter setting procedure. (☞ Page 53 Parameter Setting)
8403H	Communication error	Safety communication being refreshed Response monitoring timeout	Response monitoring timeout was detected while the safety communication was being refreshed in the safety communication with the master station.	<ul style="list-style-type: none"> When the parameter setting has no errors, there may be an influence from noise or a hardware failure. If the same error occurs again even after measures have been taken against noise, the module may be in failure. Please consult your local Mitsubishi representative.
8404H	Communication error	Safety communication error in processing Response monitoring timeout	Response monitoring timeout was detected while a safety communication error was being processed in the safety communication with the master station.	
8405H	Communication error	Safety communication receiving interval monitoring timeout	Receiving interval monitoring timeout was detected in the safety communication with the master station.	
8406H	Communication error	Safety communication receive data delay detection	Unacceptable delay was detected in the analysis of the data received from the master station.	
8407H	Communication error	Safety communication receive data loss detection	A loss was detected in the analysis of the data received from the master station.	

APPENDICES

Appendix 1 Safety Remote I/O Signals

Safety remote I/O signals are dedicated for safety control and are assigned to the safety device of the master station. The following table shows the list of safety remote I/O signals for the master station.

Item	Description
Safety remote input (SAIX)	Safety input signals from the safety remote I/O module to the master station
Safety remote output (SAIY)	Safety output signals from the master station to the safety remote I/O module



For details on the safety device, refer to the following.

MELSEC iQ-R CPU Module User's Manual (Application)

List of safety remote I/O signals

Safety remote input (SAIX)		Safety remote output (SAIY)	
Signal direction: Safety remote I/O module → Master station		Signal direction: Master station → Safety remote I/O module	
Device number	Name	Device number	Name
SAIX0	Safety input signal X0	SAIY0	Safety output signal Y0
SAIX1	Safety input signal X1	SAIY1	Safety output signal Y1
SAIX2	Safety input signal X2	SAIY2	Safety output signal Y2
SAIX3	Safety input signal X3	SAIY3	Safety output signal Y3
SAIX4	Safety input signal X4	SAIY4	Use prohibited
SAIX5	Safety input signal X5	SAIY5	
SAIX6	Safety input signal X6	SAIY6	
SAIX7	Safety input signal X7	SAIY7	
SAIX8	Safety input signal X8	SAIY8	
SAIX9	Safety input signal X9	SAIY9	Fast logic start flag
SAIXA	Safety input signal XA	SAIYA	Use prohibited
SAIXB	Safety input signal XB	SAIYB	
SAIXC	Double input discrepancy state X0, X1	SAIYC	
SAIXD	Double input discrepancy state X2, X3	SAIYD	
SAIXE	Double input discrepancy state X4, X5	SAIYE	
SAIXF	Double input discrepancy state X6, X7	SAIYF	
SAIX10	Double input discrepancy state X8, X9	SAIY10	
SAIX11	Double input discrepancy state XA, XB	SAIY11	
SAIX12	Fast logic READY	SAIY12	
SAIX13	Fast logic initial completion flag	SAIY13	
SAIX14	Use prohibited	SAIY14	
SAIX15		SAIY15	
SAIX16	External output monitor Y0	SAIY16	
SAIX17	External output monitor Y1	SAIY17	
SAIX18	External output monitor Y2	SAIY18	
SAIX19	External output monitor Y3	SAIY19	
SAIX1A	Use prohibited	SAIY1A	
SAIX1B		SAIY1B	
SAIX1C		SAIY1C	
SAIX1D		SAIY1D	
SAIX1E		SAIY1E	
SAIX1F		SAIY1F	

Details of safety remote input signals

Safety input signals

■Device number

Name	Device number
Safety input signal X0 to XB	SAIX0 to SAIXB

■Description

These signals indicate the ON/OFF state of safety remote input (SAIX□) due to the external input signals (X□) of the safety remote I/O module.

However, depending on the settings of the double wiring function and input response time, the ON/OFF state of the safety input signals X□ (SAIX□) and that of the actual external input signals (X□) may differ. For details on the double wiring function, refer to the following.

☞ Page 67 Double wiring function

Point

When "Wiring selection of input" is set to "0: Not used", the corresponding safety input signal X□ (SAIX□) is fixed to OFF.

When the ON or OFF state of the safety input signal X□ (SAIX□) cannot be read, refer to the following.

☞ Page 113 When the ON/OFF status of a safety input cannot be read

Double input discrepancy state

■Device number

Name	Device number
Double input discrepancy state X0, X1	SAIXC to SAIX11
Double input discrepancy state X2, X3	
Double input discrepancy state X4, X5	
Double input discrepancy state X6, X7	
Double input discrepancy state X8, X9	
Double input discrepancy state XA, XB	

■Description

This area stores the double input discrepancy detection state. This area turns on when a double input discrepancy detection error has occurred in a pair of the corresponding input signals.

Fast logic READY

■Device number

Name	Device number
Fast logic READY	SAIX12

■Description

This flag indicates that the fast logic function is in the enabled state. The ON/OFF state of the fast logic function is indicated.

This signal turns ON when all the following conditions are met.

- In safety drive mode
- When "Fast logic pattern setting" is set to anything other than "0: Not used"
- When fast logic initial request flag (SAIY8) is operated
- When fast logic initial completion flag (SAIX13) is operated
- When fast logic start flag (SAIY9) is operated

Fast logic initial completion flag

■Device number

Name	Device number
Fast logic initial completion flag	SAIX13

■Description

This operation flag starts the fast logic function.

Turning on and off the fast logic initial request flag (SAIY8) in the safety drive mode turns on the fast logic initial completion flag (SAIX13). After that, turning on and off the fast logic start flag (SAIY9) turns off the fast logic initial completion flag (SAIX13), turns on the fast logic READY (SAIX12), and enables the fast logic function of the safety remote I/O module.

External output monitor

■Device number

Name	Device number
External output monitor Y0 to Y3	SAIX16 to SAIX19

■Description

These signals indicate the ON/OFF state of the external output signals (Y□).

The state of the fast logic output can be monitored by monitoring the external output signal (Y□).

Do not use external output monitor Y□ in a program that operates safety functions. If the signal is used, the correct operation of the safety remote I/O module safety functions is not guaranteed.

Details of safety remote output signals

Safety output signal

■Device number

Name	Device number
Safety output signal Y0 to Y3	SAIY0 to SAIY3

■Description

These signals turn on or off the external output signals (Y□) of the safety remote I/O module.

When the safety output wiring selection function setting or the fast logic function is enabled, the ON/OFF state of the safety output signal Y□ (SAIY□) and that of the actual external output signal (Y□) may differ. For details on each function, refer to the following.

☞ Page 71 Double wiring function

☞ Page 74 Fast logic function

If the safety output signal Y□ (SAI Y□) cannot be turned on, refer to the following.

☞ Page 113 When safety output cannot be turned on

Fast logic initial request flag

■Device number

Name	Device number
Fast logic initial request flag	SAIY8

■Description

This operation flag starts the fast logic function. For details on the operation, refer to the following.

☞ Page 132 Fast logic initial completion flag

Fast logic start flag

■Device number

Name	Device number
Fast logic start flag	SAIY9

■Description

This operation flag starts the fast logic function. For details on the operation, refer to the following.

☞ Page 132 Fast logic initial completion flag

Appendix 2 Remote Control/Monitor Signals

Remote control/monitor signals are used as external input signals for functions other than the safety functions of the safety remote I/O module. Do not use these signals in a program that operates the safety functions. If used, correct operation as the safety remote I/O module is not guaranteed.

The following table shows the list of the remote control/monitor signals for the master station.

Item	Description
Remote control/monitor input signal (RX)	Control/monitor signals from the safety remote I/O module to the master station
Remote control/monitor output signal (RY)	There are no control/monitor signals from the master station to the safety remote I/O module. Using any of RY signals is not allowed.

Point

- The external I/O signals are communicated to the master station using the safety remote I/O signals (SA\X and SA\Y).
- When "Link Stop" is performed using the CC-Link IE TSN/CC-Link IE Field diagnostics or the cyclic transmission is stopped from the link special relay (SB) or link special register (SW), the input status of the remote control/monitor input signal (RX) is retained. Thus, the status may be different from the actual status of the safety remote I/O module.

List of remote control/monitor signals

The following table lists the assignment of the remote control/monitor signals.

Remote control/monitor input signal (RX)		Remote control/monitor output signal (RY)	
Signal direction: Safety remote I/O module → Master station		Signal direction: Master station → Safety remote I/O module	
Device number	Name	Device number	Name
RX0 to RXF	External input signal	RY0 to RYF	Use prohibited

Details of remote control/monitor signals

External input signal

The following table lists the assignment of the external input signals.

Device number	Name
RX0	External input signal X0
RX1	External input signal X1
RX2	External input signal X2
RX3	External input signal X3
RX4	External input signal X4
RX5	External input signal X5
RX6	External input signal X6
RX7	External input signal X7
RX8	External input signal X8
RX9	External input signal X9
RXA	External input signal XA
RXB	External input signal XB
RXC to RXF	Use prohibited

Point

Do not read or write data from/to the use-prohibited areas. If data is read or written, the correct operation of the safety remote I/O module cannot be guaranteed.

■ External input signals (RX0 to RXB)

These signals are external input signals from the safety remote I/O module to the master station. These signals can be used only in the safety drive mode.

For details on the safety drive mode, refer to the following.

☞ Page 27 Operation mode and state transition

Point

When "Wiring selection of input" is not set to "2: Single", the corresponding external input signals (RX0 to RXB) are fixed to OFF.

Appendix 3 Remote Register

List of remote registers

This section lists remote registers for a master/local module.

The remote registers shown are example with the remote registers of the safety remote I/O module assigned to the RWr0 to RWr13 and RWw0 to RWw13.

Remote register (RWr)		Remote register (RWw)	
Signal direction: Safety remote I/O module → Master/local module		Signal direction: Master/local module → Safety remote I/O module	
Device number	Name	Device number	Name
RWr0	Module status area	RWw0 to RWw13	Use prohibited
RWr1	Error code area		
RWr2	External input monitor area		
RWr3	Parameter automatic setting status monitor area		
RWr4 to RWrF	Input dark test information area		
RWr10 to RWr13	Output dark test information area		

Point

Do not read or write data from/to the use-prohibited areas. If data is read or written, the correct operation of the safety remote I/O module cannot be guaranteed.

Details of remote registers

Module status area

■Device number

Name	Device number
Module status area	RWr0

■Description

The following table indicates the safety remote I/O module status.

b15	b14	b13	b12	b11	b10	b9	b8	b7	b6	b5	b4	b3	b2	b1	b0
Use prohibited				(5)	(4)	Use prohibited						(3)	(2)	(1)	

(1) Safety module enabled flag

(2) Communication speed

(3) CC-Link IE TSN Class setting status

(4) Error status flag

(5) Remote READY

■Safety module enabled flag (RWr0.b0)

The safety module enabled flag (RWr0.b0) turns on when the set parameters can be used in the safety drive mode. When the safety module enabled flag (RWr0.b0) is off, the mode cannot be switched to the safety drive mode.

For details on the safety drive mode, refer to the following.

☞ Page 27 Operation mode and state transition

Point

The safety module enabled flag (RWr0.b0) turns off when parameters are set or changed with the engineering tool, when the safety remote I/O module detects a parameter error, or when station parameters are changed. When "Safety module validation" is performed after the parameters have been set with the engineering tool, the safety module enabled flag turns on.

■Communication speed (RWr0.b1)

The communication speed (RWr0.b1) indicates a communication speed at which the safety remote I/O module is operating.

- On: 100Mbps
- Off: 1Gbps

■CC-Link IE TSN Class setting status (RWr0.b2)

The CC-Link IE TSN Class setting status (RWr0.b2) indicates the setting status of the CC-Link IE TSN Class. (👉 Page 36 Setting the Function Setting Switches)

- On: CC-Link IE TSN Class A
- Off: CC-Link IE TSN Class B

■Error status flag (RWr0.b10)

The error status flag (RWr0.b10) turns on when an error occurs.

- Minor error

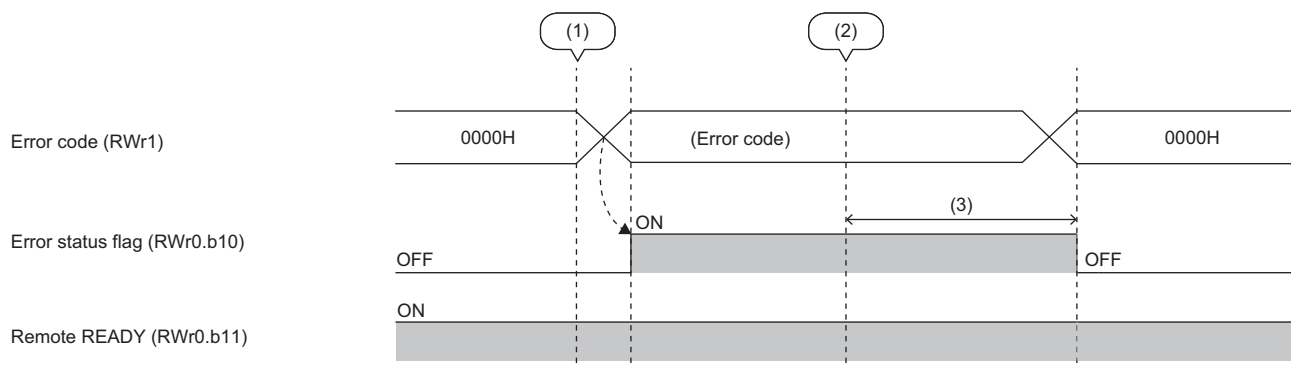

- (1) Minor error occurred
- (2) Minor error was eliminated
- (3) 5 seconds

-----> Implemented with the safety remote I/O module

- Moderate errors and major errors

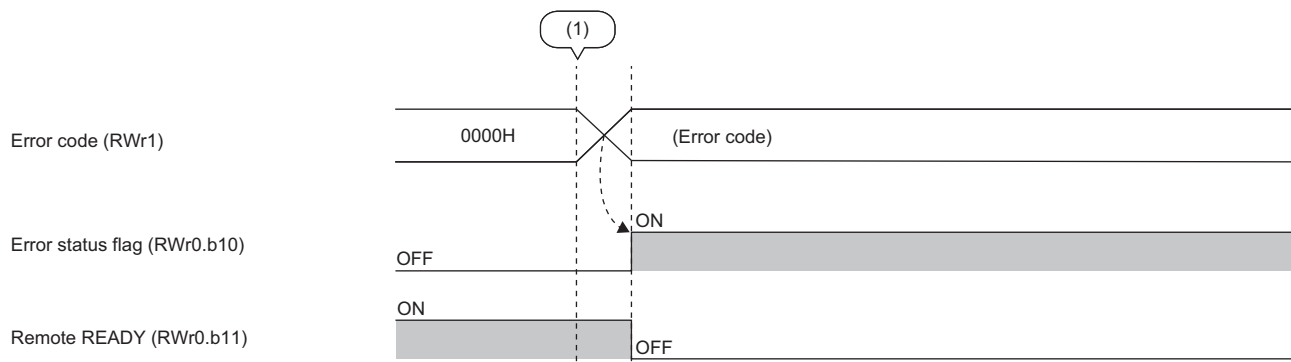

- (1) Moderate error or major error occurred

-----> Implemented with the safety remote I/O module



Point

- When a moderate error or major error occurs, recovery from the error status is not possible unless the error is cleared and the safety remote I/O module is restarted (by powering off and on the module or performing remote reset).
- When a minor error occurs, five seconds after the cause of the error is eliminated, the error code (RWr1) is automatically set to 0H and the error status flag (RWr0.b10) is turned off at the same time.

■Remote READY (RWr0.b11)

The operating status of the module can be checked. This flag is used as an interlock condition when the master station reads/writes data from/to the remote control/monitor signals or remote buffer memory areas of the safety remote I/O module.

- On: Available for module operation
- Off: Not available for module operation

When the initial processing is completed after the module power supply is powered on, Remote READY (RWr0.b11) turns on. This flag turns off when a moderate or major error occurs.

Error code area

■Device number

Name	Device number
Error code area	RWr1

■Description

The error code is stored in this area when an error occurs. ( Page 120 List of Error Codes)

Errors that occurred in the past can be checked in the error history. ( Page 118 Method for Checking Error Codes)

External input monitor area

■Device number

Name	Device number
External input monitor area	RWr2

■Description

The ON/OFF state of external input signals (X□) is indicated.

By monitoring the external input signals (X□), double discrepancy detection errors can be troubleshooted easily when they occur.

Use of b15 to b12 is prohibited.

External input monitor XB to external input monitor X0 are assigned to b11 to b0.

Parameter automatic setting status monitor area

■Device number

Name	Device number
Parameter automatic setting status monitor area	RWr3

■Description

This area stores the parameter automatic setting execution status. Details are provided below.

Parameter automatic setting execution status	Monitored value	Description
Not executed	0000H	Parameter automatic setting is not executed.
Completed successfully (non-volatile memory updated)	0002H	Parameter automatic setting was executed and completed successfully. The non-volatile memory is updated with the parameters for the parameter automatic setting.
Completed with an error	0003H	Parameter automatic setting was executed but completed with an error.
Completed successfully (non-volatile memory not updated)	0004H	Parameter automatic setting was executed and completed successfully. The non-volatile memory is not updated when parameter automatic setting is performed under the following conditions where parameter automatic setting is not required or cannot be performed. <ul style="list-style-type: none">• When the parameters stored in the non-volatile memory are the same as the parameters for the parameter automatic setting• When a non-volatile memory data error (parameter) has occurred

Input dark test information area

■Device number

Name	Device number
Input dark test information area X0 to XB	RWr4 to RWrF

■Description

The actual pulse width of test pulses that are output by the input dark test function is stored in increments of 100 μ s.

Output dark test information area

■Device number

Name	Device number
Output dark test information area Y0	RWr10
Output dark test information area Y1	RWr11
Output dark test information area Y2	RWr12
Output dark test information area Y3	RWr13

■Description

The actual pulse width of test pulses that are output by output dark test function is stored in increments of 100 μ s.

Appendix 4 Remote Buffer Memory

Remote buffer memory is divided into a parameter area, monitor area, and module control data area for each address.

The initial value is set in remote buffer memory at power-on or hardware reset.

Data can be read or written from/to remote buffer memory areas by using SLMP commands or dedicated instructions in the programs.

For details on SLMP, refer to the SLMP communication function. ( Page 100 SLMP Communication Function)

Point

Do not read/write data from/to a use prohibited area of remote buffer memory. If data is read or written, the correct operation of the safety remote I/O module cannot be guaranteed.

Remote buffer memory list

The remote buffer memory list of the safety remote I/O module is shown below.

The remote buffer memory of the safety remote I/O module is allocated as follows.

Remote buffer memory address		Area	Target
Decimal	Hexadecimal		
0 to 255	0000H to 00FFH	Parameter area	Parameter data per station
256 to 511	0100H to 01FFH		Parameter data per module
512 to 1279	0200H to 04FFH		Use prohibited
1280 to 2559	0500H to 09FFH	Monitoring area	Use prohibited
2560 to 5375	0A00H to 14FFH	Module control data area	Use prohibited
5376 to 65535	1500H to FFFFH	Use prohibited	

Point

Do not use SLMP commands as well as the REMFR instruction, REMFRIP instruction, REMTO instruction, REMTOIP instruction, and SLMPSND instruction of the dedicated instructions, to access the areas other than the above. Doing so causes a remote buffer memory access error (error code: 0201H), and the response to the SLMP command or dedicated instruction becomes an abnormal response.

- SLMP commands: An abnormal response is returned, with C05CH stored in the end code of that message.
- Dedicated instructions: The dedicated instruction is completed with an error, and 4041H is stored in the REMFR/REMTO instruction execution status of the link special register of the master station.

Parameter area

Parameters can be set in these areas using the parameter setting window of the engineering tool. Parameters cannot be set using the program.

If these parameters are changed, the safety module valid flag (RWr0.b0) turns OFF and the safety remote I/O module enters the standby mode.

For details on the standby mode, refer to the following.

 Page 27 Operation mode and state transition

Point

- Always use the engineering tool to set parameters.
- When a use-prohibited area is read from/written to, the dedicated instruction is completed successfully.

Parameter data per station

○: Enabled, ×: Disabled

Address		Name	Default value*1	Read	Write
Decimal	Hexadecimal				
0	0000H	Transmission interval monitoring time	35	○	○
1	0001H	I/O LED indication setting at error occurrence	0	○	○
2	0002H	Safety approval code	FFFFFFFFH	○	○
3	0003H				
4 to 255	0004H to 00FFH	Use prohibited	—	×	×

*1 This value is a factory default.

Parameter data per module

○: Enabled, ×: Disabled

Address		Name	Default value*1	Read	Write
Decimal	Hexadecimal				
256 to 271	0100H to 010FH	Use prohibited	—	×	×
272	0110H	Wiring selection of input X0	0000H	○	○
273	0111H	Wiring selection of input X1			
274	0112H	Wiring selection of input X2			
275	0113H	Wiring selection of input X3			
276	0114H	Wiring selection of input X4			
277	0115H	Wiring selection of input X5			
278	0116H	Wiring selection of input X6			
279	0117H	Wiring selection of input X7			
280	0118H	Wiring selection of input X8			
281	0119H	Wiring selection of input X9			
282	011AH	Wiring selection of input XA			
283	011BH	Wiring selection of input XB			
284 to 287	011CH to 011FH	Use prohibited			
288	0120H	Input response time X0	0003H	○	○
289	0121H	Input response time X1			
290	0122H	Input response time X2			
291	0123H	Input response time X3			
292	0124H	Input response time X4			
293	0125H	Input response time X5			
294	0126H	Input response time X6			
295	0127H	Input response time X7			
296	0128H	Input response time X8			
297	0129H	Input response time X9			
298	012AH	Input response time XA			
299	012BH	Input response time XB			

A

Address		Name	Default value*1	Read	Write
Decimal	Hexadecimal				
300 to 303	012CH to 012FH	Use prohibited	—	×	×
304	0130H	Double input discrepancy detection setting X0, X1	0000H	○	○
305	0131H	Double input discrepancy detection setting X2, X3			
306	0132H	Double input discrepancy detection setting X4, X5			
307	0133H	Double input discrepancy detection setting X6, X7			
308	0134H	Double input discrepancy detection setting X8, X9			
309	0135H	Double input discrepancy detection setting XA, XB			
310 to 319	0136H to 013FH	Use prohibited	—	×	×
320	0140H	Double input discrepancy auto recovery setting	0000H	○	○
321 to 335	0141H to 014FH	Use prohibited	—	×	×
336	0150H	Double input discrepancy detection time X0, X1	0001H	○	○
337	0151H	Double input discrepancy detection time X2, X3			
338	0152H	Double input discrepancy detection time X4, X5			
339	0153H	Double input discrepancy detection time X6, X7			
340	0154H	Double input discrepancy detection time X8, X9			
341	0155H	Double input discrepancy detection time XA, XB			
342 to 351	0156H to 015FH	Use prohibited	—	×	×
352	0160H	Input dark test execution setting X0	0000H	○	○
353	0161H	Input dark test execution setting X1			
354	0162H	Input dark test execution setting X2			
355	0163H	Input dark test execution setting X3			
356	0164H	Input dark test execution setting X4			
357	0165H	Input dark test execution setting X5			
358	0166H	Input dark test execution setting X6			
359	0167H	Input dark test execution setting X7			
360	0168H	Input dark test execution setting X8			
361	0169H	Input dark test execution setting X9			
362	016AH	Input dark test execution setting XA			
363	016BH	Input dark test execution setting XB			
364 to 367	016CH to 016FH	Use prohibited	—	×	×
368	0170H	Input dark test pulse OFF time setting	0000H	○	○
369	0171H	Number of pulse output for input dark test	0000H	○	○
370 to 383	0172H to 017FH	Use prohibited	—	×	×
384	0180H	Wiring selection of output Y0	0000H	○	○
385	0181H	Wiring selection of output Y1			
386	0182H	Wiring selection of output Y2			
387	0183H	Wiring selection of output Y3			
388 to 399	0184H to 018FH	Use prohibited	—	×	×
400	0190H	Output dark test execution setting Y0	0000H	○	○
401	0191H	Output dark test execution setting Y1			
402	0192H	Output dark test execution setting Y2			
403	0193H	Output dark test execution setting Y3			
404 to 415	0194H to 019FH	Use prohibited	—	×	×
416	01A0H	Output dark test pulse OFF time setting Y0	0000H	○	○
417	01A1H	Output dark test pulse OFF time setting Y1			
418	01A2H	Output dark test pulse OFF time setting Y2			
419	01A3H	Output dark test pulse OFF time setting Y3			
420 to 431	01A4H to 01AFH	Use prohibited	—	×	×
432	01B0H	Number of pulse output for output dark test Y0	0000H	○	○
433	01B1H	Number of pulse output for output dark test Y1			
434	01B2H	Number of pulse output for output dark test Y2			
435	01B3H	Number of pulse output for output dark test Y3			

Address		Name	Default value ^{*1}	Read	Write
Decimal	Hexadecimal				
436 to 463	01B4H to 01CFH	Use prohibited	—	×	×
464	01D0H	Fast logic pattern setting	0000H	○	○
465	01D1H	Fast logic interlock mode setting	0000H	○	○
466 to 511	01D2H to 01FFH	Use prohibited	—	×	×

*1 This value is a factory default.

Details of remote buffer memory areas

The remote buffer memory details of the safety remote I/O module are shown below.

Parameter data per station

■ Transmission interval monitoring time

Set the safety input data transmission interval time of the safety remote I/O module. This time is to be monitored by the master station.

Address (hexadecimal)	Name	Setting range	Default value
0000H	Transmission interval monitoring time	4 to 1000ms	35ms

Point

Set a value that meets all the following calculation formulas for the transmission interval monitoring time.

- $TM \geq SRref \times 2$
- $TM \geq SCmst \times 2 + LS \times 2$

SRref: Safety remote station refresh response processing time

TM: Transmission interval monitoring time

SCmst: Safety cycle time of the master station^{*1}

LS: Communication cycle interval^{*2}

TM: If the value of transmission interval monitoring time is exceeded the upper limit of the setting range, correct the values of SCmst: Safety cycle time of the master station and LS: Communication cycle interval. If "Communication Period Setting" is set to other than "Basic Period" in "Network Configuration Settings", multiply LS: Communication cycle interval by the multiple specified in "Multiple Period Setting" in "Communication Period Setting" in "Basic Setting". For the magnification, refer to the following.

 User's manual for the master station used

For the setting values of "Transmission Interval Monitoring Time" and "Safety Refresh Monitoring Time" for the master station, refer to the following.

 User's manual for the master station used

*1 For details on the safety cycle time, refer to the following.

 User's manual for the master station used

*2 For the communication cycle interval, refer to the following.

 User's manual for the master station used

■ I/O LED indication setting at error occurrence

Set whether the input and output points where an error is detected is indicated with an I/O LED.

Address (hexadecimal)	Name	Setting range	Default value
0001H	I/O LED indication setting at error occurrence	0b: No indication of error point 1b: Indication of error point	0b: No indication of error point

When "1: Indication of error point" is set, the I/O LED where an error occurs flashes.

The LED flashes with the following errors.

- Double input discrepancy detection error
- Input dark test error
- I/O data error
- Output read-back error
- Output dark test error

For the minor error from which the module can recover, the LED flashing stops when the error is cleared.

The value set in b1 to b15 will be ignored.

■ Safety approval code

Set a value that identifies the individual safety remote I/O module. Set a value that does not overlap with those of other safety remote I/O modules, such as a MAC address.*1

*1 When setting a MAC address, set the lower eight digits of the MAC address.

Address (hexadecimal)	Name	Setting range	Default value
0002H	Safety approval code (lower 16 bits)	00000000H to FFFFFFFFH	FFFFFFFH
0003H	Safety approval code (upper 16 bits)		

Parameter data per module

■Wiring selection of input

Set the input wiring method in units of 1 point.

Address (hexadecimal)	Name	Setting range	Default value
0110H to 011BH	Wiring selection of input X0 to XB	0: Not used 1: Double wiring (NC/NC) 2: Single	0: Not used

Point

- When "Wiring selection of input" X_n (n: even number) is set to "1: Double wiring (NC/NC)", X_{n+1}, the partner of X_n, is automatically set to "1: Double wiring (NC/NC)", and no other settings are possible.
- When "Wiring selection of input" X_n (n: even number) is set to "0: Not used" or "2: Single", set X_{n+1}, the partner of X_n, to a value other than "1: Double wiring (NC/NC)". When "1: Double wiring (NC/NC)" is set, a parameter data error (Wiring selection of input) (error code: 0560H) occurs when the parameters of the device station are written to the programmable controller.
- For unused input terminals, set "0: Not used" in "Wiring selection of input".
- When "Fast logic pattern setting" is set to other than "0: Not used", this parameter is ignored.

■Input response time

Set the input response time of the input signal in units of 1 point.

Address (hexadecimal)	Name	Setting range	Default value
0120H to 012BH	Input response time X0 to XB	0: 1.0ms 1: 1.5ms 2: 5ms 3: 10ms 4: 20ms 5: 50ms 6: 70ms	3: 10ms

Point

- Select a longer time than the input dark test pulse OFF time for the parameter. When "1: Do not perform" is selected for "Input dark test execution setting", a shorter time than the input dark test pulse OFF time can be set for the parameter.
- When "Wiring selection of input" is set to "0: Not used", this parameter is ignored.

■Double input discrepancy detection setting

Set whether to detect double input discrepancy in units of 2 points.

Address (hexadecimal)	Name	Setting range	Default value
0130H to 0135H	Double input discrepancy detection setting (X0, X1) to (XA, XB)	0: Detect 1: Do not detect	0: Detect

Point

- When "Wiring selection of input" is set to "0: Not used" or "2: Single", or when "Fast logic pattern setting" is set to "4: Pattern 4", this parameter is ignored.
- When "Fast logic pattern setting" is set to "2: Pattern 2" or "3: Pattern 3", double input discrepancy detection settings X6 and X7 are ignored.

■Double input discrepancy auto recovery setting

Set whether or not to use auto recovery when a double input discrepancy detection error occurs, on a module-by-module basis.

Address (hexadecimal)	Name	Setting range	Default value
0140H	Double input discrepancy auto recovery setting	0: Not used 1: Used	0: Not used

Point

When "0: Not used" or "2: Single" is selected in "Wiring selection of input" for all points, when "Fast logic pattern setting" is set to "4: Pattern 4", or when "Double input discrepancy detection setting" is set to "1: Do not detect", double input discrepancy detection errors do not occur and thus auto recovery is not performed.

■Double input discrepancy detection time

Set the double input discrepancy detection time in units of 2 points.

Address (hexadecimal)	Name	Setting range	Default value
0150H to 0155H	Double input discrepancy detection time (X0, X1) to (XA, XB)	1 to 6000 (×10ms)	1 (×10ms)

Point

- When "Wiring selection of input" is set to "0: Not used" or "2: Single", when "Fast logic pattern setting" is set to "4: Pattern 4", or when "Double input discrepancy detection setting" is set to "1: Do not detect", this parameter is ignored.
- When "Fast logic pattern setting" is set to "2: Pattern 2" or "3: Pattern 3", double input discrepancy detection times X6 and X7 are ignored.

■Input dark test execution setting

Set whether to perform the input dark test function of the diagnostic function in the safety remote I/O module in units of 1 point.

Address (hexadecimal)	Name	Setting range	Default value
0160H to 016BH	Input dark test execution setting X0 to XB	0: Perform 1: Do not perform	0: Perform

Point

When "Wiring selection of input" is set to "0: Not used", this parameter is ignored.

■Input dark test pulse OFF time setting

Set the width of the OFF pulses that the terminals T0 to TB output, on a module-by-module basis.

Address (hexadecimal)	Name	Setting range	Default value
0170H	Input dark test pulse OFF time	0: 400 μ s 1: 1ms 2: 2ms	0: 400 μ s

Point

When "Wiring selection of input" is set to "0: Not used" or when "Input dark test execution setting" is set to "1: Do not perform", this parameter is ignored.

■Number of pulse output for input dark test

Set the number of pulse output for input dark test on a module-by-module basis.

Address (hexadecimal)	Name	Setting range	Default value
0171H	Number of pulse output for input dark test	0: 1 time 1: 2 times 2: 3 times	0: 1 time

Point

When "Wiring selection of input" is set to "0: Not used" or when "Input dark test execution setting" is set to "1: Do not perform", this parameter is ignored.

■Wiring selection of output

Set the wiring selection of output in units of 1 point.

Address (hexadecimal)	Name	Setting range	Default value
0180H to 0183H	Wiring selection of output Y0 to Y3	0: Not used 1: Double wiring (Source/Source) 2: Single	0: Not used

Point

- When "Wiring selection of output" Y_n (n: even number) is set to "1: Double wiring (Source/Source)", only "1: Double wiring (Source/Source)" can be set for Y_{n+1}. Outputting ON of a pair of outputs turns on the output signal.
- For unused output terminals, set "0: Not used" in "Wiring selection of output".
- When Y_n (n: even number) in "Wiring selection of output" is set to "0: Not used" or "2: Single", set a value other than "1: Double wiring (Source/Source)" for Y_{n+1}.
- When "Fast logic pattern setting" is set to other than "0: Not used", this parameter is ignored.

■Output dark test execution setting

Set whether to perform the output dark test function of the diagnostic function in the safety remote I/O module in units of 1 point.

Address (hexadecimal)	Name	Setting range	Default value
0190H to 0193H	Output dark test execution setting Y0 to Y3	0: Perform 1: Do not perform	0: Perform

Point

When "Wiring selection of output" is set to "0: Not used", the points that are set to "0: Not used" ignore this setting value.

■Output dark test pulse OFF time setting

Set the width of OFF pulses used for an output dark test in units of 1 point.

Address (hexadecimal)	Name	Setting range	Default value
01A0H to 01A3H	Output dark test pulse OFF time setting Y0 to Y3	0: 400 μ s 1: 1ms 2: 2ms	0: 400 μ s

Point

When "Wiring selection of output" is set to "0: Not used" or "Output dark test execution setting" is set to "1: Do not perform", the points with those settings ignore this setting value.

■Number of pulse output for output dark test

Set the number of pulse output for output dark test in units of 1 point.

Address (hexadecimal)	Name	Setting range	Default value
01B0H to 01B3H	Number of pulse output for output dark test Y0 to Y3	0: 1 time 1: 2 times 2: 3 times	0: 1 time

Point

When "Wiring selection of output" is set to "0: Not used" or "Output dark test execution setting" is set to "1: Do not perform", the points with those settings ignore this setting value.

■Fast logic pattern setting

Set the logic patterns for the fast logic function.

Address (hexadecimal)	Name	Setting range	Default value
01D0H	Fast logic pattern setting	0: Not used 1: Pattern 1 2: Pattern 2 3: Pattern 3 4: Pattern 4	0: Not used

Point

When "Fast logic pattern setting" is set to "0: Not used", the fast logic function is disabled.

■Fast logic interlock mode setting

When the fast logic function is enabled, set whether to perform output point interlock when the output is turned off.

Address (hexadecimal)	Name	Setting range	Default value
01D1H	Fast logic interlock mode setting	0: Enable 1: Disable	0: Enable

Point

When "Fast logic pattern setting" is set to "0: Not used", this parameter is ignored.

Appendix 5 EMC and Low Voltage Directives

In each country, laws and regulations concerning electromagnetic compatibility (EMC) and electrical safety are enacted. For the products sold in the European countries, compliance with the EU's EMC Directive has been a legal obligation as EMC regulation since 1996, as well as the EU's Low Voltage Directive as electrical safety regulation since 1997.

Manufacturers who recognize their products are compliant with the EMC and Low Voltage Directives are required to attach a "CE marking" on their products in European countries.

In some other countries and regions, manufacturers are required to make their products compliant with applicable laws or regulations and attach a certification mark on the products as well. (such as UK Conformity Assessed (UKCA) marking in the UK, and Korea Certification (KC) marking in South Korea)

Each country works to make their regulatory requirements consistent across countries based on international standards.

When the requirements are consistent, measures to comply with the EMC and electrical safety regulations become common across countries.

The UK and South Korea have enacted EMC regulations whose requirements are consistent with those of the EMC Directive. The UK has also enacted electrical safety regulations whose requirements are consistent with those of the Low Voltage Directive. In this section, the requirements of the EMC and Low Voltage Directives are described as examples of those of the EMC and electrical safety regulations.

Measures to comply with the EMC Directive

The EMC Directive specifies that "products placed on the market must be so constructed that they do not cause excessive electromagnetic interference (emissions) and are not unduly affected by electromagnetic interference (immunity)".

This section summarizes the precautions on compliance with the EMC Directive of the machinery constructed with the module.

These precautions are based on the requirements and the standards of the regulation, however, it does not guarantee that the entire machinery constructed according to the descriptions will comply with abovementioned directives.

The method and judgment for complying with the EMC Directive must be determined by the person who constructs the entire machinery.

EMC Directive related standards

■Emission requirements

Specifications	Test item	Test description	Value of standard
EN 61131-2: 2007	CISPR16-2-3 Radiated emission*2	The electromagnetic waves emitted by the product are measured.	<ul style="list-style-type: none">• 30 to 230MHz QP: 40dBμV/m (measured at 10m distance)*1• 230 to 1000MHz QP: 47dBμV/m (measured at 10m distance)
	CISPR16-2-1, CISPR16-1-2 Conducted emission*2	The level of the noise which the product emits to the power supply line is measured.	<ul style="list-style-type: none">• 0.15 to 0.5MHz QP: 79dB, Mean: 66dB*1• 0.5 to 30MHz QP: 73dB, Mean: 60dB

*1 QP: Quasi-Peak value, Mean: Average value

*2 The tests were conducted with the module installed outside a control panel.

■ Immunity requirements

Specifications	Test item	Test description	Value of standard
EN 61131-2: 2007	EN 61000-4-2 Electrostatic discharge immunity ^{*1}	Static electricity is applied to the cabinet of the equipment.	<ul style="list-style-type: none"> • 8kV air discharge • 4kV contact discharge
	EN 61000-4-3 Radiated, radio-frequency electromagnetic field immunity ^{*1}	Electric fields are radiated to the product.	80% AM modulation@1kHz <ul style="list-style-type: none"> • 80 to 1000MHz: 10V/m • 1.4 to 2.0GHz: 3V/m • 2.0 to 2.7GHz: 1V/m
	EN 61000-4-4 Fast transient burst immunity ^{*1}	Burst noise is applied to the power lines and signal lines.	<ul style="list-style-type: none"> • AC/DC main power, I/O power, AC I/O (unshielded): 2kV • DC I/O, analog, communication: 1kV
	EN 61000-4-5 Surge immunity ^{*1}	A lightning surge is applied to the power lines and signal lines.	<ul style="list-style-type: none"> • AC power line, AC I/O power, AC I/O (unshielded): 2kV CM, 1kV DM • DC power line, DC I/O power: 0.5kV CM, DM • DC I/O, AC I/O (shielded), analog^{*2}, and communication lines: 1kV CM
	EN 61000-4-6 Conducted RF immunity ^{*1}	High frequency noise is applied to the power lines and signal lines.	0.15 to 80MHz, 80% AM modulation @1kHz, 10Vrms
	EN 61000-4-8 Power-frequency magnetic field immunity ^{*1}	The product is installed in an inductive magnetic field.	50Hz/60Hz, 30A/m
	EN 61000-4-11 Voltage dips and interruption immunity ^{*1}	A momentary power failure is caused to the power supply voltage.	<ul style="list-style-type: none"> • Apply at 0%, 0.5 cycles, and zero-cross point • 0%, 250/300 cycles (50/60Hz) • 40%, 10/12 cycles (50/60Hz) • 70%, 25/30 cycles (50/60Hz)

*1 The tests were conducted with the module installed outside a control panel.

*2 The accuracy of an analog-digital converter module may temporarily vary within $\pm 10\%$.

Installation in a control panel

The module is an open type device and must be installed inside a control panel.

This ensures safety as well as effective shielding of module-generated electromagnetic noise.

Note that, however, when the conditions described in the general specifications are satisfied, the module can be used outside a control panel as well. (☞ Page 20 General Specifications)

■ Control panel

- Use a conductive control panel.
- When securing the top or bottom plate using bolts, cover the grounding part on the control panel so that the part will not be painted.
- To ensure electrical contact between the inner plate and control panel, take measures such as covering the bolts so that conductivity can be ensured in the largest possible area.
- Ground the control panel with a thick ground cable so that low impedance can be ensured even at high frequencies.
- Holes in the control panel must be 10cm diameter or less. If the holes are larger than 10cm in diameter, radio waves may leak. In addition, because radio waves leak through a clearance between the control panel and its door, reduce the clearance as much as possible. The leakage of radio waves can be suppressed by the direct application of an EMI gasket on the paint surface.

Our tests have been carried out on a control panel having the damping characteristics of 37dB (max.) and 30dB (mean) (measured by 3m method, 30 to 300MHz).

■ Wiring of power cables and ground cables

Near the power supply part, provide a ground point to the control panel. Ground the FG terminal with the thickest and shortest possible ground cable (30cm or shorter).

A

Cables

Use shielded cables for the cables which are connected to the module and run out from the control panel. If a shielded cable is not used or not grounded correctly, the noise immunity will not meet the value of standard.

■Network cable

A shielded cable is used for the network cable. Strip a part of the jacket as shown below and ground the exposed shield in the largest possible area.

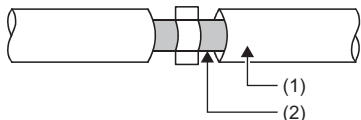

- (1) Network cable
- (2) Shield

■Grounding the cable clamp

Use shielded cables for external wiring and ground the shields of the external wiring cables to the control panel with the AD75CK cable clamp (manufactured by Mitsubishi Electric). (Ground the shield section 20 to 30cm away from the module.)

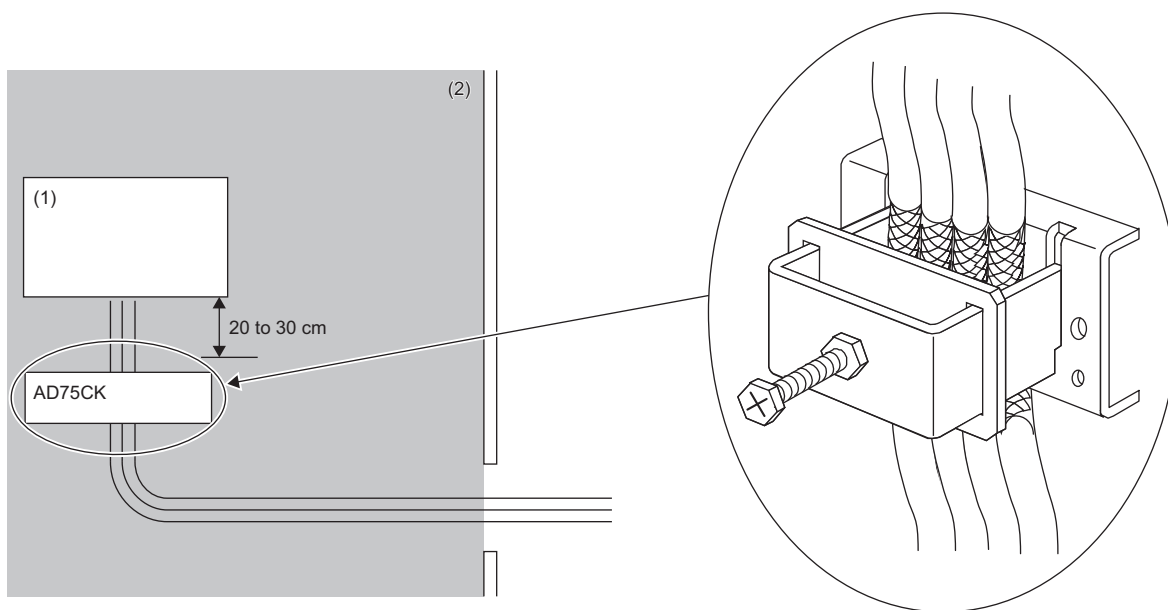

- (1) Module
- (2) Inside the control panel

For detail on AD75CK, refer to the following.

📖 AD75CK Cable Clamping Instruction Manual

External power supply

- For the external power supply for the module power supply and external power supply, use an AC/DC power supply adapter.
- Use a CE-marked product for an external power supply and always ground the FG terminal. (External power supply used for the tests conducted by Mitsubishi: TDK-Lambda Corporation DRJ240-24-1)
- Use a power cable of 10m or shorter when connecting it to the module power supply terminal.
- Use a power cable of 30m or shorter when connecting it to the external power supply for output part.

Others

■ Ferrite core

A ferrite core is effective for reducing radiated noise in the 30MHz to 100MHz frequency band.

It is recommended to install a ferrite core if a shielded cable extended out of the control panel does not provide sufficient shielding effects.

Note that the ferrite cores must be attached at the position closest to the cable hole inside the control panel. If attached at an improper position, the ferrite core will not produce any effect.

Install a ferrite core to each power cable as shown below.

- Ferrite core used for the tests conducted by Mitsubishi: ESD-SR-250 (manufactured by TOKIN Corporation), ZCAT3035-1330 (manufactured by TDK Corporation)

Ex.

Ferrite core attachment example

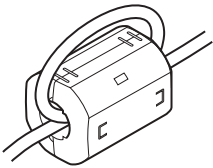

■ Noise filter (power supply line filter)

A noise filter is a component which has an effect on conducted noise. Attaching the filter can suppress more noise. (The noise filter has the effect of reducing conducted noise of 10MHz or less.)

Connect a noise filter to the external power supply of the safety remote I/O module.

The precautions for attaching a noise filter are described below.

- Do not bundle the cables on the input side and output side of the noise filter. If bundled, the output side noise will be induced into the input side cables from which the noise was filtered.

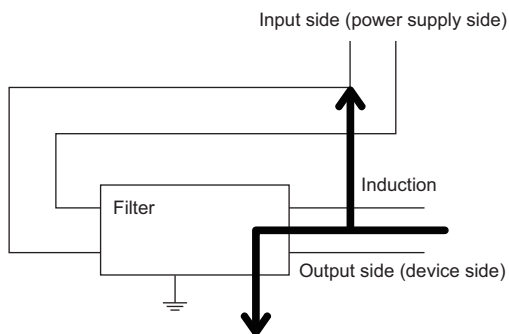

- Example of problem

Noise is induced when the input and output cables are bundled.

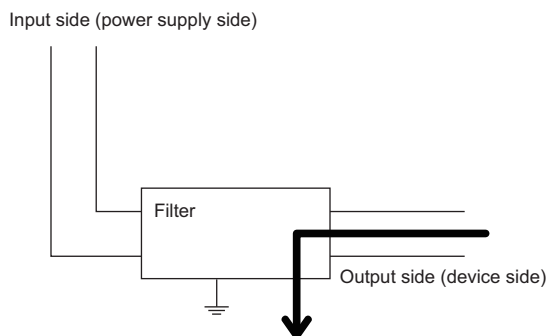

- Example of improvement

Install the input and output cables separately.

- Ground the noise filter grounding terminal to the control panel with the shortest cable possible (approx. 10cm).

A

■AC surge protective device

An AC surge protective device absorbs a lightning surge on a path for an alternating current to protect electronic devices from being damaged by the surge. When it is probable that a common-mode surge exceeding the voltage of "Value of standard \pm 2kV" will occur in the installation environment, connect the AC surge protective device.

Point 

Before using the AC surge protective device, check its specifications and precautions on using it by referring to manuals relevant to the device.

Requirements for Low Voltage Directive compliance

Module

The module operates at the rated voltage of 24VDC. The Low Voltage Directive is not applied to the modules that operate at the rated voltage of less than 50VAC and 75VDC.

External wiring

■24VDC external power supply

To connect to the module, use the power supply that meets the following conditions:

- SELV (Safety Extra Low Voltage): Product with reinforced insulation from the hazardous potential part (60V or higher)
- LVD applicable product
- 24VDC (ripple ratio: 5% or less) (allowable voltage range: 20.4 to 28.8VDC)

■External devices

For external devices connected to a module, use the one of which insulation between the interface circuit section to the module and the hazardous voltage circuit section is reinforced (if the device internally has a hazardous voltage circuit section).

■Reinforced insulation

The reinforced insulation covers the withstand voltages shown in the table below.

Rated voltage of hazardous voltage	Surge voltage withstand (1.2/50 μ s)
150VAC or less	2500V
300VAC or less	4000V

Measures to comply with the Machinery Directive

The Machinery Directive (2006/42/EC) requires that machinery satisfy the three pillars of safety: mechanical safety, electrical safety, and worker safety.

This product complies with the Machinery Directive (2006/42/EC). Before using this product, please read this manual, the relevant manuals, the manuals for standard programmable controller, and the safety standards carefully and pay full attention to safety to handle the product correctly.

The descriptions are based on the requirements of the Machinery Directive and the harmonized standards. However, they do not guarantee that the entire machinery constructed according to the descriptions complies with the Machinery Directive. The manufacturer of the machinery must determine the testing method for compliance and declare conformity to the Machinery Directive.

Specifications	Test item	Test description	Value of standard
IEC 61326-3-1: 2017	IEC 61000-4-2 IEC 61326-3-1 Electrostatic discharge immunity ^{*1}	Static electricity is applied to the cabinet of the equipment.	8kV contact discharge
	IEC 61000-4-3 IEC 61326-3-1 Radiated, radio-frequency electromagnetic field immunity ^{*1}	Electric fields are radiated to the product.	80% AM modulation@1kHz • 80 to 1000MHz: 20V/m • 1.4 to 2.0GHz: 10V/m • 2.0 to 6.0GHz: 3V/m • 84.000, 137 to 174, 219.500, 380 to 400, 420 to 470, 698 to 960MHz: 20V/m • 1.24 to 1.30, 1.428 to 2.0GHz: 10V/m • 2.0 to 2.7, 3.3 to 3.6, 5.15 to 5.925GHz: 3V/m
	IEC 61000-4-4 IEC 61326-3-1 Fast transient burst immunity ^{*1}	Burst noise is applied to the power lines and signal lines.	• AC main power, DC main power, DC I/O: 3kV • I/O, communication: 2kV
	IEC 61000-4-5 IEC 61326-3-1 Surge immunity ^{*1}	A lightning surge is applied to the power lines and signal lines.	• AC main power, AC/DC main power: 4kV • DC I/O, I/O, communication: 2kV
	IEC 61000-4-6 IEC 61326-3-1 Conducted RF immunity ^{*1}	High frequency noise is applied to the power lines and signal lines.	80% AM modulation @1kHz, • 0.15 to 80MHz: 20V • 3.39, 6.780, 13.560, 27.120, 40.680MHz: 20V
	IEC 61000-4-11 IEC 61326-3-1 Voltage dips and interruption immunity ^{*1}	A momentary power failure is caused to the power supply voltage.	• Apply at 0%, 1 cycle, and zero-cross point • 0%, 250/300 cycles (50/60Hz) • 40%, 10/12 cycles (50/60Hz) • 70%, 25/30 cycles (50/60Hz)
	IEC 61326-3-1 IEC 61000-4-6-16 Conducted common-mode voltage immunity ^{*1}	Common-mode noise is applied to the power lines and signal lines.	• 1.5 to 15kHz: 1 to 10V • 15 to 150kHz: 10V • 16.7, 50, 60, 150, 180Hz: 10V (continuously) • 16.7, 50, 60Hz: For short period of time (1s)

*1 The module is an open type device (a device designed to be housed in other equipment) and must be installed inside a conductive control panel. The tests were conducted with the module installed in a control panel.

Precautions for use of safety programmable controller

Users must prove that their entire safety system complies with the safety standards and the Machinery Directive. The third-party certification organization will validate the safety of product for the entire safety system, including a safety programmable controller and safety components.

■ Target failure measure (PFDavg/PFH) calculation

To establish a safety system, calculate the target failure measure (PFDavg/PFH) for each safety application (safety function) based on the PFDavg/PFH values of the safety programmable controller and connected safety components. The target failure measure (PFDavg/PFH) is the reliability target value for each Safety Integrity Level (SIL) defined in IEC 61508 and can be calculated by the following formula.

$PFD_{avg}/PFH = A + B + C + D + \dots$ Calculation formula of PFDavg/PFH

Variable	Definition
A*1	PFDavg/PFH of safety CPU modules
B	PFDavg/PFH of safety remote I/O modules (1) When safety input device(s) and safety output device(s) are connected to the same safety remote I/O module: $B = B1$ (2) When safety input device(s) and safety output device(s) are connected to different safety remote I/O modules: $B = B1 + B2$
B1	PFDavg/PFH of the safety remote I/O module to which safety input device(s) is connected
B2	PFDavg/PFH of the safety remote I/O module to which safety output device(s) is connected
C*1	PFDavg/PFH of safety input device(s)
D*1	PFDavg/PFH of safety output device(s)

*1 For the values of PFDavg/PFH, refer to the manuals for the safety components used.

The following table lists the PFDavg/PFH of safety remote I/O modules.

PFDavg	PFH(/h)*2
5.85×10^{-6}	3.10×10^{-9}

*2 Proof test interval is 5 years.

■ PL evaluation described in ISO 13849-1

For the PL evaluation described in ISO 13849-1, use the $MTTF_D$ (mean time to dangerous failure) and the DCavg (average diagnostic coverage) listed in the following table.

$MTTF_D$	DCavg
909	98.3

Appendix 6 How to Check Production Information and Firmware Version

Checking the production information

The production information of a safety remote I/O module can be checked with the following.

- Rating plate
- CC-Link IE TSN/CC-Link IE Field Diagnostics

Checking on the rating plate

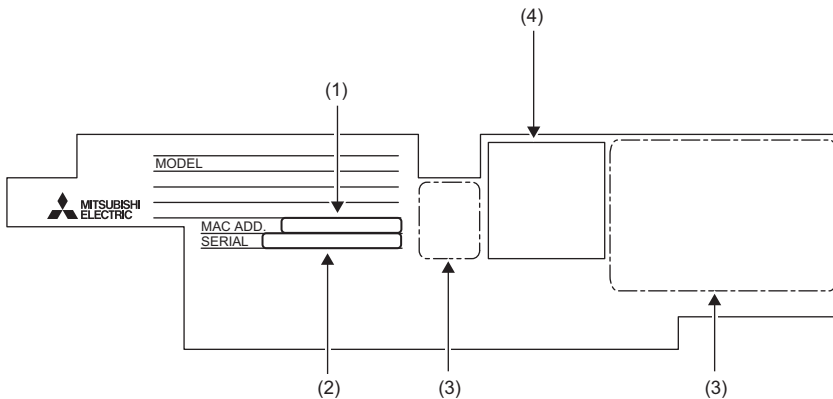

- (1) MAC address
- (2) Production information
- (3) Relevant standard symbol
- (4) QR code

Checking by using CC-Link IE TSN/CC-Link IE Field diagnostics

■Checking by each safety remote I/O module

The production information of each safety remote I/O module can be checked by following the procedure below.

Operating procedure

1. Connect the engineering tool to the CPU module.
2. Start CC-Link IE TSN/CC-Link IE Field diagnostics from the menu.
🔗 [Diagnostics] ⇒ [CC-Link IE TSN/CC-Link IE Field Diagnostics]
3. Right-click the device station whose production information to display, and select "Production Information".
4. The production information appears.

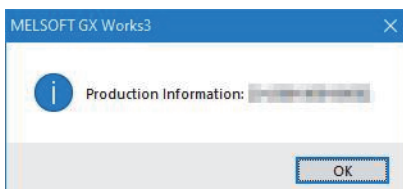

■Checking with the "Station Information List" window

For how to check the production information, refer to the following.

🔗 Page 106 Checking station information

Checking the firmware version

The firmware version of a safety remote I/O module can be checked on the "Station Information List" window. For how to check the firmware version, refer to the following.

 Page 106 Checking station information

Point

For a module on which a firmware update has not been performed yet, the firmware version can be checked with the production information. (The first two digits of production information show the firmware version.)

( Page 158 Checking the production information)

Appendix 7 External Dimensions

The external dimensions of the safety remote I/O module are shown below.

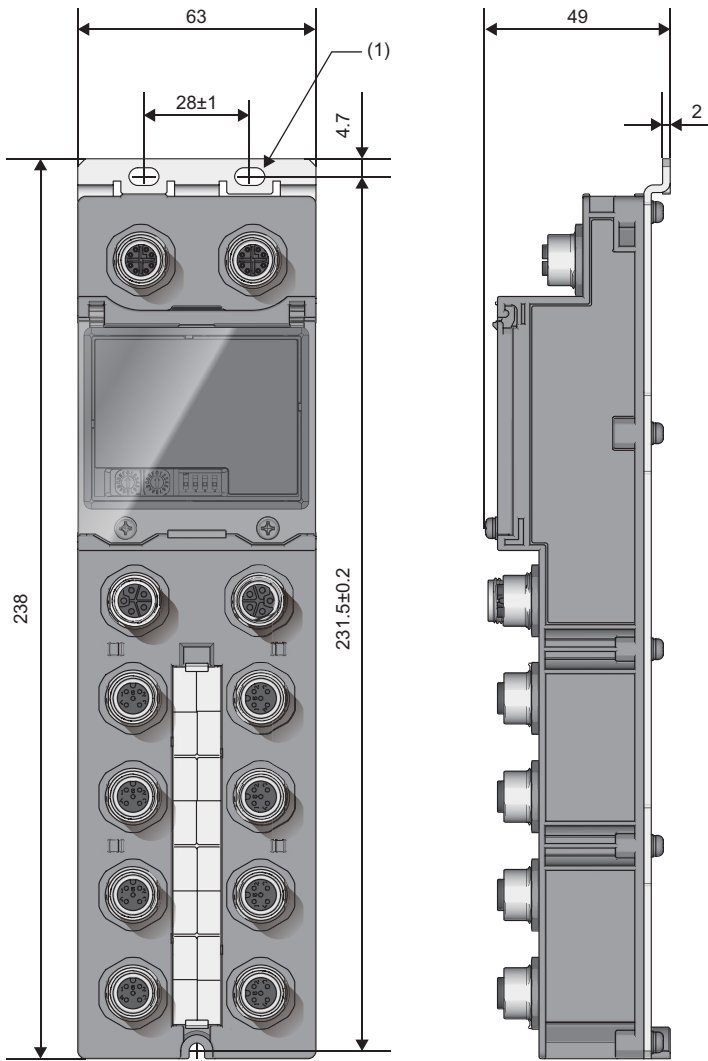

(1) 2 × 4.5×8 slotted hole (M4 mounting screw)
(Unit: mm)

INDEX

A

- Applicable master station 30
- Applicable profile 30

C

- Compatible software package 30
- Compatible software version 30

D

- DATA LINK LED 17
- Double input discrepancy auto recovery function 88
- Double input discrepancy state 131

E

- ERR. LED 17
- Error code area 138
- Error status flag (RWr0.b10) 137
- Ethernet cable 31
- External input monitor area 138
- External input signal monitor function 69
- External input signals (RX0 to RXB) 135
- External output monitor 132
- External power supply overcurrent protection 98
- External power supply overvoltage protection 98

F

- Fast logic initial completion flag 132
- Fast logic initial request flag 133
- Fast logic READY 132
- Fast logic start flag 133

I

- I/O PW LED 18
- Installation direction 39
- Installation environment 38
- Installation position 38
- IP address/station number setting switch 18

M

- Measures to comply with the EMC Directive 150
- Measures to comply with the Machinery Directive 156
- Module power supply overcurrent protection 98
- Module power supply overvoltage protection 98
- Module status area 136

O

- Operation mode and state transition 27

P

- Parameter area 141
- Parameter automatic setting status monitor area 138
- Parameter data per module 146
- Parameter data per station 144
- Precautions for wiring the safety remote I/O module to safety devices 45
- PW LED 17

R

- Requirements for Low Voltage Directive compliance 155
- RUN LED 17

S

- Safety input signals 131
- SAFETY LED 17
- Safety module enabled flag (RWr0.b0) 136,137
- Safety output signal 133
- Switching hub 31

MEMO

REVISIONS

*The manual number is given on the bottom left of the back cover.

Revision date	*Manual number	Description
August 2022	SH(NA)-082466ENG-A	First edition
October 2023	SH(NA)-082466ENG-B	■Added or modified parts SAFETY PRECAUTIONS, TERMS, GENERIC TERMS AND ABBREVIATIONS, Chapter 4, Section 7.2, 7.3, 8.1, 8.2, 8.3, 8.4, 8.5, 8.8, 10.1, 10.2, 10.6, 10.7, Appendix 4, 6

Japanese manual number: SH-082465-B

This manual confers no industrial property rights or any rights of any other kind, nor does it confer any patent licenses. Mitsubishi Electric Corporation cannot be held responsible for any problems involving industrial property rights which may occur as a result of using the contents noted in this manual.

© 2022 MITSUBISHI ELECTRIC CORPORATION

WARRANTY

Please confirm the following product warranty details before using this product.

1. Limited Warranty and Product Support.

- a. Mitsubishi Electric Company ("MELCO") warrants that for a period of eighteen (18) months after date of delivery from the point of manufacture or one year from date of Customer's purchase, whichever is less, Mitsubishi MELSEC Safety programmable logic controllers (the "Products") will be free from defects in material and workmanship.
- b. At MELCO's option, for those Products MELCO determines are not as warranted, MELCO shall either repair or replace them or issue a credit or return the purchase price paid for them.
- c. For this warranty to apply:
 - (1) Customer shall give MELCO (i) notice of a warranty claim to MELCO and the authorized dealer or distributor from whom the Products were purchased, (ii) the notice shall describe in reasonable details the warranty problem, (iii) the notice shall be provided promptly and in no event later than thirty (30) days after the Customer knows or has reason to believe that Products are not as warranted, and (iv) in any event, the notice must be given within the warranty period;
 - (2) Customer shall cooperate with MELCO and MELCO's representatives in MELCO's investigation of the warranty claim, including preserving evidence of the claim and its causes, meaningfully responding to MELCO's questions and investigation of the problem, grant MELCO access to witnesses, personnel, documents, physical evidence and records concerning the warranty problem, and allow MELCO to examine and test the Products in question onsite or at the premises where they are installed or used; and
 - (3) If MELCO requests, Customer shall remove Products it claims are defective and ship them to MELCO or MELCO's authorized representative for examination and, if found defective, for repair or replacement. The costs of removal, shipment to and from MELCO's designated examination point, and reinstallation of repaired or replaced Products shall be at Customer's expense.
 - (4) If Customer requests and MELCO agrees to effect repairs onsite at any domestic or overseas location, the Customer will pay for the costs of sending repair personnel and shipping parts. MELCO is not responsible for any re-commissioning, maintenance, or testing on-site that involves repairs or replacing of the Products.
- d. Repairs of Products located outside of Japan are accepted by MELCO's local authorized service facility centers ("FA Centers"). Terms and conditions on which each FA Center offers repair services for Products that are out of warranty or not covered by MELCO's limited warranty may vary.
- e. Subject to availability of spare parts, MELCO will offer Product repair services for (7) years after each Product model or line is discontinued, at MELCO's or its FA Centers' rates and charges and standard terms in effect at the time of repair. MELCO usually produces and retains sufficient spare parts for repairs of its Products for a period of seven (7) years after production is discontinued.
- f. MELCO generally announces discontinuation of Products through MELCO's Technical Bulletins. Products discontinued and repair parts for them may not be available after their production is discontinued.

2. Limits of Warranties.

- a. MELCO does not warrant or guarantee the design, specify, manufacture, construction or installation of the materials, construction criteria, functionality, use, properties or other characteristics of the equipment, systems, or production lines into which the Products may be incorporated, including any safety, fail-safe and shut down systems using the Products.
- b. MELCO is not responsible for determining the suitability of the Products for their intended purpose and use, including determining if the Products provide appropriate safety margins and redundancies for the applications, equipment or systems into which they are incorporated.
- c. Customer acknowledges that qualified and experienced personnel are required to determine the suitability, application, design, construction and proper installation and integration of the Products. MELCO does not supply such personnel.
- d. MELCO is not responsible for designing and conducting tests to determine that the Product functions appropriately and meets application standards and requirements as installed or incorporated into the end-user's equipment, production lines or systems.
- e. MELCO does not warrant any Product:
 - (1) repaired or altered by persons other than MELCO or its authorized engineers or FA Centers;
 - (2) subjected to negligence, carelessness, accident, misuse, or damage;
 - (3) improperly stored, handled, installed or maintained;
 - (4) integrated or used in connection with improperly designed, incompatible or defective hardware or software;
 - (5) that fails because consumable parts such as batteries, backlights, or fuses were not tested, serviced or replaced;
 - (6) operated or used with equipment, production lines or systems that do not meet applicable and commensurate legal, safety and industry-accepted standards;
 - (7) operated or used in abnormal applications;
 - (8) installed, operated or used in contravention of instructions, precautions or warnings contained in MELCO's user, instruction and/or safety manuals, technical bulletins and guidelines for the Products;
 - (9) used with obsolete technologies or technologies not fully tested and widely accepted and in use at the time of the Product's manufacture;
 - (10) subjected to excessive heat or moisture, abnormal voltages, shock, excessive vibration, physical damage or other improper environment; or
 - (11) damaged or malfunctioning due to Acts of God, fires, acts of vandals, criminals or terrorists, communication or power failures, or any other cause or failure that results from circumstances beyond MELCO's control.
- f. All Product information and specifications contained on MELCO's website and in catalogs, manuals, or technical information materials provided by MELCO are subject to change without prior notice.

- g. The Product information and statements contained on MELCO's website and in catalogs, manuals, technical bulletins or other materials provided by MELCO are provided as a guide for Customer's use. They do not constitute warranties and are not incorporated in the contract of sale for the Products.
- h. These terms and conditions constitute the entire agreement between Customer and MELCO with respect to warranties, remedies and damages and supersede any other understandings, whether written or oral, between the parties. Customer expressly acknowledges that any representations or statements made by MELCO or others concerning the Products outside these terms are not part of the basis of the bargain between the parties and are not factored into the pricing of the Products.
- i. THE WARRANTIES AND REMEDIES SET FORTH IN THESE TERMS ARE THE EXCLUSIVE AND ONLY WARRANTIES AND REMEDIES THAT APPLY TO THE PRODUCTS.
- j. MELCO DISCLAIMS THE IMPLIED WARRANTIES OF MERCHANTABILITY AND FITNESS FOR A PARTICULAR PURPOSE.

3. Limits on Damages.

- a. MELCO'S MAXIMUM CUMULATIVE LIABILITY BASED ON ANY CLAIMS FOR BREACH OF WARRANTY OR CONTRACT, NEGLIGENCE, STRICT TORT LIABILITY OR OTHER THEORIES OF RECOVERY REGARDING THE SALE, REPAIR, REPLACEMENT, DELIVERY, PERFORMANCE, CONDITION, SUITABILITY, COMPLIANCE, OR OTHER ASPECTS OF THE PRODUCTS OR THEIR SALE, INSTALLATION OR USE SHALL BE LIMITED TO THE PRICE PAID FOR PRODUCTS NOT AS WARRANTED.
- b. Although MELCO has obtained the certification for Product's compliance to the international safety standards IEC61508 and ISO13849-1 from TUV Rheinland, this fact does not guarantee that Product will be free from any malfunction or failure. The user of this Product shall comply with any and all applicable safety standard, regulation or law and take appropriate safety measures for the system in which the Product is installed or used and shall take the second or third safety measures other than the Product. MELCO is not liable for damages that could have been prevented by compliance with any applicable safety standard, regulation or law.
- c. MELCO prohibits the use of Products with or in any application involving power plants, trains, railway systems, airplanes, airline operations, other transportation systems, amusement equipments, hospitals, medical care, dialysis and life support facilities or equipment, incineration and fuel devices, handling of nuclear or hazardous materials or chemicals, mining and drilling, and other applications where the level of risk to human life, health or property are elevated.
- d. MELCO SHALL NOT BE LIABLE FOR SPECIAL, INCIDENTAL, CONSEQUENTIAL, INDIRECT OR PUNITIVE DAMAGES, FOR LOSS OF PROFITS, SALES, OR REVENUE, FOR INCREASED LABOR OR OVERHEAD COSTS, FOR DOWNTIME OR LOSS OF PRODUCTION, FOR COST OVERRUNS, OR FOR ENVIRONMENTAL OR POLLUTION DAMAGES OR CLEAN-UP COSTS, WHETHER THE LOSS IS BASED ON CLAIMS FOR BREACH OF CONTRACT OR WARRANTY, VIOLATION OF STATUTE, NEGLIGENCE OR OTHER TORT, STRICT LIABILITY OR OTHERWISE.
- e. In the event that any damages which are asserted against MELCO arising out of or relating to the Products or defects in them, consist of personal injury, wrongful death and/or physical property damages as well as damages of a pecuniary nature, the disclaimers and limitations contained in these terms shall apply to all three types of damages to the fullest extent permitted by law. If, however, the personal injury, wrongful death and/or physical property damages cannot be disclaimed or limited by law or public policy to the extent provided by these terms, then in any such event the disclaimer of and limitations on pecuniary or economic consequential and incidental damages shall nevertheless be enforceable to the fullest extent allowed by law.
- f. In no event shall any cause of action arising out of breach of warranty or otherwise concerning the Products be brought by Customer more than one year after the cause of action accrues.
- g. Each of the limitations on remedies and damages set forth in these terms is separate and independently enforceable, notwithstanding the unenforceability or failure of essential purpose of any warranty, undertaking, damage limitation, other provision of these terms or other terms comprising the contract of sale between Customer and MELCO.

4. Delivery/Force Majeure.

- a. Any delivery date for the Products acknowledged by MELCO is an estimated and not a promised date. MELCO will make all reasonable efforts to meet the delivery schedule set forth in Customer's order or the purchase contract but shall not be liable for failure to do so.
- b. Products stored at the request of Customer or because Customer refuses or delays shipment shall be at the risk and expense of Customer.
- c. MELCO shall not be liable for any damage to or loss of the Products or any delay in or failure to deliver, service, repair or replace the Products arising from shortage of raw materials, failure of suppliers to make timely delivery, labor difficulties of any kind, earthquake, fire, windstorm, flood, theft, criminal or terrorist acts, war, embargoes, governmental acts or rulings, loss or damage or delays in carriage, acts of God, vandals or any other circumstances reasonably beyond MELCO's control.

5. Choice of Law/Jurisdiction.

These terms and any agreement or contract between Customer and MELCO shall be governed by the laws of the State of New York without regard to conflicts of laws. To the extent any action or dispute is not arbitrated, the parties consent to the exclusive jurisdiction and venue of the federal and state courts located in the Southern District of the State of New York. Any judgment there obtained may be enforced in any court of competent jurisdiction.

6. Arbitration.

Any controversy or claim arising out of, or relating to or in connection with the Products, their sale or use or these terms, shall be settled by arbitration conducted in accordance with the Center for Public Resources (CPR) Rules for Non-Administered Arbitration of International Disputes, by a sole arbitrator chosen from the CPR's panels of distinguished neutrals. Judgment upon the award rendered by the Arbitrator shall be final and binding and may be entered by any court having jurisdiction thereof. The place of the arbitration shall be New York City, New York. The language of the arbitration shall be English. The neutral organization designated to perform the functions specified in Rule 6 and Rules 7.7(b), 7.8 and 7.9 shall be the CPR.

TRADEMARKS

QR Code is either a registered trademark or a trademark of DENSO WAVE INCORPORATED in the United States, Japan, and/or other countries.

The company names, system names and product names mentioned in this manual are either registered trademarks or trademarks of their respective companies.

In some cases, trademark symbols such as [™] or [®] are not specified in this manual.

SH(NA)-082466ENG-B(2310)MEE

MODEL: CCIETSN-WSIO-U-E

MODEL CODE: 13JX6A

MITSUBISHI ELECTRIC CORPORATION

HEAD OFFICE : TOKYO BUILDING, 2-7-3 MARUNOUCHI, CHIYODA-KU, TOKYO 100-8310, JAPAN
NAGOYA WORKS : 1-14, YADA-MINAMI 5-CHOME, HIGASHI-KU, NAGOYA, JAPAN

When exported from Japan, this manual does not require application to the
Ministry of Economy, Trade and Industry for service transaction permission.

Specifications subject to change without notice.