

FACTORY AUTOMATION

CC-Link IE TSN Product Catalog



CC-Link **IE** **TSN**



Automating the World



Our Factory Automation business is focused on "Automating the World" to make it a better, more sustainable environment supporting manufacturing and society, celebrating diversity and contributing towards an active and fulfilling role.

Mitsubishi Electric is involved in many areas including the following:

Energy and Electric Systems

A wide range of power and electrical products from generators to large-scale displays.

Electronic Devices

A wide portfolio of cutting-edge semiconductor devices for systems and products.

Home Appliance

Dependable consumer products like air conditioners and home entertainment systems.

Information and Communication Systems

Commercial and consumer-centric equipment, products and systems.

Industrial Automation Systems

Maximizing productivity and efficiency with cutting-edge automation technology.



The Mitsubishi Electric Group is actively solving social issues, such as decarbonization and labor shortages, by providing production sites with energy-saving equipment and solutions that utilize automation systems, thereby helping towards a sustainable society.

Committed to ever-higher customer satisfaction

Mitsubishi Electric is a global leader in researching, manufacturing and marketing electrical and electronic equipment used in areas such as communications, consumer electronics, industrial technology, energy and transportation. Within this, the industrial automation business has grown significantly since the first induction motor was manufactured over 90 years ago and has closely followed the automation industry in Japan, Asia, and beyond. Mitsubishi Electric industrial automation boasts a wide range of product areas such as production control, drives, and mechatronics that are used in various industries. The company also offers e-F@ctory and iQ Platform, leveraging its total industrial automation solution portfolio.



Realizing a smart factory with an open integrated network

Creating a smart factory requires the real-time collection of shop floor data, utilizing edge-computing devices to enable point-of-origin processing, and instantaneously feeding back results to the processing machine, cloud or other IT systems. This must all be done over a robust, high-speed network having a large-capacity data bandwidth capable of transmitting large volumes of data seamlessly across the factory while maintaining deterministic control of all systems. Mitsubishi Electric products provide the interconnectivity required for entire factories to realize IIoT*1 infrastructures, simultaneously improving productivity and quality while reducing overall cost.

*1. IIoT: Industrial Internet of Things

Contents

Features.....	8
System configuration	16
Master stations	18
Drives/GOT (HMI).....	20
Block-type remote modules	23
Managed Ethernet switches/bridge modules.....	33
Partner products	34
Development kits/communication software.....	35
General specifications	37
Support	42
Product list	46

The contents described in this catalog include features that will be supported in the future. Specifications may change without prior notice.

e-F@ctory

Maximize productivity and reduce costs with an intelligent smart factory solution

Intelligent smart factories utilize high-speed networks with large data bandwidths to meet current manufacturing needs. The combination of CC-Link IE TSN and Mitsubishi Electric's e-F@ctory solution ensures robust integration between IT and factory automation systems, providing an intelligent smart factory solution that reduces total cost while improving operations, production yield, and efficient management of the supply chain. e-F@ctory is the Mitsubishi Electric solution for adding value across the manufacturing enterprise by enhancing productivity, thereby simultaneously reducing maintenance and operating costs, and enabling the seamless flow of information throughout the plant. e-F@ctory uses a combination of factory automation and IT technologies in combination with various best-in-class partner products through its alliance program.

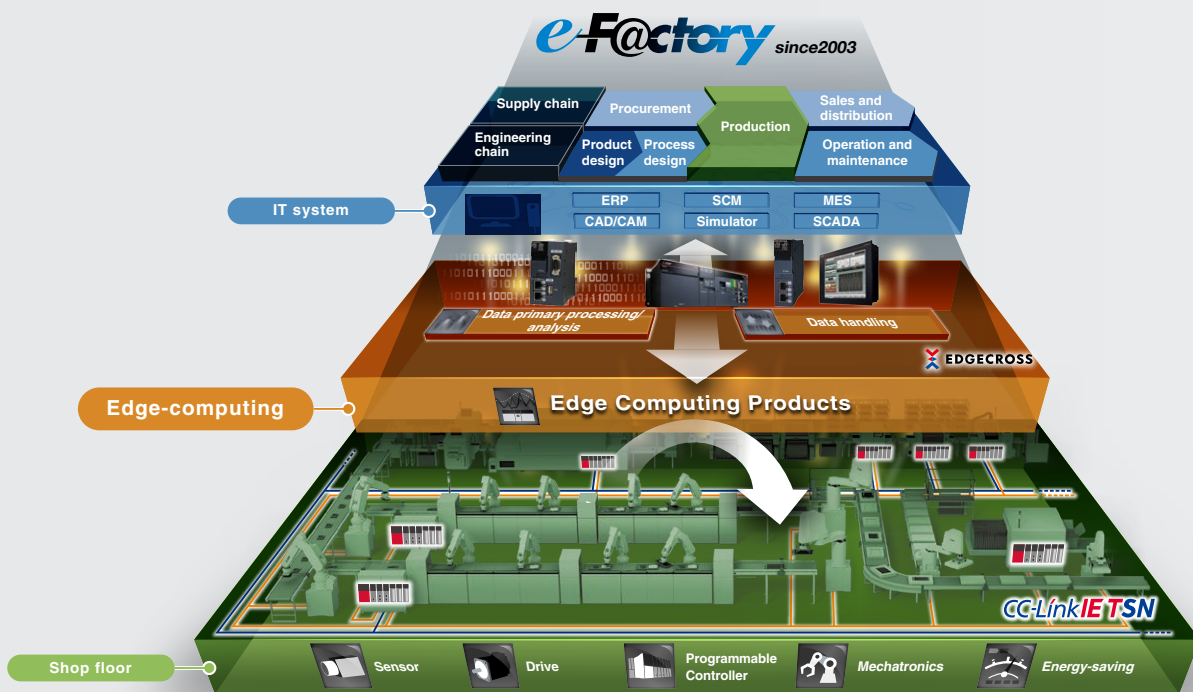

e-F@ctory

CC-Link IE TSN

- IT integration
- Open technology

- High speed, Time synchronization
- Network integration

MELSEC iQ-R

GOT2000

MELSEC iQ-F

MELFA FR

MELSERVO-J5

FREQROL-A800/E800

MITSUBISHIELECTRIC
CNC C80

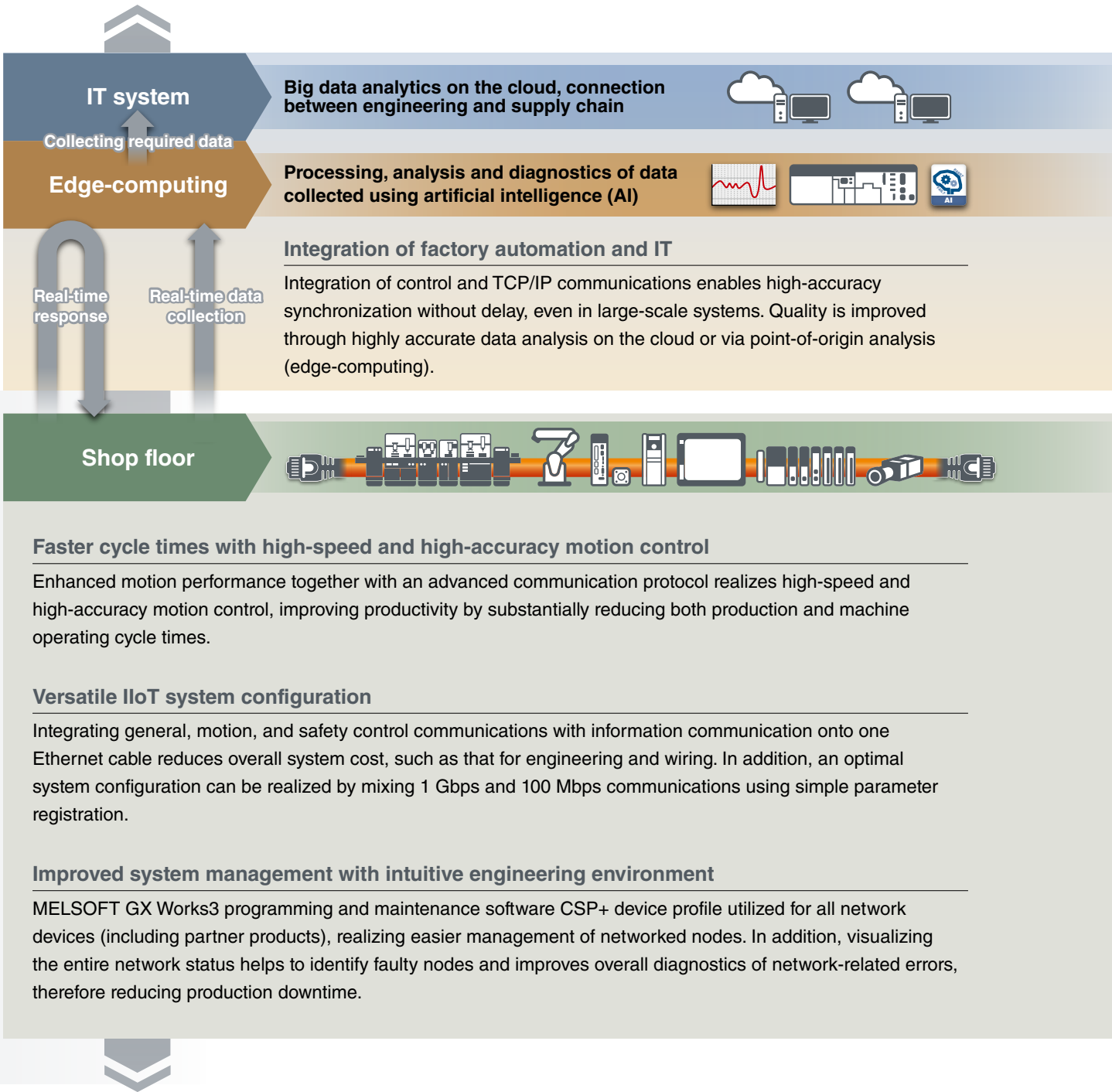

Open integrated networking across the manufacturing enterprise

Leveraging an integrated and open network utilizing TSN*1 technology realizes real-time data collection from the shop floor to IT systems

CC-Link IE TSN supports TCP/IP communications and applies it to industrial architectures through its support of TSN enabling real-time communications. With its flexible system architecture and extensive setup and troubleshooting features make CC-Link IE TSN ideal for building an IIoT infrastructure across the manufacturing enterprise.

*1. TSN: Time Sensitive Networking

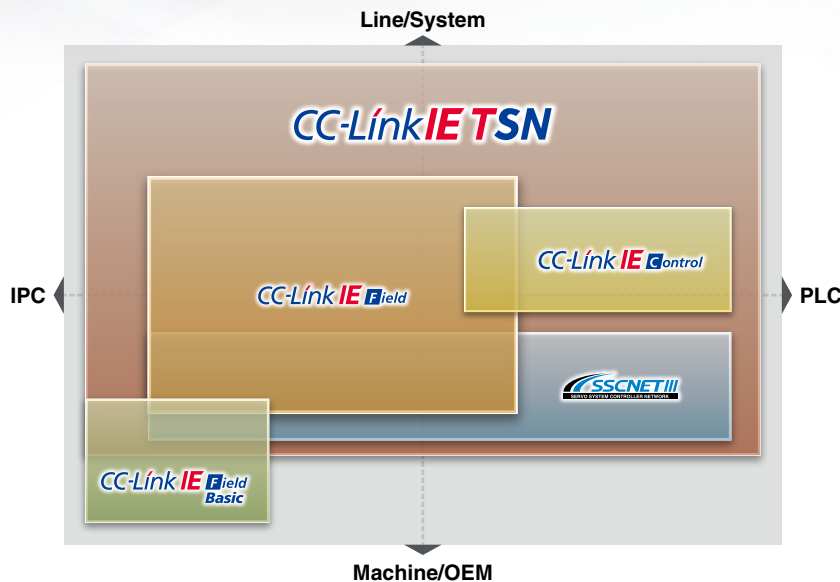
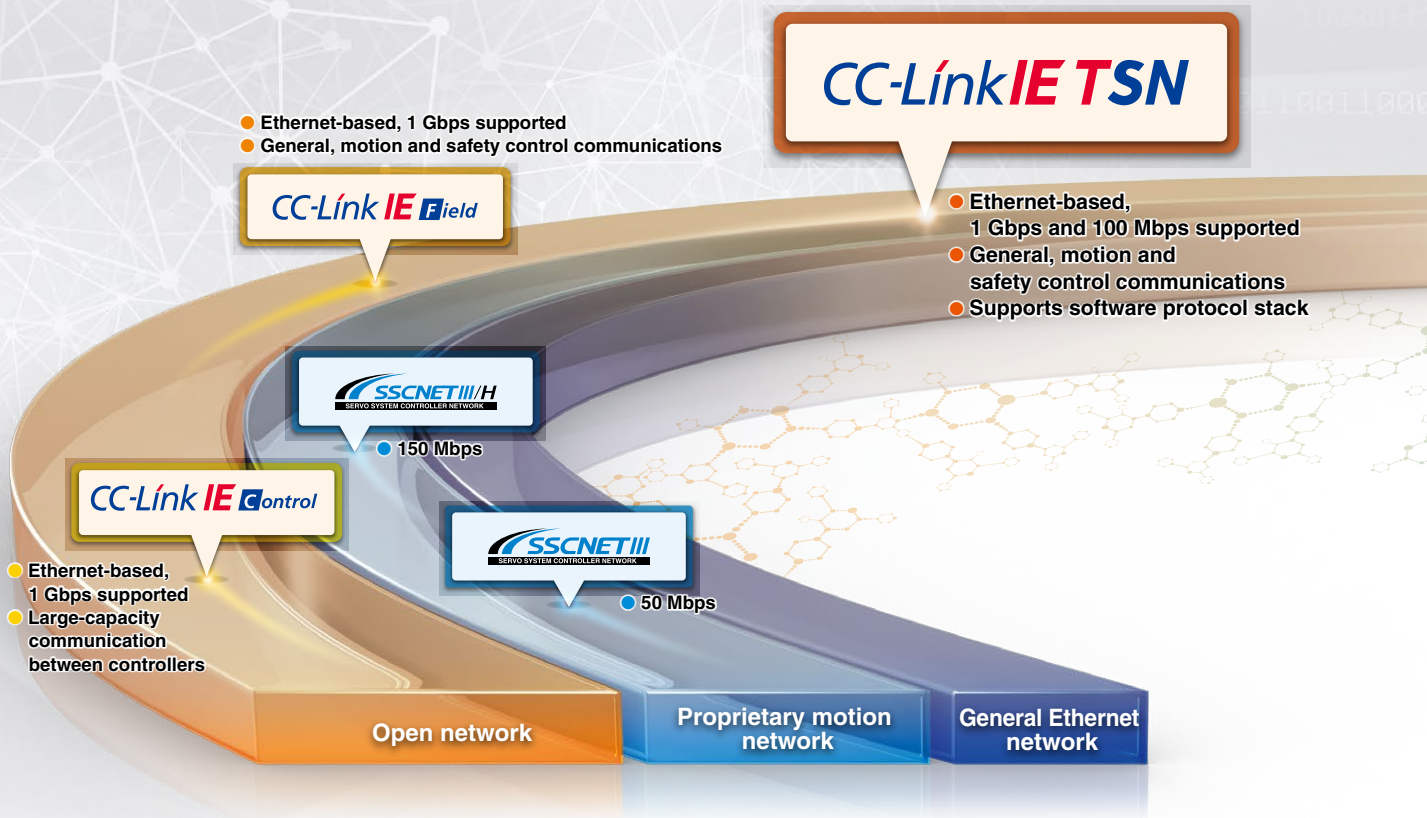

CC-Link IE TSN is an open industrial network inheriting the easy diagnostics of the CC-Link IE Field Network, the large-capacity data communications of the CC-Link IE Control Network, and the high-performance motion control features of SSCNET. Through the incorporation of TSN technology, this network further leverages control system performance to realize an open integrated network with advanced functionality.



CC-Link IE TSN
"IIoT system" movie



CC-Link IE TSN
"Integrated motion" movie

What is Time-Sensitive Networking (TSN)?

TSN is the IEEE-defined standard technology that enables deterministic messaging on standard Ethernet. The technology ensures deterministic communications by utilizing the time synchronization method (IEEE 802.1AS) and time-sharing method (IEEE 802.1Qbv). With the addition of these standards to Ethernet technology, real-time control communication and non-real time information communication can be mixed, which is not possible with conventional Ethernet communications.

TSN Technology : Features utilizing TSN technology

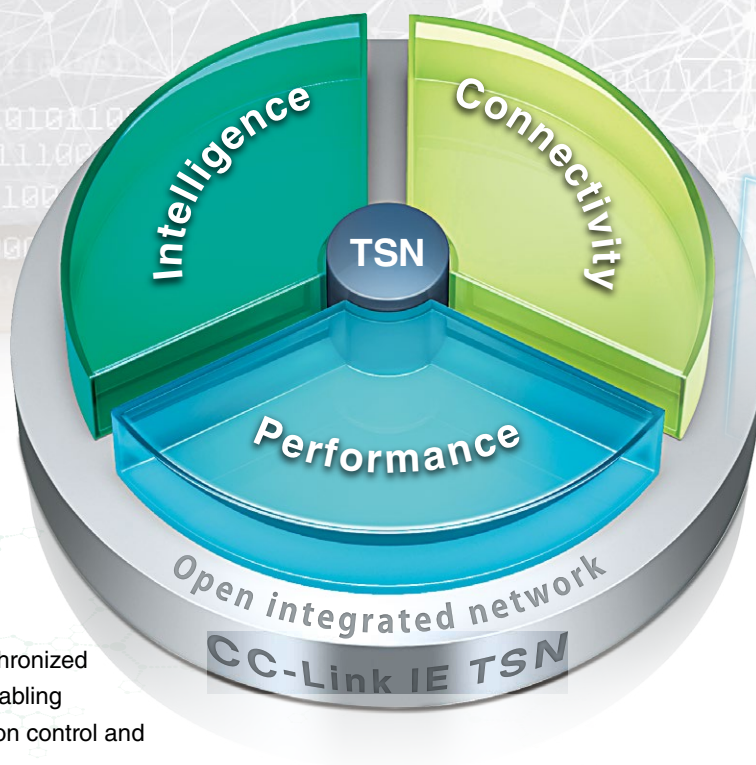

Real-time and synchronized communications enabling high-accuracy motion control and event processing

Performance

Current manufacturing trends are utilizing AI and predictive maintenance to ensure high productivity and quality are achieved simultaneously. This requires high-speed communication and deterministic control of large volumes of data to IT systems. The innovative communication technology of CC-Link IE TSN increases communication performance, enables high-accuracy motion control and high-speed I/O control without adversely affecting operating performance.

Intelligence

Intelligent networks that support industrial communications to realize easy device setup and preventive maintenance are essential for efficient operations. CC-Link IE TSN supports third-party diagnostic software, enabling troubleshooting of network devices (including standard Ethernet). Network event errors are time-stamped, enabling the actual cause of error to be easily evaluated. In addition, automatic generation of network system architectures and parameters simplifies commissioning.

Connectivity

CC-Link IE TSN is the key to realizing real-time communication in manufacturing systems utilizing TCP/IP-compatible Ethernet-based networks. It also enables third-party networks and standard Ethernet devices such as vision sensors and wireless routers to be integrated, and has multiple topology possibilities in support of highly scalable and flexible system architectures.



Performance

Reducing overall operating time with high-speed link scan

Min. communication cycle **31.25 μ s^{*1}** High-speed processing **16^{*2} x** faster Link points **2^{*3} x**

The advanced protocol built into CC-Link IE TSN is complemented by the time-sharing method functionality that enables simultaneous communications between network stations. This realizes fast communication cycle time of just 31.25 μ s^{*1} and high-speed processing 16 times faster than current network performance, resulting in high-speed and highly accurate motion control. Productivity is simultaneously improved owing to a substantial increase in control performance, which reduces overall operating time and enables high-speed and large capacity data communication.

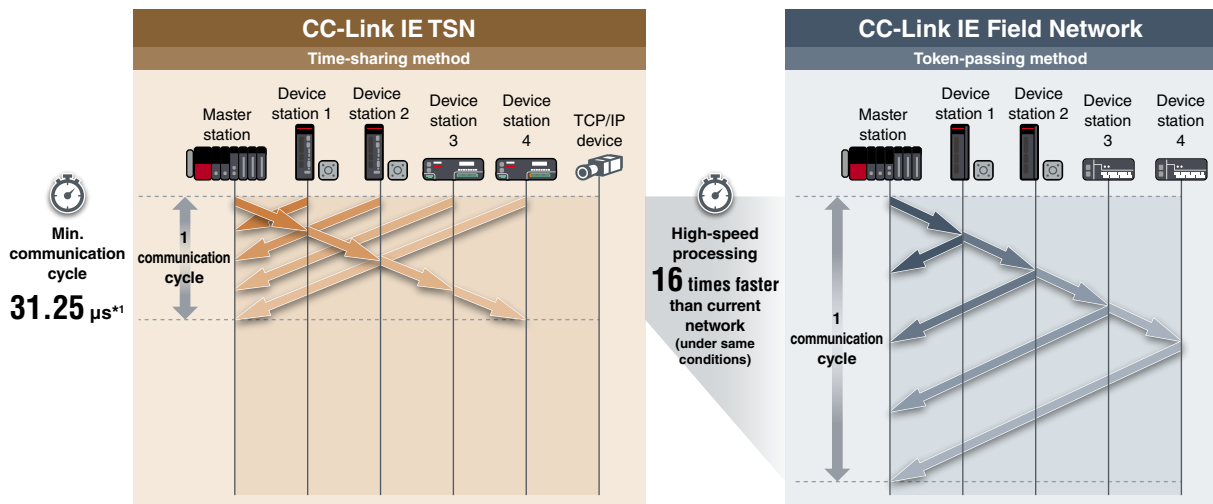

Deterministic control even when mixed with TCP/IP communication TSN Technology

Deterministic performance of cyclic communication is maintained even when mixed with slower information data (non real-time). This enables TCP/IP communication devices to be used without affecting overall control.

* Some devices cannot be connected to CC-Link IE TSN depending on the system configuration.

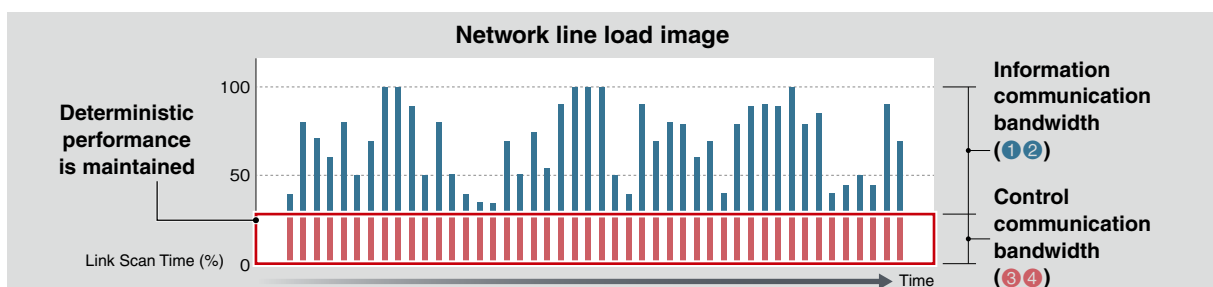
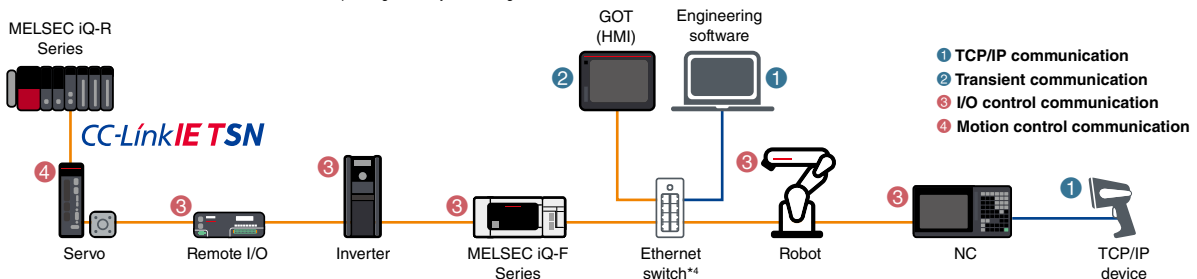

*1. This value is achieved when fast operation mode of the motion module (RD78GH) is used. For details, please refer to the "MELSEC iQ-R Motion Module User's Manual (Application) (IB-0300411EN)".
 *2. Comparison with CC-Link IE Field Network Motion
 *3. Comparison with CC-Link IE Field Network
 *4. Class B managed Ethernet switch supporting CC-Link IE TSN recommended by the CC-Link Partner Association

Optimum control when mixing devices with different communication cycles

Communication cycle 3 set points

TSN Technology

High-speed communication devices ideal for high-speed, high-accuracy control and slower response devices ideal for monitoring can be connected using the same line by separating the communication cycle according to speed. This can maximize productivity by using optimum communication cycles based on device performance, such as device stations that require high-speed control and status monitoring stations that operate at lower communication speeds.

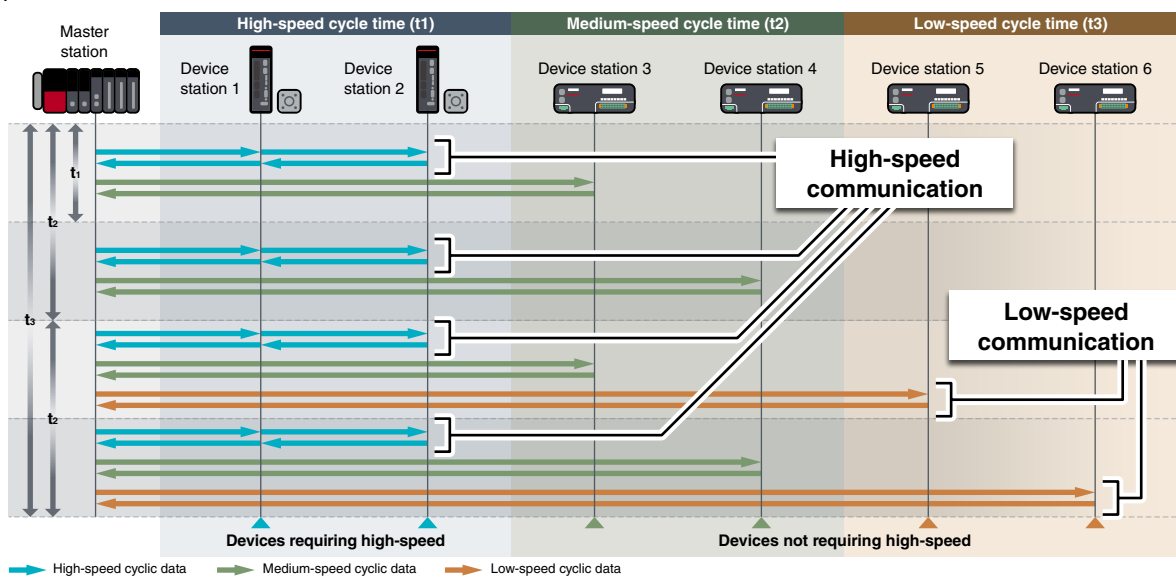

Realize high-accuracy synchronous control

Synchronization accuracy $\pm 1 \mu\text{s}$

Max. number of synchronized axes: 256 axes

TSN Technology

Servo amplifier and other device stations can be connected on the same network, enabling synchronous motion control between servo motors and device stations.

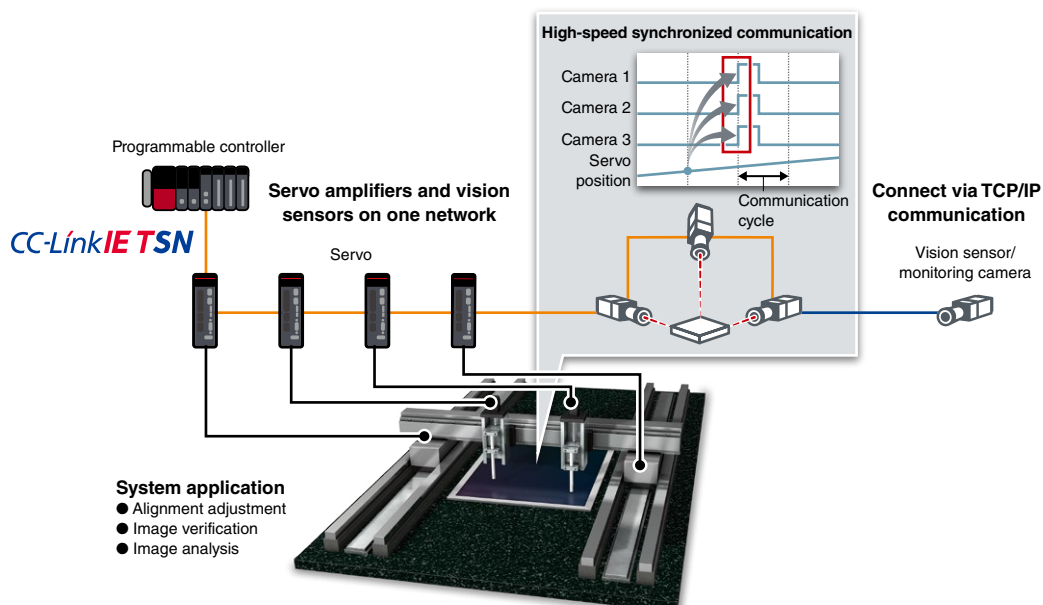

Easier parameter setting with imported device profiles (CSP+) Easy startup

Importing profiles (CSP+) describing device features into the engineering software GX Works3 realizes centralized management of connected devices including partner products. Different settings per connected device can be easily done in the same setting procedure.

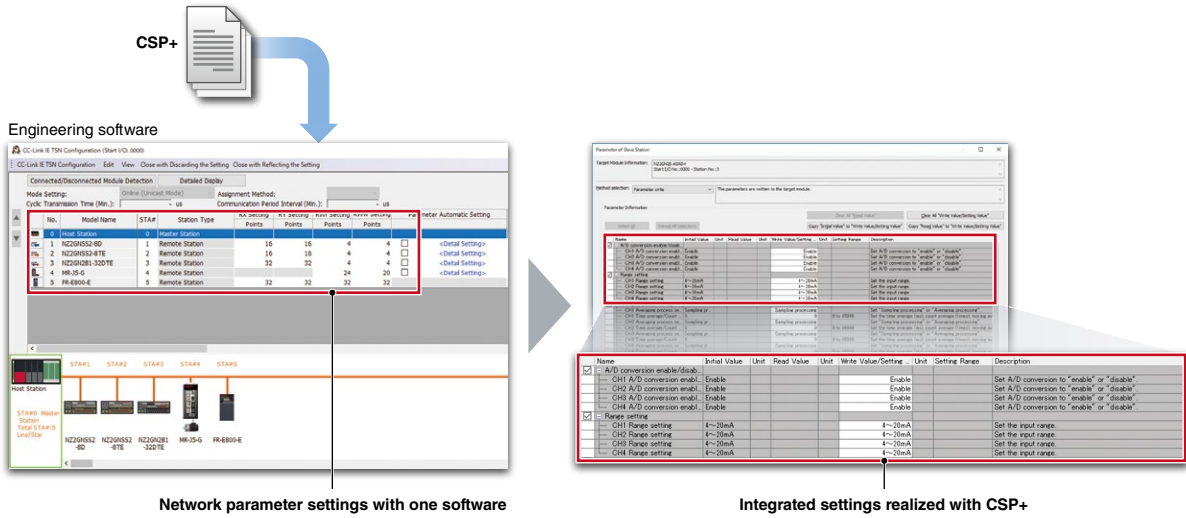

Easier troubleshooting reduces downtime Easy diagnostics

The location of a cable disconnection and error can be quickly found by visualizing the CC-Link IE TSN network system image in order of connection using the engineering software GX Works3. Since diagnostics information can be checked in real-time, a network error due to an unexpected wiring change and module setting change can be quickly found, reducing downtime.

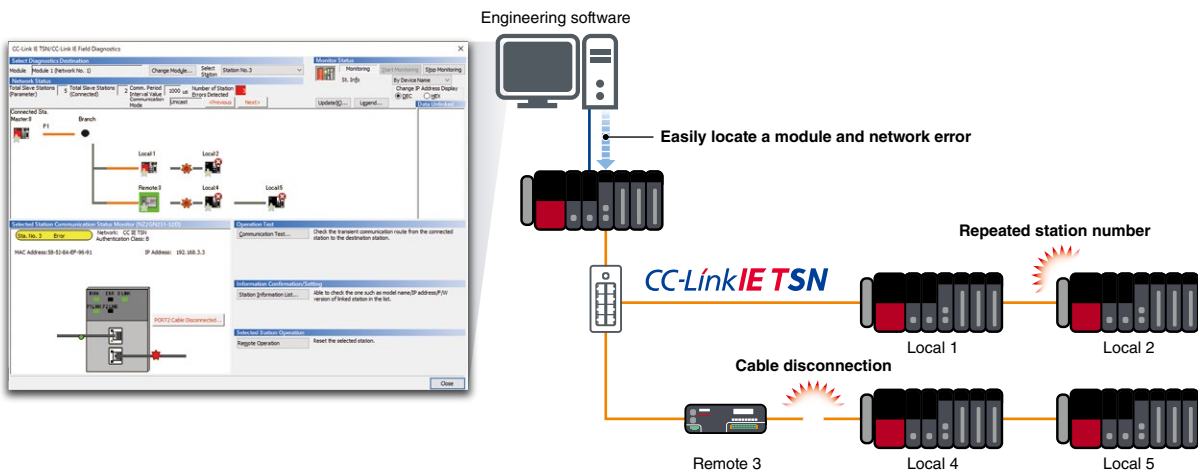



Intelligence

Auto-generation of network parameters Easy startup

Automatic generation of system parameters is relatively easy; simply connect the engineering software with the network master station. New parameters are reflected automatically even when the system configuration changes, reducing overall network setup time.

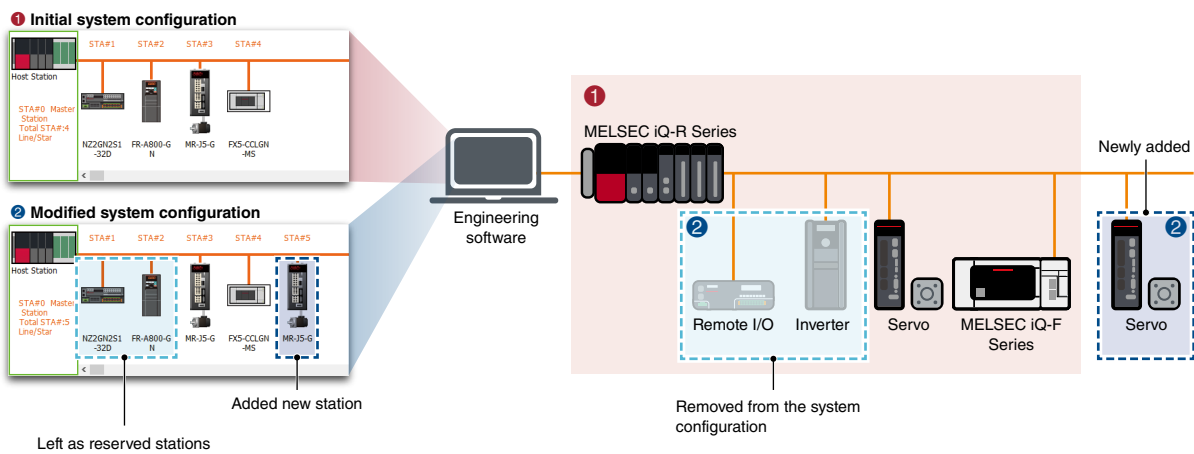

Easy diagnostics/data collection utilizing general Ethernet technology

Easy diagnostics Data collection

General Ethernet diagnostics software compatible with SNMP*1 can be used for monitoring CC-Link IE TSN and Ethernet network devices. In addition to Mitsubishi Electric's engineering software, system-wide diagnostic analysis and monitoring across the entire network are possible. CC-Link IE TSN communication software for Windows® realizes data collection at a low cost with easy setting without requiring network configuration setting change.

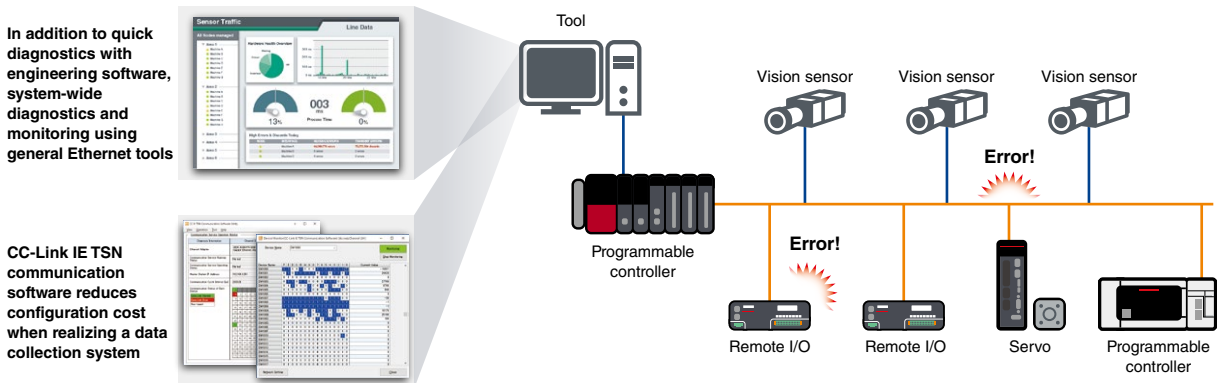

*1. SNMP: Simple Network Management Protocol

Features

System configuration

Master stations

Drives/GOT (HMI)

Block-type remote modules

Managed Ethernet switches/bridge modules

Partner products

Development kits/communication software

Error cause analysis with highly precise time synchronization

SoE

TSN Technology

Highly accurate time synchronization accuracy within $\pm 1 \mu\text{s}$ and each station connected to the network sharing time-stamp information in 1 ms increments improves system diagnostics and troubleshooting by enabling sequential analysis of stations in the network. The error history is displayed consecutively based on time-stamp data, enabling accurate analysis of the cause of error using the actual time the event occurred.

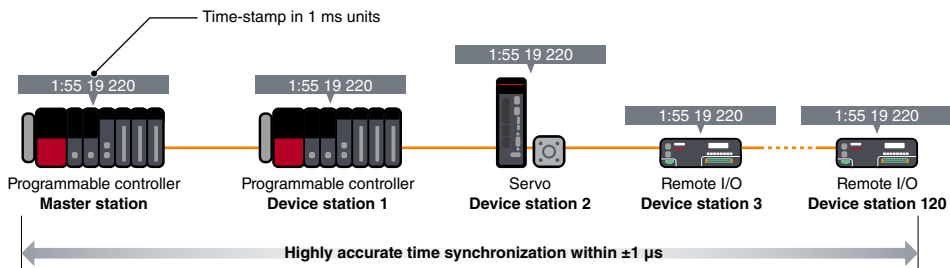

Combining with safety communications

Safety communication

CC-Link IE TSN enables control of safety and non-safety communications realizing a flexible system whereby safety communications can be easily incorporated into the main control network. Safety sub-functions (STO/SS1/SS2/SOS/SLS/SBC/SSM)*1 are also supported for drive-control devices that are on the network.

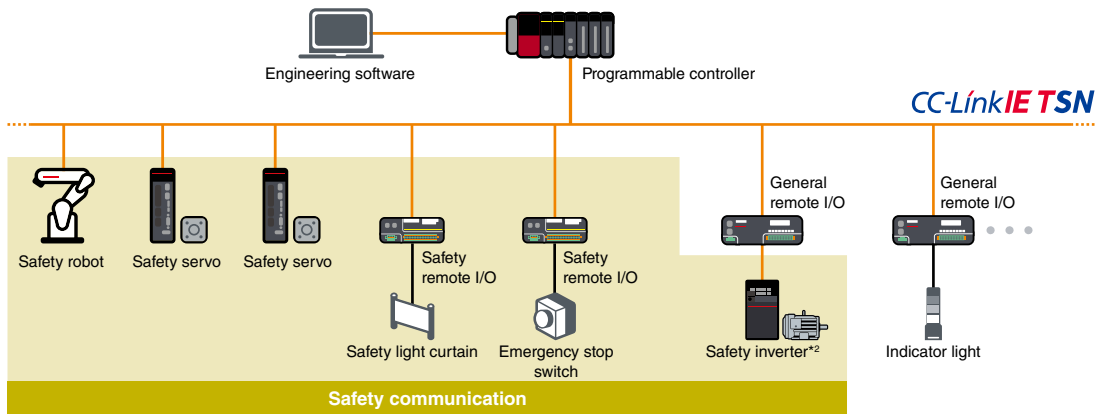

Ensure latest functional version with firmware update

CC-Link IE TSN-compatible devices can be updated, ensuring latest functional version modules.

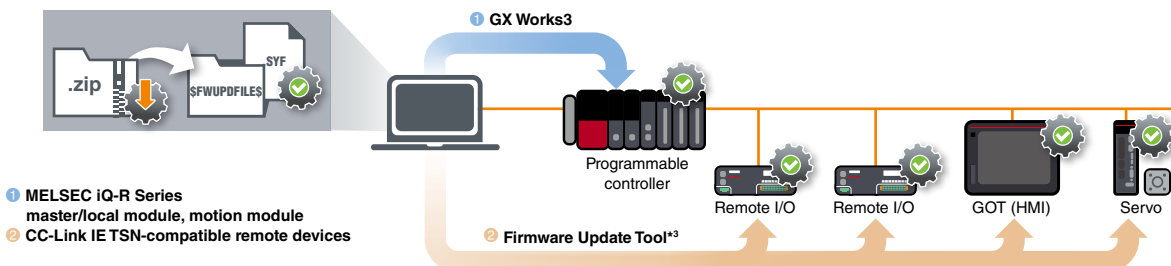

- ① MELSEC iQ-R Series master/local module, motion module
- ② CC-Link IE TSN-compatible remote devices

*1. Inverter FR-E800-SCE supports only STO/SS1/ SLS/SSM/SBC. Robot MELFA FR Series supports STO/SS1/SS2/SOS/SLS/SLP.
 *2. When mixing 100 Mbps with 1 Gbps-rated devices on the same network, connect the 100 Mbps device after a device supporting 1 Gbps (class B).
 *3. To obtain the CC-Link IE TSN Firmware Update Tool and relevant firmware update files, please contact your local Mitsubishi Electric sales office or representative.



Connectivity

Combining real-time control and TCP/IP communication

Standard Ethernet

Utilize TSN technology

Mixed communications

TSN Technology

Supporting standard Ethernet enables various network-compatible devices and diagnostic software to be used, realizing an integrated network infrastructure that is easy to maintain. Ethernet communications supporting TCP/IP communication such as information that has been collected and analyzed by edge devices and IT systems can be mixed in the same line with the real-time control communications of CC-Link IE TSN.

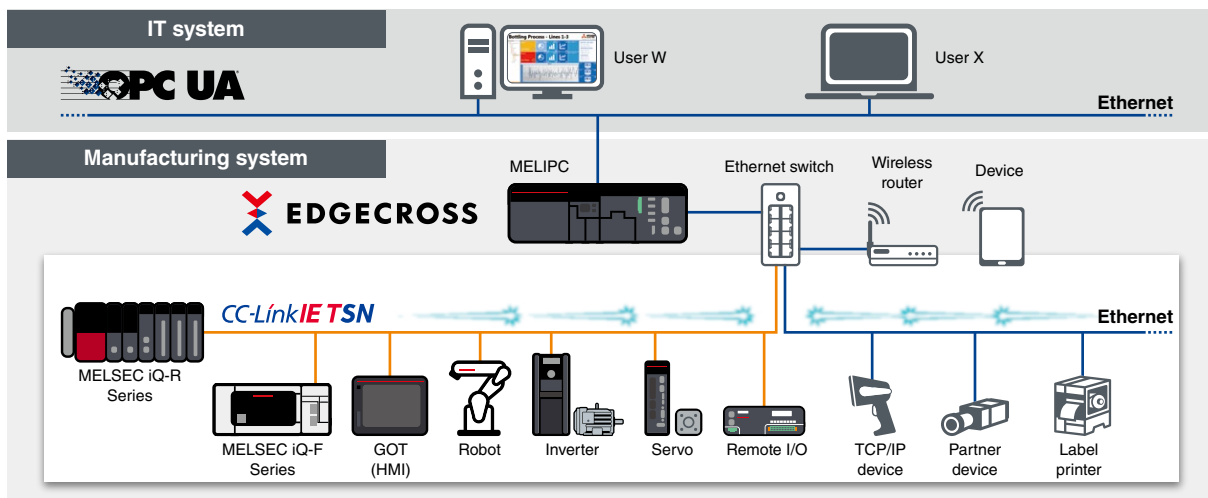

Easy replacement of remote devices

Shorter startup

Network station parameters that are stored in the CPU module are automatically distributed to remote devices when initializing the network and when returning disconnected stations to the network. Individual registration of the parameters to each station is unnecessary after replacing remote devices.

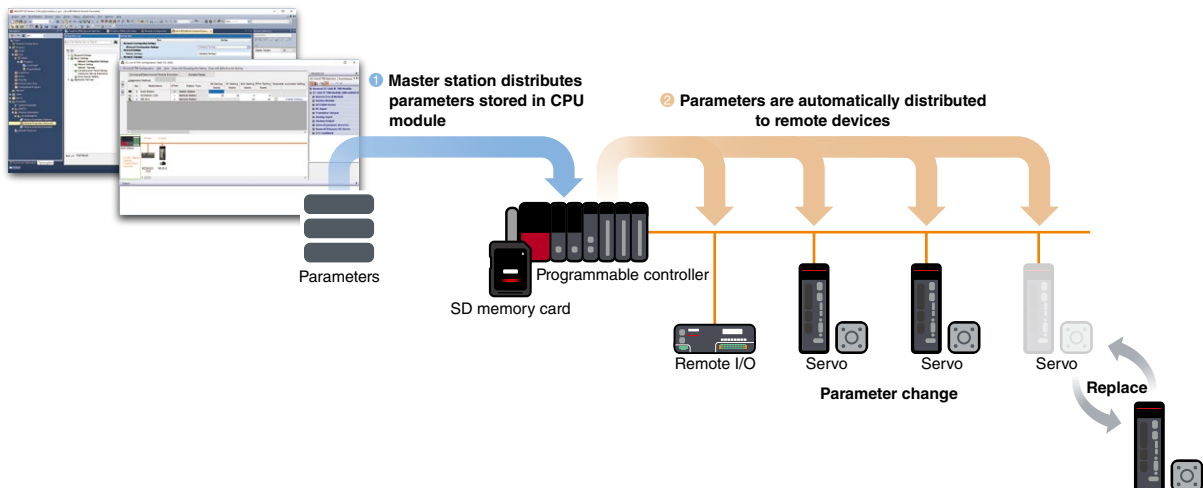

Features

System configuration

Master stations

Drives/GOT (HMI)

Block-type remote modules

Managed Ethernet switches/bridge modules

Partner products

Development kits/communication software

Flexible system configuration with multiple topologies Flexible system

Line, star, and ring topologies are supported, allowing a flexible system configuration. Use line topology for high-speed, high-performance control. This is realized when a system is configured with CC-Link IE TSN-compatible device stations only without additional branch lines. Choose a star topology if a more flexible system configuration is needed. Using Ethernet switches, device stations can be easily distributed to achieve the desired system configuration. Ring topology is ideal for systems requiring high reliability. Data communications continue with normal stations even if a cable is disconnected or an error occurs on a device station via multi-directional communication.

■ Line topology

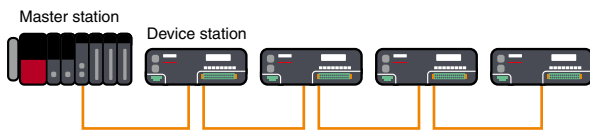

■ Star topology

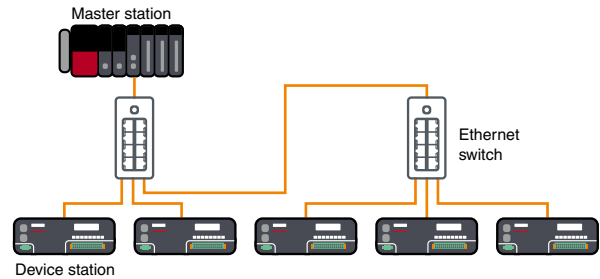

■ Ring topology

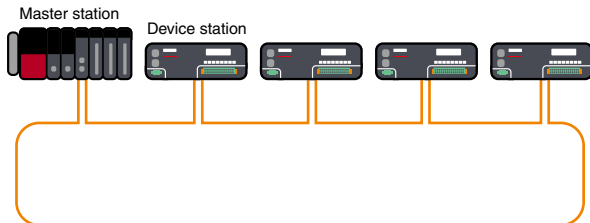

Integrate other network devices

The CC-Link IE TSN Plus master/local module (RJ71GN11-EIP) supports both CC-Link IE TSN and EtherNet/IP™. One port can be connected to the CC-Link IE TSN network, whilst the other port can be connected to the EtherNet/IP™ network. Even if both networks are used simultaneously, functions similar to the CC-Link IE TSN master/local module can be used without affecting the CC-Link IE TSN communication performance. Both networks are easily settable within the engineering software GX Works3.

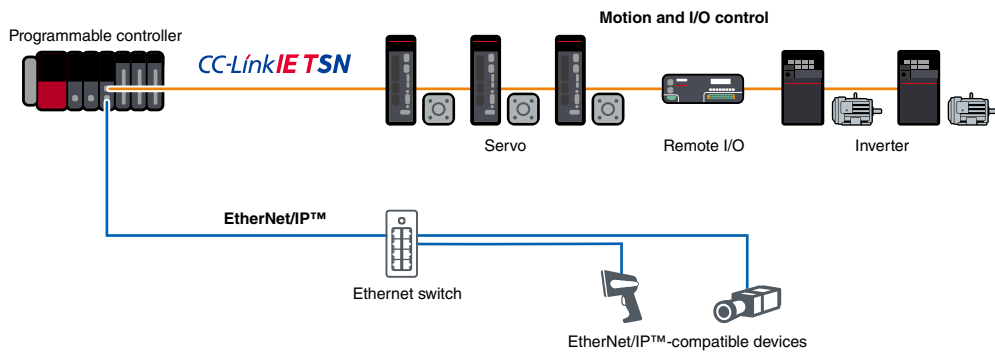

Visualization of sensors and space-saving Sensor connection (iQSS)

The AnyWireASLINK bridge module integrates AnyWireASLINK-compatible sensors via CC-Link IE TSN. Settings and diagnostics of AnyWireASLINK-compatible sensors are easily done from the engineering software GX Works3 by connecting to a programmable controller via a network.

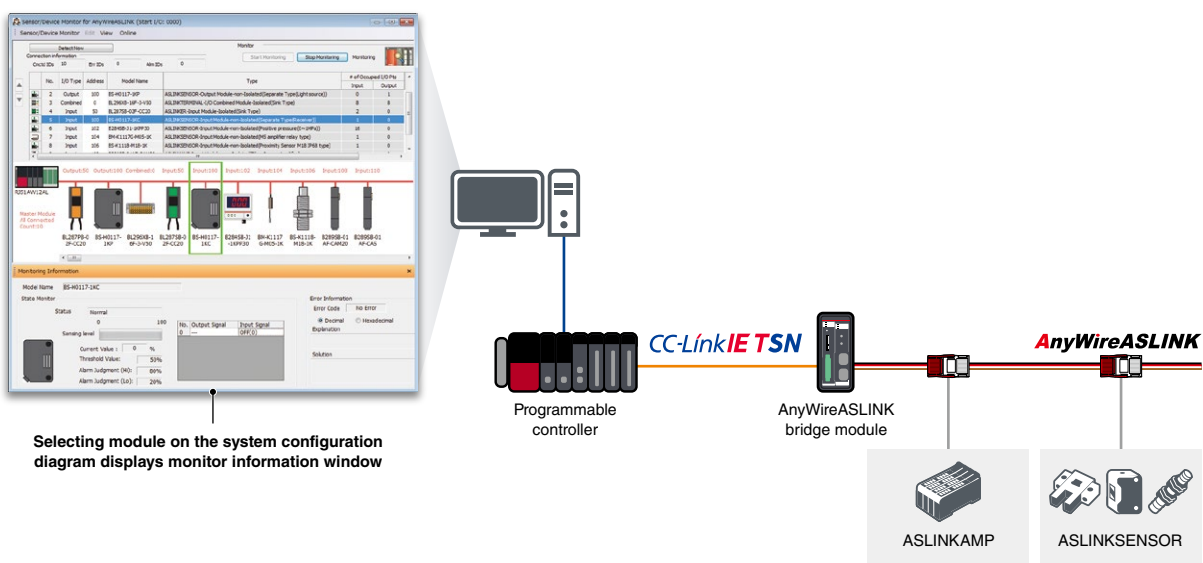

Highly scalable system utilizing best-in-class devices Various devices

Supports implementation of high-performance devices realized with a dedicated ASIC/FPGA, and low-cost devices using a software protocol stack on a standard Ethernet chip.



Item	Configuration 1	Configuration 2	Configuration 3	Configuration 4
System configuration	Hardware ^{*1} master 	Software ^{*2} master 	Hardware ^{*1} master 	Software ^{*2} master
	Hardware ^{*1} remote 	Hardware ^{*1} remote 	Software ^{*2} remote 	Software ^{*2} remote
Transmission speed				
1 Gbps	●	●	●	●
100 Mbps	●	●	●	●

*1. Hardware master/remote: Development with dedicated LSI (ASIC, FPGA)
 *2. Software master/remote: Development with software protocol stack (standard Ethernet chip)

System configuration

Seamless communication

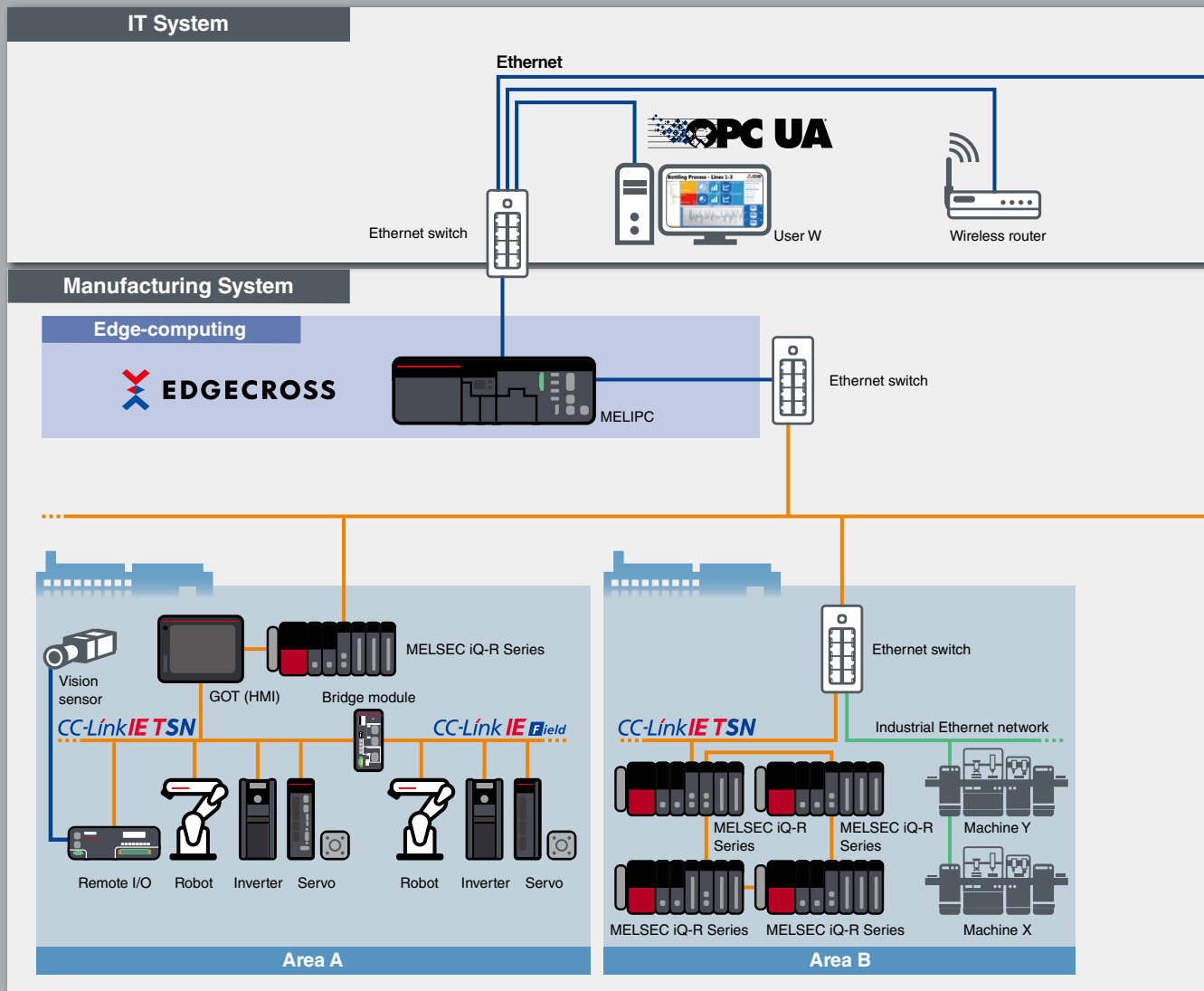

Flexible IIoT system configuration

CC-Link IE TSN utilizes TSN technology together with its support of TCP/IP communications enables mixing of information communication (non real-time) with Ethernet communication devices. This allows TCP/IP communication devices to be used without affecting real-time deterministic communications, thereby giving greater flexibility when connecting machines and equipment.

Increased productivity

Improved communication performance enables shorter production cycle time. Compared to current systems, adding further control axes and remote I/Os is much easier. In addition, optimum communication cycle times can be realized by supporting both high-speed and low-speed cycle communications according to device specifications.

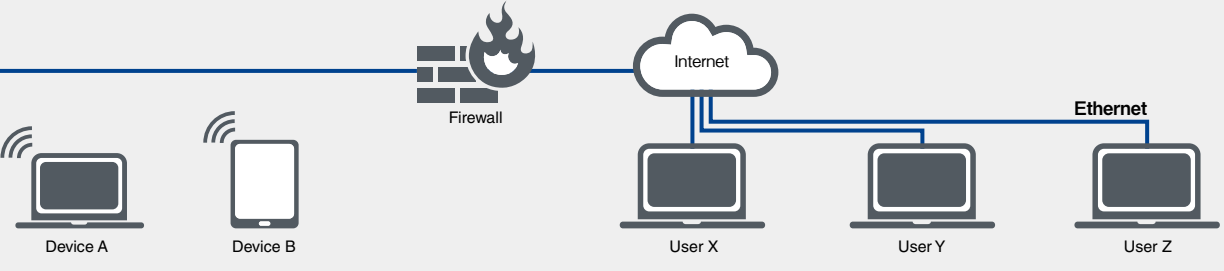

CC-Link IE TSN

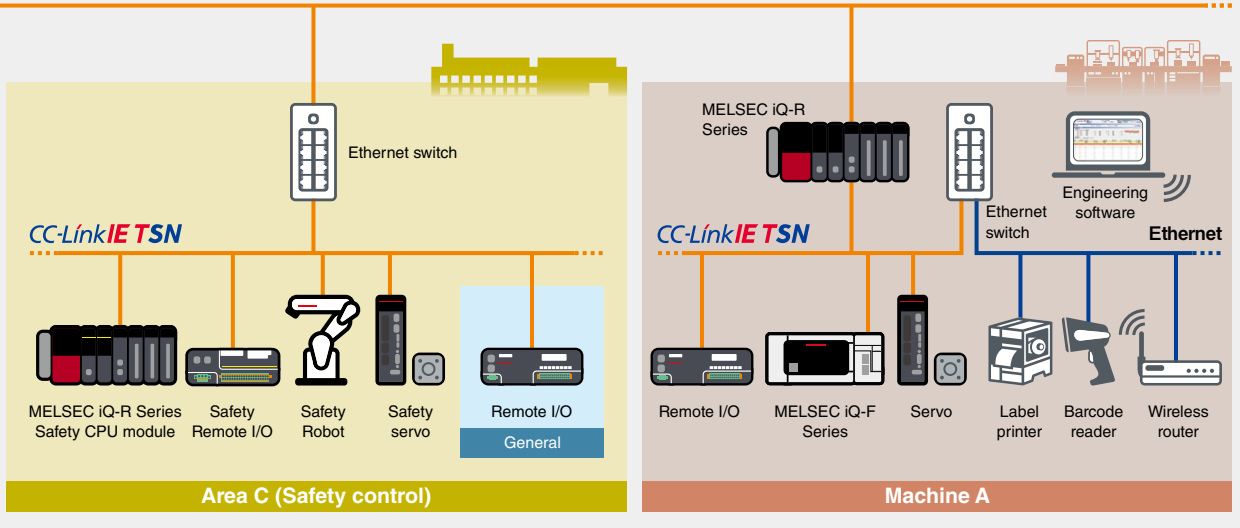

Reduce startup, engineering and maintenance costs

Through its support of SNMP, general Ethernet diagnostics software can be used to identify the network-related errors of CC-Link IE TSN and Ethernet devices more easily. The internal clocks of devices can be synchronized to within the microsecond, making it possible to log historical events in sequence and easily identify the cause of an error.

Various development methods available supporting different products

Product development for CC-Link IE TSN partner product vendors is relatively simple since various options are available. These include a dedicated ASIC/FPGA option for devices that require high performance, and a software protocol stack suitable for lower cost devices that can utilize a general Ethernet chip for network implementation.

Master stations



- Enables mixing of control and TCP/IP communications
- Automatically detects devices on the network, enabling easy network configuration
- Flexible system configuration with integrated safety communication
- Supports various types of motion control
- Highly scalable motion control modules based on the application
- Motion control software embedded in IPCs realizes CC-Link IE TSN-compatible motion control systems

MELSEC iQ-R/iQ-F Series master/local modules can be used as CC-Link IE TSN master/local stations. By supporting the simultaneous use of real-time motion control communication and TCP/IP communication, CC-Link IE TSN performance and functionality are maximized. By combining with CC-Link IE TSN-compatible servo amplifiers, motion modules also allow the use of multiple control functions, such as synchronization, cam, speed, and torque control using PLCopen® Motion Control function blocks. The ability to embed motion control software in industrial computers has enabled the realization of CC-Link IE TSN-compatible motion control systems.

Master/local module

RJ71GN11-T2 RJ71GN11-EIP FX5-CCLGN-MS

■ Network management module maximizes CC-Link IE TSN performance and functionality

- Can be used as a CC-Link IE TSN master or local station
- Enables mixing of real-time control communication and TCP/IP communication
- Automatic detection of network devices and parameter distribution realizes easy network configuration
- RJ71GN11-T2 can be used as a safety master or local station when paired with the MELSEC iQ-R Series safety CPU module
- RJ71GN11-T2 and RJ71GN11-EIP can control servo motors by using the profile mode of servo amplifiers
- RJ71GN11-EIP can connect CC-Link IE TSN devices to port 1 and EtherNet/IP™ devices to port 2 without affecting CC-Link IE TSN communication performance



RJ71GN11-T2 RJ71GN11-EIP FX5-CCLGN-MS

Motion module

RD78G RD78GH FX5-□SSC-G

■ Unlock new system capabilities together with CC-Link IE TSN

- PLCopen® Motion Control function blocks can easily perform various motion control functions such as, positioning, synchronization, cam, speed, and torque control
- Advanced motion control system realized by mixing servo amplifiers and I/O modules on one network
- Supports safety communication when paired with the MELSEC iQ-R Series safety CPU module
- FX5-□SSC-G utilizes the existing projects of the MELSEC iQ-F Series simple motion module (previous model)
- Operation mode of RD78G can be selected between “Simple Motion mode” and “PLCopen® motion control FB mode” considering the programming language and project



RD78G RD78GH FX5-80SSC-G

Motion control software

SWM-G

■ Create new value together in a PC-based environment

- Supports a CC-Link IE TSN servo control system where RTX64 (real-time extension) is installed on a PC (RTX64 is included with SWM-G)
- Meets various application needs by offering various types of motion control, such as positioning, synchronous, cam, speed, and torque control using API libraries
- Utilizes network control to connect and set various remote devices (remote I/O modules, etc.) and TCP/IP devices

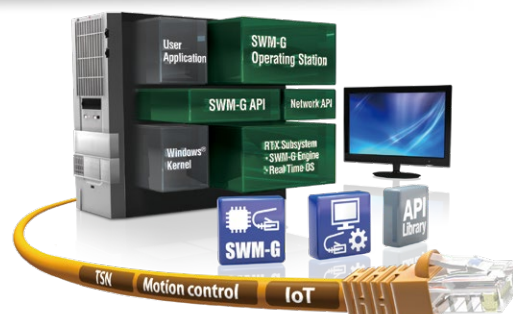

Drives/GOT (HMI)



- Quick tuning function for servo amplifiers controls vibration and suppresses overshoot within 0.3 s
- Machine diagnostics of mechanical parts (ball screws, linear guides, belts, and gears) improves predictive maintenance
- High-speed communication together with high-performance inverter improves productivity
- Robots can realize advanced operations by combining force and vision sensors
- Remote system-wide monitoring enabled using GOT Mobile function
- Various sample screens available, enabling the visualization of network device statuses from the GOT (HMI)

Drive products such as servos, inverters, and robots, together with GOT (HMI) all support CC-Link IE TSN. The MELSERVO-J5 Series servo amplifiers, when combined with motion modules, realize highly accurate motion control that contributes to the performance of smart factory production systems. The inverter A800/E800 Series is equipped with CC-Link IE TSN, enabling real-time collection of production data, and the robot MELFA FR Series and the GOT2000 Series HMI, which enhance coordination with automation devices, thereby improving productivity and efficiency.

AC servo MELSERVO-J5/MELSERVO-JET Series

MR-J5-G MR-J5W-G MR-J5-G-RJ MR-J5D-G4
MR-JET-G

Next generation MELSERVO-J5/MELSERVO-JET Series improves production systems

- Highly accurate synchronous control when combined with a motion module
- Multi-axis servo amplifier and drive unit are also available
- MR-J5-G-RJ/MR-J5D-G4 which are compatible with safety communications support safety sub-functions STO/SS1/SS2/SOS/SBC/SLS/SSM/SDI/SLI/SLT



MR-J5-G MR-J5W3-G MR-J5D3-G4 MR-JET-G

Inverter A800/E800 Series

FR-A800-GN FR-E800-E/SCE

Industry-leading high performance and quality

- Shop floor data collection in real-time using either 1 Gbps^{*1}/100 Mbps communications speed
- Enables mixing of real-time control communication and TCP/IP communication
- FR-E800-SCE which is compatible with safety communications supports safety sub-functions STO/SS1/SLS/SBC/SSM

*1. 1 Gbps will be supported in the future by FR-E800-E/SCE with option.



FR-A800-GN

FR-E800-SCE

Industrial robot MELFA FR Series controller

CR800-R

iQ Platform-compatible controller

- Seamlessly integrates the various controllers used in a production site with HMIs, the engineering environment and the network
- Multiple CPU architecture dramatically improves its interaction with FA equipment, offering highly precise control and fast yet simple information management
- Safety devices connected with the safety remote modules of the safety programmable controllers can be used via the CC-Link IE TSN master/local module



HMI GOT2000 Series CC-Link IE TSN communication unit

GT25-J71GN13-T2

■ Improves productivity and efficiency through advanced visualization of production equipment

- CC-Link IE TSN-compatible GOT (HMI) communication unit
- Use as a CC-Link IE TSN local station
- GT27 and GT25*¹ are supported

*1. GT2505, GT2512-WX, GT2510-WX, GT2507-W, GT2507T, GT2506HS, and GT2505HS are not supported.



Block-type remote modules

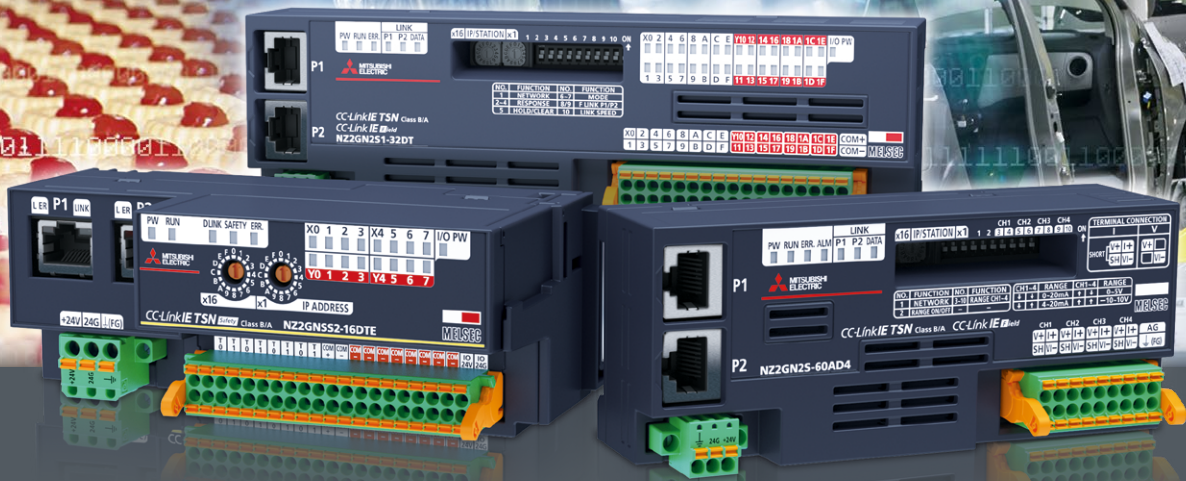

- Easily set parameters using only hardware switches*1
- Detection of low power supply voltage
- Spring-clamp terminal block reduces wiring
- Input module conforms to IEC 61131-2 Type3 (digital input standard operation range), supporting various sensors*1
- Switch to CC-Link IE Field Network device station mode*1
- Block-type remote module with safety function enables safety control
- Input/output timing can be synchronized with inter-modular synchronization cycle, enabling highly accurate control of the system*1

Block-type remote modules are recognized as device stations on the CC-Link IE TSN. They are mainly used when installation requires them to be close to connected I/Os to save on wiring. Digital I/O modules are the senses of the automation system and can be easily connected to switches, indicator lamps, sensors, and other devices. Analog modules can be connected to devices that process varying voltages and current signals. The combination of a block-type remote module with safety function and safety CPU module realizes safety network communications.

■ Easy system startup*1

The IP address for each module can be set easily using the switches on the front of the module. Additional functions can be set using switches as well, without requiring dedicated engineering software.

■ Switch to CC-Link IE Field Network device station mode*1

Setting the switches on the front of the module enables to be used as either a CC-Link IE TSN or CC-Link IE Field Network device station without requiring separate modules.

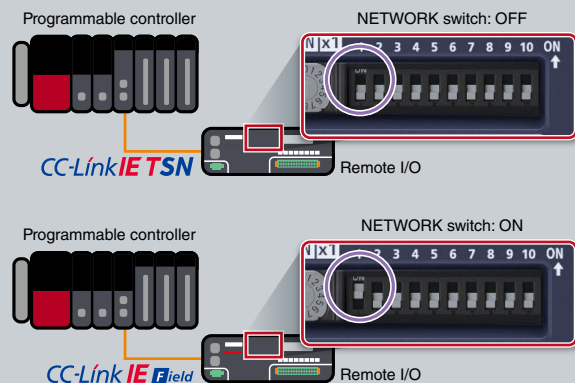
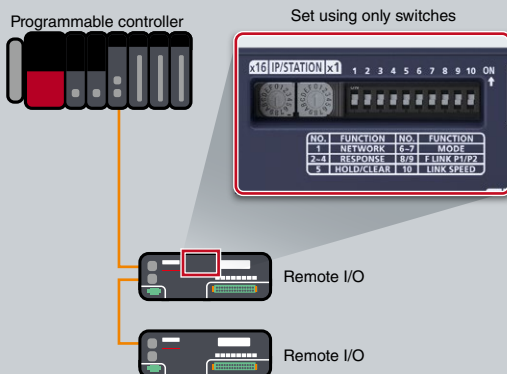

*1. Block-type remote modules with safety functions are not supported.

Input modules

- Response time can be set at 0 ms, 0.2 ms, 1 ms, 1.5 ms, 5 ms, 10 ms, 20 ms and 70 ms (initial setting is 1 ms)
- Input ON/OFF voltage and current comply with IEC 61131-2 (digital input standard operating range) Type3, supporting various sensors
- Functions can be easily setup from the front of the module using switches, without requiring dedicated engineering software

Spring-clamp terminal block

NZ2GN2S1-16D

NZ2GN2S1-32D



NZ2GN2S1-32D

Model	Input type DC input	Input points	Rated input voltage/current	Wiring type
NZ2GN2S1-16D	Positive/negative common shared	16 points	24 V DC (6.6 mA)	1-wire
NZ2GN2S1-32D	Positive/negative common shared	32 points	24 V DC (6 mA)	1-wire

Screw terminal block

NZ2GN2B1-16D

NZ2GN2B1-32D



NZ2GN2B1-32D

Model	Input type DC input	Input points	Rated input voltage/current	Wiring type
NZ2GN2B1-16D	Positive/negative common shared	16 points	24 V DC (6.6 mA)	1-wire
NZ2GN2B1-32D	Positive/negative common shared	32 points	24 V DC (6 mA)	1-wire

Sensor connector (e-CON)

NZ2GNCE3-32D



Model	Input type DC input	Input points	Rated input voltage/current	Wiring type
NZ2GNCE3-32D	Positive common	32 points	24 V DC (6.6 mA)	3-wire

40-pin connector

NZ2GNCF1-32D



Model	Input type DC input	Input points	Rated input voltage/current	Wiring type
NZ2GNCF1-32D	Positive/negative common shared	32 points	24 V DC (6.6 mA)	1-wire

Output modules

- Select either to hold or clear the output value when disconnected from the data link or when the master station's programmable controller CPU module has stopped
- Prevents module malfunction using the output overload and overheat protection function
- Functions can be easily setup from the front of the module using switches, without requiring dedicated engineering software

Spring-clamp terminal block

NZ2GN2S1-16T
 NZ2GN2S1-16TE
 NZ2GN2S1-32T
 NZ2GN2S1-32TE



NZ2GN2S1-32T

Model	Output type Transistor output	Output points	Rated load voltage/Max. load current	Wiring type
NZ2GN2S1-16T	Sink	16 points	12/24 V DC (0.5 A/point, 4 A/common)	1-wire
NZ2GN2S1-16TE	Source	16 points	12/24 V DC (0.5 A/point, 4 A/common)	1-wire
NZ2GN2S1-32T	Sink	32 points	12/24 V DC (0.5 A/point, 5 A/common)	1-wire
NZ2GN2S1-32TE	Source	32 points	12/24 V DC (0.5 A/point, 5 A/common)	1-wire

Screw terminal block

NZ2GN2B1-16T
 NZ2GN2B1-16TE
 NZ2GN2B1-32T
 NZ2GN2B1-32TE



NZ2GN2B1-32T

Model	Output type Transistor output	Output points	Rated load voltage/Max. load current	Wiring type
NZ2GN2B1-16T	Sink	16 points	12/24 V DC (0.5 A/point, 4 A/common)	1-wire
NZ2GN2B1-16TE	Source	16 points	12/24 V DC (0.5 A/point, 4 A/common)	1-wire
NZ2GN2B1-32T	Sink	32 points	12/24 V DC (0.5 A/point, 5 A/common)	1-wire
NZ2GN2B1-32TE	Source	32 points	12/24 V DC (0.5 A/point, 5 A/common)	1-wire

40-pin connector

NZ2GNCF1-32T



Model	Output type Transistor output	Output points	Rated load voltage/Max. load current	Wiring type
NZ2GNCF1-32T	Sink	32 points	12/24 V DC (0.1 A/point, 3.2 A/common)	1-wire

I/O combined modules

- Combined I/O modules include both input module and output module functions
- Response time can be set at 0 ms, 0.2 ms, 1 ms, 1.5 ms, 5 ms, 10 ms, 20 ms, and 70 ms (initial setting is 1 ms)
- Input ON/OFF voltage and current comply with IEC 61131-2 (digital input standard operating range) Type3, supporting various sensors
- Select either to hold or clear the output value when disconnected from the data link or when the master station's programmable controller CPU module has stopped
- Prevents module malfunction using the output overload and overheat protection function
- Functions can be easily setup from the front of the module using switches, without requiring dedicated engineering software

Spring-clamp terminal block

NZ2GN2S1-32DT NZ2GN2S1-32DTE



NZ2GN2S1-32DT

Model	Input type DC input	Input points	Rated input voltage/ current	Output type Transistor output	Output points	Rated load voltage/ Max. load current	Wiring type
NZ2GN2S1-32DT	Positive common	16 points	24 V DC (6 mA)	Sink	16 points	24 V DC (0.5 A/point, 4 A/common)	1-wire
NZ2GN2S1-32DTE	Negative common	16 points	24 V DC (6 mA)	Source	16 points	24 V DC (0.5 A/point, 4 A/common)	1-wire

Screw terminal block

NZ2GN2B1-32DT NZ2GN2B1-32DTE



NZ2GN2B1-32DT

Model	Input type DC input	Input points	Rated input voltage/ current	Output type Transistor output	Output points	Rated load voltage/ Max. load current	Wiring type
NZ2GN2B1-32DT	Positive common	16 points	24 V DC (6 mA)	Sink	16 points	24 V DC (0.5 A/point, 4 A/common)	1-wire
NZ2GN2B1-32DTE	Negative common	16 points	24 V DC (6 mA)	Source	16 points	24 V DC (0.5 A/point, 4 A/common)	1-wire

Sensor connector (e-CON)

NZ2GNCE3-32DT



Model	Input type DC input	Input points	Rated input voltage/ current	Output type Transistor output	Output points	Rated load voltage/ Max. load current	Wiring type
NZ2GNCE3-32DT	Positive common	16 points	24 V DC (6.6 mA)	Sink	16 points	24 V DC (0.5 A/point, 4 A/common)	3-wire

■ Analog input modules

- 200 μ s/CH analog input module conversion speed
- Functions can be easily setup from the front of the module using switches, without requiring dedicated engineering software

Spring-clamp terminal block NZ2GN2S-60AD4



Model	Input type	Number of channels
NZ2GN2S-60AD4	Analog voltage/current input	4 channels

Screw terminal block NZ2GN2B-60AD4



Model	Input type	Number of channels
NZ2GN2B-60AD4	Analog voltage/current input	4 channels

■ Analog output modules

- 200 μ s/CH analog output module conversion speed
- Functions can be easily setup from the front of the module using switches, without requiring dedicated engineering software

Spring-clamp terminal block NZ2GN2S-60DA4



Model	Output type	Number of channels
NZ2GN2S-60DA4	Analog voltage/current output	4 channels

Screw terminal block NZ2GN2B-60DA4



Model	Output type	Number of channels
NZ2GN2B-60DA4	Analog voltage/current output	4 channels

Waterproof/dustproof type (IP67) remote modules

- Complies with IP67. A control panel is no longer necessary, saving on hardware cost and space



NZ2GN12A42-16DT

Input modules

- Response time can be set at 0 ms, 0.2 ms, 1 ms, 1.5 ms, 5 ms, 10 ms, 20 ms and 70 ms

Waterproof connector (screw lock)

NZ2GN12A4-16D NZ2GN12A4-16DE

Model	Input type DC input	Input points	Rated input voltage/current	Wiring type
NZ2GN12A4-16D	Positive common	16 points	24 V DC (7.3 mA)	2- to 4-wire
NZ2GN12A4-16DE	Negative common	16 points	24 V DC (7.3 mA)	2- to 4-wire

Output modules

- Since the maximum load current is 4 A/point, a large load can be connected

Waterproof connector (screw lock)

NZ2GN12A2-16T NZ2GN12A2-16TE

Model	Output type Transistor output	Output points	Rated load voltage/ Max. load current	Wiring type
NZ2GN12A2-16T	Sink	16 points	12/24 V DC (2 A/point, 4 A/point, 12 A/common)**1	2-wire
NZ2GN12A2-16TE	Source	16 points	12/24 V DC (2 A/point, 4 A/point, 12 A/common)**1	2-wire

I/O combined modules

- The I/O combined module controls both inputs and outputs all in one module
- Response time can be set at 0 ms, 0.2 ms, 1 ms, 1.5 ms, 5 ms, 10 ms, 20 ms and 70 ms
- Since the maximum load current is 4 A/point, a large load can be connected

Waterproof connector (screw lock)

NZ2GN12A42-16DT NZ2GN12A42-16DTE

Model	Input type DC input	Input points	Rated input voltage/ current	Output type Transistor output	Output points	Rated load voltage/ Max. load current	Wiring type
NZ2GN12A42-16DT	Positive common	8 points	24 V DC (7.3 mA)	Sink	8 points	12/24 V DC (2 A/point, 4 A/point, 12 A/common)**1	2- to 4-wire (input) 2-wire (output)
NZ2GN12A42-16DTE	Negative common	8 points	24 V DC (7.3 mA)	Source	8 points	12/24 V DC (2 A/point, 4 A/point, 12 A/common)**1	2- to 4-wire (input) 2-wire (output)

*1. Maximum load current specifications may vary depending on the output terminals. For more information, please refer to the relevant product manual.

FPGA modules **NEW**

- Microsecond-fast and highly-accurate I/O response times with a field programmable gate array (FPGA)
- Operation of I/O values is processed on the order of nanoseconds in the FPGA. The logic circuit can be programmed flexibly using the Intel® Quartus® Prime Design software*1
- Various communication types are available for the Ethernet communication with a higher-level system, from which suitable one can be selected according to the application and conditions. The module can also operate stand-alone during start-up or for incidental facilities
- Customer-designed complex logic circuits can be written to the FPGA. The module is ideal for replacing the existing FPGA boards and microcomputer boards developed in-house
- Logging data can be created as a CSV file and transferred to an FTP server using FTP (client). FTP can be used simultaneously with CC-Link IE TSN
- The module supports simple CPU communication, enabling data exchange with the CPU module
- The table below shows specifications of embedded FPGA



NZ2GN2S-D41PD02

NZ2EX2S-D41A01

Item		Specifications
Embedded FPGA	Device name	5CGXFC7D6F2717N (Cyclone® V series by Intel Corporation)
	Circuit capacity	LUTs = 149.5K (650K gates), Block RAM = 7000 kbits
User usable capacity (recommended values)*2		LUTs = 35K (150K gates), Block RAM = 4400 kbits
System clock		100 MHz

*1. Please contact Intel Corporation for any inquiries on Intel products. Please visit the website below.
www.intel.com

*2. If Timing Violation occurs in the logic synthesis result, review the user circuit.

Main modules

DC input/output

NZ2GN2S-D41P01 **NEW**

Model	DC input points	Transistor output points
NZ2GN2S-D41P01	48 (4 points/common, positive/negative common shared)	48 (4 points/common, sink, 0.1 A/point)

Differential input/output

NZ2GN2S-D41D01 **NEW**

Model	Differential input points	Differential output points	Differential input/output (shared) points
NZ2GN2S-D41D01	24 (10 Mpps*3 at multiple of 4)	24 (10 Mpps at multiple of 4)	3 (5 Mpps at multiple of 2)

*3. Speeds of up to 16 Mpps can apply when compliance with the EMC Directive is not needed.

DC input/output, differential input/output

NZ2GN2S-D41PD02 **NEW**

Model	DC input points	Transistor output points	Differential input points	Differential output points	Differential input/output (shared) points
NZ2GN2S-D41PD02	32 (4 points/common, positive/negative common shared)	32 (4 points/common, sink, 0.1 A/point)	8 (10 Mpps*4 at multiple of 4)	8 (10 Mpps at multiple of 4)	1 (5 Mpps at multiple of 2)

*4. Speeds of up to 16 Mpps can apply when compliance with the EMC Directive is not needed.

Extension modules

- The extension modules increase the number of input/output points of the main modules. The number of connectable module is one. The connected extension module can be controlled from the FPGA embedded in the main module

Spring-clamp terminal block - DC input/output type

NZ2EX2S-D41P01 **NEW**

Model	DC input points	Transistor output points
NZ2EX2S-D41P01	48 (4 points/common, positive/negative common shared)	48 (4 points/common, sink, 0.1 A/point)

Spring-clamp terminal block - differential input/output type

NZ2EX2S-D41D01 **NEW**

Model	Differential input points	Differential output points	Differential input/output (shared) points
NZ2EX2S-D41D01	24 (10 Mpps* ¹ at multiple of 4)	24 (10 Mpps at multiple of 4)	3 (5 Mpps at multiple of 2)

*1. Speeds of up to 16 Mpps can apply when compliance with the EMC Directive is not needed.

Spring-clamp terminal block - analog input/output type

NZ2EX2S-D41A01 **NEW**

Model	Analog input points	Analog output points
NZ2EX2S-D41A01	36 (voltage/current, 4 μ s/36 points)	6 (voltage/current, 6 μ s/6 points)

Block-type remote modules with safety functions

- Block-type remote modules that support safety functions
- Performs safety control when used together with the MELSEC iQ-R Series safety CPU module

Input module

- Input module with safety functions
- Single or double wiring can be selected per input point
- Compliant with international safety standards, ISO 13849-1 Category 4 PL e and IEC 61508 SIL 3

Spring-clamp terminal block NZ2GNSS2-8D

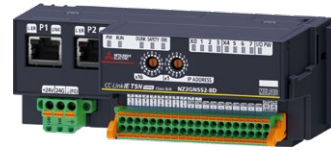

Model	Input type DC input	Input points	Rated input voltage/current	Wiring type
NZ2GNSS2-8D	Negative common	Single wiring: 8 points Double wiring: 4 points	24 V DC (7.3 mA)	2-wire

Output module

- Output module with safety functions
- Single or double wiring can be selected per output point
- Compliant with international safety standards, ISO 13849-1 Category 4 PL e and IEC 61508 SIL 3

Spring-clamp terminal block NZ2GNSS2-8TE

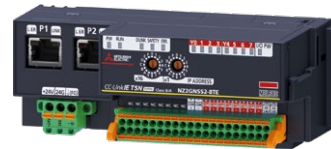

Model	Output type Transistor output	Output points	Rated load voltage/Max. load current	Wiring type
NZ2GNSS2-8TE	Source + source	Single wiring: 8 points Double wiring: 4 points	24 V DC (0.5 A/point, 4 A/common)	2-wire

I/O combined module

- I/O combined module with safety functions
- Single or double wiring can be selected per input and output point
- Compliant with international safety standards, ISO 13849-1 Category 4 PL e and IEC 61508 SIL 3
- Embedded fast logic function enables control of safety logic from within the remote module. High-speed control (response speed: 5.8 ms*¹) is realized without being affected by the safety CPU module and network processing speed

*1. Depends on the parameter settings.

Spring-clamp terminal block NZ2GNSS2-16DTE



Model	Input type DC input	Input points	Rated input voltage/ current	Output type Transistor output	Output points	Rated load voltage/ Max. load current	Wiring type
NZ2GNSS2-16DTE	Negative common	Single wiring: 8 points Double wiring: 4 points	24 V DC (7.3 mA)	Source + source	Single wiring: 8 points Double wiring: 4 points	24 V DC (0.5 A/point, 4 A/common)	2-wire

Waterproof/dustproof type (IP67) I/O combined modules

- I/O combined module with safety functions
- Compliant with international safety standards, ISO 13849-1 Category 4 PL e and IEC 61508 SIL 3 (NZ2GNS12A2-14DT complies with Category 3)
- Complies with IP67. A control panel is no longer necessary, saving on hardware cost and space
- Since the maximum load current is 4 A/point, a large load can be connected
- Embedded fast logic function enables control of safety logic from within the remote module. High-speed control (response speed: 5.8 ms^{*1}) is realized without being affected by the safety CPU module and network processing speed



NZ2GNS12A2-16DTE

*1. Depends on the parameter settings.

Waterproof connector (screw lock)

NZ2GNS12A2-14DT

NZ2GNS12A2-16DTE

Model	Input type DC input	Input points	Rated input voltage/current	Output type Transistor output	Output points	Rated load voltage/ Max. load current	Wiring type
NZ2GNS12A2-14DT	Negative common	Single wiring: 12 points Double wiring: 6 points	24 V DC (6.8 mA)	Source + sink	Single wiring: not possible Double wiring: 2 points	24 V DC (2 A/point, 4 A/point 6 A/common) ^{*2}	2-wire
NZ2GNS12A2-16DTE	Negative common	Single wiring: 12 points Double wiring: 6 points	24 V DC (6.8 mA)	Source + source	Single wiring: 4 points Double wiring: 2 points	24 V DC (2 A/point, 4 A/point 8 A/common) ^{*2}	2-wire

*2. Maximum load current specifications may vary depending on the output terminals. For more information, please refer to the relevant product manual.

Managed Ethernet switches

NZ2MHG-TSNT4 NZ2MHG-TSNT8F2

- Star topology can be configured with a managed Ethernet switch. NZ2MHG-TSNT4 is equipped with 4 Ethernet ports and NZ2MHG-TSNT8F2 is equipped with 8 Ethernet ports
- TCP/IP communication devices can be connected to empty Ethernet ports, enabling a highly-flexible advanced system
- Disruptions to the control system are kept to a minimum when an error occurs such as remote device failure and a cable disconnection
- Wiring distance between devices can be shortened, thereby reducing wiring cost. In addition, layout modification and addition/replacement of remote devices can be efficiently completed



NZ2MHG-TSNT4

NZ2MHG-TSNT8F2



This product was developed and manufactured by Moxa Inc. Please note that the specifications and guarantee conditions of the products are different from the MELSEC Series products.

Bridge modules

CC-Link IE TSN – CC-Link IE Field Network bridge module

NZ2GN-GFB NEW

- Seamlessly integrates the CC-Link IE Field Network into CC-Link IE TSN
- Can be used as a remote station on CC-Link IE TSN and either as a master or local station on the CC-Link IE Field Network
- Enables CC-Link IE TSN devices to be added to the CC-Link IE Field Network
- Enables CC-Link IE Field devices to be added to CC-Link IE TSN



CC-Link IE TSN-AnyWireASLINK bridge module*1

NZ2AW1GNAL

- Seamlessly integrates AnyWireASLINK products into CC-Link IE TSN
- AnyWireASLINK is a reduced wiring network realizing monitoring of sensors and reduced installation space
- Supports iQSS (iQ Sensor Solution), which enables parameter setup and monitoring of AnyWireASLINK products



*1. For further details, please refer to "DIGITAL LINK SENSOR AnyWireASLINK catalog (L(NA)08221E)".

Mitsubishi Electric System & Service

For details of Mitsubishi Electric System & Service Co., Ltd. products, please contact us via email.
 <Sales office> OVERSEAS SERVICE SECTION mail: osb.webmaster@melsc.jp

Industrial switching hub

DT135TXA Class A

- Compatible with 10 Mbps/100 Mbps/1 Gbps transmission speed
- Compact size unit with 5 ports
- Supports 12 V DC up to 48 V DC wide voltage-range. Two power supply inputs (redundant power supply) are also possible
- Supports the line, star, line and star combination network topologies
- Complies with UL/CE/FCC standards enabling export to Europe and North America



Ethernet cable

SC-E5EW Series

- 1000BASE-T Standard compliant. This Ethernet cable with double shield has an outstanding shield performance
- Available in lengths from 1 m to 100 m (in 1 m increments). For using in indoor movable area, available lengths are from 1 m to 45 m. Available in lengths less than 1 m also



Item	SC-E5EW-S□M ^{*1}	SC-E5EW-S□M-MV ^{*2}	SC-E5EW-S□M-L ^{*3}
Cable type	Category 5e or higher, (double shielded/STP) straight cable		
Number of core wires	8 wires (4 twisted pairs)		
Double shield	Aluminum/polyester tape, tin-plated annealed copper wire braid		
Installation environment	Indoor	Indoor movable	Indoor/outdoor
Finished outside diameter	Flame retardant PVC, 6.8 mm	Flame retardant PVC, 6.5 mm	LAP sheath, 10 mm
Connector	RJ-45 connector with shield, straight connection		
Conforming standards	IEEE802.3 1000BASE-T ANSI/TIA/EIA-568-B (Category 5e) ISO/IEC 11801		

*1. "□" in the model name denotes a cable length (0.5 m, from 1 m up to 100 m in 1 m increments).

*2. "□" in the model name denotes a cable length (0.1 m, 0.2 m, 0.3 m, 0.5 m, from 1 m up to 45 m in 1 m increments).

*3. "□" in the model name denotes a cable length (from 1 m up to 100 m in 1 m increments).

Inline coupler

SPAD-RJ45S-E5E

- 8 conductor RJ-45 female to female, shielded, fits standard type Keystone Wall Plate
- Can be used in patch panels, wall jacks, or to extend cable lengths



Item	Specifications
Adaptable connector	RJ-45 connector with shield
Operable temperature	-10...60°C
Conforming standards	IEEE 802.3 1000BASE-T ANSI/TIA/EIA-568-B (Category 5e) ISO/IEC 11801



For further inquiries concerning partner and CC-Link IE TSN products and development of supported products, please contact CLPA.



www.cc-link.org/en

For further details, please refer to the "Open Field Network CC-Link Family Compatible Product Development Guidebook (L(NA)08052E)".



Development kits

Dedicated communication LSI CP610

- CC-Link IE TSN master station/local station can be developed without considering protocols
- Allows selection of MPU and OS freely. Customized sample codes according to hardware specifications and applications can be provided
- Parameter settings and diagnostics of the CC-Link IE TSN master station/local station can be done using the CC-Link IE TSN setting tool included in the source code development kit
- Provides SPICE model for PCI Express® interface and IBIS model for other interfaces as a transmission simulation model*1



*1. Confidentiality agreement needs to be signed to provide SPICE model and IBIS model. Please consult with your local Mitsubishi Electric sales office.

Master station software development kit (SDK)

- Various systems can be configured using the software protocol stack irrespective of computers specifications
- API compliance with CANopen® makes it easy for developers of CANopen®-compatible products to develop CC-Link IE TSN-compatible products
- Source code package can be customized, enabling function expansion and porting to different development environments
- Kit with library allows system configuration at a lower cost
- Embedded functions improve devices by utilizing features such as mixing TCP/IP communication



*2. SW1DTD-GNSDK1M

*3. SW1DTD-GNSDK2M

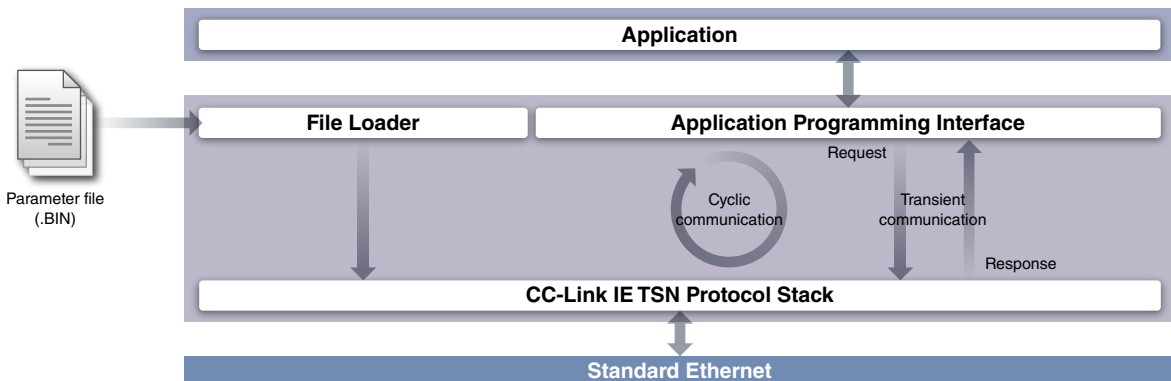

Features

System configuration

Master stations

Drives/GOT (HM)

Block-type remote modules

Managed Ethernet switches/
bridge modules

Partner products

Development kits/
communication software

■ Communication LSI embedded with GbE-PHY CP620

- CC-Link IE TSN remote station can be developed without considering protocols
- Embedded GbE-PHY enables easier communication circuit pattern development with fewer peripheral parts and circuits required around the CPU and GbE-PHY, thereby reducing board size
- Customized sample codes according to hardware specifications and applications can be provided
- Embedded hardware RTOS*1 reduces CPU load and power consumption

*1. RTOS: Real-time operating system

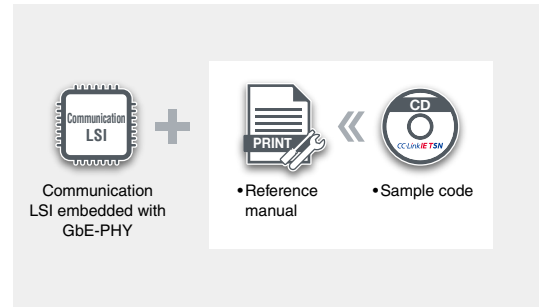

■ Sample code for CC-Link IE TSN remote station class A (provided by the CC-Link Partner Association)

- Devices supporting CC-Link IE TSN remote stations class A can be developed just by implementing software protocol stack in devices equipped with Ethernet interface

Download sample code from the CC-Link Partner Association website below.
https://www.cc-link.org/en/cclink/cclinkie/code_cclinkie_tsn.html

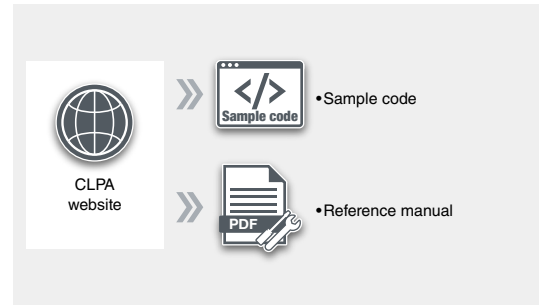

Communication software

■ CC-Link IE TSN communication software for Windows® (CC-Link IE TSN data collector enclosed)

- Easily collects accurate control data of CC-Link IE TSN devices
- Collected data from the function library can be utilized for data analysis and monitoring
- Realizes accurate data analysis by collection of control data with time-stamp
- Reduces configuration cost for realizing a simple data collection system as setup is straightforward utilizing computer-based software
- CC-Link IE TSN data collector enables integration with Edgexcross

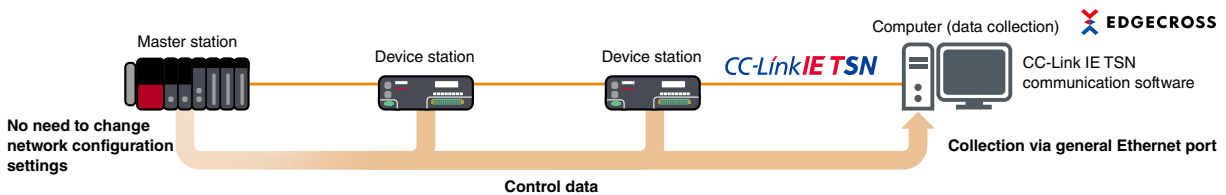

General specifications

The following table provides the environmental specifications required for using the CC-Link IE TSN master/local module and block-type modules listed in this catalog. For the environmental specifications required to use other products, please refer to the relevant product catalog or manual.

Item	MELSEC iQ-R Series master/local module Block-type remote module	MELSEC iQ-F Series master/local module
Operating ambient temperature (°C)	0...55*1	-20...55, non-freezing*2*3
Storage ambient temperature (°C)		-25...75
Operating ambient humidity (% RH)		5...95, non-condensing
Storage ambient humidity (% RH)		
Vibration resistance	Please refer to the relevant product manual	
Shock resistance	Compliant with JIS B 3502 and IEC 61131-2 (147 m/s ² , 3 times each in directions X, Y, and Z)	147 m/s ² , Action time: 11 ms, 3 times each in directions X, Y, and Z by half-sine pulse *4
Operating atmosphere	No corrosive gases*5, no flammable gases, no excessive conductive dust	
Operating altitude*6 (m)		0...2000*7
Installation location	Inside a control panel	
Overvoltage category*8		≤ II
Pollution level*9		≤ 2

*1. Enables standard MELSEC iQ-R Series modules to support extended operating ambient temperature of 0 to 60°C, ensuring the same performance as the standard operating ambient temperature (0 to 55°C). When requiring to use in an ambient temperature environment higher than 60°C, please consult your local Mitsubishi Electric representative.

*2. In the case where operating ambient temperature is lower than 0°C, the specifications are different from the above description. For details, please refer to the "MELSEC iQ-F FX5U User's Manual (Hardware)".

*3. When using FX5-CCLGN-MS manufactured in December 2020 or earlier, the operating ambient temperature is -20 to 50°C. The operating ambient temperature of the programmable controller system is the same.

*4. The criterion is shown in IEC 61131-2.

*5. For RJ71GN11-T2 and RJ71GN11-EIP, the special coated products, which improve resistance to corrosive gas concentrations as specified in IEC 60721-3-3: 1994 3C2, are available for the use in a corrosive gas environment. For details of the special coated products, please consult your local Mitsubishi Electric representative.

*6. Do not use or store the programmable controller under pressure higher than the atmospheric pressure of altitude 0 m. Doing so may cause malfunction or lead to failure.

*7. When using programmable controllers at an altitude higher than 2000 m, the upper limits of the permissible voltage and the operating ambient temperature become lower. For further details, please refer to the technical bulletin "FA-A-0152" for the MELSEC iQ-R Series and "HIME-T-P-0185" for the MELSEC iQ-F Series.

*8. This indicates the section of the power supply to which the equipment is assumed to be connected between the public electrical power distribution network and the machinery within premises. Category II applies to equipment for which electrical power is supplied from fixed facilities. The surge voltage withstand level for up to the rated voltage of 300 V is 2500 V.

*9. This index indicates the degree to which conductive material is generated in terms of the environment in which the equipment is used. Pollution level 2 is when only non-conductive pollution occurs. Temporary conductivity caused by condensation must be expected occasionally.

■ Performance specifications

Item	MELSEC iQ-R Series master/local module RJ71GN11-T2
Communication speed (bps)	1G/100M
Maximum stations per network*1	121
Connection cable	Ethernet cable (Category 5e or higher)
Overall cable distance (m)	Line: 12000 Ring: 12100 Others: Depends on the system configuration
Maximum station-to-station distance (m)	100
Max. number of networks	239
Network topology*2	Line, star*3, ring
Communication method	Time-sharing method/time-managed polling method
Maximum link points per network	
RX/RX	16384 points, 2 kbytes
RW/r/RWw	8192 points, 16 kbytes
LB	32768 points, 4 kbytes
LW	16384 points, 32 kbytes
Maximum link points per station	
RX/RX	16384 points, 2 kbytes
RW/r/RWw	8192 points, 16 kbytes
LB	32768 points, 4 kbytes
LW	16384 points, 32 kbytes
Safety communications	
Max. number of safety connections per station	120 connections
Max. number of link points per safety connection (word)	8 (input: 8, output: 8)
Transient transmission capacity	
Transient transmission capacity (byte)	Max. 1920

*1. Includes a master station.

*2. Please use a managed Ethernet switch supporting CC-Link IE TSN (class B) recommended by the CC-Link Partner Association.

*3. Line topology and star topology can be mixed.

Item	MELSEC iQ-R Series CC-Link IE TSN Plus master/local module RJ71GN11-EIP	MELSEC iQ-F Series master/local module FX5-CCLGN-MS*1	MELSEC iQ-R Series motion module RD78G□/GH□	MELSEC iQ-F Series motion module FX5-□SSC-G
Communication speed (bps)	1G/100M	1G/100M	1G/100M	1G/100M
Maximum stations per network*2	121	61 (master station)	121	21 (FX5-40SSC-G) 25 (FX5-80SSC-G)
Connection cable	Ethernet cable (Category 5e or higher)	Ethernet cable (Category 5e or higher)	Ethernet cable (Category 5e or higher)	Ethernet cable (Category 5e or higher)
Overall cable distance (m)	Line: 12000 Others: Depends on the system configuration	Line: 6000 (master station) Others: Depends on the system configuration	Line: 12000	Line: 2000 (FX5-40SSC-G) Line: 2400 (FX5-80SSC-G) Others: Depends on the system configuration
Maximum station-to-station distance (m)	100	100	100	100
Max. number of networks	239	239	239	239
Network topology*3	Line*4, star*5	Line, star*5	Line, star*5	Line, star*5
Communication method	Time-sharing method	Time-sharing method	Time-sharing method	Time-sharing method
Maximum link points per network				
RX/RV	16384 points, 2 kbytes	8192 points, 1 kbyte (master station)	16384 points, 2 kbytes	8192 points, 1 kbyte
RWt/RWw	8192 points, 16 kbytes	4096 points, 8 kbytes (master station)	8192 points, 16 kbytes	1024 points, 2 kbytes
LB	32768 points, 4 kbytes	-	-	-
LW	16384 points, 32 kbytes	-	-	-
Maximum link points per station				
RX/RV	16384 points, 2 kbytes	8192 points, 1 kbyte (master station)	16384 points, 2 kbytes	8192 points, 1 kbyte
RWt/RWw	8192 points, 16 kbytes	4096 points, 8 kbytes (master station)	8192 points, 16 kbytes	1024 points, 2 kbytes
LB	32768 points, 4 kbytes	-	-	-
LW	16384 points, 32 kbytes	-	-	-
Safety communications				
Max. number of safety connections per station	-	-	120 connections	-
Max. number of link points per safety connection (word)	-	-	8 (input: 8, output: 8)	-
Transient transmission capacity				
Transient transmission capacity (byte)	Max. 1920	Max. 1920	Max. 1920	Max. 1920
EtherNet/IP™ communications				
Data transmission speed (bps)				
1G/100M				
Class 1 communications	Number of connections	• Instance communications: 256*6 • Tag communications: 256*6	-	-
	Communication data size (byte)	1444 (per connection)*7	-	-
	RPI (communication cycle) (ms)	0.5...60000 (in increments of 0.5 ms)	-	-
	PPS (communication processing performance)*8 (pps)	12000	-	-
UCMM communications	Number of connections (number of simultaneous executions)	• Server: 96*6*9 • Client: 32	-	-
	Communication data size (byte)	• Message communications: 504 (including headers) • Tag communications: 498	-	-
Class 3 communications	Number of connections	• Server: 96*6*9 • Client: 256*6	-	-
	Communication data size (byte)	• Message communications: 1404 (per connection) • Tag communications: 496 (per connection)	-	-

*1. For specifications of local station, please refer to the "MELSEC iQ-F FX5 User's Manual (CC-Link IE TSN) (SH-082215ENG)".

*2. Includes a master station.

*3. Please use a managed Ethernet switch supporting CC-Link IE TSN (class B) recommended by the CC-Link Partner Association.

*4. The CC-Link IE TSN Plus master/local module can only be connected at the end of the network.

*5. Line topology and star topology can be mixed.

*6. The total number of connections for Class 1 communications, UCMM tag communications (server function), and Class 3 communications is 256. Therefore, the number of each connection varies depending on the number and size of separate communications.

*7. If the external device does not support Large Forward Open (CIP option specifications), the communication data size is up to 504 bytes.

*8. PPS: Number of frames that can be processed per second

*9. The maximum number of simultaneous executions (the number of connections that can be received simultaneously) for the server function is 96 for the total of UCMM and Class 3 communications server functions.

■ Network topologies

■ Line topology

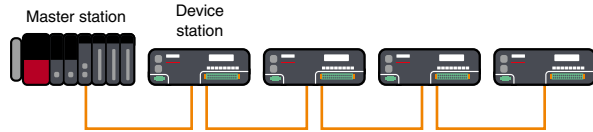

Network topology ideal for system configurations with high-speed/high-performance control

- High-speed communication is possible as the system is configured with CC-Link IE TSN-compatible device stations only
- Easier system configuration without an Ethernet switch
- Ideal for highly accurate motion control systems

■ Star topology

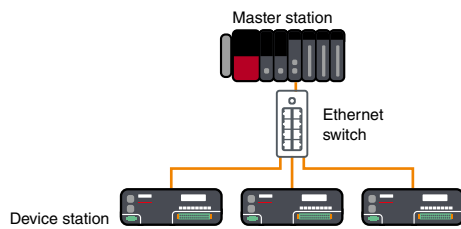

Network topology ideal for flexible system configurations

- Easily realizes distributed arrangement of device stations with an Ethernet switch
- Easy to change/rearrange equipment or system configuration
- Ideal for general production line control systems

■ Ring topology

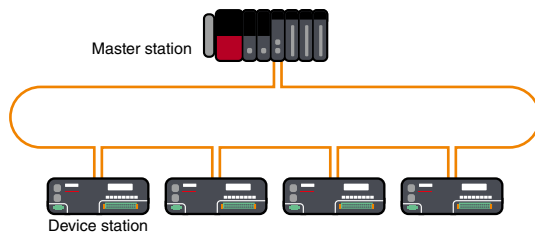

Network topology ideal for systems requiring high reliability*1

- Maintain data communications with normal stations even if a cable is disconnected or an error occurs in one of the device stations
- Configuration without requiring an Ethernet switch
- Ideal for continuously operating control system

*1. Mixing with star topology or line topology is not supported.

■CC-Link IE TSN Class

CC-Link IE TSN certifies nodes and switches to a specific class level according to its functionality and performance classification. Products can be classified as either class A or B. For the CC-Link IE TSN Class of each product, please check the CC-Link Partner Association website or the relevant product catalog or manual. Supported functions and system configuration may differ according to the CC-Link IE TSN Class of products used. For example, products compatible with class B are necessary to configure a high-speed motion control system. For details of configuring systems with both class A and class B devices, please refer to relevant master product manual.

■System configuration

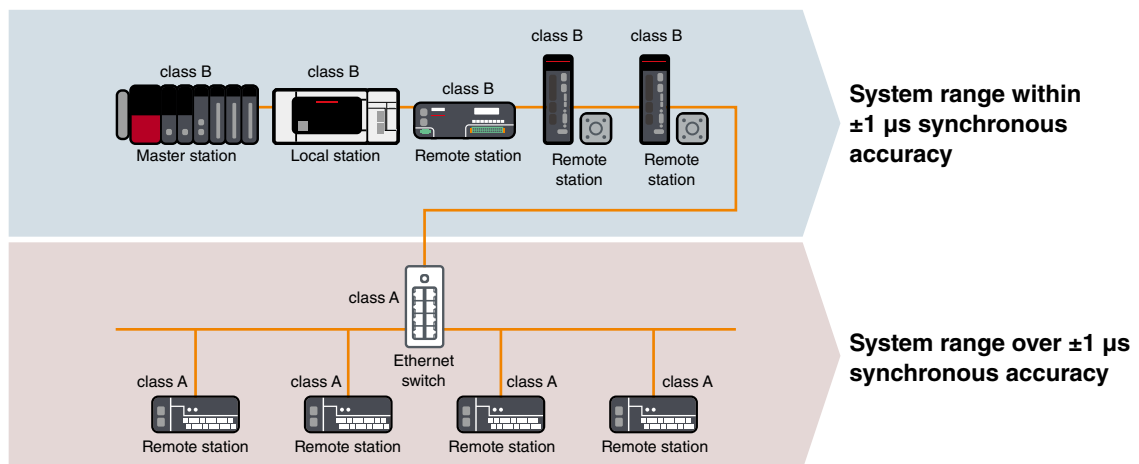

- Synchronous accuracy of a system varies relative to the combination of connected devices and switches
CC-Link IE TSN Class
- Use class B Ethernet switch when configuring a star topology with class B devices
- Use class B devices when configuring a system within $\pm 1 \mu\text{s}$ high-accuracy synchronization, connect class A devices to a separate branch line from class B devices (for details of system configuration, please refer to relevant master product manual)
- Mitsubishi Electric's block type remote modules comply both class B and A

Extensive global support coverage providing expert help whenever needed

Global FA centers

EMEA

Europe FA Center

MITSUBISHI ELECTRIC EUROPE B.V. Polish Branch

Tel: +48-12-347-65-00

Germany FA Center

MITSUBISHI ELECTRIC EUROPE B.V. German Branch

Tel: +49-2102-486-0 / Fax: +49-2102-486-7780

UK FA Center

MITSUBISHI ELECTRIC EUROPE B.V. UK Branch

Tel: +44-1707-27-8780 / Fax: +44-1707-27-8695

Czech Republic FA Center

MITSUBISHI ELECTRIC EUROPE B.V. Czech Branch

Tel: +420-734-402-587

Italy FA Center

MITSUBISHI ELECTRIC EUROPE B.V. Italian Branch

Tel: +39-039-60531 / Fax: +39-039-6053-312

Turkey FA Center

MITSUBISHI ELECTRIC TURKEY ELEKTRIK URUNLERI A.S.

Tel: +90-216-969-2500 / Fax: +90-216-661-4447

Asia-Pacific

China

Beijing FA Center

MITSUBISHI ELECTRIC AUTOMATION (CHINA) LTD. Beijing FA Center

Tel: +86-10-6518-8830 / Fax: +86-10-6518-2938

Guangzhou FA Center

MITSUBISHI ELECTRIC AUTOMATION (CHINA) LTD. Guangzhou FA Center

Tel: +86-20-8923-6730 / Fax: +86-20-8923-6715

Shanghai FA Center

MITSUBISHI ELECTRIC AUTOMATION (CHINA) LTD. Shanghai FA Center

Tel: +86-21-2322-3030 / Fax: +86-21-2322-3000

Tianjin FA Center

MITSUBISHI ELECTRIC AUTOMATION (CHINA) LTD. Tianjin FA Center

Tel: +86-22-2813-1015 / Fax: +86-22-2813-1017

Taipei FA Center

SETSUYO ENTERPRISE CO., LTD.

Tel: +886-2-2299-9917 / Fax: +886-2-2299-9963

Korea

Korea FA Center

MITSUBISHI ELECTRIC AUTOMATION KOREA CO., LTD.

Tel: +82-2-3660-9632 / Fax: +82-2-3664-0475

Thailand

Thailand FA Center

MITSUBISHI ELECTRIC FACTORY AUTOMATION (THAILAND) CO., LTD.

Tel: +66-2682-6522-31 / Fax: +66-2682-6020

ASEAN

ASEAN FA Center

MITSUBISHI ELECTRIC ASIA PTE. LTD.

Tel: +65-6470-2480 / Fax: +65-6476-7439

Malaysia

Malaysia FA Center

Malaysia FA Center

Tel: +60-3-7626-5080 / Fax: +60-3-7658-3544

Indonesia

Indonesia FA Center

PT. MITSUBISHI ELECTRIC INDONESIA Cikarang Office

Tel: +62-21-2961-7797 / Fax: +62-21-2961-7794

Vietnam

Hanoi FA Center

MITSUBISHI ELECTRIC VIETNAM COMPANY LIMITED Hanoi Branch Office

Tel: +84-24-3937-8075 / Fax: +84-24-3937-8076

Ho Chi Minh FA Center

MITSUBISHI ELECTRIC VIETNAM COMPANY LIMITED

Tel: +84-28-3910-5945 / Fax: +84-28-3910-5947

Philippines

Philippines FA Center

MELCO Factory Automation Philippines Inc.

Tel: +63-(0)2-8256-8042

India

India Ahmedabad FA Center

MITSUBISHI ELECTRIC INDIA PVT. LTD. Ahmedabad Branch

Tel: +91-7965120063

India Bangalore FA Center

MITSUBISHI ELECTRIC INDIA PVT. LTD. Bangalore Branch

Tel: +91-80-4020-1600 / Fax: +91-80-4020-1699

India Chennai FA Center

MITSUBISHI ELECTRIC INDIA PVT. LTD. Chennai Branch

Tel: +91-4445548772 / Fax: +91-4445548773

India Coimbatore FA Center

MITSUBISHI ELECTRIC INDIA PVT. LTD. Coimbatore Branch

Tel: +91-422-438-5606

India Gurgaon FA Center

MITSUBISHI ELECTRIC INDIA PVT. LTD. Gurgaon Head Office

Tel: +91-124-463-0300 / Fax: +91-124-463-0399

India Pune FA Center

MITSUBISHI ELECTRIC INDIA PVT. LTD. Pune Branch

Tel: +91-20-2710-2000 / Fax: +91-20-2710-2100

Americas

USA

North America FA Center

MITSUBISHI ELECTRIC AUTOMATION, INC.

Tel: +1-847-478-2469 / Fax: +1-847-478-2253

Mexico

Mexico City FA Center

MITSUBISHI ELECTRIC AUTOMATION, INC. Mexico Branch

Tel: +52-55-3067-7500

Mexico FA Center

MITSUBISHI ELECTRIC AUTOMATION, INC. Queretaro Office

Tel: +52-442-153-6014

Mexico Monterrey FA Center

MITSUBISHI ELECTRIC AUTOMATION, INC. Monterrey Office

Tel: +52-55-3067-7599

Brazil

Brazil FA Center

MITSUBISHI ELECTRIC DO BRASIL COMERCIO E SERVICOS LTDA.

Tel: +55-11-4689-3000 / Fax: +55-11-4689-3016

CC-Link Partner Association (CLPA) - Actively promoting worldwide adoption of CC-Link networks

Proactively supporting CC-Link, from promotion to specification development

The CC-Link Partner Association (CLPA) was established to promote the worldwide adoption of the CC-Link open-field network. By conducting promotional activities such as organizing trade shows and seminars, conducting conformance tests, and providing catalogs, brochures and website information, CLPA activities are successfully increasing the number of CC-Link partner manufacturers and CC-Link-compatible products. As such, CLPA is playing a major role in the globalization of CC-Link.



Seminar

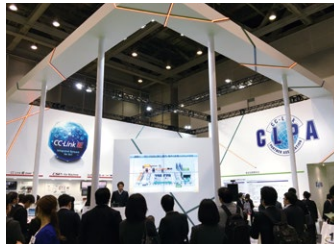

Trade show



Conformance testing lab

Visit the CLPA website for the latest CC-Link information.



CLPA website
www.cc-link.org/en



CLPA Headquarters

6F Ozone Front Bldg. 3-15-58 Ozone
Kita-ku, Nagoya 462-0825, JAPAN
TEL: +81-52-919-1588 FAX: +81-52-916-8655
e-mail: info@cc-link.org

Global influence of CC-Link continues to spread

CC-Link is supported globally by CLPA. With offices throughout the world, support for partner companies can be found locally. Each regional CLPA office undertakes various support and promotional activities to further the influence of CC-Link/CC-Link IE in that part of the world. For companies looking to increase their presence in their local area, CLPA is well placed to assist these efforts through offices in all major regions.

CLPA-Europe (Germany) **CT**

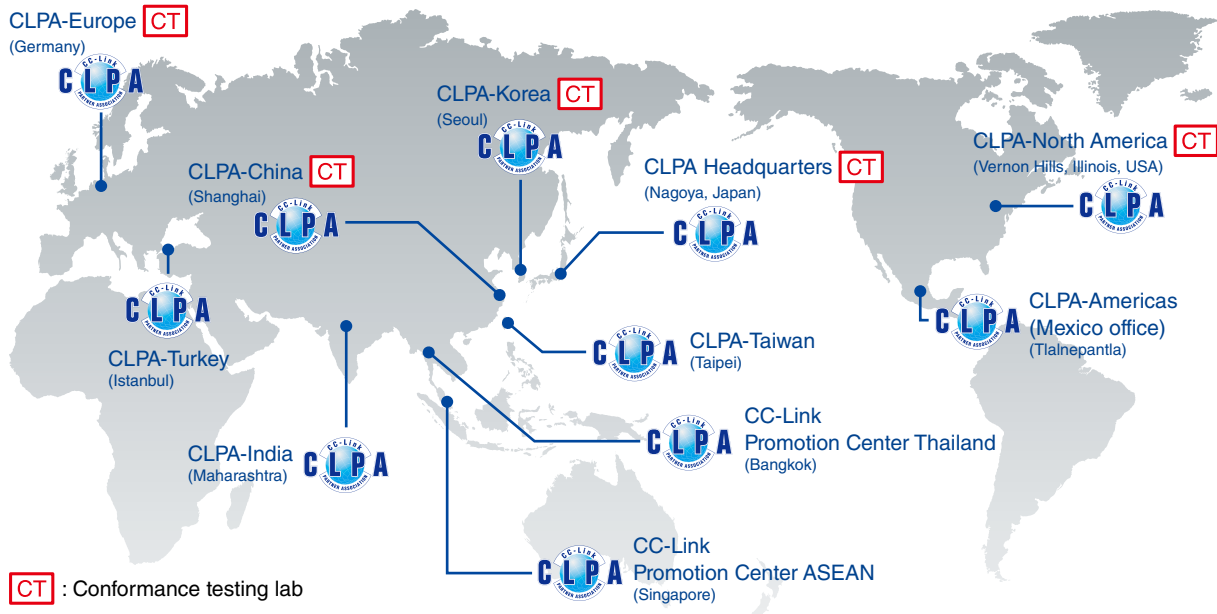

CT : Conformance testing lab

Discover the latest information in Factory Automation

Factory Automation Global website

Mitsubishi Electric Factory Automation provides a mix of services to support its customers worldwide. A consolidated global website is the main portal, offering a selection of support tools and a window to its local Mitsubishi Electric sales and support network.

From here you can find:

- Overview of available factory automation products
- Library of downloadable literature
- Support tools such as online e-learning courses, terminology dictionary, etc.
- Global sales and service network portal
- Latest news related to Mitsubishi Electric factory automation

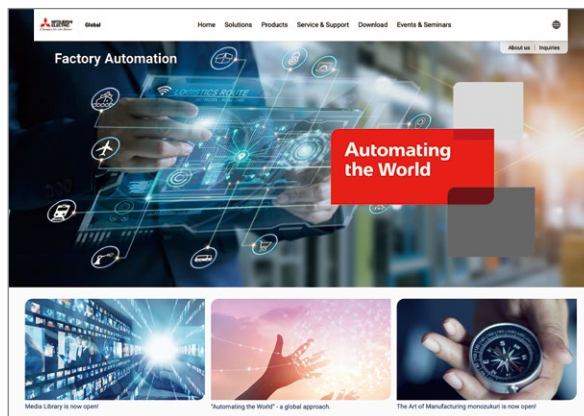

Mitsubishi Electric Factory Automation
Global website:
www.MitsubishiElectric.com/fa

Online e-learning

An extensive library of e-learning courses covering the factory automation product range has been prepared. Courses from beginner to advanced levels of difficulty are available in various languages.



Beginner level

Designed for newcomers to Mitsubishi Electric Factory Automation products gaining a background of the fundamentals and an overview of various products related to the course.

Basic to Advanced levels

These courses are designed to provide education at all levels. Various different features are explained with application examples providing an easy and informative resource for in-house company training.

Find information on products, factory automation, e-F@ctory solutions and other topics

Follow us on Social Media

YouTube



LinkedIn



Twitter



Innovative next-generation, e-Manual

e-Manual Viewer

The e-Manual viewer is a next-generation digital manual offered by Mitsubishi Electric that consolidates factory automation products manuals into an easy-to-use package with various useful features integrated into the viewer. The e-Manual allows multiple manuals to be cross-searched at once, further reducing time for setting up products and troubleshooting.

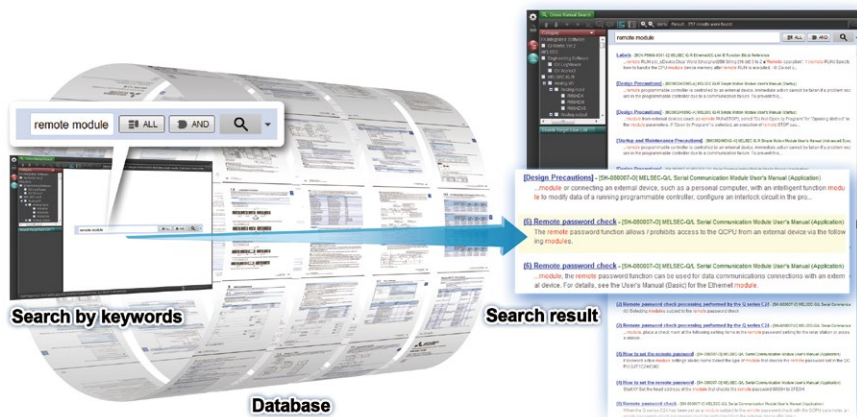

Key features included

- One-stop database containing all required manuals, with local file cache
- Included with GX Works3 engineering software
- Also available in tablet version
- Easily download manuals all at once
- Multiple users can share the latest manuals and knowhow with document sharing function
- Directly port sample programs within manuals to GX Works3
- Downloaded manuals are usable offline

Windows[®]-compliant



e-Manual Create

e-Manual Create is software for converting word files and chm files to e-Manual documents. e-Manual Create allows users to directly refer to Mitsubishi Electric e-Manuals from user's customized device maintenance manuals and such, supporting quick troubleshooting and reduction in document creation process.

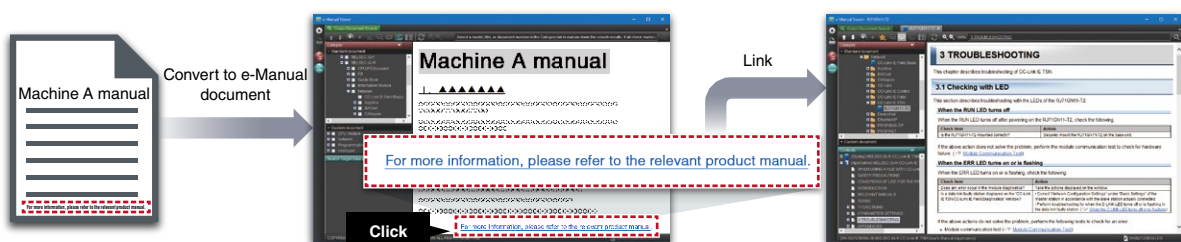

Windows[®]-compliant



* To obtain the Windows[®] version of e-Manual Viewer and e-Manual Create, please contact your local Mitsubishi Electric sales office or representative.

Product list

Model name	Outline	Station type			CC-Link IE TSN Class
		Master station	Local station	Remote station	
MELSEC iQ-R Series master/local module					
RJ71GN11-T2	Maximum number of connected stations: 121	●	●	-	B
MELSEC iQ-R Series CC-Link IE TSN Plus master/local module					
RJ71GN11-EIP	Maximum number of connected stations: 121; EtherNet/IP™-compatible	●	●	-	B
MELSEC iQ-F Series master/local module					
FX5-CCLGN-MS	Maximum number of connected stations: 61**	●	●	-	B
MELSEC iQ-R Series motion module					
RD78G4	Maximum number of control axes: 4	●	-	-	B
RD78G8	Maximum number of control axes: 8	●	-	-	
RD78G16	Maximum number of control axes: 16	●	-	-	
RD78G32	Maximum number of control axes: 32	●	-	-	
RD78G64	Maximum number of control axes: 64	●	-	-	
RD78GHV	High-performance type; Maximum number of control axes: 128	●	-	-	
RD78GHW	High-performance type; Maximum number of control axes: 256	●	-	-	
MELSEC iQ-F Series motion module					
FX5-40SSC-G	Maximum number of control axes: 4	●	-	-	B
FX5-80SSC-G	Maximum number of control axes: 8	●	-	-	
Motion control software SWM-G					
SW1DNN-SWMG-M**2	Motion control software	●	-	-	B
USB keys for motion control software					
MR-SWMG16-U	Maximum number of control axes: 16	-	-	-	-
MR-SWMG32-U	Maximum number of control axes: 32	-	-	-	-
MR-SWMG64-U	Maximum number of control axes: 64	-	-	-	-
MR-SWMG128-U	Maximum number of control axes: 128	-	-	-	-
AC servo					
MR-J5-G	MELSERVO-J5 Series servo amplifier	-	-	●	B
MR-J5W2-G	MELSERVO-J5 Series 2-axis servo amplifier	-	-	●	
MR-J5W3-G	MELSERVO-J5 Series 3-axis servo amplifier	-	-	●	
MR-J5-G-RJ	MELSERVO-J5 Series servo amplifier fully closed loop control 4-wire; load-side encoder A/B/Z-phase input supported; Safety sub-function	-	-	●	
MR-J5D-G4	MELSERVO-J5 Series drive unit (1/2/3-axis)	-	-	●	
MR-JET-G	MELSERVO-JET Series servo amplifier	-	-	●	
Inverter					
FR-A800-GN	FREQROL-A800 Series inverter	-	-	●	B
FR-A8NCG	Integrated option for FREQROL-A800 and FREQROL-F800 Series	-	-	●	
FR-E800-E	FREQROL-E800 Series inverter	-	-	●	A
FR-E800-SCE	FREQROL-E800 sub-function supported inverter	-	-	●	
Robot					
CR800-R	MELSEC iQ-R Series-compatible robot controller FR Series*3	*4	*4	*4	B
HMI GOT2000 Series					
GT25-J71GN13-T2	CC-Link IE TSN communication unit Supported models: GT27, GT25*5	-	●	-	B

*1. For specifications of local station, please refer to the "MELSEC iQ-F FX5 User's Manual (CC-Link IE TSN) (SH(NA)-082215ENG)".

*2. For information on how to obtain the software, please contact your local Mitsubishi Electric sales office or representative.

*3. CR800-R controllers with version C2 or later, produced in or after April 2021 are supported.

*4. MELSEC iQ-R Series master/local module (RJ71GN11-T2) is separately required.

*5. Not all GT25 models are supported, for more information, please refer to "GOT2000 Series catalog (L (NA) 08270ENG)".

Type	Model name	Outline	Station type			CC-Link IE TSN Class
			Master station	Local station	Remote station	
Block-type remote module						
DC input	NZ2GN2S1-16D	16 points; 24 V DC; Response time: 0...70 ms; Positive/negative common shared; Spring-clamp terminal block; 1-wire	-	-	●	B/A
	NZ2GN2S1-32D	32 points; 24 V DC; Response time: 0...70 ms; Positive/negative common shared; Spring-clamp terminal block; 1-wire	-	-	●	
	NZ2GN2B1-16D	16 points; 24 V DC; Response time: 0...70 ms; Positive/negative common shared; Screw terminal block; 1-wire	-	-	●	
	NZ2GN2B1-32D	32 points; 24 V DC; Response time: 0...70 ms; Positive/negative common shared; Screw terminal block; 1-wire	-	-	●	
	NZ2GNCE3-32D	32 points; 24 V DC; Response time: 0...70 ms; Positive common; Sensor connector (e-CON); 3-wire	-	-	●	
	NZ2GNCF1-32D	32 points; 24 V DC; Response time: 0...70 ms; Positive/negative common; 40-pin connector; 1-wire	-	-	●	
Transistor output	NZ2GN2S1-16T	16 points; 12/24 V DC; Sink; Spring-clamp terminal block; 1-wire	-	-	●	
	NZ2GN2S1-16TE	16 points; 12/24 V DC; Source; Spring-clamp terminal block; 1-wire	-	-	●	
	NZ2GN2S1-32T	32 points; 12/24 V DC; Sink; Spring-clamp terminal block; 1-wire	-	-	●	
	NZ2GN2S1-32TE	32 points; 12/24 V DC; Source; Spring-clamp terminal block; 1-wire	-	-	●	
	NZ2GN2B1-16T	16 points; 12/24 V DC; Sink; Screw terminal block; 1-wire	-	-	●	
	NZ2GN2B1-16TE	16 points; 12/24 V DC; Source; Screw terminal block; 1-wire	-	-	●	
	NZ2GN2B1-32T	32 points; 12/24 V DC; Sink; Screw terminal block; 1-wire	-	-	●	
	NZ2GN2B1-32TE	32 points; 12/24 V DC; Source; Screw terminal block; 1-wire	-	-	●	
I/O combined	NZ2GN2S1-32DT	[Input] 16 points; 24 V DC; Response time: 0...70 ms; Positive common [Output] 16 points; 24 V DC; Sink Spring-clamp terminal block; 1-wire	-	-	●	
	NZ2GN2S1-32DTE	[Input] 16 points; 24 V DC; Response time: 0...70 ms; Negative common [Output] 16 points; 24 V DC; Source Spring-clamp terminal block; 1-wire	-	-	●	
	NZ2GN2B1-32DT	[Input] 16 points; 24 V DC; Response time: 0...70 ms; Positive common [Output] 16 points; 24 V DC; Sink Screw terminal block; 1-wire	-	-	●	
	NZ2GN2B1-32DTE	[Input] 16 points; 24 V DC; Response time: 0...70 ms; Negative common [Output] 16 points; 24 V DC; Source Screw terminal block; 1-wire	-	-	●	
	NZ2GNCE3-32DT	[Input] 16 points; 24 V DC; Response time: 0...70 ms; Positive common [Output] 16 points; 24 V DC; Sink Sensor connector (e-CON); 3-wire	-	-	●	
Analog input	NZ2GN2S-60AD4	4 channels; Input: -10...10 V DC, 0...20 mA DC; Conversion speed: 200 μs/CH; Spring-clamp terminal block	-	-	●	
	NZ2GN2B-60AD4	4 channels; Input: -10...10 V DC, 0...20 mA DC; Conversion speed: 200 μs/CH; Screw terminal block	-	-	●	
Analog output	NZ2GN2S-60DA4	4 channels; Output: -10...10 V DC, 0...20 mA DC; Conversion speed: 200 μs/CH; Spring-clamp terminal block	-	-	●	
	NZ2GN2B-60DA4	4 channels; Output: -10...10 V DC, 0...20 mA DC; Conversion speed: 200 μs/CH; Screw terminal block	-	-	●	
Waterproof/dustproof type (IP67) remote module						
DC input	NZ2GN12A4-16D	16 points; 24 V DC; Response time: 0...70 ms; Positive common; Waterproof connector; 2- to 4-wire	-	-	●	B/A
	NZ2GN12A4-16DE	16 points; 24 V DC; Response time: 0...70 ms; Negative common; Waterproof connector; 2- to 4-wire	-	-	●	
Transistor output	NZ2GN12A2-16T	16 points; 12/24 V DC; Sink; Waterproof connector; 2-wire	-	-	●	
	NZ2GN12A2-16TE	16 points; 12/24 V DC; Source; Waterproof connector; 2-wire	-	-	●	
I/O combined	NZ2GN12A42-16DT	[Input] 8 points; 24 V DC; Response time: 0...70 ms; Positive common; 2- to 4-wire [Output] 8 points; 12/24 V DC; Sink; 2-wire Waterproof connector	-	-	●	
	NZ2GN12A42-16DTE	[Input] 8 points; 24 V DC; Response time: 0...70 ms; Negative common; 2- to 4-wire [Output] 8 points; 12/24 V DC; Source; 2-wire Waterproof connector	-	-	●	

Type	Model name	Outline	Station type			CC-Link IE TSN Class
			Master station	Device station		
				Local station	Remote station	
FPGA module NEW						
DC input/output	NZ2GN2S-D41P01 NEW	[Input] 48 points; 24 V DC; Response time: 1 μs or less; Positive/negative common shared [Output] 48 points; 5/12/24 V DC; Sink	-	-	●	B/A
Differential input/output	NZ2GN2S-D41D01 NEW	[Differential (RS-422) input] 24 points; Response time: 0.2 μs or less [Differential (RS-422) output] 24 points [Differential (RS-485) input/output] 3 points	-	-	●	
DC input/output, differential input/output	NZ2GN2S-D41PD02 NEW	[Input] 32 points; 24 V DC; Response time: 1 μs or less; Positive/negative common shared [Output] 32 points; 5/12/24 V DC; Sink [Differential (RS-422) input] 8 points; Response time: 0.2 μs or less [Differential (RS-422) output] 8 points [Differential (RS-485) input/output] 1 point	-	-	●	
DC input/output	NZ2EX2S-D41P01 NEW	[Input] 48 points; 24 V DC; Response time: 1 μs or less; Positive/negative common shared [Output] 48 points; 5/12/24 V DC; Sink	-	-	●	
Differential input/output	NZ2EX2S-D41D01 NEW	[Differential (RS-422) input] 24 points; Response time: 0.2 μs or less [Differential (RS-422) output] 24 points [Differential (RS-485) input/output] 3 points	-	-	●	
Analog input/output	NZ2EX2S-D41A01 NEW	[Input] 36 points; -9.9...9.9 V DC, -19.8...19.8 mA DC [Output] 6 points; -9.9...9.9 V DC, 0.2...19.8 mA DC	-	-	●	
Block-type remote module with safety functions						
DC input	NZ2GNSS2-8D	Single wiring: 8 points; Double wiring: 4 points; 24 V DC; Response time: 1...70 ms; Negative common; Spring-clamp terminal block; 2-wire	-	-	●	B/A
Transistor output	NZ2GNSS2-8TE	Single wiring: 8 points; Double wiring: 4 points; 24 V DC; Source + source; Spring-clamp terminal block; 2-wire	-	-	●	
I/O combined	NZ2GNSS2-16DTE	[Input] Single wiring: 8 points; Double wiring: 4 points; 24 V DC; Response time: 1...70 ms; Negative common [Output] Single wiring: 8 points; Double wiring: 4 points; 24 V DC Source + source; Spring-clamp terminal block; 2-wire	-	-	●	
Waterproof/dustproof type (IP67) I/O combined	NZ2GNS12A2-14DT	[Input] Single wiring: 12 points; Double wiring: 6 points; 24 V DC; Response time: 1...70 ms; Negative common [Output] Single wiring not possible; Double wiring: 2 points; 24 V DC Source + sink; Waterproof connector; 2-wire	-	-	●	
	NZ2GNS12A2-16DTE	[Input] Single wiring: 12 points; Double wiring: 6 points; 24 V DC; Response time: 1...70 ms; Negative common [Output] Single wiring: 4 points; Double wiring: 2 points; 24 V DC Source + source; Waterproof connector; 2-wire	-	-	●	
Managed Ethernet switch						
NZ2MHG-TSNT4		10 Mbps/100 Mbps/1 Gbps; Auto MDI/MDI-X; DIN rail; 4 ports	-	-	-	B/A
NZ2MHG-TSNT8F2		10 Mbps/100 Mbps/1 Gbps; Auto MDI/MDI-X; DIN rail; 8 ports	-	-	-	
Bridge module						
NZ2GN-GFB NEW		CC-Link IE TSN-CC-Link IE Field Network bridge module	-	-	●	B/A
NZ2AW1GNAL		CC-Link IE TSN-AnyWireASLINK bridge module	-	-	●	B/A

Partner products

Model name	Outline	CC-Link IE TSN Class
Industrial switching hub		
DT135TXA	10 Mbps/100 Mbps/1 Gbps Auto MDI/MDI-X; DIN rail; 5 ports; manufactured by Mitsubishi Electric System & Service Co., Ltd.	A
Ethernet cable		
SC-E5EW-S□M	Double shielded cable; Category 5e; for indoor use; manufactured by Mitsubishi Electric System & Service Co., Ltd.	-
SC-E5EW-S□M-MV	Double shielded cable; Category 5e; for indoor movable part; manufactured by Mitsubishi Electric System & Service Co., Ltd.	-
SC-E5EW-S□M-L	Double shielded cable; Category 5e; for indoor/outdoor use; manufactured by Mitsubishi Electric System & Service Co., Ltd.	-
Inline coupler		
SPAD-RJ45S-E5E	RJ-45 connector with shield 2 pieces; manufactured by Mitsubishi Electric System & Service Co., Ltd.	-

Development kits/communication software

Type	Model	Outline	CC-Link IE TSN Class
Master station communication LSI	NZ2GACP610-60	Dedicated communication LSI (CP610) 60 pieces	*1
Master station software development kit	SW1DTD-GNSDK1M-M*2	Library with source code provided; "INtime" version	
	SW1DTD-GNSDK2M-M*2	Library provided; "INtime" version	
Remote station communication LSI	NZ2GACP620-60	Communication LSI embedded with GbE-PHY (CP620) 60 pieces	*1
	NZ2GACP620-300	Communication LSI embedded with GbE-PHY (CP620) 300 pieces	
CC-Link IE TSN communication software for Windows®	SW1DND-CCIETCT-M	Computer-based CC-Link IE TSN data collection software	-

*1. Can be used for development of class B.

*2. Contract is necessary to purchase a software development kit (SDK). For further details, please contact your local Mitsubishi Electric office or representative.

CANopen is a registered trademark of CAN in Automation e.V.
Edgexcross is a registered trademark of the Edgexcross Consortium.
EtherNet/IP is a trademarks of ODVA, Inc.
IOS is a registered trademark or trademark of Cisco Systems, Inc. and/or its affiliates in the United States and certain other countries.
Microsoft and Windows are trademarks of the Microsoft group of companies.
OPC UA logo is a registered trademark of OPC Foundation.
PCI Express is a registered trademark of PCI-SIG.
The name PLCopen® is a registered trademark owned by the association PLCopen.
QR Code is a trademark or a registered trademark of DENSO WAVE INCORPORATED in JAPAN, the United States and/or other countries.
All other company names and product names used in this document are trademarks or registered trademarks of their respective companies.
Trademark symbols such as "™" and "®" might be omitted in this document.

Precautions before use

This publication explains the typical features and functions of the products herein and does not provide restrictions or other information related to usage and module combinations. Before using the products, always read the product user manuals. Mitsubishi Electric will not be held liable for damage caused by factors found not to be the cause of Mitsubishi Electric; opportunity loss or lost profits caused by faults in Mitsubishi Electric products; damage, secondary damage, or accident compensation, whether foreseeable or not, caused by special factors; damage to products other than Mitsubishi Electric products; or any other duties.

For safe use

- To use the products given in this publication properly, always read the relevant manuals before beginning operation.
- The products have been manufactured as general-purpose parts for general industries, and are not designed or manufactured to be incorporated in a device or system used in purposes related to human life.
- Before using the products for special purposes such as nuclear power, electric power, aerospace, medicine or passenger-carrying vehicles, consult with Mitsubishi Electric.
- The products have been manufactured under strict quality control. However, when installing the products where major accidents or losses could occur if the products fail, install appropriate backup or fail-safe functions in the system.

Creating Solutions Together.



Low-voltage Power Distribution Products



Transformers, Med-voltage Distribution Products



Power Monitoring and Energy Saving Products



Power (UPS) and Environmental Products



Compact and Modular Controllers



Servos, Motors and Inverters



Visualization: HMIs



Edge Computing Products



Numerical Control (NC)



Collaborative and Industrial Robots



Processing machines: EDM, Lasers



SCADA, analytics and simulation software

Mitsubishi Electric's product lineup, from various controllers and drives to energy-saving devices and processing machines, all help you to automate your world. They are underpinned by software, innovative data monitoring, and modelling systems supported by advanced industrial networking and Edgecross IT/OT connectivity. Together with a worldwide partner ecosystem, Mitsubishi Electric factory automation (FA) has everything to make IoT and Digital Manufacturing a reality.

With a complete portfolio and comprehensive capabilities that combine synergies with diverse business units, Mitsubishi Electric provides a one-stop approach to how companies can tackle the shift to clean energy and energy conservation, carbon neutrality and sustainability, which are now a universal requirement of factories, buildings, and social infrastructure.

We at Mitsubishi Electric FA are your solution partners waiting to work with you as you take a step toward the realization of sustainable manufacturing and society through the application of automation. Let's automate the world together!

Country/Region, Sales office, Tel/Fax

<p>USA mitsubishi electric automation, inc. 500 Corporate Woods Parkway, Vernon Hills, IL 60061, U.S.A. Tel :+1-847-478-2100 Fax:+1-847-478-2253</p>	<p>Mexico mitsubishi electric automation, inc. Mexico Branch Boulevard Miguel de Cervantes Saavedra 301, Torre Norte Piso 5, Int. 502, Ampliacion Granada, Miguel Hidalgo, Ciudad de Mexico, Mexico, C.P.11520 Tel :+52-55-3067-7500</p>	<p>Brazil mitsubishi electric do brasil comercio e servicos ltda. Avenida Adelino Cardana, 293, 21 andar, Bethaville, Barueri SP, Brasil Tel :+55-11-4689-3000 Fax:+55-11-4689-3016</p>
<p>Germany mitsubishi electric europe b.v. German Branch Mitsubishi-Electric-Platz 1, 40882 Ratingen, Germany Tel :+49-2102-486-0 Fax:+49-2102-486-7780</p>	<p>UK mitsubishi electric europe b.v. UK Branch Travellers Lane, UK-Hatfield, Hertfordshire, AL10 8XB, U.K. Tel :+44-1707-28-8780 Fax:+44-1707-27-8695</p>	<p>Ireland mitsubishi electric europe b.v. Irish Branch Westgate Business Park, Ballymount, Dublin 24, Ireland Tel :+353-1-4198800 Fax:+353-1-4198890</p>
<p>Italy mitsubishi electric europe b.v. Italian Branch Campus, Energy Park Via Energy Park 14, Vimercate 20871 (MB) Italy Tel :+39-039-60531 Fax:+39-039-6053-312</p>	<p>Spain mitsubishi electric europe, b.v. Spanish Branch Carretera de Rubi, 76-80-Appdo. 420, E-08190 Sant Cugat del Valles (Barcelona), Spain Tel :+34-935-65-3131 Fax:+34-935-89-1579</p>	<p>France mitsubishi electric europe b.v. French Branch 25, Boulevard des Bouvets, 92741 Nanterre Cedex, France Tel :+33-1-55-68-55-68 Fax:+33-1-55-68-57-57</p>
<p>Czech Republic mitsubishi electric europe b.v. Czech Branch Pekarska 621/7, 155 00 Praha 5, Czech Republic Tel :+420-734-402-587</p>	<p>Poland mitsubishi electric europe b.v. Polish Branch ul. Krakowska 48, 32-083 Balice, Poland Tel :+48-12-347-65-00</p>	<p>Sweden mitsubishi electric europe b.v. (Scandinavia) Hedvig Mollersgata 6, 223 55 Lund, Sweden Tel :+46-8-625-10-00 Fax:+46-46-39-70-18</p>
<p>Turkey mitsubishi electric turkey elektrik urunleri a.s. Serifali Mahallesi Kale Sokak No:41 Umraniye / Istanbul Tel :+90-216-969-2500 Fax:+90-216-661-4447</p>	<p>UAE mitsubishi electric europe b.v. Dubai Branch Dubai Silicon Oasis, P.O.BOX 341241, Dubai, U.A.E. Tel :+971-4-3724716 Fax:+971-4-3724721</p>	<p>South Africa ADROIT TECHNOLOGIES 20 Waterford Office Park, 189 Witkoppen Road, Fourways, South Africa Tel :+27-11-658-8100 Fax:+27-11-658-8101</p>
<p>China mitsubishi electric automation (china) ltd. Mitsubishi Electric Automation Center, No.1386 Hongqiao Road, Shanghai, China Tel :+86-21-2322-3030 Fax:+86-21-2322-3000</p>	<p>Taiwan SETSUYO ENTERPRISE CO., LTD. 6F, No.105, Wugong 3rd Road, Wugu District, New Taipei City 24889, Taiwan Tel :+886-2-2299-2499 Fax:+886-2-2299-2509</p>	<p>Korea mitsubishi electric automation korea co., ltd. 7F to 9F, Gangseo Hangang Xi-tower A, 401, Yangcheon-ro, Gangseo-Gu, Seoul 07528, Korea Tel :+82-2-3660-9569 Fax:+82-2-3664-8372</p>
<p>Singapore mitsubishi electric asia pte. ltd. 307 Alexandra Road, Mitsubishi Electric Building, Singapore 159943 Tel :+65-6473-2308 Fax:+65-6476-7439</p>	<p>Thailand mitsubishi electric factory automation (thailand) co., ltd. 101, True Digital Park Office, 5th Floor, Sukhumvit Road, Bang Chak, Prakanong, Bangkok, Thailand Tel :+66-2682-6522-31 Fax:+66-2682-6020</p>	<p>Vietnam mitsubishi electric vietnam company limited 11th & 12th Floor, Viettel Tower B, 285 Cach Mang Thang 8 Street, Ward 12, District 10, Ho Chi Minh City, Vietnam. Tel :+84-28-3910-5945 Fax:+84-28-3910-5947</p>
<p>Indonesia PT. MITSUBISHI ELECTRIC INDONESIA Gedung Jaya 8th Floor, JL. MH. Thamrin No.12, Jakarta Pusat 10340, Indonesia Tel :+62-21-31926461 Fax:+62-21-31923942</p>	<p>India mitsubishi electric india pvt. ltd. Pune Branch Emerald House, EL-3, J Block, M.I.D.C., Bhosari, Pune-411026, Maharashtra, India Tel :+91-20-2710-2000 Fax:+91-20-2710-2100</p>	<p>Australia mitsubishi electric australia Pty. Ltd. 348 Victoria Road, P.O. Box 11, Rydalmere, N.S.W 2116, Australia Tel :+61-2-9684-7777 Fax:+61-2-9684-7245</p>



Mitsubishi Electric's e-F@ctory concept utilizes both FA and IT technologies, to reduce the total cost of development, production and maintenance, with the aim of achieving manufacturing that is a "step ahead of the times". It is supported by the e-F@ctory Alliance Partners covering software, devices, and system integration, creating the optimal e-F@ctory architecture to meet the end users needs and investment plans.



MITSUBISHI ELECTRIC CORPORATION
 HEAD OFFICE: TOKYO BLDG., 2-7-3, MARUNOUCHI, CHIYODA-KU, TOKYO 100-8310, JAPAN