

Programmable Controller

CC-Link IE Field Network
Analog-Digital Converter Module (e-CON Type)
User's Manual

-NZ2GFCE-60ADV8
-NZ2GFCE-60ADI8



SAFETY PRECAUTIONS

(Read these precautions before using this product.)

Before using this product, please read this manual and the relevant manuals carefully and pay full attention to safety to handle the product correctly.

The precautions given in this manual are concerned with this product only. For the safety precautions of the programmable controller system, refer to the user's manual for the CPU module used.

In this manual, the safety precautions are classified into two levels: "⚠️ WARNING" and "⚠️ CAUTION".

 WARNING	Indicates that incorrect handling may cause hazardous conditions, resulting in death or severe injury.
 CAUTION	Indicates that incorrect handling may cause hazardous conditions, resulting in minor or moderate injury or property damage.

Under some circumstances, failure to observe the precautions given under "⚠️ CAUTION" may lead to serious consequences.

Observe the precautions of both levels because they are important for personal and system safety.

Make sure that the end users read this manual and then keep the manual in a safe place for future reference.

[Design Precautions]

-  **WARNING**
- When a communication failure occurs in the network, data in the master module are held. Check Data link status (each station) (SW00B0 to SW00B7) and configure an interlock circuit in the program to ensure that the entire system will operate safely.
 - Do not use any "use prohibited" signals as a remote I/O signal since they are used by the system. Do not write any data to the "use prohibited" areas in the remote register. Doing so may result in an accident due to an incorrect output or malfunction.
-

[Design Precautions]

-  **CAUTION**
- Do not install the control lines or communication cables together with the main circuit lines or power cables. Keep a distance of 100mm or more between them. Failure to do so may result in malfunction due to noise.
-

[Security Precautions]

WARNING

- To maintain the security (confidentiality, integrity, and availability) of the programmable controller and the system against unauthorized access, denial-of-service (DoS) attacks, computer viruses, and other cyberattacks from external devices via the network, take appropriate measures such as firewalls, virtual private networks (VPNs), and antivirus solutions.
-

[Installation Precautions]

WARNING

- Shut off the external power supply (all phases) used in the system before mounting or removing a module. Failure to do so may result in electric shock or cause the module to fail or malfunction.
-

[Installation Precautions]

CAUTION

- Use the module in an environment that meets the general specifications in this manual. Failure to do so may result in electric shock, fire, malfunction, or damage to or deterioration of the product.
 - Do not directly touch any conductive parts and electronic components of the module. Doing so can cause malfunction or failure of the module.
 - Securely connect the cable connectors. Poor contact may cause malfunction.
-

[Wiring Precautions]

WARNING

- Shut off the external power supply (all phases) used in the system before wiring. Failure to do so may result in electric shock or cause the module to fail or malfunction.
-

[Wiring Precautions]

CAUTION

- Check the rated voltage and terminal layout before wiring to the module, and connect the cables correctly. Connecting a power supply with a different voltage rating or incorrect wiring may cause a fire or failure.
 - Prevent foreign matter such as dust or wire chips from entering the module. Such foreign matter can cause a fire, failure, or malfunction.
 - Place the cables in a duct or clamp them. If not, dangling cable may swing or inadvertently be pulled, resulting in damage to the module or cables or malfunction due to poor contact.
 - Do not install the control lines or communication cables together with the main circuit lines or power cables. Keep a distance of 100mm or more between them. Failure to do so may result in malfunction due to noise.
 - When disconnecting the cable from the module, do not pull the cable by the cable part. For the cable with connector, hold the connector part of the cable.
 - When an overcurrent caused by an error of an external device or a failure of the programmable controller flows for a long time, it may cause smoke and fire. To prevent this, configure an external safety circuit, such as a fuse.
 - Mitsubishi Electric programmable controllers must be installed in control panels. Wiring and replacement of a module must be performed by qualified maintenance personnel with knowledge of protection against electric shock. For wiring methods, refer to "INSTALLATION AND WIRING" in this manual.
 - Dust covers or non-wired e-CON plugs must be attached to unused e-CON connectors. Failure to do so may cause the module to fail or malfunction.
 - A non-wired one-touch connector plug for power supply and FG must be connected to the unused connector for module power supply and FG. Failure to do so may cause the module to fail or malfunction. Do not carry out transition wiring by connecting the CC-Link IE Field Network remote I/O module to the connector for module power supply and FG.
 - Individually ground the FG terminal of the programmable controller with a ground resistance of 100 ohms or less. Failure to do so may result in electric shock or malfunction.
-

[Startup and Maintenance Precautions]

WARNING

- Do not touch any terminal while power is on. Doing so will cause electric shock or malfunction.
 - Shut off the external power supply (all phases) used in the system before cleaning the module or connecting/removing connectors. Failure to do so may cause the module to fail or malfunction.
-

[Startup and Maintenance Precautions]

CAUTION

- Do not disassemble or modify the module. Doing so may cause failure, malfunction, injury, or a fire.
 - Do not drop or apply strong shock to the module. Doing so may damage the module.
 - After the first use of the product, do not connect/remove connectors more than 50 times. (IEC 61131-2 compliant).
 - Before handling the module or connection cables, touch a conducting object such as a grounded metal to discharge the static electricity from the human body. Failure to do so may cause the module to fail or malfunction.
 - Startup and maintenance of a control panel must be performed by qualified maintenance personnel with knowledge of protection against electric shock. Lock the control panel so that only qualified maintenance personnel can operate it.
-

[Disposal Precautions]

CAUTION

- When disposing of this product, treat it as industrial waste.
-

CONDITIONS OF USE FOR THE PRODUCT

- (1) MELSEC programmable controller ("the PRODUCT") shall be used in conditions;
- i) where any problem, fault or failure occurring in the PRODUCT, if any, shall not lead to any major or serious accident; and
 - ii) where the backup and fail-safe function are systematically or automatically provided outside of the PRODUCT for the case of any problem, fault or failure occurring in the PRODUCT.
- (2) The PRODUCT has been designed and manufactured for the purpose of being used in general industries. MITSUBISHI ELECTRIC SHALL HAVE NO RESPONSIBILITY OR LIABILITY (INCLUDING, BUT NOT LIMITED TO ANY AND ALL RESPONSIBILITY OR LIABILITY BASED ON CONTRACT, WARRANTY, TORT, PRODUCT LIABILITY) FOR ANY INJURY OR DEATH TO PERSONS OR LOSS OR DAMAGE TO PROPERTY CAUSED BY THE PRODUCT THAT ARE OPERATED OR USED IN APPLICATION NOT INTENDED OR EXCLUDED BY INSTRUCTIONS, PRECAUTIONS, OR WARNING CONTAINED IN MITSUBISHI ELECTRIC USER'S, INSTRUCTION AND/OR SAFETY MANUALS, TECHNICAL BULLETINS AND GUIDELINES FOR the PRODUCT.
- ("Prohibited Application")
- Prohibited Applications include, but not limited to, the use of the PRODUCT in;
- Nuclear Power Plants and any other power plants operated by Power companies, and/or any other cases in which the public could be affected if any problem or fault occurs in the PRODUCT.
 - Railway companies or Public service purposes, and/or any other cases in which establishment of a special quality assurance system is required by the Purchaser or End User.
 - Aircraft or Aerospace, Medical applications, Train equipment, transport equipment such as Elevator and Escalator, Incineration and Fuel devices, Vehicles, Manned transportation, Equipment for Recreation and Amusement, and Safety devices, handling of Nuclear or Hazardous Materials or Chemicals, Mining and Drilling, and/or other applications where there is a significant risk of injury to the public or property.
- Notwithstanding the above restrictions, Mitsubishi Electric may in its sole discretion, authorize use of the PRODUCT in one or more of the Prohibited Applications, provided that the usage of the PRODUCT is limited only for the specific applications agreed to by Mitsubishi Electric and provided further that no special quality assurance or fail-safe, redundant or other safety features which exceed the general specifications of the PRODUCTS are required. For details, please contact the Mitsubishi Electric representative in your region.
- (3) Mitsubishi Electric shall have no responsibility or liability for any problems involving programmable controller trouble and system trouble caused by DoS attacks, unauthorized access, computer viruses, and other cyberattacks.

INTRODUCTION

Thank you for purchasing the CC-Link IE Field Network analog-digital converter module (e-CON type) (hereafter abbreviated as A/D converter module).

This manual describes the procedure, system configuration, parameter settings, functions, and troubleshooting of the A/D converter module.

Before using this product, please read this manual and the relevant manuals carefully and develop familiarity with the functions and performance of the A/D converter module to handle the product correctly.

When applying the program examples introduced in this manual to an actual system, ensure the applicability and confirm that it will not cause system control problems.

■ Relevant modules: NZ2GFCE-60ADV8, NZ2GFCE-60ADI8

Point

Unless otherwise specified, this manual describes the program examples in which the remote I/O signals and remote registers are assigned for an A/D converter module as follows.

- Remote input signal: RX0 to RX2F
- Remote output signal: RY0 to RY2F
- Remote register: RWr0 to RWr17
- Remote register: RWw0 to RWw17

For the assignment of remote I/O signals and remote registers, refer to the following.

 User's manual for the master/local module used

CONTENTS

SAFETY PRECAUTIONS	1
CONDITIONS OF USE FOR THE PRODUCT	5
INTRODUCTION	6
RELEVANT MANUALS	9
TERMS	10
CHAPTER 1 PART NAMES	11
CHAPTER 2 SPECIFICATIONS	13
2.1 General Specifications	13
2.2 Performance Specifications	14
NZ2GFCE-60ADV8	14
NZ2GFCE-60ADI8	15
2.3 Function List	16
2.4 List of Remote I/O Signals	17
2.5 List of Remote Register Areas	19
2.6 List of Remote Buffer Memory Areas	20
CHAPTER 3 PROCEDURES BEFORE OPERATION	26
CHAPTER 4 SYSTEM CONFIGURATION	28
4.1 Applicable Systems	28
CHAPTER 5 INSTALLATION AND WIRING	30
5.1 Station Number Setting	30
5.2 Installation Environment and Installation Position	31
Installation environment	31
Installation position	31
Installation direction	32
5.3 Installation	33
How to mount a module on a DIN rail	33
5.4 Wiring	35
Connecting a connector for module power supply and FG	35
Wiring of Ethernet cable	39
Wiring of external devices	41
CHAPTER 6 VARIOUS SETTINGS	45
6.1 Parameter Settings	45
6.2 How to Change the Parameters	52
Changing the network configuration	52
Changing the parameters without changing the network configuration	54
CHAPTER 7 FUNCTIONS	56
7.1 Mode Shift at Power-On	56
7.2 Each Function in the Sequence	57
7.3 A/D Conversion Enable/Disable Function	58
7.4 A/D Conversion Method	58
7.5 Range Switching Function	62

7.6	Maximum Value/Minimum Value Hold Function	63
7.7	Input Signal Error Detection Function	64
7.8	Alert Output Function (Process Alarm)	67
7.9	Scaling Function	70
7.10	Shift Function	73
7.11	Digital Clipping Function	77
7.12	Difference Conversion Function	81
7.13	Error Notification Function	85
7.14	CC-Link IE Field Network Diagnostic Function	88
CHAPTER 8 PROGRAMMING		90
8.1	Precautions for Programming	90
8.2	Programming Procedure	91
8.3	Program Example	91
CHAPTER 9 MAINTENANCE AND INSPECTION		99
CHAPTER 10 TROUBLESHOOTING		101
10.1	How to Check Error Codes and Alarm Codes	101
10.2	Error Code List	104
10.3	List of Alarm Codes	108
10.4	Checking the LEDs	108
10.5	Unit Test	111
10.6	Troubleshooting by Symptom	112
APPENDICES		114
Appendix 1 Details of Remote I/O Signals		114
	Remote input signals	114
	Remote output signals	120
Appendix 2 Details of Remote Register		122
Appendix 3 Details of Remote Buffer Memory		125
Appendix 4 I/O Conversion Characteristics of A/D Conversion		138
Appendix 5 Accuracy of A/D Conversion		140
Appendix 6 Processing Time of CC-Link IE Field Network		141
Appendix 7 EMC and Low Voltage Directives		142
	Measures to comply with the EMC Directive	142
	Requirements to compliance with the Low Voltage Directive	146
Appendix 8 How to Check Serial Number and Function Version		147
Appendix 9 External Dimensions		148
INDEX		150
REVISIONS		152
WARRANTY		153
TRADEMARKS		154

RELEVANT MANUALS

Manual name [manual number]	Description	Available form
MELSEC iQ-R Ethernet/CC-Link IE User's Manual (Startup) [SH-081256ENG]	Specifications, procedures before operation, system configuration, wiring, and communication examples of Ethernet, CC-Link IE Controller Network, and CC-Link IE Field Network	Print book e-Manual PDF
MELSEC iQ-R CC-Link IE Field Network User's Manual (Application) [SH-081259ENG]	Functions, parameter settings, programming, troubleshooting, I/O signals, and buffer memory of CC-Link IE Field Network	Print book e-Manual PDF
MELSEC-L CC-Link IE Field Network Master/Local Module User's Manual [SH-080972ENG]	Overview of the CC-Link IE Field Network, and specifications, procedures before operation, system configuration, installation, wiring, settings, functions, programming, and troubleshooting of the LJ71GF11-T2	Print book e-Manual PDF
MELSEC-Q CC-Link IE Field Network Master/Local Module User's Manual [SH-080917ENG]	Overview of the CC-Link IE Field Network, and specifications, procedures before operation, system configuration, installation, wiring, settings, functions, programming, and troubleshooting of the QJ71GF11-T2	Print book PDF
MELSEC iQ-R Simple Motion Module User's Manual (Network) [IB-0300307ENG]	Functions, programming, and troubleshooting regarding CC-Link IE Field Network of the RD77GF	Print book e-Manual PDF
MELSEC-Q QD77GF Simple Motion Module User's Manual (Network) [IB-0300203]	Functions, programming, and troubleshooting regarding CC-Link IE Field Network of the QD77GF16	Print book PDF

Point

e-Manual refers to the Mitsubishi Electric FA electronic book manuals that can be browsed using a dedicated tool.

e-Manual has the following features:

- Required information can be cross-searched in multiple manuals.
- Other manuals can be accessed from the links in the manual.
- The hardware specifications of each part can be found from the product figures.
- Pages that users often browse can be bookmarked.

TERMS

Unless otherwise specified, this manual uses the following terms.

Term	Description
A/D converter module	The abbreviation for the CC-Link IE Field Network analog-digital converter module (e-CON type)
CC-Link IE Field Network	A high-speed and large-capacity open field network that is based on Ethernet (1000BASE-T)
Cyclic transmission	A function by which data are periodically exchanged among stations on the network using link devices
Data link	A generic term for cyclic transmission and transient transmission
Dedicated instruction	An instruction that simplifies programming for using functions of intelligent function modules
Disconnection	A process of stopping data link if a data link error occurs
Engineering tool	The another name for the software package for the MELSEC programmable controllers
Extension module	A remote module with no CC-Link IE Field Network communication function. This module cannot be used as a single module. However, connecting the module to the main module will increase the number of I/O points per station.
Intelligent device station	A station that exchanges I/O signals (bit data) and I/O data (word data) with another station by cyclic transmission. This station can perform transient transmission as well. This station responds to a transient transmission (request) from other stations and also issues a transient transmission (request) to other stations.
Link device	A device (RX, RY, RWr, or RWw) in a module on CC-Link IE Field Network
Link special register (SW)	Word data that indicates the operating status and data link status of a module on CC-Link IE Field Network
Link special relay (SB)	Bit data that indicates the operating status and data link status of a module on CC-Link IE Field Network
Local station	A station that performs cyclic transmission and transient transmission with the master station and other local stations.
Main module	A module with the CC-Link IE Field Network communication function, which can be used as a single remote module.
Master station	A station that controls the entire network. This station can perform cyclic transmission and transient transmission with all stations. Only one master station can be used in a network.
Master/local module	The abbreviation for the CC-Link IE Field Network master/local module
REMFR	The abbreviation for ZP.REMFR.
Remote buffer memory	Buffer memory in a remote device station and intelligent device station
Remote device station	A station that exchanges I/O signals (bit data) and I/O data (word data) with another station by cyclic transmission. This station responds to a transient transmission (request) from other stations.
Remote I/O station	A station that exchanges I/O signals (bit data) with the master station by cyclic transmission
Remote input (RX)	Bit data input from a slave station to the master station (For some areas in a local station, data are input in the opposite direction.)  User's manual for the master/local module used
Remote output (RY)	Bit data output from the master station to a slave station (For some areas in a local station, data are output in the opposite direction.)  User's manual for the master/local module used
Remote register (RWr)	Information input from a slave station to the master station in units of 16 bits (1 word) (For some areas in a local station, data are input in the opposite direction.)
Remote register (RWw)	Information output from the master station to a slave station in units of 16 bits (1 word) (For some areas in a local station, data are output in the opposite direction.)
REMTO	The abbreviation for ZP.REMTO.
Reserved station	A station actually not connected to the network. This station is counted as a connected station as a station reserved for future use.
Simple motion module	The abbreviation for the QD77GF simple motion module and RD77G simple motion module
Slave station	A generic term for local station, remote I/O station, remote device station, and intelligent device station
Transient transmission	A function of communication with other stations, which is used when requested by a dedicated instruction or an engineering tool

1 PART NAMES

This chapter describes part names of the A/D converter module.

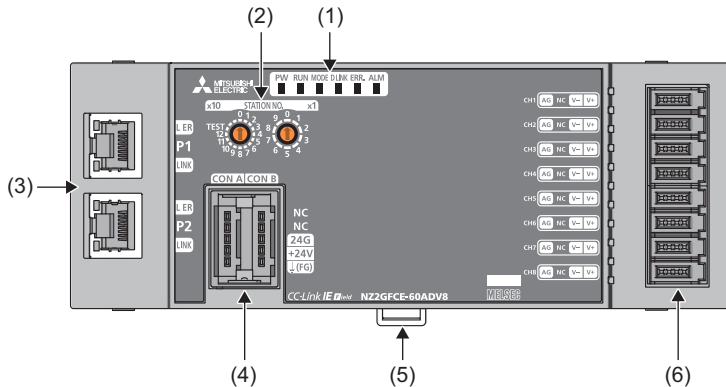

No.	Name	Application
(1)	PW LED	Indicates the power supply status of the A/D converter module. <ul style="list-style-type: none"> On: Power-on Off: Power-off
	RUN LED	Indicates the operating status of the A/D converter module. <ul style="list-style-type: none"> On: In normal operation Off: Major error occurred
	MODE LED	Indicates the mode of the A/D converter module. <ul style="list-style-type: none"> On: In online mode Flashing: In unit test mode Off: Unit test completed
	D LINK LED	Indicates the data link status of the A/D converter module. <ul style="list-style-type: none"> On: Data link (cyclic transmission being performed) Flashing: Data link (cyclic transmission stopped) Off: Data link not performed (disconnected)
	ERR. LED	Indicates the error status of the A/D converter module. <ul style="list-style-type: none"> On: Moderate error or major error occurred Flashing: Warning occurred Off: In normal operation
	ALM LED	Indicates the alert status of the A/D converter module. <ul style="list-style-type: none"> On: Alert issued Flashing: Input signal error detected Off: In normal operation
(2)	Station number setting switch	A rotary switch for the following setting and test. <ul style="list-style-type: none"> Station Number Setting (☞ Page 30 Station Number Setting) Unit Test (☞ Page 111 Unit Test) When operating the station number setting switch, use a flathead screwdriver with 3.5mm or less width of the tip.
(3)	P1	PORT1 connector for the connection to CC-Link IE Field Network (RJ45 connector) Connect an Ethernet cable. (☞ Page 39 Wiring of Ethernet cable) There are no restrictions on the connection order of the cables for the P1 connector and P2 connector.
	L ER LED	Indicates the port status. <ul style="list-style-type: none"> On: Module received abnormal data, or module performing loopback Off: Module received normal data, or module not performing loopback
	LINK LED	Indicates the link status. <ul style="list-style-type: none"> On: Link-up Off: Link-down
	P2	PORT2 connector for the connection to CC-Link IE Field Network (RJ45 connector) Connect an Ethernet cable. (☞ Page 39 Wiring of Ethernet cable) There are no restrictions on the connection order of the cables for the P1 connector and P2 connector.
	L ER LED	Same as the LEDs of the P1 connector
(4)	Connector for module power supply and FG	Connector to connect with module power supply (24VDC) and FG
(5)	DIN rail hook	A hook for mounting a module on a DIN rail
(6)	e-CON	Connector for external devices

Module status and LED status

The following table shows how module status and LED status correspond each other.

Module status		Data link status	LED status					
			PW LED	RUN LED	MODE LED	D LINK LED	ERR. LED	ALM LED
Normal mode	Disconnecting	Disconnection	On	On	On	Off	Off	Off
	Data link in operation	Data link in operation	On	On	On	On	Off	Off
	Reserved station specification in progress	Cyclic stop	On	On	On	Flashing	Off	Off
	Link stop	Cyclic stop	On	On	On	Flashing	Off	Off
Unit test	In progress	—	On	On	Flashing	Off	Off	Off
	Completed successfully	—	On	On	Off	Off	Off	Off
	Completed with an error	—	On	On	Off	Off	On	Off
Communication error		Cyclic stop	On	On	On	Flashing	Off	Off
Error	Major error	—	On	Off	*2	*1	On*3	*1
	Moderate error	—	On	On	*2	*1	On	*1
Warning	Minor error	—	On	On	*2	*1	Flashing	*1
Alarm	Alert issued	—	On	On	On	*1	*1	On
	Input signal error occurred	—	On	On	On	*1	*1	Flashing

*1 Either On, Flashing, or Off.

*2 Either On or Off.

*3 A failure of the module may not allow the LED to turn on.

2 SPECIFICATIONS

This chapter describes the specifications of the A/D converter module.

2.1 General Specifications

Item	Specifications					
Operating ambient temperature	0 to 55°C					
Storage ambient temperature	-25 to 75°C					
Operating ambient humidity	5 to 95%RH, non-condensing					
Storage ambient humidity						
Vibration resistance	Compliant with JIS B 3502 and IEC 61131-2		Frequency	Constant acceleration	Half amplitude	Sweep count
			Under intermittent vibration	5 to 8.4Hz	—	3.5mm
		8.4 to 150Hz		9.8m/s ²	—	
		Under continuous vibration	5 to 8.4Hz	—	1.75mm	—
8.4 to 150Hz	4.9m/s ²		—			
Shock resistance	Compliant with JIS B 3502 and IEC 61131-2 (147m/s ² , 3 times each in X, Y, and Z directions)					
Operating atmosphere	No corrosive gases					
Operating altitude* ¹	0 to 2000m					
Installation location	Inside a control panel* ²					
Overvoltage category* ³	II or less					
Pollution degree* ⁴	2 or less					
Equipment class	Class I					

*1 Do not use or store the A/D converter module under pressure higher than the atmospheric pressure of altitude 0m. Doing so may cause malfunction. When using the A/D converter module under pressure, please consult your local Mitsubishi representative.

*2 If the environment satisfies the operating ambient temperature, operating ambient humidity and other conditions, the module can be used even outside the control panel.

*3 This indicates the section of the power supply to which the equipment is assumed to be connected between the public electrical power distribution network and the machinery within premises.
Category II applies to equipment for which electrical power is supplied from fixed facilities. The surge voltage withstand level for up to the rated voltage of 300V is 2500V.



*4 This index indicates the degree to which conductive material is generated in terms of the environment in which the equipment is used. Pollution degree 2 is when only non-conductive pollution occurs. A temporary conductivity caused by condensing must be expected occasionally.

Point 

For compliance with the EMC Directive, refer to "EMC and Low Voltage Directives" in this manual. ( Page 142 EMC and Low Voltage Directives)

2.2 Performance Specifications

NZ2GFCE-60ADV8

Item		Description			
Station type		Remote device station			
Number of analog input channels		8 channels/module			
Analog input	Voltage	-10 to 10VDC (input resistance 1M Ω)			
Digital output		16-bit signed binary (-16384 to 16383)			
I/O characteristics, maximum resolution ^{*1}		Input	Input range	Digital output value	Maximum resolution
		Voltage	-10 to 10V	-16000 to 16000	0.625mV
			0 to 5V	0 to 16000	0.3125mV
	1 to 5V		0.25mV		
Conversion accuracy ^{*2}	Ambient temperature (25 \pm 5 $^{\circ}$ C)	\pm 0.2%			
	Ambient temperature (0 to 55 $^{\circ}$ C)	\pm 0.3%			
Conversion speed		1ms/channel			
Absolute maximum input		Voltage: \pm 15V			
Isolation method		Between communication system terminal—all analog input terminals: Digital isolator isolation Between power supply system terminal—all analog input terminals: Transformer isolation Between input channels: Non-isolation			
Withstand voltage		Between all power supply and communication system terminals—all analog input terminals 500VDC for 1 minute			
Noise immunity		Noise voltage 500Vp-p, noise width 1 μ s, noise frequency 25 to 60Hz (noise simulator condition)			
External interface	Communication part	RJ45 connector			
	Module power supply part	Connector for module power supply and FG (five pins, crimping type) For compatible plugs, refer to the following:  Page 35 Compatible plugs			
	I/O part	e-CON (four pins, crimping type) For e-CON plugs, refer to the following:  Page 41 Reference connector list			
Applicable DIN rail		TH35-7.5Fe, TH35-7.5Al (compliant with IEC 60715)			
Applicable wire size	For power supply	Core: 0.66 to 0.98mm ² (18 AWG)			
	For I/O	Core: 0.08 to 0.5mm ² (28 to 20 AWG)			
Cyclic transmission	RX/Ry points	48 points			
	RWr/RWw points ^{*3}	24 points			
Communication cable		An Ethernet cable that meets the 1000BASE-T standard: Category 5e or higher (double shielded, STP), straight cable			
Applicability of extension module		Mounting not allowed			
External power supply		24VDC (20.4 to 28.8VDC) Inrush current: 13.0A, 0.2ms or lower Current consumption: 150mA			
Weight		0.22kg			

*1 For details on the I/O conversion characteristics, refer to the following:

 Page 138 I/O Conversion Characteristics of A/D Conversion

*2 Except for the conditions under noise influence.

*3 Default value set by an engineering tool. Number of points can be changed with an engineering tool. For how to set the number of points, refer to the following:

 Page 45 Parameter Settings

NZ2GFCE-60ADI8

Item		Description			
Station type		Remote device station			
Number of analog input channels		8 channels/module			
Analog input	Current	0 to 20mADC (input resistance 250Ω)			
Digital output		16-bit signed binary (-16384 to 16383)			
I/O characteristics, maximum resolution*1		Input	Input range	Digital output value	Maximum resolution
		Current	0 to 20mA	0 to 16000	1.25μA
			4 to 20mA		1μA
Conversion accuracy*2	Ambient temperature (25±5°C)	±0.2%			
	Ambient temperature (0 to 55°C)	±0.3%			
Conversion speed		1ms/channel			
Absolute maximum input		Current: ±30mA*3			
Isolation method		Between communication system terminal—all analog input terminals: Digital isolator isolation Between power supply system terminal—all analog input terminals: Transformer isolation Between input channels: Non-isolation			
Withstand voltage		Between all power supply and communication system terminals—all analog input terminals 500VDC for 1 minute			
Noise immunity		Noise voltage 500Vp-p, noise width 1μs, noise frequency 25 to 60Hz (noise simulator condition)			
External interface	Communication part	RJ45 connector			
	Module power supply part	Connector for module power supply and FG (five pins, crimping type) For compatible plugs, refer to the following: ☞ Page 35 Compatible plugs			
	I/O part	e-CON (four pins, crimping type) For e-CON plugs, refer to the following: ☞ Page 41 Reference connector list			
Applicable DIN rail		TH35-7.5Fe, TH35-7.5Al (compliant with IEC 60715)			
Applicable wire size	For power supply	Core: 0.66 to 0.98mm ² (18 AWG)			
	For I/O	Core: 0.08 to 0.5mm ² (28 to 20 AWG)			
Cyclic transmission	RX/Ry points	48 points			
	RWr/RWw points*4	24 points			
Communication cable		An Ethernet cable that meets the 1000BASE-T standard: Category 5e or higher (double shielded, STP), straight cable			
Applicability of extension module		Mounting not allowed			
External power supply		24VDC (20.4 to 28.8VDC) Inrush current: 13.0A, 0.2ms or lower Current consumption: 150mA			
Weight		0.22kg			

*1 For details on the I/O conversion characteristics, refer to the following:

☞ Page 138 I/O Conversion Characteristics of A/D Conversion

*2 Except for the conditions under noise influence.

*3 This current value is an instantaneous value at which no breakdown occurs in the internal resistance of the module. The maximum input current value for constant application is 24mA.

*4 Default value set by an engineering tool. Number of points can be changed with an engineering tool. For how to set the number of points, refer to the following:

☞ Page 45 Parameter Settings

2.3 Function List

Item		Description	Reference	
A/D conversion enable/disable function		Allows A/D conversion to be enabled or disabled for each channel. Disabling the A/D conversion for unused channels reduces the conversion cycles.	Page 58 A/D Conversion Enable/Disable Function	
A/D conversion method	Sampling processing	Performs A/D conversion on analog input values sequentially, storing the digital operation values into the remote register.	Page 58 Sampling processing	
	Averaging processing	Time average	Performs A/D conversion for a set period of time and averages the total value excluding the maximum and the minimum values, storing the averaged value into the remote register. The number of processing times within the set period of time varies depending on the number of channels used (number of channels where A/D conversion is enabled).	Page 59 Time average
		Count average	Performs A/D conversion a set number of times and averages the total value excluding the maximum and the minimum values, storing the averaged value into the remote register. Time taken to store the mean value by count average varies depending on the number of channels used (the number of channels where A/D conversion is enabled).	Page 59 Count average
		Moving average	Takes in digital output values a set number of times at every sampling period and averages these values, storing the averaged value into the remote register. The target range for average processing moves at each sampling, thereby allowing the latest digital operation value to be obtained.	Page 60 Moving average
Range switching function		Allows the input range to be selected for each channel from the following: <ul style="list-style-type: none"> • Voltage: 1 to 5V, 0 to 5V, -10 to 10V • Current: 4 to 20mA, 0 to 20mA 	Page 62 Range Switching Function	
Maximum value/minimum value hold function		For each channel, stores the maximum and minimum values of digital operation values into the remote buffer memory.	Page 63 Maximum Value/Minimum Value Hold Function	
Input signal error detection function		Easily detects a disconnection of analog input signals.	Page 64 Input Signal Error Detection Function	
Alert output function (process alarm)		Outputs an alert when a digital operation value falls within the alert output range set in advance.	Page 67 Alert Output Function (Process Alarm)	
Scaling function		Performs scale conversion on a digital operation value within the range of the scaling upper limit value and the scaling lower limit value, both of which are set at desired values.	Page 70 Scaling Function	
Shift function		Adds the conversion value shift amount specified to a digital operation value and stores it into the remote register. This function facilitates fine adjustment at the system start-up.	Page 73 Shift Function	
Digital clipping function		Allows the maximum value and the minimum value of a digital output value to be fixed at 16000 and 0 or -16000 respectively if a voltage or current exceeding the input range is input.	Page 77 Digital Clipping Function	
Difference conversion function		Subtracts the difference conversion reference value from a digital operation value and stores the obtained value into the remote register.	Page 81 Difference Conversion Function	
Error notification function		Notifies an error to the master station by the remote input signal if a moderate error or a major error occurs in the A/D converter module.	Page 85 Error Notification Function	
CC-Link IE Field Network diagnostic function		Allows the presence or absence of a network error to be checked by accessing the engineering tool connected to the CPU module.	Page 88 CC-Link IE Field Network Diagnostic Function	
iQ Sensor Solution data backup/restoration function		Setting data of slave station is backed up in the SD memory card of the CPU module in the master station. Setting data of slave station backed up in the SD memory card of the CPU module in the master station is restored in the slave station.	 iQ Sensor Solution Reference Manual	

2.4 List of Remote I/O Signals

This section lists I/O signals for a master/local module.

The I/O signal assignment shown assumes that the remote I/O signals of the A/D converter module are assigned to RX0 to RX2F and RY0 to RY2F.

Remote input (RX) indicates the input signal from A/D converter module to master/local module.

Remote output (RY) indicates the output signal from master/local module to A/D converter module.

For details on the remote I/O signals, refer to the following:

 Page 114 Details of Remote I/O Signals

Point

Do not use any "Use prohibited" remote I/O signals. Doing so may result in an accident due to an incorrect output or malfunction.

Remote input		Remote output	
Signal direction: A/D converter module → Master/local module		Signal direction: Master/local module → A/D converter module	
Device No.	Description	Device No.	Description
RX0	Use prohibited	RY0	Use prohibited
RX1	Use prohibited	RY1	Use prohibited
RX2	Use prohibited	RY2	Use prohibited
RX3	Use prohibited	RY3	Use prohibited
RX4	Use prohibited	RY4	Use prohibited
RX5	Use prohibited	RY5	Use prohibited
RX6	Use prohibited	RY6	Use prohibited
RX7	Warning flag	RY7	Use prohibited
RX8	Use prohibited	RY8	Use prohibited
RX9	Initial data setting completed flag	RY9	Initial data setting request flag
RXA	Error flag	RYA	Error clear request flag
RXB	Remote READY	RYB	Use prohibited
RXC	Use prohibited	RYC	Use prohibited
RXD	Use prohibited	RYD	Use prohibited
RXE	Use prohibited	RYE	Use prohibited
RXF	Use prohibited	RYF	Use prohibited
RX10	CH1 A/D conversion completed flag	RY10	Use prohibited
RX11	CH2 A/D conversion completed flag	RY11	Use prohibited
RX12	CH3 A/D conversion completed flag	RY12	Use prohibited
RX13	CH4 A/D conversion completed flag	RY13	Use prohibited
RX14	CH5 A/D conversion completed flag	RY14	Use prohibited
RX15	CH6 A/D conversion completed flag	RY15	Use prohibited
RX16	CH7 A/D conversion completed flag	RY16	Use prohibited
RX17	CH8 A/D conversion completed flag	RY17	Use prohibited
RX18	Alert output signal	RY18	Use prohibited
RX19	Use prohibited	RY19	Use prohibited
RX1A	Use prohibited	RY1A	Use prohibited
RX1B	Use prohibited	RY1B	Use prohibited
RX1C	Input signal error detection signal	RY1C	Use prohibited
RX1D	Maximum value/minimum value reset completed flag	RY1D	Maximum value/minimum value reset request
RX1E	Use prohibited	RY1E	Use prohibited
RX1F	Use prohibited	RY1F	Use prohibited
RX20	CH1 Difference conversion state flag	RY20	CH1 Difference conversion trigger
RX21	CH2 Difference conversion state flag	RY21	CH2 Difference conversion trigger
RX22	CH3 Difference conversion state flag	RY22	CH3 Difference conversion trigger
RX23	CH4 Difference conversion state flag	RY23	CH4 Difference conversion trigger

Remote input		Remote output	
Signal direction: A/D converter module → Master/local module		Signal direction: Master/local module → A/D converter module	
Device No.	Description	Device No.	Description
RX24	CH5 Difference conversion state flag	RY24	CH5 Difference conversion trigger
RX25	CH6 Difference conversion state flag	RY25	CH6 Difference conversion trigger
RX26	CH7 Difference conversion state flag	RY26	CH7 Difference conversion trigger
RX27	CH8 Difference conversion state flag	RY27	CH8 Difference conversion trigger
RX28	Use prohibited	RY28	Use prohibited
RX29	Use prohibited	RY29	Use prohibited
RX2A	Use prohibited	RY2A	Use prohibited
RX2B	Use prohibited	RY2B	Use prohibited
RX2C	Use prohibited	RY2C	Use prohibited
RX2D	Use prohibited	RY2D	Use prohibited
RX2E	Use prohibited	RY2E	Use prohibited
RX2F	Use prohibited	RY2F	Use prohibited

2.5 List of Remote Register Areas

This section lists remote register areas for a master/local module.

The remote register area assignment shown assumes that the remote register areas of the A/D converter module are assigned to RWr0 to RWr17 and RWw0 to RWw17.

Remote register (RWr) is the information input from A/D converter module to master/local module.

Remote register (RWw) is the information output from master/local module to A/D converter module.

For details on the remote register, refer to the following:

 Page 122 Details of Remote Register

Point

Do not read/write data from/to any "Use prohibited" remote register areas. Doing so may result in an accident due to an incorrect output or malfunction.

Remote register (RWr)		Remote register (RWw)	
Signal direction: A/D converter module → Master/local module		Signal direction: Master/local module → A/D converter module	
Device No.	Description	Device No.	Description
RWr0	Latest error code	RWw0	Use prohibited
RWr1	Latest warning code	RWw1	Use prohibited
RWr2	CH1 Digital operation value	RWw2	CH1 Shifting amount to conversion value
RWr3	CH2 Digital operation value	RWw3	CH2 Shifting amount to conversion value
RWr4	CH3 Digital operation value	RWw4	CH3 Shifting amount to conversion value
RWr5	CH4 Digital operation value	RWw5	CH4 Shifting amount to conversion value
RWr6	CH5 Digital operation value	RWw6	CH5 Shifting amount to conversion value
RWr7	CH6 Digital operation value	RWw7	CH6 Shifting amount to conversion value
RWr8	CH7 Digital operation value	RWw8	CH7 Shifting amount to conversion value
RWr9	CH8 Digital operation value	RWw9	CH8 Shifting amount to conversion value
RWrA	Input signal error detection flag	RWwA	Use prohibited
RWrB	Alert output flag	RWwB	Use prohibited
RWrC	Use prohibited	RWwC	Use prohibited
RWrD	Use prohibited	RWwD	Use prohibited
RWrE	Use prohibited	RWwE	Use prohibited
RWrF	Use prohibited	RWwF	Use prohibited
RWr10	CH1 Difference conversion reference value	RWw10	Use prohibited
RWr11	CH2 Difference conversion reference value	RWw11	Use prohibited
RWr12	CH3 Difference conversion reference value	RWw12	Use prohibited
RWr13	CH4 Difference conversion reference value	RWw13	Use prohibited
RWr14	CH5 Difference conversion reference value	RWw14	Use prohibited
RWr15	CH6 Difference conversion reference value	RWw15	Use prohibited
RWr16	CH7 Difference conversion reference value	RWw16	Use prohibited
RWr17	CH8 Difference conversion reference value	RWw17	Use prohibited

2.6 List of Remote Buffer Memory Areas

This section lists the remote buffer memory areas of the A/D converter module.

Remote buffer memory notation

■ A/D conversion enable/disable setting (address: 0102H)

An example of A/D conversion enable/disable setting (address: 0102H) is used for explanation.

Terminology	Description
A/D conversion enable/disable setting	Setting item
(Address: 0102H)	Indicates an address for the remote buffer memory.

For details on the remote buffer memory, refer to the following:

☞ Page 125 Details of Remote Buffer Memory

○: Access permitted, ×: Access not permitted

Remote buffer memory address		Area	Target	Access method	
Decimal	Hexadecimal			CC IE Field configuration of the engineering tool	REMFR instruction, REMTO instruction ^{*1}
0 to 255	0000H to 00FFH	Parameter area	Station-based parameter data	○ ^{*2}	○
256 to 511	0100H to 01FFH		Module-based parameter data		
512 to 1279	0200H to 04FFH		System area		
1280 to 1535	0500H to 05FFH	Monitor area	Station-based monitor data	×	○
1536 to 1791	0600H to 06FFH		Module-based monitor data		
1792 to 2559	0700H to 09FFH		System area		
2560 to 4095	0A00H to 0FFFH	Error history area	Station-based error history data	○ ^{*2}	○
4096 to 4351	1000H to 10FFH	Module control data area	Station-based control data	×	○
4352 to 4607	1100H to 11FFH		Module-based control data		
4608 to 5375	1200H to 14FFH		System area		

*1 For the REMFR and REMTO instructions, refer to the following:

📖 User's manual for the master/local module used

*2 For the access method, refer to the following:

Parameter area (☞ Page 45 Parameter Settings)

Error history area (☞ Page 101 How to Check Error Codes and Alarm Codes)

Point

Do not access any system area using the REMFR or REMTO instruction. Doing so may cause malfunction.

Parameter area (address: 0000H to 04FFH)

For the parameter area, parameters can be set by means of the CC IE Field configuration of the engineering tool, or the REMTO instruction.

The parameters in the parameter area are backed up to the non-volatile memory.

The parameters backed up to the non-volatile memory are read out to the parameter area when the module power supply is turned off and on or the module is reset by remote reset.

For the parameters written from the parameter settings of the CC IE Field configuration of the engineering tool, the write to the non-volatile memory is also completed at the same time. For the parameters written using the REMTO instruction, the timing of the write to the non-volatile memory is at the time of turning on Initial data setting request flag (RY9) from off. At this time, even an invalid parameter is written to the non-volatile memory as well. With an invalid parameter written, turning off and on the power supply causes the invalid parameter to be read from the non-volatile memory, resulting in the error code being stored into Latest error code (RWr0). Take corrective action with reference to the error code list. (☞ Page 104 Error Code List)

■ Station-based parameter data

Address		Description
Decimal	Hexadecimal	
0 to 255	0000H to 00FFH	System area

■ Module-based parameter data

R: Readable from program, W: Writable from program

Address		Description	Default value ^{*1}	Read/Write	Necessity of RY9 ^{*2}
Decimal	Hexadecimal				
256 to 257	0100H to 0101H	System area	—	—	—
258	0102H	A/D conversion enable/disable setting	0000H	R/W	○
259	0103H	Range setting (CH1 to CH4)	*3	R/W	○
260	0104H	Range setting (CH5 to CH8)	*3	R/W	○
261	0105H	Averaging process setting (CH1 to CH4)	0000H	R/W	○
262	0106H	Averaging process setting (CH5 to CH8)	0000H	R/W	○
263	0107H	CH1 Time average/Count average/Moving average	0	R/W	○
264	0108H	CH2 Time average/Count average/Moving average	0	R/W	○
265	0109H	CH3 Time average/Count average/Moving average	0	R/W	○
266	010AH	CH4 Time average/Count average/Moving average	0	R/W	○
267	010BH	CH5 Time average/Count average/Moving average	0	R/W	○
268	010CH	CH6 Time average/Count average/Moving average	0	R/W	○
269	010DH	CH7 Time average/Count average/Moving average	0	R/W	○
270	010EH	CH8 Time average/Count average/Moving average	0	R/W	○
271	010FH	Input signal error detection setting (CH1 to CH4)	0000H	R/W	○
272	0110H	Input signal error detection setting (CH5 to CH8)	0000H	R/W	○
273	0111H	Alert output setting	00FFH	R/W	○
274	0112H	CH1 Process alarm lower lower limit value	0	R/W	○
275	0113H	CH1 Process alarm lower upper limit value	0	R/W	○
276	0114H	CH1 Process alarm upper lower limit value	0	R/W	○
277	0115H	CH1 Process alarm upper upper limit value	0	R/W	○
278	0116H	CH2 Process alarm lower lower limit value	0	R/W	○
279	0117H	CH2 Process alarm lower upper limit value	0	R/W	○
280	0118H	CH2 Process alarm upper lower limit value	0	R/W	○

Address		Description	Default value* ¹	Read/Write	Necessity of RY9* ²
Decimal	Hexadecimal				
281	0119H	CH2 Process alarm upper upper limit value	0	R/W	○
282	011AH	CH3 Process alarm lower lower limit value	0	R/W	○
283	011BH	CH3 Process alarm lower upper limit value	0	R/W	○
284	011CH	CH3 Process alarm upper lower limit value	0	R/W	○
285	011DH	CH3 Process alarm upper upper limit value	0	R/W	○
286	011EH	CH4 Process alarm lower lower limit value	0	R/W	○
287	011FH	CH4 Process alarm lower upper limit value	0	R/W	○
288	0120H	CH4 Process alarm upper lower limit value	0	R/W	○
289	0121H	CH4 Process alarm upper upper limit value	0	R/W	○
290	0122H	CH5 Process alarm lower lower limit value	0	R/W	○
291	0123H	CH5 Process alarm lower upper limit value	0	R/W	○
292	0124H	CH5 Process alarm upper lower limit value	0	R/W	○
293	0125H	CH5 Process alarm upper upper limit value	0	R/W	○
294	0126H	CH6 Process alarm lower lower limit value	0	R/W	○
295	0127H	CH6 Process alarm lower upper limit value	0	R/W	○
296	0128H	CH6 Process alarm upper lower limit value	0	R/W	○
297	0129H	CH6 Process alarm upper upper limit value	0	R/W	○
298	012AH	CH7 Process alarm lower lower limit value	0	R/W	○
299	012BH	CH7 Process alarm lower upper limit value	0	R/W	○
300	012CH	CH7 Process alarm upper lower limit value	0	R/W	○
301	012DH	CH7 Process alarm upper upper limit value	0	R/W	○
302	012EH	CH8 Process alarm lower lower limit value	0	R/W	○
303	012FH	CH8 Process alarm lower upper limit value	0	R/W	○
304	0130H	CH8 Process alarm upper lower limit value	0	R/W	○
305	0131H	CH8 Process alarm upper upper limit value	0	R/W	○
306	0132H	Digital clipping enable/disable setting	00FFH	R/W	○
307	0133H	Scaling enable/disable setting	00FFH	R/W	○
308	0134H	CH1 Scaling lower limit value	0	R/W	○
309	0135H	CH1 Scaling upper limit value	0	R/W	○
310	0136H	CH2 Scaling lower limit value	0	R/W	○
311	0137H	CH2 Scaling upper limit value	0	R/W	○
312	0138H	CH3 Scaling lower limit value	0	R/W	○
313	0139H	CH3 Scaling upper limit value	0	R/W	○
314	013AH	CH4 Scaling lower limit value	0	R/W	○
315	013BH	CH4 Scaling upper limit value	0	R/W	○
316	013CH	CH5 Scaling lower limit value	0	R/W	○
317	013DH	CH5 Scaling upper limit value	0	R/W	○
318	013EH	CH6 Scaling lower limit value	0	R/W	○
319	013FH	CH6 Scaling upper limit value	0	R/W	○
320	0140H	CH7 Scaling lower limit value	0	R/W	○
321	0141H	CH7 Scaling upper limit value	0	R/W	○
322	0142H	CH8 Scaling lower limit value	0	R/W	○
323	0143H	CH8 Scaling upper limit value	0	R/W	○
324 to 511	0144H to 01FFH	System area	—	—	—

*1 This value is the value of factory default or the value of initialization by Parameter area initialization command (address: 1002H).

*2 This shows the items enabled by turning on and off Initial data setting request flag (RY9).

*3 NZ2GFCE-60AD18: 0000H, NZ2GFCE-60ADV8: 2222H

■System area

Address		Description
Decimal	Hexadecimal	
512 to 1279	0200H to 04FFH	System area

Monitor area (address: 0500H to 09FFH)

■Station-based monitor data

Address		Description
Decimal	Hexadecimal	
1280 to 1535	0500H to 05FFH	System area

■Module-based monitor data

R: Readable from program

Address		Description	Default value ^{*1}	Read/Write
Decimal	Hexadecimal			
1536	0600H	CH1 Maximum value	0	R
1537	0601H	CH1 Minimum value	0	R
1538	0602H	CH2 Maximum value	0	R
1539	0603H	CH2 Minimum value	0	R
1540	0604H	CH3 Maximum value	0	R
1541	0605H	CH3 Minimum value	0	R
1542	0606H	CH4 Maximum value	0	R
1543	0607H	CH4 Minimum value	0	R
1544	0608H	CH5 Maximum value	0	R
1545	0609H	CH5 Minimum value	0	R
1546	060AH	CH6 Maximum value	0	R
1547	060BH	CH6 Minimum value	0	R
1548	060CH	CH7 Maximum value	0	R
1549	060DH	CH7 Minimum value	0	R
1550	060EH	CH8 Maximum value	0	R
1551	060FH	CH8 Minimum value	0	R
1552	0610H	Range setting monitor (CH1 to CH4)	*2	R
1553	0611H	Range setting monitor (CH5 to CH8)	*2	R
1554 to 1791	0612H to 06FFH	System area	—	—

*1 Value at the time of turning off and on the module power supply or at the time of remote reset.

*2 NZ2GFCE-60AD18: 0000H, NZ2GFCE-60ADV8: 2222H

■System area

Address		Description
Decimal	Hexadecimal	
1792 to 2559	0700H to 09FFH	System area

Error history area (address: 0A00H to 0FFFH)

■ Station-based error history data

R: Readable from program

Address		Description	Default value ^{*1}	Read/Write	
Decimal	Hexadecimal				
2560	0A00H	Error history data 1	Error code	0000H	R
2561	0A01H		Order of generation	0000H	R
2562	0A02H		[Error time] First two digits of the year/Last two digits of the year	0000H	R
2563	0A03H		[Error time] Month/Day	0000H	R
2564	0A04H		[Error time] Hour/Minute	0000H	R
2565	0A05H		[Error time] Second/00H (Fixed)	0000H	R
2566	0A06H		CH1 Digital operation value	0000H	R
2567	0A07H		CH2 Digital operation value	0000H	R
2568	0A08H		CH3 Digital operation value	0000H	R
2569	0A09H		CH4 Digital operation value	0000H	R
2570	0A0AH		CH5 Digital operation value	0000H	R
2571	0A0BH		CH6 Digital operation value	0000H	R
2572	0A0CH		CH7 Digital operation value	0000H	R
2573	0A0DH		CH8 Digital operation value	0000H	R
2574 to 2575	0A0EH to 0A0FH		System area	—	—
2576 to 2591	0A10H to 0A1FH		Error history data 2	Same as Error history data 1.	
2592 to 2607	0A20H to 0A2FH	Error history data 3	Same as Error history data 1.		
2608 to 2623	0A30H to 0A3FH	Error history data 4	Same as Error history data 1.		
2624 to 2639	0A40H to 0A4FH	Error history data 5	Same as Error history data 1.		
2640 to 2655	0A50H to 0A5FH	Error history data 6	Same as Error history data 1.		
2656 to 2671	0A60H to 0A6FH	Error history data 7	Same as Error history data 1.		
2672 to 2687	0A70H to 0A7FH	Error history data 8	Same as Error history data 1.		
2688 to 2703	0A80H to 0A8FH	Error history data 9	Same as Error history data 1.		
2704 to 2719	0A90H to 0A9FH	Error history data 10	Same as Error history data 1.		
2720 to 2735	0AA0H to 0AAFH	Error history data 11	Same as Error history data 1.		
2736 to 2751	0AB0H to 0ABFH	Error history data 12	Same as Error history data 1.		
2752 to 2767	0AC0H to 0ACFH	Error history data 13	Same as Error history data 1.		
2768 to 2783	0AD0H to 0ADFH	Error history data 14	Same as Error history data 1.		
2784 to 2799	0AE0H to 0AEFH	Error history data 15	Same as Error history data 1.		
2800 to 4095	0AF0H to 0FFFH	System area	—	—	

*1 This value is the value of factory default or the value of initialization by Error history clear command (address: 1000H).

Module control data area (address: 1000H to 14FFH)

■ Station-based control data

R: Readable from program, W: Writable from program

Address		Description	Default value ^{*1}	Read/Write
Decimal	Hexadecimal			
4096	1000H	Error history clear command	0	R/W
4097	1001H	Error history clear completed	0	R
4098	1002H	Parameter area initialization command	0	R/W
4099	1003H	Parameter area initialization completed	0	R
4100 to 4351	1004H to 10FFH	System area	—	—

*1 Value at the time of turning off and on the module power supply or at the time of remote reset.

■ Module-based control data

Address		Description
Decimal	Hexadecimal	
4352 to 4607	1100H to 11FFH	System area

■ System area

Address		Description
Decimal	Hexadecimal	
4608 to 5375	1200H to 14FFH	System area

3 PROCEDURES BEFORE OPERATION

This chapter describes the procedures before operation.

1. Station number setting

Use the station number setting switch to set the station number of the A/D converter module.

☞ Page 30 Station Number Setting

2. Installation

Install the A/D converter module on a DIN rail.

☞ Page 31 Installation Environment and Installation Position

☞ Page 33 Installation

3. Wiring

Connect a power supply, an Ethernet cable, and external devices to the A/D converter module.

☞ Page 35 Wiring

4. Parameter setting and programming

Set parameters and create a program.

☞ Page 45 Parameter Settings

☞ Page 52 How to Change the Parameters *1

☞ Page 90 PROGRAMMING

*1 To replace the module, refer to the point below.

Point

To replace the module, follow the procedure described below:

- Turn off the module power supply and remove the A/D converter module.
 - Prepare a new A/D converter module and follow the illustration above as instructed from "Station number setting" to "Parameter setting and programming". (No re-setting of network parameters of the master station is required.)
 - Carry out operation check and then restart the control.
-

4 SYSTEM CONFIGURATION

This chapter describes how to configure the system using an A/D converter module.

For the configuration on CC-Link IE Field Network, refer to the following:

 User's manual for the master/local module used

4.1 Applicable Systems

Supported master station

For the use of an A/D converter module, select a product for the master station from the following list.

Model	First five digits of serial number
RJ71GF11-T2 RJ71EN71	(no restriction)
RD77GF	
LJ71GF11-T2 QJ71GF11-T2	
QD77GF16	14102 or later
	14111 or later

Information on "Supported master station" described above is the ones at the point when this manual was issued.

For latest information, please visit the website of CC-Link Partner Association.

www.cc-link.org

Ethernet cables

For the specifications of the Ethernet cable, refer to the following:

 User's manual for the master/local module used

Supported software package

Configuring and diagnosing the A/D converter module requires GX Works2 or GX Works3. According to the master station used, install the following version of GX Works2 or GX Works3.

Engineering tool	Software version
GX Works2	Version 1.560J or later
GX Works3	Version 1.032J or later

Point

When the latest profile of the A/D converter module is necessary, please consult your local Mitsubishi representative.

The profile is a setting file that stores information required for the start-up, operation, and maintenance of devices supporting the CC-Link family. A module is added to "Module List" of the CC IE Field configuration window by profile registration to GX Works2 or GX Works3. For the profile registration, refer to the following.

 GX Works2 Version 1 Operating Manual (Common)

 GX Works3 Operating Manual

5 INSTALLATION AND WIRING

This chapter describes the installation and wiring of the A/D converter module.

5.1 Station Number Setting

Setting method

Set the station number with the rotary switch on the front of the module. Set the station number in the power-off state because the set value is enabled at power-on.

- The dial x10 is used to set the hundreds and tens place of a station number.
- The dial x1 is used to set the ones place of a station number.

Ex.

For the station number 115, set the switch as shown below.

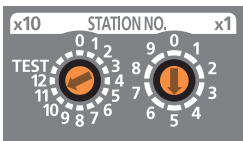

Setting range

Set the station number from 1 to 120. A value other than 1 to 120 causes a communication error, resulting in the D LINK LED flashing.

Point

- While the module power supply is in an on state, changing the station number setting switch causes a minor error, resulting in the ERR. LED flashing. When the station number setting switch is set back to the previous state, the module recovers from the error after five seconds, resulting in the ERR. LED turning off.
- For the station number setting, avoid duplication with the other station numbers. Number duplication causes a communication error, which does not allow the D LINK LED to light up.

5.2 Installation Environment and Installation Position

Installation environment

Installation location

Do not install the A/D converter module in places where:

- Ambient temperature is outside the range of 0 to 55°C;
- Ambient humidity is outside the range of 5 to 95% RH;
- Condensation occurs due to rapid temperature change;
- Corrosive gas or combustible gas is present;
- There are a high level of conductive powder such as dust and iron powder, oil mist, salinity, or organic solvent;
- It is exposed to direct sunlight;
- A strong electric field or strong magnetic field is generated; and
- The module is subject to vibration and shock.

Installation surface

Install the A/D converter module on a flat surface. Unevenness on the installation surface causes application of an excessive force to the printed-circuit board, which may lead to a malfunction.

Installation position

When installing the A/D converter module in a control panel, provide a clearance of at least 60mm shown by (1) from the surroundings including adjacent structures and modules to ensure good ventilation and easy module replacement.

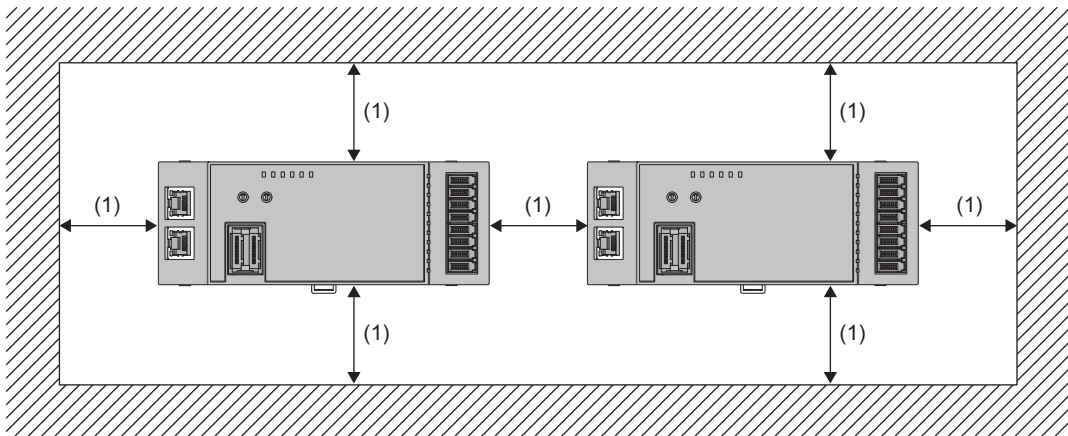

Installation direction

The A/D converter module can be installed in six directions.
Use a DIN rail (1) to install the module.

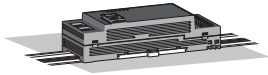
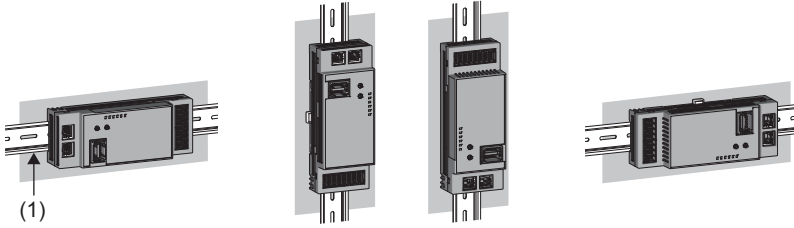
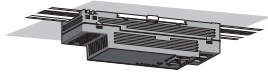

5.3 Installation

How to mount a module on a DIN rail

Point

The usage instructions for a DIN rail stopper is shown as one example. Fix the module according to the manual of the DIN rail stopper used.

Mounting procedure

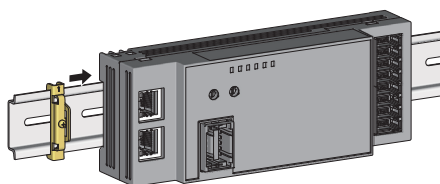
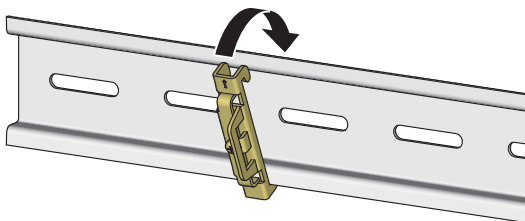
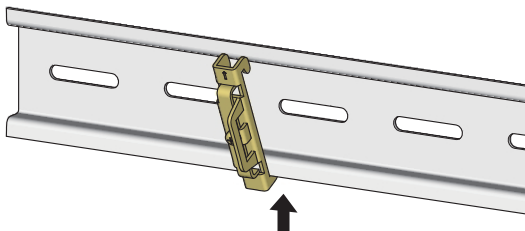
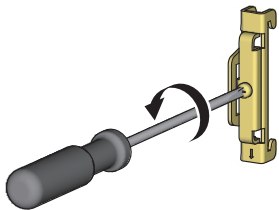
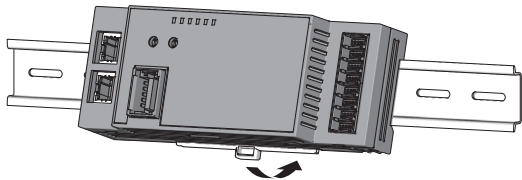
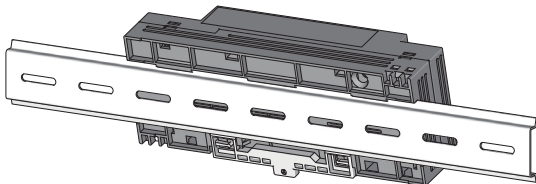

1. Hang the upper tabs of the module on the upper side of the DIN rail.
2. Push the module to the back until the DIN rail hook of the module clicks.
3. Loosen the screw on the DIN rail stopper.
4. Hitch the bottom hook of the DIN rail stopper to the bottom of the DIN rail. Hitch the hook according to the orientation of the arrow on the front of the stopper.
5. Hitch the upper hook of the DIN rail stopper to the top of the DIN rail.
6. Slide the DIN rail stopper up to the left side of the module.

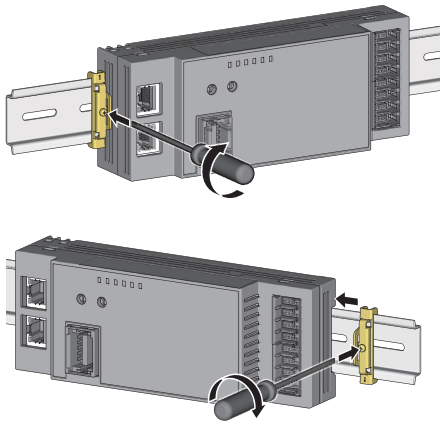

7. Hold the DIN rail stopper in the direction opposite to the arrow on the stopper and tighten the screw with a screwdriver.
8. Install the DIN rail stopper on the right side of the module in the same procedure. For the installation on the right side, be aware that the orientation of the DIN rail stopper is upside down.

Point

Do not slide a module from the edge of the DIN rail when mounting it. Doing so may damage the metal part located on the back of the module.

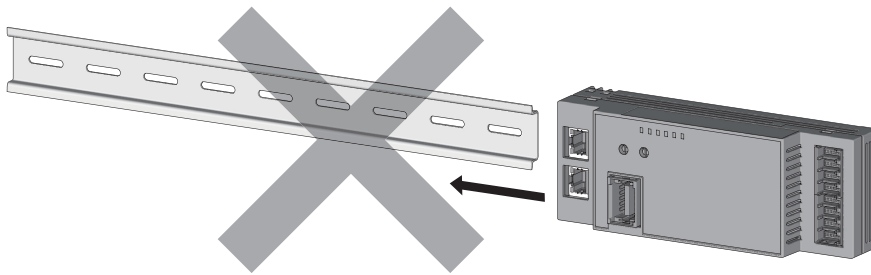

Removal procedure

1. Remove the DIN rail stoppers. Remove the stoppers from the DIN rail in a procedure opposite to the installation procedure.
2. While pushing the DIN rail hook downward with a flathead screwdriver, pull the bottom part of the module to remove it from the DIN rail.

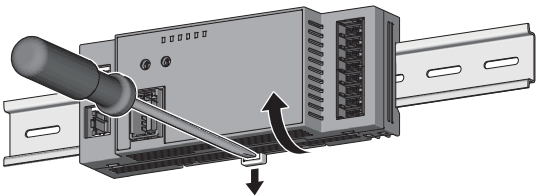

Applicable DIN rail model (compliant with IEC 60715)

- TH35-7.5Fe
- TH35-7.5Al

Space between DIN rail mounting screws

When installing a DIN rail, tighten the screws at a pitch of 200mm or less.

DIN rail stopper

Use a stopper that is attachable to the DIN rail.

5.4 Wiring

Connecting a connector for module power supply and FG

This section describes how to connect a connector for module power supply and FG to the A/D converter module.

Compatible plugs

A/D converter modules require one-touch connector plugs for power supply and FG.

The following table shows the compatible plugs.

Product name	Mitsubishi Electric product model name	Part name (manufacturer)	Specifications			Cover color
			Core size of compatible cables	Outer size of compatible cables	Maximum rated current	
One-touch connector plug for power supply and FG ^{*1*2*3}	A6CON-PW5P	35505-6080-A00 GF (3M Japan Limited)	0.75mm ² (0.66 to 0.98mm ²) (18 AWG) Wire diameter: 0.16mm or larger Insulating coating material PVC (heat-resistant vinyl)	φ2.2 to 3.0mm	7A ^{*5}	Gray
	A6CON-PW5P-SOD	35505-6180-A00 GF (3M Japan Limited)		φ2.0 to 2.3mm		Blue
Online connector for power supply and FG ^{*4}	A6CON-PWJ5P	35720-L200-A00 AK (3M Japan Limited)	—	—	—	—

*1 The A6CON-□□5P manufactured by Mitsubishi Electric Corporation consists of 10 pieces.

*2 One-touch connector plugs for power supply and FG cannot be reused after once crimped.

*3 Choose a suitable connector by checking the jacket diameter of compatible cables.

*4 The A6CON-□□J5P manufactured by Mitsubishi Electric Corporation consists of 5 pieces.

*5 Use the cables and modules to be connected within their allowable current value.

Contact of the plug manufacturer is as follows.

3M Japan Limited

Terminal layout of a connector for module power supply and FG

Terminal layout of a connector for module power supply and FG is as follows.

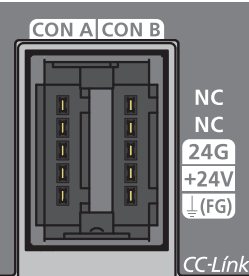
External appearance of a connector for module power supply and FG	Terminal layout		
	Pin number	CON A	CON B
	1	FG	FG
	2	+24V	+24V
	3	24G	24G
	4	NC	NC
	5	NC	NC

Reference tool products used for wiring

Pliers can be used to crimp one-touch connector plug for module power supply and FG. However, use the following tool for secure crimping.

Product name	Model	Contact
Simple crimping tool	M-Tool-N	Suzuden Corporation

Wiring procedure

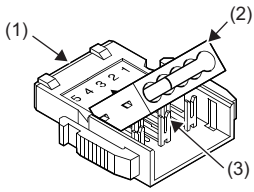

- (1) Main plug
- (2) Plug cover
- (3) Metal contacts

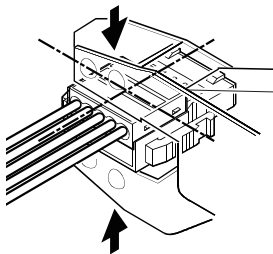
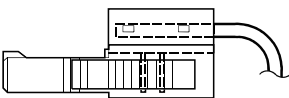
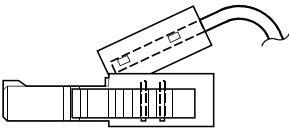

Side view

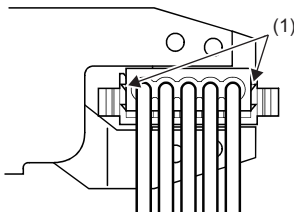

- (1) Latch

Example of correct crimping

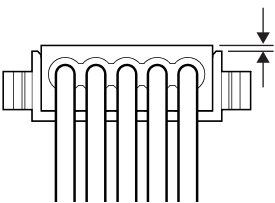

Example of incorrect crimping

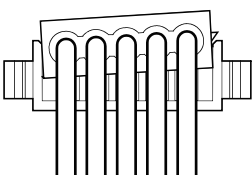

1. Check that the plug cover has been installed into the main plug. Do not squeeze the plug cover into the main plug before cable insertion. Plugs cannot be reused after once crimped.
2. Lift the rear of the plug cover and insert the cable to the end.^{*1} If the cable has not been fully inserted to the end, it may cause a crimping failure.
3. After the cable is installed, position the plug cover parallel to the main plug to allow metal contacts into the plug cover.
4. Hold the center of the plug cover with a special crimping tool and press the cover vertically.^{*2} Fully press the latch holders at both edges of the plug cover. Check that the latch is engaged in the main plug.
5. Viewing from the wire direction, check that main plug and plug cover are set in parallel. The lift of the plug cover from the main plug should be 0.2mm or less. As shown in the example of incorrect crimping, any plug cover lifted aslant or the lift of the plug cover from the main plug being 0.2mm or more may cause a crimping failure. To reach the state as shown in the example of correct crimping, use the special crimping tool to fully press the plug cover.

Example of correct crimping

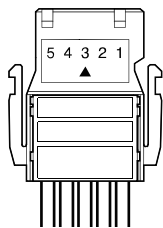

Example of incorrect crimping

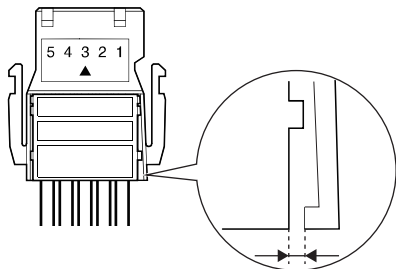

*1 Use compatible cables.

*2 As for the special crimping tool, refer to the following:

 Page 35 Reference tool products used for wiring

Point 

When cat5 cables are used, peel the jacket of the cables by 2cm or more. If the wires are not the same length, use a wire-cutting plier to align the tip length of the wires before inserting to connectors.

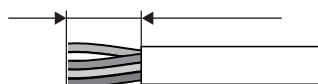

Precautions for transition wiring

When a transition wiring is used for connector for module power supply and FG, a current flows through in the module. If any transition wiring is used, design the current at the following allowable module current or lower.

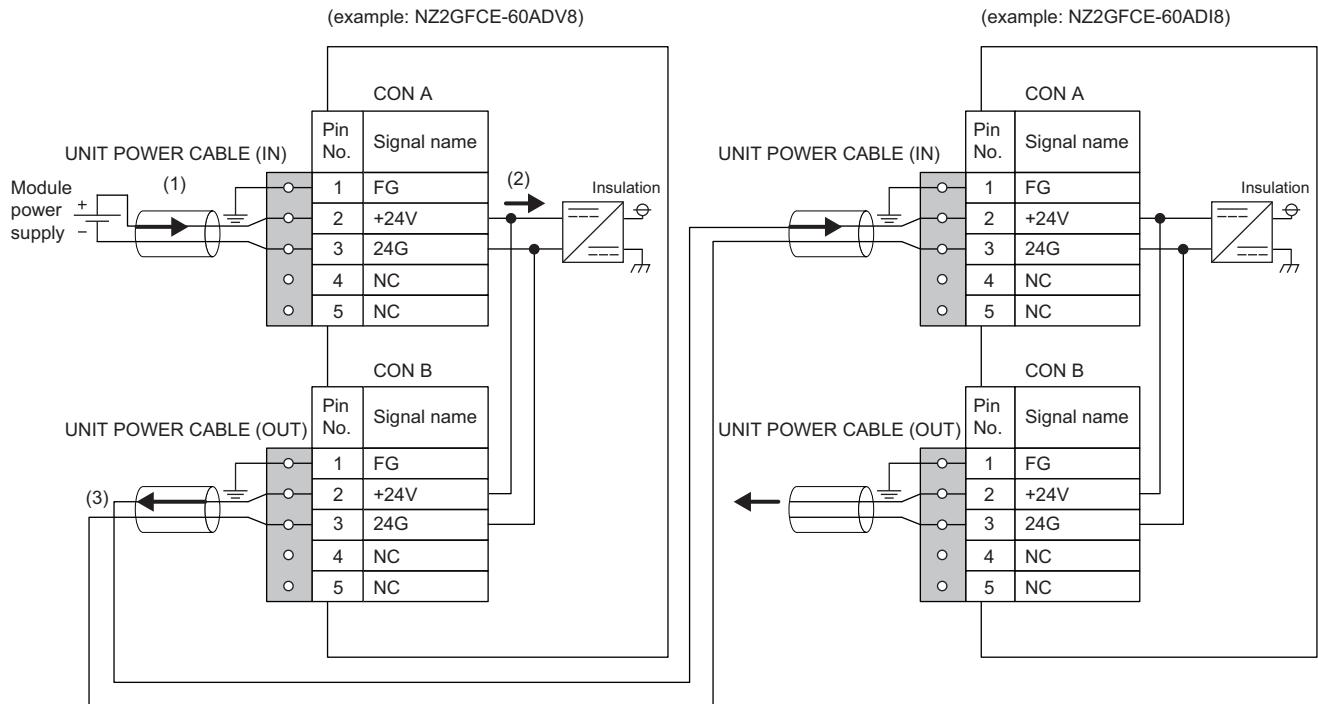

No.	Name	Description	Maximum current consumption	Allowable module current
(1)	Module power supply (IN)	External power supply to run the module	—	1.5A ^{*1*}
(2)	Module power supply	Power supply for module operation	Current consumption of the module ^{*3}	—
(3)	Module power supply (OUT)	Power supply for other modules connected with transition wiring	Depends on the module connected.	—

*1 1.5A for both the NZ2GFCE-60ADV8 and the NZ2GFCE-60ADI8.

*2 Design (1) so as the (2) + (3) (for number of connected modules) value to become allowable module current value.

*3 For details on module current consumption, refer to the following:

☞ Page 14 Performance Specifications

Wiring of Ethernet cable

Connecting an Ethernet cable

■Connecting

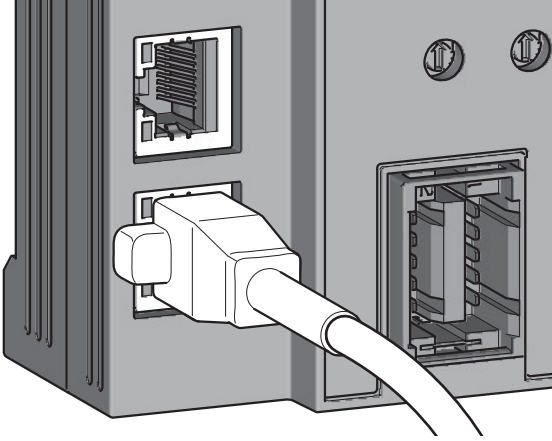

1. Turn off the module power supply of the A/D converter module and the power supply of the external devices.
2. With attention to the orientation of the cable, push the Ethernet cable connector into the A/D converter module until it clicks.

3. Power on the module.
4. Power on the external device.
5. Check if the LINK LED on the port into which the Ethernet cable is connected is on. ^{* 1}

*1 The time taken for the LINK LED to turn on after connection of the cable may vary. The LINK LED normally turns on in a few second. However, if link-up processing is repeated due to a condition of a device on the line, the longer time may be required. If the LINK LED does not turn on, refer to the following and take a corrective action.

☞ Page 110 When the LINK LED turns off

Point

- PORT1 connector and PORT2 connector need not to be distinguished. When only one connector is used in star topology, either PORT1 connector or PORT2 connector can be used.
- When two connectors are used in line topology or ring topology, there is no restriction on the connection combination of PORT1 connector and PORT2 connector. For example, the connection from PORT1 to PORT1 and the connection from PORT1 to PORT2 are both possible.
- Connection between PORT1 and PORT1 or between PORT2 and PORT2

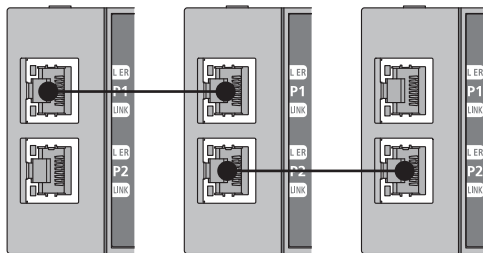

- Connection between PORT1 and PORT2

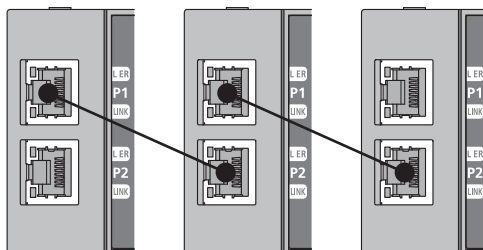

■ Disconnecting

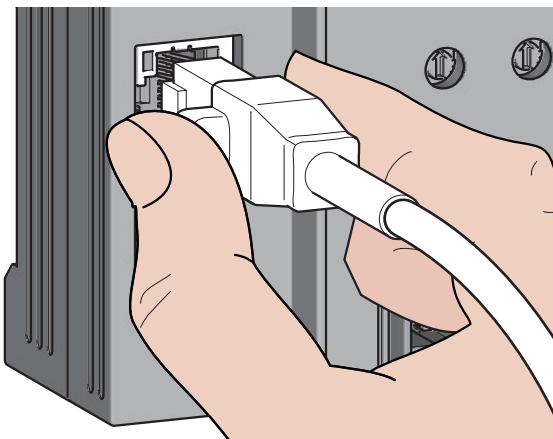

1. Power off the module power supply.
2. With the latch of the Ethernet cable pressed, unplug the cable.

Precautions

■ Laying Ethernet cables

- Place the Ethernet cables in a duct or clamp them. If not, dangling cable may swing or inadvertently be pulled, resulting in damage to the module or cables or malfunction due to poor contact.
- Do not touch the core of the connector of the cable or the module, and protect it from dirt and dust. If any oil from your hand, or any dirt or dust sticks to the core, it can increase transmission loss, causing data link to fail.
- Check the following:
 - Is any Ethernet cable disconnected?
 - Does any Ethernet cable short?
 - Are the connectors securely connected?

■ Broken cable latch

Do not use Ethernet cables with broken latches. Doing so may cause the cable to unplug or malfunction.

■ Connecting and disconnecting an Ethernet cable

Hold the connector part when connecting and disconnecting the Ethernet cable. Pulling the cable connected to the module may result in damage to the module or cable or malfunction due to poor contact.

■ Connector to which an Ethernet cable is not connected

To prevent dust from entering the module, attach the provided connector cover.

■ Maximum station-to-station distance for an Ethernet cable (maximum cable length)

The maximum station-to-station distance is 100m. However, the distance may be shorter depending on the operating environment of the cable. For details, contact the manufacturer of the cables used.

■ Bending radius of an Ethernet cable

There are restrictions on the bending radius of the Ethernet cable. Check the bending radius in the specifications of the Ethernet cables used.

Wiring of external devices

Reference connector list

The following list shows the e-CON plugs.

Model	Manufacturer	Specifications			Cover color
		Core size of compatible cables	Outer size of compatible cables	Maximum rated current	
ECN-M014R	Mitsubishi Electric System & Service Co., Ltd.	0.14 to 0.30mm ² (26 to 24 AWG)	φ0.8 to 1.0mm	2.0A	Red
ECN-M024Y			φ1.0 to 1.2mm		Yellow
ECN-M034OR			φ1.2 to 1.6mm		Orange
ECN-M044GN		0.30 to 0.50mm ² (22 to 20 AWG)	φ1.0 to 1.2mm		Green
ECN-M054BL			φ1.2 to 1.6mm		Blue
ECN-M064GY			φ1.6 to 2.0mm		Gray

For how to wire e-CON plugs, refer to the manufacturer's site.
Mitsubishi Electric System & Service Co., Ltd.

Terminal layout of e-CON

Terminal layout of e-CON is as follows.

■NZ2GFCE-60ADV8

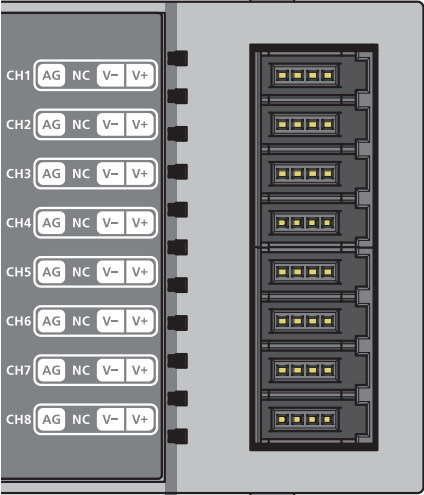
External appearance of e-CON	Terminal layout				
	Channel	Signal name			
	CH1	AG	NC	V-	V+
	CH2	AG	NC	V-	V+
	CH3	AG	NC	V-	V+
	CH4	AG	NC	V-	V+
	CH5	AG	NC	V-	V+
	CH6	AG	NC	V-	V+
	CH7	AG	NC	V-	V+
	CH8	AG	NC	V-	V+

■NZ2GFCE-60ADI8

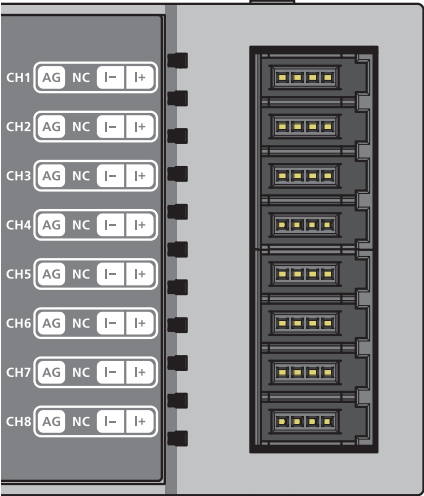
External appearance of e-CON	Terminal layout				
	Channel	Signal name			
	CH1	AG	NC	I-	I+
	CH2	AG	NC	I-	I+
	CH3	AG	NC	I-	I+
	CH4	AG	NC	I-	I+
	CH5	AG	NC	I-	I+
	CH6	AG	NC	I-	I+
	CH7	AG	NC	I-	I+
	CH8	AG	NC	I-	I+



Do not wire the NC terminals. Doing so can cause malfunction or failure of the module.

Precautions

To obtain the maximum performance from the functions of the A/D converter module and improve the system reliability, an external wiring with high durability against noise is required.

Wiring precautions are as follows:

- Use separate cables for the AC control circuit and the external I/O signals of the A/D converter module to avoid the influence of the AC side surges or induction.
- Do not place the cables close together or bind them with the main circuit lines, high voltage lines, or load cables from equipment other than the programmable controller. Fully separate the cables from the circuit containing high frequency such as high voltage lines and main load circuit of an inverter. If not, noise, surges, or induction may affect the system.
- Ground the shield wires or shielded cables at a single point on the programmable controller side. However, depending on the external noise conditions, it may be better to ground them externally.

External wiring

The following figure shows the external wiring.

■NZ2GFCE-60ADV8

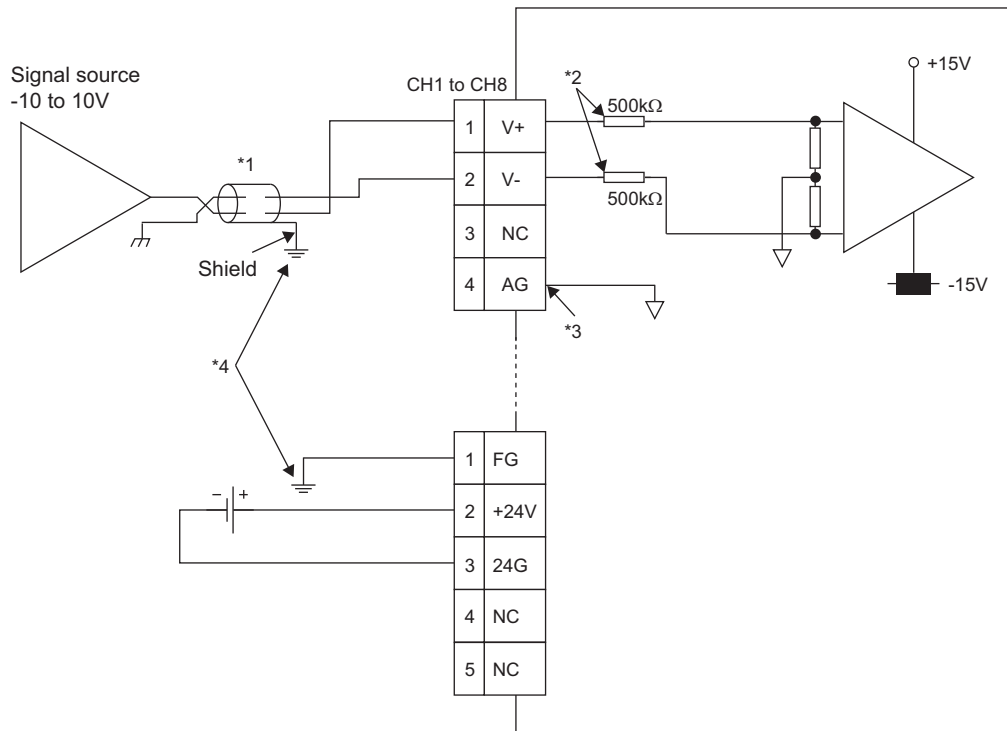

*1 For the cable, use the 2-core shielded twisted pair cable.

*2 These indicate input resistance of the NZ2GFCE-60ADV8.

*3 If there is any potential difference between AG terminal and GND of the external device, or if the GND is shared by the external devices connected to channels, connect the AG terminal with the GND of the external devices.

*4 Be sure to ground shield wires of the channel cables and FG terminal.

■NZ2GFCE-60ADI8

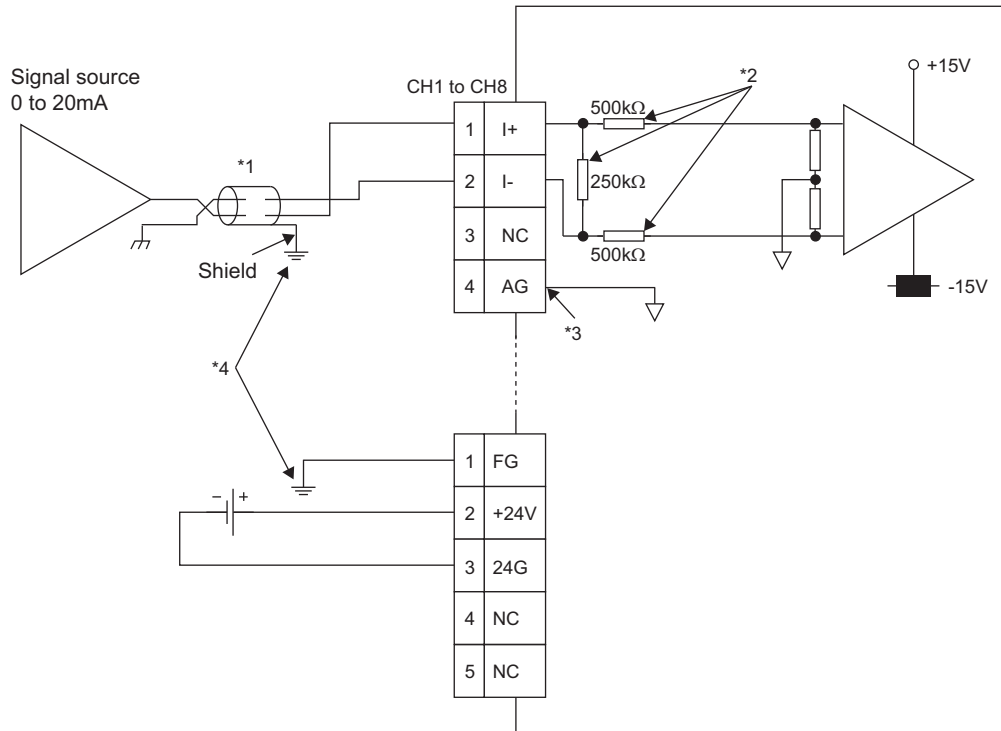

*1 For the cable, use the 2-core shielded twisted pair cable.

*2 These indicate input resistance of the NZ2GFCE-60ADI8.

*3 If there is any potential difference between AG terminal and GND of the external device, or if the GND is shared by the external devices connected to channels, connect the AG terminal with the GND of the external devices.

*4 Be sure to ground shield wires of the channel cables and FG terminal.

6 VARIOUS SETTINGS

This chapter describes how to set up various settings of the A/D converter module.
This chapter uses GX Works2 for explanation.

6.1 Parameter Settings

Set the parameter of this module with the network parameter written to the CPU module of the master station. For the setting procedure of the master station, refer to the following:

User's manual for the master/local module used

Point

- Before parameter settings, "Set network configuration setting in CC IE Field configuration window" needs to be selected on the "MELSECNET/CC IE/Ethernet Module Configuration" window.

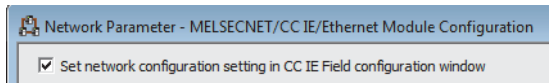

- Setting fewer points of the remote I/O signal or remote register than actual points that the A/D converter module possesses does not cause an error. In this case, data of all the set points are subject to cyclic transmission in order.

Precautions

■ Before parameter settings

For the precautions before parameter settings, refer to the following.

GX Works3 Operating Manual

GX Works2 Version 1 Operating Manual (Common)

■ Parameter settings

- When using the A/D converter module, always enable the block data assurance per station. When it is disabled, correct operation of the A/D converter module cannot be guaranteed. For details on the block data assurance per station, refer to the following: User's manual for the master/local module used.

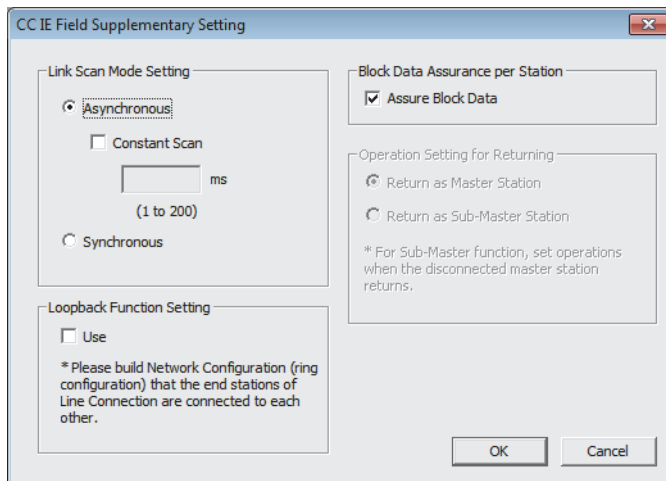

- Do not set the parameters using the CCPASET instruction in the master station. Executing the CCPASET instruction results in the module operating with block data assurance per station deactivated, where proper performance as the A/D converter module cannot be guaranteed. (The CCPASET instruction is intended to configure parameters for a master/local module. For details on the CCPASET instruction, refer to the following: User's manual for the master/local module used.)

Setting procedure

1. Open the CC IE Field configuration window.

For the master/local module QJ71GF11-T2

☞ Project window ⇒ [Parameter] ⇒ [Network Parameter] ⇒ [Ethernet / CC IE / MELSECNET] ⇒ [CC IE Field Configuration Setting] button

2. On the CC IE Field configuration window, from "List of stations", select the A/D converter module.

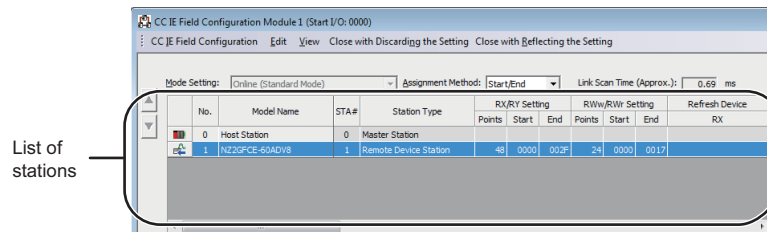

3. Open the "Parameter Processing of Slave Station" window.

☞ [CC IE Field Configuration] ⇒ [Online] ⇒ [Parameter Processing of Slave Station]

4. Set "Method selection" to "Parameter write".

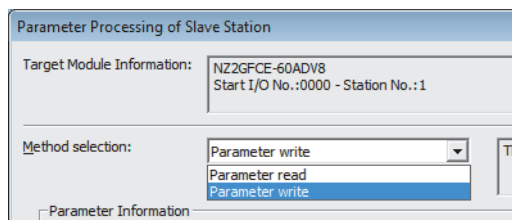

5. Double-click the item to be changed, and enter the setting value.

- Items to be selected from a pull-down list

Double-click the item to be set, and from the pull-down list that appears, select the desired item.

- Items to be entered via text box

Double-click the item to be set, and enter the desired value.

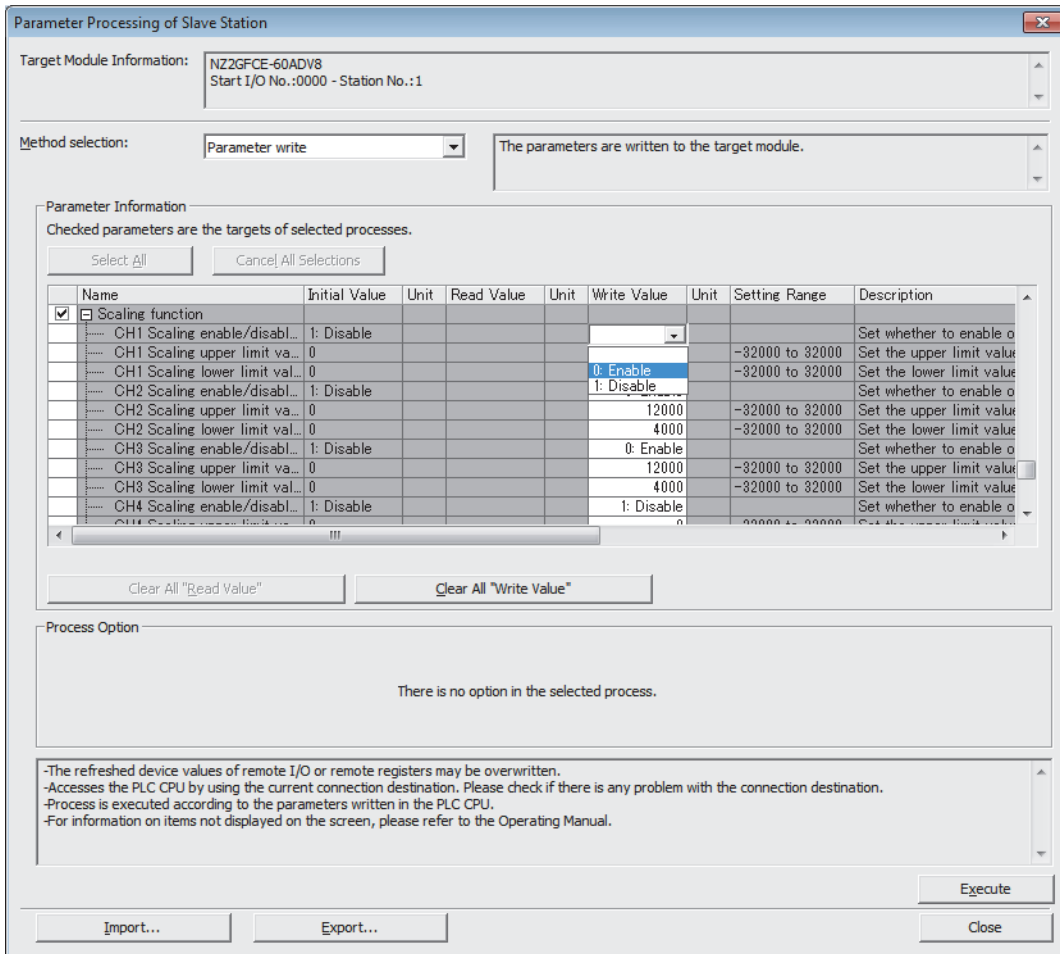

Setting item		Reference
A/D conversion enable/disable setting	CH1 A/D conversion enable/disable setting	Page 58 A/D Conversion Enable/Disable Function
	CH2 A/D conversion enable/disable setting	
	CH3 A/D conversion enable/disable setting	
	CH4 A/D conversion enable/disable setting	
	CH5 A/D conversion enable/disable setting	
	CH6 A/D conversion enable/disable setting	
	CH7 A/D conversion enable/disable setting	
	CH8 A/D conversion enable/disable setting	
Range setting	CH1 Range setting	Page 62 Range Switching Function
	CH2 Range setting	
	CH3 Range setting	
	CH4 Range setting	
	CH5 Range setting	
	CH6 Range setting	
	CH7 Range setting	
	CH8 Range setting	

Setting item		Reference
Averaging process setting	CH1 Averaging process setting	Page 58 A/D Conversion Method
	CH1 Time average/Count average/Moving average	
	CH2 Averaging process setting	
	CH2 Time average/Count average/Moving average	
	CH3 Averaging process setting	
	CH3 Time average/Count average/Moving average	
	CH4 Averaging process setting	
	CH4 Time average/Count average/Moving average	
	CH5 Averaging process setting	
	CH5 Time average/Count average/Moving average	
	CH6 Averaging process setting	
	CH6 Time average/Count average/Moving average	
	CH7 Averaging process setting	
	CH7 Time average/Count average/Moving average	
	CH8 Averaging process setting	
	CH8 Time average/Count average/Moving average	
Input signal error detection function	CH1 Input signal error detection setting	Page 64 Input Signal Error Detection Function
	CH2 Input signal error detection setting	
	CH3 Input signal error detection setting	
	CH4 Input signal error detection setting	
	CH5 Input signal error detection setting	
	CH6 Input signal error detection setting	
	CH7 Input signal error detection setting	
	CH8 Input signal error detection setting	

Setting item	Reference	
Alert output function	CH1 Alert output setting	Page 67 Alert Output Function (Process Alarm)
	CH1 Process alarm upper upper limit value	
	CH1 Process alarm upper lower limit value	
	CH1 Process alarm lower upper limit value	
	CH1 Process alarm lower lower limit value	
	CH2 Alert output setting	
	CH2 Process alarm upper upper limit value	
	CH2 Process alarm upper lower limit value	
	CH2 Process alarm lower upper limit value	
	CH2 Process alarm lower lower limit value	
	CH3 Alert output setting	
	CH3 Process alarm upper upper limit value	
	CH3 Process alarm upper lower limit value	
	CH3 Process alarm lower upper limit value	
	CH3 Process alarm lower lower limit value	
	CH4 Alert output setting	
	CH4 Process alarm upper upper limit value	
	CH4 Process alarm upper lower limit value	
	CH4 Process alarm lower upper limit value	
	CH4 Process alarm lower lower limit value	
	CH5 Alert output setting	
	CH5 Process alarm upper upper limit value	
	CH5 Process alarm upper lower limit value	
	CH5 Process alarm lower upper limit value	
	CH5 Process alarm lower lower limit value	
	CH6 Alert output setting	
	CH6 Process alarm upper upper limit value	
	CH6 Process alarm upper lower limit value	
	CH6 Process alarm lower upper limit value	
	CH6 Process alarm lower lower limit value	
	CH7 Alert output setting	
	CH7 Process alarm upper upper limit value	
	CH7 Process alarm upper lower limit value	
	CH7 Process alarm lower upper limit value	
	CH7 Process alarm lower lower limit value	
	CH8 Alert output setting	
CH8 Process alarm upper upper limit value		
CH8 Process alarm upper lower limit value		
CH8 Process alarm lower upper limit value		
CH8 Process alarm lower lower limit value		
Digital clipping function	CH1 Digital clipping enable/disable setting	Page 77 Digital Clipping Function
	CH2 Digital clipping enable/disable setting	
	CH3 Digital clipping enable/disable setting	
	CH4 Digital clipping enable/disable setting	
	CH5 Digital clipping enable/disable setting	
	CH6 Digital clipping enable/disable setting	
	CH7 Digital clipping enable/disable setting	
	CH8 Digital clipping enable/disable setting	

Setting item		Reference
Scaling function	CH1 Scaling enable/disable setting	Page 70 Scaling Function
	CH1 Scaling upper limit value	
	CH1 Scaling lower limit value	
	CH2 Scaling enable/disable setting	
	CH2 Scaling upper limit value	
	CH2 Scaling lower limit value	
	CH3 Scaling enable/disable setting	
	CH3 Scaling upper limit value	
	CH3 Scaling lower limit value	
	CH4 Scaling enable/disable setting	
	CH4 Scaling upper limit value	
	CH4 Scaling lower limit value	
	CH5 Scaling enable/disable setting	
	CH5 Scaling upper limit value	
	CH5 Scaling lower limit value	
	CH6 Scaling enable/disable setting	
	CH6 Scaling upper limit value	
	CH6 Scaling lower limit value	
	CH7 Scaling enable/disable setting	
	CH7 Scaling upper limit value	
	CH7 Scaling lower limit value	
	CH8 Scaling enable/disable setting	
	CH8 Scaling upper limit value	
	CH8 Scaling lower limit value	

6. Click the [Execute] button to open the following window.

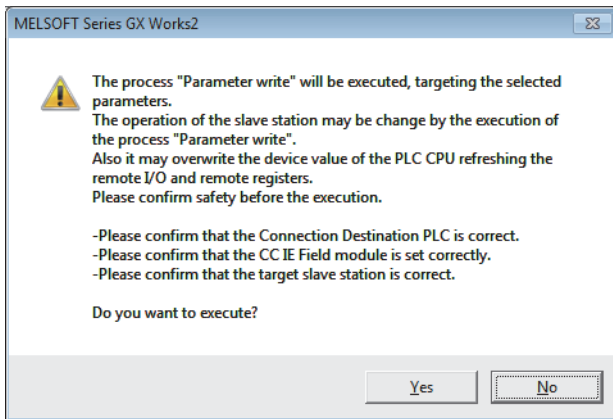

7. Click the [Yes] button.

8. The parameters are written to the A/D converter module.

Point

- Set all the items for the parameter. If any blank exists, the parameters cannot be written to the A/D converter module.
- To read the parameter from the A/D converter module, set "Method selection" to "Parameter read" and click the [Execute] button.
- The parameters are checked when they are written to the A/D converter module. If the following message is displayed during the writing, take corrective action for the error code in <>. For details on the error codes, refer to the list of error codes (Page 104 Error Code List) and the user's manual for the master/local module used.

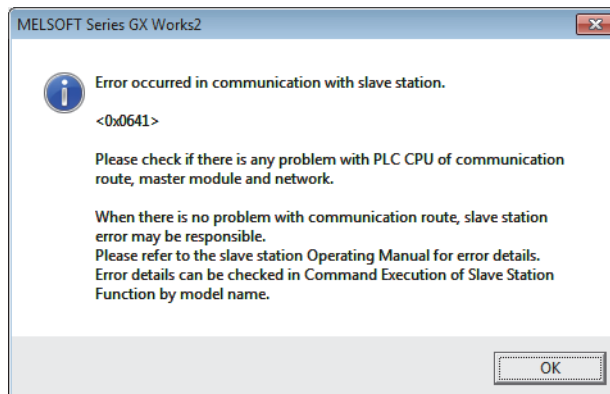

6.2 How to Change the Parameters

This section describes the procedures to change the parameters.

The precautions to take when changing the parameters are the same as the following:

☞ Page 45 Precautions

Changing the network configuration

To change the network configuration reusing the already created project, set the parameters in the following steps:

1. Turn off the module power supply.
2. Connect the modules again according to the desired network configuration.
3. Turn on the module power supply.
4. Open the CC IE Field configuration window.

For the master/local module QJ71GF11-T2

☞ Project window ⇒ [Parameter] ⇒ [Network Parameter] ⇒ [Ethernet / CC IE / MELSECNET] ⇒ [CC IE Field Configuration Setting] button

5. Set up the slave station with drag and drop, and enter the station number for the slave station. Change values as necessary.

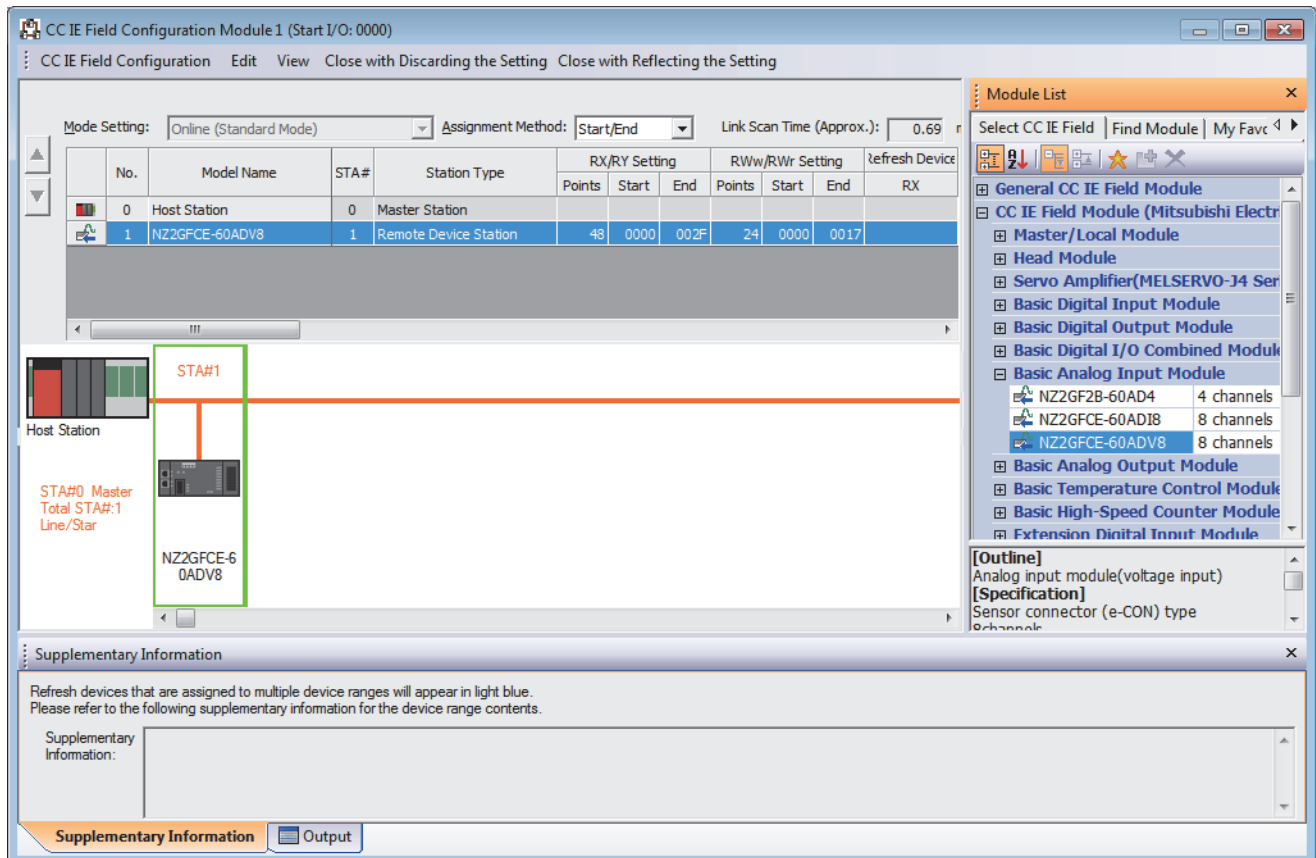

6. Close the CC IE Field configuration window.

☞ [CC IE Field Configuration] ⇒ [Close with Reflecting the Setting]

7. Click the [Refresh Parameters] button to open the refresh parameter setting window.

8. Set up the refresh parameters. Change values as necessary.

	Link Side					PLC Side			
	Dev. Name	Points	Start	End		Dev. Name	Points	Start	End
Transfer SB	SB	512	0000	01FF	↔	SB	512	0000	01FF
Transfer SW	SW	512	0000	01FF	↔	SW	512	0000	01FF
Transfer 1	RX	48	0000	002F	↔	X	48	1000	102F
Transfer 2	RY	48	0000	002F	↔	Y	48	1000	102F
Transfer 3	RWw	24	0000	0017	↔	W	24	001000	001017
Transfer 4	RWr	24	0000	0017	↔	W	24	001100	001117
Transfer 5					↔				
Transfer 6					↔				
Transfer 7					↔				
Transfer 8					↔				

9. Write the set parameters to the CPU module of the master station, and reset the CPU module.

10. Put the CPU module of the master station into RUN.

Setting up the network configuration is now complete.

Changing the parameters without changing the network configuration

To change only the module parameters of the already set-up slave station without changing the network configuration, take the following steps:

1. Open the CC IE Field configuration window.

For the master/local module QJ71GF11-T2

Project window ⇒ [Parameter] ⇒ [Network Parameter] ⇒ [Ethernet / CC IE / MELSECNET] ⇒ [CC IE Field Configuration Setting] button

2. On the CC IE Field configuration window, from "List of stations", select the A/D converter module.

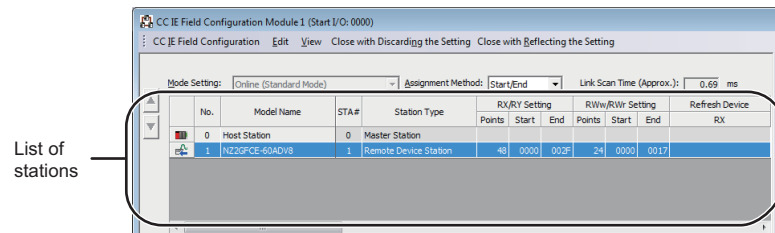

3. Open the "Parameter Processing of Slave Station" window.

[CC IE Field Configuration] ⇒ [Online] ⇒ [Parameter Processing of Slave Station]

4. Set "Method selection" to "Parameter read".

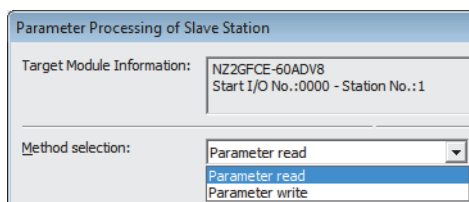

5. Click the [Execute] button to open the following window.

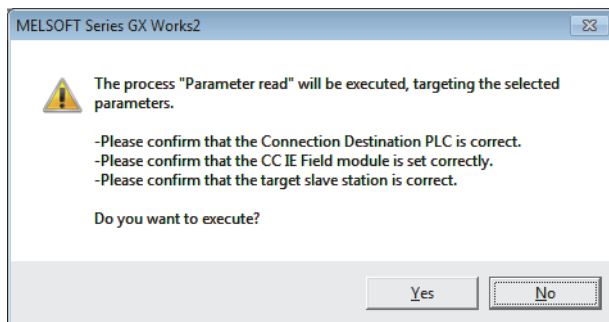

6. Click the [Yes] button.

7. The parameters are read from the A/D converter module.

Name	Initial Value	Unit	Read Value	Unit	Write Value	Unit	Setting Range
<input checked="" type="checkbox"/> A/D conversion enable/disab...							
CH1 A/D conversion enabl...	0: Enable		0: Enable				
CH2 A/D conversion enabl...	0: Enable		0: Enable				
CH3 A/D conversion enabl...	0: Enable		0: Enable				
CH4 A/D conversion enabl...	0: Enable		0: Enable				
CH5 A/D conversion enabl...	0: Enable		0: Enable				
CH6 A/D conversion enabl...	0: Enable		0: Enable				
CH7 A/D conversion enabl...	0: Enable		0: Enable				
CH8 A/D conversion enabl...	0: Enable		0: Enable				
<input checked="" type="checkbox"/> Range setting							
CH1 Range setting	2: 1 to 5V		2: 1 to 5V				
CH2 Range setting	2: 1 to 5V		2: 1 to 5V				

8. Set "Method selection" to "Parameter write".

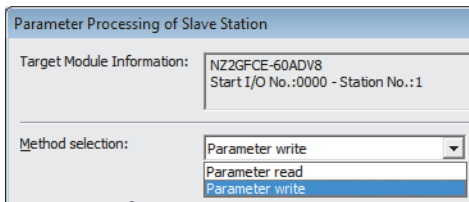

9. Set "Write Value". Follow the next steps to set the value:

- Click the title cell of "Read Value" to select all the items and copy them.
- Click the title cell of "Write Value" to select all the items, and paste the copy.
- Select the items to be changed, and set new values.

Name	Initial Value	Unit	Read Value	Unit	Write Value	Unit	Setting Range
<input checked="" type="checkbox"/> A/D conversion enable/disab...							
..... CH1 A/D conversion enabl...	0: Enable		0: Enable		1: Disable		
..... CH2 A/D conversion enabl...	0: Enable		0: Enable		0: Enable		
..... CH3 A/D conversion enabl...	0: Enable		0: Enable		0: Enable		
..... CH4 A/D conversion enabl...	0: Enable		0: Enable		0: Enable		
..... CH5 A/D conversion enabl...	0: Enable		0: Enable		0: Enable		
..... CH6 A/D conversion enabl...	0: Enable		0: Enable		0: Enable		
..... CH7 A/D conversion enabl...	0: Enable		0: Enable		0: Enable		
..... CH8 A/D conversion enabl...	0: Enable		0: Enable		0: Enable		
<input checked="" type="checkbox"/> Range setting							
..... CH1 Range setting	2: 1 to 5V		2: 1 to 5V		2: 1 to 5V		
..... CH2 Range setting	2: 1 to 5V		2: 1 to 5V		2: 1 to 5V		

10. Click the [Execute] button to open the following window.

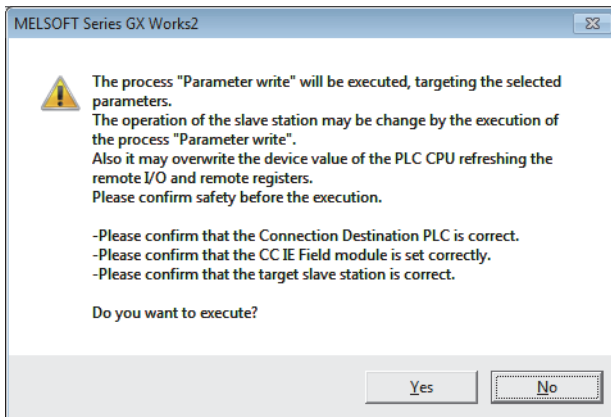

11. Click the [Yes] button.

12. The parameters are written to the A/D converter module. Setting the module parameters of the slave station is complete.

7 FUNCTIONS

This chapter describes the details of the functions available in the A/D converter module, and the setting procedures for those functions.

For details on remote I/O signals, remote register, and remote buffer memory, refer to the following:

- ☞ Page 114 Details of Remote I/O Signals
- ☞ Page 122 Details of Remote Register
- ☞ Page 125 Details of Remote Buffer Memory

Point

The Δ of error codes and alarm codes described in this chapter has a numerical value corresponding to the error definition. For details on the numerical value, refer to the following:

- ☞ Page 104 Error Code List
 - ☞ Page 108 List of Alarm Codes
-

7.1 Mode Shift at Power-On

At power-on, the A/D converter module enters any of the following modes:

- Unit test mode
- Normal mode

Unit test mode

If x10 of the station number setting switch is set to TEST and x1 of the switch is set to 0, the mode shifts to the unit test mode.

For details, refer to the following:

- ☞ Page 111 Unit Test

Normal mode

If the station number setting switch is set to 1 to 120, the mode shifts to normal mode.

7.2 Each Function in the Sequence

An analog input value and digital operation value are processed by the functions in the order shown below. If multiple functions are enabled, the output of the first-processed function is used as the input of the next function.

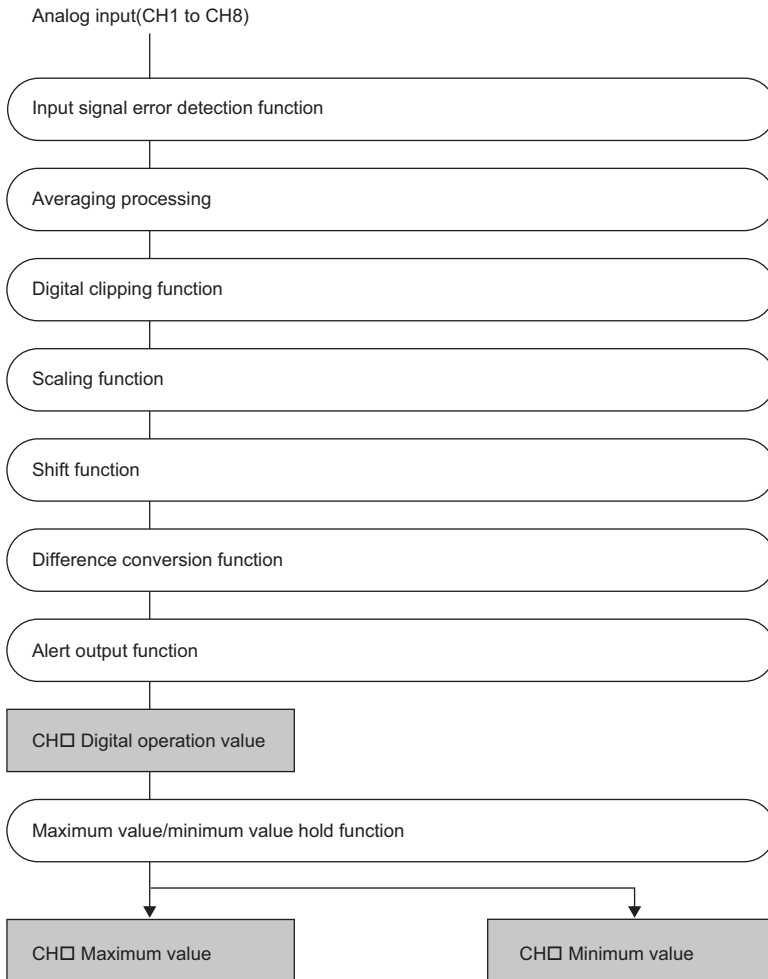

Digital operation value

Digital values after sampling processing or averaging processing have been performed are called digital output values. The values obtained by operating the digital output value using the digital clipping function, scaling function, shift function, or difference conversion function are stored.

Maximum and minimum values

The maximum and minimum values of the digital operation values are stored.

7.3 A/D Conversion Enable/Disable Function

This function allows A/D conversion to be enabled or disabled for each channel.
Disabling the A/D conversion for unused channels reduces the conversion cycles.

Setting procedure

The setting procedure for the A/D converter module is as follows:

1. Set "Method selection" to "Parameter write".

☞ CC IE Field configuration window ⇒ Select the A/D converter module in "List of stations". ⇒ [CC IE Field Configuration]
⇒ [Online] ⇒ [Parameter Processing of Slave Station]

2. Set "CH□ A/D conversion enable/disable setting" to either "0: Enable" or "1: Disable".

Name	Initial Value	Unit	Read Value	Unit	Write Value
<input checked="" type="checkbox"/> A/D conversion enable/disable...					
CH1 A/D conversion enabl...	0: Enable				
CH2 A/D conversion enabl...	0: Enable				
CH3 A/D conversion enabl...	0: Enable				0: Enable
CH4 A/D conversion enabl...	0: Enable				1: Disable

7.4 A/D Conversion Method

Set whether to perform sampling processing or averaging processing for each channel.

Sampling processing

For the A/D converter module, digital operation values are stored into CH□ Digital operation value (RWr2 to RWr9) at every sampling period.

The sampling period of the A/D converter module varies depending on the number of channels used (number of channels where A/D conversion is enabled).

Sampling period [ms] = Number of channels used × Conversion speed (1ms)

Disabling the A/D conversion for unused channels reduces the sampling period.

Ex.

Sampling period when number of channels used is set to 3 channels (CH1 to CH3):

$$3 \times 1 = 3\text{ms}$$

Averaging processing

This processing performs averaging processing on digital values for each channel, storing the mean values into CH□ Digital operation value (RWr2 to RWr9).

There are three types of averaging processing as follows:

- Time average
- Count average
- Moving average

■Time average

This processing performs A/D conversion for a set time and averages the total excluding the maximum and minimum values, storing the average value into CH□ Digital operation value (RWr2 to RWr9).

The number of processing times varies depending on the sampling period.

Processing times (times) = Setting time ÷ Sampling period

Ex.

The number of processing times assuming the following settings is as follows.

Item	Setting
Number of channels used (number of channels where A/D conversion is enabled)	4 channels (CH1 to CH4)
Conversion speed	1ms/channel
Setting time	150ms

$$150 \div (4 \times 1) = 37.5 \text{ times}$$

37 measurements are performed to output a mean value. (Rounded to an integer)

Point

For the time average, the valid lower limit value to be set is given by: Minimum number of processing times, 4 × Sampling period.

4 channels (conversion speed: 1ms/channel):

$$4 \times (4 \times 1) = 16\text{ms}$$

If the number of processing times falls below four due to the set time, Time average setting out-of-range (error code: 020□) occurs, where the digital operation value becomes 0.

■Count average

This processing performs A/D conversion for a set number of times and averages the total excluding the maximum and minimum values, storing the average value into CH□ Digital operation value (RWr2 to RWr9).

The time taken to store the mean value obtained by count average into CH□ Digital operation value (RWr2 to RWr9) varies depending on the sampling period.

Processing time (ms) = Set number of times × Sampling period

Ex.

The processing time assuming the following settings is as follows.

Item	Setting
Number of channels used (number of channels where A/D conversion is enabled)	4 channels (CH1 to CH4)
Conversion speed	1ms/channel
Set number of times	20 times

$$20 \times (4 \times 1) = 80\text{ms}$$

→ An average value is output every 80ms.

Point

Because the count average requires a sum of at least two counts except the maximum and minimum values, the set number of times should be set to four or more.

■ Moving average

This processing averages the digital output values taken in at each sampling period for a specified number of times, storing the average value into CH□ Digital operation value (RWr2 to RWr9).

Because the averaging processing is performed on a moving set of sampling processing, the latest digital operation value can be obtained.

The moving average processing for a set number of times of four is shown below:

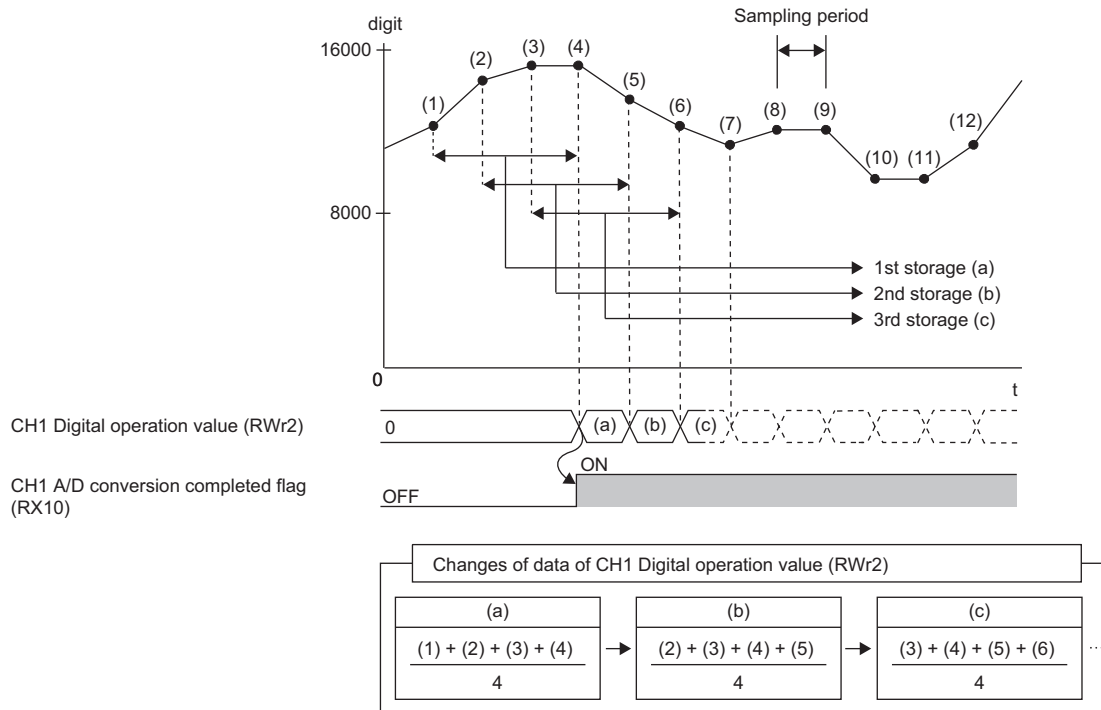

Setting procedure

The setting procedure for the A/D converter module is as follows:

■ Sampling processing

1. Set "Method selection" to "Parameter write".

☞ CC IE Field configuration window ⇒ Select the A/D converter module in "List of stations". ⇒ [CC IE Field Configuration] ⇒ [Online] ⇒ [Parameter Processing of Slave Station]

2. Set "CH□ A/D conversion enable/disable setting" to "0: Enable".

Name	Initial Value	Unit	Read Value	Unit	Write Value
<input checked="" type="checkbox"/> A/D conversion enable/disable...					
CH1 A/D conversion enabl...	0: Enable				
CH2 A/D conversion enabl...	0: Enable				
CH3 A/D conversion enabl...	0: Enable				0: Enable
CH4 A/D conversion enabl...	0: Enable				1: Disable

3. Set "CH□ Averaging process setting" to "0: Sampling processing".

Name	Initial Value	Unit	Read Value	Unit	Write Value
<input checked="" type="checkbox"/> Averaging process setting					
CH1 Averaging process se...	0: Sampling ...				
CH1 Time average/Count ...	0				
CH2 Averaging process se...	0: Sampling ...				
CH2 Time average/Count ...	0				
CH3 Averaging process se...	0: Sampling ...				
CH3 Time average/Count ...	0				

■Averaging processing

1. Set "Method selection" to "Parameter write".

☞ CC IE Field configuration window ⇒ Select the A/D converter module in "List of stations". ⇒ [CC IE Field Configuration] ⇒ [Online] ⇒ [Parameter Processing of Slave Station]

2. Set "CH□ A/D conversion enable/disable setting" to "0: Enable".

Name	Initial Value	Unit	Read Value	Unit	Write Value
<input checked="" type="checkbox"/> A/D conversion enable/disable...					
..... CH1 A/D conversion enabl...	0: Enable				
..... CH2 A/D conversion enabl...	0: Enable				
..... CH3 A/D conversion enabl...	0: Enable				
..... CH4 A/D conversion enabl...	0: Enable				

3. Specify the type of averaging processing for "CH□ Averaging process setting".

Name	Initial Value	Unit	Read Value	Unit	Write Value
<input checked="" type="checkbox"/> Averaging process setting					
..... CH1 Averaging process se...	0: Sampling ...				
..... CH1 Time average/Count ...	0				
..... CH2 Averaging process se...	0: Sampling ...				
..... CH2 Time average/Count ...	0				
..... CH3 Averaging process se...	0: Sampling ...				
..... CH3 Time average/Count ...	0				

Setting item	Setting range
CH□ Averaging process setting	<ul style="list-style-type: none"> • 1: Time average • 2: Count average • 3: Moving average

4. Set the value of averaging processing in "CH□ Time average/Count average/Moving average".

Name	Initial Value	Unit	Read Value	Unit	Write Value
<input checked="" type="checkbox"/> Averaging process setting					
..... CH1 Averaging process se...	0: Sampling ...				1: Time aver...
..... CH1 Time average/Count ...	0				1000

Setting item	Selected processing for "CH□ Averaging process setting"	Setting range
CH□ Time average/Count average/Moving average	1: Time average*1	4 to 5000(ms)
	2: Count average	4 to 65000 (times)
	3: Moving average	2 to 128 (times)

*1 For time average, set a value of (4 × Sampling period) ms or more. A value less than this criterion results in Time average setting out-of-range (error code: 020□H) being stored in Latest error code (RWr0), Error flag (RXA) turning on, and the ERR. LED lighting up. In CH□ Digital operation value (RWr2 to RWr9), 0 is stored.

7.5 Range Switching Function

The input range can be selected for each channel from the following ranges:

- Voltage: 1 to 5V, 0 to 5V, -10 to 10V
- Current: 4 to 20mA, 0 to 20mA

Setting procedure

The setting procedure for the A/D converter module is as follows:

1. Set "Method selection" to "Parameter write".

☞ CC IE Field configuration window ⇒ Select the A/D converter module in "List of stations". ⇒ [CC IE Field Configuration] ⇒ [Online] ⇒ [Parameter Processing of Slave Station]

2. Set "CH□ A/D conversion enable/disable setting" to "0: Enable".

Name	Initial Value	Unit	Read Value	Unit	Write Value
<input checked="" type="checkbox"/> A/D conversion enable/disable...					
CH1 A/D conversion enabl...	0: Enable				
CH2 A/D conversion enabl...	0: Enable				
CH3 A/D conversion enabl...	0: Enable				
CH4 A/D conversion enabl...	0: Enable				

3. Set up "CH□ Range setting".

Name	Initial Value	Unit	Read Value	Unit	Write Value
<input checked="" type="checkbox"/> Range setting					
CH1 Range setting	2: 1 to 5V				
CH2 Range setting	2: 1 to 5V				
CH3 Range setting	2: 1 to 5V				
CH4 Range setting	2: 1 to 5V				
CH5 Range setting	2: 1 to 5V				

7.6 Maximum Value/Minimum Value Hold Function

For each channel, this function stores the maximum value and the minimum value of digital operation values into the following remote buffer memory.

A/D converter module	Remote buffer memory address	
	Maximum value	Minimum value
CH1	0600H	0601H
CH2	0602H	0603H
CH3	0604H	0605H
CH4	0606H	0607H
CH5	0608H	0609H
CH6	060AH	060BH
CH7	060CH	060DH
CH8	060EH	060FH

If averaging processing is specified, the values are updated per averaging process cycle. Otherwise they are updated per sampling period.

Resetting maximum and minimum values

How to update current values of maximum value and minimum value of the A/D converter module consists of the following two methods:

- Turn on and off Maximum value/minimum value reset request (RY1D).
- Turn on and off Initial data setting request flag (RY9).

Target of the maximum and minimum values

The maximum and minimum values of digital operation values are stored into the remote buffer memory.

For details, refer to the following:

 Page 57 Each Function in the Sequence

7.7 Input Signal Error Detection Function

This function simply detects a disconnection of an analog input signal.

The following figure schematically shows how the input signal error detection works in the A/D converter module.

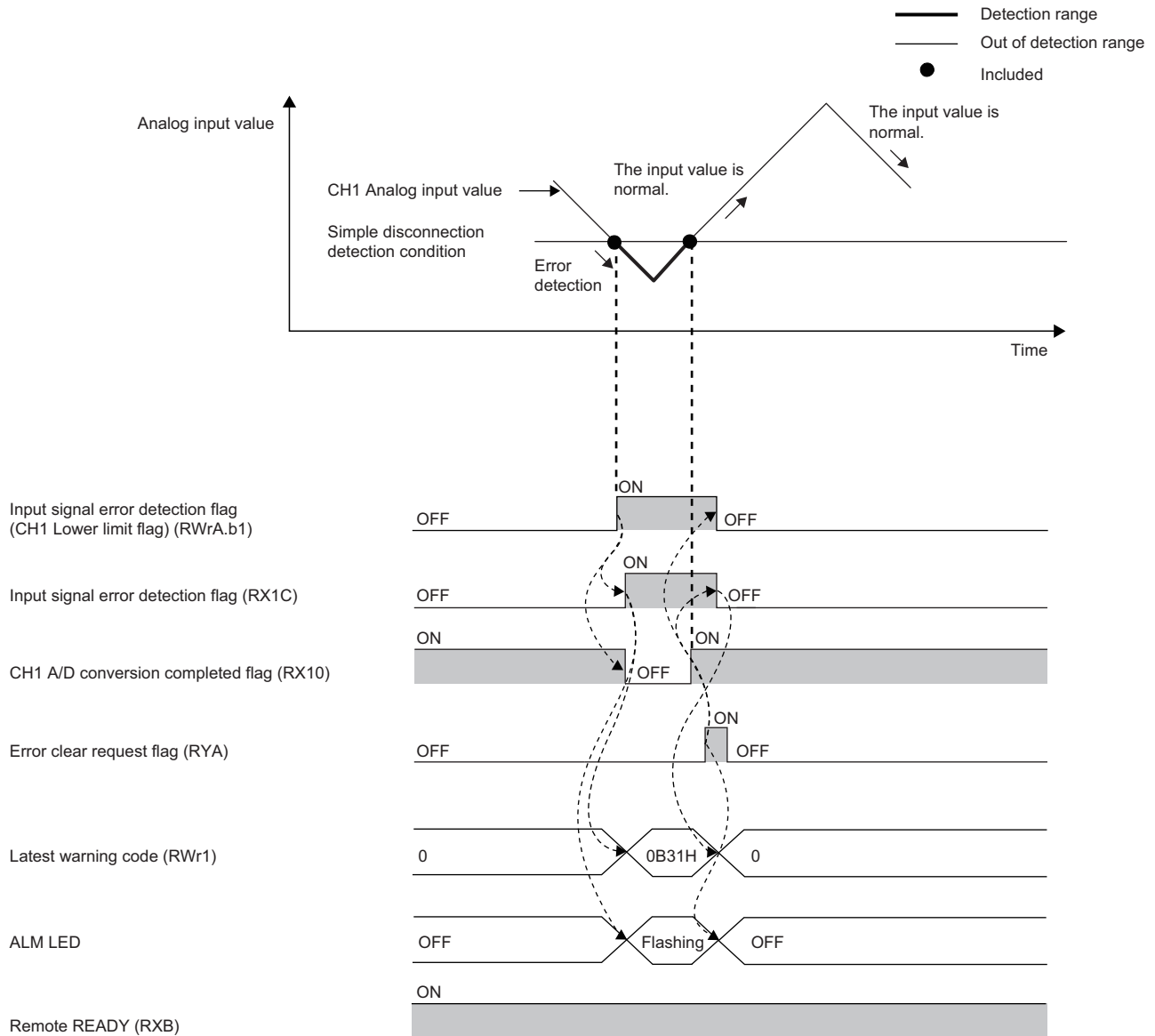

-----> Executed by the A/D converter module.

Detection condition

When the following condition is satisfied, a disconnection is simply detected.

Input range ^{*1}	Simple disconnection detection condition
4 to 20mA	Input analog value \leq 2mA
1 to 5V	Input analog value \leq 0.5V

*1 An input range other than the above results in Simple disconnection detection setting error (error code: 082□H) being stored in Latest error code (RWr0), Error flag (RXA) turning on, and the ERR. LED lighting up, with operation at the previous settings.

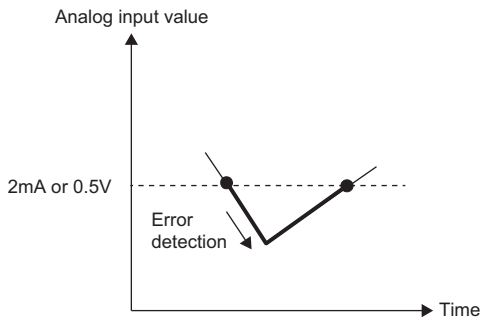

Notification

If the analog input value is satisfied the simple disconnection detection condition, the A/D converter module results in the following state and an error is notified.

- Input signal error detection flag (RWrA): The bit of the corresponding channel turns on. (Page 123 Input signal error detection flag)
- Input signal error detection signal (RX1C): On
- ALM LED of the A/D converter module: Flashing

In addition, Input signal error detection (alarm code: 0B3□H) is stored in Latest warning code (RWr1).

Operation

The digital operation value of the channel in which an error is detected is held at the value just before the error detection, and CH□ A/D conversion completed flag (RX10 to RX17) of the corresponding channel turns off.

In addition, once the analog input value returns to a value that is larger than the criteria of simple disconnection detection, A/D conversion restarts regardless of the reset of Input signal error detection flag (RWrA) and Input signal error detection signal (RX1C). After the first update, CH□ A/D conversion completed flag (RX10 to RX17) of the corresponding channel turns on again. (The ALM LED of the A/D converter module keeps flashing.)

Point

The digital operation value is not updated while the input signal error is being detected.

Once the analog input value is out of the simple disconnection detection condition, updating the digital operation value restarts.

Detection cycle

This function is executed per sampling period.

Clearing the input signal error detection

Check that the analog input value returns to a value that is larger than the criteria of simple disconnection detection and Error flag (RXA) turns off, and then turn on and off Error clear request flag (RYA).

When the input signal error is cleared, the A/D converter module results in the following state:

- Input signal error detection flag (RWrA) is cleared.
- Input signal error detection signal (RX1C) turns off.
- The ALM LED turns off.
- The alarm code stored in Latest warning code (RWr1) is cleared.

Setting procedure

The setting procedure for the A/D converter module is as follows:

1. Set "Method selection" to "Parameter write".

 CC IE Field configuration window ⇒ Select the A/D converter module in "List of stations". ⇒ [CC IE Field Configuration] ⇒ [Online] ⇒ [Parameter Processing of Slave Station]

2. Set "CH□ A/D conversion enable/disable setting" to "0: Enable".

	Name	Initial Value	Unit	Read Value	Unit	Write Value
<input checked="" type="checkbox"/>	A/D conversion enable/disable...					
	CH1 A/D conversion enabl...	0: Enable				
	CH2 A/D conversion enabl...	0: Enable				
	CH3 A/D conversion enabl...	0: Enable				0: Enable
	CH4 A/D conversion enabl...	0: Enable				1: Disable

3. Set "CH□ Input signal error detection setting" to "4: Simple disconnection detection".

	Name	Initial Value	Unit	Read Value	Unit	Write Value
<input checked="" type="checkbox"/>	Input signal error detection fu...					
	CH1 Input signal error dete...	0: Disable				
	CH2 Input signal error dete...	0: Disable				
	CH3 Input signal error dete...	0: Disable				0: Disable
	CH4 Input signal error dete...	0: Disable				4: Simple disconnection detection

7.8 Alert Output Function (Process Alarm)

This function outputs an alert when a digital operation value falls within the alert output range set in advance. The following figure schematically shows how the alert output behaves in the A/D converter module.

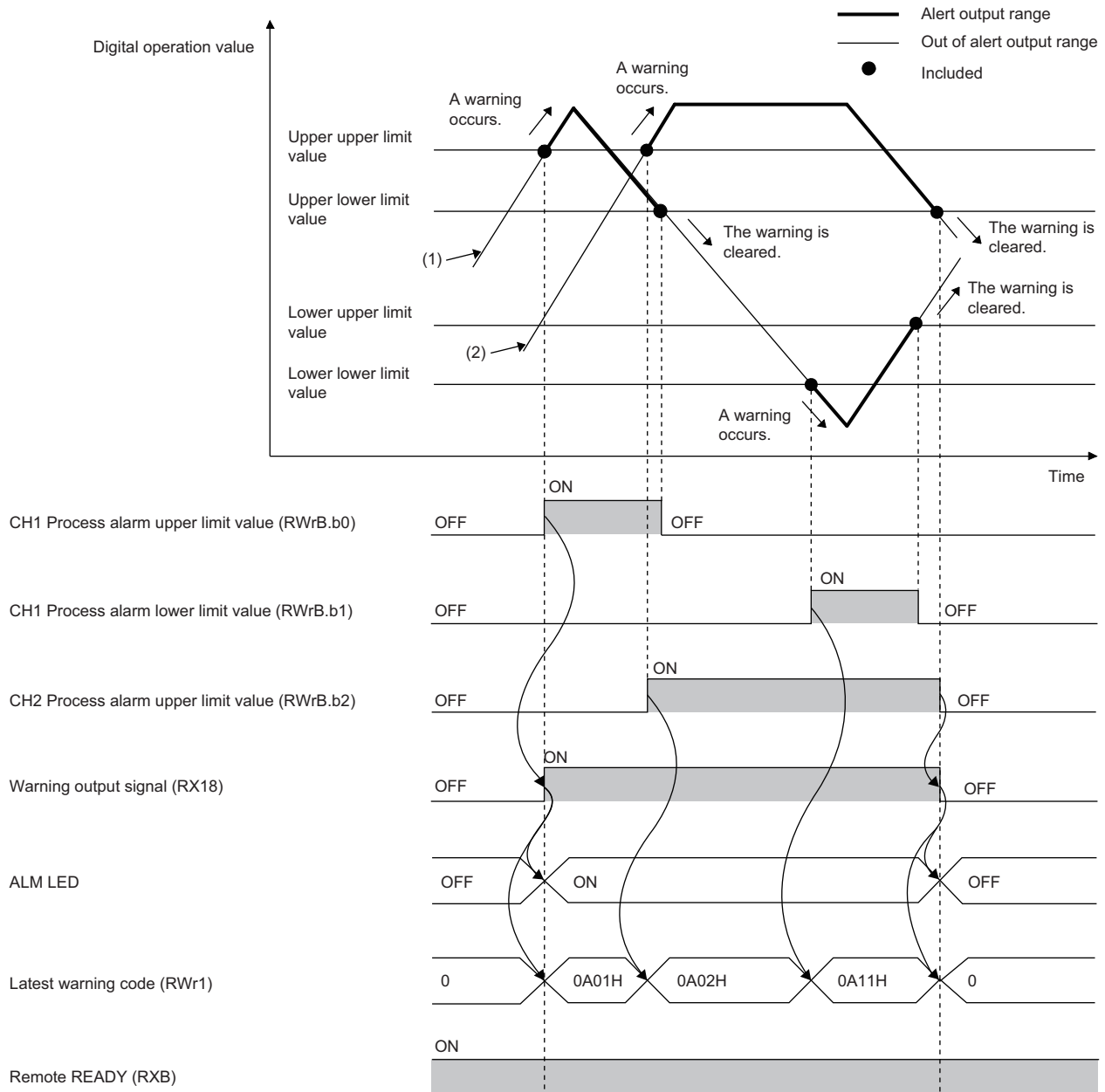

- (1) CH1 Digital operation value
- (2) CH2 Digital operation value

Notification

If a digital operation value enters the alert output range, being equal to or greater than the process alarm upper upper limit value, or being equal to or less than the process alarm lower lower limit value, Alert output flag (RWrB), Alert output signal (RX18), and the turning on of the ALM LED of the A/D converter module notify an alert.

- Alert output flag (RWrB): The bit corresponding to the contents of the alert turns on. ( Page 123 Alert output flag)
- Alert output signal (RX18): On
- ALM LED of the A/D converter module: On

In addition, Process alarm occurrence (alarm code: 0A△□H) is stored in Latest warning code (RWr1).

Operation

After alert output, if a digital operation value enters out of the alert output setting range, being less than the process alarm upper lower limit value, or being greater than the process alarm lower upper limit value, the bit corresponding to the channel number of Alert output flag (RWrB) is turned off.

Once all the channels return to out of the alert output setting range, Alert output signal (RX18) turns off and the ALM LED goes off.

Detection cycle

When time average is specified, the function is executed per set time (for averaging). When count average is specified, the function is executed per set count (for averaging).

In addition, when sampling processing and moving average are specified, the function is executed per sampling period.

Clearing the alarm code

When a digital operation value enters the following range, Process alarm occurrence (alarm code: 0A△□H) stored in Latest warning code (RWr1) is automatically cleared.

Process alarm lower upper limit value < Digital operation value < Process alarm upper lower limit value

Alert output target

Alert output target is CH□ Digital operation value (RWr2 to RWr9).

When using the digital clipping function, scaling function, shift function, and difference conversion function, set values considering these functions for the process alarm upper upper limit value, upper lower limit value, lower upper limit value, and lower lower limit value.

Setting procedure

The setting procedure for the A/D converter module is as follows:

1. Set "Method selection" to "Parameter write".

 CC IE Field configuration window ⇒ Select the A/D converter module in "List of stations". ⇒ [CC IE Field Configuration] ⇒ [Online] ⇒ [Parameter Processing of Slave Station]

2. Set "CH□ A/D conversion enable/disable setting" to "0: Enable".

Name	Initial Value	Unit	Read Value	Unit	Write Value
<input checked="" type="checkbox"/> A/D conversion enable/disable...					
..... CH1 A/D conversion enabl...	0: Enable				
..... CH2 A/D conversion enabl...	0: Enable				
..... CH3 A/D conversion enabl...	0: Enable				0: Enable
..... CH4 A/D conversion enabl...	0: Enable				1: Disable

3. Set "CH□ Alert output setting" to "0: Enable".

Name	Initial Value	Unit	Read Value	Unit	Write Value
<input checked="" type="checkbox"/> Alert output function					
..... CH1 Alert output setting	1: Disable				
..... CH1 Process alarm upper ...	0				
..... CH1 Process alarm upper l...	0				0: Enable
..... CH1 Process alarm lower ...	0				1: Disable

4. Specify the values for "CH□ Process alarm upper upper limit value", "CH□ Process alarm upper lower limit value", "CH□ Process alarm lower upper limit value", and "CH□ Process alarm lower lower limit value".

Name	Initial Value	Unit	Read Value	Unit	Write Value
<input checked="" type="checkbox"/> Alert output function					
..... CH1 Alert output setting	1: Disable				0: Enable
..... CH1 Process alarm upper ...	0				16000
..... CH1 Process alarm upper l...	0				10000
..... CH1 Process alarm lower ...	0				3000
..... CH1 Process alarm lower l...	0				0

Item	Setting range
CH□ Process alarm upper upper limit value	-32768 to 32767
CH□ Process alarm upper lower limit value	
CH□ Process alarm lower upper limit value	
CH□ Process alarm lower lower limit value	

Point

Set the range meeting the condition: Process alarm upper upper limit value \geq Process alarm upper lower limit value \geq Process alarm lower upper limit value \geq Process alarm lower lower limit value.

7.9 Scaling Function

Scaling function allows scale conversion on a digital output value within the range of the scaling upper limit value and the scaling lower limit value, both of which are set at desired values. This function saves many steps to create a scale conversion program.

The value after scale conversion is stored in CH□ Digital operation value (RWr2 to RWr9).

How to interpret the scaling setting

Ex.

If the input range is set to -10 to 10V:

For the scaling lower limit value, set a value corresponding to the lower limit of the input range (-16000), and for the scaling upper limit value, set a value corresponding to the upper limit of the input range (16000).

Calculation of the digital operation value

Scale conversion is performed on the digital values using the following formula:

(Values after the decimal point are rounded off during scale conversion.)

- If the input range is -10 to 10V

$$D_Y = \frac{D_X \times (S_H - S_L)}{32000} + \frac{(S_H + S_L)}{2}$$

- If the input range is any of 0 to 5V, 1 to 5V, 0 to 20mA, or 4 to 20mA

$$D_Y = \frac{D_X \times (S_H - S_L)}{16000} + S_L$$

Item	Description
D_Y	Digital operation value
D_X	Digital output value
S_H	Scaling upper limit value
S_L	Scaling lower limit value

Setting procedure

The setting procedure for the A/D converter module is as follows:

1. Set "Method selection" to "Parameter write".

 CC IE Field configuration window ⇒ Select the A/D converter module in "List of stations". ⇒ [CC IE Field Configuration] ⇒ [Online] ⇒ [Parameter Processing of Slave Station]

2. Set "CH□ A/D conversion enable/disable setting" to "0: Enable".

Name	Initial Value	Unit	Read Value	Unit	Write Value
<input checked="" type="checkbox"/> A/D conversion enable/disable...					
CH1 A/D conversion enabl...	0: Enable				
CH2 A/D conversion enabl...	0: Enable				
CH3 A/D conversion enabl...	0: Enable				0: Enable
CH4 A/D conversion enabl...	0: Enable				1: Disable

3. Set "CH□ Scaling enable/disable setting" to "0: Enable".

Name	Initial Value	Unit	Read Value	Unit	Write Value
<input checked="" type="checkbox"/> Scaling function					
CH1 Scaling enable/disable...	1: Disable				
CH1 Scaling upper limit va...	0				
CH1 Scaling lower limit val...	0				0: Enable
CH2 Scaling enable/disable...	1: Disable				1: Disable

4. Set the values in "CH□ Scaling upper limit value" and "CH□ Scaling lower limit value".

Name	Initial Value	Unit	Read Value	Unit	Write Value
<input checked="" type="checkbox"/> Scaling function					
CH1 Scaling enable/disable...	1: Disable				1: Disable
CH1 Scaling upper limit va...	0				16000
CH1 Scaling lower limit val...	0				4000

Item	Setting range
CH□ Scaling upper limit value	-32000 to 32000
CH□ Scaling lower limit value	

Point

- Even if the scaling upper limit value and the scaling lower limit value are set so that the change is larger than the maximum resolution described in the performance specifications, the resolution will not increase.
- Set a value in the range satisfying the condition: Scaling upper limit value > Scaling lower limit value.

Example of the scaling setting

Ex.

When the following setting is used for the channel 1 with the set input range of 0 to 5V:

- "CH1 Scaling enable/disable setting": "0: Enable"
- "CH1 Scaling upper limit value": 12000
- "CH1 Scaling lower limit value": 4000

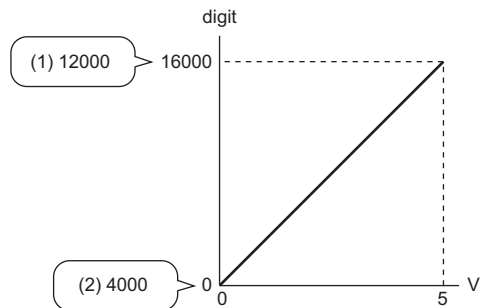

digit: Digital output value
 V: Analog input voltage (V)
 (1) Scaling upper limit value
 (2) Scaling lower limit value

Analog input voltage	Digital output value	Digital operation value
0V	0	4000
1V	3200	5600
2V	6400	7200
3V	9600	8800
4V	12800	10400
5V	16000	12000

Ex.

When the following setting is used for the channel 1 with the set input range of -10 to 10V:

- "CH1 Scaling enable/disable setting": "0: Enable"
- "CH1 Scaling upper limit value": 12000
- "CH1 Scaling lower limit value": 4000

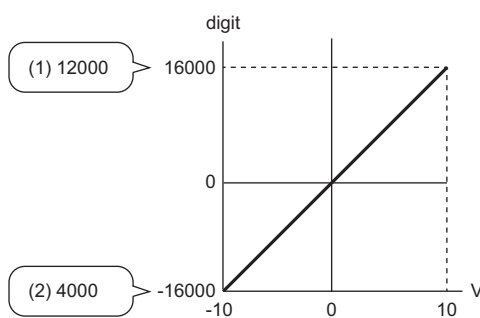

digit: Digital output value
 V: Analog input voltage (V)
 (1) Scaling upper limit value
 (2) Scaling lower limit value

Analog input voltage	Digital output value	Digital operation value
-10V	-16000	4000
-5V	-8000	6000
0V	0	8000
5V	8000	10000
10V	16000	12000

7.10 Shift Function

This function adds (shifts) the set conversion value shift amount to a digital output value. When the conversion value shift amount is changed, it is reflected to the digital operation value in real time. Therefore, fine adjustment can be easily performed when the system starts.

Operation

The set conversion value shift amount is added to digital output value. Then, the digital operation value after shift-and-add is stored in CH□ Digital operation value (RWr2 to RWr9).

When the scaling function is used, the conversion value shift amount is added to the value obtained after the scale-conversion.

The shift amount is added in every sampling period for sampling processing, while it is added in every averaging process cycle for averaging processing.

If a value is set to the conversion value shift amount, this conversion value shift amount is added regardless of turning on and off Initial data setting request flag (RY9).

Setting procedure

The setting procedure for the A/D converter module is as follows:

1. Set "Method selection" to "Parameter write".

 CC IE Field configuration window ⇒ Select the A/D converter module in "List of stations". ⇒ [CC IE Field Configuration] ⇒ [Online] ⇒ [Parameter Processing of Slave Station]

2. Set "CH□ A/D conversion enable/disable setting" to "0: Enable".

	Name	Initial Value	Unit	Read Value	Unit	Write Value
<input checked="" type="checkbox"/>	A/D conversion enable/disable...					
	CH1 A/D conversion enabl...	0: Enable				
	CH2 A/D conversion enabl...	0: Enable				
	CH3 A/D conversion enabl...	0: Enable				0: Enable
	CH4 A/D conversion enabl...	0: Enable				1: Disable

3. Set the value to be added to CH□ Shifting amount to conversion value (RWw2 to RWw9).

Item	Setting range
CH□ Shifting amount to conversion value (RWw2 to RWw9)	-32768 to 32767 (Default value: 0)

Point

If the digital operation value exceeds the range of -32768 to 32767 as a result of shift-and-add, the digital operation value is fixed to the lower limit value (-32768) or the upper limit value (32767).

Setting example

Ex.

When conversion value shift amount "10" is added to the channel 1 with the set input range of 0 to 5V:

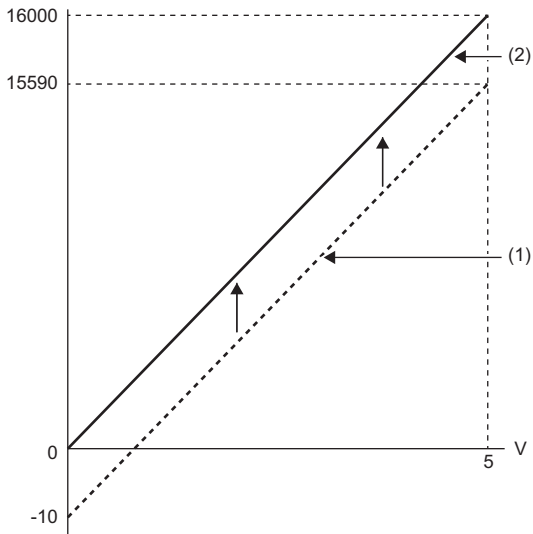

V: Analog input voltage (V)
 (1) CH1 Digital output value
 (2) CH1 Digital operation value (RWr2)

Analog input voltage	Digital output value	Digital operation value
0V	-10	0
5V	15990	16000

Ex.

When conversion value shift amount "20000" is added to the channel 1 with the set input range of -10 to 10V:

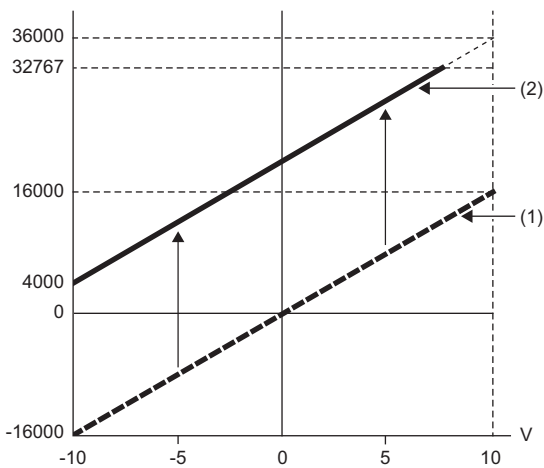

V: Analog input voltage (V)
 (1) CH1 Digital output value
 (2) CH1 Digital operation value (RWr2)

Analog input voltage	Digital output value	Digital operation value
-10V	-16000	4000
-5V	-8000	12000
0V	0	20000
5V	8000	28000
10V	16000	32767*

*1 Because the value exceeds the range of -32768 to 32767, it is fixed to 32767 (the upper limit value).

Example of combined use of scaling function and shift function

Ex.

When the following setting is used for the channel 1 with the set input range of 0 to 5V:

- "CH1 Scaling enable/disable setting": "0: Enable"
- "CH1 Scaling upper limit value": 12000
- "CH1 Scaling lower limit value": 2000
- CH1 Shifting amount to conversion value (RWw2): 2000

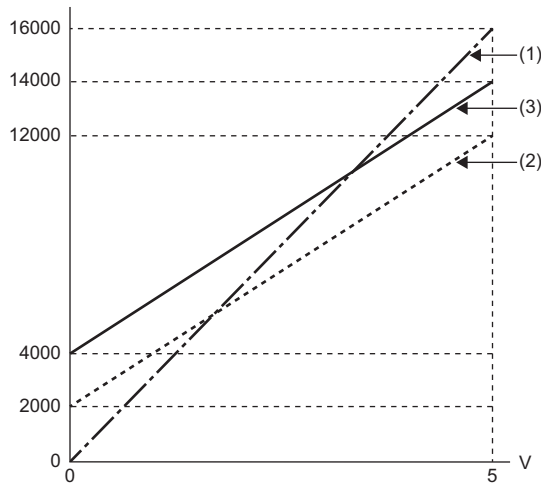

V: Analog input voltage (V)

(1) CH1 Digital output value

(2) Value after scaling

(3) CH1 Digital operation value (RWw2)

Analog input voltage	Digital output value	Value after scaling	Digital operation value
0V	0	2000	4000
1V	3200	4000	6000
2V	6400	6000	8000
3V	9600	8000	10000
4V	12800	10000	12000
5V	16000	12000	14000

1. Set "Method selection" to "Parameter write".

CC IE Field configuration window ⇒ Select the A/D converter module in "List of stations". ⇒ [CC IE Field Configuration] ⇒ [Online] ⇒ [Parameter Processing of Slave Station]

2. Set "CH1 A/D conversion enable/disable setting" to "0: Enable".

Name	Initial Value	Unit	Read Value	Unit	Write Value
<input checked="" type="checkbox"/> A/D conversion enable/disable...					
CH1 A/D conversion enabl...	0: Enable				
CH2 A/D conversion enabl...	0: Enable				
CH3 A/D conversion enabl...	0: Enable				0: Enable
CH4 A/D conversion enabl...	0: Enable				1: Disable

3. Set "CH1 Scaling enable/disable setting" to "0: Enable".

Name	Initial Value	Unit	Read Value	Unit	Write Value
<input checked="" type="checkbox"/> Scaling function					
CH1 Scaling enable/disable...	1: Disable				
CH1 Scaling upper limit va...	0				
CH1 Scaling lower limit va...	0				0: Enable
CH2 Scaling enable/disable...	1: Disable				1: Disable

4. Set the values in "CH1 Scaling upper limit value" and "CH1 Scaling lower limit value".

Name	Initial Value	Unit	Read Value	Unit	Write Value
<input checked="" type="checkbox"/> Scaling function					
CH1 Scaling enable/disable...	1: Disable				0: Enable
CH1 Scaling upper limit va...	0				12000
CH1 Scaling lower limit va...	0				2000

5. Set CH1 Shifting amount to conversion value (RWw2) to "2000".

Point 

When the shift function, digital clipping function, and scaling function are used together, shift-and-add is executed on the value after digital clipping and scale conversion. In this case, the range of the digital operation value is determined as -32768 to 32767.

For a setting example of when the digital clipping function, scaling function, and shift function are used together, refer to the following:

 Page 79 Example of combined use of digital clipping function, scaling function, shift function

7.11 Digital Clipping Function

The range of a digital operation value is fixed between the maximum digital output value and the minimum digital output value if the input voltage or current exceeds the input range.

How to interpret the digital clipping setting

The following table shows how the output range of a digital operation value changes by enabling the digital clipping function for each range.

Input range	Output range			
	Digital clipping function disabled		Digital clipping function enabled	
	NZ2GFCE-60ADV8	NZ2GFCE-60ADI8	NZ2GFCE-60ADV8	NZ2GFCE-60ADI8
4 to 20mA	—	-384 to 16383	—	0 to 16000
0 to 20mA				
1 to 5V	-384 to 16383	—	0 to 16000	—
0 to 5V				
-10 to 10V	-16384 to 16383	—	-16000 to 16000	—

Setting procedure

The setting procedure for the A/D converter module is as follows:

1. Set "Method selection" to "Parameter write".

☞ CC IE Field configuration window ⇒ Select the A/D converter module in "List of stations". ⇒ [CC IE Field Configuration] ⇒ [Online] ⇒ [Parameter Processing of Slave Station]

2. Set "CH□ A/D conversion enable/disable setting" to "0: Enable".

Name	Initial Value	Unit	Read Value	Unit	Write Value
<input checked="" type="checkbox"/> A/D conversion enable/disable...					
CH1 A/D conversion enabl...	0: Enable				
CH2 A/D conversion enabl...	0: Enable				
CH3 A/D conversion enabl...	0: Enable				0: Enable
CH4 A/D conversion enabl...	0: Enable				1: Disable

3. Set "CH□ Digital clipping enable/disable setting" to "0: Enable".

Name	Initial Value	Unit	Read Value	Unit	Write Value
<input checked="" type="checkbox"/> Digital clipping function					
CH1 Digital clipping enable...	1: Disable				
CH2 Digital clipping enable...	1: Disable				
CH3 Digital clipping enable...	1: Disable				0: Enable
CH4 Digital clipping enable...	1: Disable				1: Disable

Example of combined use of digital clipping function and scaling function

Ex.

When the following setting is used for the channel 1 with the set input range of 0 to 5V:

- "CH1 Scaling enable/disable setting": "0: Enable"
- "CH1 Scaling upper limit value": 24000
- "CH1 Scaling lower limit value": 0
- "CH1 Digital clipping enable/disable setting": "0: Enable"

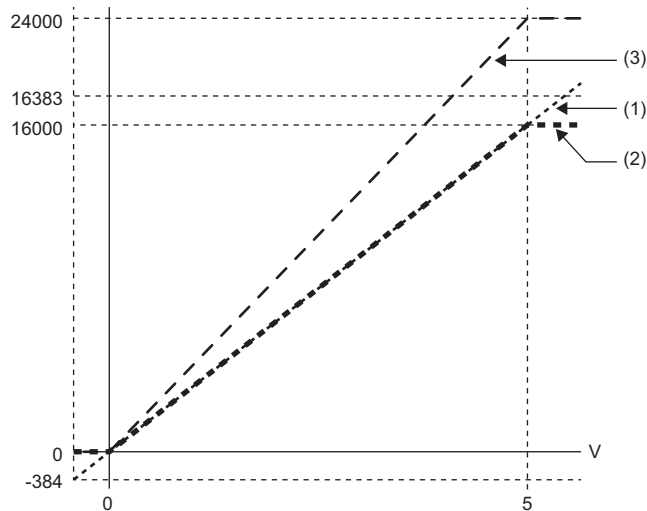

V: Analog input voltage (V)

(1) CH1 Digital output value

(2) Value after digital clipping

(3) CH1 Digital operation value (RWr2)

Input voltage	Digital output value	Digital operation value
-0.12V	-384	0
0V	0	0
1V	3200	4800
2V	6400	9600
3V	9600	14400
4V	12800	19200
5V	16000	24000
5.12V	16383	24000

1. Set "Method selection" to "Parameter write".

🔗 CC IE Field configuration window ⇒ Select the A/D converter module in "List of stations". ⇒ [CC IE Field Configuration] ⇒ [Online] ⇒ [Parameter Processing of Slave Station]

2. Set "CH1 A/D conversion enable/disable setting" to "0: Enable".

Name	Initial Value	Unit	Read Value	Unit	Write Value
<input checked="" type="checkbox"/> A/D conversion enable/disable...					
CH1 A/D conversion enabl...	0: Enable				0: Enable
CH2 A/D conversion enabl...	0: Enable				0: Enable
CH3 A/D conversion enabl...	0: Enable				0: Enable
CH4 A/D conversion enabl...	0: Enable				1: Disable

3. Set "CH1 Scaling enable/disable setting" to "0: Enable".

Name	Initial Value	Unit	Read Value	Unit	Write Value
<input checked="" type="checkbox"/> Scaling function					
CH1 Scaling enable/disable...	1: Disable				0: Enable
CH1 Scaling upper limit va...	0				0
CH1 Scaling lower limit va...	0				0: Enable
CH2 Scaling enable/disable...	1: Disable				1: Disable

4. Set the values in "CH1 Scaling upper limit value" and "CH1 Scaling lower limit value".

Name	Initial Value	Unit	Read Value	Unit	Write Value
<input checked="" type="checkbox"/> Scaling function					
CH1 Scaling enable/disable...	1: Disable				0: Enable
CH1 Scaling upper limit va...	0				24000
CH1 Scaling lower limit va...	0				0

5. Set "CH1 Digital clipping enable/disable setting" to "0: Enable".

<input checked="" type="checkbox"/>	☐ Digital clipping function					
	CH1 Digital clipping enable...	1: Disable				
	CH2 Digital clipping enable...	1: Disable				
	CH3 Digital clipping enable...	1: Disable			0: Enable	
	CH4 Digital clipping enable...	1: Disable			1: Disable	

Example of combined use of digital clipping function, scaling function, shift function

Ex.

When the following setting is used for the channel 1 with the set input range of 0 to 5V:

- "CH1 Scaling enable/disable setting": "0: Enable"
- "CH1 Scaling upper limit value": 12000
- "CH1 Scaling lower limit value": 2000
- "CH1 Digital clipping enable/disable setting": "0: Enable"
- CH1 Shifting amount to conversion value (RWw2): 2000

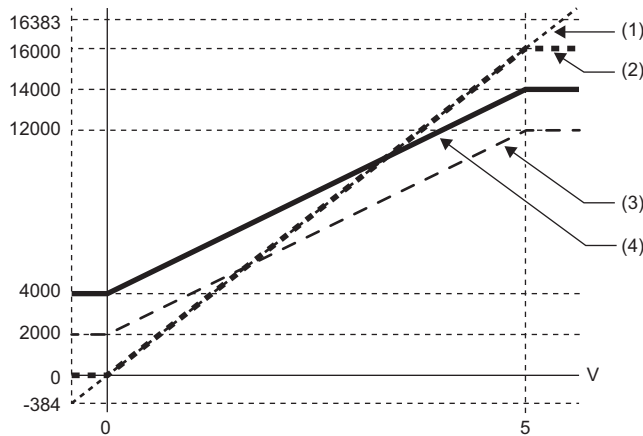

- V: Analog input voltage (V)
 (1) CH1 Digital output value
 (2) Value after digital clipping
 (3) Value after scaling
 (4) CH1 Digital operation value (RWw2)

Input voltage	Digital output value	Digital operation value
-0.12V	-384	4000
0V	0	4000
1V	3200	6000
2V	6400	8000
3V	9600	10000
4V	12800	12000
5V	16000	14000
5.12V	16383	14000

1. Set "Method selection" to "Parameter write".

☞ CC IE Field configuration window ⇒ Select the A/D converter module in "List of stations". ⇒ [CC IE Field Configuration]
 ⇒ [Online] ⇒ [Parameter Processing of Slave Station]

2. Set "CH1 A/D conversion enable/disable setting" to "0: Enable".

<input checked="" type="checkbox"/>	☐ A/D conversion enable/disab...					
	CH1 A/D conversion enabl...	0: Enable				
	CH2 A/D conversion enabl...	0: Enable				
	CH3 A/D conversion enabl...	0: Enable			0: Enable	
	CH4 A/D conversion enabl...	0: Enable			1: Disable	

3. Set "CH1 Scaling enable/disable setting" to "0: Enable".

<input checked="" type="checkbox"/>	Scaling function					
	CH1 Scaling enable/disabl...	1: Disable				
	CH1 Scaling upper limit va...	0				
	CH1 Scaling lower limit val...	0				
	CH2 Scaling enable/disabl...	1: Disable				

4. Set the values in "CH1 Scaling upper limit value" and "CH1 Scaling lower limit value".

<input checked="" type="checkbox"/>	Scaling function					
	CH1 Scaling enable/disabl...	1: Disable				0: Enable
	CH1 Scaling upper limit va...	0				12000
	CH1 Scaling lower limit val...	0				2000

5. Set "CH1 Digital clipping enable/disable setting" to "0: Enable".

<input checked="" type="checkbox"/>	Digital clipping function					
	CH1 Digital clipping enable...	1: Disable				
	CH2 Digital clipping enable...	1: Disable				
	CH3 Digital clipping enable...	1: Disable				0: Enable
	CH4 Digital clipping enable...	1: Disable				1: Disable

6. Set CH1 Shifting amount to conversion value (RWw2) to "2000".

Point

When the digital clipping function is used with the scaling function, shift function, and difference conversion function, the scale conversion, shift addition, and difference conversion are executed on the value after digital clipping.

7.12 Difference Conversion Function

The digital operation value at the start of this function is treated as "0" (reference value). Thereafter, the difference between the actual digital operation value and the reference value is stored as the digital operation value.

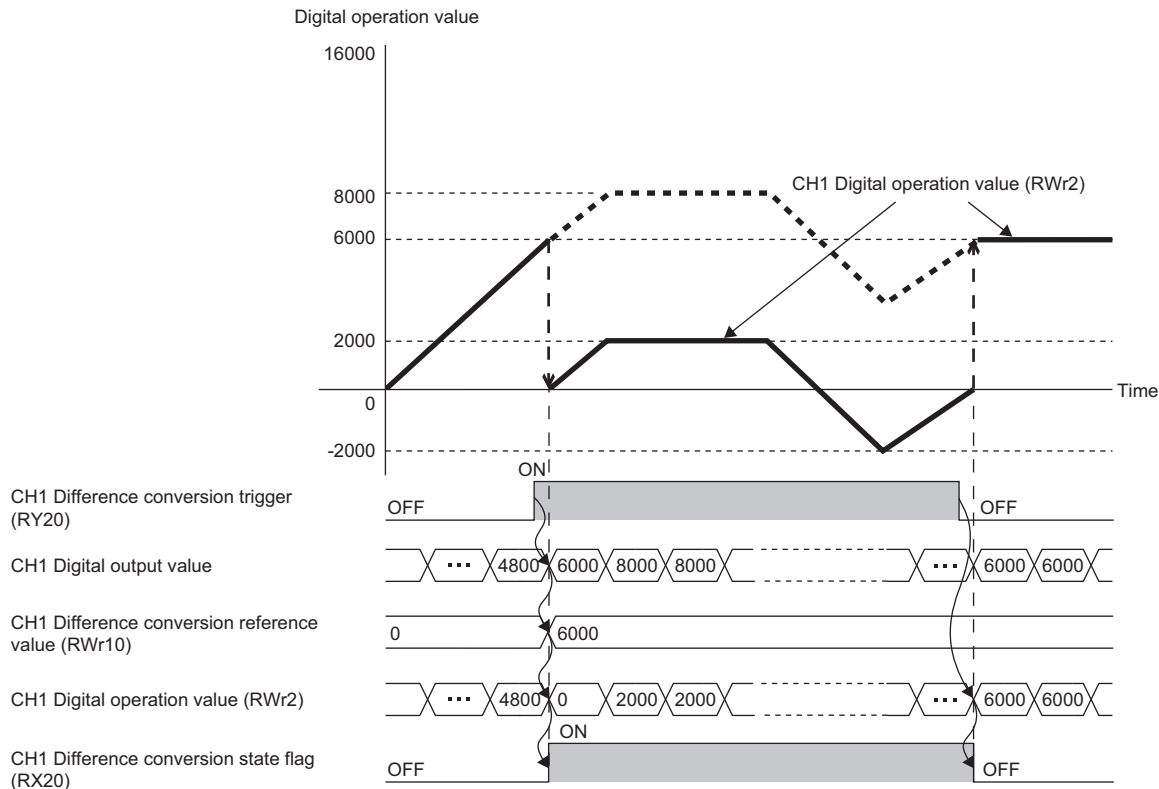

Operation

When the difference conversion starts, the digital operation value at that time (the data stored inside the A/D converter module before difference conversion) is determined as the difference conversion reference value. The value acquired by subtracting the difference conversion reference value from the digital operation value is stored in CH□ Digital operation value (RWr2 to RWr9). CH□ Digital operation value (RWr2 to RWr9) at the start of this function is "0" (because the digital operation value is equal to the difference conversion reference value at the start).

$$\text{Digital operation value after difference conversion} = \text{Digital operation value} - \text{Difference conversion reference value}$$

How to use the function

Starting difference conversion

1. Change CH□ Difference conversion trigger (RY20 to RY27) from No request (OFF) to Trigger request (ON).

The rising edge from No request (OFF) to Trigger request (ON) is detected as a trigger. When a trigger is detected, the digital operation value at the starting point is output to CH□ Difference conversion reference value (RWr10 to RWr17) and the value obtained by subtracting the difference conversion reference value from the digital operation value is stored in CH□ Digital operation value (RWr2 to RWr9). After the storage, CH□ Difference conversion state flag (RX20 to RX27) changes to Converting difference (ON).

Stopping difference conversion

1. Change CH□ Difference conversion trigger (RY20 to RY27) from Trigger request (ON) → No request (OFF).

Change from Trigger request (ON) to No request (OFF) results in the difference conversion stopping and CH□ Difference conversion state flag (RX20 to RX27) changing to Not converted (OFF). After that, the digital operation value before difference conversion is stored in CH□ Digital operation value (RWr2 to RWr9).

Points for the use

■ Operation when an input signal error occurs

In the event of an input signal error, changing CH□ Difference conversion trigger (RY20 to RY27) from No request (OFF) to Trigger request (ON) does not allow difference conversion to start. After the analog input value returns out of detection range, change CH□ Difference conversion trigger (RY20 to RY27) from No request (OFF) to Trigger request (ON) again. If an input signal error occurs in the status of Trigger request (ON), the difference conversion starts just when the analog input value returns out of detection range, treating the digital output value as the difference conversion reference value.

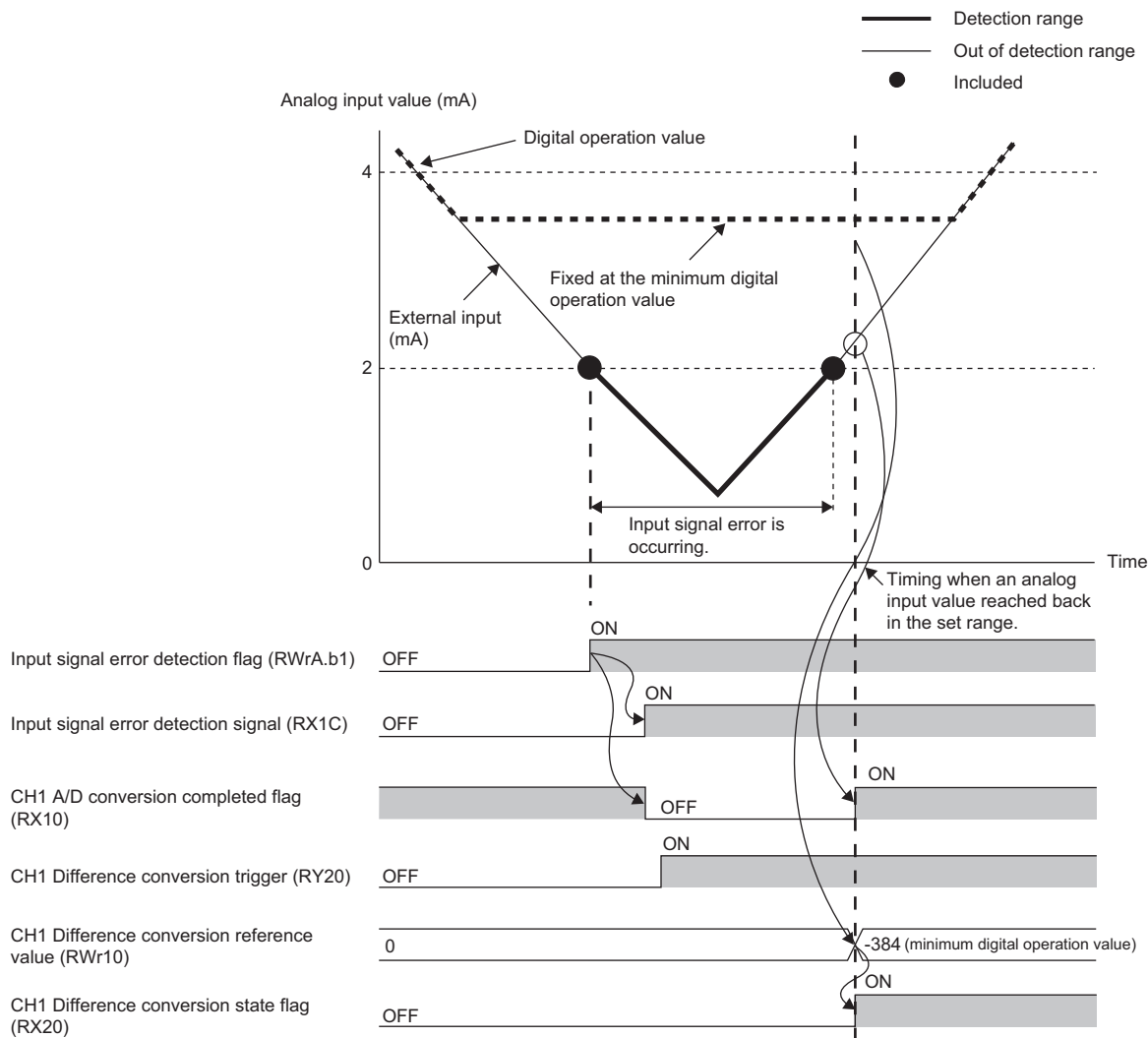

■ Operation when Initial data setting request flag (RY9) is switched

- During difference conversion, turning on and off Initial data setting request flag (RY9) results in the difference conversion continuing without updating the difference conversion reference value. At this time, even if the digital clipping function, scaling function, and shift function are set valid, the difference conversion reference value is not updated. To update the difference conversion reference value, change CH□ Difference conversion trigger (RY20 to RY27) as follows: Trigger request (ON) → No request (OFF) → Trigger request (ON).

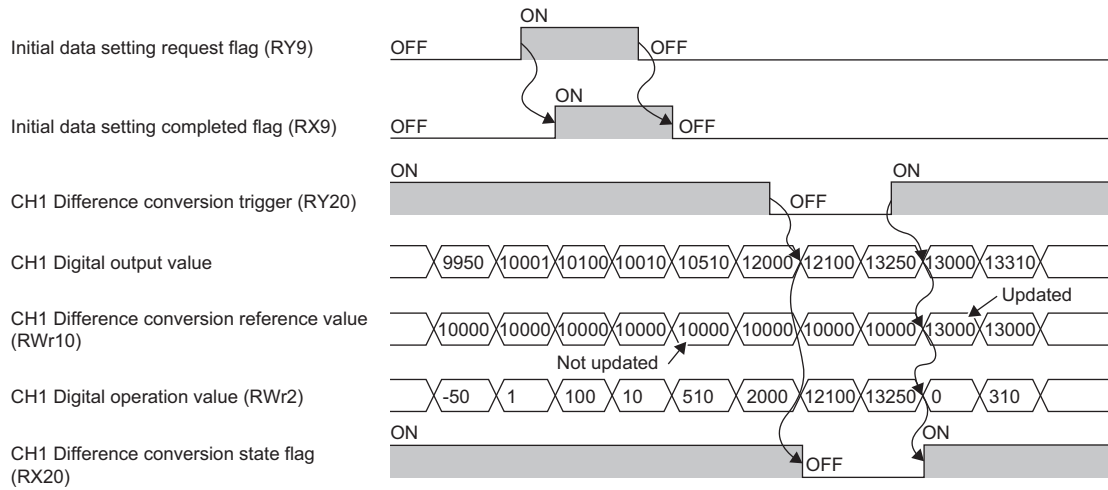

- Before CH□ A/D conversion completed flag (RX10 to RX17) turns on by turning on Initial data setting request flag (RY9), changing CH□ Difference conversion trigger (RY20 to RY27) from No request (OFF) to Trigger request (ON) results in operation with the difference conversion reference value taking on the digital operation value at the time when CH□ A/D conversion completed flag (RX10 to RX17) turns on.

■How the maximum value/minimum value operates

When the difference conversion starts, the maximum value and the minimum value of the values resulting from the difference conversion are stored in Maximum value and Minimum value. Turning on Maximum value/minimum value reset request (RY1D) allows the maximum value and the minimum value after the start of the difference conversion to be checked. Not turning on Maximum value/minimum value reset request (RY1D) causes the maximum and minimum values before the difference conversion and the maximum and minimum values after the difference conversion to be mixed up.

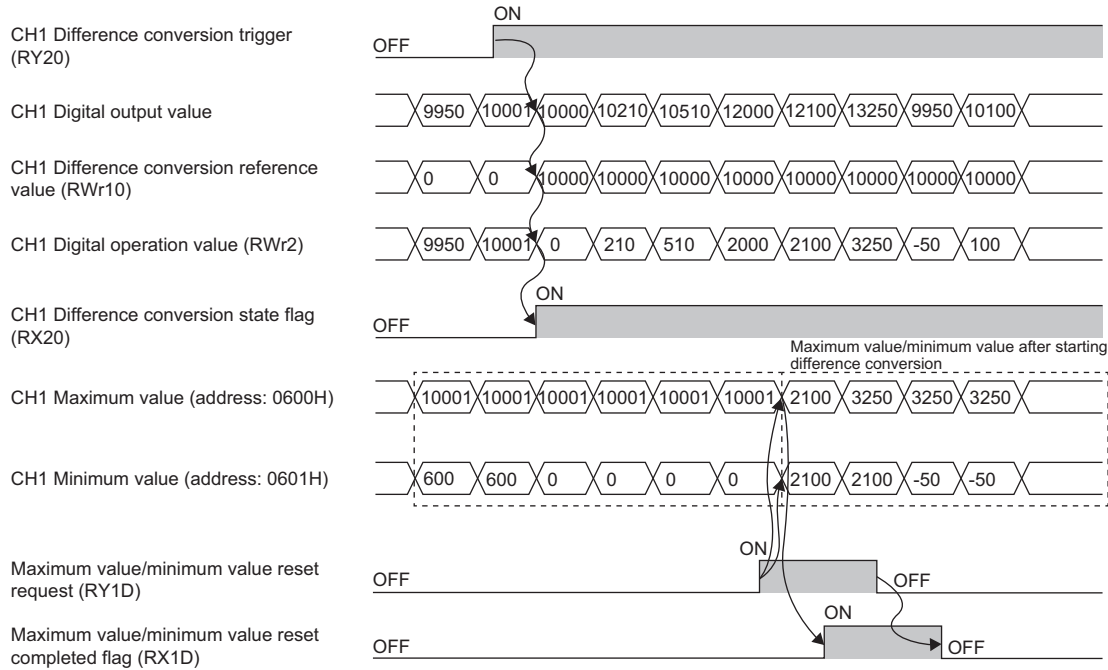

■Operation with the averaging processing set

If the difference conversion starts while the averaging processing is set, the digital output value at the completion of the averaging processing is determined as the difference conversion reference value. In addition, CH□ Difference conversion state flag (RX20 to RX27) changes to Converting difference (ON).

Point

- The difference conversion function can be started at any timing.
- When the difference conversion function is used with the digital clipping function, scaling function, and shift function, each processed digital operation value is determined as a difference conversion reference value.

7.13 Error Notification Function

When an error, warning, or alarm occurs, the A/D converter module notifies the master station of it using remote input signals and the remote register.

Point 

The notification of the error, warning, or alarm can be checked on the LED on the front of the module.

For details, refer to the following:

 Page 11 PART NAMES

Notification of an error

The A/D converter module notifies the master station of an error in the following method.

Item	Description	Reference
Error flag (RXA)	Turns on when a moderate error or major error occurs.	Page 116 Error flag
Latest error code (RWr0)	An error code is stored when a moderate error or major error occurs.	Page 122 Latest error code

Method for clearing an error

The method for clearing an error depends on the error type.

Error type	Clearing an error
Major error	The error cannot be cleared.
Moderate error	Eliminate the cause of the error and then turn on Error clear request flag (RYA) or Initial data setting request flag (RY9).

Notification of a warning or alarm

The A/D converter module notifies that a warning or alarm occurs to the master station in the following method.

Item	Description	Reference
Warning flag (RX7)	Turns on when a minor error occurs.	Page 114 Warning flag
Latest warning code (RWr1)	The error code or alarm code is stored when a minor error occurs.	Page 122 Latest warning code

■How to clear a warning or an alarm

The method for clearing an error depends on the error type.

Error type		Clearing an error	
Minor error	Warning	A warning is cleared five seconds after the error cause is removed.	
	Alarm	Input signal error detection	After the analog input value returns to a value that is larger than the criteria of disconnection detection, turn on Error clear request flag (RYA) or Initial data setting request flag (RY9). The error of the input signal error detection is not automatically cleared. Latest warning code (RWr1) is cleared when the other minor errors are cleared while an input signal error occurs. The warning codes can be checked in the error history on the engineering tool. For the error history, refer to the following: ☞ Page 101 Checking by executing a command of the slave station ☞ Page 134 Error history data
		Alert output	The error is automatically cleared when the digital operation value returns to within the set range between the process alarm upper lower limit value and the process alarm lower upper limit value.

A warning results in the following state five seconds after the error cause is removed.

- Warning flag (RX7) turns off.
- Latest warning code (RWr1) is cleared.
- The ERR. LED turns off.

Ex.

Operation to clear Station number switch changed error (error code: 0940H)

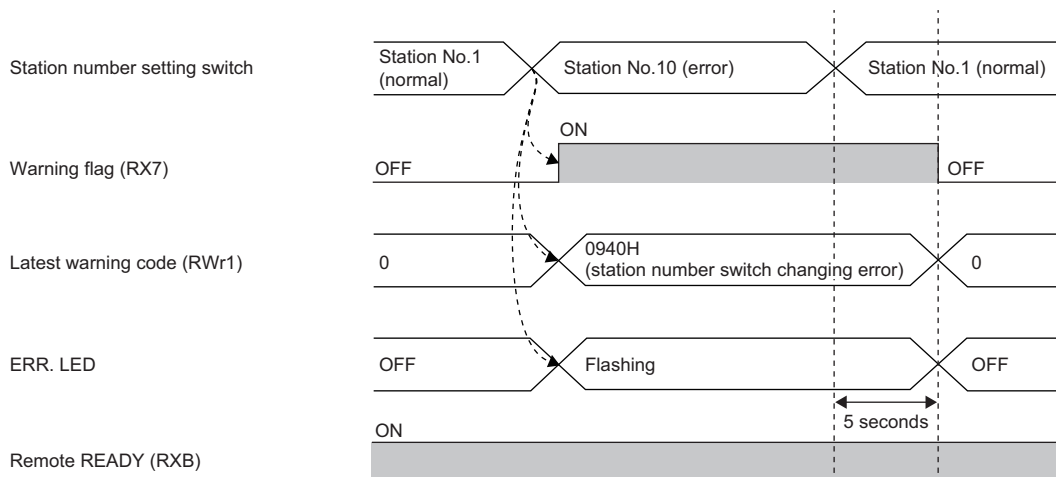

-----> Executed by the A/D converter module.

For the method for clearing an alarm, refer to the following:

☞ Page 64 Input Signal Error Detection Function

☞ Page 67 Alert Output Function (Process Alarm)

Method for clearing an error by executing the command of the slave station

The following shows how to clear an error by executing the command of the slave station.

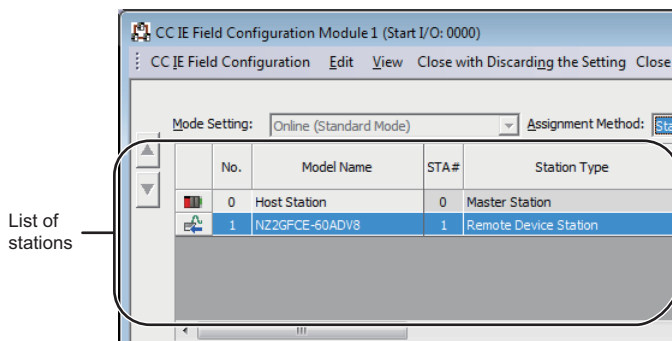

1. On the CC IE Field configuration window, from "List of stations", select the A/D converter module.

2. Open the "Command Execution of Slave Station" window.

[CC IE Field Configuration] ⇒ [Online] ⇒ [Command Execution of Slave Station]

3. Set "Method selection" to "Error clear request" and click the [Execute] button.

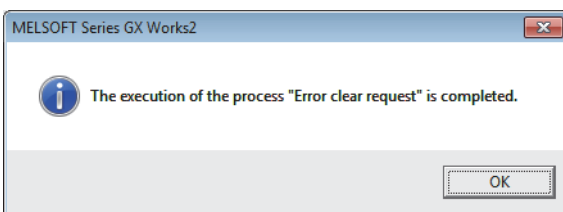
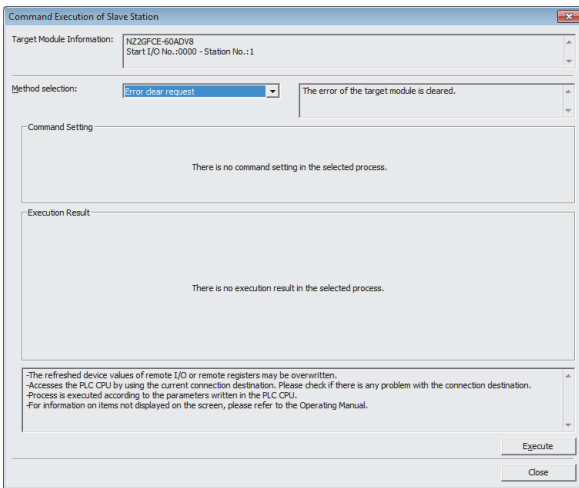

4. In the window that appears (shown left), click the [OK] button.

5. The error for the A/D converter module is cleared.

7.14 CC-Link IE Field Network Diagnostic Function

This function can be used by accessing the engineering tool connected to the CPU module, enabling the detection of a network error.

How to use the function

The following instructions assume the use of GX Works2 as the engineering tool.

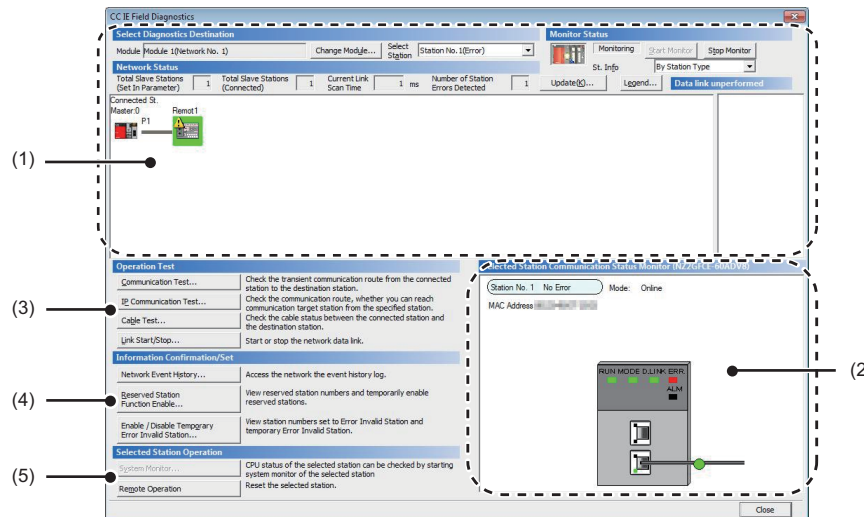

1. Establish a connection between GX Works2 and the CPU module.
2. Go to the menu of GX Works2 and start up the CC-Link IE Field Network diagnostics.

 [Diagnostics] ⇒ [CC IE Field Diagnostics]



Item to be diagnosed	Description	Reference
(1) Network configuration and error condition	Allows the condition of the CC-Link IE Field Network to be checked. If an error or a warning occurs in the A/D converter module, an icon appears to show the status of the station.	User's manual for the master/local module used
(2) Display of selected-station status and error details	The communication status of the station selected in "Networks Status" can be checked.	
(3) Communication Test	The transient communication route and whether the communication is established from the connected station to the destination station can be checked.	
	IP Communication Test The reaching time and the route of the IP communication from the connected station to the target station can be checked.	
	Cable Test The cable status between the connected station and the destination station can be checked.	
	Link Start/Stop The network data link can be started and stopped.	
(4) Network Event History	The history of various events that occurred in the network can be checked.	
	Reserved Station Function Enable A reservation for a station can be temporarily canceled, and the cancellation can be disabled. Also, the station numbers for the modules set as reserved stations can be checked on a list.	
	Enable / Disable Temporary Error Invalid Station A station not set as an error invalid station can be temporarily set as an error invalid station, and the error invalid station setting can be disabled. Also, the station numbers for the modules set as (temporarily) error invalid stations can be checked on a list.	
(5) System Monitor	The system monitor on the selected station is activated and the status of the module can be checked. This function is unavailable for the A/D converter module.	
	Remote Operation The selected station can be reset through the remote operation.	Page 89 Remote Operation

Some master/local module or simple motion module may not support all the diagnostics.
 For details, refer to the user's manual for the master/local module or the simple motion module used.

-  User's manual for the master/local module used
-  User's manual for the simple motion module used

Remote Operation

1. Select the slave station to be reset and click the [Remote Operation] button.

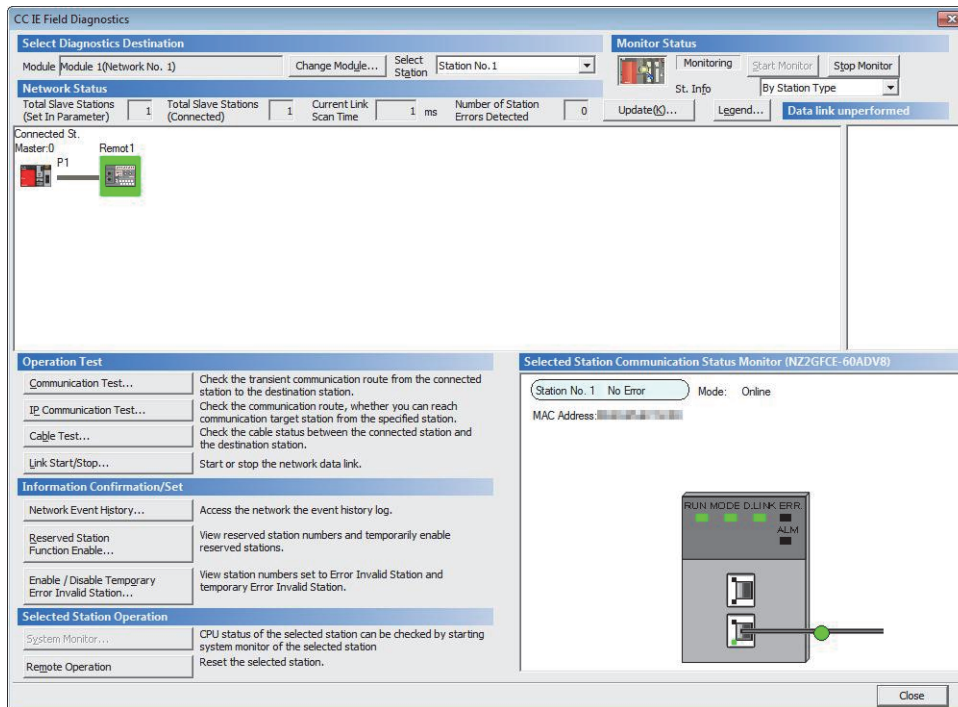

2. In the dialog box that appears (shown below), click the [Yes] button to start remote reset.

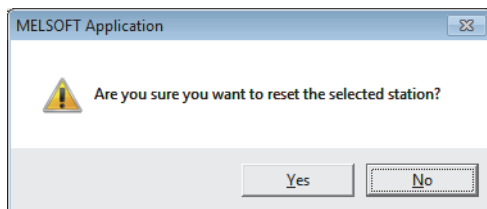

3. In the dialog box that appears (shown below), click the [OK] button.

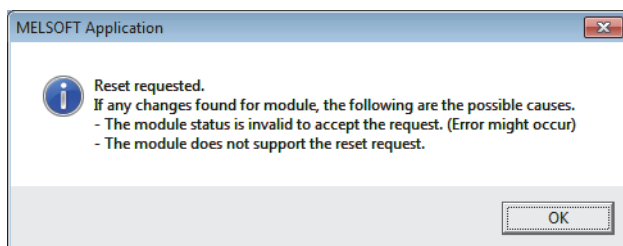

8 PROGRAMMING

This chapter describes the programming of the A/D converter module.

8.1 Precautions for Programming

This section describes precautions when creating the program of CC-Link IE Field Network.

Program for cyclic transmission

For a program for cyclic transmission, provide interlock between the following link special relay (SB) and the link special register (SW).

- Data link status of the own station (master station) (SB0049)
- Data link status of each station (SW00B0 to SW00B7)

For the link special relay (SB) and link special register (SW), refer to the following:

 User's manual for the master/local module used

Ex.

Interlock example

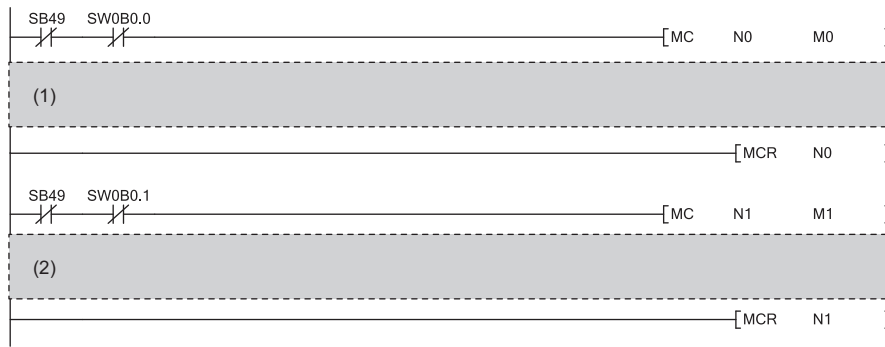

- (1) Program for communications with station number 1
 (2) Program for communications with station number 2

Program for transient transmission

For a program for transient transmission, provide interlock between the following link special relay (SB) and the link special register (SW).

- Baton pass status of the own station (master station) (SB0047)
- Baton pass status of each station (SW00A0 to SW00A7)

For the link special relay (SB) and link special register (SW), refer to the following:

 User's manual for the master/local module used

Ex.

Interlock example

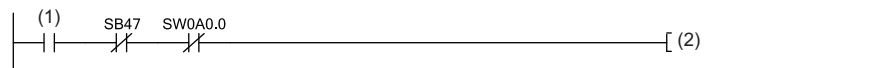

- (1) Start contact
 (2) Dedicated instruction for station number 1

8.2 Programming Procedure

Create a program to execute A/D conversion as illustrated by the following procedure.

1. Set parameters.

☞ Page 45 Parameter Settings

2. Create an auxiliary program (error reset program).^{*1}

*1 A program to be added depending on the control (created as required)

8.3 Program Example

System configuration

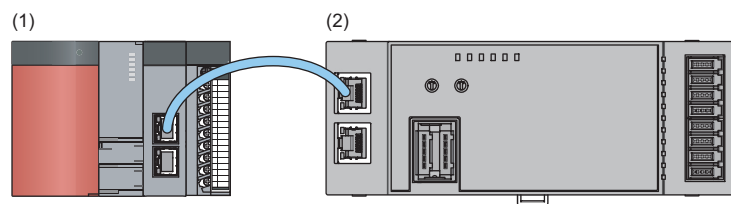

(1) Master station (station number 0)

- Power supply module: Q62P
- CPU module: Q10UDHCPU
- Master/local module: QJ71GF11-T2 (start I/O number: 0000H to 001FH)
- Input module: QX10 (start I/O number: 0020H to 002FH)

(2) Remote device station (station number 1)

- A/D converter module (NZ2GFCE-60ADV8)

Point 

For the settings using the engineering tool, the procedure is described based on the use of GX Works2.

■Assignment of link devices

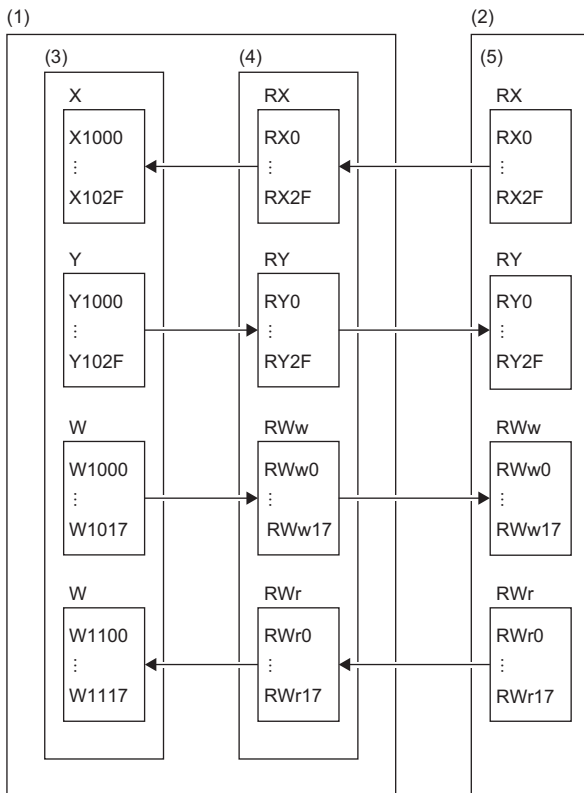

(1) Master station (station number 0)

(2) Remote device station (station number 1)

(3) CPU module

(4) Master/local module

(5) A/D converter module

Programming conditions

Digital operation values resulting from A/D conversion of CH1, CH3, and CH7 of the A/D converter module are read out to the master station. A/D conversion takes place at the time of sampling processing for CH1, every 50 count averages for CH3, and every 10 moving averages for CH7.

Initial settings

Setting item		Setting value
A/D conversion enable/disable setting	CH2 A/D conversion enable/disable setting	1: Disable
	CH4 A/D conversion enable/disable setting	
	CH5 A/D conversion enable/disable setting	
	CH6 A/D conversion enable/disable setting	
	CH8 A/D conversion enable/disable setting	
Averaging process setting	CH3 Averaging process setting	2: Count average
	CH3 Time average/Count average/Moving average	50
	CH7 Averaging process setting	3: Moving average
	CH7 Time average/Count average/Moving average	10
Input signal error detection function	CH1 Input signal error detection setting	4: Simple disconnection detection
	CH7 Input signal error detection setting	4: Simple disconnection detection
Alert output function	CH3 Alert output setting	0: Enable
	CH3 Process alarm upper upper limit value	16000
	CH3 Process alarm upper lower limit value	10000
	CH3 Process alarm lower upper limit value	3000
	CH3 Process alarm lower lower limit value	0
Digital clipping function	CH3 Digital clipping enable/disable setting	0: Enable
	CH7 Digital clipping enable/disable setting	0: Enable
Scaling function	CH7 Scaling enable/disable setting	0: Enable
	CH7 Scaling upper limit value	32000
	CH7 Scaling lower limit value	0

For the parameters other than the above, use the initial value.

Devices used by user

Device	Description	
X20	Digital operation value read command	QX10 (X20 to X2F)
X22	Error reset command	
X24	Maximum value/minimum value read command	
X26	Maximum value/minimum value reset command	
X1007	Warning flag	NZ2GFCE-60ADV8 (RX0 to RX2F)
X1009	Initial data setting completed flag	
X100A	Error flag	
X100B	Remote READY	
X1010	CH1 A/D conversion completed flag	
X1012	CH3 A/D conversion completed flag	
X1016	CH7 A/D conversion completed flag	
X1018	Alert output signal	
X101C	Input signal error detection flag	
X101D	Maximum value/minimum value reset completed flag	
Y100A	Error clear request flag	
Y101D	Maximum value/minimum value reset request	
W1100	Latest error code	Remote register RWr
W1101	Latest warning code	
W1102	CH1 Digital operation value	
W1104	CH3 Digital operation value	
W1108	CH7 Digital operation value	
W110A	Input signal error detection flag	
W110B	Alert output flag	
D2002	CH1 Digital operation value	Device for storage
D2004	CH3 Digital operation value	
D2008	CH7 Digital operation value	
D2010	CH1 Maximum value	
D2011	CH1 Minimum value	
D2014	CH3 Maximum value	
D2015	CH3 Minimum value	
D2022	CH7 Maximum value	
D2023	CH7 Minimum value	
D2030	Latest error code	
D2031	Latest warning code	
D2032	Input signal error detection flag	
D2033	Alert output flag	
F1	CH3 Upper limit alert issued	
F2	CH3 Lower limit alert issued	
F3	CH1 Simple disconnection occurred	
F4	CH7 Simple disconnection occurred	
F5	Maximum value/minimum value read completed with an error	
M0	Communication ready flag (station number 1)	
M300	Maximum value/minimum value read flag	
M310	REMTO instruction completed flag	
M311	REMTO instruction completed-with-error flag	
SM400	Always ON	
SB47	Baton pass status of the own station	
SB49	Data link status of the own station (master station)	
SW0A.0	Baton pass status of each station (station number 1)	
SW0B0.0	Data link status of each station (station number 1)	
N0	Nesting (station number 1)	

Setting procedure

Connect GX Works2 to the master station to set up the settings.

1. Create a project on GX Works2.

On "Series", select "QCPU (Q mode)" and on "Type", select "Q10UDH".

 [Project] ⇒ [New]

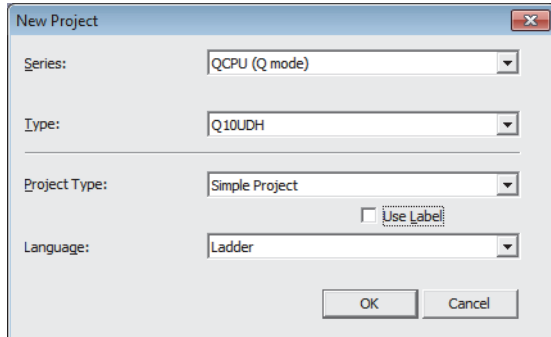

2. Open the network parameter setting window and configure the settings as shown below.

 Project window ⇒ [Parameter] ⇒ [Network Parameter] ⇒ [Ethernet / CC IE / MELSECNET]

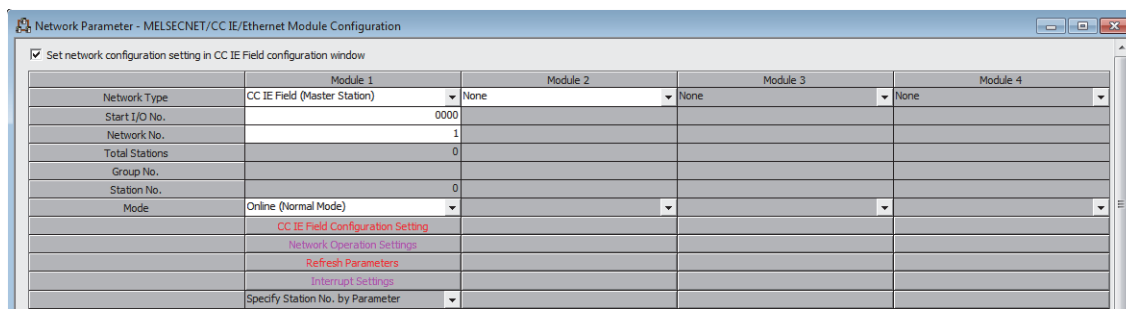

3. Open the CC IE Field configuration window and set up the configuration and station number of a slave station as shown below.

 [CC IE Field Configuration Setting] button

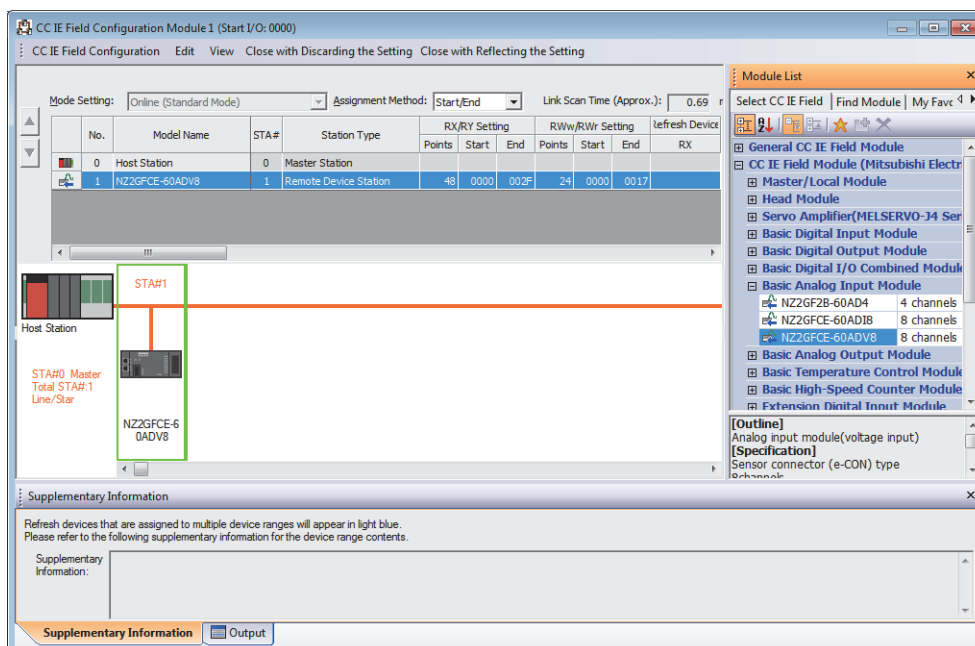

4. Close the CC IE Field configuration window.

 [CC IE Field Configuration] ⇒ [Close with Reflecting the Setting]

5. Open the refresh parameter setting window and configure the settings as shown below.

 [Refresh Parameters] button

	Link Side					PLC Side			
	Dev. Name	Points	Start	End		Dev. Name	Points	Start	End
Transfer SB	SB	512	0000	01FF	↔	SB	512	0000	01FF
Transfer SW	SW	512	0000	01FF	↔	SW	512	0000	01FF
Transfer 1	RX	48	0000	002F	↔	X	48	1000	102F
Transfer 2	RY	48	0000	002F	↔	Y	48	1000	102F
Transfer 3	RWw	24	0000	0017	↔	W	24	001000	001017
Transfer 4	RWr	24	0000	0017	↔	W	24	001100	001117
Transfer 5					↔				
Transfer 6					↔				
Transfer 7					↔				
Transfer 8					↔				

6. Write the set parameters to the CPU module of the master station, and reset the CPU module, or turn off and on the power supply.

 [Online] ⇒ [Write to PLC]

7. Open the "Parameter Processing of Slave Station" window.

 Project window ⇒ [Parameter] ⇒ [Network Parameter] ⇒ [Ethernet / CC IE / MELSECNET] ⇒ [CC IE Field Configuration Setting] button ⇒ Select the A/D converter module in "List of stations" ⇒ [CC IE Field Configuration] ⇒ [Online] ⇒ [Parameter Processing of Slave Station]

8. Set "Method selection" to "Parameter write".

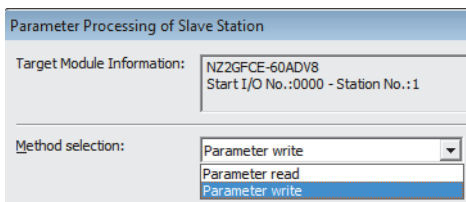

9. Set "Write Value". Follow the next steps to set the value:

- Click the title cell of "Initial Value" to select all the items, and copy them.
- Click the title cell of "Write Value" to select all the items, and paste the copy.
- Select the items to be changed, and set new values as described in Initial settings ( Page 93 Initial settings).

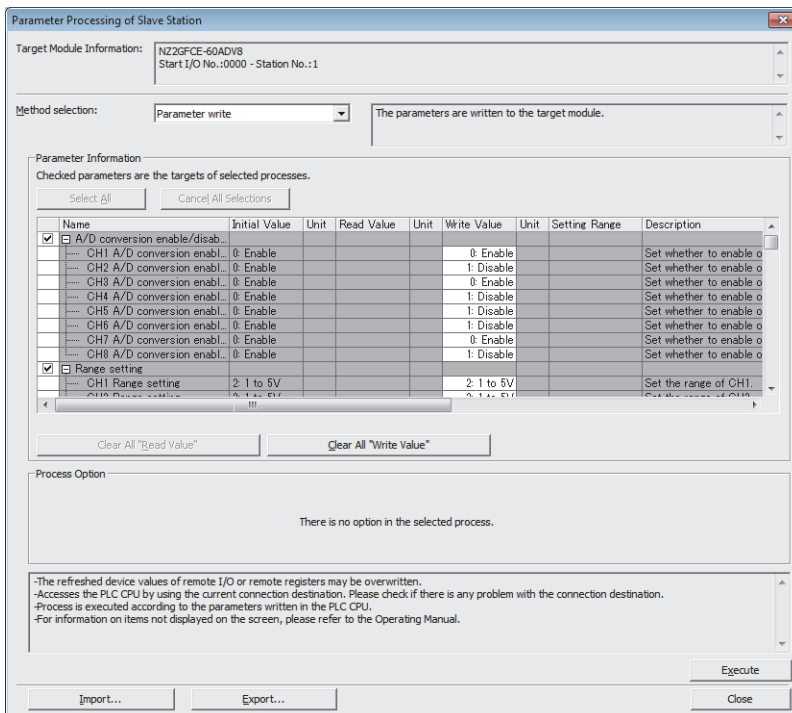

Name	Initial Value	Unit	Read Value	Unit	Write Value	Unit	Setting Range	Description
<input checked="" type="checkbox"/> A/D conversion enable/disable...								
<input type="checkbox"/> CH1 A/D conversion enable...	0: Enable				0: Enable			Set whether to enable o
<input type="checkbox"/> CH2 A/D conversion enable...	0: Enable				1: Disable			Set whether to enable o
<input type="checkbox"/> CH3 A/D conversion enable...	0: Enable				0: Enable			Set whether to enable o
<input type="checkbox"/> CH4 A/D conversion enable...	0: Enable				1: Disable			Set whether to enable o
<input type="checkbox"/> CH5 A/D conversion enable...	0: Enable				1: Disable			Set whether to enable o
<input type="checkbox"/> CH6 A/D conversion enable...	0: Enable				1: Disable			Set whether to enable o
<input type="checkbox"/> CH7 A/D conversion enable...	0: Enable				0: Enable			Set whether to enable o
<input type="checkbox"/> CH8 A/D conversion enable...	0: Enable				1: Disable			Set whether to enable o
<input checked="" type="checkbox"/> Range setting								
<input type="checkbox"/> CH1 Range setting	2: 1 to 5V				2: 1 to 5V			Set the range of CH1.

10. Click the [Execute] button to write the parameters to the A/D converter module.

Program example

1. Create the following program with GX Works2.

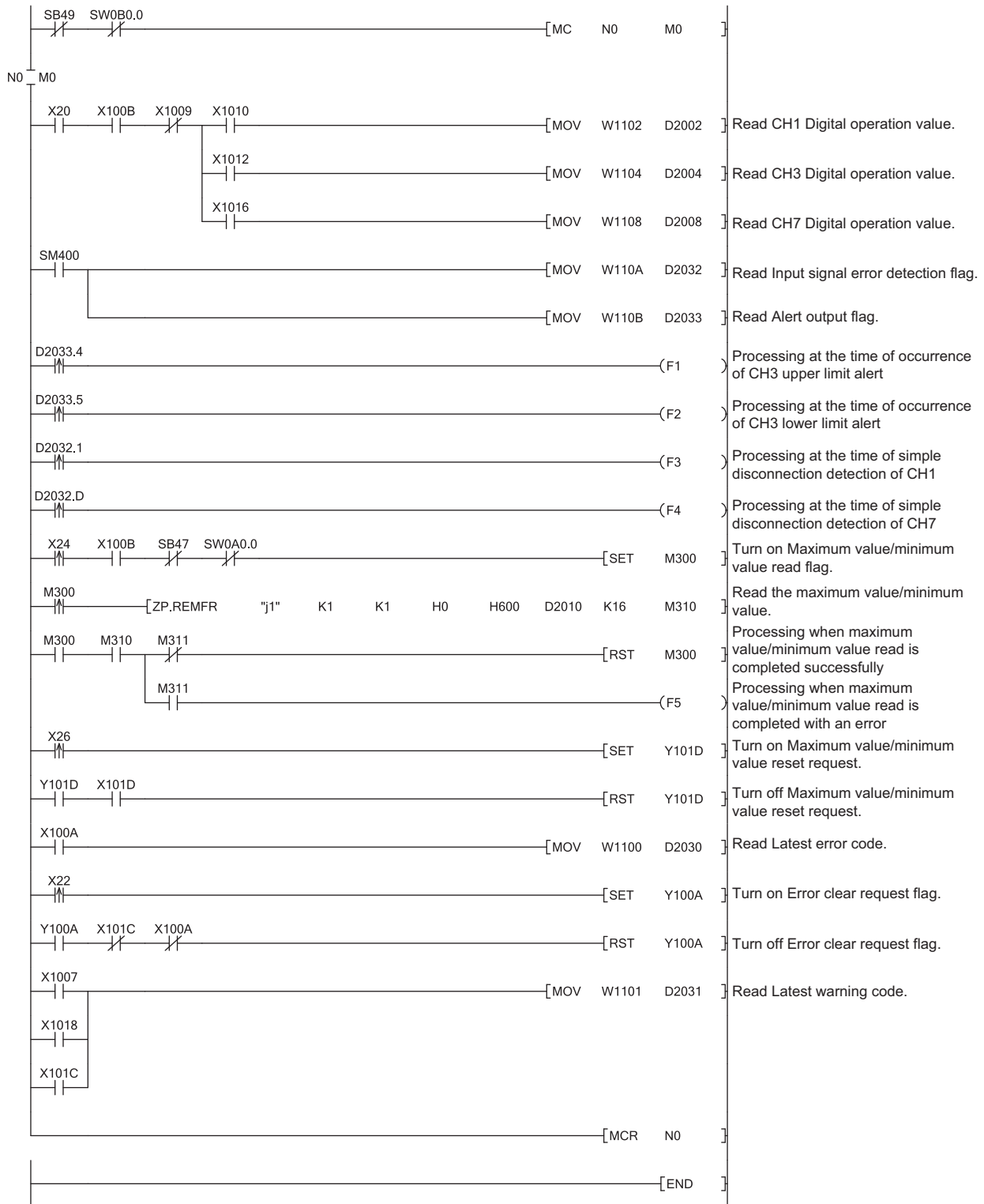

Point

If the master station does not receive a response for several link scans from the A/D converter module, it is recognized as a cyclic transmission faulty station, resulting in the bit of corresponding station of the data link status of each station (SW00B0 to SW00B7) turning on.

2. Write the program to the CPU module of the master station, and reset the CPU module, or turn off and on the power supply.

3. Put the CPU module of the master station into RUN.

9 MAINTENANCE AND INSPECTION

There are no special inspection item as an A/D converter module; however, to maintain the best condition of the system, perform the inspection in accordance with the items described in the user's manual for the CPU module used.

MEMO

10 TROUBLESHOOTING

This chapter describes errors that may occur while the A/D converter module is used, and those troubleshooting.

10.1 How to Check Error Codes and Alarm Codes

10

Error codes can be checked by any of the following methods:

- Checking by executing a command of the slave station (☞ Page 101 Checking by executing a command of the slave station)
- Checking by Latest error code (RWr0) (☞ Page 103 Checking by Latest error code (RWr0))
- Checking by Latest warning code (RWr1) (☞ Page 103 Checking by Latest warning code (RWr1))

Alarm codes can be checked by any of the following methods:

- Checking by executing a command of the slave station (☞ Page 101 Checking by executing a command of the slave station)
- Checking by Latest warning code (RWr1) (☞ Page 103 Checking by Latest warning code (RWr1))

Checking by executing a command of the slave station

The procedure below shows how to check the errors by executing a command of the slave station.

1. On the CC IE Field configuration window, from "List of stations", select the A/D converter module.

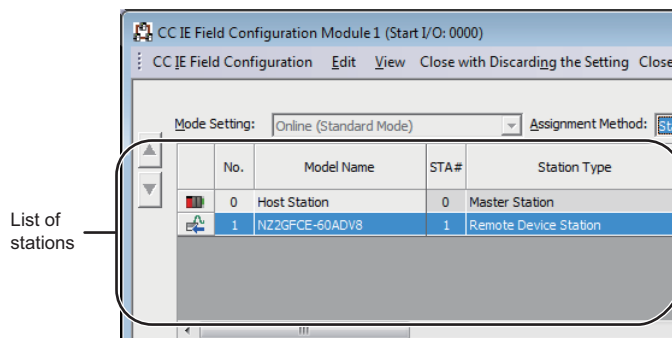

2. Open the "Command Execution of Slave Station" window.

☞ [CC IE Field Configuration] ⇒ [Online] ⇒ [Command Execution of Slave Station]

3. Set "Method selection" to "Error history read" and click the [Execute] button.

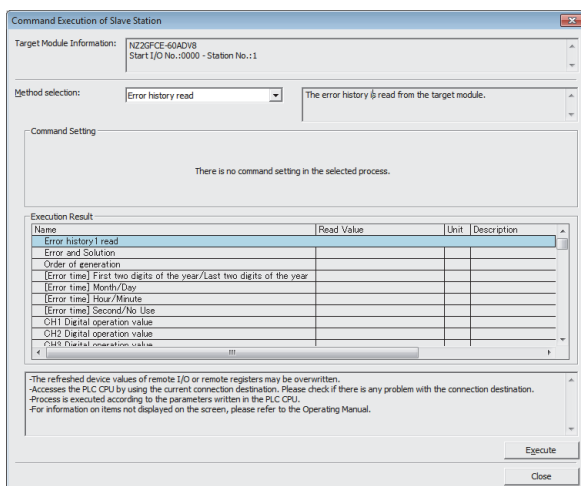

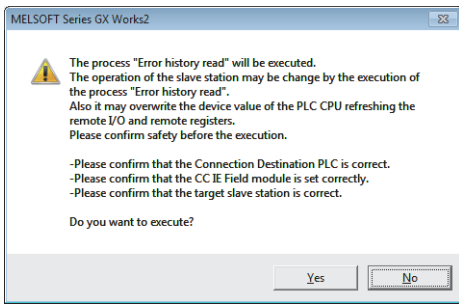

4. In the window that appears (shown left), click the [Yes] button.

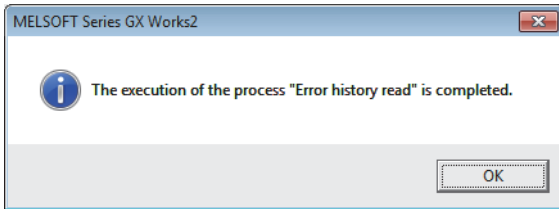

5. In the window that appears (shown left), click the [OK] button.

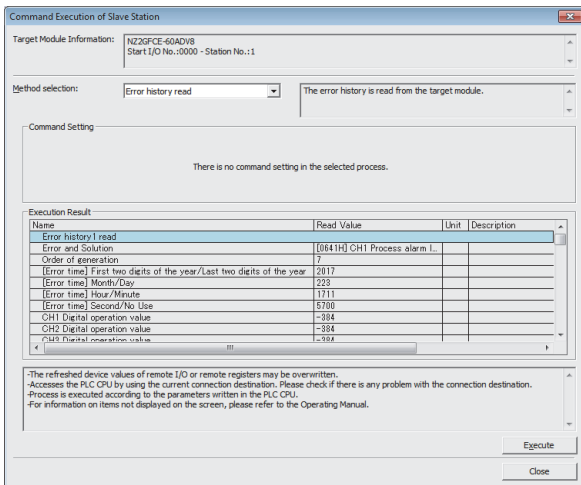

6. The error history of the A/D converter module is displayed in "Execution Result".

Item	Storage contents
Error and Solution	Shows how to take the appropriate action for the error that has occurred.
Order of generation	Shows the order of error occurrence. (A value between 0 and 65535 is stored.)
[Error time] First two digits of the year/Last two digits of the year	Shows the date and time of error occurrence. (When the tens place of Month, Hour and Second is "0", "0" is omitted.)
[Error time] Month/Day	
[Error time] Hour/Minute	
[Error time] Second/No Use	
CH1 Digital operation value	Stores the value in CH□ Digital operation value (RWr2 to RWr9) at the time of occurrence of an error.
CH2 Digital operation value	
CH3 Digital operation value	
CH4 Digital operation value	
CH5 Digital operation value	
CH6 Digital operation value	
CH7 Digital operation value	
CH8 Digital operation value	

- The error history registers 15 errors at a maximum. If 16 or more errors occur, errors are deleted from the oldest.
- If the same error occurs continuously, only the error that occurred first is stored to the error history.
- Even after the module power supply is turned off and on, the error history remains.
- The clock information of the error that occurred is based on the clock information acquired from the CPU module of the master station. To obtain the accurate data and time of an error, synchronize the clock information of the CPU module to the real time.
- Reading the error history of this module requires the CPU module to be in the STOP state. With the RUN state, the read would fail.
- To initialize the error history, go to the "Command Execution of Slave Station" window to set "Method selection" to "Error history clear request", and then click the [Execute] button.

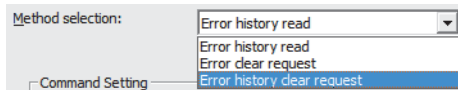

Checking by Latest error code (RWr0)

Carry out a check with the remote register of the master/local module.

[Online] ⇒ [Monitor] ⇒ [Device/Buffer Memory Batch]

Ex.

When the refresh target device for Latest error code (RWr0) is W1100

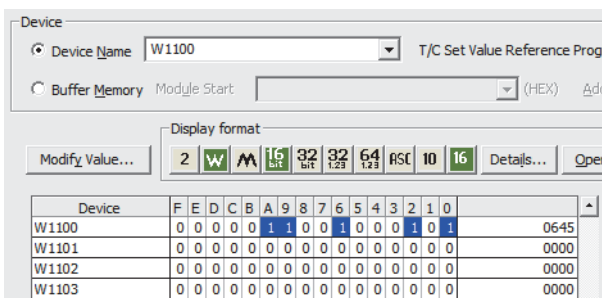

Checking by Latest warning code (RWr1)

Carry out a check with the remote register of the master/local module.

[Online] ⇒ [Monitor] ⇒ [Device/Buffer Memory Batch]

Ex.

When the refresh target device for Latest warning code (RWr1) is W1101

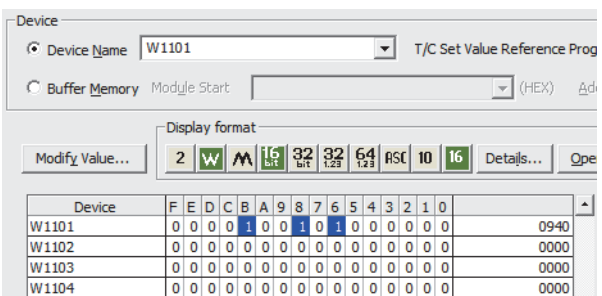

10.2 Error Code List

This section describes error codes.

Error codes are classified by error number as follows.

Error code	Classification	Reference
0000H to 0FFFH, 1F00H to 1F40H, D52BH	Errors relating to the A/D converter module	Page 104 List of error codes (0000H to 0FFFH, 1F00H to 1F40H, D52BH)
D000H to DFFFH (D52BH excluded)	Errors relating to CC-Link IE Field Network (communication error)	Page 107 List of error codes (D000H to DFFFH (D52BH excluded))

List of error codes (0000H to 0FFFH, 1F00H to 1F40H, D52BH)

The errors are classified into the following three types:

Classification	Description
Major error	This error is a sign that recovery is impossible, with the RUN LED turning off.
Moderate error	This error is a sign that the module cannot continue to operate, with the ERR. LED turning on.
Minor error	This error is a sign that the module can continue to operate, with the ERR. LED flashing.

If any of these errors occurs, check that the D LINK LED lights up, and take the corrective actions corresponding to the error code in the list below.

Error code (hexadecimal)	Classification	Error name	Description and cause	Action
0010H	Major error	Hardware failure	Module hardware error	Turn off and on the module power supply. If this error persists, the failure of the module is a possible cause. Please consult your local Mitsubishi representative.
010□H	Moderate error	Range setting out-of-range	Values out of the range are set in Range setting (CH1 to CH4) (address: 0103H) and Range setting (CH5 to CH8) (address: 0104H). □ indicates the number of the channel that has been incorrectly set.	Set Range setting (CH1 to CH4) (address: 0103H) and Range setting (CH5 to CH8) (address: 0104H) to values within the allowable range.
0130H	Moderate error	Non-volatile memory data error (parameter)	The parameter data stored in the non-volatile memory are abnormal.	<ul style="list-style-type: none"> Set Not commanded (0) → Commanded (1) → Not commanded (0) in Parameter area initialization command (address: 1002H) and set the parameters of the non-volatile memory to default values. Set the parameters again. Take measures to reduce noise with a shield wire for connection. If this error persists, the failure of the module is a possible cause. Please consult your local Mitsubishi representative.
0140H	Minor error	Non-volatile memory data error (error history)	The error history data stored in the non-volatile memory are abnormal.	<ul style="list-style-type: none"> The module will be automatically recovered immediately after the error occurs. Note that the error history of the errors that have occurred will be lost. Take measures to reduce noise with a shield wire for connection. If this error persists, the failure of the module is a possible cause. Please consult your local Mitsubishi representative.
0160H	Minor error	Remote buffer memory access error	A buffer memory area other than the remote buffer memory areas has been accessed using the REMFR/REMTO instruction.	Correct the setting data of the REMFR/REMTO instruction to access the remote buffer memory.

Error code (hexadecimal)	Classification	Error name	Description and cause	Action
020□H ^{*1}	Moderate error	Time average setting out-of-range	The time averaging setting in CH□ Time average/Count average/Moving average (address: 0107H to 010EH) is out of the range of 4 to 5000ms. □ indicates the number of the channel where an error has occurred.	Set the time averaging setting to a value in the range of 4 to 5000ms.
			The time averaging setting set in CH□ Time average/Count average/Moving average (address: 0107H to 010EH) is less than "4 × Sampling period" (ms). □ indicates the number of the channel where an error has occurred.	Adjust the time average value to be equal to or greater than "4 × Sampling period" (ms).
030□H ^{*1}	Moderate error	Count average setting out-of-range	The count averaging setting set in CH□ Time average/Count average/Moving average (address: 0107H to 010EH) is out of the range of 4 to 65000 times. □ indicates the number of the channel where an error has occurred.	Adjust the count average value to fall within the range of 4 to 65000 times.
031□H ^{*1}	Moderate error	Moving average setting out-of-range	The moving count averaging setting set in CH□ Time average/Count average/Moving average (address: 0107H to 010EH) is out of the range of 2 to 128 times. □ indicates the number of the channel where an error has occurred.	Set the moving average count value to a value in the range of 2 to 128.
06△□H ^{*1}	Moderate error	Process alarm setting error	The settings in CH1 Process alarm lower limit value (address: 0112H) to CH8 Process alarm upper upper limit value (address: 0131H) have an inconsistency in magnitude relation. □ indicates the number of the channel that has been incorrectly set. △ indicates that the set values are in one of the following conditions: 2:Process alarm lower lower limit value > Process alarm lower upper limit value 3:Process alarm lower upper limit value > Process alarm upper lower limit value 4:Process alarm upper lower limit value > Process alarm upper upper limit value	Adjust the settings in CH1 Process alarm lower lower limit value (address: 0112H) to CH8 Process alarm upper upper limit value (address: 0131H).
081□H ^{*1}	Moderate error	Input signal error detection setting out-of-range	A value out of the setting range is set for a bit corresponding to any channel of Input signal error detection setting (CH1 to CH4) (address: 010FH) and Input signal error detection setting (CH5 to CH8) (address: 0110H). □ indicates the number of the channel where an error has occurred.	Set the value in the channel, where an error has occurred in Input signal error detection setting (CH1 to CH4) (address: 010FH) or Input signal error detection setting (CH5 to CH8) (address: 0110H), to either of the following: • Disable (0H) • Simple disconnection detection (4H)
082□H	Moderate error	Simple disconnection detection setting error	A channel where the input range is other than the following is set to Simple disconnection detection (4H) in Input signal error detection setting (CH1 to CH4) (address: 010FH) and Input signal error detection setting (CH5 to CH8) (address: 0110H). • 4 to 20mA • 1 to 5V □ indicates the number of the channel where an error has occurred.	• Set the input range of the channel that allows simple disconnection detection within the range of 4 to 20mA or 1 to 5V. • Set Input signal error detection setting (CH1 to CH4) (address: 010FH) and Input signal error detection setting (CH5 to CH8) (address: 0110H) of the corresponding channel without simple disconnection detection to a value other than Simple disconnection detection (4H).
090□H ^{*1}	Moderate error	Scaling setting out-of-range	The values set in CH1 Scaling lower limit value (address: 0134H) to CH8 Scaling upper limit value (address: 0143H) are out of the range of -32000 to 32000. □ indicates the number of the channel where an error has occurred.	Adjust the value to fall within the range of -32000 to 32000 in CH1 Scaling lower limit value (address: 0134H) to CH8 Scaling upper limit value (address: 0143H).

Error code (hexadecimal)	Classification	Error name	Description and cause	Action
091□H*1	Moderate error	Scaling upper/lower limit value inverted	CH1 Scaling lower limit value (address: 0134H) to CH8 Scaling upper limit value (address: 0143H) have been set as follows: Scaling lower limit value ≥ Scaling upper limit value. □ indicates the number of the channel where an error has occurred.	Adjust the settings of CH1 Scaling lower limit value (address: 0134H) to CH8 Scaling upper limit value (address: 0143H) as follows: Scaling lower limit value < Scaling upper limit value.
0940H	Minor error	Station number switch changed error	The setting of the station number switch has been changed while the module power supply is on.	Set the switch again to the station number that has been set when the module power supply was turned on.
0950H	Moderate error	Clock data out-of-range	The clock data acquired from the CPU module is invalid.	The influence of noise or the hardware failure is a possible cause. If the same error occurs again even after measures have been taken against noise, please consult your local Mitsubishi representative.
0960H	Major error	Communication error 3	An invalid data that implies an altered setting of the communication LSI has been received.	Take measures against noise and reset the module. If the same error occurs again, the hardware failure of the module is a possible cause. Please consult your local Mitsubishi representative.
0970H	Major error	Communication error 4	An invalid data that implies an altered setting of the communication LSI has been received.	Take measures against noise and reset the module. If the same error occurs again, the hardware failure of the module is a possible cause. Please consult your local Mitsubishi representative.
D52BH	Major error	Communication error 2	An error has occurred in the communication.	<ul style="list-style-type: none"> The malfunction due to noise or other factors is a possible cause. Check the distance of the wire and cables and the grounding condition of the individual devices, and then take measures against noise. Execute a unit test for the module. If the same error occurs again, the hardware failure of the module is a possible cause. Please consult your local Mitsubishi representative.

*1 To clear the error, modify the set value within the range and perform one of the following two operations:
Turning on and off Error clear request flag (RYA)
Turning on and off Initial data setting request flag (RY9)

Point

For two or more errors, only the latest error code is stored in Latest error code (RWr0) or Latest warning code (RWr1).

The errors that have occurred in the past can be checked in the error history of the engineering tool.

For the error history, refer to the following:

 Page 101 Checking by executing a command of the slave station

 Page 134 Error history data

List of error codes (D000H to DFFFH (D52BH excluded))

While any of these errors occurs, the ERR. LED does not turn on. Based on the behavior of the D LINK LED at the occurrence of an error, the errors are classified into two types, each of which requires different troubleshooting.

■Communication errors where the D LINK LED flashes or turns off

This type of communication error results in the D LINK LED flashing or being turned off. Troubleshoot the problem with the CC-Link IE Field Network diagnostics. ( Page 88 CC-Link IE Field Network Diagnostic Function)

Error code (hexadecimal)	Error name	Description and cause	Action
D0E0H	Station type mismatch	The network parameters are incorrect or out of the range.	In the network configuration settings of the master station, change the station type of the module to the remote device station.
D0E1H	Own station set to reserved station	The network parameters are incorrect or out of the range.	<ul style="list-style-type: none"> In the network configuration settings of the master station, cancel the reserved station specification. Change the station number of the module to a station number that is not specified as a reserved station.
D0E2H	Own station's station number duplication error	The settings of the station number switch are invalid or out of the range.	<ul style="list-style-type: none"> Change the station number avoiding duplication of the station number with other stations. After taking the above action, power off and on or reset all the stations where this station number duplication error has been detected.
D0E3H	Own station's station number out-of-range	The network parameters are incorrect or out of the range.	Add the station information of the module to the network configuration settings of the master station.
D72AH	Station number switch out-of-range (a value other than 1 to 120)	A station number out of the range has been set.	Set the station number within the allowable range.

■Communication errors where the D LINK LED does not change

This type of communication error results in no change of the D LINK LED. These errors are not shown in CC-Link IE Field Network diagnostics because they are automatically recovered after the occurrence. Troubleshooting them requires the error history to be read out. ( Page 101 Checking by executing a command of the slave station)

Error code (hexadecimal)	Error name	Description and cause	Action
D217H	Transient data request command error	The transient data request command is incorrect.	Correct the request command at the transient request source, and execute the command again.
D2A0H	Receive buffer full error	There is an overload of the received transient data.	<ul style="list-style-type: none"> Check the network status using CC-Link IE Field Network diagnostics of the engineering tool to take the appropriate action. When the target station is overloaded and cannot receive transient data, the data needs to be resent to the target station after a period of time.
D2A3H	Transient data length error	The received transient data is incorrect.	Correct the number of data (frame length) at the transient request source, and retry the execution.
DF01H	Received transient split error	The received transient data is split.	Set the transient data size that the module can accommodate, and modify the transient data to the one that is not split. Then send it again.

Point

For two or more errors, only the latest error code is stored in Latest error code (RWr0) or Latest warning code (RWr1).

The errors that have occurred in the past can be checked in the error history of the engineering tool.

For the error history, refer to the following:

 Page 101 Checking by executing a command of the slave station

 Page 134 Error history data

10.3 List of Alarm Codes

Here is the list of alarm codes:

Alarm code (hexadecimal)	Classification	Alarm name	Description and cause	Action
0A△□H	Minor error	Process alarm occurrence	A process alarm has occurred. □ indicates the number of the channel where a process alarm has occurred. △ indicates the status as follows: 0: Process alarm upper limit 1: Process alarm lower limit	When the digital operation value falls within the setting range, the corresponding bit of Alert output flag (RWrB) and Alert output signal (RX18) turn off automatically and Latest warning code (RWr1) is cleared.
0B△□H	Minor error	Input signal error detection	An input signal error has occurred. □ indicates the number of the channel where an input signal error has occurred. △ indicates the status as follows: 3: Simple disconnection detection This alarm code is stored when an input signal error is detected according to the setting of the input signal error detection function.	After the analog input value falls within the range, turning on and off Error clear request flag (RYA) results in the corresponding bit of Input signal error detection flag (RWrA) and Input signal error detection signal (RX1C) turning off.

10.4 Checking the LEDs

This section describes how to troubleshoot the system by the LEDs.

When the PW LED does not turn on

Check item	Action
Is any LED other than the PW LED turned on?	If any LED other than the PW LED turns on, the hardware failure is a possible cause. Please consult your local Mitsubishi representative.
Is the module power supply (24VDC) wired?	Wire the module power supply (24VDC).
Is the module power supply (24VDC) supplied?	Supply the module power supply (24VDC).
Does the voltage of the module power supply (24VDC) conform to the specified range?	Adjust the voltage value to conform to the range of performance specifications.

When the RUN LED does not turn on

Check item	Action
Does any hardware error occur?	Verify that the voltage of the module power supply lies in the range of performance specifications. ☞ Page 14 Performance Specifications After the check, turn off and on the module power supply. If the RUN LED does not turn on even after the module power supply is turned off and on, the failure of the module is a possible cause. Please consult your local Mitsubishi representative.

When the MODE LED flashes

Check item	Action
Is the A/D converter module in the unit test?	If the A/D converter module is in the unit test, the MODE LED turns off after the unit test is completed. Take corrective action according to the result of the unit test. ☞ Page 111 Unit Test

When the D LINK LED turns off

Check item	Action
Does the own station in network operate normally?	Connect the engineering tool to the master station, and then check if a data link is established in the own station by using CC-Link IE Field Network diagnostics. 📖 User's manual for the master/local module used
Are 1000BASE-T-compliant Ethernet cables used?	Replace the cable with a 1000BASE-T-compliant Ethernet cable. 📖 User's manual for the master/local module used
Is the station-to-station distance 100m or less?	Change the station-to-station distance to 100m or less.
Does the cabling condition (bending radius) meet the specifications?	Refer to the manual for the Ethernet cable used, and correct the bend radius.
Is any Ethernet cable disconnected?	Replace the Ethernet cable.
Do other stations connected to the A/D converter module operate normally?	Check if the power supplies of the other stations are turned on.
Does the switching hub normally operate?	<ul style="list-style-type: none"> • Check if a 1000BASE-T-compliant switching hub is used. 📖 User's manual for the master/local module used <ul style="list-style-type: none"> • Check if the power supply of the switching hub is turned on.
Is the station number of the A/D converter module duplicated with any of other stations?	Two or more stations are duplicated. Change the setting so that all the station numbers differ.

When the D LINK LED flashes

Check item	Action
Does the station number setting of the A/D converter module match the station number of the A/D converter module that is set up in the network configuration settings of the master station or in the CC IE Field configuration?	Match the station number of the A/D converter module with the station number that is set up in the network configuration settings of the master station or in the CC IE Field configuration.
Is the station type a remote device station?	In the network configuration settings of the master station, change the station type to the remote device station.
Is the A/D converter module a reserved station?	Change the setting of reserved/error invalid station to other than the reserved station in the network configuration settings of the master station.
Is stop of the data link checked through CC-Link IE Field Network diagnostics?	Check the link status through CC-Link IE Field Network diagnostics and start the link when the data link is stopped.
Is the station number setting switch set to other than 1 to 120?	The setting range for the station number setting switch is 1 to 120. Set the number between 1 and 120.
Has the connection been changed to the other master station with a different network number?	<ul style="list-style-type: none"> • Correct the connection to the previous master station. • To communicate with the master station with a different network number, power off and on the A/D converter module.

When the L ER LED turns on

Check item	Action
Are Ethernet cables normal?	<ul style="list-style-type: none"> • Check if 1000BASE-T-compliant Ethernet cables are used. 📖 User's manual for the master/local module used <ul style="list-style-type: none"> • Check if the station-to-station distance is 100m or less. • Check if the Ethernet cables are not disconnected.
Does the switching hub used in the system operate normally?	<ul style="list-style-type: none"> • Check if a 1000BASE-T-compliant switching hub is used. 📖 User's manual for the master/local module used <ul style="list-style-type: none"> • Check if the power supply of the switching hub is turned on.
Do other stations connected to the A/D converter module operate normally?	Check if the power supplies of the other stations are turned on.
Is the mode of the master station set to other than Online?	Change the mode of the master station to Online.
Is there any noise affecting the system?	<ul style="list-style-type: none"> • Check the wiring condition of the Ethernet cables. • Ground the control panel where the A/D converter module is installed.
Is the loopback function enabled for the master station?	When the loopback function is enabled, check if the ring topology is correctly configured for the port where the L ER LED is on. 📖 User's manual for the master/local module used

When the LINK LED turns off

Check item	Action
Are Ethernet cables normal?	<ul style="list-style-type: none"> • Check if 1000BASE-T-compliant Ethernet cables are used. 📖 User's manual for the master/local module used • Check if the station-to-station distance is 100m or less. • Check if the Ethernet cables are not disconnected.
Do the switching hub and other stations used in the system operate normally?	Check if the power supplies of the switching hub and other stations are turned on.

Point

If link-up processing is repeated due to a condition of a device on the line, it may take a longer time for the LINK LED to turn on. This phenomenon may be eliminated by changing the module PORT into which the Ethernet cable is connected (example: PORT1 → PORT2).

For the wiring of Ethernet cable, refer to the following.

📄 Page 39 Wiring of Ethernet cable

When the ERR. LED turns on

Check item	Action
Does any error occur?	Identify the error factor of the A/D converter module with the engineering tool to take the corrective action. 📄 Page 101 How to Check Error Codes and Alarm Codes

When the ALM LED turns on or flashes

■When ALM LED turns on

Check item	Action
Is an alert issued in the A/D converter module?	Check Alert output flag (RWrB).

■When the ALM LED flashes

Check item	Action
Does any input signal error occur in the A/D converter module?	Check Input signal error detection flag (RWrA).

10.5 Unit Test

The purpose of a unit test is to check if there is any abnormality in the A/D converter module hardware.

1. Turn off the module power supply.
2. Connect the PORT1 and PORT2 connectors of the A/D converter module with an Ethernet cable.
3. Set up the station number setting switch as follows:
 - x10: TEST
 - x1: 0
4. Turn on the module power supply.
5. Unit test begins.

The MODE LED flashes during the unit test.



6. Upon the completion of the unit test, the MODE LED turns off.
 - When completed normally, the ERR. LED does not turn on, remaining off.
 - When completed with an error, the ERR. LED turns on. If the unit test is completed with an error, replace the Ethernet cable and run the test again. If completed with an error again, the hardware failure in the A/D converter module is a possible cause. Please consult your local Mitsubishi representative.

Point

When the unit test is completed with an error, the error details can be checked in the error history.

To check the error history, set the station number of the A/D converter module and connect the module to the master station with an Ethernet cable.

For the error history, refer to the following:

-  Page 101 Checking by executing a command of the slave station
 -  Page 134 Error history data
-

10.6 Troubleshooting by Symptom

This section describes troubleshooting problem by problem.

Troubleshooting by symptom is suitable for the case where modules fail to operate normally even though no error has occurred in the A/D converter module. If an error occurs in the A/D converter module, identify the cause of the error using the engineering tool.

When digital operation value cannot be read

Check item	Action
Is there any problem with the wiring, such as looseness or disconnection of analog signal lines?	Check the faulty area by checking signal line visually or conductively.
Is the CPU module in the STOP state?	Change the state of the CPU module to RUN.
Is the input range setting correct?	Verify Range setting (CH1 to CH4) (address: 0103H) and Range setting (CH5 to CH8) (address: 0104H) by using the engineering tool or the dedicated instruction. If the input range setting is incorrect, set the range again by program or parameter setting.
Is A/D conversion enable/disable setting set to A/D conversion disabled for the channels where the analog value is to be input?	Check A/D conversion enable/disable setting (address: 0102H) by using the engineering tool or the dedicated instruction. Then, set A/D conversion enabled by program or parameter setting.
Is Initial data setting request flag (RY9) executed?	Turn on and off Initial data setting request flag (RY9) using the engineering tool to check if the digital operation value is stored in CH□ Digital operation value (RWr2 to RWr9). When the problem has been solved, check the program again.
Does the voltage of the module power supplied externally reach to the voltage of the performance specifications?	Check if module power supply voltage is within the range of performance specifications.  Page 14 Performance Specifications After the check, turn off and on the module power supply. If the RUN LED does not turn on even after the module power supply is turned off and on, the failure of the module is a possible cause. Please consult your local Mitsubishi representative.
Are the setting values of the averaging process setting correct?	When the time average processing is selected, set the value to be not less than "Four (times) × Sampling period". If the condition above is not met, 0 is stored into the digital operation value.
Is there any potential difference between the AG terminal and the external device GND?	Connect the AG terminal and the external device GND.

Point

If the digital operation value cannot be read even after the above actions are taken, the failure of the A/D converter module is a possible cause.

Please consult your local Mitsubishi representative.

When an A/D conversion completed flag does not turn on in the normal mode

Check item	Action
Does any input signal error occur?	Check Input signal error detection flag (RWrA).

When the digital operation value is out of the accuracy range

Check item	Action
Is any measure against noise taken?	Take measures to reduce noise, such as using a shield wire for connection.

Parameter read or write, or CC-Link IE Field Network diagnostics fails.

Check item	Action
Is the D LINK LED of the A/D converter module on?	<p>Check the D LINK LED of the A/D converter module and if it is not on, perform troubleshooting by referring to the following:</p> <ul style="list-style-type: none"> ☞ Page 109 When the D LINK LED turns off ☞ Page 109 When the D LINK LED flashes <p>Check other LEDs by referring to the following.</p> <ul style="list-style-type: none"> ☞ Page 108 Checking the LEDs
Is the version of the module on the master station correct?	<p>Check the serial number (first five digits) of the module on the master station, and if it is prior to the supported versions, replace the module with a module of the supported version. For the supported version, refer to the following:</p> <ul style="list-style-type: none"> ☞ Page 28 Supported master station
Is the version of the engineering tool supported?	<p>Check the version of the engineering tool, and if it is prior to the supported versions, update the engineering tool. For the supported version, refer to the following:</p> <ul style="list-style-type: none"> ☞ Page 28 Supported software package
Are network parameter settings same as the settings of the CPU module?	<p>Perform "Verify with PLC" and check that network parameter settings match the settings of the CPU module. If they differ, match the settings by performing "Read from PLC" and "Write to PLC", and write the parameters to modules on slave stations.</p>

APPENDICES

Appendix 1 Details of Remote I/O Signals

This section describes the details of remote I/O signals for the master/local module.

The described assignment of device numbers assumes that the remote I/O signals of A/D converter modules are assigned as follows:

- Remote input signals: RX0 to RX2F
- Remote output signals: RY0 to RY2F

Remote input signals

Warning flag

■Device number

Signal name	Device number
Warning flag	RX7

■Description

Warning flag (RX7) turns on when a minor error occurs.

Eliminating the cause of the minor error occurred and waiting for five seconds results in Latest warning code (RWr1) turning to 0000H and Warning flag (RX7) turning off.

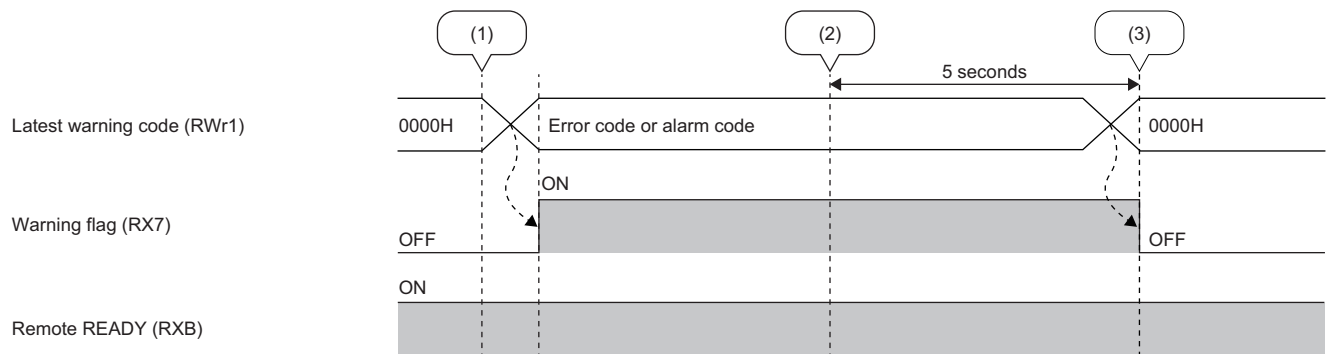

-----> Executed by the A/D converter module.

- (1) A minor error occurred.
- (2) A minor error resolved.
- (3) Five seconds lapsed.

Initial data setting completed flag

■Device number

Signal name	Device number
Initial data setting completed flag	RX9

■Description

Upon completion of the change of operating conditions after the following is executed, Initial data setting completed flag (RX9) turns on.

1. Use the REMTO instruction to write parameter data to the remote buffer memory.
2. Turn on Initial data setting request flag (RY9).

For the buffer memory areas that require Initial data setting request flag (RY9) to be turned on and off to enable the written parameter data, refer to the following:

☞ Page 20 List of Remote Buffer Memory Areas

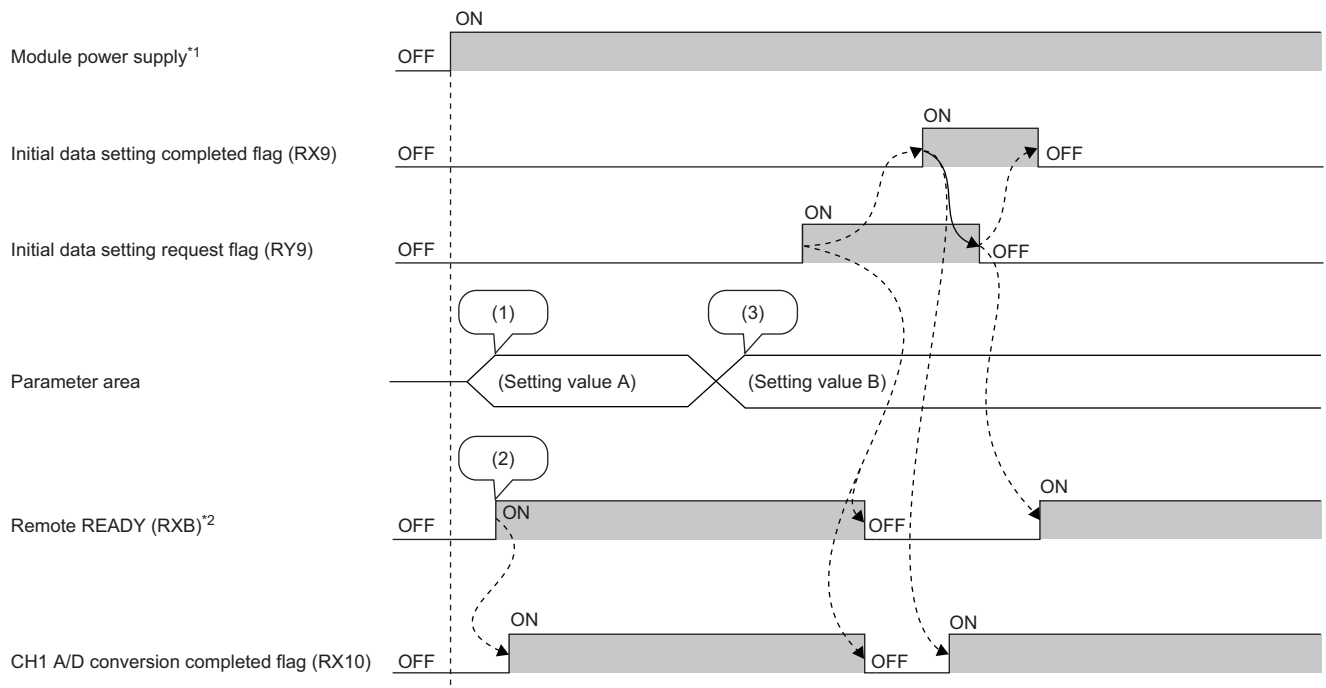

-----> Executed by the A/D converter module.

————> Executed by the program.

(1) Setting is read from the non-volatile memory.

(2) Operation is started with setting value A.

(3) The setting value is changed by the user.

*1 For data link to be made at the power-on of the module power supply

*2 When turning on and off Initial data setting request flag (RY9), check that Remote READY (RXB) turns on before starting the control.

Error flag

■ Device number

Signal name	Device number
Error flag	RXA

■ Description

Error flag (RXA) turns on when a moderate error or major error occurs.

To clear Latest error code (RWr0), turn on and off Error clear request flag (RYA).

- With a moderate error

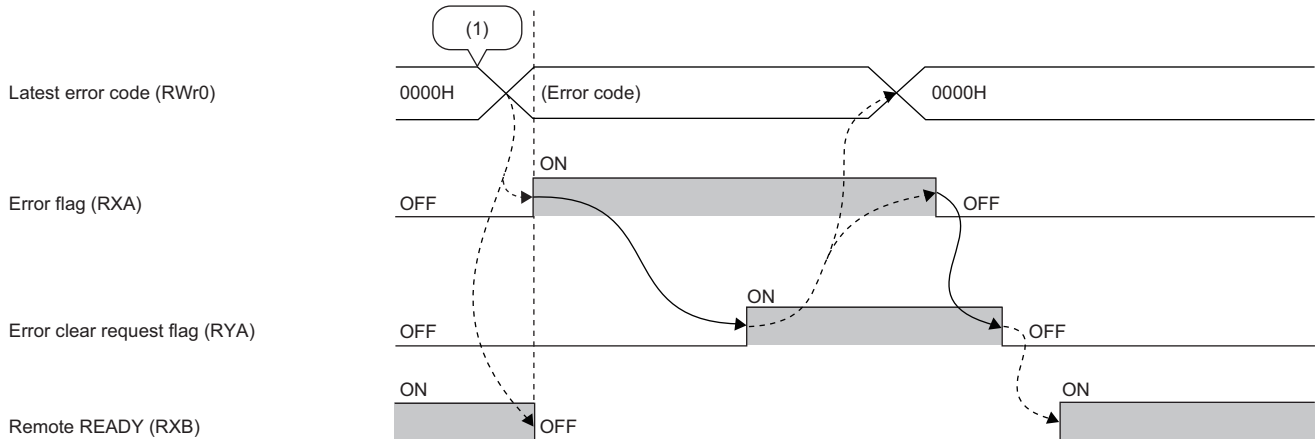

-----> Executed by the A/D converter module.

—————> Executed by the program.

(1) Error occurred.

- With a major error

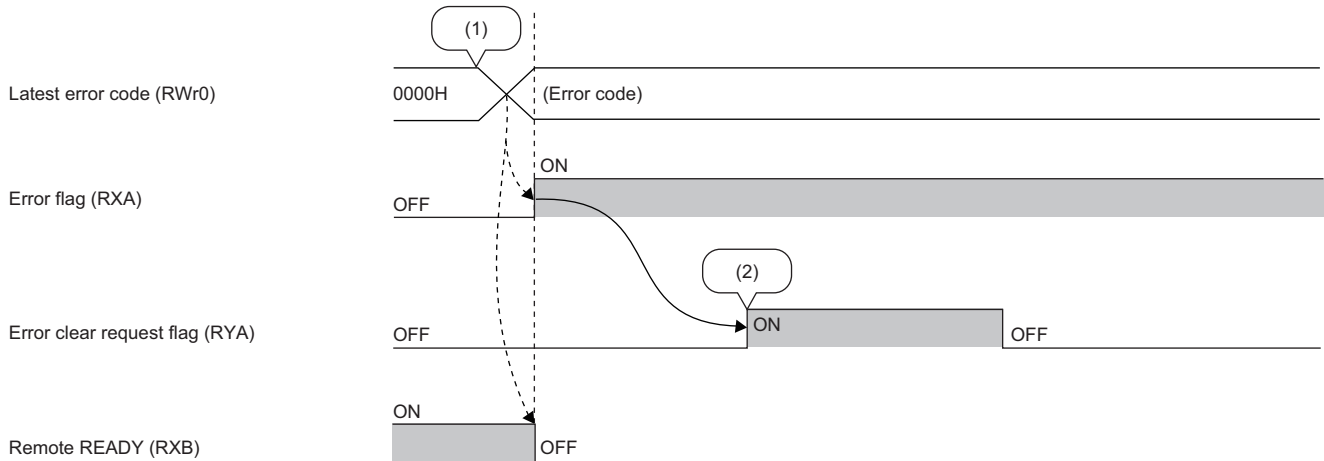

-----> Executed by the A/D converter module.

—————> Executed by the program.

(1) Error occurred.

(2) Major errors will not be cleared even if Error clear request is executed.

■ Error history

The error history is not cleared even if Error clear request flag (RYA) is turned on and off. To clear the error history, set "1" in Error history clear command (address: 1000H).

For the error history clear, refer to the following:

☞ Page 135 Error history clear command

Remote READY

■Device number

Signal name	Device number
Remote READY	RXB

■Description

Upon turning on the module power supply, Remote READY (RXB) turns on.

This signal is used as an interlock condition when the master station reads/writes data from/to the remote register or remote buffer memory areas of the A/D converter module.

As Error flag (RXA) turns on, Remote READY (RXB) turns off.

A/D conversion completed flag

■Device number

Signal name	Device number							
	CH1	CH2	CH3	CH4	CH5	CH6	CH7	CH8
CH□ A/D conversion completed flag	RX10	RX11	RX12	RX13	RX14	RX15	RX16	RX17

■Description

CH□ A/D conversion completed flag (RX10 to RX17) turns on as the A/D conversion is completed in the A/D conversion enabled channels.

Turning on and off Initial data setting request flag (RY9) makes the signal return to the default state (off). When A/D conversion is completed, the signal turns on.

Alert output signal

■Device number

Signal name	Device number
Alert output signal	RX18

■Description

Alert output signal (RX18) turns on at the detection of a process alarm.

■Process alarm

- The signal turns on when the digital operation value, in the channel where the alert output setting (process alarm) is active and A/D conversion is enabled, exceeds the range set in CH1 Process alarm lower limit value (address: 0112H) to CH8 Process alarm upper limit value (address: 0131H). In addition, the corresponding bit in Alert output flag (RW rB) turns to "1" and the ALM LED of the A/D converter module turns on.
- When the digital operation values for all the conversion-enabled channels are obtained within the setting range, the corresponding values and status become as follows.

Item	Status
Latest warning code (RW r1)	0000H
Bit position corresponding to the channel relevant to Alert output flag (RW rB)	OFF
Alert output signal (RX18)	OFF
ALM LED of the A/D converter module	Off

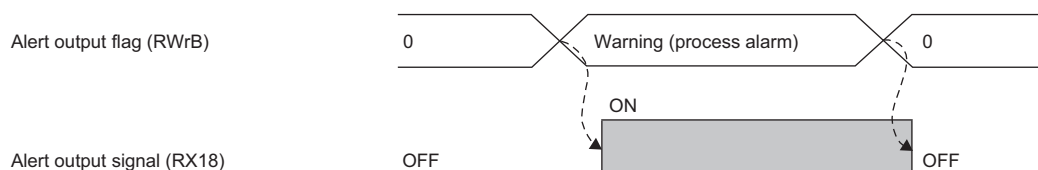

-----> Executed by the A/D converter module.

Input signal error detection signal

■Device number

Signal name	Device number
Input signal error detection signal	RX1C

■Description

Input signal error detection signal (RX1C) turns on at the detection of a disconnection in any of the A/D conversion enabled channels where Input signal error detection setting (CH1 to CH4) (address: 010FH) or Input signal error detection setting (CH5 to CH8) (address: 0110H) is set to Simple disconnection detection (4H). After the analog input value returns to a value that is larger than the criteria of simple disconnection detection (2mA or lower, or 0.5V or lower), turning on and off Error clear request flag (RYA) results in Input signal error detection signal (RX1C) turning off.

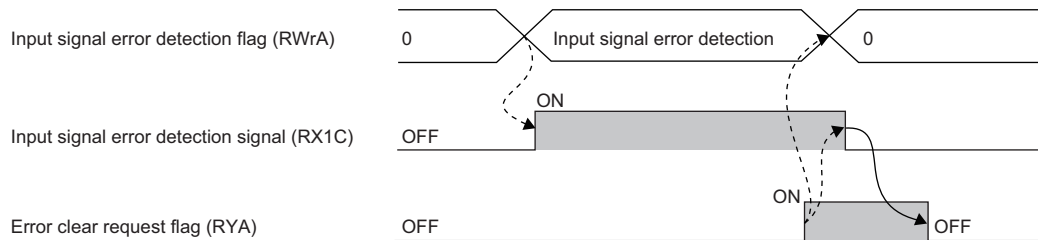

-----> Executed by the A/D converter module.

—————> Executed by the program.

Check that Input signal error detection signal (RX1C) is off before turning off Error clear request flag (RYA). Turning off Error clear request flag (RYA) before Input signal error detection signal (RX1C) turns off does not allow Input signal error detection signal (RX1C) to be cleared.

■When Input signal error detection signal turns on

- CH□ A/D conversion completed flag (RX10 to RX17) in the corresponding channels turns off.
- For the error-detected channel, the digital operation value immediately before the error detection is held in the buffer memory.
- The ALM LED flashes.

■When Input signal error detection signal turns off

- The ALM LED turns off.
- Latest warning code (RWr1) is cleared.

Point

Once the analog input value returns to a value enough to pass the simple disconnection detection criterion (2mA or lower, or 0.5V or lower), A/D conversion restarts whether or not Input signal error detection signal (RX1C) is reset. Completion of the first A/D conversion after the restart results in CH□ A/D conversion completed flag (RX10 to RX17) in the corresponding channel turning on again. Averaging processing starts over after the A/D conversion resumed.

Maximum value/minimum value reset completed flag

■Device number

Signal name	Device number
Maximum value/minimum value reset completed flag	RX1D

■Description

Maximum value/minimum value reset completed flag (RX1D) turns on when the maximum value stored in CH□ Maximum value (address: 0600H, 0602H, 0604H, 0606H, 0608H, 060AH, 060CH, 060EH) and the minimum value stored in CH□ Minimum value (address: 0601H, 0603H, 0605H, 0607H, 0609H, 060BH, 060DH, 060FH) are reset by turning on and off Maximum value/minimum value reset request (RY1D).

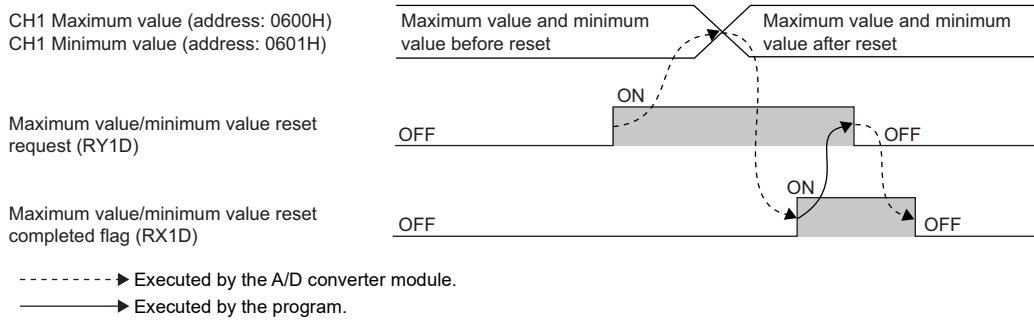

Difference conversion state flag

■Device number

Signal name	Device number							
	CH1	CH2	CH3	CH4	CH5	CH6	CH7	CH8
CH□ Difference conversion state flag	RX20	RX21	RX22	RX23	RX24	RX25	RX26	RX27

■Description

CH□ Difference conversion state flag (RX20 to RX27) allows the difference conversion status to be checked.

Difference conversion status	CH□ Difference conversion state flag (RX20 to RX27)
Not converted	OFF
Converting difference	ON

- Changing CH□ Difference conversion trigger (RY20 to RY27) from No request (OFF) → Trigger request (ON) results in CH□ Difference conversion state flag (RX20 to RX27) turning to Converting difference (ON).
- Changing CH□ Difference conversion trigger (RY20 to RY27) from Trigger request (ON) → No request (OFF) results in CH□ Difference conversion state flag (RX20 to RX27) turning from Converting difference (ON) → Not converted (OFF).

Remote output signals

Initial data setting request flag

■Device number

Signal name	Device number
Initial data setting request flag	RY9

■Description

Turn on Initial data setting request flag (RY9) after writing parameter data to the remote buffer memory with a program.

Upon completion of the change of operating conditions, Initial data setting completed flag (RX9) turns on.

For the timing of turning the flag on and off, refer to the following.

☞ Page 115 Initial data setting completed flag

Error clear request flag

■Device number

Signal name	Device number
Error clear request flag	RYA

■Description

Error clear request flag (RYA) is used for clearing Error flag (RXA), Input signal error detection signal (RX1C), and Latest error code (RWr0).

■When a moderate error or input signal error detection occurs

Eliminating the cause of the error and turning on Error clear request flag (RYA) allows the error status to be cleared, resulting in Error flag (RXA) turning off.

Before Error flag (RXA) turns off, turning off Error clear request flag (RYA) does not allow Error flag (RXA) to turn off.

For the timing of turning the flag on and off, refer to the following.

☞ Page 116 Error flag

☞ Page 118 Input signal error detection signal

■When a major error occurs

Error flag (RXA) does not turn off even by turning on and off Error clear request flag (RYA).

For the timing of turning the flag on and off, refer to the following.

☞ Page 116 Error flag

Maximum value/minimum value reset request

■Device number

Signal name	Device number
Maximum value/minimum value reset request	RY1D

■Description

Turning on and off Maximum value/minimum value reset request (RY1D) allows CH□ Maximum value (address: 0600H, 0602H, 0604H, 0606H, 0608H, 060AH, 060CH, 060EH) and CH□ Minimum value (address: 0601H, 0603H, 0605H, 0607H, 0609H, 060BH, 060DH, 060FH) to be cleared.

For the timing of when to turn on and off, refer to the following:

☞ Page 119 Maximum value/minimum value reset completed flag

Difference conversion trigger

■ Device number

Signal name	Device number							
	CH1	CH2	CH3	CH4	CH5	CH6	CH7	CH8
CH□ Difference conversion trigger	RY20	RY21	RY22	RY23	RY24	RY25	RY26	RY27

■ Description

CH□ Difference conversion trigger (RY20 to RY27) is used as a trigger to start and stop the difference conversion.

Difference conversion trigger	Setting value
No request	OFF
Trigger request	ON

■ Starting/Stopping the difference conversion

- Changing CH□ Difference conversion trigger (RY20 to RY27) from No request (OFF) to Trigger request (ON) initiates difference conversion.
- Changing CH□ Difference conversion trigger (RY20 to RY27) from Trigger request (ON) to No request (OFF) stops the difference conversion.

For details on the difference conversion function, refer to the following:

☞ Page 81 Difference Conversion Function

Appendix 2 Details of Remote Register

This section describes the details of the remote register areas for a master/local module.

The described assignment of device numbers assumes that the remote register areas of A/D converter modules are assigned as follows:

- RWr0 to RWr17
- RWw0 to RWw17

Latest error code

■Device number

Remote register name	Device number
Latest error code	RWr0

■Description

An error code is stored in Latest error code (RWr0) when a moderate error or major error occurs.

Turning on Error clear request flag (RYA) after eliminating the cause of the error clears the error code.

Errors that occurred in the past can be checked with Error history data □ (address: 0A00H to 0AEFH). For the error history, refer to the following:

☞ Page 134 Error history data

Latest warning code

■Device number

Remote register name	Device number
Latest warning code	RWr1

■Description

An error code is stored in Latest warning code (RWr1) when a minor error occurs. An alarm code is stored in Latest warning code (RWr1) when an alarm occurs.

After a minor error has occurred, eliminating the cause of the error and then waiting for five seconds results in Latest warning code (RWr1) being automatically cleared.

Eliminating the cause of the minor error occurred and waiting for five seconds result in the error code being automatically cleared.

For details on how to clear alarm codes, refer to the following:

☞ Page 108 List of Alarm Codes

Errors or alarms that occurred in the past can be checked with Error history data □ (address: 0A00H to 0AEFH). For the error history, refer to the following:

☞ Page 134 Error history data

Digital operation value

■Device number

The device number of this remote register area is as follows:

Remote register name	Device number							
	CH1	CH2	CH3	CH4	CH5	CH6	CH7	CH8
CH□ Digital operation value	RWr2	RWr3	RWr4	RWr5	RWr6	RWr7	RWr8	RWr9

■Description

The digital operation value which is obtained by the digital clipping function, scaling function, shift function, and difference conversion function is stored in CH□ Digital operation value (RWr2 to RWr9) as 16-bit signed binary data.

Input signal error detection flag

■Device number

Remote register name	Device number							
	CH1	CH2	CH3	CH4	CH5	CH6	CH7	CH8
Input signal error detection flag	RWrA							

■Description

Input signal status can be checked with Input signal error detection flag (RWrA) for each channel.

b15	b14	b13	b12	b11	b10	b9	b8	b7	b6	b5	b4	b3	b2	b1	b0
CH8	(1)	CH7	(1)	CH6	(1)	CH5	(1)	CH4	(1)	CH3	(1)	CH2	(1)	CH1	(1)
(2)		(2)		(2)		(2)		(2)		(2)		(2)		(2)	

(1) Not used (0)

(2) Lower limit flag (0: normal, 1: abnormal)

■The state of Input signal error detection flag (RWrA)

- When Input signal error detection setting (CH1 to CH4) (address: 010FH) and Input signal error detection setting (CH5 to CH8) (address: 0110H) are set to Simple disconnection detection (4H), disconnection in any of the channels where the simple disconnection detection is set is monitored. When the analog input value satisfies the disconnection detection condition (2mA or lower, or 0.5V or lower), the bit of the lower limit flag in the corresponding channel turns to Abnormal (1).
- When the input signal error detection function is used, an error detected in any of the channels where A/D conversion is set to be enabled results in Input signal error detection signal (RX1C) turning on.

■Clearing Input signal error detection flag (RWrA)

- After the analog input value returns to a value that is larger than the criteria of disconnection detection (2mA or lower or 0.5V or lower), turning on and off Error clear request flag (RYA) results in this flag being cleared.
- Turning on and off Initial data setting request flag (RY9) results in this flag being cleared.

Alert output flag

■Device number

Remote register name	Device number							
	CH1	CH2	CH3	CH4	CH5	CH6	CH7	CH8
Alert output flag	RWrB							

■Description

Whether the upper limit value or the lower limit value causes the alert can be checked for each channel with Alert output flag (RWrB).

b15	b14	b13	b12	b11	b10	b9	b8	b7	b6	b5	b4	b3	b2	b1	b0
CH8		CH7		CH6		CH5		CH4		CH3		CH2		CH1	
(2)	(1)	(2)	(1)	(2)	(1)	(2)	(1)	(2)	(1)	(2)	(1)	(2)	(1)	(2)	(1)

(1) Upper limit value (0: normal (default), 1: alarm ON)

(2) Lower limit value (0: normal (default), 1: alarm ON)

■The state of Alert output flag

- If the value is out of the range specified in CH1 Process alarm lower limit value (address: 0112H) to CH8 Process alarm upper limit value (address: 0131H), Alert output flag (RWrB) corresponding to each channel turns to Alarm ON (1).
- Of the A/D conversion enabled channels and the alert output enabled channels, an alert detected even in one channel results in Alert output signal (RX18) turning on.

■Clearing Alert output flag

- When the digital operation value returns within the setting range, Alert output flag (RWrB) is automatically cleared.
- Turning on and off Initial data setting request flag (RY9) results in this flag being cleared.

Difference conversion reference value

■Device number

The device number of this remote register area is as follows:

Remote register name	Device number							
	CH1	CH2	CH3	CH4	CH5	CH6	CH7	CH8
CH□ Difference conversion reference value	RWr10	RWr11	RWr12	RWr13	RWr14	RWr15	RWr16	RWr17

■Description

The digital operation value at the start of the difference conversion is stored in CH□ Difference conversion reference value (RWr10 to RWr17) as 16-bit signed binary data as the difference conversion reference value.

Point

- The difference conversion reference value is updated when CH□ Difference conversion trigger (RY20 to RY27) is turned from No request (OFF) to Trigger request (ON).
- Even if CH□ Difference conversion state flag (RX20 to RX27) is turned from Converting difference (ON) to Not converted (OFF), CH□ Difference conversion reference value (RWr10 to RWr17) is not cleared. For the difference conversion function, refer to the following:

 Page 81 Difference Conversion Function

Shifting amount to conversion value

■Device number

Remote register name	Device number							
	CH1	CH2	CH3	CH4	CH5	CH6	CH7	CH8
CH□ Shifting amount to conversion value	RWw2	RWw3	RWw4	RWw5	RWw6	RWw7	RWw8	RWw9

■Description

Set the conversion value shift amount that is to be used for the shift function in CH□ Shifting amount to conversion value (RWw2 to RWw9) as 16-bit signed binary data. The digital operation values after shift-and-add are stored to CH□ Digital operation value (RWr2 to RWr9).

For details on the shift function, refer to the following:

 Page 73 Shift Function

■Setting range

-32768 to 32767 (Default value: 0)

■Enabling the setting

Once a value is set, the conversion value shift amount is valid regardless of turning on and off Initial data setting request flag (RY9).

Appendix 3 Details of Remote Buffer Memory

This section describes the details of the remote buffer memory areas.

A/D conversion enable/disable setting

■Address

Remote buffer memory name	Address
A/D conversion enable/disable setting	0102H

■Description

Set whether to enable or disable A/D conversion in A/D conversion enable/disable setting (address: 0102H) for each channel.

b15	b14	b13	b12	b11	b10	b9	b8	b7	b6	b5	b4	b3	b2	b1	b0
Fixed to "0".								CH8	CH7	CH6	CH5	CH4	CH3	CH2	CH1
								0: A/D conversion enabled (default value) 1: A/D conversion disabled							

■Enabling the setting

Turn on and off Initial data setting request flag (RY9) to enable the setting.

Range setting

■Address

Remote buffer memory name	Address
Range setting (CH1 to CH4)	0103H
Range setting (CH5 to CH8)	0104H

■Description

Set input ranges to Range setting (CH1 to CH4) (address: 0103H) and Range setting (CH5 to CH8) (address: 0104H) for each channel.

Address	b15	b14	b13	b12	b11	b10	b9	b8	b7	b6	b5	b4	b3	b2	b1	b0
0103H	CH4				CH3				CH2				CH1			
0104H	CH8				CH7				CH6				CH5			

If A/D conversion enable/disable setting (address: 0102H) is set to A/D conversion disabled, the range is not changed. To change the range, set A/D conversion enable/disable setting (address: 0102H) to A/D conversion enabled and turn on and off Initial data setting request flag (RY9).

■Setting value

The following table lists the setting values.

Input range	Setting value	
	NZ2GFCE-60ADV8	NZ2GFCE-60ADI8
4 to 20mA	—	0H (Default value)
0 to 20mA	—	1H
1 to 5V	2H (Default value)	—
0 to 5V	3H	—
-10 to 10V	4H	—

Point

Setting data other than the above results in Range setting out-of-range (error code: 010□H) being stored in Latest error code (RW_r0), Error flag (RXA) turning on, and the ERR. LED lighting up. A channel where data other than the above is set operates in the same way as when the A/D conversion is disabled.

■Enabling the setting

Turn on and off Initial data setting request flag (RY9) to enable the setting.

Averaging process setting

■Address

Remote buffer memory name	Address
Averaging process setting (CH1 to CH4)	0105H
Averaging process setting (CH5 to CH8)	0106H

■Description

Set Averaging process setting (CH1 to CH4) (address: 0105H) and Averaging process setting (CH5 to CH8) (address: 0106H) to select a processing from sampling processing and averaging processing for each channel.

There are the following types of averaging processing: time average, count average, and moving average.

Address	b15	b14	b13	b12	b11	b10	b9	b8	b7	b6	b5	b4	b3	b2	b1	b0
0105H	CH4				CH3				CH2				CH1			
0106H	CH8				CH7				CH6				CH5			

■Setting value

The following table lists the setting values.

Processing method	Setting value
Sampling processing	0H (Default value)
Time average	1H
Count average	2H
Moving average	3H

■Enabling the setting

Turn on and off Initial data setting request flag (RY9) to enable the setting.



A channel to which a value out of the above range is written operates with the sampling processing.

A

Time average/Count average/Moving average

■Address

Remote buffer memory name	Address							
	CH1	CH2	CH3	CH4	CH5	CH6	CH7	CH8
CH□ Time average/Count average/Moving average	0107H	0108H	0109H	010AH	010BH	010CH	010DH	010EH

■Description

CH□ Time average/Count average/Moving average (address: 0107H to 010EH) is used for setting the time average, count average, or moving average for each channel where the averaging processing is specified.

The default value 0 is stored for all channels.

■Setting range

The following table lists the setting ranges.

Processing method	Setting value
Time average ^{*1}	4 to 5000(ms)
Count average ^{*2}	4 to 65000 (times)
Moving average ^{*2}	2 to 128 (times)

*1 For time average, set a value of (4 × Sampling period)ms or more. A value less than this criterion results in Time average setting out-of-range (error code: 020□H) being stored in Latest error code (RWr0), Error flag (RXA) turning on, and the ERR. LED lighting up. In CH□ Digital operation value (RWr2 to RWr9), 0 is stored.

*2 Setting data other than the above results in Count average setting out-of-range (error code 030□H) or Moving average setting out-of-range (error code: 031□H) being stored in Latest error code (RWr0), Error flag (RXA) turning on, and the ERR. LED lighting up. The A/D conversion processing is performed with the settings just before the error.

■Enabling the setting

Turn on and off Initial data setting request flag (RY9) to enable the setting.

Point

- By default, 0 is set and so change the value according to the processing method.
- For the channel where any value is set up, setting the sampling processing results in the set value being ignored.

Input signal error detection setting

■Address

Remote buffer memory name	Address
Input signal error detection setting (CH1 to CH4)	010FH
Input signal error detection setting (CH5 to CH8)	0110H

■Description

Set the condition for detecting an error of input signals to Input signal error detection setting (CH1 to CH4) (address: 010FH) and Input signal error detection setting (CH5 to CH8) (address: 0110H) for each channel.

Address	b15	b14	b13	b12	b11	b10	b9	b8	b7	b6	b5	b4	b3	b2	b1	b0
010FH	CH4				CH3				CH2				CH1			
0110H	CH8				CH7				CH6				CH5			

■Setting value

The following table lists the setting values.

Detection method for input signal error	Setting value
Disable	0H (Default value)
Simple disconnection detection	4H

■Enabling the setting

Turn on and off Initial data setting request flag (RY9) to enable the setting.



Simple disconnection detection (4H) is valid only when the input range is 1 to 5V or 4 to 20mA. Setting a channel with the other input ranges to Simple disconnection detection (4H) causes Simple disconnection detection setting error (error code: 082□H).

Alert output setting

■Address

Remote buffer memory name	Address
Alert output setting	0111H

■Description

Set whether to enable or disable the alert output of process alarm in Alert output setting (address 0111H) for each channel.

b15	b14	b13	b12	b11	b10	b9	b8	b7	b6	b5	b4	b3	b2	b1	b0
Fixed to "0".								CH8	CH7	CH6	CH5	CH4	CH3	CH2	CH1
0: Enable 1: Disable (Default value)															

■Enabling the setting

Turn on and off Initial data setting request flag (RY9) to enable the setting.

Process alarm

■Address

Remote buffer memory name	Address							
	CH1	CH2	CH3	CH4	CH5	CH6	CH7	CH8
CH□ Process alarm lower lower limit value	0112H	0116H	011AH	011EH	0122H	0126H	012AH	012EH
CH□ Process alarm lower upper limit value	0113H	0117H	011BH	011FH	0123H	0127H	012BH	012FH
CH□ Process alarm upper lower limit value	0114H	0118H	011CH	0120H	0124H	0128H	012CH	0130H
CH□ Process alarm upper upper limit value	0115H	0119H	011DH	0121H	0125H	0129H	012DH	0131H

■Description

- Set a lower lower limit value of alert output function (process alarm) to CH□ Process alarm lower lower limit value (address: 0112H, 0116H, 011AH, 011EH, 0122H, 0126H, 012AH, 012EH).
- Set a lower upper limit value of alert output function (process alarm) to CH□ Process alarm lower upper limit value (address: 0113H, 0117H, 011BH, 011FH, 0123H, 0127H, 012BH, 012FH).
- Set an upper lower limit value of alert output function (process alarm) to CH□ Process alarm upper lower limit value (address: 0114H, 0118H, 011CH, 0120H, 0124H, 0128H, 012CH, 0130H).
- Set an upper upper limit value of alert output function (process alarm) to CH□ Process alarm upper upper limit value (address: 0115H, 0119H, 011DH, 0121H, 0125H, 0129H, 012DH, 0131H).

For details on alert output function (process alarm), refer to the following:

 Page 67 Alert Output Function (Process Alarm)

■Setting range

-32768 to 32767 (Default value: 0)

■Enabling the setting

Turn on and off Initial data setting request flag (RY9) to enable the setting.

Point

- To use process alarms, set four items: process alarm upper upper limit value, process alarm upper lower limit value, process alarm lower upper limit value, and process alarm lower lower limit value.
- An error occurs in a channel with a set value out of the range above or a set value not meeting the following condition: Process alarm upper upper limit value \geq Process alarm upper lower limit value \geq Process alarm lower upper limit value \geq Process alarm lower lower limit value. An error results in Process alarm setting error (error code: 06△□H) being stored in Latest error code (RWr0), Error flag (RXA) turning on, and the ERR. LED lighting up, resulting in operation with the set value just before the error.
- By default, 0 is set and so change the set value.
- When any of scaling function, shift function, digital clipping function, and difference conversion function is used, alert targets are digital operation values that reflect the operations of each function. Set values considering operation results of each function.

Digital clipping enable/disable setting

■Address

Remote buffer memory name	Address							
	CH1	CH2	CH3	CH4	CH5	CH6	CH7	CH8
Digital clipping enable/disable setting	0132H							

■Description

Set whether to enable or disable the digital clipping function in Digital clipping enable/disable setting (address: 0132H) for each channel.

b15	b14	b13	b12	b11	b10	b9	b8	b7	b6	b5	b4	b3	b2	b1	b0
Fixed to "0".								CH8	CH7	CH6	CH5	CH4	CH3	CH2	CH1
								0: Enable 1: Disable (Default value)							

For details on the digital clipping function, refer to the following:

☞ Page 77 Digital Clipping Function

■Enabling the setting

Turn on and off Initial data setting request flag (RY9) to enable the setting.

Scaling enable/disable setting

■Address

Remote buffer memory name	Address							
	CH1	CH2	CH3	CH4	CH5	CH6	CH7	CH8
Scaling enable/disable setting	0133H							

■Description

Set whether to enable or disable scaling in Scaling enable/disable setting (address: 0133H) for each channel.

b15	b14	b13	b12	b11	b10	b9	b8	b7	b6	b5	b4	b3	b2	b1	b0
Fixed to "0".								CH8	CH7	CH6	CH5	CH4	CH3	CH2	CH1
								0: Enable 1: Disable (Default value)							

■Enabling the setting

Turn on and off Initial data setting request flag (RY9) to enable the setting.

Scaling

■Address

Remote buffer memory name	Address							
	CH1	CH2	CH3	CH4	CH5	CH6	CH7	CH8
CH□ Scaling lower limit value	0134H	0136H	0138H	013AH	013CH	013EH	0140H	0142H
CH□ Scaling upper limit value	0135H	0137H	0139H	013BH	013DH	013FH	0141H	0143H

■Description

- Set a lower limit value of the range for scale conversion in CH□ Scaling lower limit value (address: 0134H, 0136H, 0138H, 013AH, 013CH, 013EH, 0140H, 0142H).
- Set an upper limit value of the range for scale conversion in CH□ Scaling upper limit value (address: 0135H, 0137H, 0139H, 013BH, 013DH, 013FH, 0141H, 0143H).

For details on the scaling function, refer to the following:

 Page 70 Scaling Function

■Setting range

-32000 to 32000^{*1} (Default value: 0)

*1 Scaling upper limit value > Scaling lower limit value

■Enabling the setting

Turn on and off Initial data setting request flag (RY9) to enable the setting.

Point

- An error occurs in a channel with a set value out of the above range or a set value not meeting the following condition: Scaling upper limit value > Scaling lower limit value. Scaling setting out-of-range (error code: 090□H) or Scaling upper/lower limit value inverted (error code: 091□H) is stored in Latest error code (RWr0), Error flag (RXA) turning on, and the ERR. LED lighting up, resulting in operation with a set value just before the error.
- With Scaling enable/disable setting (address: 0133H) set to Disabled (1), the settings of CH□ Scaling lower limit value (address: 0134H, 0136H, 0138H, 013AH, 013CH, 013EH, 0140H, 0142H) and CH□ Scaling upper limit value (address: 0135H, 0137H, 0139H, 013BH, 013DH, 013FH, 0141H, 0143H) are ignored.

Maximum value/minimum value

■Address

Remote buffer memory name	Address							
	CH1	CH2	CH3	CH4	CH5	CH6	CH7	CH8
CH□ Maximum value	0600H	0602H	0604H	0606H	0608H	060AH	060CH	060EH
CH□ Minimum value	0601H	0603H	0605H	0607H	0609H	060BH	060DH	060FH

■Description

- The maximum value of converted digital operation value is stored in CH□ Maximum value (address: 0600H, 0602H, 0604H, 0606H, 0608H, 060AH, 060CH, 060EH) as 16-bit signed binary data.
- The minimum value of converted digital operation value is stored in CH□ Minimum value (address: 0601H, 0603H, 0605H, 0607H, 0609H, 060BH, 060DH, 060FH) as 16-bit signed binary data.

The following operations update CH□ Maximum value (address: 0600H, 0602H, 0604H, 0606H, 0608H, 060AH, 060CH, 060EH) and CH□ Minimum value (address: 0601H, 0603H, 0605H, 0607H, 0609H, 060BH, 060DH, 060FH) to current values:

- Initial data setting request flag (RY9) is turned on and off and the setting is changed.
- Maximum value/minimum value reset request (RY1D) is turned on and off.

Point

- If averaging processing is specified, the maximum value is updated per averaging process cycle. Otherwise it is updated per sampling period.
- When using the scaling function, shift function, digital clipping function, and difference conversion function, values computed by each function are stored in the maximum value.

Range setting monitor

■Address

Remote buffer memory name	Address
Range setting monitor (CH1 to CH4)	0610H
Range setting monitor (CH5 to CH8)	0611H

■Description

Range setting monitor (CH1 to CH4) (address: 0610H) and Range setting monitor (CH5 to CH8) (address: 0611H) are used to check the input range values that have been set.

Address	b15	b14	b13	b12	b11	b10	b9	b8	b7	b6	b5	b4	b3	b2	b1	b0
0610H	CH4				CH3				CH2				CH1			
0611H	CH8				CH7				CH6				CH5			

Point

If A/D conversion enable/disable setting (address: 0102H) is set to A/D conversion disabled, the range is not changed. Thus, values in Range setting monitor (CH1 to CH4) (address: 0610H) and Range setting monitor (CH5 to CH8) (address: 0611H) are not updated.

■Monitored value

The following table lists the monitored values.

A/D converter module	Monitored value	Description
NZZGFCE-60ADI8	0H (Default value)	4 to 20mA
	1H	0 to 20mA
NZZGFCE-60ADV8	2H (Default value)	1 to 5V
	3H	0 to 5V
	4H	-10 to 10V

Error history data

■Address

The remote buffer memory address of this area is as follows:

Remote buffer memory name	Address
Error history data□	0A00H to 0AEFH

■Description

Up to 15 errors occurred in the module are recorded in Error history data □ (address: 0A00H to 0AEFH).

■Error history data 1 (address: 0A00H to 0A0FH)

The following table shows the storage contents for Error history data 1 (address: 0A00H to 0A0FH).

Address	b15	b14	b13	b12	b11	b10	b9	b8	b7	b6	b5	b4	b3	b2	b1	b0
0A00H	Error code															
0A01H	Order of generation															
0A02H	First two digits of the year								Last two digits of the year							
0A03H	Month								Day							
0A04H	Hour								Minute							
0A05H	Second								00H (Fixed)							
0A06H	CH1 Digital operation value															
⋮	⋮															
0A0DH	CH8 Digital operation value															
0A0EH	System area															
0A0FH																

Point

Error history data 2 to Error history data 15 (address: 0A10H to 0AEFH) store data in the same format as Error history data 1 (address: 0A00H to 0A0FH).

For the error code, refer to the following:

☞ Page 104 Error Code List

Ex.

The following table shows the storage contents and their examples of the error history data items.

Item	Storage contents	Storage example ^{*1}
Error code	The error code of the error that occurred is stored.	—
Order of generation	The order of error occurrence is stored. (A value between 0H and FFFFH is stored.)	0001H
First two digits of the year/Last two digits of the year ^{*2}	The items on the left are stored in BCD code.	2012H
Month/Day ^{*2}		0901H
Hour/Minute ^{*2}		1330H
Second/00H (Fixed) ^{*2}		5000H
CH1 Digital operation value ⋮ CH8 Digital operation value	Stores the value in CH□ Digital operation value (RWr2 to RWr9) at the time of occurrence of an error.	—

*1 This example assumes that a second error has occurred at 13:30:50 on September 1, 2012.

*2 The clock information of the error that occurred is based on the clock information acquired from the CPU module of the master station.
When an error has occurred before the clock information is acquired from the CPU module, the error time is not recorded.

■Storage order of the error history

The latest error is stored in Error history data 1 (address: 0A00H to 0A0FH).

Errors that occurred in the past are stored in Error history data 2 to Error history data 15 (address: 0A10H to 0AEFH) in reverse chronological order.

If 16 or more errors occur, errors are deleted from the oldest.

Error history clear command

■Address

Remote buffer memory name	Address
Error history clear command	1000H

■Description

Error history clear command (address: 1000H) is used to clear the error history stored in the non-volatile memory.

b15	b14	b13	b12	b11	b10	b9	b8	b7	b6	b5	b4	b3	b2	b1	b0
Fixed to "0".															(1)

(1) 0: Not commanded (Default value), 1: Commanded

■Behavior of error history clear

Setting Error history clear command (address: 1000H) to Commanded (1) allows the error history to be cleared.

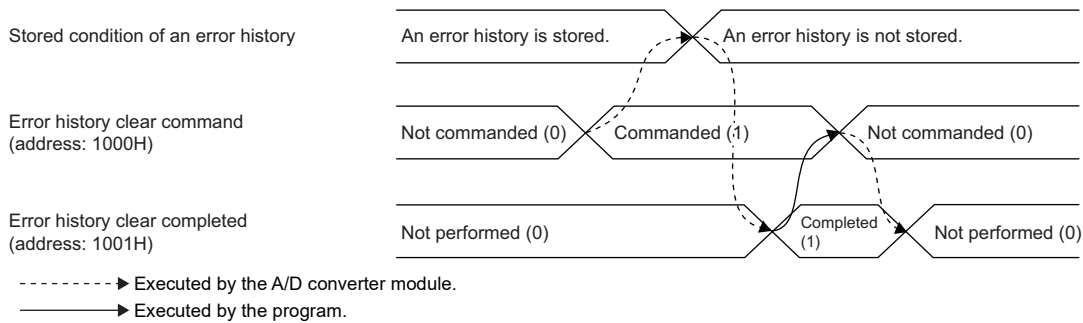

Error history clear completed

■Address

Remote buffer memory name	Address
Error history clear completed	1001H

■Description

Error history clear completed (address: 1001H) shows the error history clear completed status stored in the non-volatile memory.

b15	b14	b13	b12	b11	b10	b9	b8	b7	b6	b5	b4	b3	b2	b1	b0
Fixed to "0".															(1)

(1) 0: Not performed (Default value), 1: Completed

■Behavior of error history clear

Upon completion of the error history clear, Error history clear completed (address: 1001H) turns to Completed (1).

For the timing "Not performed (0)→Completed (1)→Not performed (0)", refer to the following:

☞ Page 135 Error history clear command

Parameter area initialization command

■Address

Remote buffer memory name	Address
Parameter area initialization command	1002H

■Description

Parameter area initialization command (address: 1002H) is used to set parameters in remote buffer memory areas and non-volatile memory to a default value.

In the event of Non-volatile memory data error (parameter) (error code: 0130H), using this command makes it possible to recover the module.

b15	b14	b13	b12	b11	b10	b9	b8	b7	b6	b5	b4	b3	b2	b1	b0
Fixed to "0".															(1)

(1) 0: Not commanded (Default value), 1: Commanded

■Behavior of parameter area initialization

Setting Parameter area initialization command (address: 1002H) to Commanded (1) sets the parameters in the non-volatile memory back to default values.

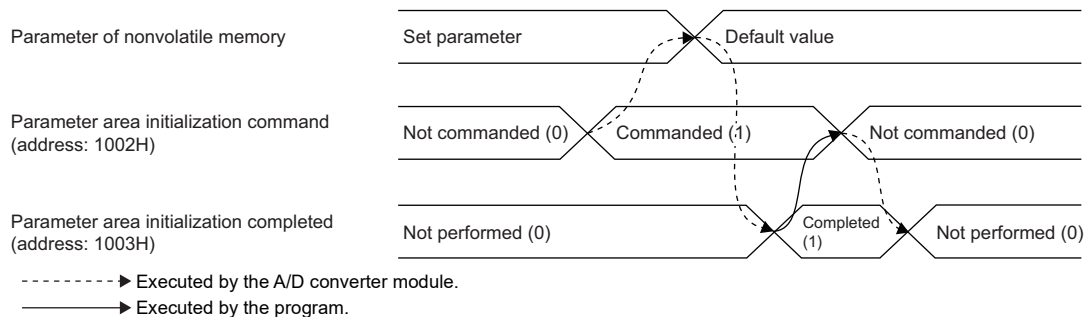

Point

An execution of Parameter area initialization command (address: 1002H) does not clear the following remote input signals and remote register:

- Warning flag (RX7)
- Error flag (RXA)
- Alert output signal (RX18)
- Input signal error detection signal (RX1C)

In addition, Remote READY (RXB) does not turn on.

After the execution of Parameter area initialization command (address: 1002H), turning off and on the module power supply enables the module to operate normally.

Parameter area initialization completed

■Address

Remote buffer memory name	Address
Parameter area initialization completed	1003H

■Description

Parameter area initialization completed (address 1003H) shows whether the parameters stored in the non-volatile memory is initialized or not.

b15	b14	b13	b12	b11	b10	b9	b8	b7	b6	b5	b4	b3	b2	b1	b0
Fixed to "0".															(1)

(1) 0: Not performed (Default value), 1: Completed

■Behavior of parameter area initialization

Upon the completion of setting the parameters stored in the non-volatile memory back to their default values, Parameter area initialization completed (address: 1003H) turns to Completed (1). For the timing "Not performed (0)→Completed (1)→Not performed (0)", refer to the following:

☞ Page 136 Parameter area initialization command

Appendix 4 I/O Conversion Characteristics of A/D Conversion

The I/O conversion characteristics of A/D conversion are expressed by the slope of the straight line connecting the offset value and the gain value, both of which are used when an analog signal from outside the programmable controller (voltage or current) is converted to the corresponding digital output value.

Offset value

The analog input value (voltage or current) corresponding to the digital output value 0

Gain value

The analog input value (voltage or current) corresponding to the digital output value 16000

Voltage input characteristics

The following graph shows the voltage input characteristics.

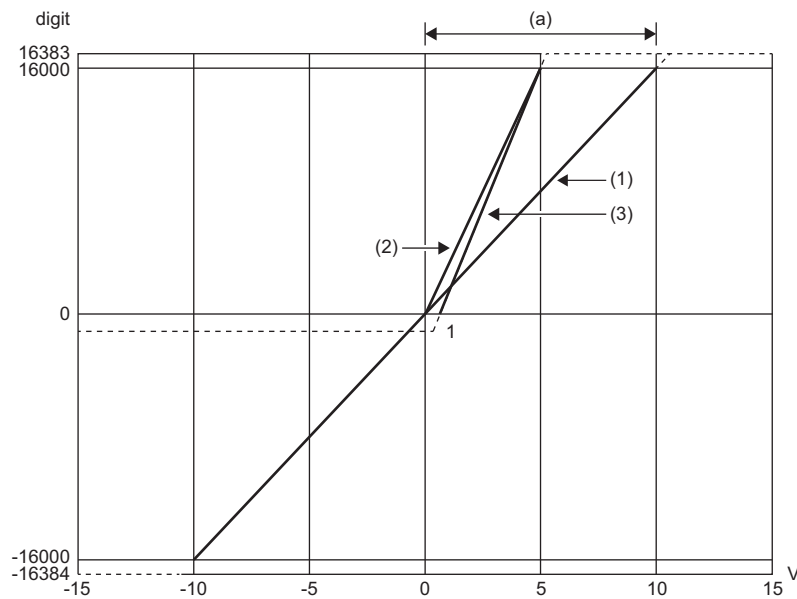

digit: Digital output value
V: Analog input voltage (V)
(a) Practical analog input range

No.	Input range setting	Offset value	Gain value	Digital output value ^{*1}	Maximum resolution
(1)	-10 to 10V	0V	10V	-16000 to 16000	0.625mV
(2)	0 to 5V	0V	5V	0 to 16000	0.3125mV
(3)	1 to 5V	1V	5V	0 to 16000	0.25mV

*1 When the analog input value exceeds the range of digital output values, the digital output value is fixed to the maximum or minimum value.

Input range setting	Digital output value	
	Minimum	Maximum
-10 to 10V	-16384	16383
0 to 5V	-384	
1 to 5V		

Point

- Use the value within the practical analog input range and practical digital output range. If a value is out of the range, the maximum resolution and accuracy may not fall within the range of performance specifications. (Do not use the value in the dotted line region in the graph of voltage input characteristics.)
- Do not set the voltage over $\pm 15V$. Doing so can cause breakdown of the elements.

Current input characteristics

The following graph shows the current input characteristics.

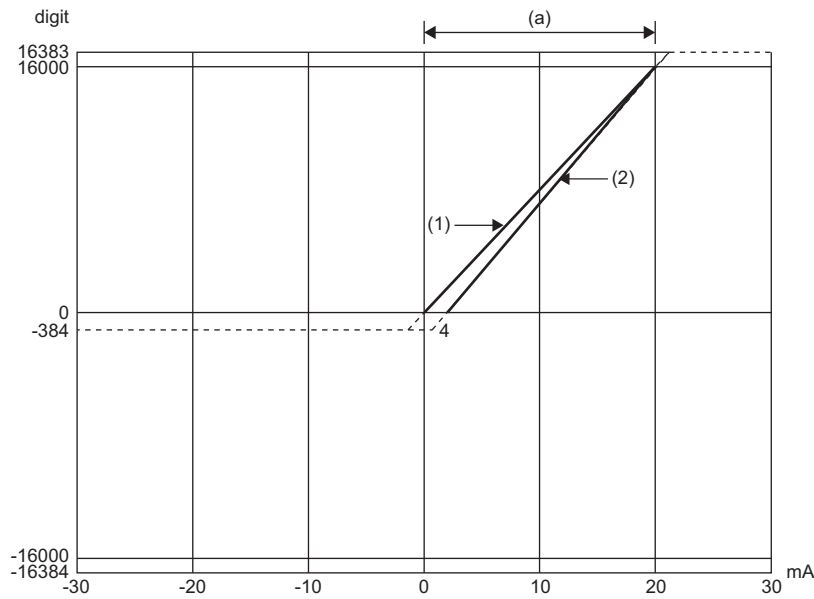

digit: Digital output value
 mA: Analog input current (mA)
 (a) Practical analog input range

No.	Input range setting	Offset value	Gain value	Digital output value ^{*1}	Maximum resolution
(1)	0 to 20mA	0mA	20mA	0 to 16000	1.25 μ A
(2)	4 to 20mA	4mA	20mA		1 μ A

*1 When the analog input value exceeds the range of digital output values, the digital output value is fixed to the maximum or minimum value.

Input range setting	Digital output value	
	Minimum	Maximum
0 to 20mA	-384	16383
4 to 20mA		

Point

- Use the value within the practical analog input range and practical digital output range. If a value is out of the range, the maximum resolution and accuracy may not fall within the range of performance specifications. (Do not use the value in the dotted line region in the graph of current input characteristics.)
- Do not set the current over ± 30 mA. Doing so can cause breakdown of the elements.

A

Appendix 5 Accuracy of A/D Conversion

Accuracy of A/D conversion is the accuracy of the maximum value of digital output value.

An input characteristic change by changing the input range does not sacrifice the accuracy, which is maintained within the described range of the performance specifications.

The following figure shows the fluctuation range of accuracy with the range of -10 to 10V selected.

The accuracy of digital value output is $\pm 0.2\%$ (± 32 digit) at an ambient temperature of $25 \pm 5^\circ\text{C}$; $\pm 0.3\%$ (± 48 digit) at an ambient temperature of 0 to 55°C (except for the conditions under noise influence).

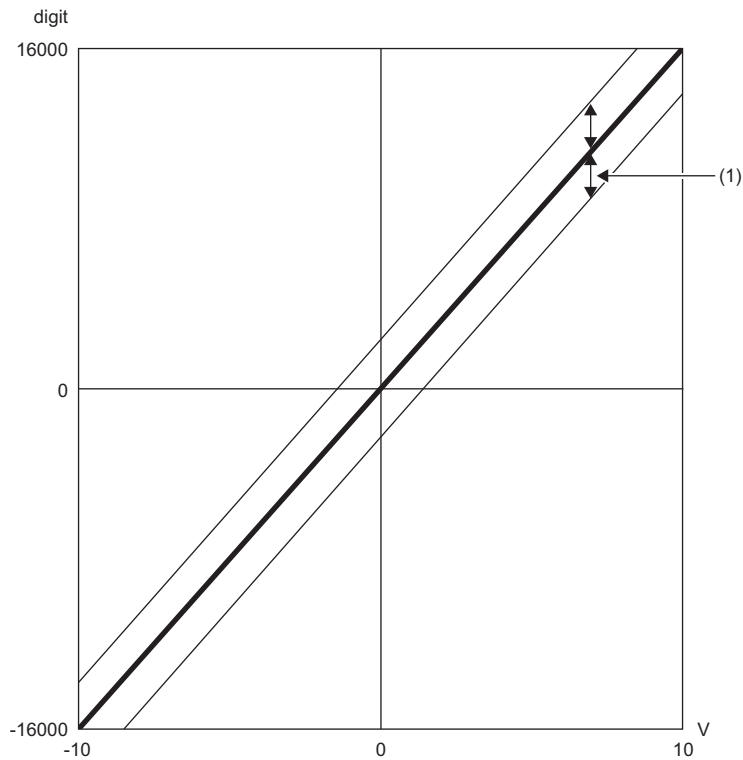

digit: Digital output value
V: Analog input value (V)
(1) Fluctuation range

Appendix 6 Processing Time of CC-Link IE Field Network

The processing time of CC-Link IE Field Network is the time taken for the A/D converter module to take in analog input values and store the data into devices of the CPU module at the master station.

The processing time of CC-Link IE Field Network depends on the following processing time:

- Sequence scan time of the master station
- Link scan time
- Processing time of the remote device station: Sampling period

For details on the processing time of CC-Link IE Field Network, refer to the following:

 User's manual for the master/local module used

Appendix 7 EMC and Low Voltage Directives

In each country, laws and regulations concerning electromagnetic compatibility (EMC) and electrical safety are enacted. For the products sold in the European countries, compliance with the EU's EMC Directive has been a legal obligation as EMC regulation since 1996, as well as the EU's Low Voltage Directive as electrical safety regulation since 1997.

Manufacturers who recognize their products are compliant with the EMC and Low Voltage Directives are required to attach a "CE marking" on their products in European countries.

In some other countries and regions, manufacturers are required to make their products compliant with applicable laws or regulations and attach a certification mark on the products as well (such as UK Conformity Assessed (UKCA) marking in the UK, and Korea Certification (KC) marking in South Korea).

Each country works to make their regulatory requirements consistent across countries based on international standards.

When the requirements are consistent, measures to comply with the EMC and electrical safety regulations become common across countries.

The UK and South Korea have enacted EMC regulations whose requirements are consistent with those of the EMC Directive. The UK has also enacted electrical safety regulations whose requirements are consistent with those of the Low Voltage Directive. In this section, the requirements of the EMC and Low Voltage Directives are described as examples of those of the EMC and electrical safety regulations.

Measures to comply with the EMC Directive

The EMC Directive sets requirements for emission (conducted and radiated electromagnetic interference emitted by a product) and immunity (the ability of a product not to be influenced by externally generated electromagnetic interference).

This section describes the precautions for machinery constructed with modules to comply with the EMC Directive.

These precautions are based on the requirements of the EMC Directive and the harmonized standards. However, they do not guarantee that the entire machinery constructed according to the descriptions complies with the EMC Directive.

The manufacturer of the machinery must determine the testing method for compliance and declare conformity to the EMC Directive.

EMC Directive related standards

■ Emission requirements

Standard	Test item	Test details	Standard value
EN61131-2: 2007	CISPR16-2-3 Radiated emission* ²	Radio waves from the product are measured.	<ul style="list-style-type: none">• 30M to 230MHz QP: 40dBμV/m (measured over 10m)^{*1}• 230M to 1000MHz QP: 47dBμV/m (measured over 10m)
	CISPR16-2-1, CISPR16-1-2 Conducted emission* ²	Noise from the product to the power line is measured.	<ul style="list-style-type: none">• 150k to 500kHz QP: 79dB, Mean: 66dB^{*1}• 500k to 30MHz QP: 73dB, Mean: 60dB

*1 QP (Quasi-Peak): quasi-peak value, Mean: mean value

*2 The module is an open type device (a device designed to be housed in other equipment) and must be installed inside a conductive control panel. The tests were conducted with the module installed in a control panel.

■Immunity requirements

Standard	Test item	Test details	Standard value
EN61131-2: 2007	EN61000-4-2 Electrostatic discharge immunity ^{*1}	Immunity test in which electrostatic is applied to the cabinet of the equipment.	<ul style="list-style-type: none"> • 8kV air discharge • 4kV contact discharge
	EN61000-4-3 Radiated, radio-frequency, electromagnetic field immunity ^{*1}	Immunity test in which electric fields are irradiated to the product.	<ul style="list-style-type: none"> • 80% AM modulation@1kHz • 80M to 1000MHz: 10V/m • 1.4G to 2.0GHz: 3V/m • 2.0G to 2.7GHz: 1V/m
	EN61000-4-4 Electrical first transient/burst immunity ^{*1}	Immunity test in which burst noise is applied to the power line and signal line.	<ul style="list-style-type: none"> • AC/DC main power supply, I/O power supply, AC I/O (unshielded): 2kV • DC I/O, analog, communication cable: 1kV
	EN61000-4-5 Surge immunity ^{*1}	Immunity test in which lightning surge is applied to the power line and signal line.	<ul style="list-style-type: none"> • AC power line, AC I/O power supply, AC I/O (unshielded): 2kV CM, 1kV DM • DC power line, DC I/O power supply: 0.5kV CM, DM • DC I/O, AC I/O (shielded), analog^{*2}, communication: 1kV CM
	EN61000-4-6 Conducted RF immunity ^{*1}	Immunity test in which high frequency noise is applied to the power line and signal line	0.15M to 80MHz, 80% AM modulation @1kHz, 10Vrms
	EN61000-4-8 Power-frequency magnetic field immunity ^{*1}	Immunity test in which the product is installed in inductive magnetic field	50Hz/60Hz, 30A/m
	EN61000-4-11 Voltage dips and interruption immunity ^{*1}	Immunity test in which power supply voltage is momentarily interrupted	<ul style="list-style-type: none"> • Apply at 0%, 0.5 cycles and zero-cross point • 0%, 250/300 cycles (50/60Hz) • 40%, 10/12 cycles (50/60Hz) • 70%, 25/30 cycles (50/60Hz)

*1 The module is an open type device (a device designed to be housed in other equipment) and must be installed inside a conductive control panel. The tests were conducted with the module installed in a control panel.

*2 The accuracy of an A/D converter module can indicate momentary fluctuation within $\pm 10\%$.

Installation in a control panel

The module is an open type device and must be installed inside a control panel.

This ensures safety as well as effective shielding of module-generated electromagnetic noise.

■Control panel

- Use a conductive control panel.
- When securing the top or bottom plate using bolts, cover the grounding part on the control panel so that the part will not be painted.
- To ensure electrical contact between the inner plate and control panel, take measures such as covering the bolts so that conductivity can be ensured in the largest possible area.
- Ground the control panel with a thick ground cable so that low impedance can be ensured even at high frequencies.
- Holes in the control panel must be 10cm diameter or less. If the holes are larger than 10cm, radio wave may be emitted. In addition, because radio waves leak through a clearance between the control panel and its door, reduce the clearance as much as possible. The leakage of radio waves can be suppressed by the direct application of an EMI gasket on the paint surface.

Our tests have been carried out on a control panel having the damping characteristics of 37dB (max.) and 30dB (mean) (measured by 3m method, 30 to 300MHz).

■Wiring of power cables and ground cables

Near the power supply part, provide a grounding point to the control panel. Ground the FG terminal with the thickest and shortest possible ground cable (30cm or shorter).

Cables

Use shielded cables for the cables which are connected to the module and run out from the control panel. If a shielded cable is not used or not grounded correctly, the noise immunity will not meet the specified value.

■Cables for the CC-Link IE Field Network

Shielded cables should be used for the CC-Link IE Field Network. Strip a part of the jacket as shown below and ground the exposed shield in the largest possible area.

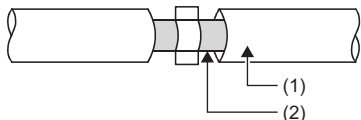

- (1) CC-Link IE Field Network cable
- (2) Shield

■Grounding the cable clamp

Use shielded cables for external wiring and ground the shields of the external wiring cables to the control panel with the AD75CK cable clamp (manufactured by Mitsubishi Electric Corporation). (Ground the shield section 20 to 30cm away from the module.)

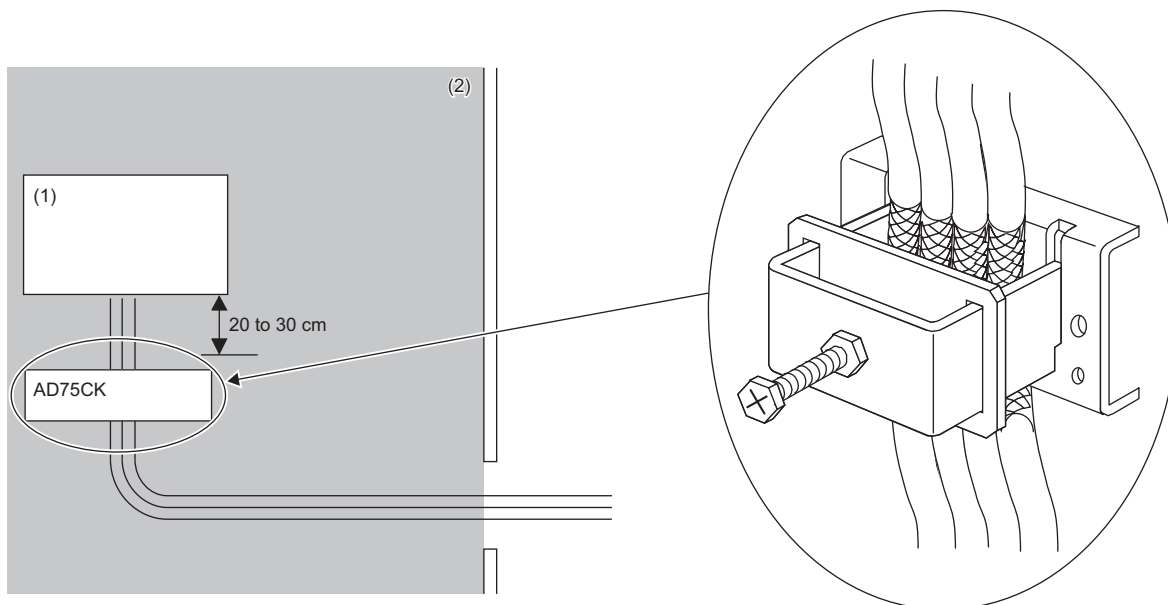

- (1) Module
- (2) Inside a control panel

For details on the AD75CK, refer to the following:

📖 AD75CK-type Cable Clamping Instruction Manual

■Analog I/O signal line

Use a signal line of 30m or shorter when connecting it to the analog I/O terminals of the module.

External power supply

- Use a CE-marked product for an external power supply and always ground the FG terminal. (External power supply used for the tests conducted by Mitsubishi Electric Corporation: TDK-Lambda DLP-120-24-1, IDEC PS5R-SF24, PS5R-F24)
- Use a power cable of 10m or shorter when connecting it to the module power supply terminal.

Others

■ Ferrite core

A ferrite core has the effect of reducing radiation noise in the 30MHz to 100MHz band.

It is recommended to attach ferrite cores if shielded cables coming out of the control panel do not provide sufficient shielding effects.

Note that the ferrite cores must be attached at the position closest to the cable hole inside the control panel. If attached at an improper position, the ferrite core will not produce any effect.

For the FG terminal on an A/D converter module that is connected to the external power supply and CC-Link IE Field Network cables, attach a ferrite core 4cm away from the module.

(Ferrite core used for the tests conducted by Mitsubishi Electric Corporation: NEC TOKIN ESD-SR-250, TDK ZCAT3035-1330)

Ex.

Attachment

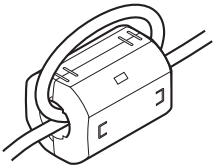

■ Noise filter (power supply line filter)

A noise filter is a component which has an effect on conducted noise. Attaching the filter can suppress more noise. (The noise filter has the effect of reducing conducted noise of 10MHz or less.)

Connect a noise filter to the external power supply of an A/D converter module. Use a noise filter with the damping characteristics equivalent to those of MA1206 (manufactured by TDK-Lambda Corporation). Note that a noise filter is not required if the module is used in Zone A defined in EN61131-2.

The precautions for attaching a noise filter are described below.

- Do not bundle the cables on the input side and output side of the noise filter. If bundled, the output side noise will be induced into the input side cables from which the noise was filtered.

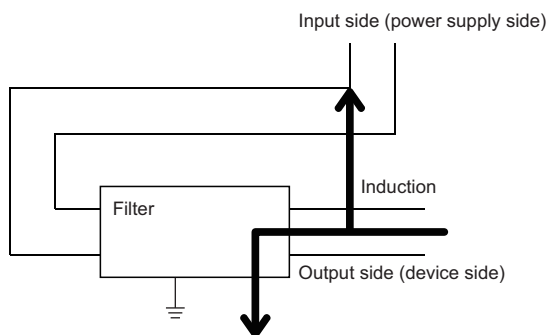

- Example of failure
Bundle of input and output wires all together induces noise.

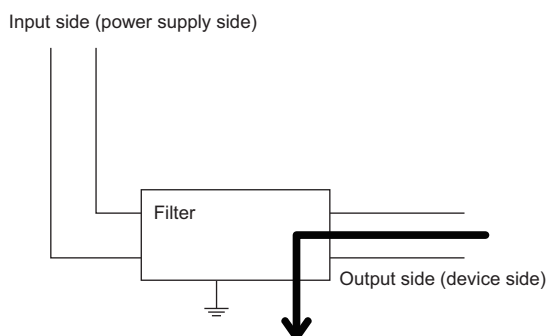

- Example of countermeasure
Route the input and output wires separated from each other.

- Ground the noise filter grounding terminal to the control panel with the shortest cable possible (approx. 10cm).

A

Requirements to compliance with the Low Voltage Directive

The module operates at the rated voltage of 24VDC.

The Low Voltage Directive is not applied to the modules that operate at the rated voltage of less than 50VAC and 75VDC.

Appendix 8 How to Check Serial Number and Function Version

The serial number and the function version of the A/D converter module can be checked on the rating plate. The serial number can also be checked on the production information in CC-Link IE Field Network diagnostics.

Checking on the rating plate

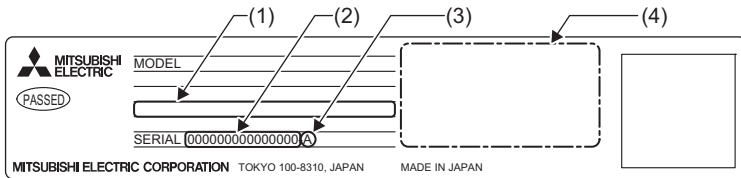

- (1) MAC address
- (2) Serial number
- (3) Function version
- (4) Compliant standard symbol

Checking on CC-Link IE Field Network diagnostics

1. Connect GX Works2 to the CPU module.
2. Start CC-Link IE Field Network diagnostics from the menu of GX Works2.
- 🔗 [Diagnostics] ⇄ [CC IE Field Diagnostics]
3. Right-click the slave station and then select "Production Information" to display the production information.

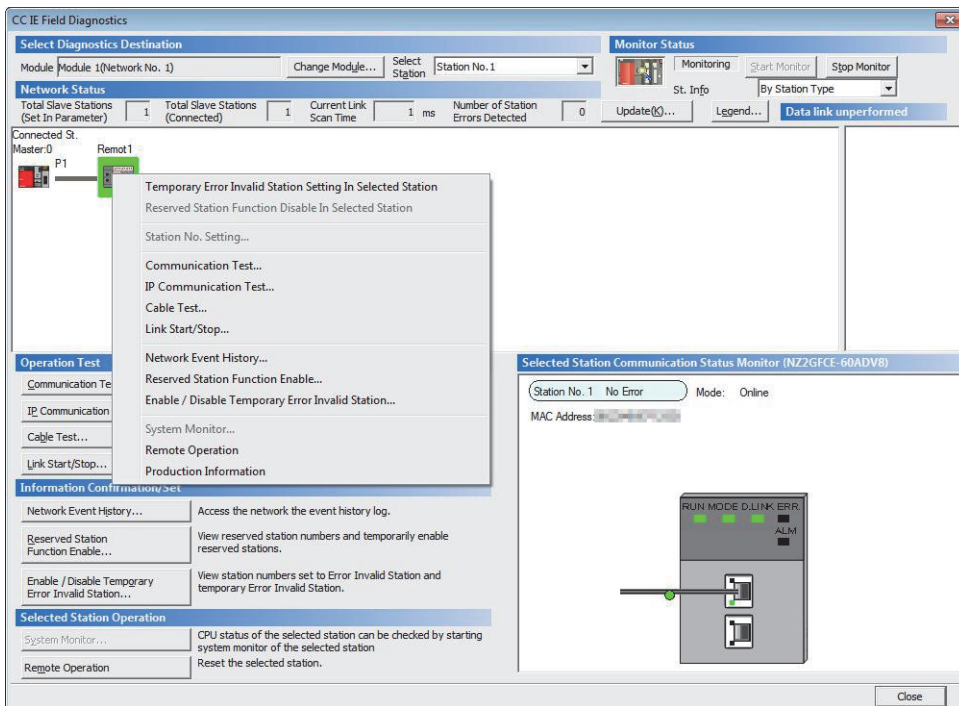

4. The production information is displayed. The production information shows the serial number marked on the rating plate.

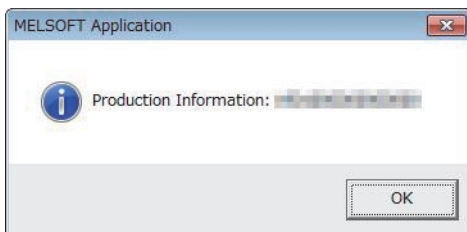

Appendix 9 External Dimensions

External dimensions of the A/D converter module is as follows.

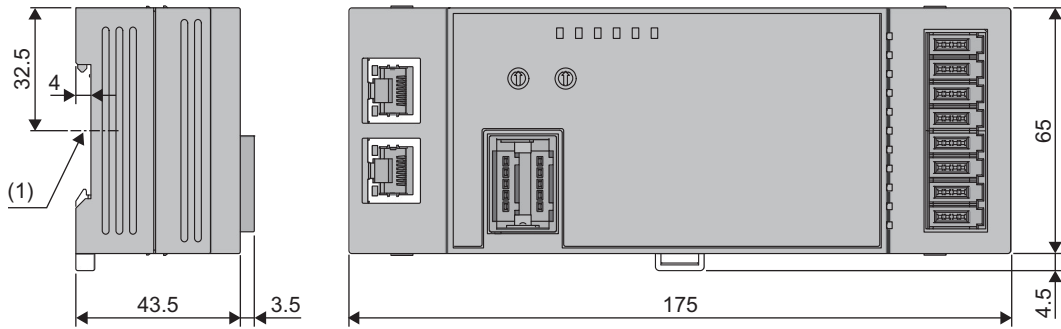

(Unit: mm)

(1) Center of DIN rail

MEMO

A

INDEX

A

A/D conversion completed flag	117
A/D conversion enable/disable function	58
A/D conversion enable/disable setting	125
A/D conversion method	58
Accuracy of A/D conversion	140
Alert output flag	123
Alert output function (process alarm)	67
Alert output setting	129
Alert output signal	117
ALM LED	11
Applicable DIN rail model (compliant with IEC 60715)	34
Applicable systems	28
Averaging process setting	127
Averaging processing	58

B

Bending radius of an Ethernet cable	40
---	----

C

CC-Link IE Field Network diagnostic function	88
Checking by executing a command of the slave station	101
Checking by Latest error code (RWr0)	103
Checking by Latest warning code (RWr1)	103
Checking the LEDs	108
Compatible plugs	35
Connecting a connector for module power supply and FG	35
Connecting an Ethernet cable	39
Connector for module power supply and FG	11
Count average	59
Current input characteristics	139

D

D LINK LED	11
Details of remote I/O signals	114
Details of remote register	122
Difference conversion function	81
Difference conversion reference value	124
Difference conversion state flag	119
Difference conversion trigger	121
Digital clipping enable/disable setting	131
Digital clipping function	77
Digital operation value	57,122
DIN rail hook	11
DIN rail stopper	34

E

e-CON	11
ERR. LED	11
Error clear request flag	120
Error code list	104
Error flag	116
Error history area (address: 0A00H to 0FFFH) . . .	24
Error history clear command	135

Error history clear completed	135
Error history data	134
Error notification function	85
External dimensions	148
External wiring	43

G

Gain value	138
General specifications	13

H

How to check error codes and alarm codes	101
How to mount a module on a DIN rail	33

I

Initial data setting completed flag	115
Initial data setting request flag	120
Input signal error detection flag	123
Input signal error detection function	64
Input signal error detection setting	129
Input signal error detection signal	118
Installation and wiring	30
Installation direction	32
Installation environment	31
Installation environment and installation position	31
Installation position	31

L

Latest error code	122
Latest warning code	122
Laying Ethernet cables	40
List of alarm codes	108
List of remote buffer memory areas	20
List of remote I/O signals	17
List of remote register areas	19

M

Maintenance and inspection	99
Maximum station-to-station distance for an Ethernet cable (maximum cable length) . . .	40
Maximum value/minimum value	133
Maximum value/minimum value hold function . . .	63
Maximum value/minimum value reset completed flag	119
Maximum value/minimum value reset request . . .	120
Measures to comply with the EMC Directive . . .	142
MODE LED	11
Module control data area (address: 1000H to 14FFH)	25
Monitor area (address: 0500H to 09FFH)	23
Moving average	60

O

Offset value	138
------------------------	-----

P

P1	11
P2	11
Parameter area (address: 0000H to 04FFH)	21
Parameter area initialization command	136
Parameter area initialization completed	137
Parameter settings	45
Part names	11
Performance specifications	14
Precautions for programming	90
Precautions for transition wiring	38
Procedures before operation	26
Process alarm	130
Processing time of CC-Link IE Field Network	141
Program example	91
Programming	90
Programming procedure	91
PW LED	11

R

Range setting	126
Range setting monitor	133
Range switching function	62
Reference connector list	41
Remote READY	117
Requirements to compliance with the Low Voltage Directive	146
RUN LED	11

S

Sampling processing	58
Scaling	132
Scaling enable/disable setting	131
Scaling function	70
Shift function	73
Shifting amount to conversion value	124
Station number setting	30
Station number setting switch	11
System configuration	28

T

Terminal layout of a connector for module power supply and FG	35
Terminal layout of e-CON	41
Terms	10
Time average	59
Time average/Count average/Moving average	128
Troubleshooting	101
Troubleshooting by symptom	112

U

Unit test	111
-----------	-----

V

Voltage input characteristics	138
-------------------------------	-----

W

Warning flag	114
Wiring of Ethernet cable	39
Wiring of external devices	41

REVISIONS

*The manual number is given on the bottom left of the back cover.

Print date	*Manual number	Revision
April 2017	SH(NA)-081710ENG-A	First edition
March 2021	SH(NA)-081710ENG-B	■Added or modified parts SAFETY PRECAUTIONS, CONDITIONS OF USE FOR THE PRODUCT
November 2022	SH(NA)-081710ENG-C	■Added or modified part Appendix 7

Japanese manual number: SH-081709-C

This manual confers no industrial property rights or any rights of any other kind, nor does it confer any patent licenses. Mitsubishi Electric Corporation cannot be held responsible for any problems involving industrial property rights which may occur as a result of using the contents noted in this manual.

© 2017 MITSUBISHI ELECTRIC CORPORATION

WARRANTY

Please confirm the following product warranty details before using this product.

1. Gratis Warranty Term and Gratis Warranty Range

If any faults or defects (hereinafter "Failure") found to be the responsibility of Mitsubishi occurs during use of the product within the gratis warranty term, the product shall be repaired at no cost via the sales representative or Mitsubishi Service Company.

However, if repairs are required onsite at domestic or overseas location, expenses to send an engineer will be solely at the customer's discretion. Mitsubishi shall not be held responsible for any re-commissioning, maintenance, or testing on-site that involves replacement of the failed module.

[Gratis Warranty Term]

The gratis warranty term of the product shall be for one year after the date of purchase or delivery to a designated place. Note that after manufacture and shipment from Mitsubishi, the maximum distribution period shall be six (6) months, and the longest gratis warranty term after manufacturing shall be eighteen (18) months. The gratis warranty term of repair parts shall not exceed the gratis warranty term before repairs.

[Gratis Warranty Range]

- (1) The range shall be limited to normal use within the usage state, usage methods and usage environment, etc., which follow the conditions and precautions, etc., given in the instruction manual, user's manual and caution labels on the product.
- (2) Even within the gratis warranty term, repairs shall be charged for in the following cases.
 1. Failure occurring from inappropriate storage or handling, carelessness or negligence by the user. Failure caused by the user's hardware or software design.
 2. Failure caused by unapproved modifications, etc., to the product by the user.
 3. When the Mitsubishi product is assembled into a user's device, Failure that could have been avoided if functions or structures, judged as necessary in the legal safety measures the user's device is subject to or as necessary by industry standards, had been provided.
 4. Failure that could have been avoided if consumable parts (battery, backlight, fuse, etc.) designated in the instruction manual had been correctly serviced or replaced.
 5. Failure caused by external irresistible forces such as fires or abnormal voltages, and Failure caused by force majeure such as earthquakes, lightning, wind and water damage.
 6. Failure caused by reasons unpredictable by scientific technology standards at time of shipment from Mitsubishi.
 7. Any other failure found not to be the responsibility of Mitsubishi or that admitted not to be so by the user.

2. Onerous repair term after discontinuation of production

- (1) Mitsubishi shall accept onerous product repairs for seven (7) years after production of the product is discontinued. Discontinuation of production shall be notified with Mitsubishi Technical Bulletins, etc.
- (2) Product supply (including repair parts) is not available after production is discontinued.

3. Overseas service

Overseas, repairs shall be accepted by Mitsubishi's local overseas FA Center. Note that the repair conditions at each FA Center may differ.

4. Exclusion of loss in opportunity and secondary loss from warranty liability

Regardless of the gratis warranty term, Mitsubishi shall not be liable for compensation to:

- (1) Damages caused by any cause found not to be the responsibility of Mitsubishi.
- (2) Loss in opportunity, lost profits incurred to the user by Failures of Mitsubishi products.
- (3) Special damages and secondary damages whether foreseeable or not, compensation for accidents, and compensation for damages to products other than Mitsubishi products.
- (4) Replacement by the user, maintenance of on-site equipment, start-up test run and other tasks.

5. Changes in product specifications

The specifications given in the catalogs, manuals or technical documents are subject to change without prior notice.

TRADEMARKS

The company names, system names and product names mentioned in this manual are either registered trademarks or trademarks of their respective companies.

In some cases, trademark symbols such as [™] or [®] are not specified in this manual.

SH(NA)-081710ENG-C(2211)MEE

MODEL: CCIEF-AD-ECON-U-E

MODEL CODE: 13JX68

mitsubishi electric corporation

HEAD OFFICE : TOKYO BUILDING, 2-7-3 MARUNOUCHI, CHIYODA-KU, TOKYO 100-8310, JAPAN
NAGOYA WORKS : 1-14, YADA-MINAMI 5-CHOME, HIGASHI-KU, NAGOYA, JAPAN

When exported from Japan, this manual does not require application to the
Ministry of Economy, Trade and Industry for service transaction permission.

Specifications subject to change without notice.