

MITSUBISHI

Peripheral Connection Module Type AJ65BT-G4-S3

User's Manual

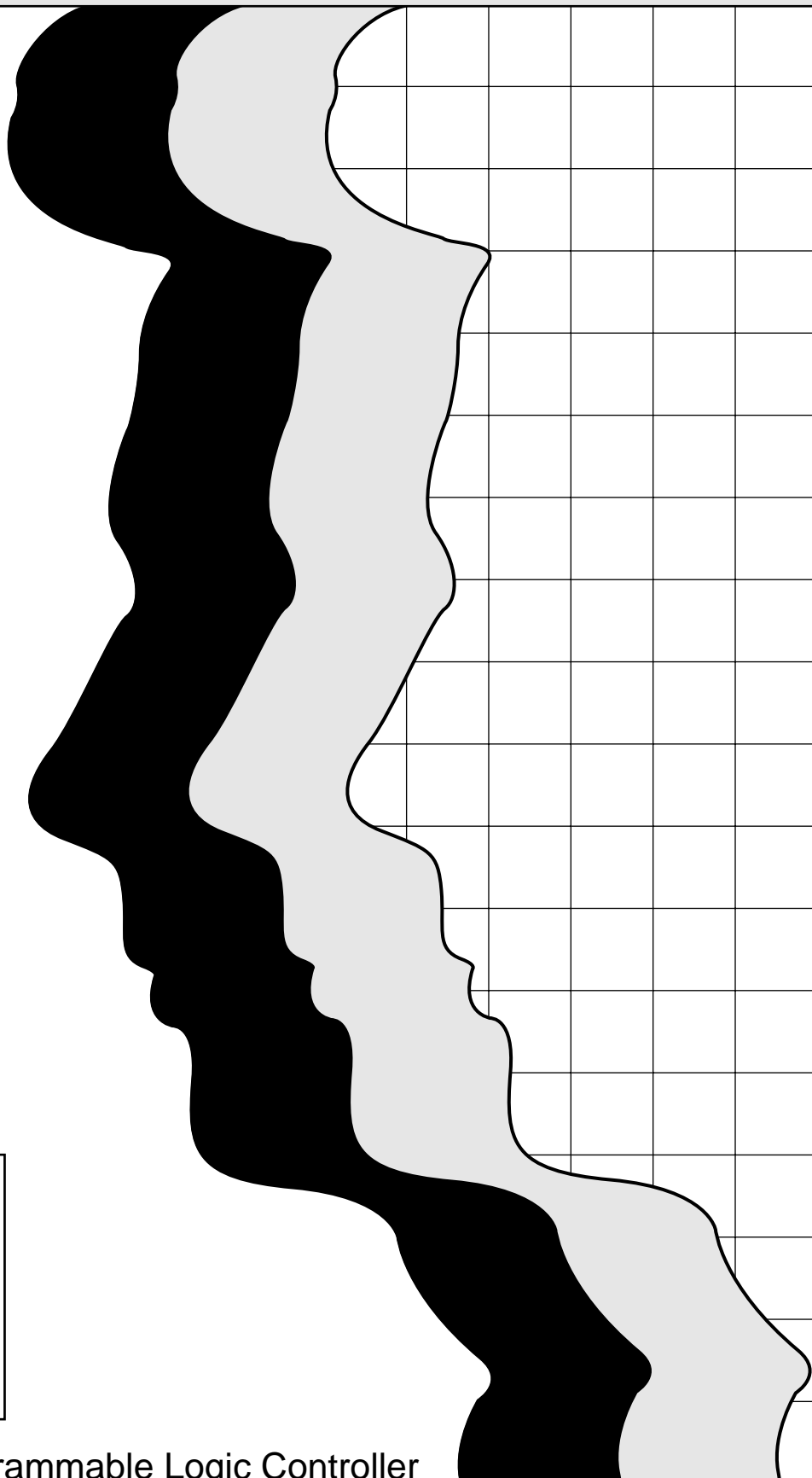

Mitsubishi Programmable Logic Controller

● SAFETY PRECAUTIONS ●

(Always read these instructions before using this equipment.)

Before using this product, please read this manual and the relevant manuals introduced in this manual carefully and pay full attention to safety to handle the product correctly.

The precautions given in this manual are concerned with this product. For the safety precautions of the programmable controller system, please read the CPU module user's manual.

In this manual, the safety precautions are ranked as "DANGER" and "CAUTION".



DANGER

Indicates that incorrect handling may cause hazardous conditions, resulting in death or severe injury.



CAUTION

Indicates that incorrect handling may cause hazardous conditions, resulting in medium or slight personal injury or physical damage.

Note that the  CAUTION level may lead to a serious consequence according to the circumstances. Always follow the instructions of both levels because they are important to personal safety.

Please save this manual to make it accessible when required and always forward it to the end user.

[Design Precautions]

DANGER

- When using the peripheral device for the online operation of the running PLC (e.g. data change, forced output, program change or operating status change (remote RUN/STOP etc.)), establish an interlock circuit outside the PLC system so that the whole system always operates on the safe side. Also, the user should determine corrective and other actions to be taken when a data communication error occurs between the peripheral device and PLC.

CAUTION

- Do not bunch the control wires or communication cables with the main circuit or power wires, or install them close to each other. They should be installed 100 mm (3.94 inch) or more from each other. Not doing so could result in noise that would cause malfunction.

[Installation Precautions]

CAUTION

- Use the PLC in an environment that meets the general specifications contained in the CPU user's manual to use. Using this module in an environment outside the range of the general specifications could result in fire, malfunction, and damage to or deterioration of the product.
- Securely fix the module using the DIN rail or mounting screws and fully tighten the mounting screws within the specified torque range. If the screws are loose, it may result in fallout, short circuits, or malfunctions. Tightening the screw too far may cause damages to the screws and/or the module, resulting in a fallout, short circuits, or malfunctions.
- Do not directly touch the module's conductive parts or electronic components. Doing so could cause malfunction or failure in the module.

[Wiring Precautions]

DANGER

- Before starting installation or wiring work, be sure to shut off all phases of external power supply used by the system. Not doing so could result in electric shock or damage to the product.
- When switching power on or starting operation after mounting, wiring, operation check or other work, always close the terminal cover. Not doing so can cause a short circuit or misoperation due to module damage or cable connection fault.

CAUTION

- Before wiring the module, confirm the rated voltage and terminal arrangement of the product. A fire or failure can occur if the power supply connected is different from the rating or wiring is incorrect.
- Tighten the terminal screws within the range of the specified torque. If the terminal screws are loose, it may result in short circuits, or malfunctions. Tightening the terminal screws too far may cause damages to the terminal screws and/or the module, resulting in short circuits, or malfunctions.
- Be sure there are no foreign substances such as sawdust or wiring debris inside the module. Such debris could cause fires, failure, or malfunction.
- Be sure to earth the FG terminal to the protective earth conductor. Not doing so may cause misoperation.

[Wiring Precautions]

CAUTION

- Do not install the control lines together with the communication cables, or bring them close to each other. Failure to do so may cause malfunctions due to noise.
- The communication cables and power supply cable connected to the module must be placed in a conduit or fixed with a clamp. Not doing so can damage the module or cables due to dangling, moved or accidentally pulled cables or can cause misoperation due to cable contact failure.
- Do not grab on the cable when removing the communication or power cable connected to the module. When removing the cable with a connector, hold the connector on the side that is connected to the module. When disconnecting a cable without a connector, first loosen the screws on the part that is connected to the module. Pulling the cable when it is still connected to the module may cause damage to the module or cable, or misoperation due to cable contact failure.
- Before connecting the cables, check the type of interface to be connected.
Do not connect the cables to the equipment of different interface specifications. It can cause the module to fail.
- Perform correct pressure-displacement, crimp-contact or soldering for wire connections using the tools specified by the manufactures. Attach connectors to the module securely. Doing so could cause malfunction or failure in the module.

[Starting and Maintenance Precautions]

DANGER

- Do not touch the connector while the power is on.
Doing so could cause malfunction.
- Before cleaning or tightening the terminal screws and module mounting screws, be sure to shut off all phases of external power supply used by the system.
Failure to shut off all phases could lead to module trouble or malfunctioning.
If the screws are loose, it may result in fallout, short circuits, or malfunctions.
Tightening the screws too far may cause damages to the screws and/or the module, resulting in a fallout, short circuits, or malfunctions.

[Starting and Maintenance Precautions]

CAUTION

- Do not disassemble or modify the module.
Doing so could cause failure, malfunction, injury, or fire.
- The module case is made of resin. Do not drop it or give it hard impact.
This can damage the module.
- Before installing or removing the module on the panel, be sure to shut off all phases of external power supply used by the system.
Failure to shut off all phases could lead to module trouble or malfunctioning.
- While power is on, do not change the switch settings (except SW1 (operation mode setting) of the operation setting DIP switches).
This can cause a failure or misoperation.
- When mounting, wiring or operation check is not performed, always close the terminal cover.
Not doing so can cause a short circuit or misoperation due to module damage or cable connection fault.
- Do not install/remove the terminal block more than 50 times after the first use of the product.
(IEC 61131-2 compliant)

[Operating Precautions]

DANGER

- Before using the peripheral device for the online operation of the running PLC (e.g. data change, forced output, program change or operating status change (remote RUN/STOP etc.)), thoroughly read the manual to ensure complete safety.
Otherwise, an improper operation may cause machine damage or accident.

[Disposal Precautions]

CAUTION

- When disposing of the product, handle it as industrial waste.

REVISIONS

* The manual number is given on the bottom left of the back cover.

Print Date	*Manual Number	Revision
Oct., 2000	SH(NA)-080105-A	First edition
Jun., 2006	SH(NA)-080105-B	<p>Partial Correction</p> <p>SAFETY PRECAUTIONS, About Manuals, Confirmation to the EMC Directive and Low Voltage Instruction, About the Generic Terms and Abbreviations, Meanings and Definitions of Terms, Section 2.2, 2.3, 2.4, 3.1, 3.2, 4.2.1, 4.3, 4.4.1, 4.4.2, Chapter 5, Section 5.1, 5.2, 5.3, Chapter 6, Section 6.1, 6.2.1, 6.2.2, 6.2.3, 6.4.1, Appendix1, 3.2</p>

Japanese Manual Version SH-080104-B

This manual confers no industrial property rights or any rights of any other kind, nor does it confer any patent licenses. Mitsubishi Electric Corporation cannot be held responsible for any problems involving industrial property rights which may occur as a result of using the contents noted in this manual.

© 2000 MITSUBISHI ELECTRIC CORPORATION

INTRODUCTION

Thank you for the Mitsubishi MELSEC-A Series of General Purpose Programmable Logic Controllers. Please read this manual carefully so that equipment is used to its optimum.

CONTENTS

SAFETY PRECAUTIONS	A- 1
REVISIONS	A- 5
INTRODUCTION.....	A- 6
CONTENTS.....	A- 6
About Manuals	A- 8
Conformation to the EMC Directive and Low Voltage Instruction	A- 8
About the Generic Terms and Abbreviations	A- 9
Meanings and Definitions of Terms	A-10
Product Makeup	A-10
1 OVERVIEW	1- 1 to 1- 2
1.1 Features	1- 1
2 SYSTEM CONFIGURATION	2- 1 to 2- 5
2.1 Overall Configuration	2- 1
2.2 Connectable Peripheral Devices	2- 1
2.3 Instructions for System Configuration	2- 2
2.4 Instructions for Use of the G4-S3	2- 5
3 SPECIFICATIONS	3- 1 to 3- 2
3.1 General Specifications	3- 1
3.2 Performance Specifications	3- 2
4 PRE-OPERATION SETTINGS AND PROCEDURE	4- 1 to 4- 7
4.1 Pre-Operation Procedure.....	4- 1
4.2 Loading and Installation	4- 2
4.2.1 Handling instructions.....	4- 2
4.2.2 Installation environment	4- 2
4.3 Names of the Parts and Their Settings	4- 3
4.4 Wiring.....	4- 5
4.4.1 About the CC-Link dedicated cables	4- 5
4.4.2 Connection of cables with the modules.....	4- 5
4.5 Hardware Check Test Operation Procedure.....	4- 6

5 OPERATIONS FOR USING GX DEVELOPER VERSION 6 OR LATER	5- 1 to 5- 7
--	--------------

5.1 Setting Operations Required for Connection to G4-S3	5- 1
5.2 Accessible Range	5- 4
5.3 Available Functions	5- 5

6 OPERATIONS FOR USING OTHER THAN GX DEVELOPER VERSION 5 OR EARLIER	6- 1 to 6-18
---	--------------

6.1 About the QnA mode and A mode	6- 1
6.2 Setting Operations Required for Connection to G4-S3	6- 2
6.2.1 Using GX Developer	6- 2
6.2.2 Using GPPQ	6- 6
6.2.3 Using GPPA	6- 9
6.3 Accessible Range	6-12
6.4 Available Functions	6-13
6.4.1 Using GX Developer	6-13
6.4.2 Using GPPQ	6-15
6.4.3 Using GPPA	6-18

7 TROUBLESHOOTING	7- 1 to 7- 4
-------------------	--------------

7.1 Online Operation of the Peripheral Devices Cannot Be Performed for the CPU Specified as the Access Destination	7- 1
7.2 How to Check an Error with the Indicator LEDs	7- 2
7.3 Communication Error Occurs between Master Station and G4-S3	7- 3

APPENDICES	App- 1 to App- 5
------------	------------------

Appendix 1 Comparison Between AJ65BT-G4 and AJ65BT-G4-S3	App- 1
Appendix 2 Outline Dimension Drawing	App- 2
Appendix 3 Initial Setting Examples of CC-Link	App- 3
Appendix 3.1 Initial setting example for A series CC-Link master station	App- 3
Appendix 3.2 Initial setting example for Q (Q mode)/QnA series CC-Link master station	App- 4

INDEX	Index- 1 to Index- 2
-------	----------------------

About Manuals

The following manuals are also related to this product.
In necessary, order them by quoting the details in the tables below.

Related Manuals

Manual Name	Manual Number (Model Code)
CC-Link System Master/Local Module type AJ61BT11/A1SJ61BT11 User's Manual Describes the system configuration, performance specifications, functions, handling, wiring and troubleshooting of the AJ61BT11 and A1SJ61BT11. (Sold separately)	IB-66721 (13J872)
CC-Link System Master/Local Module type AJ61QBT11/A1SJ61QBT11 User's Manual Describes the system configuration, performance specifications, functions, handling, wiring and troubleshooting of the AJ61QBT11 and A1SJ61QBT11. (Sold separately)	IB-66722 (13J873)
CC-Link System Master/Local Module User's Manual QJ61BT11N Describes the system configuration, performance and specifications, functions, handling, wiring and troubleshooting of the QJ61BT11N. (Sold separately)	SH-080394E (13JR64)
GX Developer Version8 Operating Manual Describes the online functions of GX Developer including the programming procedure, printing out procedure, monitoring procedure, and debugging procedure. (Sold separately)	SH-080373E (13JU41)
Type SW2IVD-GPPQ GPP Software package Operating Manual(Online) Describes the online functions, such as the monitoring and debugging methods, of the SW2IVD-GPPQ. (Sold separately)	IB-66775 (13J922)
Type SW2IVD-GPPQ GPP Software package Operating Manual(Offline) Describes the offline functions, such as the programming method, print-out method and file maintenance, of the SW2IVD-GPPQ. (Sold separately)	IB-66774 (13J921)
Type SW4IVD-GPPA(GPP) Operating Manual Describes the system configuration, performance specifications, functions, system start-up procedure, detailed operation of each GPP function, and error messages of the SW4IVD-GPPA(GPP). (Sold separately)	IB-66855 (13JL62)
Type A6GPP/A6PHP(SW4GP-GPPA) Operating Manual Describes the system configuration, performance specifications, functions, system start-up procedure, detailed operation of each GPP function, and error messages of the SW4GP-GPPA. (Sold separately)	IB-66259 (13J717)

Conformation to the EMC Directive and Low Voltage Instruction

When incorporating the Mitsubishi PLC into other machinery or equipment and keeping compliance with the EMC and low voltage directives, refer to Chapter 3, "EMC Directives and Low Voltage Directives" of the User's Manual (Hardware) included with the CPU module or base unit used.

The CE logo is printed on the rating plate of the PLC, indicating compliance with the EMC and low voltage directives.

To conform this product to the EMC Directive and Low Voltage Directive, refer to the Section of "CC-Link Modules" in Chapter 3 "EMC Directive and Low Voltage Directive" in the User's Manual (Hardware) of the CPU module used or the PLC CPU supplied with the base unit.

About the Generic Terms and Abbreviations

Unless otherwise specified, the following generic names and abbreviations are used in this manual to describe the AJ65BT-G4-S3 peripheral device connection module.

Generic Term/Abbreviation	Description
A1SJ61BT11	Abbreviation for the A1SJ61BT11 CC-Link system Master/local module.
A1SJ61QBT11	Abbreviation for the A1SJ61QBT11 CC-Link system Master/local module.
ACPU	Generic name for the MELSEC-A series PLC CPUs.
AJ61BT11	Abbreviation for the AJ61BT11 CC-Link system Master/local module.
AJ61QBT11	Abbreviation for the AJ61QBT11 CC-Link system Master/local module.
CC-Link	Abbreviation for Control & Communication Link.
G4-S3	Abbreviation for the AJ65BT-G4-S3 peripheral device connection module.
GPPA	Abbreviation for the SW□-GPPA type GPP function software package.
GPPQ	Abbreviation for the SW□-GPPQ type GPP function software package.
GX Developer	Abbreviation for the GX Developer (SW2D5C/F-GPPW-E or later).
Intelligent device station	Station which can make transient transmission. The G4-S3 is an Intelligent device station.
Local module	Generic name for the AJ61BT11, A1SJ61BT11, AJ61QBT11, A1SJ61QBT11, QJ61BT11 and QJ61BT11N when used as Local stations.
Local station	Station which has a CPU and can communicate with the Master and other Local stations.
Master module	Generic name for the AJ61BT11, A1SJ61BT11, AJ61QBT11, A1SJ61QBT11, QJ61BT11 and QJ61BT11N when used as the Master stations.
Master station	Station which controls Remote and Local stations. One Master station is required in a single system.
Master/local module	Generic name for the AJ61BT11, A1SJ61BT11, AJ61QBT11, A1SJ61QBT11, QJ61BT11 and QJ61BT11N.
MELSEC PLC programming software	Generic name for GX Developer, GPPQ and GPPA.
Peripheral device	Peripheral device that the MELSEC PLC programming software is installed.
Personal computer	Personal computer of IBM PC/AT [®] or a 100%-compatible machine.
QCPU	Generic name for the MELSEC-Q series PLC CPUs.
QJ61BT11	Abbreviation for the QJ61BT11N and QJ61BT11 CC-Link system Master/local module.
QnACPU	Generic name for the MELSEC-QnA series PLC CPUs.
Remote device station	Remote station which handles bit data and word data.
Remote I/O station	Remote station which handles bit data only.
Remote module	Generic name for modules used as Remote I/O, Remote device and Intelligent device stations.

Meanings and Definitions of Terms

The terms used in this manual have the following meanings and definitions.

- (1) Other station (Single network)
Indicates the PLC CPU of the Master or Local station connected in the CC-Link system where the G4-S3 is connected.

- (2) Other station (Coexistence network)
Indicates the PLC CPU on the other network connected via the Master or Local station in the CC-Link system where the G4-S3 is connected.

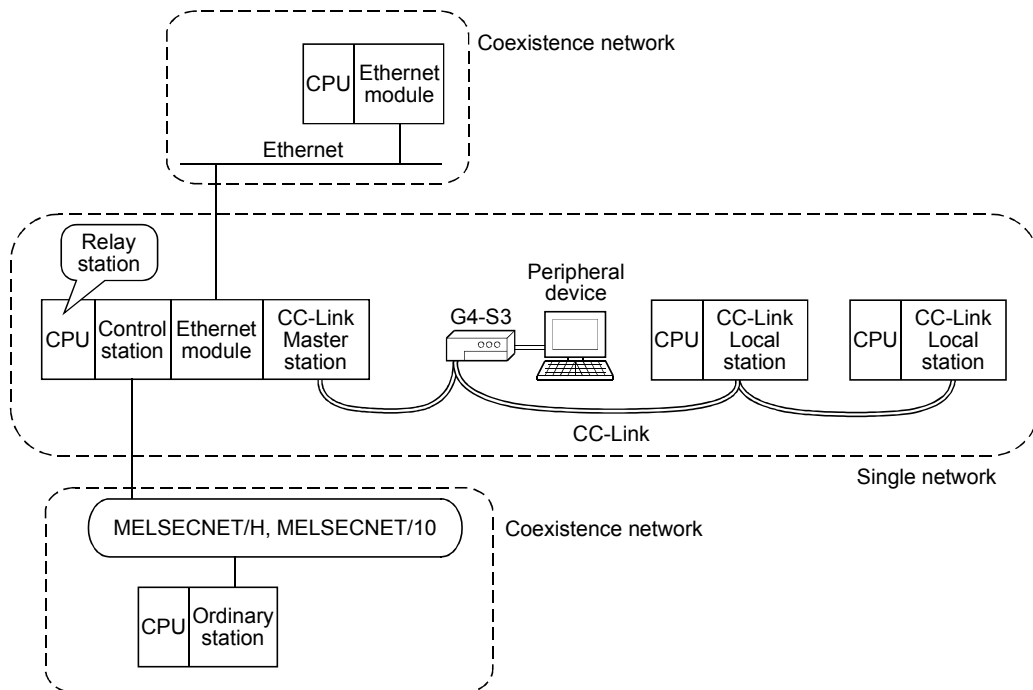

Product Makeup

The G4-S3 consists of the following product.

Model name	Product name	Quantity
AJ65BT-G4-S3	Peripheral connection module type AJ65BT-G4-S3	1

2 SYSTEM CONFIGURATION

This chapter describes the system configuration for use of the G4-S3.

2.1 Overall Configuration

The overall configuration for use of the G4-S3 is shown below.
You can connect up to 26 G4-S3 modules to one master module.

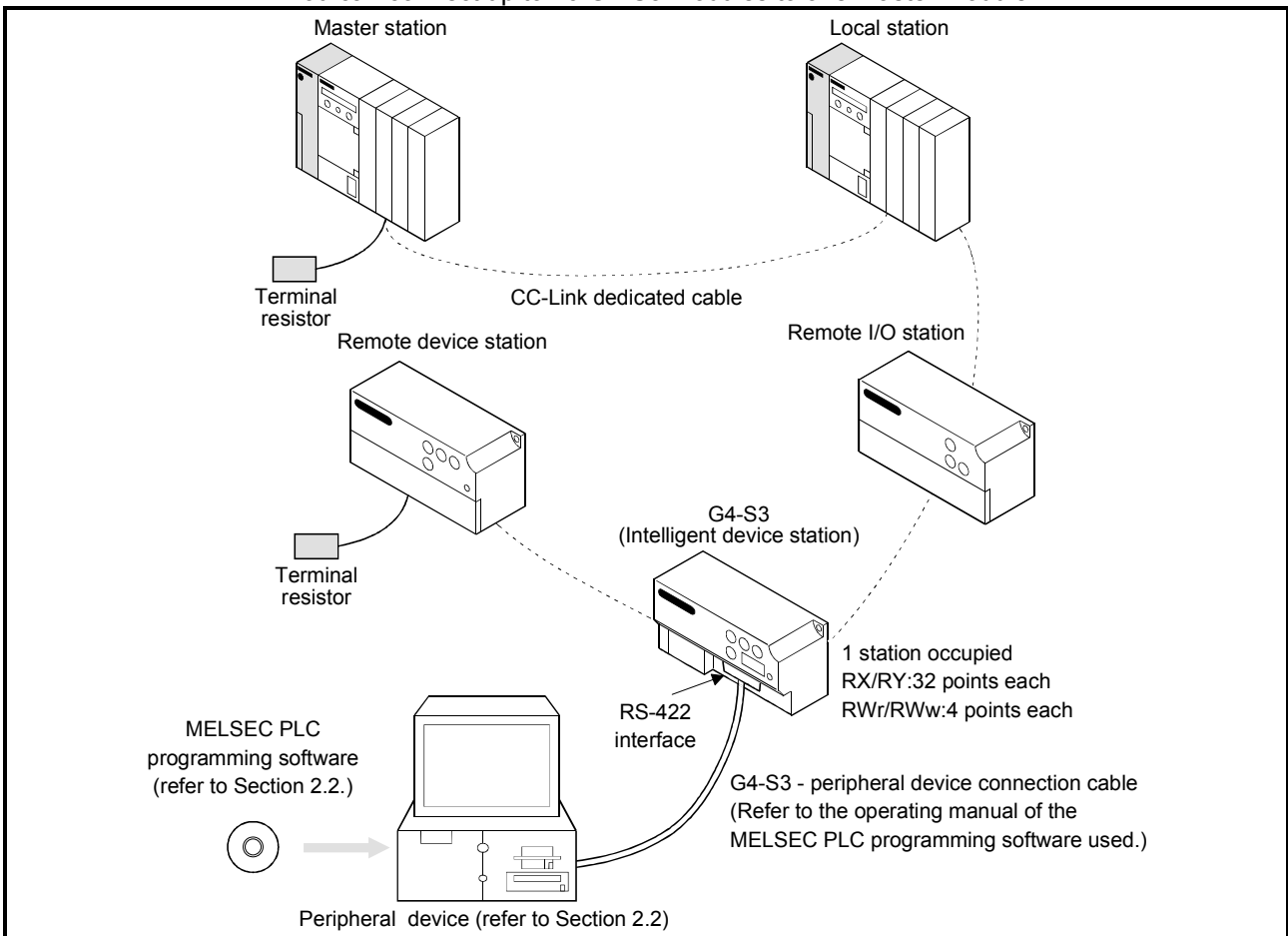

For the max. overall distance of the system, refer to the CC-Link system Master/local module user's manual.

2.2 Connectable Peripheral Devices

The following table lists the peripheral devices that may be connected with the G4-S3 and the usable MELSEC PLC programming software.

Connectable Peripheral Device	Available MELSEC PLC Programming Software		Remarks
Personal computer	Windows® compatible	GX Developer (SWnD5C/F-GPPW-E)	n may be replaced by any of 2 to 5.
		GX Developer (SWnD5C-GPPW-E)	n may be replaced by any of 6 or later.
A7PHP, LM7000	SW□IVD-GPPA, SW□IVD-GPPQ		—
A7HGP	SW0RX-GPPA, SW0SRX-GPPA, SW□SRXV-GPPA, SW□S-GPPA		
A6GPP, A6HGP, A6PHP	SW□HX-GPPA		
	SW3GP-GPPA, SW4GP-GPPA, SW□GP-GPPAU, SW3-GPPA, SW3-HGPA		

2.3 Instructions for System Configuration

When using the G4-S3, follow these system configuration instructions.

(1) Master/local module with which the G4-S3 may be used

(a) When using the AJ61BT11, A1SJ61BT11, AJ61QBT11 or A1SJ61QBT11

The G4-S3 may be used with the Master/local module whose function version is B or later and whose software version is J or later.

The modules that do not support the versions described above cannot be used.

The function version is indicated in the DATE field of the rating plate.

<Large Type>



Year and month of manufacture

Function version

<Small Type>

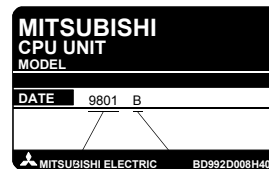

Year and month of manufacture

Function version

* The function version is indicated on the plate of only version B or later.

The software version is indicated on the module version seal on the module front.

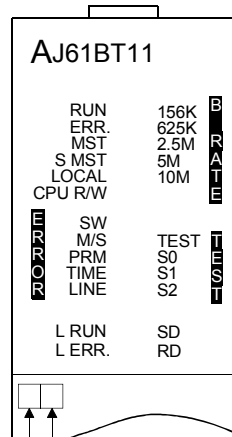

Software version

Hardware version

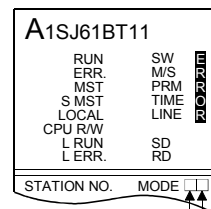

Software version

Hardware version

(b) When using the QJ61BT11

For access to the multiple PLC system (refer to POINT), use the QJ61BT11 of function version B when making access to the non-control PLC of the Master/local module (QJ61BT11).

The function version is given in the rating plate.

* The function version may also be checked on GX Developer.

(When checking the function version on the "rating plate" on the side face of the module)

The function version of the corresponding module is indicated by the alphabet at the end of the serial number given in the SERIAL field of the rating plate.

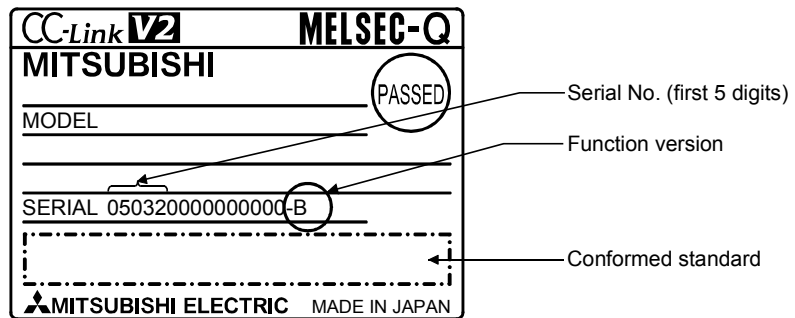

(When checking the function version on GX Developer)

The following method to check the function version of the corresponding module on GX Developer assumes that GX Developer Version 6 or later is used.

The function version is displayed on the "Product Information List" or "Module Detail Information" screen of GX Developer.

How to check the function version on the "Product Information List" screen is given below.

1) Setting procedure

Choose "Diagnostics" → "System monitor" → "Product Information List".

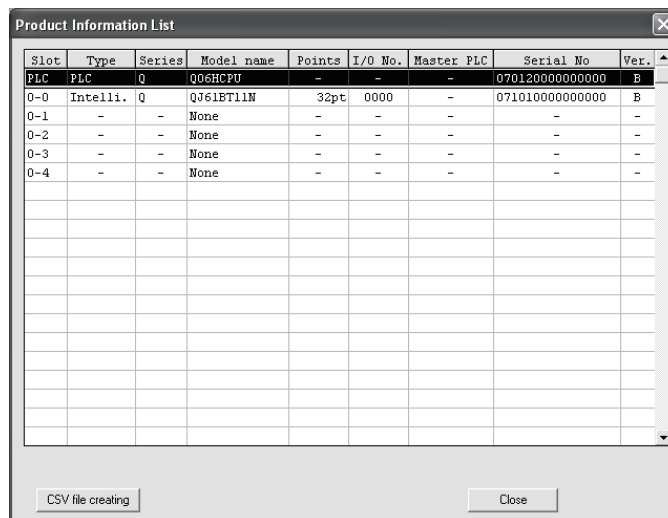

2) Ver.

The function version of the corresponding module appears in the Ver. field.

POINT
A multiple PLC system can be configured by using the function version B of the QCPU (Q mode).

(2) About station number setting of the G4-S3

Set the station number of the G4-S3 in the following range.

- (a) When making access to the Master or local station on CC-Link
Set the station number of the G4-S3 within the range 1 to 64.
- (b) When making access to the PLC in the other network system
Set the station number of the G4-S3 within the range 1 to 64 when making access to the Q series PLC in the other network system via the Master or local station on CC-Link where the G4-S3 is connected.
Set the station number of the G4-S3 within the range 1 to 63 when making access to the A or QnA series PLC.

(3) Accessible PLC CPUs

The following table indicates the accessible PLC CPUs on a MELSEC PLC programming software basis.

Set the operation mode of the G4-S3 according to the accessed PLC CPU.

MELSEC PLC Programming Software	G4-S3 Operation Mode	PLC CPU			
		QCPU (Q mode)	QnACPU	QCPU (A mode)	ACPU
GX Developer Version 6 or later	Q mode	○	○	○	○
	QnA mode	×	○	×	×
	A mode	×	×	○	○
GX Developer Version 4 and 5	Q mode	—			
	QnA mode	×	○	×	×
	A mode	×	×	○	○
GX Developer Version 2 and 3	Q mode	—			
	QnA mode	×	○	×	×
	A mode	×	×	○*1	○
SW□IVD-GPPQ, SW□NX-GPPQ	Q mode	—			
	QnA mode	×	○	×	×
	A mode	—			
SW□IVD-GPPA, SW0RX-GPPA, SW0SRX-GPPA, SW□SRXV-GPPA, SW□S-GPPA, SW□HX-GPPA	Q mode	—			
	QnA mode	—			
	A mode	×	×	○*2	○
SW3GP-GPPA, SW4GP-GPPA, SW3-GPPA, SW3-HGPA	Q mode	—			
	QnA mode	—			
	A mode	×	×	○*2*3	○*3
SW□GP-GPPAU	Q mode	—			
	QnA mode	—			
	A mode	×	×	○*1*4	○*4

○: Accessible, ×: Inaccessible, —: Setting disallowed

- *1 Set the accessed CPU type to the A4U.
- *2 Set the accessed CPU type to any of the A4U, A3A and A3H.
For details, refer to Section 2.2.2 of the QCPU (A mode) User's Manual.
- *3 Only the AnACPU and AnNCPUs are accessible.
- *4 Only the AnUCPU is accessible.

2.4 Instructions for Use of the G4-S3

The instructions for use of the G4-S3 are given below.

- (1) When the MELSEC-A series CC-Link system Master/local module is used, a "communications error" may occur in rare cases on the peripheral device side connected to the G4-S3. Check the following points and take a proper action.
 - (a) Among the factors in occurrence of a "communications error" is the frequent execution of the FROM/TO instruction by the PLC CPU for the buffer memory of the MELSEC-A series CC-Link system Master/local module.
 - * The MELSEC-A series special function module gives priority to access from the PLC CPU in processing. Therefore, making frequent access to the buffer memory not only increases the scan time of the PLC CPU but also causes a delay in processing of the special function module, leading to the factor in occurrence of a "communications error".
 - * When the MELSEC-Q or QnA series CC-Link system Master/local module is used, the above factor will not cause a "communications error".
 - (b) When making access to the buffer memory of the MELSEC-A series CC-Link system Master/local module, add the normally closed contact of the input signal (XnC) of the same module to the contact of the FROM/TO instruction as a corrective action for a "communications error".
 (XnC: FROM/TO instruction enable/disable signal. When XnC is OFF, the FROM/TO instruction is enabled for execution.)
 Adding the N/C contact of XnC allows normal data communications.
- (2) One time of access from the MELSEC PLC programming software to the PLC ends after several communications depending on the processing. For example, when the PLC is monitored, several communications are made to perform one time of monitor processing, and monitor processing communications are repeated until monitor ending operation is performed.
 - * Access to PLC CPUs on different networks will cause a considerable delay depending on the number of stations to be accessed and access conditions.
 - * The following example gives the guidelines of access time for accessing the PLC CPU via CC-Link.
 The access time is about 40 seconds in all cases.

	Item	Description
Conditions	CC-Link system	Only the Master station and G4-S3 are connected.
	Accessed PLC CPU	Q12HCPU (STOP status) of the Master station
	Data transmission rate	<ul style="list-style-type: none"> • CC-Link system : 10Mbps • Between G4-S3 and peripheral device : 19200bps (GX Developer Version 6 or later used)
	Access made	Read/write of sequence program (10k steps)

- (3) The online operation performed from the peripheral device via the G4-S3 should be started when the L RUN LED of the G4-S3 is ON. You cannot perform online operation while the L RUN LED is off.
 - *The L RUN LED of the G4-S3 is ON when the initial communication of the CC-Link is complete.
- (4) While the G4-S3 is operating, the DIP switches (SW1, SW6) can be used to change the operation mode. Also, before changing the operation mode of the G4-S3 to the "QnA mode", match the transmission speed setting of the G4-S3 to that of the peripheral device side software and start up the G4-S3.

3 SPECIFICATIONS

3.1 General Specifications

The following table shows the general specifications of the G4-S3.

Item	Specifications					
Operating ambient temperature	0 to 55 °C					
Storage ambient temperature	-20 to 75 °C					
Operating ambient humidity	10 to 90 % RH, non-condensation					
Storage ambient humidity	10 to 90 % RH, non-condensation					
Vibration resistance	Conforming to JIS B 3502, IEC 61131-2	—	Frequency	Acceleration	Amplitude	Sweep Count 10 times each in X, Y and Z directions (for 80 min.)
		Under intermittent vibration	10 to 57 Hz	—	0.075 mm	
			57 to 150 Hz	9.8 m/s ²	—	
		Under continuous vibration	10 to 57 Hz	—	0.035 mm	
57 to 150 Hz	4.9 m/s ²		—			
Shock resistance	Conforming to JIS B3502, IEC 61131-2 (147 m/s ² , 3 times in each of 3 directions X, Y, Z)					
Operating ambience	No corrosive gases					
Operating altitude*3	2000 m(6562 ft.) max.					
Installation location	Inside control panel					
Overvoltage category *1	II max.					
Pollution level *2	2 max.					

*1: This indicates the section of the power supply to which the equipment is assumed to be connected between the public electrical power distribution network and the machinery within premises. Category II applies to equipment for which electrical power is supplied from fixed facilities.

The surge voltage withstand level for up to the rated voltage of 300 V is 2500 V.

*2: This index indicates the degree to which conductive material is generated in terms of the environment in which the equipment is used.

Pollution level 2 is when only non-conductive pollution occurs. A temporary conductivity caused by condensing must be expected occasionally.

*3: Do not use or store the PLC in the environment where the pressure is higher than the atmospheric pressure at sea level. Otherwise, malfunction may result. To use the PLC in high-pressure environment, contact your nearest Mitsubishi representative.

3.2 Performance Specifications

The following table indicates the performance specifications of the G4-S3.

Item	Specifications
RS-422 interface	For connection of peripheral device, 1 channel
CC-Link station type	Intelligent device station
Number of stations occupied	1 station (RX/Ry 32 points each RWr/RWw 4 points each)
Permissible instantaneous power failure time	1ms
Transmission speed/max. transmission distance	(Refer to Control & Communication Link System Master/Local Module User's Manual.)
Connection cable (for CC-Link)	
Max. number of modules connected	Up to 26
Terminal block	7-pin terminal block (M3.5 × 7screws)
Applicable cable size	0.75 to 2.00mm ²
Applicable crimping terminal	RAV1.25-3, RAV2-3.5 (conforming to JIS C2805)
Module mounting screws	Screws of M4 × 0.7mm × 16mm or larger DIN rail may also be used for mounting.
Applicable DIN rails	TH35-7.5Fe, TH35-7.5Al, TH35-15Fe (conforming to JIS C 2812)
24VDC internal current consumption	0.19A
Power supply (for module drive)	24VDC (15.6 to 28.8V)
Noise immunity	Measure using a noise simulator of noise voltage 500Vp-p, noise width 1μs and noise frequency 25 to 60Hz.
Insulation resistance	10MΩ or more across all DC external terminals and grounding terminal using a 500VDC insulation resistance tester.
Withstanding voltage	500VAC for 1 minute across all DC external terminals and grounding terminal
Weight	0.36kg
Outline dimensions	80mm(3.15inch) × 170mm(6.70inch) × 63.5mm(2.50inch)

4 PRE-OPERATION SETTINGS AND PROCEDURE

4.1 Pre-Operation Procedure

The following flowchart indicates a pre-operation procedure for the G4-S3.

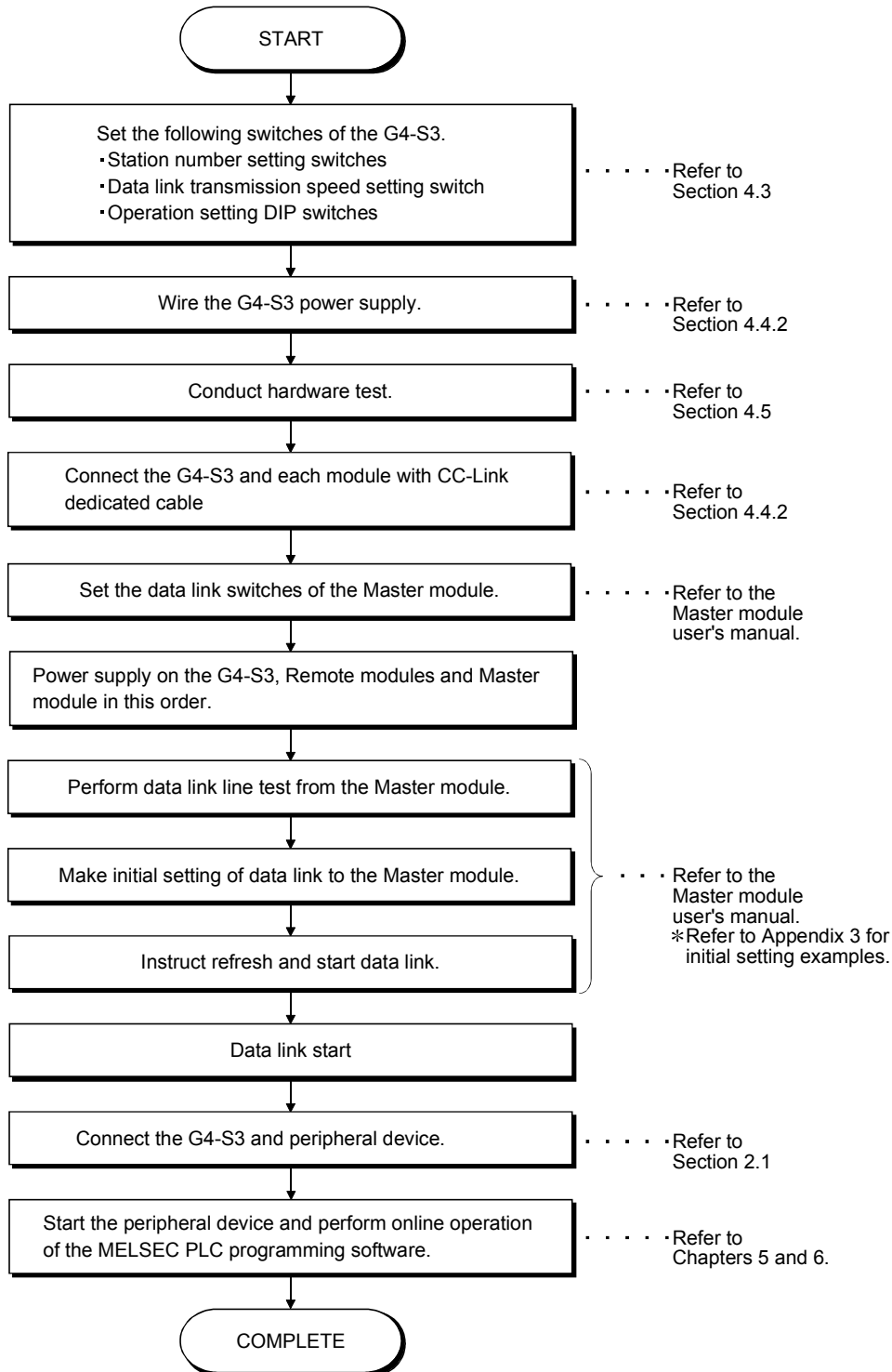

4.2 Loading and Installation

This section gives the handling instructions to be followed from unpacking to installation of the G4-S3 and its installation environment.

4.2.1 Handling instructions

This section gives the handling instructions of the G4-S3.

POINT
For handling instructions such as module installation/removal, read ●SAFETY PRECAUTIONS● given at the beginning of this manual.

- (1) Tighten the terminal screws and mounting screws of the module within the following ranges.

Screw Location	Tightening Torque Range
Module mounting screw (M4 screw)	0.78 to 1.18 N•m
Terminal block terminal screw (M3.5 screw)	0.59 to 0.88 N•m
Terminal block mounting screw (M4 screw)	0.78 to 1.18 N•m
RS-422 connector mounting screw (M2.6 screw)	0.19 to 0.24 N•m

- (2) When using the DIN rail adapter, note the following in mounting the DIN rail.
- (a) Applicable DIN rail type (conforming to JIS C 2812)
 - TH35-7.5Fe
 - TH35-7.5Al
 - TH35-15Fe
 - (b) DIN rail mounting screw pitch
 - When mounting the DIN rail, tighten screws in 200mm(7.88inch) or less pitch.



4.2.2 Installation environment

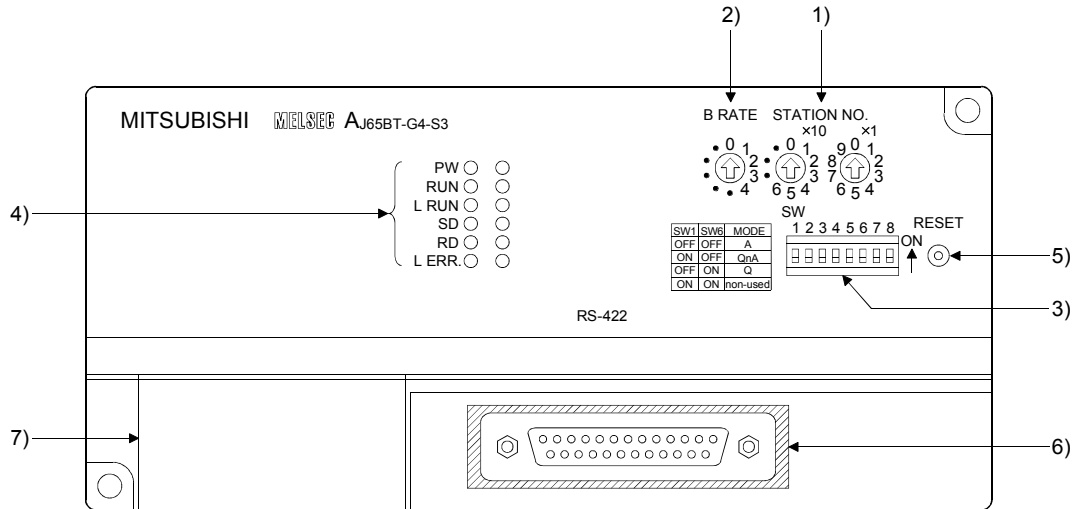

 <p>CAUTION</p>	<p>When installing the module, avoid the following environment. If the environment of the module used is outside the range of general specifications, an electric shock, fire, misoperation or product damage or deterioration can occur.</p> <ul style="list-style-type: none"> ● Ambient temperature outside the range 0 to 55°C ● Ambient humidity outside the range 10 to 90%RH ● Condensation due to sudden temperature changes ● Corrosive or combustible gasses ● Dust, conductive powder (e.g. metal filings), oil mist, salt and organic solvent ● Direct sunlight ● Strong power and magnetic fields ● Vibration and impact
---	---

4.3 Names of the Parts and Their Settings

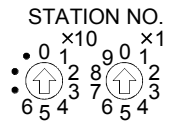
This section provides the names of the G4-S3 parts and how to set them.

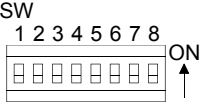

No.	Name	Description														
1)	Station number setting switches 	Set the station number of the G4-S3 within the range 1 to 63 or 1 to 64.(Refer to Section 2.3) (If the station number you set is other than, 1 to 64, the L ERR. LED is ON.) Use " ×10" to set the station number tens place. Use " ×1" to set the station number unit's place. (Factory setting : 00)														
2)	Data link transmission speed setting switch B RATE 	Used to set the transmission speed of the G4-S3. (For data link) <table border="1" style="width: 100%; border-collapse: collapse;"> <thead> <tr> <th>No. to Be Set</th> <th>Transmission Speed</th> </tr> </thead> <tbody> <tr> <td>0</td> <td>156kbps</td> </tr> <tr> <td>1</td> <td>625kbps</td> </tr> <tr> <td>2</td> <td>2.5Mbps</td> </tr> <tr> <td>3</td> <td>5Mbps</td> </tr> <tr> <td>4</td> <td>10Mbps</td> </tr> <tr> <td>Other than 0 to 4</td> <td>Unused(If the value you set is other than 0 to 4, the L.ERR LED is ON to indicate a communication error.)</td> </tr> </tbody> </table> <p style="text-align: right;">(Factory setting : 0(156kbps))</p>	No. to Be Set	Transmission Speed	0	156kbps	1	625kbps	2	2.5Mbps	3	5Mbps	4	10Mbps	Other than 0 to 4	Unused(If the value you set is other than 0 to 4, the L.ERR LED is ON to indicate a communication error.)
No. to Be Set	Transmission Speed															
0	156kbps															
1	625kbps															
2	2.5Mbps															
3	5Mbps															
4	10Mbps															
Other than 0 to 4	Unused(If the value you set is other than 0 to 4, the L.ERR LED is ON to indicate a communication error.)															

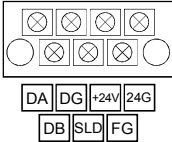
No.	Name	Description																																																										
3)	Operation setting DIP switches 	Used to set the operational specifications of the G4-S3.																																																										
		<table border="1"> <thead> <tr> <th rowspan="2">SW No.</th> <th rowspan="2">Setting Item</th> <th colspan="2">Setting Switch Position</th> <th rowspan="2">Description</th> </tr> <tr> <th>ON</th> <th>OFF</th> </tr> </thead> <tbody> <tr> <td rowspan="4">1,6</td> <td rowspan="4">Operation mode</td> <td>SW1</td> <td>SW6</td> <td>Operation mode</td> <td rowspan="4"> When using GX Developer Version 6 or later, set to the Q mode. When using any other software, make setting according to the accessed PLC CPU. Can be changed during operation. </td> </tr> <tr> <td>OFF</td> <td>OFF</td> <td>A mode</td> </tr> <tr> <td>ON</td> <td>OFF</td> <td>QnA mode</td> </tr> <tr> <td>OFF</td> <td>ON</td> <td>Q mode</td> </tr> <tr> <td>ON</td> <td>ON</td> <td>Must not be set.</td> </tr> <tr> <td rowspan="4">2,3</td> <td rowspan="4">Peripheral device transmission speed (bps)</td> <td>SW2</td> <td>SW3</td> <td>Transmission Speed</td> <td rowspan="4"> When setting the operation mode of the G4-S3 to the QnA mode, make setting according to the peripheral device. (Valid for only the QnA mode.) Invalid for the A and Q modes. Must not be changed during operation. </td> </tr> <tr> <td>OFF</td> <td>OFF</td> <td>9600bps</td> </tr> <tr> <td>ON</td> <td>OFF</td> <td>19200bps</td> </tr> <tr> <td>OFF</td> <td>ON</td> <td>38400bps</td> </tr> <tr> <td>ON</td> <td>ON</td> <td>Must not be set.</td> </tr> <tr> <td>4,5</td> <td>Parity bit yes/no</td> <td colspan="2">Fixed to OFF</td> <td>_____</td> </tr> <tr> <td>7</td> <td>Not used</td> <td colspan="2">Fixed to OFF</td> <td>_____</td> </tr> <tr> <td>8</td> <td>Test mode</td> <td>Test mode</td> <td>Online mode</td> <td>Set this switch to ON when making hardware test.</td> </tr> </tbody> </table>	SW No.	Setting Item	Setting Switch Position		Description	ON	OFF	1,6	Operation mode	SW1	SW6	Operation mode	When using GX Developer Version 6 or later, set to the Q mode. When using any other software, make setting according to the accessed PLC CPU. Can be changed during operation.	OFF	OFF	A mode	ON	OFF	QnA mode	OFF	ON	Q mode	ON	ON	Must not be set.	2,3	Peripheral device transmission speed (bps)	SW2	SW3	Transmission Speed	When setting the operation mode of the G4-S3 to the QnA mode, make setting according to the peripheral device. (Valid for only the QnA mode.) Invalid for the A and Q modes. Must not be changed during operation.	OFF	OFF	9600bps	ON	OFF	19200bps	OFF	ON	38400bps	ON	ON	Must not be set.	4,5	Parity bit yes/no	Fixed to OFF		_____	7	Not used	Fixed to OFF		_____	8	Test mode	Test mode	Online mode	Set this switch to ON when making hardware test.
		SW No.			Setting Item	Setting Switch Position		Description																																																				
			ON	OFF																																																								
		1,6	Operation mode	SW1	SW6	Operation mode	When using GX Developer Version 6 or later, set to the Q mode. When using any other software, make setting according to the accessed PLC CPU. Can be changed during operation.																																																					
				OFF	OFF	A mode																																																						
				ON	OFF	QnA mode																																																						
OFF	ON			Q mode																																																								
ON	ON	Must not be set.																																																										
2,3	Peripheral device transmission speed (bps)	SW2	SW3	Transmission Speed	When setting the operation mode of the G4-S3 to the QnA mode, make setting according to the peripheral device. (Valid for only the QnA mode.) Invalid for the A and Q modes. Must not be changed during operation.																																																							
		OFF	OFF	9600bps																																																								
		ON	OFF	19200bps																																																								
		OFF	ON	38400bps																																																								
ON	ON	Must not be set.																																																										
4,5	Parity bit yes/no	Fixed to OFF		_____																																																								
7	Not used	Fixed to OFF		_____																																																								
8	Test mode	Test mode	Online mode	Set this switch to ON when making hardware test.																																																								
		(Factory setting : All switches in OFF position)																																																										
4)	Indicator LEDs PW ○ RUN ○ L RUN ○ SD ○ RD ○ L ERR. ○ Refer to Section 7.2 for details of the indicator LEDs.	PW	ON : Power on.	OFF : Power off.																																																								
		RUN	ON : Normal operation.	OFF : 24VDC power OFF or Watchdog timer error.																																																								
		L RUN	ON : Normal communication.	OFF : Communication fault. (time excess error.)																																																								
		SD	ON to indicate data transmission.																																																									
		RD	ON to indicate data receive.																																																									
		L ERR.	ON	: Indicates a communication data error (CRC error) or station number setting/data link transmission speed setting error.																																																								
			Flicker at regular intervals	: Indicates that the station number setting or data link transmission speed setting switch position was changed while power is on.																																																								
	Flicker at irregular intervals	: Indicates that the terminal resistor is left unconnected or that the module or CC-Link dedicated cable is affected by noise.																																																										
	OFF	: Normal communication																																																										
5)	Reset switch RESET 	Hardware reset. Used to reset to the power-on status.																																																										
6)	RS-422 interface * 1	Interface for connecting the peripheral device. The cable as used to connect the peripheral device and QnACPU/ACPU may be used as the connection cable. Refer to the operating manual of the MELSEC PLC programming software used.																																																										
7)	Power supply and data link terminal block 	Terminal block for power supply and data link. For the wiring method, refer to Section 4.4.2.																																																										

* 1 Do not connect the RS-232 equipment to the RS-422 interface. Doing so will damage the RS-422 interface hardware of the G4-S3, disabling communication.

POINT

When the accessed Master/local station is the AJ61BT11 or A1SJ61BT11, set SW8 of the condition setting switches of the Master/local station to OFF.

4.4 Wiring

4.4.1 About the CC-Link dedicated cables

Use the CC-Link dedicated cables for the CC-Link system. If a cable other than the CC-Link dedicated cable is used, the performance of the CC-Link system cannot be guaranteed.

For the specifications of the CC-Link dedicated cables or any other inquiries, visit the following site:

CC-Link Partner Association website: <http://www.cc-link.org/>

REMARK

For details, refer to the CC-Link cable wiring manual issued by CC-Link Partner Association.

4.4.2 Connection of cables with the modules

The following diagram shows how to wire CC-Link dedicated cables between the Master module and Remote module.

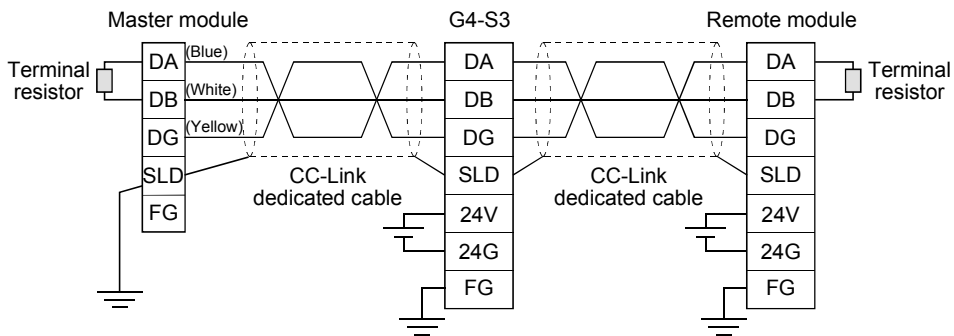

POINT

"Terminal resistors" must be connected to the sections between DA and DB of the modules at the both ends of the CC-Link.
 When connecting the terminal resistor to the G4-S3, use the terminal resistor supplied with the Master module.
 (Refer to the Control & Communication Link System Master/Local Module User's Manual.)

4.5 Hardware Check Test Operation Procedure

The following procedure indicates how to perform the G4-S3 hardware check test (hereinafter referred to as "the hardware test") operation.
 Always perform the hardware test before incorporating the G4-S3 into the CC-Link system.

(Step 1)

When the CC-Link dedicated cables are used for the connection of the G4-S3 and peripheral devices, disconnect each cable.

(Step 2)

Connect the RS-422 single-station loopback cable to the G4-S3.
 Refer to the RS-422 single-station loopback cable specifications given below and fabricate the cable on the user side.

RS-422 Interface	Pin number	Cable Connection
	2	← <input type="text"/>
	3	<input type="text"/>
	4	← <input type="text"/>
	5	<input type="text"/>
	15	← <input type="text"/>
	16	<input type="text"/>
	17	← <input type="text"/>
	18	<input type="text"/>
	20	<input type="text"/>
	21	<input type="text"/>

(Step 3)

Set the operation setting DIP switch SW8 of the G4-S3 to ON (test mode).
 (Refer to Section 4.3.)
 Set the station number setting switches to 0.(Refer to Section 4.3.)

(Step 4)

Power supply on the G4-S3. If it is already on, press the reset switch.

(Step 5)

Check the L ERR. LED of the G4-S3.

L ERR. LED Status	Error Definition
Flickers at intervals of 0.5 seconds for 30 seconds or longer.	Normal
Flickers at intervals of 2 seconds	ROM check error
Flickers at intervals of 4 seconds	RAM check error
Flickers at intervals of 6 seconds	Data link loopback check error
Flickers at intervals of 8 seconds	RS-422 loopback check error
ON	Hardware fault

When the L ERR. LED is ON or flickers at intervals of 2, 4, 6 or 8 seconds, make sure that.

- 1) The CC-Link dedicated cable is not connected to the G4-S3 (if connected, disconnect).
- 2) The operation setting DIP switch SW8 of the G4-S3 is set to ON (test mode) and the station number setting switches are set to 0.
- 3) The peripheral device connection cable is not connected to the G4-S3 (if connected, disconnect).

Then, perform the hardware test again. If the L ERR. LED is still ON or flickers at 2, 4, 6, or 8-second intervals after the test, the possible cause is a hardware fault. Consult your sales representative.

(Step 6)

Power supply off the G4-S3, disconnect the RS-422 single-station loopback cable, and set the operation setting DIP switch SW8 to OFF.

Set the station number setting switches to the station number assigned to the G4-S3 in the CC-Link system.

5 OPERATIONS FOR USING GX DEVELOPER VERSION 6 OR LATER

This chapter gives instructions for using GX Developer Version 6 or later to access the PLC CPUs, how to operate GX Developer, and other information.

POINT
<p>(1) When using the G4-S3 and GX Developer Version 6 or later together, set the operation mode of the G4-S3 to "Q mode". By setting "Q mode", online operations on the personal computer are applicable to all QCPUs, QnACPU, and ACPU without changing the operation mode.</p> <p>(2) Refer to Section 2.3(3) for the MELSEC PLC programming software compatible with each operation mode of the G4-S3. When using GX Developer not given in Section 2.3(3), check whether the Q mode of the G4-S3 operation mode is usable or not with the manual of the software used.</p>

5.1 Setting Operations Required for Connection to G4-S3

(1) Settings

Make the following settings to use G4-S3 and GX Developer.

(a) Settings of AJ65BT-G4-S3

Switch (Switch number)		Setting																				
		Q mode		QnA mode		A mode																
Station No. setting switches		As set by user																				
Data link transmission speed setting switch		As set by user (match to the transmission speed of the CC-Link module)																				
Operation setting DIP switches	Operation mode setting (SW1, SW6)	<table border="1"> <tr><th>SW</th><th>Setting</th></tr> <tr><td>SW1</td><td>OFF</td></tr> <tr><td>SW6</td><td>ON</td></tr> </table>	SW	Setting	SW1	OFF	SW6	ON	<table border="1"> <tr><th>SW</th><th>Setting</th></tr> <tr><td>SW1</td><td>ON</td></tr> <tr><td>SW6</td><td>OFF</td></tr> </table>	SW	Setting	SW1	ON	SW6	OFF	<table border="1"> <tr><th>SW</th><th>Setting</th></tr> <tr><td>SW1</td><td>OFF</td></tr> <tr><td>SW6</td><td>OFF</td></tr> </table>	SW	Setting	SW1	OFF	SW6	OFF
	SW	Setting																				
	SW1	OFF																				
	SW6	ON																				
SW	Setting																					
SW1	ON																					
SW6	OFF																					
SW	Setting																					
SW1	OFF																					
SW6	OFF																					
Peripheral device transmission speed (SW2, SW3)	Setting need not be made (Automatic setting)		Setting need not be made (Automatic setting)		Setting need not be made (Automatic setting)																	
Parity bit yes/no setting (SW4, SW5)	<table border="1"> <tr><th>SW</th><th>Setting</th></tr> <tr><td>SW4</td><td>OFF</td></tr> <tr><td>SW5</td><td>OFF</td></tr> </table>	SW	Setting	SW4	OFF	SW5	OFF	<table border="1"> <tr><th>SW</th><th>Setting</th></tr> <tr><td>SW4</td><td>OFF</td></tr> <tr><td>SW5</td><td>OFF</td></tr> </table>	SW	Setting	SW4	OFF	SW5	OFF	<table border="1"> <tr><th>SW</th><th>Setting</th></tr> <tr><td>SW4</td><td>OFF</td></tr> <tr><td>SW5</td><td>OFF</td></tr> </table>	SW	Setting	SW4	OFF	SW5	OFF	
SW	Setting																					
SW4	OFF																					
SW5	OFF																					
SW	Setting																					
SW4	OFF																					
SW5	OFF																					
SW	Setting																					
SW4	OFF																					
SW5	OFF																					
- (SW7)	OFF		OFF		OFF																	
Test mode setting (SW8)	OFF (Online mode)		OFF (Online mode)		OFF (Online mode)																	

(b) Settings of GX Developer

Setting item		Setting		
		Q mode	QnA mode	A mode
Transfer setup	Transmission speed	As set by user		
	PLC side I/F	G4 module (Computer type: AJ65BT-G4-S3 (Q mode))	G4 module (Computer type: AJ65BT-G4-S3 (QnA mode))	G4 module (Computer type: AJ65BT-G4-S3 (A mode))
	Other station	Either Other station (Single network) or Other station (Co-existence network)		
	Network route	Fixed to CC-Link		
	Co-existence network route	As set by user		

(2) General procedure

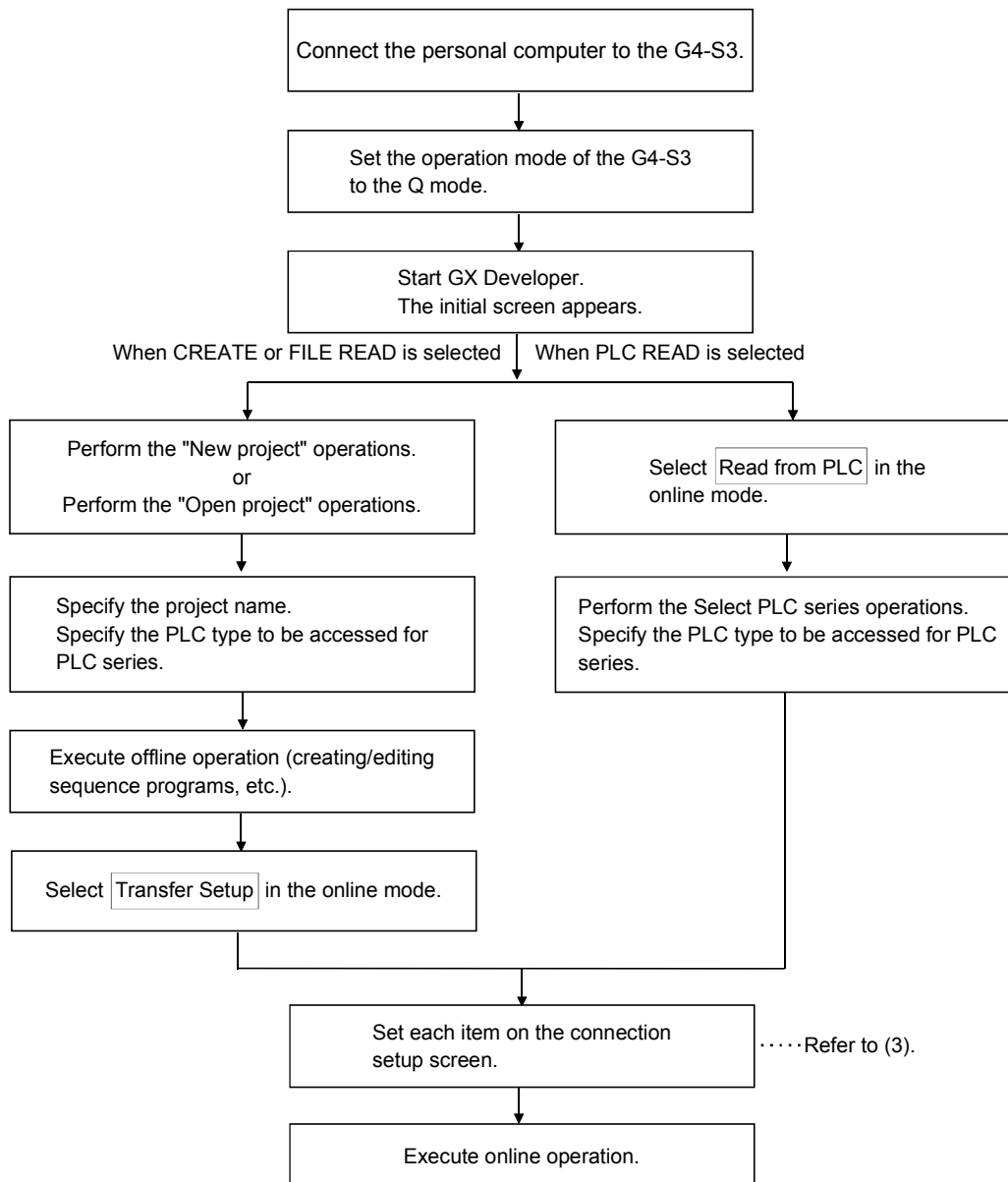

5

(3) Setting of the connection setup screen

(For GX Developer Version 8)

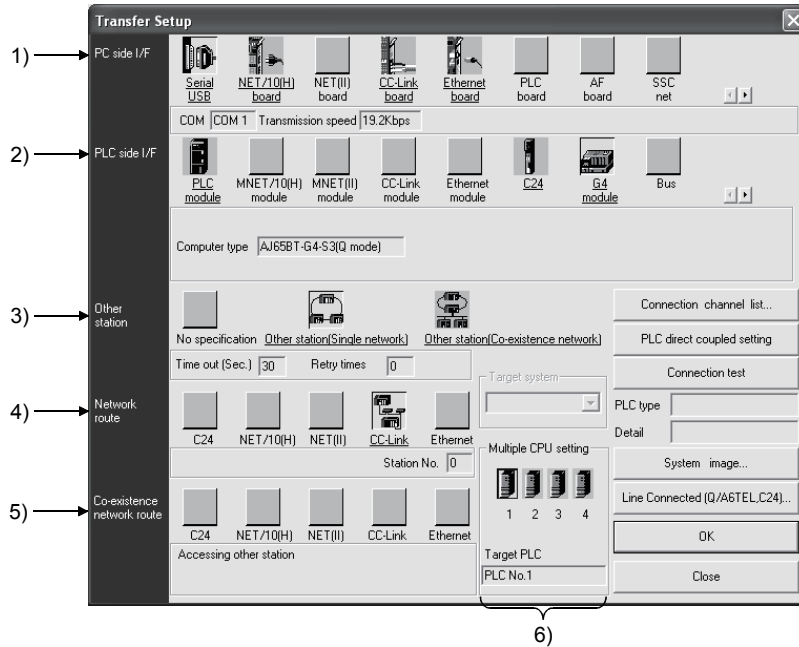

No.	Setting Item	Description										
1)	PC side I/F	Always select "Serial". Set the PC side interface and transmission speed in "PC side I/F Serial setting".										
2)	PLC side I/F	Select "G4 module". Also set the module type to "AJ65BT-G4-S3 (Q mode)".										
3)	Other station	Select "Other station (Single network)" or "Other station (Coexistence network)". Change the timeout period for data communication if necessary.										
4)	Network route	"CC-Link" is automatically selected. To access the PLC station on the CC-Link system, specify the station No. of the access station. To access the other station on the coexistence network via the CC-Link system, specify the station number of the relayed Master/local station in the CC-Link system.										
5)	Coexistence network route	When "Other station (Coexistence network)" is selected for "Other station" above, specify the network (No.) to be passed and the station No. of the PLC to be accessed. The specifying item varies depending on the PLC to be accessed. <table border="1" style="width: 100%; border-collapse: collapse;"> <thead> <tr> <th style="width: 50%;">Access Destination</th> <th style="width: 50%;">Setting Item</th> </tr> </thead> <tbody> <tr> <td>The PLC CPU of the other station on the multi-drop connection via a serial communication module</td> <td>Select "C24" and specify the station No. of the serial communication module to be accessed.</td> </tr> <tr> <td>The PLC of the other station on the MELSECNET/H (including MELSECNET/10, Ethernet) system</td> <td>Select "NET/10(H)" and specify the network No. and station No. of the access destination.</td> </tr> <tr> <td>The PLC CPU of the other station on the MELSECNET(II) system</td> <td>Select "NET(II)" and specify the station No. of the access destination.</td> </tr> <tr> <td>The PLC CPU of the other station on the Ethernet system</td> <td>Select "Ethernet" and specify the network No. and station No. of the access destination.</td> </tr> </tbody> </table> <p>* The concept of the network No. and station No. for the Ethernet system is the same as that for the MELSECNET/H, MELSECNET/10. Use the network No. and station No. for the MELSECNET/H, MELSECNET/10 specified to the target Ethernet interface module.</p>	Access Destination	Setting Item	The PLC CPU of the other station on the multi-drop connection via a serial communication module	Select "C24" and specify the station No. of the serial communication module to be accessed.	The PLC of the other station on the MELSECNET/H (including MELSECNET/10, Ethernet) system	Select "NET/10(H)" and specify the network No. and station No. of the access destination.	The PLC CPU of the other station on the MELSECNET(II) system	Select "NET(II)" and specify the station No. of the access destination.	The PLC CPU of the other station on the Ethernet system	Select "Ethernet" and specify the network No. and station No. of the access destination.
Access Destination	Setting Item											
The PLC CPU of the other station on the multi-drop connection via a serial communication module	Select "C24" and specify the station No. of the serial communication module to be accessed.											
The PLC of the other station on the MELSECNET/H (including MELSECNET/10, Ethernet) system	Select "NET/10(H)" and specify the network No. and station No. of the access destination.											
The PLC CPU of the other station on the MELSECNET(II) system	Select "NET(II)" and specify the station No. of the access destination.											
The PLC CPU of the other station on the Ethernet system	Select "Ethernet" and specify the network No. and station No. of the access destination.											
6)	Multiple PLC setting	When the access target is a multiple PLC system, specify the CPU No. of the PLC CPU to be accessed.										

5.2 Accessible Range

(1) Accessible range

Access can be made to the PLC CPUs on CC-Link where the G4-S3 is connected.

Also, access can be made independently of the PLC CPU type (QCPU (Q mode), QnACPU, ACP, QCPU (A mode)).

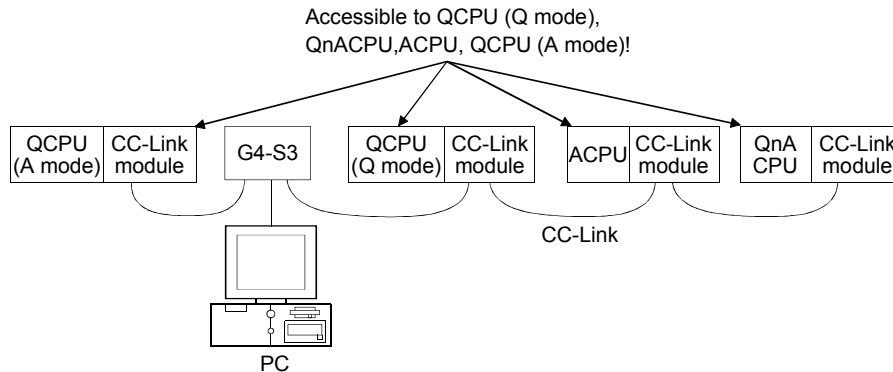

(2) Instructions for access to multiple PLC system

If all the QCPU (Q mode) and network modules (*) of the following stations have the function version of B, access to the control PLC and non-control PLC of the network modules can be made.

- Own station (station fitted with the Master/local module of G4-S3)
- Accessed station

When the network module of the accessed station has the function version of A, access may be made to only the control PLC (No. 1) of the network module.

* The following modules are accessible to the other station via the network. For details, refer to the manual of the module used.

- CC-Link module (Master/local module on the same CC-Link as the G4-S3)
- MELSECNET/H, MELSECNET/10 network module
- Q and QnA series Ethernet interface modules
- Q and QnA series serial communication modules

REMARK

When making access to the multiple PLC system, specify the accessed QCPU on the connection setup screen of GX Developer. (Make selection in the "Multiple PLC setting" item)

5.3 Available Functions

The following table indicates the online-operation functions of usable GX Developer Version 6 or later for access to the PLC CPU via the G4-S3.

Refer to the GX Developer operating manual for offline-operation functions and others not given below.

○: Available, ×: Unavailable, –: No function

(1) Common functions

Online(Common functions)		Accessed CPU		
		QCPU (Q mode)	QnACPU	ACPU, QCPU (A mode)
Transfer setup	Designates a PLC destination.	○	○	○
Read from PLC	Reads data from PLC.	○	○	○
Write to PLC	Writes data to PLC.	○	○	○
Verify with PLC	Verifies data with PLC data.	○	○	○
Write to PLC (Flash ROM)				
Write the program memory to ROM	Writes program memory data to the standard ROM/IC memory card (ROM).	○	×	×
Write to PLC (Flash ROM)	Writes data to the standard ROM/IC memory card (ROM).	○	×	×
Delete PLC data	Deletes PLC data.	○	○	×
Change PLC data attributes	Change PLC data attributes.	×	○	×
PLC user data				
Read PLC user data	Reads user data from the PLC.	○	×	×
Write PLC user data	Writes user data to the PLC.	○	×	×
Delete PLC user data	Deletes user data of the PLC.	○	×	×
Monitor				
Monitor mode	Places the circle edit screen in monitor mode.	○	○	○
Monitor (write mode)	Sets the circuit (monitor write) mode.	○	○	○
Start monitor (All windows)	Starts monitoring all open windows.	○	○	○
Stop monitor (All windows)	Stops monitoring all open windows.	○	○	○
Start monitor	Restarts the stopped monitor.	○	○	○
Stop monitor	Stops the monitor.	○	○	○
Change current value monitor (Decimal)	Displays the current device value of the circuit monitor in decimal form.	○	○	○
Change current value monitor (Hexadecimal)	Displays the current device value of the circuit monitor in hexadecimal form.	○	○	○
Device batch	Monitors devices in batch mode.	○	○	○
Entry data monitor	Entry data mode.	○	○	○
Buffer memory batch	Monitors the buffer memory in batch mode.	○	○	○
Monitor condition setup	Sets the monitor execution conditions.	×	×	×
Monitor stop condition setup	Sets the monitor stop conditions.	×	×	×
Program monitor list	Monitors a program list.	○	○	×
Interrupt program monitor list	Lists the interrupt programs.	○	○	×
Scan time measurement	Measures the scan time.	○	○	×
Entry ladder monitor	Entry the ladder block.	○	○	○
Delete all entry ladder	Delete all entry ladder.	○	○	○

Online(Common functions)		Accessed CPU		
		QCPU (Q mode)	QnACPU	ACPU, QCPU (A mode)
Debug				
Device test	Turns on or off the device or changes the value.	○	○	○
Forced input output registration/cancellation	Registers forced input output of X/Y devices.	○	×	×
Debug	Executes/disables the debugging function.	×	○	○
Skip execution	Makes settings for skip.	×	○	×
Partial execution	Makes settings for partial operation.	×	○	○
Step execution	Makes settings for step execution.	×	○	○
Trace	Execute sampling trace.	○	○	○
Remote operation	Operates the PLC remotely.	○	○	○
Password (Keyword) setup				
Register	Registers or changes the password (keyword).	○	○	○
Delete	Cancels the password (keyword).	○	○	○
Disable	Unlocks access by passwords (keywords).	○	○	○
Clear PLC memory	Clears the PLC memory cassette or device memory.	○	○	○
Format PLC memory	Formats the PLC memory.	○	○	×
Arrange PLC memory	Arranges the data area within the PLC memory.	○	○	×
Set time	Sets the internal timer of the PLC.	○	○	○
Diagnosis (Common functions)				
PLC diagnostics	Diagnoses the PLC.	○	○	○
Network diagnostics	Diagnoses the network. (Network monitor only)	○	○	○
CC-Link diagnostics	CC-Link diagnostics.	○	○	○
System monitor	Monitors the system status of the PLC.	○	×	×
Tool (Common functions)				
Start ladder logic test	Starts the ladder logic test.	○	○	○
Set TEL data				
Connection	Connect the line for A6TEL/Q6TEL.	×	×	×
Disconnect	Disconnect the line.	×	×	×
TEL data	Set the report data of A6TEL or Q6TEL.	×	×	×
AT command	Entry the modem.	×	×	×
Call book	Set the call book.	×	×	×
Intelligent function module utility				
Required utility list	Starts the intelligent function module utility.	○	-	-

(2) Ladder editing functions

Conversion(Ladder editing functions)		Accessed CPU		
		QCPU (Q mode)	QnACPU	ACPU, QCPU (A mode)
Convert (Online change)	Converts the program and writes it during run.	○	○	○
View (Ladder editing functions)				
Elapsed time	Displays the elapsed time.	×	×	×

(3) SFC editing functions

Online(Common functions)		Accessed CPU		
		QCPU (Q mode)	QnACPU	ACPU, QCPU (A mode)
Debug (SFC)				
Device test	Sets the device value.	○	○	○
Block brake	Block brake.	×	○	○
Step brake	Step brake.	×	○	○
Block run	Block run.	×	○	○
Step run	Step run.	×	○	○
1 step run	1 step run.	×	○	○
Block forced stopping	Block forced stopping.	×	○	×
Step forced stopping	Step forced stopping.	×	○	×
Reset stored step	Reset stored step.	×	○	×
Run all block	Run all block.	×	×	○

POINT

Refer to the GX Developer operating manual for details of the available functions.

6 OPERATIONS FOR USING OTHER THAN GX DEVELOPER VERSION 5 OR EARLIER

This chapter provides precautions for using the following MELSEC PLC programming software other than GX Developer Version 5 or earlier to access the PLC CPUs, how to operate the following software, and other information.

(MELSEC PLC programming software which will be explained)

- GX Developer Version 5 or earlier
- GPPQ
- GPPA

POINT
(1) When using the MELSEC PLC programming software explained in this chapter, access to the QnACPU or ACPU can be made. (2) Before starting online operations from the peripheral device, set the operation mode of the G4-S3 according to the accessed PLC CPU. (The QnA or A mode can be set as the operation mode of the G4-S3. You cannot set it to the Q mode to access the PLC CPU.) (3) Use GX Developer Version 6 or later to make access to the QCPU (Q mode) or to the ACPU/QCPU (A mode) of the other station (coexistence network).

6.1 About the QnA mode and A mode

6

When the MELSEC PLC programming software used is other than GX Developer Version 5 or earlier, the operation mode must be set to the QnA or A mode using the operation setting DIP switches on the G4-S3 front.

Set to either mode after considering the following conditions.

(1) Condition for choosing the QnA mode

When the access target is the QnACPU, set the G4-S3 to the QnA mode.

(2) Condition for choosing the A mode

When the access target is the ACPU or QCPU (A mode), set the G4-S3 to the A mode.

Access can be made to only the ACPU on CC-Link where the G4-S3 is connected.

POINT
The accessible PLC CPU depends on the MELSEC PLC programming software used. Refer to Section 2.3(3) for details.

6.2 Setting Operations Required for Connection to G4-S3

This section explains operations to be performed for connection to the G4-S3 and access to the PLC CPU.

6.2.1 Using GX Developer

(1) Settings

Make the following settings to use G4-S3 and GX Developer Version 5 or earlier.

(a) Settings of AJ65BT-G4-S3

Switch (Switch number)		Setting													
		QnA mode		A mode											
Station No. setting switches		As set by user													
Data link transmission speed setting switch		As set by user (match to the transmission speed of the CC-Link module)													
Operation setting DIP switches	Operation mode setting (SW1, SW6)	<table border="1"> <tr><th>SW</th><th>Setting</th></tr> <tr><td>SW1</td><td>ON</td></tr> <tr><td>SW6</td><td>OFF</td></tr> </table>	SW	Setting	SW1	ON	SW6	OFF	<table border="1"> <tr><th>SW</th><th>Setting</th></tr> <tr><td>SW1</td><td>OFF</td></tr> <tr><td>SW6</td><td>OFF</td></tr> </table>	SW	Setting	SW1	OFF	SW6	OFF
	SW	Setting													
	SW1	ON													
	SW6	OFF													
	SW	Setting													
SW1	OFF														
SW6	OFF														
Peripheral device transmission speed (SW2, SW3)	As set by user (match to the transmission speed of the GX Developer)	<p>9600bps</p> <table border="1"> <tr><th>SW</th><th>Setting</th></tr> <tr><td>SW2</td><td>OFF</td></tr> <tr><td>SW3</td><td>OFF</td></tr> </table>	SW	Setting	SW2	OFF	SW3	OFF							
SW	Setting														
SW2	OFF														
SW3	OFF														
Parity bit yes/no setting (SW4, SW5)	<table border="1"> <tr><th>SW</th><th>Setting</th></tr> <tr><td>SW4</td><td>OFF</td></tr> <tr><td>SW5</td><td>OFF</td></tr> </table>	SW	Setting	SW4	OFF	SW5	OFF	<table border="1"> <tr><th>SW</th><th>Setting</th></tr> <tr><td>SW4</td><td>OFF</td></tr> <tr><td>SW5</td><td>OFF</td></tr> </table>	SW	Setting	SW4	OFF	SW5	OFF	
SW	Setting														
SW4	OFF														
SW5	OFF														
SW	Setting														
SW4	OFF														
SW5	OFF														
- (SW7)	OFF	OFF													
Test mode setting (SW8)	OFF (Online mode)	OFF (Online mode)													

(b) Settings of GX Developer

Setting item		Setting	
		QnA mode	A mode
Transfer setup	Transmission speed	As set by user	9.6kbps
	PLC side I/F	G4 module	
	Other station	Either Other station (Single network) or Other station (Co-existence network)	Other station (Single network)
	Network route	Fixed to CC-Link	
	Co-existence network route	As set by user	Cannot be set

(2) General procedure

(For GX Developer Version 5)

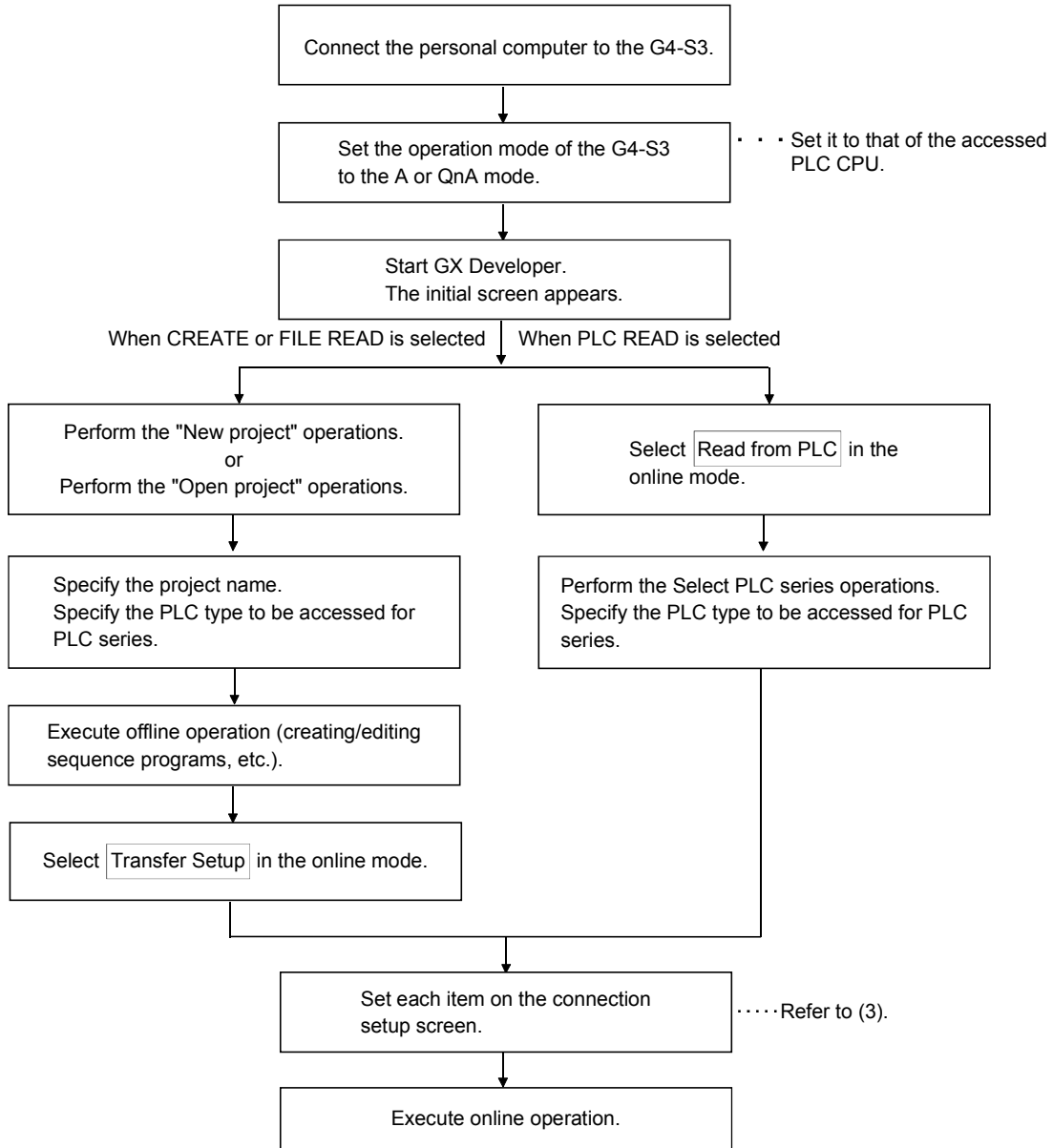

POINT
The operation mode of the G4-S3 can be changed if the G4-S3 is operating.

(3) Setting of the connection setup screen

- (a) For access to QnACPU
(Set operation mode of G4-S3 to QnA mode)

(For GX Developer Version 5)

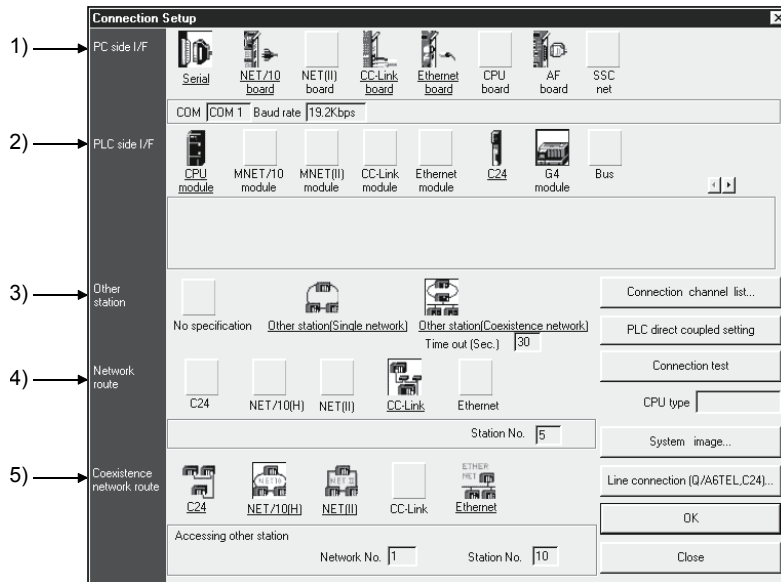

No.	Setting Item	Description										
1)	PC side I/F	Always select "Serial". Set the PC side interface and transmission speed in "PC side I/F Serial setting".										
2)	PLC side I/F	Select "G4 module".										
3)	Other station	Select "Other station (Single network)" or "Other station (Coexistence network)". Change the timeout period for data communication if necessary.										
4)	Network route	"CC-Link" is automatically selected. To access the PLC station on the CC-Link system, specify the station No. of the access station. To access the other station on the coexistence network via the CC-Link system, specify the station number of the relayed Master/local station in the CC-Link system.										
5)	Coexistence network route	When "Other station (Coexistence network)" is selected for "Other station" above, specify the network (No.) to be passed and the station No. of the PLC to be accessed. The specifying item varies depending on the PLC to be accessed. <table border="1" style="width: 100%; border-collapse: collapse;"> <thead> <tr> <th>Access Destination</th> <th>Setting Item</th> </tr> </thead> <tbody> <tr> <td>The PLC CPU of the other station on the multi-drop connection via a serial communication module</td> <td>Select "C24" and specify the station No. of the serial communication module to be accessed.</td> </tr> <tr> <td>The PLC of the other station on the MELSECNET/H (including MELSECNET/10, Ethernet) system</td> <td>Select "NET/10(H)" and specify the network No. and station No. of the access destination.</td> </tr> <tr> <td>The PLC CPU of the other station on the MELSECNET(II) system</td> <td>Select "NET(II)" and specify the station No. of the access destination.</td> </tr> <tr> <td>The PLC CPU of the other station on the Ethernet system</td> <td>Select "Ethernet" and specify the network No. and station No. of the access destination.</td> </tr> </tbody> </table> <p>* The concept of the network No. and station No. for the Ethernet system is the same as that for the MELSECNET/H, MELSECNET/10. Use the network No. and station No. for the MELSECNET/H, MELSECNET/10 specified to the target Ethernet interface module.</p>	Access Destination	Setting Item	The PLC CPU of the other station on the multi-drop connection via a serial communication module	Select "C24" and specify the station No. of the serial communication module to be accessed.	The PLC of the other station on the MELSECNET/H (including MELSECNET/10, Ethernet) system	Select "NET/10(H)" and specify the network No. and station No. of the access destination.	The PLC CPU of the other station on the MELSECNET(II) system	Select "NET(II)" and specify the station No. of the access destination.	The PLC CPU of the other station on the Ethernet system	Select "Ethernet" and specify the network No. and station No. of the access destination.
Access Destination	Setting Item											
The PLC CPU of the other station on the multi-drop connection via a serial communication module	Select "C24" and specify the station No. of the serial communication module to be accessed.											
The PLC of the other station on the MELSECNET/H (including MELSECNET/10, Ethernet) system	Select "NET/10(H)" and specify the network No. and station No. of the access destination.											
The PLC CPU of the other station on the MELSECNET(II) system	Select "NET(II)" and specify the station No. of the access destination.											
The PLC CPU of the other station on the Ethernet system	Select "Ethernet" and specify the network No. and station No. of the access destination.											

(b) For access to ACPU or QCPU (A mode)
(Set operation mode of G4-S3 to A mode)

(For GX Developer Version 5)

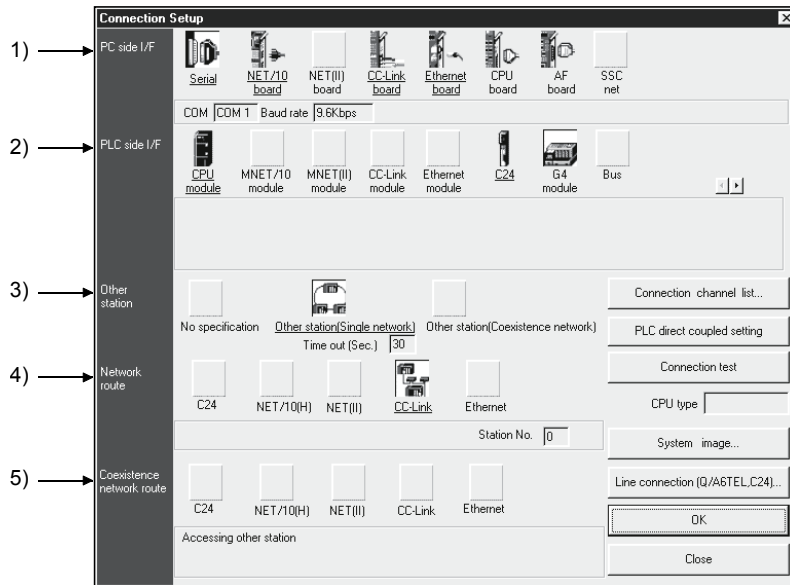

No.	Setting Item	Description
1)	PC side I/F	Always select "Serial". In the "PC side I/F Serial setting" field, set the PC side interface. The transmission speed may only be confirmed. (Cannot be changed).
2)	PLC side I/F	Select "G4 module".
3)	Other station	"Other station (Single network)" is automatically selected. Change the timeout period for data communication if necessary.
4)	Network route	"CC-Link" is automatically selected. Specify the station No. of the access station on the CC-Link system.
5)	Coexistence network route	(Setting impossible)

6.2.2 Using GPPQ

When using GPPQ, set the G4-S3 to the QnA mode.

(1) Settings

Make the following settings to use GPPQ.

Setting Side		Settings
G4-S3	Operation mode	QnA mode
	Transmission speed	Set according to transmission speed of GPPQ.
GPPQ (Connection setting)	PC side interface	Via Serial com for QnA...
	Transmission speed	Any
	Station # of Serial Com Unit Station	<ul style="list-style-type: none"> • When accessing PLC CPU on same CC-Link Set the station number of the accessed Master/local station on CC-Link. • When accessing PLC CPU of other station (coexistence network) Set the station number of the relayed Master/local station on CC-Link.
	Parity	Odd

(2) General procedure

(For SW2IVD-GPPQ)

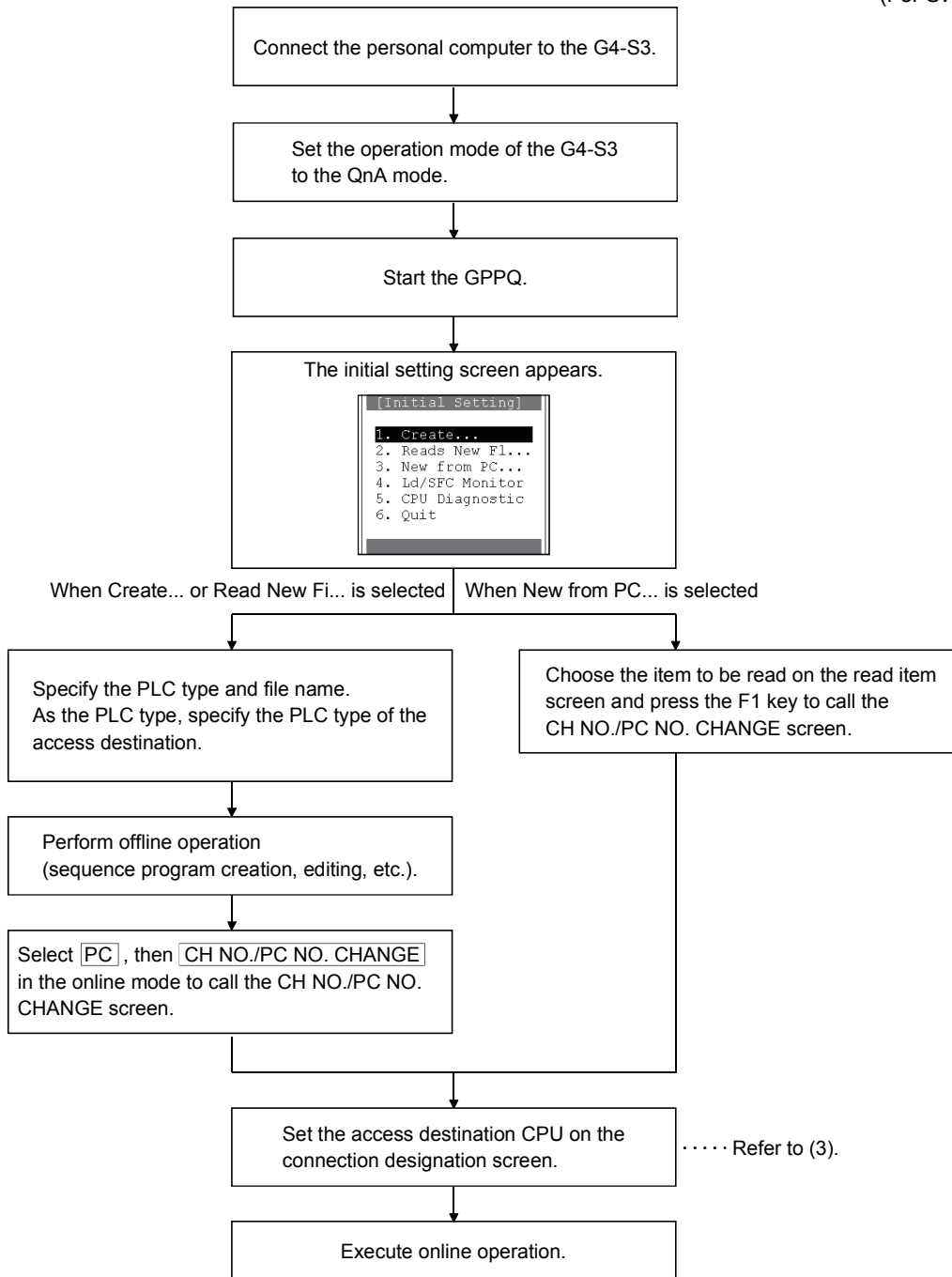

(3) Setting of connection designation screen

(For SW2IVD-GPPQ)

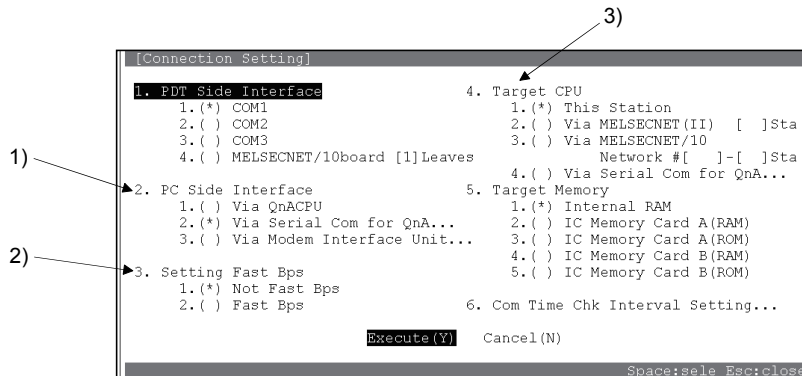

No.	Setting Item	Description								
1)	PC side interface	<p>Always specify "Via Serial Com for QnA". When "Via Serial Com for QnA" is specified, the "Via Serial Com for QnA" (PC side interface) screen appears.</p> <p>Specify the speed selected using the G4-S3 operation setting DIP switches SW2, 3 (peripheral-to-peripheral transmission speed setting). (Refer to Section 4.3.)</p> <p>When performing operation for the PLC CPU of the Master/local station on CC-Link, specify the station number of the accessed Master/local station. When performing operation for the other station on the coexistence network, specify the station number of the Master/local station on its own CC-Link which first intervenes in the coexistence network.</p>								
2)	Setting Fast Bps	<p>Specify "Not Fast Bps". If "Fast Bps" is specified, high-speed communication cannot be made.</p>								
3)	Target CPU	<p>What is specified depends on the PLC to be accessed.</p> <table border="1"> <thead> <tr> <th>Access Destination</th> <th>Setting Item</th> </tr> </thead> <tbody> <tr> <td>PLC on CC-Link Master/local station</td> <td>Specify "This Station".</td> </tr> <tr> <td>Other station PLC in MELSECNET(II) system</td> <td>Specify "Via MELSECNET(II)" and specify the station number of the access destination.</td> </tr> <tr> <td>Other station PLC in MELSECNET/10 (including Ethernet) system</td> <td>Specify "Via MELSECNET/10" and specify the network number and station number of the access destination.</td> </tr> </tbody> </table>	Access Destination	Setting Item	PLC on CC-Link Master/local station	Specify "This Station".	Other station PLC in MELSECNET(II) system	Specify "Via MELSECNET(II)" and specify the station number of the access destination.	Other station PLC in MELSECNET/10 (including Ethernet) system	Specify "Via MELSECNET/10" and specify the network number and station number of the access destination.
Access Destination	Setting Item									
PLC on CC-Link Master/local station	Specify "This Station".									
Other station PLC in MELSECNET(II) system	Specify "Via MELSECNET(II)" and specify the station number of the access destination.									
Other station PLC in MELSECNET/10 (including Ethernet) system	Specify "Via MELSECNET/10" and specify the network number and station number of the access destination.									

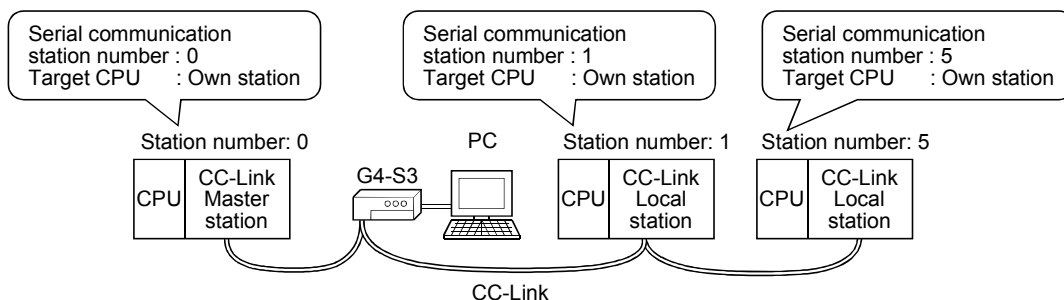

6.2.3 Using GPPA

When using GPPA, set the G4-S3 to the A mode.

(1) Settings

Make the following settings to use GPPA.

Setting Side		Settings
G4-S3	Operation mode	A mode
	Transmission speed	No need to set
GPPA (CH NO. PC NO. Change)	PC NO.	Via MELSECNET(II)
	PC NO.	Set the station number of the accessed Master/local station on CC-Link.

(2) General procedure

(For SW4IVD-GPPA)

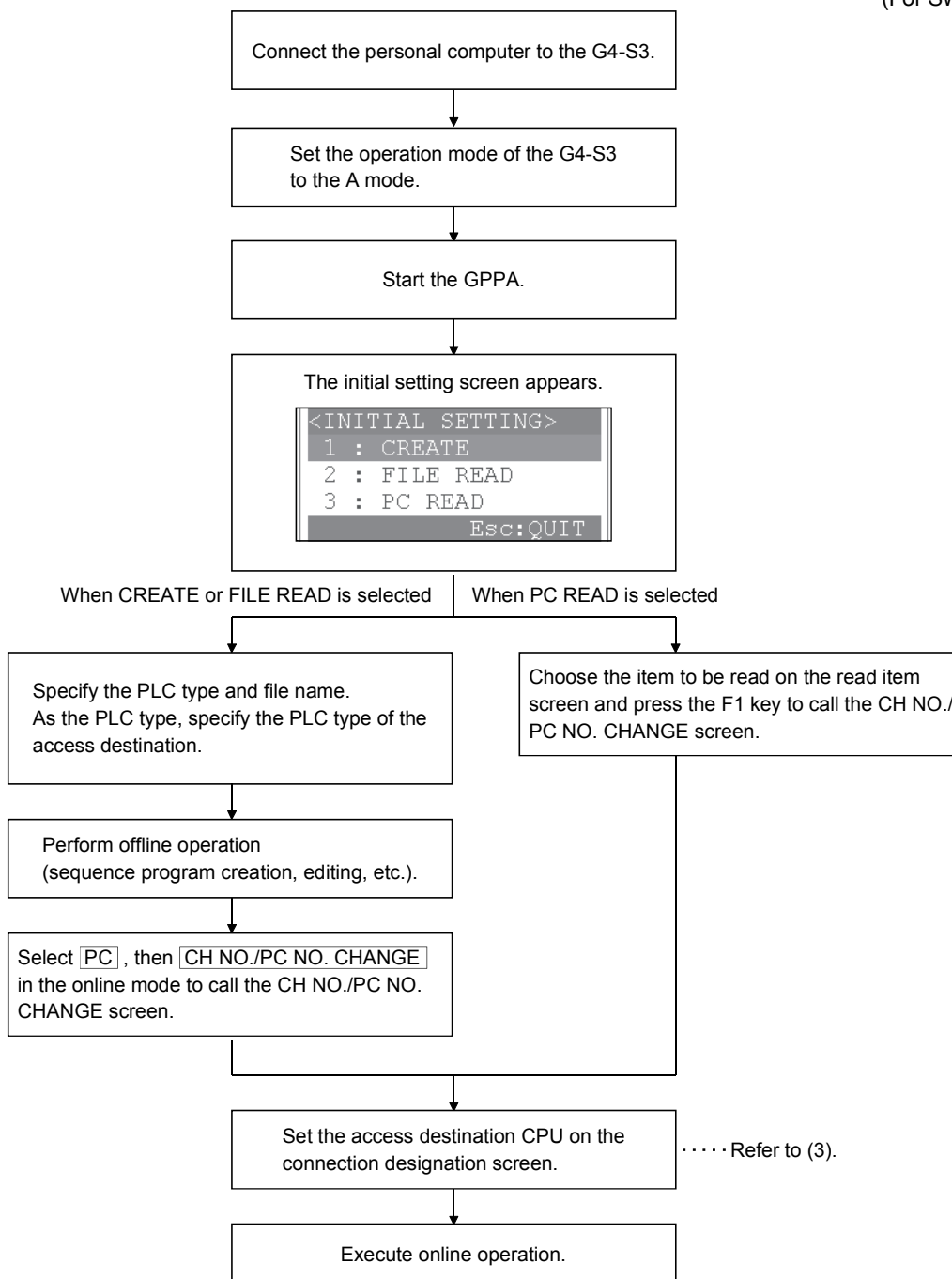

(3) Setting of the CH No./PC No. change screen

(For SW4IVD-GPPA)

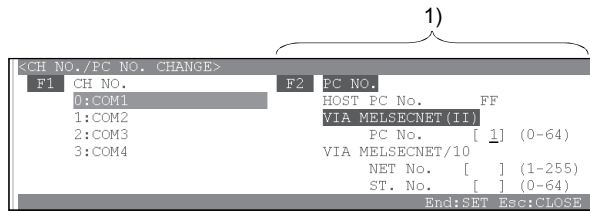

No.	Setting Item	Description						
1)	PC NO.	<p>Select "VIA MELSECNET(II)" and set the station number of the Master/local station of the CC-Link module to which the G4-S3.</p> <table border="1"> <thead> <tr> <th>Access Destination</th> <th>PC Number to Be Specified</th> </tr> </thead> <tbody> <tr> <td>CC-Link Master station</td> <td>"VIA MELSECNET(II)" : Specify 0.</td> </tr> <tr> <td>CC-Link Local station</td> <td>"VIA MELSECNET(II)" : Specify any of 1 to 64.</td> </tr> </tbody> </table>	Access Destination	PC Number to Be Specified	CC-Link Master station	"VIA MELSECNET(II)" : Specify 0.	CC-Link Local station	"VIA MELSECNET(II)" : Specify any of 1 to 64.
Access Destination	PC Number to Be Specified							
CC-Link Master station	"VIA MELSECNET(II)" : Specify 0.							
CC-Link Local station	"VIA MELSECNET(II)" : Specify any of 1 to 64.							

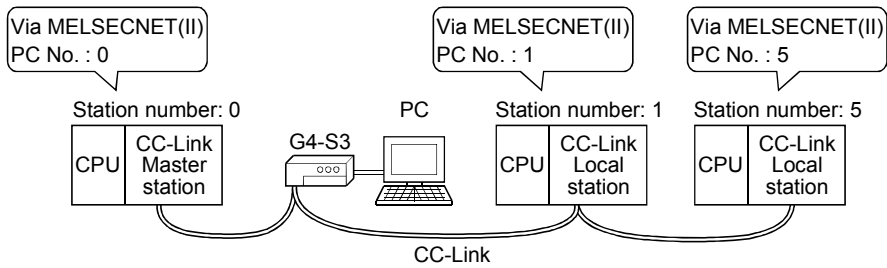

6.3 Accessible Range

(1) When using the QnA mode

Access can be made to the QnACPU on CC-Link where the G4-S3 is connected.

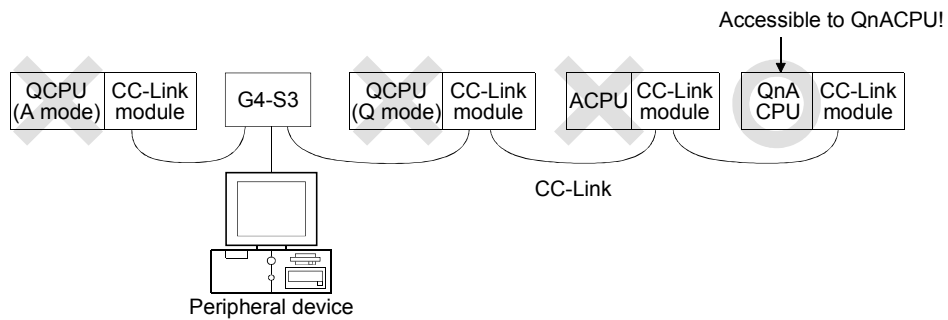

(2) When using the A mode

Access can be made to the ACPU and QCPU (A mode) on CC-Link where the G4-S3 is connected.

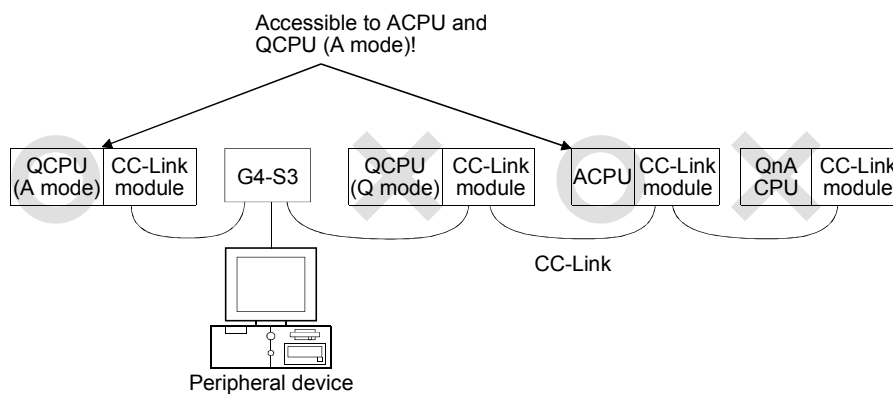

6.4 Available Functions

The following tables indicate the online-operation functions of the MELSEC PLC programming software available for access to the PLC CPU via the G4-S3.

Refer to the operating manual of the used MELSEC PLC programming software for the offline-operation functions and others not given below.

6.4.1 Using GX Developer

The following online-operation functions are available for use of GX Developer Version 5 or earlier.

○: Available, ×: Unavailable

(1) Common functions

Online(Common functions)		Availability	
		QnA mode	A mode
Transfer setup	Designates a PLC destination.		
Read from PLC	Reads data from PLC.		
Write to PLC	Writes data to PLC.		○
Verify with PLC	Verifies data with PLC data.		
Write to PLC (Flash ROM)			
Write the program memory to ROM	Writes program memory data to the standard ROM/IC memory card (ROM).		×
Write to PLC (Flash ROM)	Writes data to the standard ROM/IC memory card (ROM).		
Delete PLC data	Deletes PLC data.	○	×
Change PLC data attributes	Change PLC data attributes.		
PLC user data			
Read PLC user data	Reads user data from the PLC.		
Write PLC user data	Writes user data to the PLC.		×
Delete PLC user data	Deletes user data of the PLC.		
Monitor			
Monitor mode	Places the circle edit screen in monitor mode.		
Monitor (write mode)	Sets the circuit (monitor write) mode.		
Start monitor (All windows)	Starts monitoring all open windows.		
Stop monitor (All windows)	Stops monitoring all open windows.		
Start monitor	Restarts the stopped monitor.		
Stop monitor	Stops the monitor.		
Change current value monitor (Decimal)	Displays the current device value of the circuit monitor in decimal form.		○
Change current value monitor (Hexadecimal)	Displays the current device value of the circuit monitor in hexadecimal form.		
Device batch	Monitors devices in batch mode.		
Entry data monitor	Entry data mode.		
Buffer memory batch	Monitors the buffer memory in batch mode.		
Monitor condition setup	Sets the monitor execution conditions.		×
Monitor stop condition setup	Sets the monitor stop conditions.		
Program monitor list	Monitors a program list.		
Interrupt program monitor list	Lists the interrupt programs.	○	×
Scan time measurement	Measures the scan time.		
Entry ladder monitor	Entry the ladder block.		○
Delete all entry ladder	Delete all entry ladder.		
Debug			
Device test	Turns on or off the device or changes the value.		○
Debug	Executes/disables the debugging function.		
Skip execution	Makes settings for skip.	○	×
Partial execution	Makes settings for partial operation.		
Step execution	Makes settings for step execution.		○

Online(Common functions)		Availability	
		QnA mode	A mode
Trace	Execute sampling trace.	○	
Remote operation	Operates the PLC remotely.	○	
Keyword setup		○	
Register	Registers or changes the keyword.		
Delete	Cancels the keyword.		
Disable	Unlocks access by keywords.		
Clear PLC memory	Clears the PLC memory cassette or device memory.	○	
Format PLC memory	Formats the PLC memory.	○	×
Arrange PLC memory	Arranges the data area within the PLC memory.	○	
Set time	Sets the internal timer of the PLC.	○	
Diagnosis (Common functions)		○	
PLC diagnostics	Diagnoses the PLC.		
Network diagnostics	Diagnoses the network. (Network monitor only) * When the A mode is used, the AnUCPU is monitored as the AnACPU.		
CC-Link diagnostics	CC-Link diagnostics.		
System monitor	Monitors the system status of the PLC.		
Tool (Common functions)		×	
Start ladder logic test	Starts the ladder logic test.		
Set TEL data			
Connection	Connect the line for A6TEL/Q6TEL.		
Disconnect	Disconnect the line.		
TEL data	Set the report data of A6TEL or Q6TEL.		
AT command	Entry the modem.		
Call book	Set the call book.		

(2) Ladder editing functions

Conversion(Ladder editing functions)		Availability	
		QnA mode	A mode
Convert (Online change)	Converts the program and writes it during run.	○	○

(3) SFC editing functions

Online(SFC editing functions)		Availability	
		QnA mode	A mode
Debug (SFC)		○	
Device test	Sets the device value.		
Block brake	Block brake.		
Step brake	Step brake.		
Block run	Block run.		
Step run	Step run.		
1 step run	1 step run.		
Block forced stopping	Block forced stopping.		
Step forced stopping	Step forced stopping.		
Reset stored step	Reset stored step.		
Run all block	Run all block.	×	○

POINT

Refer to the GX Developer operating manual for details of the available functions.

6.4.2 Using GPPQ

The following online-operation functions are available for use of GPPQ.

○: Available, ×: Unavailable

Mode	Menu	Function	Availability		
Initial setting		New PLC data read	○		
		Ladder monitoring			
		CPU diagnostic			
Initial setting mode		New PLC read			
Ladder mode(ladder write)		Write during RUN			
Ladder mode (monitor)		Ladder monitoring	○		
		Device registration monitoring			
		ON/OFF cause automatic search			
Ladder mode (test)		Monitor trigger stop	○		
		Forced ON/OFF			
		Present value change			
		Set value change			
Ladder mode (debugging)		Step execution	○		
		Partial execution			
Ladder mode	PC	Read, write, verify	○		
		Read a new file for editing			
		File list			
		Connection designation			
		Remote operation			
	Monitoring/test			Batch device monitoring	
				Batch multi-device monitoring	
				ON/OFF cause automatic search	
				Scan time measurement	
				Device registration monitoring	
				Monitoring condition setting	×
				Monitoring stop condition setting	
				Monitor data registration/utilization	
				Device test	
				Sampling/monitoring trace	
				Step execution	
				Partial execution	
				Skip execution	
				I/O, link, buffer memory simulation	
				Monitoring field value display switching	
				Program run status monitoring	
				Local device setting	
				Option	Monitoring destination setting
List mode	PC	Read, write, verify			
		Read a new file for editing			
		File list			
		Connection designation			
		Remote operation			

Mode	Menu	Function	Availability
Parameter mode	PC	Read, write, verify	
		Read a new file for editing	
		File list	
		Connection designation	
		Remote operation	
Device mode	Buffer memory simulation		
	PC	Read, write, verify	
		Read a new file for editing	
		File list	
		Connection designation	
		Remote operation	
Online mode	Drive name selection		
	File selection		
	PC	Read, write, verify	
		Read a new file for editing	
		File list	
		Remote operation	
		Write option	
		Password registration	
		Device memory operation	
		Batch PLC memory operation	
		Delete	
		Title creation	
	Find	Find first/last	
		Find file	
		Find number	
		Find data	
	Trace	Sampling trace	
		Monitoring trace	
		Status latch	
		Programming trace	
	Test	Device test	
		Local device setting	
	PC diagnostic mode	Diagnosis target selection	
Present error display			
Fault history display			
CPU message			
Module detail display			
PC		Fault history clear	
		Clock setting	
		Module loading/unloading during RUN	
Display		Present error display	
		Fault history display	
		CPU message	
		Module detail display	
		CPU panel	
	Detail HELP display		

Mode	Menu	Function	Availability
PC diagnostic mode	Network	Line monitoring (host/other station)	○
		Status monitoring	
		Error history monitoring	
		Transient transmission monitoring	
		Network test	
		Online network status diagnostic	
		Loop test	
		Setting check test	
		Station sequence check test	
		Communication test	
		Device monitoring (when Remote station is connected)	
	Network (CC-Link diagnostic)	Line monitoring (host station)	
		Line monitoring (other station)	
		Device monitoring	
		Network test	
		Line test	
		Parameter test	
	Documentation mode	PC	
Read a new file for editing			
File list			
Connection designation			
Remote operation			
File maintenance mode	PC	File ← PLC (read)	
		File → PLC (write)	
		File, PLC verify	
		File deletion	
		File list	
		Connection designation	
		Remote operation	
		Write option	
		Password registration	
		IC memory card	File ← IC memory card (read)
	File → IC memory card (write)		
	File, IC memory card verify		
	File deletion		
	File list		
	Write option		
	Password registration		
	Title creation		

POINT
Refer to the GPPQ operating manual for details of the available functions.

6.4.3 Using GPPA

The following online-operation functions are available for use of GPPA.

○: Available, ×: Unavailable

Mode	Menu		Function	Availability	
Programming menu	Ladder	Auxiliary	Ladder modification during PLC CPU RUN	×	
		Monitoring	Circuit monitoring, registration monitoring	○	
			Present value monitoring display switching		
			Monitor screen stop		
		Test	Forced ON/OFF		
			SET/RST		
			Present value changing		
			Step run		
			Offline designation		
			16-point registration monitoring		
			Batch device monitoring		
			Batch buffer memory monitoring		
			Display switching, main/sub switching		
			Monitoring destination setting		
Online menu	PC		Read, write, verify		×
		Test			
		Password registration			
		DWR setting			
		CH No. PLC No. changing			
	Network monitoring (other than AnUCPU)	Loop monitoring(when Master station is connected)			
		Loop monitoring(when Local station is connected)			
		Loop monitoring(when Remote I/O station is connected)			
		Batch monitoring(when Remote I/O station is connected)			
	Network monitoring (AnUCPU)	Line monitoring, status monitoring			
		Error history monitoring			
		Network test			
	Network diagnostic	Loop test			
		Setting check			
		Station sequence check test, communication test			
	Status latch	Setting	Setting		
			PLC read		
			All clear		
	Status latch		PLC read		
		Sampling trace	Registration	Registration	
	Capacity				
	PLC write, PLC read				
	All clear				
	Display		Display		
	Monitoring trace	Registration	Registration		
			All clear		
			Display		
	Drawing menu	Comment	PLC read, PLC write	○	
		Extra comments 1, 2, 3, 4	PLC read (Expansion comment 1 only), PLC write (Expansion comment 1 only)		

POINT

Refer to the GPPA operating manual for details of the available functions.

7 TROUBLESHOOTING

7.1 Online Operation of the Peripheral Devices Cannot Be Performed for the CPU Specified as the Access Destination

The following table lists the causes and corrective actions when online operations cannot be performed from the peripheral device.

Cause	Corrective Action						
CC-Link communication error occurred.	Check the indicator LEDs. (Refer to section 7.2 and 7.3.)						
Cable is not connected properly between G4-S3 and peripheral device.	<p>Check the connection cable. Whether cable connection between G4-S3 and peripheral device is proper or not can be checked using the remote input signal of the G4-S3.</p> <table border="1" data-bbox="608 703 1415 808"> <thead> <tr> <th data-bbox="608 703 778 739">Input Number</th> <th data-bbox="778 703 1082 739">Signal Name</th> <th data-bbox="1082 703 1415 739">Status</th> </tr> </thead> <tbody> <tr> <td data-bbox="608 739 778 808">RX(n+1)A</td> <td data-bbox="778 739 1082 808">Remote station ready signal</td> <td data-bbox="1082 739 1415 808"> ON : Normal connection OFF : Connection error </td> </tr> </tbody> </table> <p>n: Indicates the first I/O number of the G4-S3 assigned to the Master module by station number setting.</p>	Input Number	Signal Name	Status	RX(n+1)A	Remote station ready signal	ON : Normal connection OFF : Connection error
Input Number	Signal Name	Status					
RX(n+1)A	Remote station ready signal	ON : Normal connection OFF : Connection error					
Operation setting DIP switches of the G4-S3 are not set to correct positions.	Check the operation setting DIP switches. (Refer to Section 4.3.)						
PLC cannot be accessed from peripheral device.	<p>If error message "CANNOT COMMUNICATE WITH PLC" appears on the peripheral screen, check for:</p> <ul style="list-style-type: none"> • Incorrect station number specified for the station to communicate with. • Abnormal data communication between master module and G4-S3. (This can be checked by the indicator LED.) • Abnormal operation of the PLC to be accessed. (This can be checked by the ERROR LED and special relay/special data register.) • Abnormal data link of the MELSECNET when access is made to the other station via the MELSECNET. (This can be checked by the special relay/special data register, etc. for MELSECNET.) • A fault of the cable for connection between peripheral device and G4-S3. (Refer to the Corrective Action of the second Cause above.) • When the MELSEC-A series CC-Link system Master/local module is used, add the normally closed contact (OFF) of XnC to the contact of the FROM/TO instruction as described in Section 2.4(1). 						
MELSEC PLC programming software setting error	<p>If any of the following error messages is displayed on the peripheral device screen, first check the PLC station number setting, etc. of the access destination. (Refer to Chapter 5 and 6.)</p> <ul style="list-style-type: none"> • "Password is not released" • "Cannot receive from PLC(time over)" • "PLC type incorrect" <p>When online operation cannot be performed after checking and correct setting are made in accordance with Chapter 6 or when the error message displayed on the peripheral device screen is other than the above, refer to the operating manual of the software used and take corrective action.</p>						

POINT

When the accessed Master/local station is the AJ61BT11 or A1SJ61BT11, set SW8 of the condition setting switches of the Master/local station to OFF.

7.2 How to Check an Error with the Indicator LEDs

This section describes how to check an error using the indicator LEDs of the G4-S3. For errors related to the PLC CPU and Master module, refer to the user's manuals of the PLC CPU and Master/Local module.

(1) If the PW LED of the G4-S3 goes OFF

Cause	Corrective Action
24VDC power is not supplied to the G4-S3 or voltage is insufficient.	Check the voltage of the 24VDC power supply.

(2) If the RUN LED of the G4-S3 goes OFF

Cause	Corrective Action
Watchdog timer error occurred.	Switch on power of the G4-S3 again *1. If the RUN LED does not turn ON after power is switched on again, the hardware may be faulty. Consult your sales representative.

(3) If the L RUN LED of the G4-S3 goes OFF

Cause	Corrective Action
Watchdog timer error occurred.	Switch on power of the G4-S3 again *1. If the L RUN LED does not turn ON after power is switched on again, the hardware may be faulty. Consult your sales representative.
CC-Link dedicated cable is broken or shorted.	Check and repair the CC-Link dedicated cable.
Master station stopped link.	Check for an error at Master station.
Station number was repeated.	Switch power on again after correcting the station number setting of the module of which station number was repeated. *1
Station number setting switch or data link transmission setting switch setting is wrong.	Switch power on again after correcting the station number setting switch or data link transmission setting switch setting. *1

(4) If the L ERR. LED of the G4-S3 flickers at regular intervals

Cause	Corrective Action
Station number setting switch or data link transmission speed setting switch setting was changed during normal operation.	Return the station number or data link transmission speed to the previous setting. If the L RUN LED does not turn ON with the previous setting, the hardware may be faulty. Consult your sales representative.
Station number setting switches or data link transmission speed setting switch is faulty	If the L ERR. LED begins to flicker although the switch setting was not changed during operation, the hardware may be faulty. Consult your sales representative.

(5) If the L ERR. LED of the G4-S3 flickers at irregular intervals

Cause	Corrective Action
Terminal resistors are left unconnected.	Check that the terminal resistors are connected. If not, connect them and switch power on again *1.
Modules or CC-Link dedicated cable are affected by noise.	<ul style="list-style-type: none"> • Connect both ends of the shielded wire of the CC-Link dedicated cable to grounded via SLD and FG of each module. • Securely connect the FG terminal of the module to ground. • Securely ground the piping when running cables in piping.

(6) If the L ERR. LED of the G4-S3 is ON

Cause	Corrective Action
Station number setting switch or data link transmission setting switch setting is wrong.	Switch power on again after correcting the station number setting switch or data link transmission setting switch setting. *1

*1: Switch power on again: Power supply on the G4-S3 again or press on the reset switch of the G4-S3.

7.3 Communication Error Occurs between Master Station and G4-S3

If any repeated station number bit in any of the link special registers SW0098 to SW009B (repeated station number status) switches on, check the G4-S3 of the corresponding station number in the following flowchart.

Troubleshooting flowchart used when the "ERR" LED of the Master station flickers

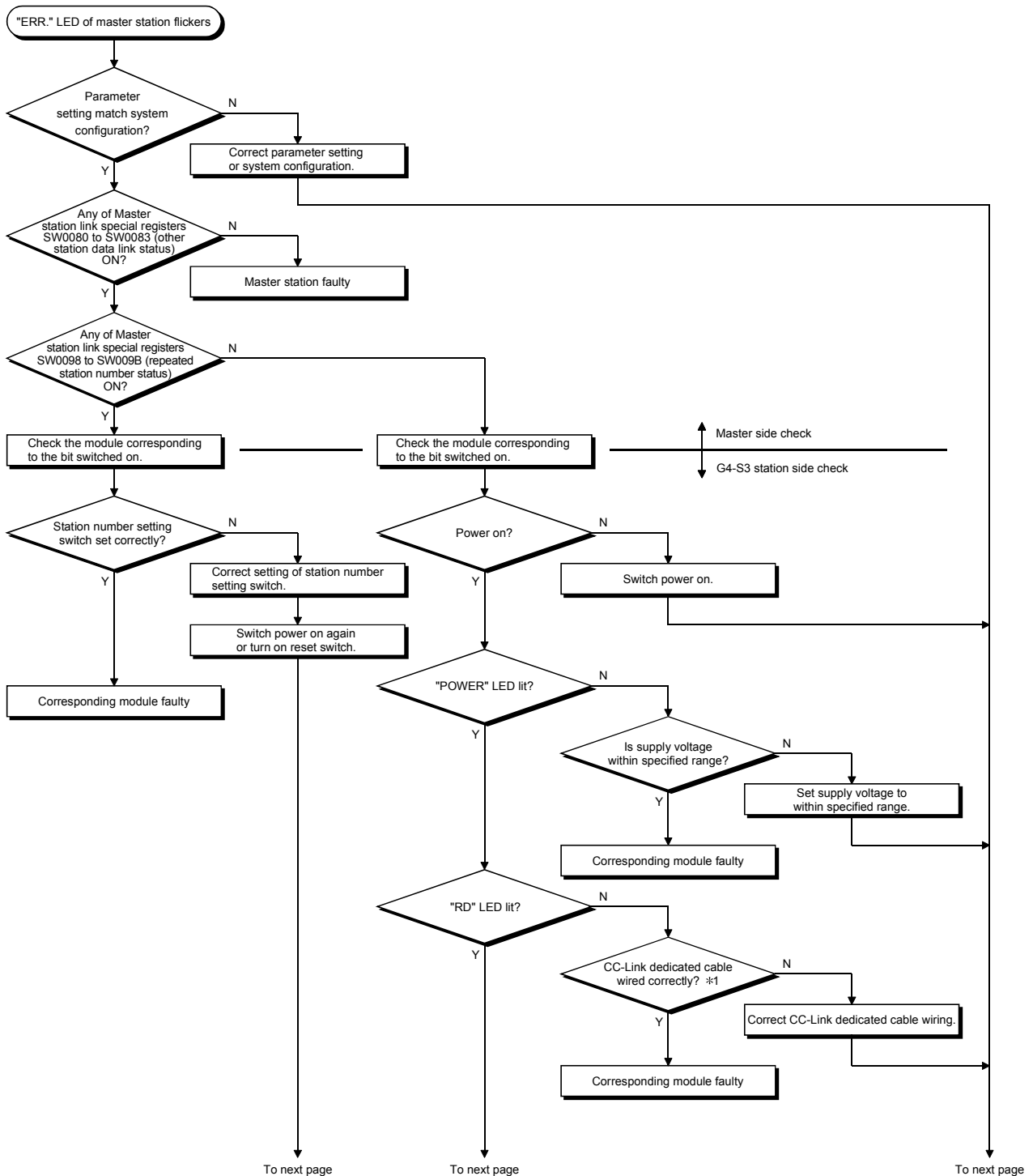

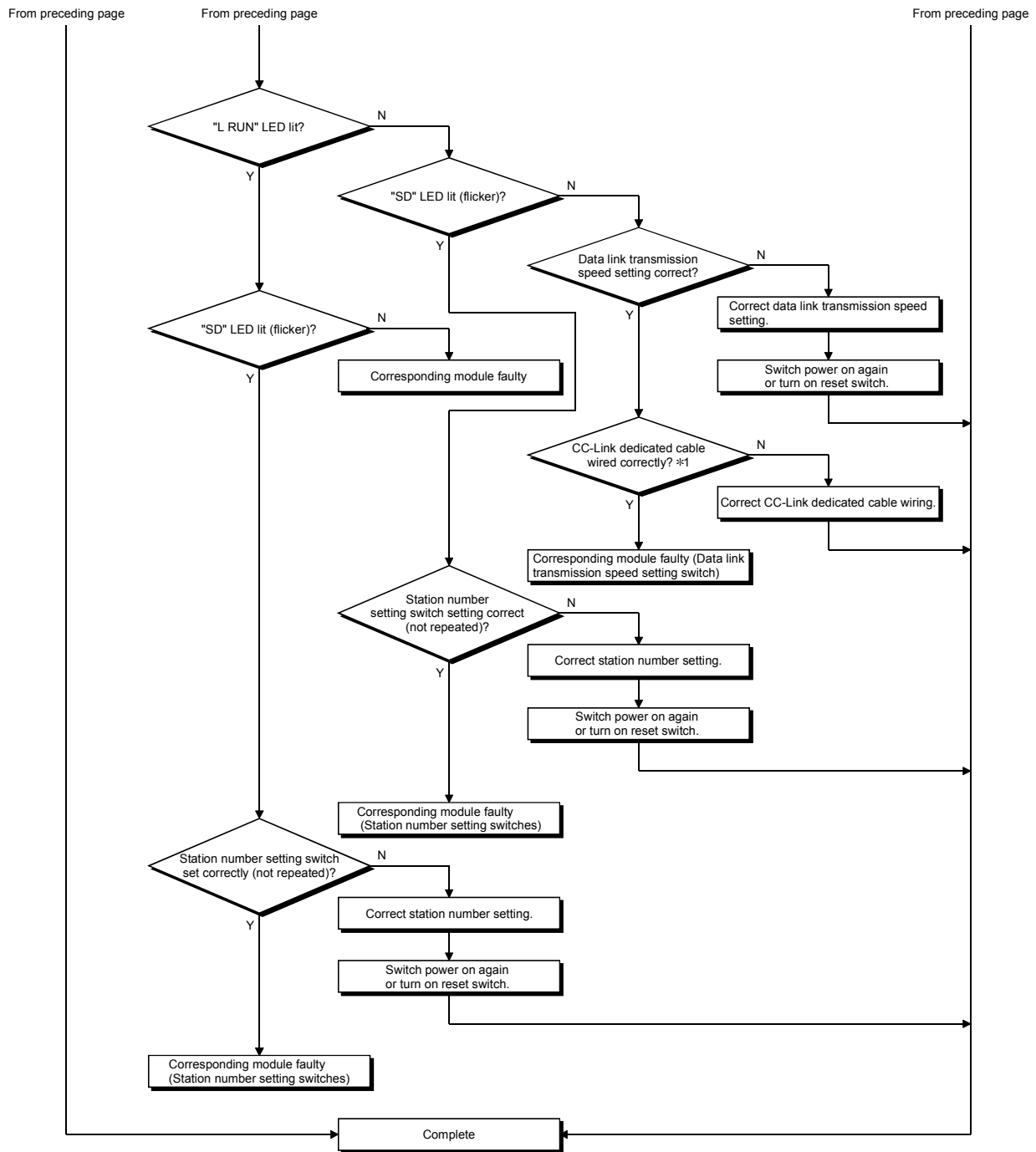

*1: Check for short circuit, reverse connection, wire breakage, no terminal resistor, improper FG connection, improper overall distance and improper interstation distance.

POINT

When a "communications error" occurs during access from the peripheral device
 When the MELSEC-A series CC-Link system Master/local module is used, confirm the description in Section 2.4 (1) and add the normally closed contact (OFF) of the input signal (XnC) to the contact of the FROM/TO instruction given to the buffer memory.

APPENDICES

Appendix 1 Comparison Between AJ65BT-G4 and AJ65BT-G4-S3

There are the following differences between the AJ65BT-G4 and AJ65BT-G4-S3.

Description	AJ65BT-G4	AJ65BT-G4-S3
Q mode	Cannot be set.	Setting the Q mode enables access to the QCPU (Q mode).
Access to QCPU (Q mode) or to ACPU or QCPU (A mode) of other station (coexistence network)	Inaccessible	Enabled by using GX Developer Version 6 or later.
Automatic setting of transmission speed	Cannot be set.	When the Q mode is used, the transmission speed between peripheral device and G4-S3 is automatically set.

Appendix 2 Outline Dimension Drawing

The outline dimension drawing of the G4-S3 is shown below.

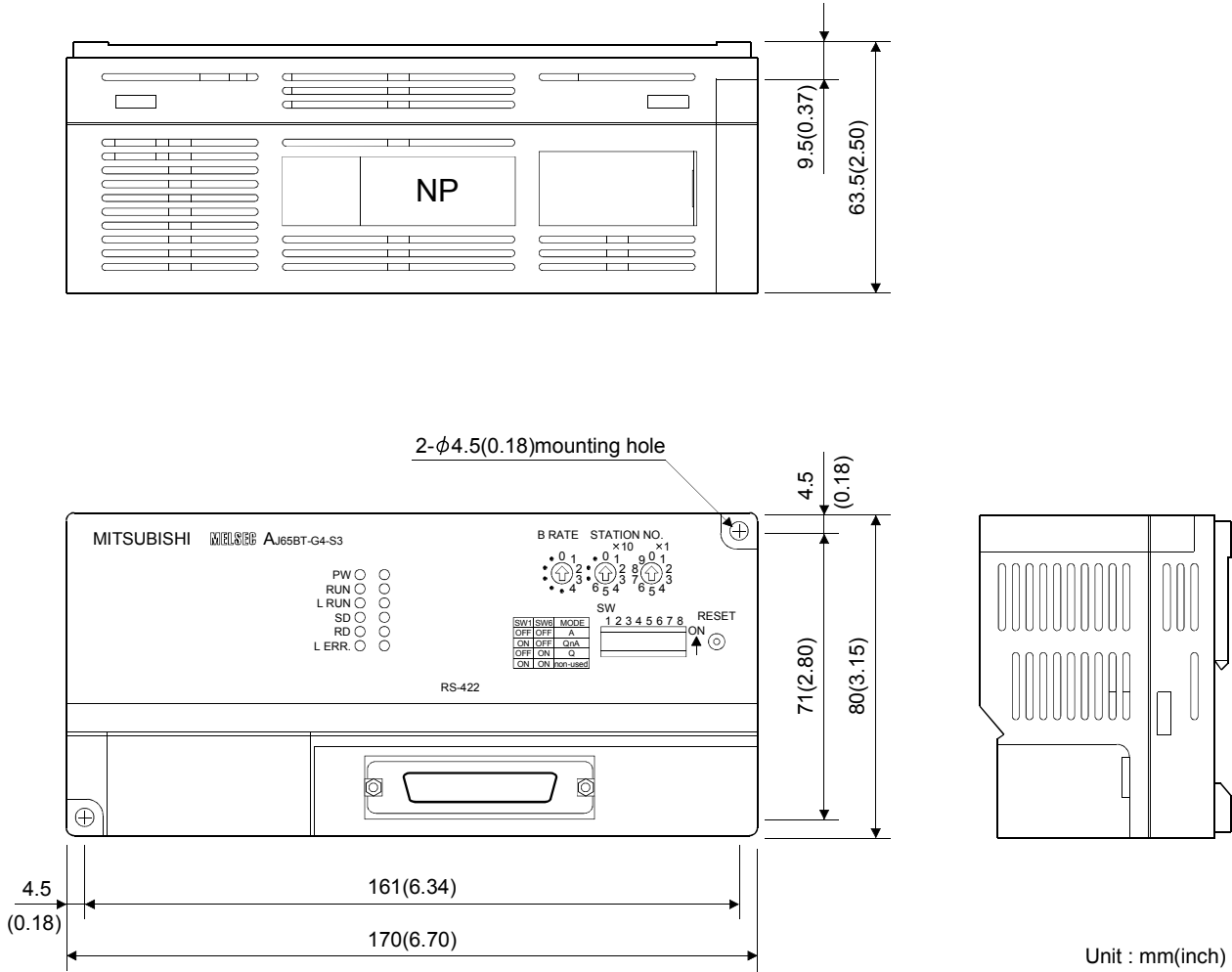

Appendix 3 Initial Setting Examples of CC-Link

To perform data link of the CC-Link system, the initial settings of CC-Link must be made to the Master station of CC-Link.

This section provides the examples of the initial settings to be made to the Master module of the CC-Link system for access to the PLC CPU from the peripheral device via the G4-S3.

The following system configuration is used for the initial setting examples explained in this section.

(1) System configuration for initial setting examples

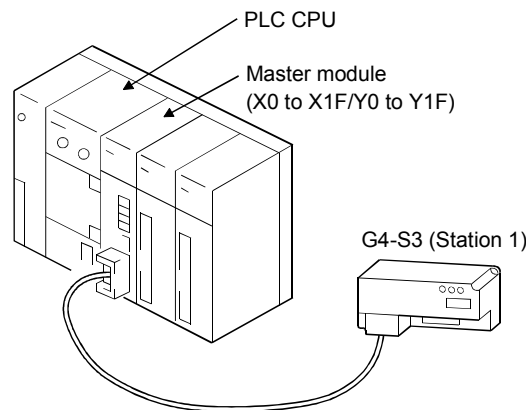

Appendix 3.1 Initial setting example for A series CC-Link master station

The following initial setting program example for the A series CC-Link Master station is designed to make access to the ACPU/QCPU (A mode) from the peripheral device via the G4-S3 (operation mode is A mode).

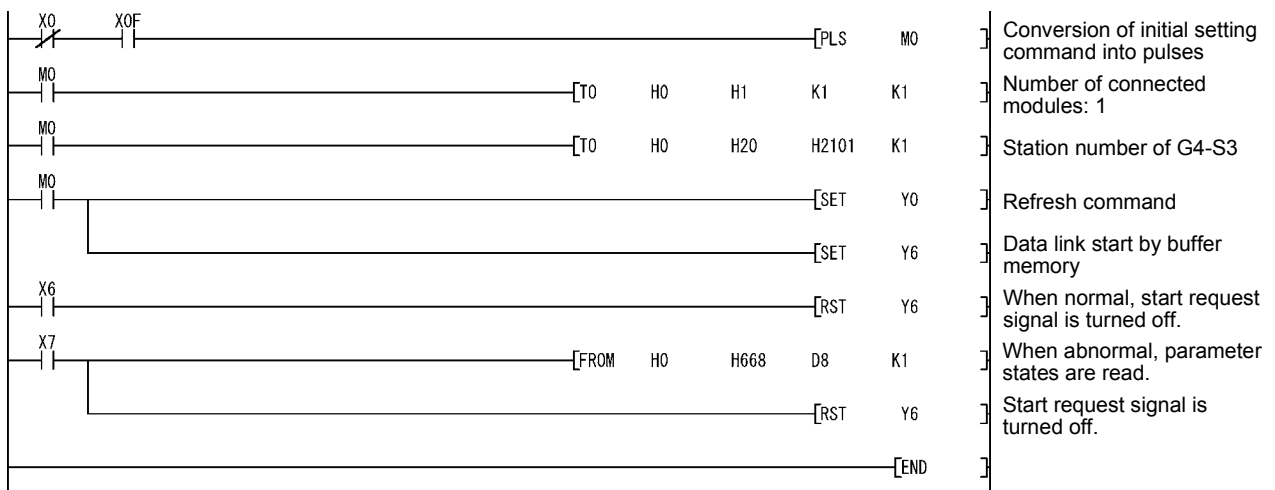

Appendix 3.2 Initial setting example for Q (Q mode)/QnA series CC-Link master station

The following initial setting example for the Q (Q mode)/QnA series CC-Link Master station is designed to make access to the QCPU (Q mode) or QnACPU from the peripheral device via the G4-S3 (operation mode is Q or QnA mode).

<Parameter setting screen (for GX Developer Version 8)>

When the PLC series is the QCPU (Q mode)

	1	2
Start I/O No.	0000	
Operational setting	Operational settings	
Type	Master station	
Master station data link type	PLC parameter auto start	
Mode	Remote net(Ver.1 mode)	
All connect count	1	
Remote input(RX)		
Remote output(RY)		
Remote register(RW/r)		
Remote register(RW/w)		
Ver.2 Remote input(RX)		
Ver.2 Remote output(RY)		
Ver.2 Remote register(RW/r)		
Ver.2 Remote register(RW/w)		
Special relay(SB)		
Special register(SW)		
Retrv count	3	
Automatic reconnection station count	1	
Stand by master station No.		
PLC down select	Stop	
Scan mode setting	Asynchronous	
Delay information setting	0	
Station information setting	Station information	
Remote device station initial setting	Initial settings	
Interrupt setting	Interrupt settings	

When the PLC series is the QnACPU

	1	2	3	4
Start I/O No.	0000			
Type	Master station			
All connect count	1			
Remote input(RX)				
Remote output(RY)				
Remote register(RW/r)				
Remote register(RW/w)				
Special relay(SB)				
Special register(SW)				
Retrv count	3			
Automatic reconnection station count	1			
Wait master station No.	0			
PLC down select	Stop			
Scan mode setting	Asynchronous			
Delay information setting	0			
Station information setting	Station information			

<Station information setting screen (for GX Developer Version 8)>

When the PLC series is the QCPU (Q mode)

Station No.	Station type	Expanded cycle setting	Exclusive station count	Remote station ports	Reserve/invalid station select	Intelligent buffer select[word]
1/1	Intelligent device station	single	Exclusive station 1	32 points	No setting	Send Receive Automatic

When the PLC series is the QnACPU

Station No.	Station type	Exclusive station count	Reserve/invalid station select	Intelligent buffer select[word]
1/1	Intelligent device station	Exclusive station 1	No setting	Send Receive Automatic

INDEX

[A]
 A mode 6- 1
 Abbreviation.....A- 9
 Accessible PLC CPUs 2- 4
 Accessible range
 For use of other than GX Developer
 Version 5 or earlier 6-12
 For use of GX Developer
 Version 6 or later 5- 4

[C]
 Cable 4- 5
 CC-Link dedicated cables 4- 5
 Comparison between
 AJ65BT-G4 and AJ65BT-G4-S3App- 1
 Configuration
 Product makeupA-10
 System 2- 1
 Connection of cables with the modules..... 4- 5

[D]
 Data link terminal block 4- 4
 Data link transmission speed
 setting switch 4- 3
 DIN rail 4- 2

[E]
 EMC directiveA- 8

[F]
 Features..... 1- 1

[G]
 General procedure
 For use of GPPQ 6- 7
 For use of any of GX Developer
 Version 5 or earlier 6- 3
 For use of GPPA 6-10
 For use of GX Developer
 Version 6 or later 5- 2
 General specifications..... 3- 1
 Generic term.....A- 9

[H]
 Hardware check test4- 6

[I]
 Indicator LED4- 4
 Initial setting examples App- 3
 Installation4- 2
 Installation environment.....4- 2
 Instructions for system configuration.....2- 2
 Instructions
 For system configuration2- 2
 For use of G4-S3.....2- 5

[L]
 LED.....4- 4
 Loading and installation4- 2
 Low voltage instruction A- 8

[M]
 MELSEC PLC programming software2- 4

[N]
 Name of the parts and their settings4- 3
 Names4- 3

[O]
 Operation setting DIP switches4- 4
 Outline dimension drawing App- 2
 Overview 1- 1

[P]
 Peripheral devices2- 1
 Performance specifications3- 2
 Power supply and data link terminal block....4- 4
 Pre-operation procedure.....4- 1
 Procedure.....4- 1
 Product makeup..... A-10

[Q]
 QnA mode6- 1

[R]
 Related manuals A- 8
 Reset switch4- 4
 RS-422 interface4- 4

[S]

Safety precautions.....	A- 1
Setting example	
When any of GX Developer	
Version 5 or earlier is used	6- 4
When GPPA is used.....	6-11
When GPPQ is used	6- 8
When GX Developer	
Version 6 or later is used.....	5- 3
Setting operation	
When any of GX Developer	
Version 5 or earlier is used	6- 2
When GPPA is used.....	6- 9
When GPPQ is used	6- 6
When GX Developer	
Version 6 or later is used.....	5- 1
Specification	
General specifications	3- 1
Performance specifications	3- 2
Station number setting switches	4- 3
System configuration.....	2- 1

[T]

Terminal resistor.....	4- 5
Terms.....	A-10
Test	
Hardware check.....	4- 6
Tightening torque range	4- 2
Troubleshooting.....	7- 1

[U]

Usable functions	
When any of GX Developer	
Version 5 or earlier is used	6-13
When GPPA is used.....	6-18
When GPPQ is used	6-15
When GX Developer	
Version 6 or later is used.....	5- 5

[W]

Wiring.....	4- 5
-------------	------

WARRANTY

Please confirm the following product warranty details before using this product.

1. Gratis Warranty Term and Gratis Warranty Range

If any faults or defects (hereinafter "Failure") found to be the responsibility of Mitsubishi occurs during use of the product within the gratis warranty term, the product shall be repaired at no cost via the sales representative or Mitsubishi Service Company.

However, if repairs are required onsite at domestic or overseas location, expenses to send an engineer will be solely at the customer's discretion. Mitsubishi shall not be held responsible for any re-commissioning, maintenance, or testing on-site that involves replacement of the failed module.

[Gratis Warranty Term]

The gratis warranty term of the product shall be for one year after the date of purchase or delivery to a designated place.

Note that after manufacture and shipment from Mitsubishi, the maximum distribution period shall be six (6) months, and the longest gratis warranty term after manufacturing shall be eighteen (18) months. The gratis warranty term of repair parts shall not exceed the gratis warranty term before repairs.

[Gratis Warranty Range]

- (1) The range shall be limited to normal use within the usage state, usage methods and usage environment, etc., which follow the conditions and precautions, etc., given in the instruction manual, user's manual and caution labels on the product.
- (2) Even within the gratis warranty term, repairs shall be charged for in the following cases.
 1. Failure occurring from inappropriate storage or handling, carelessness or negligence by the user. Failure caused by the user's hardware or software design.
 2. Failure caused by unapproved modifications, etc., to the product by the user.
 3. When the Mitsubishi product is assembled into a user's device, Failure that could have been avoided if functions or structures, judged as necessary in the legal safety measures the user's device is subject to or as necessary by industry standards, had been provided.
 4. Failure that could have been avoided if consumable parts (battery, backlight, fuse, etc.) designated in the instruction manual had been correctly serviced or replaced.
 5. Failure caused by external irresistible forces such as fires or abnormal voltages, and Failure caused by force majeure such as earthquakes, lightning, wind and water damage.
 6. Failure caused by reasons unpredictable by scientific technology standards at time of shipment from Mitsubishi.
 7. Any other failure found not to be the responsibility of Mitsubishi or that admitted not to be so by the user.

2. Onerous repair term after discontinuation of production

- (1) Mitsubishi shall accept onerous product repairs for seven (7) years after production of the product is discontinued. Discontinuation of production shall be notified with Mitsubishi Technical Bulletins, etc.
- (2) Product supply (including repair parts) is not available after production is discontinued.

3. Overseas service

Overseas, repairs shall be accepted by Mitsubishi's local overseas FA Center. Note that the repair conditions at each FA Center may differ.

4. Exclusion of loss in opportunity and secondary loss from warranty liability

Regardless of the gratis warranty term, Mitsubishi shall not be liable for compensation of damages caused by any cause found not to be the responsibility of Mitsubishi, loss in opportunity, lost profits incurred to the user by Failures of Mitsubishi products, special damages and secondary damages whether foreseeable or not, compensation for accidents, and compensation for damages to products other than Mitsubishi products, replacement by the user, maintenance of on-site equipment, start-up test run and other tasks.

5. Changes in product specifications

The specifications given in the catalogs, manuals or technical documents are subject to change without prior notice.

6. Product application

- (1) In using the Mitsubishi MELSEC programmable logic controller, the usage conditions shall be that the application will not lead to a major accident even if any problem or fault should occur in the programmable logic controller device, and that backup and fail-safe functions are systematically provided outside of the device for any problem or fault.
- (2) The Mitsubishi programmable logic controller has been designed and manufactured for applications in general industries, etc. Thus, applications in which the public could be affected such as in nuclear power plants and other power plants operated by respective power companies, and applications in which a special quality assurance system is required, such as for Railway companies or Public service purposes shall be excluded from the programmable logic controller applications.

In addition, applications in which human life or property that could be greatly affected, such as in aircraft, medical applications, incineration and fuel devices, manned transportation, equipment for recreation and amusement, and safety devices, shall also be excluded from the programmable logic controller range of applications.

However, in certain cases, some applications may be possible, providing the user consults their local Mitsubishi representative outlining the special requirements of the project, and providing that all parties concerned agree to the special circumstances, solely at the users discretion.

Microsoft, Windows, Windows NT are registered trademarks of Microsoft Corporation in the United States and other countries.

Ethernet is a registered trademark of Xerox Corporation in the United States.

Other company names and product names used in this document are trademarks or registered trademarks of respective companies.

SPREAD

Copyright(c) 1998 FarPoint Technologies, Inc.

Peripheral Connection Module Type AJ65BT-G4-S3

User's Manual

MODEL	AJ65BTG4S3-U-S-E
MODEL CODE	13JR17
SH(NA)-080105-B(0606)MEE	

 **MITSUBISHI ELECTRIC CORPORATION**

HEAD OFFICE : TOKYO BUILDING, 2-7-3 MARUNOUCHI, CHIYODA-KU, TOKYO 100-8310, JAPAN
NAGOYA WORKS : 1-14, YADA-MINAMI 5-CHOME, HIGASHI-KU, NAGOYA, JAPAN

When exported from Japan, this manual does not require application to the Ministry of Economy, Trade and Industry for service transaction permission.

Specifications subject to change without notice.