

**MITSUBISHI ELECTRIC**

## ATTACHMENT (for 5.7", 8.4", 10.4") (for GOT2000/GOT1000 Series)

### User's Manual

**GT15-70ATT-98**  
**GT15-70ATT-87**  
**GT15-60ATT-97**  
**GT15-60ATT-96**  
**GT15-60ATT-87**  
**GT15-60ATT-77**  
**GT15-50ATT-95W**  
**GT15-50ATT-85**

Thank you for choosing Mitsubishi Electric Graphic Operation Terminal (GOT).

**Prior to use, please read both this manual and detailed manual thoroughly to fully understand the product.**

<b>MODEL</b>	GT15-ATT-U
<b>MODEL CODE</b>	1D7M02
IB(NA)-0800296-J(2307)MEE	

© 2004 MITSUBISHI ELECTRIC CORPORATION

#### [INSTALLATION PRECAUTIONS]

##### ⚠ CAUTION

- When mounting the attachment to the control panel, tighten clamp screws in the specified torque range so that it will be securely fixed. Failure to do so may cause the attachment to drop from the control panel.
- When mounting the GOT to the attachment, tighten clamp screws in the range of 0.36 to 0.48N·m so that it will be securely fixed. Loose tightening may cause the GOT to drop from the attachment. Overtightening may damage and drop screws and/or GOT, causing the GOT to drop off, fail or malfunction.

#### [DISPOSAL PRECAUTIONS]

##### ⚠ CAUTION

- Dispose of this product as industrial waste.

#### Manuals

The following shows manuals relevant to this product.

Manual name	Manual number (Type code)
GOT2000 Series User's Manual (Hardware) (Sold separately)	SH-081194ENG (1D7MJ5)
GT16 User's Manual (Hardware)	SH-080928ENG
GT15 User's Manual	SH-080528ENG

For the latest e-Manuals and PDF manuals, consult your local sales office.

#### Referenced Standard: GB/T15969.2

(Requirement of Chinese standardized law)

#### Product Components

The attachment consists of the following items.

Model	Product	Quantity
GT15-70ATT-98	Attachment	1
	Clamp screw (M4x8mm)	4
GT15-70ATT-87	Attachment	1
	Clamp screw (M4x8mm)	4
GT15-60ATT-97	Attachment	1
	Clamp screw (M4x8mm)	4
GT15-60ATT-96	Attachment	1
	Clamp screw (M4x8mm)	4
GT15-60ATT-87	Attachment	1
	Clamp screw (M4x8mm)	4
GT15-50ATT-95W	Attachment	1
	Clamp screw (M4x8mm)	4
GT15-50ATT-85	Attachment	1
	Clamp screw (M4x8mm)	4

## 1. Overview

This User's Manual describes the GOT2000/GOT1000 series panel fixing attachment (hereafter abbreviated as the attachment). The attachment is used for replacing the products listed in the table below with the GOT2000 series or GOT1000 series. Use of the attachment eliminates the need for additional machining of the control panel or similar enclosure. There are the following attachment types. Refer to the following manuals for the applicable GOT.

- GOT2000 Series User's Manual (Hardware)
- GT16 User's Manual (Hardware)
- GT15 User's Manual

Product	Model	Description	
Attachment	GT15-70ATT-98	For replacing GT168□, GT158□, A985GOT	
	GT15-70ATT-87	For replacing A870GOT-SWS/TWS or A8GT-70GOT-TB/TW/SB/SW	
	GT15-60ATT-97	For replacing GT167□, GT157□, or A97□ GOT	
	GT15-60ATT-96	For replacing A960GOT	
	GT15-60ATT-87	For replacing A870GOT-EWS, A8GT-70GOT-EB/EW, A77GOT-EL, or A77GOT-EL-S5/S3	
	GT15-60ATT-77	For replacing A77GOT-CL, A77GOT-CL-S5/S3, A77GOT-L, or A77GOT-L-S5/S3	
	GT15-50ATT-95W	For replacing A956WGOT, F940WGOT	
	GT15-50ATT-85	For replacing A85□ GOT	
	*1 The GP250□ and GP260□ manufactured by SCHNEIDER E.J.H. can also be replaced.		

## 2. Specifications

The following table indicates the performance specifications of the attachment. The general specifications of the attachment are the same as those of the GOT. For the general specifications of the GOT, refer to the user's manual of the GOT for which the attachment is to be used. After replacement, GOT with the attachment is IP4X-rated but not IP67F-rated (waterproof and dustproof).

Item	Specifications			
	GT15-70ATT-98	GT15-60ATT-97	GT15-60ATT-96	GT15-70ATT-87
Mounting panel thickness	2 to 3 mm (0.08 to 0.12 inch)			
Weight	0.29(0.64)	0.40(0.88)	0.24(0.53)	0.12(0.26)

Unit: kg (lb)

Item	Specifications			
	GT15-60ATT-87	GT15-50ATT-85	GT15-50ATT-95W	GT15-60ATT-77
Mounting panel thickness	2 to 3 mm (0.08 to 0.12 inch)			
Weight	0.25(0.55)	0.11(0.24)	0.17(0.37)	0.34(0.75)

Unit: kg (lb)

## 3. Part Names and External Dimensions

- (1) GT15-70ATT-98, GT15-60ATT-97, GT15-60ATT-96, GT15-60ATT-87, GT15-60ATT-77

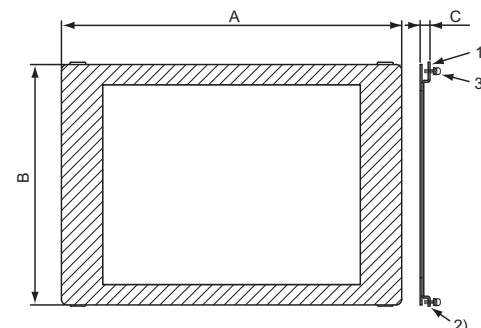

Model name	A	B	C
GT15-70ATT-98	314 (12.4)	240 (9.4)	8.5 (0.3)
GT15-60ATT-97	300 (11.8)	212 (8.3)	8.5 (0.3)
GT15-60ATT-96	270 (10.6)	195 (7.7)	8.5 (0.3)
GT15-60ATT-87	278 (10.9)	195 (7.7)	8.5 (0.3)
GT15-60ATT-77	313 (12.3)	195 (7.7)	8.5 (0.3)

Unit: mm (inch)

No.	Name	Description
1	Upper hook	Hook for hanging the attachment on the control panel upper part.
2	Lower hook	Hook for hanging the attachment on the control panel lower part.
3	Clamp screw	Screw for fixing the attachment to the control panel (M4x8mm)

#### SAFETY PRECAUTIONS

(Always read these precautions before using this equipment.)

Before using this product, please read this manual and the relevant manuals introduced in this manual carefully and pay full attention to safety to handle the product correctly.

The precautions given in this manual are concerned with this product.

In this manual, the safety precautions are ranked as "DANGER" and "CAUTION".

**WARNING** Indicates that incorrect handling may cause hazardous conditions, resulting in death or severe injury.

**CAUTION** Indicates that incorrect handling may cause hazardous conditions, resulting in medium or slight personal injury or physical damage.

Note that the ⚠ CAUTION level may lead to a serious accident according to the circumstances.

Always follow the precautions of both levels because they are important to personal safety.

Please save this manual to make it accessible when required and always forward it to the end user.

#### (2) GT15-70ATT-87

Model	A	B	C
GT15-70ATT-87	311 (12.2)	222 (8.7)	5.5 (0.2)

Unit: mm (inch)

#### (3) GT15-50ATT-95W, GT15-50ATT-85

Model	A	B	C
GT15-50ATT-95W	216 (8.1)	137 (5.4)	2.6 (0.1)
GT15-50ATT-85	194 (7.6)	137 (5.4)	2.6 (0.1)

Unit: mm (inch)

## 4. Installation Procedure

- (1) GT15-70ATT-98, GT15-60ATT-97, GT15-60ATT-96, GT15-60ATT-87, GT15-60ATT-77

The following figures show an example of the GT15-60ATT-97 installation.

Follow the same procedure for installing the other models.

- 1) The model is indicated on the attachment. The upper part of the attachment has the model indication. (Example of model indication)

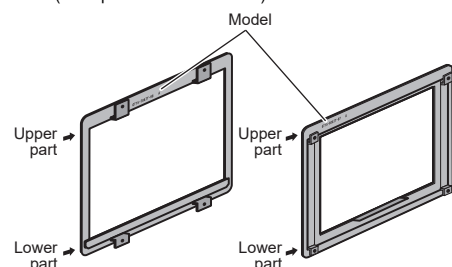

- 2) Hang the two upper hooks on the upper part over the mounting holes in the control panel. Refer to the figure shown in 1).

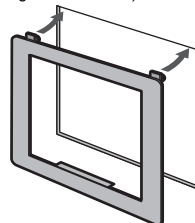

- 3) While lifting the attachment upward, hang the two lower hooks on the lower part of the control panel.

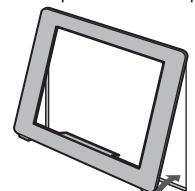

- 4) Fix the attachment to the control panel with four clamp screws in the torque range of 0.2 to 0.28N·m.

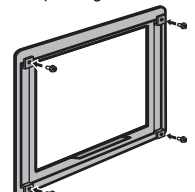

- 5) Place the GOT into the attachment from the front, and fix it by tightening the mounting screws included with the GOT in the torque range of 0.36 to 0.48N·m.

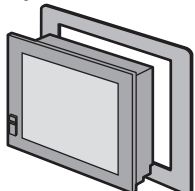

- (2) GT15-70ATT-87, GT15-50ATT-95W, GT15-50ATT-85

The following figures show an example of the GT15-70ATT-87 installation.

Follow the same procedure for installing the other models.

- 1) The model is indicated on the attachment. The position of the model indication does not affect the performance of the attachment. (Example of model indication)

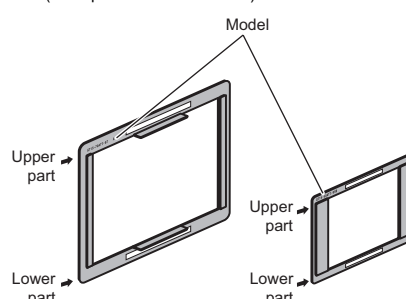

- 2) Remove two-sided tapes from the rear face of the attachment.

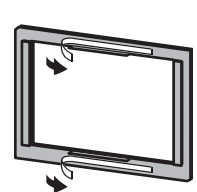

- 3) Fix the attachment to fit the mounting hole on the control panel. If the control panel is dirty, the attachment might fall, causing an injury. Wipe the control panel, and then install the attachment.

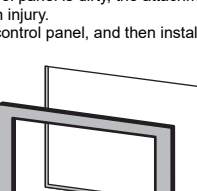

- 4) Place the GOT into the attachment from the front, and fix it by tightening the mounting screws included with the GOT in the torque range of 0.36 to 0.48N·m.

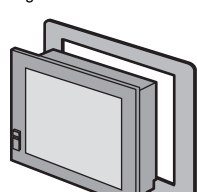

#### Warranty

Mitsubishi Electric will not be held liable for damage caused by factors found not to be the cause of Mitsubishi Electric; machine damage or lost profits caused by faults in the Mitsubishi Electric products; damage, secondary damage, accident compensation caused by special factors unpredictable by Mitsubishi Electric; damages to products other than Mitsubishi Electric products; and to other duties.

#### For safe use

- This product has been manufactured as a general-purpose part for general industries, and has not been designed or manufactured to be incorporated in a device or system used in purposes related to human life.
- Before using the product for special purposes such as nuclear power, electric power, aerospace, medicine or passenger movement vehicles, consult with Mitsubishi Electric.
- This product has been manufactured under strict quality control. However, when installing the product where major accidents or losses could occur if the product fails, install appropriate backup or failsafe functions in the system.

#### Sales office/Tel

Americas
Mitsubishi Electric Automation, Inc. 500 Corporate Woods Parkway, Vernon Hills, IL 60061, U.S.A. Tel: +1-847-478-2100
Mitsubishi Electric do Brasil Comercio e Servicos Ltda. Avenida Adelinio Cardana, 293, 21 andar, Bethaville, Barueri SP, Brazil Tel: +55-11-4688-3000
Mitsubishi Electric Automation, Inc. Mexico Branch Boulevard Miguel de Cervantes Saavedra 301, Torre Norte Piso 5, Ampliacion Granada, Miguel Hidalgo, Ciudad de Mexico, Mexico, C.P.11520 Tel: +52-55-3067-7512
Europe
Mitsubishi Electric Europe B.V. German Branch Mitsubishi-Electric-Platz 1, 40862 Ratingen, Germany Tel: +49-2102-486-0
Mitsubishi Electric Europe B.V. UK Branch Travelers Lane, UK Hatfield, Hertfordshire, AL10 8XB, U.K. Tel: +44-1707-28-8780
Mitsubishi Electric Europe B.V. Italian Branch Centro Direzionale Colleoni - Palazzo Sirio, Viale Colleoni 7, 20864 Agrate Brianza (MB), Italy Tel: +39-039-60531
Mitsubishi Electric Europe B.V. Spanish Branch Carretera de Rubi, 75-80-Appdo. 420, E-08190 Sant Cugat del Valles (Barcelona), Spain Tel: +34-935-65-3131
Mitsubishi Electric Europe B.V. French Branch 25, Boulevard des Bouvets, 92741 Nanterre Cedex, France Tel: +33-1-55-68-55-68
Mitsubishi Electric Europe B.V. Czech Branch Pekarska 621/7, 155 00 Praha 5, Czech Republic Tel: +420-255 719 200
Mitsubishi Electric Turkey A.S. Umranli Branch Sanifal Mahallesi Nispetiye Sokak No:5, TR-34775 Umranli / Istanbul, Turkey Tel: +90-216-526-3990
Mitsubishi Electric Europe B.V. Polish Branch ul. Krakowska 48, 32-083 Balice, Poland Tel: +48-12-347-65-00
Africa
Adroit Technologies 20 Waterford Office Park, 189 Witkoppen Road, Fourways, South Africa Tel: +27-11-658-8100
Asia-Pacific
Mitsubishi Electric Automation (China) Ltd. Mitsubishi Electric Automation Center, No.1386 Hongqiao Road, Shanghai, China Tel: +86-21-2322-3030
SETSUYO ENTERPRISE CO., LTD. 6F, No.105, Wugong 3rd Road, Wugong District, New Taipei City 24889, Taiwan Tel: +886-2-2299-2499
Mitsubishi Electric Automation Korea Co., Ltd. 7F to 9F, Gangseo Hangang X-tower A, 401, Yangcheon-ro, Gangseo-Gu, Seoul 07528, Korea Tel: +82-2-3660-9569
Mitsubishi Electric Asia Pte. Ltd. 307 Alexandra Road, Mitsubishi Electric Building, Singapore 159943 Tel: +65-6473-2308
Mitsubishi Electric Factory Automation (Thailand) Co., Ltd. 12th Floor, SV City Building, Office Tower 1, No. 896/19 and 20 Rama 3 Road, Kwaeng Bangpang, Khet Yannawa, Bangkok 10120, Thailand Tel: +66-2682-6522 to 31
PT. Mitsubishi Electric Indonesia Gedung Jaya 8th Floor, J.L. MH. Thamrin No.12, Jakarta Pusat 10340, Indonesia Tel: +62-21-3192-6461
Mitsubishi Electric Vietnam Company Limited 11th & 12th Floor, Viettel Tower B, 285 Cach Mang Thang 8 Street, Ward 12, District 10, Ho Chi Minh City, Vietnam. Tel: +84-28-3910-5945
Mitsubishi Electric India Pvt. Ltd. Pune Branch Emerald House, EL-3, 3 Block, M.I.D.C., Bhosari, Pune - 411026, Maharashtra, India Tel: +91-20-2710-2000
MITSUBISHI ELECTRIC AUSTRALIA PTY. LTD. 348 Victoria Road, P.O. Box 11, Rydalmere, N.S.W 2116, Australia Tel: +61-2-9684-7777

#### MITSUBISHI ELECTRIC CORPORATION

HEAD OFFICE: TOKYO BLDG., 2-7-3, MARUNOUCHI, CHIYODA-KU, TOKYO 100-8310, JAPAN  
NAGOYA WORKS: 1-14, YADA-MINAMI 5-CHOME, HIGASHI-KU, NAGOYA 461-8670, JAPAN

When exported from Japan, this manual does not require application to the Ministry of Economy, Trade and Industry for service transaction permission.

Specifications subject to change without notice.  
Printed in Japan, July 2023.