

MITSUBISHI ELECTRIC

GOT2000 Series RGB Output Unit

User's Manual

GT27-ROUT

Thank you for choosing Mitsubishi Electric Graphic Operation Terminal (GOT).

Prior to use, please read both this manual and detailed manual thoroughly to fully understand the product.

MODEL	GT27-ROUT-U-JE
MODEL CODE	1D7MQ1
IB(NA)-0800548-D(2307)MEE	

© 2015 MITSUBISHI ELECTRIC CORPORATION

SAFETY PRECAUTIONS
(Always read these precautions before using this equipment.)

Before using this product, please read this manual and the relevant manuals introduced in this manual carefully and pay full attention to safety to handle the product correctly. The precautions given in this manual are concerned with this product. In this manual, the safety precautions are ranked as "WARNING" and "CAUTION".

WARNING Indicates that incorrect handling may cause hazardous conditions, resulting in death or severe injury.

CAUTION Indicates that incorrect handling may cause hazardous conditions, resulting in medium or slight personal injury or physical damage.

Note that the CAUTION level may lead to a serious accident according to the circumstances. Always follow the precautions of both levels because they are important to personal safety. Please save this manual to make it accessible when required and always forward it to the end user.

DESIGN PRECAUTIONS

CAUTION

- Do not bunch the control wires or communication cables with the main circuit or power wires, or lay them close to each other. As a guide, separate the lines by a distance of at least 100mm (3.94 inches) otherwise malfunctions may occur due to noise.

[INSTALLATION PRECAUTIONS]

- WARNING**
- Be sure to shut off all phases of the external power supply used by the system before mounting or removing this unit to/from the GOT. Not doing so can cause a unit failure or malfunction.
 - Before connecting the Bus connection cable to this unit, always shut off GOT power and PLC CPU power externally in all phases. Not doing so can cause a malfunction.
- CAUTION**
- Use this unit in the environment that satisfies the general specifications described in the User's Manual for the GOT used. Not doing so can cause an electric shock, fire, malfunction or product damage or deterioration.
 - Do not drop the unit or subject it to string shock. A unit damage may result.
 - When installing this unit to the GOT, fit it to the connection interface of the GOT and tighten the mounting screws in the specified torque range (0.36 N·m to 0.48 N·m) with a Phillips-head screwdriver No.2. Undertightening can cause a drop, failure or malfunction. Overtightening can cause a drop, failure or malfunction due to screw or unit damage.

[WIRING PRECAUTIONS]

- WARNING**
- Be sure to shut off all phases of the external power supply used by the system before wiring. Failure to do so may result in an electric shock, product damage or malfunctions.
- CAUTION**
- Exercise care to avoid foreign matter such as chips and wire cuttings entering the unit. Not doing so can cause a fire, failure or malfunction.
 - Make sure to securely connect the cable to the connector of unit. Incorrect connection may cause malfunctions.

[STARTUP AND MAINTENANCE PRECAUTIONS]

- WARNING**
- Before starting cleaning, always shut off GOT power externally in all phases. Not doing so can cause a unit failure or malfunction. Undertightening can cause the GOT to drop, short circuit or malfunction. Overtightening can cause a short circuit or malfunction due to the damage of the screws or unit.
 - Do not disassemble or modify any unit. This will cause failure, malfunction, injuries, or fire.
 - Do not touch the conductive areas and electronic parts of this unit directly. Doing so can cause a unit malfunction or failure.
- CAUTION**
- Always secure the cables connected to the unit, e.g. run them in conduits or clamp them. Not doing so can cause unit or cable damage due to dangling, moved or accidentally pulled cables or can cause a malfunction due to a cable contact fault.
 - Do not hold the cable part when unplugging any cable connected to the unit. Doing so can cause unit or cable damage or a malfunction due to a cable contact fault.
 - Always make sure to touch the grounded metal to discharge the electricity charged in the body, etc., before touching the unit. Failure to do so may cause a failure or malfunctions of the unit.

- CAUTION**
- Always secure the cables connected to the unit, e.g. run them in conduits or clamp them. Not doing so can cause unit or cable damage due to dangling, moved or accidentally pulled cables or can cause a malfunction due to a cable contact fault.
 - Do not hold the cable part when unplugging any cable connected to the unit. Doing so can cause unit or cable damage or a malfunction due to a cable contact fault.
 - Always make sure to touch the grounded metal to discharge the electricity charged in the body, etc., before touching the unit. Failure to do so may cause a failure or malfunctions of the unit.

[DISPOSAL PRECAUTIONS]

- CAUTION**
- Dispose of this product as industrial waste.

[TRANSPORTATION PRECAUTIONS]

- CAUTION**
- Make sure to transport the GOT main unit and/or relevant unit(s) in the manner they will not be exposed to the impact exceeding the impact resistance described in the general specifications of the User's Manual for the GOT used, as they are precision devices. Failure to do so may cause the unit to fail. Check if the unit operates correctly after transportation.
 - When fumigants that contain halogen materials such as fluorine, chlorine, bromine, and iodine are used for disinfecting and protecting wooden packaging from insects, they cause malfunction when entering our products. Please take necessary precautions to ensure that remaining materials from fumigant do not enter our products, or treat packaging with methods other than fumigation (heat method). Additionally, disinfect and protect wood from insects before packing products.

Manual

The following shows manuals relevant to this product.

Manual name	Manual number (Model code)
GOT2000 Series User's Manual (Hardware) (Sold separately)	SH-081194ENG (1D7MJ5)
GOT2000 Series Connection Manual (Microcomputers, MODBUS/Fieldbus Products, Peripherals) For GT Works3 Version1	SH-081200ENG

For the latest e-Manuals and PDF manuals, consult your local sales office.

Compliance with the EMC and Low Voltage Directives

To configure a system meeting the requirements of the EMC and Low Voltage Directives when incorporating the Mitsubishi GOT (EMC and Low Voltage Directives compliant) into other machinery or equipment, refer to "EMC AND LOW VOLTAGE DIRECTIVES" of the General Description included with the GOT used. The CE mark, indicating compliance with the EMC and Low Voltage Directives, is printed on the rating plate of the GOT.

Compliance with the new China RoHS directive

GOT 相关的基于“电器电子产品有害物质限制使用管理办法”要求的表示方法

15 Note: This symbol mark is for China only.

含有害6物质的名称、含量、含有部件
本产品中所含的有害6物质的名称、含量、含有部件如下表所示。

部件名称	有害物质					
	铅 (Pb)	汞 (Hg)	镉 (Cd)	六价铬 (Cr(VI))	多溴联苯 (PBB)	多溴二苯醚 (PBDE)
出路线路板	×	○	○	○	○	○
树脂壳体、电缆、线材	○	○	○	○	○	○
钣金部件、螺钉等金属部件	○	○	○	○	○	○

本表格依据 SJ/T11364 的规定编制。
○：表示该有害物质在该部件所有均质材料中的含量均在 GB/T26572 规定的限量要求以下。
×：表示该有害物质至少在该部件的某一均质材料中的含量超出 GB/T26572 规定的限量要求。

Referenced Standard: GB/T15969.2 (Requirement of Chinese standardized law)

Packing List

After unpacking the box, check that the following products are included.

Model	Product	Quantity
GT27-ROUT	GT27 RGB output unit GT27-ROUT	1
	Mounting screw set (2 screws (26 mm), 2 stickers)	2
	GOT2000 Series RGB Output Unit User's Manual (This manual)	1

1. OVERVIEW

This user's manual describes the GT27 RGB output unit GT27-ROUT (hereinafter referred to as the RGB output unit). By mounting the RGB output unit to a GT27 unit, the screen displayed on the GOT can be displayed on an external display.

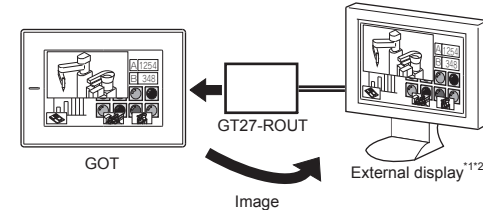

- *1: Depending on the peripheral device connected, noise coming from power cables may cause the GOT or a PLC to malfunction. In this case, install the following line filter to the power lines of the device. Recommended line filter: TDK Lambda RSHN-2003 (or equivalent products)
- *2: If the screen flickers due to the noise from the RGB cable, attach the following ferrite core to the input section of the RGB cable. Recommended ferrite core: TDK Lambda ZCAT3035-1330 (or equivalent products)

To use the RGB output unit, set the controller settings. For the settings and system configurations, refer to GOT2000 Series Connection Manual (Microcomputer, MODBUS Products, Peripherals) for GT Works3 Version 1. For the details of the RGB output function, refer to GT Designer3 (GOT2000) Help.

2. SPECIFICATIONS

The following shows the performance specifications of the RGB output unit. The general specifications of the RGB output unit are the same as those of the GOT.

For the general specifications of the GOT, refer to the GOT2000 Series User's Manual (Hardware).

2.1 RGB output unit

Item	Specifications		
	GT2715-X	GT2712-S GT2710-S GT2708-S	GT2710-V GT2708-V
Output format	Analog RGB		
Display size	XGA: 1024 X 768 dot	SVGA: 800 X 600 dot	VGA: 640 X 480 dot
Number of channels	1 channel		
Dot clock	65,000 MHz	40,000 MHz	25,175 MHz
Horizontal scanning frequency	48.4 kHz	37.9 kHz	31.5 kHz
Vertical scanning frequency	60 Hz		
Timing chart	Refer to 2.2	Refer to 2.3	Refer to 2.4
Connector for external connection	D-Sub15 pin: female		
Internal current consumption	5.0 VDC	0.34 A	
Weight	0.22 kg		

2.2 GT2715-X Timing Chart

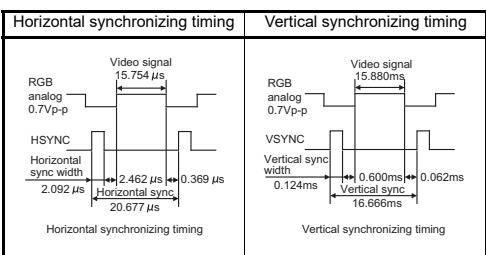

2.3 GT2712-S, GT2710-S, and GT2708-S Timing Chart

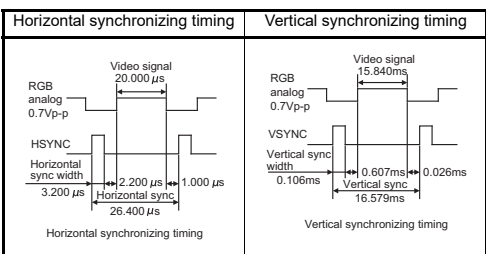

2.4 GT2710-V and GT2708-V Timing Chart

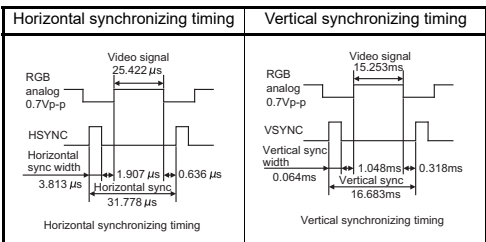

3. PART NAMES AND EXTERNAL DIMENSIONS

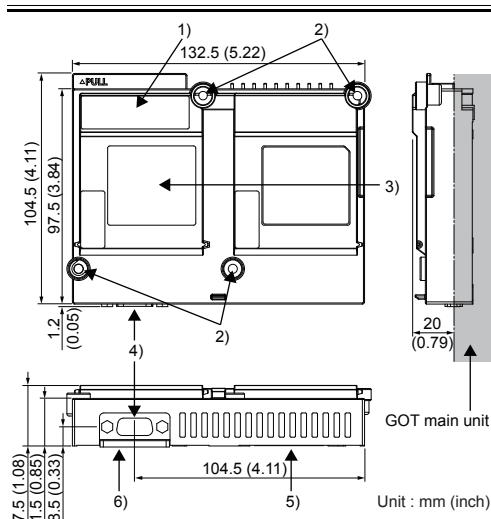

No.	Name	Description
1)	Extension connector	Connector for connecting an extension unit
2)	Mounting screw	Screw for fixing the GOT
3)	Rating plate	-
4)	Connector for RGB output	Connector for connecting RGB cables
5)	Auxiliary extension connector	Auxiliary extension connector connected to the GOT
6)	Interface connector	Extension connector connected to the GOT

4. INSTALLATION AND REMOVAL PROCEDURE

4.1 Unit Installation

The installation procedure for the RGB output unit is explained using the GT2712.

- Turn off the GOT.
- Pull up the two hooks in the extension unit cover (two covers) of the GOT to remove the cover toward the opposite side of the hooks of the cover as a fulcrum.

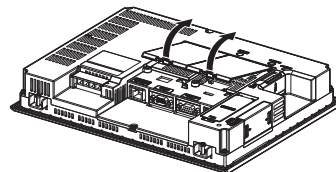

- Connect the RGB output unit to the auxiliary extension interface and the extension interface on the GOT. Then, tighten 4 mounting screws (26 mm) with a torque of 0.36 N·m to 0.48 N·m to fix the unit.

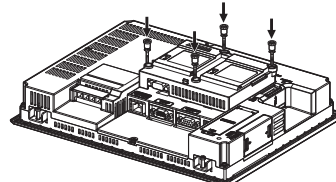

- For connecting an extension unit to the extension connector on the RGB input unit, remove the stickers. For connecting no extension unit to the extension connector, to avoid static electricity, cover over 4 mounting screws with the accessory stickers for the RGB output unit. Leave the stickers in place.

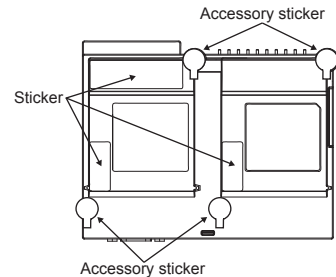

4.2 Unit Removal

For removing the RGB output unit, reverse the procedure of the installation.

Warranty

Mitsubishi Electric will not be held liable for damage caused by factors found not to be the cause of Mitsubishi Electric; machine damage or lost profits caused by faults in the Mitsubishi Electric products; damage, secondary damage, accident compensation caused by special factors unpredictable by Mitsubishi Electric; damages to products other than Mitsubishi Electric products; and to other duties.

For safe use

- This product has been manufactured as a general-purpose part for general industries, and has not been designed or manufactured to be incorporated in a device or system used in purposes related to human life.
- Before using the product for special purposes such as nuclear power, electric power, aerospace, medicine or passenger movement vehicles, consult with Mitsubishi Electric.
- This product has been manufactured under strict quality control. However, when installing the product where major accidents or losses could occur if the product fails, install appropriate backup or failsafe functions in the system.

Sales office/Tel

Americas
Mitsubishi Electric Automation, Inc.
500 Corporate Woods Parkway, Vernon Hills, IL 60061, U.S.A.
Tel: +1-847-478-2100

Mitsubishi Electric do Brasil Comercio e Servicos Ltda.
Avenida Adelino Cardana, 293, 21 andar, Bethaville, Barueri SP, Brazil
Tel: +55-11-4689-3000

Mitsubishi Electric Automation, Inc. Mexico Branch
Boulevard Miguel de Cervantes Saavedra 301, Torre Norte Piso 5, Ampliacion Granada, Miguel Hidalgo, Ciudad de Mexico, Mexico, C.P.11520
Tel: +52-55-3067-7512

Europe
Mitsubishi Electric Europe B.V. German Branch
Mitsubishi-Electric-Platz 1, 40862 Ratingen, Germany
Tel: +49-2102-486-0

Mitsubishi Electric Europe B.V. UK Branch
Travellers Lane, UK-Hatfield, Hertfordshire, AL10 8XB, U.K.
Tel: +44-1077-28-9780

Mitsubishi Electric Europe B.V. Italian Branch
Centro Direzionale Collettoni - Palazzo Sirio, Viale Collettoni 7, 20864 Agrate Brianza (MB), Italy
Tel: +39-039-60531

Mitsubishi Electric Europe B.V. Spanish Branch
Carretera de Rubi, 75-80-Appdo. 420, E-08190 Sant Cugat del Valles (Barcelona), Spain
Tel: +34-935-65-3131

Mitsubishi Electric Europe B.V. French Branch
25, Boulevard des Bouvets, 92741 Nanterre Cedex, France
Tel: +33-1-55-68-55-68

Mitsubishi Electric Europe B.V. Czech Branch
Peckarska 621/7, 155 00 Praha 5, Czech Republic
Tel: +420-255 719 200

Mitsubishi Electric Turkey A.S. Umranli Branch
Santral Mahallesi Nutuk Sokak No:5, TR-34775 Umranli / Istanbul, Turkey
Tel: +90-216-526-3990

Mitsubishi Electric Europe B.V. Polish Branch
ul. Krakowska 48, 32-083 Balice, Poland
Tel: +48-12-347-65-00

Africa

Adroit Technologies
20 Waterford Office Park, 189 Witkoppen Road, Fourways, South Africa
Tel: +27-11-658-8100

Asia-Pacific

Mitsubishi Electric Automation (China) Ltd.
Mitsubishi Electric Automation Center, No.1386 Hongqiao Road, Shanghai, China
Tel: +86-21-2322-3030

SETSUYO ENTERPRISE CO., LTD.
6F, No.105, Wugong 3rd Road, Wugong District, New Taipei City 24889, Taiwan
Tel: +886-2-2299-2499

Mitsubishi Electric Automation Korea Co., Ltd.
7F to 9F, Gangseo Hangang X-tower A, 401, Yangcheon-ro, Gangseo-Gu, Seoul 07528, Korea
Tel: +82-2-3660-9569

Mitsubishi Electric Asia Pte. Ltd.
307 Alexandra Road, Mitsubishi Electric Building, Singapore 159943
Tel: +65-6473-2308

Mitsubishi Electric Factory Automation (Thailand) Co., Ltd.
12th Floor, SV City Building, Office Tower 1, No. 896/19 and 20 Rama 3 Road, Kwaeng Bangpoo, Khet Yannawa, Bangkok 10120, Thailand
Tel: +66-2082-8522 to 31

PT. Mitsubishi Electric Indonesia
Gedung Jaya 8th Floor, J.L. MH. Thamrin No.12, Jakarta Pusat 10340, Indonesia
Tel: +62-21 3192-6461

Mitsubishi Electric Vietnam Company Limited
11th & 12th Floor, Viettel Tower B, 285 Cach Mang Thang 8 Street, Ward 12, District 10, Ho Chi Minh City, Vietnam.
Tel: +84-28-3910-5945

Mitsubishi Electric India Pvt. Ltd. Pune Branch
Emerald House, EL-3, 3 Block, M.I.D.C., Bhosari, Pune - 411026, Maharashtra, India
Tel: +91-20-2710-2000

MITSUBISHI ELECTRIC AUSTRALIA PTY. LTD.
348 Victoria Road, P.O. Box 11, Rydalmere, N.S.W 2116, Australia
Tel: +61-2-9684-7777

MITSUBISHI ELECTRIC CORPORATION
HEAD OFFICE: TOKYO BLDG., 2-7-3, MARUNOUCHI, CHIYODA-KU, TOKYO 100-8310, JAPAN
NAGOYA WORKS: 1-14, YADA-MINAMI 5-CHOME, HIGASHI-KU, NAGOYA 461-8670, JAPAN

When exported from Japan, this manual does not require application to the Ministry of Economy, Trade and Industry for service transaction permission.

Specifications subject to change without notice.
Printed in Japan, July 2023.