

GRAPHIC OPERATION TERMINAL

GOT2000

GOT2000 Series

MES Interface Function Manual

For GT Works3 Version1

SAFETY PRECAUTIONS

Always read the precautions before using this product.

Also read this manual and the relevant manuals mentioned in this manual carefully, and use the product properly while paying full attention to safety.

Note that the precautions in this manual apply only to this product.

The safety precautions are divided into the following levels: warnings and cautions.



Indicates that incorrect handling may cause hazardous conditions, resulting in death or severe injury.



Indicates that incorrect handling may cause hazardous conditions, resulting in minor or moderate injury or property damage.

Note that failure to observe  CAUTION may lead to a serious accident depending on the circumstances.

Make sure to observe both warnings and cautions to ensure personal safety.

Ensure that this manual is easily accessible to all users of this product.

[DESIGN PRECAUTIONS]

WARNING

- Before performing the test operation, read this manual carefully to understand the operation procedure.
- To maintain the security (confidentiality, integrity, and availability) of the GOT and the system against unauthorized access, DoS^{*1} attacks, computer viruses, and other cyberattacks from unreliable networks and devices via network, take appropriate measures such as firewalls, virtual private networks (VPNs), and antivirus solutions.

Mitsubishi Electric shall have no responsibility or liability for any problems involving GOT trouble and system trouble by unauthorized access, DoS attacks, computer viruses, and other cyberattacks.

*1 DoS: A denial-of-service (DoS) attack disrupts services by overloading systems or exploiting vulnerabilities, resulting in a denial-of-service (DoS) state.

CAUTIONS FOR USING

GOTs that support the MES interface function

The MES interface function is available on GT27, GT25, and GS25.

To use the MES interface function, install the required system application (extended function) on the GOT.

For applicable models, refer to the following:

☞ Page 23 Connection between GOT and Controllers

Option function board that supports the MES interface function

For the option function board that supports the MES interface function, refer to the following:

☞ Page 25 Required Equipment, Software, and System Application (Extended Function)

Relational databases that support the MES interface function

For the option function board that supports the MES interface function, refer to the following:

☞ Page 26 Server computer

Connection type used for the MES interface function

To utilize the MES interface function, the Ethernet connection is used.

Install an Ethernet communication unit, and configure the Ethernet setting in Communication Settings of GT Designer3.

For applicable Ethernet communication units, refer to the following:

☞ Page 25 Required Equipment, Software, and System Application (Extended Function)

For the Ethernet connection, refer to the following.

📖 GOT2000 Series Connection Manual (Mitsubishi Electric Products) For GT Works3 Version1

CONTENTS

SAFETY PRECAUTIONS	1
CAUTIONS FOR USING	2
INTRODUCTION	6
Manuals for GT Works3	6
Abbreviations, Generic Terms, and Model Icons	8
CHAPTER 1 OVERVIEW	15
1.1 Features	16
1.2 What is the MES Interface Function?	20
CHAPTER 2 SYSTEM CONFIGURATION	21
2.1 System Configuration	21
Overall system configuration	21
System configuration when installing software used for the MES Interface Function	22
2.2 Connection between GOT and Controllers	23
Connection type used for the MES Interface Function	23
Precautions for inverter or servo amplifier connection	24
2.3 Required Equipment, Software, and System Application (Extended Function)	25
2.4 Operating Environment	26
Configuration computer	26
Server computer	26
Combinations of OSs, databases, DB Connection Service, and DB Connection Service Setting Tool	30
2.5 Cautions on System Configuration	30
CHAPTER 3 SPECIFICATIONS	31
3.1 Performance Specifications	32
3.2 GOT Devices Available for the MES Interface Function	34
3.3 Function List and Setting Item List	35
3.4 GOT Internal Device (GS)	38
GOT internal device list	38
MES Interface Function area	39
CHAPTER 4 SETTINGS AND PROCEDURES BEFORE USE OF THE MES INTERFACE FUNCTION	41
4.1 Settings and Procedures before Use of the MES Interface Function	41
4.2 Installation and Uninstallation	42
CHAPTER 5 MES INTERFACE FUNCTION	43
5.1 DB Interface Function	43
DB interface function operation	43
Job execution procedure	44
Tag function	45
Trigger monitoring function	46
Trigger buffering function	48
SQL text transmission (Communication action)	50
Arithmetic processing function (Operation action)	51
Resource data send function (Resource data send action)	51

	Program execution function	53
	DB buffering function	54
5.2	Precautions	61

CHAPTER 6 MES INTERFACE FUNCTION SETTING 63

6.1	MES Interface Function Setting Screen	63
6.2	Displaying the MES Interface Function Setting Screen	64
6.3	Screen Structure	65
	Screen structure	65
	Operations using the Edit items tree	66
6.4	Setting	67
6.5	Device Tag Settings	68
	Setting items in Device tag settings	69
	Setting items in Array setting	70
	Setting items in Component setting	72
6.6	Server Service Settings	78
	Setting items in Server service settings	79
6.7	Job Settings	83
	Setting items in Job settings	84
	Setting items in Trigger conditions	87
	Setting items in Program execution	94
	Setting items in DB Buffering	97
	Notify errors (job cancellation) that occur during job execution	98
	One-shot execution	99
6.8	Job Settings - Actions	100
	Setting items in Communication action	104
	Setting items in Operation action	125
	Setting items in Transmit resource action	128
6.9	System Setting	139
	Setting items in DB buffering settings	140
	Setting item of the option setting	143
6.10	Import and Export	144
	Importing the MES interface settings	144
	Exporting the MES interface settings	145
6.11	Diagnosis	146
	Checking the MES Interface Function status (Status)	146
	Manipulating the MES Interface Function status (Operation)	147
	Changing the job status (Change job status)	147
	Checking the connection of the previous job execution (Connection result of previous job execution)	148
	Manipulating DB buffering (DB buffering operation)	149
	Checking the trigger buffering (Trigger buffering status)	150
6.12	Working Log	151
	MES Interface Execute Log	151
	Job Execute Log	152
6.13	Precautions	156

CHAPTER 7 DB CONNECTION SERVICE AND SETTING TOOL 159

7.1	DB Connection Service Functions	159
7.2	Setting ODBC of Database	161
7.3	Starting DB Connection Service Setting Tool	171

7.4	Screen Structure of DB Connection Service Setting Tool	172
	Screen structure	172
	Menu configuration	172
7.5	Setting Items of DB Connection Service Setting Tool	173
	Service port (required) (Range: 1024 to 65535, Default: 5112)	174
	DB access timeout (required) (Range: 1 to 3600; Default: 30)	174
	Limit IP addresses which permit to connect	174
	Output access log	175
	Output SQL failed log	176
7.6	Importing/Exporting Files	177
7.7	Help	178
7.8	Output Log Specifications	179
	Access log	180
	SQL failure log	181
CHAPTER 8 TROUBLESHOOTING		183
8.1	Error Handling and Recovery Method	183
	MES Interface Function setting	184
	When using DB Connection Service Setting Tool	186
8.2	Error Code List	187
	Error log in the Working log	187
	DB Connection Service	190
CHAPTER 9 APPENDICES		197
9.1	Usable Characters and ASCII Code Tables by Setting Items	197
	ASCII code table	197
	Characters applicable to item names, component names, variable names, etc.	198
	Characters applicable to character string constants, etc.	199
	Characters applicable to field names, table names, etc.	199
9.2	About Monitoring Interval Timeout	200
9.3	Warning Messages in Windows Vista(R)	202
	Overview of warning messages	202
	Methods for disabling warning messages	202
9.4	Tables for Used Terms	206
9.5	Application Example of MES Interface Function	207
	REVISIONS	211
	Intellectual Property Rights	212

INTRODUCTION

Thank you for choosing Mitsubishi Electric Graphic Operation Terminal (GOT).

Before using the product, read this manual carefully and make sure you understand the functions and performance of the GOT for correct use.

☞ Manuals for GT Works3

☞ Abbreviations, Generic Terms, and Model Icons

Manuals for GT Works3

The electronic manuals related to this product are installed together with the screen design software.

If you need the printed manuals, consult your local sales office.

Manuals for GT Designer3 (GOT2000)



e-Manual refers to the Mitsubishi Electric FA electronic book manuals that can be browsed using a dedicated tool.

e-Manual has the following features:

- Required information can be cross-searched in multiple manuals.
- Other manuals can be accessed from the links in the manual.
- Hardware specifications of each part can be found from the product figures.
- Pages that users often browse can be bookmarked.
- Sample programs can be copied to the engineering tool.

■Screen design software-related manuals

Manual name	Manual number (Model code)	Format
GT Works3 Installation Instructions	-	PDF
GT Designer3 (GOT2000) Screen Design Manual	SH-081220ENG (1D7ML9)	PDF e-Manual
GT Converter2 Version3 Operating Manual for GT Works3	SH-080862ENG	PDF e-Manual
GOT2000 Series MES Interface Function Manual for GT Works3 Version1	SH-081228ENG	PDF e-Manual

■Connection manuals

Manual name	Manual number (Model code)	Format
GOT2000 Series Connection Manual (Mitsubishi Electric Products) For GT Works3 Version1	SH-081197ENG (1D7MJ8)	PDF e-Manual
GOT2000 Series Connection Manual (Non-Mitsubishi Electric Products 1) For GT Works3 Version1	SH-081198ENG	PDF e-Manual
GOT2000 Series Connection Manual (Non-Mitsubishi Electric Products 2) For GT Works3 Version1	SH-081199ENG	PDF e-Manual
GOT2000 Series Connection Manual (Microcomputers, MODBUS/Fieldbus Products, Peripherals) For GT Works3 Version1	SH-081200ENG	PDF e-Manual
GOT2000 Series Handy GOT Connection Manual For GT Works3 Version1	SH-081867ENG (1D7MS9)	PDF e-Manual
GOT2000 Series Connection Manual (α2 Connection) for GT Works3 Version1	JY997D52301	PDF e-Manual

■GT SoftGOT2000 manuals

Manual name	Manual number (Model code)	Format
GT SoftGOT2000 Version1 Operating Manual	SH-081201ENG	PDF e-Manual
MELSOFT GT OPC UA Client Operating Manual	SH-082174ENG	PDF

■GOT2000 series user's manuals

Manual name	Manual number (Model code)	Format
GOT2000 Series User's Manual (Hardware)	SH-081194ENG (1D7MJ5)	PDF e-Manual
GOT2000 Series User's Manual (Utility)	SH-081195ENG (1D7MJ6)	PDF e-Manual
GOT2000 Series User's Manual (Monitor)	SH-081196ENG (1D7MJ7)	PDF e-Manual

■GOT SIMPLE series user's manuals

Manual name	Manual number	Format
GOT SIMPLE Series User's Manual	JY997D52901	PDF e-Manual

■Manuals related to GT Works3 add-on projects

Manual name	Manual number (Model code)	Format
GT Works3 Add-on License for GOT2000 Enhanced Drive Control (Servo) Project Data Manual (Fundamentals)	SH-082072ENG (1D7MV1)	PDF e-Manual
GT Works3 Add-on License for GOT2000 Enhanced Drive Control (Servo) Project Data Manual (Screen Details)	SH-082074ENG (1D7MV3)	PDF e-Manual

Manuals for GT Designer3 (GOT1000)

















Refer to the Help and manuals for GT Designer3(GOT1000)



























Abbreviations, Generic Terms, and Model Icons

The following shows the abbreviations, generic terms, and model icons used in this manual.





GOT

■GOT2000 series

Abbreviations and generic terms			Description	Meaning of icon	
				Available	Unavailable
GT27	GT27-X	GT2715-X	GT2715-XTBA GT2715-XTBD		
		GT27-S	GT2712-S		
	GT2710-S		GT2710-STBA GT2710-STBD		
	GT2708-S		GT2708-STBA GT2708-STBD		
	GT27-V	GT2710-V	GT2710-VTBA GT2710-VTWA GT2710-VTBD GT2710-VTWD		
			GT2708-V		
		GT2705-V	GT2705-VTBD		
GT25			All GT25 models		
GT25-W	GT2512-WX	GT2512-WXTBD GT2512-WXTSD			
		GT2510-WX			GT2510-WXTBD GT2510-WXTSD
		GT2507-W			GT2507-WTBD GT2507-WTSD
		GT2507T-W			GT2507T-WTSD
GT25-S	GT2512-S	GT2512-STBA GT2512-STBD			
		GT2512F-S			GT2512F-STNA GT2512F-STND
GT25-V	GT2510-V	GT2510-VTBA GT2510-VTWA GT2510-VTBD GT2510-VTWD			
		GT2510F-V			GT2510F-VTNA GT2510F-VTND
	GT2508-V	GT2508-VTBA GT2508-VTWA GT2508-VTBD GT2508-VTWD			
		GT2508F-V			GT2508F-VTNA GT2508F-VTND
	GT2505-V	GT2505-VTBD			
GT25HS-V Handy GOT	GT2506HS-V	GT2506HS-VTBD			
	GT2505HS-V	GT2505HS-VTBD			
GT23	GT23-V	GT2310-V	GT2310-VTBA GT2310-VTBD		
		GT2308-V	GT2308-VTBA GT2308-VTBD		

Abbreviations and generic terms		Description	Meaning of icon	
			Available	Unavailable
GT21		All GT21 models		
GT21-W	GT2107-W	GT2107-WTBD GT2107-WTSD		
GT21-Q	GT2105-Q	GT2105-QTBDS GT2105-QMBDS		
GT21-R	GT2104-R	GT2104-RTBD		
GT21-P	GT2104-P	GT2104-PMBD		
		GT2104-PMBDS		
		GT2104-PMBDS2		
		GT2104-PMBLS		
	GT2103-P	GT2103-PMBD		
		GT2103-PMBDS		
		GT2103-PMBDS2		
		GT2103-PMBLS		
GT SoftGOT2000		GT SoftGOT2000 Version1		

■GOT SIMPLE series

Abbreviations and generic terms		Description	Meaning of icon	
			Available	Unavailable
GS25		GS2512-WXTBD		
GS21	GS21-W-N	GS2110-WTBD-N GS2107-WTBD-N		
	GS21-W	GS2110-WTBD GS2107-WTBD		

■GOT1000 series, GOT900 series, and GOT800 series

Abbreviations and generic terms		Description	Meaning of icon	
			Available	Unavailable
GOT1000 Series		GOT1000 Series	-	
GOT900 Series		GOT-A900 Series GOT-F900 Series	-	
GOT800 Series		GOT-800 Series	-	

Communication unit

Abbreviations and generic terms	Description
Bus connection unit	GT15-QBUS GT15-QBUS2 GT15-ABUS GT15-ABUS2 GT15-75QBUSL GT15-75QBUS2L GT15-75ABUSL GT15-75ABUS2L
Serial communication unit	GT15-RS2-9P GT15-RS4-9S GT15-RS4-TE
MELSECNET/H communication unit	GT15-J71LP23-25 GT15-J71BR13
CC-Link IE TSN communication unit	GT25-J71GN13-T2
CC-Link IE Controller Network communication unit	GT15-J71GP23-SX
CC-Link IE Field Network communication unit	GT15-J71GF13-T2
CC-Link communication unit	GT15-J61BT13
Wireless LAN communication unit	GT25-WLAN
Serial multi-drop connection unit	GT01-RS4-M
Connection conversion adapter	GT10-9PT5S
Field network adapter unit	GT25-FNADP
Ethernet communication unit	GT25-J71E71-100
RS-232/485 signal conversion adapter	GT14-RS2T4-9P

Option unit

Abbreviations and generic terms	Description
Printer unit	GT15-PRN
Video input unit	GT27-V4-Z (A set of GT16M-V4-Z and GT27-IF1000)
RGB input unit	GT27-R2, GT27-R2-Z (A set of GT16M-R2-Z and GT27-IF1000)
Video/RGB input unit	GT27-V4R1-Z (A set of GT16M-V4R1-Z and GT27-IF1000)
RGB output unit	GT27-ROUT, GT27-ROUT-Z (A set of GT16M-ROUT-Z and GT27-IF1000)
Digital video output unit	GT27-VHOUT
Multimedia unit	GT27-MMR-Z (A set of GT16M-MMR-Z and GT27-IF1000)
Video signal conversion unit	GT27-IF1000
External I/O unit	GT15-DIO, GT15-DIOR
Sound output unit	GT15-SOUT
SD card unit	GT21-03SDCD

Option

Abbreviations and generic terms	Description
SD card	NZ1MEM-2GBSD NZ1MEM-4GBSD NZ1MEM-8GBSD NZ1MEM-16GBSD L1MEM-2GBSD L1MEM-4GBSD
Battery	GT11-50BAT GT15-BAT
Protective sheet	GT27-15PSGC GT25-12WPSGC GT25-12PSGC GT25-10WPSGC GT25-10PSGC GT25-08PSGC GT21-07WPSGC GT25T-07WPSVC GT25-05PSGC GT25-05PSGC-2 GT21-05PSGC GT21-04RPSGC-UC GT21-03PSGC-UC GT21-04PSGC-UC GT27-15PSCC GT25-12WPSCC GT25-12PSCC GT25-10WPSCC GT25-10PSCC GT25-08PSCC GT25-05PSCC GT25-05PSCC-2 GT25-12PSCC-UC GT25-10PSCC-UC GT25-08PSCC-UC GT21-07WPSCC GT21-05PSCC GT21-04RPSCC-UC GT21-04PSCC-UC GT21-03PSCC-UC GT16H-60PSC GT14H-50PSC
Antibacterial/antiviral protective sheet	GT25-12PSAC GT25-10PSAC GT25-08PSAC
Environmental protection sheet	GT25F-12ESGS GT25F-10ESGS GT25F-08ESGS
Protective cover for oil	GT20-15PCO GT20-12PCO GT20-10PCO GT20-08PCO GT21-12WPCO GT21-10WPCO GT21-07WPCO GT25T-07WPCO GT25-05PCO GT25-05PCO-2 GT05-50PCO GT21-04RPCO GT10-30PCO GT10-20PCO
USB environmental protection cover	GT25-UCOV GT25-05UCOV GT21-WUCOV

Abbreviations and generic terms	Description
Stand	GT15-90STAND GT15-80STAND GT15-70STAND GT05-50STAND GT25-10WSTAND GT21-07WSTAND GT25T-07WSTAND
Attachment	GT15-70ATT-98 GT15-70ATT-87 GT15-60ATT-97 GT15-60ATT-96 GT15-60ATT-87 GT15-60ATT-77 GT21-04RATT-40
Panel-mounted USB port extension	GT14-C10EXUSB-4S GT10-C10EXUSB-5S
Connector conversion box	GT16H-CNB-42S GT16H-CNB-37S GT11H-CNB-37S
Emergency stop switch guard cover	GT16H-60ESCOV GT14H-50ESCOV
Wall-mounting attachment	GT14H-50ATT

Software

■Software related to GOT

Abbreviations and generic terms	Description
GT Works3	SW1DND-GTWK3-J, SW1DND-GTWK3-E, SW1DND-GTWK3-C
GT Designer3 Version1	Screen design software GT Designer3 for GOT2000 and GOT1000 series
GT Designer3	Screen design software for GOT2000 series included in GT Works3
GT Designer3 (GOT2000)	
GT Designer3 (GOT1000)	Screen design software for GOT1000 series included in GT Works3
Speech synthesis license	GT Works Text to Speech License (SW1DND-GTVO-M)
Add-on license	GT Works3 add-on license for GOT2000 enhanced drive control (servo) project data (SW1DND-GTSV-MZ)
GENESIS64 Advanced	GENESIS64 server application (GEN64-APP)
GENESIS64 Basic SCADA	GENESIS64 server application (GEN64-BASIC)
GENESIS64	Generic term of GENESIS64 Advanced and GENESIS64 Basic SCADA
GOT Mobile function license for GT SoftGOT2000	License required to use the GOT Mobile function with GT SoftGOT2000 (SGT2K-WEBSKEY-□)
GT Simulator3	Screen simulator GT Simulator3 for GOT2000, GOT1000 and GOT900 series
GT SoftGOT2000	GOT2000 compatible HMI software GT SoftGOT2000
GT OPC UA Client	MELSOFT GT OPC UA Client (SW1DNN-GTOUC-MD)
GT Converter2	Data conversion software GT Converter2 for GOT1000 and GOT900 series
GT Designer2 Classic	Screen design software GT Designer2 Classic for GOT900 series
GT Designer2	Screen design software GT Designer2 for GOT1000 and GOT900 series
DU/WIN	Screen design software FX-PCS-DU/WIN for GOT-F900 series

■Software related to iQ Works

Abbreviations and generic terms	Description
iQ Works	iQ Platform compatible engineering environment MELSOFT iQ Works
MELSOFT Navigator	Integrated development environment software included in SW □ DND-IQWK (iQ Platform compatible engineering environment MELSOFT iQ Works) (□ represents a version.)
MELSOFT iQ AppPortal	SW□DND-IQAPL-M type integrated application management software (□ represents a version.)

■Other software

Abbreviations and generic terms		Description
GX Works3		SW □ DND-GXW3-E (-EA, -EAZ) type programmable controller engineering software (□ represents a version.)
GX Works2		SW □ DNC-GXW2-E (-EA, -EAZ) type programmable controller engineering software (□ represents a version.)
Controller simulator	GX Simulator3	Simulation function of GX Works3
	GX Simulator2	Simulation function of GX Works2
	GX Simulator	SW □ D5C-LLT-E (-EV) type ladder logic test tool function software package (SW5D5C-LLT (-V) or later versions) (□ represents a version.)
GX Developer		SW □ D5C-GPPW-E (-EV)/SW □ D5F-GPPW (-V) type software package (□ represents a version.)
GX LogViewer		SW□DNN-VIEWER-E type software package (□ represents a version.)
MI Configurator		Configuration and monitor tool for Mitsubishi Electric industrial computers (SW□DNNMICONF-M) (□ represents a version.)
PX Developer		SW □ D5C-FBDQ-E type FBD software package for process control (□ represents a version.)
MT Works2		Motion controller engineering environment MELSOFT MT Works2 (SW □ DND-MTW2-E) (□ represents a version.)
MT Developer		SW□RNC-GSV type integrated start-up support software for motion controller Q series (□ represents a version.)
CW Configurator		Setting/monitoring tools for the C Controller module and MELSECWinCPU (SW□DND-RCCPU-E) (□ represents a version.)
MR Configurator2		SW □ DNC-MRC2-E type servo configuration software (□ represents a version.)
MR Configurator		MRZJW□-SETUP type servo configuration software (□ represents a version.)
FR Configurator2		Inverter setup software (SW □ DND-FRC2-E) (□ represents a version.)
FR Configurator		Inverter setup software (FR-SW □ -SETUP-WE) (□ represents a version.)
NC Configurator2		CNC parameter setting support tool (FCSB1221)
NC Configurator		CNC parameter setting support tool
FX Configurator-FP		Parameter setting, monitoring, and testing software package for FX3U-20SSC-H (SW □ D5CFXSSCE) (□ represents a version.)
FX Configurator-EN-L		FX3U-ENET-L type Ethernet module setting software (SW1D5-FXENETL-E)
FX Configurator-EN		FX3U-ENET type Ethernet module setting software (SW1D5C-FXENET-E)
RT ToolBox2		Robot program creation software (3D-11C-WINE)
RT ToolBox3		Robot program creation software (3F-14C-WINE)
MX Component		MX Component Version □ (SW □ D5C-ACT-E, SW □ D5C-ACT-EA) (□ represents a version.)
MX Sheet		MX Sheet Version □ (SW □ D5C-SHEET-E, SW □ D5C-SHEET-EA) (□ represents a version.)
CPU Module Logging Configuration Tool		CPU module logging configuration tool (SW1DNN-LLUTL-E)

License key (for GT SoftGOT2000)

Abbreviations and generic terms	Description
License key	GT27-SGTKEY-U

Others

Abbreviations and generic terms	Description
IAI	IAI Corporation
AZBIL	Azbil Corporation
OMRON	OMRON Corporation
KEYENCE	KEYENCE CORPORATION
KOYO EI	KOYO ELECTRONICS INDUSTRIES CO., LTD.
JTEKT	JTEKT CORPORATION
SHARP	Sharp Corporation
SHINKO	Shinko Technos Co., Ltd.
CHINO	CHINO CORPORATION
TOSHIBA	TOSHIBA CORPORATION
SHIBAURA MACHINE	SHIBAURA MACHINE CO.,LTD.
PANASONIC	Panasonic Corporation
PANASONIC IDS	Panasonic Industrial Devices SUNX Co., Ltd.
HITACHI IES	Hitachi Industrial Equipment Systems Co., Ltd.
HITACHI	Hitachi, Ltd.
HIRATA	Hirata Corporation
FUJI	FUJI ELECTRIC CO., LTD.
MURATEC	Muratec products manufactured by Murata Machinery, Ltd.
YASKAWA	YASKAWA Electric Corporation
YOKOGAWA	Yokogawa Electric Corporation
RKC	RKC INSTRUMENT INC.
ALLEN-BRADLEY	Allen-Bradley products manufactured by Rockwell Automation, Inc.
CLPA	CC-Link Partner Association
GE	GE Intelligent Platforms, Inc.
HMS	HMS Industrial Networks
LS IS	LS Industrial Systems Co., Ltd.
MITSUBISHI INDIA	Mitsubishi Electric India Pvt. Ltd.
ODVA	Open DeviceNet Vendor Association, Inc.
SCHNEIDER	Schneider Electric SA
SICK	SICK AG
SIEMENS	Siemens AG
SCHNEIDER EJH	Schneider Electric Japan Holdings Ltd.
PLC	Programmable controller manufactured by its respective company
Control equipment	Control equipment manufactured by its respective company
Temperature controller	Temperature controller manufactured by its respective company
Indicating controller	Indicating controller manufactured by its respective company
Controller	Controller manufactured by its respective company
Industrial switch (for CC-Link IE TSN Class B)	CC-Link IE TSN Class B (Synchronized Realtime Communication) hub certified by CC-Link Partner Association
Industrial switch (for CC-Link IE TSN Class A)	CC-Link IE TSN Class A (Realtime Communication) hub certified by CC-Link Partner Association

1 OVERVIEW

Page 16 Features

Page 20 What is the MES Interface Function?

The MES interface function allows SQL text transmission from a GOT to a database in the server computer connected via the Ethernet, enabling writing GOT's device values to the database and reading database values to set them to GOT's devices. This direct communication with the server computer eliminates the need for gateway equipment, realizing reduction in the maintenance cost and improvement in reliability.

Point

The MES interface function is available on GT27, GT25, and GS25.

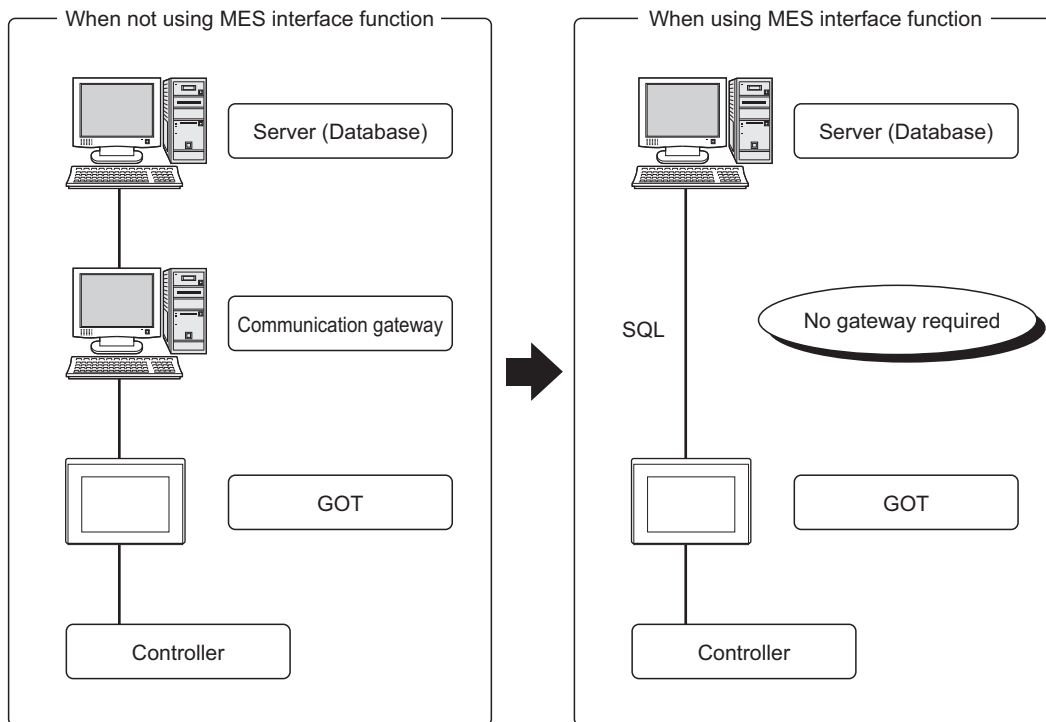

1.1 Features

This section explains the features of the MES interface function.

Simple setting enables connection to the information system without programming.

Access to information system databases can be realized simply by making the necessary settings with the setting tool.

Since there is no need to create programs for generating SQL texts, the engineering costs for system construction and the work period can be reduced.

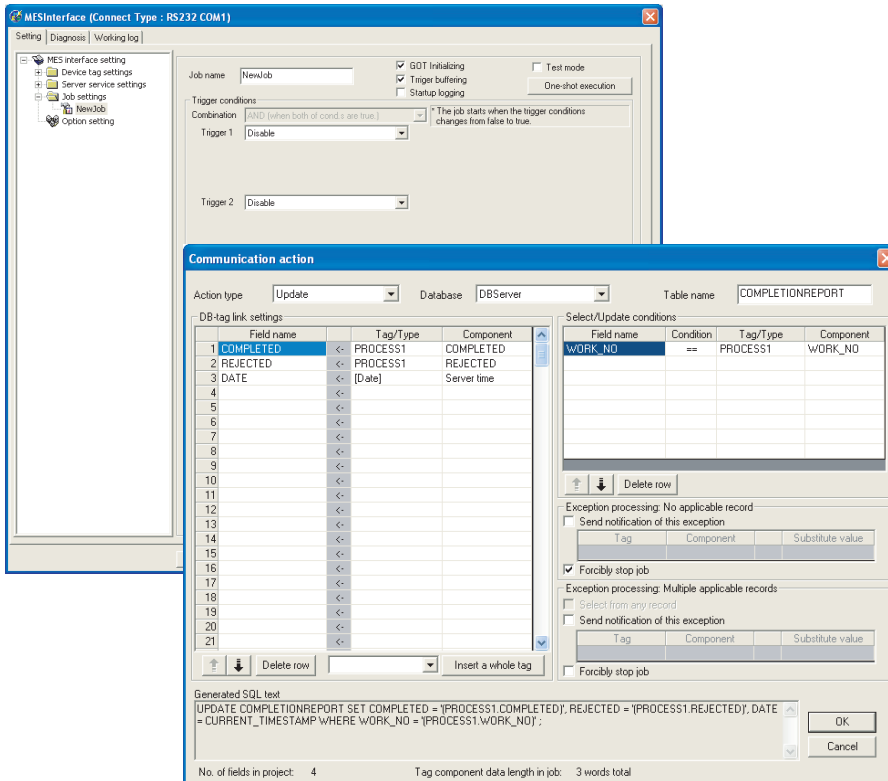

Important data can be protected.

■ Buffering of send data (SQL text) during a communication error

When an error occurs during communications with a database, the SQL texts failed to be sent can be buffered in the GOT. After recovery, the buffered SQL texts are automatically sent to the database. (Manual operation is also possible.)

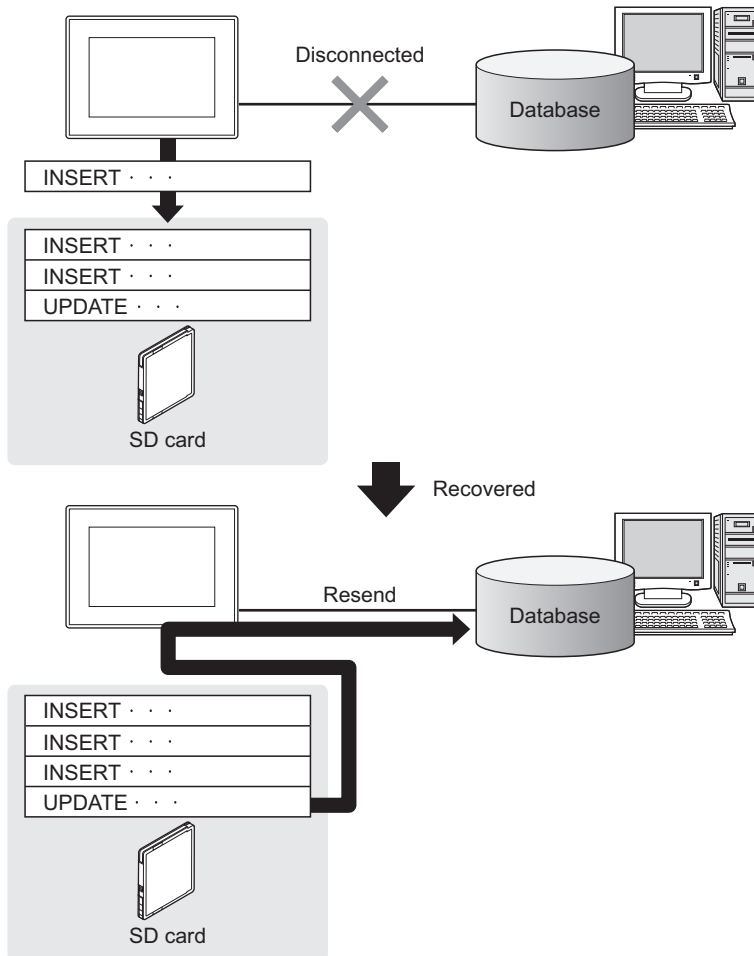

■ Obtaining logs in the event of access errors

After connection to a database, if a communication error occurs, the error details can be recorded as a log on the database side. Analyzing the log is useful for data protection and error analysis.

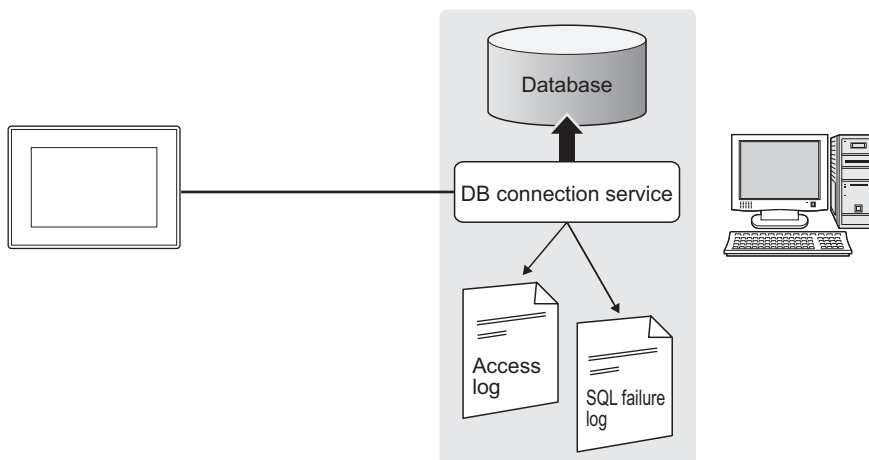

The information system load can be reduced.

Data can be monitored on the GOT and when the conditions are met, the data can be sent to the information system. This can reduce the information system load, compared to the case of the conventional system that constantly samples and monitors data.

[With the MES interface function]

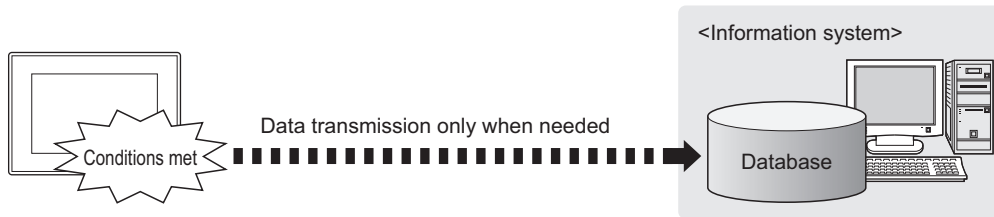

[Conventional system]

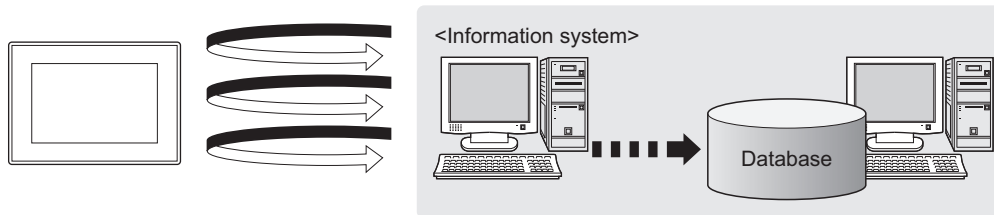

Access independent of the database table configuration is possible.

Freely designed database tables can be used for access to databases.

The MES interface function offers not only the high flexibility in designing a new system but also the capability of reconstructing the existing system without changing the database tables.

Various controller information can be stored and changed in the database.

Controllers can be connected in a variety of topologies and their information can be stored into a database via GOT devices. Also, data read out from the database can be set to controllers as parameters via GOT devices.

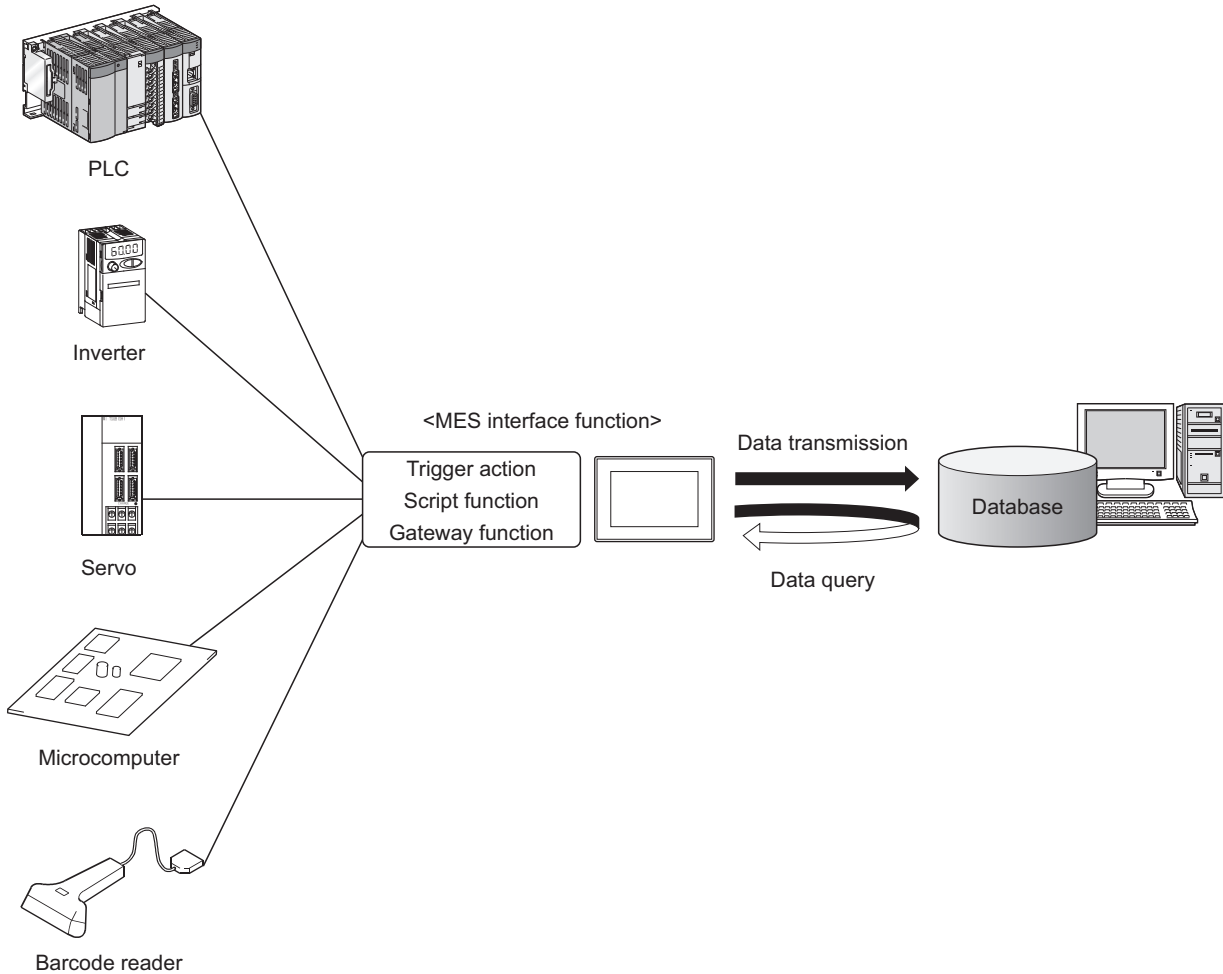

Other features

■Reducing setting mistakes by use of tag names

Tag names can be assigned to devices. Assigning recognizable tag names can reduce setting mistakes.

■Supporting system construction

The diagnostic function allows checking the operating status of the MES interface function (in real time, log). Modification of the job status and test operation of a project under design is also possible.

1.2 What is the MES Interface Function?

The items listed below are used with the MES interface function. For equipment required for the MES interface function, refer to the following:

☞ Page 25 Required Equipment, Software, and System Application (Extended Function)

Item	Description	Reference section
System application (extended function) [MES Interface]	System application (extended function) running on the GOT to implement the MES interface function	☞ Page 43 MES INTERFACE FUNCTION
MES interface function setting	This function allows the MES interface function setting in GT Designer3.	☞ Page 63 MES INTERFACE FUNCTION SETTING
DB Connection Service	Software that runs on the server computer and links databases with the GOT. Install the software from either of the following. <ul style="list-style-type: none">• Disk5 folder in GT Works3 DVD• Contact your local distributor.	☞ Page 159 DB CONNECTION SERVICE AND SETTING TOOL
DB Connection Service Setting Tool	Software that runs on the server computer and changes the settings of the DB Connection Service. Install the software from either of the following. <ul style="list-style-type: none">• Disk5 folder in GT Works3 DVD• Contact your local distributor.	☞ Page 159 DB CONNECTION SERVICE AND SETTING TOOL

2 SYSTEM CONFIGURATION

- ☞ Page 21 System Configuration
- ☞ Page 23 Connection between GOT and Controllers
- ☞ Page 25 Required Equipment, Software, and System Application (Extended Function)
- ☞ Page 26 Operating Environment
- ☞ Page 30 Cautions on System Configuration

This chapter explains the system configuration available for the MES interface function.

2.1 System Configuration

Overall system configuration

This section shows the overall system configuration when using the MES interface function.

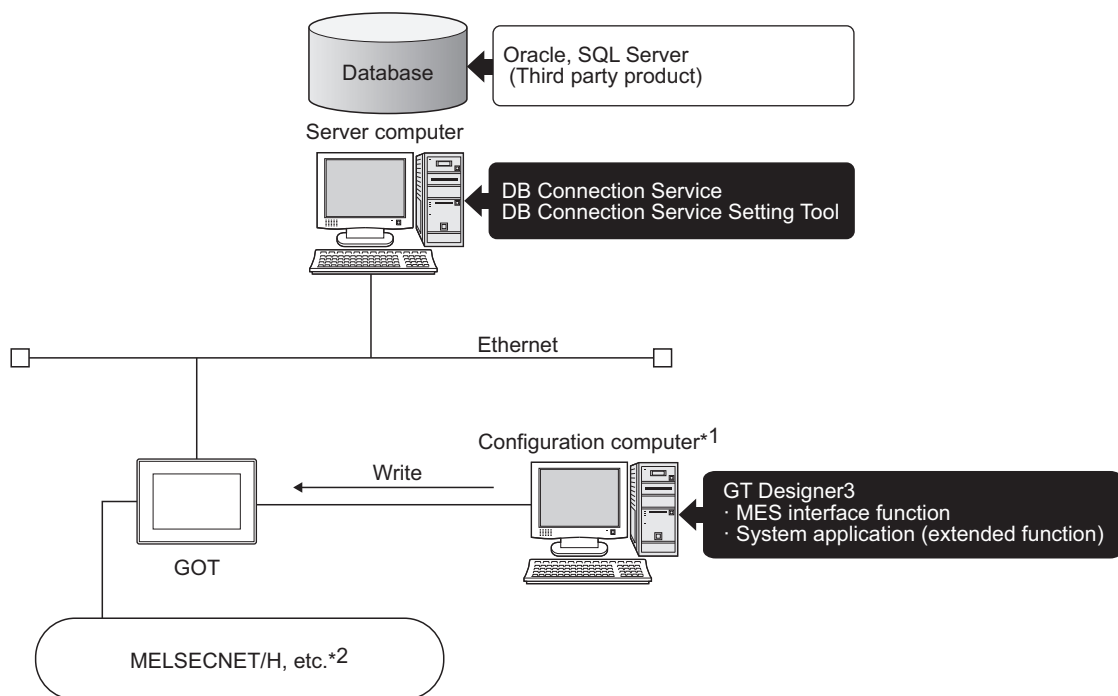

*1 One personal computer can be used as both the configuration computer and the server computer.

*2 For controllers available for the MES interface function, refer to the following.

- ☞ Page 23 Connection between GOT and Controllers

System configuration when installing software used for the MES Interface Function

The following shows system configuration when installing software used for the MES interface function.

When installing the DB Connection Service and DB Connection Service Setting Tool on a server computer

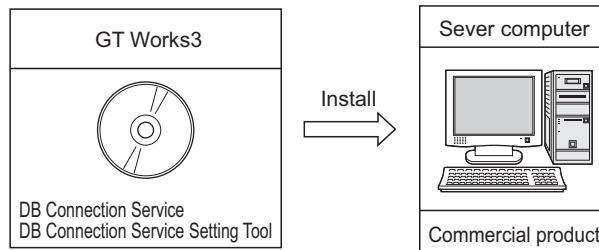

Point

- When installing DB Connection Service on a database server computer, the ODBC setting for the database used must be made beforehand.
 ➔ Page 161 Setting ODBC of Database
- When installing DB Connection Service on an application server computer, an account for user program execution must be created beforehand.

When installing GT Designer3 on a configuration computer

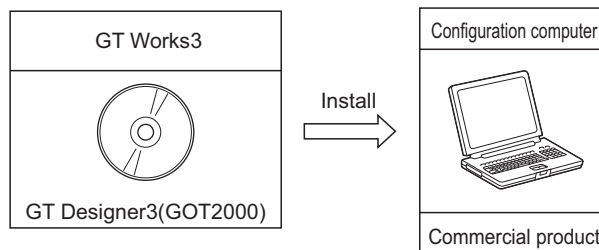

When installing a system application (extended function) of [MES Interface] on the GOT

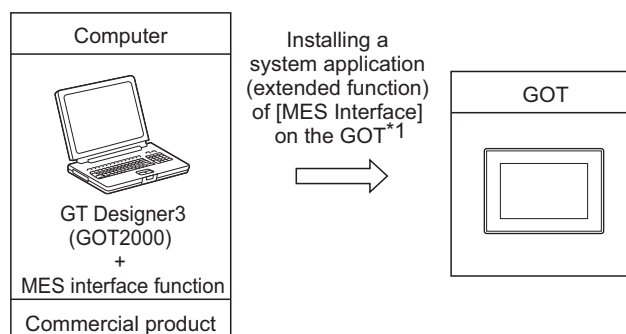

*1 For equipment used for installation, refer to the following manual:
 📖 GT Works3 Version1 Installation Procedure Manual

2.2 Connection between GOT and Controllers

Connection type used for the MES Interface Function

The following table shows the GOT supporting the MES interface function and availability in each connection type.

For system configuration when using the MES interface function, refer to the following manual:

 GOT2000 Series Connection Manual for GT Works3 and a controller used

○: Applicable △: Partly restricted ×: Not applicable

Connection type		GT27, GT25, GS25
Mitsubishi Electric PLC connection ^{*4}	Bus connection	○
	Direct CPU connection (serial)	○
	Computer link connection	○
	Ethernet connection	○
	MELSECNET/H connection (PLC to PLC network)	○
	MELSECNET/10 connection (PLC to PLC network)	△ ^{*1}
	CC-Link IE controller network connection	○
	CC-Link IE field network connection	○
	CC-Link connection (Intelligent device station)	△ ^{*2}
CC-Link connection (via G4)	○	
Inverter connection	○ ^{*3}	
Servo amplifier connection	○ ^{*3}	
Robot controller connection ^{*5}	○	
CNC connection ^{*6}	Serial connection	○
	Ethernet connection	○
	MELSECNET/10 connection (PLC to PLC network)	△ ^{*1}
	CC-Link connection (Intelligent device station)	△ ^{*2}
Third party PLC connection	Serial connection	○
	Ethernet connection	○
Third party safety controller connection	○	
Third party servo amplifier connection	×	
Third party robot controller connection	×	
Third party temperature controller connection	○	
Microcomputer connection	Serial connection	○
	Ethernet connection	○
MODBUS [®] /RTU connection	○	
MODBUS [®] /TCP connection	○	

*1 For the MELSECNET/10 connection, use the MELSECNET/H communication unit.
The MELSECNET/10 communication unit cannot be used.

*2 For the CC-Link connection, use the CC-Link communication unit (GT15-J61BT13).
The CC-Link communication unit (GT15-75J61BR13-Z) cannot be used.

*3 For the inverter or servo amplifier connection, use the trigger action or the script function to assign devices.
For how to assign devices, refer to the following:

 Page 24 Precautions for inverter or servo amplifier connection

*4 Including connection to the motion controller CPU (Q series and A series), CNC C70, and CRnQ-700

*5 Applicable to the CRnD-700 only.

For the CRnQ-700, refer to the above Mitsubishi Electric PLC connection.

*6 Applicable to the MELDAS C6/C64 only.

For the CNC C70, refer to the above Mitsubishi Electric PLC connection.

Precautions for inverter or servo amplifier connection

In the inverter or servo amplifier connection, the trigger action or the script function must be used for device assignment. For the trigger action and the script function, refer to the following manual.

📖 GT Designer3 (GOT2000) Screen Design Manual

The following are device assignment examples.

Example 1) Setting for assigning devices of the inverter [FREQROL 500/700/800, SENSORLESS SERVO] to the GOT's internal devices using the trigger action

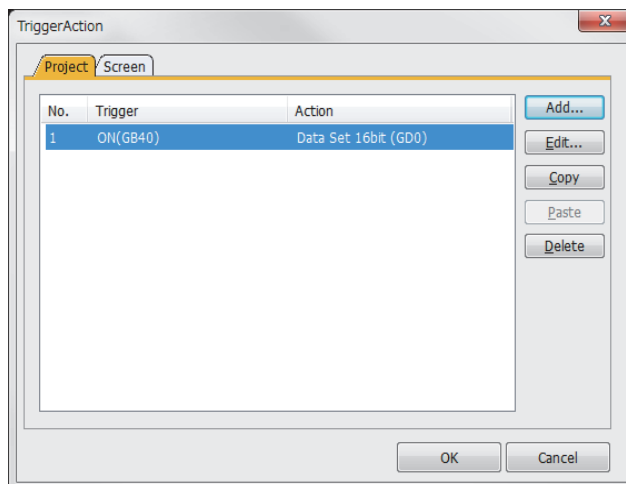

Example 2) Setting for assigning devices of the inverter [FREQROL 500/700/800, SENSORLESS SERVO] to the GOT's internal devices using the trigger action

Setting item	Setting content	Remarks
Trigger	ON Device GB40	Ordinary (GB40 is always ON.)
Operation device	[w:GD0]=[0-0:w:A0];	Assigns devices A0 to A15 of the inverter that has channel No. 1 and station No. 0 to device GD0.
	[w:GD10]=[0-0:w:Pr0];	Assigns devices Pr 0 to Pr 15 of the inverter that has channel No. 1 and station No. 0 to device GD 10.
	[w:GD20]=[0-0:w:PG0];	Assigns devices PG0 to PG15 of the inverter that has channel No.1 and station No.0 to device GD20.
	[w:GD31600]=[@3:0-16:w:A0];	Assigns devices A0 to A15 of the inverter that has channel No.3 and station No.16 to device GD31600.

2.3 Required Equipment, Software, and System Application (Extended Function)

Required equipment and software

The following table lists the equipment and software required for use of the MES interface function.

Application		Required equipment/software	Module name
Executing the MES interface function on the GOT		Licence Key for MES Interface function	GT25-MESIFKEY
Connecting the GOT to Ethernet		Built-in Ethernet interface	-
		Ethernet communication unit	GT25-J71E71-100
Connecting the GOT to controllers		For connection to a controller, refer to the following.  GOT2000 Series Connection Manual For GT Works3 Version1 compatible for a controller used	
Setting the MES interface function	Setting the MES interface function	GT Designer3 Version1.108N or later (MES interface function)	-
	DB buffering function, log output function, diagnostics function	SD card	NZ1MEM-2GBSD, NZ1MEM-4GBSD, NZ1MEM-8GBSD, NZ1MEM-16GBSD, L1MEM-2GBSD, L1MEM-4GBSD, Commercially available CF card (128MB or more) ^{*1}

*1 Some models with the operations checked by our company are usable.

For applicable SD cards, refer to the following Technical News.

 Operation Check Results of Non-Mitsubishi SD Cards on GOT2000 Series Units (GOT-A-0065)

For installation of the required equipment, refer to the following manual.

 GOT2000 Series User's Manual (Hardware)

For connection of the required equipment, refer to the following manual.

 GOT2000 Series Connection Manual for GT Works3

Required system application (extended function)

To use the MES interface function, a system application (extended function) of [MES Interface] is required.

Setting [MES Interface] installs the advanced system application (MES Interface) automatically into the package data.

Point

To use the MES Interface function, the BootOS Version of GOT D or later is required.

When the old version, license registration to use the MES interface function can not be.

2.4 Operating Environment

Configuration computer

The operating environment for the configuration computer is identical to those for GT Designer3.

For the operating environment for GT Designer3, refer to the following manual.

 GT Designer3 (GOT2000) Screen Design Manual

Server computer

This section explains the operating environment for the server computer.

Item	Description				
Personal computer	Personal computer or Server on which the following operating systems and relational database can run				
OS(English Version) ^{*1}	<table border="1"> <tbody> <tr> <td>When using DB Connection Service Version 2 and DB Connection Service Setting Tool Version 2^{*2}*3*4*5*12</td> <td> Microsoft Windows Server 2019 Standard Microsoft Windows Server 2016 Standard Microsoft Windows Server 2012 R2 Standard Microsoft Windows Server 2012 Standard Microsoft Windows Server 2008 R2 Standard Microsoft Windows 10 Enterprise Microsoft Windows 10 Pro Microsoft Windows 8.1 Enterprise Microsoft Windows 8.1 Pro Microsoft Windows 8 Enterprise Microsoft Windows 8 Pro Microsoft Windows 7 Ultimate Microsoft Windows 7 Enterprise Microsoft Windows 7 Professional </td> </tr> <tr> <td>When using DB Connection Service Version 1 and DB Connection Service Setting Tool Version 1</td> <td> Microsoft Windows Server 2012 R2 ^{*2}*3*4*5*6*7 Microsoft Windows Server 2012 ^{*2}*3*4*5*6*7 Microsoft Windows Server 2008 R2 ^{*2}*3*4*6*7*8*9 Microsoft Windows Server 2008 ^{*2}*3*4*6*7*8*9 Microsoft Windows Server 2003 x64 Edition ^{*2}*3*8 Microsoft Windows Server 2003 ^{*2}*3 Microsoft Windows 2000 Server Service Pack2 or later ^{*2} Microsoft Windows 10 Enterprise ^{*2}*3*4*5*7*9 Microsoft Windows 10 Pro ^{*2}*3*4*5*7*9 Microsoft Windows 8.1 Enterprise ^{*2}*3*4*5*7*9 Microsoft Windows 8.1 Pro ^{*2}*3*4*5*7*9 Microsoft Windows 8 Enterprise ^{*2}*3*4*5*7*9 Microsoft Windows 8 Pro ^{*2}*3*4*5*7*9 Microsoft Windows 7 Ultimate ^{*2}*3*4*7*9*10 Microsoft Windows 7 Enterprise ^{*2}*3*4*7*9*10 Microsoft Windows 7 Professional ^{*2}*3*4*7*9*10 Microsoft Windows Vista Ultimate ^{*3}*4*7*9 Microsoft Windows Vista Enterprise ^{*3}*4*7*9 Microsoft Windows Vista Business ^{*2}*3*4*7*9 Microsoft Windows XP Professional ^{*2}*3*11 Microsoft Windows 2000 Professional Service Pack2 ^{*2} </td> </tr> </tbody> </table>	When using DB Connection Service Version 2 and DB Connection Service Setting Tool Version 2 ^{*2} *3*4*5*12	Microsoft Windows Server 2019 Standard Microsoft Windows Server 2016 Standard Microsoft Windows Server 2012 R2 Standard Microsoft Windows Server 2012 Standard Microsoft Windows Server 2008 R2 Standard Microsoft Windows 10 Enterprise Microsoft Windows 10 Pro Microsoft Windows 8.1 Enterprise Microsoft Windows 8.1 Pro Microsoft Windows 8 Enterprise Microsoft Windows 8 Pro Microsoft Windows 7 Ultimate Microsoft Windows 7 Enterprise Microsoft Windows 7 Professional	When using DB Connection Service Version 1 and DB Connection Service Setting Tool Version 1	Microsoft Windows Server 2012 R2 ^{*2} *3*4*5*6*7 Microsoft Windows Server 2012 ^{*2} *3*4*5*6*7 Microsoft Windows Server 2008 R2 ^{*2} *3*4*6*7*8*9 Microsoft Windows Server 2008 ^{*2} *3*4*6*7*8*9 Microsoft Windows Server 2003 x64 Edition ^{*2} *3*8 Microsoft Windows Server 2003 ^{*2} *3 Microsoft Windows 2000 Server Service Pack2 or later ^{*2} Microsoft Windows 10 Enterprise ^{*2} *3*4*5*7*9 Microsoft Windows 10 Pro ^{*2} *3*4*5*7*9 Microsoft Windows 8.1 Enterprise ^{*2} *3*4*5*7*9 Microsoft Windows 8.1 Pro ^{*2} *3*4*5*7*9 Microsoft Windows 8 Enterprise ^{*2} *3*4*5*7*9 Microsoft Windows 8 Pro ^{*2} *3*4*5*7*9 Microsoft Windows 7 Ultimate ^{*2} *3*4*7*9*10 Microsoft Windows 7 Enterprise ^{*2} *3*4*7*9*10 Microsoft Windows 7 Professional ^{*2} *3*4*7*9*10 Microsoft Windows Vista Ultimate ^{*3} *4*7*9 Microsoft Windows Vista Enterprise ^{*3} *4*7*9 Microsoft Windows Vista Business ^{*2} *3*4*7*9 Microsoft Windows XP Professional ^{*2} *3*11 Microsoft Windows 2000 Professional Service Pack2 ^{*2}
When using DB Connection Service Version 2 and DB Connection Service Setting Tool Version 2 ^{*2} *3*4*5*12	Microsoft Windows Server 2019 Standard Microsoft Windows Server 2016 Standard Microsoft Windows Server 2012 R2 Standard Microsoft Windows Server 2012 Standard Microsoft Windows Server 2008 R2 Standard Microsoft Windows 10 Enterprise Microsoft Windows 10 Pro Microsoft Windows 8.1 Enterprise Microsoft Windows 8.1 Pro Microsoft Windows 8 Enterprise Microsoft Windows 8 Pro Microsoft Windows 7 Ultimate Microsoft Windows 7 Enterprise Microsoft Windows 7 Professional				
When using DB Connection Service Version 1 and DB Connection Service Setting Tool Version 1	Microsoft Windows Server 2012 R2 ^{*2} *3*4*5*6*7 Microsoft Windows Server 2012 ^{*2} *3*4*5*6*7 Microsoft Windows Server 2008 R2 ^{*2} *3*4*6*7*8*9 Microsoft Windows Server 2008 ^{*2} *3*4*6*7*8*9 Microsoft Windows Server 2003 x64 Edition ^{*2} *3*8 Microsoft Windows Server 2003 ^{*2} *3 Microsoft Windows 2000 Server Service Pack2 or later ^{*2} Microsoft Windows 10 Enterprise ^{*2} *3*4*5*7*9 Microsoft Windows 10 Pro ^{*2} *3*4*5*7*9 Microsoft Windows 8.1 Enterprise ^{*2} *3*4*5*7*9 Microsoft Windows 8.1 Pro ^{*2} *3*4*5*7*9 Microsoft Windows 8 Enterprise ^{*2} *3*4*5*7*9 Microsoft Windows 8 Pro ^{*2} *3*4*5*7*9 Microsoft Windows 7 Ultimate ^{*2} *3*4*7*9*10 Microsoft Windows 7 Enterprise ^{*2} *3*4*7*9*10 Microsoft Windows 7 Professional ^{*2} *3*4*7*9*10 Microsoft Windows Vista Ultimate ^{*3} *4*7*9 Microsoft Windows Vista Enterprise ^{*3} *4*7*9 Microsoft Windows Vista Business ^{*2} *3*4*7*9 Microsoft Windows XP Professional ^{*2} *3*11 Microsoft Windows 2000 Professional Service Pack2 ^{*2}				
CPU	1 GBHz or more				
Memory	<ul style="list-style-type: none"> When using Windows Server 2019, Windows Server 2016, Windows Server 2012 R2, Windows Server 2012, Windows Server 2008 R2, Windows Server 2008, Windows Server 2003 x64 Edition, Windows 10 (64 bit), Windows 8.1 (64 bit), Windows 8 (64 bit), or Windows 7 (64 bit): 2 GB or more recommended When using the Windows Server 2003, Windows Server 2000, Windows 10 (32 bit), Windows 8.1 (32 bit), Windows 8 (32 bit), Windows7 (32 bit) and Windows Vista (32 bit): 1 GB or more recommended When using the Windows XP and Windows 2000: 512 MB or more recommended 				
Display	A display where the above OS and after-mentioned databases can run				
Free hard disk space	64 MB or more (After database installation)				
Interface	Ethernet				

Item	Description
Database	<p>When using DB Connection Service Version 2 and DB Connection Service Setting Tool Version 2^{*13}</p> <p>When using the DB interface function: Relational database (any of the following)</p> <p>Oracle 19c Standard^{*12} Oracle 19c Enterprise^{*12} Oracle 18c Express^{*12} Oracle 18c Standard^{*12} Oracle 18c Enterprise^{*12} Oracle 12c Express^{*12} Oracle 12c Standard^{*12} Oracle 12c Enterprise^{*12} Oracle 11g Express^{*12} Oracle 11g Standard^{*12} Oracle 11g Enterprise^{*12} Microsoft SQL Server 2019 Express^{*12*20} Microsoft SQL Server 2019 Standard^{*12*20} Microsoft SQL Server 2019 Enterprise^{*12*20} Microsoft SQL Server 2017 Express^{*12*20} Microsoft SQL Server 2017 Standard^{*12*20} Microsoft SQL Server 2017 Enterprise^{*12*20} Microsoft SQL Server 2016 Express^{*12*20} Microsoft SQL Server 2016 Standard^{*12*20} Microsoft SQL Server 2016 Enterprise^{*12*20} Microsoft SQL Server 2014 Express^{*12*20} Microsoft SQL Server 2014 Standard^{*12*20} Microsoft SQL Server 2014 Enterprise^{*12*20} Microsoft SQL Server 2012 Express^{*12*20} Microsoft SQL Server 2012 Standard^{*12*20} Microsoft SQL Server 2012 Enterprise^{*12*20} Microsoft SQL Server 2008 R2 Express^{*8*12*20} Microsoft SQL Server 2008 R2 Standard^{*8*12*20} Microsoft SQL Server 2008 R2 Enterprise^{*8*12*20} Microsoft Access 2019^{*9*16*17*18*19*23} Microsoft Access 2016^{*11*14*16*17*18*19} Microsoft Access 2013^{*11*14*16*17*18*19} Microsoft Access 2010^{*11*14*16*17*18*19} MySQL Community^{*12*21*22} MySQL Standard^{*12*21} PostgreSQL^{*12*21}</p> <hr/> <p>When using DB Connection Service Version 1 and DB Connection Service Setting Tool Version 1^{*13*15}</p> <p>When using the DB interface function: Relational database (any of the following)</p> <p>Oracle 18c^{*12} Oracle 12c^{*12} Oracle 11g^{*9} Oracle 10g^{*11} Oracle 9i^{*11} Oracle 8i^{*11} Microsoft SQL Server 2014^{*9*20} Microsoft SQL Server 2012^{*9*20} Microsoft SQL Server 2008 R2^{*8*9*20} Microsoft SQL Server 2008^{*8*9*20} Microsoft SQL Server 2005^{*11} Microsoft SQL Server 2000^{*11} Microsoft SQL Server 2000 Desktop Engine(MSDE 2000)^{*20} Microsoft Access 2013^{*11*16*17*18*19} Microsoft Access 2010^{*11*16*17*18*19} Microsoft Access 2007^{*16*17*18*19} Microsoft Access 2003^{*16*17} Microsoft Access 2000^{*16*17}</p>
Other hardware	<ul style="list-style-type: none"> • Installation: Mouse, keyboard, and DVD drive or CD drive • Running: Mouse and keyboard

*1 When multiple displays are set, the screen of this product may not appear properly.

*2 For installation, administrator privileges are required.

You are recommended to log in with administrator privileges to use DB Connection Service.

*3 The following functions cannot be used.

If any of the following functions is used, this product may not operate properly.

- Activating the application with Windows compatibility mode
- Fast user switching
- Remote desktop
- Power saving function (standby, hibernation, or sleep)
- Change your desktop themes (fonts)

*4 Log in as a standard user or administrator to use this product.

- *5 The following functions cannot be used.
 - Modern UI Style
 - Hyper-V
 - Windows Touch or the touch feature
 - Tablet mode
 - Remote desktop
- *6 Server Core installation is not supported. Be sure to perform a full installation.
- *7 The following functions cannot be used.

If any of the following functions is used, this product may not operate properly.

 - DPI setting other than the normal size (Windows Vista)
 - Setting the size of text and illustrations on the screen to any size other than [Small-100%] (For Windows 10, Windows 8.1, Windows 8, and Windows 7)
- *8 The Itanium processor (IA64) is not supported.
- *9 32-bit and 64-bit are available.
- *10 Windows XP Mode is not supported.
- *11 Only 32-bit is available.
- *12 Only 64-bit is available.
- *13 The language versions of the database, DB Connection Service, and DB Connection Service Setting Tool must be the same.
- *14 Only 32-bit DB Connection Service Version 2 and DB Connection Service Setting Tool Version 2 are supported.
- *15 For the 32-bit version of DB Connection Service and DB Connection Service Setting Tool, use the 32-bit version of a database.
- *16 Up to 127 fields can be updated for a communication action.
- *17 Do not access the same file with multiple GOTs and MES interface modules simultaneously.
- *18 Memo-type fields in Rich Text Format cannot be used.
- *19 A field having multiple values cannot be used.
- *20 Set [SQL Server and Windows] for the security authentication mode.
- *21 Open source database.

The following versions have been validated by our company.

 - MySQL 5.7.10, 5.7.15, and 5.7.17
 - PostgreSQL 9.4.5 and 9.5.4
- *22 Use the MariaDB ODBC driver.
- *23 Microsoft 365 Access up to the same version as Microsoft Access 2019 can also be used.

When using Microsoft 365 Access, select Microsoft Access 2019 in [MES Interface Configuration Tool].

How to set security authentication mode (SQL Server and Windows)

- When Microsoft SQL Server 2019, 2017, 2016, 2014, 2012, 2008 R2, or 2008 is used Set the security authentication mode in the SQL Server Properties (Configure) screen.

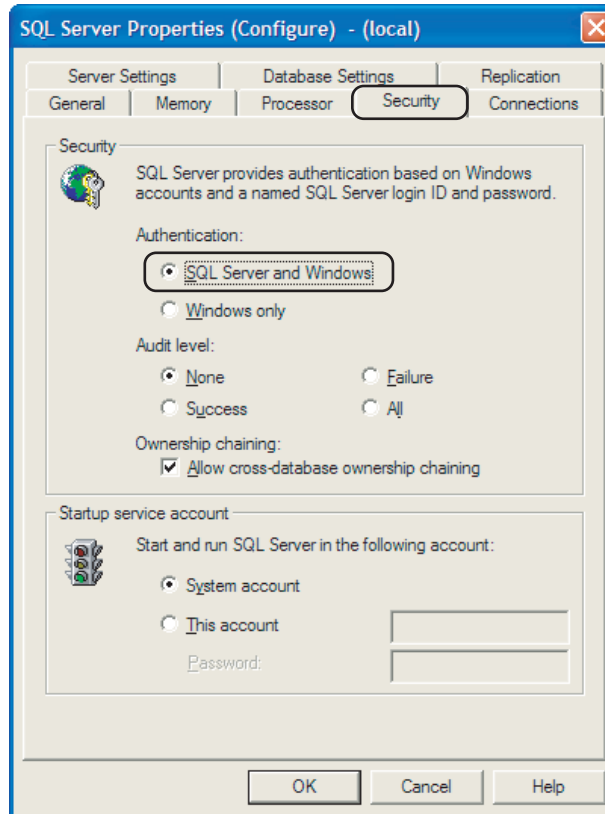

- When Microsoft SQL Server 2000 Desktop Engine (MSDE 2000) is used When installing MSDE2000, specify a command parameter.
setup sapwd = "sa" SECURITYMODE=SQL
(sa: Specify an arbitrary password.)

Combinations of OSs, databases, DB Connection Service, and DB Connection Service Setting Tool

Combinations of OSs, databases, DB Connection Service, and DB Connection Service Setting Tool

○: Available, -: Not available

Combination of OS and database		DB Connection Service and DB Connection Service Setting Tool		
		Version 1	Version 2 (32 bit)	Version 2 (64 bit)
OS (32 bit)	Oracle (32 bit)	○	-	-
	MySQL (32 bit)	-	-	-
	Microsoft SQL Server (32 bit)	○	-	-
	Microsoft Access (32 bit)	○	○	-
	PostgreSQL (32 bit)	-	-	-
OS (64 bit)	Oracle (64 bit)	○	○	○
	MySQL (64 bit)	-	○	○
	Microsoft SQL Server (64 bit)	○	○	○
	Microsoft Access (64 bit)	-	○	○
	PostgreSQL (64 bit)	-	○	○

2.5 Cautions on System Configuration

Relational databases that support the MES interface function

For the relational databases that support the MES interface function, refer to the following:

 Page 26 Server computer

Clock control

To synchronize the clocks between the GOT and a controller, set the time setting function and the time notification function on GT Designer3 or in the GOT utility.

For the time setting function and the time notification function, refer to the following.

 GT Designer3 (GOT2000) Screen Design Manual

 GOT2000 Series User's Manual (Utility)

3 SPECIFICATIONS

- ☞ Page 32 Performance Specifications
- ☞ Page 34 GOT Devices Available for the MES Interface Function
- ☞ Page 35 Function List and Setting Item List
- ☞ Page 38 GOT Internal Device (GS)

This chapter explains the performance specifications, functions and devices of the MES interface function.

3.1 Performance Specifications

The following are the performance specifications of the MES interface function.

Item		Specifications	Reference section
DB interface	No. of connected databases	Up to 8 databases/project	☞ Page 79 Setting items in Server service settings
	No. of connectable databases*3	<ul style="list-style-type: none"> • Oracle 19c • Oracle 18c • Oracle 12c • Oracle 11g • Oracle 10g • Oracle 9i • Oracle 8i • MySQL • Microsoft SQL Server 2019 • Microsoft SQL Server 2017 • Microsoft SQL Server 2016 • Microsoft SQL Server 2014 • Microsoft SQL Server 2012 • Microsoft SQL Server 2008 R2 • Microsoft SQL Server 2008 • Microsoft SQL Server 2005 • MicrosoftSQL Server 2000 • Microsoft SQL Server 2000 Desktop Engine(MSDE 2000) • Microsoft Access 2019 • Microsoft Access 2016 • Microsoft Access 2013 • Microsoft Access 2010 • Microsoft Access 2007 • Microsoft Access 2003 • Microsoft Access 2000 • PostgreSQL 	
Job	Allowable number of settings	Up to 64 jobs/project	☞ Page 84 Setting items in Job settings
	Trigger buffering	Up to 128 tag components/tag	
trigger conditions	No. of conditions can be combined	Up to 2 conditions • (Combination can be selected either AND or OR)/job	☞ Page 87 Setting items in Trigger conditions
	Condition type	20 types (Time specification (6 types), Specified time period, comparison between tag component values (6 types), comparison between tag component value and constant value (6 types), At module startup) and Handshake operation	
	Validation interval	One second at the minimum	
Action	Allowable number of settings	Up to 10 actions/job	☞ Page 100 Job Settings - Actions
	Communication action type	5 types (Select, Update, Insert, MultiSelect, Delete)	
	No. of communication action fields	Up to 8192 fields/project • [DB-Tag link setting]: Up to 256 rows/communication action • [Select/Update/Delete conditions]: Up to 8 rows/communication action • [Select sort settings]: Maximum 8 rows/communication action	☞ Page 104 Setting items in Communication action
	No. of records/data selectable for communication action	Up to 40000 records/MultiSelect communication action Up to 45000 words/job	
	No. of operations possible for operation action	(Up to 20 dyadic operations)/operation action	
	Operators for operation action	6 types (Addition, subtraction, multiplication, division, remainder, character string combination)	
	No. of resource data send action fields	Maximum 8192 fields/project	☞ Page 128 Setting items in Transmit resource action

Item		Specifications	Reference section	
DB interface	Device tag	No. of tags	Up to 64 tags/project	☞ Page 72 Setting items in Component setting
		No. of tag components	Up to 256 tag components/tag Up to 4096 tag components/project	
		Data type	Signed single-precision integer (16 bits), signed double-precision integer (32 bits), single-precision floating point (32 bits), character string, Unicode character string, bit	
		Character string length	Up to 255 characters	
		No. of statistical processings	Up to 64 tag components	
		Statistical processing	6 types (Average, maximum, minimum, moving average* ¹ , moving maximum* ¹ , moving minimum* ¹)	
Program execution	Allowable number of settings	(Once before execution of the initial action + once after execution of the final action)/job* ²	☞ Page 94 Setting items in Program execution	
DB buffering	Buffering capacity for communication errors* ²	Maximum capacity: SD card capacity -32M bytes (16 Mbytes to 512 Mbytes)	☞ Page 140 Setting items in DB buffering settings	
Working log	Log capacity for MES interface function execution	Maximum capacity: 1 Mbyte (SD card)	☞ Page 151 Working Log	
	Log capacity for job execution events	Maximum capacity: 2 Mbytes (SD card)		

*1 [No. of samples] can be set up to 20.

*2 How to estimate the buffering time from the buffering capacity is shown below.

Buffering time = (Allowable No. of bufferings) ÷ (Frequency [times/hour]) [h]

Allowable No. of bufferings = (Capacity to be used) ÷ (SQL text length + Overhead (4 bytes))

SQL text length = Total field character length + 6 × No. of fields + Total data length + 20 [bytes]

[Calculation Example]

In the case of the capacity of 64 Mbytes, the field name of 16 characters, the data length of 32 characters, access to 256 fields by one action per job, and executing once per 30 seconds

SQL text length = (16 × 256) + 6 × 256 + (32 × 256) = 13844 [bytes]

Allowable No. of bufferings = (64 × 1024 × 1024) ÷ (13844 + 4) ≒ 4846

Buffering time = 4846 ÷ (60 ÷ 30 × 60) ≒ 40 [h]

*3 For the operating environment of the database, refer to the following.

☞ Page 26 Server computer

☞ Page 30 Combinations of OSs, databases, DB Connection Service, and DB Connection Service Setting Tool

3.2 GOT Devices Available for the MES Interface Function

The following are GOT devices that can be set in the Device tag settings of the MES interface function.

Type	Description	Available setting range
GOT bit register	Bit register inside the GOT Can be used as a bit device.	GB64 to GB65535 ^{*1}
GOT data register	Data register inside the GOT Can be used as a word device.	GD0 to GD65535
GOT special register	Special register inside the GOT Stores GOT's internal information, communication status, error information, etc. Can be used as a word device.	GS0 to GS1023 ^{*2}
Gateway device	Used when making interaction between the MES interface function and the gateway function. Virtual device for indirectly reading or writing the controller devices that are monitored by another GOT. Can be used as a word device.	1-1: EG0 to 239-64: EG32767 ^{*3}

*1 For GB0 to GB63, refer to the following manual.

 GT Designer3 (GOT2000) Screen Design Manual

*2 Do not write any value to a write-prohibited GOT special register.

Setting a value to the GOT special register may affect the GOT operation.

For the GOT special register, refer to the following manual.

 GT Designer3 Version1 Screen Design Manual (Fundamentals)

*3 Specify the gateway device in the following format.

(Network No.) - (Station No.) : EG (Device No.)

Network No. : 1 to 239

Station No. : 1 to 64

Device No. : 0 to 32767

Point

The gateway function setting is required for use of the gateway devices.

For the gateway setting, refer to the following manual.

 GT Designer3 (GOT2000) Screen Design Manual

3.3 Function List and Setting Item List

This section provides the lists of the functions and setting items that can be set for the MES interface function.

MES interface function list

Function	Description	Reference section
DB interface function	Executes communication with the database in units of jobs.	☞ Page 43 DB Interface Function ☞ Page 100 Job Settings - Actions
Tag function	Collects data in the internal devices or gateway devices of the GOT on the network in units of tags. Assigning a database field to a tag component allows reading or writing of a database value or device data that is specified by the tag component.	☞ Page 45 Tag function ☞ Page 68 Device Tag Settings
Trigger monitoring function	Monitors values such as the time and tag values and, when the trigger condition changes from false to true (when the conditions are met), starts a job.	☞ Page 46 Trigger monitoring function ☞ Page 87 Setting items in Trigger conditions
Trigger buffering function	Allows the system to buffer the data and the time that trigger conditions are met to the user area of the GOT when too many trigger conditions (data transmission conditions) are met simultaneously. The action (operation and transmission of the data) for the buffered data is executed later. Even when the data transmission triggers are activated frequently, no triggers are missed so that all the jobs are executed.	☞ Page 48 Trigger buffering function ☞ Page 84 Setting items in Job settings
SQL text transmission (Communication action)	Automatically creates an SQL text and communicates with the database. The following communication actions are selectable. <ul style="list-style-type: none"> • Select • Update • Insert • MultiSelect • Delete 	☞ Page 50 SQL text transmission (Communication action) ☞ Page 104 Setting items in Communication action
Arithmetic processing function (Operation action)	Allows operations of tag component values.	☞ Page 51 Arithmetic processing function (Operation action) ☞ Page 125 Setting items in Operation action
Resource data send function (Resource data send action)	Sends the resource data collected in the GOT to the database. A SQL text (INSERT) is used for sending the resource data to the database.	☞ Page 50 SQL text transmission (Communication action) ☞ Page 51 Resource data send function (Resource data send action) ☞ Page 128 Setting items in Transmit resource action
Program execution function	Executes programs in the application server computer before execution of the first action and after execution of the last one in a job.	☞ Page 53 Program execution function ☞ Page 94 Setting items in Program execution
DB buffering function	Temporarily stores SQL texts into a CF card when they cannot be sent due to network disconnection or failure of the database server computer. After recovery, the buffered SQL texts are automatically sent to the database. (Manual operation is also possible.)	☞ Page 54 DB buffering function ☞ Page 140 Setting items in DB buffering settings ☞ Page 148 Checking the connection of the previous job execution (Connection result of previous job execution) ☞ Page 149 Manipulating DB buffering (DB buffering operation)
Diagnostics function	Used to stop/restart the MES interface function, check job operations and configure the settings.	☞ Page 146 Diagnosis

Function	Description	Reference section	
DB server function	Allows direct access to a database upon request of the DB interface function.	☞ Page 159 DB Connection Service Functions	
	ODBC connection function	Executes the operation requested by the DB interface function or returns a response.	☞ Page 161 Setting ODBC of Database
	Connection setting function	Restricts IP addresses of GOTs that can be connected to the database.	☞ Page 173 Setting Items of DB Connection Service Setting Tool
	Log output function	Outputs the execution status of DB Connection Service to the log.	☞ Page 179 Output Log Specifications

List of the MES interface setting items

Function	Description	Reference section	
Device tag settings	Configure the settings for the tag function.	☞ Page 68 Device Tag Settings	
	Array setting	Configure this setting when writing multiple records extracted from a database to the same tag component.	☞ Page 70 Setting items in Array setting
	Component setting	Configure the settings for assigning GOT devices to tags.	☞ Page 72 Setting items in Component setting
Server service settings	Configure the settings for access to a server computer.	☞ Page 78 Server Service Settings	
Job settings	Configure the settings for the DB interface function.	☞ Page 83 Job Settings	
	trigger conditions	Configure the settings for startup conditions of the job.	☞ Page 87 Setting items in Trigger conditions
	Trigger buffering	Set whether to utilize the trigger buffering function or not.	☞ Page 84 Setting items in Job settings
	Communication action	Configure the settings for communications with a database.	☞ Page 104 Setting items in Communication action
	Operation action	Configure the settings for operation of tag component values.	☞ Page 125 Setting items in Operation action
	Resource data send action	Configure the settings for sending the resource data to the database.	☞ Page 128 Setting items in Transmit resource action
	program execution	Configure the settings for the program execution function.	☞ Page 94 Setting items in Program execution
	DB buffering	Set whether to utilize the DB buffering function or not.	☞ Page 97 Setting items in DB Buffering
	One-shot execution	Execute a job as a one-shot task.	☞ Page 99 One-shot execution
System setting	Configure the DB buffering function setting.	☞ Page 139 System Setting	
	DB buffering setting	Configure the settings for the DB buffering function.	☞ Page 140 Setting items in DB buffering settings
	Option Setting	Set whether to enable the additional setting.	☞ Page 143 Setting item of the option setting
diagnosis	Perform the remote diagnosis for the MES Interface function.	☞ Page 146 Diagnosis	
	Status	The operation status of the MES Interface function can be checked.	☞ Page 146 Checking the MES Interface Function status (Status)
	Operation	The operation of the MES interface function can be controlled.	☞ Page 147 Manipulating the MES Interface Function status (Operation)
	Change Job Status	The job status can be changed.	☞ Page 147 Changing the job status (Change job status)
	Connection result of previous job execution	Connection with the server computer set in [Server Service setting], which is made at the time of the previous job execution, can be displayed.	☞ Page 148 Checking the connection of the previous job execution (Connection result of previous job execution)
	DB buffering operation	The DB buffering can be operated.	☞ Page 149 Manipulating DB buffering (DB buffering operation)
MESI/F Log	Displays the working log of the MES Interface function.	☞ Page 151 Working Log	
	MES Interface Execute Log	Displays the MES Interface function execution log.	☞ Page 151 MES Interface Execute Log
	Job Execute Log	Displays the job execution event log.	☞ Page 152 Job Execute Log

List of setting items of DB Connection Service Setting Tool

Function	Description	Reference section
Service port	Specify the number of the port where the DB Connection Service operates.	☞ Page 173 Setting Items of DB Connection Service Setting Tool
DB access timeout	Set a timeout time (unit: seconds) used when no response may be returned after requesting program execution or value writing/reading from the GOT to a database.	
IP address setting	Determine whether or not to restrict IP addresses of GOTs whose connection to DB Connection Service is permitted.	
Output access log	Set whether or not to output the access log.	
Output SQL failed log	Set whether or not to output the SQL failure log.	

3.4 GOT Internal Device (GS)

GOT internal device list

The list of the GOT internal devices (GS) used for the MES interface module is shown below.

Point

- For details of any other GOT internal devices (GS) than the shown areas used for the MES interface function, refer to the following manual.
 GT Designer3 (GOT2000) Screen Design Manual
- Values stored in the GOT internal devices (GS) are cleared to 0 when the GOT is powered OFF and then ON or is reset.

GS	Application	Name	Initial value	Reference section
275	MES interface function area	Monitoring interval timeout count	0	 Page 39 MES Interface Function area
670		No. of trigger buffer data	0	
671		Trigger buffer overflow count	0	
672 to 675		Trigger buffer overflow flag for a job	0	

MES Interface Function area

This section explains the details of the special registers used for the MES interface function.

Monitoring interval timeout count (GS275)

The cumulative number of times that a monitoring interval timeout has occurred is stored.

If monitoring interval timeout occurs frequently, check the number of job settings and the trigger condition setting.

For the monitoring interval timeout, refer to the following:

 Page 200 About Monitoring Interval Timeout

No. of trigger buffer data (GS670)

The number of trigger buffer data is stored.

When many trigger buffer data is stored for a long time, the GOT becomes busy. As a result, some data may not be collected.

Check the number of job settings for which [Trigger buffering] is enabled and the trigger condition setting.

Trigger buffer overflow count (GS671)

The cumulative number of times that a trigger buffer overflow has occurred is stored.

The trigger buffer overflow means that 129th trigger data is discarded without being buffered when 128 trigger data is already buffered.

If trigger buffer overflow occurs frequently, check the number of job settings for which [Trigger buffering] is enabled and the trigger condition setting.

Trigger buffer overflow flag for a job (GS672 to GS675)

The flag indicates the status of trigger buffer overflow for each job.

When a trigger buffer overflow occurs for a job, the internal device corresponding to the job turns ON. The following table shows the internal devices that are corresponding to jobs 1 to 64.

Name	Job and internal device															
GS672	b0	b1	b2	b3	b4	b5	b6	b7	b8	b9	b10	b11	b12	b13	b14	b15
Jobs 1 to 16	1	2	3	4	5	6	7	8	9	10	11	12	13	14	15	16
GS673	b0	b1	b2	b3	b4	b5	b6	b7	b8	b9	b10	b11	b12	b13	b14	b15
Jobs 17 to 32	17	18	19	20	21	22	23	24	25	26	27	28	29	30	31	32
GS674	b0	b1	b2	b3	b4	b5	b6	b7	b8	b9	b10	b11	b12	b13	b14	b15
Jobs 33 to 48	33	34	35	36	37	38	39	40	41	42	43	44	45	46	47	48
GS675	b0	b1	b2	b3	b4	b5	b6	b7	b8	b9	b10	b11	b12	b13	b14	b15
Jobs 49 to 64	49	50	51	52	53	54	55	56	57	58	59	60	61	62	63	64

4 SETTINGS AND PROCEDURES BEFORE USE OF THE MES INTERFACE FUNCTION

☞ Page 41 Settings and Procedures before Use of the MES Interface Function

☞ Page 42 Installation and Uninstallation

4.1 Settings and Procedures before Use of the MES Interface Function

This chapter explains the procedures and settings to be done before use of the MES interface function. The flowcharts for use of the MES interface function are shown here.

4

Point 

Start the server computer, and then the GOT.

Starting the server computer

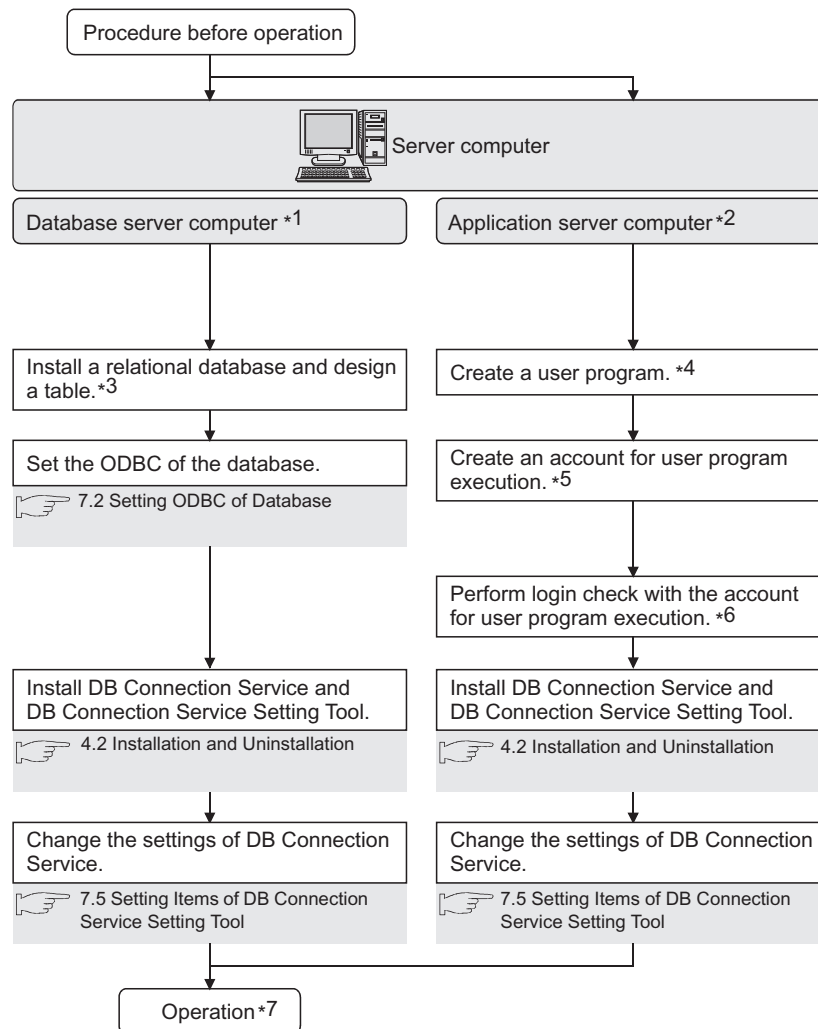

*1 Be sure to make the settings to use the DB interface function.

☞ Page 43 DB Interface Function

*2 Make the settings when using the program execution function.

☞ Page 53 Program execution function

*3 Restart the personal computer after installing the relational database.

Communication with GOT may fail if not restarted.

- *4 Create it only when necessary.
An existing program, a program included in OS, or a commercially available program can also be used.
- *5 Always set a password for the account for user program execution.
Use of an account without password will result in execution failure by OS.
- *6 If the login is not confirmed, the program execution function may not operate properly.
When installing DB Connection Service and DB Connection Service Setting Tool, log in using a user name with administrative right.
- *7 Do not log in the server computer using an account for user program execution during user program execution.
Doing so may cause incorrect operation of the program execution function.

Starting the GOT

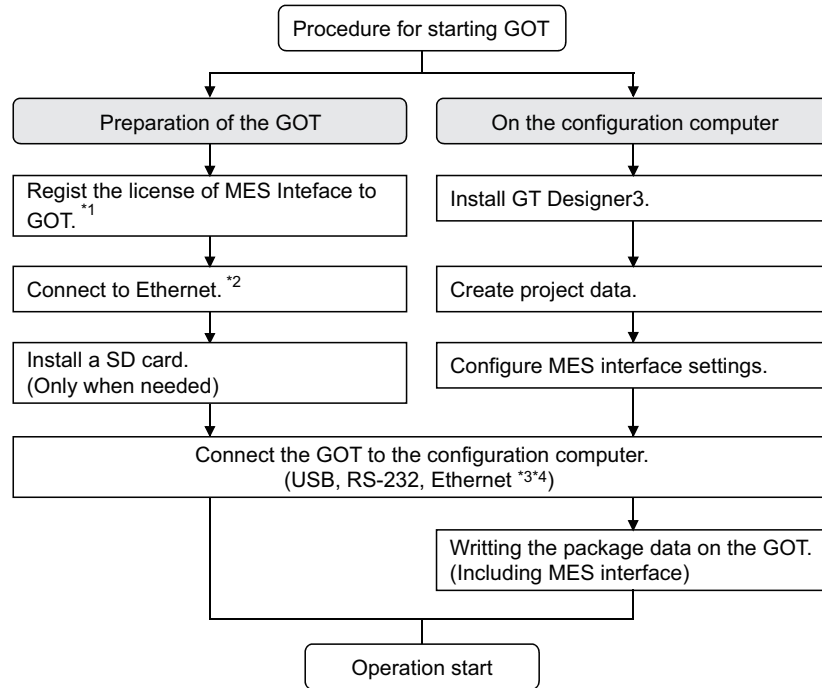

- *1 Register the license of MES functionality in utility.
- *2 For connecting GOT to a device supporting 10BASE(-T/2/5), configure the network that supports both 10Mbps and 100Mbps communication speeds by using a switching hub.
- *3 When using the MES interface function only on the Ethernet, the GOT port No. setting in Communication Detail Settings is ignored.
- *4 Use the Ethernet interface built in the GOT.

4.2 Installation and Uninstallation

For how to install and uninstall each execution software for the MES interface function on the operating environment, refer to the following manual.

GT Works3 Version1 Installation Procedure Manual

5 MES INTERFACE FUNCTION

☞ Page 43 DB Interface Function

☞ Page 61 Precautions

You can use the MES interface function by installing a system application (extended function) of [MES Interface] on the GOT. This chapter describes the MES interface function.

Point

The MES interface function settings are configured on the MES interface function setting screen of GT Designer3.

☞ Page 63 MES INTERFACE FUNCTION SETTING

5.1 DB Interface Function

The DB interface function executes access to the database in units of jobs.

DB interface function operation

The operation of the DB interface function is shown below.

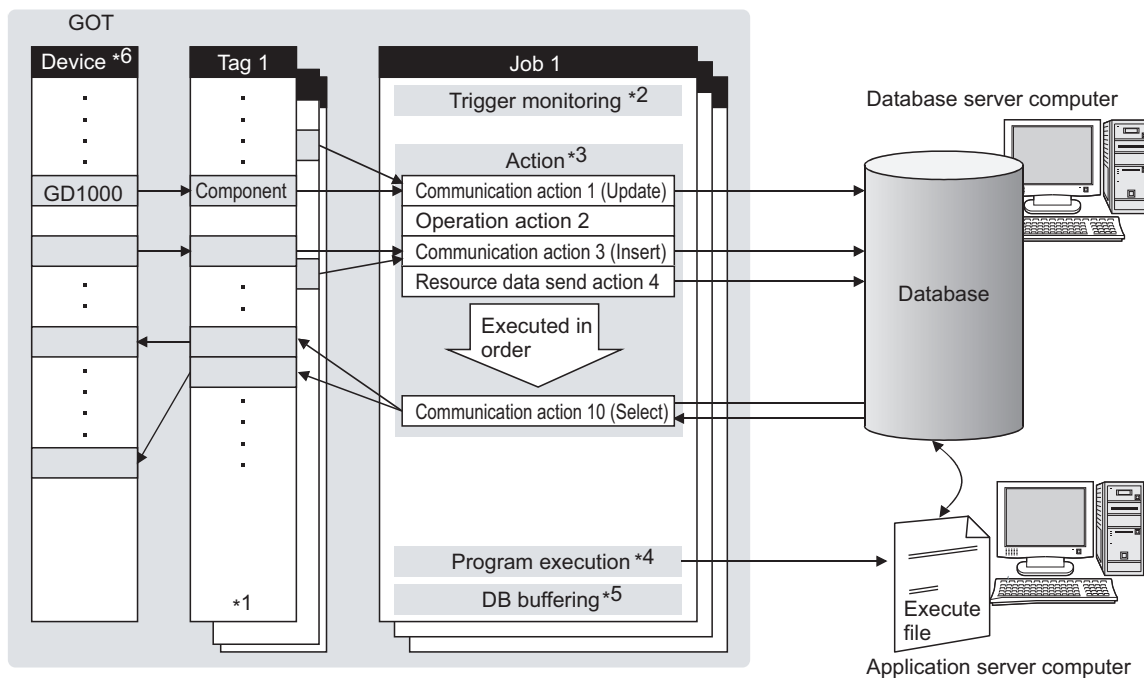

*1 Collects tag data.

☞ Page 45 Tag function

*2 Activates a job.

☞ Page 46 Trigger monitoring function

*3 Accesses the database and performs arithmetic processing.

☞ Page 50 SQL text transmission (Communication action)

☞ Page 51 Arithmetic processing function (Operation action)

☞ Page 51 Resource data send function (Resource data send action)

*4 Executes programs.

☞ Page 53 Program execution function

*5 Temporarily stores SQL texts that cannot be sent due to a communication error.

☞ Page 54 DB buffering function

*6 For devices usable for the MES interface function, refer to the following.

☞ Page 34 GOT Devices Available for the MES Interface Function

Job execution procedure

The following is the job execution procedure.

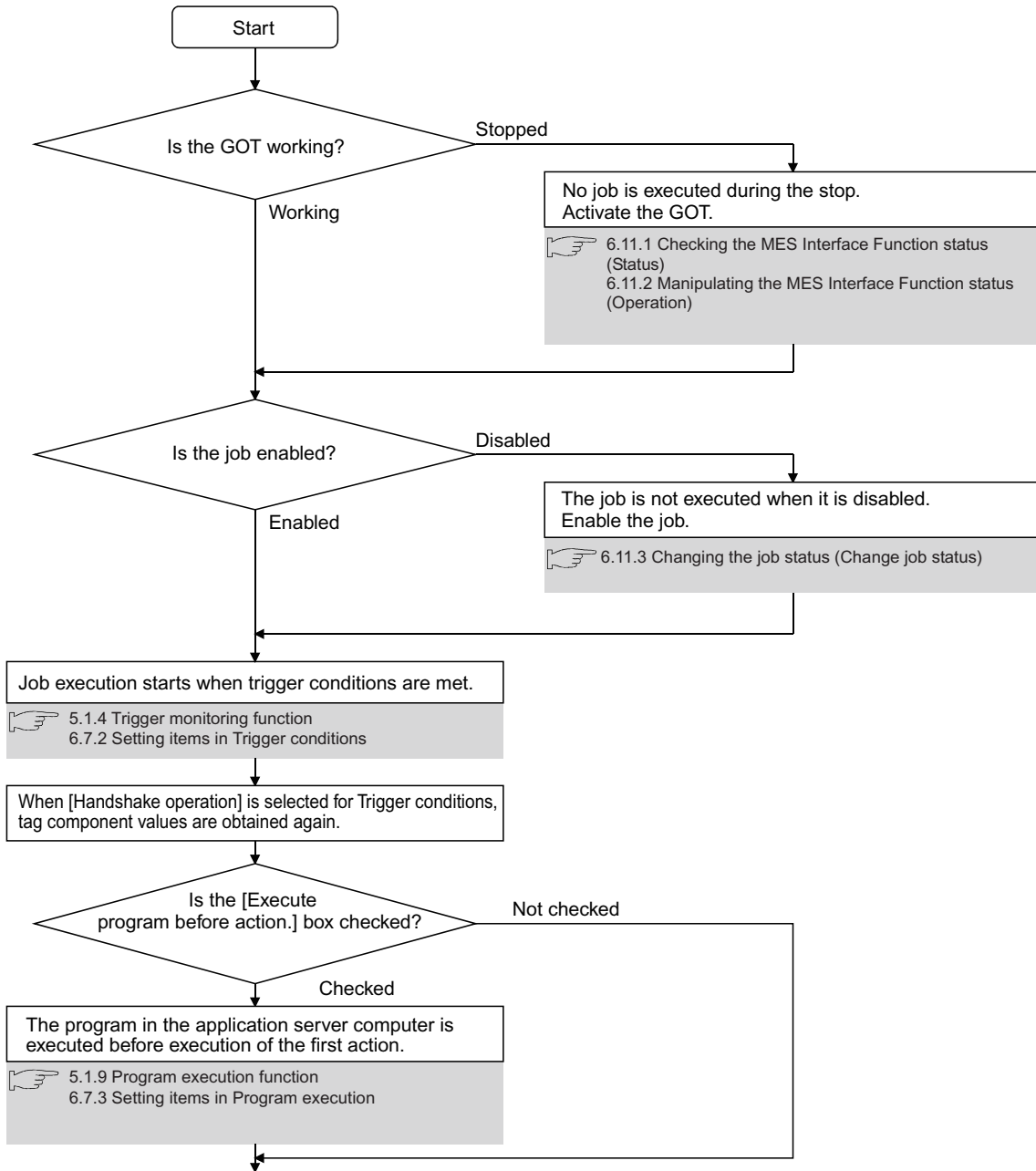

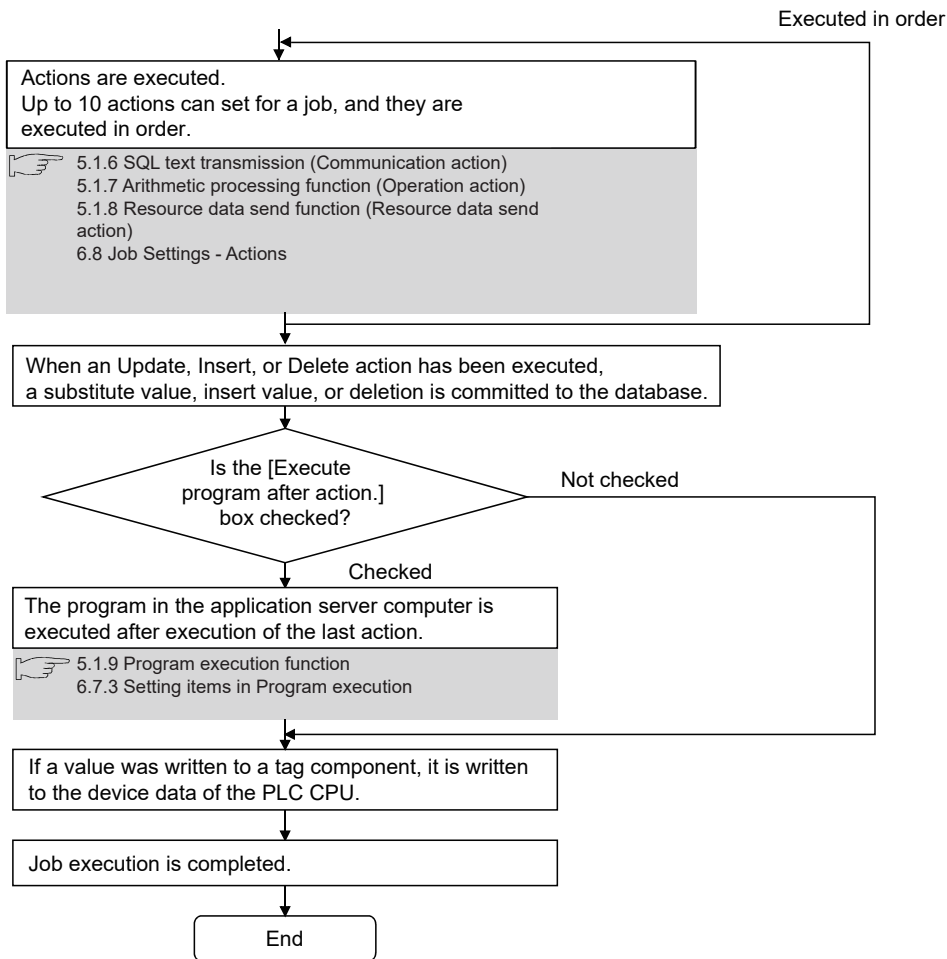

Point

For the case where an error occurs during job execution, refer to the following:
 Page 62 When an error occurs in job execution

Tag function

The tag function collects device data of the GOTs on the network in units of tags.

Assigning a database field to a tag component allows reading or writing of a database value or device data that is specified by the tag component.

For the tag function setting, refer to the following:

Page 68 Device Tag Settings

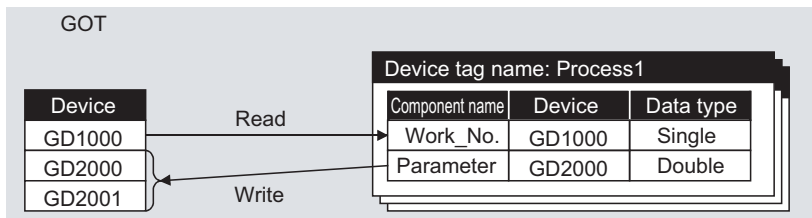

Trigger monitoring function

The trigger monitoring function monitors values such as the time and tag values and, when the trigger condition changes from false to true (when the condition is met), starts a job.

The following setting options are available as conditions for start.

- [Time specification startup]: Starts the job at the specified time.
- [Specified time period startup]: Starts the job at the specified intervals (Unit: Seconds).
- [Value monitoring startup]: Compares the actual tag component value with the condition value (tag component value or constant value) at every sampling times, and starts the job when the condition is met.
- [Handshake operation]: Starts the job on request from the GOT. Completion of job execution can be reported to the GOT.
- [At GOT startup]: Starts the job only once when the GOT starts up.

Two kinds of conditions can be used in combination for starting a job.

For the trigger monitoring function setting, refer to the following:

☞ Page 87 Setting items in Trigger conditions

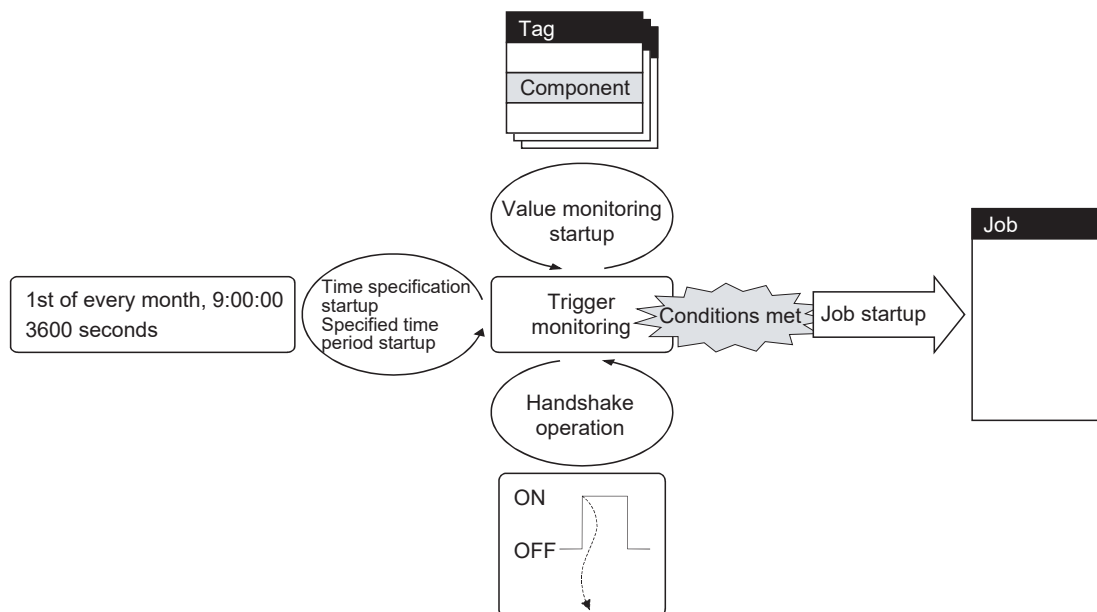

In [Value monitoring startup], tag component values used for triggering monitoring and those used in the activated job are collected at different timings without synchronization.

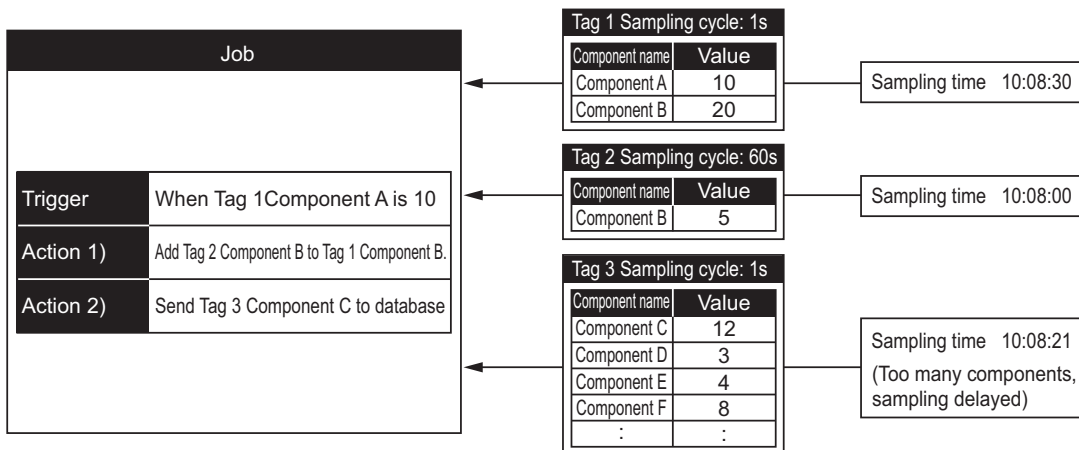

To synchronize collection of the above tag component values, perform either of the following (Plan 1) or (Plan 2).

(Plan 1)

Use [Handshake operation].

☞ Page 93 Handshake operation

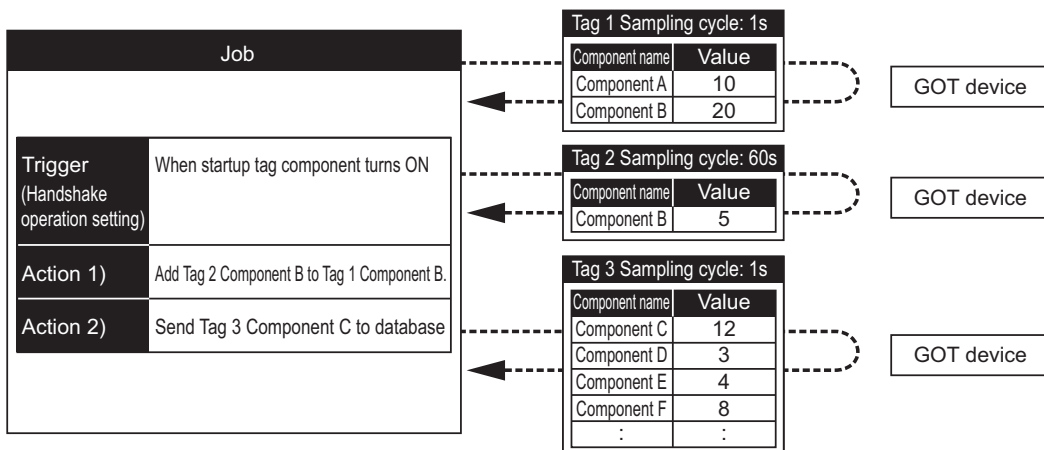

(Plan 2)

Put the tag components used in a job into one tag.

Since the tag components collect the specified GOT device values during job execution, the execution time of the job is increased.

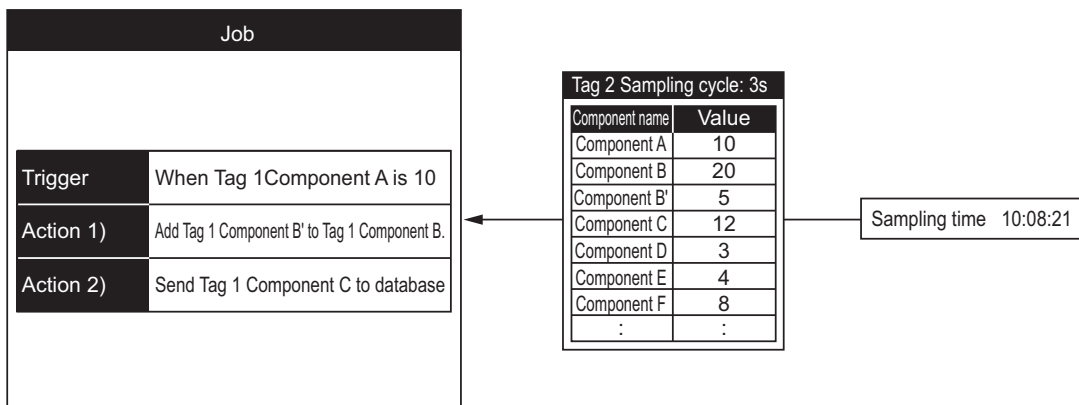

Trigger buffering function

When too many trigger conditions (data transmission conditions) are met simultaneously, the trigger buffering function allows the system to buffer the data and time trigger conditions are met to the user area of the GOT. The action (operation and transmission of the data) for the buffered data is executed later.

Even when the data transmission triggers are activated frequently, no triggers are missed so that all the jobs are executed. Enable [Trigger buffering] in each job setting to utilize the trigger buffering function.

Trigger buffering function

The following describes the behavior of a job for which [Trigger buffering] is enabled.

■When normal (Interval that trigger conditions are met is longer than processing time of action)

- When trigger conditions are met, the tag data and the time are stored in the trigger buffer.
- The action, which is specified by the data stored in the trigger buffer, is executed immediately.

[GOT]

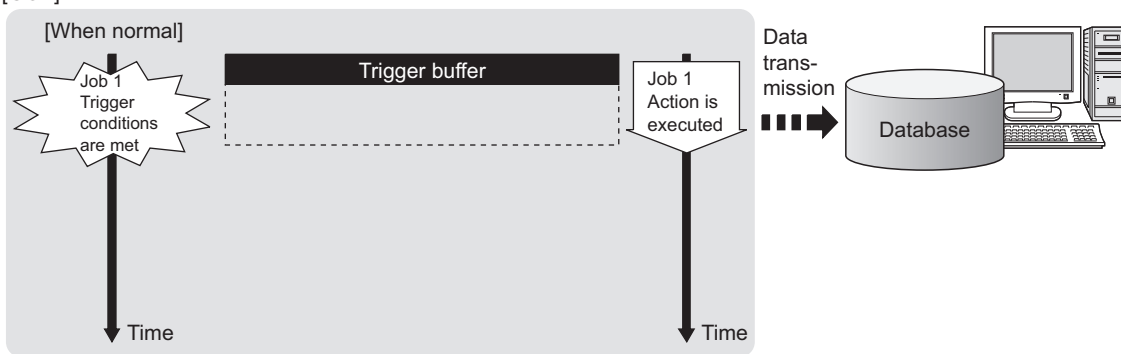

■When busy (Interval that trigger conditions are met is shorter than processing time of action)

- Tag data and time that conditions are met are stored to the trigger buffer every time the conditions are met.
- If an action cannot complete before another condition is met, up to 128 trigger data can be stored.

[GOT]

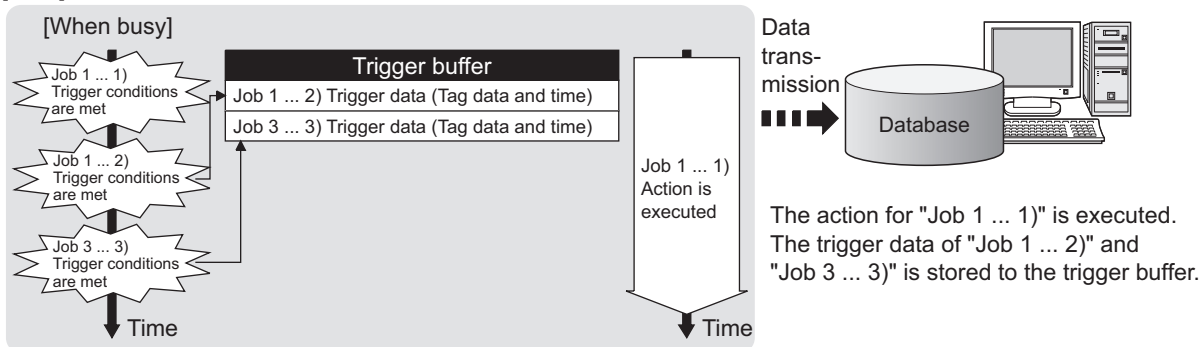

- The numbers 1) to 3) correspond to the order of that trigger conditions are met.
- In this example, the jobs 1 and 3 access the same database.

■When becoming less busy (Interval that trigger conditions are met is longer than processing time of action)

- The action, which is specified by the data stored in the trigger buffer, is read and executed sequentially.
- When the action for the trigger data in the trigger buffer completes, the trigger data is cleared, and another trigger data can be stored.

[GOT]

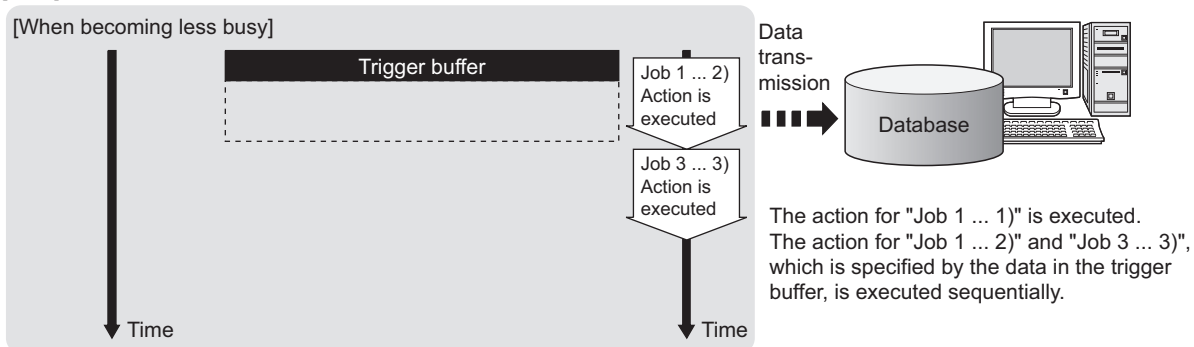

- The numbers 1) to 3) correspond to the order of that trigger conditions are met.
- In this example, the jobs 1 and 3 access the same database.

Point

- For job operation for which [Trigger buffering] is disabled, refer to the following:
 - ☞ Page 61 Operation behavior of jobs
- Whether the condition is changed from false to true is judged at collection of the tag.
 - ☞ Page 87 Setting items in Trigger conditions

Maximum times of trigger buffering

■The trigger buffering function allows up to 128 trigger data (tag data and time) to be stored simultaneously.

A job can be stored for unlimited number of times.

■Check status of the trigger buffering in the following.

- Number of jobs in the trigger buffer (GS670)
- [MES Interface] - [Diagnostics] tab
 - ☞ Page 150 Checking the trigger buffering (Trigger buffering status)

■If 128 conditions are already met and another condition is met, the trigger of the new condition is discarded.

Check the number of discards in the trigger buffer overflow (GS671).

Clearing trigger buffer

Any of the following operation clears the trigger buffer.

- Power off the GOT.
- Reset the GOT (when changing the communication settings, etc.)
- Install the OS from GT Designer3
- Download project data, etc.
- Stop the MES interface function operation by [MES Interface] - [Diagnostics]
 - ☞ Page 147 Manipulating the MES Interface Function status (Operation)

SQL text transmission (Communication action)

The SQL text transmission function allows automatic creation of SQL texts, enabling communications with the database. The following communication actions are selectable.

- Select
- Update
- Insert
- MultiSelect
- Delete

For the SQL text transmission setting, refer to the following:

☞ Page 104 Setting items in Communication action

Select and MultiSelect

Select and MultiSelect are used to write a database value to a tag component or temporary variable by sending SQL text to the database.

When a value is stored in the temporary variable area, it can be used as a variable for other actions.

Update and Insert

Update and Insert are used to add a tag component value or a temporary variable to an SQL text and write the value to the database.

Delete

Delete is used to delete a record from the database.

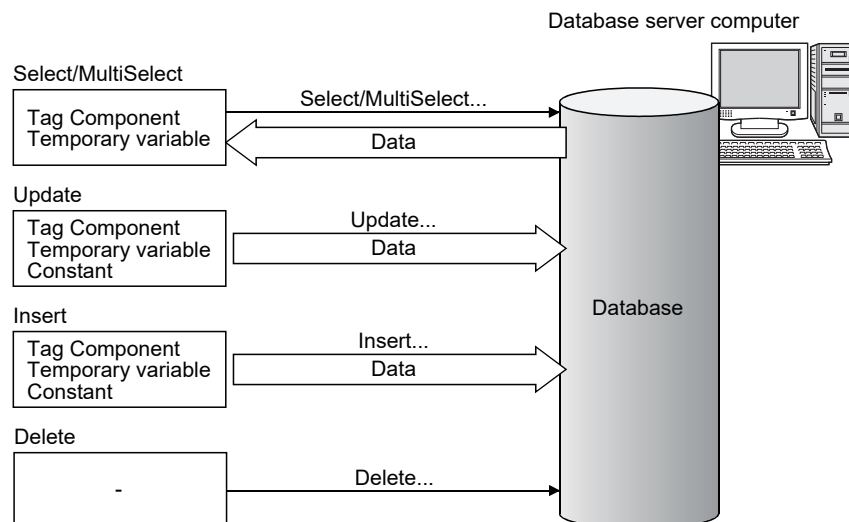

Arithmetic processing function (Operation action)

The arithmetic processing function performs operations for tag component values. In this function, up to 20 dyadic operations can be processed per operation action. By storing an operation result in the temporary variable area, complicated operations are also executable. For the arithmetic processing function setting, refer to the following:

☞ Page 125 Setting items in Operation action

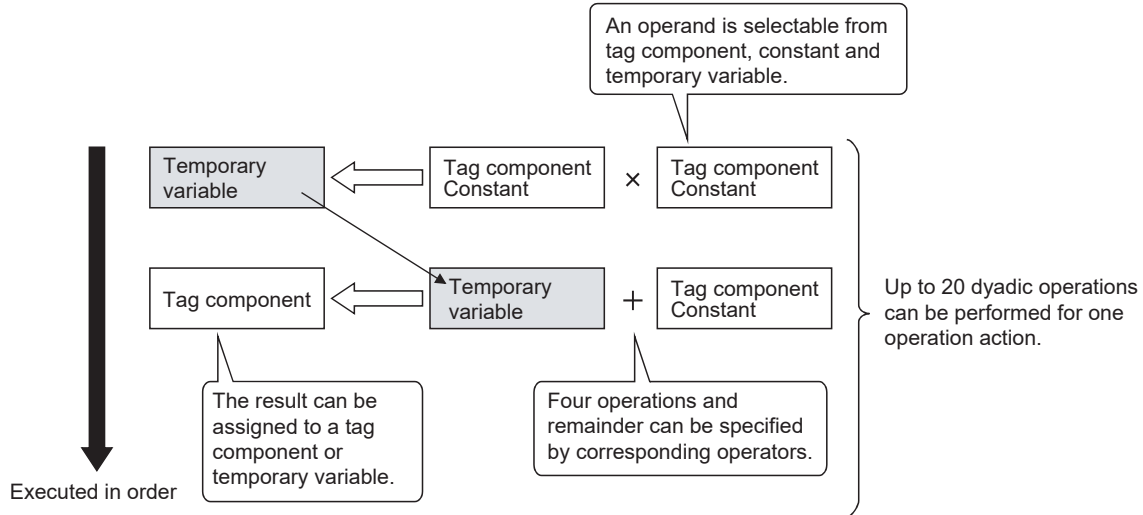

Resource data send function (Resource data send action)

The resource data send function allows the GOT to send resource data collected in a GOT buffering area and a CF card to a database. Device values for controllers, alarm data for the GOT, and others can be stored to the database without any communication programs.

For the resource data send function settings, refer to the following.

☞ Page 128 Setting items in Transmit resource action

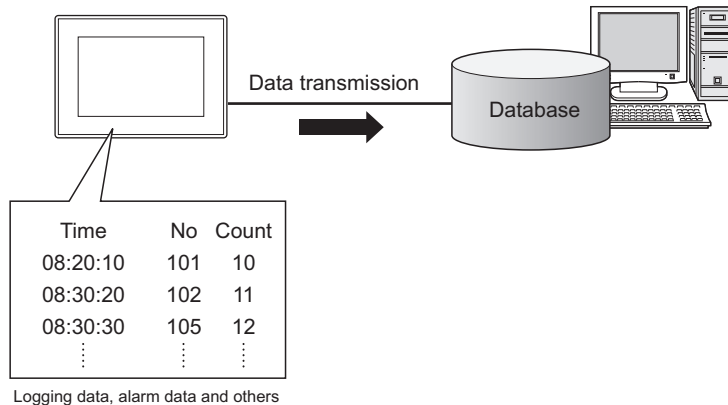

Resource data send function

Available data to be sent

For using the resource data send function, set [Transmit resource action] in the action for [Job settings].

The following resource data can be sent to a database.

Resource data	Description	
Logging data	Logging data collected by the logging function	
Alarm data	Advanced user alarm	Alarm data collected by the advanced user alarm observation setting
	Advanced system alarm	Alarm data collected by the advanced system alarm observation setting
Operation log data	GOT operation history data collected by the operation log function	

■Resource data to be sent

- Settings on the resource data send action for the collected resource data

The GOT sends the resource data before and after turning on the GOT.

Specifying the number of resource data and the time of collecting the data or others are available.

This setting allows the GOT to send resource data when the loads on the GOT and controllers are lower.

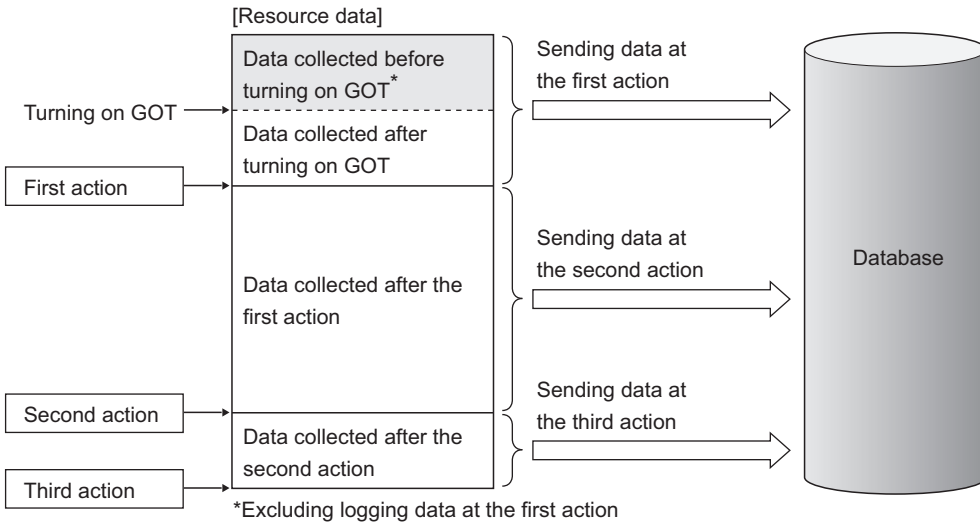

Point

The GOT sends the resource data to the database only one time. The GOT does not send the sent data to the database on the subsequent actions. Unnecessary data is not stored to the database.

The GOT may send the sent data to the database in the following cases.

- When turning on the GOT
- When restarting the GOT (Downloading a project data or others)

☞ Page 156 Precautions

- Sending one resource data at the multiple resource data send actions

When one resource data is sent at the multiple resource data send actions, the resource data is sent and stored to the database for each action.

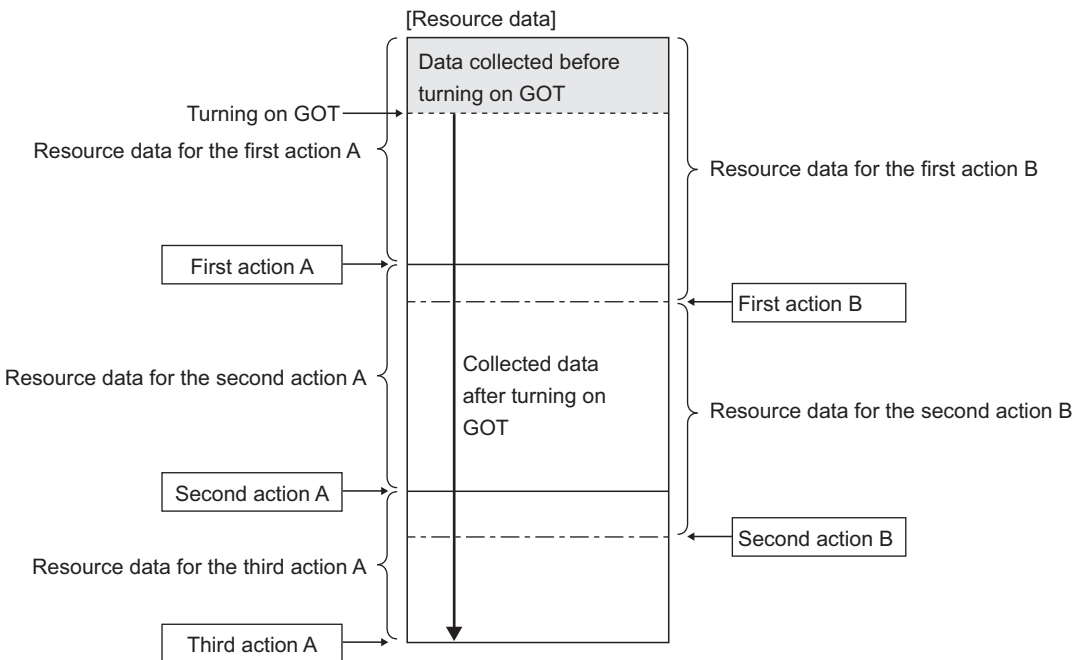

Program execution function

The program execution function is used for executing programs in the application server computer before execution of the first action and after execution of the last one in a job.

For the program execution function setting, refer to the following:

☞ Page 94 Setting items in Program execution

Programs that can be executed from [Command line] are applicable.

Since program execution is set on the application server computer as described below, more sophisticated data linkage can be realized.

Before executing the first action of the job

By executing programs before the first action of the job, data required for the job can be produced on the database in advance.

After executing the last action of the job

By executing programs after the last action of the job, data written to the database by the job can be utilized for programs on the application server computer.

DB buffering function

DB buffering function

The DB buffering function temporarily stores SQL texts into a CF card when they cannot be sent due to network disconnection or failure of the database server computer.

After recovery, the buffered SQL texts are automatically sent to the database. (Manual operation is also possible.)

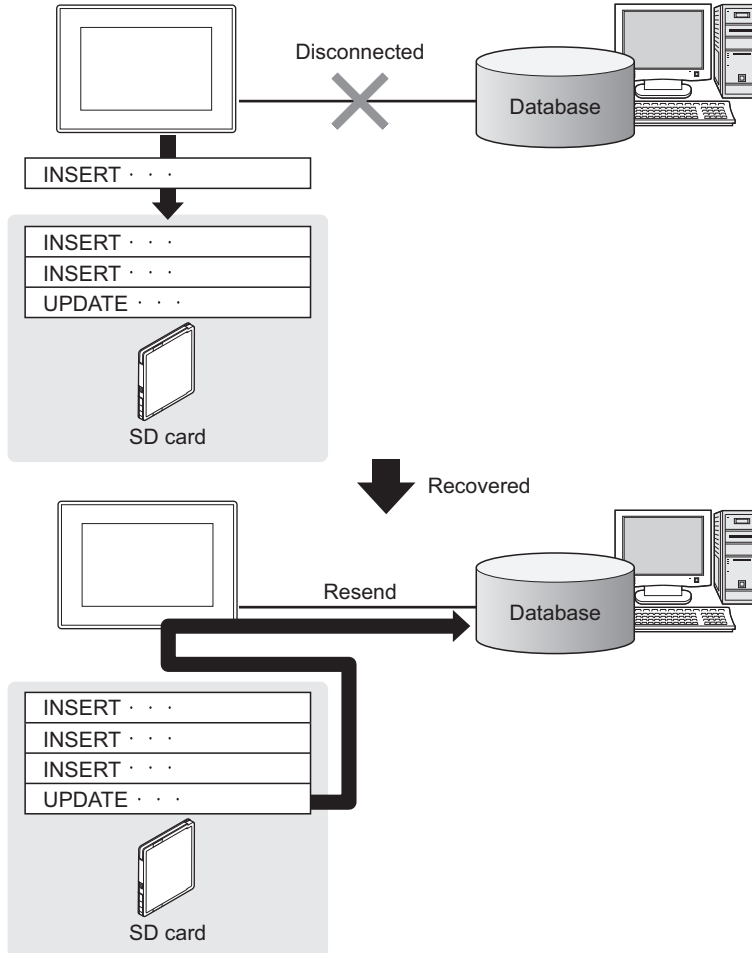

Point

- To automatically send SQL texts after recovery, irrespective of transmission sequence, select the auto-resend processing.
☞ Page 58 Automatically resending data after recovery
- To send SQL texts after recovery, without changing the transmission sequence, select the manual resend processing.
☞ Page 59 Manually resending data

Factors for starting DB buffering

The DB buffering is conducted when SQL texts cannot be sent to the database by the following factors:

- Network disconnection
- Failure of the database server computer
- Failure of the database software

Point

- If an error occurs when the sent SQL text is executed on the database, by some reason such as its incorrectness or inconsistency with the database, buffering is not performed and an SQL failure log is output on the database server computer.

☞ Page 159 DB Connection Service Functions

- When SQL texts cannot be sent to the database due to network disconnection or failure of the database server computer, DB buffering is not performed until the connection timeout is detected (approx. 10 seconds).

☞ Page 60 When SQL texts cannot be sent to the database

Even if a trigger condition is met again during connection timeout detection, the corresponding job is not executed.

☞ Page 61 Operation behavior of jobs

- If SQL texts cannot be sent to the database due to failure of database software, DB buffering is not performed until detection of DB access timeout.

☞ Page 60 When SQL texts cannot be sent to the database

Time for detecting DB access timeout is set to 30 seconds by default.

☞ Page 174 DB access timeout (required) (Range: 1 to 3600; Default: 30)

Even if a trigger condition is met again during detection of DB access timeout, the corresponding job is not executed.

☞ Page 61 Operation behavior of jobs

Jobs applicable to DB buffering

Jobs performing Update, Insert, and Delete actions can be stored in the DB buffer.

Setting the DB buffering

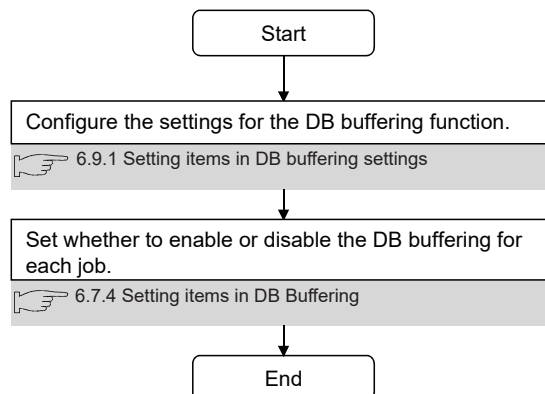

DB buffering operation

■ When no data are currently stored in the DB buffer

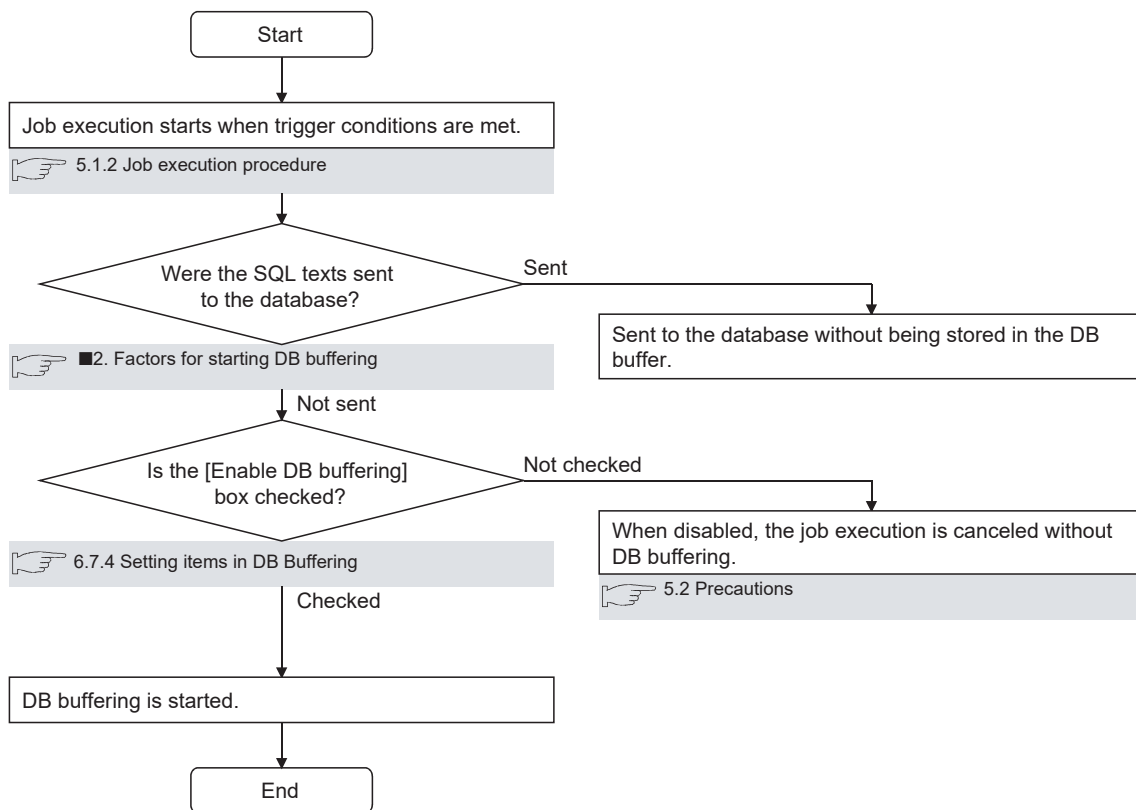

Point

Check the DB buffer status (No. of bufferings, utilization) and prevent the full status of the DB buffer.

☞ Page 97 Setting items in DB Buffering

☞ Page 149 Manipulating DB buffering (DB buffering operation)

■ When some data are currently stored in the DB buffer

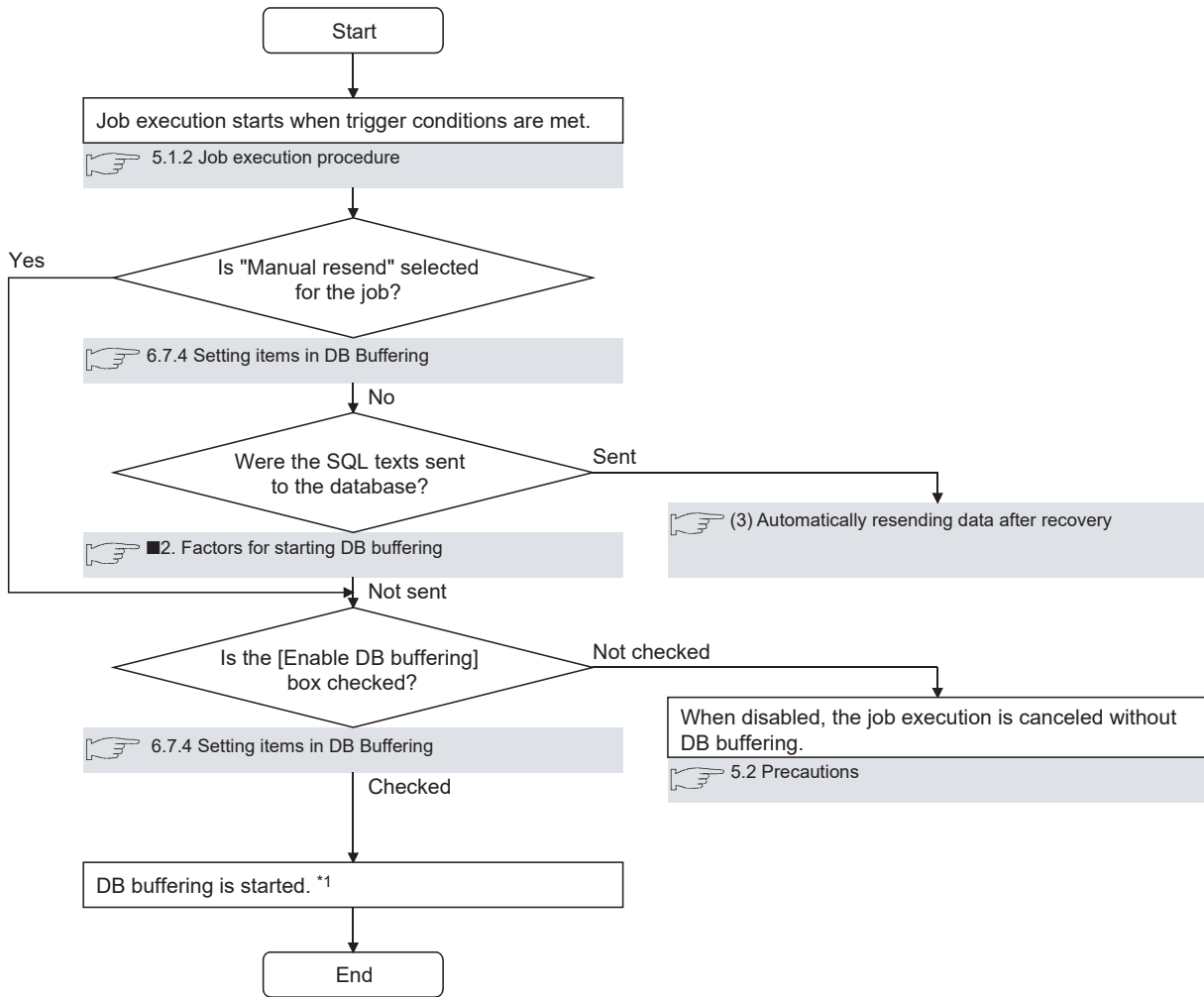

*1 When accumulated job data currently exist in the DB buffer.

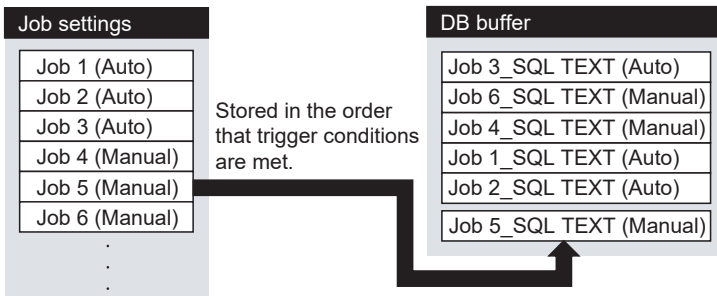

Point

Check the DB buffer status (No. of bufferings, utilization) and prevent the full status of the DB buffer.
 ➔ Page 97 Setting items in DB Buffering
 ➔ Page 149 Manipulating DB buffering (DB buffering operation)

■ Automatically resending data after recovery

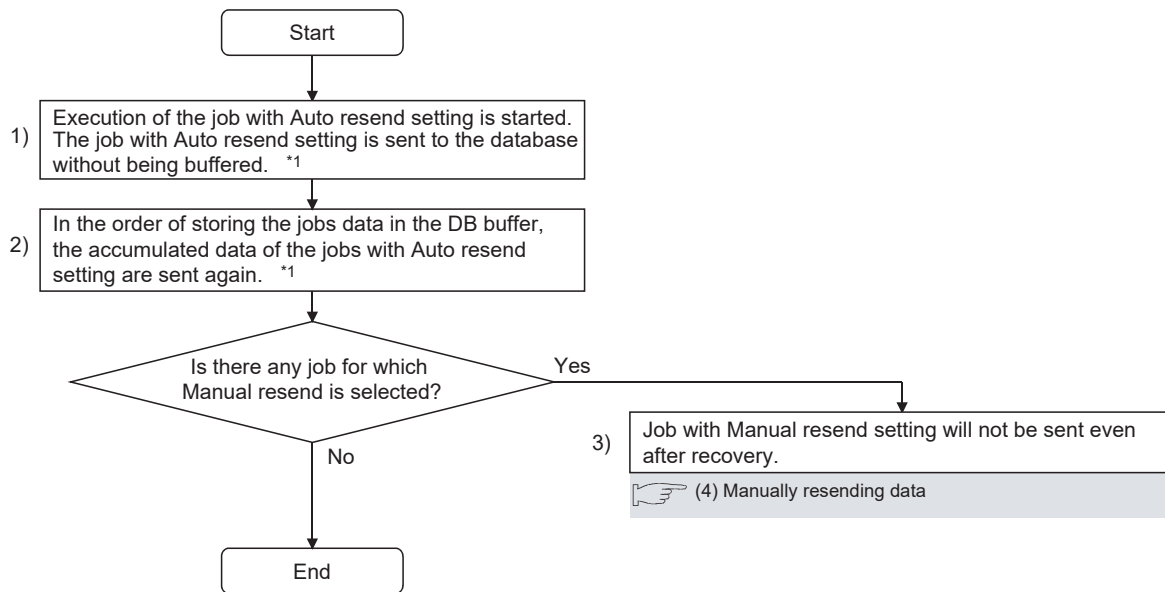

*1 Automatically resends job data after recovery.
The numbers 1) to 3) correspond to those shown in the above.

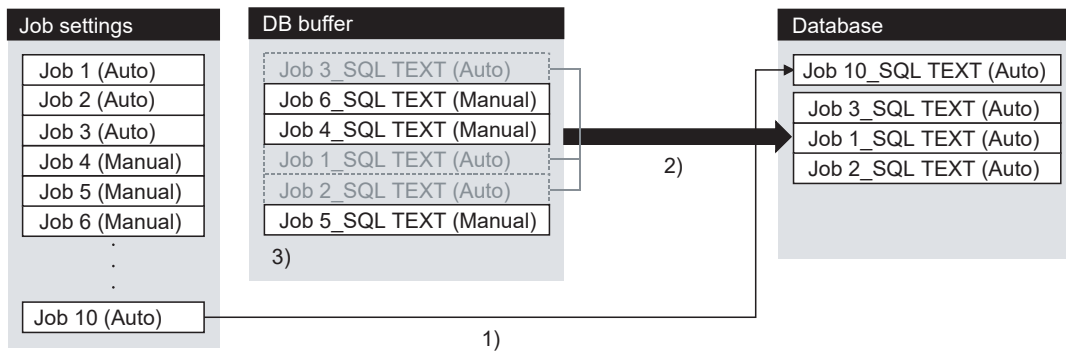

Manually resending data

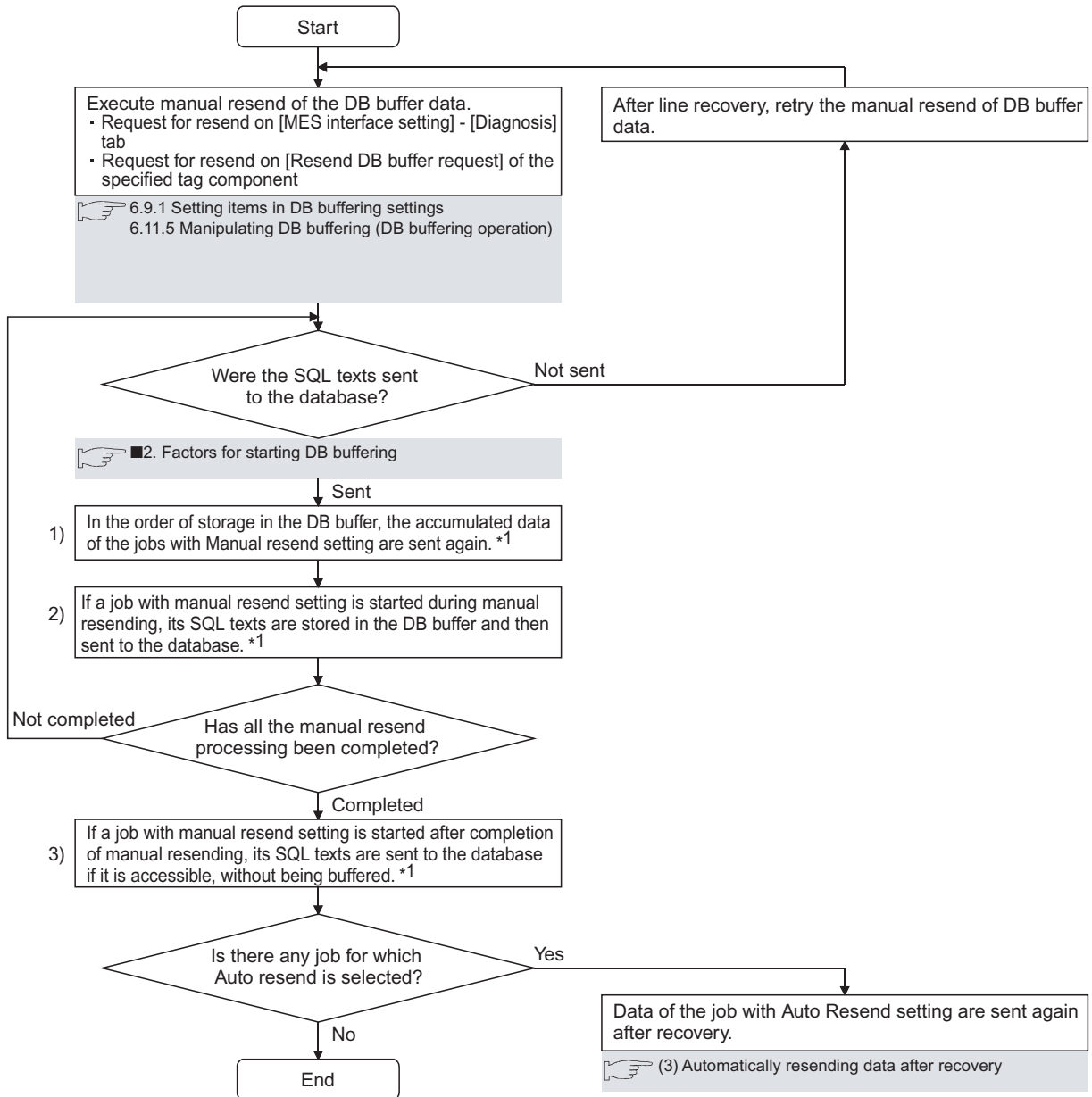

*1 Manually resending data

The numbers 1) to 3) correspond to those shown in the above.

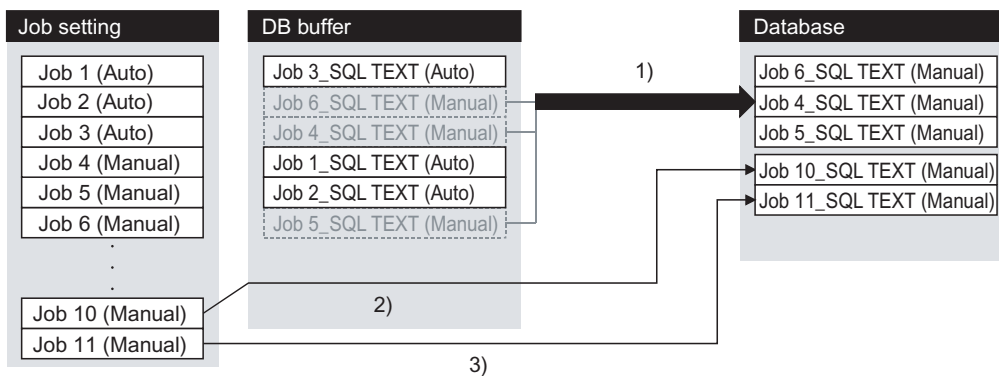

If any of the jobs for which manual resend is selected exists in the DB buffer, it remains there after recovery until manual resend is executed.

Clearing the DB buffer

The DB buffer is cleared by the following:

- After downloading the project data, for which the MES interface function is set, to the GOT, powering OFF and ON or restarting the GOT
- Clear request from [MES interface setting screen] - [Diagnosis tab].

☞ Page 150 Checking the trigger buffering (Trigger buffering status)

- Clear request from [Clear DB buffer request] of the specified tag component

☞ Page 140 Setting items in DB buffering settings

When SQL texts cannot be sent to the database

■When auto-send is selected for the job

1. If SQL texts cannot be sent to the database due to network disconnection or failure of the database server computer or database software, the system starts DB buffering after detection of a timeout.
2. After DB buffering is started, whether SQL texts can be sent to the database or not is checked every time each job is activated.
3. When the system has not been recovered from network disconnection or failure of the database server computer or database software, DB buffering is executed after detection of the timeout.

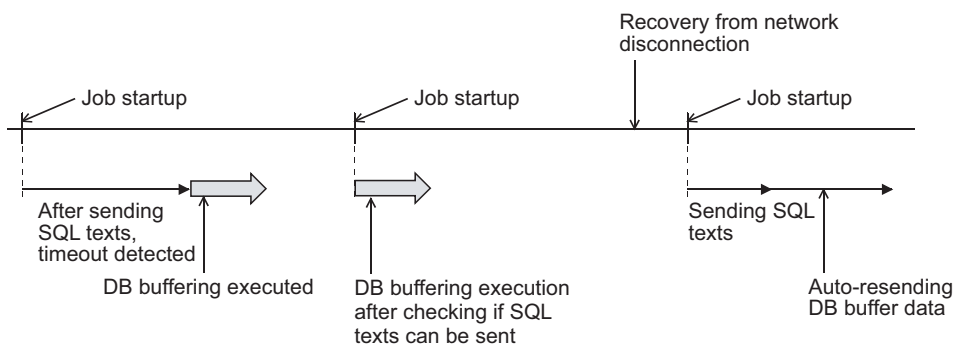

■When manual resend is selected for the job

1. If SQL texts cannot be sent to the database due to network disconnection or failure of the database server computer or database software, the system starts DB buffering after detection of a timeout.
2. After started, DB buffering is performed without checking whether SQL texts can be sent to the database or not for each job activation.
3. The data stored in the DB buffer are resend when manual resend is executed.

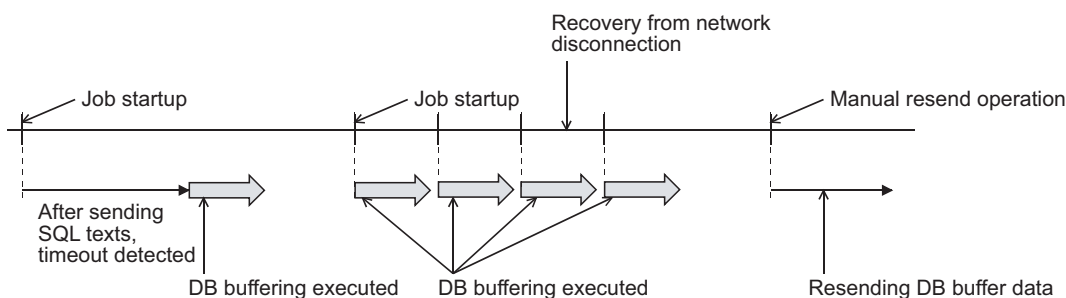

Precaution on the DB buffering

Do not remove the CF card from the GOT during DB buffering.

5.2 Precautions

Operation behavior of jobs

■When a trigger condition for a job is met again during execution of the job

- Jobs for which [Trigger buffering] is disabled

A new job is not executed during execution of the previous job.

(Example)

When a trigger condition for a job is met again during execution of the job set to [Value monitoring startup]

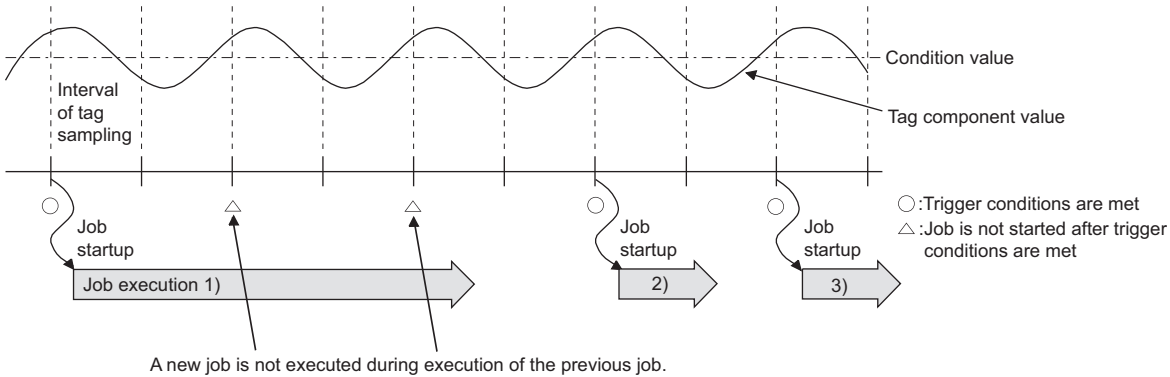

- Jobs for which [Trigger buffering] is enabled

Trigger data is stored to the trigger buffer, and the job for the stored trigger data is executed after completion of the previous job.

(Example)

When a trigger condition for a job is met again during execution of the job set to [Value monitoring startup]

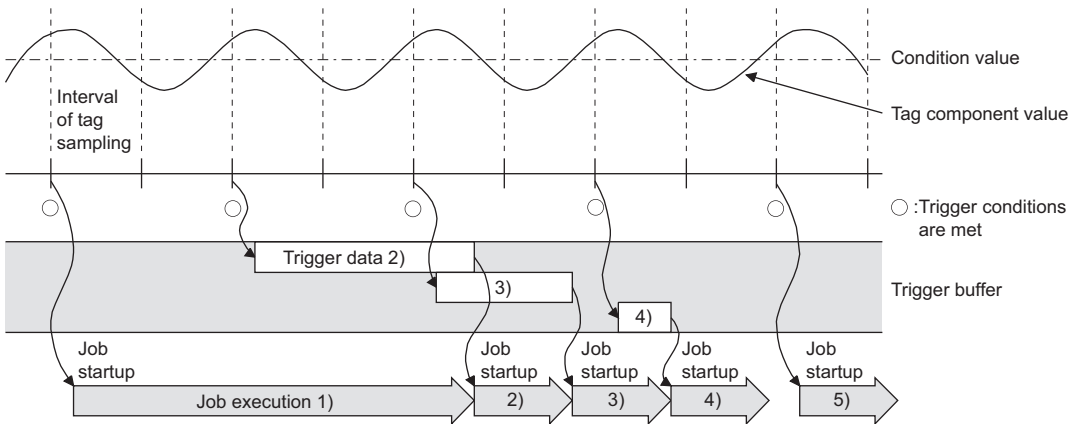

■When trigger conditions for multiple jobs are met concurrently

- Up to three jobs can start their executions concurrently in the order in [Job settings].
- After completion of these jobs, executions of the other jobs are started sequentially.

Note that, if a job uses the same item in [Server service settings] that is currently used for another job, the job is not executed until another job execution is completed.

■When actions are set for a job

When actions are set for a job, if a communication error occurs, a timeout time will be generated.

In the case of multiple action settings, timeout time is generated for each action.

For the timeout time, refer to the following.

☞ Page 173 Setting Items of DB Connection Service Setting Tool

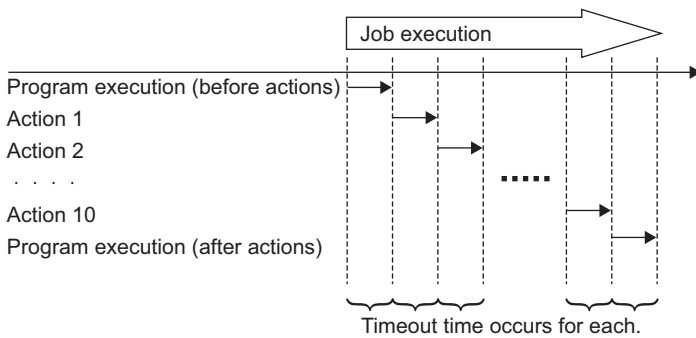

The time taken until completion of the job is obtained from the formula shown below.

No. of communications × Timeout time

No. of communications: Total number of set communication actions and program executions

Example) Time taken until completion of a job in the event of a communication error

No. of communications: $10 + 1 + 1 = 12$

Time taken until job completion: $12 \times 30s = 360s$

Item	Setting
Communication action	12
Program execution (before action)	1
Program execution (after action)	1
Timeout	30 seconds

■Monitoring interval timeout

Depending on the number of set jobs or the trigger condition setting, the monitoring interval timeout may be generated.

☞ Page 200 About Monitoring Interval Timeout

When an error occurs in job execution

■The job execution is canceled when the error cause is the following:

- Failure in device data writing due to network disconnection within the PLC system
- Failure in device data writing, or operation error
- Failure in access to the database (Except jobs for which [Enable DB buffering] is selected)

☞ Page 54 DB buffering function

■If a job execution is canceled, the operation processed before the error occurrence returns to the status before the job execution.

Point

The following explains access to GOT device data and the database.

- GOT device data

Since all of data are written to the device data area in the GOT at a time upon completion of job execution, any change due to the error is not reflected in the device data of the GOT.

- Database

Rollback is executed assuming the time immediately before job activation as a commit point.

When an error occurs during inserting data into a database, the data inserted into the database before occurring the error are reflected.

■When [Notify errors (job cancellation) that occur during job execution] has been selected, a value is assigned to the specified tag component.

☞ Page 98 Notify errors (job cancellation) that occur during job execution

6 MES INTERFACE FUNCTION SETTING

- ☞ Page 63 MES Interface Function Setting Screen
- ☞ Page 64 Displaying the MES Interface Function Setting Screen
- ☞ Page 65 Screen Structure
- ☞ Page 67 Setting
- ☞ Page 68 Device Tag Settings
- ☞ Page 78 Server Service Settings
- ☞ Page 83 Job Settings
- ☞ Page 100 Job Settings - Actions
- ☞ Page 139 System Setting
- ☞ Page 144 Import and Export
- ☞ Page 146 Diagnosis
- ☞ Page 151 Working Log
- ☞ Page 156 Precautions

6.1 MES Interface Function Setting Screen

6

The MES interface function setting screen is a screen for configuring various settings required for the MES interface function. In addition, the operation status of the MES interface function and the working log can be checked, and other operations such as stop/restart of the MES interface function can be also performed.

6.2 Displaying the MES Interface Function Setting Screen

1. Start GT Designer3.

For how to start GT Designer3, refer to the following manual.

📖 GT Designer3 (GOT2000) Screen Design Manual

2. Perform the following:

- Select [Common] → [MES Interface] from the menu.

3. The MES interface screen is displayed. Configure the settings referring to the following descriptions.

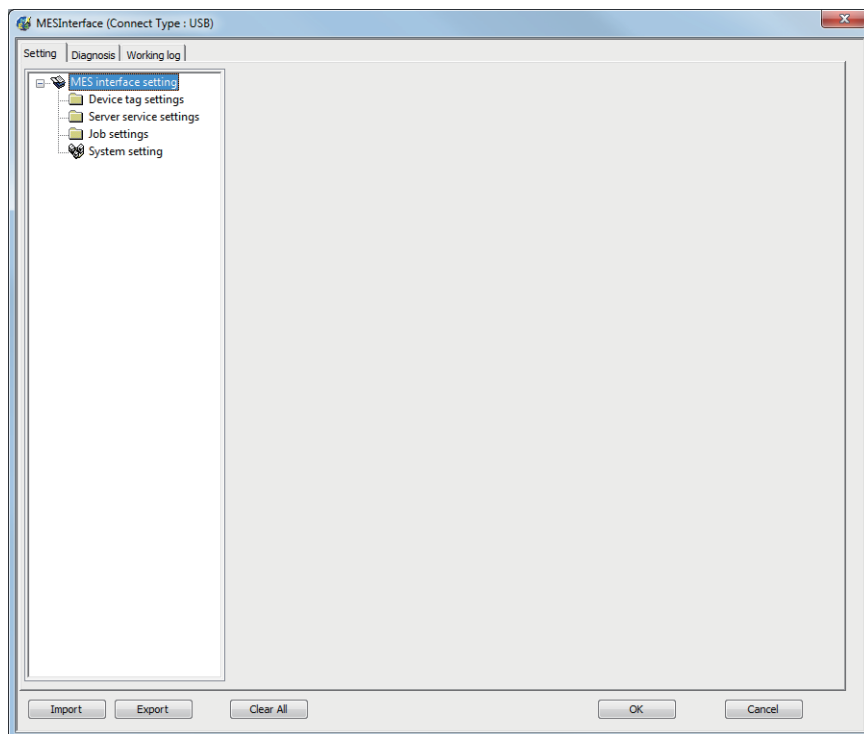

6.3 Screen Structure

This section explains the structure of the MES interface function setting screen.

Screen structure

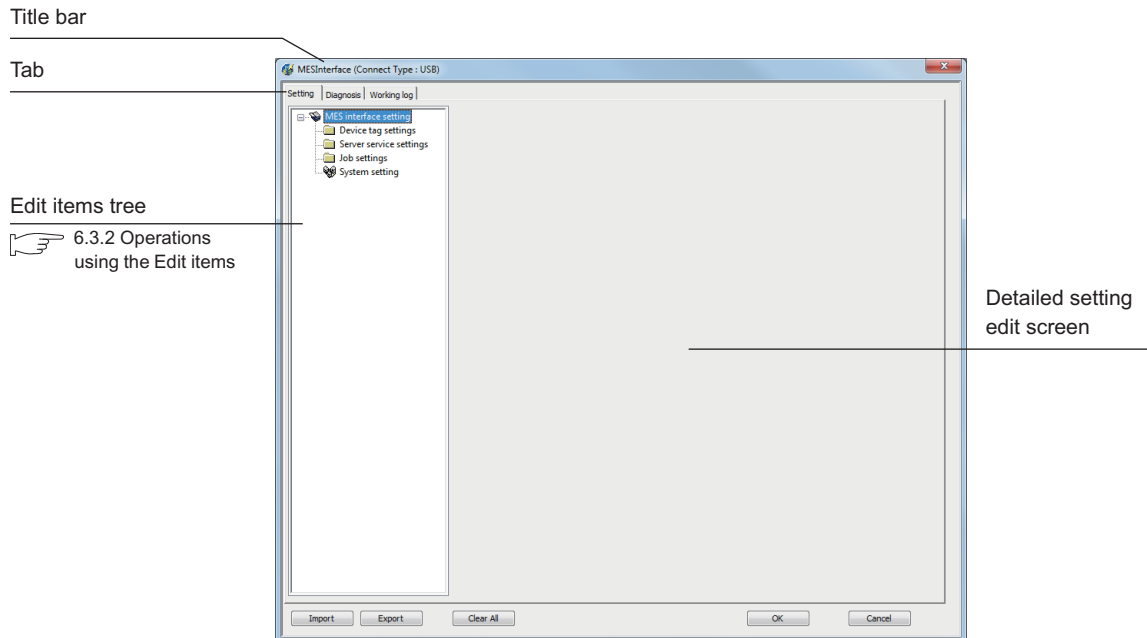

Point

- Display on the title bar

On the title bar, the status of connection to the GOT is displayed. The connection status displays are shown below.

Connection type	Display	Remarks
RS232	(Connect Type RS232 COM1)	Displays the communication port.
USB	(Connect Type USB)	-
Ethernet	(Connect Type Ethernet 192.168.3.10)	Displays the IP address.

Operations using the Edit items tree

The Edit items tree shows overall MES interface function settings in a tree. This section explains the operations using the Edit items tree.

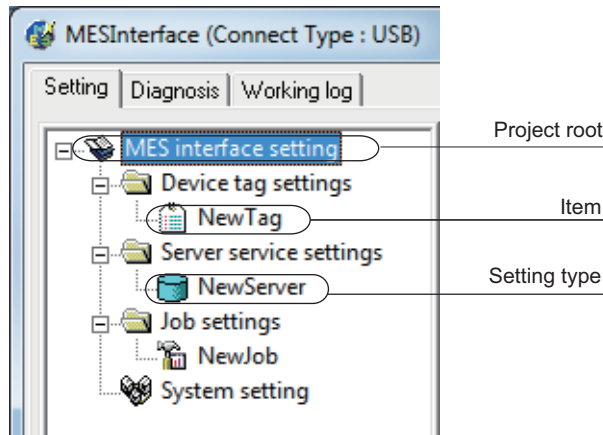

Selecting an item

1. When double-clicking the project root or each setting type, some items are displayed.
2. Selecting one of the items displays the corresponding edit screen on the detailed setting edit screen area.

Adding an item

1. Selecting an item or a setting type to be added and performing either of the following will add the item.
 - Select an item of the same type or a setting type, right-click the mouse, and choose [Add].
 - Double-click a setting type that contains no item.
2. When the item is added properly, it is automatically selected and the edit screen is switched to the one for the added item.

Point

Since the number of items that can be added is limited depending on the setting type, refer to the relevant section of each item.

Deleting an item

1. Select an item to be deleted and right-click the mouse. Selecting [Delete] deletes the item.

Point

For precautions on the item deletion, refer to the following.

Page 156 When deleting an item

Replicating an item

1. Select an item to be copied, right-click it to display the menu. Selecting [Copy & Paste] replicates the item.
2. When the item is added properly, it is automatically selected and the edit screen is switched to the one for the added item.

Point

Since the number of items that can be added is limited depending on the setting type, refer to the relevant section of each item.

6.4 Setting

Configure the settings for the MES interface function.

1. Click the "Setting" tab.
 2. The "Setting" sheet is displayed on the detailed setting edit screen.
- For each of the setting items, refer to the section shown below.

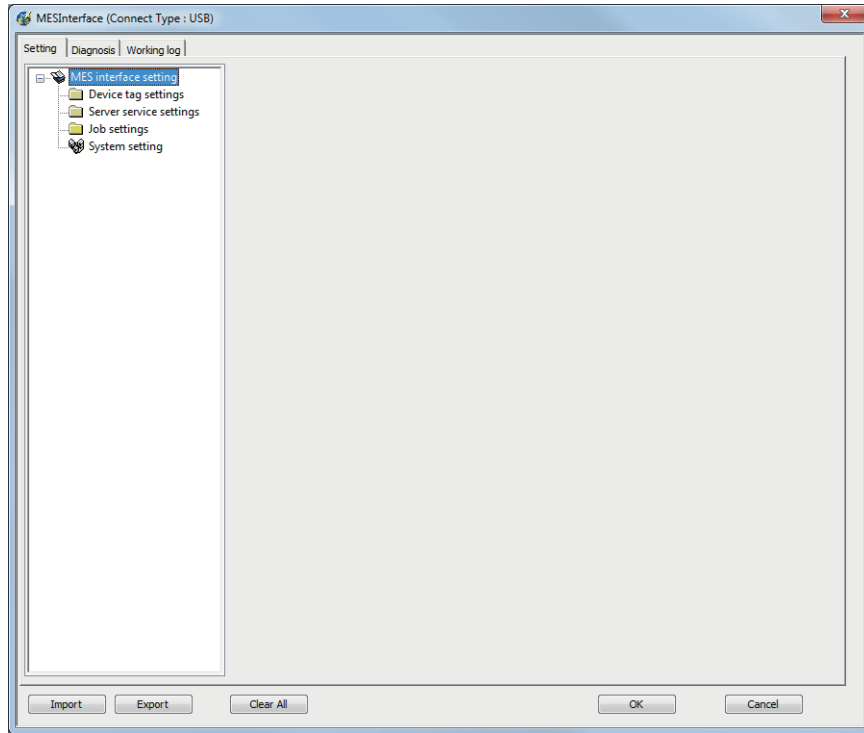

Item	Description	Reference section
Device tag settings	Configure the settings for the tag function.	Page 68 Device Tag Settings
Server service settings	Configure the settings for access to a server computer.	Page 78 Server Service Settings
Job settings	Configure the settings for the DB interface function.	Page 83 Job Settings
System setting	Configure the settings for the DB buffering function, and set whether to enable the additional setting.	Page 139 System Setting
Import, Export	Imports or exports the MES interface settings.	Page 144 Import and Export

6.5 Device Tag Settings

Configure the settings for the tag function.

For the tag function, refer to the following:

☞ Page 45 Tag function

Configured tags are used in [Job settings], etc.

1. Double-clicking [Device tag settings] in the Edit items tree displays relevant items.
2. Selecting one of the items displays the corresponding edit screen on the detailed setting edit screen area.

Make the setting referring to the following descriptions.

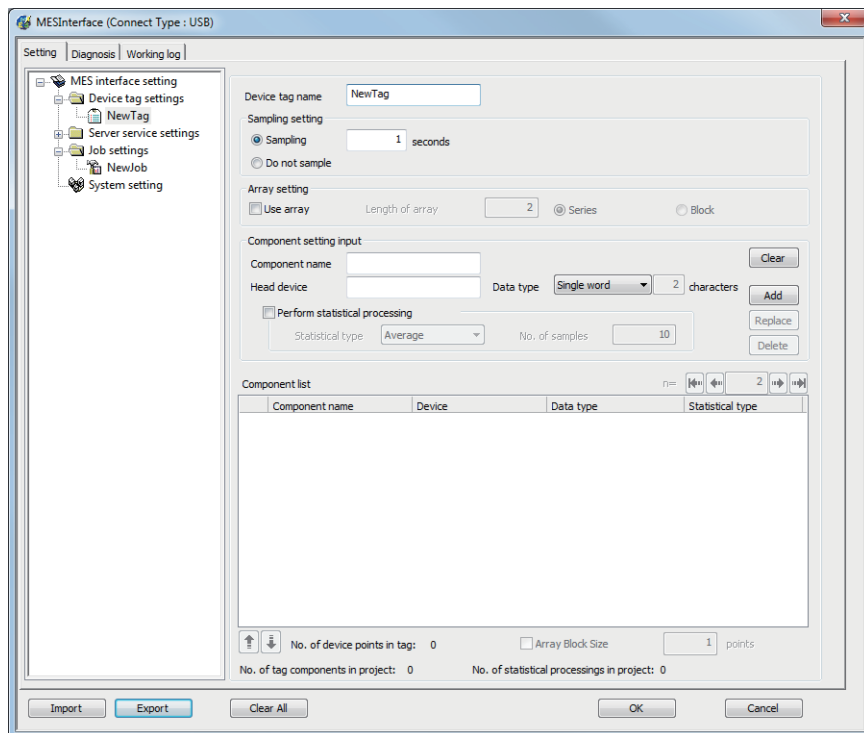

Point

- How to add, delete, or copy an item

For addition, deletion or copying of items, refer to the following:

☞ Page 66 Operations using the Edit items tree

- When an item is added or copied, a "New Tag" item is added.

Setting items in Device tag settings

Up to 64 items can be set in [Device tag settings] within one project.

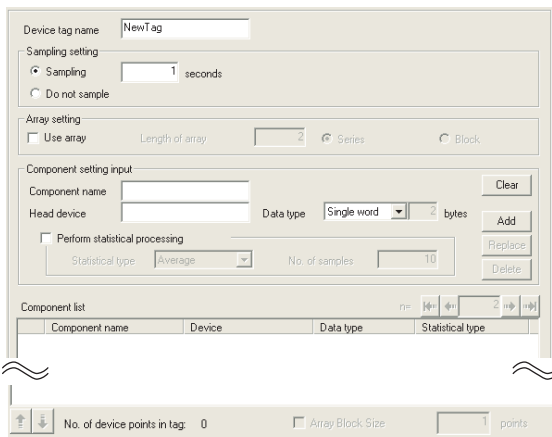

Item	Description
Device tag name	Enter a device tag name. (Up to 16 characters)
Sampling setting	Set whether to periodically sample the tag or not. Set a sampling interval to sample the tag.
Array setting	Set whether to use arrays for the tag or not. ☞ Page 70 Setting items in Array setting
Component setting input	Configure the tag component settings. ☞ Page 72 Setting items in Component setting
Component list	Displays a list of the components that have been already set. ☞ Page 72 Setting items in Component setting
Array block size	Make setting when changing the block size manually.
No. of tag components in project	Displays the number of all the tag components in the project.
No. of statistical processings in project	Displays the number of the components in the project, for which [Perform statisticcical processing] is selected.
No. of device points in tag	Displays the number of total device points used in [Device Tag setting].

Device tag name (Up to 16 characters)

Enter a device tag name.

Configured tags are used in [Job settings], etc.

For characters that can be used for device tag names, refer to the following:

☞ Page 198 Characters applicable to item names, component names, variable names, etc.

Note that using the name same as the one set in [Server service settings] is not allowed.

Sampling setting

■When sampling is enabled

The tag is sampled in the specified interval.

When selecting [Sampling], also set a sampling interval in units of seconds. The setting range for the interval is 1 to 32767 seconds.

■When sampling is disabled

The tag is not sampled. When [Do not sample] is selected, statistical processing cannot be performed for tag component values.

Point

- The GOT becomes less busy if [Do not sample] is selected for the following tags.

Tags only for writing

Tags for sampling device values with the handshake operation.

For the handshake operation, refer to the following:

 Page 93 Handshake operation

- When [Do not sample] is selected, the setting items for reading tags cannot be selected for the tag. (Except cases that [Handshake operation] is set for the trigger conditions.)

Tag component values set in [Select/Update/Delete conditions] of [Select] in [Communication action]

- When [Array setting] is set for the tag, [Do not sample] is fixed for the sampling setting.

Setting items in Array setting

An array is a data format, in which the specified number of data of the same data type are arranged sequentially. The Array setting is set when writing multiple records extracted from a database to the same tag component.

Either of the following can be selected for device assignment to each tag component.

- Assigning consecutive devices to each tag component (series)
- Handling all tag components as a block and assigning the same kind of devices in a series of blocks (block)

Tags with array settings are used for [MultiSelect].

 Page 104 Setting items in Communication action

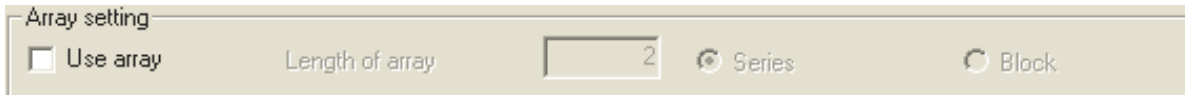

Array setting

Use array Length of array Series Block

Use array

When the [Use array] checkbox is checked, the tag is arranged as arrays.

Point

- When the array setting is set, device data are not collected.
- The array setting is unavailable for the tags set for the actions in [Job settings].

Length of array (Range: 2 to 40000, Default: 2)

Set the number of arrays for the tag.

Series/Block (Default: Series)

Select a method for the array setting.

■Series

Devices of respective tag components are arranged consecutively.

(Example) When [Length of array] is set to 4 with [series] setting

Only the start device (device in n=1) need be set.

Devices in and after n=2 are configured automatically.

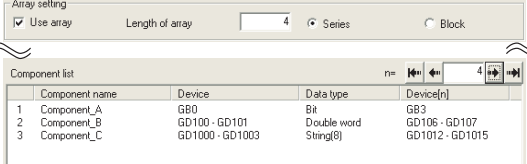

	n=1	n=2	n=3	n=4
Component A	GB0	GB1	GB2	GB3
Component B	GD100 to GD101	GD102 to GD103	GD104 to GD105	GD106 to GD107
Component C	GD1000 to GD1003	GD1004 to GD1007	GD1008 to GD1011	GD1012 to GD1015

■Block

Devices of all tag components are arranged as a block.

The size of the block can be changed in [array block size].

For [array block size], refer to the following.

☞ Page 72 Setting items in Component setting

Usually, the block size need not be changed because it is automatically adjusted to avoid device duplication.

(Example) When [Length of array] is set to 4 with [block] setting

Only the start device (device in n=1) need be set.

Devices in and after n=2 are configured automatically

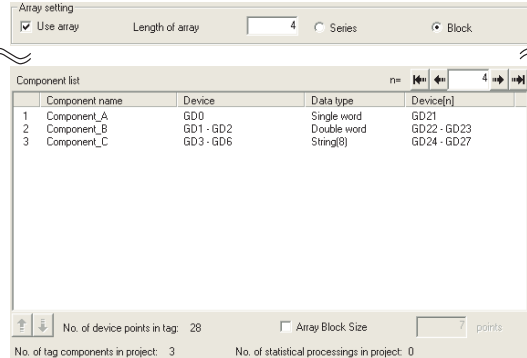

	n=1	n=2	n=3	n=4
Component A	GD0	GD7	GD14	GD21
Component B	GD1 to GD2	GD8 to GD9	GD15 to GD16	GD22 to GD23
Component C	GD3 to GD6	GD10 to GD13	GD17 to GD20	GD24 to GD27

Point

When device types are different, [block] cannot be selected.

For the device types, refer to the following.

☞ Page 34 GOT Devices Available for the MES Interface Function

Setting items in Component setting

Configure the settings for assigning GOT devices to tags.

Up to 256 components can be set for one tag.

Up to 4096 components can be set for one project.

(Adding a component)

- Set required items in [Component setting input], and click the **Add** button.
- The component is added in [Component list].

(Modifying a component)

- When a component to be modified is selected in [Component list], its settings are displayed in [Component setting input].
- Modify the item settings in [Component setting input], and click the **Replace** button.











(Deleting a component)

- Select a component to be deleted in [Component list], and click the **Delete** button.

(Deleting the settings in [Component setting input])

- Clicking the **Clear** button deletes the settings in [Component setting input].

Item	Description	
Component setting input	Component name	Enter a component name. (Up to 16 characters)
	Head device	Set device name.
	Data type	Select the data type of the sampling data.
	Character string length	Set the character string length when [Data type] is set to [String] or [String [Unicode]]. ☞ Page 74 Character string length ([Data type]: [String]) ☞ Page 74 Character string length ([Data type]: [String [Unicode]])
	Perform statistical processing	Set whether to perform statistical processing or not.
Component List	Component name	Displays a component name.
	Device	Displays a device range used.
	Data type	Displays a data type.
	Statistical type	When [Perform statistical processing] is set, displays the type of statistical processing.
	Device [n]	When [Array setting] is set, displays the device range of array No.n. For a display example, refer to the following. ☞ Page 70 Setting items in Array setting

Item		Description
Component List	n (Array No.)	Displays the array No. that is currently displayed in [Device [n]] of [Component List].
	 button	If this is clicked, the device range of the first array is displayed in [Device [n]] of [Component List]. When the device range of the first array is already displayed, this button cannot be clicked.
	 button	If this is clicked, the device range of the previous array is displayed in [Device [n]] of [Component List]. When the device range of the first array is already displayed, this button cannot be clicked.
	 button	If this is clicked, the device range of the next array is displayed in [Device [n]] of [Component List]. When the device range of the last array is already displayed, this button cannot be clicked.
	 button	If this is clicked, the device range of the last array is displayed in [Device [n]] of [Component List]. When the device range of the last array is already displayed, this button cannot be clicked.
	 button	Selecting a component in [Component List] and clicking the  button reverses the order between the selected component and the one immediately above it. The  button cannot be clicked on the first component.
 button	Selecting a component in [Component List] and clicking the  button reverses the order between the selected component and the one immediately below it. The  button cannot be clicked on the last component.	
Array block size		Make setting when changing the block size manually.

Point

The following are displayed on the status bar of [Device Tag setting].

- [No. of tag components in project]

The total number of tag components in the project is displayed.

- [No. of statistical processings in project]

The number of component settings in the project, for which [Perform statistical processing] is checked, is displayed.

- [No. of device points in tag]

The total number of device points used in [Device tag settings] is displayed.

Up to 40000 device points can be set for a tag with [Array setting].

Component name (Up to 16 characters)

Enter a component name.

For characters that can be used for component names, refer to the following:

 Page 198 Characters applicable to item names, component names, variable names, etc.

Device

- Set a device type and an actual device number.
- Bit specification is not allowed for word devices.
- For accessible devices, refer to the following:

 Page 34 GOT Devices Available for the MES Interface Function

Data type

Select the data type of the sampling data (device data).

Item	Description	Selectable Device
Single word	Handles data as single word data (16-bit Integer type).	Word
Double word	Handles data as double word data (32-bit Integer type).	Word
Real number	Handles data as floating point data.	Word
String ^{*1,2}	Handles data as character strings.	Word
String [Unicode] ^{*2,3}	Handles data as Unicode character strings.	Word
Bit	Handles data as bit data (in units of bits (0/1)).	Bit

*1 When [Data type] is [String], device values are processed as follows:

- When the device value is not an ASCII code or JIS code

It is replaced with "." (period: 2EH).

- When the device value is a model-dependent character

The character code may be converted when an action is executed.

 Page 198 Characters applicable to item names, component names, variable names, etc.

*2 If the device stores a character string that contains a termination character (NULL code: 00H or 0000H), the characters subsequent to the termination character are ignored.

(The character string is regarded as terminated.)

*3 This item is selectable when [Enable additional setting] is selected.

Character string length ([Data type]: [String])

Set the character string length when [Data type] is set to [String].

■Setting range of the character string length

- When [Enable additional setting] is selected: 1 to 255 characters
- When [Enable additional setting] is deselected: 2 to 32 characters (even numbers only)

■Number of devices to be used

The number of word devices to be used equals the character string length divided by 2. (An odd-numbered length is incremented by 1 and then divided by 2.)

■When [String] is selected, data are stored as follows:

- When the value length is shorter than the character string length

NULL codes (00H) are stored after the stored values.

Example: "ABCD" is stored in the device of the tag component, whose character length is 8.

A	B	C	D
41h 42h	43h	44h	00h 00h 00h 00h

- When the value length is longer than the character string length

The values whose quantity is equal to the character string length are stored.

Example: "ABCD" is attempted to be stored in the device of the tag component, whose character length is 2.

"AB"

Character string length ([Data type]: [String [Unicode]])

Set the character string length when [Data type] is set to [String [Unicode]].

■Setting range of the character string length

1 to 255 characters

■Number of devices to be used

The number of consecutive word devices to be used equals the character string length.

■Storage order of a character code

A character code is stored from lower-order bytes to upper-order bytes.

A	B	C	D
41H 00H	42H 00H	43H 00H	44H 00H

When [Data type] is set to [String [Unicode]] for a device, if you specify the device for a text display or text input object, select [Display in order of High -> Low] in the object setting dialog.

Perform statistical processing

■Set whether to perform statistical processing or not.

Up to 64 components that have [Perform statistical processing] setting can be set in all projects. (Check [No. of statistical processings in project] on the status bar.)

When the [Perform statistical processing] box is checked, statistical processing is performed for tag component values.

Statistically processed values can be used by specifying the tag component values, for which [Perform statistical processing] is selected, in [Job setting].

Note that this setting is not available when:

- [Do not sample] is selected in [Sampling setting].
- The data type of the tag component is [String].
- [Array setting] is set.

■When [Perform statistical processing] is selected, set the following items.

Item	Description
Statistical type	Select a type of the statistical processing.
No. of samples	Specify the number of samples when [Moving average], [Moving maximum], or [Moving minimum] is selected.

- Statistical type

Select a type of the statistical processing.

Item	Description
Average ^{*1}	An average value after starting sampling
Maximum ^{*1}	The maximum value after starting sampling
Minimum ^{*1}	The minimum value after starting sampling
Moving average ^{*2*3}	An average of the tag component values that are collected at sampling intervals for the number of times specified by [No. of samples] Since the processing range moves at each sampling, the latest value can be obtained.
Moving maximum ^{*2*3}	The maximum value in the tag component values that are collected at sampling intervals for the number of times specified by [No. of samples] Since the processing range moves at each sampling, the latest value can be obtained.
Moving minimum ^{*2*3}	The minimum value in the tag component values that are collected at sampling intervals for the number of times specified by [No. of samples] Since the processing range moves at each sampling, the latest value can be obtained.

*1 If a statistical value of [Average], [Maximum], or [Minimum] is reset, a value obtained after resetting will be stored.

- How to reset a statistical value of [Average], [Maximum], or [Minimum]

Perform substitution of some value for the relevant tag component using [Operation action] of a job.

For operation actions, refer to the following:

 Page 125 Setting items in Operation action

The statistical processing is reset and a value processed after the substitution is stored.

*2 Statistical values of [Moving average], [Moving maximum], and [Moving minimum] cannot be reset.

*3 When a tag component having [Moving average], [Moving maximum], or [Moving minimum] setting is specified in a job, the job is not activated until data are collected for the specified number of times after start of sampling.

- No. of samples (2 to 20)

Specify the number of samples when [Moving average], [Moving maximum], or [Moving minimum] is selected.
 (Moving average when [No. of samples] is 4)

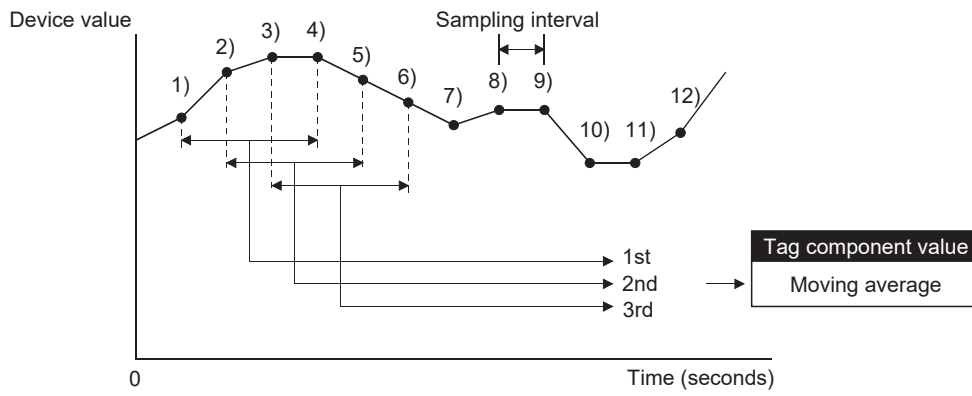

<Change in tag component values>

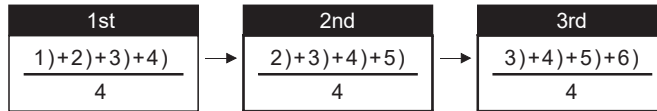

n (Array No.)

When [Array setting] is set, the device range of array No.n, is displayed in [Device [n]] of [Component List].



To change the [Device [n]] display, use the following methods.

- Enter a value in the box.
- Change the value with the , , , or button.

Array block size

When [block] is selected in [Array setting], [array block size] setting is available.

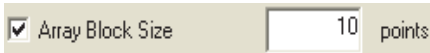

Usually, the block size need not be changed because the it is automatically adjusted to avoid duplication of components.

Change [array block size] when:

- Setting a desired number for the start device No. of each block.
- Adding any component in the future.

The following example explains the cases where [array block size] is manually set and is not set.

(Example) When [Component D] is to be added in the future

- When 10 is set for [array block size], device numbers are not changed.
- When nothing is set for [array block size], device numbers in and after array No.2 are changed.

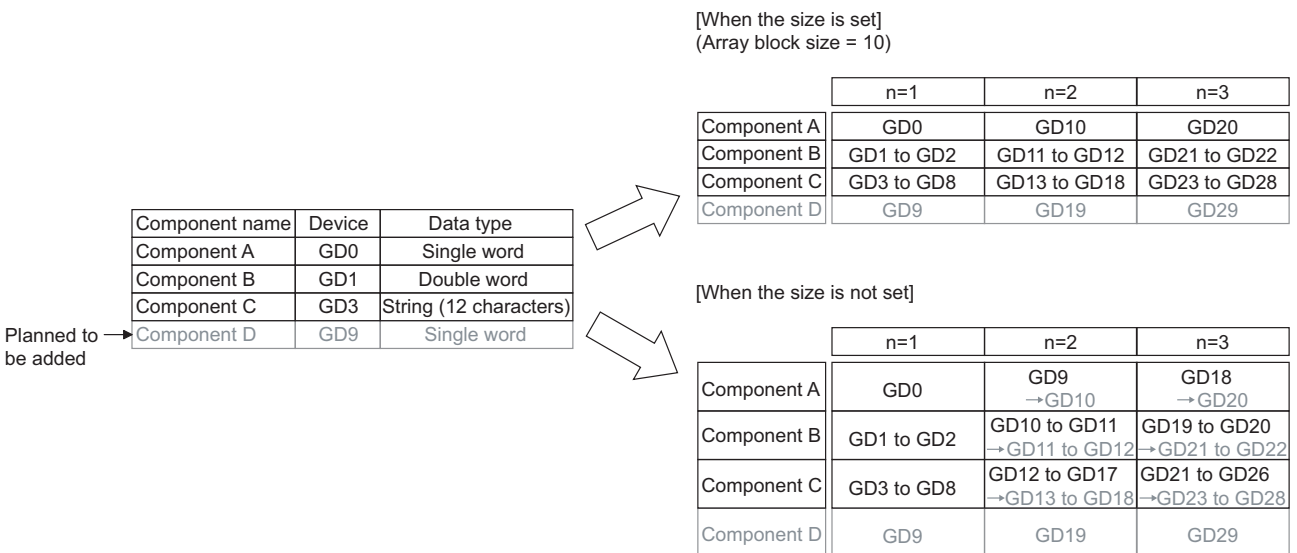

Precautions on [Component setting]

If a wrong device number is set for a component in [Component setting], an error will occur on another component that has the same access target CPU setting.

Correct the device number in [Component setting].

6.6 Server Service Settings

Configure the settings for the access to a server computer.

The set server service name is used in [Job setting].

1. Double-clicking [Server Service setting] in the Edit items tree displays relevant items.
 2. Selecting one of the items displays the corresponding edit screen on the detailed setting edit screen area.
- Make the setting referring to the following descriptions.

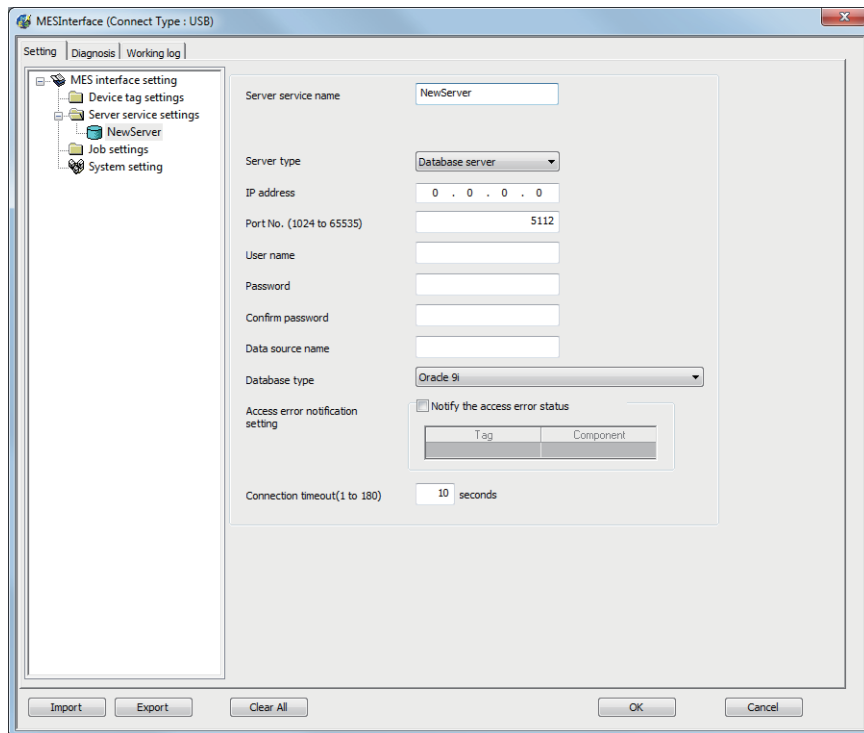

- How to add, delete, or copy an item

For addition, deletion or copying of items, refer to the following:

☞ Page 66 Operations using the Edit items tree

- When an item is added or copied, a "NewServer" item is added.

Setting items in Server service settings

Up to 8 items can be set in [Server service settings] within one project.

Item	Description
Sever service name	Enter a server service name. (Up to 16 characters)
Server type	Select the server type of the server computer to be accessed.
IP address	Enter a decimal IP address of the server computer where DB Connection Service is installed.
Port No.	Set a port number of the server computer. (Range: 1024 to 65535, Default: 5112)
User name	Set a user name used to access the server computer. (Up to 30 characters)
Password/Confirm password	Set a password used to access the server computer. (Up to 30 characters)
Data source name	Set the name of the ODBC data source to be accessed.
Database type	Select the type of the database server.
Access error notification setting	Set whether to enable or disable notification of the access error status.
Connection timeout	In case a connection error occurs on the network between the GOT and the server computer, set a timeout time during which the GOT will detect the error. (Range: 1 to 180 seconds, Default: 10 seconds)

Server service name (Up to 16 characters)

Enter a server service name.

The set server service name is used in [Job setting].

For characters that can be used for server service names, refer to the following:

☞ Page 198 Characters applicable to item names, component names, variable names, etc.

Note that using the name same as the one of the device tags set in [Device tag settings] is not allowed.

Server type

Select the server type of the server computer to be accessed.

The following server types are selectable.

Item	Description
Database server	Used in [Communication action] of [Job setting].
Application server	Used in [Program execution] of [Job setting].

IP address

Enter a decimal IP address of the server computer where DB Connection Service is installed.

Port No. (Range: 1024 to 65535, Default: 5112)

Set a port number of the server computer.

Set the same value in [Port No.] as the one set in [Service port] of DB Connection Service.

☞ Page 173 Setting Items of DB Connection Service Setting Tool

User name (Up to 30 characters)

Set a user name used to access the server computer.

For characters that can be used for user names, refer to the following:

☞ Page 199 Characters applicable to character string constants, etc.

■When [Database server] is selected for [Server type]

Set a user name that is required for ODBC access.

■When [Application server] is selected for [Server type]

Set the account user name used for the operating system (OS) of the application server computer.

Password/Confirm password (Up to 30 characters)

Set a password used to access the server computer.

For characters that can be used for passwords, refer to the following:

☞ Page 199 Characters applicable to character string constants, etc.

Data source name

When selecting [Database server] for [Server type], set the name of the ODBC data source to be accessed.

For characters that can be used for data source names, refer to the following:

☞ Page 199 Characters applicable to field names, table names, etc.

Database type

When selecting [Database server] for [Server type], select a database type.

The following shows the database(s) applicable to each [Database type] that can be selected.

Database type	Applicable database
Oracle 8i	Oracle 8i
Oracle 9i	Oracle 9i
Oracle 10g/11g/12c	<ul style="list-style-type: none"> • Oracle 19c • Oracle 18c • Oracle 12c • Oracle 11g • Oracle 10g
SQL Server	<ul style="list-style-type: none"> • Microsoft SQL Server 2019 • Microsoft SQL Server 2017 • Microsoft SQL Server 2016 • Microsoft SQL Server 2014 • Microsoft SQL Server 2012 • Microsoft SQL Server 2008 R2 • Microsoft SQL Server 2008 • Microsoft SQL Server 2005 • Microsoft SQL Server 2000
MSDE2000	Microsoft SQL Server 2000 Desktop Engine (MSDE 2000)
Access2000	Microsoft Access 2000
Access2003/2007/2010/2013/2016	<ul style="list-style-type: none"> • Microsoft Access 2019 • Microsoft Access 2016 • Microsoft Access 2013 • Microsoft Access 2010 • Microsoft Access 2007 • Microsoft Access 2003
MySQL	MySQL
PostgreSQL	PostgreSQL

Access error notification setting

■[Notify the access error status.]

Set whether to enable or disable notification of the access error status.

If the [Notify the access error status.] box is checked, an error occurred in access to the server computer is reported to a tag component.

■When [Notify the access error status.] is selected, choose a tag component into whose device the access error status data is stored.

Tags that have a tag component with [Array setting] cannot be selected.

Data are stored as follows depending on the data type.

Data type of tag component	Description
Bit	OFF: Normal/Not accessed/Network line disconnected ON: Access error status
String	"0": Normal/Not accessed/Network line disconnected "1": Access error status
Other than the above	0: Normal/Not accessed/Network line disconnected 1: Access error status

Connection timeout (Range: 1 to 180 seconds, Default: 10 seconds)

In case a connection error occurs on the network between the GOT and the server computer, set a timeout time during which the GOT will detect the error.

Usually, this setting is not needed.

In any of the following cases, adjust the connection timeout time if necessary.

■Reduce the connection timeout time to:

- Make the time elapsed from occurrence of a connection error to the start of DB buffering shorter.
- Make the time elapsed from occurrence of a connection error to notification of an access error and job cancellation shorter.

■Increase the connection timeout time when:

- A connection timeout occurs in spite of normal network condition.

Point

The relation of the values set for [Connection timeout] and [DB access timeout time] in [DB Connection Service Setting Tool] must be as follows:

- Connection timeout value \leq DB access timeout value
-

6.7 Job Settings

Configure the settings for the DB interface function.

For the DB interface function, refer to the following:

☞ Page 43 DB Interface Function

1. Double-clicking [Job settings] in the Edit items tree displays relevant items.
 2. Selecting one of the items displays the corresponding edit screen on the detailed setting edit screen area.
- Make the setting referring to the following descriptions.

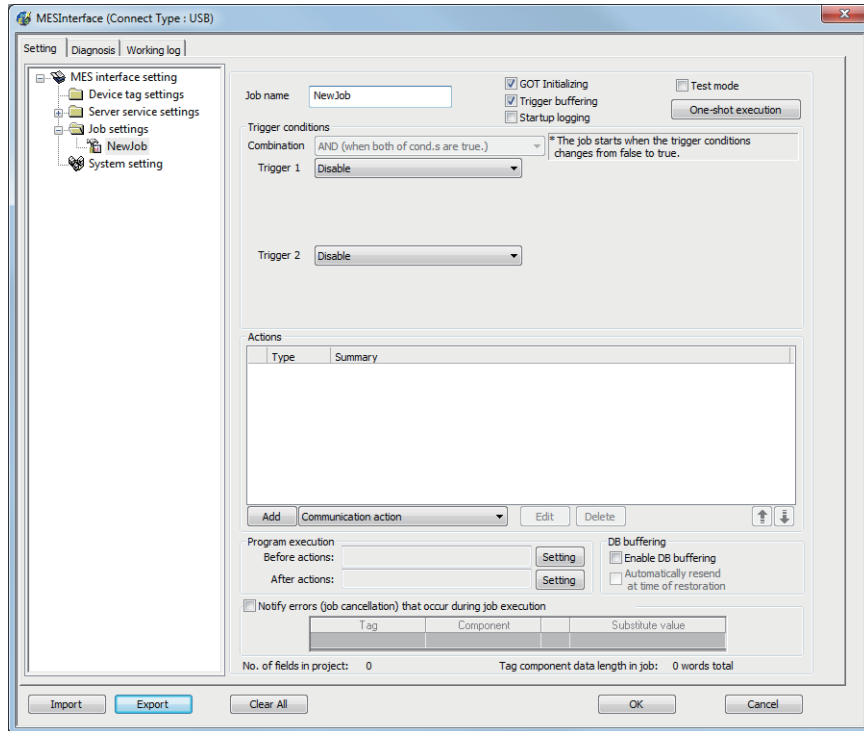

Point

- How to add, delete, or copy an item

For addition, deletion or copying of items, refer to the following:

☞ Page 66 Operations using the Edit items tree

- When an item is added or copied, a "New Job" item is added.

Setting items in Job settings

Up to 64 items can be set in [Job settings] within one project.

For job operations, refer to the following:

☞ Page 61 Precautions

Item	Description
Job name	Enter a job name. (Up to 16 characters)
GOT Initializing	Set whether to enable the job at startup of the GOT or not.
Trigger buffering	Set whether to enable the trigger buffering or not.
Startup logging	Set whether to output the startup history of the job to the log or not.
Test mode	Set whether to operate the job in test mode or not.
Trigger conditions	Configure the settings for startup conditions of the job. ☞ Page 87 Setting items in Trigger conditions
Action	Configure the action settings. ☞ Page 100 Job Settings - Actions
Program execution	Configure the settings for the program execution function. ☞ Page 94 Setting items in Program execution
DB buffering	Configure the settings for the DB buffering function. ☞ Page 97 Setting items in DB Buffering
Notify errors (job cancellation) that occur during job execution	Set whether to enable or disable notification of errors (job cancellation) that occur during job execution. ☞ Page 98 Notify errors (job cancellation) that occur during job execution
No. of fields in project	Displays the total number of fields in the project.
Tag component data length in job	Displays the total data length of the tag components in the job.

Job name (Up to 16 characters)

Enter a job name.

For characters that can be used for job names, refer to the following:

 Page 198 Characters applicable to item names, component names, variable names, etc.

GOT Initializing

■Set whether to enable the job at startup of the GOT or not.

If the [GOT Initializing] box is not checked, the job is disabled at startup of the GOT. (Even if trigger conditions are met, the job is not executed.)

■When the GOT is ON, the enable/disable setting of the job can be changed in [Change Job Status] on the [Diagnosis] tab.

 Page 147 Changing the job status (Change job status)

Trigger buffering

■Set whether to enable the trigger buffering function or not.

For the trigger buffering function, refer to the following:

 Page 48 Trigger buffering function

■Precautions for enabling [Trigger buffering]

- [Handshake operation] cannot be selected for the trigger conditions.
- A tag component cannot be selected for the substitution tag in [Operation action].
- Tag component values cannot be set for [DB-tag link setting] in [Select] of [Communication action].
- [Communication action] - [MultiSelect] cannot be selected.
- Up to 4096 words can be used for the total data length of tag components in one job. (The current data length is displayed on the status bar of [Job setting].)

Point

The tag component data length in one job refers to the total data length of the tag components set in [Communication action] and [Operation action]. In [Communication action], tag components are set in [DB-tag link setting] and [Select/Update/Delete conditions].

All tags in one job are treated as different tags even if there are the same tags.

Startup logging

■Set whether to output the startup history of the job to the log or not.

If this function is enabled, the job startup timing can be checked during system start-up or tune-up.

When the [Startup logging] box is checked, the startup history of the job (date and time, job name, trigger conditions) is saved on a CF card.

The startup log can be confirmed in [Job Execute Log] on the [Working log] tab.

 Page 152 Job Execute Log

■When the log capacity becomes full (Log capacity: 1MB × 2)

The first half of the data are deleted.

The latest log is stored after the remaining data.

■When this function is enabled, a processing time is required for saving or deleting the startup history of the job.

It is recommended to disable this function during system operation.

Test mode

■Set whether to operate the job in test mode or not.

Up to 4 jobs can be set to [Test mode].

When the [Test mode] box is checked, the test mode is activated, and execution details of the job can be confirmed before operation.

Job execution can be confirmed in [Job Execute Log] on the [Working log] tab.

■When [Test mode] is selected

The following are performed in the test mode.

Operations other than the following are identical to the actual operations.

- Startup data are logged.
- Detailed data are logged.
- Data are not written to GOT devices.
- No data are written to the database.

Setting items in Trigger conditions

Configure the settings for startup conditions of the job.

The job is activated when the trigger condition value is changed from false to true.

At the time of power-up, at restart of the MES interface function, or at the end of one-shot execution, all the conditions are initialized to false, and the job is started up when the initial condition is true.

Item	Description
Combination	Selects conjunction of Trigger 1 and 2.
Trigger 1	Selects Trigger 1.
Trigger 2	Selects Trigger 2.

Combination









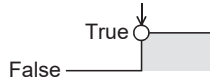
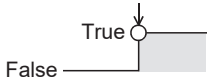
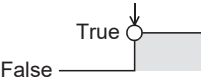
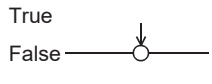
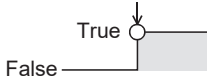

■Selects a combination of [Trigger 1] and [Trigger 2].

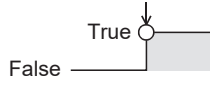
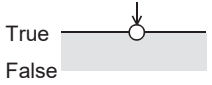
- OR (When either of them is true, the result is true.)
- AND (When both of them are true, the result is true.)

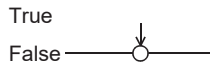
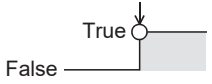
When the combination result of [Trigger 1] and [Trigger 2] is changed from false to true, the job is activated.

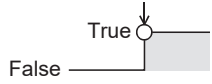
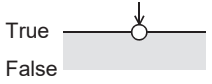
■The following shows the timings at which the combination result of [Trigger 1] and [Trigger 2] is changed from false to true.

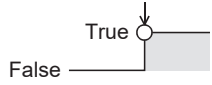
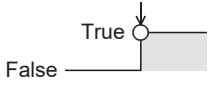
(In any other cases, because the combination result is not changed from false to true, the job is not activated.)

Combination	Trigger 1	Trigger 2	Combination result
OR (When either of them is true, the result is true.)	(Changed from false to true) 	(Remained false) 	(Changed from false to true) 
	(Changed from false to true) 	(Changed from false to true) 	(Changed from false to true) 
	(Remained false) 	(Changed from false to true) 	(Changed from false to true) 
AND (When both of them are true, the result is true.)	(Changed from false to true) 	(Remained true) 	(Changed from false to true) 
	(Changed from false to true) 	(Changed from false to true) 	(Changed from false to true) 
	(Remained true) 	(Changed from false to true) 	(Changed from false to true) 

Trigger 1, Trigger 2

Refer to the following table and select items for Trigger 1 and Trigger 2.

○: Selectable, ×: Not selectable

Item	Description	Trigger 1	Trigger 2
Disable	No trigger conditions ☞ Page 89 Disable	○	○
Time specification startup	When the specified date, time and day of the week match the actual date, time and day of the week, the condition changes from false to true, resulting in job startup. ☞ Page 89 Time specification startup	○	○
Specified time period startup	The condition is alternated between true and false in the specified cycles (unit: seconds), and when it changes from false to true, the job is activated. ☞ Page 90 Specified time period startup	○	○
Value monitoring startup	The actual tag component value is compared with the condition value (tag component value or constant value) at every sampling times, and the job is activated when the condition changes from false to true. ☞ Page 91 Value monitoring startup	○	○
GOT Initializing	The job is activated only once when the GOT is started up. ☞ Page 92 GOT Initializing	○	○
Handshake operation	The job is activated when [Handshake startup] of the GOT turns ON. Upon completion of the job execution, [Completion notification] of the GOT turns ON. ☞ Page 93 Handshake operation	○	×

Disable

■When [Disable] is selected for [Trigger 1] or [Trigger 2]

Another trigger is regarded as a trigger condition.

■When [Disable] is selected for both [Trigger 1] and [Trigger 2]

The job is not activated by trigger conditions.

The job can be executed only by one-shot execution.

Time specification startup

■When the specified date, time and day of the week match the actual date, time and day of the week, the condition changes from false to true, resulting in job startup.

■When [Time specification startup] is selected, the date, time, and day of the week must be set.

- Year, Month, Day, Hour, and Minute

Directly enter the date and time.

Matching with the actual date and time is not checked for any field that remains blank.

Item	Description
Year (4 digits)	0000 to 9999
Month	1 to 12
Day	1 to 31
Hour	0 to 23
Minute	0 to 59

- Day

Specify a day of the week.

Check the checkbox of the day to be specified.

If no box is checked, it means "every day".

(Example) The following shows that the job is to be activated at 17:30 on Monday through Friday.

(Example) The following shows that the job is to be activated at 9:00 on the 1st day of every month.

Point

If [Startup logging] is selected, each job startup can be confirmed with the time to the second in the startup log. The startup log can be checked on the [Working log] tab.

☞ Page 151 Working Log

Specified time period startup

■The condition is alternated between true and false in the specified cycles (unit: seconds), and when it changes from false to true, the job is activated.

■When [Specified time period startup] is selected, set the cycle.

(Range: 1 to 32767 seconds)

(Example)

The following shows that the job is activated at 60-second intervals for an hour from 12:00 to 13:00 every day.

Value monitoring startup

■ The actual tag component value is compared with the condition value (tag component value or constant value) at every sampling times, and the job is activated when the condition changes from false to true.

Even if the trigger condition becomes true temporarily between samplings, the job is not activated unless it is true at time of sampling.

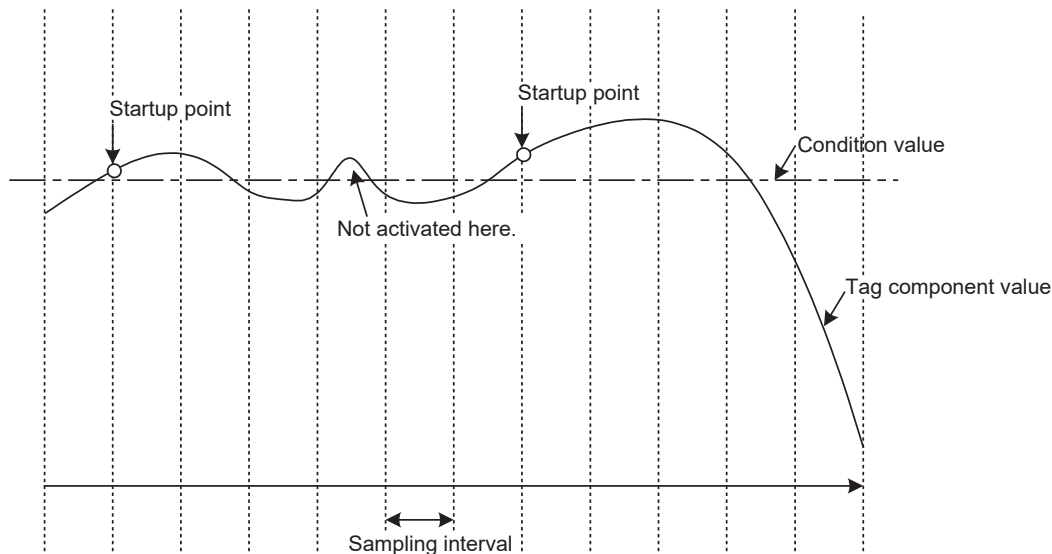

■ When [Value monitoring startup] is selected, specify conditions for comparison.

Trigger 1 Value monitoring startup

Tag	Component	Condition	Tag/Type	Component

- Tag, Component

Select a tag component to be compared with.

Tags that have a tag component with [Array setting] cannot be selected.

- Condition

Select a condition for comparison.

Item	Description
=	The tag component value is equal to the condition value.
≠	The tag component value is not equal to the condition value.
≥	The tag component value is equal to or greater than the condition value. (Not selectable when [Data type] of the tag component is [bit] or [String])
>	The tag component value is greater than the condition value. (Not selectable when [Data type] of the tag component is [bit] or [String])
<	The tag component value is smaller than the condition value. (Not selectable when [Data type] of the tag component is [bit] or [String])
≤	The tag component value is equal to or smaller than the condition value. (Not selectable when [Data type] of the tag component is [bit] or [String])

- Tag/Type

Select a tag or constant that is used as a condition for comparison.

Tags that have a tag component with [Array setting] cannot be selected.

- Component

Select or enter a component/constant value that is used as a condition for comparison.

(Example)

The following shows that the job is activated when the value of the tag component (Process 1, Temperature) reaches 45 or higher.

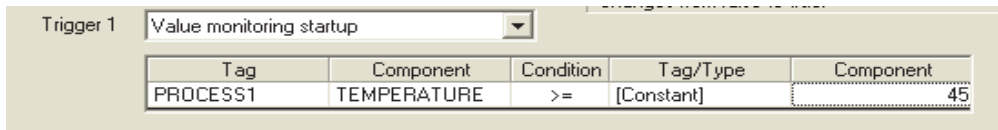

(Example)

To activate the job repeatedly while the condition of [Value monitoring startup] is met,

Make settings as follows:

Item	Description
Combination	AND (When both of them are true, the result is true.)
Trigger 1, Trigger 2	[Value monitoring startup], [Specified time period startup]

As the condition alternates between true and false as shown below, job startup can be repeated while the [Value monitoring startup] condition is met.

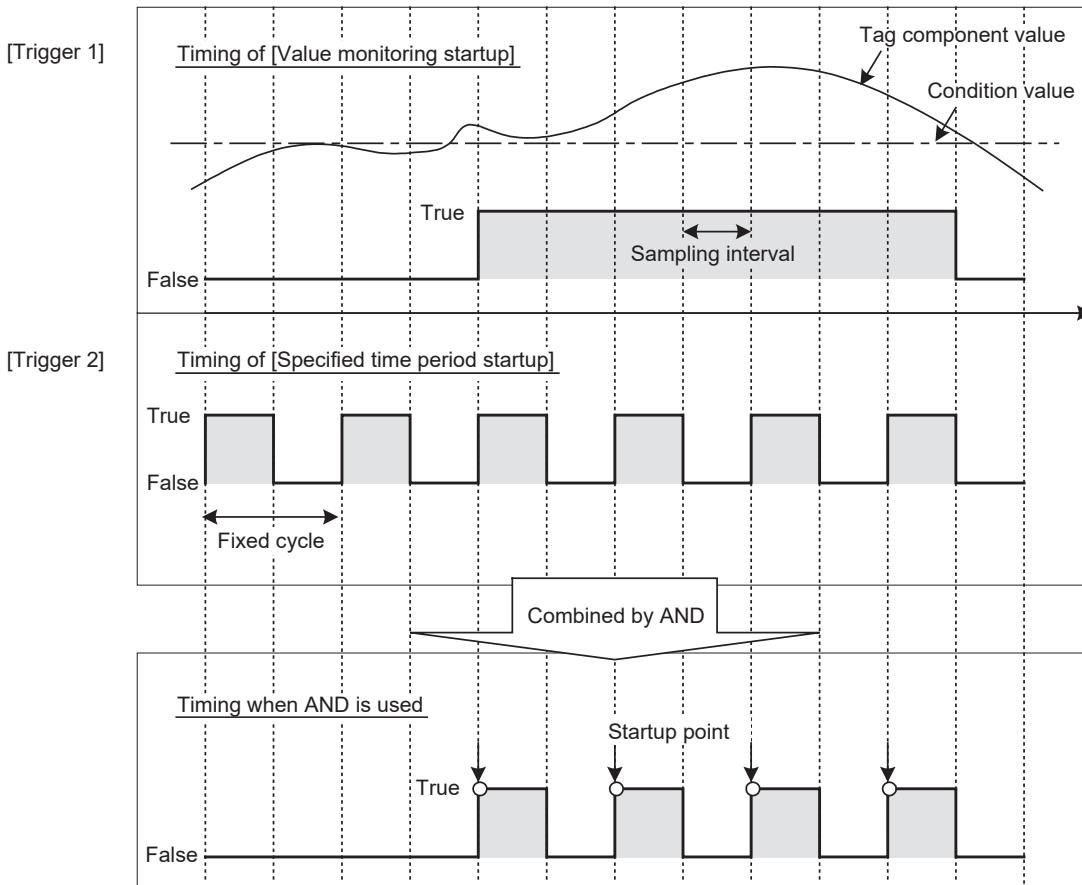

GOT Initializing

The job is activated only once when the GOT is started up.

Handshake operation

■The job is activated when [Handshake startup] of the GOT turns ON.

Upon completion of the job execution, [Completion notification] of the GOT turns ON.

[Handshake operation] is a startup method by which completion of job execution can be notified to a GOT.

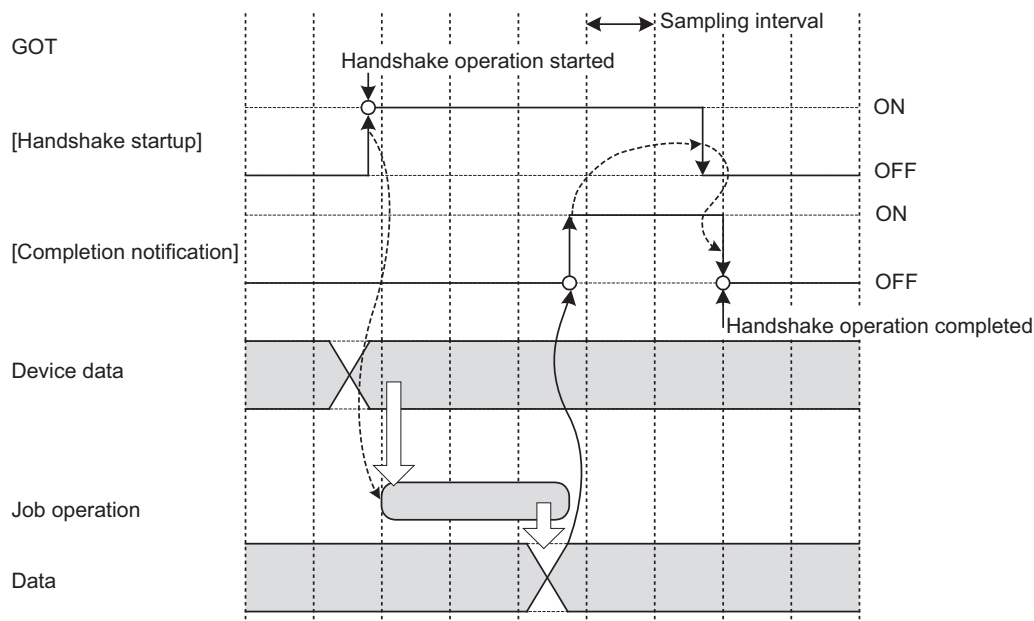

1. When [Handshake startup] turns ON in the sequence program, the GOT collects tag component values used for the job and executes the job.
2. Upon completion of the job execution, [Completion notification] of the GOT is turned ON.*¹
3. After confirming that [Completion notification] is ON, turn OFF [Handshake startup] of the GOT manually or using a user-created program such as a script.
4. When [Handshake startup] turns OFF, the GOT turns OFF [Completion notification], causing the handshake operation to be completed.
5. After confirming the completion of the handshake operation, the next job is executed.

*¹ If an error occurs during job execution, [Completion notification] does not turn ON.

To detect such an error, enable [Notify errors (job cancellation) that occur during job execution].

☞ Page 98 Notify errors (job cancellation) that occur during job execution

■[Handshake operation] is selectable only in [Trigger 1].

When [Handshake operation] is selected, selection is not allowed for [Trigger 2].

For selection of [Handshake operation], set the following items.

Trigger 1	Handshake operation	
	Tag	Component
Handshake startup	PROCESS1	START
Completion notification	PROCESS1	COMPLETION

Item	Description
Handshake startup	Select a tag component used to request for job startup. (Selectable only when [Data type] of the tag component is [bit]) Tags that have a tag component with [Array setting] cannot be selected.
Completion notification	Select a tag component that allows notification of execution completion of the job. (Selectable only when [Data type] of the tag component is [bit]) Tags that have a tag component with [Array setting] cannot be selected.

*¹ Do not specify the same [Completion notification] to multiple jobs.

Setting items in Program execution

Configure the settings for the program execution function.

For the program execution function, refer to the following:

☞ Page 53 Program execution function

1. Click the **Setting** button of [Before actions] or [After actions].

- Before actions:

Set a program to be performed before execution of the first action of the job.

- After actions:

Set a program to be performed after execution of the last action of the job.

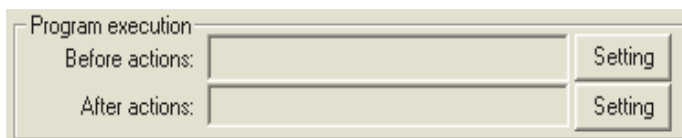

2. [Program execution setting (before action)] or [Program execution setting (after action)] is displayed.

Make the setting referring to the following descriptions.

After completing the setting, click the **OK** button.

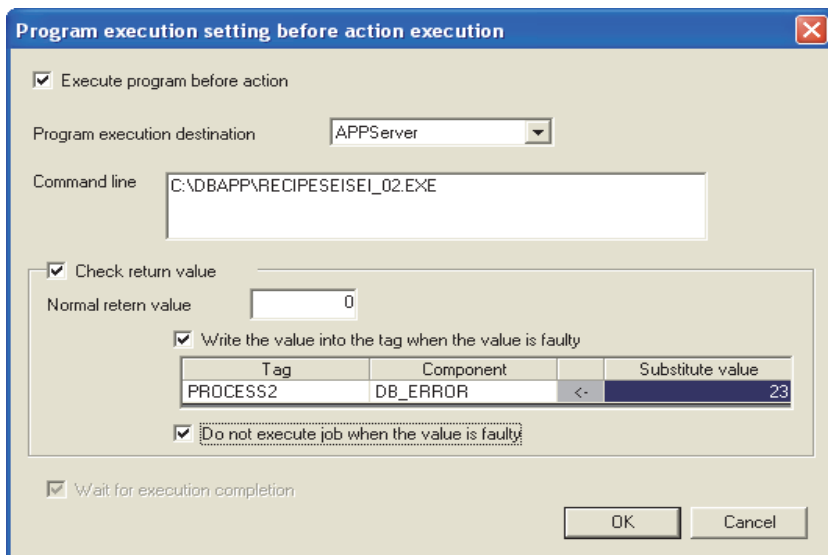

Program execution setting before action execution

Execute program before action

Program execution destination: APPServer

Command line: C:\DBAPP\RECIPESEISEI_02.EXE

Check return value

Normal return value: 0

Write the value into the tag when the value is faulty

Tag	Component	Substitute value
PROCESS2	DB_ERROR	<- 23

Do not execute job when the value is faulty

Wait for execution completion

OK Cancel

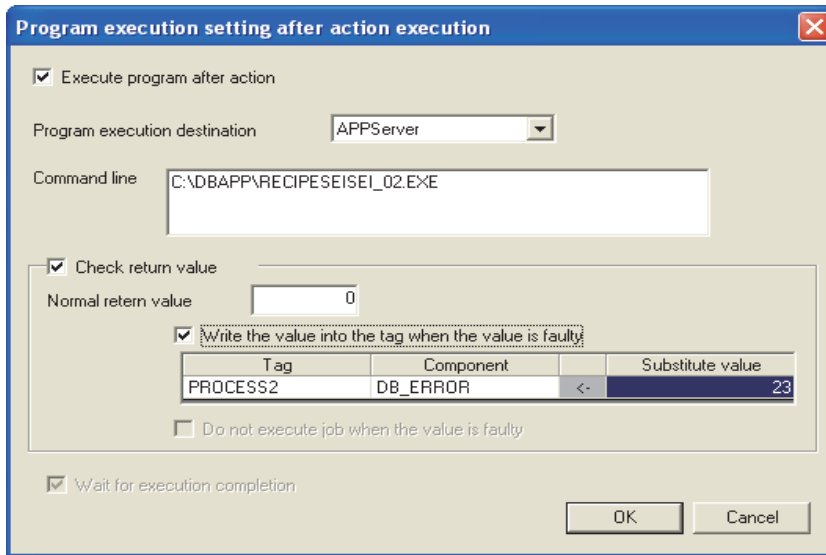

Item	Description
Execute program before (after) action	Set whether or not to enable program execution before or after execution of actions.
Program execution destination	Select an application server to be accessed.
Command line	Enter a command line for the program that is executed on the application server computer. (Up to 127 characters)
Check return value	Set whether to check the return value or not.
Wait for execution completion	Set whether or not to wait for execution completion of the program before executing the next processing.

Execute program before action, or Execute program after action

- Set whether or not to enable program execution before or after execution of actions.
- When [Execute program before action] or [Execute program after action] is enabled, make the setting described in this section (2) and subsequent sections.

Program execution destination

Select an application server to be accessed.

Command line (Up to 127 characters)

Enter a command line for the program that is executed on the application server computer.*1*2

For characters that can be used for command lines, refer to the following:

☞ Page 197 ASCII code table

*1 Programs that need to be run with administrator privileges (by a user in Administrators group) are not executable.

*2 To execute a program including any displays, place the application server computer into the logon status.

Check return value

■Set whether to check the return value or not.

When the [Check return value] box is checked, the return value (End code) of the executed program is checked.

If no return value is returned within the [DB access timeout] time set in DB Connection Service Setting Tool, a timeout error is detected and the job execution is canceled.

For [DB access timeout], refer to the following:

 Page 173 Setting Items of DB Connection Service Setting Tool

■When [Check return value] is selected, set the following items.

- Normal return value (Default: 0)

Set a normal return value.

- Write the value into the tag when the value is faulty.

When the [Write the value into the tag when the value is faulty] box is checked, if the return value is not normal, a value is assigned to the specified tag component.

Set a tag component to which a value is assigned when this is selected.

- Tag, Component

Select a tag component to which a value is assigned.

Tags that have a tag component with [Array setting] cannot be selected.

- Substitute value

Directly enter a substitute value.

The following shows the settable substitute values.

Data type of tag component	Settable substitute value
Single word Double word Real number	Up to 16 characters • Signed decimal notation Example: -521.98 • Signed exponential notation Example: -5.2198E02
String	When [Enable additional setting] is selected: Up to 255 characters When [Enable additional setting] is deselected: Up to 32 characters For characters that can be used for character strings, refer to the following:  Page 199 Characters applicable to character string constants, etc.
String [Unicode]	Up to 255 characters
Bit	[ON] or [OFF]

- Do not execute job when the value is faulty. ([Program execution setting (before action)] only)

When the [Do not execute job when the value is faulty] box is checked, if the return value is faulty, the job execution is canceled.

Wait for execution completion

If the [Wait for execution completion] box is checked, the next processing is executed after completion of the program execution.

When [Check return value] is selected, [Wait for execution completion] is always selected.

Setting items in DB Buffering

Set whether to utilize the DB buffering function or not.

For the DB buffering function, refer to the following:

☞ Page 54 DB buffering function

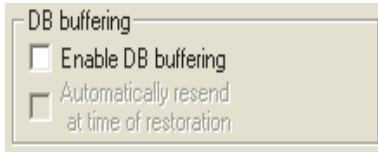

Item	Description
Enable DB buffering	Set whether to enable the DB buffering or not.
Automatically resend at time of restoration	Set whether or not to automatically resend data after recovery. When the [Automatically resend at time of restoration] box is checked, resend processing is automatically performed after recovery. When the [Automatically resend at time of restoration] box is not checked, resend processing is manually performed after recovery.

Point

Before resending data, the GOT communicates with the database.

At this time, if an action for communicating with the same database is set for a job, a long time is required for execution of the job.

In the case of a large buffering size, it is advisable to resend the data manually while any job that is set to communicate with the database is not in execution, so that no problem will arise even if the MES interface function processing is affected.

Notify errors (job cancellation) that occur during job execution

Set whether to enable or disable notification of errors (job cancellation) that occur during job execution.

Job execution is canceled when access to the database fails or when type mismatch is found.

☞ Page 61 Precautions

☞ Page 157 Operation of numerical values

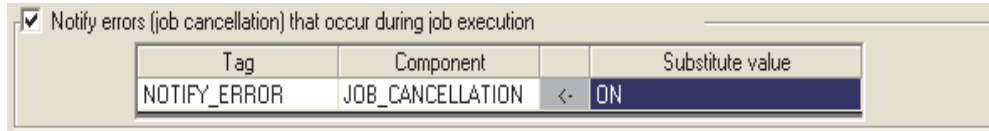

Notify errors (job cancellation) that occur during job execution

■Set whether to enable or disable notification of errors (job cancellation) that occur during job execution.

When [Notify errors (job cancellation) that occur during job execution] box is checked, if job execution is canceled, a value is assigned to the specified tag component.

■When [Notify errors (job cancellation) that occur during job execution] has been selected, set a tag component to which a value is assigned.

- Tag, Component

Select a tag component to which a value is assigned.

Tags that have a tag component with [Array setting] cannot be selected.

- Substitute value

Directly enter a substitute value.

The following shows the settable substitute values.

Data type of tag component	Settable substitute value
Single word Double word Real number	Up to 16 characters • Signed decimal notation Example: -521.98 • Signed exponential notation Example: -5.2198E02
String	When [Enable additional setting] is selected: Up to 255 characters When [Enable additional setting] is deselected: Up to 32 characters For characters that can be used for character strings, refer to the following: ☞ Page 199 Characters applicable to character string constants, etc.
String [Unicode]	Up to 255 characters
Bit	[ON] or [OFF]

One-shot execution

Execute a job as a one-shot task.

Doing so allows the user to check the execution result of the currently editing [Job setting].

Procedure for one-shot execution

Point

- In [One-shot execution], settings of [Startup logging] and [DB Buffering] are not executed.
- All of job operations running with the MES interface function are temporarily disabled during one-shot execution.

1. Click the button with the [Job settings] edit screen displayed.
2. Clicking the button performs one-shot job execution ignoring the trigger conditions.
3. Check the execution result that is displayed in the [View details] dialog box.

For the display of the [View details] dialog box, refer to the following:

 Page 155 Updating the Job Execute Log

Point

A dialog box indicating the current processing status is displayed until completion of one-shot execution.

Precautions for one-shot execution

■Precautions before one-shot execution

One-shot execution can be performed only when the MES interface function is active.

When the MES interface function is not active, check the status and restart the operation before starting one-shot execution.

For restart of the MES interface function, refer to the following:

 Page 147 Manipulating the MES Interface Function status (Operation)

■Precautions during one-shot execution

Do not perform the following during one-shot execution.

- Do not disconnect the cable that is connected to the GOT during one-shot execution.

Doing so will cause the MES interface function to be inoperative.

- Do not remove the CF card from the GOT during one-shot execution.

Doing so will cause the MES interface function to be inoperative.

If the MES interface function becomes inoperative, check the status and restart the operation on the [Diagnosis] tab.

For restart of the MES interface function, refer to the following:

 Page 147 Manipulating the MES Interface Function status (Operation)

■Connection result after the one-shot execution is performed

After you perform the one-shot execution to connect a database server computer, the connection result is not reflected to [Connection result of previous job execution] in the [Diagnosis] tab.

■Job execution result after the one-shot execution is performed

After you perform the one-shot execution to execute a job, the job execution result is not reflect to the database. (The rollback is executed.)

6.8 Job Settings - Actions

The following shows types of actions.

Up to 10 actions can be set for one job.

- [Communication action]

For communicating the GOT with a database

- [Operation action]

For operating tag component values

- [Transmit resource action]

For sending the resource data to the database

(Adding an action)

- Select [Communication action], [Operation action], or [Transmit resource action] from the list box next to the **Add** button, and click the **Add** button.
- The Communication action dialog box, the Operation action dialog box, or the Transmit resource action dialog box is displayed.

☞ Page 104 Setting items in Communication action

☞ Page 125 Setting items in Operation action

☞ Page 128 Setting items in Transmit resource action

(Modifying an action)

- Select an action to be modified in [Action list], and click the **Edit** button.
- The Communication action dialog box, the Operation action dialog box, or the Transmit resource action dialog box is displayed.

☞ Page 104 Setting items in Communication action

☞ Page 125 Setting items in Operation action

☞ Page 128 Setting items in Transmit resource action

(Deleting an action)

- Select an action to be deleted in [Action list], and click the **Delete** button.

(Copying an action)

- Select an action to be copied in [Action list], choose [Replicate the selected action] from the list box next to the **Add** button, and click the **Add** button.

(Copying an action of another job within the project)

1. Select [Replicate actions of other jobs] in the list box next to the **Add** button, and click the **Add** button.
2. The [Replicate actions] dialog box is displayed.

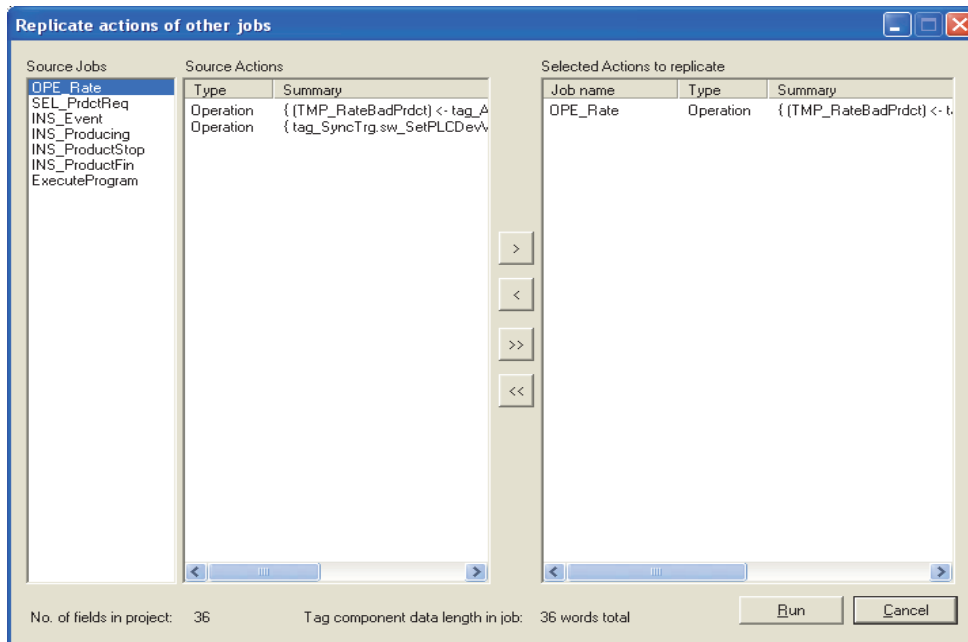

3. By repeating the following steps 4 to 6, set copy targets in [Selected Actions to replicate].
4. From [Source Jobs], select a job that includes a desired action.
5. Actions of the job selected in step 4 are listed in [Source Actions]. Select an action to be copied. (Multiple actions are selectable.)
6. Clicking the **>** button moves the action(s) selected in step 5 in [Selected Actions to replicate].

Item	Description
> button	Puts the action(s) selected in [Source Actions] into [Selected Actions to replicate].
>> button	Puts all of the actions in [Source Actions] into [Selected Actions to replicate].
< button	Deletes the action(s) selected in [Selected Actions to replicate] from the box.
<< button	Deletes all of the actions in [Selected Actions to replicate] from the box.

7. Clicking the **Run** button executes copying.

Copied actions are located after existing actions.

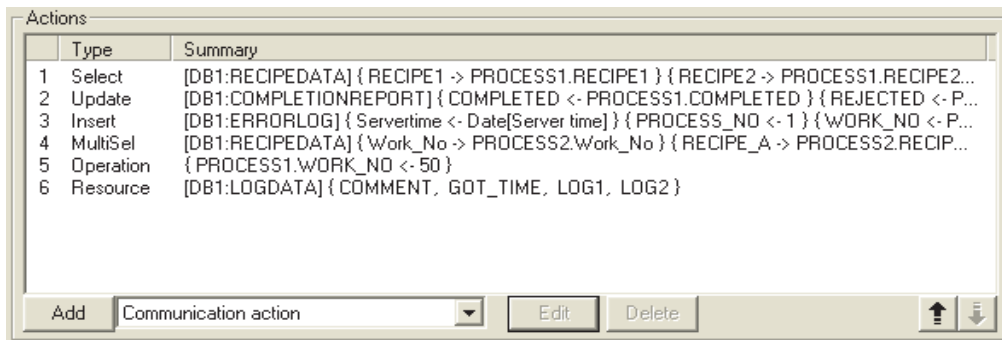

Item	Description
Type	The types of the existing actions are displayed.
Summary	Details of the existing actions are displayed.
↑ button	Selecting an action in [Action list] and clicking the ↑ button reverses the order between the selected one and the one immediately above it. The ↑ button cannot be clicked on the first action.
↓ button	Selecting an action in [Action list] and clicking the ↓ button reverses the order between the selected one and the one immediately below it. The ↓ button cannot be clicked on the last action.

Point

When more than one action are set, they are executed in order, starting from the top.

Type

The types of the existing actions are displayed.

Item	Description
Select	[Select] of [Communication action]
Update	[Update] of [Communication action]
Insert	[Insert] of [Communication action]
MultiSelect	[MultiSelect] of [Communication action]
Delete	[Delete] of [Communication action]
Operation	[Operation action]
Resource	[Transmit resource action]

Summary

Details of the existing actions are displayed.

Item	Description ^{*1*2}
Select MultiSelect	[Database: Table name]{DB-tag link setting No.1}...{DB-tag link setting No.n} {DB-tag link setting} = {Field name -> Tag component/Constant value}
Update Insert	[Database: Table name]{DB-tag link setting No.1}...{DB-tag link setting No.n} {DB-tag link setting} = {Field name <- Tag component/Constant value}
Delete	[Database: Table name]
Operation	{Operation action No.1}...{Operation action No.n} With substitution setting: {Operation action} = {Substitution tag component/Constant value <- Operation tag component/Constant value Operator Operation tag component/ Constant value} Without substitution setting: {Operation action} = {Substitution tag component/Constant value <- Operation tag component/Constant value}
Resource	[Database: Table name]{Comment storing field name, Time storing field name, Field name No.1, ..., Field name No.n}

*1 Display format of the tag component/constant value

Item	Description
Tag component	Device tag name, component name
Numerical value	Numerical value
String	"Character string"
Date	GOT time: Date [GOT time] Server time: Date [Server time]
Date String	"Date [Date String]"
Variable	(Variable name)

*2 Display format of the operator

Item	Description
+ (Addition)	+
- (Subtraction)	-
× (Multiplication)	×
÷ (Division)	÷
% (Remainder)	%

Setting items in Communication action

Configure the settings for communications with a database.

1. Performing the operation for adding or modifying an action displays the [Communication action] dialog box.
2. Make the setting referring to the following descriptions.
3. Clicking the button after setting adds or modifies the action.
4. For the operation for adding or modifying an action, refer to the following:

 Page 100 Job Settings - Actions

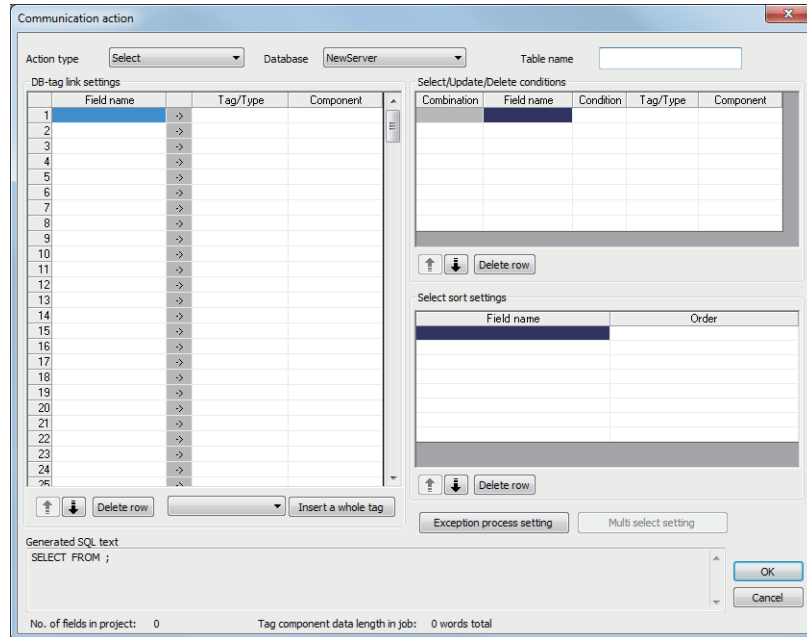

Item	Description
Action type	Select an action type.
Database	Set a table name of the database to be accessed.
Table name	Set a table name of the database to be accessed.
DB-tag link settings ^{*1}	Set assignments between field values and tag component values (or constant values)
Select/Update/Delete conditions ^{*1}	When [Select], [Update], [MultiSelect], or [Delete] is selected for [Action type], set the conditions of the records to be selected, updated, or deleted.
Select sort settings ^{*1}	When [Select] or [MultiSelect] is selected for [Action type], set a condition for sorting selected records.
<input type="button" value="Exception process setting"/> button	Set the processing to be performed in the following cases: <ul style="list-style-type: none"> • No applicable record exists when [Select], [Update], [MultiSelect], or [Delete] is selected for [Action type]. • Multiple applicable records exist when [Select], [Update], or [Delete] is selected for [Action type]. • The number of records to be multi-selected is greater than the number of arrays set in [Array setting] of the tag when [MultiSelect] is selected for [Action type].
<input type="button" value="Multi select setting"/> button	When [MultiSelect] is selected, detailed settings can be configured by clicking this.
Generated SQL text	Displays SQL text that is generated in the currently editing [Communication action].
No. of fields in project	Displays the total number of fields in the project.
Tag component data length in job	Displays the total data length of the tag components in the job.
<input type="button" value="↑"/> button	Selecting a row and clicking the <input type="button" value="↑"/> button reverses the order between the selected row and the one immediately above it. The <input type="button" value="↑"/> button cannot be clicked on the first row.
<input type="button" value="↓"/> button	Selecting a row and clicking the <input type="button" value="↓"/> button reverses the order between the selected row and the one immediately below it. The <input type="button" value="↓"/> button cannot be clicked on the last row.
<input type="button" value="Delete row"/> button	Selecting a row and clicking the <input type="button" value="Delete row"/> button deletes the row.

Item	Description
Insert a whole tag button	<ul style="list-style-type: none"> All of the tags set in [Device tag settings] are inserted into [Tag] and [Component]. Select a row into which data are inserted and choose a tag in a list box next to the Insert a whole tag button. Clicking the Insert a whole tag button inserts all of the tag components into contiguous rows starting from the selected one. The existing data set in the rows starting from the selected one are moved down.

*1 Up to 8192 fields can be set in [DB-tag link settings], [Select/Update/Delete conditions], and [Select sort settings] for one project. (Check [No. of fields in project] in the lower left of the Communication action dialog box.)

Point 

- Entry of [Component]
- When data are entered in [Component] by [Insert a whole tag] or with the [Field name] space blank, the data are copied to the [Field name] space.
 (Characters not allowed for [Field name] are not entered.)
 Because of this, setting the same name to each of the field name and tag component name is useful.

Action type

Select an action type.

Item	Description
Select	[Select] substitutes a field value of the record, whose conditions are met, for a substitute value (tag component value/variable).
Update *1	[Update] substitutes a substitute value (tag component value/variable) for a field value of the record whose conditions are met.
Insert	Generates a new value, and inserts an insert value (tag component value/constant value/variable) into a field of the generated record.
MultiSelect	Substitutes field values of the records, whose conditions are met, for substitute values (tag component values).
Delete	Deletes the record that meets the specified conditions.

*1 With Microsoft Access, the following restrictions are placed.

- Up to 127 fields can be updated for a communication action.
- Do not access the same file with multiple GOTs and MES interface modules simultaneously.

Database

Select a database to be accessed.

Table name (1 to 32 characters)

Set a table name of the database to be accessed.
 For characters that can be used for table names, refer to the following:
 Page 199 Characters applicable to field names, table names, etc.

DB-tag link settings

Set assignments between field values and tag component values (or constant values).

Up to 256 rows can be set in [DB-tag link settings] for each communication action.

■When [Select] is selected for [Action type]

[Select] substitutes a field value of the record, whose conditions are met, for a substitute value (tag component value/variable).

In [Select/Update/Delete conditions], set the conditions of the record to be selected.

☞ Page 115 Select/Update/Delete conditions

Conditions for sorting the selected records are set in [Select sort settings].

☞ Page 116 Select sort settings

- Field name (1 to 32 characters)

Set a field name for the field value to be selected.

For characters that can be used for field names, refer to the following:

☞ Page 199 Characters applicable to field names, table names, etc.

- Tag

Select a tag or variable for which a value is substituted.

Tags that have a tag component with [Array setting] cannot be selected.

- Component

Select or directly enter a component value or a variable of the substitution target.

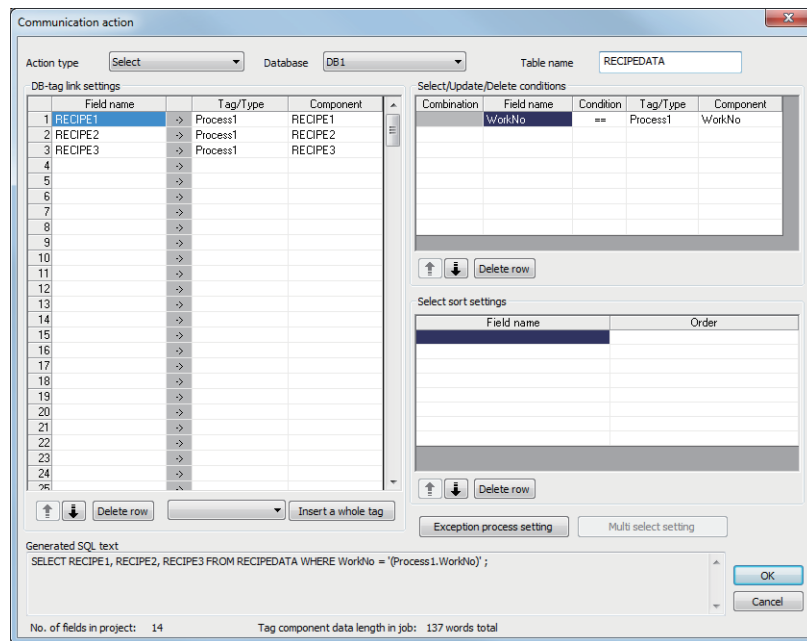

Database: DB1, Table name: RecipeData

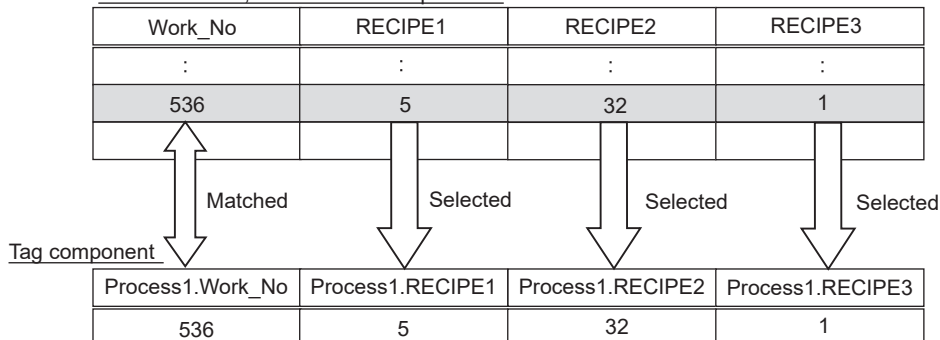

■When [Update] is selected for [Action type]

[Update] substitutes a substitute value (tag component value/variable) for a field value of the record whose conditions are met.

In [Select/Update/Delete conditions], set the conditions of the record to be updated.

☞ Page 115 Select/Update/Delete conditions

- Field name (1 to 32 characters)

Set a field name for the field value to be updated.

For characters that can be used for field names, refer to the following:

☞ Page 199 Characters applicable to field names, table names, etc.

- Tag

Select a tag, constant, or variable which is substituted.

Tags that have a tag component with [Array setting] cannot be selected.

- Component

Select or directly enter a Component value or a variable that is to be substituted.

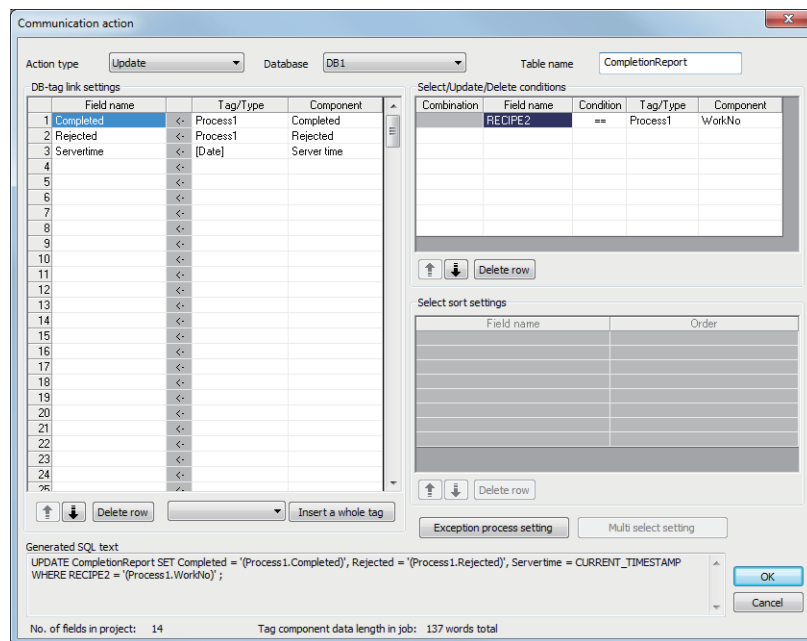

Database: DB1, Table name: CompletionReport

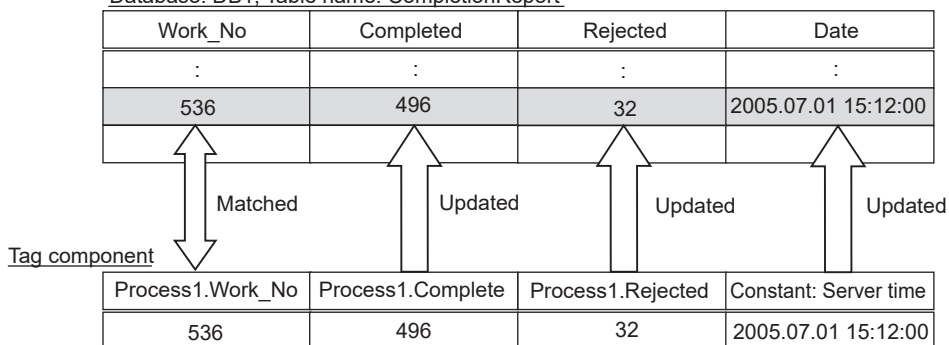

■When [Insert] is selected for [Action type]

[Insert] generates a new record, and inserts an insert value (tag component value/constant value/variable) into a field of the generated record.

- Field name (1 to 32 characters)

Set a field name for the field value to be inserted.

For characters that can be used for field names, refer to the following:

☞ Page 199 Characters applicable to field names, table names, etc.

- Tag

Select a tag, constant, or variable which is substituted.

Tags that have a tag component with [Array setting] cannot be selected.

- Component

Select or directly enter a Component value or a variable that is to be substituted.

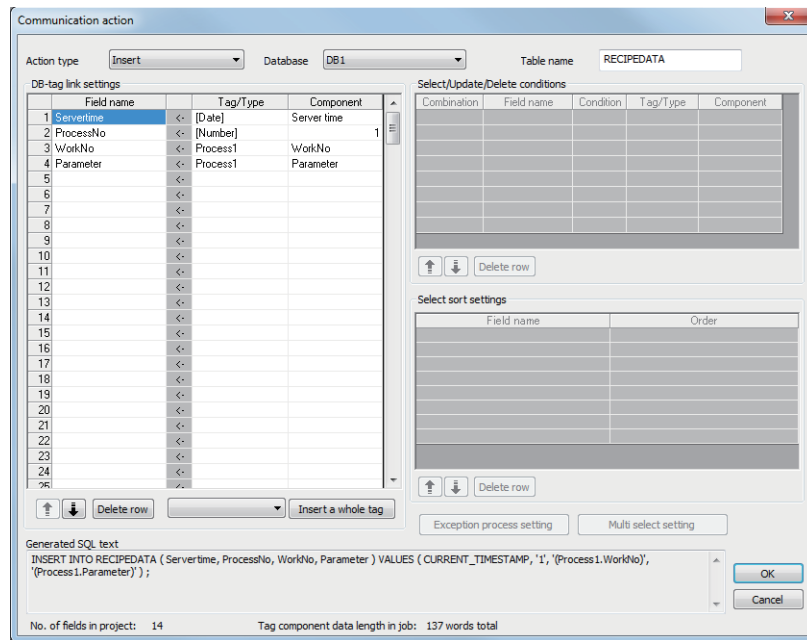

Database: DB1, Table name: ERRORLOG

Date	Process No	Work_No	Parameter
:	:	:	:
2005.07.01 15:12:00	1	536	8

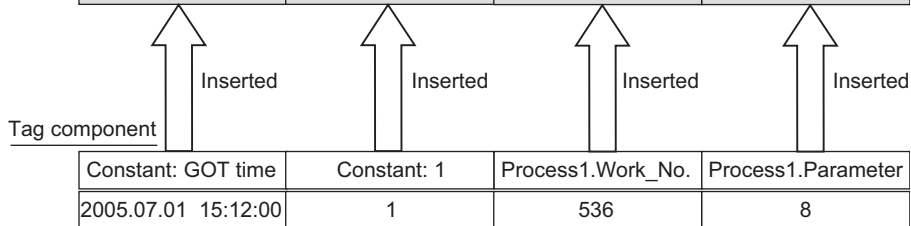

■When [MultiSelect] is selected for [Action type]

[MultiSelect] substitutes field values of the records, whose conditions are met, for substitute values (tag component values).

In [Select/Update/Delete conditions], set the conditions of the records to be multi-selected.

☞ Page 115 Select/Update/Delete conditions

Conditions for sorting the selected records are set in [Select sort settings].

☞ Page 116 Select sort settings

- Field name (Up to 32 characters)

Set a field name for the field values to be multi-selected.

For characters that can be used for field names, refer to the following.

☞ Page 199 Characters applicable to field names, table names, etc.

- Tag

Only the tags with [Array setting] can be selected.

- Component

Select a target component.

- When [MultiSelect] is used in a job, the total of [Tag component data length in job] must be 45000 words or less.

[Tag component data length in job] represents a total length of the tag component data set for the following:
[DB-tag link settings] in [Communication action]

[Select/Update/Delete conditions] in [Communication action]

[Operation action]

Even if the same tag component is set more than once in the same job, each setting is handled separately.
(The number of settings can be confirmed on the status bar of [Job setting], or in the [Communication action] or [Operation action] dialog box.)

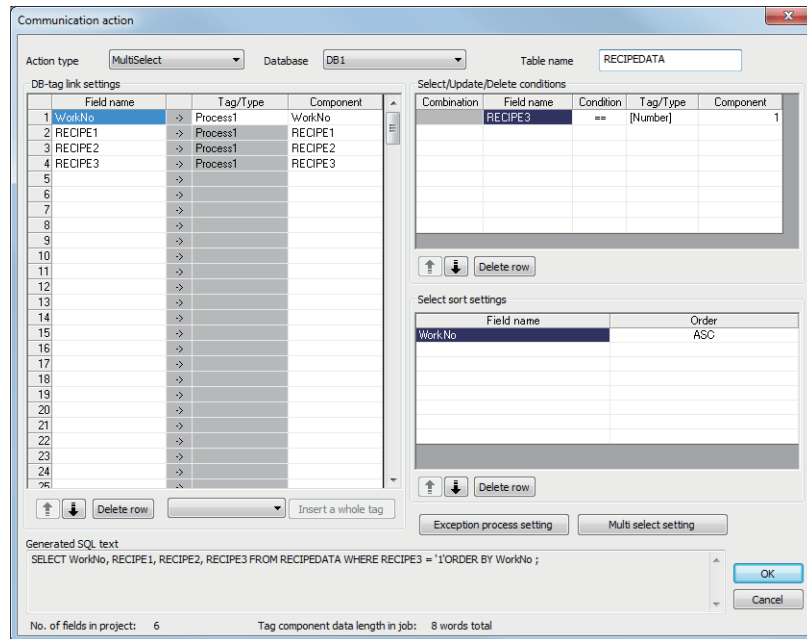

Database: DB1, Table name: RECIPEDATA

Work_No	RECIPE_A	RECIPE_B	RECIPE_C
:	:	:	:
536	5	32	1
537	6	33	0
538	7	34	1
539	8	35	0
540	9	36	1

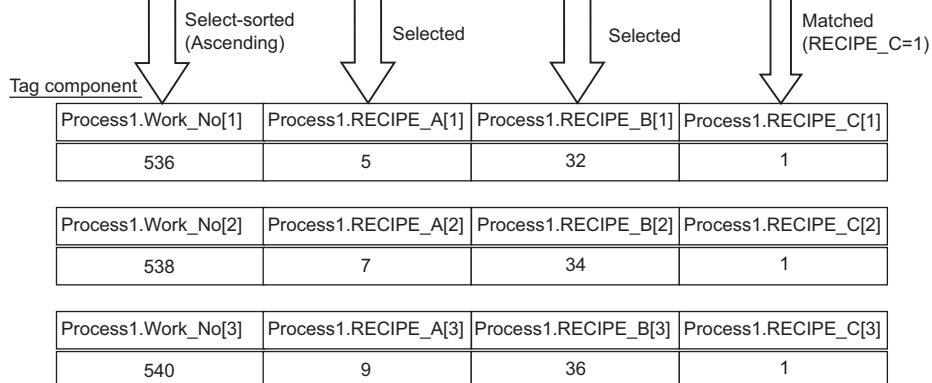

■When [Delete] is selected for [Action type]

[Delete] deletes the record that meets the specified conditions.

In [Select/Update/Delete conditions], set the conditions of the record to be deleted.

☞ Page 115 Select/Update/Delete conditions

Communication action

Action type: Delete Database: DB1 Table name: CompletionReport

DB-tag link settings

	Field name	Tag/Type	Component
1			
2			
3			
4			
5			
6			
7			
8			
9			
10			
11			
12			
13			
14			
15			
16			
17			
18			
19			
20			
21			
22			
23			
24			
25			
26			

Select/Update/Delete conditions

Combination	Field name	Condition	Tag/Type	Component
	field1	==	[Number]	1
AND	field2	==	[Number]	2

Select sort settings

Field name	Order

Generated SQL text

```
DELETE FROM CompletionReport WHERE field1 = '1' AND field2 = '2';
```

No. of fields in project: 14 Tag component data length in job: 137 words total

Point

If multiple applicable records exist, all these records are deleted.
If [Select/Update/Delete conditions] is not set, all records are deleted from the specified table.

■About tag components

Tag component values can be used as the component or constant values for each action, or as the condition values of [Select/Update/Delete conditions].

The following table lists data types of tag components and those of assignable fields.

If the data type of a tag component does not match the one of its substitution target field, an error occurs, resulting in cancellation of job execution.



The data type of a tag component will change through operation processing of a job.

☞ Page 157 Operation of numerical values

Data type of tag component	Data type of assignable field				
	Oracle	SQL Server MSDE 2000	Access	MySQL	PostgreSQL
Bit type (Numeric type: Integer) Single-precision type Double-precision type	NUMBER CHAR VARCHAR	bit int smallint tinyint float real char varchar text ^{*1}	Yes/No type Byte type Integer type Long integer type Single type Double type AutoNumber type Currency type Text type ^{*1*2} Memo type ^{*1*2}	TINYINT [UNSIGNED] SMALLINT [UNSIGNED] MEDIUMINT [UNSIGNED] INT [UNSIGNED] BIGINT [UNSIGNED] DECIMAL[(M[,0])][UNSIGNED] DECIMAL(M,D)[UNSIGNED] FLOAT [UNSIGNED] DOUBLE [UNSIGNED] [NATIONAL] CHAR[(M)] [NATIONAL] VARCHAR(M)	Smallint Integer bigint numeric(p,0) numeric(p,s) real double precision character(n) character varying(n)
(Numeric type: Floating point) Floating-point type ^{*3}	NUMBER CHAR VARCHAR	float real char varchar text ^{*1}	Single type Double type Text type ^{*1*2} Memo type ^{*1*2}	DECIMAL(M,D)[UNSIGNED] FLOAT [UNSIGNED] DOUBLE [UNSIGNED] [NATIONAL] CHAR[(M)] [NATIONAL] VARCHAR(M)	numeric(p,s) real double precision character(n) character varying(n)
Character string	CHAR VARCHAR	char varchar text ^{*1}	Text type ^{*2} Memo type ^{*2}	[NATIONAL] CHAR[(M)] [NATIONAL] VARCHAR(M)	character(n) character varying(n)

*1 Not available for [Select/Update/Delete conditions].

*2 For Microsoft Access 2019/2016/2013/2010/2007, memo-type fields in Rich Text Format cannot be used.

*3 Values are assigned with precision of six decimal digits.

■About constants

Constants can be used as the component or constant values for each action, or as the condition values of [Select/Update/Delete conditions].

The following table lists constant types and the data types of assignable fields.

If the type of a constant does not match the data type of its substitution target field, an error occurs, resulting in cancellation of job execution.

Constant type	Values that can be entered in [Component]	Data type of assignable field				
		Oracle	SQL Server MSDE 2000	Access	MySQL	PostgreSQL
[Number]	Up to 16 characters • Signed decimal notation (Example: -521.98) • Signed exponential notation (Example: -5.2198E03)	NUMBER	bit ^{*1} int ^{*1} smallint ^{*1} tinyint ^{*1} float real	Yes/No type Byte type Integer type Long integer type Single type Double type AutoNumber type Currency type	TINYINT [UNSIGNED] SMALLINT [UNSIGNED] MEDIUMINT [UNSIGNED] INT [UNSIGNED] BIGINT [UNSIGNED] DECIMAL[(M,0)][UNSIGNED] DECIMAL(M,D)[UNSIGNED] FLOAT [UNSIGNED] DOUBLE [UNSIGNED] [NATIONAL] CHAR(M) [NATIONAL] VARCHAR(M)	Smallint Integer bigint numeric(p,0) numeric(p,s) real double precision
[String]	When [Enable additional setting] is selected: 1 to 255 Unicode characters When [Enable additional setting] is deselected: 1 to 32 ASCII characters	CHAR VARCHAR	char varchar text ^{*3}	Text type ^{*4} Memo type ^{*4}	[NATIONAL] CHAR(M) [NATIONAL] VARCHAR(M)	character[(n)] character varying[(n)]
[Date] ^{*2}	When using the date and time of the database server: Select [Server time]. When using the date and time of the GOT: Select [GOT time].	DATE	datetime smalldatetime	Date/Time type	DATETIME[(fsp)] TIMESTAMP[(fsp)]	timestamp[(p)] [without time zone]
[Date String]	Up to 32 characters For characters that can be used for character strings, refer to the following:  Page 199 Characters applicable to character string constants, etc. Specify the date and time of the GOT in the following format. Year (4 digits): YYYY Year (2 digits): YY Month (2 digits): MM Day (2 digits): DD Hour (2 digits): hh Minute (2 digits): mm Second (2 digits): ss Example: "YYYY-MM-DD hh:mm:ss" → "2005-07-01 15:12:00"	CHAR VARCHAR	char varchar text ^{*3}	Text type ^{*4} Memo type ^{*4}	[NATIONAL] CHAR(M) [NATIONAL] VARCHAR(M)	character[(n)] character varying[(n)]

*1 Signed integer notation only

*2 Clock precision:

When [GOT time] is selected: In units of seconds

When [Server time] is selected: Depends on the database server.

*3 Not available for [Select/Update/Delete conditions].

*4 For Microsoft Access 2019/2016/2013/2010/2007, memo-type fields in Rich Text Format cannot be used.

■About variables

Variables can be used as the component or constant values for each action, or as the condition values of [Select/Update/Delete conditions].

The following table lists data types of variables and those of assignable fields.

If the type of a variable does not match the data type of its substitution target field, an error occurs, resulting in cancellation of job execution.

Up to 64 variables can be set for one job.

Point

- A variable is valid only in a single job execution and is not held.
- The initial variable value before substitution processing is the numerical value of zero.
- The data type of a variable will change through operation processing of a job

 Page 157 Operation of numerical values

Data type of variable	Values (variable names) that can be entered in [Component]	Data type of assignable field				
		Oracle	SQL Server MSDE 2000	Access	MySQL	PostgreSQL
Bit type (Numeric type: Integer) Single-precision type Double-precision type	Up to 16 characters. For characters that can be used for variables, refer to the following:  Page 198 Characters applicable to item names, component names, variable names, etc.	NUMBER CHAR VARCHAR	bit int smallint tinyint float real char varchar ^{*1} text ^{*1}	Yes/No type Byte type Integer type Long integer type Single type Double type AutoNumber type Currency type Text type ^{*1*2} Memo type ^{*1*2}	TINYINT [UNSIGNED] SMALLINT [UNSIGNED] MEDIUMINT [UNSIGNED] INT [UNSIGNED] BIGINT [UNSIGNED] DECIMAL[(M[,0])][UNSIGNED] DECIMAL(M,D)[UNSIGNED] FLOAT [UNSIGNED] DOUBLE [UNSIGNED] [NATIONAL] CHAR[(M)] [NATIONAL] VARCHAR(M)	Smallint Integer bigint numeric(p[,0]) numeric(p,s) real double precision character[(n)] character varying[(n)]
(Numeric type: Floating point) Floating-point type ^{*3}		NUMBER CHAR VARCHAR	float real char varchar text ^{*1}	Single type Double type Text type ^{*1*2} Memo type ^{*1*2}	DECIMAL(M,D)[UNSIGNED] FLOAT [UNSIGNED] DOUBLE [UNSIGNED] [NATIONAL] CHAR[(M)] [NATIONAL] VARCHAR(M)	numeric(p,s) real double precision character[(n)] character varying[(n)]
Character string		CHAR VARCHAR	char varchar text ^{*1}	Text type ^{*2} Memo type ^{*2}	[NATIONAL] CHAR[(M)] [NATIONAL] VARCHAR(M)	character[(n)] character varying[(n)]

*1 Not available for [Select/Update/Delete conditions].

*2 For Microsoft Access 2019/2016/2013/2010/2007, memo-type fields in Rich Text Format cannot be used.

*3 Values are assigned with precision of six decimal digits.

Select/Update/Delete conditions

When [Select], [Update], [MultiSelect], or [Delete] is selected for [Action type], set the conditions of the records to be selected, updated, multi-selected, or deleted.

If a record has a field value that matches a condition value, the record is selected, updated, or deleted.

In [Select/Update/Delete conditions], up to eight rows can be set for one communication action.

Point

In the following cases, exception processing is executed.

- There are no applicable record to be selected, updated, multi-selected, or deleted.
- There are multiple applicable records to be selected, updated, or deleted.
- The number of records to be multi-selected is greater than the number of arrays set in [Array setting] of the tag.

For details of the exception processing, refer to the following.

☞ Page 118 Exception processing setting

Combine

Select a method by which conditions set in respective lines are combined.

Select "AND" or "OR".

If "AND" and "OR" are combined, the database will process "AND" first and then "OR".

Item	Description
AND	The condition of the line just above the corresponding line and the condition of the corresponding line
OR	The condition of the line just above the corresponding line or the condition of the corresponding line

Field name (1 to 32 characters)

Set a field name that is used for comparison.

For characters that can be used for field and table names, refer to the following:

☞ Page 199 Characters applicable to field names, table names, etc.

Condition

Select a condition for comparison.

Item	Description
=	The field value is equal to the condition value.
≠	The field value is not equal to the condition value.
≥	The field value is equal to or greater than the condition value.
>	The field value is greater than the condition value.
<	The field value is smaller than the condition value.
≤	The field value is equal to or smaller than the condition value.

Tag

Select a tag or constant that is used as a condition for comparison.

Tags that have a tag component with [Array setting] cannot be selected.

■Component

Select or directly enter a component/constant value that is used as a condition for comparison.

If [Variable] is selected for [Tag], select or directly enter a variable.

Point

For tag components, constants or variables, refer to the following:

☞ Page 112 About tag components

☞ Page 113 About constants

☞ Page 114 About variables

Select sort settings

When [Select] or [MultiSelect] is selected in [Action type], set conditions for sorting the records to be selected/multi-selected.

If multiple sort conditions are set, the database will process the conditions in order, starting from the top.

In [Select sort settings], settings of up to eight lines are allowed for each communication action.

Field name	Order

■Field name (Up to 32 characters)

Set a field name for records to be selected.

For characters that can be used for field names and table names, refer to the following.

☞ Page 199 Characters applicable to field names, table names, etc.

Order

Set the order of sorting the selected records.

Item	Description
Ascending order	Sorts the records so that the specified fields are arranged in ascending order.
Descending order	Sorts the records so that the specified fields are arranged in descending order.

Database (before sorting)

ORDER_NO	PRODUCT_CODE	DELIVERY_DATE
200	707	2007-01-31
201	662	2007-01-10
202	666	2007-01-29
203	662	2007-01-31
204	707	2007-01-10
205	666	2007-01-29
206	707	2007-01-10
207	662	2007-01-29
208	662	2007-01-31

Sorting conditions in [Select sort settings]

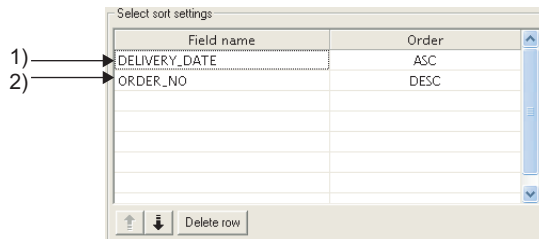

Selected records [sorting results]

ORDER_NO	PRODUCT_CODE	DELIVERY_DATE
↑ 206	707	2007-01-10
2) 204	707	2007-01-10
201	662	2007-01-10
↑ 207	662	2007-01-29
2) 205	666	2007-01-29
202	666	2007-01-29
↑ 208	662	1) 2007-01-31
2) 203	662	2007-01-31
200	707	↓ 2007-01-31

- 1) First, selected records are sorted in ascending order of DELIVERY_DATE.
- 2) Then, records of the same DELIVERY_DATE are sorted in descending order of ORDER_NO.

Exception processing setting

A click on the [Exception process setting] button displays the [Exception process setting] dialog box.

(Example) When [Select] is selected for [Action type]

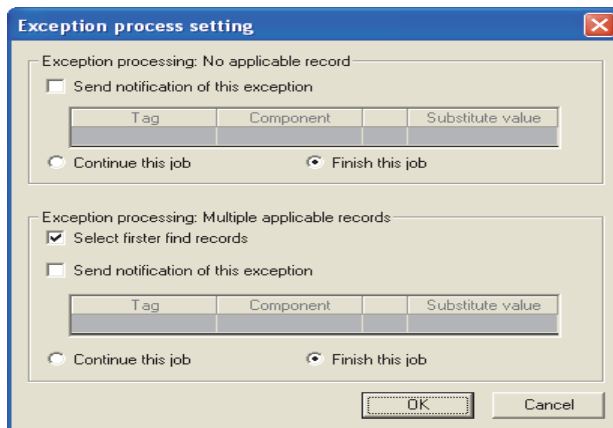

■ Exception processing: No applicable record

When [Select], [Update], [MultiSelect], or [Delete] is selected for [Action type], set processing for the case where no applicable record exists.



- Send notification of this exception

When [Send notification of this exception] is selected, if there is no applicable record to be selected, updated, multi-selected, or deleted, a substitute value is assigned to the specified tag component.

When [Send notification of this exception] is selected, set a tag component to which the value is assigned.

- Tag, Component

Select a tag component to which a value is assigned.

Tags that have a tag component with [Array setting] cannot be selected.

- Substitute value

Directly enter a substitute value.

The following shows the settable substitute values.

Data type of tag component	Settable substitute value
Single word Double word Real number	Up to 16 characters • Signed decimal notation Example: -521.98 • Signed exponential notation Example: -5.2198E02
String	When [Enable additional setting] is selected: Up to 255 characters When [Enable additional setting] is deselected: Up to 32 characters For characters that can be used for character strings, refer to the following: ☞ Page 199 Characters applicable to character string constants, etc.
String [Unicode]	Up to 255 characters
Bit	[ON] or [OFF]

- Continue this job

After execution of exception processing described in the above 1), the system continues executions of other actions.

- Finish this job (Default: Finish this job)

After execution of exception processing described in the above 1), the job is forcibly terminated without executing remaining actions.

The substitute or insert values and record deletions prior to the exception processing execution are committed to the database, and these values are written to the relevant tag components.

Point 

-
- When a job is forcibly terminated, an error occurred during job execution (job cancellation) is not notified.
 - ☞ Page 98 Notify errors (job cancellation) that occur during job execution
 - If [Enable DB buffering] is selected for a job, its exception processing setting is disabled.
 - ☞ Page 97 Setting items in DB Buffering
-

■ Exception processing: Multiple applicable records

When [Select], [Update], or [Delete] is selected for [Action type], set processing for the case where multiple applicable records exist.

- Select firster find records (Default: Checked)

When [Select] is selected for [Action type], checking the [Select firster find records] box allows extraction of the head record from multiple applicable records.

If this item is deselected, the Select, Update, or Delete action is not executed.

Point

When [Update] or [Delete] is selected for [Action type], if multiple applicable records exist, all of them are updated or deleted.

- Send notification of this exception

When [Send notification of this exception] is selected, if there are multiple applicable records to be selected, updated, or deleted, a substitute value is assigned to the specified tag component.

When [Send notification of this exception] is selected, set a tag component to which the value is assigned.

- Tag, Componen

Select a tag component to which a value is assigned.

Tags that have a tag component with [Array setting] cannot be selected.

- Substitute value

Directly enter a substitute value.

The following shows the settable substitute values.

Data type of tag component	Settable substitute value
Single word Double word Real number	Up to 16 characters • Signed decimal notation Example: -521.98 • Signed exponential notation Example: -5.2198E02
String	When [Enable additional setting] is selected: Up to 255 characters When [Enable additional setting] is deselected: Up to 32 characters For characters that can be used for character strings, refer to the following: Page 199 Characters applicable to character string constants, etc.
String [Unicode]	Up to 255 characters
Bit	[ON] or [OFF]

- Continue this job

After executions of exception processing described in the above 1) and 2), the system continues executions of other actions.

- Finish this job (Default: Finish this job)

After execution of exception processing described in 1) and 2), the job is forcibly terminated without executing remaining actions.

The substitute or insert values and record deletions prior to the exception processing execution are committed to the database, and these values are written to the relevant tag components.

Point

- When a job is forcibly terminated, an error occurred during job execution (job cancellation) is not notified.
 Page 98 Notify errors (job cancellation) that occur during job execution
- If [Enable DB buffering] is selected for a job, its exception processing setting is disabled.
 Page 97 Setting items in DB Buffering

■ Exception processing: Applicable records overflow

When [MultiSelect] is selected for [Action type], set processing for the case where the number of records to be selected is greater than the number of arrays set in [Array setting].



- Select firster find records (Default: Checked)

When the [Select firster find records] checkbox is checked, if the number of records selected by [Select/Update conditions] is greater than the number of arrays set in [Array setting], records equivalent to the number of arrays are actually selected.

When this checkbox is not checked, the select processing is not performed.

Point

If the [Select firster find records] checkbox is not checked, the following is performed.

- When [Notify the number of acquired records] is set in [Multi select setting], 0 is notified.
- When [Clear the unused tag components by zero] is set in [Multi select setting], 0 is assigned.

☞ Page 122 Multi select setting

- Send notification of this exception

If the [Send notification of this exception] checkbox is checked, a value is assigned to the specified tag component when the number of records selected by [Select/Update conditions] is greater than the number of arrays set in [Array setting].

[Array setting] is less than the number of records selected by [Select/Update conditions].

When selecting this, set a tag component to which a value is assigned.

- Tag, Component

Select a tag component to which a value is assigned.

Tags that have a tag component with [Array setting] cannot be selected.

- Substitute value

Directly enter a substitute value.

The following shows the settable substitute values.

Data type of tag component	Settable substitute value
Single word Double word Real number	Up to 16 characters • Signed decimal notation Example: -521.98 • Signed exponential notation Example: -5.2198E02
String	When [Enable additional setting] is selected: Up to 255 characters When [Enable additional setting] is deselected: Up to 32 characters For characters that can be used for character strings, refer to the following: ☞ Page 199 Characters applicable to character string constants, etc.
String [Unicode]	Up to 255 characters
Bit	[ON] or [OFF]

- Continue this job

After executions of exception processing described in the above 1) and 2), the system continues executions of other actions.

- Finish this job (Default: Finish this job)

After executions of exception processing described in the above 1) and 2), the system forcibly terminates the job without executing other actions.

The substitute or insert values and record deletions prior to the exception processing execution are committed to the database, and these values are written to the relevant tag components.

Point

- When a job is forcibly terminated, an error occurred during job execution (job cancellation) is not notified.

☞ Page 98 Notify errors (job cancellation) that occur during job execution

- If [Enable DB buffering] is selected for a job, its exception processing setting is disabled.

☞ Page 97 Setting items in DB Buffering

Multi select setting

A click on the **[Multi select setting]** button displays the **[Multi select setting]** dialog box.
Complete the setting, referring to the following explanation.

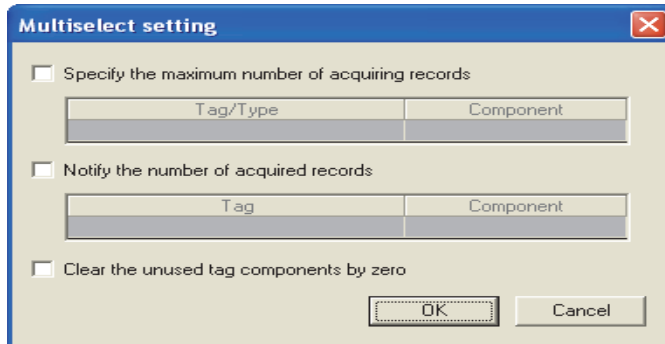

■Specify the maximum number of acquiring records

If the **[Specify the maximum number of acquiring records]** checkbox is checked, records of up to the specified number are acquired.

The GOT acquires the records in the order that the records are extracted from the database.

When selecting this, set a tag for which a value is specified.

- Tab/Type

Select a tag for which a value is specified.

Tags that have a tag component with **[Array setting]** cannot be selected.

- Component

Select a component, or directly enter a constant value.

The following shows the setting range of **[Component]**.

Setting of [Tag/Type]	Setting range of [Component]
[Number]	[0] to [40000]
Device tag	Tag component whose data type is set to [Single word] or [Double word]

Point

- When the select sort settings are set, the GOT acquires the records in the set sorting orders.
- An error occurs if the specified tag component value is 0 or less.

☞ Page 62 When an error occurs in job execution

■Send notification of selected record number

When the **[Notify the number of acquired records]** checkbox is checked, the number of actually acquired records is notified to the specified tag component.

When selecting this, set a tag component to which a value is notified.

- Tag

Select a tag component to which a value is notified.

Tags that have a tag component with **[Array setting]** cannot be selected.

■Clear the unused tag components by zero

When the [Clear the unused tag components by zero] checkbox is checked, if the specified number of arrays of the tag component is less than the number of actually acquired records, zeros are assigned to other array areas.

(Example) When the specified number of arrays of the tag component is "6" and the number of actually acquired records is "4":

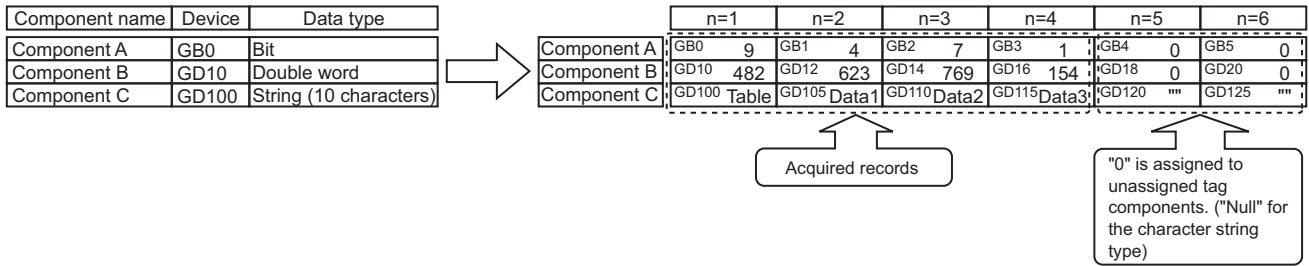

Generated SQL text

The SQL text generated by the currently editing [Communication action] is displayed.

It indicates the display format of the tag component/constant value.

Note that data of Tag component, Date, Date String, and Variable are generated at job execution, and displayed in the format shown below. (It is different from the actual SQL text.)

Actions of [Select] and [MultiSelect] generate SQL texts with SELECT. With the SQL text, the user cannot identify which action is executed.

Item		Description
Tag component		'(Device tag name, component name)'
Numerical value		'Number'
String		'String'
Date	Oracle 8i	GOT time: TO_DATE('(Date and time [YYYYMMDDhhmmss]), 'YYYYMMDDHH24MISS') Server time: sysdate
	Oracle 19c Oracle 18c Oracle 12c Oracle 11g Oracle 10g Oracle 9i	GOT time: TO_DATE('(Date and time [YYYYMMDDhhmmss]), 'YYYYMMDDHH24MISS') Server time: CURRENT_TIMESTAMP
	SQL Server MSDE 2000	GOT time: '(Date and time [YYYY-MM-DD hh:mm:ss])' Server time: CURRENT_TIMESTAMP
	Access	GOT time: '(Date and time [YYYY-MM-DD hh:mm:ss])' Server time: NOW()
	MySQL	GOT time: '(Date and time [YYYY-MM-DD hh:mm:ss])' Server time: NOW(3)
	PostgreSQL	GOT time: '(Date and time [YYYY-MM-DD hh:mm:ss])' Server time: CURRENT_TIMESTAMP
Date String		'(Date[String])'
Variable		'(Variable name)'

Setting items in Operation action

Configure the settings for operation of tag component values.
Up to 20 dyadic operations can be set for one operation action.

1. Performing the operation for adding or modifying an action displays the [Operation action] dialog box.
Make the setting referring to the following descriptions.

Clicking the button after setting adds or modifies the action.

For the operation for adding or modifying an action, refer to the following:

Page 100 Job Settings - Actions

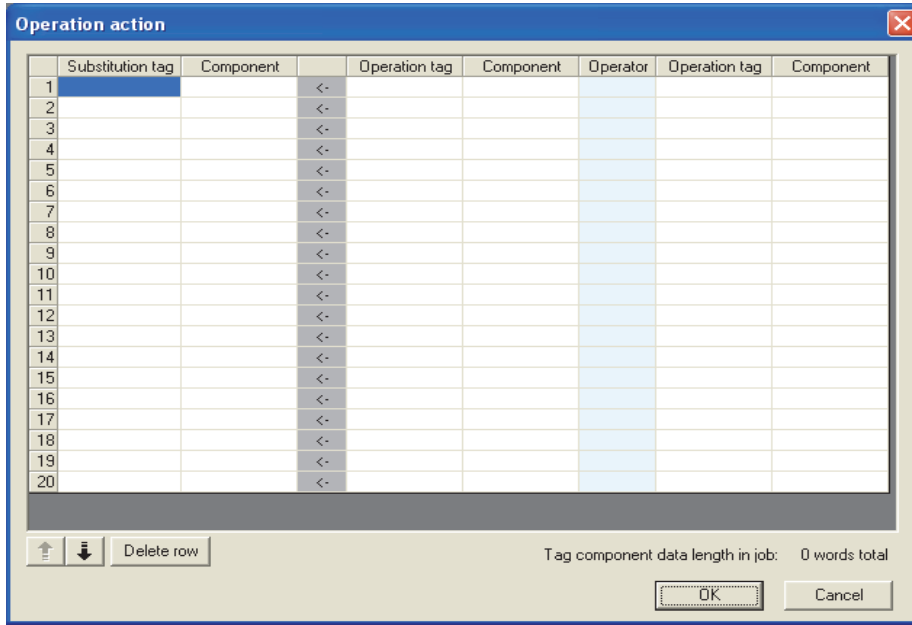

Item	Description
Substitution tag	Select a tag or variable to which a value is assigned. Tags that have a tag component with [Array setting] cannot be selected.
Component	Select or directly enter a component value or a variable of the substitution target.
Operation tag	Select a tag, constant, or variable which is computed. Tags that have a tag component with [Array setting] cannot be selected.
Component	Select or directly enter a component/constant value or a variable that is to be computed.
Operator	Select an operator. [] (None), [+] (Addition), [-] (Subtraction), [×] (Multiplication), [÷] (Division), [%] (Remainder)
<input type="button" value="↑"/> button	Selecting a row and clicking the <input type="button" value="↑"/> button reverses the order between the selected row and the one immediately above it. The <input type="button" value="↑"/> button cannot be clicked on the first row.
<input type="button" value="↓"/> button	Selecting a row and clicking the <input type="button" value="↓"/> button reverses the order between the selected row and the one immediately below it. The <input type="button" value="↓"/> button cannot be clicked on the last row.
<input type="button" value="Delete row"/> button	Selecting a row and clicking the <input type="button" value="Delete row"/> button deletes the row.
Tag component data length in job	Displays the total data length of the tag components in the job.

Point

Operation actions are executed in order, from the top to the bottom.

About constants

Constants can be used for [Operation tag] - [Component] and not for [Operator].

The following shows the constant types and values that can be entered in the [Component] column.

Constant type	Values that can be entered in [Component]
[Number]	Up to 16 characters <ul style="list-style-type: none"> • Signed decimal notation (Example: -521.98) • Signed exponential notation (Example: -5.2198E03)
[String]	When [Enable additional setting] is selected: 1 to 255 Unicode characters When [Enable additional setting] is deselected: 1 to 32 ASCII characters
[Date String]	Up to 32 characters For characters that can be used for character strings, refer to the following:  Page 199 Characters applicable to character string constants, etc. Specify the date and time of the GOT in the following format. Year (4 digits): YYYY Year (2 digits): YY Month (2 digits): MM Day (2 digits): DD Hour (2 digits): hh Minute (2 digits): mm Second (2 digits): ss Example: "YYYY-MM-DD hh:mm:ss" → "2005-07-01 15:12:00"

About variables

Variables can be used for [Component] of [Substitution tag] or [Component] of [Operation tag].

By using a variable, a value computed in [Operation action] can be assigned to a database, or to a tag component (In the latter case, operation is performed based on a value extracted from the database).

The following table shows the variable types and values that can be entered in the [Component] column.

Up to 64 variables can be set for one job.

Point

- A variable is valid only in a single job execution and is not held.
- The initial variable value before substitution processing is the numerical value of zero.
- The data type of a variable will change through operation processing of a job.

 Page 157 Operation of numerical values

Variable type	Values (variable names) that can be entered in [Component]
[Variable]	Up to 16 characters For characters that can be used for variables, refer to the following:  Page 198 Characters applicable to item names, component names, variable names, etc.

Setting example of [Operation action]

The following is a case in which correction power is calculated using a correction voltage and it is assigned to a tag component (Process 1. Correction power).

The tag component value (Process 1. Correction power) obtained from the following [Operation action] is:
 (Process 1.Voltage × 100 + 50) × Current

	Substitution tag	Component		Operation tag	Component	Operator	Operation tag	Component
1	[Variable]	CORRECTION_V	<	PROCESS1	VOLTAGE	*	[Number]	100
2	[Variable]	CORRECTION_V	<	[Variable]	CORRECTION_V	+	[Number]	50
3	PROCESS1	CORRECTION_P	<	[Variable]	CORRECTION_V	*	PROCESS1	CURRENT
4			<					
5			<					
6			<					
7			<					
8			<					
9			<					
10			<					
11			<					
12			<					
13			<					
14			<					
15			<					
16			<					
17			<					
18			<					
19			<					
20			<					

Tag component data length in job: 5 words total

OK Cancel

Setting items in Transmit resource action

Configure the settings for sending the resource data collected in a GOT to a database.



Before setting [Transmit resource action], configure the settings to collect the resource data (the logging setting, the advanced user alarm observation, the advanced system alarm observation, and the operation log setting).

For details, refer to the following manual.

GT Designer3 (GOT2000) Screen Design Manual

The settings for collecting the resource data must be matched to the settings for the resource data send action. When the settings are not matched, an error may occur at the job execution.

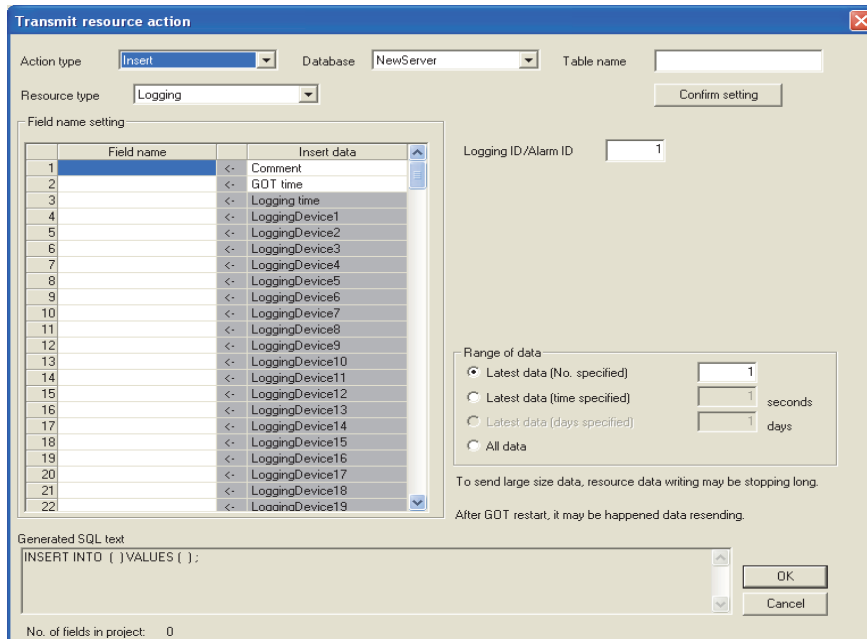

Item	Description
Action type	Select an action type.
Database	Select a database to be accessed.
Table name	Select a table name of the database to be accessed.
Resource type	Select a resource data type.
Field name setting*1	Set the assignments between the resource data to be sent and the field value for the database.
Confirm setting button	Clicking this button checks that the settings for collecting the resource data are matched to the settings for the resource data send action. An error message is displayed when the settings are not matched. For the displayed error message, refer to the following. Page 156 Precautions
Logging ID/Alarm ID	Set the logging ID for the logging setting or the alarm ID that is set on the advanced alarm observation.
Operation log file	Clicking the Set operation log file name button displays the stored location for the operation log data to be sent.
Range of data	Specify the number of resource data to be sent for each action.
Generated SQL text	Displays the SQL text that is generated during editing the data for [Transmit resource action].

*1 Up to 8192 fields can be set in [Field name setting] for each project.
(Check [No. of fields in project] in the lower left of the Transmit resource action dialog box.)

Action type

Select an action type.

The selectable action type is the insert only.

Item	Description
Insert	Generates a new record, and assigns a value (resource data) into a field.

Database

Select a database to be accessed.

Table name (1 to 32 characters)

Set a table name of the database to be accessed.

For characters that can be used for table names, refer to the following:

 Page 199 Characters applicable to field names, table names, etc.

Resource type

(Default: Logging)

Select a resource data type.

Item	Description
Logging	Device values of a controller that are collected at any timing or in specified intervals.
User Alarm	Alarm data that are collected in specified intervals for the advanced user alarm observation setting
System Alarm	Alarm data for controllers and a network that are collected by the advanced system alarm observation setting
Operation log	GOT operation history data collected by the operation log function

Field name setting

Set the assignments between the resource data to be sent and the field values for the database.

The resource data types vary according to [Resource type].

(Example) Screen for settings of sending logging data

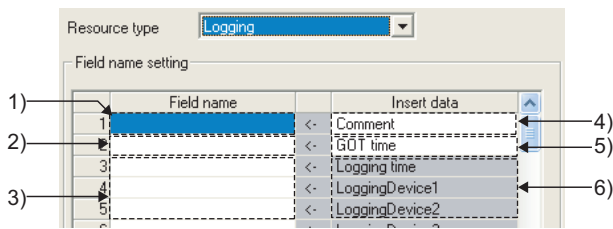

Item	Description
Field name ^{*3*5} (0 to 32 characters)	1) First row (comment) ^{*1} A field name for sending a comment to the database can be set. 2) Second row (time) ^{*1} A field name that specifies a date and time for a resource data send action can be set. 3) Third row or later (resource data) A field name for sending the resource data to the database can be set. Input the field name for [Insert data] to be sent.
Insert data ^{*2}	4) First row (0 to 32 characters, Default: Comment) ^{*1*4} The comment to be inserted into the database can be set. 5) Second row (Default: GOT time) The date and time for inserting the data to the database can be selected from [GOT time] or [Server time]. 6) Third row or later (resource data) The list of resource data to be inserted to the database is displayed. ☞ Page 131 When selecting [Logging] for [Resource type] ☞ Page 131 When selecting [User Alarm] for [Resource type] ☞ Page 132 When selecting [System Alarm] for [Resource type] ☞ Page 132 When selecting [Operation Log] for [Resource type]

*1 When setting [Field name], fields for the storing comment and the time data are created in the database. (The setting for the field name is not necessarily required.)

*2 When [Field name] is not inputted, no resource data is sent.

*3 For the types of data to be sent in the fields, refer to the following.

☞ Page 112 About tag components

*4 For characters that can be used for character strings, refer to the following:

☞ Page 199 Characters applicable to character string constants, etc.

*5 For characters that can be used for field and table names, refer to the following:

☞ Page 199 Characters applicable to field names, table names, etc.

The following shows the resource data to be sent and the types of the data.

■When selecting [Logging] for [Resource type]

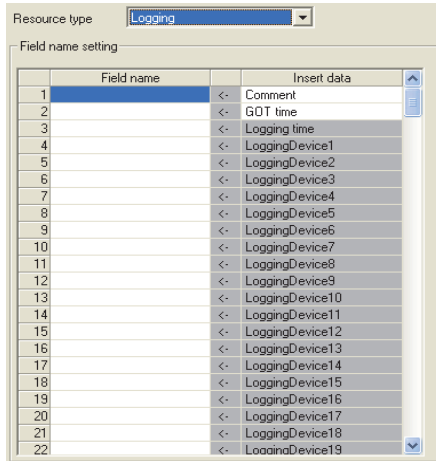

Insert data	Data type
Logging time	Date
LoggingDevice (1 to 250)*1	Numeric type (Integer, floating point)

*1 The numbers of 1 to 250 correspond to the rows set for the number of the block number in the logging setting.



The following shows the range of data that can be handled as logging data of real numbers (64 bits).
-9.9999999999999999E+30 to 9.9999999999999999E+31

■When selecting [User Alarm] for [Resource type]

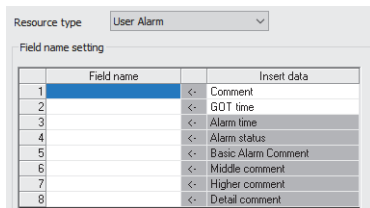

Insert data	Data type
Alarm time*1	Date
Alarm status*2	Character string
Basic Alarm Comment*3	Character string
Middle comment*3	Character string
Higher comment*3	Character string
Detail comment*3	Character string

- *1 The date and time when the status of [Alarm status] is changed.
Example: If the alarm status changes to [Rstr], the alarm restoration date is sent as [Alarm time].
- *2 The alarm status is sent as shown below.
For occurrence status: [Ocr]
For check status: [Chk]
For restoration status: [Rstr]
- *3 The first column data of the column number set in the comment group is sent.



Up to 512 of one-byte and two-byte characters can be set in a comment for the advanced user alarm.
Set the length of character string on the database more than that for the comment.

■When selecting [System Alarm] for [Resource type]

Field name	Insert data
1	Comment
2	GOT time
3	Alarm time
4	Alarm status
5	Comment

Insert data	Data type
Alarm time ^{*1}	Date
Alarm status ^{*2}	Character string
Comment	Character string

- *1 The date and time when the status of [Alarm status] is changed.
Example: If the alarm status changes to [Rstr], the alarm restoration date is sent as [Alarm time].
- *2 The alarm status is sent as shown below.
For occurrence status: [Ocr]
For check status: [Chk]
For restoration status: [Rstr]

Point

Up to 512 of one-byte and two-byte characters can be set in a comment for the advanced system alarm.
Set the length of character string on the database more than that for the comment.

■When selecting [Operation Log] for [Resource type]

Field name	Insert data
1	Comment
2	GOT time
3	Logging time(DATE)
4	Log No.(NO)
5	Screen No.(SCRN_NO)
6	Action type(ACT_ABBR)
7	Action type(ACTION)
8	Object name(OPNAME)
9	Operation level(OPERATOR)
10	Operation level(OPE_ID)
11	User ID(USER_ID)
12	Action No.(ACT_NO)
13	Data type(DATA_TYPE)
14	Device name(DEV_NAME)
15	Change value(CHG_VALUE)
16	Previous value(PREV_VALUE)

Insert data ^{*1}	Data type
Logging time(DATE)	Date
Log No.(NO)	Numeric type (Integer)
Screen No.(SCRN_NO)	Character string
Action type(ACT_ABBR)	Character string
Action type(ACTION)	Character string
Object name(OPNAME)	Character string
Operation level(OPERATOR)	Character string
Operation level(OPE_ID)	Numeric type (Integer)
User ID(USER_ID)	Numeric type (Integer)
Action No.(ACT_NO)	Numeric type (Integer)
Data type(DATA_TYPE)	Character string
Device name(DEV_NAME)	Character string
Change value(CHG_VALUE)	Character string
Previous value(PREV_VALUE)	Character string

- *1 The data to be sent vary according to the operation log target.
For details of the collected data in the operation log, refer to the following manual.
 GT Designer3 (GOT2000) Screen Design Manual

■Data types

The following table shows the data types of resource data and the data types of data to be sent in the field.

When the data type of the resource data does not match that of data to be sent in the field, an error occurs, resulting in the cancellation of the job execution.

Data type of resource data	Data type of data to be sent in field				
	Oracle	SQL Server MSDE 2000	Access	MySQL	PostgreSQL
Date	DATE	datetime smalldatetime	Date/Time type	DATETIME[(fsp)] TIMESTAMP[(fsp)]	timestamp[(p)] [without time zone]
Character string	CHAR VARCHAR	char varchar text	Text type ^{*1} Memo type ^{*1}	[NATIONAL] CHAR[(M)] [NATIONAL] VARCHAR(M)	character[(n)] character varying[(n)]
Numeric type	NUMBER CHAR VARCHAR	bit int smallint tinyint float real char varchar text	Yes/No type Byte type Integer type Long integer type Single type Double type AutoNumber type Currency type Text type ^{*1} Memo type ^{*1}	TINYINT [UNSIGNED] SMALLINT [UNSIGNED] MEDIUMINT [UNSIGNED] INT [UNSIGNED] BIGINT [UNSIGNED] DECIMAL[(M,D)][UNSIGNED] DECIMAL(M,D)[UNSIGNED] FLOAT [UNSIGNED] DOUBLE [UNSIGNED] [NATIONAL] CHAR[(M)] [NATIONAL] VARCHAR(M)	Smallint Integer bigint numeric(p,0) numeric(p,s) real double precision character[(n)] character varying[(n)]

*1 For Microsoft Access 2019/2016/2013/2010/2007, memo-type fields in Rich Text Format cannot be used.

Logging ID/Alarm ID

When selecting [Logging] or [Advanced user alarm] for [Resource type], set the logging ID of logging data or the alarm ID for advanced user alarm data.

Logging ID/Alarm ID

Operation log file

The GOT displays the operation log file when [Operation log] is selected for [Resource type] only.

Clicking the **Set operation log file name** button displays the stored location for the operation log file.

The GOT can send the displayed operation log file to the database.

Inputting the data directly to [Drive Name], [Folder Name], and [File Name] are not available.

Point

When the operation log settings are changed after setting [Transmit resource action], click the

Set operation log file name button to set the operation log file again.

The settings for [Operation log file] are not automatically changed.

When the displayed data on [Operation log file] does not exist, an error occurs at the job execution.

Range of data

Specify the maximum number of resource data to be sent for one resource data send action.

When [Operation Log] is selected for [Resource type], [Range of data] is fixed to [Latest data (days specified)].

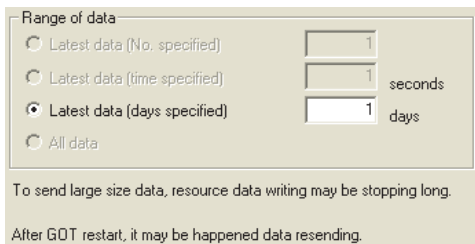

Item	Description
Latest data (No. specified)	Specify the maximum number of resource data collected in the GOT after the last action. (Range:1 to 99999, Default:1)
Latest data (time specified)*1	Specify the time period from the job execution time to the specified time for sending the collected resource data. (Range:1 to 99999, Default:1 (seconds))
Latest data (days specified)*1	Specify the number of days including in the date at the job execution for sending the resource data. (This item cannot be specified for sending the logging data, the advanced user alarm data, and the advanced system alarm data.) (Range:1 to 400, Default:1 (days))
All data	All the resource data collected in the GOT after the last action.

For details of *1, refer to the following.

*1 Resource data to be sent after changing the GOT time and date

When changing the GOT time, the resource data to be sent may differ from the resource data to be sent without changing the GOT time. The following shows the resource data to be sent after changing the GOT time and date.

Logging data

- Executing the next action before the time of the last action

Example 1) Changing the time from 11:40 to 11:10, and executing the next action at 11:20

: Time specified (300 seconds)

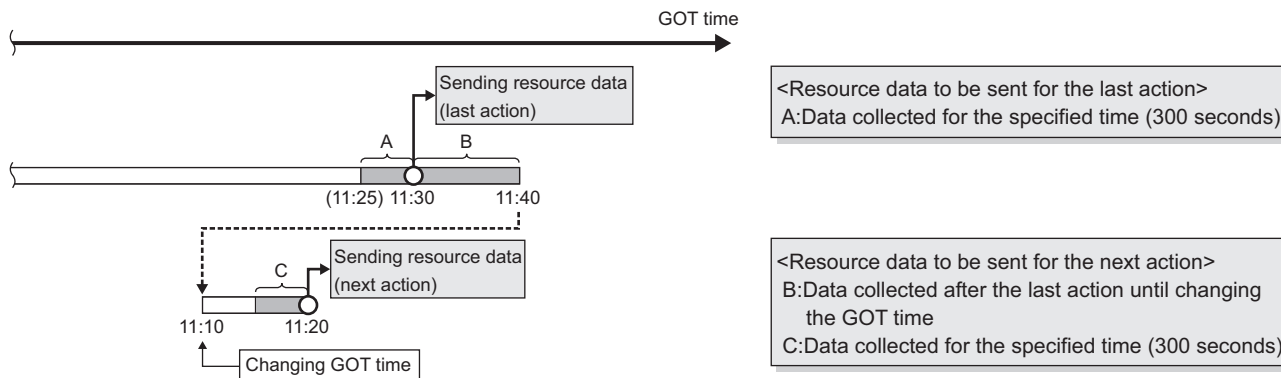

- Executing the next action after the time of the last action

Example 1) Changing the time from 11:40 to 11:20, and executing the next action at 11:35

: Time specified (300 seconds)

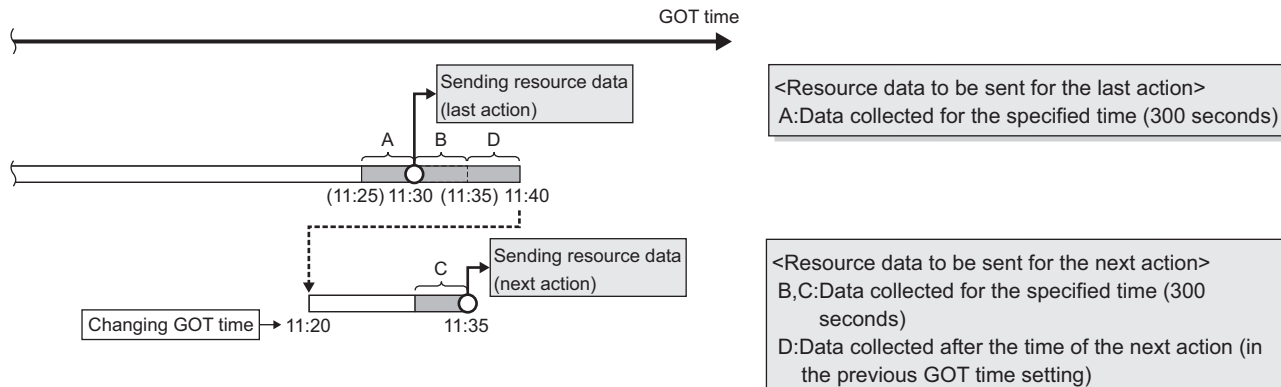

Example 2) Changing the time from 11:58 to 12:58, and executing the next action at 13:00

: Time specified (300 seconds)

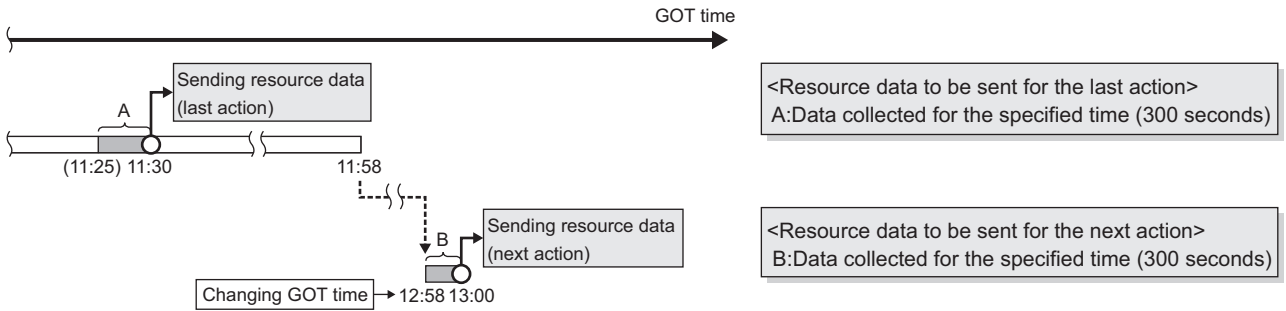

Advanced user alarm data/advanced system alarm data

- Executing the next action before the time of the last action

(The GOT does not send all the data collected after the last action.)

Example 1) Changing the time from 11:40 to 11:00, and executing the next action at 11:20

: Time specified (300 seconds)

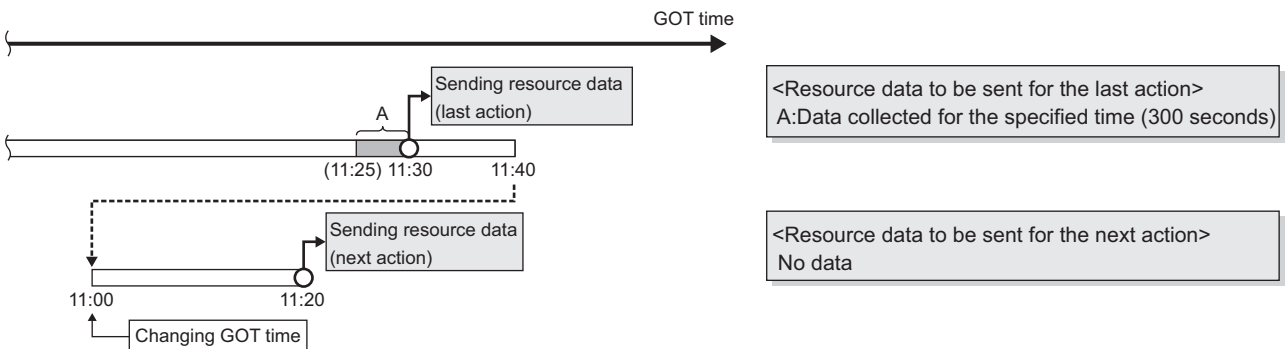

- Executing the next action after the time of the last action

Example 1) Changing the time from 11:40 to 11:20, and executing the next action at 11:35

: Time specified (300 seconds)

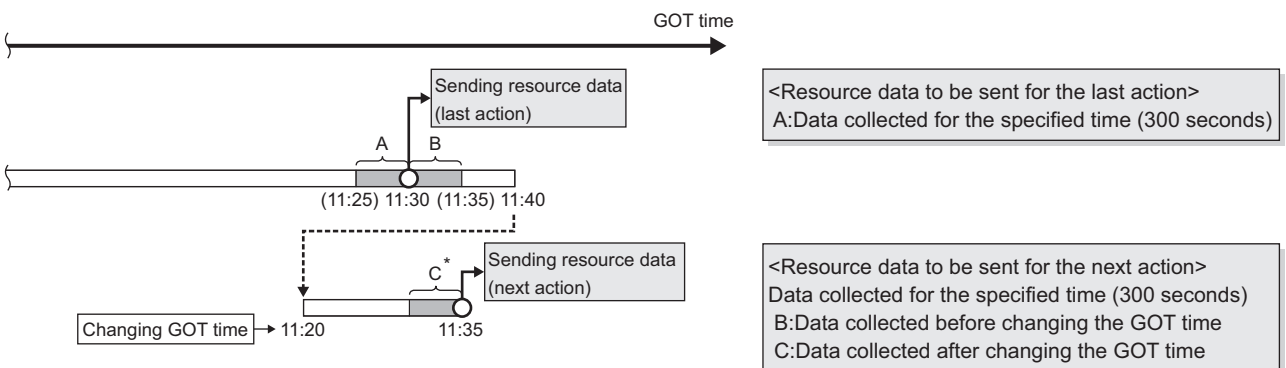

* The data collected before the last action are not sent by the next action even though the data is collected within the specified time.

Operation log data

- Executing the next action before the time of the last action

(The GOT does not send all the data collected after the last action.)

Example 1) Changing the time from 0:40 to 23:40 on the previous day, and executing the next action at 23:50

: Days specified (1 day)

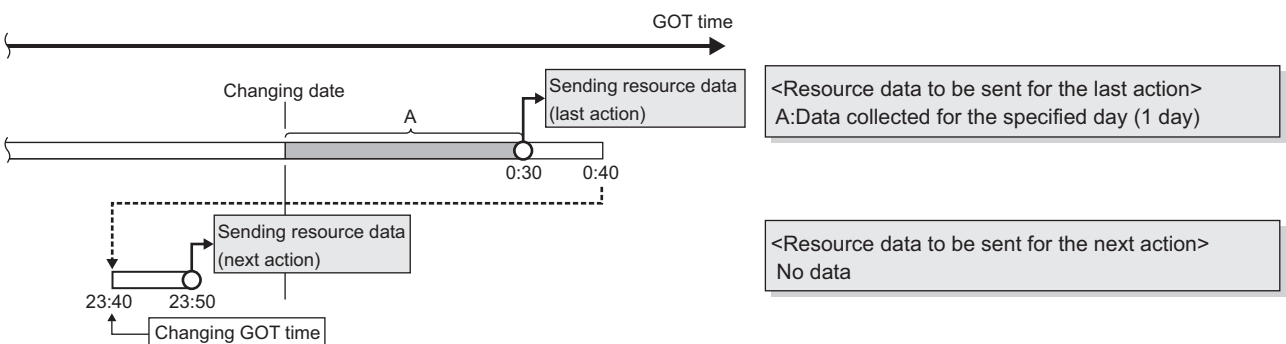

Example 2) Changing the time from 0:40 to 0:10 on the same day, and executing the next action at 0:20

: Days specified (1 day)

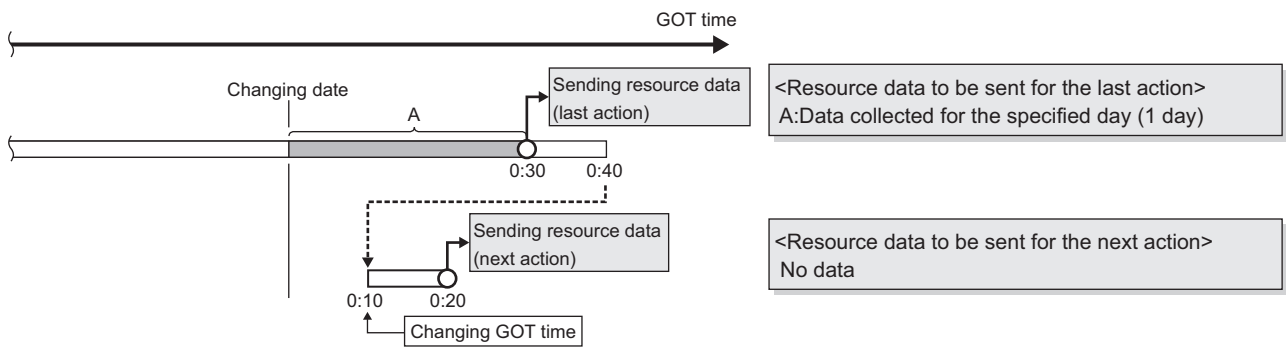

- Executing the next action after the time of the last action

Example 1) Changing the time from 23:40 to 0:10 on the next day, and executing the next action at 0:20

: Days specified (1 day)

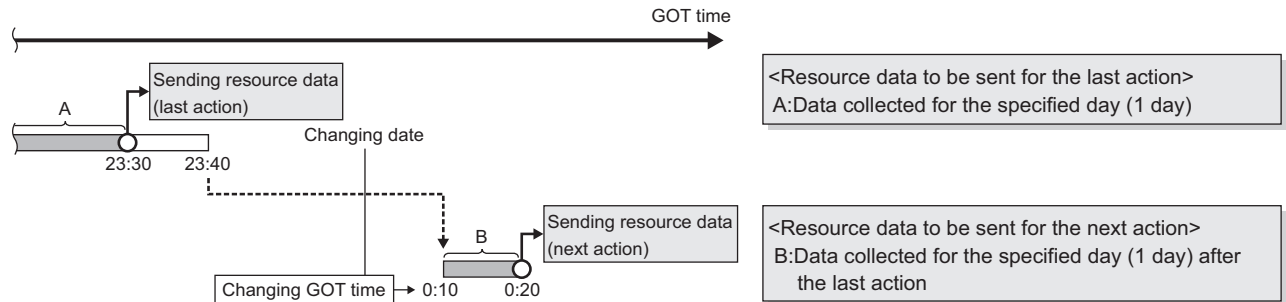

Example 2) Changing the time from 0:40 to 0:50 on the same day, and executing the next action at 1:00

: Days specified (1 day)

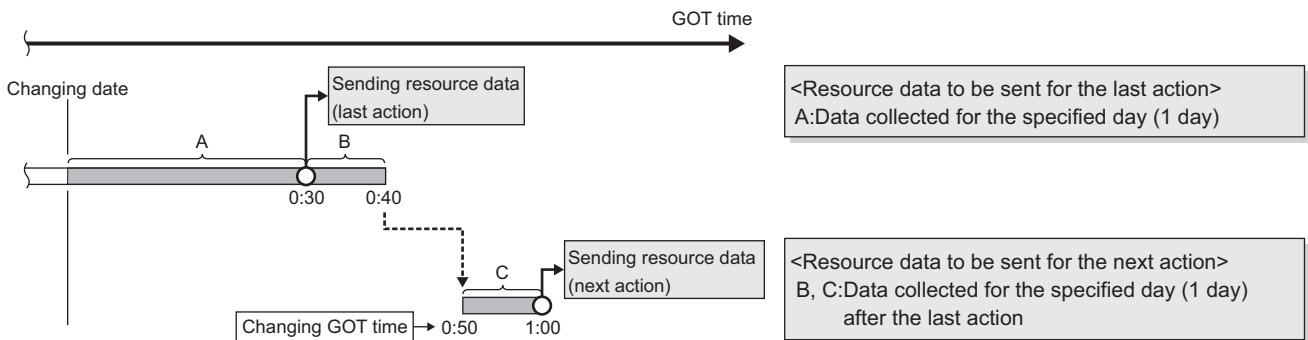

Point

- The GOT sends the resource data only one time, regardless of the settings for [Range of data]. The GOT does not send the sent data to the database.

The GOT may send the sent data when restarting the GOT for downloading the project data and others.

☞ Page 156 Precautions

- When an action fails due to the communication error between the GOT and the server computer or others, the GOT sends the failed action data at the next action.
- The time to complete the resource data send action (Reference value (seconds))

The following shows the resource data send time for the resource type, and the number of resource data (100, 500, 1000, 10000).

Under the following conditions, the values for sending data differ from the reference values in the following table.

Loads on the GOT or loads on between the GOT and the server computer or others
MES interface function setting

Resource type	Number of resource data			
	100	500	1000	10000
Logging ^{*1*2}	7 (5)	31 (23)	59 (42)	582 (410)
Advanced user alarm ^{*3}	2	5	8	88
Advanced system alarm ^{*3}	2	5	8	-
Operation log ^{*4}	1	5	9	82

*1 The logging is collected by the buffer historical and the device points set to 250 points and a 100ms cycle for the logging setting.

*2 When collecting data every 100ms cycle is canceled, the value is shown in the parentheses.

*3 When sending the alarm comment with 512 one-byte characters.

*4 When the numbers of insert fields are 7 to 13 by one action.

Generated SQL text

The SQL (INSERT) text generated by the currently editing data for [Transmit resource action] is displayed.

The SQL text shows the display type for the resource data, the character string, and the date.

The GOT does not send the resource data without setting the field name for [Field name setting]. The data with no field name are not included in the SQL text.

The following table shows the display type for the generated resource data and the date at the job execution. (The display type differs from the actual data at the job execution.)

Item		Description
Resource data*1		'Data name'
String		'String'
Date	Oracle 8i	GOT time: TO_DATE('(Date and time[YYYYMMDDhhmmss]), 'YYYYMMDDHH24MISS') Server time: sysdate
	Oracle 19c Oracle 18c Oracle 12c Oracle 11g Oracle 10g Oracle 9i	GOT time: TO_DATE('(Date and time[YYYYMMDDhhmmss]), 'YYYYMMDDHH24MISS') Server time: CURRENT_TIMESTAMP
	SQL Server MSDE 2000	GOT time: '(Date and time[YYYY-MM-DD hh:mm:ss])' Server time: CURRENT_TIMESTAMP
	Access	GOT time: '(Date and time[YYYY-MM-DD hh:mm:ss])' Server time: NOW()

*1 For the data name, refer to the following.

 Page 130 Field name setting

6.9 System Setting

Configure the DB buffering function setting.

1. Click [System setting] in the Edit items tree.
2. The setting items of [System setting] appear on the detailed setting edit screen.
Make the setting referring to the following descriptions.

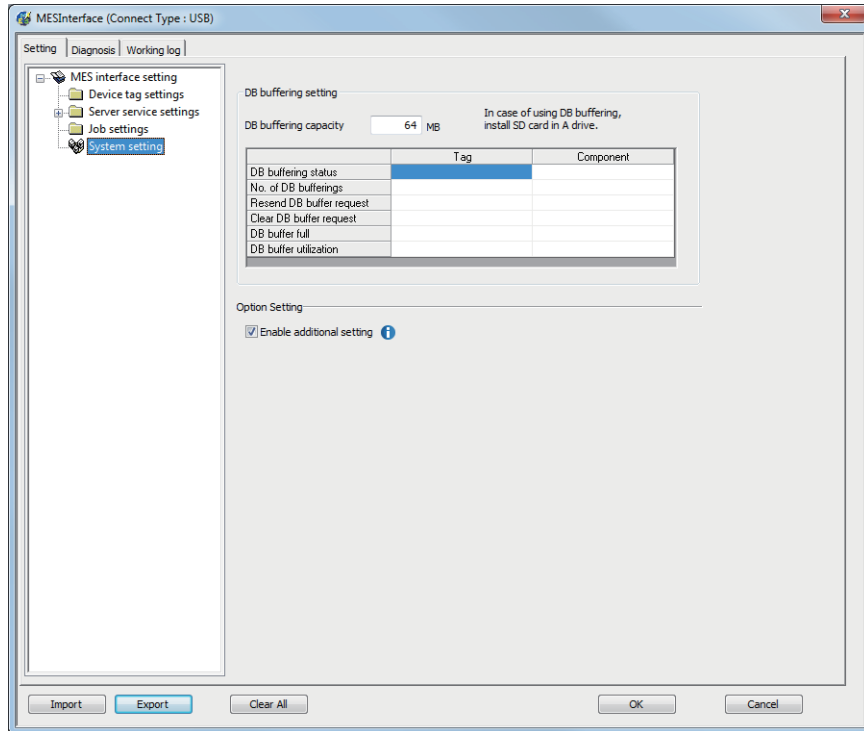

Setting items in DB buffering settings

Configure the settings for the DB buffering function.

For the DB buffering function, refer to the following:

☞ Page 54 DB buffering function

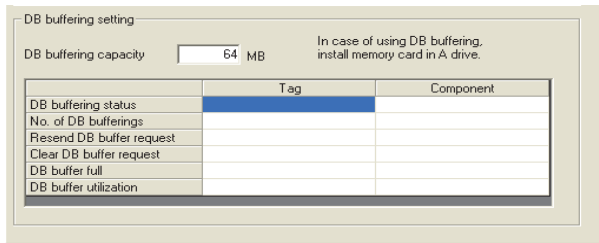

DB buffering capacity (Range: 16MB to 512MB, Default: 64MB)

Set the capacity used for DB buffering out of the entire CF card capacity within the following range.

Maximum capacity = CF card capacity - 32M bytes

DB buffering status

■ Select a tag component into whose device whether data are currently accumulated in the DB buffer or not is stored.

Tags that have a tag component with [Array setting] cannot be selected.

■ Data are stored as follows depending on the data type.

Data type of tag component	Description
Bit	OFF : Not accumulated ON : One or more data accumulated
String	"0" : Not accumulated "1" : One or more data accumulated
Other than the above	0 : Not accumulated 1 : One or more data accumulated

No. of DB bufferings

■ Select a tag component into whose device whether data are currently accumulated in the DB buffer or not is stored.

Tags that have a tag component with [Array setting] cannot be selected.

■ Data are stored as follows depending on the data type.

Data type of tag component	Description
Bit	OFF : Not accumulated ON : One or more data accumulated
String	"0" : Not accumulated 1 or greater : Number of buffering data that are accumulated
Other than the above	0 : Not accumulated 1 or greater : Number of buffering data that are accumulated

Resend DB buffer request

■Select a tag component used to request for resend processing of the DB buffer.

Tags that have a tag component with [Array setting] cannot be selected.

■The following explains the operation of the resend processing using [Resend DB buffer request].

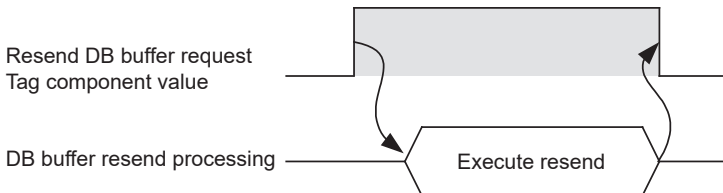
Data type of tag component	Description
Bit	<p>The resend processing of the DB buffer is performed when the specified tag component is ON. Normal: Turns OFF after completion of the resend processing.^{*1*2} Error: Outputs an error code to MES interface Execute Log, and turns OFF.</p> 
String	<p>The resend processing of the DB buffer is performed when "1" is written to the specified tag component. Normal: "0" is written after completion of the resend processing.^{*1*2} Error: Outputs an error to the MES interface Execute Log, and "0" is written.</p>
Other than the above	<p>The resend processing of the DB buffer is performed when "1" is written to the specified tag component. Normal: "0" is written after completion of the resend processing.^{*1*2} Error: Outputs an error to the MES interface Execute Log, and "0" is written.</p>

*1 Do not change the value of the specified tag component until the resend processing is completed. Even if the value changes, the resend processing is not interrupted.

*2 To make another DB buffer resend request after completion of resend processing, wait for a sampling interval of the specified tag component or more, and then set the device as follows:

- Bit type: ON
- Character string type: "1"
- Other than the above: 1

Clear DB buffer request

■Select a tag component used to request for clear processing of the DB buffer.

Tags that have a tag component with [Array setting] cannot be selected.

■The following explains the operation of the clear processing using [Clear DB buffer request].

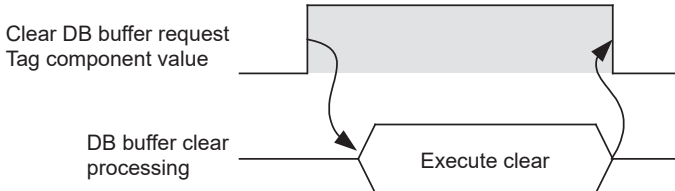
Data type of tag component	Description
Bit	<p>The clear processing of the DB buffer is performed when the specified tag component is ON. Turns OFF after completion of the clear processing.^{*1*2}</p> 
String	<p>The DB buffer is cleared when "1" is written to the specified tag component. "0" is written after completion of the clear processing.^{*1*2}</p>
Other than the above (Including string)	<p>The DB buffer is cleared when "1" is written to the specified tag component. "0" is written after completion of the clear processing.^{*1*2}</p>

*1 Do not change the value of the specified tag component until the clear processing is completed. Even if the value changes, the clear processing is not interrupted.

*2 To make another DB buffer clear request after completion of clear processing, wait for a sampling interval of the specified tag component or more, and then set the device as follows:

- Bit type: ON
- Character string type: "1"
- Other than the above: 1

DB buffering full

■Select a tag component into whose device the status of whether the DB buffer is full or not is stored.

Tags that have a tag component with [Array setting] cannot be selected.

■Data are stored as follows depending on the data type.

Data type of tag component	Description
Bit	OFF : DB buffer is not full. ON : DB buffer is full.
String	"0" : DB buffer is not full. "1" : DB buffer is full.
Other than the above	0 : DB buffer is not full. 1 : DB buffer is full.

■When the DB buffer becomes full, buffering operation will be stopped.

After buffering operation is stopped, even if a job for which DB buffering is enabled is activated, its SQL texts are discarded without being buffered.

Execution of a job for which DB buffering is enabled is not canceled.

Point

Check the DB buffer utilization to prevent the "DB buffer full" status.

For the DB buffer utilization, refer to the following.

 Page 142 DB buffer utilization

DB buffer utilization

■Select a tag component into whose device the utilization of the DB buffer area (unit: %) is stored.

Tags that have a tag component with [Array setting] cannot be selected

■Data are stored as follows depending on the data type

Data type of tag component	Description
Bit	OFF : Not accumulated ON : One or more data accumulated
String	"0" : Not accumulated Other than "0" : Utilization of DB buffer area (Unit: %)
Other than the above	0 : Not accumulated Other than 0 : Utilization of DB buffer area (Unit: %)

Setting item of the option setting

Set whether to enable the additional setting.

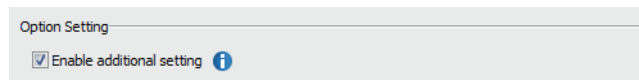

Enable additional setting

This item is settable when version 1.14Q or later, or version 2 of DB Connection Service and DB Connection Service Setting Tool are used.

When this item is selected, the setting ranges of the following items are changed.

The changes vary with the version of DB Connection Service and DB Connection Service Setting Tool.

o: Supported, -: Not supported

Edit items tree	Description	DB Connection Service and DB Connection Service Setting Tool		
		Version 1.14Q or later	Version 2.00A	Version 2.02C or later
[Device tag settings]	[String [Unicode]] is selectable for [Data type].	o	o	o
	When [String] or [String [Unicode]] is selected for [Data type], the character string length can be set to 1 to 255 characters.			
[Server service settings]	[MySQL] and [PostgreSQL] are selectable for [Database type].	-	o	o
	SQL Server 2016 is usable as a database.	-	o	o
	SQL Server 2017 is usable as a database.	-	-	o
[Job settings]	[Delete] is selectable for [Action type].	o	o	o
	When [[String]] is selected for [Tag/Type] or [Operation tag], 1 to 255 Unicode characters can be entered into [Component].			
	[String [Unicode]] is selectable for [Component].			
	When a string-type or Unicode-string-type component is selected for [Component], 1 to 255 Unicode characters can be entered for a substitute value.			

6.10 Import and Export

The MES interface settings can be imported or exported.
MES interface setting files (*.gtmes) are supported.

Importing the MES interface settings

1. Click the [Import] button.

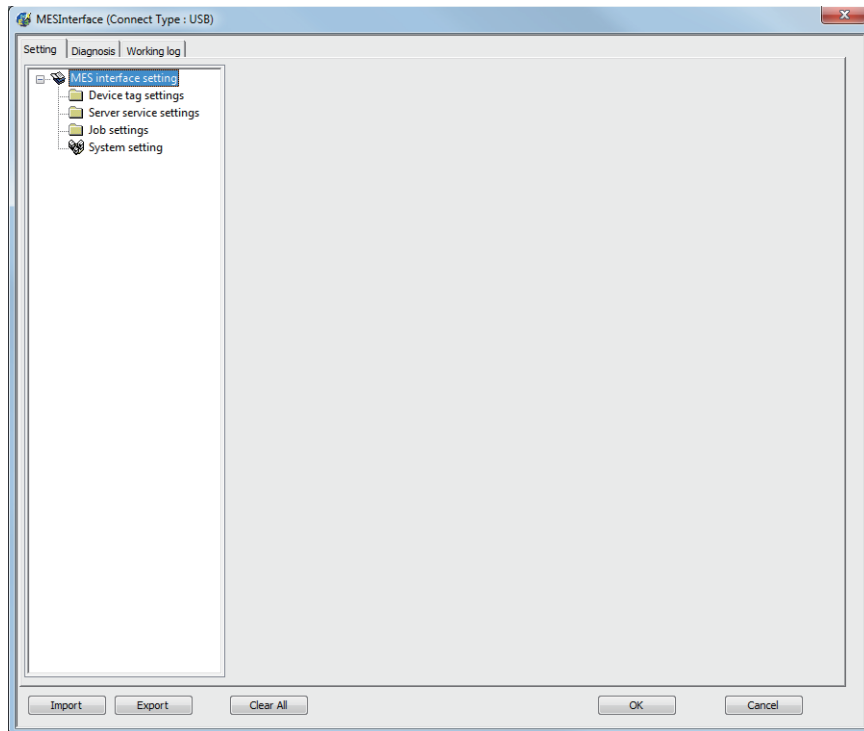

2. Select a MES interface setting file (*.gtmes) to be imported.

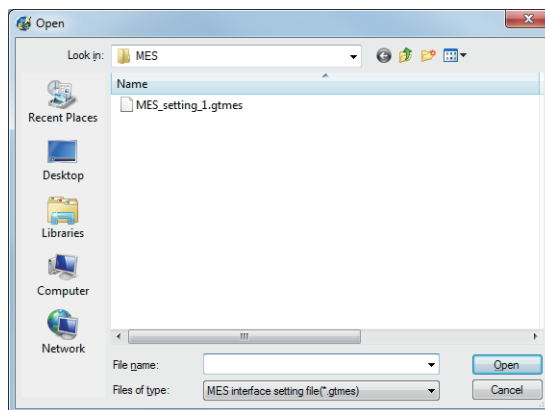

3. If an item has been set in the import destination, the following dialog appears.

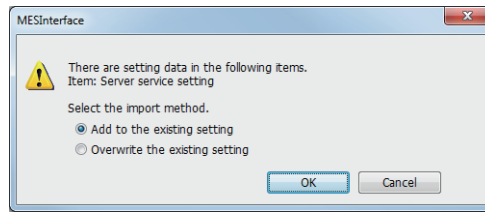

- [Add to the existing setting]

Retains the existing settings of the import destination, and adds the settings imported from the MES interface setting file.

If a same-name setting already exists in the import destination, the import will be canceled.

- [Overwrite the existing setting]

Deletes all settings in the import destination, and imports settings from the MES interface setting file.

4. Click the [OK] button to import the MES interface settings.

Exporting the MES interface settings

1. Click the [Export] button.

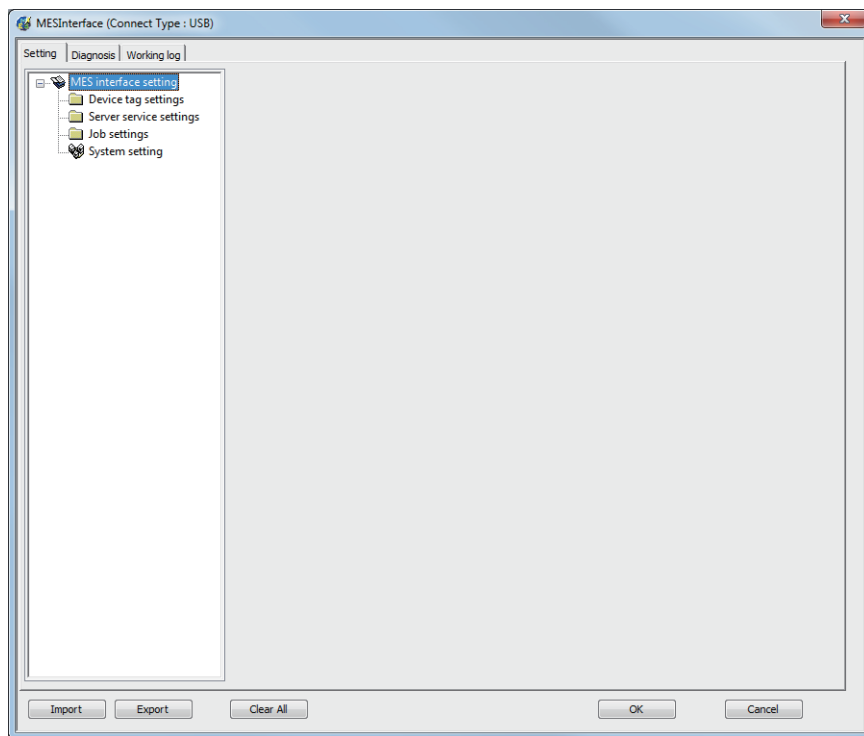

2. Set [File Name] and click the [Save] button.

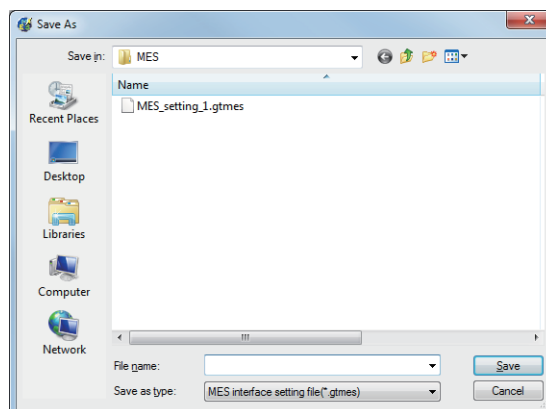

3. The MES interface settings are exported to the file (*.gtmes).

6.11 Diagnosis

Perform the remote diagnosis for the MES interface function.

1. Click the [Diagnosis] tab.
 2. The [Diagnosis] sheet is displayed.
- Operate it referring to the following descriptions.

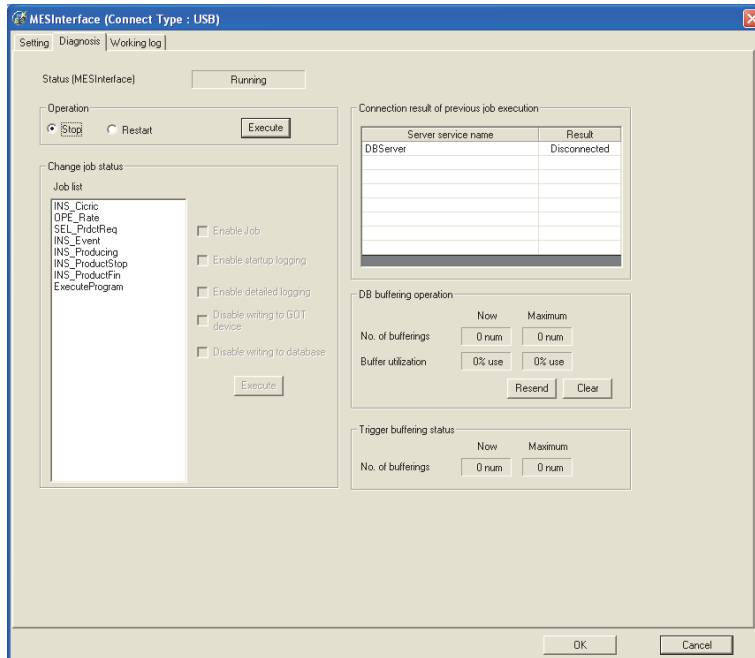

Checking the MES Interface Function status (Status)

The operation status of the MES interface function can be checked.

The following explains the display of [Status].

The display of [Status] is updated every 3 seconds.



Display	Description
Running	The MES interface function is working normally.
Stopped	The MES interface function is stopped. Even if trigger conditions are met, no job will be executed during stop of the function.
Initializing	The GOT is in process of powering from OFF to ON, or resetting. Even if trigger conditions are met, no job will be executed during initialization.
Starting	The MES interface function is starting up after processing of the above Initializing status. Even if trigger conditions are met, no job will be executed during startup.
Stopping	The MES interface function is being stopped.
Getting status	The MES interface function setting screen is attempting to acquire the status from the MES interface function.
Connection failed	The MES interface function setting screen failed to connect to the MES interface function and could not acquire the status.
Error	The MES interface setting has not been done, or the MES interface function is stopped due to an error.

Manipulating the MES Interface Function status (Operation)

The operation of the MES interface function can be controlled.



Stop

Selecting the [Stop] radio button and clicking the **Execute** button stops the operation of the MES interface function.

Point

If a job is in execution, the MES interface function will stop upon completion of the job.

For completion of a job in which a communication error has occurred, refer to the following:

☞ Page 62 When actions are set for a job

Restart

Selecting the [Restart] radio button and clicking the **Execute** button restarts the operation of the stopped MES interface function.

Changing the job status (Change job status)

The job status can be changed.

Point

The job status changed by this operation returns to the status set in [Job settings] by powering OFF and ON or resetting the GOT.

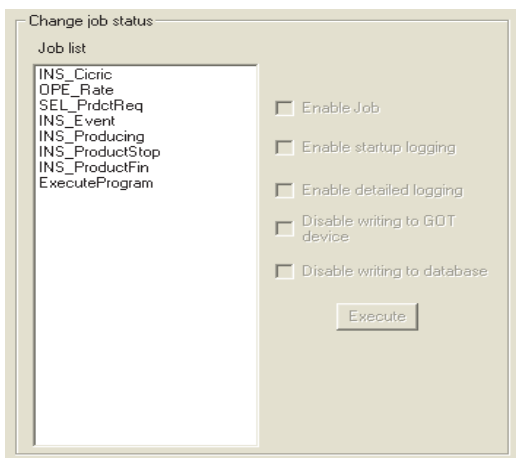

1. From [Job list], select the job whose status is to be changed.
2. Select a checkbox of the status to be changed.

Item	Description
Enable job	<ul style="list-style-type: none"> • Checked The job is enabled and thereby it is executed when the trigger conditions are met. • Not checked The job is disabled, and thereby it is not executed even if the trigger conditions are met.
Enable startup logging *1	<ul style="list-style-type: none"> • Checked The startup logging is enabled, and thereby startup records are logged. • Not checked The startup logging is disabled, and thereby startup records are not logged.
Enable detailed logging *2	<ul style="list-style-type: none"> • Checked The detailed logging is enabled, and thereby detailed records are logged. • Not checked The detailed logging is disabled, and thereby detailed records are not logged.

Item	Description
Disable writing to GOT device	<ul style="list-style-type: none"> • Checked Writing to PLC devices is disabled. • Not checked Writing to PLC devices is enabled.
Disable writing to database	<ul style="list-style-type: none"> • Checked *3 Writing to the database is disabled. • Not checked Writing to the database is enabled.

*1 The startup log can be confirmed in [Job Execute Log] on the [Working log] tab.

☞ Page 152 Job Execute Log

*2 [Enable detailed logging] is selectable only when [Test mode] is selected in [Job settings].

☞ Page 86 Test mode

When [Enable detailed logging] is checked, [Enable startup logging] is also selected.

The detailed log can be confirmed in [Job Execute Log] on the [Working log] tab.

☞ Page 152 Job Execute Log

*3 When [Disable writing to database] is checked, the following processing are executed.

- The SQL text is sent to a database, and then the rollback is executed at the last.

Errors occur when the server service settings and the settings for the actions in [Job settings], including table names and field names, are incorrect. When an error occurs, check the settings.

3. Clicking the button changes the job status.

Checking the connection of the previous job execution (Connection result of previous job execution)

Connection with the server computer set in [Server service settings], which is made at the time of the previous job execution, can be checked.

The following explains the display of [Connection result of previous job execution].

Server service name	Result
DBServer	Disconnected

Displayed result	Description
Connected	Normally connected to the server computer at the time of the previous job execution.
Disconnected	Initial status (Not connected to the database server computer), or normal connection could not be established at the previous job execution and thereby the line was disconnected.

Point

- The display of the connection result is not changed until the next job is executed to communicate the database server computer.
- The result of the one-shot communication with the database server computer is not reflected.

Manipulating DB buffering (DB buffering operation)

Operate the DB buffering.

For the DB buffering function, refer to the following:

☞ Page 54 DB buffering function

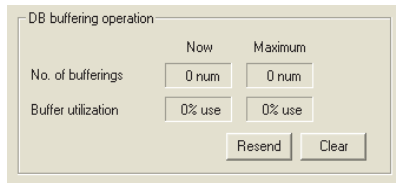

Number of bufferings and Buffer utilization

This section explains checking the number of data buffered, the current buffer utilizations, and the highest buffer utilizations of the DB buffering function.

Display	Description	
	Current value	Highest value ^{*2}
No. of bufferings ^{*1}	Shows the current number of bufferings (number of buffered jobs).	Shows the number of bufferings (number of buffered jobs) in the past.
Buffer utilization ^{*1}	Shows the current buffer utilization.	Shows the highest buffer utilization in the past.

*1 A value is not displayed when the value is being obtained or could not be obtained.

*2 Any of the following operation clears the highest value.

- Power off the GOT.
- Reset the GOT (when changing the communication settings, etc.)
- Install the OS from GT Designer3
- Download project data, etc.
- Restart the MES interface function
- One-shot execution

Note that the highest value is not cleared if the MES interface function was stopped by the diagnostics function.

Resending data stored in the DB buffer

Clicking the **Resend** button executes the resend processing of the SQL texts stored in the DB buffer, when manual resend is selected for the jobs of the SQL texts.

If resend processing fails, an error will be output to the MES interface Execute Log.

Clearing the DB buffer

Clicking the **Clear** button clears all of the SQL texts that are stored in the DB buffer.

Checking the trigger buffering (Trigger buffering status)

This section explains checking the number of data buffered, the current buffer utilizations, and the highest buffer utilizations of the trigger buffering function.

For the trigger buffering function, refer to the following:

☞ Page 48 Trigger buffering function

Display	Description	
	Current value	Highest value ^{*2}
No. of bufferings ^{*1}	Shows the current number of bufferings (number of buffered jobs).	Shows the number of bufferings (number of buffered jobs) in the past.

*1 A value is not displayed when the value is being obtained or could not be obtained.

*2 Any of the following operation clears the highest value.

- Power off the GOT.
- Reset the GOT (when changing the communication settings, etc.)
- Install the OS from GT Designer3
- Download project data, etc.
- Restart the MES interface function
- One-shot execution

Point

When a large number of data is buffered, check the number of job settings and the trigger condition setting.

6.12 Working Log

The operation log of the MES interface function can be checked.

In [Working log], the MES interface Execute Log and the Job Execute Log of the GOT can be checked.

1. Click the [Working log] tab.
2. The [Working log] sheet is displayed.
3. Click the [Acquire] button.
4. Log data are displayed.

Operate this screen referring to the following descriptions.

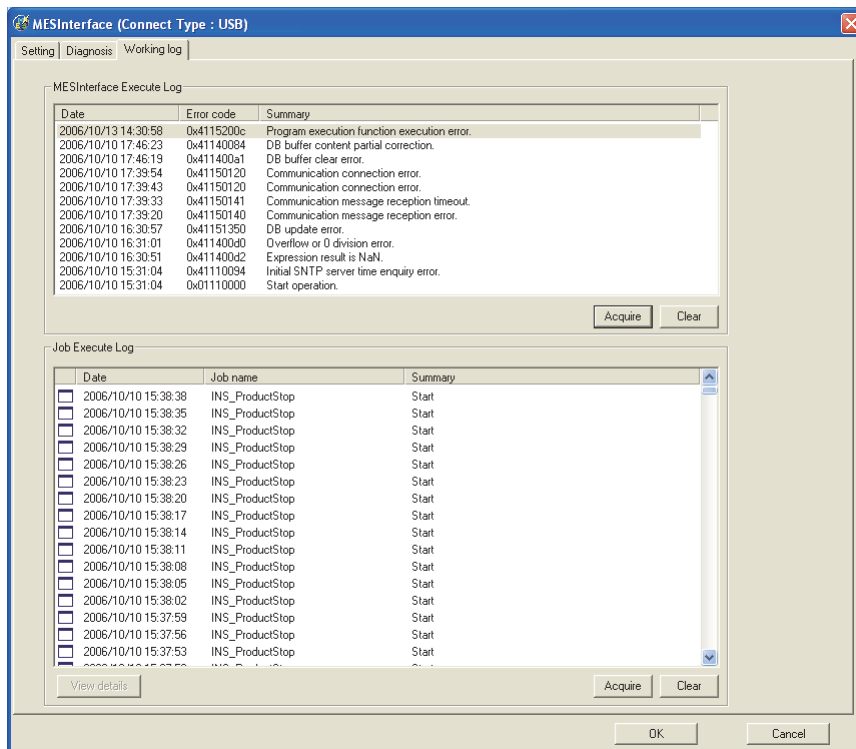

MES Interface Execute Log

The MES interface function execution log is displayed.

Data displayed in the MES Interface Execute Log are shown below.

Item	Description
Date	Displays the date and time on which an error occurred.
Error code	Displays an error code of the error occurred. For error codes, refer to the following: Page 187 Error Code List
Summary	Displays an error message.

Updating the MES interface Execute Log

Clicking the [Acquire] button updates the MES interface Execute Log.

Clearing the MES interface Execute Log

Clicking the [Clear] button clears the historical data in the MES interface Execute Log.

Job Execute Log

This area displays event log data of the jobs whose executions have been completed.

There are two kinds of Job Execute Log data: [Startup log] and [Detailed log], by which the job startup history and job execution details can be checked respectively.

Startup log

Startup log data of the jobs, each of which has [Startup logging] setting in [Job settings], are displayed.





☞ Page 85 Startup logging

The following explains the display of the Startup log.

■Icon

The completion status of the job is displayed as an icon in the Job Execute Log area.

The following explains the status of each icon.

Icon	Description
	The job was completed normally. (No detailed log)
	The job was completed normally. (With detailed log) Selecting the job and clicking the <input type="button" value="View details"/> button displays the [View details] dialog box.
	The job was canceled. (No detailed log)
	The job was canceled. (With detailed log) Selecting the job and clicking the <input type="button" value="View details"/> button displays the [View details] dialog box.

■Date

The date and time of job startup is displayed.

■Job name

Started jobs are displayed.

■Summary

Trigger instructions are displayed.

Display	Description
Start	Shows that any job other than handshake operation was activated.
Handshake start	Shows that job execution of handshake operation was activated.
Handshake end	Shows that job execution of handshake operation was completed.

Detailed log

Detailed log data of the jobs, each of which has [Test mode] setting in [Job settings], are displayed.

☞ Page 86 Test mode



Do not remove the CF card from the GOT during detailed log output.

1. Selecting a job of or icon and clicking the **View details** button displays the [View details] dialog box. The following explains the display of the [View details] dialog box.

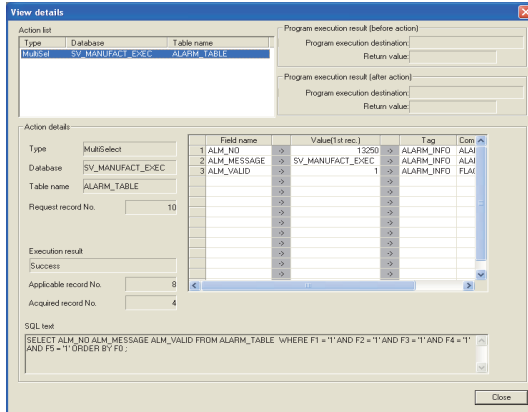

Item	Description
Action list	Displays a list of executed job actions. Selecting an action displays its action details.
Program execution result (before action)	Displays a program execution result before execution of the first action.
Program execution result (after action)	Displays a program execution result after execution of the last action.
Action details ^{*1*2*3}	Displays the action details.

*1 In the case of Communication action

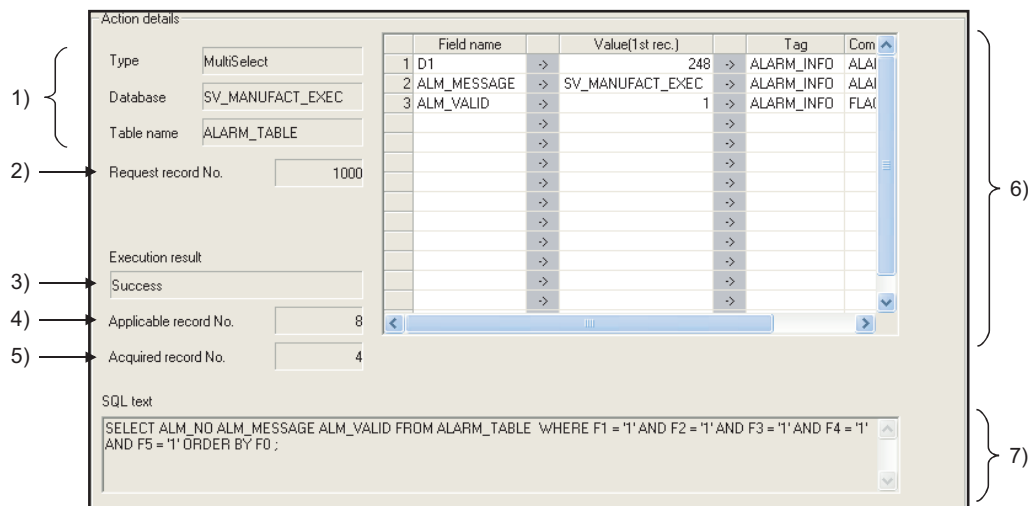

Display		Description
1)	Type, Database, Table name	Displays data of [Action type], [Database], and [Table name], which were set in [Communication action].
2)	Request record No.	Displays the number of records specified for [Specify the maximum number of acquiring records] in the Multi select setting screen for the communication action. When the number of records is not specified, [No specification] is displayed.
3)	Execution result	Displays the execution result of the SQL text. <ul style="list-style-type: none"> • When succeeded [Success] is displayed. • When failed [Failed] is displayed.
4)	Applicable record No. (Insert records No.)	<ul style="list-style-type: none"> • When [Select] or [MultiSelect] is selected for [Action type] The number of the records meeting the Select/Update/Delete conditions is displayed. • When [Update] is selected for [Action type] The number of updated records is displayed. • When [Insert] is selected for [Action type] ([Insert records No.] is displayed.) The number of inserted records is displayed. • When [Delete] is selected for [Action type] The number of the deleted records is displayed.
5)	Acquired record No.	Displays the number of acquired records when [Select] or [MultiSelect] is selected for [Action type].
6)	DB-tag link settings	Displays data of [DB-tag link settings], which were set in [Communication action].
7)	SQL text	The SQL text executed in [Communication action] is displayed.

*2 In the case of Operation action

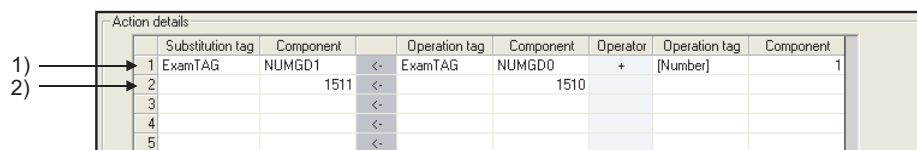

Display		Description
1)	Upper row	Displays the settings of [Operation action].
2)	Lower row	Displays values calculated in [Operation action].

*3 In the case of Transmit resource action

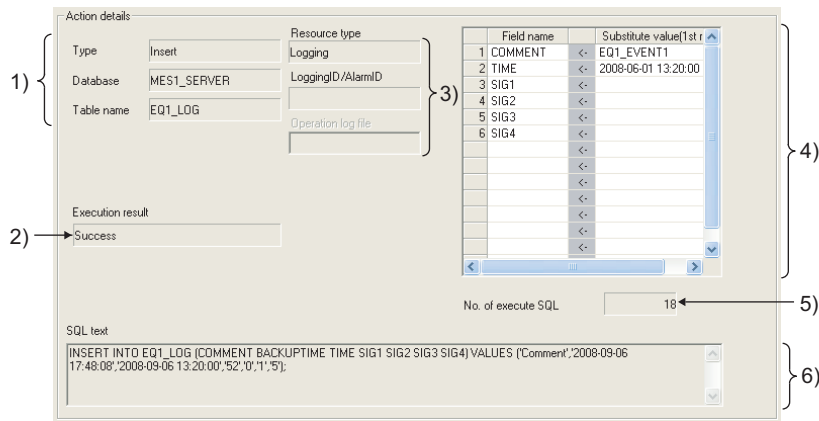

Display		Description
1)	Type, Database, Table name	Displays data of [Action type], [Database], and [Table name], which were set in [Communication action].
2)	Execution result	Displays the execution result of the SQL text. <ul style="list-style-type: none"> • When succeeded [Success] is displayed. • When failed [Failed] is displayed.
3)	Resource type, Logging ID/Alarm ID, Operation log file	Displays the data of [Resource type], [Logging ID/Alarm ID], and [Operation log file] (the stored location for the operation log file) set for [Transmit resource action].
4)	Field name setting	Displays the field name set on [Field name setting] in [Transmit resource action] and the substitute value. <ul style="list-style-type: none"> • When the resource data to be sent exists Displays the substitute value sent the first. • When the resource data to be sent does not exist. (all or part of the substitute value for the field) No data is inserted to [Value(1st rec.)].
5)	No. of execute SQL	Displays the number of the SQL texts sent for [Transmit resource action]. Displays 0 in the following cases. <ul style="list-style-type: none"> • When sending no resource data (substitute values for all the fields) • When a communication error occurs between the GOT and the database • When the SQL text cannot be sent to the database.
6)	SQL text	Displays the SQL text executed for [Transmit resource action]. Displays no data when sending no resource data (all or part of substitute values for the field)

Updating the Job Execute Log

Clicking the **Acquire** button updates the Job Execute Log.

Clearing the Job Execute Log

Clicking the **Clear** button clears the Job Execute Log.

6.13 Precautions

Precautions for the MES interface function setting are described below.

When adding, editing or deleting a MES interface setting

Adding a new MES interface setting, or editing or deleting an existing one is performed on the MES interface function setting screen.

To newly add, edit or delete a MES interface setting, have the MES interface function setting screen displayed on GT Designer3.

When deleting an item

Deleting an item such as [Device tag settings] is not allowed when the selected item is used for another item such as [Job settings].

As the error dialog box appears, identify the location, stop using it for another item, and then delete the item.

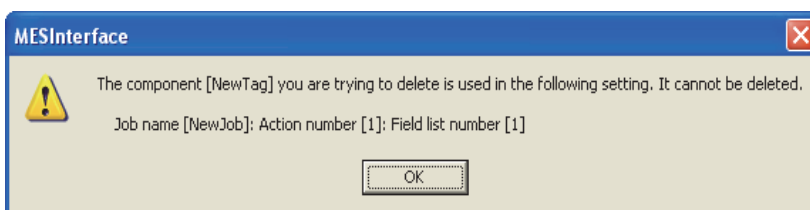

Up to ten locations of usage are displayed in the error dialog box.

If the item is used in 11 other items or more, the dialog box is displayed as shown below.

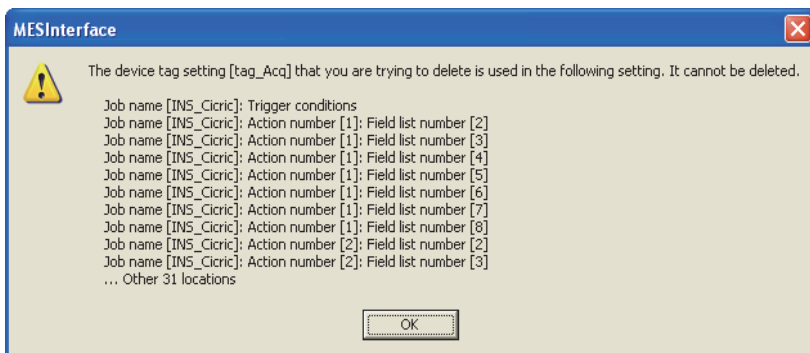

Type mismatch

Value substitution

A value is assigned to a tag component after the type of the source is converted into the type of the tag component.

A value is assigned to a variable after the type of the variable is converted into the type of the substitution source.

(Example) Type conversion of tag components and variables

Because the operation result is out of the range for the integer type, the variable Temp1 is the floating-point type.

Operation action								
	Substitution tag	Component		Operation tag	Component	Operator	Operation tag	Component
1	[Variable]	Temp1	<-	[Number]	2000000000	+	[Number]	1000000000
2	DataTag	Data1	<-	[Variable]	Temp1			
3			<-					

A value is assigned after being converted to the type for the tag component. For example, when the tag component, Data1, is double-precision type data, the type of the variable, Temp1, is converted from floating-point to double-precision first, and then the converted value is assigned.

If a type that cannot be converted is assigned to a tag component, the job execution is canceled.

At this time, "Type conversion to tag component error" is displayed in the MES interface Execute Log.

■Operation of numerical values

There are two kinds of numerical values: Integer type and Floating-point type.

- Integer type : Represents the bit type, single-precision type, and double-precision type of tag components.
- Floating-point type : Represents the floating-point type of tag components.

The following table lists operation items and types of the results.

Item	Operation result
Operation of floating-point type	Floating-point type in all cases
Addition, subtraction, multiplication of Integer type	In the range from -2147483648 to 2147483647 : Integer type Exceeding the above range : Floating-point type
Division of Integer type	Divisible : Integer type Not divisible : Floating-point type When zero divide is executed, the job execution is canceled. At this time, "Zero divide error" is displayed in the MES interface Execute Log.

■Operation between character string type values

- + operator

Combines character strings.

Example: "ABCDEFGH" + "IJK" → "ABCDEFGHIJK"

- Other operators

When both of the operands can be converted to numerical values, the operation is performed using the numerical values. Both or either of them cannot be converted to numerical values, the job execution is canceled.

At this time, "Operation error" is displayed in the MES interface Execute Log.

Example:"312"×"4" → "1248"

"31AH" × "4" → Cancellation of job execution

- Operation between a character string type value and a numerical type value

Same as the case of the operation between character string type values

Precautions resource data send action

■Checking resource data

The settings for collecting the resource data must be matched to the settings for the resource data send action. When the settings are not matched, an error may occur at the job execution.

When setting for the resource data send action, click the button, and then check that [No problem in the resource setting.] is displayed.

When the resource data send action setting differs from the setting for collecting the resource data, the following error message are displayed.

Resource type	Error message	Corrective action
Logging	Logging function setting does not exist.	Set [Logging Setting].
	The logging ID is not available.	Set the logging ID in [Logging ID/Alarm ID] that is set for [Logging Setting].
User alarm	User alarm function setting does not exist.	Set [Advanced User Alarm Observation].
	The alarm ID is not available.	Set the alarm ID in [Logging ID/Alarm ID] that is set for [User Alarm].
System alarm	System alarm function is not available.	Check [Use System Alarm] for [System Alarm].
Operation log	Operation log function is not available.	Check [Use Operation Log Settings] for [Operation Log Setting].
	The operation log file name is mismatch.	Click the Set operation log file name button to obtain the stored file for the operation log setting.

■Conditions for sending the sent resource data

When restarting the GOT, the GOT may send the sent data.

Multiple records are created in the database when the GOT sends the sent data.

The following shows conditions for sending the sent resource data

Resource type	Condition
Logging	No sent resource data is sent.
User alarm	When restarting the GOT, the sent resource data is stored in the alarm log file.
System alarm	When restarting the GOT, the sent resource data is stored in the alarm log file.
Operation log	When restarting the GOT, the sent resource data is stored in the operation log file.

■Collecting no resource data when executing an action

- When the data in the field set for [Field name setting] does not exist.

The GOT sends the data of "" (Null) to the field.

The following resource data shows the resource data types with no data depending on conditions.

Resource type	Insert data	Action execution
Logging	LoggingDevice	Sending no data
User alarm	Comments	Sending ""(Null) data
System alarm	None	-
Operation log	Object name(OPNAME), Operation level(OPERATOR), Operation level(OPE_ID), User ID(USER_ID), Action No.(ACT_NO), Data type(DATA_TYPE), Device name(DEV_NAME), Change value(CHG_VALUE), Previous value(PREV_VALUE)	Sending no data

Point

Set "null-capable" in the fields for the database.

Without setting "null-capable", an error occurs at the job execution.

For the database setting, refer to the manual for the database to be used.

- Collecting no resource data after the last action

The action is succeeded without communicating the GOT with the database. (The MESInterface Execute Log is output.)

The access log is not output to the server computer.

How to connect the configuration computer and the GOT to perform a diagnosis or check the operation log

If you connect the configuration computer and the GOT via a PLC, you cannot perform a diagnosis or check the operation log of the MES interface function.

Connect the configuration computer and the GOT directly via USB or Ethernet.

7 DB CONNECTION SERVICE AND SETTING TOOL

- ☞ Page 159 DB Connection Service Functions
- ☞ Page 161 Setting ODBC of Database
- ☞ Page 171 Starting DB Connection Service Setting Tool
- ☞ Page 172 Screen Structure of DB Connection Service Setting Tool
- ☞ Page 173 Setting Items of DB Connection Service Setting Tool
- ☞ Page 177 Importing/Exporting Files
- ☞ Page 178 Help
- ☞ Page 179 Output Log Specifications

This chapter explains DB Connection Service and DB Connection Service Setting Tool.

7.1 DB Connection Service Functions

Installing DB Connection Service on the server computer allows to use the MES interface function of the GOT.

The following shows the functions of the DB Connection Service.

Point

- It is necessary to install DB Connection Service on all the database server computers and application server computers to be accessed from the GOT.
- When using DB Connection Service on a database server computer, the ODBC setting for the database used must be made beforehand.
 - ☞ Page 161 Setting ODBC of Database
- When using DB Connection Service on an application server computer, an account for user program execution must be created beforehand.
- Changes to the DB Connection Service settings are made with DB Connection Service Setting Tool.
 - ☞ Page 173 Setting Items of DB Connection Service Setting Tool

7

ODBC connection function

The ODBC connection function connects the GOT and the ODBC interface for database.

The following shows operation on the database server computer.

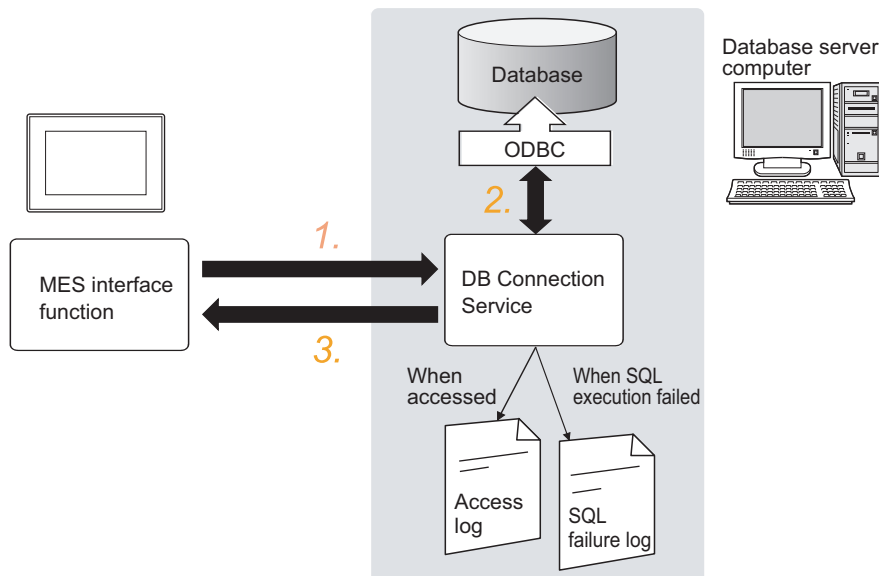

1. Receives SQL texts from the GOT.
2. Accesses the database via ODBC interface and executes the SQL text.

- Sends the SQL text execution results to the GOT.

Program execution function

The program execution function executes a program on an application server computer upon request from the GOT. The following shows operation on the application server computer.

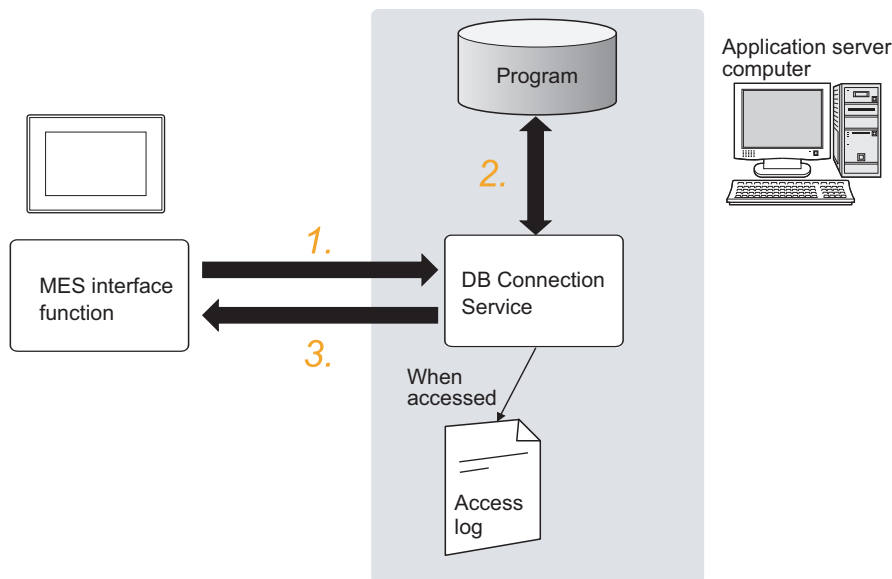

- Receives a program execution request from the GOT.
- Executes programs on the application server computer.
- Sends the program execution results to the GOT.

IP filter function

☞ Page 174 Limit IP addresses which permit to connect

The IP filter function allows specification of the IP address of the GOT that can connect to the DB Connection Service, ensuring the security of the server computer.

Batch specification using the mask bit length specification is possible.

If the IP filter function is not used, any GOT can connect to DB Connection Service.

Log output function

DB Connection Service outputs an access log and an SQL failure log.

■Access log

☞ Page 175 Output access log

The communication contents between the GOT and DB Connection Service are output to the access log. For access log specifications, refer to the following.

☞ Page 180 Access log

■SQL failure log

☞ Page 176 Output SQL failed log

If data cannot be updated/inserted normally due to an error such as no table at SQL text execution, the error information is output to the SQL failure log.

For SQL failure log specifications, refer to the following.

☞ Page 181 SQL failure log

7.2 Setting ODBC of Database

When using DB Connection Service on a database server computer, the ODBC setting for the database used must be done beforehand.

For the ODBC setting, refer to the following.

📖 Manuals and online help for the database software and operating system (OS) used

When Oracle is used

(The following shows a setting example when Oracle 11g runs on Microsoft Windows 7 Professional Operating System.)

Set the following conditions.

- Data source name *1 : SAMPLEDS
- TNS Service Name *2 : SAMPLETNS
- OracleHome: OraDb11g_home1

*1 Data source name can be set as desired.

For [Data source name] in [Server service settings], use the name set with this setting.

*2 The TNS service name is the name for accessing an Oracle database.

The name is entered when installing Oracle and creating a database instance.

This can be checked with [Configuration and Migration Tools] - [Net Manager] - [Service naming] of Oracle. .

(Start)

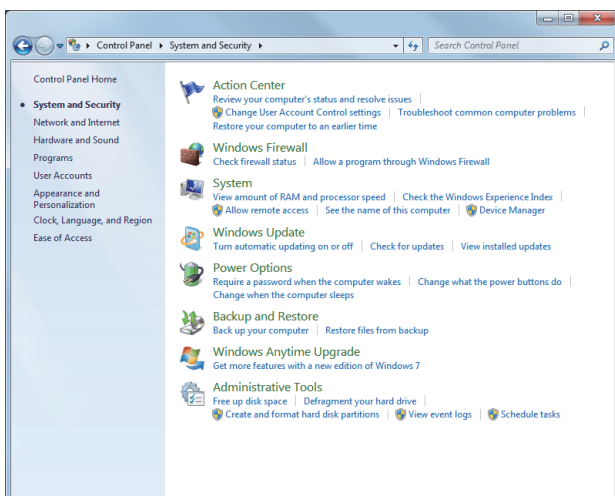
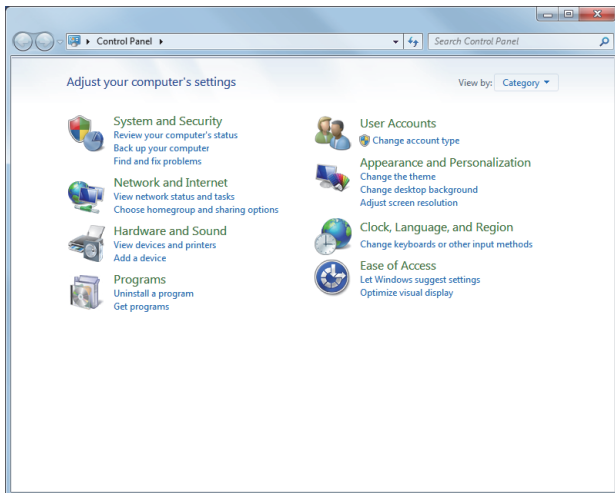

1. Select [System and Security] in the Control Panel.
To display Control Panel, select [Start] → [Control Panel].

7

2. Select [Administrative Tools].

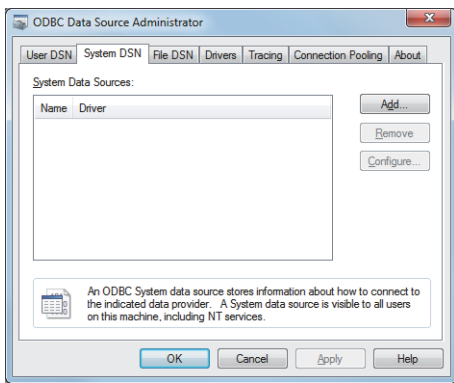

↓

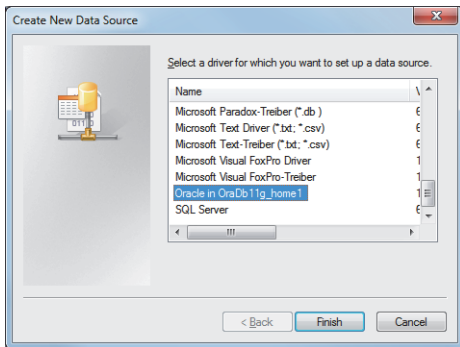

↓

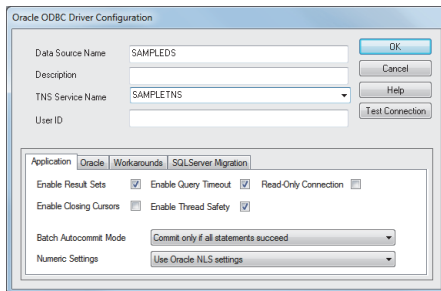

↓

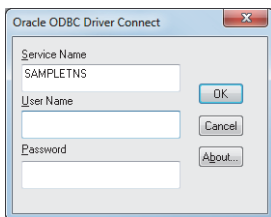

↓

(Completed)

3. Double-clicking [Data Sources (ODBC)] displays the [ODBC Data Source Administrator] dialog box. Select the [System DSN] tab, and click the **Add** button.

4. In the [Create New Data Source] dialog box, select [Oracle in OraDb11g_home1].

5. In the displayed [Oracle ODBC Driver Configuration] dialog box, set the following.

- [Data Source Name]: SAMPLEDS
- [TNS Service Name]: SAMPLETNS

6. Clicking the **Connection test** button displays the [Oracle ODBC Driver Connect] dialog box.

Enter the user name and password, then click the **OK** button.

If the connection is normal, the confirmation dialog box appears.

7. Click the **OK** button to close the confirmation dialog box.

When Microsoft SQL Server or MSDE 2000 is used

(The following shows a setting example when Microsoft SQL Server 2000 runs on Microsoft Windows 7 Professional Operating System.)

Set the following conditions.

- Data source name^{*1}: SAMPLEDS
- Server name^{*2}: SAMPLESRV

*1 Data source name can be set as desired.

For [Data source name] in [Server service settings], use the name set with this setting.

*2 The server name is the name for accessing a Microsoft SQL Server 2000 database. This name is entered when installing Microsoft SQL Server 2000.

This can be checked with the SQL Server service manager server.

(Start)

↓

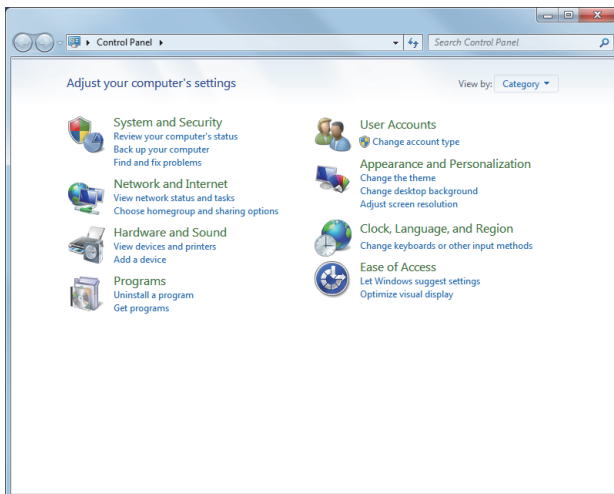

1. Select [System and Security] in the Control Panel.
To display Control Panel, select [Start] → [Control Panel].

↓

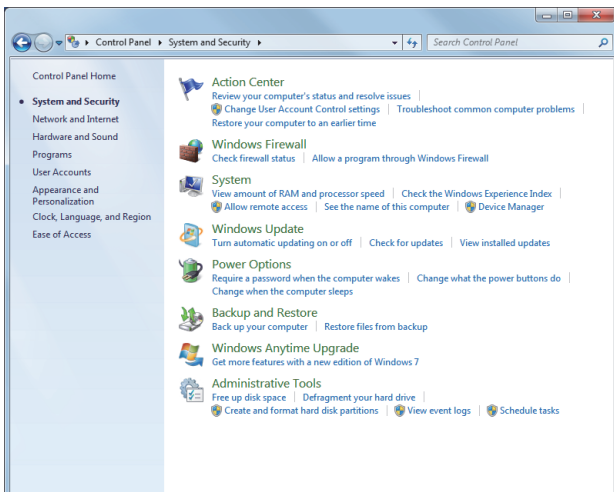

2. Select [Administrative Tools].

↓

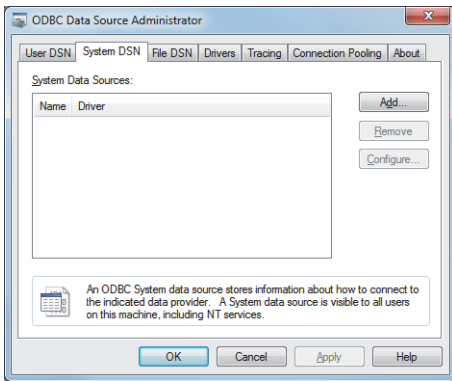

3. Double clicking [Data Sources (ODBC)] displays [ODBC Data Source Administrator] dialog box. Select the [System DSN] tab, then click the button.

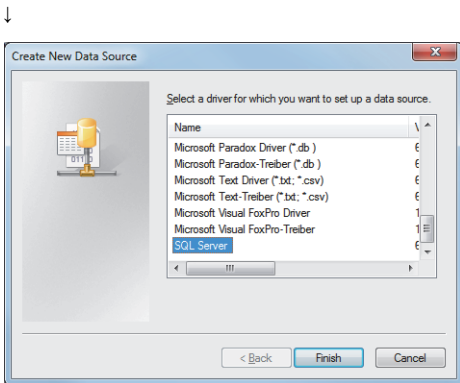

4. The [Create New Data Source] dialog box is displayed, then select [SQL Server].

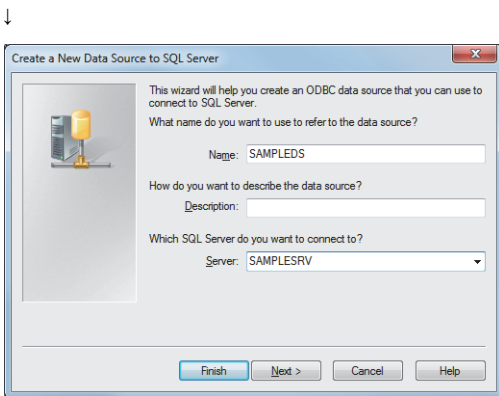

5. The [Create a New Data Source to SQL Server] dialog box is displayed, then set the following.
 - [Name]: SAMPLEDS
 - [Server]: SAMPLESRV

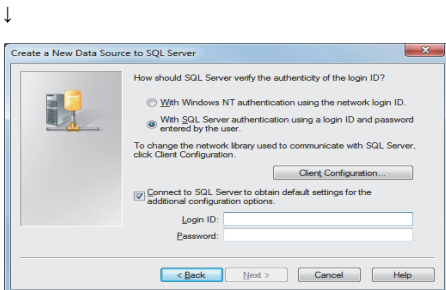

6. Select the [With SQL Server authentication using a login ID and password entered by the user.] radio button, then enter [Login ID] and [Password].

↓
(End)

7. In the [ODBC Microsoft SQL Server Setup] dialog box, click the [Test Data Source] button to check that the connection is normal.
8. Click the button to close the confirmation dialog box.

When Microsoft Access is used

(The following shows a setting example when Microsoft Access 2003 runs on Microsoft Windows 7 Professional Operating System.)

Set the following conditions.

- Data source name*1: SAMPLEDS
- Database name*2: C \ mes \ sampledb.mdb

*1 Data source name can be set as desired.

For [Data source name] in [Server service settings], use the name set with this setting.

*2 The database name is the name for accessing a Microsoft Access 2003 database. Specify a database file path created with Microsoft Access 2003.

(Start)

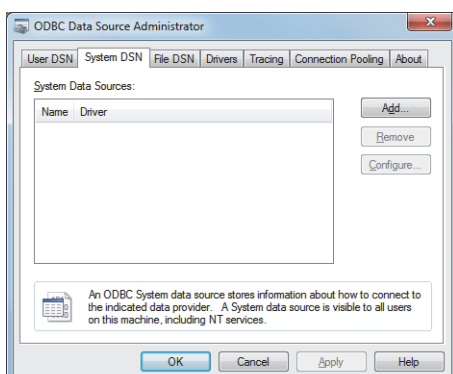
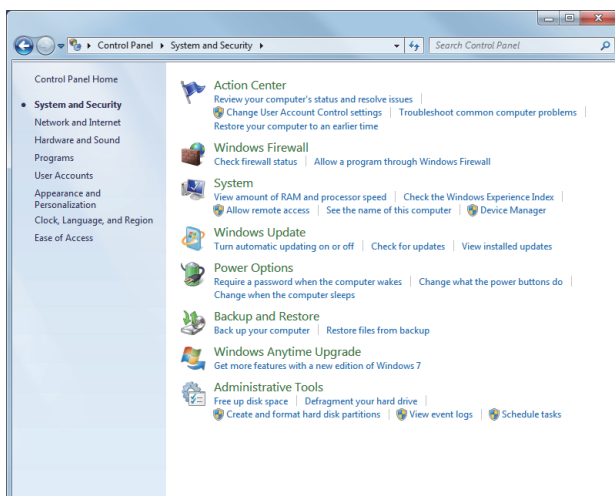
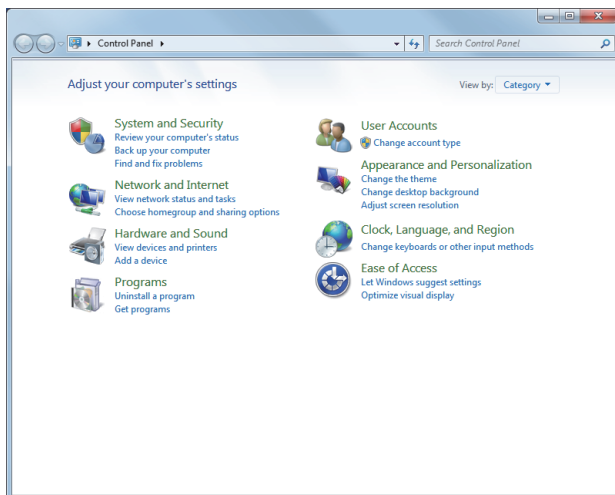

1. Select [System and Security] in the Control Panel.
To display Control Panel, select [Start] → [Control Panel].

2. Select [Administrative Tools].

3. Double clicking [Data Sources (ODBC)] displays [ODBC Data Source Administrator] dialog box.
Select the [System DSN] tab, then click the **Add** button.

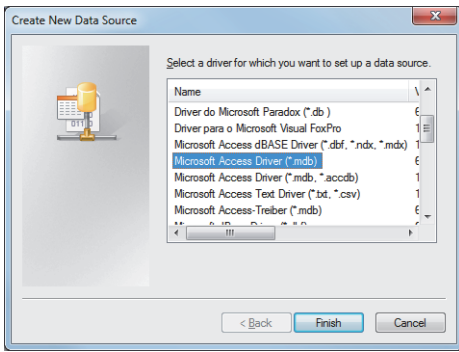

↓

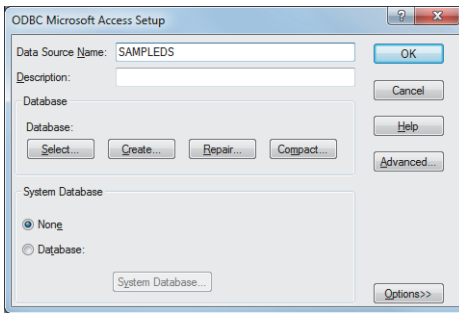

↓

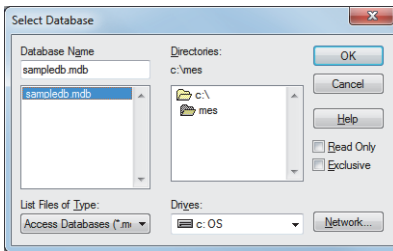

↓

(End)

4. The [Create New Data Source] dialog box is displayed, then select [Microsoft Access Driver (*.mdb)]. For Microsoft Access 2016/2013/2010/2007, select [Microsoft Access Driver (*.mdb, *.accdb)].

5. The [ODBC Microsoft Access Setup] dialog box is displayed. Set the following and click the [Database] [Select] button.

- [Data Source Name]: SAMPLEDS

6. The [Select Database] dialog box is displayed. Select the following and click the button.

- [Database Name]: sampledb.mdb
- [Directories]: C:\mes

7. Click the button to close the confirmation dialog box.

When MySQL is used

The following shows a setting example when MySQL runs on Microsoft Windows 10 Pro Operating System.

Set the following conditions.

- Data source name *1: SAMPLEDS

*1 Data source name can be set as desired.

For [Data source name] in [Server service settings], use the name set with this setting.

(Start)

↓

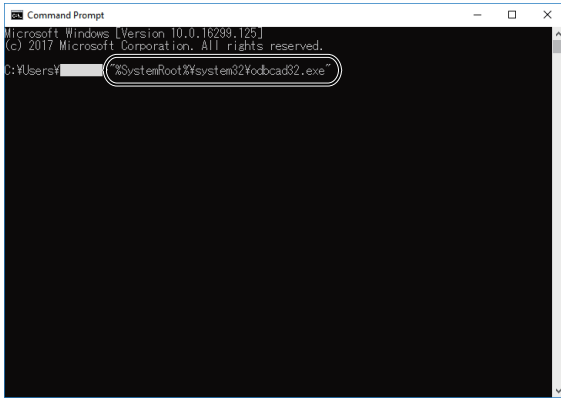

↓

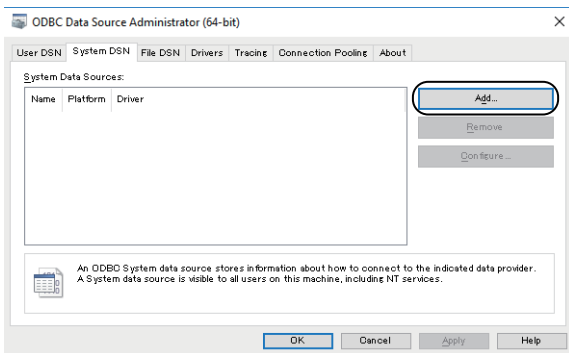

↓

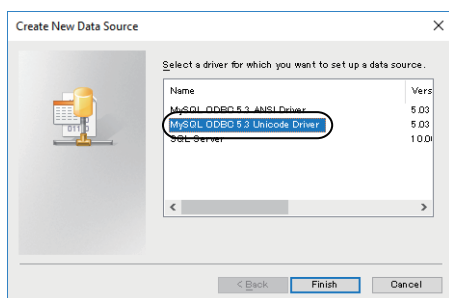

↓

1. Enter the following command line in the Command Prompt to display the [ODBC Data Source Administrator (64-bit)] dialog.

"%SystemRoot%\system32\odbcad32.exe"

2. On the [System DSN] tab, click the [Add] button to display the [Create New Data Source] dialog.

3. Select [MySQL ODBC 5.3 Unicode Driver] and click the [Finish] button to display the [MySQL Connector/ODBC Data Source Configuration] dialog.

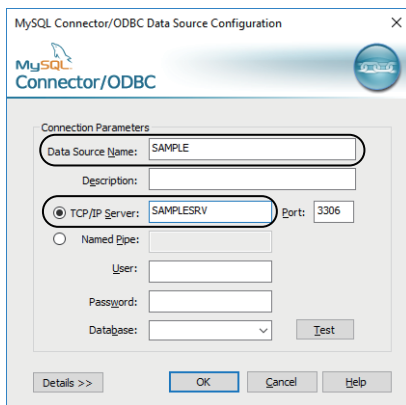

↓

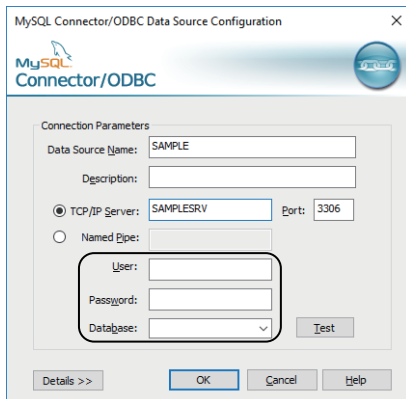

↓

(End)

4. Configure the following settings.

[Data Source Name]: SAMPLE

[TCP/IP Server]: SAMPLESRV

5. Enter a user name and a password, and select a database to be used.

6. Click the [Test] button to check for database connectivity.

7. In the [MySQL Connector/ODBC Data Source Configuration] dialog, click the [OK] button.

When PostgreSQL is used

The following shows a setting example when PostgreSQL runs on Microsoft Windows 10 Pro Operating System.

Set the following conditions.

- Data source name*1: SAMPLEDS

*1 Data source name can be set as desired.

For [Data source name] in [Server service settings], use the name set with this setting.

(Start)

↓

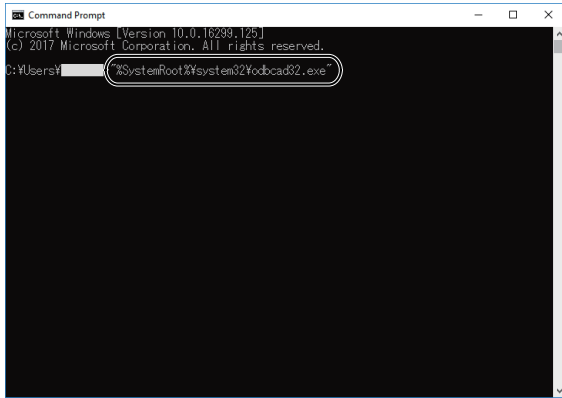

↓

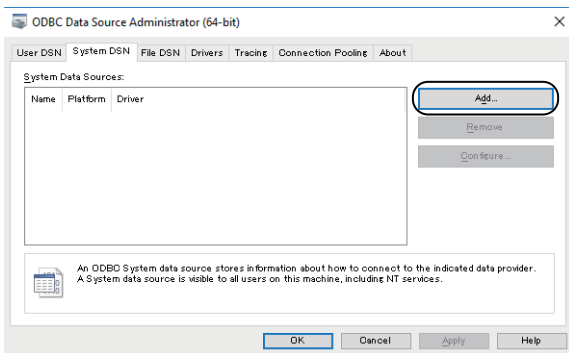

↓

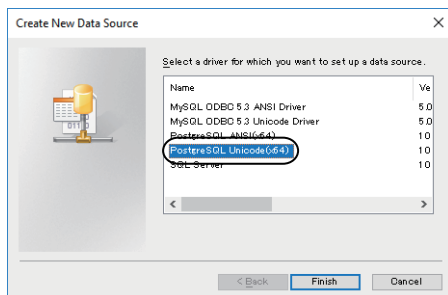

↓

1. Enter the following command line in the Command Prompt to display the [ODBC Data Source Administrator (64-bit)] dialog.

"%SystemRoot%\system32\odbcad32.exe"

2. On the [System DSN] tab, click the [Add] button to display the [Create New Data Source] dialog.

3. Select [PostgreSQL Unicode(x64)] and click the [Finish] button to display the [PostgreSQL Unicode ODBC Driver (psqlODBC) Setup] dialog.

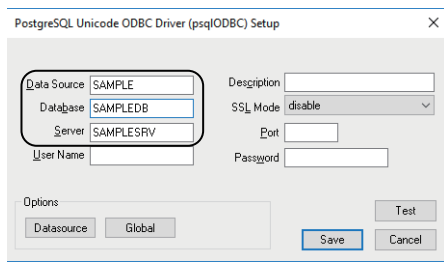

↓

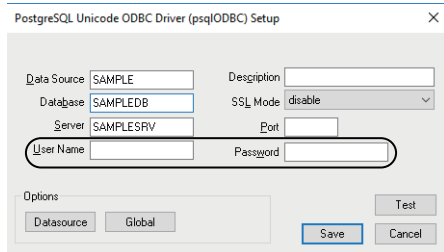

↓

(End)

4. Configure the following settings.

[Data Source]: SAMPLE

[Server]: SAMPLESRV

[Database]: SAMPLEDB

5. Enter a user name and a password.

6. Click the [Test] button to check for database connectivity.

7. In the [PostgreSQL Unicode ODBC Driver (psqLODBC) Setup] dialog, click the [Save] button.

7.3 Starting DB Connection Service Setting Tool

Point

Only one DB Connection Service Setting Tool can be activated.

When Windows 10, Windows 8.1, Windows 8, Windows 7, or Windows Vista is used

1. From the Windows start menu^{*1}, select → [MELSOFT]^{*2} → [MES Interface] → [DB connection service setting tool].

*1 Select [All Programs] on the [Start] screen, or select [Start] → [All Programs].

*2 [MELSOFT Application] appears for a version of GT Works3 earlier than 1.136S.

2. The following dialog box appears.

Click [Allow].

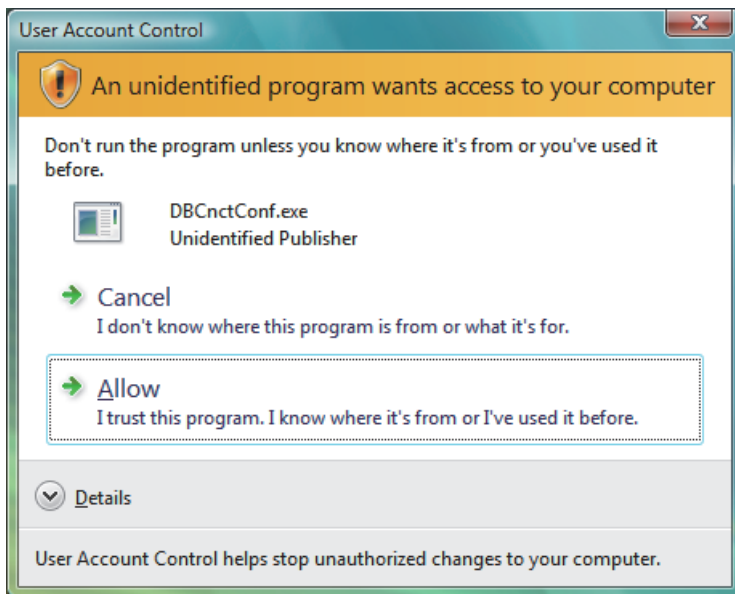

3. DB Connection Service Setting Tool is started.

When Windows XP is used

Select [Start] → [All Programs] → [MELSOFT Application] → [MES Interface] → [DB connection service setting tool].

After selecting it, DB Connection Service Setting Tool is started.

7.4 Screen Structure of DB Connection Service Setting Tool

This section explains the screen structure of DB Connection Service Setting Tool.

Screen structure

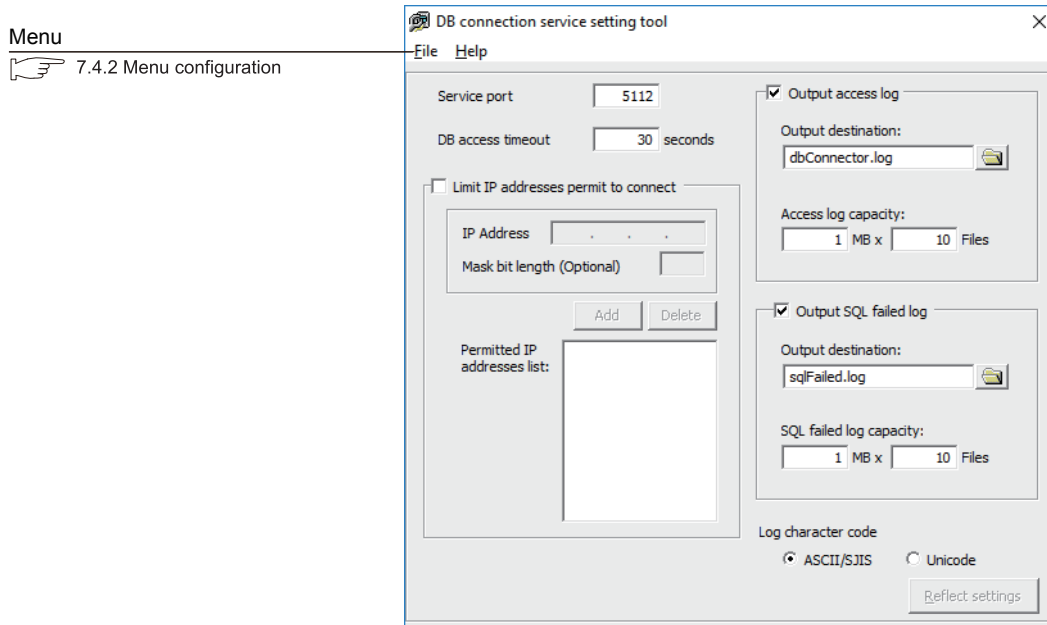

Menu configuration

This section shows each command provided on the menu bar.

File

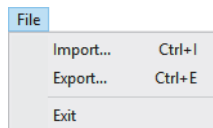

Item	Description	Reference section
Import	Imports an existing file.	☞ Page 177 Importing/Exporting Files
Export	Exports the DB Connection Service Setting Tool to a file.	
Exit	Exits the DB Connection Service Setting Tool.	—

Help

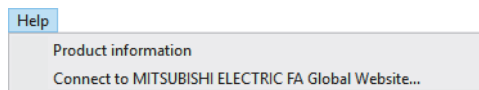

Item	Description	Reference section
Product information	Displays product information of the DB Connection Service Setting Tool.	☞ Page 178 Help
Connect to MITSUBISHI ELECTRIC FA Global Website	Connects to the Mitsubishi Electric Factory Automation Global Website.	

7.5 Setting Items of DB Connection Service Setting Tool

The following shows how to change the DB Connection Service settings.

1. Set the following items and click the **Reflect settings** button.
 2. After updating the settings, check for an error by selecting [Administrative Tools] - [Event Viewer] in Windows®.
- ☞ Page 184 Error checking procedure

Point

- Change the DB Connection Service settings while a job using the DB Connection Service is not operating. The status is as follows:
 - The GOT is powered OFF.
 - The MES interface function operation is stopped by [MES interface setting] - [Diagnosis] tab.
- ☞ Page 147 Manipulating the MES Interface Function status (Operation)
- If any changed settings are entered with a job using DB Connection Service being operating, the execution of the connected job is canceled and a communication error occurs.
- Also, for a job to which [Enable DB buffering] is selected, SQLtexts are buffered in the DB buffer.

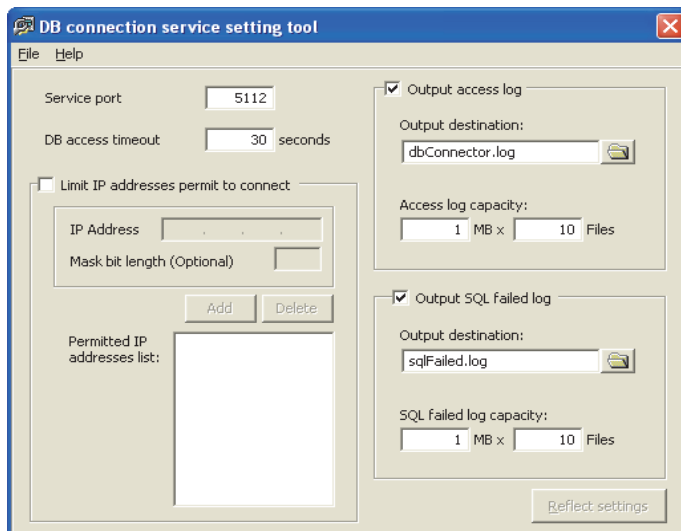

Item	Description
Service port (required)	Set the number of a port through which the DB Connection Service operates.
DB access timeout	Set a DB access timeout time (Unit: seconds) for writing/reading a database value from the GOT to the server computer, or for the case where no response is returned after request for program execution.
Limit IP addresses which permit to connect	Specify whether or not to set IP addresses to which connection is to be permitted.
Output access log	Set whether or not to output the access log.
Output SQL failed log	Set whether or not to output the SQL failure log.

Service port (required) (Range: 1024 to 65535, Default: 5112)

The specified port number is used for communications with the GOT.

Set the number of a port through which the DB Connection Service operates.

Set the same value in [Service port] as the one set in [Port No.] in [Server service settings] under [MES interface setting].

 Page 79 Setting items in Server service settings

DB access timeout (required) (Range: 1 to 3600; Default: 30)

Set a DB access timeout time (Unit: seconds) for writing/reading a database value from the GOT to the server computer, or for the case where no response is returned after request for program execution.

When a timeout occurs, the connection with the GOT is disconnected and job execution is canceled.

Point

Set a value to [DB access timeout] so that the relation with a value set in [Connection timeout] in [MES Interface Configuration Tool] is as follows:

- Connection timeout value \leq DB access timeout value

Limit IP addresses which permit to connect

Specify whether or not to set IP addresses to which connection is to be permitted.

If the [limit IP addresses which permit to connect] box is checked, connection is permitted from only the GOT with the specified IP address.

For IP addresses that are permitted to connect to DB Connection Service, at least one IP address setting is required and up to 64 addresses can be set.

If the box is not checked, connection from any GOT will be permitted.

When [limit IP addresses which permit to connect] is selected, set IP address(es).

■ Adding an IP address to permit its connection

- <Specifying individual IP addresses>

1. Set the following items and click the button.

Item	Description
IP address	Set an IP address in decimal notation so that its connection will be permitted.
Mask bit length	(Blank)

2. The IP address is added to the [Permitted IP addresses list].

(Example) 192.168.0.64

- <Specifying IP addresses in a batch>

1. Set the following items and click the button

Item	Description
IP address	Set an IP address in decimal notation so that its connection will be permitted.
Mask bit length	Set the effective bit length of the set IP address. (Range: 1 to 32)

2. The IP address/mask bit length is added to the [Permitted IP addresses list].

(Example) 192.168.0.64/26

(Example) Specifying IP addresses in a batch

If [192.168.0.64] is set for [IP address] and [26] for [Mask bit length], the IP addresses set for connection permission are [192.168.0.64] to [192.168.0.127], as the logical product is [192.168.0.64].

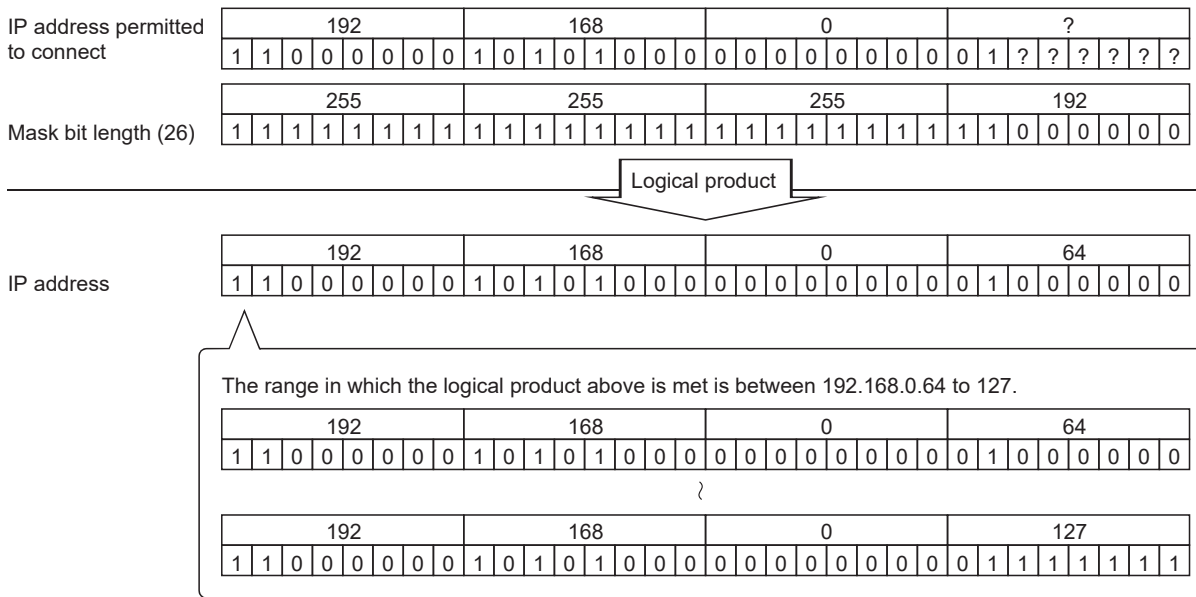

Deleting an IP address with connection permission

Select the IP address to be deleted from [Permitted IP addresses list], then click the button.

Output access log

(Default: Output)

Set whether or not to output the access log.

When [Output access log] is selected, set the following items.

Item	Description
Output destination	Set the output destination of the log file.
Access log capacity	Set the capacity for one access log file and the number of files.

Output destination (Default: "dbConnector.log")

Set the output destination of the log file.

If no output destination is set, the log is output to the install folder.

If a read-only file is specified, the log is not output and an [Access log output error] is output to [Event Viewer] of [Administrative Tools] in Windows®.

Access log capacity (Range: 1 to 10MB × 2 to 100 files, Default: 1MB × 10 files)

Set the capacity for one access log file and number of files.

If the log exceeds the capacity for one file, the data are copied to a file of the original name with a number attached and a new log file is created.

If the total number of files exceeds the set number of files, files are deleted in order from the oldest one.

(Example) When [Output destination] is set as [dbConnector.log] and [Access capacity] as [1MB × 3 files]

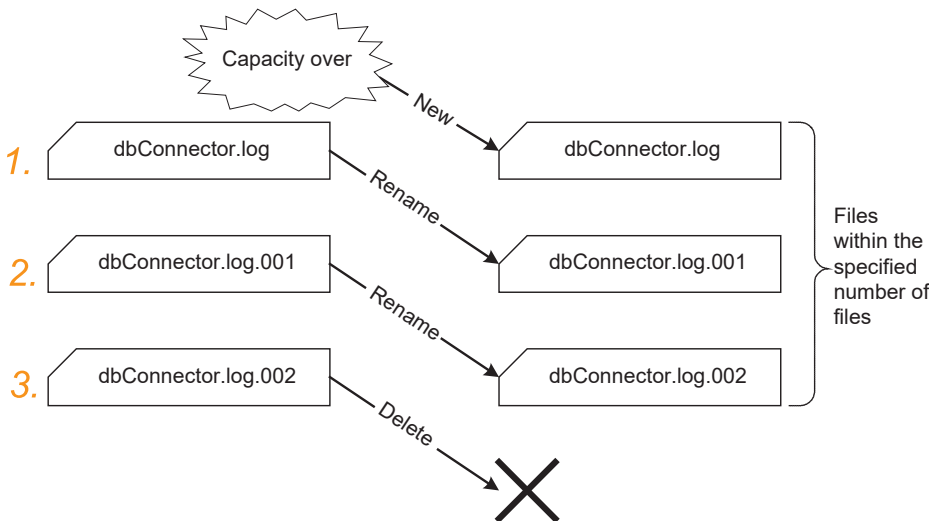

1. When [dbConnector.log] exceeds 1M byte, it is renamed as [dbConnector.log.001]. A new [dbConnector.log] is created and logging resumes.
2. [dbConnector.log.001] is renamed as [dbConnector.log.002].
3. The total number of files exceeds 3 if [dbConnector.log.002] is renamed, therefore [dbConnector.log.002] is deleted.

Output SQL failed log

(Default: Output)

Set whether or not to output the SQL failure log.

When [Output SQL failed log] is selected, set the following items.

Item	Description
Output destination	Set the output destination of the log file.
SQL failure log capacity	Set the capacity for one SQL failure log file and the number of files.

■Output destination (Default: "SQLFailed.log")

Set the output destination of the log file.

If no output destination is set, the log is output to the install folder.

If a read-only file is specified, the log is not output and an [SQL failure log output error] is output to [Event Viewer] of [Administrative Tools] in Windows®.

■SQL failure log capacity (Range: 1 to 10MB × 2 to 100 files, Default: 1MB × 10 files)

Set the capacity for one SQL failure log file and the number of files.

If the log exceeds the capacity for one file, the data are copied to a file of the original name with a number attached and a new log file is created.

If the total number of files exceeds the set number of files, files are deleted in order from the oldest one.

7.6 Importing/Exporting Files

Import/export files.

Import

An existing file can be imported.

1. Select [File] → [Import] from the menu.
2. The [Open] dialog box is displayed.

Set the following items, then click the **Open** button.

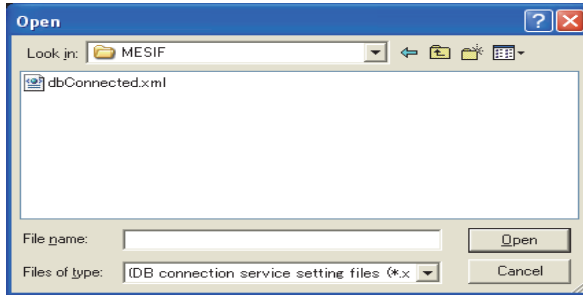

Item	Description
Look in	Select the location where the file is stored.
File name	Specify the name of the file to be imported.
Files of type	Select a type of the file to be imported. • DB connection service setting files

7

Export

DB Connection Service Setting Tool can be exported to a file.

1. Select [File] → [Export] from the menu.
2. The [Save As] dialog box is displayed.

Set the following items, then click the button.

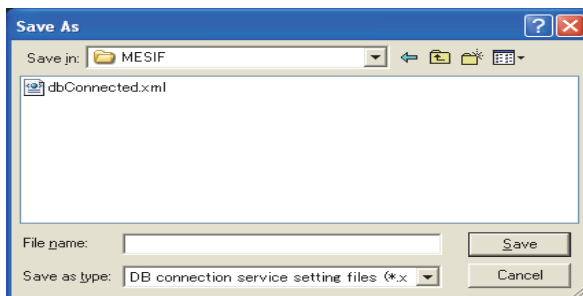

Item	Description
Save in	Select the location where the file is to be saved.
File name	Specify the name of the file to be saved.
Files of type	Select a type of the file to be saved. • DB connection service setting files

7.7 Help

The product information of the DB Connection Service Setting Tool and the Connect to Mitsubishi Electric Factory Automation Global Website screen can be displayed.

Product information

1. Select [Help] → [Product information] from the menu.
2. The [Product information] dialog box of the DB Connection Service Setting Tool is displayed.

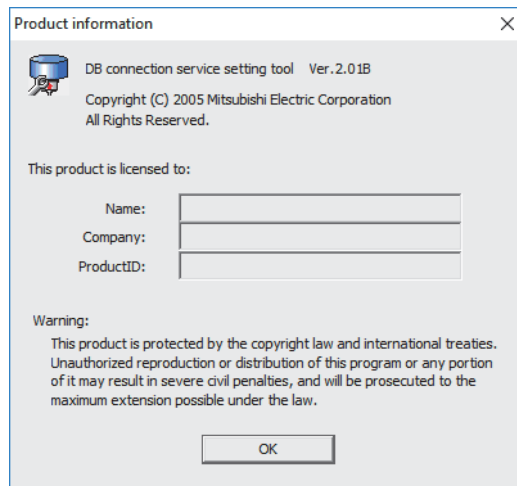

Connect to Mitsubishi Electric Factory Automation Global Website

1. Select [Help] → [Connect to MITSUBISHI ELECTRIC FA Global Website] from the menu.
2. The [Connect to MITSUBISHI ELECTRIC FA Global Website] dialog box is displayed.

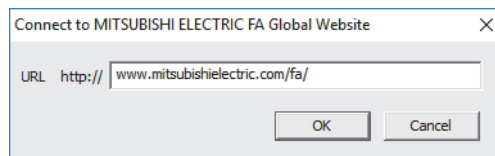

3. Click the to display the Mitsubishi Electric Factory Automation Global Website. Online manuals and other information can be viewed on the website.

7.8 Output Log Specifications

The following shows the output log format for the access log and SQL failure log given in Section 7.8.1 and later.
 [Date] [Error code] message Line feed

Item	Description			
Output character	First line			
	[Date]	Year	1st to 4th bytes from the line head	Four-digit integer for year (Numbers)
		Year - Month delimiter	5th byte from the line head	"/" (Slash: 2FH)
		Month	6th and 7th bytes from the line head	2-digit integer (01 to 12) (Numbers)
		Month - Day delimiter	8th byte from the line head	"/" (Slash: 2FH)
		Day	9th and 10th bytes from the line head	2-digit integer (01 to 31) (Numbers)
		Day - Hour delimiter	11th byte from the line head	" " (Space: 20H)
		Hour	12th and 13th bytes from the line head	2-digit integer (00 to 23) (Numbers)
		Hour - Minute delimiter	14th byte from the line head	":" (Colon: 3AH)
		Minute	15th and 16th bytes from the line head	2-digit integer (00 to 59) (Numbers)
		Minute - Second delimiter	17th byte from the line head	":" (Colon: 3AH)
		Second	18th and 19th bytes from the line head	2-digit integer (00 to 59) (Numbers)
		Second - Millisecond delimiter	20th byte from the line head	"." (Period: 2EH)
		Millisecon	21st to 23rd bytes from the line head	3-digit integer (000 to 999) (Numbers)
		Millisecond - Error code delimiter	24th byte from the line head	" " (Space: 20H)
		[Error code] ^{*1}	25th to 34th bytes from the line head	Alphanumeric character of "0x"+8-digit hexadecimal
		Error code - Message delimiter	35th byte from the line head	" " (Space: 20H)
		Message	36th and later bytes from the line head	Compliant with the specifications of each log
		Line feed	End of line	CR + LF (0DH, 0AH)
	Second line (For database errors only)			
		Tab	Line head	TAB (09H)
		Database message header	2nd to 17th bytes from the line head	"Database Message "
		Database message header - Database message delimiter	18th byte from the line head	" " (Space: 20H)
	Database message	19th and later bytes from the line head	Error messages that the database outputs	
	Line feed	End of line	CR + LF (0DH, 0AH)	

*1 For error codes, refer to the following:

 Page 187 Error Code List

Access log

The following explains the access log contents.

Service start/end

■Start

Item	Description
Output log format	[Date] [Error code] Service Start
Example	2005/07/01 12:00:00.000 0x00000000 Service Start

■End

Item	Description
Output log format	[Date] [Error code] Service Stop
Example	2005/07/01 12:00:00.000 0x00000000 Service Stop

Connection/disconnection from the GOT

■Connection

Item	Description
Output log format	[Date] [Error code] SID [Session ID]:MIFWS Connected:[Source IP]:[Target data source]:[Connection ID]
Example	2005/07/01 12:00:00.000 0x00000000 SID 0:MIFWS Connected:192.168.3.3:DataSource:ID

■Disconnection

Item	Description
Output log format	[Date] [Error code] SID [Session ID]:MIFWS Disconnected:[Source IP]:[Target data source]:[Connection ID]
Example	2005/07/01 12:00:00.000 0x00000000 SID 0:MIFWS Disconnected:192.168.3.3:DataSource:ID

Connection/disconnection to a database

■Connection

Item	Description
Output log format	[Date] [Error code] SID [Session ID]:DB Connect:[Target data source]: [Connection ID]:[Connection result ^{*1}]
Example	2005/07/01 12:00:00.000 0x00000000 SID 0:DB Connect:DataSource:ID:Success

*1 When succeeded: Success, when failed: Failed

■Disconnection

Item	Description
Output log format	[Date] [Error code] SID [Session ID]:DB Disconnect:[Target data source]: [Connection ID]:[Disconnection result ^{*1}]
Example	2005/07/01 12:00:00.000 0x00000000 SID 0:DB Disconnect:DataSource:ID:Success

*1 When succeeded: Success, when failed: Failed

SQL text reception/processing results

■SELECT

Item	Description
Output log format	[Date] [Error code] SID [Session ID]:SQL<[SQL text]>:[Processing result ^{*1}](No. of selected records)
Example	2005/07/01 12:00:00.000 0x00000000 SID 0:SQL<SELECT COL from TABLE;>:Success(1)

*1 When succeeded: Success ((No. of selected records)), when failed: Failed (Line feed) Database message

■UPDATE

Item	Description
Output log format	[Date] [Error code] SID [Session ID]:SQL<[SQL text]>:[Processing result ^{*1}](No. of updated records)
Example	2005/07/01 12:00:00.000 0x00000000 SID 0:SQL<UPDATE TABLE SET COL = ">:Success(1)

*1 When succeeded: Success ((No. of updated records)), when failed: Failed (Line feed) Database message

■INSERT

Item	Description
Output log format	[Date] [Error code] SID [Session ID]:SQL<[SQL text]>:[Processing result ^{*1}](No. of inserted records)
Example	2005/07/01 12:00:00.000 0x00000000 SID 0:SQL<INSERT INTO TABLE (COL) VALUES (")>:Success(1)

*1 When succeeded: Success (No. of inserted records), when failed: Failed (Line feed) Database message

■COMMIT

Item	Description
Output log format	[Date] [Error code] SID [Session ID]:COMMIT:[Processing result ^{*1}]
Example	2005/07/01 12:00:00.000 0x00000000 SID 0:COMMIT:Success

*1 When succeeded: Success, when failed: Failed (Line feed) Database message

■ROLLBACK

Item	Description
Output log format	[Date] [Error code] SID [Session ID]:ROLLBACK:[Processing result ^{*1}]
Example	2005/07/01 12:00:00.000 0x00000000 SID 0:ROLLBACK:Success

*1 When succeeded: Success, when failed: Failed (Line feed) Database message

■GetNext (Request for next record)

Item	Description
Output log format	[Date] [Error code] SID [Session ID]:GetNext:[Processing result ^{*1}]
Example	2005/07/01 12:00:00.000 0x00000000 SID 0:GetNext:Success

*1 When succeeded: Success, when failed: Failed (Line feed) Database message

■DELETE

Item	Description
Output log format	[Date] [Error code] SID [Session ID]:SQL<[SQL text]>:[Processing result ^{*1}](Number of deleted records)
Example	2005/07/01 12:00:00.000 0x00000000 SID 0:SQL<DELETE FROM TABLE;>:Success(1)

*1 When succeeded: Success(No. of deleted records), when failed: Failed (Line feed) Database message

Program execution reception/processing results

Item	Description
Output log format	[Date] [Error code] SID ProgramExec:[Source IP]:<[Command line]>:[Processing result ^{*1}](Return value)
Example	2005/07/01 12:00:00.000 0x00000000 ProgramExec:192.168.3.3:<hoge.exe>:Success(0)

*1 When succeeded: Success (Return value), when failed: Failed only

SQL failure log

The following shows the SQL failure log contents.

Item	Description
Output log format	[Date] [Error code] [Target data source]:[SQL text]
Example	2005/07/01 12:00:00.000 0x00000000 DataSource:INSERT INTO TABLE (COL) VALUES (") ; Database Message 0x00000388 [Oracle][ODBC][Ora]ORA-00904: "NUM" :invalid identifier

8 TROUBLESHOOTING

Page 183 Error Handling and Recovery Method

Page 187 Error Code List

8.1 Error Handling and Recovery Method

This section describes how to check an error output when using the MES interface function.

Error checking and restoration

The following lists the points to be checked when an error occurred, and corresponding recovery methods.

Error type	Check point	Recovery method
MES interface setting error	<ul style="list-style-type: none">Check a warning dialog displayed when a setting out of the permitted range was made in the MES interface function setting.	<ul style="list-style-type: none">When a value out of the permitted range has been entered in the MES interface function setting, disable the entry and return to the previous status.
MES interface function execution error	<ul style="list-style-type: none">Check the GOT for a system alarm.Check the MES interface Execute Log.Check the status information.Check the value of the tag component used for notification.	<ul style="list-style-type: none">If any problem is found in the setting, reconfigure the MES interface setting and restart the GOT.For an error of the GOT or a controller, restore it to normal condition according to its specifications.
DB Connection Service setting error	<ul style="list-style-type: none">Check a warning dialog displayed when a setting out of the permitted range was made in DB Connection Service Setting Tool.	<ul style="list-style-type: none">When a value out of the permitted range has been entered in DB Connection Service Setting Tool, disable the entry and return to the previous status.
DB Connection Service execution error	<ul style="list-style-type: none">Check Event Viewer of Windows®.Check the access log file.Check the SQL log file.	<ul style="list-style-type: none">If any problem is found in the setting, reconfigure the settings in DB Connection Service Setting Tool and restart DB Connection Service.If the server computer has a problem, resolve it and restart DB Connection Service.

8

Point

If more than one error are displayed in the error log of [MESI/F Log] or by error dialog boxes, take corrective actions in chronological order.

Error checking procedure

For error codes, refer to the following:

 Page 187 Error Code List

Item	Checking procedure
MES interface function execution error	Shows how to check an error occurred in execution of the MES interface function.
System alarm checking procedure	<ul style="list-style-type: none"> For the system alarm checking procedure, refer to the following manual.  GT Designer3 (GOT2000) Screen Design Manual
Working log checking procedure *1	<ul style="list-style-type: none"> Connect the operating GOT to a configuration computer. Display the Working log sheet in the MES interface setting. Display the detailed log from the Working log sheet and check the data.
Status checking procedure	<ul style="list-style-type: none"> Connect the operating GOT to a configuration computer. Display the Diagnosis sheet in the MES interface setting and check the data.
Notification tag component value checking procedure	<ul style="list-style-type: none"> Set a notification tag in the MES interface setting. Add a setting for monitoring the tag value on the GOT screen. On the GOT screen, check if an error or exception has occurred in the tag or not. Notification tags can be set for the following four items: [Job settings] - [Communication action] - [Exception process setting] - [Exception processing: No applicable record] [Job settings] - [Communication action] - [Exception process setting] - [Exception processing: Multiple applicable records] [Job settings] - [Communication action] - [Exception process setting] - [Exception processing: Applicable records overflow] [Job settings] - [Notify errors (job cancellation) that occur during job execution] [Server service settings] - [Access error notification setting]
DB Connection Service execution error	Shows how to check an error occurred in execution of DB Connection Service.
Windows® Event Viewer checking procedure	<ul style="list-style-type: none"> From the Windows® start menu, select [Control Panel] - [Performance and Maintenance] - [Administrative Tools] - [Event Viewer]. (Windows® XP) Select the Application log to display the list. Click on [Source] (sorting the list by the source name), and check for "DB Connector."
Access log checking procedure	<ul style="list-style-type: none"> In DB Connection Service Setting Tool, select [Output access log]. Display the output file with Windows® Notepad.
SQL log checking procedure	<ul style="list-style-type: none"> In DB Connection Service Setting Tool, select [[Output SQL failed log]. Display the output file with Windows® Notepad.

*1 A CF card is required.

MES Interface Function setting

This section explains troubleshooting information on the setting of the MES interface function.

Common to all settings

Symptom	Checked item	Corrective action
GT Designer3 cannot communicate with GOT.	Is the GOT communicating with another GT Designer3?	<ul style="list-style-type: none"> Check that no other GT Designer3 is running and communicating on the same personal computer. Check that GT Designer3 is not running and communicating on other personal computers.
	Is there any disconnection in the connection route?	<ul style="list-style-type: none"> Connect the cables properly.
	Is there any problem on the personal computer?	<ul style="list-style-type: none"> Replace it with another computer.
	Is the port number correct? (In RS-232 or Ethernet connection)	<ul style="list-style-type: none"> Check the port number setting.
	Is the GOT connected to the network? (When using Ethernet connection)	<ul style="list-style-type: none"> Issue the ping command from the personal computer to the GOT to confirm the network connection.
	Is the IP address setting correct? (When using Ethernet connection)	<ul style="list-style-type: none"> Correct the IP address setting.
	Is there a firewall and/or a proxy server in the connection route? (In Ethernet connection)	<ul style="list-style-type: none"> Ask your network administrator about the firewall and proxy server settings.
All the text is not displayed in a table. (The text display is truncated.)	Isn't the column width narrow?	<ul style="list-style-type: none"> Adjust the column width of the table.  Page 65 Screen structure

[Device tag settings]

☞ Page 68 Device Tag Settings

Symptom	Checked item	Corrective action
Unable to change or delete an item in [Device tag settings].	Is the selected item used in [Job settings]?	<ul style="list-style-type: none"> As the error dialog box appears, identify the location, stop using it for another item, and then delete the item. An item used for another item is unable to be deleted.
	Is the selected item used in [DB buffering setting] of [System setting]?	
	Is the selected item used in [Access error notification setting] of [Server service settings]?	
Unable to set or change [Device tag name].	Is the same name used for [Server service name] or another [Device tag name]?	<ul style="list-style-type: none"> Because a unique name must be used for [Server service name] and [Device tag name], use a different name.

[Server service settings]

☞ Page 78 Server Service Settings

Symptom	Checked item	Corrective action
The user name specified for creating a user in Oracle and the user name specified in the GOT are the same including uppercase and lowercase letters, but login attempts fail.	Is [Enable additional setting] for the option setting in the MES interface function setting selected?	<ul style="list-style-type: none"> If attempts to log in to Oracle fail although [Enable additional setting] for the option setting in the MES interface function is selected, set the user name displayed on Oracle Enterprise Manager or other tools to the "user name" for the server service settings in the MES interface function setting. The uppercase and lowercase letters of the user names must be matched.

[Job settings]

☞ Page 83 Job Settings

Symptom	Checked item	Corrective action
Unable to set [DB buffering setting].	Is there any Select action set for the job?	<ul style="list-style-type: none"> Do not use Select actions in the job where DB buffering is enabled. The DB buffering is not available for jobs performing Select actions.
Unable to set a new variable.	Are there 64 variables that were already defined in the job?	<ul style="list-style-type: none"> Delete any unnecessary variable settings of the job. Up to 64 variables can be set for one job.
Unable to select [Trigger 2] in [Trigger conditions].	Is [Handshake operation] selected for [Trigger 1]?	<ul style="list-style-type: none"> Select any other than [Handshake operation] for [Trigger 1]. When [Handshake operation] is selected, selection is not allowed for [Trigger 2].
Unable to set [Exception processing setting] in [Communication action].	Is the DB buffering enabled?	<ul style="list-style-type: none"> Disable the DB buffering.
	Is [Insert] set for [Action type]?	<ul style="list-style-type: none"> Set any other than [Insert] for [Action type].

[Diagnosis] tab

☞ Page 146 Diagnosis

Symptom	Checked item	Corrective action
GT Designer3 cannot communicate with GOT.	Has a system application (extended function) of [MES Interface] been installed?	<ul style="list-style-type: none"> Install the package data on the GOT.

[Working log] tab

Page 151 Working Log

Symptom	Checked item	Corrective action
GT Designer3 cannot communicate with GOT.	Has a system application (extended function) of [MES Interface] been installed?	<ul style="list-style-type: none">• Install the package data on the GOT.
No log is displayed.	Is there a CF card inserted?	<ul style="list-style-type: none">• Install a CF card.• Turn ON the CF card access switch.
	Is the MES interface function operating?	<ul style="list-style-type: none">• On the Diagnosis tab, check the MES interface function status.

When using DB Connection Service Setting Tool

This section explains troubleshooting information on the setting of DB Connection Service Setting Tool.

Page 159 DB CONNECTION SERVICE AND SETTING TOOL

Symptom	Checked item	Corrective action
Unable to start DB Connection Service Setting Tool.	Has DB Connection Service Setting Tool been already started?	<ul style="list-style-type: none">• Terminate the already started DB Connection Service Setting Tool.• Only one DB Connection Service Setting Tool can be activated.
Unable to reflect the setting.	Was a user ID having the administrator authority used for the login?	<ul style="list-style-type: none">• Log in again with a user ID having the administrator authority.
Unable to save the setting.	Is there no permitted IP address?	<ul style="list-style-type: none">• Uncheck the [limit IP addresses which permit to connect] checkbox, or add an IP address for which connection is permitted.
[Access log output error] is recorded in [Event Viewer] of [Administrative Tools] in Windows®.	Is the file set in [Output destination] read-only?	<ul style="list-style-type: none">• Correct the file specification.
	Is the access to the folder containing the file set in [Output destination] authorized?	<ul style="list-style-type: none">• Check the right of access to the folder.
	Is the drive space of the server computer full?	<ul style="list-style-type: none">• Check the free space on the drive.
[SQL failure log output error] is recorded in [Event Viewer] of [Administrative Tools] in Windows®.	Is the file set in [Output destination] read-only?	<ul style="list-style-type: none">• Correct the file specification.
	Is the access to the folder containing the file set in [Output destination] authorized?	<ul style="list-style-type: none">• Check the right of access to the folder.
	Is the drive space of the server computer full?	<ul style="list-style-type: none">• Check the free space on the drive.

8.2 Error Code List

The error code list is shown below.

For the error output checking method, refer to the following.

 Page 183 Error Handling and Recovery Method

Error log in the Working log

Error code	Error description	Cause and corrective action
0x41130001	Tag value collecting error	<ul style="list-style-type: none"> The device value cannot be collected. Check the device settings and the network configuration.
0x41140029	Setting read error	<ul style="list-style-type: none"> The set data are erroneous. Download them again. In the case of one-shot job execution, the CF card may be corrupted. Replace the CF card.
0x4114002A		
0x4114002B	DB connection service communication error	<ul style="list-style-type: none"> Check the Ethernet connection. An Ethernet communication error has occurred. Check if [Server service settings] are correct.  Page 78 Server Service Settings Check if the ODBC setting is correct.  Page 161 Setting ODBC of Database
0x4114002C	DB Connection Service version incompatibility	<p>The installed version of DB Connection Service does not support the additional setting. Install DB Connection Service Version 1.14Q or later, or Version 2.</p>  Page 143 Setting item of the option setting
0x4114005F	Type conversion error	<ul style="list-style-type: none"> The data cannot be converted to the specified type. Change the setting so that type conversion will be available in any case.
0x41140061	Tag write error	<ul style="list-style-type: none"> Failed to write data to the tag. Check if data can be written to the device specified for the tag component.
0x41140065	Failed to perform the tag access.	<ul style="list-style-type: none"> Check if [Device tag settings] are correct.  Page 68 Device Tag Settings
0x41140069	Tag value read error	<ul style="list-style-type: none"> Failed to read data from the tag. Check if [Device tag settings] are correct.  Page 68 Device Tag Settings
0x41140077	Type conversion to tag component error	<ul style="list-style-type: none"> The data could not be converted to the type specified for the tag component. Change the setting so that type conversion will be available in any case.
0x41140081	DB buffer content error	<ul style="list-style-type: none"> Data stored in the DB buffer are invalid. The CF card may be corrupted. Replace the CF card.
0x41140083		
0x41140084	Partial correction of DB buffer content	<ul style="list-style-type: none"> A part of invalid data in the DB buffer has been corrected. A part of the DB buffered data in the CF card may have been corrupted.
0x41140086	DB buffer clear error	<ul style="list-style-type: none"> Failed to clear the DB buffer. The CF card may be corrupted. Replace the CF card.
0x41140087	DB buffer file error	<ul style="list-style-type: none"> The DB buffer file is invalid. The CF card may be corrupted. Replace the CF card.
0x41140089	DB buffer content error	<ul style="list-style-type: none"> Data stored in the DB buffer are invalid. The CF card may be corrupted. Replace the CF card.
0x41140093	DB buffer full error	<ul style="list-style-type: none"> Because the DB buffer became full, the data could not be stored in the DB buffer. Ensure the CF card capacity.
0x41140099	DB buffering error	<ul style="list-style-type: none"> Failed in file operation during DB buffering operation. Check the CF card, and if corrupted, replace it.
0x4114009F	DB buffer read error	<ul style="list-style-type: none"> Data in the DB buffer could not be read normally. Check the CF card, and if corrupted, replace it.

Error code	Error description	Cause and corrective action
0x411400A1	DB buffer clear error	<ul style="list-style-type: none"> Failed to clear the DB buffer. Check the CF card, and if corrupted, replace it.
0x411400A3	DB buffer read error	<ul style="list-style-type: none"> Data in the DB buffer could not be read normally. Check the CF card, and if corrupted, replace it.
0x411400A5	DB buffer empty error	<ul style="list-style-type: none"> The DB buffer is empty. Check the CF card, and if corrupted, replace it.
0x411400A6	DB buffer content error	<ul style="list-style-type: none"> Data stored in the DB buffer are invalid. Check the CF card, and if corrupted, replace it.
0x411400B2	Character string number conversion error	<ul style="list-style-type: none"> Character strings could not be converted to numerical values. Change the setting so that type conversion will be available in any case.
0x411400B6		
0x411400BA		
0x411400C0		
0x411400D0	Overflow or zero divide error	<ul style="list-style-type: none"> Division by zero was attempted. Change the setting to avoid division by zero.
0x411400D2	Operation error	<ul style="list-style-type: none"> Invalid operation was performed. Change the setting so that any invalid operation will not be performed.
0x411400D4	Logging function is not running.	<ul style="list-style-type: none"> Check that the option OS for the logging function for installed on the GOT. Check that the logging setting is configured.
0x411400D6	Invalid logging ID.	<ul style="list-style-type: none"> The logging ID is invalid. Set the logging ID for the logging setting.
0x411400DC	Advanced system alarm function is not available.	<ul style="list-style-type: none"> The advanced system alarm setting is invalid. Set the advanced system alarm observation setting.
0x411400E2	Invalid alarm ID.	<ul style="list-style-type: none"> The alarm ID is invalid. Set the alarm ID for the advanced user alarm observation setting.
0x411400E8	Invalid max number of select record.	<ul style="list-style-type: none"> The maximum number of obtained records is invalid. Set the tag component value specified as the maximum number of records 1 or more.
0x411400EA	Operation log function is not running	<ul style="list-style-type: none"> Check that the required system application (extended function) is installed on the GOT. Check that the operation log setting is configured.
0x411400EE	Unable to find the operation log file.	<ul style="list-style-type: none"> The MES interface function in the GOT cannot access the operation log file. Check that the CF card including the operation log file is installed in the GOT.
0x411400F0	Unable to open the operation log file.	
0x411400F2	Unable to acquire the operation log file.	
0x41150110	Communication start error	<ul style="list-style-type: none"> An error occurred in the Ethernet communication, and the communication failed to start. Check the Ethernet connection. Check if [Server service settings] are correct. ☞ Page 78 Server Service Settings • Check if the ODBC setting is correct. ☞ Page 161 Setting ODBC of Database
0x41150120	Communication connection error	<ul style="list-style-type: none"> An Ethernet communication error has occurred. Check the Ethernet connection. Check if [Server service settings] are correct. ☞ Page 78 Server Service Settings • Check if the ODBC setting is correct. ☞ Page 161 Setting ODBC of Database
0x41150121	Communication connection timeout	
0x41150130	Message transmission error	
0x41150131	Message transmission timeout	<ul style="list-style-type: none"> Check if the ODBC setting is correct. ☞ Page 161 Setting ODBC of Database
0x41150140	Message reception error	<ul style="list-style-type: none"> An Ethernet communication error has occurred. Check the Ethernet connection. Check if [Server Service setting] are correct. ☞ Page 78 Server Service Settings • Check if the ODBC setting is correct. ☞ Page 161 Setting ODBC of Database • Check the error information of DB Connection Service (access log file). ☞ Page 180 Access log
0x41150141	Message reception timeout	
0x41150160	DB transaction status error	<ul style="list-style-type: none"> Check the transaction status of the database.
0x41150161	DB transaction start status error	
0x41150162	DB transaction end status error	

Error code	Error description	Cause and corrective action
0x41150300	Unsupported DB Connection Service error	<ul style="list-style-type: none"> The connection to unsupported DB Connection Service is failed. Check the version of DB Connection Service.
0x41150301	Unsupported communication timeout setting	<ul style="list-style-type: none"> The connection to DB Connection Service with unsupported communication timeout is failed. Check the version of DB Connection Service.
0x41151010	Database connection error	<ul style="list-style-type: none"> An Ethernet communication error has occurred. Check the Ethernet connection. Check if [Server service settings] are correct. ☞ Page 78 Server Service Settings Check if the ODBC setting is correct. ☞ Page 161 Setting ODBC of Database
0x41151110	Message reception error	<ul style="list-style-type: none"> An Ethernet communication error has occurred. Check the Ethernet connection. Check if [Server Service setting] are correct. ☞ Page 78 Server Service Settings
0x41151120	Received message data error	<ul style="list-style-type: none"> Check if the ODBC setting is correct. ☞ Page 161 Setting ODBC of Database Check the error information of DB Connection Service (access log file). ☞ Page 180 Access log
0x41151180	Waiting for DB access (program execution) completion timeout	<ul style="list-style-type: none"> No response is received from DB Connection Service. Check the server and the network.
0x41151320	SELECT execution error	<ul style="list-style-type: none"> Check the sent SQL text and database contents.
0x41151330	COMMIT execution error	<ul style="list-style-type: none"> Check if the table and field settings are correct.
0x41151340	ROLLBACK execution error	☞ Page 100 Job Settings - Actions
0x41151350	DB update error	
0x41151410	SQL execution error	
0x41151420	ODBC connection error during SQL execution	
0x41152005	Execution error (Program execution function)	<ul style="list-style-type: none"> Check if the program specified with the program execution function is executable with the specified account.
0x41152006		
0x41152007	Specified program file not exist (Program execution function)	<ul style="list-style-type: none"> There is no execution file of the program that is specified for the program execution function. Check if the program specified with the program execution function is executable with the specified account.
0x41152008	Specified program file duplicated (Program execution function)	<ul style="list-style-type: none"> There are more than one execution file of the program that is specified for the program execution function. Check if the program specified with the program execution function is executable with the specified account.
0x41152009 to 0x41152014	Execution error (Program execution function)	<ul style="list-style-type: none"> Check if the program specified with the program execution function is executable with the specified account.

DB Connection Service

The DB Connection Service outputs errors to the Windows® Event Log, access log, and SQL failure log.
For Windows Vista®, DB Connection Service Client also outputs errors to Windows® Event Log.



Event log of Windows®

■Event log output warning list of DB Connection Service (Source name: DBConnector)

Warning event ID	Error description and cause	Corrective action
1	There is no setting file. Start the service using the default setting.	<ul style="list-style-type: none"> Configure the settings again with DB Connection Service Setting Tool. ☞ Page 173 Setting Items of DB Connection Service Setting Tool

■Event log output warning list of DB Connection Service (Source name: DBConnector)

Error event ID	Error description and cause	Corrective action
1	Unable to start the service due to insufficient memory.	<ul style="list-style-type: none"> Add more memory to the personal computer.
2	Unable to start the service due to insufficient resources.	
5	Failed to read the setting file. The service is stopped.	<ul style="list-style-type: none"> Refer to the actions of error codes 101 to 129. Actions are displayed with error codes 101 to 129.
6	Failed to initialize the log file. The service is stopped.	<ul style="list-style-type: none"> Refer to the actions of error codes 401 to 403, and 501 to 503. Actions are displayed with error codes 401 to 403, and 501 to 503.
9	The server port has already been opened. The service is stopped.	<ul style="list-style-type: none"> Change the server port No. with DB Connection Service Setting Tool. ☞ Page 173 Setting Items of DB Connection Service Setting Tool
101	The computer ran out of memory while reading the setting file.	<ul style="list-style-type: none"> Terminate any unnecessary applications. Add more memory to the personal computer.
102	The setting file path is too long.	<ul style="list-style-type: none"> Reinstall the DB Connection Service to the directory whose path name is shorter.
103	The setting file name indicates the directory.	<ul style="list-style-type: none"> Reinstall the DB Connection Service.
104	The setting file could not be opened.	
105	Description of the setting file is not correct.	<ul style="list-style-type: none"> Terminate other applications, and make the setting again with DB Connection Service Setting Tool. ☞ Page 173 Setting Items of DB Connection Service Setting Tool
108	The server port No. setting is not correct.	<ul style="list-style-type: none"> Configure the settings again with DB Connection Service Setting Tool. ☞ Page 173 Setting Items of DB Connection Service Setting Tool
109	The server port No. setting is out of range.	
110	The timeout time setting is not correct.	
111	The timeout time setting is out of range.	
112	There are too many connection-permitted IP address settings.	
113	Description of the connection-permitted IP address setting is not correct.	
114	The mask bit length setting of the connection-permitted IP address is not correct.	
115	The mask bit length setting of the connection-permitted IP address is out of range.	
116	The access log setting is not correct.	
117	The setting of the access log file name is not correct.	
118	The access log file name is too long.	

Error event ID	Error description and cause	Corrective action	
119	The maximum file size setting for the access log is not correct.	<ul style="list-style-type: none"> • Configure the settings again with DB Connection Service Setting Tool.  Page 173 Setting Items of DB Connection Service Setting Tool	
120	The maximum file size setting for the access log is out of range.		
121	The maximum number of access log files is not set correctly.		
122	The maximum number of access log files is out of range.		
123	The SQL failure log setting is not correct.		
124	The setting of the SQL failure log file name is not correct.		
125	The SQL failure log file name is too long.		
126	The maximum file size setting for the SQL failure log is not correct.		
127	The maximum file size setting for the SQL failure log is out of range.		
128	The maximum number of SQL failure log files is not set correctly.		
129	The maximum number of SQL failure log files is out of range.		
401	The computer ran out of memory when initializing the access log file.		<ul style="list-style-type: none"> • Terminate any unnecessary applications. • Add more memory to the personal computer.
402	The computer ran out of resources when initializing the access log file.		
403	The full path name of the access log file is too long.	<ul style="list-style-type: none"> • Shorten the path to the access log file with DB Connection Service Setting Tool.  Page 173 Setting Items of DB Connection Service Setting Tool	
404	The access log file could not be opened.	<ul style="list-style-type: none"> • If no directory exists for storing the access log file, create it. • When the attribute of the access log file is set to read-only, cancel the setting. • If read/write is disabled for the access log file, enable it in the security setting. • When the access log file name represents a directory, rename or delete the directory. • When the access log file has been open in another application, terminate the application. • Check the disk device for any fault. 	
405	The log could not be written to the access log file.	<ul style="list-style-type: none"> • When the disk space is full, ensure a free disk space. • When the access log file has been open in another application, terminate the application. • Check the disk device for any fault. 	
406	Failed to delete an old access log file.	<ul style="list-style-type: none"> • When the attribute of the oldest access log file is set to read-only, cancel the setting. • If read/write is disabled for the oldest access log file, enable it in the security setting. • When the oldest access log file has been open in another application, terminate the application. • Check the disk device for any fault. 	
407	Failed to rename the access log file.	<ul style="list-style-type: none"> • When the attributes of the new and old access log files are set to read-only, cancel the setting. • If read/write is disabled for the new and old access log files, enable it in the security setting. • When the new and old access log files have been open in another application, terminate the application. • Check the disk device for any fault. 	
501	The computer ran out of memory when initializing the SQL failure log file.	<ul style="list-style-type: none"> • Terminate any unnecessary applications. • Add more memory to the personal computer. 	
502	The computer ran out of resources when initializing the SQL failure log file.		
503	The full path name of the SQL failure log file is too long.	<ul style="list-style-type: none"> • Shorten the path to the SQL failure log file with DB Connection Service Setting Tool.  Page 173 Setting Items of DB Connection Service Setting Tool	

Error event ID	Error description and cause	Corrective action
504	The SQL failure log file could not be opened.	<ul style="list-style-type: none"> • If no directory exists for storing the SQL failure log file, create it. • When the attribute of the SQL failure log file is set to read-only, cancel the setting. • If read/write is disabled for the SQL failure log file, enable it in the security setting. • When the SQL failure log file name represents a directory, rename or delete the directory. • When the SQL failure log file has been open in another application, terminate the application. • Check the disk device for any fault.
505	The log could not be written to the SQL failure log file.	<ul style="list-style-type: none"> • When the disk space is full, ensure a free disk space. • When the SQL failure log file has been open in another application, terminate the application. • Check the disk device for any fault.
506	Failed to delete an old SQL failure log file.	<ul style="list-style-type: none"> • When the attribute of the oldest SQL failure log file is set to read-only, cancel the setting. • If read/write is disabled for the oldest SQL failure log file, enable it in the security setting. • When the oldest SQL failure log file has been open in another application, terminate the application. • Check the disk device for any fault.
507	Failed to rename the SQL failure log file.	<ul style="list-style-type: none"> • When the attributes of the new and old SQL failure log files are set to read-only, cancel the setting. • If read/write is disabled for the new and old SQL failure log files, enable it in the security setting. • When the new and old SQL failure log files have been open in another application, terminate the application. • Check the disk device for any fault.

■Event log output error list of DB Connection Service Client (source name: DBCnctClient)

Error code	Error description and cause	Corrective action
50	Unable to start DB Connection Service Client.	<ul style="list-style-type: none"> • Terminate unnecessary applications. • Add more memory to the computer.
51		
52		
53		

Access log of DB Connection Service

Error code	Error description and cause	Corrective action
0x20100001	(Service Not Start.) Failed to start the service due to insufficient memory.	<ul style="list-style-type: none"> • Terminate any unnecessary applications. • Add more memory to the personal computer.
0x20100002	(Service Not Start.) Failed to start the service due to insufficient resources.	
0x20100011	(Service Not Start.) Failed to start the service due to failure of the server port initialization.	<ul style="list-style-type: none"> • If a firewall software has been installed, make the specified server port operational.
0x20100012	(Service Not Start.) Another application has opened the server port.	<ul style="list-style-type: none"> • Terminate the application that has opened the server port. • Set another server port No. with DB Connection Service Setting Tool. <p> Page 173 Setting Items of DB Connection Service Setting Tool</p>
0x20200001	(Not Initialize a service for each client: [IP address]) Failed to initialize a service for each client due to insufficient memory.	<ul style="list-style-type: none"> • Terminate any unnecessary applications. • Add more memory to the personal computer.
0x20200002	(Deny network connection request from [IP address]) Rejected the connection request from the non-permitted IP address.	<ul style="list-style-type: none"> • Using DB Connection Service Setting Tool, add the IP address to those with connection permission. <p> Page 173 Setting Items of DB Connection Service Setting Tool</p>
0x20300001	(SID [Session ID]: Request Receive Error: [IP address]) Failed to receive data due to insufficient memory.	<ul style="list-style-type: none"> • Terminate any unnecessary applications. • Add more memory to the personal computer.
0x20300010	(SID [Session ID]: Request Receive Error: [IP address]) Connection disconnected during request reception.	<ul style="list-style-type: none"> • Check if it is connected to the network. • Check if the gateway and/or hub is operating.
0x20300011	(SID [Session ID]: Request Receive Error: [IP address]) Timed out during request reception.	<ul style="list-style-type: none"> • Check if the power of the GOT has not been turned off.
0x20300012	(SID [Session ID]: Request Receive Error: [IP address]) Detected failure of the MES interface module while waiting for or receiving a request.	
0x20300013	(SID [Session ID]: Request Receive Error: [IP address]) Receive I/O error	
0x20300014	(SID [Session ID]: Request Receive Error: [IP address]) Buffer overrun (Request length exceeded)	<ul style="list-style-type: none"> • Check the source IP address setting. • Check the version of a system application (extended function) of [MES Interface].
0x20300015	(SID [Session ID]: Request Receive Error: [IP address]) Received an invalid request.	
0x20310010	(SID [Session ID]: Response Transmit Error: [IP address]) Failed to transmit a response due to disconnection.	<ul style="list-style-type: none"> • Check if it is connected to the network. • Check if the power of the GOT has not been turned off.
0x20310011	(SID [Session ID]: Response Transmit Error: [IP address]) Timed out during response transmission.	
0x20310012	(SID [Session ID]: Response Transmit Error: [IP address]) Detected failure of the MES interface module during response transmission.	
0x20310013	(SID [Session ID]: Response Transmit Error: [IP address]) Send I/O error	
0x20400001	(SID [Session ID]: DB Connect: [Data source]: [User]: Failed) Failed in DB connection due to insufficient memory.	<ul style="list-style-type: none"> • Terminate any unnecessary applications. • Add more memory to the personal computer.
0x20400002	(SID [Session ID]: DB Connect: [Data source]: [User]: Failed) Failed in DB connection due to insufficient resources.	
0x20400010	(SID [Session ID]: DB Connect: [Data source]: [User]: Failed) Invalid DB connection request	<ul style="list-style-type: none"> • Check the source IP address setting. • Check the version of a system application (extended function) of [MES Interface].
0x20400020	(SID [Session ID]: DB Connect: [Data source]: [User]: Failed) Failed to create a DB handle.	<ul style="list-style-type: none"> • Terminate any unnecessary applications. • Add more memory to the personal computer.

Error code	Error description and cause	Corrective action
0x20400022	(SID [Session ID]: DB Connect: [Data source]: [User]: Failed) Failed in DB connection.	<ul style="list-style-type: none"> Set correct data source name, user name, and password in [Server service settings] of [MES interface setting]. ☞ Page 78 Server Service Settings Check if the personal computer is restarted after the database is installed. Restart the personal computer if not restarted. When the server computer is running a 64 bit OS, call the [ODBC Data Source Administrator] dialog box. To call this dialog box, enter the following command line in the Command Prompt. %SystemRoot%\SysWOW64\odbcad32.exe
0x20600001	(SID [Session ID]: SQL<...>: Failed) (SID [Session ID]: COMMIT: Failed) (SID [Session ID]: ROLLBACK: Failed) (SID [Session ID]: GetNext: Failed) (SID [Session ID]: Reset: Failed) Failed in SQL execution due to insufficient memory.	<ul style="list-style-type: none"> Terminate any unnecessary applications. Add more memory to the personal computer.
0x20600002	(SID [Session ID]: SQL<...>: Failed) (SID [Session ID]: COMMIT: Failed) (SID [Session ID]: ROLLBACK: Failed) (SID [Session ID]: GetNext: Failed) (SID [Session ID]: Reset: Failed) Failed in SQL execution due to insufficient resources.	
0x20600010	(SID [Session ID]: SQL<...>: Failed) (SID [Session ID]: COMMIT: Failed) (SID [Session ID]: ROLLBACK: Failed) (SID [Session ID]: GetNext: Failed) (SID [Session ID]: Reset: Failed) Invalid SQL execution request	<ul style="list-style-type: none"> Check the source IP address setting. Check the version of a system application (extended function) of [MES Interface].
0x20600020	(SID [Session ID]: SQL<...>: Failed) (SID [Session ID]: COMMIT: Failed) (SID [Session ID]: ROLLBACK: Failed) (SID [Session ID]: GetNext: Failed) (SID [Session ID]: Reset: Failed) DB Connection Service does not support the SQL instruction to be executed.	
0x20600021	(SID [Session ID]: SQL<...>: Failed) (SID [Session ID]: COMMIT: Failed) (SID [Session ID]: ROLLBACK: Failed) (SID [Session ID]: GetNext: Failed) (SID [Session ID]: Reset: Failed) Failed in preparation before SQL execution.	<ul style="list-style-type: none"> Correctly set a database type for [DB server setting], a table name in the job for the communication action setting, or the resource data send action setting in [MES Interface]. ☞ Page 78 Server Service Settings
0x20600022	(SID [Session ID]: SQL<...>: Failed) (SID [Session ID]: COMMIT: Failed) (SID [Session ID]: ROLLBACK: Failed) (SID [Session ID]: GetNext: Failed) (SID [Session ID]: Reset: Failed) Failed to obtain the number of fields in the record that is to be obtained by the SQL execution.	
0x20600023	(SID [Session ID]: SQL<...>: Failed) (SID [Session ID]: COMMIT: Failed) (SID [Session ID]: ROLLBACK: Failed) (SID [Session ID]: GetNext: Failed) (SID [Session ID]: Reset: Failed) Failed in SQL execution.	<ul style="list-style-type: none"> Correct the following MES interface settings. In [DB server setting], set a correct database type. In the communication action setting or resource data send action setting of the job, set a correct table name, field names, Select/Update/Delete conditions, and types of data to be stored into the fields. ☞ Page 78 Server Service Settings
0x20600025	(SID [Session ID]: SQL<...>: Failed) (SID [Session ID]: COMMIT: Failed) (SID [Session ID]: ROLLBACK: Failed) (SID [Session ID]: GetNext: Failed) (SID [Session ID]: Reset: Failed) No record was updated or inserted by the SQL execution.	<ul style="list-style-type: none"> In [MES interface setting], set update conditions correctly for the Communication action setting of the Job settings. ☞ Page 104 Setting items in Communication action Check if the database has been filled with registered data.
0x2060002B	(SID [Session ID]: *** Transmitting Commit Success Response Failed. ***) Failed to transmit the COMMIT success response.	<ul style="list-style-type: none"> Check if it is connected to the network. Check if the gateway and/or hub is operating. Check if the power of the GOT has not been turned off.

Error code	Error description and cause	Corrective action
0x20700001	(ProgramExec: [IP address]: <...>: Failed) Failed in remote execution due to insufficient memory.	<ul style="list-style-type: none"> • Terminate any unnecessary applications. • Add more memory to the personal computer.
0x20700002	(ProgramExec: [IP address]: <...>: Failed) Failed in remote execution due to insufficient resources.	
0x20700010	(ProgramExec: [IP address]: <...>: Failed) Invalid remote execution request	<ul style="list-style-type: none"> • Check the source IP address setting. • Check the version of a system application (extended function) of [MES Interface].
0x20700020	(ProgramExec: [IP address]: <...>: Failed) Failed to log on in remote execution.	<ul style="list-style-type: none"> • In [MES interface setting], set correct user name and password for the application server setting. ☞ Page 78 Server Service Settings • Check if the user account is invalid or not by Administrative Tools of Windows. • Check if the setting is forcing the user to enter password at next logon by Administrative Tools of Windows. • Check if the user password is expired or not by Administrative Tools of Windows®.
0x20700021	(ProgramExec: [IP address]: <...>: Failed) Failed to load user profile during remote execution.	<p>No user profile for Windows has been created. Confirm that the user ID set for the application server setting of the MES interface setting can be used to log on Windows, and reexecute.</p>
0x20700023	(ProgramExec: [IP address]: <...>: Failed) Failed to generate process during remote execution.	<ul style="list-style-type: none"> • Check if the application to be executed in remote execution exists or not. • Check if the name of the application to be executed in remote execution is a directory. • Make a proper security setting for the application to be executed in remote execution.
0x20700024	(ProgramExec: [IP address]: <...>: Failed) Timeout or aborted of waiting to complete remote execution.	<ul style="list-style-type: none"> • Set the longer time to the DB access timeout for DB Connection Service Setting Tool. • Exit the application for the remote execution before logging off.
0x20800010	(SID [Session ID]: TCPOpen Request Error: [IP address]) Invalid TCPOpen request	<ul style="list-style-type: none"> • Check the source IP address setting. • Check the version of a system application (extended function) of [MES Interface].

SQL failure log of DB Connection Service

Error code	Error description and cause	Corrective action
0x20600001	Failed in SQL execution due to insufficient memory.	<ul style="list-style-type: none"> • Terminate any unnecessary applications. • Add more memory to the personal computer.
0x20600002	Failed in SQL execution due to insufficient resources.	
0x20600020	DB Connection Service does not support the SQL instruction to be executed.	<ul style="list-style-type: none"> • Check the source IP address setting. • Check the version of a system application (extended function) of [MES Interface].
0x20600021	Failed in preparation before SQL execution.	<ul style="list-style-type: none"> • Correctly set a database type for [DB server setting], a table name in the job for the communication action setting, or the resource data send action setting in [MES Interface]. ☞ Page 78 Server Service Settings
0x20600022	Failed to obtain the number of fields in the record that is to be obtained by the SQL execution.	
0x20600023	Failed in SQL execution.	<ul style="list-style-type: none"> • Correct the following MES interface settings. In [Server service setting], set a correct database type. In [Job settings], set a correct table name, field names, Select/Update/Delete conditions, and types of data to be stored into the fields in the communication action setting or resource data send action setting. ☞ Page 78 Server Service Settings
0x20600025	No record was updated or inserted by the SQL execution.	<ul style="list-style-type: none"> • In [MES interface setting], set update conditions correctly for the Communication action setting of the Job settings. ☞ Page 104 Setting items in Communication action • Check if the database has been filled with registered data.
0x2060002B	(Data source name: *** Transmitting Commit Success Response Failed. ***) Failed to transmit the COMMIT success response.	<ul style="list-style-type: none"> • Check if it is connected to the network. • Check if the gateway and/or hub is operating. • Check if the power of the GOT has not been turned off.

- ☞ Page 197 Usable Characters and ASCII Code Tables by Setting Items
- ☞ Page 200 About Monitoring Interval Timeout
- ☞ Page 202 Warning Messages in Windows Vista(R)
- ☞ Page 206 Tables for Used Terms
- ☞ Page 207 Application Example of MES Interface Function

9.1 Usable Characters and ASCII Code Tables by Setting Items

ASCII code table

	2	3	4	5	6	7
0	(SP)	0	@	P	`	p
1	!	1	A	Q	a	q
2	[2	B	R	b	r
3	#	3	C	S	c	s
4	\$	4	D	T	d	t
5	%	5	E	U	e	u
6	&	6	F	V	f	v
7	'	7	G	W	g	w
8	(8	H	X	h	x
9)	9	I	Y	i	y
A	*	:	J	Z	j	z
B	+	;	K	[k	{
C	,	<	L	\	l	
D	-	=	M]	m	}
E	.	>	N	^	n	~
F	/	?	O	_	o	

Characters applicable to item names, component names, variable names, etc.

ASCII characters

The shaded characters can be used.

(However, neither a number nor an underscore (_) can be used as the first character.)

	2	3	4	5	6	7
0	(SP)	0	@	P	`	p
1	!	1	A	Q	a	q
2	[2	B	R	b	r
3	#	3	C	S	c	s
4	\$	4	D	T	d	t
5	%	5	E	U	e	u
6	&	6	F	V	f	v
7	'	7	G	W	g	w
8	(8	H	X	h	x
9)	9	I	Y	i	y
A	*	:	J	Z	j	z
B	+	;	K	[k	{
C	,	<	L	\	l	
D	-	=	M]	m	}
E	.	>	N	^	n	~
F	/	?	O	_	o	

Reserved terms

The following words are reserved terms and therefore cannot be used.

Reserved terms	
A	abstract
B	boolean, break, byte
C	case, catch, char, class, cons, continue
D	DATETIME, debugger, default, delete, do, double
E	else, enum, event, exit, export, extends
F	false, final, finally, float, for, function
G	goto
I	if, implements, import, in, include, Infinity, instanceof, int, interface, invoke
L	long
N	NaN, native, new, null
O	oneshot
P	package, private, protected, public
R	return
S	short, static, super, switch, synchronized, SYSTEM
T	this, throw, throws, trace, transient, true, try, typeof
U	undefined
V	var, void, volatile
W	while, with

Characters applicable to character string constants, etc.

The shaded characters can be used.

	2	3	4	5	6	7
0	(SP)	0	@	P	`	p
1	!	1	A	Q	a	q
2	[2	B	R	b	r
3	#	3	C	S	c	s
4	\$	4	D	T	d	t
5	%	5	E	U	e	u
6	&	6	F	V	f	v
7	'	7	G	W	g	w
8	(8	H	X	h	x
9)	9	I	Y	i	y
A	*	:	J	Z	j	z
B	+	;	K	[k	{
C	,	<	L	\	l	
D	-	=	M]	m	}
E	.	>	N	^	n	~
F	/	?	O	_	o	

Characters applicable to field names, table names, etc.

The shaded characters can be used.

(However, a number cannot be used as the first character.)

	2	3	4	5	6	7
0	(SP)	0	@	P	`	p
1	!	1	A	Q	a	q
2	[2	B	R	b	r
3	#	3	C	S	c	s
4	\$	4	D	T	d	t
5	%	5	E	U	e	u
6	&	6	F	V	f	v
7	'	7	G	W	g	w
8	(8	H	X	h	x
9)	9	I	Y	i	y
A	*	:	J	Z	j	z
B	+	;	K	[k	{
C	,	<	L	\	l	
D	-	=	M]	m	}
E	.	>	N	^	n	~
F	/	?	O	_	o	

9.2 About Monitoring Interval Timeout

Depending on the number of set jobs or the trigger condition setting, the monitoring interval timeout may be generated in the MES interface function.

This section explains monitoring interval timeout.

Point

Although up to 64 jobs can be registered and trigger conditions can be set to each of them, some adjustment in trigger condition settings is required depending on the number of the jobs.

Monitoring interval timeout

The monitoring interval timeout means that the trigger detection time (the time provided for the trigger monitoring function to determine if the trigger conditions are met) becomes longer than the time limit of trigger occurrence (monitoring interval).

When a monitoring interval timeout occurs, the job may not be executed even though set trigger conditions are met.

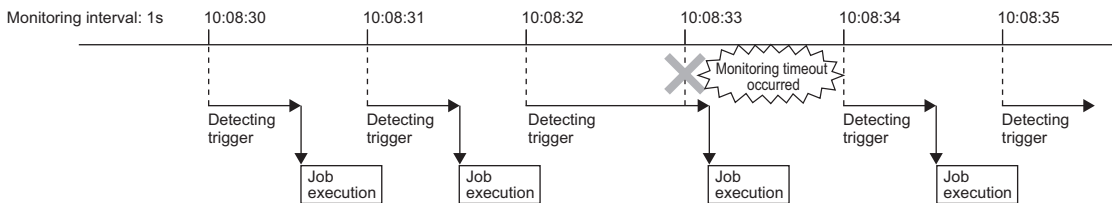

Causes of monitoring interval timeout

A monitoring interval timeout occurs when the total jobs cannot be processed in a monitoring interval.

The monitoring interval includes the following sampling intervals.

- Sampling interval set for [Sampling setting] in [Device tag settings] when selecting [Value monitoring startup] or [Handshake operation] for [Trigger conditions] in [Job settings]

☞ Page 68 Device Tag Settings

- Sampling interval set for [Trigger conditions] when selecting [Specified time period startup] for [Trigger conditions] in [Job settings]

☞ Page 87 Setting items in Trigger conditions

Point

In the following cases, monitoring interval timeouts do not occur.

- When selecting [Time specification startup] or [GOT Initializing] for [Trigger conditions] in [Job settings]
- When the total jobs are processed in a monitoring interval

(Example 1)

When the time for trigger detection is shorter than the monitoring interval

Since processing for trigger detection is performed within each monitoring interval, no monitoring interval timeout occurs.

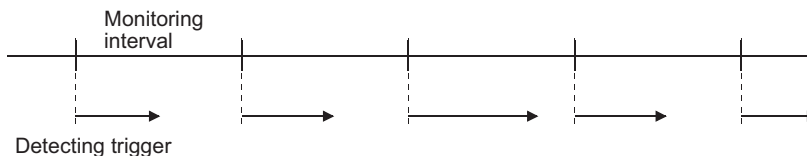

(Example 2)

When the time for trigger detection is longer than the monitoring interval

Since processing for trigger detection cannot be completed within each monitoring interval, monitoring interval timeout occurs.

The processing for trigger detection is performed at the next timing after the monitoring interval.

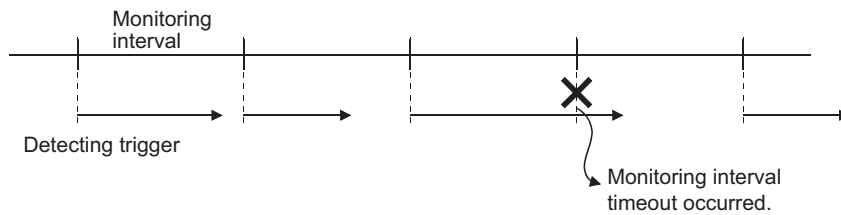

Point

If monitoring interval timeout occurs, set the monitoring interval for each job longer than the processing time for trigger detection.

For details on the processing time for trigger detection, refer to the following.

Page 201 Processing time for trigger detection

How to check the monitoring interval timeout

The monitoring interval timeout can be checked in the Monitoring interval timeout count area (GS275).

For the Monitoring interval timeout count area, refer to the following.

Page 39 Monitoring interval timeout count (GS275)

Processing time for trigger detection

Total number of trigger conditions × 100 (ms) can be assumed as a processing time for trigger detection.

Total number of trigger conditions is the total of those set for individual jobs.

Note that [Trigger 1] and [Trigger 2] are counted separately.

Also, [Handshake operation] must be counted as "2" for each.

(Example 3)

Processing time for trigger detection, which is required for [Job settings] shown below

Since the number of trigger conditions is 12, the assumed processing time for trigger detection is: $12 \times 100 = 1200$ (ms)

Setting a value of 1200ms or longer to the monitoring interval in all jobs can prevent occurrence of the monitoring interval timeout.

Job name	Trigger conditions [Trigger 1]	Trigger conditions [Trigger 2]
Job 1	[Value monitoring startup]	[Value monitoring startup]
Job 2	[Value monitoring startup]	[Value monitoring startup]
Job 3	[Handshake operation]	-
Job 4	[Specified time period startup]	-
Job 5	[Time specification startup]	-
Job 6	[Value monitoring startup]	[Value monitoring startup]
Job 7	[Handshake operation]	-

9.3 Warning Messages in Windows Vista(R)

Overview of warning messages

In Windows Vista®, a User Account Control feature has been added.

When installing/uninstalling GT Works3, or starting [DB Connection Service Setting Tool], a warning message is displayed.

Methods for disabling warning messages

Point

The User Account Control (UAC) is provided to protect the system from being destroyed (e.g. prevention of start-up of a program which will execute an unintended operation).

Before taking either of the methods described below, understand that the security function offered by UAC will be disabled and consider the risk.

The following two methods are available for preventing warning messages.

Disabling the User Account Control function

The following shows a procedure for disabling the User Account Control function.

1. Select [Start] - [Control Panel].

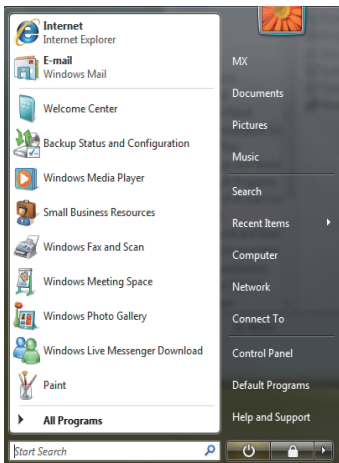

↓

2. Select [User Accounts].

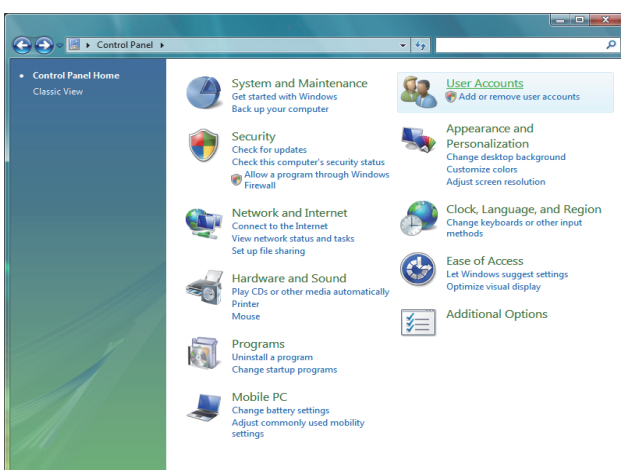

↓

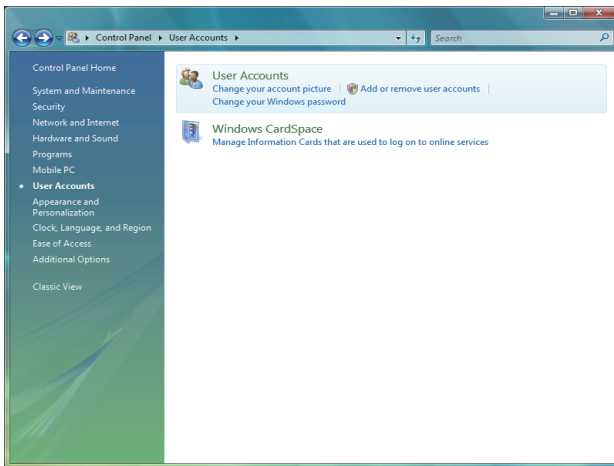

↓

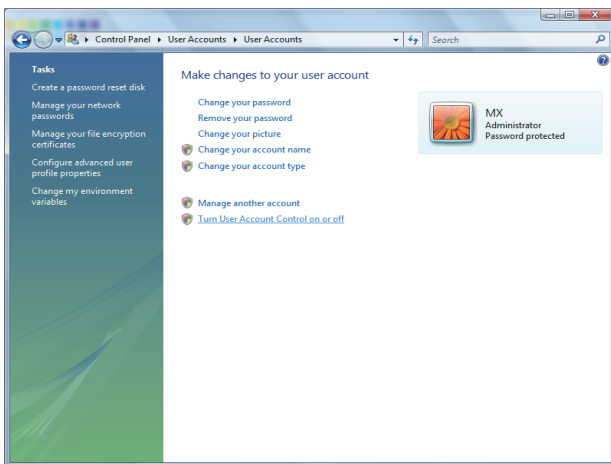

↓

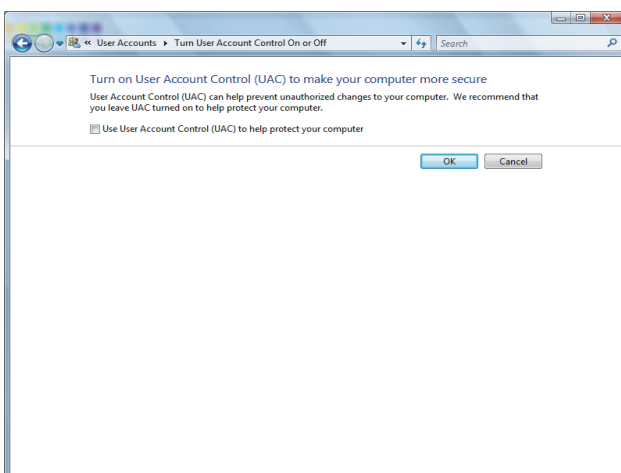

↓

(End)

3. Select [User Accounts].

4. Select [Turn User Account Control on or off]. When User Account Control is enabled in Windows Vista®, the following screen appears. Click the [Continue] button.

5. Deselect [Turn on User Account Control (UAC) to make your computer more secure].

Method for permitting programs without any warning message

The following shows a procedure for permitting programs without any warning message.

1. Select [Start] - [Control Panel].

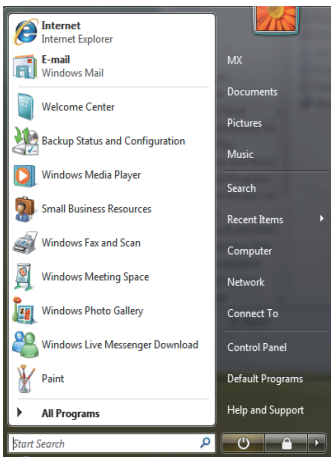

↓

2. Select [Classic View].

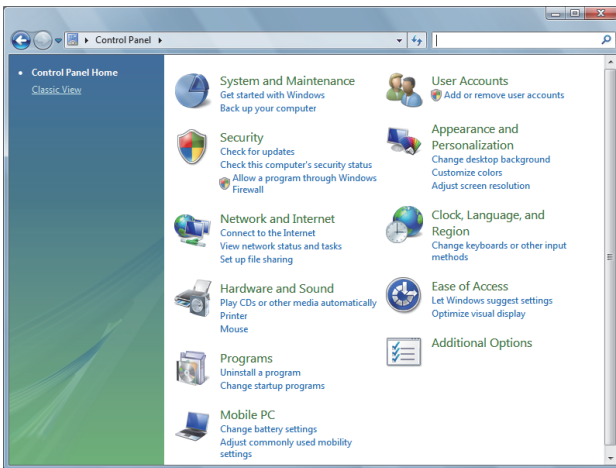

↓

3. Select [Administrative Tools].

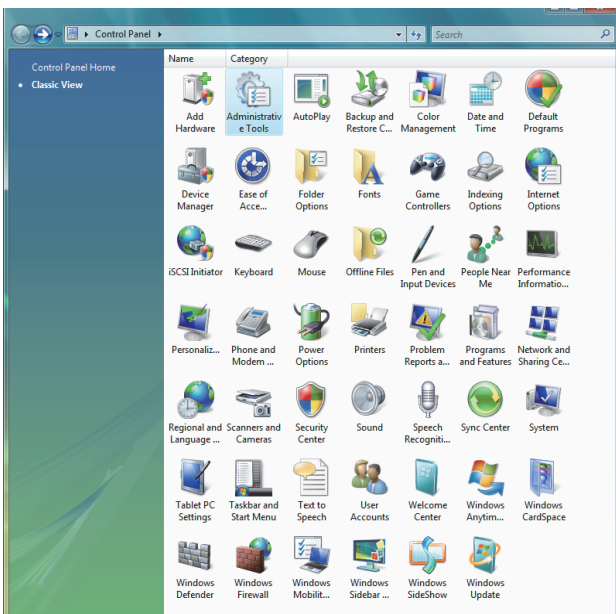

↓

4. Select [Local Security Policy]. When User Account Control is enabled in Windows Vista®, the following screen appears. Click the **Continue** button.

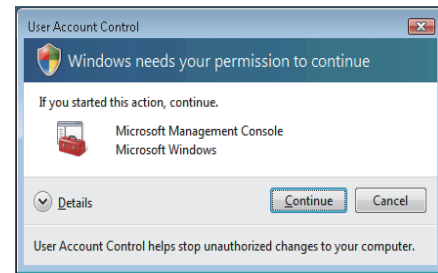
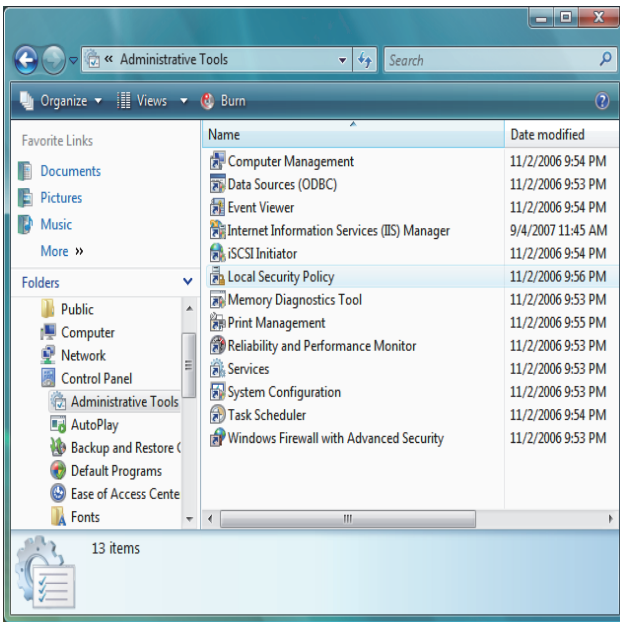

5. Select [Local Policies].

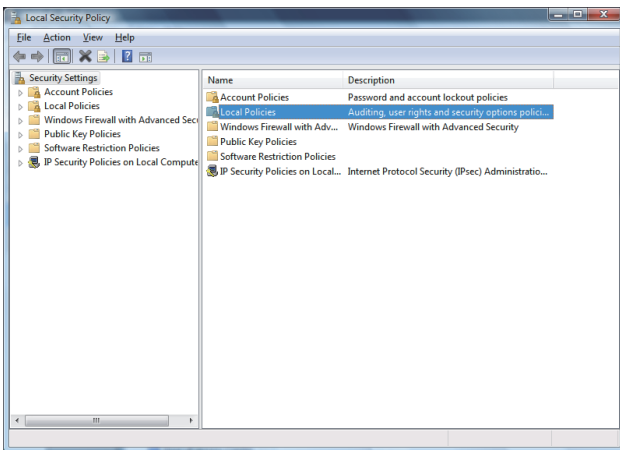

6. Select [Security Options].

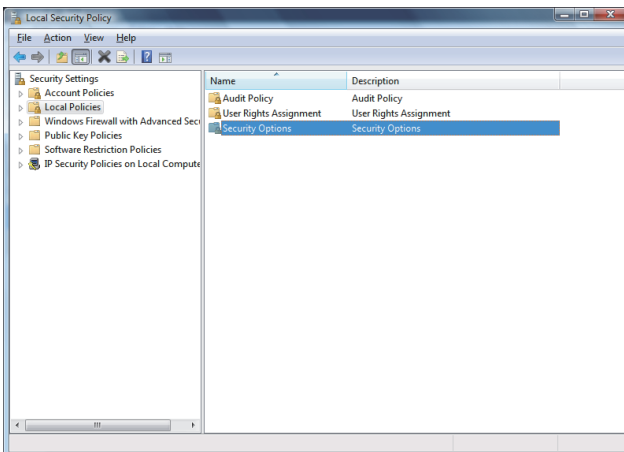

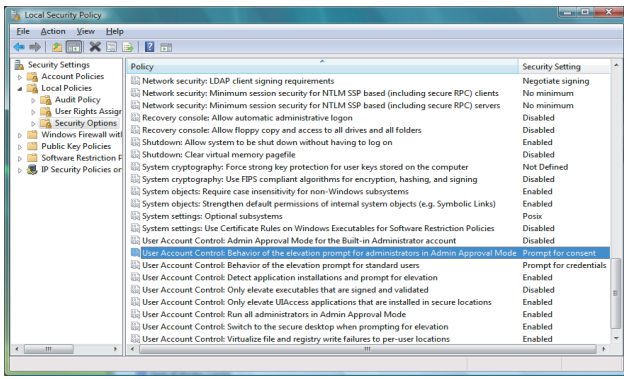

7. Select [User Account Control: Behavior of the elevation prompt for administrators in Admin Approval Mode, Prompt for consent].

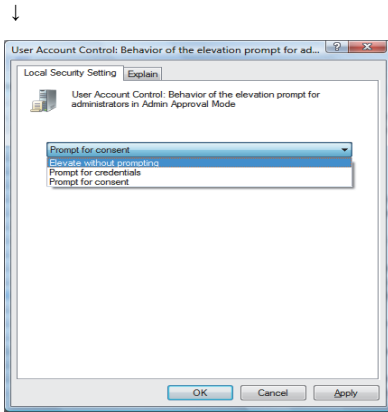

8. Select [Elevate without prompting] on the [Local Security Setting] tab, and click the button.

(End)

9.4 Tables for Used Terms

In GT Designer3, some different terms are used for the same meaning on the MES interface function setting screen and other setting screens.

They are listed in the tables shown below.

In the case of Device tag settings

MES interface function setting	Others
Single word	Signed Decimal (Data length: 16 bits) Signed BIN Signed BIN16
Double word	Signed Decimal (Data length: 32 bits) Signed BIN32
Real number	Real
String	ASCII Display
bytes	Digits

In the case of Job settings

MES interface function setting	Others
Specified time period startup	Sampling
Value monitoring startup	Rise Fall
=	==
≠	! =
<-	=
Variable	temporary works

9.5 Application Example of MES Interface Function

The following is an example of the system where the MES interface function is used.

Example) A system where manufacturing information is collected in a GOT and managed in a database

In the company-wide integrated system in which parts acceptance, manufacturing processing, assembly, shipment, and inventory control are managed, information of the actual performance is managed in a database using the MES interface function.

A process line control PLC handles information on process line (equipment) stop, running time, down time, quantity of production, and the number of rejected products.

On the GOT, the status of each process line is displayed, allowing control by operators.

By the MES interface function, the termination time of the process line, regularly-checked operation rate, and fraction defective information are managed.

The system configuration is illustrated below.

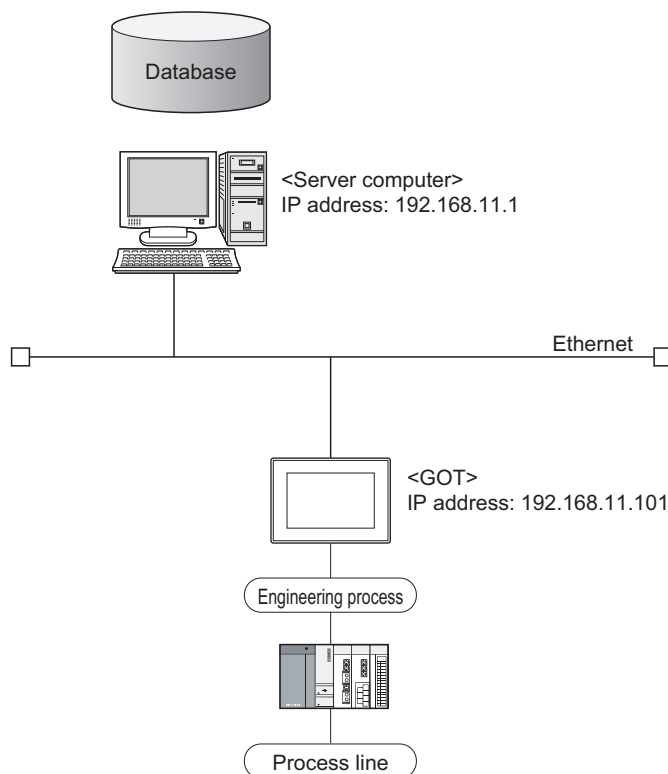

Setup on the server computer (database)

The actual performance for every 5 seconds, and fraction defective and operation rate for every hour are managed using the database.

■Table setting

- Table name: PROCESS
- Field:

Name	Data type	Size	Scale	NULL	Default
DATETIME	CHAR	32		Possible	
PERFORMANCE	NUMBER	10	0	Possible	
REJECT	NUMBER	10	1	Possible	
WORKINGRATE	NUMBER	10	1	Possible	

- ODBC setting

ODBC data source name: PROCESS

Driver: OracleHome2

TNS service name: PROCESS

- DB Connection Service setting

Service port No.: 5112

Timeout: 10 seconds

Setup on the configuration computer (GT Designer3)

■IP address setting

- Communication Settings
- Extend I/F-1: 1
 CH No.: *
 Driver: Ethernet Download
- Detailed setting
- IP address: 192.168.11.101
 Ethernet Download: 5014
 Default Gateway: 0.0.0.0
 Subnet mask: 255.255.255.0

■Script

No.	Trigger	Operation	Remarks
1	During M101=ON	[w:GD540]=[w:D540]; [w:GD542]=[w:D542]; [b:M101]=0;	M101: Operation stop flag D540: Operation time D542: Accumulated down time
2	When M102 rises	[w:GD544]=[w:D544]; [w:GD546]=[w:D546]; [b:GB102]=[b:M102]; [b:M102]=0;	M102: Completion notification (The GOT collects PLC information upon completion of the processing.)

■Screen design

For how to create the screens, refer to the following manual.

 GT Designer3 (GOT2000) Screen Design Manual

■MES interface setting

- Device tag settings

Device tag name	Sampling cycle	Component name	Data type	Device
Normal sampling	5 seconds	Operation time	Single word	GD540
		Accumulated down time	Single word	GD542
		Performance	Single word	GD544
		Rejected	Single word	GD546
		Fraction defective	Real number	GD548
		WorkingRate	Real number	GD550
Sync. trigger	5 seconds	Stop flag	Bit	GB101

- Server service settings

Service name	Type	IP address/Port No.
DBServer	Database server	192.168.11.1

- Job settings

Job name	Trigger	Processing	Remarks
Startup	Startup	• Initializing tags	
Status report	Value monitoring GB102=ON	• Inserting the time and performance data into the database (DBServer)	Calculation of the operation rate
Regular report	Specified time period 1 hour	• Calculating fraction defective from the actual performance and the number of rejected products • Calculating the operation rate from the operation time and the accumulated down time • Inserting the time, operation rate and fraction defective into the database (DBServer)	• Temporary variables F_DEFECT: Fraction defective OPERAT_R: Operation rate

Operation results

The operation results (database data) of the above system are as follows:

DATETIME	PERFORMANCE	REJECT	WORKINGRATE
2006/3/2 10:12:01	1		
2006/3/2 10:24:32	2		
2006/3/2 10:53:17	3		
2006/3/2 11:00:00		0	87.35
2006/3/2 11:05:42	4		
2006/3/2 11:17:31	5		
:	:	:	:

REVISIONS

* The manual number is given on the bottom left of the back cover.

Print Date	* Manual Number	Revision
Jan., 2014	SH(NA)-081228ENG-A	GT Works3 Version 1.108N
Apr., 2014	SH(NA)-081228ENG-B	GT Works3 Version 1.111R <ul style="list-style-type: none"> • GT25 is supported. • Writing errors have been corrected.
Oct., 2014	SH(NA)-081228ENG-C	GT Works3 Version 1.122C <ul style="list-style-type: none"> • Compatible with Windows 8.1 and Windows Server 2012 R2 • Compatible with Oracle 12c and Access2013
Apr., 2015	SH(NA)-081228ENG-D	<ul style="list-style-type: none"> • The following SD cards are supported. NZ1MEM-2GBSD, NZ1MEM-4GBSD, NZ1MEM-8GBSD, NZ1MEM-16GBSD
May, 2016	SH(NA)-081228ENG-E	GT Works3 Version 1.155M <ul style="list-style-type: none"> • Compatible with Microsoft SQL Server 2014
Aug., 2016	SH(NA)-081228ENG-F	GT Works3 Version 1.160S <ul style="list-style-type: none"> • The GOT2000 series Ethernet communication unit (GT25-J71E71-100) is supported.
Jan., 2017	SH(NA)-081228ENG-G	GT Works3 Version 1.170C <ul style="list-style-type: none"> • Compatible with Windows 10 • Writing errors have been corrected.
Jun., 2017	SH(NA)-081228ENG-H	GT Works3 Version 1.180N <ul style="list-style-type: none"> • Compatible with Microsoft Windows Server 2016 • Compatible with Microsoft SQL Server 2016 and Microsoft Access 2016 • Compatible with DB Connection Service Version 2 and DB Connection Service Setting Tool Version 2 • [Option setting] has been changed to [System setting]. • The additional setting is supported.
Dec., 2017	SH(NA)-081228ENG-I	Partial corrections.
Apr., 2018	SH(NA)-081228ENG-J	GT Works3 Version 1.195D <ul style="list-style-type: none"> • Compatible with MySQL and PostgreSQL • [Delete] has been added as a communication action. • Importing and exporting the MES interface settings are supported.
Jan., 2019	SH(NA)-081228ENG-K	GT Works3 Version 1.210U <ul style="list-style-type: none"> • Compatible with Microsoft SQL Server 2017
Oct., 2019	SH(NA)-081228ENG-L	Partial corrections.
Oct., 2020	SH(NA)-081228ENG-M	Partial corrections.
Jan., 2021	SH(NA)-081228ENG-N	Partial corrections.
May, 2021	SH(NA)-081228ENG-O	<ul style="list-style-type: none"> • Changed the name of the direct CPU connection to the direct CPU connection (serial). • Partial corrections.
Apr., 2022	SH(NA)-081228ENG-P	GT Works3 Version 1.275M <ul style="list-style-type: none"> • Partial corrections.
Oct., 2022	SH(NA)-081228ENG-Q	GT Works3 Version 1.285X <ul style="list-style-type: none"> • Compatible with Microsoft Windows Server 2019 • Compatible with Oracle 18c, Oracle 19c, Microsoft SQL Server 2019, and Microsoft Access 2019
Jan., 2023	SH(NA)-081228ENG-R	Partial corrections.
Apr., 2023	SH(NA)-081228ENG-S	GT Works3 Version 1.295H <ul style="list-style-type: none"> • GS2512-WXTBD is supported.

This manual confers no industrial property rights or any rights of any other kind, nor does it confer any patent licenses. Mitsubishi Electric Corporation cannot be held responsible for any problems involving industrial property rights which may occur as a result of using the contents noted in this manual.

©2014 MITSUBISHI ELECTRIC CORPORATION

Intellectual Property Rights

■Trademarks

MELDAS, MELSEC, iQ Platform, MELSOFT, GOT, CC-Link, CC-Link/LT, and CC-Link IE are trademarks or registered trademarks of Mitsubishi Electric Corporation in Japan and other countries.

Microsoft, Microsoft Access, Excel, SQL Server, Visual Basic, Visual C++, Visual C#, Windows, Windows NT, Windows Server, and Windows Vista are trademarks of the Microsoft group of companies.

MODBUS is a registered trademark of Schneider Electric SA.

DeviceNet is a trademark of ODVA (Open DeviceNet Vendor Association, Inc.).

VNC is a registered trademark of RealVNC Ltd. in the United States and other countries.

Unicode is a trademark or registered trademark of Unicode, Inc. in the United States and other countries.

PictBridge is a registered trademark of Canon Inc.

Adobe and Adobe Reader are registered trademarks of Adobe Systems Incorporated.

Oracle and JavaScript are registered trademarks of Oracle Corporation and/or its affiliates in the United States and other countries.

QR Code is a trademark or registered trademark of DENSO WAVE INCORPORATED in Japan, the United States, and/or other countries.

Anybus is a registered trademark of HMS Industrial Networks AB.

Android and Google Chrome are trademarks or registered trademarks of Google Inc.

IOS is a trademark or registered trademark of Cisco in the United States and other countries and is used under license.

Safari and iPhone are trademarks of Apple Inc. registered in the United States and other countries. The iPhone trademark is used under license from AIPHONE CO., LTD.

Intel and Intel Core are trademarks or registered trademarks of Intel Corporation in the United States and other countries.

Other company and product names herein are trademarks or registered trademarks of their respective owners.

■Copyrights

VS-FlexGrid Pro

Copyright © 2003 ComponentOne LLC.

The screens (screenshots) are used in accordance with the Microsoft Corporation guideline.

SH(NA)-081228ENG-S(2304)MEE

MODEL: GOT2000-O-MES-E

MODEL CODE: -

MITSUBISHI ELECTRIC CORPORATION

HEAD OFFICE: TOKYO BLDG., 2-7-3, MARUNOUCHI, CHIYODA-KU, TOKYO 100-8310, JAPAN
NAGOYA WORKS: 1-14, YADA-MINAMI 5-CHOME, HIGASHI-KU, NAGOYA 461-8670, JAPAN

When exported from Japan, this manual does not require application to the
Ministry of Economy, Trade and Industry for service transaction permission.

Specifications subject to change without notice.