

**MITSUBISHI** *Changes for the Better*

GT1155-QTBDQ, GT1155-QTBDA,  
GT1155-QSBDQ, GT1155-QSBDA,  
GT1150-QLBDQ, GT1150-QLBDA

**GT11 Dedicated to Bus Connection  
General Description**

MODEL	GT11-BUS-U-HW-E
MODEL CODE	1D7M70
IB(NA)-0800385ENG-C(0801)MEE	

This manual describes the part names, dimensions, mounting, and specifications of the product. Before use, read this manual and manuals of relevant products fully to acquire proficiency in handling and operating the product. Make sure to learn all the product information, safety information, and precautions.

And, store this manual in a safe place so that you can take it out and read it whenever necessary. Always forward it to the end user.

The company name and the product name to be described in this manual are the registered trademarks or trademarks of each company.

Effective November 2007  
Specifications are subject to change without notice.

© 2007 Mitsubishi Electric Corporation  
Japanese Manual Version IB-0800384-C

**Safety Precaution** (Read these precautions before using.)  
Before using this product, please read this manual and the relevant manuals introduced in this manual carefully and pay full attention to safety to handle the product correctly.

The precautions given in this manual are concerned with this product. In this manual, the safety precautions are ranked as "DANGER" and "CAUTION".

<b>DANGER</b>	Indicates that incorrect handling may cause hazardous conditions, resulting in death or severe injury.
<b>CAUTION</b>	Indicates that incorrect handling may cause hazardous conditions, resulting in medium or slight personal injury or physical damage.

Depending on circumstances, procedures indicated by "CAUTION" may also be linked to serious results.  
In any case, it is important to follow the directions for usage.

**DESIGN PRECAUTIONS** **DANGER**

- Some failures of the GOT or cable may keep the outputs on or off. An external monitoring circuit should be provided to check for output signals which may lead to a serious accident. Not doing so can cause an accident due to false output or malfunction.
- If a communication fault (including cable disconnection) occurs during monitoring on the GOT, communication between the GOT and programmable controller CPU is suspended and the GOT becomes inoperative. The programmable controller CPU goes down, and then the GT1155-QTBDQ, GT1155-QTBDA, GT1155-QSBDQ, GT1155-QSBDA, GT1150-QLBDQ, and GT1150-QLBDA become inoperative. A system where the GOT is used should be configured to perform any significant operation to the system by using the switches of a device other than the GOT on the assumption that a GOT communication fault will occur. Not doing so can cause an accident due to false output or malfunction.
- Do not use the GOT as the warning device that may cause a serious accident. An independent and redundant hardware or mechanical interlock is required to configure the device that displays and outputs serious warning. Failure to observe this instruction may result in an accident due to incorrect output or malfunction.
- Incorrect operation of the touch switch(s) may lead to a serious accident if the GOT backlight is gone out. When the GOT backlight goes out, the POWER LED flickers (green/orange) and the display section turns black and causes the monitor screen to appear blank, while the input of the touch switch(s) remains active. This may confuse an operator in thinking that the GOT is in "screensaver" mode, who then tries to release the GOT from this mode by touching the display section, which may cause a touch switch to operate. Note that the following occurs on the GOT when the backlight goes out.
  - The POWER LED flickers (green/orange) and the monitor screen appears blank.

**DESIGN PRECAUTIONS** **CAUTION**

- Do not bundle the control and communication cables with main-circuit, power or other wiring. Run the above cables separately from such wiring and keep them a minimum of 100mm (3.94in.) apart. Not doing so may cause a malfunction.

**MOUNTING PRECAUTIONS** **DANGER**

- Be sure to shut off all phases of the external power supply used by the system before mounting or removing the GOT to/from the panel. Not doing so can cause the unit to fail or malfunction.

**MOUNTING PRECAUTIONS** **CAUTION**

- Use the GOT in the environment that satisfies the general specifications described in this manual. Not doing so can cause an electric shock, fire, malfunction or product damage or deterioration.
- When mounting the GOT to the control panel, tighten the mounting screws in the specified torque range. Undertightening can cause the GOT to drop, short circuit or malfunction. Overtightening can cause a drop, short circuit or malfunction due to the damage of the screws or the GOT.
- When inserting/removing a CF card into/from the GOT, turn the CF card access switch off in advance. Failure to do so may corrupt data within the CF card.
- When inserting a CF card into the GOT, push it into the insertion slot until the CF card eject button will pop out. Failure to do so may cause a malfunction due to poor contact.
- When removing a CF card from the GOT, make sure to support the CF card by hand, as it may pop out. Failure to do so may cause the CF card to drop from the GOT and break.

**WIRING PRECAUTIONS** **DANGER**

- Be sure to shut off all phases of the external power supply used by the system before wiring. Failure to do so may result in an electric shock, product damage or malfunctions.
- Always ground the FG terminal of the GOT power to the protective ground conductor. Failure to do so may cause electric shocks and malfunctions.
- Correctly wire the GOT power supply section after confirming the rated voltage and terminal arrangement of the product. Not doing so can cause a fire or failure.
- Tighten the terminal screws of the GOT power supply section in the specified torque range. Undertightening can cause a short circuit or malfunction. Overtightening can cause a short circuit or malfunction due to the damage of the screws or the GOT.
- Exercise care to avoid foreign matter such as chips and wire offcuts entering the GOT. Not doing so can cause a fire, failure or malfunction.

**WIRING PRECAUTIONS** **CAUTION**

- Plug the communication cable into the connector of the connected unit and tighten the mounting and terminal screws in the specified torque range. Undertightening can cause a short circuit or malfunction. Overtightening can cause a short circuit or malfunction due to the damage of the screws or unit.
- Plug the bus connection cable for connecting to the QnACPU, ACP, and motion controller CPU (A series) into the bus interface of the GOT until it "clicks" after plugging, check that it has been inserted snugly. Not doing so can cause a malfunction due to a contact fault.

**TEST OPERATION PRECAUTIONS** **DANGER**

- Before performing the test operations of the user creation monitor screen (such as turning ON or OFF bit device, changing the word device current value, changing the settings or current values of the timer or counter, and changing the buffer memory current value), read through the manual carefully and make yourself familiar with the operation method. During test operation, never change the data of the devices which are used to perform significant operation for the system. False output or malfunction can cause an accident.

**STARTUP/MAINTENANCE PRECAUTIONS** **DANGER**

- When power is on, do not touch the terminals. Doing so can cause an electric shock or malfunction.
- Connect the battery correctly. Do not discharge, disassemble, heat, short, solder or throw the battery into the fire. Incorrect handling may cause the battery to generate heat, burst or take fire, resulting in injuries or fires.
- Before starting cleaning or terminal screw retightening, always switch off the power externally in all phases. Not switching the power off in all phases can cause a unit failure or malfunction. Undertightening can cause a short circuit or malfunction. Overtightening can cause a short circuit or malfunction due to the damage of the screws or unit.

**STARTUP/MAINTENANCE PRECAUTIONS** **CAUTION**

- Do not disassemble or modify the unit. Doing so can cause a failure, malfunction, injury or fire.
- Do not touch the conductive and electronic parts of the unit directly. Doing so can cause a unit malfunction or failure.
- The cables connected to the unit must be run in ducts or clamped. Not doing so can cause the unit or cable to be damaged due to the dangling, motion or accidental pulling of the cables or can cause a malfunction due to a cable connection fault.
- When unplugging the cable connected to the unit, do not hold and pull the cable portion. Doing so can cause the unit or cable to be damaged or can cause a malfunction due to a cable connection fault.

**DISPOSAL PRECAUTIONS** **CAUTION**

- When disposing of the product, handle it as industrial waste.

**TRANSPORTATION PRECAUTIONS** **CAUTION**

- When transporting lithium batteries, make sure to treat them based on the transport regulations.
- Before transporting the GOT, turn the GOT power on and check that the battery voltage status is normal on the Time setting & display screen (utilities screen). In addition, confirm that the adequate battery life remains on the rating plate. Transporting the GOT with the low battery voltage or the battery the reached battery life may destabilize the backup data unstable during transportation.
- Make sure to transport the GOT main unit and/or relevant unit(s) in the manner they will not be exposed to the impact exceeding the impact resistance described in the general specifications of this manual, as they are precision devices. Failure to do so may cause the unit to fail. Check if the unit operates correctly after transportation.

**Associated Manuals**

The following manuals are relevant to this product. When these loose manuals are required, please consult with our local distributor.

Manual name	Contents	Manual Number (Model Code)
GT11 User's Manual (sold separately)	Describes the GT11 hardware-relevant content such as part names, external dimensions, mounting, power supply wiring, specifications, and introduction to option devices.	JY97D17501 (09R815)
GOT1000 Series Connection Manual 1/3, 2/3, 3/3 (sold separately) *1	Describes system configurations of the connection method applicable to GOT1000 series and cable creation method	SH-080532ENG (1D7M26)
GT Designer2 Version2 Basic Operation/Data Transfer Manual (For GOT1000 Series) (sold separately) *1	Describes methods of the GT Designer2 installation operation, basic operation for drawing and transmitting data to GOT1000 series	SH-080529ENG (1D7M24)
GT Designer2 Version2 Screen Design Manual (For GOT1000 Series) 1/3, 2/3, 3/3 (sold separately) *1	Describes specifications and settings of the object functions used in GT Designer2	SH-080530ENG (1D7M25)
GOT1000 Series Extended/Option Functions Manual (sold separately) *1	Describes extended functions and option functions applicable to GOT series.	SH-080544ENG (1D7M32)

\*1 Stored in the GT Works 2/GT Designer2 in PDF format.

For details of a programmable controller to be connected, refer to the programmable controller user's manual respectively.

**Bundled Items**

Product Name	Model Name	Specifications
GOT	GT1155-QTBDQ	320x240 dots, TFT color LCD (256 colors), built-in battery and backlight, built-in bus interface for connecting to the QCPU (Q mode) and motion controller CPU (Q series), built-in serial interface
	GT1155-QTBDA	320x240 dots, TFT color LCD (256 colors), built-in battery and backlight, built-in bus interface for connecting to the QnACPU, ACP, and motion controller CPU (A series), built-in serial interface
	GT1155-QSBDQ	320x240 dots, STN color LCD (256 colors), built-in battery and backlight, built-in bus interface for connecting to the QCPU (Q mode) and motion controller CPU (Q series), built-in serial interface
	GT1155-QSBDA	320x240 dots, STN color LCD (256 colors), built-in battery and backlight, built-in bus interface for connecting to the QnACPU, ACP, and motion controller CPU (A series), built-in serial interface
	GT1150-QLBDQ	320x240 dots, STN monochrome LCD (black/white, 16 scales), built-in battery and backlight, built-in bus interface for connecting to the QCPU (Q mode) and motion controller CPU (Q series), built-in serial interface
	GT1150-QLBDA	320x240 dots, STN monochrome LCD (black/white, 16 scales), built-in battery and backlight, built-in bus interface for connecting to the QnACPU, ACP, and motion controller CPU (A series), built-in serial interface

Bundled item	Quantity	Bundled item	Quantity
Mounting brackets	4	GT11 General Description (This manual)	1

**1. Features**

- Improved monitoring performance and connectivity to FA devices
  - High speed monitoring through high speed communication at maximum of 115.2kbps.
  - Multiple languages are displayed using the Unicode2.1-compatible fonts and beautiful characters are drawn using the TrueType and high quality fonts.
  - High speed display and high speed touch switch response.
- More efficient GOT operations including screen design, startup, adjustment, management and maintenance works
  - The 3MB user memory is included as standard.
  - Font installation is available to increase the system fonts.
- Enhanced support of FA setup tools
  - Transferring or monitoring the sequence programs using the personal computer connected to GOT, during direct connection to Q, QnA or A series programmable controller CPU (FA Transparent function).
  - The USB connector is positioned on the GOT front. This enables the system startup to be performed more efficiently using FA device setup tool, and eliminates the indirect works (opening and closing the control panel, cable replacement, cable rewiring) in order to improve the working efficiency.

**2. Part Name**

**2.1 Front Panel**

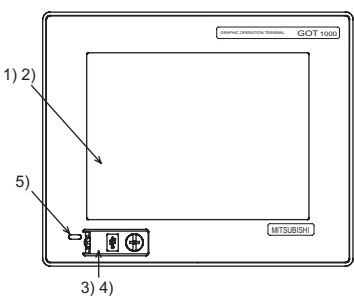

**2.2 Back Panel**

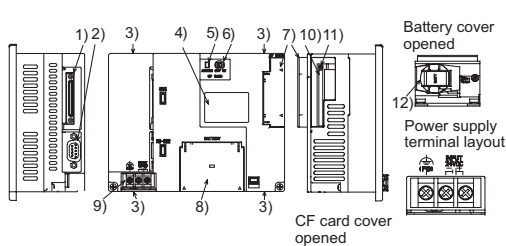

No	Name	Specifications
1)	Display screen	Displays the utility screen and the user creation screen. GT1155-QTBDQ, GT1155-QTBDA ***320x240 dots, TFT color liquid crystal GT1155-QSBDQ, GT1155-QSBDA ***320x240 dots, STN color liquid crystal GT1150-QLBDQ, GT1150-QLBDA ***320x240 dots, STN monochrome(white/black) liquid crystal, 16 scales
2)	Touch key	For operating the touch switches in the utility screen and the user creation screen
3)	USB interface	USB interface for connecting a personal computer (OS installation, project data download, transparent)
4)	USB environmental protection cover	Opens/Closes when the USB interface is used.
5)	POWER LED	Lit in green : Power is correctly supplied Lit in orange : Screen saving Blinking in orange/green : Blown backlight bulb Not lit : Power is not supplied

For the personal computer connection, refer to the following.

→ GT Designer2 Version□ Basic Operation/Data Transfer Manual

No	Name	Specifications
1)	BUS interface	For connecting to the QCPU (Q mode) and motion controller CPU (Q series) with the GT1155-QTBDQ, GT1155-QSBDQ, and GT1150-QLBDQ
2)	RS-232 interface	For connecting to a controller (bar code reader) or personal computer (OS install, project data download, transparent) (D-sub 9-pin male)
3)	Hole for unit installation fitting	Hole for the inserting installation fittings (accessory) during the GOT installation to the panel (4 holes at top and bottom)
4)	Rating plate(nameplate)	-
5)	CF card access LED	ON: The CF card is accessed. OFF: The CF card is not accessed.
6)	CF card access switch	Switch for disabling the access to the CF card before removing the CF card from the GOT ON :The CF card is accessed. (CF card removal prohibited) OFF :The CF card is not accessed. (CF card removal available)
7)	CF card cover	Open or close when inserting or removing the CF card.
8)	Battery cover	Open or close when replacing the battery.
9)	Power terminal	Power terminal and FG terminal (for power supply (24VDC) to GOT and grounding)
10)	CF card interface	Interface for installing the CF card to GOT
11)	CF card eject button	Button for removing the CF card
12)	Battery	GT11-50BAT battery for storing clock data, alarm history and recipe data (The project data is stored in the built-in flash memory.)

For the connection to the programmable controller or personal computer, refer to the following.

→ GOT 1000 Series Connection Manual

**3. Specifications**

**3.1 General Specifications**

Item	Specifications	
Operating ambient temperature	Display section 0 to 50°C	
	Other than display section 0 to 55°C (When mounted horizontally), 0 to 50°C (When mounted vertically)	
Storage ambient temperature	-20 to 60°C	
Operating ambient humidity*1	10 to 90% RH, non-condensing	
Storage ambient humidity*1	10 to 90% RH, non-condensing	
Vibration resistance	Conforms to JIS B3502, IEC 61131-2	
	Under intermittent vibration	Frequency: 5 to 9Hz, Acceleration: 9.8m/s <sup>2</sup> , Half-amplitude: 3.5mm
	Under continuous vibration	Frequency: 5 to 9Hz, Acceleration: --, Half-amplitude: 1.75mm
		Frequency: 9 to 150Hz, Acceleration: 4.9m/s <sup>2</sup> , Half-amplitude: --
Shock resistance	Conforms to JIS B3502, IEC 61131-2 (147 m/s <sup>2</sup> , 3 times each in X, Y and Z directions)	
Operating atmosphere	No corrosive gas	
Operating altitude*2	2000 m (6562 ft) max.	
Installation location	Inside control panel	
Overvoltage category*3	II or less	
Pollution degree*4	2 or less	
Cooling method	Self-cooling	

\*1 The wet-bulb temperature is 39°C or less for STN LCDs.

\*2 Do not use or store the GOT under pressure higher than the atmospheric pressure of altitude 0m (0ft.). Failure to observe this instruction may cause a malfunction.

\*3 This indicates the section of the power supply to which the equipment is assumed to be connected between the public electrical power distribution network and the machinery within the premises. Category II applies to equipment for which electrical power is supplied from fixed facilities. The surge voltage withstand level for up to the rated voltage of 300 V is 2500 V.

\*4 This index indicates the degree to which conductive material is generated in the environment where the equipment is used. In pollution degree 2, only non-conductive pollution occurs but temporary conductivity may be produced due to condensation.

**3.2 Performance Specifications**

Item	Specifications		
	GT1155-QTBDQ GT1155-QTBDA	GT1155-QSBDQ GT1155-QSBDA	GT1150-QLBDQ GT1150-QLBDA
Display section*1	Type	TFT color liquid crystal	STN color liquid crystal
	Screen size	5.7"	STN monochrome (white/black) liquid crystal
	Resolution	320x240 dots	
	Display size	W115(4.53)x H86(3.39)[mm](inch)	
	Display character	16-dot standard font: 20 characters x 15 lines, 12-dot standard font: 26 characters x 20 lines (Horizontal format)	
	Display color	256 colors	Monochrome (white/black), 16 scales
	Display angle	Left/Right: 70 degrees, Top: 70 degrees, Bottom: 50 degrees (Horizontal format)	Left/Right: 55 degrees, Top: 65 degrees, Bottom: 70 degrees (Horizontal format)
	Contrast adjustment	-	16-level adjustment
	Intensity of LCD only	400[cd/m <sup>2</sup> ]	380[cd/m <sup>2</sup> ]
	Intensity adjustment	-	220[cd/m <sup>2</sup> ]
Life*2	Approx. 50,000h (Operating ambient temperature of 25°C)		
	Cold cathode fluorescent tube (irreplaceable by a user) backlight shutdown detection function is included. Backlight off/screen saving time can be set.		
Backlight	Life	Approx. 75,000h or longer, Guaranteed: 1 year (Time for display intensity reaches 50% at the operating ambient temperature of 25°C)	Approx. 54,000h or longer, Guaranteed: 1 year (Time for display intensity reaches 50% at the operating ambient temperature of 25°C)
	Number of touch keys	300 keys/screen (Matrix structure of 15 lines x 20 columns)	
Touch panel	Key size	Minimum 16x16 dots (per key)	
	Number of points touched simultaneously	Maximum of 2 points	
Memory	Life	1 million times or more (operating force 0.98N max.)	
	C drive*3	Flash memory (Internal), for storing project data (3Mbytes) and OS	
Battery	Life (Number of write times)	100,000 times	
	D drive	SRAM (Internal), 512kbytes (battery backup)	
Battery	Backup target	GT11-50BAT lithium battery	
	Life	Clock data, alarm history and recipe data	
Buzzer output	Life	Approx. 5 years (Operating ambient temperature of 25°C), Guaranteed: 1 year	
Environmental protective structure*4	Equivalent to IP67 (JEM1030) (front section) when the USB environmental protective cover is attached		
	External dimensions	W167(6.57)x H135(5.32)x D65(2.56)[mm](inch)(Excluding USB environmental protective cover)	
Panel cutting dimensions	W153(6.03)x H121(4.77)[mm](inch)		
Weight	0.9kg (Excluding mounting fixtures)		
Compatible software package	GT Designer2 Version2 or later*5		

\*1 Bright dots (always lit) and dark dots (unlit) may appear on a liquid crystal display panel. It is impossible to completely avoid this symptom, as the liquid crystal display comprises of a great number of display elements. Flickers may be observed depending on the display color. Please note that these dots appear due to its characteristic and are not caused by product defect.

\*2 The GOT screen saving/backlight off function prevents images from becoming permanently etched on the display screen and increases the backlight life.

\*3 ROM in which new data can be written without deleting the written data.

\*4 Compliant with IP67 when the USB environmental protection cover is attached. Not compliant when a USB cable is connected. Note that this does not guarantee all users' operation environment.

\*5 For the GT1155-QSBDA, use GT Designer2 Version2 with the version 2.59M or later.

### 3.3 Built-in Interface Specifications

Item	Specifications	
	GT1155-QTBDQ GT1155-QSBDQ GT1150-QLBDQ	GT1155-QTBDA GT1155-QSBDA GT1150-QLBDA
BUS	Bus interface for connecting to the QCPU (Q mode) and motion controller CPU (Q series) 1ch Application: For communicating with a programmable controller	Bus interface for connecting to the QnACPU, ACPU, and motion controller CPU (A series) 1ch Application: For communicating with a programmable controller
Built-in interface	RS-232 Conforming to serial RS232 standard, 1ch Transmission speed: 115,200/57,600/38,400/19,200/9,600/4,800bps Connector shape: D-sub 9-pin (Male) Application: Bar code reader connection, Personal computer communication (Project data upload/download, OS installation, transparent function)	USB Conforming to serial USB (Full Speed 12Mbps), device, 1ch Application: Personal computer communication (Project data upload/download, OS installation, transparent function)
CF card	Conforming to PCMCIA, compact flash slot, 1ch Connector shape: Dedicated for TYPE I Application: Data transfer, data storage	

### 3.4 Power Supply Specifications

Item	Specifications		
	GT1155-QTBDQ GT1155-QTBDA	GT1155-QSBDQ GT1155-QSBDA	GT1150-QLBDQ GT1150-QLBDA
Input power supply voltage	24VDC (+10% -15%), ripple voltage 200mV or less		
Fuse (built-in, not exchangeable)	1.0A		
Power consumption	11.16W (465mA/24VDC) or less	9.72W (405mA/24VDC) or less	7.92W (330mA/24VDC) or less
At backlight off	5.04W (210mA/24VDC) or less		
Inrush current	26A or less (26.4V) 4ms		
Permissible instantaneous power failure time <sup>1</sup>	Within 10ms		
Noise immunity	Noise voltage: 500Vp-p, Noise width: 1μs (by noise simulator of 25to 60Hz noise frequency)		
Dielectric withstand voltage <sup>2</sup>	500VAC for 1 minute (across power supply terminals and earth)		
Insulation resistance <sup>2</sup>	10MΩ or larger by a 500VDC insulation resistance tester (across power supply terminals and earth)		
Applicable wire size	0.75 to 2[mm <sup>2</sup> ]		
Applicable solderless terminal	Solderless terminal for M3 screw RAV1.25-3, V2-N3A, FV2-N3A		
Applicable tightening torque (Terminal block terminal screw)	0.5 to 0.8[N·m]		

- <sup>1</sup> The GOT continues to operate even upon 5ms or shorter instantaneous power failure. The GOT stops operating if there is extended power failure or voltage drop, while it automatically resumes operation as soon as the power is restored.
- <sup>2</sup> A surge absorber is connected between the power supply and earth terminal so that the GOT does not malfunction due to applied lightning surge noise. Values without a surge absorber are described for the dielectric withstand voltage and the insulation resistance.

### 3.5 External Dimensions

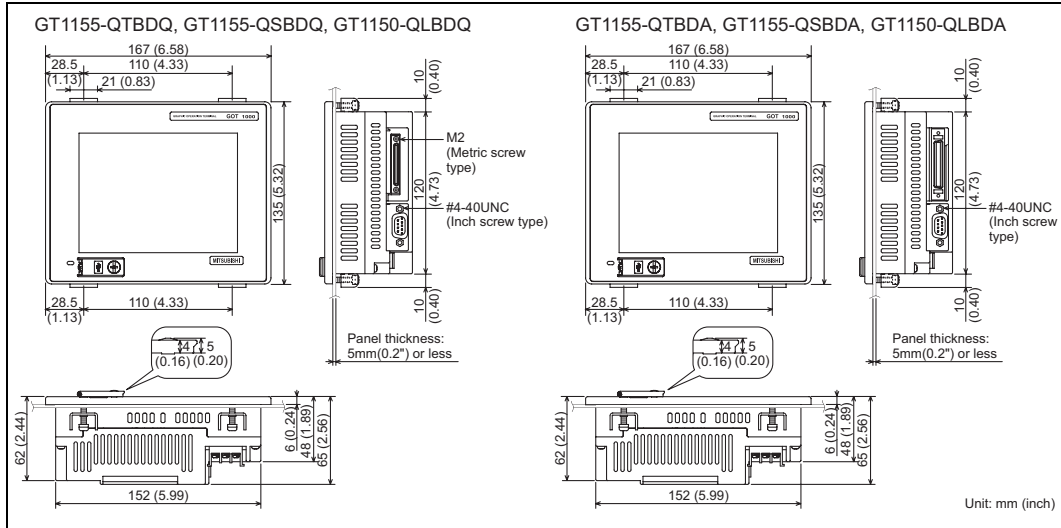

### 4. EMC and Low Voltage Directive

For the products sold in European countries, the conformance to the EMC Directive, which is one of the European Directives, has been a legal obligation since 1996. Also, conformance to the Low Voltage Directive, another European Directives, has been a legal obligation since 1997.

Manufacturers who recognize their products must conform to the EMC and Low Voltage Directive are required to declare that their products conform to these Directives and put a "CE mark" on their products.

For the EMC and low voltage directives conformance method for the GOT1000 series, refer to the GT11 User's Manual. The above manual can be downloaded from the Information site for Mitsubishi industrial automation products MELFANSweb website.

Also, conformance to the EMC Directives of the GOT1000 series can be confirmed with the MELFANSweb website. For latest information, please confirm on the MELFANSweb website. (MELFANSweb website: <http://www7f.mitsubishielectric.co.jp/english/index.html>)

Mitsubishi GOTs conform to the following standards:  
EN61131-2: 2003 Programmable controllers-Equipment requirements and tests

### 5. Installation

#### 5.1 Control Panel Inside Dimensions for Mounting GOT

Mount the GOT onto the control panel while considering the following control panel inside dimensions.

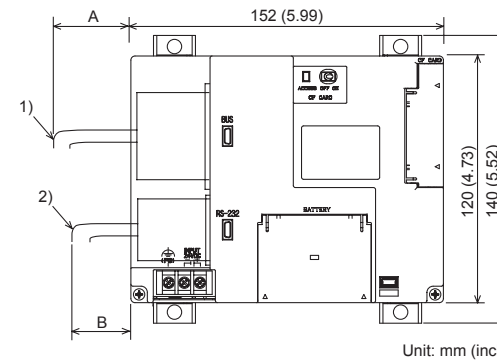

Model Name	A	B
GT1155-QTBDQ GT1155-QSBDQ GT1150-QLBDQ	56 (2.21)	40 (1.58)
GT1155-QTBDA GT1155-QSBDA GT1150-QLBDA	38 (1.50)	40 (1.58)

No	Name
1)	Bus connection cable
2)	Personal computer connection cable/bar code reader connection cable

#### Applicable cable

Some cables may need to be longer than the specified dimensions when connecting to the GOT. Therefore, consider the connector dimensions and bending radius of the cable as well for installation.

### 5.2 Panel Cutting Dimensions

Make holes in the panel according to the dimensions list below. Also, ensure 10mm spaces in upper and lower parts of the panel for mounting fixtures.

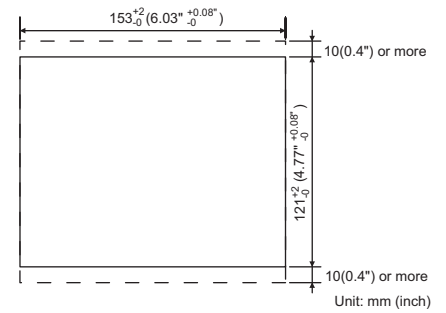

### 5.3 Mounting Position

When mounting the GOT, the clearances shown on the right must be left from a structure or the other device.

Secure 50mm (1.97") or more on the left, right and bottom sides of the GOT to structures or other devices. Secure 80mm (3.15") or more on the top of the GOT from structures or other devices to allow good ventilation. If devices (such as a contactor) generating radiated noise or those generating heat are arranged around the GOT, secure 100mm (3.94") or more on the back panel.

When using the CF card, secure a sufficient distance on the left side to allow installation and removal of the CF card. [Securing 100mm (3.94") or more is recommended.]

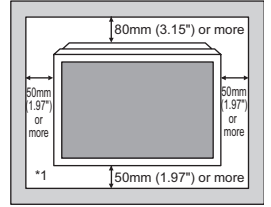

### 5.4 Control Panel Inside Temperature and Mounting Angle

When mounting the main unit to a control panel or similar, set the display section as shown below.

When the temperature inside the control panel is 40 to 55°C (Horizontal mount), 40 to 50°C (Vertical mount), the mounting angle should be in the range 60° to 105° degrees.

- The GOT will be deteriorated earlier if it is used at the mounting angle other than the above. Therefore, the temperature inside the control panel should be within 40°C.

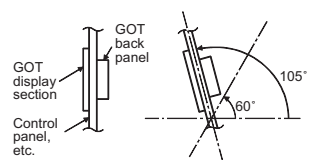

### 5.5 Installation Procedure

The GOT is designed to be embedded into a panel. Mount the GOT by following the procedure below. For panel cutting dimensions, refer to Section 4.2. Note that the panel thickness should be within 5mm.

#### 1) Inserting into the panel face

Insert the GOT from the front side of the panel.

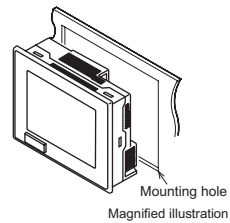

#### 2) Fixing the GOT

Engage the hook of the mounting fitting (accessory) to the unit fixing hole of the GOT and tighten the screw until the GOT is fixed with the mounting bolt (accessory). The GOT will be fixed in 4 upper/lower parts. Tighten the mounting screw with the specified torque. (Failure to do so may distort the panel and make a surface waviness on the protective sheet.)

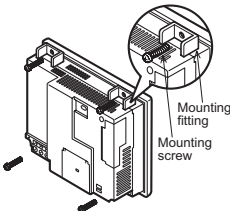

3) A protection film is attached on the display section of GOT prior to shipment. Remove the film when the installation is completed.

### 6. Wiring

#### 6.1 Power Supply Wiring

Connect the power terminal on the GOT rear face with the 24VDC terminal of the external power. Use 0.75mm<sup>2</sup> or more cables so as not to produce voltage drops. Use solderless terminals for M3 screws, and be sure to tighten the screws with a tightening torque of 0.5 to 0.8N·m.

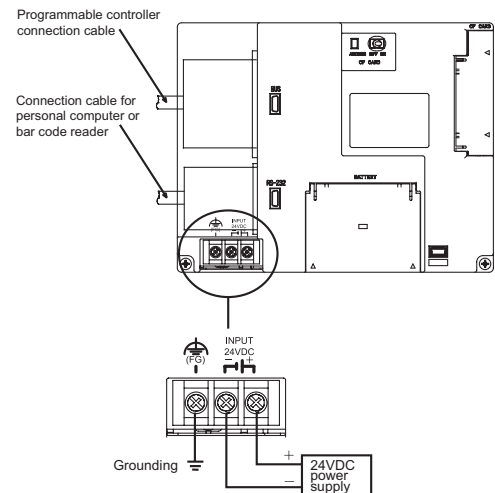

- The independent grounding is basically required. Ground the GOT with a ground resistance of 100Ω or less.
- If the independent grounding is impossible, carry out the shared grounding as shown in fig.2) below.

- Use the cable of 2mm<sup>2</sup> or more for grounding. Set the grounding point closer to the GOT to make the grounding cable short as possible.

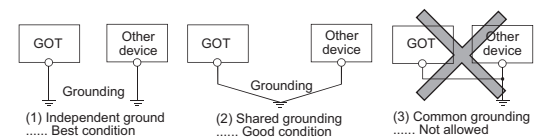

#### 1) Recommended terminal shape

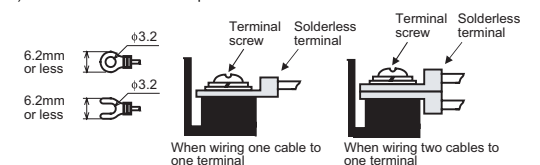

Applicable solderless terminal	RAV 1.25-3, V2-N3A and FV2-N3A
--------------------------------	--------------------------------

### 7. Maintenance and Inspection

The GOT does not include consumable components that will cause the shorten life. However, note that battery life is 5 years and LCD life is 50,000 hours. The life of backlight in GT1155-QTBDQ, GT1155-QTBDA, GT1155-QSBDQ, GT1155-QSBDA is 75,000 hours and that in GT1150-QLBDQ, GT1150-QLBDA is 54,000 hours. It is recommended to replace the battery periodically. (For the replacement of the liquid crystal screen and backlight, please consult your nearest sales office or FA Center.)

#### 7.1 Daily Inspection

##### Daily inspection items

No.	Inspection Item	Inspection Method	Criterion	Action	
1	GOT mounting status	Check for loose mounting screws.	Securely mounted	Tighten screws within the specified torque range	
2	Connection status	Loose terminal screws	Retighten screws with screwdriver	Not loose	Retighten terminal screws
		Proximate solderless terminals	Visual check	Proper intervals	Correct
3	Usage status	Loose connectors	Visual check	Not loose	Retighten connector fixing screws
		Dirt on protection sheet	Visual check	Not outstanding	Replace with new one
3	Foreign material attachment	Foreign material attachment	Visual check	No foreign matter sticking	Remove clean

Refer to the following for the model names of the protection sheet or the replacement procedure. → GT11 User's Manual

#### 7.2 Periodic Inspection

##### Yearly or half-yearly inspection items

The following inspection should also be performed when equipment has been moved or modified or the wiring changed.

No.	Inspection Item	Inspection Method	Criterion	Action	
1	Surrounding environment	Ambient temperature	Make measurement with thermometer or hygrometer	Display section 0 to 50°C Other portions 0 to 55°C	For use in control panel, temperature inside control panel is ambient temperature
		Ambient humidity	Measure corrosive gas	10 to 90%RH	
		Atmosphere	No corrosive gas		
2	Power supply voltage check	24VDC Measure voltage across terminals.	20.4 to 26.4VDC	Change supply power	

No.	Inspection Item	Inspection Method	Criterion	Action	
3	Connection status	Loose terminal screws	Retighten screws with screwdriver	Not loose	Retighten terminal screws
		Proximate solderless terminals	Visual check	Proper intervals	Correct
		Loose connectors	Visual check	Not loose	Retighten connector fixing screws

### 7.3 Battery Replacement

The battery backs up clock data, alarm history and recipe data. Screen data is stored in the flash memory and data is retained even if the battery is dead.

- Battery model name  
GT11□□ is shipped with the following battery.

Product name	Model name
Battery	GT11-50BAT

#### Battery replacement procedure

- Turn the GOT power off.
- Open the back cover of the GOT.
- Remove the old battery from the holder.
- Disconnect the old battery connector and insert the new battery connector within 30s. (Clock data, alarm history, and recipe data is retained by the GOT condenser for 30 seconds.)
- Insert the new battery into the holder and close the back cover.

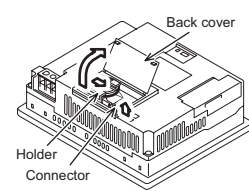

#### How to confirm production year and month

The production year and month of the battery built in the purchased GOT can be confirmed by the production No. (serial No.) marked on the GOT main unit.

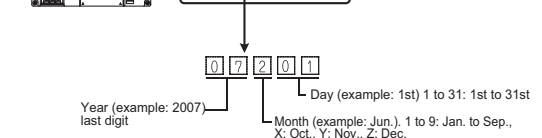
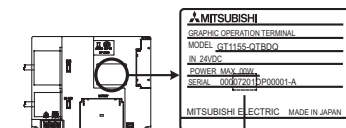

- Battery life  
Approximate battery life:  
5 years (ambient temperature: 25°C) [Guaranteed for 1 year]  
Battery replacement: In 4 to 5 years

Approximate life is 5 years, but life may be shorter depending on the ambient temperature, therefore, note that the battery must be replaced in 4 to 5 years. Make sure to purchase a new battery as needed as it self-discharges.

Battery status can be confirmed on a GOT utility screen. For details of battery status or how to output alarm, refer to the following: → GT11 User's Manual

### Warranty

Mitsubishi will not be held liable for damage caused by factors found not to be the cause of Mitsubishi; machine damage or lost profits caused by faults in the Mitsubishi products; damage, secondary damage, accident compensation caused by special factors unpredictable by Mitsubishi; damages to products other than Mitsubishi products; and to other duties.

#### For safe use

- This product has been manufactured as a general-purpose part for general industries, and has not been designed or manufactured to be incorporated in a device or system used in purposes related to human life.
- Before using the product for special purposes such as nuclear power, electric power, aerospace, medicine or passenger movement vehicles, consult with Mitsubishi.
- This product has been manufactured under strict quality control. However, when installing the product where major accidents or losses could occur if the product fails, install appropriate backup or failsafe functions in the system.

Country/Region	Sales office/Tel
U.S.A.	Mitsubishi Electric Automation Inc. 500 Corporate Woods Parkway Vernon Hills, IL 60061, U.S.A. Tel: +1-847-478-2100
Brazil	MELCO-TEC Rep. Com.e Assessoria Tecnica Ltda. Rua Correia Dias, 184, Edificio Paraiso Trade Center-8 andar Paraiso, Sao Paulo, SP Brazil Tel: +55-11-5908-8331
Germany	Mitsubishi Electric Europe B.V. German Branch Goltzhaer Strasse 8 D-40880 Ratingen, GERMANY Tel: +49-2102-486-0
U.K.	Mitsubishi Electric Europe B.V. UK Branch Travellers Lane, Hatfield, Hertfordshire., AL10 8XB, U.K. Tel: +44-1707-276100
Italy	Mitsubishi Electric Europe B.V. Italian Branch Centro Dir. Collocti, Pal. Perseo-Ing.2 Via Paracelso 12, I-20041 Agrate Brianza., Milano, Italy Tel: +39-039-60531
Spain	Mitsubishi Electric Europe B.V. Spanish Branch Carretera de Rubi 75-90, E-08190 Sant Cugat del Valles, Barcelona, Spain Tel: +34-93-565-3131
France	Mitsubishi Electric Europe B.V. French Branch 25 Boulevard des Bouvets, F-92741 Nanterre Cedex, France TEL: +33-1-5568-5568
South Africa	Circuit Breaker Industries Ltd. Private Bag 2016, ZA-1600 Isando, South Africa Tel: +27-11-928-2000
Hong Kong	Mitsubishi Electric Automation (Hong Kong) Ltd. 10th Floor, Manulife Tower, 169 Electric Road, North Point, Hong Kong Tel: +852-2887-8870
China	Mitsubishi Electric Automation (Shanghai) Ltd. 4/F Zhi Fu Plaza, No.80 Xin Chang Road, Shanghai 200003, China Tel: +86-21-6120-0808
Taiwan	Settsuyo Enterprise Co., Ltd. 6F No.105 Wu-Kung 3rd Rd., Wu-Ku Hsiang, Taipei Hsine, Taiwan Tel: +886-2-2299-2499
Korea	Mitsubishi Electric Automation Korea Co., Ltd. 1490-5, Gyang-dong, Gangseo-ku Seoul 157-200, Korea Tel: +82-2-3660-9552
Singapore	Mitsubishi Electric Asia Pte. Ltd. 307 Alexandra Road #05-01/02, Mitsubishi Electric Building, Singapore 159943 Tel: +65-6470-2460
Thailand	Mitsubishi Electric Automation (Thailand) Co., Ltd. Bang-Chan Industrial Estate No.111 Moo 4, Serithai Rd, T.Kannayao, A.Kannayao, Bangkok 10230 Thailand Tel: +66-2-517-1325
Indonesia	P.T. Autotekindo Sumber Makmur Muara Karang Selatan, Block A/Utara No.1 Kav. No.11 Kawasan Industri Pergudangan Jakarta - Utara 14440, P.O.Box 5045 Jakarta, 11050 Indonesia Tel: +62-21-6630833
India	Messung Systems Pvt. Ltd. Electronic Sadan NO.III Unit No15, M.I.D.C Bhosari, Pune-411026, India Tel: +91-20-2712-3130
Australia	Mitsubishi Electric Australia Pty. Ltd. 348 Victoria Road, Rydalmere, N.S.W 2116, Australia Tel: +61-2-9684-7777

**MITSUBISHI ELECTRIC CORPORATION**  
HEAD OFFICE: TOKYO BUILDING, 2-7-3 MARUNOUCHI, CHYODA-KU, TOKYO 100-8310, JAPAN  
NAGOYA WORKS: 1-14, YADA-MINAMI 5-CHOME, HIGASHI-KU, NAGOYA, JAPAN

When exported from Japan, this manual does not require application to the Ministry of Economy, Trade and Industry for service transaction permission.  
Specifications subject to change without notice.  
Printed in Japan on recycled paper.