

Programmable Controller

MELSEC iQ-R series MELSEC *L* series MELSEC **Q** series

MELSEC Communication Protocol Reference Manual

-RJ71C24
-RJ71C24-R2
-RJ71C24-R4
-LJ71C24
-LJ71C24-R2
-LJ71E71-100
-QJ71C24N
-QJ71C24N-R2
-QJ71C24N-R4
-QJ71C24
-QJ71C24-R2
-QJ71E71-100
-QJ71E71-B5
-QJ71E71-B2



SAFETY PRECAUTIONS

(Read these precautions before using this product.)

Before using this product, please read this manual and the relevant manuals carefully and pay full attention to safety to handle the product correctly.

Note that these precautions apply only to this product. For the safety precautions of the programmable controller system, please read the User's Manual for the CPU module used.

In this manual, the safety precautions are classified into two levels: "⚠ WARNING" and "⚠ CAUTION".

 WARNING	Indicates that incorrect handling may cause hazardous conditions, resulting in death or severe injury.
 CAUTION	Indicates that incorrect handling may cause hazardous conditions, resulting in minor or moderate injury or property damage.

Under some circumstances, failure to observe the precautions given under "⚠ CAUTION" may lead to serious consequences.

Observe the precautions of both levels because they are important for personal and system safety.

Make sure that the end users read this manual and then keep the manual in a safe place for future reference.

[Design precautions]

WARNING

- When connecting an external device with a CPU module or intelligent function module to modify data of a running programmable controller, configure an interlock circuit in the program to ensure that the entire system will always operate safely. For other forms of control (such as program modification, parameter change, forced output, or operating status change) of a running programmable controller, read the relevant manuals carefully and ensure that the operation is safe before proceeding. Improper operation may damage machines or cause accidents.
 - Especially, when a remote programmable controller is controlled by an external device, immediate action cannot be taken if a problem occurs in the programmable controller due to a communication failure. To prevent this, configure an interlock circuit in the program, and determine corrective actions to be taken between the external device and CPU module in case of a communication failure.
 - Do not write any data to the "system area" and "write-protect area" of the buffer memory in the module. Also, do not use any "use prohibited" signals as an output signal from the CPU module to each module. Doing so may cause malfunction of the programmable controller system. For the "system area", "write-protect area", and the "use prohibited" signals, refer to the user's manual for the module used.
-

[Security Precautions]

WARNING

- To maintain the security (confidentiality, integrity, and availability) of the programmable controller and the system against unauthorized access, denial-of-service (DoS) attacks, computer viruses, and other cyberattacks from external devices via the network, take appropriate measures such as firewalls, virtual private networks (VPNs), and antivirus solutions.
-

[Operating precautions]

CAUTION

- When changing data and operating status, and modifying program of the running programmable controller from an external device such as a personal computer connected to an intelligent function module, read relevant manuals carefully and ensure the safety before operation. Incorrect change or modification may cause system malfunction, damage to the machines, or accidents.
 - Do not power off the programmable controller or reset the CPU module while the setting values in the buffer memory are being written to the flash ROM in the module. Doing so will make the data in the flash ROM undefined. The values need to be set in the buffer memory and written to the flash ROM again. Doing so also can cause malfunction or failure of the module.
-

CONDITIONS OF USE FOR THE PRODUCT

- (1) MELSEC programmable controller ("the PRODUCT") shall be used in conditions;
- i) where any problem, fault or failure occurring in the PRODUCT, if any, shall not lead to any major or serious accident; and
 - ii) where the backup and fail-safe function are systematically or automatically provided outside of the PRODUCT for the case of any problem, fault or failure occurring in the PRODUCT.
- (2) The PRODUCT has been designed and manufactured for the purpose of being used in general industries. MITSUBISHI ELECTRIC SHALL HAVE NO RESPONSIBILITY OR LIABILITY (INCLUDING, BUT NOT LIMITED TO ANY AND ALL RESPONSIBILITY OR LIABILITY BASED ON CONTRACT, WARRANTY, TORT, PRODUCT LIABILITY) FOR ANY INJURY OR DEATH TO PERSONS OR LOSS OR DAMAGE TO PROPERTY CAUSED BY the PRODUCT THAT ARE OPERATED OR USED IN APPLICATION NOT INTENDED OR EXCLUDED BY INSTRUCTIONS, PRECAUTIONS, OR WARNING CONTAINED IN MITSUBISHI ELECTRIC USER'S, INSTRUCTION AND/OR SAFETY MANUALS, TECHNICAL BULLETINS AND GUIDELINES FOR the PRODUCT.
- ("Prohibited Application")
- Prohibited Applications include, but not limited to, the use of the PRODUCT in;
- Nuclear Power Plants and any other power plants operated by Power companies, and/or any other cases in which the public could be affected if any problem or fault occurs in the PRODUCT.
 - Railway companies or Public service purposes, and/or any other cases in which establishment of a special quality assurance system is required by the Purchaser or End User.
 - Aircraft or Aerospace, Medical applications, Train equipment, transport equipment such as Elevator and Escalator, Incineration and Fuel devices, Vehicles, Manned transportation, Equipment for Recreation and Amusement, and Safety devices, handling of Nuclear or Hazardous Materials or Chemicals, Mining and Drilling, and/or other applications where there is a significant risk of injury to the public or property.
- Notwithstanding the above restrictions, Mitsubishi Electric may in its sole discretion, authorize use of the PRODUCT in one or more of the Prohibited Applications, provided that the usage of the PRODUCT is limited only for the specific applications agreed to by Mitsubishi Electric and provided further that no special quality assurance or fail-safe, redundant or other safety features which exceed the general specifications of the PRODUCTS are required. For details, please contact the Mitsubishi Electric representative in your region.
- (3) Mitsubishi Electric shall have no responsibility or liability for any problems involving programmable controller trouble and system trouble caused by DoS attacks, unauthorized access, computer viruses, and other cyberattacks.

INTRODUCTION

Thank you for purchasing the Mitsubishi Electric programmable controllers.

This manual describes the supported devices, access range, communication procedure, and message format required for using MELSEC communication protocols listed below.

Before using this product, thoroughly read this manual and the related manuals to develop full familiarity with the functions and performance of the programmable controller to ensure correct use.

Make sure that the end users read this manual and then keep the manual in a safe place for future reference.

Relevant products

RJ71C24, RJ71C24-R2, RJ71C24-R4,

LJ71C24, LJ71C24-R2, LJ71E71-100,

QJ71C24N, QJ71C24N-R2, QJ71C24N-R4, QJ71C24, QJ71C24-R2, QJ71E71-100, QJ71E71-B5, QJ71E71-B2

CONTENTS

SAFETY PRECAUTIONS	1
CONDITIONS OF USE FOR THE PRODUCT	3
INTRODUCTION	4
RELEVANT MANUALS	13
TERMS	14
GENERIC TERMS AND ABBREVIATIONS	14
DISCONTINUED MODELS	15

PART 1 MELSEC COMMUNICATION PROTOCOL

CHAPTER 1 ABILITY OF MC PROTOCOL	18
1.1 Purposes	18
1.2 Features	19
CHAPTER 2 SUPPORTED DEVICES AND ACCESSIBLE RANGES	20
2.1 Supported Devices	20
2.2 Accessible Range and Accessible Modules	20
CHAPTER 3 COMMUNICATION PROCEDURE	22
3.1 Features of Communication Process	22
3.2 Considerations	23
Considerations when connecting C24	25
Considerations when connecting E71	26

PART 2 MESSAGE FORMATS

CHAPTER 4 MESSAGES OF SERIAL COMMUNICATION MODULE	28
4.1 Types and Purposes of Messages	28
Formats and codes	28
Frame	28
4.2 Message Formats of Each Protocol	29
Format 1	29
Format 2	30
Format 3	31
Format 4	32
Format 5	33
4.3 Details of Setting Data	34
Control code	34
Number of data bytes	35
Block number	36
Frame ID No.	36
Sum check code	36
End code	38
Error code	38

CHAPTER 5 MESSAGES OF Ethernet INTERFACE MODULE 39

5.1	Types and Purposes of Messages	39
	Code	39
	Frame	40
5.2	Message Format	41
5.3	Details of Setting Data	42
	Header	42
	Subheader	42
	Request data length and response data length	43
	Monitoring timer	43
	End code	44
	Error information	44

CHAPTER 6 ACCESS ROUTE SETTINGS 45

6.1	Accessible Ranges and Setting Data for Each Frame	45
	4C frame	45
	3C frame	46
	2C frame	46
	1C frame	47
	4E frame, 3E frame	48
	1E Frame	49
6.2	Details of Setting Data	50
	Station No.	50
	Network No., PC No.	52
	Request destination module I/O No., request destination module station No.	55
	Self-station No.	58

PART 3 COMMAND

CHAPTER 7 COMMANDS AND FUNCTIONS 60

7.1	Command List	60
	Commands for 4C/3C/4E/3E frame	61
	Commands for 2C frame	64
	Commands for 1C/1E frame	64

CHAPTER 8 DEVICE ACCESS 65

8.1	Data to be Specified in Commands	65
	Devices	65
	Device code list	68
	Number of device points	70
	Access points	70
	Number of blocks	71
	Read data, write data	72
	Set/reset	78
	Monitor condition specification	79
8.2	Batch Read and Write	86
	Batch read in word units (command: 0401)	86
	Batch read in bit units (command: 0401)	90
	Batch write in word units (command: 1401)	92

	Batch write in bit units (command: 1401)	95
8.3	Random Read and Write	97
	Random read in word units (command: 0403)	97
	Random write in word units (test) (command: 1402)	104
	Random write in bit units (test) (command: 1402)	108
8.4	Batch Read and Write Multiple Blocks	111
	Batch read multiple blocks (command: 0406)	111
	Batch write multiple blocks (command: 1406)	115
8.5	Device Memory Monitor	119
	Monitoring procedure	119
	Register monitor data (command: 0801)	120
	Monitor (command: 0802)	121
CHAPTER 9 LABEL ACCESS		124
9.1	Data to be Specified in Commands	124
	Labels	124
	Abbreviation specification of label	128
	Points	130
	Data type ID	131
	Data length, unit specification	132
	Read data, write data	134
9.2	Batch Read and Write	135
	Batch read array type labels (command: 041A)	135
	Batch write array type labels (command: 141A)	141
9.3	Random Read and Write	145
	Random read labels (command: 041C)	145
	Random write labels (command: 141B)	148
CHAPTER 10 BUFFER MEMORY ACCESS		151
10.1	Buffer Memory	151
	Data to be specified in commands	151
	Batch read (command: 0613)	153
	Batch write (command: 1613)	155
10.2	Intelligent Function Module	157
	Accessible modules	157
	Data to be specified in commands	158
	Batch read (command: 0601)	161
	Batch write (command: 1601)	163
CHAPTER 11 CONTROL MODULE OPERATION		165
11.1	Data to be specified in commands	165
	Mode	165
	Clear mode	165
	Model name and model code	166
	Remote password	169
	Loopback data	170
	Communication error information	171
11.2	Remote Operation	172
	Remote RUN (command: 1001)	172
	Remote STOP (command: 1002)	174

Remote PAUSE (command: 1003)	175
Remote latch clear (command: 1005)	176
Remote RESET (command: 1006)	177
Read CPU model name (command: 0101)	178
11.3 Remote Password	179
Execution procedure	179
Unlock (command: 1630)	180
Lock (command: 1631)	182
11.4 Loopback Test	184
Loopback test (command: 0619)	184
11.5 Clear Error Information	186
Turn indicator LED OFF, initialize error code (command: 1617)	186
Turn COM.ERR. LED OFF (command: 1617)	188

CHAPTER 12 FILE CONTROL 189

12.1 Execution Procedure.	189
Procedure to read information from all files in directory (folder)	189
Procedure to read files	190
Procedure to overwrite files	190
Procedure to create new file and write data	191
Procedure to delete files	192
Procedure to copy files	192
Procedure to modify file creation date and time	192
12.2 Considerations	193
12.3 Data to be specified in commands	194
Password	194
Drive No.	197
File No.	198
Number of files	199
Number of characters	199
Directory specification	199
File name specification	201
Attribute	204
Creation date and time (last edit date and time)	205
File size	206
File pointer No.	207
Offset address	207
Number of bytes	208
Read data, write data	208
Open mode	209
Close type	209
12.4 File Check.	210
Read directory/file information (command: 1810)	210
Search directory/file information (command: 1811)	216
12.5 File Creation and Deletion	219
Create new file (command: 1820)	219
Delete file (command: 1822)	222
Copy file (command: 1824)	225
12.6 File Modification	229
Modify file attribute (command: 1825)	229

Modify file creation date and time (command: 1826)	232
Open file (command: 1827)	235
Read file (command: 1828)	239
Write to file (command: 1829)	241
Close file (command: 182A)	243

CHAPTER 13 SERIAL COMMUNICATION MODULE DEDICATED COMMANDS 245

13.1 User Frame	245
Data to be specified in command	246
Read registered data (command: 0610)	248
Register data (command: 1610)	250
Delete registered data (command: 1610)	252
13.2 Global Function	254
Global signal ON/OFF (command: 1618)	255
13.3 Transmission sequence initialization function	257
Initialize transmission sequence (command: 1615)	257
13.4 Mode Switching Function	258
Data to be specified in command	258
Switch mode (command: 1612)	262
13.5 Programmable controller CPU monitoring function	265
Data to be specified in command	265
Register (command: 0630)	268
Deregister (command: 0631)	278
13.6 On-demand function	279
Settings for using the on-demand function	279
Execution procedure	280
Execution timing	281
On-demand (command: 2101)	282

PART 4 COMPATIBILITY WITH QnA SERIES

CHAPTER 14 MELSEC-QnA SERIES SUPPORTED SPECIFICATIONS 286

14.1 Frames and Commands that can be used	286
14.2 Accessible Modules	286
14.3 Considerations	287

CHAPTER 15 QnACPU DEDICATED COMMANDS 288

15.1 QnACPU Dedicated Commands List	288
15.2 Defragmentation of Drive Memory	289
Data to be specified in commands	290
Read drive memory usage status (command: 0205)	293
Defragment drive memory (command: 1207)	295
15.3 File Control	297
Considerations for file control	297
Data to be specified in commands	298
File control execution procedure for the QnACPU	306
Read file information table without header statement (command: 0201)	308
Read file information table with header statement (command: 0202)	311
Read file presence (Search file) (command: 0203)	314
Read file No. usage status (command: 0204)	316

Read file (command: 0206)	318
Register and deregister file locks (command: 0808)	321
Create new file (Register file name) (command: 1202)	323
Write to file (command: 1203)	325
Modify file information (command: 1204)	329
Delete file (command: 1205)	335
Copy file (command: 1206)	337

PART 5 COMPATIBILITY WITH A SERIES

CHAPTER 16 MELSEC-A SERIES SUPPORTED SPECIFICATIONS 342

16.1 Frames and Commands that can be Used	342
16.2 Accessible modules	342
16.3 Considerations	343

CHAPTER 17 COMMUNICATING USING 1C FRAMES 344

17.1 Message Format	344
17.2 Details of Setting Data	346
Command	346
Message wait.	347
Character area.	347
Error code	348
17.3 Command and Function Lists for 1C Frame.	349
17.4 Device Memory Read and Write	350
Considerations.	350
Data to be specified in command	351
Batch read (bit units) (command: BR, JR)	354
Batch read (word units) (command: WR, QR)	356
Batch write (bit units) (command: BW, JW)	358
Batch write (word units) (command: WW, QW)	360
Test (random write) (bit units) (command: BT, JT)	362
Test (random write) (word units) (command: WT, QT)	364
Monitor (Command: BM, JM, WM, QM, MB, MJ, MN, MQ)	366
17.5 Read and Write Extended File Register.	371
Considerations for reading and writing extended file register	371
Specification method for extended file register	372
Data to be specified in command	374
Batch read (command: ER)	375
Batch write (command: EW)	376
Test (random write) (command: ET)	377
Monitor (command: EM, ME)	378
Direct read (command: NR)	381
Direct write (command: NW)	382
17.6 Read and write Buffer Memory of Special Function Module.	383
Data to be specified in command	383
Accessible modules	385
Batch read (command: TR)	386
Batch write (command: TW)	388
17.7 Loopback Test	389
Loopback test (Command: TT)	389

CHAPTER 18 COMMUNICATING USING 1E FRAMES	391
18.1 Message Format	391
18.2 Details of Setting Data	391
Header	392
Subheader	392
PC No.	393
ACPU monitoring timer	394
End code, Abnormal code	395
18.3 Commands and Function List for 1E Frame	396
18.4 Read and Write Device Memory	397
Considerations	397
Data to be specified in command	397
Batch read in bit units (command: 00)	403
Batch read in word units (command: 01)	405
Batch write in bit units (command: 02)	407
Batch write in word units (command: 03)	409
Test in bit units (random write) (command: 04)	410
Test in word units (random write) (command: 05)	412
Monitor device memory (command: 06, 07, 08, 09)	414
18.5 Read and Write Extended File Register	418
Data to be specified in command	418
Batch read (command: 17)	419
Batch write (command: 18)	421
Test (random write) (command: 19)	423
Monitor extended file registers (command: 1A, 1B)	425
Direct read (command: 3B)	428
Direct write (command: 3C)	430
18.6 Read and Write Buffer Memory of Special Function Module	432
Data to be specified in command	432
Accessible modules	433
Batch read (command: 0E)	434
Batch write (command: 0F)	436
APPENDIX	438
Appendix 1 Read/Write by Device Extension Specification	438
Accessing link direct devices	440
Accessing module access devices	442
Accessing CPU buffer memory access device	444
Access for index modification	446
Accessing devices for indirect specification	451
Appendix 2 Processing Time	454
Time chart and communication time of C24 transmission sequence	454
Transmission time when accessing other stations	456
Number of scans required for processing	459
Appendix 3 Compatibility with Multiple CPU Systems	462
When RCPU is configured in the multiple CPU system	462
When QCPU is configured in the multiple CPU system	463
Appendix 4 Applicable Commands for Online Program Change	464
Commands that cannot be executed during RUN	464
Commands that enable/disable online change	464

Setting method for writing data to CPU during RUN	465
Appendix 5 Number of Processing per One Communication	466
Commands for 4C/3C/4E/3E frame	466
Commands for 2C frame	469
Commands for 1C frame	469
Commands for 1E frame	470
Appendix 6 Accessible Modules for Each Command	471
Commands for 4C/3C/4E/3E frame	471
Commands for 2C frame	475
Commands for 1C frame	476
Commands for 1E frame	478
Appendix 7 Setting Examples	479
Setting examples of message for serial communication module	479
Setting examples of message for Ethernet interface module	483
Setting examples of access route	487
 INDEX	 491
<hr/>	
REVISIONS	494
WARRANTY	495
TRADEMARKS	496

RELEVANT MANUALS

Manual name [manual number]	Description	Available form
MELSEC Communication Protocol Reference Manual [SH-080008] (this manual)	Explains the specifications, access ranges, message protocols, and functions of MELSEC communication protocol.	e-Manual PDF

Point

e-Manual refers to the Mitsubishi Electric FA electronic book manuals that can be browsed using a dedicated tool.

e-Manual has the following features:

- Required information can be cross-searched in multiple manuals.
- Other manuals can be accessed from the links in the manual.
- The hardware specifications of each part can be found from the product figures.
- Pages that users often browse can be bookmarked.
- Sample programs can be copied to an engineering tool.

User's manuals for the module

Serial communication module

Manual name [manual number]	Description	Available form
MELSEC iQ-R Serial Communication Module User's Manual(Application) [SH-081251ENG]	Explains the functions, input/output signals, buffer memory, parameter settings, and trouble shooting of serial communication module.	Print book e-Manual PDF
MELSEC iQ-R Serial Communication Module User's Manual(Startup) [SH-081250ENG]	Explains the specifications, procedures prior to operation, system configurations, wiring, and data communication examples of serial communication module.	Print book e-Manual PDF
MELSEC-L Serial Communication Module User's Manual (Basic) [SH-080894ENG]	Explains the overview of the module and describes the applicable system configuration, the specifications, the procedures prior to operations, the basic methods of communicating with the external device, maintenance and inspection, and the troubleshooting of serial communication module.	Print book e-Manual PDF
Q Corresponding Serial Communication Module User's Manual (Basic) [SH-080006]	Explains the overview of the module and describes the applicable system configuration, the specifications, the procedures prior to operations, the basic methods of communicating with the external device, maintenance and inspection, and the troubleshooting of serial communication module.	Print book PDF
MELSEC-Q/L Serial Communication Module User's Manual (Application) [SH-080007]	Explains the information on how to perform data communication with external devices using serial communication module's special functions.	Print book e-Manual PDF

Ethernet interface module

Manual name [manual number]	Description	Available form
MELSEC-L Ethernet Interface Module User's Manual (Basic) [SH-081105ENG]	Explains the information on the specifications of Ethernet interface module, the procedures for data communications with external devices, circuit connection (open/close), fixed buffer exchange, random access buffer exchange, and the troubleshooting.	Print book e-Manual PDF
Q Corresponding Ethernet Interface Module User's Manual (Basic) [SH-080009]	Explains the information on the specifications of Ethernet interface module, the procedures for data communications with external devices, circuit connection (open/close), fixed buffer exchange, random access buffer exchange, and the troubleshooting.	Print book PDF
MELSEC-Q/L Ethernet Interface Module User's Manual (Web function) [SH-080180]	Explains how to use the Web function of Ethernet interface module.	Print book e-Manual PDF

TERMS

This manual uses the terms listed in the following table unless otherwise noted.

Term	Description
Buffer memory	Memory in an intelligent function module to store data such as setting values and monitor values. For CPU modules, it refers to memory to store data such as setting values and monitor values of the Ethernet function, or data used for data communication of the multiple CPU system function.
Connected station (host station)	A station directly connected to external devices.
Control CPU	A CPU module that controls connected I/O modules and intelligent function modules. In a multiple CPU system, there are multiple CPU modules and each connected module can be controlled by a different CPU module.
Engineering tool	A tool used for setting up programmable controllers, programming, debugging, and maintenance.
External device	A device which sends request message to the supported devices, such as a personal computer, HIM, measuring instrument, ID units, barcode readers, regulators, and C24s.
MC protocol	An abbreviation for the MELSEC communication protocol. This protocol is used to access a MC protocol-compatible device or a programmable controller connected to a MC protocol-compatible device from an external device.
Multidrop connection	A connection when connecting multiple target devices or other C24s in 1:n or m:n basis by using an RS-422/485 interface of a serial communication module.
Other station	A station connected to the connected station (host station) on the network.
Relay station	A station that relays data link to other station with mounting more than one network modules on one programmable controller.
Request message	A processing request message sent from external devices to the supported devices.
Response message	A processing result message sent from SLMP compatible devices in response to the request message.
User frame	A data name used when registering the fixed format part in a message to be transmitted between an external device and a serial communication module, and using it for data transmission and reception. (The content of data in a user frame must be the same as the specifications of the external device.)

GENERIC TERMS AND ABBREVIATIONS

Unless otherwise specified, this manual uses the following generic terms and abbreviations.

Generic term/ abbreviation	Description
ACPU	A MELSEC-A series CPU module
C24	A serial communication module
CC-Link IE	CC-Link IE Controller Network and CC-Link IE Field Network
CPU module	A MELSEC programmable controller CPU
E71	An Ethernet interface module
Built-in Ethernet port CPU module	A MELSEC-Q series and MELSEC-L series CPU module with built-in Ethernet port
LCPU	A MELSEC-L series CPU module
LHCPU	A MELSEC iQ-L series CPU module
QCPU	A MELSEC-Q series CPU module
QnACPU	A MELSEC-QnA series CPU module
RCPU	A MELSEC iQ-R series CPU module
Intelligent function module	A MELSEC iQ-R series modules, MELSEC-Q series modules, and MELSEC-L series module that have functions other than input or output, such as A/D or D/A converter modules
Supported device	A device which receives MELSEC communication protocol messages
Special function module	A MELSEC-A series and MELSEC-QnA series module that have functions other than input or output, such as A/D or D/A converter modules
Network module	A MELSEC programmable controller which can be connected to Ethernet, CC-Link IE Field Network, CC-Link IE Controller Network, MELSECNET/H, and MELSECNET/10
Module access device	A module access device of MELSEC iQ-R series or an intelligent function module device of MELSEC-Q/L series

DISCONTINUED MODELS

The following models are described in this manual, but have no longer been produced.

For the onerous repair term after discontinuation of production, refer to "WARRANTY" in this manual.

Model	Production discontinuation
QJ71C24	January 2004
QJ71C24-R2	January 2004
QJ71E71-B2	February 2017
QJ71E71-B5	February 2017

MEMO

MELSEC communication protocol (hereinafter abbreviated as MC protocol) is a communication protocol for MELSEC programmable controller used when accessing programmable controller from an external device via C24 or E71. This part explains the overview and basic operations of MC protocol.

1 ABILITY OF MC PROTOCOL

2 SUPPORTED DEVICES AND ACCESSIBLE RANGES

3 COMMUNICATION PROCEDURE

1 ABILITY OF MC PROTOCOL

This chapter explains the purposes and features of the MC protocol.

1.1 Purposes

MC protocol performs data communication to control a programmable controller system on the external devices (such as a personal computer, GOT).

Reading and writing data

By reading/writing data to/from the device memory of the CPU module and buffer memory of the intelligent function modules, the following operations can be performed:

■Reading data

Operation monitoring, data analysis, production control, etc. of the CPU module can be performed on the external device.

■Writing data

Production instructions can be issued from the external device.

Reading and writing files

By reading/writing files such as programs and parameters stored in the CPU module, the following operations can be performed:

■Reading files

File management for the CPU modules of the connected station (host station) and other station can be performed on the external device.

■Writing files

Execution programs can be modified (replaced) by writing file data stored in the external device to the programmable controller CPU as necessary.

Remote control of CPU module

The CPU module can be remotely controlled from the external device by performing remote RUN/STOP/PAUSE/Latch Clear/RESET operations.

Monitoring CPU module

The status of CPU module and data in the device memory can be sent to an external device at constant intervals, upon the occurrence of a mechanical error, or when certain conditions are satisfied.

Data transmission from CPU module to external device (On-demand function)

The emergency data that is required to notify to external devices can be sent from the CPU module.

1.2 Features

Communication from external device without using sequential programs

The programmable controller transmits data in accordance with the commands from an external device. Thus, a program for data communication is not required for CPU module. (When using on-demand functions with C24, a sequence program for data communication from CPU module is required.)

Communication protocols of C24/E71

The message formats and control procedures for an external device to access a programmable controller are defined for each supported device.

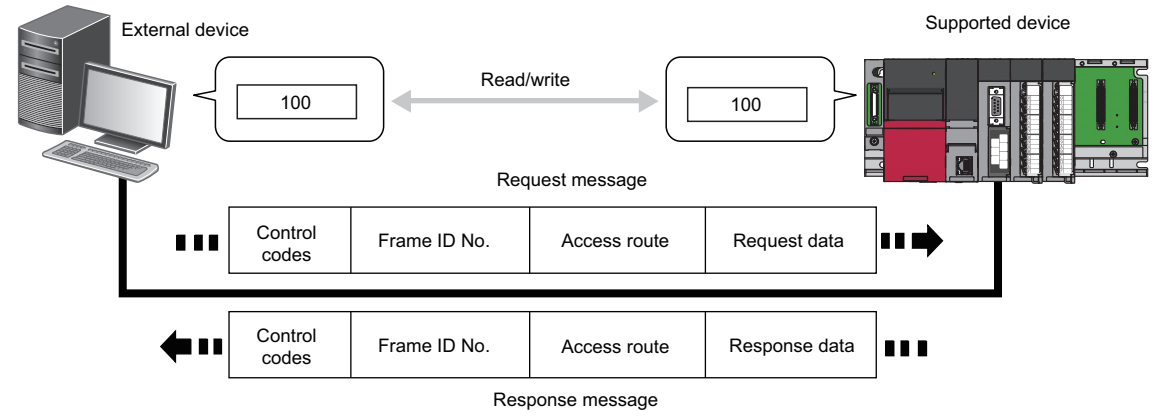

Accessible via various network

By using MC protocol, accessing other station via various network can be performed seamlessly.

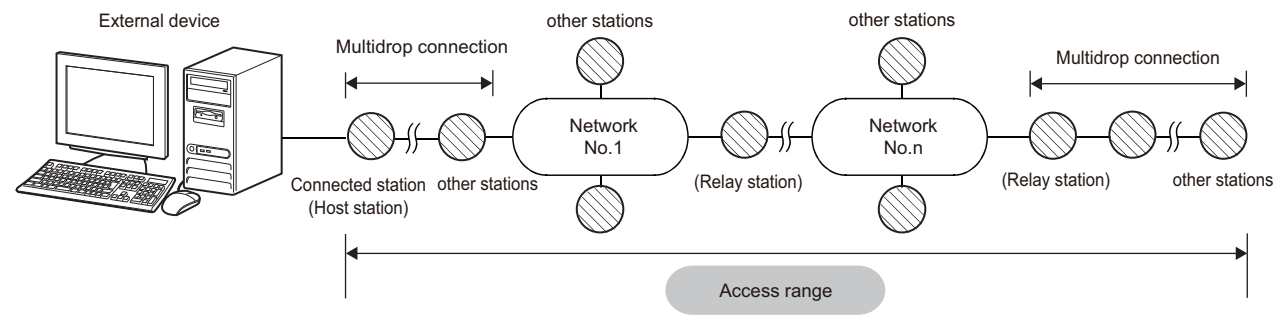

2 SUPPORTED DEVICES AND ACCESSIBLE RANGES

This chapter explains the supported modules and accessible modules.

2.1 Supported Devices

Communications using the MC protocol can be performed as an external device if a device can incorporate application programs and send/receive data using the control procedures of the MC protocol.

This manual explains MC protocol communication when connecting the devices shown below and external devices.

Type	Series	Model name	Reference
Serial communication module	MELSEC iQ-R series	RJ71C24, RJ71C24-R2, RJ71C24-R4	Page 28 MESSAGES OF SERIAL COMMUNICATION MODULE
	MELSEC-L series	LJ71C24, LJ71C24-R2	
	MELSEC-Q series	QJ71C24N, QJ71C24N-R2, QJ71C24N-R4, QJ71C24, QJ71C24-R2	
Ethernet interface module	MELSEC-L series	LJ71E71-100	Page 39 MESSAGES OF Ethernet INTERFACE MODULE
	MELSEC-Q series	QJ71E71-100, QJ71E71-B5, QJ71E71-B2	

2.2 Accessible Range and Accessible Modules

A CPU module and other station on the network can be accessed via a supported device.

Accessible range

The following devices are accessible.

- Supported devices that are connected to the external device directly (connected station)
- Other stations on the same network with the supported devices^{*1}
- Other stations on the other network that are connected to other station in the same network with the supported device.^{*1}

^{*1} Other station on which network No. and station No. is set, and a multidrop connection station can be accessed.

The accessible range differs in types (frames) of a message format.

The following figure shows the maximum range that can be accessed.

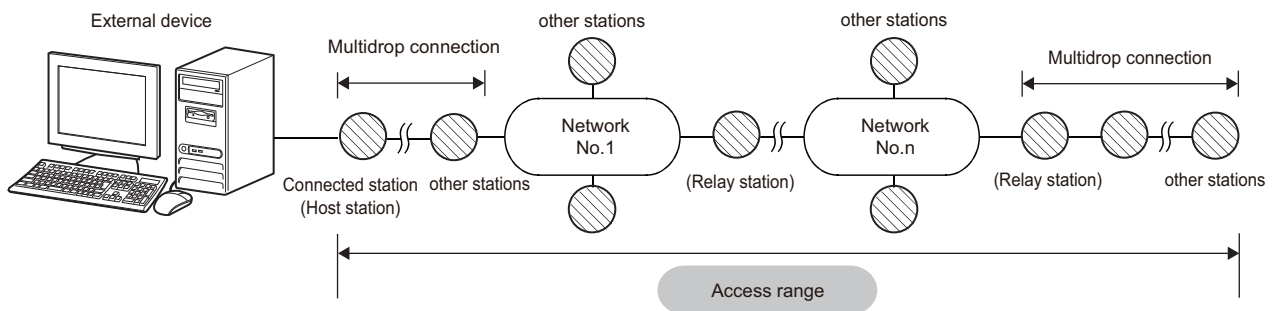

For the accessible range of each message, refer to the following sections.

Message formats of serial communication modules	Message formats of Ethernet interface modules
<ul style="list-style-type: none"> • Page 45 Accessible range of 4C frame • Page 46 Accessible range of 3C frame • Page 46 Accessible range of 2C frame • Page 47 Accessible range of 1C frame 	<ul style="list-style-type: none"> • Page 48 Accessible range of 4E frame, 3E frame • Page 49 Accessible range of 1E frame

For details on the accessible range of programmable controllers of other stations on a network system, refer to the manual for the network system used.

The multiple CPU system is supported. For details on the multiple CPU system, refer to the following section.

☞ Page 462 Compatibility with Multiple CPU Systems

Accessible modules

The following modules in the accessible range can be accessed

However, the commands that can be used have some restrictions. (☞ Page 471 Accessible Modules for Each Command)

For the access to A series and QnA series modules, refer to the following sections.

- For QnA series: ☞ Page 286 MELSEC-QnA SERIES SUPPORTED SPECIFICATIONS
- For A series: ☞ Page 342 MELSEC-A SERIES SUPPORTED SPECIFICATIONS

For the restrictions for model name and version of the supported module, refer to the manual of each module.

■Connectable modules

The following modules can be connected from an external device with the serial communication.

- Serial communication module
- CPU modules that have serial communication function

For the serial communication functions, refer to the user's manual of the CPU module used.

📖 MELSEC-L CPU Module User's Manual (Function Explanation, Program Fundamentals)

📖 QnUCPU User's Manual (Function Explanation, Program Fundamentals)

The following modules can be connected from an external device with the Ethernet communication.

- Ethernet interface module
- Built-in Ethernet CPU module

For Ethernet built-in CPU modules, refer to the user's manual of the CPU module used.

📖 MELSEC-L CPU Module User's Manual (Built-In Ethernet Function)

📖 QnUCPU User's Manual (Communication via Built-in Ethernet Port)

■Accessible modules via supported device

The following modules are accessible from the connected station (host station) or other station.

- CPU module
- MELSECNET/H remote I/O station
- CC-Link IE Field Network head module
- Intelligent function module

■Modules that can be relayed between networks

The networks that can be relayed by setting the network No. and station No., and the devices that can be relayed are shown below.

Network	Module type	Model name
CC-Link IE Field Network	CC-Link IE Field Network master/local-equipped module	RJ71GF11-T2, RJ71EN71 (when using the CC-Link IE Field Network function)
	CC-Link IE Field Network master/local module	LJ71GF11-T2, QJ71GF11-T2, QS0J71GF11-T2
CC-Link IE Controller Network	CC-Link IE Controller Network-equipped module	RJ71GP21-SX
	CC-Link IE Controller Network module	QJ71GP21-SX, QJ71GP21S-SX
MELSECNET/H	MELSECNET/H module	QJ71LP21, QJ71LP21-25, QJ71LP21S-25, QJ71LP21G, QJ71BR11, QJ71NT11B
Ethernet	Ethernet interface module	RJ71EN71, LJ71E71-100, QJ71E71-100, QJ71E71-B5, QJ71E71-B2, QJ71E71

In the circumstances that multiple network modules with the same network No. are mounted on the station with C24/E71, the access to other stations is performed via the network module mounted on the slot that has the lowest base unit number when the network No. is specified.

Point

The following networks are accessible.

- Ethernet (Setting the network No. and station No. are required.)
- CC-Link IE Controller Network
- CC-Link IE Field Network
- MELSECNET/H

Up to 8 connection targets (relay stations: 7 stations) can be accessed.

3 COMMUNICATION PROCEDURE

This chapter explains the considerations when performing communication from an external devices to the programmable controller system using MC protocol.

3.1 Features of Communication Process

The following shows the features of data communication using MC protocol.

Request messages and response messages

There are two types of messages in MC protocol; request message and response message.

The request message sent from the external device is processed in the CPU module via MC protocol supported devices. The processing result is returned as a response message to the external device.

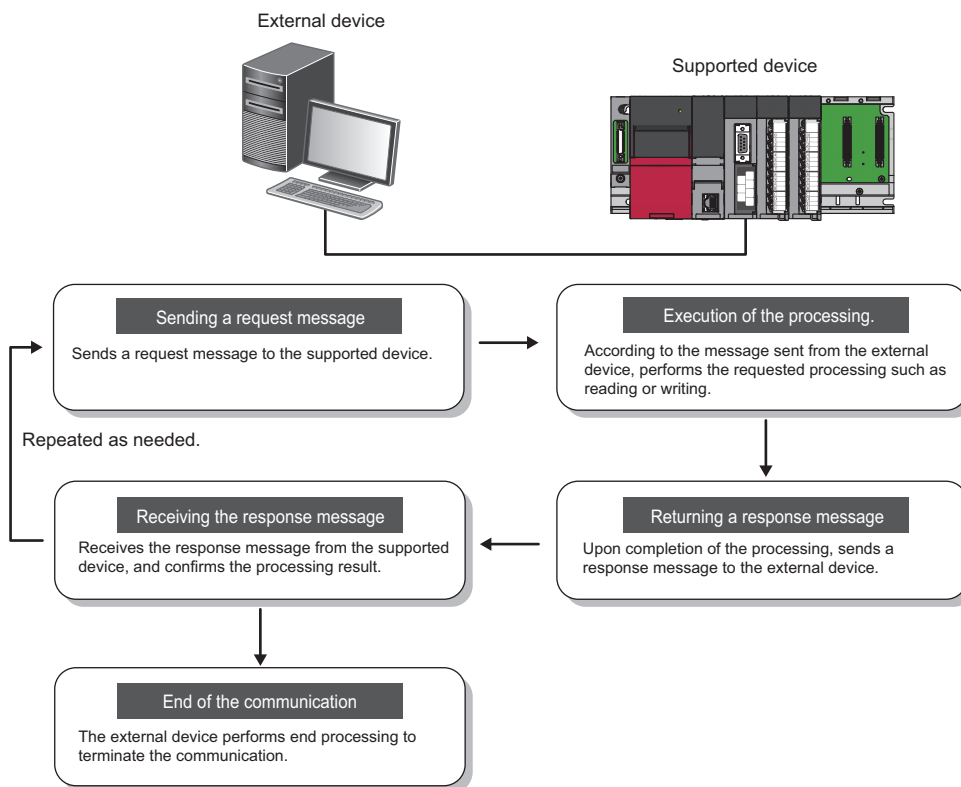

Half-duplex communication

Data communication by MC protocol is performed with half-duplex communication.*1

When accessing CPU module, send the next command message after receiving the response message against the previously sent command message from the CPU module. (The command messages cannot be sent until the reception of the response message is completed.)

When the system between external devices and CPU module is configured with an m:n connection, the next command message cannot be sent until data communication between either of the external devices and CPU modules is completed.

*1 When using the on-demand function using C24, full-duplex communication can be performed.

3.2 Considerations

The following are the considerations when performing data communication.

When accessing CPU module

The following are the considerations when accessing a CPU module from an external device via a supported device.

■ Processing timing of CPU module

Processing for a request message is performed during an END processing of CPU module.

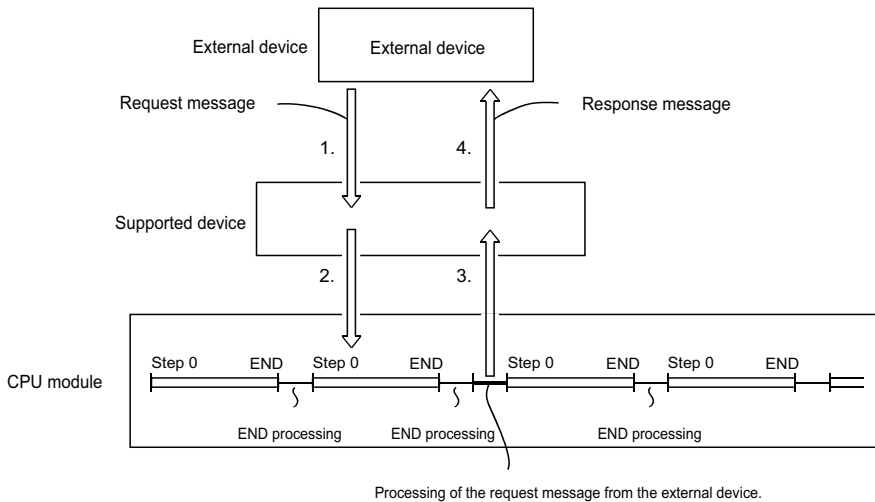

1. Send a request message from the external device to a supported device.
2. When the request message is received from the external device to the target device, a data read request or write request is issued to the CPU module.
3. In accordance with the request issued from the external device during END processing from the external device, CPU modules reads/writes data and then sends the processing result back to the supported device.
4. Once the supported device receives a processing result from the CPU module, send a response message including the processing result to the external device.

■ Read or write data while CPU module is in RUN

- Due to process the request from the external device, scan time of the CPU module will be extended. If the extension of the scan time affects the control, access the CPU module several times with less number of points.
- Before writing, check whether the online change is enabled (such as whether the system protection is unlocked or not) on the CPU module side.

■ When the access target CPU module is protected by system protection

An error occurs at the access target, and an abnormal response is sent back to the external device. Unlock the system protection of the CPU module side, and resend the request message.

■ When access requests are sent to one station from several external devices at the same time

Depending on the request timing, the processing requested from the external device may be on hold until several END processing take place. By using either of the following methods, multiple requests can be processed in one scan.

- Execute COM instruction by program.
- Ensure 1 to 100 ms of service processing time using "Service Processing Setting" of Engineering tool.

When accessing MELSECNET/H or MELSECNET/10 remote I/O station

The following are the considerations when accessing a MELSECNET/H remote I/O station or MELSECNET/10 remote I/O station from external devices.

■Considerations for supported frames

1E frame cannot be used for communication.

■Functions that can be used

The functions that can be used for remote I/O station are as follows:

Function	MELSECNET/H remote I/O station	MELSECNET/10 remote I/O station
Read/write device memory	○	—
Read/write buffer memory	○	—
Read/write intelligent function module	○	○
Programmable controller CPU monitoring function (only when C24 is mounted) *1	○	—

*1 The monitoring target devices can be registered within the device range of MELSECNET/H remote I/O station.

Only reading from/writing to the buffer memory of intelligent function module is available for MELSECNET/10 remote I/O stations supported by QnA/A series.

■When writing data

When writing data to the devices of the remote I/O station or intelligent function module mounted on the remote I/O station, set the setting of online program change to allow with Engineering tool.

( Page 465 Setting method for writing data to CPU during RUN)

■Accessible range of other station

Accessing MELSECNET/H remote master station and MELSECNET/H remote I/O station can be performed from E71 with MELSECNET/H remote I/O station mounted.

Other station cannot be accessed via a remote I/O station. (A remote I/O station does not work as a relay station.)

Considerations when connecting C24

The following shows the considerations when performing data communication between C24.

Conditions that C24 transmission sequence becomes initial status

The transmission sequence of C24 becomes initial status under the following conditions.

- When turning the power ON, changing the status of reset switch on the front of the CPU, and switching modes.
- When the transmission of a response message for the command message reception is completed.
- When a transmission sequence initialization request is received.

Abnormal response from C24

An abnormal response to the external device using MC protocol is issued when an error is detected in the request sent to the connected station (host station). Therefore, an abnormal response may be issued while sending request from the external device in the full-duplex communication.

Replacement of other station CPU modules to communicate with

C24 imports and retains the information of other station CPU modules after started up.

When replacing the other station CPU module to perform data communication after starting up C24, reboot the C24 if the model name of the CPU module is changed. (Reset the programmable controller of the connected station (host station)/CPU reset).

Framing error on external device

A framing error may occur on the external device when nothing is sent from C24 to the external device via RS-422/485.

📖 Q Corresponding Serial Communication Module User's Manual (Basic)

📖 MELSEC-L Serial Communication Module User's Manual (Basic)

📖 MELSEC iQ-R Serial Communication Module User's Manual(Application)

Skip reading data until C24 sends either STX, ACK, or NAK on the external device.

Before the data communication, check the C24 interface specification written in the following manuals.

📖 Q Corresponding Serial Communication Module User's Manual (Basic)

📖 MELSEC-L Serial Communication Module User's Manual (Basic)

📖 MELSEC iQ-R Serial Communication Module User's Manual(Startup)

Installation of multiple C24s

When multiple external devices that are connected to each C24 request access to the CPU module at the same time, the CPU module decides the order of access.

The access priority order cannot be set by user.

Considerations when connecting E71

Send of request message

Before sending a request message, check that the supported device is ready to receive the request message.

When sending multiple request messages

For 4E frame, send the request message with appending "Serial No." to the subheader on the external device. By appending "Serial No.", the send source can be identified when multiple request messages have been sent.

When sending request message continuously

When sending request messages consecutively without waiting for the reception of the response message using 4E frame, make sure that the number of command messages shown below are not exceeded.

Name	Model name	Applicable number of commands for processing per one connection ^{*1}
Ethernet interface module	QJ71E71-100, LJ71E71-100	1 + (57 ÷ Number of connections to be used)
	QJ71E71-B2, QJ71E71-B5	1 + (10 ÷ Number of connections to be used)
CPU module	Q03UDVCPUP, Q04UDVCPUP, Q04UDPVCPU, Q06UDVCPUP, Q06UDPVCPU, Q13UDVCPUP, Q13UDPVCPU, Q26UDVCPUP, Q26UDPVCPU	1 + (Number of messages that can be stored in receive buffer (576) ÷ Number of connections to be used)

*1 If the calculation result became decimal, the number after the decimal points will be rounded off to positive number.

When exceeded number of commands were sent, an error may occur in the supported device, or response messages may not be returned from the supported device.

When sending the request message which exceeds the number of commands, decrease the frequency of request message transmission.

When the response message corresponding to the request message does not return

If the response message is not returned from the supported device, resend the request message from the external device after the specified time set with "Monitoring timer" of the request message is elapsed.

Replacement of devices

After replacing a device on Ethernet due to failure, the devices may not communicate properly because of the change of the MAC address. (When replaced with the device that has the same IP address)

When a device in the Ethernet network is replaced, restart all devices in the network.

This part explains the message format of MC protocol.

4 MESSAGES OF SERIAL COMMUNICATION MODULE

5 MESSAGES OF Ethernet INTERFACE MODULE

6 ACCESS ROUTE SETTINGS

4 MESSAGES OF SERIAL COMMUNICATION MODULE

This section explains the specifications of the messages of MC protocol and access range when connecting with serial communication from an external device.

4.1 Types and Purposes of Messages

The messages of MC protocol can be classified as shown in the following table depending on the supported device and its intended purpose.

Formats and codes

There are five formats for the message that can be used for serial communication module.

Setting value	Format	Code of communication data	Remarks	Reference
1	Format 1	ASCII code	—	Page 29 Format 1
2	Format 2	ASCII code	Format with block number appended	Page 30 Format 2
3	Format 3	ASCII code	Format enclosed with STX and ETX	Page 31 Format 3
4	Format 4	ASCII code	Format with CR and LF appended at the end	Page 32 Format 4
5	Format 5	Binary code	Can be used by 4C frame.	Page 33 Format 5

Set the format with the communication protocol setting of Engineering tool.

Point

Communication using binary code shorten the communication time since the amount of communication data is reduced by approximately half as compared to the one using ASCII code.

Frame

This section explains the types and purposes of the frames (data communication messages) used by the external device to access the supported devices using MC protocol.

The frames for serial communication modules are as follows:

Frame	Features and purposes	Compatible message format	Format
4C frame	Accessible from external devices with the maximum access range.	Dedicated protocols for MELSEC-QnA series serial communication modules (QnA extension frame).	Formats 1 to 5
3C frame	These message formats are simplified compared to the 4C frame.	Dedicated protocols for MELSEC-QnA series serial communication modules (QnA frame).	Formats 1 to 4
2C frame	Data communication software for MELSEC-QnA series programmable controllers can be used.	Dedicated protocols for MELSEC-QnA series serial communication modules (QnA simplified frame).	
1C frame	These frames have the same message structures as when accessing the CPU module using an MELSEC-A series computer link module. Data communication software for MELSEC-A series programmable controllers can be used.	Dedicated protocols for MELSEC-A series computer link modules	

4.2 Message Formats of Each Protocol

This section explains the message format and setting data per each format.

Format 1

Message format

Request message

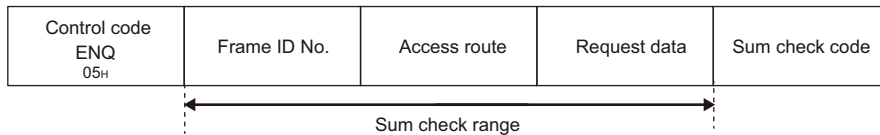

Response message (Normal completion: Response data)

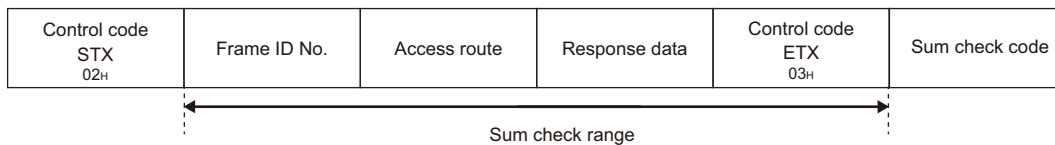

Response message (Normal completion: No response data)

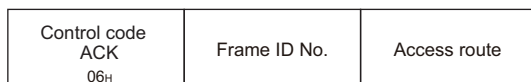

Response message (Abnormal completion)

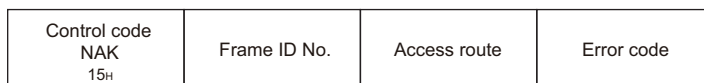

Setting data

Set the following items.

Item	Description	Reference
Control code (ENQ, STX, ACK, NAK, ETX)	A code is defined for control.	Page 34 Control code
Frame ID No.	Specify the frame to be used.	Page 36 Frame ID No.
Access route	Specify the access route.	Page 45 ACCESS ROUTE SETTINGS
Request data	Set the command that indicates the request content. Refer to "Request data" rows of each command.	Page 60 COMMANDS AND FUNCTIONS
Response data	Store the read data for the command. Refer to "Response data" rows of each command.	
Sum check code	The value of the lower one byte (8 bits) of the additional result regarding the data in the sum check target range as a binary data.	Page 36 Sum check code
Error code	Error code indicates the content of occurred error.	Page 38 Error code

Format 2

Message format

Request message

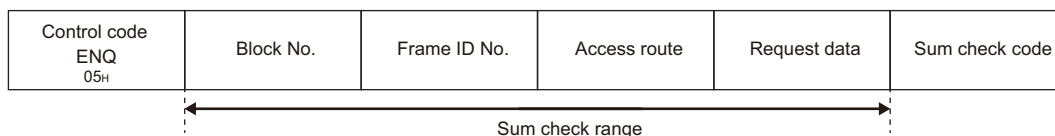

Response message (Normal completion: Response data)

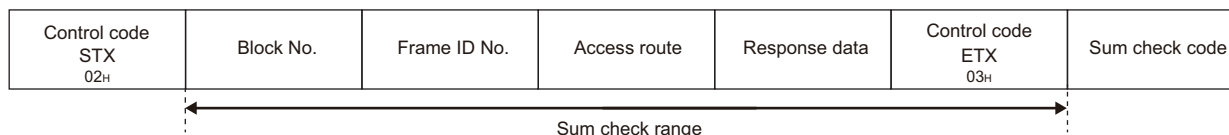

Response message (Normal completion: No response data)

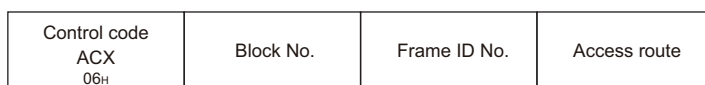

Response message (Abnormal completion)



Setting data

Set the following items.

Item	Description	Reference
Control code (ENQ, STX, ACK, NAK, ETX)	A code is defined for control.	Page 34 Control code
Block number	This can set arbitrarily in the range of '00H' to 'FFH'. It is used for data defragmentation.	Page 36 Block number
Frame ID No.	Specify the frame to be used.	Page 36 Frame ID No.
Access route	Specify the access route.	Page 45 ACCESS ROUTE SETTINGS
Request data	Set the command that indicates the request content. Refer to "Request data" rows of each command.	Page 60 COMMANDS AND FUNCTIONS
Response data	Store the read data for the command. Refer to "Response data" rows of each command.	
Sum check code	The value of the lower one byte (8 bits) of the additional result regarding the data in the sum check target range as a binary data.	Page 36 Sum check code
Error code	Error code indicates the content of occurred error.	Page 38 Error code

Format 3

Message format

Request message

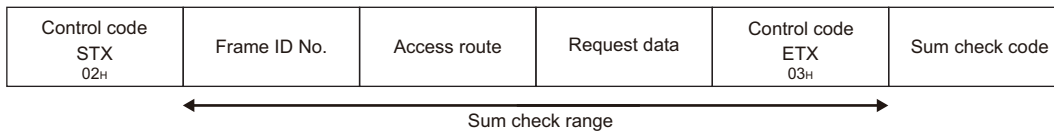

Response message (Normal completion: Response data)

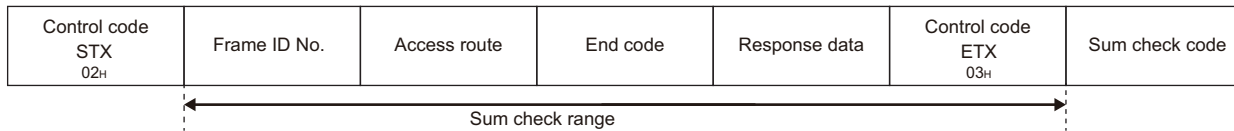

Response message (Normal completion: No response data)

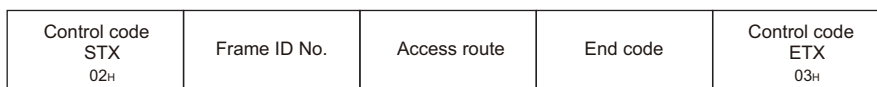

Response message (Abnormal completion)

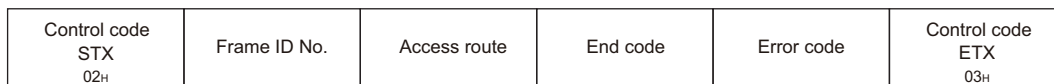

Setting data

Set the following items.

Item	Description	Reference
Control code (STX, ETX)	A code is defined for control.	Page 34 Control code
Frame ID No.	Specify the frame to be used.	Page 36 Frame ID No.
Access route	Specify the access route.	Page 45 ACCESS ROUTE SETTINGS
Request data	Set the command that indicates the request content. Refer to "Request data" rows of each command.	Page 60 COMMANDS AND FUNCTIONS
Response data	Store the read data for the command. Refer to "Response data" rows of each command.	
Sum check code	The value of the lower one byte (8 bits) of the additional result regarding the data in the sum check target range as a binary data.	Page 36 Sum check code
End code	Indicates that the processing result is a normal completion or abnormal completion. <ul style="list-style-type: none"> 4C/3C/2C frame: QACK (normal), QNAK (abnormal) 1C frame: GG (normal completion), NN (abnormal completion) 	Page 38 End code
Error code	Error code indicates the content of occurred error.	Page 38 Error code

Format 4

Message format

Request message

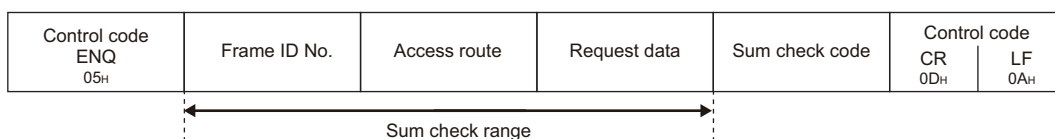

Response message (Normal completion: Response data)

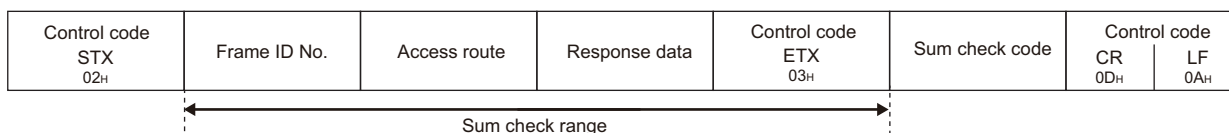

Response message (Normal completion: No response data)

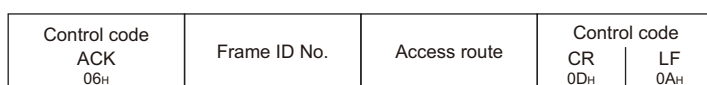

Response message (Abnormal completion)

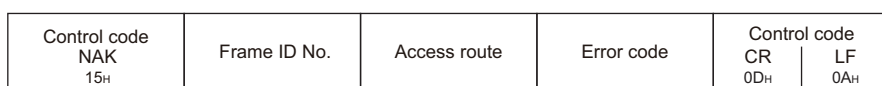

Setting data

Set the following items.

Item	Description	Reference
Control code (ENQ, STX, ACK, NAK, ETX, CR, LF)	A code is defined for control.	Page 34 Control code
Frame ID No.	Specify the frame to be used.	Page 36 Frame ID No.
Access route	Specify the access route.	Page 45 ACCESS ROUTE SETTINGS
Request data	Set the command that indicates the request content. Refer to "Request data" rows of each command.	Page 60 COMMANDS AND FUNCTIONS
Response data	Store the read data for the command. Refer to "Response data" rows of each command.	
Sum check code	The value of the lower one byte (8 bits) of the additional result regarding the data in the sum check target range as a binary data.	Page 36 Sum check code
Error code	Error code indicates the content of occurred error.	Page 38 Error code

Format 5

Message format

Request message

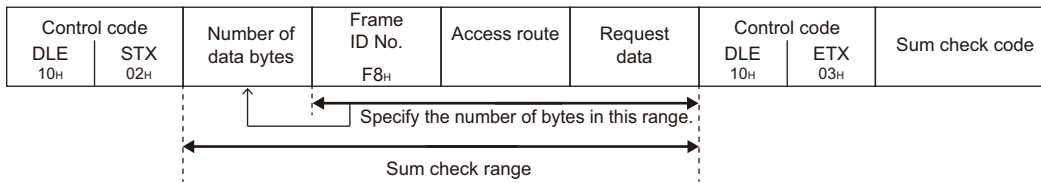

Response message (Normal completion: Response data)

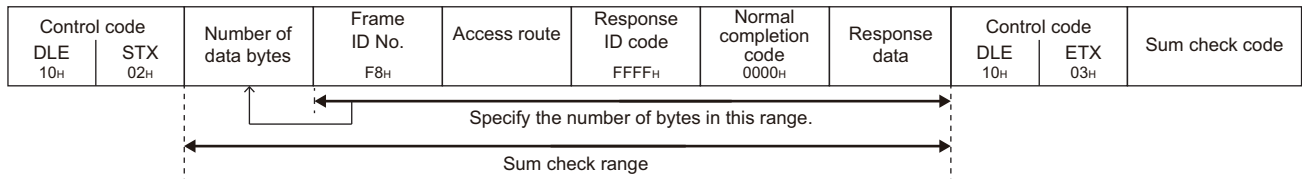

Response message (Normal completion: No response data)

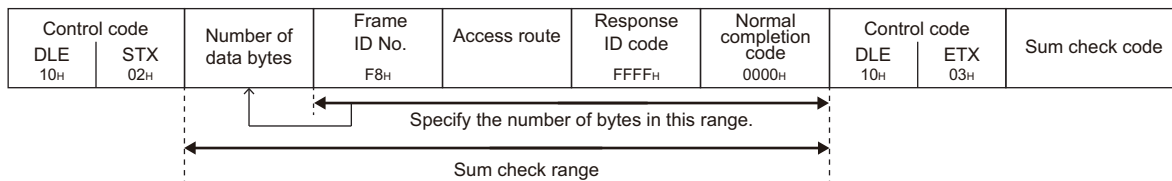

Response message (Abnormal completion)

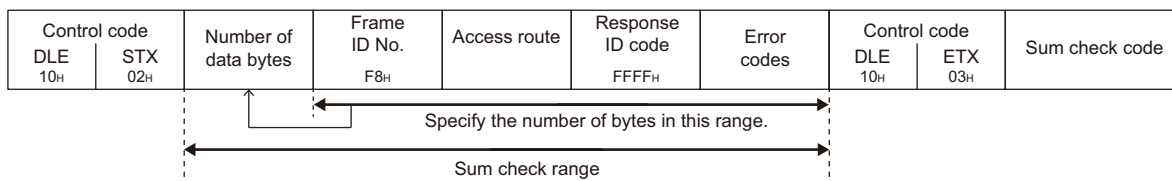

Setting data

Set the following items.

Item	Description	Reference
Control code (DLE, STX, ETX)	A code is defined for control.	Page 34 Control code
Number of data bytes	A number of bytes from a frame ID No. to control code (DLE, ETX).	Page 35 Number of data bytes
Frame ID No.	Specify the frame to be used.	Page 36 Frame ID No.
Access route	Specify the access route.	Page 45 ACCESS ROUTE SETTINGS
Request data	Set the command that indicates the request content. Refer to "Request data" rows of each command.	Page 60 COMMANDS AND FUNCTIONS
Response data	Store the read data for the command. Refer to "Response data" rows of each command.	
Sum check code	The value of the lower one byte (8 bits) of the additional result regarding the data in the sum check target range as a binary data.	Page 36 Sum check code
Response ID code	This indicates a response message. The 2-byte numerical value, 'FFFFH' is stored.	—
Normal completion code	This indicates the processing is completed normally. The 2-byte value, '0000H' is stored.	—
Error code	Error code indicates the content of occurred error.	Page 38 Error code

4.3 Details of Setting Data

This section explains how to specify the common data items and their content in each message.

Control code

Control code is a data that has special meaning (such as head data of a message) for C24 transmission control.

Control code used in a message (format 1 to format 4) in ASCII code

The control code used for a message in ASCII code (format 1 to format 4) is shown in the following table.

Symbol name	Description	Code (hexadecimal)
STX	Start of Text	02H
ETX	End of Text	03H
EOT	End of Transmission	04H
ENQ	Enquiry	05H
ACK	Acknowledge	06H
LF	Line Feed	0AH
CL	Clear	0CH
CR	Carriage Return	0DH
NAK	Negative Acknowledge	15H

■EOT(04H), CL(0CH)

EOT and CL are codes for initializing the transmission sequence for data communications in ASCII code using the MC protocol and for placing C24 into wait state to receive commands from an external device.

The transmission sequence is initialized with the command (command code: 1615) when binary code (format 5) is used. When performing the following at an external device, send the EOT/CL to the C24 depending on the format used.

- Canceling a read/write request by command previously sent. (If a write request is issued, the write request cannot be canceled when the data has already written to the CPU module.)
- Placing C24 into the wait state to receive commands before commands are sent.
- Placing C24 into the state where it has been started up when data communication cannot be performed normally.

The message structure when sending EOT, CL is shown below.

Only the following data is sent. The station No. and PC No. are not required.

Format	EOT	CL
Format 1 to format 3	EOT 04H	CL 0CH
Format 4	EOT CR LF 04H 0DH 0AH	CL CR LF 0CH 0DH 0AH

When C24 receives EOT or CL, it proceeds as follows.

- C24 terminates any read/write processing performed to the CPU module upon request from the external device. In this case, C24 does not send a response message to the command previously received.
- C24 initializes the transmission sequence of the MC protocol from which the EOT/CL is received on the interface side and placing C24 into wait state to receive commands from an external device.
- C24 does not send a response message to the EOT or CL reception. (It does not send anything to external devices.)
- When it receives EOT or CL while the on-demand function (data transmission function from the CPU module to external devices) is being performed, C24 terminates to transmit the on-demand data to external devices. (Page 279 On-demand function)

Control code used in a message (format 5) in binary code

The control code used for a message in binary code (format 5) is shown in the table below.

Symbol name	Description	Code (hexadecimal)
STX	Start of Text	02H
ETX	End of Text	03H
DLE	Data Link Escape	10H

Additional code (10H)

The additional code is added to distinguish the data when the control code DLE (10H) is the same as the setting data in the frame 5.

When '10H' is included in the data from "Number of data bytes" and "Request data" in the request message, the additional code '10H' is added in front of the data.

When '10H' is included in the data from "Number of data bytes" and "Response data" in the response message, the additional code '10H' is added.

('10H' is transmitted as '10H' + '10H'.)



Calculate the following value except for the additional code.

- Number of data bytes (setting item of format 5)
- Sum check code

Number of data bytes

A number of data bytes indicates the total number of bytes from the frame ID No. to control code.

Range

Calculate the data in the range from frame ID No. before DLE (10H) except for the additional code. (Page 35 Additional code (10H))

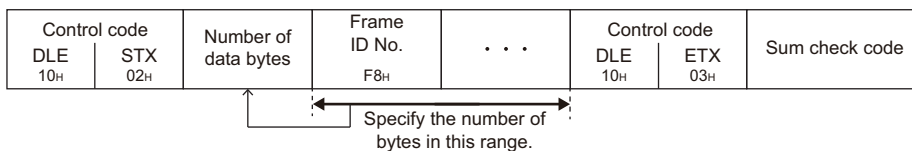

Setting method

Set the data in binary code (format 5) at data communication.

Send 2-byte numerical value from the lower byte (L: bits 0 to 7).

Ex.

Response message (Normal completion: Response data)

- Frame ID No.: 1 byte
- Access route: 7 byte
- Response ID code, normal completion code: 4 bytes
- Response data: 2 bytes + additional code (10H) 1 byte

Number of data bytes = 1 + 7 + 4 + 2 = 14 (0EH)

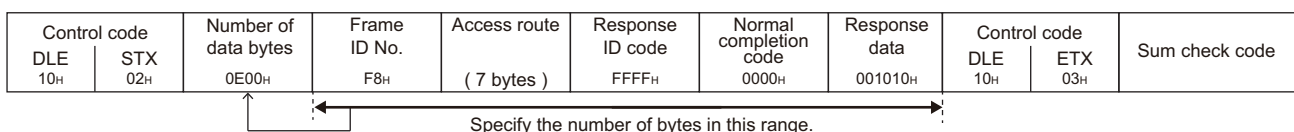

Block number

Block number is an arbitrary number defined by an external device and used for data defragmentation.

Block number converts data to 2-digit (hexadecimal) ASCII code within the range of '00H' to 'FFH' and sent them from the upper digits.

C24 only checks if the block number is specified within the correct range. It does not check whether the block numbers are sent in order.

Frame ID No.

Specify the frame to be used.

Type	Setting value
4C frame	F8
3C frame	F9
2C frame	FB
1C frame	— (Not required)

Setting method

■Data communication in ASCII code

Convert the numerical value to 2-digit ASCII code (hexadecimal), and send it from the upper digits.

■Data communication in binary code

Send a 1-byte numerical value.

Ex.

For 4C frame (F8)

ASCII code	Binary code			
<table border="1"><tr><td>F 8</td></tr><tr><td>46H , 38H</td></tr></table>	F 8	46H , 38H	<table border="1"><tr><td>F8H</td></tr></table>	F8H
F 8				
46H , 38H				
F8H				

Sum check code

Set the sum check code when performing sum check.

For sum check code, set the value to be calculated from the data with the range of sum check for error detection.

Sum check

Sum check is a function for detecting error when data changes while data transmission.

Set the sum check existence by Engineering tool.

■When sum check code is set to "Exist"

Attach a sum check code to the request message.

C24 checks the sum check code. The sum check code is added to the response message.

■When sum check code is set to "None"

The sum check code is not required for the request message.

C24 does not check the sum check code. The sum check code is not added to the response message.

Sum check range

The sum check range of each message format is as follows:

Format	Message structure	Reference
Format 1 to format 3		Page 29 Format 1 Page 30 Format 2 Page 31 Format 3
Format 4		Page 32 Format 4
Format 5		Page 33 Format 5

Calculation of a sum check code

For sum check code, set the numerical values of the lower 1 byte (8 bits) of the added result (sum) as binary data within the sum check range.

Calculate sum check code except for the additional code. (☞ Page 35 Additional code (10H))

Ex.

In the following case of 1C frame format 1, the sum check code will be 'C0'.

Formula: $30H + 30H + 46H + 46H + 42H + 52H + 33H + 4DH + 30H + 30H + 30H + 30H = 2C0H$

Sum check code: 'C0' (ASCII code 43H, 30H)

ENQ	Station No.		PC No.		Command		Message wait	Character area				Sum check code	
0	0	F	F	B	R	3	M	0	0	0	0	C	0
05H	30H	30H	46H	46H	42H	52H	33H	4DH	30H	30H	30H	43H	30H

← Sum check range (from Message wait to Sum check code)

In the following case of 4C frame format 5, the sum check code will be '05'.

Formula: $12H + 00H + F8H + 05H + 07H + 03H + 04H + 00H + 01H + 00H + 01H + 04H + 01H + 00H + 40H + 00H + 00H + 9CH + 05H + 00H = 205H$

Sum check code: '05' (ASCII code 30H, 35H)

DLE	STX	Number of data bytes		Frame ID No.	Station No.	Network No.	PC No.	Request destination module I/O No.		Request destination module Station No.	Self-station No.	Command		Subcommand		Head device			Device code	Number of device points		DLE	ETX	Sum check Code	
L	H	L	H	F8H	05H	07H	03H	L	H	01H	00H	L	H	L	H	L	-	H	9CH	L	H	10H	03H	H	L
10H	02H	12H	00H	F8H	05H	07H	03H	04H	00H	01H	00H	01H	04H	01H	00H	40H	00H	00H	9CH	05H	00H	10H	03H	30H	35H

← Sum check range (excluding additional codes) (from Device code to Sum check Code)

Setting method

■Data communication in ASCII code

Convert the numerical value to 2-digit ASCII code (hexadecimal), and send it from the upper digits.

■Data communication in binary code

The same as the data communication in ASCII code, use the numerical value converted to the 2 digit ASCII code (hexadecimal).

Send 2-byte numerical value from the upper byte (H: bits 8 to 15).

Ex.

Sum check code: '05' (ASCII code 30H, 35H)

ASCII code, binary code

0	5
30H	35H

End code

Indicates that the processing result is a normal completion or abnormal completion.

The following fixed value is stored.

Processing result	4C frame, 3C frame, 2C frame	1C frame												
Normal completion	<table border="1"><tr><td>Q</td><td>A</td><td>C</td><td>K</td></tr><tr><td>51H</td><td>41H</td><td>43H</td><td>48H</td></tr></table>	Q	A	C	K	51H	41H	43H	48H	<table border="1"><tr><td>G</td><td>G</td></tr><tr><td>47H</td><td>47H</td></tr></table>	G	G	47H	47H
Q	A	C	K											
51H	41H	43H	48H											
G	G													
47H	47H													
Abnormal completion	<table border="1"><tr><td>Q</td><td>N</td><td>A</td><td>K</td></tr><tr><td>51H</td><td>4EH</td><td>41H</td><td>48H</td></tr></table>	Q	N	A	K	51H	4EH	41H	48H	<table border="1"><tr><td>N</td><td>N</td></tr><tr><td>4EH</td><td>4EH</td></tr></table>	N	N	4EH	4EH
Q	N	A	K											
51H	4EH	41H	48H											
N	N													
4EH	4EH													

Error code

Error code indicates the content of occurred error.

If more than one error occurs at the same time, the error code detected first is returned.

For the content of error code and its corrective action, refer to the user's manual of the module used.

📖 Q Corresponding Serial Communication Module User's Manual (Basic)

📖 MELSEC-L Serial Communication Module User's Manual (Basic)

📖 MELSEC iQ-R Serial Communication Module User's Manual(Application)

Setting method

■Data communication in ASCII code

Convert the numerical value to 4-digit ASCII code (hexadecimal), and send it from the upper digits.

■Data communication in binary code

Send 2-byte numerical value from the lower byte (L: bits 0 to 7).

Ex.

When error code 7151H is returned

ASCII code	Binary code										
<table border="1"><tr><td>7</td><td>1</td><td>5</td><td>1</td></tr><tr><td>37H</td><td>31H</td><td>35H</td><td>31H</td></tr></table>	7	1	5	1	37H	31H	35H	31H	<table border="1"><tr><td>51H</td><td>71H</td></tr></table>	51H	71H
7	1	5	1								
37H	31H	35H	31H								
51H	71H										

For the error code of 1C frame, refer to the following section.

📖 Page 348 Error code

5 MESSAGES OF Ethernet INTERFACE MODULE

This section explains the specifications of the messages and access range of MC protocol when connecting with Ethernet communication from an external device.

5.1 Types and Purposes of Messages

The messages of MC protocol can be classified as shown in the following table depending on the supported device and its intended purpose.

Code

ASCII code and binary code are available.

Set the operation settings with Engineering tool.

Point

Communication using binary code shorten the communication time since the amount of communication data is reduced by approximately half as compared to the one using ASCII code.

5

Data storage order

The data size and the storing order of values for data in each item vary between ASCII code and binary code.

■Data communication in ASCII code

Data is stored in order from the upper byte to the lower byte.

■Data communication in binary code

Data is stored in order from the lower byte to the upper byte.

Ex.

Subheader of 4E frame request message (serial No. is '1234')

ASCII code	Binary code																																																
<p style="text-align: center;">Serial number</p> <table border="1" style="width: 100%; border-collapse: collapse;"> <tr> <td style="text-align: center;">5</td> <td style="text-align: center;">4</td> <td style="text-align: center;">0</td> <td style="text-align: center;">0</td> <td style="text-align: center;">1</td> <td style="text-align: center;">2</td> <td style="text-align: center;">3</td> <td style="text-align: center;">4</td> <td style="text-align: center;">0</td> <td style="text-align: center;">0</td> <td style="text-align: center;">0</td> <td style="text-align: center;">0</td> </tr> <tr> <td style="text-align: center;">35H</td> <td style="text-align: center;">34H</td> <td style="text-align: center;">30H</td> <td style="text-align: center;">30H</td> <td style="text-align: center;">31H</td> <td style="text-align: center;">32H</td> <td style="text-align: center;">33H</td> <td style="text-align: center;">34H</td> <td style="text-align: center;">30H</td> <td style="text-align: center;">30H</td> <td style="text-align: center;">30H</td> <td style="text-align: center;">30H</td> </tr> <tr> <td colspan="4" style="text-align: center;">(Fixed value)</td> <td colspan="4"></td> <td colspan="4" style="text-align: center;">(Fixed value)</td> </tr> </table>	5	4	0	0	1	2	3	4	0	0	0	0	35H	34H	30H	30H	31H	32H	33H	34H	30H	30H	30H	30H	(Fixed value)								(Fixed value)				<p style="text-align: center;">Serial number</p> <table border="1" style="width: 100%; border-collapse: collapse;"> <tr> <td style="text-align: center;">54H</td> <td style="text-align: center;">00H</td> <td style="text-align: center;">34H</td> <td style="text-align: center;">12H</td> <td style="text-align: center;">00H</td> <td style="text-align: center;">00H</td> </tr> <tr> <td colspan="2" style="text-align: center;">(Fixed value)</td> <td colspan="2"></td> <td colspan="2" style="text-align: center;">(Fixed value)</td> </tr> </table>	54H	00H	34H	12H	00H	00H	(Fixed value)				(Fixed value)	
5	4	0	0	1	2	3	4	0	0	0	0																																						
35H	34H	30H	30H	31H	32H	33H	34H	30H	30H	30H	30H																																						
(Fixed value)								(Fixed value)																																									
54H	00H	34H	12H	00H	00H																																												
(Fixed value)				(Fixed value)																																													

Frame

This section explains the types and purposes of the frames (data communication messages) used by the external device to access the supported devices using MC protocol.

The frames for Ethernet interface modules are as follows:

Frame	Features and purposes	Compatible message format	Correspondence code
4E frame	A message format that a "Serial No." (arbitrary number for message identification) is added to 3E frame. By appending a "Serial No.", the send source can be identified when multiple request messages have been sent.	Message formats for SLMP	ASCII code Binary code
3E frame	These frames have the same message structures as when accessing the CPU module using MELSEC-QnA series Ethernet interface module. Data communication software for MELSEC-QnA series programmable controllers can be used.	Message formats for SLMP Message formats for MELSEC-QnA series Ethernet interface modules	ASCII code Binary code
1E frame	These frames have the same message structures as when accessing the CPU module using an MELSEC-A series Ethernet interface module. Data communication software for MELSEC-A series programmable controllers can be used.	Message formats for MELSEC-A series Ethernet interface modules	ASCII code Binary code

5.2 Message Format

This section explains the message format and setting data for 4E frame and 3E frames.

For the message format for 1E frame, refer to the following section.

☞ Page 391 Message Format

Message format

Request message

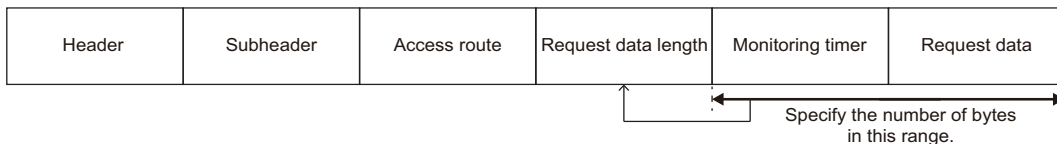

Response message (Normal completion: Response data)

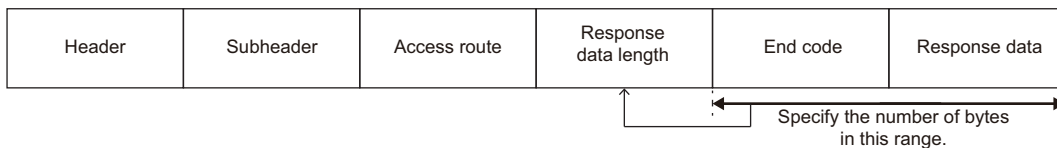

Response message (Normal completion: No response data)

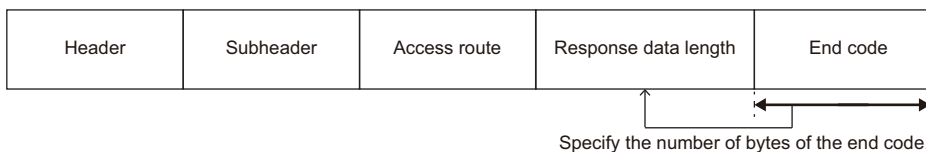

Response message (Abnormal completion)

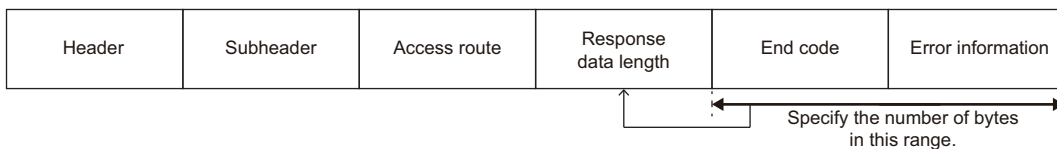

Setting data

Set the following items.

Item	Description	Reference
Header	A header of Ethernet. Normally, it is added automatically.	Page 42 Header
Subheader	The value to be set according to type of message is defined. • 4E frame: Set a serial No. • 3E frame: Fixed value (Request message '5000', Response message 'D000')	Page 42 Subheader
Access route	Specify the access route.	Page 45 ACCESS ROUTE SETTINGS
Request data length	Specify the data length from the monitoring timer to the request data.	Page 43 Request data length and response data length
Monitoring timer	Set the wait time up to the completion of reading and writing processing.	Page 43 Monitoring timer
Request data	For the request data, set the command that indicates the request content. Refer to "Request data" rows of each command.	Page 60 COMMANDS AND FUNCTIONS
Response data length	The data length from an end code to a response data (at normal completion) or an error information (at abnormal completion) is stored.	Page 43 Request data length and response data length
Response data	For the response data, store the read data for the command at normal completion. Refer to "Response data" rows of each command.	Page 60 COMMANDS AND FUNCTIONS
End code	The command processing result is stored.	Page 44 End code
Error information	Store the information of a station on which an error occurred and information of a command.	Page 44 Error information

5.3 Details of Setting Data

This section explains how to specify the common data items and their content in each message.
For the setting data with 1E frame, refer to the following section.

☞ Page 391 Details of Setting Data

Header

A header for TCP/IP and UDP/IP. A header of a request message is added on the external device side and sent. Normally, it is added automatically by an external device. A header for a response message is set automatically by E71.

Subheader

The value to be set according to type of message is defined.

Setting method for 4E frame

Set the fixed value (request message: '5400', response message: 'D400') and a serial No. (0000H to FFFFH).
A serial No. is an arbitrary number that is added on the external device side for message recognition. When a request message is sent with a serial No. added, the same serial No. is added to the response message. Use a serial No. when transmitting more than one request messages from an external device to the same supported device.

Point

Serial No. added on the external device side must be managed at the external device side.

■Data communication in ASCII code

It's 12 bytes in total.

A fixed value is set by 4-digit ASCII code.

For the serial No., convert the numerical value to 4-digit ASCII code (hexadecimal), and send it from the upper digits.

The 4-byte '0' (30H) is inserted after the serial No.

■Data communication in binary code

It's 6 bytes in total.

A fixed value is set in 2 bytes.

For the serial No., send 2-byte numerical value from the lower byte (L: bits 0 to 7).

The 2-byte '0' (00H) is inserted after the serial No.

Ex.

Request message (serial No. '1234')

ASCII code	Binary code																																																																								
<table border="1"> <tr> <td colspan="8">Serial number</td> </tr> <tr> <td>5</td><td>4</td><td>0</td><td>0</td> <td>1</td><td>2</td><td>3</td><td>4</td> <td>0</td><td>0</td><td>0</td><td>0</td> </tr> <tr> <td>35H</td><td>34H</td><td>30H</td><td>30H</td> <td>31H</td><td>32H</td><td>33H</td><td>34H</td> <td>30H</td><td>30H</td><td>30H</td><td>30H</td> </tr> <tr> <td colspan="4">(Fixed value)</td> <td colspan="8">(Free)</td> </tr> </table>	Serial number								5	4	0	0	1	2	3	4	0	0	0	0	35H	34H	30H	30H	31H	32H	33H	34H	30H	30H	30H	30H	(Fixed value)				(Free)								<table border="1"> <tr> <td colspan="4">Serial number</td> </tr> <tr> <td></td><td></td><td></td><td></td> <td></td><td></td><td></td><td></td> </tr> <tr> <td>54H</td><td>00H</td><td>34H</td><td>12H</td> <td>00H</td><td>00H</td><td></td><td></td> </tr> <tr> <td colspan="2">(Fixed value)</td> <td colspan="6">(Free)</td> </tr> </table>	Serial number												54H	00H	34H	12H	00H	00H			(Fixed value)		(Free)					
Serial number																																																																									
5	4	0	0	1	2	3	4	0	0	0	0																																																														
35H	34H	30H	30H	31H	32H	33H	34H	30H	30H	30H	30H																																																														
(Fixed value)				(Free)																																																																					
Serial number																																																																									
54H	00H	34H	12H	00H	00H																																																																				
(Fixed value)		(Free)																																																																							

Setting method for 3E frame

Set the fixed value (request message: '5000', response message: 'D000').

Request message

ASCII code	Binary code										
<table border="1"> <tr> <td>5</td><td>0</td><td>0</td><td>0</td> </tr> <tr> <td>35H</td><td>30H</td><td>30H</td><td>30H</td> </tr> </table>	5	0	0	0	35H	30H	30H	30H	<table border="1"> <tr> <td>50H</td><td>00H</td> </tr> </table>	50H	00H
5	0	0	0								
35H	30H	30H	30H								
50H	00H										

Response message

ASCII code	Binary code										
<table border="1"><tr><td>D</td><td>0</td><td>0</td><td>0</td></tr><tr><td>44H</td><td>30H</td><td>30H</td><td>30H</td></tr></table>	D	0	0	0	44H	30H	30H	30H	<table border="1"><tr><td>D0H</td><td>00H</td></tr></table>	D0H	00H
D	0	0	0								
44H	30H	30H	30H								
D0H	00H										

Request data length and response data length

For the request data length, specify the data length from the monitoring timer to the request data.

For the response data length, the data length from an end code to a response data (at normal completion) or an error information (at abnormal completion) is stored.

Setting method

Specify the data length in hexadecimal. (Unit: byte)

■Data communication in ASCII code

Convert the numerical value to 4-digit ASCII code (hexadecimal), and send it from the upper digits.

■Data communication in binary code

Send 2-byte numerical value from the lower byte (L: bits 0 to 7).

Ex.

The data length is 24 bytes

ASCII code	Binary code										
<table border="1"><tr><td>0</td><td>0</td><td>1</td><td>8</td></tr><tr><td>30H</td><td>30H</td><td>31H</td><td>38H</td></tr></table>	0	0	1	8	30H	30H	31H	38H	<table border="1"><tr><td>18H</td><td>00H</td></tr></table>	18H	00H
0	0	1	8								
30H	30H	31H	38H								
18H	00H										

Monitoring timer

Set the wait time up to the completion of reading and writing processing.

Set the wait time from when E71 on the connection station requests processing to the access target to when the response is returned.

- 0000H (0): Wait infinitely (Waits until a processing is completed.)
- 0001H to FFFFH (1 to 65535): Waiting time (unit: 250 ms)

To perform normal data communication, using the timer within the setting range in the table below is recommended depending on the communication destination.

Access target	Monitoring timer
Connected station (host station)	0001H to 0028H (0.25 s to 10 s)
Other station	0002H to 00F0H (0.5s to 60s)

Setting method

■Data communication in ASCII code

Convert the numerical value to 4-digit ASCII code (hexadecimal), and send it from the upper digits.

■Data communication in binary code

Send 2-byte numerical value from the lower byte (L: bits 0 to 7).

Ex.

When specifying 10H (16 × 250 ms = 4 seconds) for the monitoring timer

ASCII code	Binary code										
<table border="1"><tr><td>0</td><td>0</td><td>1</td><td>0</td></tr><tr><td>30H</td><td>30H</td><td>31H</td><td>30H</td></tr></table>	0	0	1	0	30H	30H	31H	30H	<table border="1"><tr><td>10H</td><td>00H</td></tr></table>	10H	00H
0	0	1	0								
30H	30H	31H	30H								
10H	00H										

End code

The command processing result is stored.

At normal completion, '0' is stored.

At abnormal completion, an error code of the access target is stored.

Error code indicates the content of occurred error.

If more than one error occurs at the same time, the error code detected first is returned.

For the content of error code and its corrective action, refer to the user's manual of the module used.

📖 QCPU User's Manual (Hardware Design, Maintenance and Inspection)

📖 MELSEC-L CPU Module User's Manual (Hardware Design, Maintenance and Inspection)

📖 Q Corresponding Ethernet Interface Module User's Manual (Basic)

📖 MELSEC-L Ethernet Interface Module User's Manual (Basic)

📖 MELSEC iQ-R Serial Communication Module User's Manual(Application)

Setting method

■Data communication in ASCII code

Convert the numerical value to 4-digit ASCII code (hexadecimal), and send it from the upper digits.

■Data communication in binary code

Send 2-byte numerical value from the lower byte (L: bits 0 to 7).

Ex.

Normal completion

ASCII code	Binary code										
<table border="1"><tr><td>0</td><td>0</td><td>0</td><td>0</td></tr><tr><td>30H</td><td>30H</td><td>30H</td><td>30H</td></tr></table>	0	0	0	0	30H	30H	30H	30H	<table border="1"><tr><td>00H</td><td>00H</td></tr></table>	00H	00H
0	0	0	0								
30H	30H	30H	30H								
00H	00H										

Error code C051H

ASCII code	Binary code										
<table border="1"><tr><td>C</td><td>0</td><td>5</td><td>1</td></tr><tr><td>43H</td><td>30H</td><td>35H</td><td>31H</td></tr></table>	C	0	5	1	43H	30H	35H	31H	<table border="1"><tr><td>51H</td><td>C0H</td></tr></table>	51H	C0H
C	0	5	1								
43H	30H	35H	31H								
51H	C0H										

Error information

Store the information of a station on which an error occurred and information of a command.

Access route	Command	Subcommand
--------------	---------	------------

- Access route: The information of a station which sent an error response is stored. It may differ from the contents of a request message.
- Command, subcommand: The command and the subcommand when an error occurred are stored.

6 ACCESS ROUTE SETTINGS

This chapter explains the accessible range of each frame of MC protocol and data to specify the access target.

6.1 Accessible Ranges and Setting Data for Each Frame

The accessible range of each frame and the data items to set an access route are as shown below.

4C frame

Accessible range of 4C frame

The following ranges can be accessed.

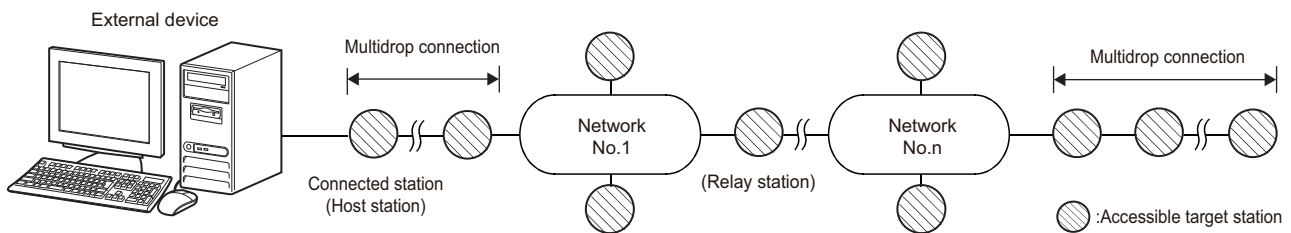

4C frame is supported by multiple CPU system. (Page 462 Compatibility with Multiple CPU Systems)

Message format (Setting example for accessing connected station (host station))

■Data communication in ASCII code (Format 1 to Format 4)

Station No.	Network No.	PC No.	Request destination module I/O No.	Request destination module station No.	Self-station No.
0 0	0 0	F F	0 3 F F	0 0	0 0
30H, 30H	30H, 30H	46H, 46H	30H, 33H, 46H, 46H	30H, 30H	30H, 30H

■Data communication in binary code (Format 5)

Station No.	Network No.	PC No.	Request destination module I/O No.	Request destination module station No.	Self-station No.
00H	00H	FFH	FFH, 03H	00H	00H

Setting data

Set the following items.

Item	Description	Reference
Station No.	Specify the station to be connected from an external device.	Page 50 Station No.
Network No.	Specify the network No. of an access target.	Page 52 Network No., PC No.
PC No.	Specify the network module station No. of an access target.	
Request destination module I/O No.	<ul style="list-style-type: none"> When accessing a multidrop connection station via network, specify the start input/output number of a multidrop connection source module. Specify the CPU module of the multiple CPU system and redundant system. 	Page 55 Request destination module I/O No., request destination module station No.
Request destination module station No.	When accessing a multidrop connection station via network, specify the station No. of an access target module.	
Self-station No.	At the time of m:n multidrop connection, specify the station No. of a request source external device.	Page 58 Self-station No.

3C frame

Accessible range of 3C frame

The following ranges can be accessed.

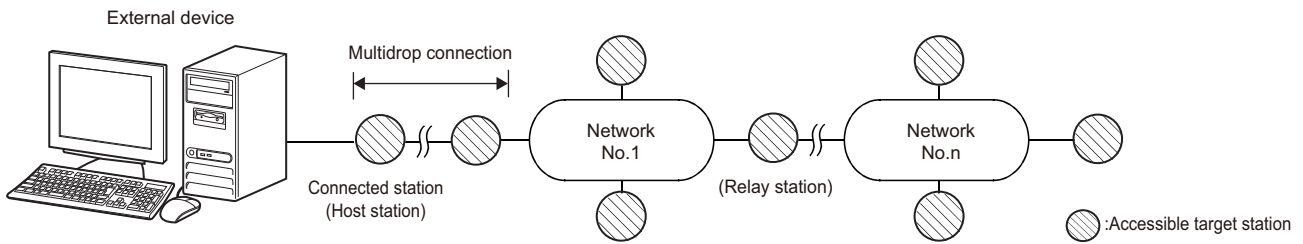

Message format (Setting example for accessing connected station (host station))

Station No. Network No. PC No. Self-station No.

0	0	0	0	F	F	0	0
30 _H	30 _H	30 _H	30 _H	46 _H	46 _H	30 _H	30 _H

Setting data

Set the following items.

Item	Description	Reference
Station No.	Specify the station to be connected from an external device.	Page 50 Station No.
Network No.	Specify the network No. of an access target.	Page 52 Network No., PC No.
PC No.	Specify the network module station No. of an access target.	
Self-station No.	At the time of m:n multidrop connection, specify the station No. of a request source external device.	Page 58 Self-station No.

2C frame

Accessible range of 2C frame

The following ranges can be accessed.

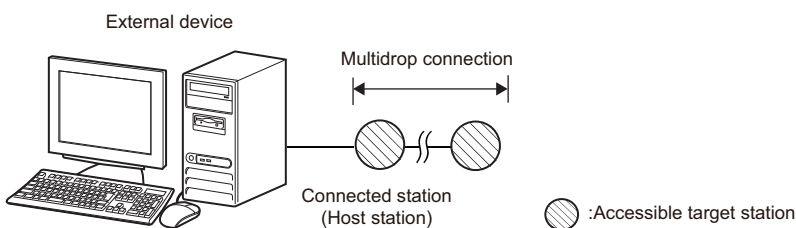

Message format (Setting example for accessing connected station (host station))

Station No. Self-station No.

0	0	0	0
30 _H	30 _H	30 _H	30 _H

Setting data

Set the following items.

Item	Description	Reference
Station No.	Specify the station to be connected from an external device.	Page 50 Station No.
Self-station No.	At the time of m:n multidrop connection, specify the station No. of a request source external device.	Page 58 Self-station No.

1C frame

Accessible range of 1C frame

The following ranges can be accessed.

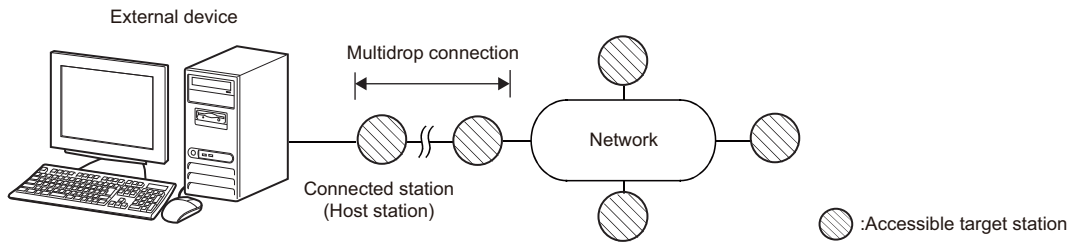

When accessing a device, only the applicable device range for MELSEC-A series module can be accessed.

([Page 352 Accessible device range](#))

Message format (Setting example for accessing connected station (host station))

Station No. PC No.

0	0	F	F
30H	30H	46H	46H

Setting data

Set the following items.

Item	Description	Reference
Station No.	Specify the station to be connected from an external device.	Page 50 Station No.
PC No.	Specify the network module station No. of an access target.	Page 52 Network No., PC No.

1E Frame

Accessible range of 1E frame

The following ranges can be accessed.

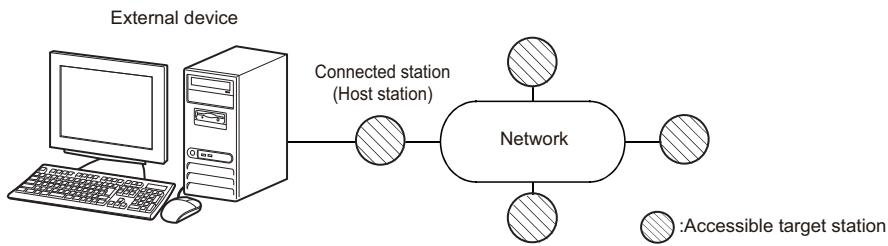

When accessing a device, only the applicable device range for MELSEC-A series module can be accessed.

(☞ Page 399 Accessible device range)

Message format (Setting example for accessing connected station (host station))

■ Data communication in ASCII code

PC No.

F	F
46H	46H

■ Data communication in binary code

PC No.

FFH

Setting data

Set the following items.

Item	Description	Reference
PC No.	Specify the network module station No. of an access target.	Page 52 Network No., PC No.

6.2 Details of Setting Data

This section explains the content and specification method of the data items to set the access route.

○: Necessary, —: Unnecessary

Item	Frames for C24				Frames for E71			Reference
	4C	3C	2C	1C	4E	3E	1E	
Station No.	○	○	○	○	—	—	—	Page 50 Station No.
Network No.	○	○	—	—	○	○	—	Page 52 Network No., PC No.
PC No.				○	○	○	○	
Request destination module I/O No.	○	—	—	—	○	○	—	Page 55 Request destination module I/O No., request destination module station No.
Request destination module station No.								
Self-station No.	○	○	○	—	—	—	—	Page 58 Self-station No.

Station No.

Specify the station accessed from an external device.

Accessing the connected station (host station)

Specify '0' when accessing the connected station (host station).

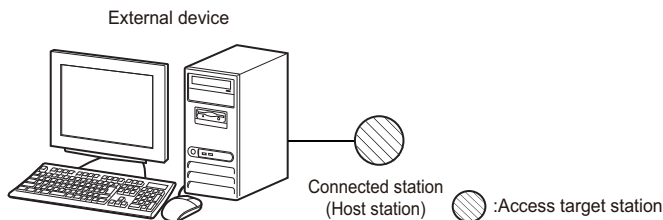

Accessing multidrop connection station

Specify the station No. of an access target station from '0' to '31' (00H to 1FH) when connecting with the multidrop connection.

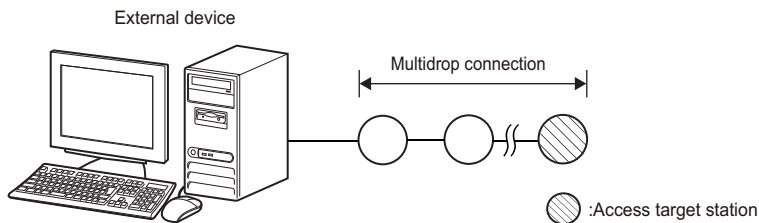

■When accessing all stations connected with the multidrop connection with the global function

Specify 'FF' (FFH) when turning ON/OFF the global signal to all station connected with the multidrop connection using the global function. By specifying 0 to 31 (00H to 1FH), X1A/X1B turns ON only on the specified station, and does not turn ON on the other stations.

(Page 254 Global Function)

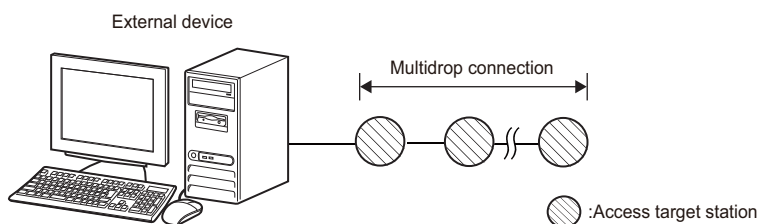

Accessing other stations via network

Specify the station No. from 0 to 31 (00H to 1FH) of a station that relays multidrop connection and network when accessing other stations via network.

Specify '0' when accessing other stations via network without the multidrop connection.

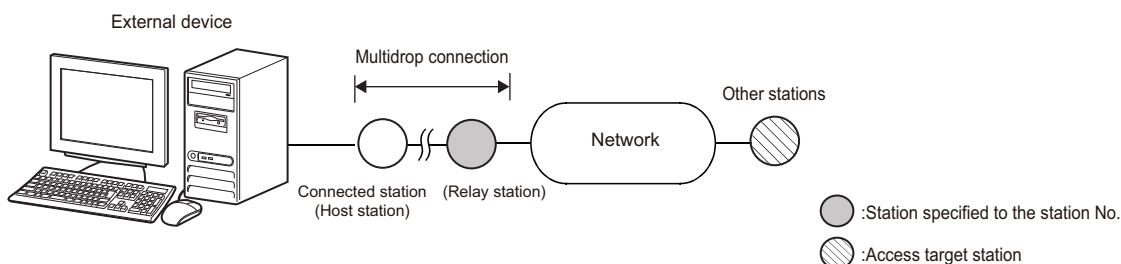

Setting method

■Data communication in ASCII code

Convert the numerical value to 2-digit ASCII code (hexadecimal), and send it from the upper digits.

■Data communication in binary code

Send a 1-byte numerical value.

Ex.

When the station No. setting for C24 to be accessed is '5'

ASCII code	Binary code					
<table border="1"> <tr> <td>0</td> <td>5</td> </tr> <tr> <td>30H</td> <td>35H</td> </tr> </table>	0	5	30H	35H	<table border="1"> <tr> <td>05H</td> </tr> </table>	05H
0	5					
30H	35H					
05H						

When accessing all station connected with the multidrop connection using the global function

ASCII code	Binary code					
<table border="1"> <tr> <td>F</td> <td>F</td> </tr> <tr> <td>46H</td> <td>46H</td> </tr> </table>	F	F	46H	46H	<table border="1"> <tr> <td>FFH</td> </tr> </table>	FFH
F	F					
46H	46H					
FFH						

Point

The station No. of the serial communication module can be checked by using the following parameters of Engineering tool.

- GX Works2: "Station Number Setting" in "Switch Setting"
- GX Works3: "Station Number Settings" in "Module Parameter"

Network No., PC No.

Specify the network No. and station No. that are set with the parameters for the access target network module.
Specify a fixed value when accessing the connection station.

Point

Specify the network No. with the value shown below.
Specifying improper value may result in no response returned.

Accessing the connected station (host station)

Specify '0' for the network No., and 'FF' for the PC No.

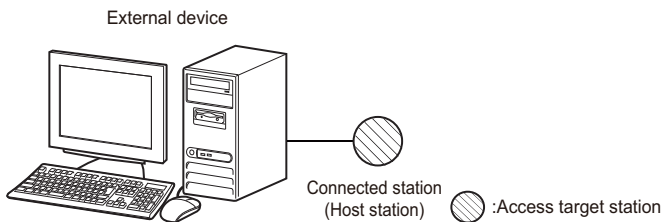

■When using the on-demand function

Specify '0' for the network No., and 'FE' for the PC No.

(☞ Page 279 On-demand function)

Accessing multidrop connection station

Specify '0' for the network No., and 'FF' for the PC No.

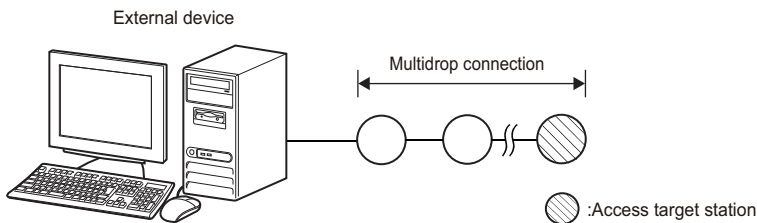

Accessing other stations via network

Specify the network No. and station No. of an access target.

Access target	Network No.	PC No.
Other station of which station No. is set	01H to EFH (1 to 239)	01H to 78H (1 to 120)
Specified control station/master station ^{*1}	Stations with network No.240 to 255 are not accessible.	7DH
Current control station/Master station ^{*2}		7EH

*1 Access the station set as a control station/master station by parameters.

*2 Access the station which is operating as a control station/master station.

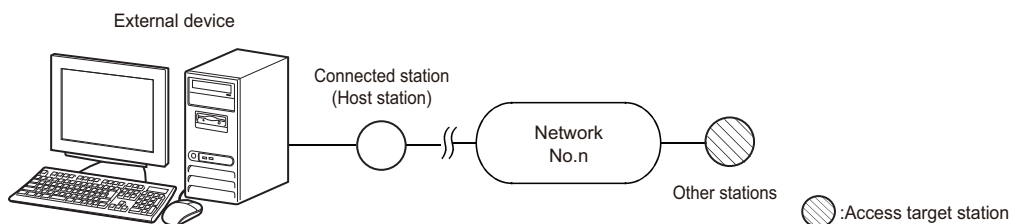

■When accessing with the "Valid Module During Other Station Access" setting

1C frame and 1E frame do not have the setting of network No.

When specifying the network of access target is required because more than one network module is mounted on the connection station, set the "Valid Module During Other Station Access" with Engineering tool.

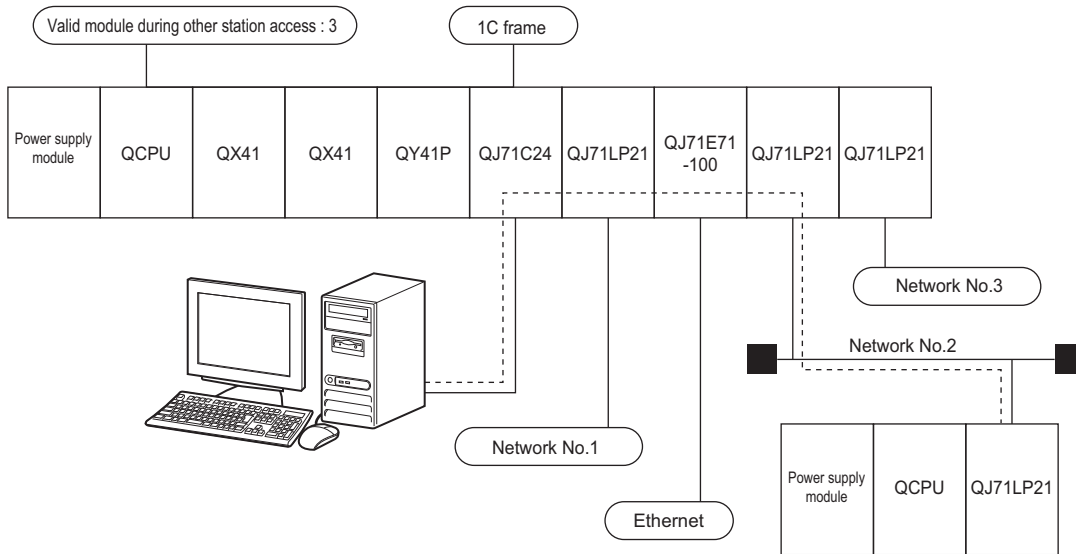

When accessing in accordance with the setting of "Valid Module During Other Station Access" using a frame with the network No. set is desired, specify 'FEH' (254) to the network No.

When accessing other station via C24/E71 mounted on MELSECNET/H remote I/O station, the access to the other station specified with the PC No. of MELSECNET/H remote I/O station is available by specifying 'FEH' to the network No.

Accessing multidrop connection station via network

Specify the network No. and station No. of a station relaying the network routed through and multidrop connection station.

Access target	Network No.	PC No.
Multidrop connection station via network	01H to EFH (1 to 239) Stations with network No.240 to 255 are not accessible.	01H to 78H (1 to 120)

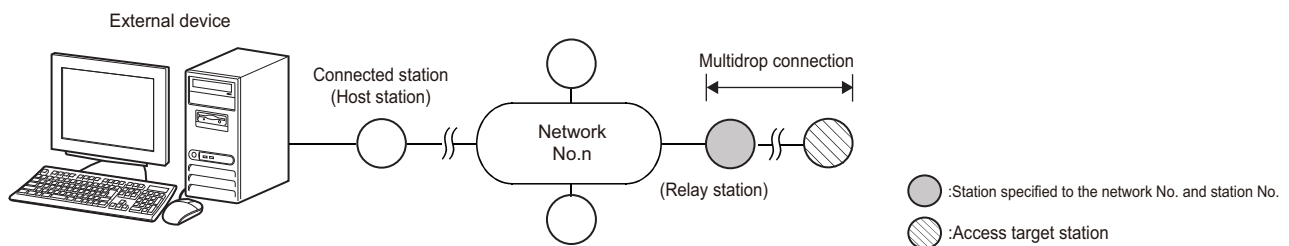

Setting method

■Data communication in ASCII code

Convert the numerical value to 2-digit ASCII code (hexadecimal), and send it from the upper digits.

■Data communication in binary code

Send a 1-byte numerical value.

Ex.

Accessing connected station (host station) or multidrop connection station

ASCII code		Binary code	
Network No.	PC No.	Network No.	PC No.
0 0	F F		
30H 30H	46H 46H	00H	FFH

When accessing other station of which network No. is '2' and station No. is '3'

ASCII code		Binary code	
Network No.	PC No.	Network No.	PC No.
0 2	0 3		
30H 32H	30H 33H	02H	03H

Point

The network No. and station No. of the network module can be checked by using the following parameters of Engineering tool.

- GX Works2: "Network Parameter"
- GX Works3: "Module Parameter"

The network No. and the station No. of the network module are normally set in decimal. However, the network No. and the PC No. are set in hexadecimal.

Request destination module I/O No., request destination module station No.

Specify these numbers when an access target is as shown below.

- Multidrop connection station
- CPU module on multiple CPU system
- CPU module on redundant system, CC-Link IE Field Network remote head module

Specify the fixed value when the access target is other than those listed above.

Request destination module I/O No.	Request destination module station No.
03FFH	00H

Accessing multidrop connection station

When connecting to an access target with a direct multidrop connection, it can be accessed by specifying a station No.

(☞ Page 50 Station No.).

For the request destination module I/O No. and the request destination module station No., specify the fixed value.

Request destination module I/O No.	Request destination module station No.
03FFH	00H

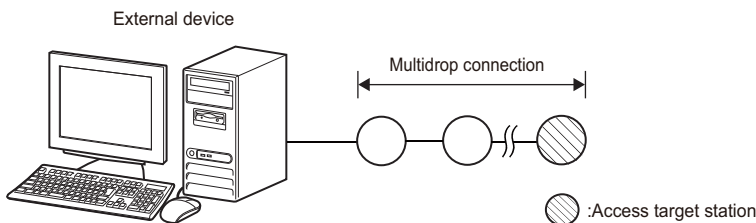

■For 4E frame and 3E frame

When accessing a multidrop connection station with the frames (4E frame, 3E frame) for Ethernet interface module, specify the start input/output number of a multidrop connection source module (relay station) and the station No. of an access target module.

Access target	Request destination module I/O No.	Request destination module station No.
MELSEC iQ-R series module	0000H to 02FFH: Values obtained by dividing the start input/output number by 16	00H to 1FH (0 to 31): Station No.
MELSEC-Q/L series module	0000H to 01FFH: Values obtained by dividing the start input/output number by 16	

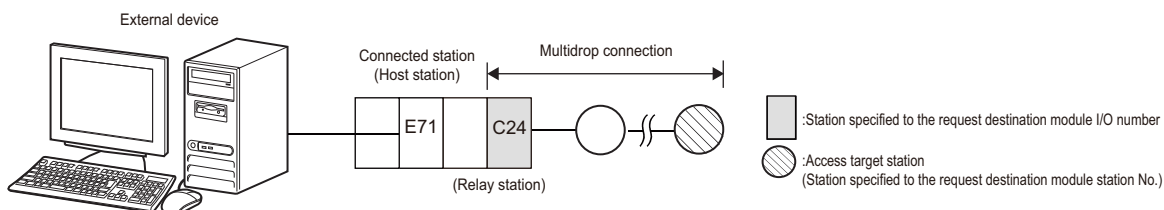

Accessing multidrop connection station via network

Specify the start input/output number of a multidrop connection source module (relay station) and the station No. of an access target.

Access target	Request destination module I/O No.	Request destination module station No.
MELSEC iQ-R series module	0000H to 02FFH: Values obtained by dividing the start input/output number by 16	00H to 1FH (0 to 31): Station No.
MELSEC-Q/L series module	0000H to 01FFH: Values obtained by dividing the start input/output number by 16	

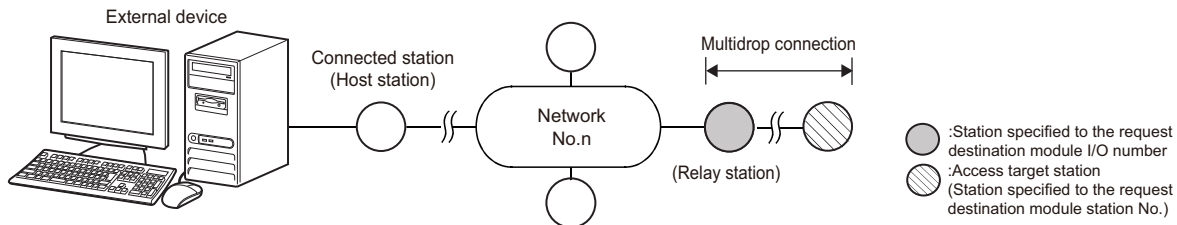

Accessing multiple CPU system, redundant system

Specify the access target with the request destination module I/O No. Specify the fixed value (00H) for the station No.

Access target		Request destination module I/O No.	Request destination module station No.	
Multiple CPU system	Control CPU	03FFH	00H	
	Non-control CPU	Multiple CPU No.1		03E0H
		Multiple CPU No.2		03E1H
		Multiple CPU No.3		03E2H
		Multiple CPU No.4		03E3H
Redundant system	CPU module	Control system ^{*1}	03D0H	
		Standby system ^{*1}	03D1H	
		System A	03D2H	
		System B	03D3H	
	CC-Link IE Field Network remote head module	Remote head No.1	03E0H	
		Remote head No.2	03E1H	
		Control system ^{*1}	03D0H	
		Standby system ^{*1}	03D1H	

*1 When executing a command that manages files, specify the I/O number other than that of the control system (03D0H) and standby system (03D1H). Otherwise, the access target is changed and the files cannot be read/written.

Setting method

For the request destination module I/O No., specify the value obtained by dividing the start input/output number assigned to the module by 16 in 4 digits (hexadecimal).

■Data communication in ASCII code

For the request destination module I/O No., convert the numerical value to 4-digit ASCII code (hexadecimal), and send it from the upper digits.

For the request destination module station No., convert the numerical value to 2-digit ASCII code (hexadecimal), and send it from the upper digits.

■Data communication in binary code

For the request destination module I/O No., the 2-byte value is sent from the lower byte (L: bit 0 to 7).

For the request destination module station No., the 1-byte value is sent.

Ex.

Accessing the connected station (host station)

ASCII code		Binary code	
Request destination module I/O No.	Request destination module station No.	Request destination module I/O No.	Request destination module station No.
0 3 F F	0 0	FFH 03H	00H
30H 33H 46H 46H	30H 30H		

Accessing multidrop connection station via network

- Start input/output number: 0080H (input/output signal: 0080H to 009FH)
- Request destination module I/O No.: 0008H
- Station No.: 5

ASCII code		Binary code	
Request destination module I/O No.	Request destination module station No.	Request destination module I/O No.	Request destination module station No.
0 0 0 8	0 5	08H 00H	05H
30H 30H 30H 38H	30H 35H		

Point

The station No. of the serial communication module can be checked by using the following parameters of Engineering tool.

- GX Works2: "Station Number Setting" in "Switch Setting"
- GX Works3: "Station Number Settings" in "Module Parameter"

When accessing the non-control CPU (multiple CPU No.2) on multiple CPU system

ASCII code		Binary code	
Request destination module I/O No.	Request destination module station No.	Request destination module I/O No.	Request destination module station No.
0 3 E 1	0 0	E1H 03H	00H
30H 33H 45H 31H	30H 30H		

Self-station No.

Specify this when more than one external device (m stations) and more than one C24s (n stations) are connected with the multidrop connection.

Specify the fixed value (00H) for any cases other than multidrop connection in a m:n basis.

When external devices are connected with the m:n multidrop connection

Specify the station No. of request source external device, 0 to 31 (00H to 1FH).

For the station No. (m stations) of external devices, the value which is not set to C24 (n stations) of the multidrop connection is used.

(The total of 'm' and 'n' is up to 32 stations.)

- Station No. of a request source external device: Specify it to the self-station No.
- Station No. of the connected station C24: Specify it to the station No. ( Page 50 Station No.)

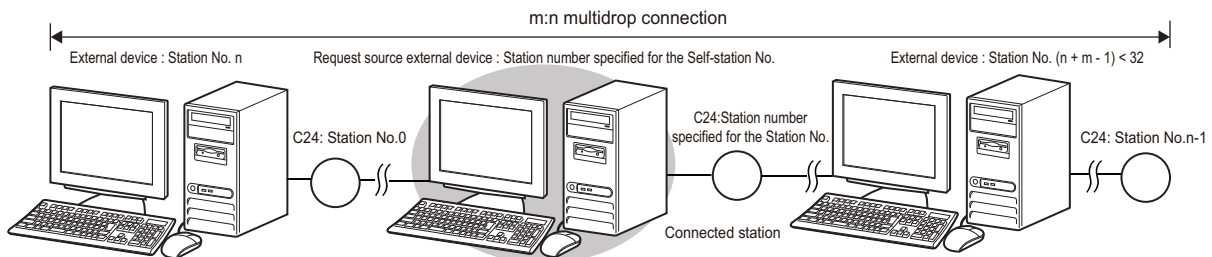

Setting method

■Data communication in ASCII code

Convert the numerical value to 2-digit ASCII code (hexadecimal), and send it from the upper digits.

■Data communication in binary code

Send a 1-byte numerical value.

Ex.

For connection other than m:n multidrop connection

ASCII code	Binary code
<div style="border: 1px solid black; padding: 5px; width: fit-content;"> 0 0 30H 30H </div>	<div style="border: 1px solid black; padding: 5px; width: fit-content;"> 00H </div>

For accessing with the m:n multidrop connection

Station No. assigned to a request source external device: 31 (1FH)

ASCII code	Binary code
<div style="border: 1px solid black; padding: 5px; width: fit-content;"> 1 F 31H 46H </div>	<div style="border: 1px solid black; padding: 5px; width: fit-content;"> 1FH </div>

This part explains the functions that can be specified by a message of MC protocol and the message format of request data and message data of each command.

7 COMMANDS AND FUNCTIONS

8 DEVICE ACCESS

9 LABEL ACCESS

10 BUFFER MEMORY ACCESS

11 CONTROL MODULE OPERATION

12 FILE CONTROL

13 SERIAL COMMUNICATION MODULE DEDICATED COMMANDS

7 COMMANDS AND FUNCTIONS

This chapter explains the commands of MC protocol.

The functions of a message is defined by each command. The message format for request data and response data varies with commands. Depending on the type of frame to be used, the specific value is assigned to a command. The value of command is specified at the head of a request data.

Request message

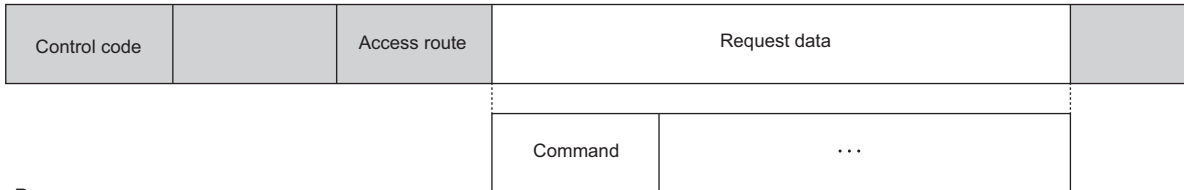

Response message



The explanation of each command in Part 3, the message format of request data and response data are explained.

For the message formats other than request data and response data, refer to the following sections.

☞ Page 28 MESSAGES OF SERIAL COMMUNICATION MODULE

☞ Page 39 MESSAGES OF Ethernet INTERFACE MODULE

7.1 Command List

The following shows the list of commands.



There are some commands that cannot be executed while the CPU module is in RUN. Refer to the following section.

☞ Page 464 Applicable Commands for Online Program Change



For details on the number of points processed per communication and modules can be accessed by each command, refer to the following sections.

☞ Page 466 Number of Processing per One Communication

☞ Page 471 Accessible Modules for Each Command

Commands for 4C/3C/4E/3E frame

The following shows the commands for 4C/3C/4E/3E frame.

For 4C/3C/4E/3E frame, specify subcommands in the request message as well.

Device access

Function		Command	Description	Subcommand		
Batch read and write	Batch read in word units	0401	Read values from devices in word units. Read the values in batch with specifying the consecutive device points.	0000	For MELSEC-Q/L series	
				0002	For MELSEC iQ-R series	
	Batch read in bit units		0001	For MELSEC-Q/L series		
			0003	For MELSEC iQ-R series		
	Batch write in word units		1401	Write values to devices in word units. Write the consecutive devices in batch with specifying the consecutive device points.	0000	For MELSEC-Q/L series
					0002	For MELSEC iQ-R series
Batch write in bit units	0001	For MELSEC-Q/L series				
	0003	For MELSEC iQ-R series				
Random read and write	Random read in word units	0403		Read values from devices in word or double-word units. Read device values with specifying device numbers. Discontinuous device numbers can be specified.	0000	For MELSEC-Q/L series
					0002	For MELSEC iQ-R series
			0040	Monitor condition specified		
	Random write in word units (test)	1402	Write values to devices in word or double-word units. Write device values with specifying device numbers. Discontinuous device numbers can be specified.	0000	For MELSEC-Q/L series	
				0002	For MELSEC iQ-R series	
	Random write in bit units (test)		0001	For MELSEC-Q/L series		
			0003	For MELSEC iQ-R series		
	Batch read and write multiple blocks	Batch read multiple blocks	0406	Read values for specified multiple blocks by handling consecutive word devices or bit devices as one block. Each block can be specified with discontinuous device numbers.	0000	For MELSEC-Q/L series
0002					For MELSEC iQ-R series	
Batch write multiple blocks		0000		For MELSEC-Q/L series		
		0002		For MELSEC iQ-R series		
Monitor device memory	Register monitor data	0801	Register devices to be monitored.	0000	For MELSEC-Q/L series	
				0002	For MELSEC iQ-R series	
			0040	Monitor condition specified		
	Monitor	0802	Read the values of registered devices.	0000	—	



Even when an access target is a MELSEC iQ-R or MELSEC iQ-L series module, devices whose types and ranges are equivalent to MELSEC-Q/L series can be accessed by using subcommands for MELSEC-L/Q series. (☞ Page 471 Accessible Modules for Each Command)

Label access

Function		Command	Description	Subcommand	
Batch read and write	Batch read array type labels	041A	Read the values from array type labels. Read the values in batch with specifying the consecutive array elements. Specify the array type labels or array type elements of structure type labels.	0000	For MELSEC iQ-R series
	Batch write array type labels	141A	Write the values to array type labels. Write the values in batch with specifying the consecutive array elements. Specify the array type labels or array type elements of structure type labels.	0000	For MELSEC iQ-R series
Random read and write	Random read labels	041C	Read values with specifying multiple labels.	0000	For MELSEC iQ-R series
	Random write labels	141B	Write values with specifying multiple labels.	0000	For MELSEC iQ-R series

Buffer memory access

Function		Command	Description	Subcommand	
Buffer memory	Batch read	0613	Read data from the buffer memory of the host station (supported device).	0000	—
	Batch write	1613	Write data to the buffer memory of the host station (supported device).	0000	—
Intelligent function module	Batch read	0601	Read data from the buffer memory of an intelligent function module.	0000	—
	Batch write	1601	Write data to the buffer memory of an intelligent function module.	0000	—

Module control

Function		Command	Description	Subcommand	
Remote control	Remote RUN	1001	Perform remote RUN to the access target module.	0000	—
	Remote STOP	1002	Perform remote STOP to the access target module.	0000	—
	Remote PAUSE	1003	Perform remote PAUSE to the access target module.	0000	—
	Remote latch clear	1005	Perform remote latch clear to the access target module.	0000	—
	Remote RESET	1006	Perform remote RESET to the access target module.	0000	—
	Read CPU model name	0101	Read model name and model code from the access target module.	0000	—
Remote password	Unlock	1630	Specify a remote password to enable communications with other devices. (Change a device from the locked state to unlocked state.)	0000	—
	Lock	1631	Specify a remote password to disable communications with other devices. (Change a device from the unlocked state to locked state.)	0000	—
Loopback test		0619	Test to check whether communications between external device and connection station operate normally.	0000	—
Clear error information	Turn indicator LED OFF, initialize communication error information/error code	1617	Turn OFF the error LED, and initialize communication error information and error code.	000□	—

File control

Function		Command	Description	Subcommand		
File check	Read directory/ file information	1810	For the specified storage destination file, read the file name, file creation date and time (last edit date and time) etc.	0000	For MELSEC-Q/L series	
				0040	For MELSEC iQ-R series	
	Search directory/file information	1811	Read the file No. of the specified file.	0000	For MELSEC-Q/L series	
				0040	For MELSEC iQ-R series	
File creation and deletion	Create new file	1820	Create a file with specifying its size. (Reserve a storage area for the specified file.)	0000	For MELSEC-Q/L series	
				0040	For MELSEC iQ-R series	
	Delete file	1822	Delete a file.	0000	For MELSEC-Q series	
				0004	For MELSEC-L series	
				0040	For MELSEC iQ-R series	
	Copy file	1824	Copy a file.	0000	For MELSEC-Q series	
				0004	For MELSEC-L series	
				0040	For MELSEC iQ-R series	
	File modification	Modify file attribute	1825	Change the file attribute.	0000	For MELSEC-Q series
					0004	For MELSEC-L series
0040					For MELSEC iQ-R series	
Modify file creation date and time		1826	Modify the file creation date and time (last edit date and time).	0000	For MELSEC-Q/L series	
				0040	For MELSEC iQ-R series	
Open file		1827	Open a file and lock the file so that the file contents are not modified from other devices.	0000	For MELSEC-Q series	
				0004	For MELSEC-L series	
				0040	For MELSEC iQ-R series	
Read file		1828	Read a file content.	0000	—	
Write to file		1829	Write content to a file.	0000	—	
Close file	182A	Close a file and unlock the file which has been locked by the 'open file' (command: 1827).	0000	—		



For the QnACPU dedicated commands, refer to the following section.

Page 288 QnACPU Dedicated Commands List

Serial communication dedicated commands

Function		Command	Description	Subcommand	
User frame	Read registered data	0610	Read the registered content of user frames.	0000	—
	Register data	1610	Register user frames to C24.	0000	—
	Delete registered data		Delete the registered user frame.	0001	—
Global		1618	Turn ON/OFF the global signal (X1A/X1B). This can be performed to a connected station and multidrop connection station.	0000 0001	—
Initialize transmission sequence		1615	Terminate a current processing request, and place C24 into the wait state to receive commands. This can be performed to a connected station and multidrop connection station.	0000	—
Switch mode		1612	Switch the operation mode and transmission specifications of the specified interface. This can be performed to a connected station and multidrop connection station.	0000	—
Programmable controller CPU monitoring	Register	0630	Register the conditions to monitor and start the programmable controller CPU monitoring.	0000	—
	Deregister	0631	End the programmable controller CPU monitoring.	0000	—
On-demand		2101	Issue a transmission request to C24 from CPU module, and transmit data to external devices.	—	—

Commands for 2C frame



The following shows the commands for 2C frame.

The commands for 4C/3C frame are equivalent to the following device access commands and subcommands.

Function		2C frame command	4C/3C frame		Description
			command	subcommand	
Batch read and write	Batch read in bit units	1	0401	0001	Read values from devices in bit units. Read the values in batch with specifying the consecutive device points.
	Batch read in word units	2		0000	Read values from devices in word units. Read the values in batch with specifying the consecutive device points.
	Batch write in bit units	3	1401	0001	Write values to devices in bit units. Write the consecutive devices in batch with specifying the consecutive device points.
	Batch write in word units	4		0000	Write values to devices in word units. Write the consecutive devices in batch with specifying the consecutive device points.
Random read and write	Random read in word units	5	0403	0000	Read values from devices in word or double-word units. Read device values with specifying device numbers. Discontinuous device numbers can be specified.
	Random write in bit units (test)	6	1402	0001	Write values to devices in bit units. Write device values with specifying device numbers. Discontinuous device numbers can be specified.
	Random write in word units (test)	7		0000	Write values to devices in word or double-word units. Write device values with specifying device numbers. Discontinuous device numbers can be specified.
Monitor device memory	Register monitor data	8	0801	0000	Register devices to be monitored.
	Monitor	9	0802	0000	Read the values of registered devices.

Commands for 1C/1E frame

For the commands for 1C/1E frame, refer to the following sections.

-  Page 349 Command and Function Lists for 1C Frame
-  Page 396 Commands and Function List for 1E Frame

8 DEVICE ACCESS

This chapter explains the commands to read and write devices.







8.1 Data to be Specified in Commands

This section explains the contents and specification methods for data items which are set in each command related to device access.

Devices

Specify the device to be accessed by a device code and a device number.

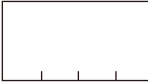
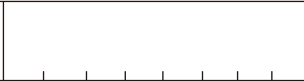
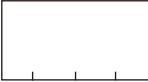
- The data order differs between ASCII code or binary code.
- The data size to be set differs between MELSEC-Q/L series subcommands (subcommand: 0000, 0001) and MELSEC iQ-R series subcommands (subcommand: 0002, 0003).

Subcommand type	ASCII code	Binary code
For MELSEC-Q/L series	<div style="display: flex; justify-content: space-around;"> <div style="text-align: center;">Device code  (2 digits)</div> <div style="text-align: center;">Device number  (6 digits)</div> </div>	<div style="display: flex; justify-content: space-around;"> <div style="text-align: center;">Device number  (3 bytes)</div> <div style="text-align: center;">Device code  (1 byte)</div> </div>
For MELSEC iQ-R series	<div style="display: flex; justify-content: space-around;"> <div style="text-align: center;">Device code  (4 digits)</div> <div style="text-align: center;">Device number  (8 digits)</div> </div>	<div style="display: flex; justify-content: space-around;"> <div style="text-align: center;">Device number  (4 bytes)</div> <div style="text-align: center;">Device code  (2 bytes)</div> </div>

Point 

When accessing any of the following devices, use the device extension specification (subcommand: 008□).

- Link direct device
- Module access device
- CPU buffer memory access device

For the message format for device extension specification, refer to the following section.

 Page 438 Read/Write by Device Extension Specification

Device codes

Specify the device name to be accessed.

Specify the device within the range of the access target module.

For the values of each device code, refer to the following section.

☞ Page 68 Device code list

■Data communication in ASCII code

Convert the numerical value to 2-digit or 4-digit ASCII code (hexadecimal), and send it from the upper digits.

- For MELSEC-Q/L series: 2-digit ASCII code
- For MELSEC iQ-R series: 4-digit ASCII code

The '*' in a device code can also be specified with a space (code: 20H).

■Data communication in binary code

Send the 1-byte or 2-byte numerical value from the lower byte (L: bits 0 to 7).

- For MELSEC-Q/L series: 1 byte
- For MELSEC iQ-R series: 2 bytes

Ex.

For input (X)

Subcommand type	ASCII code	Binary code
For MELSEC-Q/L series	<div style="border: 1px solid black; padding: 5px; display: inline-block;"> X * 58H 2AH </div>	<div style="border: 1px solid black; padding: 5px; display: inline-block;"> 9CH </div>
For MELSEC iQ-R series	<div style="border: 1px solid black; padding: 5px; display: inline-block;"> X * * * 58H 2AH 2AH 2AH </div>	<div style="border: 1px solid black; padding: 5px; display: inline-block;"> 9CH 00H </div>

Device number

Specify the number of device to be accessed.

Specify the device number within the range of the access target module.

■Data communication in ASCII code

Convert the numerical value to 6-digit or 8-digit ASCII code, and sent it from the upper digits.

Specify the device number in decimal or hexadecimal, depending on the device type. (☞ Page 68 Device code list)

- For MELSEC-Q/L series: 6-digit ASCII code
- For MELSEC iQ-R series: 8-digit ASCII code (10 digits at device extension specification)

The '0' in the upper digits can also be specified with a space (code: 20H).

■Data communication in binary code

Send the 3-byte or 4-byte numerical value in order from the lower byte (L: bit 0 to 7).

For a device of which device number is in decimal, convert it to hexadecimal and specify.

- For MELSEC-Q/L series: 3 bytes^{*1}
- For MELSEC iQ-R series: 4 bytes^{*1}

^{*1} For C24, the additional code may be added. (☞ Page 35 Additional code (10H))

Ex.

For input (X) 1234 (a device of which device number is in hexadecimal)

Subcommand type	ASCII code	Binary code																				
For MELSEC-Q/L series	<table border="1"> <tr><td>0</td><td>0</td><td>1</td><td>2</td><td>3</td><td>4</td></tr> <tr><td>30H</td><td>30H</td><td>31H</td><td>32H</td><td>33H</td><td>34H</td></tr> </table>	0	0	1	2	3	4	30H	30H	31H	32H	33H	34H	<table border="1"> <tr><td>34H</td><td>12H</td><td>00H</td></tr> </table>	34H	12H	00H					
0	0	1	2	3	4																	
30H	30H	31H	32H	33H	34H																	
34H	12H	00H																				
For MELSEC iQ-R series	<table border="1"> <tr><td>0</td><td>0</td><td>0</td><td>0</td><td>1</td><td>2</td><td>3</td><td>4</td></tr> <tr><td>30H</td><td>30H</td><td>30H</td><td>30H</td><td>31H</td><td>32H</td><td>33H</td><td>34H</td></tr> </table>	0	0	0	0	1	2	3	4	30H	30H	30H	30H	31H	32H	33H	34H	<table border="1"> <tr><td>34H</td><td>12H</td><td>00H</td><td>00H</td></tr> </table>	34H	12H	00H	00H
0	0	0	0	1	2	3	4															
30H	30H	30H	30H	31H	32H	33H	34H															
34H	12H	00H	00H																			

For internal relay (M) 1234 (a device of which device number is in decimal)

For binary code, convert the device number to hexadecimal. '1234' (decimal) → '4D2' (hexadecimal)

Subcommand type	ASCII code	Binary code																				
For MELSEC-Q/L series	<table border="1"> <tr><td>0</td><td>0</td><td>1</td><td>2</td><td>3</td><td>4</td></tr> <tr><td>30H</td><td>30H</td><td>31H</td><td>32H</td><td>33H</td><td>34H</td></tr> </table>	0	0	1	2	3	4	30H	30H	31H	32H	33H	34H	<table border="1"> <tr><td>D2H</td><td>04H</td><td>00H</td></tr> </table>	D2H	04H	00H					
0	0	1	2	3	4																	
30H	30H	31H	32H	33H	34H																	
D2H	04H	00H																				
For MELSEC iQ-R series	<table border="1"> <tr><td>0</td><td>0</td><td>0</td><td>0</td><td>1</td><td>2</td><td>3</td><td>4</td></tr> <tr><td>30H</td><td>30H</td><td>30H</td><td>30H</td><td>31H</td><td>32H</td><td>33H</td><td>34H</td></tr> </table>	0	0	0	0	1	2	3	4	30H	30H	30H	30H	31H	32H	33H	34H	<table border="1"> <tr><td>D2H</td><td>04H</td><td>00H</td><td>00H</td></tr> </table>	D2H	04H	00H	00H
0	0	0	0	1	2	3	4															
30H	30H	30H	30H	31H	32H	33H	34H															
D2H	04H	00H	00H																			

For internal relay (M) 16 (with additional code)

For C24 binary code, specify '10H' as '10H + 10H'. (☞ Page 35 Additional code (10H))

Subcommand type	Binary code (For C24)	Binary code (For E71)								
For MELSEC-Q/L series	<table border="1"> <tr><td>DLE</td><td></td></tr> <tr><td>10H</td><td>10H, 00H, 00H</td></tr> </table>	DLE		10H	10H, 00H, 00H	<table border="1"> <tr><td>10H</td><td>00H</td><td>00H</td></tr> </table>	10H	00H	00H	
DLE										
10H	10H, 00H, 00H									
10H	00H	00H								
For MELSEC iQ-R series	<table border="1"> <tr><td>DLE</td><td></td></tr> <tr><td>10H</td><td>10H, 00H, 00H, 00H</td></tr> </table>	DLE		10H	10H, 00H, 00H, 00H	<table border="1"> <tr><td>10H</td><td>00H</td><td>00H</td><td>00H</td></tr> </table>	10H	00H	00H	00H
DLE										
10H	10H, 00H, 00H, 00H									
10H	00H	00H	00H							

Device code list

The following shows the device code of each device and the notation of device number (decimal/hexadecimal).

The data to be set differs between MELSEC-Q/L series commands (subcommand: 0000, 0001) and MELSEC iQ-R series subcommand (0002, 0003).

—: Inaccessible

Device				For MELSEC-Q/L series		For MELSEC iQ-R series		
Device name	Symbol	Type	Notation	ASCII	Binary	ASCII	Binary	
Special relay	SM	Bit	Decimal	SM	91H	SM**	0091H	
Special register	SD	Word	Decimal	SD	A9H	SD**	00A9H	
Input	X	Bit	Hexadecimal	X*	9CH	X***	009CH	
Output	Y		Hexadecimal	Y*	9DH	Y***	009DH	
Internal relay	M		Decimal	M*	90H	M***	0090H	
Latch relay	L		Decimal	L*	92H	L***	0092H	
Annunciator	F		Decimal	F*	93H	F***	0093H	
Edge relay	V		Decimal	V*	94H	V***	0094H	
Link relay	B		Hexadecimal	B*	A0H	B***	00A0H	
Data register	D		Word	Decimal	D*	A8H	D***	00A8H
Link register	W	Hexadecimal		W*	B4H	W***	00B4H	
Timer	Contact	TS	Bit	Decimal	TS	C1H	TS**	00C1H
	Coil	TC			TC	C0H	TC**	00C0H
	Current value	TN			Word	TN	C2H	TN**
Long timer ^{*1}	Contact	LTS	Bit	Decimal	—	—	LTS*	0051H
	Coil	LTC			—	—	LTC*	0050H
	Current value	LTN			Double word	—	—	LTN*
Retentive timer	Contact	STS	Bit	Decimal	SS	C7H	STS*	00C7H
	Coil	STC			SC	C6H	STC*	00C6H
	Current value	STN			Word	SN	C8H	STN*
Long retentive timer ^{*1}	Contact	LSTS	Bit	Decimal	—	—	LSTS	0059H
	Coil	LSTC			—	—	LSTC	0058H
	Current value	LSTN			Double word	—	—	LSTN
Counter	Contact	CS	Bit	Decimal	CS	C4H	CS**	00C4H
	Coil	CC			CC	C3H	CC**	00C3H
	Current value	CN			Word	CN	C5H	CN**
Long counter ^{*1}	Contact	LCS	Bit	Decimal	—	—	LCS*	0055H
	Coil	LCC			—	—	LCC*	0054H
	Current value	LCN			Double word	—	—	LCN*
Link special relay	SB	Bit	Hexadecimal	SB	A1H	SB**	00A1H	
Link special register	SW	Word	Hexadecimal	SW	B5H	SW**	00B5H	
Step relay	S	Bit	Decimal	S*	98H	S***	0098H	
Direct access input	DX	Bit	Hexadecimal	DX	A2H	DX**	00A2H	
Direct access output	DY		Hexadecimal	DY	A3H	DY**	00A3H	
Index register	Index register	Z	Word	Decimal	Z*	CCH	Z***	00CCH
	Long index register ^{*2}	LZ			Double word	—	—	LZ**
File register ^{*3}	Block switching method	R	Word	Decimal	R*	AFH	R***	00AFH
	Serial number access method	ZR		Hexadecimal	ZR	B0H	ZR**	00B0H
Extended data register ^{*4}	D	Word	Decimal	D*	A8H	—	—	
Extended link register ^{*4}	W	Word	Hexadecimal	W*	B4H	—	—	
Refresh data register	RD	Word	Decimal	—	—	RD**	002CH	
Network No. specified device	J□□	☞ Page 440 Accessing link direct devices						
Link direct device								

Device				For MELSEC-Q/L series		For MELSEC IQ-R series	
Device name	Symbol	Type	Notation	ASCII	Binary	ASCII	Binary
I/O No. specified device	U	<ul style="list-style-type: none"> ☞ Page 442 Accessing module access devices ☞ Page 444 Accessing CPU buffer memory access device 					
Module access device	U□\G	Word	Decimal	G	ABH	G***	00ABH
CPU buffer memory access device	U3E□\G	Word	Decimal	—	—	G**	00ABH
	U3E□\HG	Word	Decimal	—	—	HG**	002EH

*1 ☞ Page 69 Considerations when accessing long timer, long retentive timer, or long counter

*2 ☞ Page 69 Considerations when accessing long index register

*3 ☞ Page 69 Consideration when accessing file register

*4 ☞ Page 69 Consideration when accessing extended data register or extended link register

Considerations

■Devices that cannot be specified

- Devices which are not listed on the list cannot be specified by the command for device access of MC protocol.
- The available device type and device range are in accordance with the device specifications of access target module. Specify the device that can be used for the access target module.
- Accessing a local device is not available.
- When accessing a device that cannot be specified, create a program etc. to copy a value and store the value temporarily in the device that can be specified and access it.
- When a device can be assigned to a standard global label in GX Works3, even the device, to which a device code cannot be specified, can be accessed by specifying the label name. (☞ Page 124 LABEL ACCESS)

■Considerations when accessing long timer, long retentive timer, or long counter

Use any of the following commands.

Device			Read	Write
Long timer Long retentive timer	Contact	LTS, LSTS	Page 86 Batch read in word units (command: 0401)*1	Page 108 Random write in bit units (test) (command: 1402)
	Coil	LTC, LSTC		
	Current value	LTN, LSTN	Page 86 Batch read in word units (command: 0401) Page 97 Random read in word units (command: 0403)	Page 104 Random write in word units (test) (command: 1402)
Long counter	Contact	LCS	Page 86 Batch read in word units (command: 0401) Page 90 Batch read in bit units (command: 0401)	Page 92 Batch write in word units (command: 1401) Page 95 Batch write in bit units (command: 1401) Page 108 Random write in bit units (test) (command: 1402)
	Coil	LCC		
	Current value	LCN	Page 86 Batch read in word units (command: 0401) Page 97 Random read in word units (command: 0403)	Page 92 Batch write in word units (command: 1401) Page 104 Random write in word units (test) (command: 1402)

*1 When reading data with a current value (LTN, LSTN) specified, the values of contacts and coils will be stored in the read data.

■Considerations when accessing long index register

Use a command to which double word access points can be specified.

- ☞ Page 97 Random read in word units (command: 0403)
- ☞ Page 104 Random write in word units (test) (command: 1402)
- ☞ Page 120 Register monitor data (command: 0801)

■Consideration when accessing file register

The file register specified to "Use File Register of Each Program" in "CPU Parameter" or "PLC parameter" of the CPU module cannot be accessed from external devices.

If the file register of the CPU module is consist of multiple blocks, use the device code of the serial number access method.

To specify the file register with the serial number access method, refer to the manual of CPU module.

■Consideration when accessing extended data register or extended link register

If the access target CPU module does not support the access to the extended data register D65536 or later, and the extended link register W10000 or later, replace the extended data register to the file register (ZR) and specify again. For the replacement method, refer to the manual of Q/LCPU module.

Number of device points

Specify the number of device points to be read or written.

Setting method

■Data communication in ASCII code

Convert the numerical value to 4-digit ASCII code (hexadecimal), and send it from the upper digits.

Use capitalized code for alphabetical letter.

■Data communication in binary code

Send the 2-byte numerical value^{*1} in order from the lower byte (L: bit 0 to 7).

*1 For C24, the additional code may be added. (☞ Page 35 Additional code (10H))

Ex.

For 5 points and 20 points

Number of device points	ASCII code	Binary code										
5 points	<table border="1"> <tr><td>0</td><td>0</td><td>0</td><td>5</td></tr> <tr><td>30H</td><td>30H</td><td>30H</td><td>35H</td></tr> </table>	0	0	0	5	30H	30H	30H	35H	<table border="1"> <tr><td>05H</td><td>00H</td></tr> </table>	05H	00H
0	0	0	5									
30H	30H	30H	35H									
05H	00H											
20 points	<table border="1"> <tr><td>0</td><td>0</td><td>1</td><td>4</td></tr> <tr><td>30H</td><td>30H</td><td>31H</td><td>34H</td></tr> </table>	0	0	1	4	30H	30H	31H	34H	<table border="1"> <tr><td>14H</td><td>00H</td></tr> </table>	14H	00H
0	0	1	4									
30H	30H	31H	34H									
14H	00H											

Access points

Specify the number of device points to be accessed in word unit, double word unit, or bit unit.

Setting method

■Data communication in ASCII code

Convert the numerical value to 2-digit ASCII code (hexadecimal), and send it from the upper digits.

Use capitalized code for alphabetical letter.

■Data communication in binary code

Send the 1-byte^{*1} numerical value (hexadecimal).

*1 For C24, the additional code may be added. (☞ Page 35 Additional code (10H))

Ex.

For 5 points and 20 points

Number of device points	ASCII code	Binary code					
5 points	<table border="1"> <tr><td>0</td><td>5</td></tr> <tr><td>30H</td><td>35H</td></tr> </table>	0	5	30H	35H	<table border="1"> <tr><td>05H</td></tr> </table>	05H
0	5						
30H	35H						
05H							
20 points	<table border="1"> <tr><td>1</td><td>4</td></tr> <tr><td>31H</td><td>34H</td></tr> </table>	1	4	31H	34H	<table border="1"> <tr><td>14H</td></tr> </table>	14H
1	4						
31H	34H						
14H							

Number of bit access points

Specify the number of device points to be accessed in bit units.

Number of word access points, number of double word access points

Specify the number of device points to be accessed in word unit or double word unit.

Number of blocks

Specify the number of blocks of the device to be accessed in hexadecimal.

Set each number of blocks within the following range.

- Number of word device blocks + Number of bit device blocks ≤ 120

Point

In the following case, calculate it as access point × 2.

- When accessing module of MELSEC iQ-R series by setting device extension specification (subcommand: 008□)

Setting method

■Data communication in ASCII code

Convert the numerical value to 2-digit ASCII code (hexadecimal), and send it from the upper digits.

Use capitalized code for alphabetical letter.

■Data communication in binary code

Send the 1-byte^{*1} numerical value (hexadecimal).

*1 For C24, the additional code may be added. (Page 35 Additional code (10H))

Ex.

For 5 points and 20 points

Number of device points	ASCII code	Binary code					
5 points	<table border="1"><tr><td>0</td><td>5</td></tr><tr><td>30H</td><td>35H</td></tr></table>	0	5	30H	35H	<table border="1"><tr><td>05H</td></tr></table>	05H
0	5						
30H	35H						
05H							
20 points	<table border="1"><tr><td>1</td><td>4</td></tr><tr><td>31H</td><td>34H</td></tr></table>	1	4	31H	34H	<table border="1"><tr><td>14H</td></tr></table>	14H
1	4						
31H	34H						
14H							

Number of word device blocks

Specify the number of blocks of the word device.

Number of bit device blocks

Specify the number of blocks of the bit device.

Read data, write data

The read device value is stored for reading, and the data to be written is stored for writing.
 The data order differs between bit units or word units.

For bit units

The following shows the data to be read and written in bit units.

■Data communication in ASCII code

The ON/OFF status of each device are represented with single-digit ASCII code.

- For ON: '1' (31H)
- For OFF: '0' (30H)

■Data communication in binary code

Represent the ON/OFF status of each device in 4-bit per 1 point.

- For ON: '1'
- For OFF: '0'

When the number of points is odd number, the lowest 4 bits are set to '0'.

Ex.

When indicating ON/OFF status of five points from M10

M10	M11	M12	M13	M14																												
ON	OFF	ON	OFF	ON																												
ASCII code	Binary code (For C24)*1			Binary code (For E71)																												
<table border="1"> <tr> <td>1</td> <td>0</td> <td>1</td> <td>0</td> <td>1</td> </tr> <tr> <td>31H</td> <td>30H</td> <td>31H</td> <td>30H</td> <td>31H</td> </tr> </table>	1	0	1	0	1	31H	30H	31H	30H	31H	<table border="1"> <tr> <td>DLE</td> <td>DLE</td> <td>DLE</td> <td></td> <td></td> </tr> <tr> <td>10H</td> <td>10H</td> <td>10H</td> <td>10H</td> <td>10H</td> </tr> </table>	DLE	DLE	DLE			10H	10H	10H	10H	10H	<table border="1"> <tr> <td></td> <td></td> <td></td> <td></td> <td></td> </tr> <tr> <td>10H</td> <td>10H</td> <td>10H</td> <td></td> <td></td> </tr> </table>						10H	10H	10H		
1	0	1	0	1																												
31H	30H	31H	30H	31H																												
DLE	DLE	DLE																														
10H	10H	10H	10H	10H																												
10H	10H	10H																														

*1 For C24, the additional code may be added. (☞ Page 35 Additional code (10H))

For word units (16-point unit for bit device)

The following shows the data to be read and written in word units.

When handling data other than bit data, refer to the following section.

☞ Page 77 Considerations for handling real number data and character string data

■Data communication in ASCII code

Convert the 1-word(16 points of bit device) numerical value to 4-digit ASCII code (hexadecimal), and send it from the upper digits.

Use capitalized code for alphabetical letter.

The ON/OFF status of bit device is a value of hexadecimal 1-digit in 4-point units.

Ex.

When indicating ON/OFF status of 32 points from M16

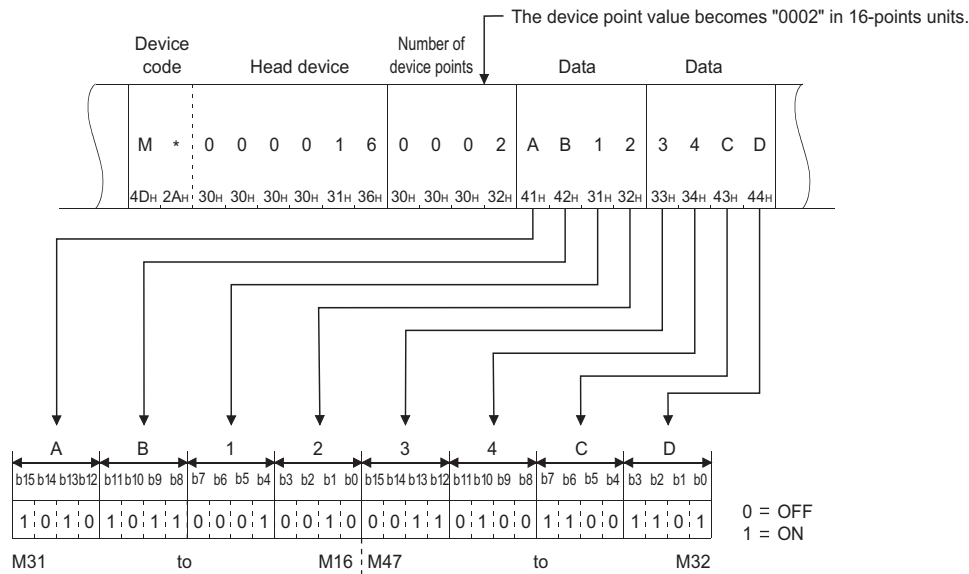

Ex.

When indicating the stored data of D350 and D351

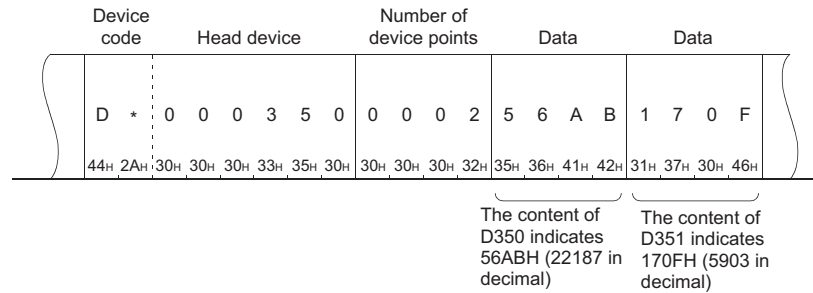

■Data communication in binary code

Send the numerical value in order from the lower byte (L: bit 0 to 7) by handling 16 points unit as 2 bytes.

Ex.

When indicating ON/OFF status of 32 points from M16

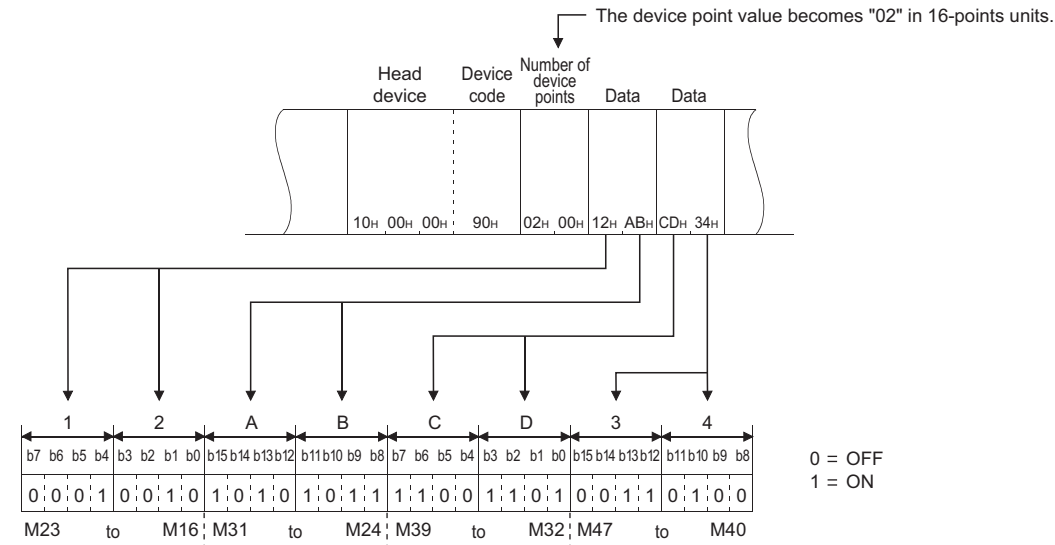

Ex.

When indicating the stored data of D350 and D351

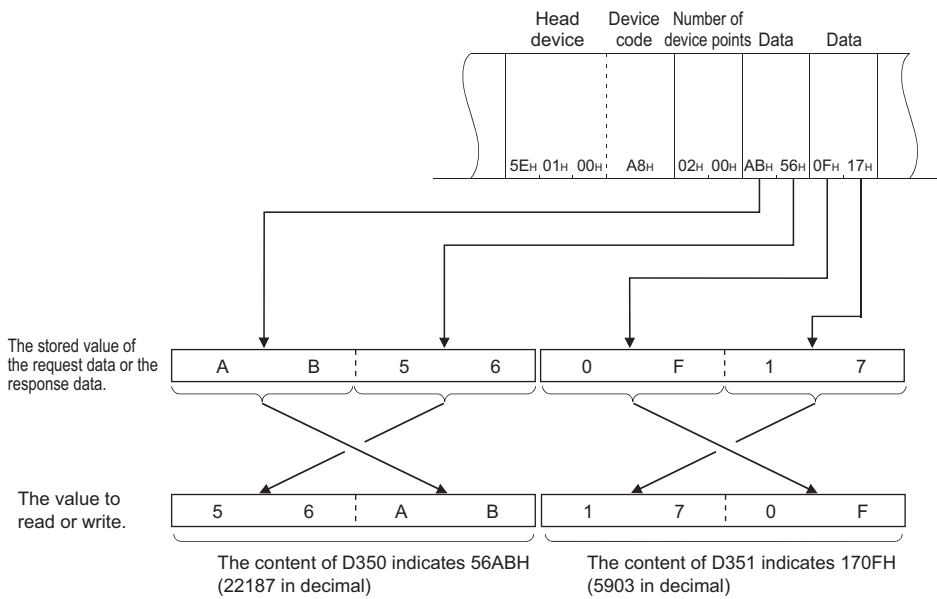

For double word unit (32-point unit for bit device)

The following shows the data to be read and written in double word units.

■Data communication in ASCII code

Convert the 2-word numerical value (32 points of bit device) to 8-digit ASCII code (hexadecimal), and send it from the upper digits.

Use capitalized code for alphabetical letter.

The ON/OFF status of the bit device is 1-digit hexadecimal value in 4-point units.

Ex.

When indicating ON/OFF status of 32 points from M16

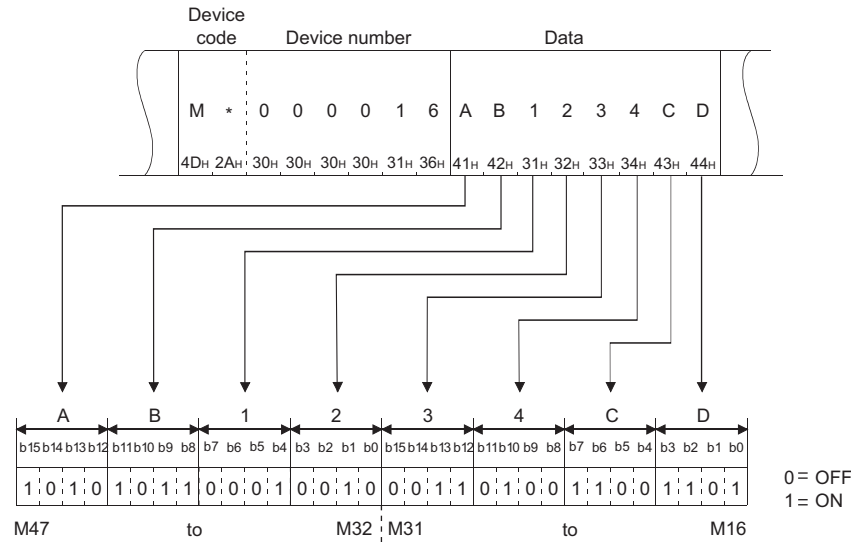

Ex.

When indicating the stored data of D350 (D351)

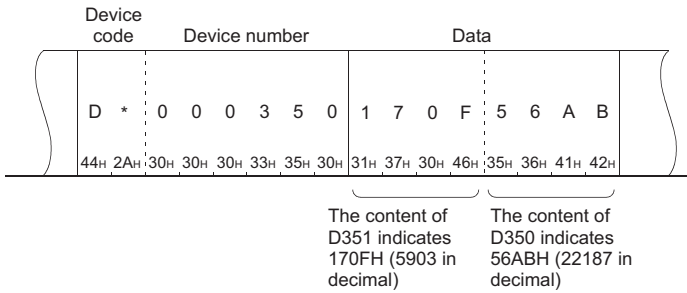

■ Data communication in binary code

Send the numerical value in order from the lower byte (L: bit 0 to 7) by handling 32 points unit as 4 bytes.

Ex.

When indicating ON/OFF status of 32 points from M16

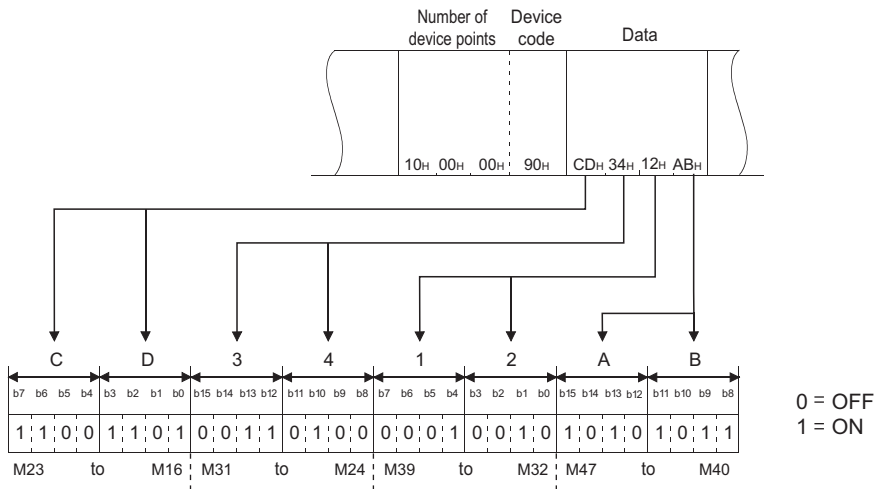

Ex.

When indicating the stored data of D350 (D351)

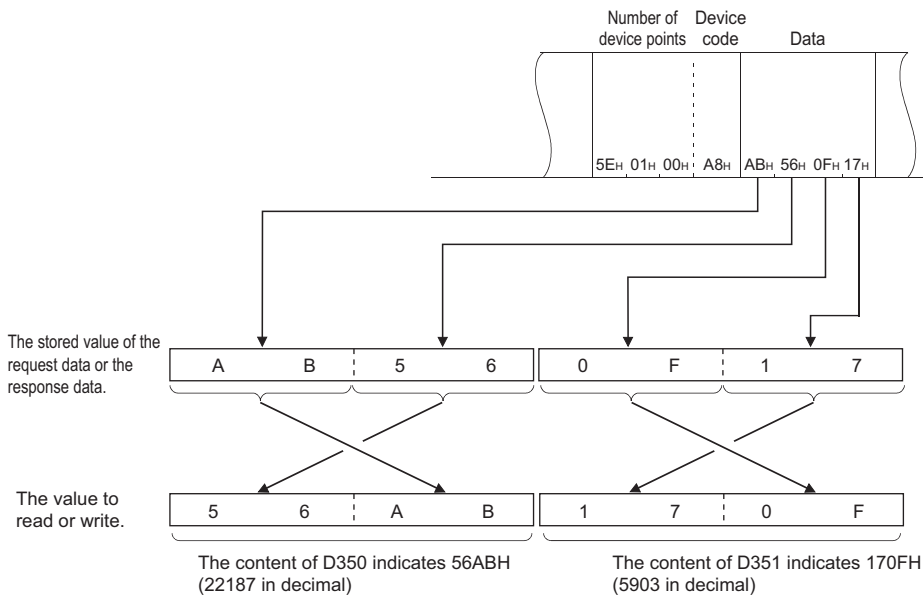

Considerations for handling real number data and character string data

The word data and double word data are handled as integer value (16-bit data or 32-bit data).

When data other than integer (real number, character string) is stored in a device, the stored value is read as integer value.

- When real number (0.75) is stored in D0 and D1: D0 = 0000H, D1 = 3F40H
- When character string ('12AB') is stored in D2 and D3: D2 = 3231H, D3 = 4241H

For data to be used as real number or character string data in the instructions of the programmable controller, write it to the device/label according to the defined data specification method. For more details on how to specify data used in instructions, refer to the programming manual of the CPU module used.

■ For character string data

The following shows the images how character string data is stored.

Item	For ASCII code character string	For Unicode character string
Character string to be stored	'ABC'	'ABCD'
Character code	'41H', '42H', '43H'	'41H', '42H', '43H', '44H'
Image when character string data is stored from D0	NULL indicates 00H. 	NULL indicates 00H.
		NULL indicates 0000H.

Ex.

Write ASCII code character string data used in the instructions which handle character strings to word device

Store the character string ('ABCD') to D0 and D1: D0 = 4241H ('BA'), D1 = 4443H ('DC')

Specify the following data for write data.

ASCII code	Binary code

Point

When communicating ASCII code character string data in ASCII code, data is rearranged every two characters and stored.

Set/reset

Specify the ON/OFF status of bit device.

- For ON: '1'

Subcommand type	ASCII code	Binary code										
For MELSEC-Q/L series	<table border="1"> <tr> <td>0</td> <td>1</td> </tr> <tr> <td>30H</td> <td>31H</td> </tr> </table>	0	1	30H	31H	<table border="1"> <tr> <td>01H</td> </tr> </table>	01H					
0	1											
30H	31H											
01H												
For MELSEC iQ-R series	<table border="1"> <tr> <td>0</td> <td>0</td> <td>0</td> <td>1</td> </tr> <tr> <td>30H</td> <td>30H</td> <td>30H</td> <td>31H</td> </tr> </table>	0	0	0	1	30H	30H	30H	31H	<table border="1"> <tr> <td>01H</td> <td>00H</td> </tr> </table>	01H	00H
0	0	0	1									
30H	30H	30H	31H									
01H	00H											

- For OFF: '0'

Subcommand type	ASCII code	Binary code										
For MELSEC-Q/L series	<table border="1"> <tr> <td>0</td> <td>0</td> </tr> <tr> <td>30H</td> <td>30H</td> </tr> </table>	0	0	30H	30H	<table border="1"> <tr> <td>00H</td> </tr> </table>	00H					
0	0											
30H	30H											
00H												
For MELSEC iQ-R series	<table border="1"> <tr> <td>0</td> <td>0</td> <td>0</td> <td>0</td> </tr> <tr> <td>30H</td> <td>30H</td> <td>30H</td> <td>30H</td> </tr> </table>	0	0	0	0	30H	30H	30H	30H	<table border="1"> <tr> <td>00H</td> <td>00H</td> </tr> </table>	00H	00H
0	0	0	0									
30H	30H	30H	30H									
00H	00H											

Monitor condition specification

The following explains the data to be used when specifying monitor conditions by the following commands.

- Random read in word units (command: 0403)
- Register monitor data (command: 0801)

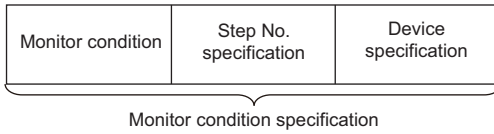

Item			Description	Reference
Step No. specification	File specification	File No.	Specify the registration number of file which includes a program to be the conditions in a module. The number for specification can be obtained from the file control command.	Page 82 Step No. specification Page 298 File No. Page 299 File name, extension, and attribute
		File name	Specify the file name, extension, attribute of a file which includes a program to be the conditions.	
		Extension		
		Attribute		
	SFC specification	SFC pattern	Specify this when a program is SFC.	Page 84 SFC specification
		SFC block No.	Specify the SFC block No. and SFC step No. which include a step to be the conditions.	
		SFC step No.		
Step No.		Specify the step No., pointer (P) No., or interrupt pointer (I) No. for a program to be the condition.	Page 84 Step No.	
Device specification	Word device value specification	Device	Specify the device to be a condition.	Page 85 Mask value, monitor conditions when word device value is specified
		Mask value	Specify this when detecting arbitrary bit range of word device.	
		Monitor condition value	Specify the device value to be a condition.	
	Bit device value specification	Device	Specify the device to be a condition.	Page 85 Monitor conditions when bit device value is specified
		Monitor condition value	Specify the device value to be a condition.	

Point

The monitor conditions can be specified by following QCPUs.

- Basic model QCPU
- High Performance model QCPU
- Process CPU

To access a module which does not support this function, select the subcommand that does not specify monitor conditions. For more information on the supported modules, refer to the following section.

 Page 471 Accessible Modules for Each Command

When the subcommands which do not specify monitor conditions are selected, each data for specifying the monitor conditions are not necessary.

Specification of read timing by monitor condition

The read timing can be changed by specifying monitor conditions according to the selection of subcommand.

■When do not specify monitor condition

Data is read by the END processing after a read request.

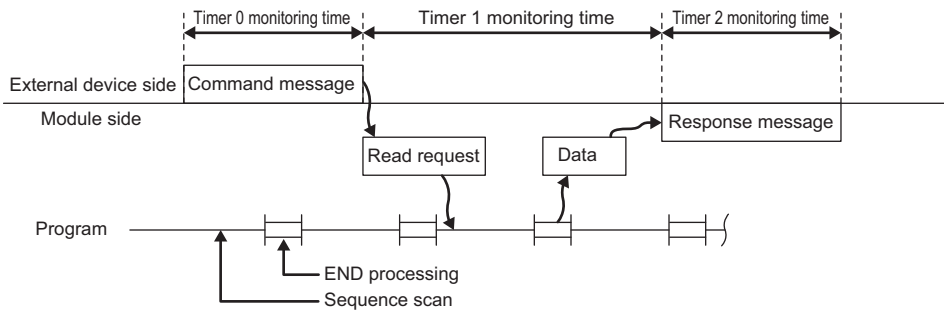

■When monitor condition is specified

Data is read by the END processing after the specified monitor conditions are satisfied.

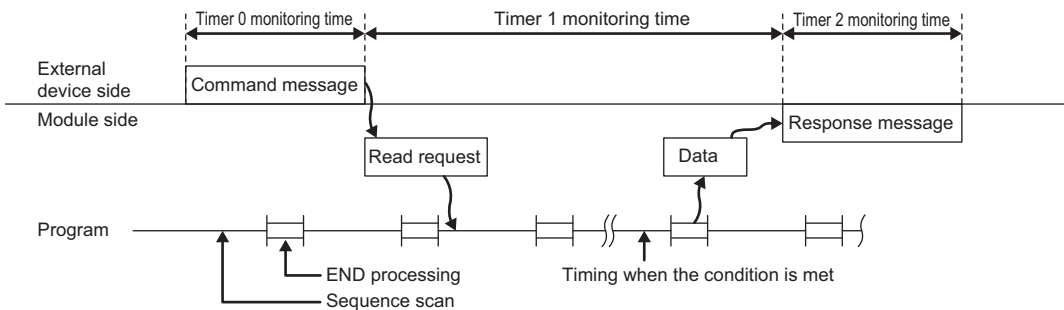

Point

Monitoring with multiple conditions to the device memory of the same CPU module cannot be performed at the same time. When this command, to which a monitor condition is specified, is executed while monitor with other conditions is being performed, the command is completed abnormally.

Monitor condition

Following conditions can be specified as "Monitor condition" for read timing.

Conditions that can be specified		Condition satisfaction timing
Step No. specification		When specified program step is executed
Device specification	Word device value specification	When specified word device value reached the specified value
	Bit device value specification	When specified bit device turned ON/OFF

When the step No. specification and device specification are specified together, the read processing is performed when both of the conditions are satisfied.

Specify the following values according to the conditions.

○: Specified, —: Not specified

Step No. specification	Device specification	ASCII code	Binary code										
○	—	<table border="1"> <tr><td>0</td><td>1</td><td>0</td><td>F</td></tr> <tr><td>30H</td><td>31H</td><td>30H</td><td>46H</td></tr> </table>	0	1	0	F	30H	31H	30H	46H	<table border="1"> <tr><td>01H</td><td>0FH</td></tr> </table>	01H	0FH
0	1	0	F										
30H	31H	30H	46H										
01H	0FH												
—	○ Word device value specification	<table border="1"> <tr><td>0</td><td>2</td><td>0</td><td>F</td></tr> <tr><td>30H</td><td>32H</td><td>30H</td><td>46H</td></tr> </table>	0	2	0	F	30H	32H	30H	46H	<table border="1"> <tr><td>02H</td><td>0FH</td></tr> </table>	02H	0FH
0		2	0	F									
30H	32H	30H	46H										
02H	0FH												
○	<table border="1"> <tr><td>0</td><td>3</td><td>0</td><td>F</td></tr> <tr><td>30H</td><td>33H</td><td>30H</td><td>46H</td></tr> </table>	0	3	0	F	30H	33H	30H	46H	<table border="1"> <tr><td>03H</td><td>0FH</td></tr> </table>	03H	0FH	
0	3	0	F										
30H	33H	30H	46H										
03H	0FH												
—	○ Bit device value specification	<table border="1"> <tr><td>0</td><td>4</td><td>0</td><td>F</td></tr> <tr><td>30H</td><td>34H</td><td>30H</td><td>46H</td></tr> </table>	0	4	0	F	30H	34H	30H	46H	<table border="1"> <tr><td>04H</td><td>0FH</td></tr> </table>	04H	0FH
0		4	0	F									
30H	34H	30H	46H										
04H	0FH												
○	<table border="1"> <tr><td>0</td><td>5</td><td>0</td><td>F</td></tr> <tr><td>30H</td><td>35H</td><td>30H</td><td>46H</td></tr> </table>	0	5	0	F	30H	35H	30H	46H	<table border="1"> <tr><td>05H</td><td>0FH</td></tr> </table>	05H	0FH	
0	5	0	F										
30H	35H	30H	46H										
05H	0FH												

Step No. specification

Specify a condition using a step No. of program.

Data is read at the END processing immediately after a step of the specified program is executed.

■When step No. is specified

Specify the following items.

Item			Description	Reference
Step No. specification	File specification	File No.	Specify the registration number of file which includes a program to be the conditions in a module. The number for specification can be obtained from the file control command.*1	Page 298 File No.
		File name	Specify the file name, extension, attribute of a file which includes a program to be the conditions.	Page 299 File name, extension, and attribute
		Extension		
	Attribute			
SFC specification	SFC pattern	Specify this when a program is SFC.	Page 84 SFC specification	
	SFC block No.	Specify the SFC block No. and SFC step No. which include a step to be the conditions.		
	SFC step No.			
Step No.	Specify the step No., pointer (P) No., or interrupt pointer (I) No. for a program to be the condition.		Page 84 Step No.	

*1 When 'FFFFH' is specified to the file, the specified file is searched with the file name and extension. In this case, a read and write request from a supported device to the CPU module may be delayed more than one sequence scan time.

■When step No. is not specified

Set the following when a monitor condition without step No. specification is selected.

- File No.: 0
- File name, extension, attribute: Space (20H)
- SFC specification, step No.: 0

ASCII code

File No.	File name	Extension	Attribute	SFC pattern	Block No.	Step No.	Step No.
0 0 0 0				0 0 0 0	0 0 0 0	0 0 0 0	0 ... 0
30H, 30H, 30H, 30H	20H, 20H, 20H, 20H, 20H, 20H, 20H, 20H	20H, 20H, 20H	20H	30H, 30H, 30H, 30H	30H, 30H, 30H, 30H	30H, 30H, 30H, 30H	30H, ... 30H (8 digits)
File specification				SFC specification			

Binary code

File No.	File name	Extension	Attribute	Step No.	Step No.	Block No.	SFC pattern
00H, 00H				00H, 00H, 00H, 00H	00H, 00H	00H, 00H	00H, 00H
File specification				SFC specification			

Device specification

Specify a condition using a device and its value.

Data is read at the END processing immediately after the specified device reached the specified value.

■When word device value is specified

Set the following when a monitor condition which specifies word device value is selected.

Item	Description		Reference		
Device specification	Word device value specification	Device	Specify the device to be a condition.	Page 65 Devices	
		Mask value	Specify this when detecting arbitrary bit range of word device.		Page 85 Mask value, monitor conditions when word device value is specified
		Monitor condition value	Specify the device value to be a condition.		
	Bit device value specification	Device	Specify an arbitrary device.	—	
		Monitor condition value	Specify the fixed value (0).		

ASCII code

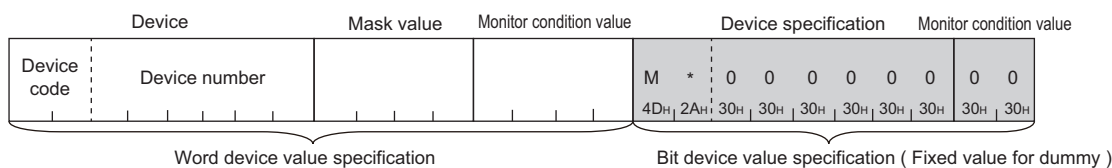

Binary code

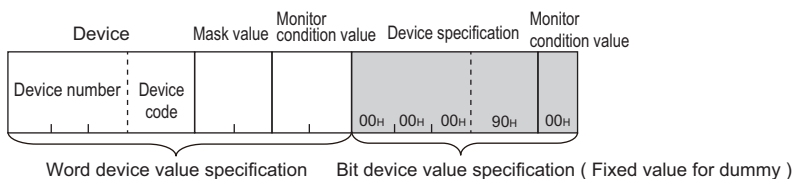

■When bit device value is specified

Set the following when a monitor condition which specifies bit device value is selected.

Item	Description		Reference	
Device specification	Word device value specification	Device	Specify an arbitrary device.	—
		Mask value	Specify the fixed value (0).	
		Monitor condition value		
	Bit device value specification	Device	Specify the device to be a condition.	Page 65 Devices
		Monitor condition value	Specify the condition with the following value. 02H: Condition is satisfied at rising (OFF→ON) 04H: Condition is satisfied at falling (ON→OFF)	

ASCII code

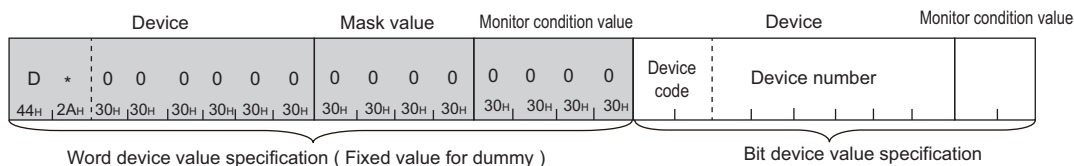

Binary code

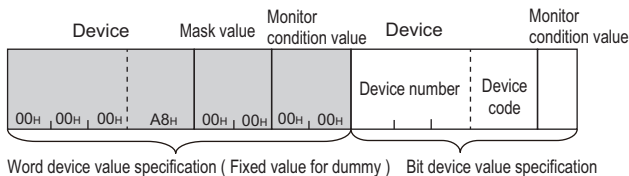

■When no device is specified

Set the following when monitor condition without device specification is selected.

ASCII code

D	*	0	0	0	0	0	0	0	0	0	0	0	M	*	0	0	0	0	0	0	0	0	0	0
44H	2AH	30H	30H	30H	30H	30H	30H	30H	30H	30H	30H	30H	4DH	2AH	30H	30H	30H	30H	30H	30H	30H	30H	30H	30H

Binary code

00H	00H	00H	A8H	00H	00H	00H	00H	00H	00H	90H	00H
-----	-----	-----	-----	-----	-----	-----	-----	-----	-----	-----	-----

SFC specification

The block No. and step No. of SFC (MELSP3) program can be specified as a monitor condition.

Specify the following values.

Condition	SFC pattern	SFC block No.	SFC step No.
Specify an SFC program.	0003H	0000H to 013FH (0 to 319)	0000H to 01FFH (0 to 511)
Do not specify SFC program	0000H	0000H	0000H

■Data communication in ASCII code

Convert the numerical value to 4-digit ASCII code (hexadecimal), and send it from the upper digits.

■Data communication in binary code

Send the 2-byte numerical value*¹ in order from the lower byte (L: bit 0 to 7).

*¹ For C24, the additional code may be added. (☞ Page 35 Additional code (10H))

Ex.

For 0003H

ASCII code	Binary code										
<table border="1"> <tr> <td>0</td><td>0</td><td>0</td><td>3</td> </tr> <tr> <td>30H</td><td>30H</td><td>30H</td><td>33H</td> </tr> </table>	0	0	0	3	30H	30H	30H	33H	<table border="1"> <tr> <td>03H</td><td>00H</td> </tr> </table>	03H	00H
0	0	0	3								
30H	30H	30H	33H								
03H	00H										

Step No.

Specify the step No., pointer (P) No., or interrupt pointer (I) No. of the sequence program.

Specify a following 4-byte value.

Condition	b31	b30	b29 to b0
Specify the step No. of a sequence program	0	0	(Step No. of the arbitrary sequence program)
Specify pointer No.	0	1	(Arbitrary pointer No.)
Specify an interrupt pointer No.	1	0	(Arbitrary interrupt pointer No.)
Do not specify	00000000H		

■Data communication in ASCII code

Convert the numerical value to 8-digit (hexadecimal) ASCII code, and send it from the upper digits.

■Data communication in binary code

Send the 4-byte numerical value*¹ in order from the lower byte (L: bit 0 to 7).

*¹ For C24, the additional code may be added. (☞ Page 35 Additional code (10H))

Ex.

When specifying the interrupt pointer I28 (8000001CH)

ASCII code	Binary code																				
<table border="1"> <tr> <td>8</td><td>0</td><td>0</td><td>0</td><td>0</td><td>0</td><td>1</td><td>C</td> </tr> <tr> <td>38H</td><td>30H</td><td>30H</td><td>30H</td><td>30H</td><td>30H</td><td>31H</td><td>43H</td> </tr> </table>	8	0	0	0	0	0	1	C	38H	30H	30H	30H	30H	30H	31H	43H	<table border="1"> <tr> <td>1CH</td><td>00H</td><td>00H</td><td>80H</td> </tr> </table>	1CH	00H	00H	80H
8	0	0	0	0	0	1	C														
38H	30H	30H	30H	30H	30H	31H	43H														
1CH	00H	00H	80H																		

Mask value, monitor conditions when word device value is specified

Specify the value of word device to be set as a monitor condition.

Arbitrary bit range of word devices can only be specified by specifying mask value.

(Logical AND by each bit of the specified word device data and the designated mask value is compared with the monitor condition value.)

■Data communication in ASCII code

Convert the numerical value to 4-digit ASCII code (hexadecimal), and send it from the upper digits.

■Data communication in binary code

Send the 2-byte numerical value*¹ in order from the lower byte (L: bit 0 to 7).

*¹ For C24, the additional code may be added. (Page 35 Additional code (10H))

Ex.

Specifying when bit 0 to 14 of D0 reaches 1000 (3E8H) as a condition

- Mask value: 7FFFH

ASCII code	Binary code										
<table border="1"> <tr> <td>7</td> <td>F</td> <td>F</td> <td>F</td> </tr> <tr> <td>37H</td> <td>46H</td> <td>46H</td> <td>46H</td> </tr> </table>	7	F	F	F	37H	46H	46H	46H	<table border="1"> <tr> <td>FFH</td> <td>7FH</td> </tr> </table>	FFH	7FH
7	F	F	F								
37H	46H	46H	46H								
FFH	7FH										

- Monitor condition value: 03E8H

ASCII code	Binary code										
<table border="1"> <tr> <td>0</td> <td>3</td> <td>E</td> <td>8</td> </tr> <tr> <td>30H</td> <td>33H</td> <td>45H</td> <td>38H</td> </tr> </table>	0	3	E	8	30H	33H	45H	38H	<table border="1"> <tr> <td>E8H</td> <td>03H</td> </tr> </table>	E8H	03H
0	3	E	8								
30H	33H	45H	38H								
E8H	03H										

Monitor conditions when bit device value is specified

Specify a bit device status change as the monitor condition from either rising (OFF → ON) or falling (ON → OFF).

Condition	ASCII code	Binary code					
Rising (OFF→ON)	<table border="1"> <tr> <td>0</td> <td>2</td> </tr> <tr> <td>30H</td> <td>32H</td> </tr> </table>	0	2	30H	32H	<table border="1"> <tr> <td>02H</td> </tr> </table>	02H
0	2						
30H	32H						
02H							
Falling (ON→OFF)	<table border="1"> <tr> <td>0</td> <td>4</td> </tr> <tr> <td>30H</td> <td>34H</td> </tr> </table>	0	4	30H	34H	<table border="1"> <tr> <td>04H</td> </tr> </table>	04H
0	4						
30H	34H						
04H							

8.2 Batch Read and Write

Read or write the values of consecutive devices in batch by specifying the number of device points.

Batch read in word units (command: 0401)

Read values from devices in word units.



When accessing any of the following devices, use the device extension specification (subcommand: 008□).

- Link direct device
- Module access device
- CPU buffer memory access device

For the message format for device extension specification, refer to the following section.

Page 438 Read/Write by Device Extension Specification

Message format

The following shows the message format of the request data and response data of the command.

Request data

Command	Subcommand	Head device	Number of device points

Response data

The value of read device is stored in word units. The data order differs between ASCII code or binary code. (Page 72 Read data, write data)

Data specified by request data

Command

Frame	ASCII code	Binary code										
4C/3C/4E/3E frame	<table border="1"> <tr><td>0</td><td>4</td><td>0</td><td>1</td></tr> <tr><td>30H</td><td>34H</td><td>30H</td><td>31H</td></tr> </table>	0	4	0	1	30H	34H	30H	31H	<table border="1"> <tr><td>01H</td><td>04H</td></tr> </table>	01H	04H
0	4	0	1									
30H	34H	30H	31H									
01H	04H											
2C frame	<table border="1"> <tr><td>2</td></tr> <tr><td>32H</td></tr> </table>	2	32H	—								
2												
32H												

Subcommand

Type	ASCII code	Binary code										
For MELSEC-Q/L series	<table border="1"> <tr><td>0</td><td>0</td><td>0</td><td>0</td></tr> <tr><td>30H</td><td>30H</td><td>30H</td><td>30H</td></tr> </table>	0	0	0	0	30H	30H	30H	30H	<table border="1"> <tr><td>00H</td><td>00H</td></tr> </table>	00H	00H
0	0	0	0									
30H	30H	30H	30H									
00H	00H											
For MELSEC iQ-R series	<table border="1"> <tr><td>0</td><td>0</td><td>0</td><td>2</td></tr> <tr><td>30H</td><td>30H</td><td>30H</td><td>32H</td></tr> </table>	0	0	0	2	30H	30H	30H	32H	<table border="1"> <tr><td>02H</td><td>00H</td></tr> </table>	02H	00H
0	0	0	2									
30H	30H	30H	32H									
02H	00H											

For 2C frame, the specification is not required. Functions and specification methods are equivalent to the subcommands for MELSEC-Q/L series.

■ Head device

Specify the head device of the consecutive devices. (☞ Page 65 Devices)

Restriction

The following devices cannot be specified.

- Long timer (contact: LTS, coil: LTC)
- Long retentive timer (contact: LSTS, coil: LSTC)
- Long index register (LZ)

☞ Page 69 Considerations when accessing long timer, long retentive timer, or long counter

☞ Page 69 Considerations when accessing long index register

■ Number of device points

Specify the number of device points to be read within the following range in word units. (☞ Page 70 Number of device points)

Access target	Range		
	Word device	Bit device	Double word device
MELSEC iQ-R series module MELSEC iQ-L series module MELSEC-Q/L series module	1 to 960 points	1 to 960 words (1 to 15360 points)	1 to 960 words (LCN: 1 to 480 points) (LTN, LSTN: 1 to 240 points)
MELSEC-QnA series module Module on other station via MELSEC-QnA series network module	1 to 480 points	1 to 480 words (1 to 7680 points)	—
MELSEC-A series module	1 to 64 points	1 to 32 words (1 to 512 points)	—

Read 16-point bit device by specifying one point of "Number of device points".

Set the head device number for MELSEC-A series module with a multiple of 16.

■ Considerations for reading a long timer or long retentive timer device

When reading data with a current value (LTN, LSTN) specified as the head device, the values of contacts and coils will be stored in the response data.

The configuration of the response data is as follows:

Data	Description
1st word	The current value is stored.
2nd word	
3rd word	b0: The value of the coil is stored. b1: The value of the contact is stored. b2 to b15: Used by the system
4th word	Used by the system

Specify four words per one device as the number of device points in the request data.

Ex.

When reading the two points of the long timer (LT0 and LT1), specify LTN0 as the head device and eight words as the number of device points.

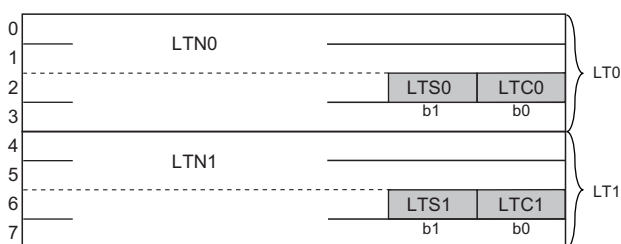

Communication example (Reading bit device)

Read the value of M100 to M131 (for 2 words). (Subcommand: for MELSEC-Q/L series)

■Data communication in ASCII code

(Request data)

Subcommand				Device code		Head device number				Number of device points					
0	4	0	1	0	0	M	*	0	0	0	1	0	0	0	2
30H	34H	30H	31H	30H	30H	4DH	2AH	30H	30H	30H	31H	30H	30H	30H	32H

(Response data)

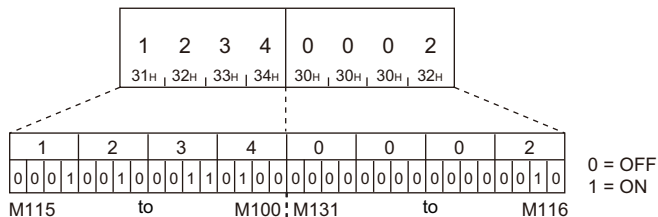

■Data communication in binary code

(Request data)

Subcommand		Device code		Head device number		Number of device points	
01H	04H	00H	00H	64H	00H	90H	02H

(Response data)

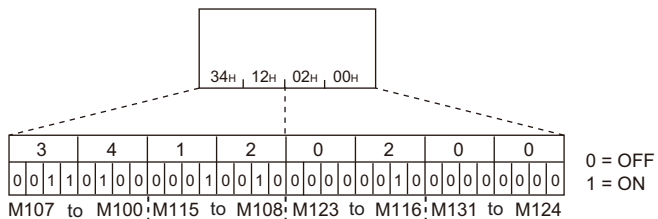

Communication example (Reading word device)

Read values of T100 to T102. (Subcommand: for MELSEC-Q/L series)

T100 = 4660 (1234H), T101 = 2 (2H), T102 = 7663 (1DEFH) are stored.

■Data communication in ASCII code

(Request data)

Subcommand				Device code	Head device number	Number of device points
0	4	0	1	T	N	0 0 0 1 0 0
30H	34H	30H	31H	54H	4EH	30H, 30H, 30H, 31H, 30H, 30H
0	0	0	0			0 0 0 3
30H	30H	30H	30H			30H, 30H, 30H, 33H

(Response data)

1	2	3	4	0	0	0	2	1	D	E	F
31H	32H	33H	34H	30H	30H	30H	32H	31H	44H	45H	46H
T100				T101				T102			

■Data communication in binary code

(Request data)

Subcommand		Head device number	Device code	Number of device points
01H	04H	00H, 00H	64H	03H, 00H
			C2H	

(Response data)

34H	12H	02H	00H	EFH	1DH
T100		T101		T102	

Batch read in bit units (command: 0401)

Read values from devices in bit units.

Point

When accessing any of the following devices, use the device extension specification (subcommand: 008□).

- Link direct device
- Module access device
- CPU buffer memory access device

For the message format for device extension specification, refer to the following section.

☞ Page 438 Read/Write by Device Extension Specification

Message format

The following shows the message format of the request data and response data of the command.

Request data

Command	Subcommand	Head device	Number of device points
---------	------------	-------------	-------------------------

Response data

The value of read device is stored in bit units. The data order differs between ASCII code or binary code. (☞ Page 72 Read data, write data)

Data specified by request data

Command

Frame	ASCII code	Binary code										
4C/3C/4E/3E frame	<table border="1"> <tr><td>0</td><td>4</td><td>0</td><td>1</td></tr> <tr><td>30H</td><td>34H</td><td>30H</td><td>31H</td></tr> </table>	0	4	0	1	30H	34H	30H	31H	<table border="1"> <tr><td>01H</td><td>04H</td></tr> </table>	01H	04H
0	4	0	1									
30H	34H	30H	31H									
01H	04H											
2C frame	<table border="1"> <tr><td>1</td></tr> <tr><td>31H</td></tr> </table>	1	31H	—								
1												
31H												

Subcommand

Type	ASCII code	Binary code										
For MELSEC-Q/L series	<table border="1"> <tr><td>0</td><td>0</td><td>0</td><td>1</td></tr> <tr><td>30H</td><td>30H</td><td>30H</td><td>31H</td></tr> </table>	0	0	0	1	30H	30H	30H	31H	<table border="1"> <tr><td>01H</td><td>00H</td></tr> </table>	01H	00H
0	0	0	1									
30H	30H	30H	31H									
01H	00H											
For MELSEC iQ-R series	<table border="1"> <tr><td>0</td><td>0</td><td>0</td><td>3</td></tr> <tr><td>30H</td><td>30H</td><td>30H</td><td>33H</td></tr> </table>	0	0	0	3	30H	30H	30H	33H	<table border="1"> <tr><td>03H</td><td>00H</td></tr> </table>	03H	00H
0	0	0	3									
30H	30H	30H	33H									
03H	00H											

For 2C frame, the specification is not required. Functions and specification methods are equivalent to the subcommands for MELSEC-Q/L series.

■Head device

Specify the head device of the consecutive devices. (☞ Page 65 Devices)

Restriction

The following devices cannot be specified.

- Long timer (contact: LTS, coil: LTC)
- Long retentive timer (contact: LSTS, coil: LSTC)
- Long index register (LZ)

☞ Page 69 Considerations when accessing long timer, long retentive timer, or long counter

☞ Page 69 Considerations when accessing long index register

■Number of device points

Specify the number of device points to be read within the following range. (☞ Page 70 Number of device points)

Access target	C24	E71	
		ASCII code	Binary code
MELSEC iQ-R series module MELSEC iQ-L series module MELSEC-Q/L series module	1 to 7904 points	1 to 3584 points	1 to 7168 points
MELSEC-QnA series module Module on other station via MELSEC-QnA series network module	1 to 3952 points	1 to 1792 points	1 to 3584 points
MELSEC-A series module	1 to 256 points		

Communication example

Read values of M100 to M107. (Subcommand: for MELSEC-Q/L series)

■Data communication in ASCII code

(Request data)

Subcommand	Device code	Head device number	Number of device points
0 4 0 1 30H, 34H, 30H, 31H	0 0 0 1 30H, 30H, 30H, 31H	M * 4DH, 2AH	0 0 0 1 0 0 30H, 30H, 30H, 31H, 30H, 30H
			0 0 0 8 30H, 30H, 30H, 38H

(Response data)

0 0 0 1 0 0 1 1 30H, 30H, 30H, 31H, 30H, 30H, 31H, 31H	0 = OFF 1 = ON
M100 to M107	

■Data communication in binary code

(Request data)

Subcommand	Device code	Head device number	Number of device points
01H, 04H	01H, 00H	64H, 00H, 00H	90H, 08H, 00H

(Response data)

00H, 01H, 00H, 11H	0 = OFF 1 = ON
M101 to M107	
M100	

Batch write in word units (command: 1401)

Write values to devices in word units.



When accessing any of the following devices, use the device extension specification (subcommand: 008□).

- Link direct device
- Module access device
- CPU buffer memory access device

For the message format for device extension specification, refer to the following section.

☞ Page 438 Read/Write by Device Extension Specification

Message format

The following shows the message format of the request data and response data of the command.

Request data

Command	Subcommand	Head device	Number of device points	Write data
---------	------------	-------------	-------------------------	------------

Response data

There is no response data for this command.

Data specified by request data

Command

Frame	ASCII code	Binary code										
4C/3C/4E/3E frame	<table border="1"> <tr><td>1</td><td>4</td><td>0</td><td>1</td></tr> <tr><td>31H</td><td>34H</td><td>30H</td><td>31H</td></tr> </table>	1	4	0	1	31H	34H	30H	31H	<table border="1"> <tr><td>01H</td><td>14H</td></tr> </table>	01H	14H
1	4	0	1									
31H	34H	30H	31H									
01H	14H											
2C frame	<table border="1"> <tr><td>4</td></tr> <tr><td>34H</td></tr> </table>	4	34H	—								
4												
34H												

Subcommand

Type	ASCII code	Binary code										
For MELSEC-Q/L series	<table border="1"> <tr><td>0</td><td>0</td><td>0</td><td>0</td></tr> <tr><td>30H</td><td>30H</td><td>30H</td><td>30H</td></tr> </table>	0	0	0	0	30H	30H	30H	30H	<table border="1"> <tr><td>00H</td><td>00H</td></tr> </table>	00H	00H
0	0	0	0									
30H	30H	30H	30H									
00H	00H											
For MELSEC iQ-R series	<table border="1"> <tr><td>0</td><td>0</td><td>0</td><td>2</td></tr> <tr><td>30H</td><td>30H</td><td>30H</td><td>32H</td></tr> </table>	0	0	0	2	30H	30H	30H	32H	<table border="1"> <tr><td>02H</td><td>00H</td></tr> </table>	02H	00H
0	0	0	2									
30H	30H	30H	32H									
02H	00H											

For 2C frame, the specification is not required. Functions and specification methods are equivalent to the subcommands for MELSEC-Q/L series.

Head device

Specify the head device of the consecutive devices. (☞ Page 65 Devices)

Restriction

The following devices cannot be specified.

- Long timer (contact: LTS, coil: LTC, current value: LTN)
- Long retentive timer (contact: LSTS, coil: LSTC, current value: LSTN)
- Long index register (LZ)

☞ Page 69 Considerations when accessing long timer, long retentive timer, or long counter

☞ Page 69 Considerations when accessing long index register

Number of device points

Specify the number of device points to be written within the following range in word units. (☞ Page 70 Number of device points)

Access target	Range		
	Word device	Bit device	Double word device
MELSEC iQ-R series module MELSEC iQ-L series module MELSEC-Q/L series module	1 to 960 points	1 to 960 words (1 to 15360 points)	1 to 960 words (1 to 480 points)
MELSEC-QnA series module Module on other station via MELSEC-QnA series network module	1 to 480 points	1 to 480 words (1 to 7680 points)	—
MELSEC-A series module	1 to 64 points	1 to 10 words (1 to 160 points)	—

For bit device, read 16-point bit device by specifying one point of "Number of device points".

Set the head device number for MELSEC-A series module with a multiple of 16.

Write data

Specify the data to be written for the number of device points in hexadecimal. (☞ Page 72 Read data, write data)

Communication example (Writing bit device)

Write the values to M100 to M131 (for 2 words). (Subcommand: for MELSEC-Q/L series)

Data communication in ASCII code

Subcommand				Device code		Head device number				Number of device points				Write data											
1	4	0	1	0	0	M	*	0	0	0	1	0	0	0	0	0	2	2	3	4	7	A	B	9	6
31H	34H	30H	31H	30H	30H	4DH	2AH	30H	30H	30H	31H	30H	30H	30H	30H	30H	32H	32H	33H	34H	37H	41H	42H	39H	36H

2	3	4	7	A	B	9	6
0	0	1	0	0	0	1	1
0	0	1	1	0	1	0	1
0	0	1	0	0	1	1	1
0	1	1	1	1	0	1	0
1	0	1	0	1	0	1	1
1	0	1	1	0	1	1	0
1	0	1	1	0	1	1	0
1	0	1	1	0	1	1	0

M115 to M116 to M100;M131 to M116

0 = OFF
1 = ON

Data communication in binary code

Subcommand				Device code		Head device number				Write data							
01H	14H	00H	00H	64H	00H	90H	02H	00H	00H	47H	23H	96H	ABH				

4	7	2	3	9	6	A	B
0	1	0	0	0	1	1	1
0	0	1	0	0	0	1	1
1	0	0	1	0	1	1	1
0	1	0	1	0	1	1	0
1	0	1	1	0	1	1	0
1	0	1	1	0	1	1	0
1	0	1	1	0	1	1	0
1	0	1	1	0	1	1	0

M107 to M100;M115 to M108;M123 to M116;M131 to M124

0 = OFF
1 = ON

Communication example (Writing word device)

Write '6549' (1995H) to D100, '4610' (1202H) to D101, and '4400' (1130H) to D102. (Subcommand: for MELSEC-Q/L series)

■Data communication in ASCII code

Subcommand				Device code		Head device number				Number of device points				Write data											
1	4	0	1	0	*	0	0	0	1	0	0	0	3	1	9	9	5	1	2	0	2	1	1	3	0
31H	34H	30H	31H	30H	2AH	30H	30H	30H	31H	30H	30H	30H	33H	31H	39H	39H	35H	31H	32H	30H	32H	31H	31H	33H	30H
													D100				D101				D102				

■Data communication in binary code

Subcommand		Device code		Head device number		Number of device points		Write data											
01H	14H	00H	00H	64H	00H	00H	00H	95H	19H	02H	12H	30H	11H						
								D100		D101		D102							

Batch write in bit units (command: 1401)

Write values to devices in bit units.



When accessing any of the following devices, use the device extension specification (subcommand: 008□).

- Link direct device
- Module access device
- CPU buffer memory access device

For the message format for device extension specification, refer to the following section.

☞ Page 438 Read/Write by Device Extension Specification

Message format

The following shows the message format of the request data and response data of the command.

Request data

Command	Subcommand	Head device	Number of device points	Write data
---------	------------	-------------	-------------------------	------------

Response data

There is no response data for this command.

Data specified by request data

Command

Frame	ASCII code	Binary code										
4C/3C/4E/3E frame	<table border="1"> <tr><td>1</td><td>4</td><td>0</td><td>1</td></tr> <tr><td>31H</td><td>34H</td><td>30H</td><td>31H</td></tr> </table>	1	4	0	1	31H	34H	30H	31H	<table border="1"> <tr><td>01H</td><td>14H</td></tr> </table>	01H	14H
1	4	0	1									
31H	34H	30H	31H									
01H	14H											
2C frame	<table border="1"> <tr><td>3</td></tr> <tr><td>33H</td></tr> </table>	3	33H	—								
3												
33H												

Subcommand

Type	ASCII code	Binary code										
For MELSEC-Q/L series	<table border="1"> <tr><td>0</td><td>0</td><td>0</td><td>1</td></tr> <tr><td>30H</td><td>30H</td><td>30H</td><td>31H</td></tr> </table>	0	0	0	1	30H	30H	30H	31H	<table border="1"> <tr><td>01H</td><td>00H</td></tr> </table>	01H	00H
0	0	0	1									
30H	30H	30H	31H									
01H	00H											
For MELSEC iQ-R series	<table border="1"> <tr><td>0</td><td>0</td><td>0</td><td>3</td></tr> <tr><td>30H</td><td>30H</td><td>30H</td><td>33H</td></tr> </table>	0	0	0	3	30H	30H	30H	33H	<table border="1"> <tr><td>03H</td><td>00H</td></tr> </table>	03H	00H
0	0	0	3									
30H	30H	30H	33H									
03H	00H											

For 2C frame, the specification is not required. Functions and specification methods are equivalent to the subcommands for MELSEC-Q/L series.

■Head device

Specify the head device of the consecutive devices. (☞ Page 65 Devices)

Restriction

The following devices cannot be specified.

- Long timer (contact: LTS, coil: LTC, current value: LTN)
- Long retentive timer (contact: LSTS, coil: LSTC, current value: LSTN)
- Long counter (current value: LCN)
- Long index register (LZ)

☞ Page 69 Considerations when accessing long timer, long retentive timer, or long counter

☞ Page 69 Considerations when accessing long index register

■Number of device points

Specify the number of device points to be written within the following range. (☞ Page 70 Number of device points)

Access target	C24	E71	
		ASCII code	Binary code
MELSEC iQ-R series module MELSEC iQ-L series module MELSEC-Q/L series module	1 to 7904 points	1 to 3584 points	1 to 7168 points
MELSEC-QnA series module Module on other station via MELSEC-QnA series network module	1 to 3952 points	1 to 1792 points	1 to 3584 points
MELSEC-A series module	1 to 160 points		

■Write data

Specify the value to be written to a device for the number equivalent to the specified number of device points. (☞ Page 72 Read data, write data)

Communication example

Write values to M100 to M107. (Subcommand: for MELSEC-Q/L series)

■Data communication in ASCII code

Subcommand		Device code	Head device number	Number of device points	Write data																						
1	4	0	1	0	0	0	1	M	*	0	0	0	1	0	0	0	0	0	8	1	1	0	0	1	1	0	0
31H	34H	30H	31H	30H	30H	30H	31H	4DH	2AH	30H	30H	30H	31H	30H	30H	30H	30H	38H	31H	31H	30H	30H	31H	31H	30H	30H	
																				M100	to	M107	0 = OFF 1 = ON				

■Data communication in binary code

Subcommand		Device code		Write data										
Head device number	Number of device points	Head device number	Number of device points											
01H	14H	01H	00H	64H	00H	00H	90H	08H	00H	11H	00H	11H	00H	0 = OFF 1 = ON
										to		M107		
												M106		
												M101		
												M100		

8.3 Random Read and Write

Read or write device values by specifying the device numbers. It can be specified with discontinuous device numbers.

Random read in word units (command: 0403)

Read values from devices in word units and double word units. It can be specified with discontinuous device number.

Point 

When accessing any of the following devices, use the device extension specification (subcommand: 008□).

- Link direct device
- Module access device
- CPU buffer memory access device

For the message format for device extension specification, refer to the following section.

 Page 438 Read/Write by Device Extension Specification

Message format

The following shows the message format of the request data and response data of the command.

Request data

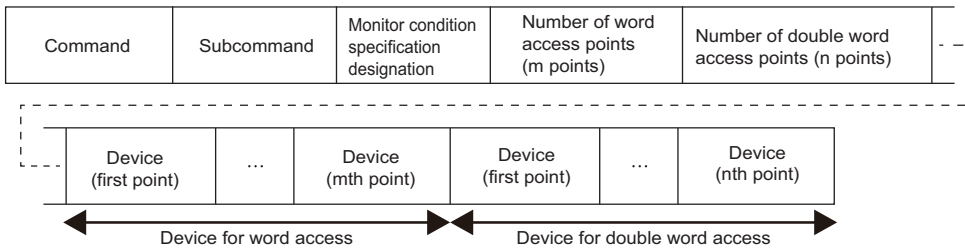

Response data

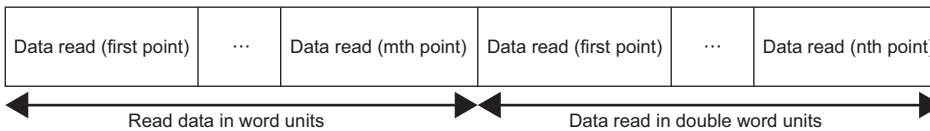

The value of read device is stored in word units and in double word units. The data order differs between ASCII code or binary code. ( Page 72 Read data, write data)

Data specified by request data

Command

Frame	ASCII code	Binary code										
4C/3C/4E/3E frame	<table border="1" style="margin: auto;"> <tr><td>0</td><td>4</td><td>0</td><td>3</td></tr> <tr><td>30H</td><td>34H</td><td>30H</td><td>33H</td></tr> </table>	0	4	0	3	30H	34H	30H	33H	<table border="1" style="margin: auto;"> <tr><td>03H</td><td>04H</td></tr> </table>	03H	04H
0	4	0	3									
30H	34H	30H	33H									
03H	04H											
2C frame	<table border="1" style="margin: auto;"> <tr><td>5</td></tr> <tr><td>35H</td></tr> </table>	5	35H	—								
5												
35H												

Subcommand

The read timing can be changed by specifying monitor conditions according to the selection of subcommand. (Page 79 Monitor condition specification)

For 2C frame, the specification is not required. Functions and specification methods are equivalent to the subcommands that do not specify monitor conditions for MELSEC-Q/L series.

When do not specify monitor condition

Type	ASCII code	Binary code										
For MELSEC-Q/L series	<table border="1"> <tr><td>0</td><td>0</td><td>0</td><td>0</td></tr> <tr><td>30H</td><td>30H</td><td>30H</td><td>30H</td></tr> </table>	0	0	0	0	30H	30H	30H	30H	<table border="1"> <tr><td>00H</td><td>00H</td></tr> </table>	00H	00H
0	0	0	0									
30H	30H	30H	30H									
00H	00H											
For MELSEC iQ-R series	<table border="1"> <tr><td>0</td><td>0</td><td>0</td><td>2</td></tr> <tr><td>30H</td><td>30H</td><td>30H</td><td>32H</td></tr> </table>	0	0	0	2	30H	30H	30H	32H	<table border="1"> <tr><td>02H</td><td>00H</td></tr> </table>	02H	00H
0	0	0	2									
30H	30H	30H	32H									
02H	00H											

When specifying a monitoring condition^{*1}

*1 The access targets to which a monitor conditions can be specified have some restrictions. (Page 471 Accessible Modules for Each Command)

Type	ASCII code	Binary code										
For MELSEC-Q/L series	<table border="1"> <tr><td>0</td><td>0</td><td>4</td><td>0</td></tr> <tr><td>30H</td><td>30H</td><td>34H</td><td>30H</td></tr> </table>	0	0	4	0	30H	30H	34H	30H	<table border="1"> <tr><td>40H</td><td>00H</td></tr> </table>	40H	00H
0	0	4	0									
30H	30H	34H	30H									
40H	00H											

Point

At monitor condition specification, use the subcommand 00C0 for the device extension specification. The message format for device extension specification is the same as that of 008 □. Refer to it by substituting 008 □ to 00C0.

Page 438 Read/Write by Device Extension Specification

Monitor condition specification

Specify the conditions for timing to read data. (Page 79 Monitor condition specification)

When do not specify the monitor condition, the specification of this data item is not required.

Number of word access points, number of double word access points

Specify the number of device points to be read within the following range. (Page 70 Access points)

Access target	Range
MELSEC iQ-R series module (subcommand: 0000) MELSEC iQ-L series module (subcommand: 0000) MELSEC-Q/L series module (subcommand: 0000)	$1 \leq \text{Number of word access points} + \text{Number of double word access points} \leq 192$ points
MELSEC iQ-R series module (subcommand: 0002, 008□) MELSEC iQ-L series module (subcommand: 0080) MELSEC-Q/L series module (subcommand: 0080) MELSEC-QnA series module Module on other station via MELSEC-QnA series network module	$1 \leq \text{Number of word access points} + \text{Number of double word access points} \leq 96$ points
MELSEC-A series module	Cannot be used.

The number of point is specified in the following units depending on device type.

Device type	Number of word access points	Number of double word access points
Bit device	16-point units	32-point units
Word device, double word device	1 word units	2 word units

Point

When using subcommand for MELSEC-Q/L series module, calculate it as access points $\times 2$ in the following case.

- When specifying the file register (ZR) of High Performance model QCPU

■ Device

Specify the device to be read. (☞ Page 65 Devices)

Point

The number of points equivalent to the specified 'Number of word access points' and 'Number of double word access points' is specified for 'Device', respectively. When '0' is specified for the access points, this specification is not required.

Restriction

The following devices cannot be specified.

- Long timer (contact: LTS, coil: LTC)
- Long retentive timer (contact: LSTS, coil: LSTC)
- Long counter (contact: LCS, coil: LCC)

☞ Page 69 Considerations when accessing long timer, long retentive timer, or long counter

Communication example (Monitor condition is not specified)

Read values of D0, T0, M100 to M115, X20 to X2F with word access. Read values of D1500 to D1501, Y160 to Y17F, M1111 to M1142 with 4 double word access. (Subcommand: for MELSEC-Q/L series)

D0 = 6549 (1995H), T0 = 4610 (1202H), D1500 = 20302 (4F4EH), D1501 = 19540 (4C54H) are stored.

■Data communication in ASCII code

(Request data)

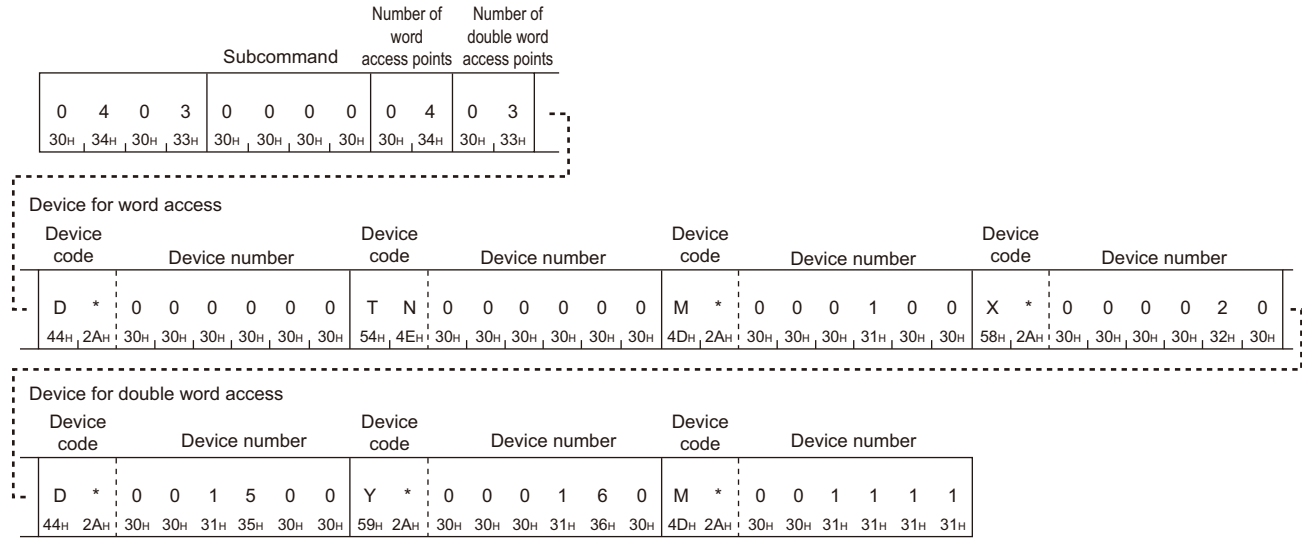

(Response data)

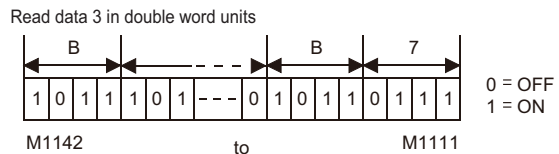
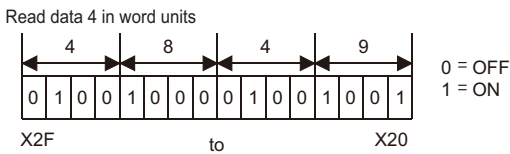
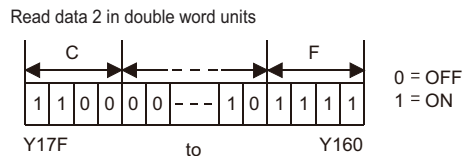
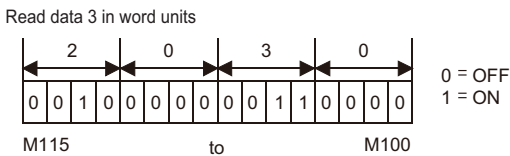
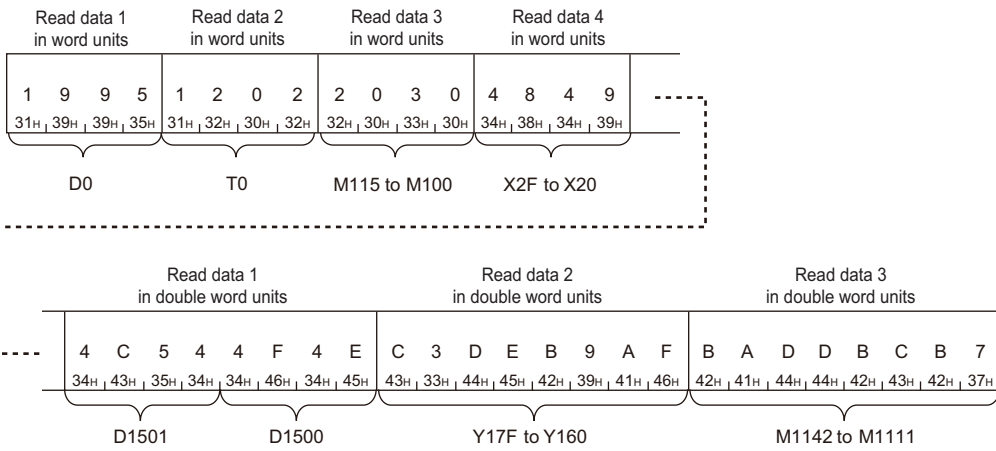

■ Data communication in binary code

(Request data)

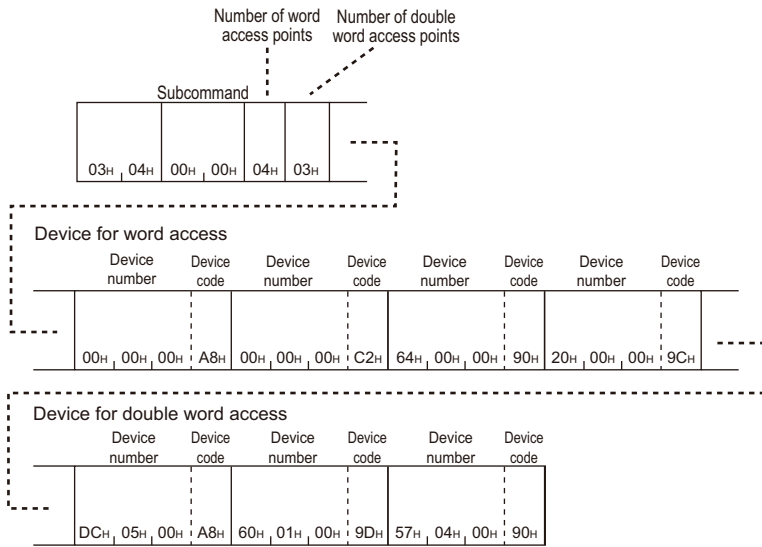

(Response data)

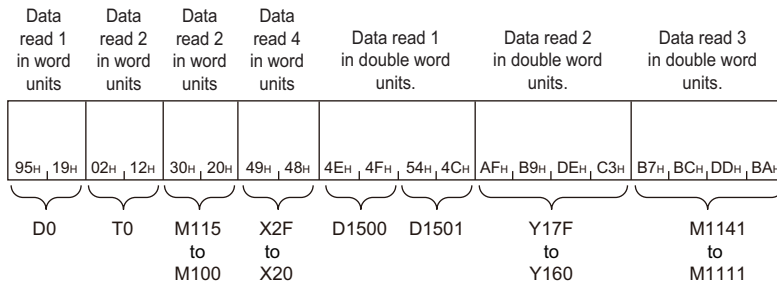

Data read 3 in word units

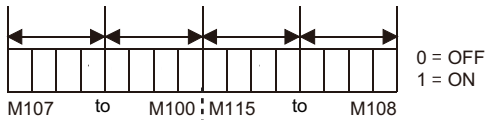

Data read 2 in double word units

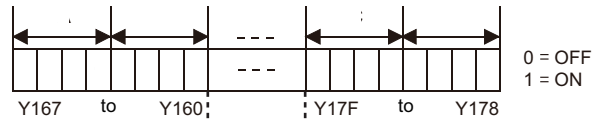

Data read 4 in word units

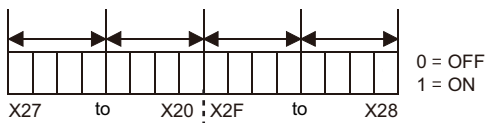

Data read 3 in double word units

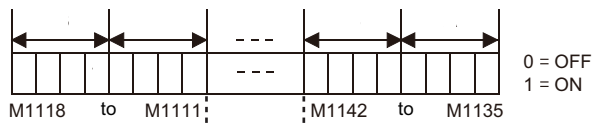

Communication example (Monitor condition is specified)

Read values of D0, T0, M100 to M115, X20 to X2F with word access. Read values of D1500 to D1501, Y160 to Y17F, M1111 to M1142 with 4 double word access.

The monitor condition is as follows: When the value of link register (W100) reached '7BH' (123) while the step No.1000 of program file CONB1.QPG is being executed.

■Data communication in ASCII code

(Request data)

Subcommand		Monitor condition		File No.		File name						Extension			Attribute												
0	4	0	3	0	0	4	0	0	3	0	F	0	0	0	1	C	O	N	B	1	Q	P	G				
30H	34H	30H	33H	30H	30H	34H	30H	30H	33H	30H	46H	30H	30H	30H	31H	43H	4FH	4EH	42H	31H	20H	20H	20H	51H	50H	47H	20H

File designation

SFC pattern		Block No.		Step No.		Step No.									
0	0	0	0	0	0	0	0	0	0	0	0	0	3	E	8
30H	30H	30H	30H	30H	30H	30H	30H	30H	30H	30H	30H	30H	33H	45H	38H

SFC designation (not specified)

Device code	Device number				Mask value				Monitor condition value		Device code	Device number				Monitor condition value									
W	*	0	0	0	1	0	0	F	F	F	F	0	0	7	B	M	*	0	0	0	0	0	0	0	0
57H	2AH	30H	30H	30H	31H	30H	30H	46H	46H	46H	46H	30H	30H	37H	42H	4DH	2AH	30H	30H	30H	30H	30H	30H	30H	30H

Word device value designation Bit device value designation
(Fixed value for dummy)

Number of word access points	Number of double word access points
0	0
4	3
30H	34H
30H	33H

Device for word access

D	*	0	0	0	0	0	0	T	N	0	0	0	0	0	0	M	*	0	0	0	1	0	0	X	*	0	0	0	0	2	0
44H	2AH	30H	30H	30H	30H	30H	30H	54H	4EH	30H	30H	30H	30H	30H	30H	4DH	2AH	30H	30H	30H	31H	30H	30H	58H	2AH	30H	30H	30H	30H	32H	30H

Device for double word access

D	*	0	0	1	5	0	0	Y	*	0	0	0	1	6	0	M	*	0	0	1	1	1	1
44H	2AH	30H	30H	31H	35H	30H	30H	59H	2AH	30H	30H	30H	31H	36H	30H	4DH	2AH	30H	30H	31H	31H	31H	31H

(Response data)

It is the same as the communication example when monitor condition is not specified. (Page 100 Data communication in ASCII code)

■Data communication in binary code

(Request data)

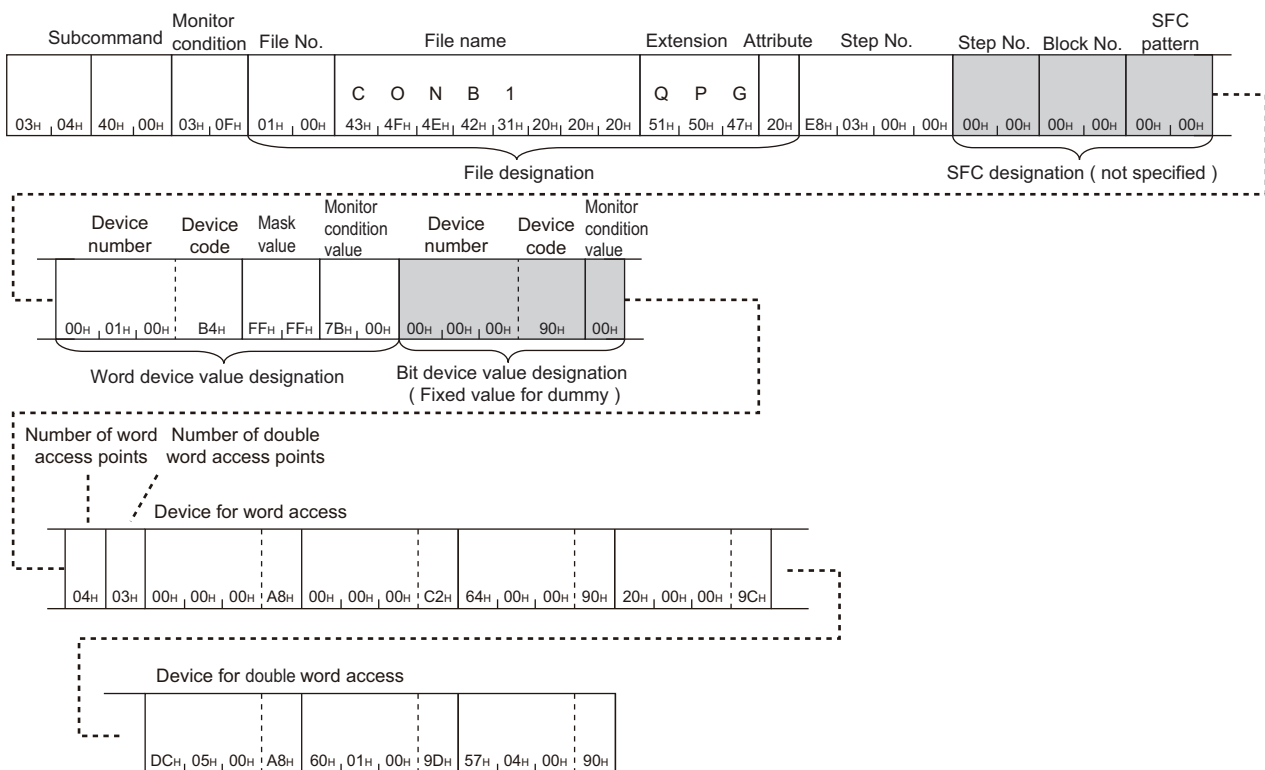

(Response data)

It is the same as the communication example when monitor condition is not specified. (Page 101 Data communication in binary code)

Random write in word units (test) (command: 1402)

Write values to devices in word units and double word units. It can be specified with discontinuous device numbers.

Point

When accessing any of the following devices, use the device extension specification (subcommand: 008□).

- Link direct device
- Module access device
- CPU buffer memory access device

For the message format for device extension specification, refer to the following section.

☞ Page 438 Read/Write by Device Extension Specification

Message format

The following shows the message format of the request data and response data of the command.

Request data

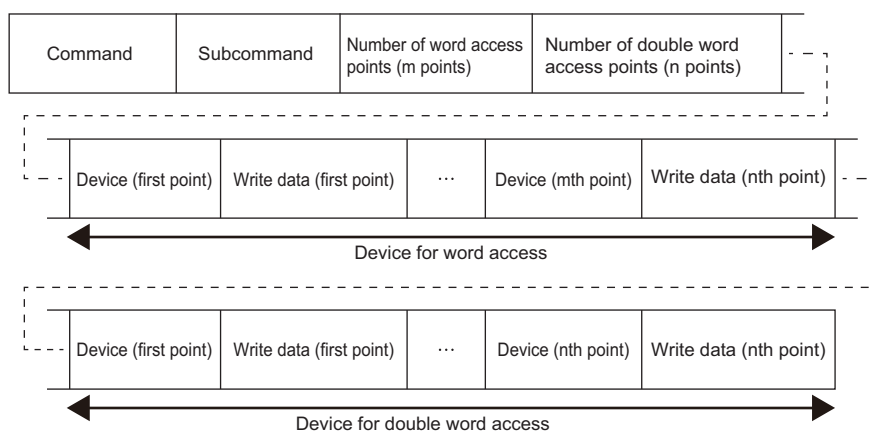

Response data

There is no response data for this command.

Data specified by request data

Command

Frame	ASCII code	Binary code										
4C/3C/4E/3E frame	<table border="1"> <tr><td>1</td><td>4</td><td>0</td><td>2</td></tr> <tr><td>31H</td><td>34H</td><td>30H</td><td>32H</td></tr> </table>	1	4	0	2	31H	34H	30H	32H	<table border="1"> <tr><td>02H</td><td>14H</td></tr> </table>	02H	14H
1	4	0	2									
31H	34H	30H	32H									
02H	14H											
2C frame	<table border="1"> <tr><td>7</td></tr> <tr><td>37H</td></tr> </table>	7	37H	—								
7												
37H												

Subcommand

Type	ASCII code	Binary code										
For MELSEC-Q/L series	<table border="1"> <tr><td>0</td><td>0</td><td>0</td><td>0</td></tr> <tr><td>30H</td><td>30H</td><td>30H</td><td>30H</td></tr> </table>	0	0	0	0	30H	30H	30H	30H	<table border="1"> <tr><td>00H</td><td>00H</td></tr> </table>	00H	00H
0	0	0	0									
30H	30H	30H	30H									
00H	00H											
For MELSEC iQ-R series	<table border="1"> <tr><td>0</td><td>0</td><td>0</td><td>2</td></tr> <tr><td>30H</td><td>30H</td><td>30H</td><td>32H</td></tr> </table>	0	0	0	2	30H	30H	30H	32H	<table border="1"> <tr><td>02H</td><td>00H</td></tr> </table>	02H	00H
0	0	0	2									
30H	30H	30H	32H									
02H	00H											

For 2C frame, the specification is not required. Functions and specification methods are equivalent to the subcommands for MELSEC-Q/L series.

■Number of word access points, number of double word access points

Specify the number of device points to be written within the following range. (🔗 Page 70 Access points)

Access target	Range
MELSEC iQ-R series module (subcommand: 0000) MELSEC iQ-L series module (subcommand: 0000) MELSEC-Q/L series module (subcommand: 0000)	$1 \leq (\text{Number of word access points} \times 12) + (\text{Number of double word access points} \times 14) \leq 1920$ points
MELSEC iQ-R series module (subcommand: 0002, 008□) MELSEC iQ-L series module (subcommand: 0080) MELSEC-Q/L series module (subcommand: 0080) MELSEC-QnA series module Module on other station via MELSEC-QnA series network module	$1 \leq (\text{Number of word access points} \times 12) + (\text{Number of double word access points} \times 14) \leq 960$ points
MELSEC-A series module	$1 \leq \text{Number of word access points} \leq 10$ points

The number of point is specified in the following units depending on device type.

Device type	Number of word access points	Number of double word access points
Bit device	16-point units	32-point units
Word device, double word device	1 word units	2 word units

■Device

Specify a device to be written. (🔗 Page 65 Devices)

Set the head device number with a multiple of 16 for bit device access of MELSEC-A series module.

■Write data

Specify the values to be written to device. (🔗 Page 72 Read data, write data)

Specify the write data in hexadecimal.

Point

Specify 'Device' and 'Write data' with number of points which are specified in 'Number of word access points' and 'Number of double word access points'. When the access point is set to '0', the specification is not required.

Communication example

Write values to devices as follows. (Subcommand: for MELSEC-Q/L series)

Item	Device to be written
Word access	D0, D1, M100 to M115, X20 to X2F
Double word access	D1500 to D1501, Y160 to Y17F, M1111 to M1142

■Data communication in ASCII code

(Request data)

Subcommand				Number of word access points				Number of double word access points			
1	4	0	2	0	0	0	0	0	4	0	3
31H	34H	30H	32H	30H	30H	30H	30H	30H	34H	30H	33H

Device for word access

D	*	0	0	0	0	0	0	0	5	5	0	D	*	0	0	0	0	0	1	0	5	7	5
44H	2AH	30H	30H	30H	30H	30H	30H	30H	35H	35H	30H	44H	2AH	30H	30H	30H	30H	30H	31H	30H	35H	37H	35H

Device code	Device number	Write data 1	Device code	Device number	Write data 2																		
M	*	0	0	0	1	0	0	0	5	4	0	X	*	0	0	0	0	2	0	0	5	8	3
4DH	2AH	30H	30H	30H	31H	30H	30H	30H	35H	34H	30H	58H	2AH	30H	30H	30H	30H	32H	30H	30H	35H	38H	33H

Device for double word access

Device code	Device number	Write data 3																													
D	*	0	0	1	5	0	0	0	4	3	9	1	2	0	2	Y	*	0	0	0	1	6	0	2	3	7	5	2	6	0	7
44H	2AH	30H	30H	31H	35H	30H	30H	30H	34H	33H	39H	31H	32H	30H	32H	59H	2AH	30H	30H	30H	31H	36H	30H	32H	33H	37H	35H	32H	36H	30H	37H

Device code	Device number	Write data 4													
M	*	0	0	1	1	1	1	0	4	2	5	0	4	7	5
4DH	2AH	30H	30H	31H	31H	31H	31H	30H	34H	32H	35H	30H	34H	37H	35H

Write data 1 in word units

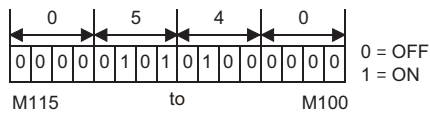

Write data 3 in double word units

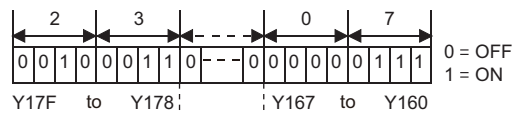

Write data 2 in word units

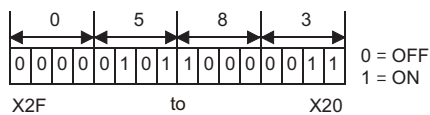

Write data 4 in double word units

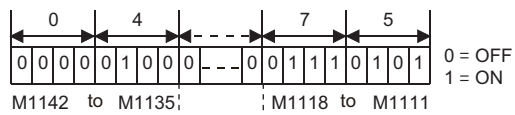

■ Data communication in binary code

(Request data)

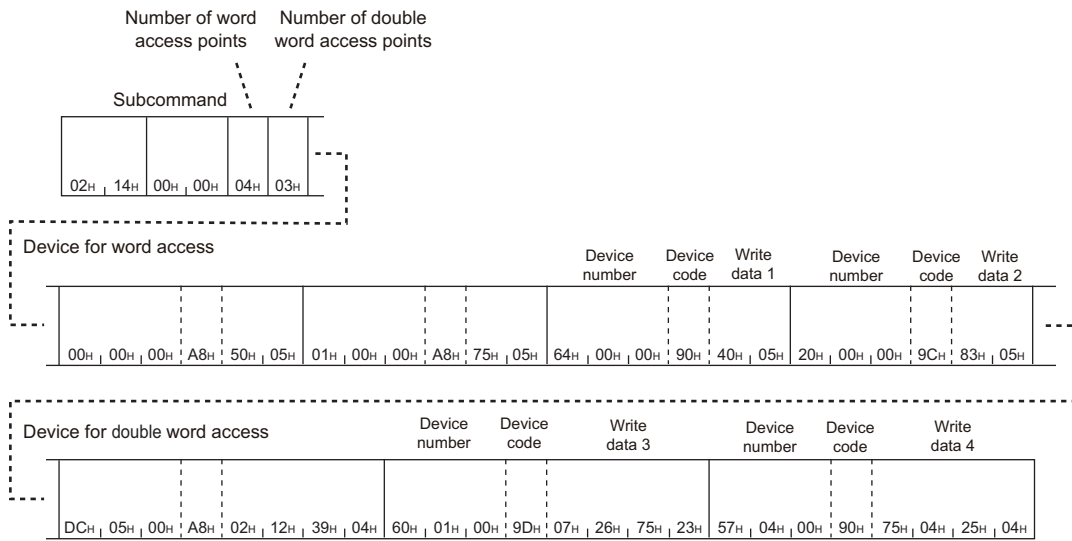

Write data 1 in word units

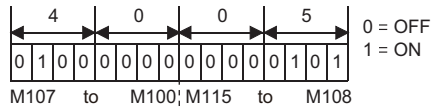

Write data 3 in double word units

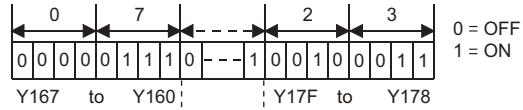

Write data 2 in word units

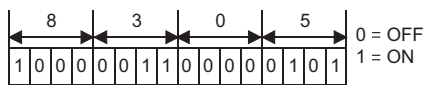

Write data 4 in double word units

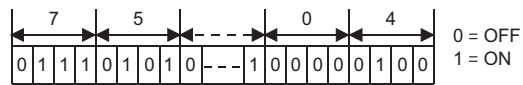

Random write in bit units (test) (command: 1402)

Write values to devices in bit units. It can be specified with discontinuous device number.



When accessing any of the following devices, use the device extension specification (subcommand: 008□).

- Link direct device
- Module access device
- CPU buffer memory access device

For the message format for device extension specification, refer to the following section.

Page 438 Read/Write by Device Extension Specification

Message format

The following shows the message format of the request data and response data of the command.

Request data

Command	Subcommand	Number of bit access points (n points)	Device (first point)	Set/reset (first point)	...	Device (nth point)	Set/reset (nth point)
---------	------------	--	----------------------	-------------------------	-----	--------------------	-----------------------

Response data

There is no response data for this command.

Request data

Command

Frame	ASCII code	Binary code										
4C/3C/4E/3E frame	<table border="1"> <tr><td>1</td><td>4</td><td>0</td><td>2</td></tr> <tr><td>31H</td><td>34H</td><td>30H</td><td>32H</td></tr> </table>	1	4	0	2	31H	34H	30H	32H	<table border="1"> <tr><td>02H</td><td>14H</td></tr> </table>	02H	14H
1	4	0	2									
31H	34H	30H	32H									
02H	14H											
2C frame	<table border="1"> <tr><td>6</td></tr> <tr><td>36H</td></tr> </table>	6	36H	—								
6												
36H												

Subcommand

Type	ASCII code	Binary code										
For MELSEC-Q/L series	<table border="1"> <tr><td>0</td><td>0</td><td>0</td><td>1</td></tr> <tr><td>30H</td><td>30H</td><td>30H</td><td>31H</td></tr> </table>	0	0	0	1	30H	30H	30H	31H	<table border="1"> <tr><td>01H</td><td>00H</td></tr> </table>	01H	00H
0	0	0	1									
30H	30H	30H	31H									
01H	00H											
For MELSEC iQ-R series	<table border="1"> <tr><td>0</td><td>0</td><td>0</td><td>3</td></tr> <tr><td>30H</td><td>30H</td><td>30H</td><td>33H</td></tr> </table>	0	0	0	3	30H	30H	30H	33H	<table border="1"> <tr><td>03H</td><td>00H</td></tr> </table>	03H	00H
0	0	0	3									
30H	30H	30H	33H									
03H	00H											

For 2C frame, the specification is not required. Functions and specification methods are equivalent to the subcommands for MELSEC-Q/L series.

Number of bit access points

Specify the number of device points to be written within the following range. (Page 70 Number of device points)

Access target	Range
MELSEC iQ-R series module (subcommand: 0001) MELSEC iQ-L series module (subcommand: 0001) MELSEC-Q/L series module (subcommand: 0001)	1 to 188 points
MELSEC iQ-R series module (subcommand: 0003, 008□) MELSEC iQ-L series module (subcommand: 0081) MELSEC-Q/L series module (subcommand: 0081) MELSEC-QnA series module Module on other station via MELSEC-QnA series network module	1 to 94 points

Access target	Range
MELSEC-A series module	1 to 20 points

■Device

Specify a device to be written. (☞ Page 65 Devices)

Specify a bit device.

■Set/reset

Specify the ON/OFF status of bit devices. (☞ Page 78 Set/reset)

Point

The number of points equivalent to the specified "Number of bit access points" is specified for "Device" and "Set/reset", respectively.

Communication example

Turn M50 OFF, and turn Y2F ON. (Subcommand: for MELSEC-Q/L series)

■Data communication in ASCII code

(Request data)

Subcommand				Number of bit access points	Device code	Device number	Set/reset	Device code	Device number	Set/reset
1	4	0	2	0	2	M *	0 0 0 0 5 0	0 0	Y *	0 0 0 0 2 F 0 1
31H	34H	30H	32H	30H	32H	4DH, 2AH	30H, 30H, 30H, 30H, 35H, 30H	30H, 30H	59H, 2AH	30H, 30H, 30H, 30H, 32H, 46H, 30H, 31H

■Data communication in binary code

(Request data)

Subcommand	Number of bit access points	Device code	Set/reset	Device code	Set/reset
02H, 14H	01H, 00H	02H	32H, 00H, 00H	90H, 00H	2FH, 00H, 00H
					9DH, 01H

8.4 Batch Read and Write Multiple Blocks

Read or write values for specified multiple blocks by handling consecutive devices as one block.

Batch read multiple blocks (command: 0406)

Read values for specified multiple blocks by handling consecutive word devices or bit devices as one block. Each block can be specified with discontinuous device numbers.

Restriction

When communicating with a Universal model QCPU or an LCPU, if other than "Specify service process execution counts" is selected for "Service Processing Setting" of the CPU module, data separation may occur. To avoid data separation, select "Specify service process execution counts".

Point

When accessing any of the following devices, use the device extension specification (subcommand: 008□).

- Link direct device
- Module access device
- CPU buffer memory access device

For the message format for device extension specification, refer to the following section.

☞ Page 438 Read/Write by Device Extension Specification

Message format

The following shows the message format of the request data and response data of the command.

Request data

Command	Subcommand	Number of word device blocks (m points)	Number of bit device blocks (n points)	Block of word device (first point)	...	Block of word device (mth point)
				Block of bit device (first point)	...	Block of bit device (nth point)

Response data

The value of read device is stored in hexadecimal. The data order differs between ASCII code or binary code. (☞ Page 72 Read data, write data)

Data for the number of word device blocks			Data for the number of bit device blocks		
Word device			Bit device		
Data in the first block	...	Data in the mth block	Data in the first block	...	Data in the nth block

Data specified by request data

Command

ASCII code	Binary code										
<table border="1"> <tr> <td>0</td> <td>4</td> <td>0</td> <td>6</td> </tr> <tr> <td>30H</td> <td>34H</td> <td>30H</td> <td>36H</td> </tr> </table>	0	4	0	6	30H	34H	30H	36H	<table border="1"> <tr> <td>06H</td> <td>04H</td> </tr> </table>	06H	04H
0	4	0	6								
30H	34H	30H	36H								
06H	04H										

Subcommand

Type	ASCII code	Binary code										
For MELSEC-Q/L series	<table border="1"> <tr> <td>0</td> <td>0</td> <td>0</td> <td>0</td> </tr> <tr> <td>30H</td> <td>30H</td> <td>30H</td> <td>30H</td> </tr> </table>	0	0	0	0	30H	30H	30H	30H	<table border="1"> <tr> <td>00H</td> <td>00H</td> </tr> </table>	00H	00H
0	0	0	0									
30H	30H	30H	30H									
00H	00H											
For MELSEC iQ-R series	<table border="1"> <tr> <td>0</td> <td>0</td> <td>0</td> <td>2</td> </tr> <tr> <td>30H</td> <td>30H</td> <td>30H</td> <td>32H</td> </tr> </table>	0	0	0	2	30H	30H	30H	32H	<table border="1"> <tr> <td>02H</td> <td>00H</td> </tr> </table>	02H	00H
0	0	0	2									
30H	30H	30H	32H									
02H	00H											

Number of word device blocks, number of bit device blocks

Specify the number of device blocks to be read in hexadecimal. ( Page 71 Number of blocks)

Specify the total number of each block within the following range.

Access target	Range
MELSEC iQ-R series module (subcommand: 0000) MELSEC iQ-L series module (subcommand: 0000) MELSEC-Q/L series module (subcommand: 0000) MELSEC-QnA series module	1≤Number of word device blocks + Number of bit device blocks≤120 points
MELSEC iQ-R series module (subcommand: 0002, 008□) MELSEC iQ-L series module (subcommand: 0080) MELSEC-Q/L series module (subcommand: 0080)	1≤Number of word device blocks + Number of bit device blocks≤60 points

Block of word device, block of bit device



Specify the device to be read by handling consecutive devices as one block.

Point

Specify the block with the number of points equivalent to the specified "Number of word device blocks" and "Number of bit device blocks", respectively. When '0' is specified, this specification is not required.

Specify the following items for each block.

Block (1 point)	
Head device	Number of device points

- Device: Specify the head device of the consecutive devices. ( Page 65 Devices)
- Number of device points: Specify the number of device points to be read. ( Page 70 Number of device points)

Specify the total number of device points for each block within the range of 1 to 960.

Word device is 1-word per one point, and bit device is 16-bit for one point.

Point

Use a bit device block when the contact and coil for the following devices are specified.

- Timer
- Retentive timer
- Counter

Restriction

The following devices cannot be specified.

- Long timer (contact: LTS, coil: LTC, current value: LTN)
- Long retentive timer (contact: LSTS, coil: LSTC, current value: LSTN)
- Long counter (contact: LCS, coil: LCC, current value: LCN)
- Long index register (LZ)

 Page 69 Considerations when accessing long timer, long retentive timer, or long counter

 Page 69 Considerations when accessing long index register

Communication example

Read values from device as follows. (Subcommand: for MELSEC-Q/L series)

Item	Content to be read
Word device	Block 1: D0 to D3 (4 points) Block 2: W100 to W107 (8 points)
Bit device	Block 1: M0 to M31 (2 points) Block 2: M128 to M159 (2 points) Block 3: B100 to B12F (3 points)

■Data communication in ASCII code

(Request data)

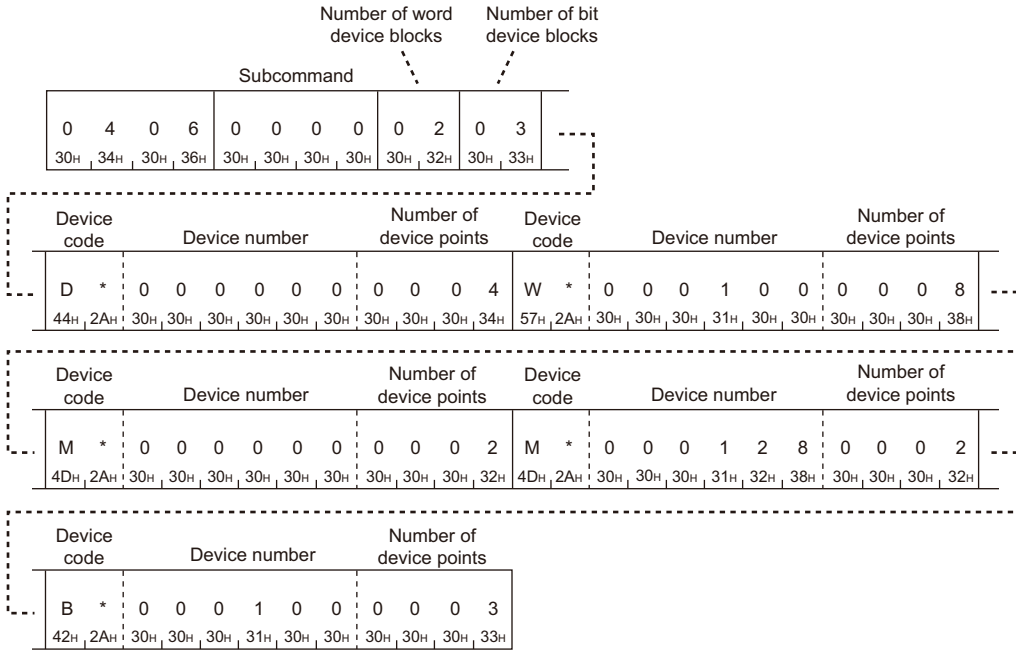

(Response data)

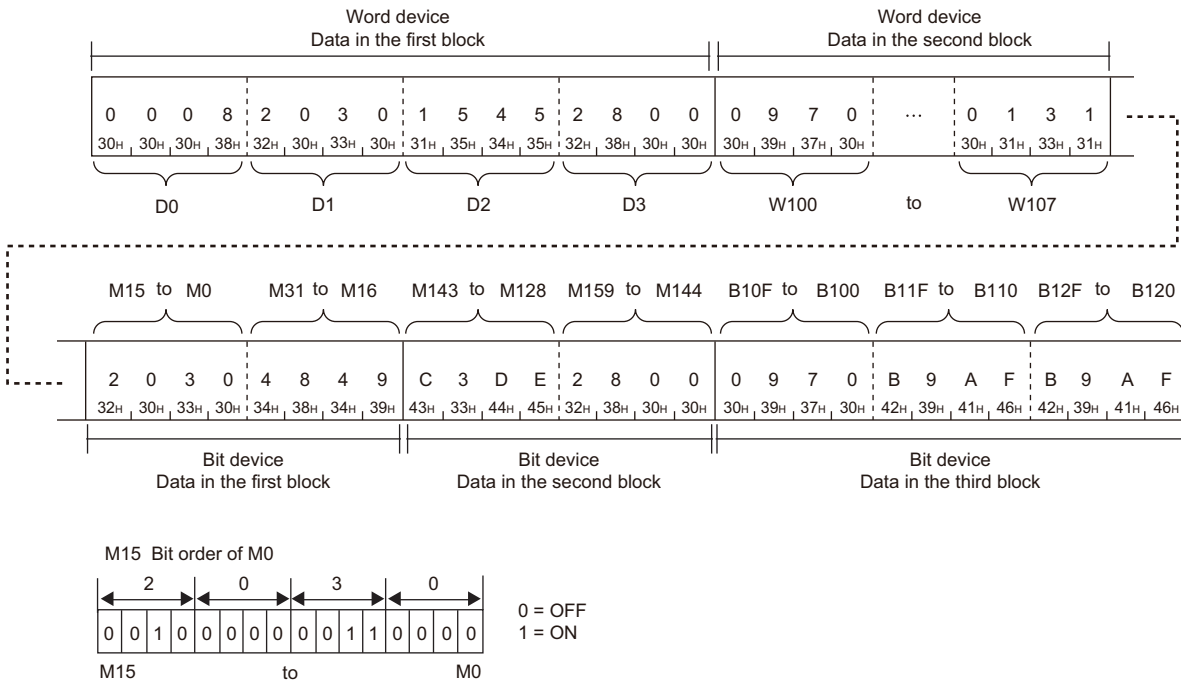

■Data communication in binary code

(Request data)

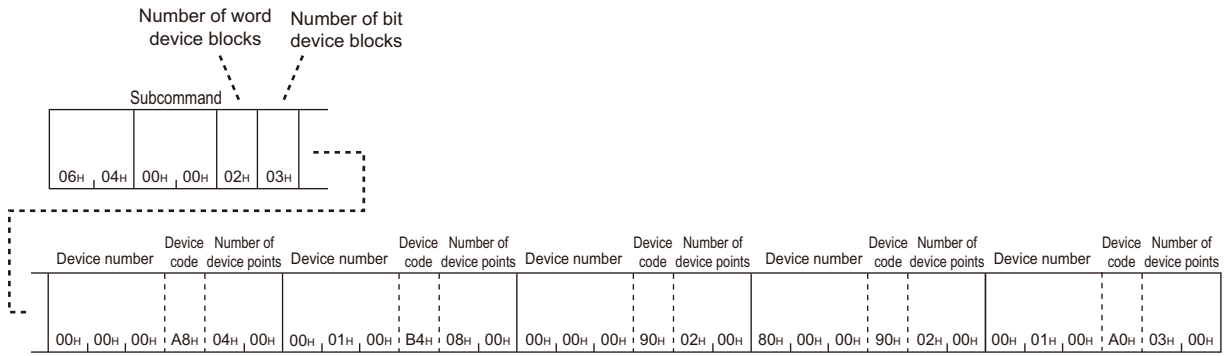

(Response data)

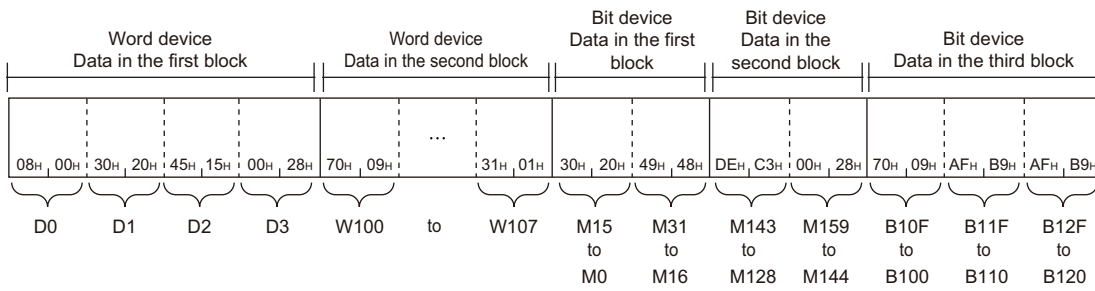

M15 Bit order of M0

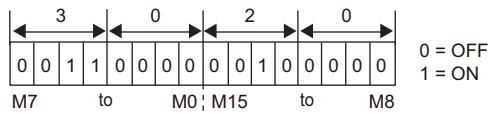

Batch write multiple blocks (command: 1406)

Write values for specified multiple blocks by handling consecutive word devices or bit devices as one block. Each block can be specified with discontinuous device numbers.

Restriction

When communicating with a Universal model QCPU or an LCPU, if other than "Specify service process execution counts" is selected for "Service Processing Setting" of the CPU module, data separation may occur. To avoid data separation, select "Specify service process execution counts".

Point

When accessing any of the following devices, use the device extension specification (subcommand: 008□).

- Link direct device
- Module access device
- CPU buffer memory access device

For the message format for device extension specification, refer to the following section.

☞ Page 438 Read/Write by Device Extension Specification

Message format

The following shows the message format of the request data and response data of the command.

Request data

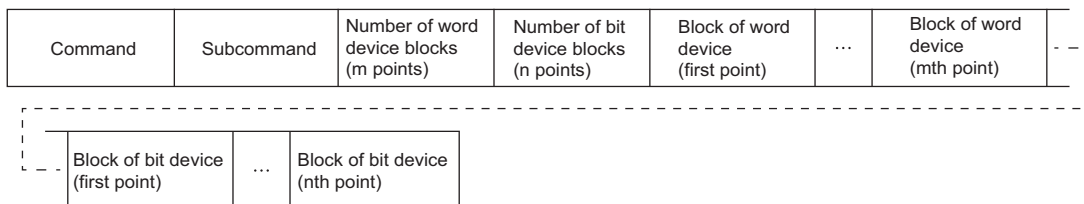

Response data

There is no response data for this command.

Data specified by request data

Command

ASCII code	Binary code										
<table border="1"> <tr><td>1</td><td>4</td><td>0</td><td>6</td></tr> <tr><td>31H</td><td>34H</td><td>30H</td><td>36H</td></tr> </table>	1	4	0	6	31H	34H	30H	36H	<table border="1"> <tr><td>06H</td><td>14H</td></tr> </table>	06H	14H
1	4	0	6								
31H	34H	30H	36H								
06H	14H										

Subcommand

Type	ASCII code	Binary code										
For MELSEC-Q/L series	<table border="1"> <tr><td>0</td><td>0</td><td>0</td><td>0</td></tr> <tr><td>30H</td><td>30H</td><td>30H</td><td>30H</td></tr> </table>	0	0	0	0	30H	30H	30H	30H	<table border="1"> <tr><td>00H</td><td>00H</td></tr> </table>	00H	00H
0	0	0	0									
30H	30H	30H	30H									
00H	00H											
For MELSEC iQ-R series	<table border="1"> <tr><td>0</td><td>0</td><td>0</td><td>2</td></tr> <tr><td>30H</td><td>30H</td><td>30H</td><td>32H</td></tr> </table>	0	0	0	2	30H	30H	30H	32H	<table border="1"> <tr><td>02H</td><td>00H</td></tr> </table>	02H	00H
0	0	0	2									
30H	30H	30H	32H									
02H	00H											

Number of word device blocks, number of bit device blocks

Specify the number of device blocks to be written in hexadecimal. (☞ Page 71 Number of blocks)

Specify the total number of each block within the following range.

Access target	Range
MELSEC iQ-R series module (subcommand: 0000) MELSEC iQ-L series module (subcommand: 0000) MELSEC-Q/L series module (subcommand: 0000) MELSEC-QnA series module	$1 \leq \text{Number of word device blocks} + \text{Number of bit device blocks} \leq 120$ points
MELSEC iQ-R series module (subcommand: 0002, 008□) MELSEC iQ-L series module (subcommand: 0080) MELSEC-Q/L series module (subcommand: 0080)	$1 \leq \text{Number of word device blocks} + \text{Number of bit device blocks} \leq 60$ points

■Block of word device, Block of bit device

Specify the device to be written by handling consecutive devices as one block.



Specify the block with the number of points equivalent to the specified "Number of word device blocks" and "Number of bit device blocks", respectively. When '0' is specified, this specification is not required.

Specify the following items for each block.

Block (1 point)		
Head device	Number of device points	Write data

- Device: Specify the head device of the consecutive devices. (Page 65 Devices)
- Number of device points: Specify the number of device points to be written. (Page 70 Number of device points)
- Write data: Specify the data to be written for the number of device points in hexadecimal. (Page 72 Read data, write data)

Specify the number of device points within the following range.

Subcommand	Range
When using MELSEC-Q/L series (0000, 0080)	$1 \leq (\text{Total number of each block} \times 4) + (\text{Total number of device}) \leq 960$ points
When using MELSEC iQ-R series (0002, 0082)	$1 \leq (\text{Total number of each block} \times 9) + (\text{Total number of device}) \leq 960$ points

Word device is 1-word per one point, and bit device is 16-bit for one point.



Use a bit device block when the contact and coil for the following devices are specified.

- Timer
- Retentive timer
- Counter



The following devices cannot be specified.

- Long timer (contact: LTS, coil: LTC, current value: LTN)
- Long retentive timer (contact: LSTS, coil: LSTC, current value: LSTN)
- Long counter (contact: LCS, coil: LCC, current value: LCN)
- Long index register (LZ)

Page 69 Considerations when accessing long timer, long retentive timer, or long counter

Page 69 Considerations when accessing long index register

■Data communication in binary code

(Request data)

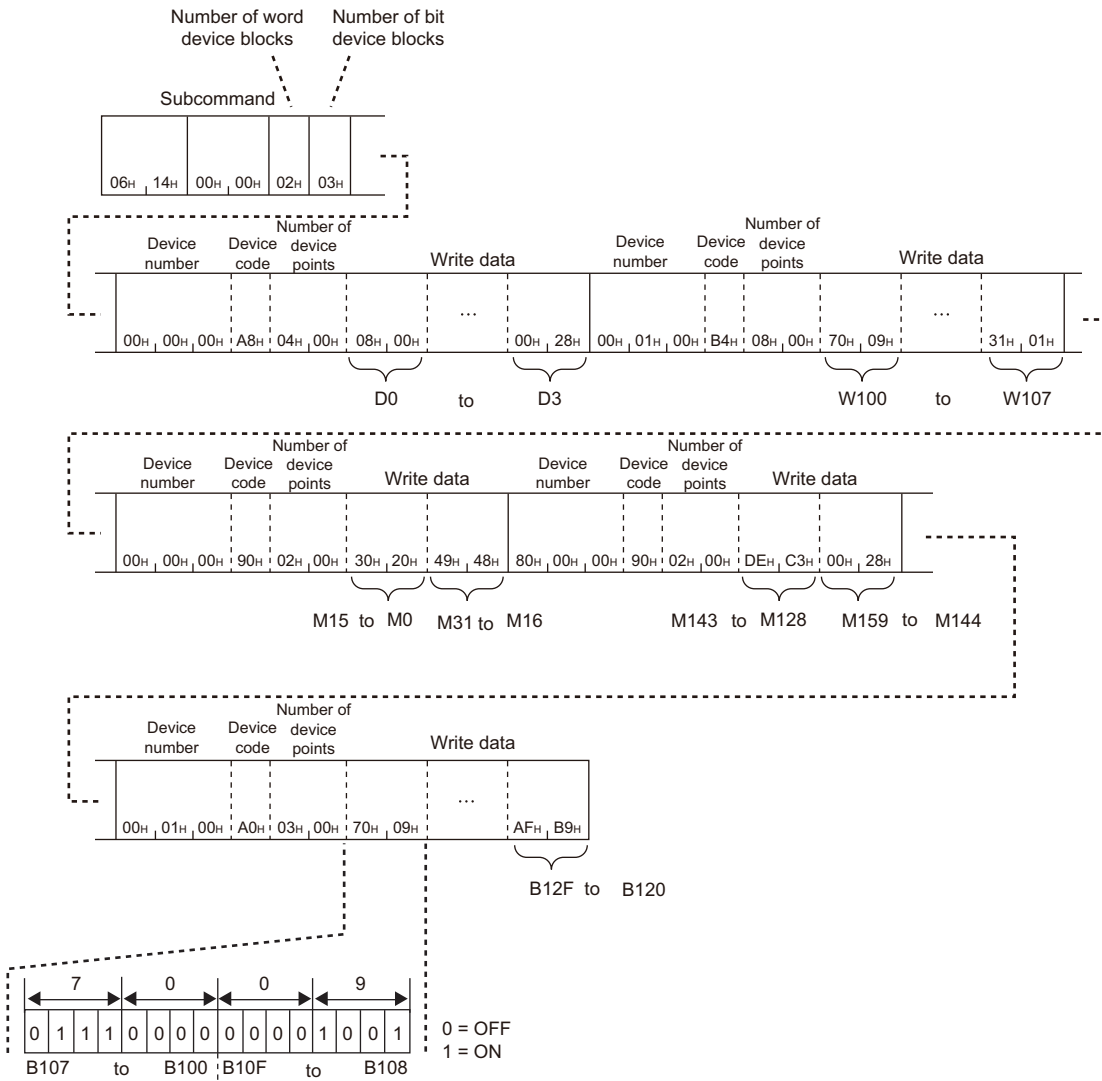

8.5 Device Memory Monitor

Read the registered device data, and monitor it.

Monitoring procedure

The following shows the procedure to monitor devices.

1. Registration of monitor device

Register a device to be read. (☞ Page 120 Register monitor data (command: 0801))

2. Execution of monitor

Read values from a registered device. (☞ Page 121 Monitor (command: 0802))

3. Registration of monitor device

Reregister a device when a device to be read is changed. (☞ Page 120 Register monitor data (command: 0801))

Point 

- Monitoring with multiple conditions to the device memory of the same CPU module cannot be performed at the same time. If monitor (command: 0802) is executed while monitor with other conditions is being performed, the command is completed abnormally.
 - Register devices to be read with the 'register monitor data' (command: 0801) before executing the 'monitor' (command: 0802). If the 'monitor' (command: 0802) is executed without the registration, the command is completed abnormally.
 - When the access target module is restarted, the registered content is deleted. Register the devices to be read again with the 'register monitor data' (command: 0801).
-

Register monitor data (command: 0801)

Register devices to be monitored.

Message format

The following shows the message format of the request data and response data of the command.

Request data

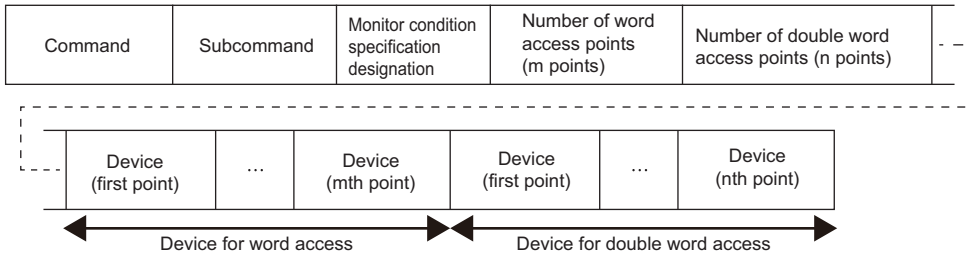

Response data

There is no response data for this command.

Data specified by request data

Command

Frame	ASCII code	Binary code										
4C/3C/4E/3E frame	<table border="1"> <tr> <td>0</td> <td>8</td> <td>0</td> <td>1</td> </tr> <tr> <td>30H</td> <td>38H</td> <td>30H</td> <td>31H</td> </tr> </table>	0	8	0	1	30H	38H	30H	31H	<table border="1"> <tr> <td>01H</td> <td>08H</td> </tr> </table>	01H	08H
0	8	0	1									
30H	38H	30H	31H									
01H	08H											
2C frame	<table border="1"> <tr> <td>8</td> </tr> <tr> <td>38H</td> </tr> </table>	8	38H	—								
8												
38H												

The data other than commands is the same as the data specified by 'random read in word units' (command: 0403).

☞ Page 97 Random read in word units (command: 0403)

Monitor (command: 0802)

Read value of registered device.

Message format

The following shows the message format of the request data and response data of the command.

Request data

Command	Subcommand
---------	------------

Response data

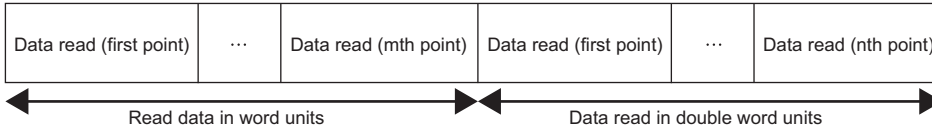

The value of read device is stored in word units and in double word units. The data order differs between ASCII code or binary code. (Page 72 Read data, write data)

Data specified by request data

Command

Frame	ASCII code	Binary code										
4C/3C/4E/3E frame	<table border="1"> <tr> <td>0</td> <td>8</td> <td>0</td> <td>2</td> </tr> <tr> <td>30H</td> <td>38H</td> <td>30H</td> <td>32H</td> </tr> </table>	0	8	0	2	30H	38H	30H	32H	<table border="1"> <tr> <td>02H</td> <td>08H</td> </tr> </table>	02H	08H
0	8	0	2									
30H	38H	30H	32H									
02H	08H											
2C frame	<table border="1"> <tr> <td>9</td> </tr> <tr> <td>39H</td> </tr> </table>	9	39H	—								
9												
39H												

Subcommand

ASCII code	Binary code										
<table border="1"> <tr> <td>0</td> <td>0</td> <td>0</td> <td>0</td> </tr> <tr> <td>30H</td> <td>30H</td> <td>30H</td> <td>30H</td> </tr> </table>	0	0	0	0	30H	30H	30H	30H	<table border="1"> <tr> <td>00H</td> <td>00H</td> </tr> </table>	00H	00H
0	0	0	0								
30H	30H	30H	30H								
00H	00H										

For 2C frame, the specification is not required. Functions and specification methods are equivalent to the subcommands for MELSEC-Q/L series.

Communication example

Read the following devices registered by the 'register monitor data' (command: 0801).

- Word access: D0, T0, M100 to M115, X20 to X2F
- Double word access: D1500 to D1501, Y160 to Y17F, M1111 to M1142

D0 = 6549 (1995H), T0 = 4610 (1202H), D1500 = 20302 (4F4EH), D1501 = 19540 (4C54H) are stored.

■Data communication in ASCII code

(Request data)

0	8	0	2	0	0	0	0
30H	38H	30H	32H	30H	30H	30H	30H

(Response data)

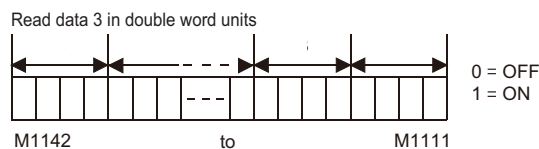
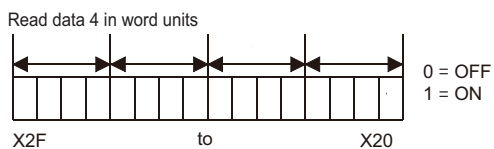
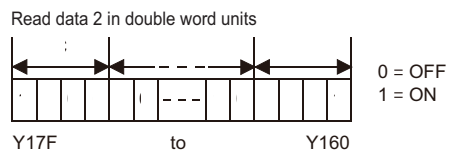
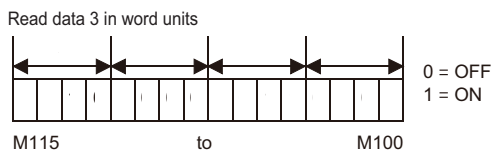
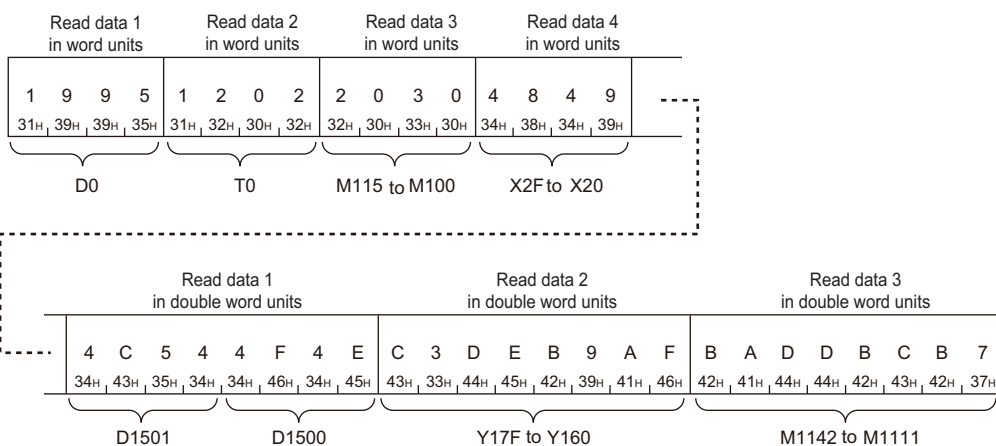

■ Data communication in binary code

(Request data)

02H, 08H	00H, 00H
----------	----------

(Response data)

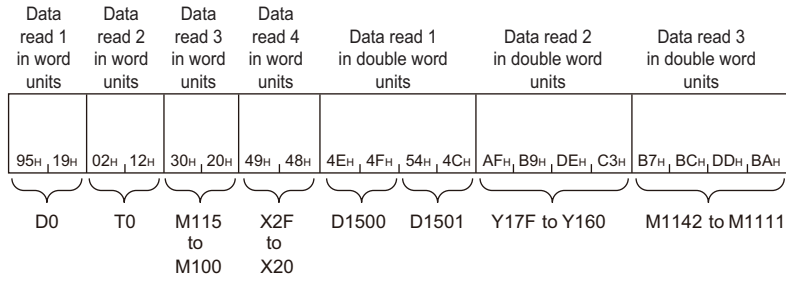

Data read 3 in word units

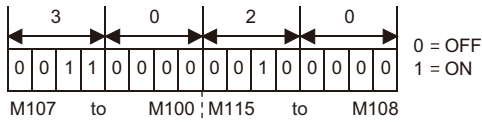

Data read 2 in double word units

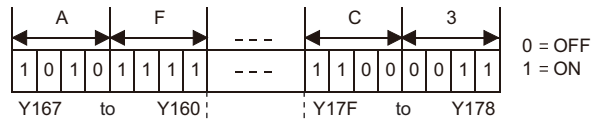

Data read 4 in word units

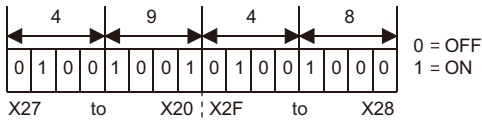

Data read 3 in double word units

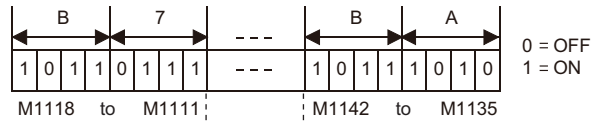

9 LABEL ACCESS

This section explains the commands to read and write devices using the standard global label of GX Works3. The commands can be used when the connected station and request target is MELSEC iQ-R series module.

Restriction

- Local labels and module labels cannot be accessed.
- The global labels set with GX Works2 cannot be accessed.
- Safety global labels, safety local labels, and standard/safety shared global labels of the safety CPU cannot be accessed.
- Enable "Access from External Device" with the global label setting editor of GX Works3 at the time of label access. (Disabled by default.)

9.1 Data to be Specified in Commands

This section explains the contents and specification methods for data items which are set in each command related to label access.

Labels

Specify the global label name to be accessed.

The "Label name" is specified by variable length. Specify the length of character string by "Label name length". (Null is unnecessary at the end of a label name character string.)

ASCII code	Binary code												
<table border="1"> <tr> <td>Label name length</td> <td>Label name</td> </tr> <tr> <td><input type="text"/></td> <td><input type="text"/></td> </tr> <tr> <td>(4 digits)</td> <td>(Variable length)</td> </tr> </table>	Label name length	Label name	<input type="text"/>	<input type="text"/>	(4 digits)	(Variable length)	<table border="1"> <tr> <td>Label name length</td> <td>Label name</td> </tr> <tr> <td><input type="text"/></td> <td><input type="text"/></td> </tr> <tr> <td>(2 bytes)</td> <td>(Variable length)</td> </tr> </table>	Label name length	Label name	<input type="text"/>	<input type="text"/>	(2 bytes)	(Variable length)
Label name length	Label name												
<input type="text"/>	<input type="text"/>												
(4 digits)	(Variable length)												
Label name length	Label name												
<input type="text"/>	<input type="text"/>												
(2 bytes)	(Variable length)												

Label name length

Specify the number of characters of a label name.

■Data communication in ASCII code

Convert the numerical value to 4-digit ASCII code (hexadecimal), and send it from the upper digits.

■Data communication in binary code

Send 2-byte^{*1} numerical values from lower byte (L: bits 0 to 7).

*1 For C24, the additional code may be added. ( Page 35 Additional code (10H))

Ex.

When the number of characters is three.

ASCII code	Binary code										
<table border="1"> <tr> <td>0</td> <td>0</td> <td>0</td> <td>3</td> </tr> <tr> <td>30H</td> <td>30H</td> <td>30H</td> <td>33H</td> </tr> </table>	0	0	0	3	30H	30H	30H	33H	<table border="1"> <tr> <td>03H</td> <td>00H</td> </tr> </table>	03H	00H
0	0	0	3								
30H	30H	30H	33H								
03H	00H										

Label name

Specify the character string of a label name.

■Data communication in ASCII code

Convert the numerical value of UTF-16, which indicates a global label name, to ASCII code (hexadecimal), and send it from the upper digits.

■Data communication in binary code

Send the numerical value of UTF-16, which indicates a global label name from lower byte (L: bit 0 to 7).

Ex.

When 'A'

(UTF-16: 'A'= 0041)

ASCII code	Binary code										
<table border="1"> <tr> <td>0</td> <td>0</td> <td>4</td> <td>1</td> </tr> <tr> <td>30H</td> <td>30H</td> <td>34H</td> <td>41H</td> </tr> </table>	0	0	4	1	30H	30H	34H	41H	<table border="1"> <tr> <td>41H</td> <td>00H</td> </tr> </table>	41H	00H
0	0	4	1								
30H	30H	34H	41H								
41H	00H										

Labels of the simple data type

Specify the label name as it is.

Bit specification (example: Lbl.3) and digit specification (example: K4Lb1) cannot be used.

Ex.

When the label name is 'Lb1'

Item	Value of code corresponding to character		
	L	b	l
File name	L	b	l
UTF-16	004C	0062	006C
ASCII code	30303443	30303632	30303643
Binary code	4C00	6200	6C00

Array type label

Specify the element number with square brackets '['] after label name. (UTF-16F: '[' = 005B, ']' = 005D)

The element name of array cannot be specified in the square bracket. Specify a numerical value of the element number.

Ex.

When the element number of array name 'Lb1' is '20'

- Label name length: 7H
- Label name character string: Lbl[20]

Item	Value of code corresponding to character						
	L	b	l	[2	0]
File name	L	b	l	[2	0]
UTF-16	004C	0062	006C	005B	0032	0030	005D
ASCII code	30303443	30303632	30303643	30303542	30303332	30303330	30303544
Binary code	4C00	6200	6C00	5B00	3200	3000	5D00

■Decimal/hexadecimal notation of element numbers

An element number can be specified in decimal or hexadecimal.

The element numbers can be distinguished by attaching 'k' or 'h' in front of the numerical value. (UTF-16: 'k'= 006B, 'h'= 0068)

When only numerical value is specified, it will be handled as a decimal number.

- Decimal: Numerical value only, or attach 'k' in front of the numerical value. (Example: Lbl[10], Lbl[k10])
- Hexadecimal: Attach 'h' in front of the numerical value. (Example: Lbl[h10])

■Two-dimensional array, three-dimensional array,

Up to three-dimensional arrays can be specified.

For two-dimension and three-dimension array, specify an element number by separating with comma (',') in a square bracket. (UTF-16: ','= 002C)

Ex.

When the element numbers are 2, 1, 3 of three-dimensional array of array name 'Lbl'

- Label name length: AH
- Label name character string: Lbl[2,1,3]

Item	Value of code corresponding to character									
File name	L	b	l	[2	,	1	,	3]
UTF-16	004C	0062	006C	005B	0032	002C	0031	002C	0033	005D
ASCII code	30303443	30303632	30303643	30303542	30303332	30303243	30303331	30303243	30303333	30303544
Binary code	4C00	6200	6C00	5B00	3200	2C00	3100	2C00	3300	5D00

Restriction

Two-dimensional array and three-dimensional array bit type labels cannot be specified with the 'batch read/write array type labels' (command: 041A, 141A).

Structure labels

Specify the structure labels by attaching period '.' as an element name. (UTF-16: '.' = 002E)

Specify the element name for the end member. Only specifying a structure name cannot set the whole structure as a target.

Ex.

For the element name 'Data' of the structure name 'Str1'

- Label name length: 9H
- Label name character string: Str1.Data

Item	Value of code corresponding to character								
File name	S	t	r	1	.	D	a	t	a
UTF-16	0053	0074	0072	0031	002E	0044	0061	0074	0061
ASCII code	30303533	30303734	30303732	30303331	30303245	30303434	30303631	30303734	30303631
Binary code	5300	7400	7200	3100	2E00	4400	6100	7400	6100

■Array member

When the structure member is an array type, specify the array element number with square bracket '[']' as is the case in array type label.

Ex.

When the element name 'Data' of structure name 'Str1', and 'Data' is a two-dimensional array element.

- Label name length: EH
- Label name character string: Str1.Data[1,3]

Item	Value of code corresponding to character													
File name	S	t	r	1	.	D	a	t	a	[1	,	3]
UTF-16	0053	0074	0072	0031	002E	0044	0061	0074	0061	005B	0031	002C	0033	005D
ASCII code	3030	3030	3030	3030	3030	3030	3030	3030	3030	3030	3030	3030	3030	3030
	3533	3734	3732	3331	3245	3434	3631	3734	3631	3542	3331	3243	3333	3544
Binary code	5300	7400	7200	3100	2E00	4400	6100	7400	6100	5B00	3100	2C00	3300	5D00

■ Structure member

When the structure member is a structure type, specify the element name by delimiting with period '.' up to the end member.

Ex.

When specifying the member, 'memberB1', of the structure member name 'memberA3' for the structure type label name 'LabelA'

- Label name character string: LabelA.memberA3.memberB1

Restriction 

When arbitrary device is assigned, the structure type label with structure type members cannot be specified.

Timer type label, counter type label

The labels of the following data types are handled as a structure with a contact, coil, and current value for its element.

- Timer
- Retentive timer
- Counter
- Long timer
- Long retentive timer
- Long counter

Specify the following element name with adding a period '.'. (UTF-16: '.' = 002E)

Item	Element name	Example when a label name is 'Lb1'
Contact	S	Lb1.S
Coil	C	Lb1.C
Current value	N	Lb1.N

Ex.

For the contact of timer type label name 'Lb1'

- Label name length: 6H
- Label name character string: Lb1.S

Item	Value of code corresponding to character					
Label name	L	b	l	1	.	S
UTF-16	004C	0062	006C	0031	002E	0053
ASCII code	30303443	30303632	30303643	30303331	30303245	30303533
Binary code	4C00	6200	6C00	3100	2E00	5300

Restriction 

The labels of which data type is timer, counter, retentive timer, long timer, long counter, or long retentive timer cannot be specified with the 'batch read/write array type labels' (command: 041A, 141A).

Abbreviation specification of label

Abbreviation specification can be used when specifying a structure type label as an access target.

When a label name or a structure member name is specified by the abbreviation specification, the character string specified as a "label name" can be simplified using "%n" (n: offset value).

Ex.

When a structure type label name 'LabelA' and its structure member name 'memberA3' is specified as abbreviation specification, they can be abbreviated as follows.

(LabelA= %1, memberA3= %2)

Actual label name	Abbreviated label name
LabelA.memberA1	%1.memberA1
LabelA.memberA2	%1.memberA2
LabelA.memberA3.memberB1	%1.%2.memberB1
LabelA.memberA3.memberB2	%1.%2.memberB2

When do not abbreviate labels

Specify '0'.

ASCII code	Binary code										
<table border="1"> <tr> <td>0</td> <td>0</td> <td>0</td> <td>0</td> </tr> <tr> <td>30H</td> <td>30H</td> <td>30H</td> <td>30H</td> </tr> </table>	0	0	0	0	30H	30H	30H	30H	<table border="1"> <tr> <td>00H</td> <td>00H</td> </tr> </table>	00H	00H
0	0	0	0								
30H	30H	30H	30H								
00H	00H										

When abbreviate labels

Specify the points to be specified and label name.

Label names can be abbreviated ('%1' to '%n') as an offset value (1 to n) in the specified order.

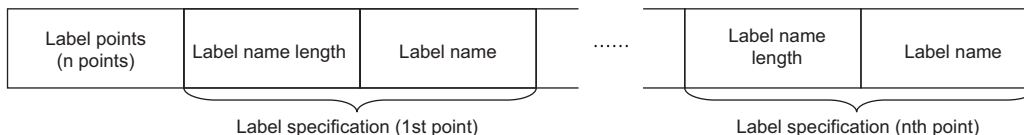

The character strings that include a dot (.) cannot be abbreviated. Abbreviate character string in a label name or member name unit.

The label name and member name of the array type cannot be abbreviated.

Ex.

The example that cannot be abbreviated is as follows:

Actual label name	String that cannot be abbreviated	String that can be abbreviated
LabelA.memberA3.memberB1	"LabelA.memberA3.memberB1", "LabelA.memberA3"	'LabelA', 'memberA3', 'memberB1'
LabelA.memberA4[1].memberB1	"memberA4", "memberA4[1]"	"LabelA", "memberB1"

Label points

Specify the label points which abbreviate a label names by abbreviation specification. (📖 Page 130 Points)

Label specification

Specify the following items for each label for the points specified by label points. (📖 Page 124 Labels)

- Label name length: Specify the number of characters of a label name or structure member name.
- Label name: Specify a global label name or a structure member name.

Ex.

When a structure type label name 'LabelA' and its structure member name 'memberA3' is specified as abbreviation specification

(1) LabelA

Item	Value of code corresponding to character					
Label name	L	a	b	e	l	A
UTF-16	004C	0061	0062	0065	006C	0041
ASCII code	30303443	30303631	30303632	30303635	30303643	30303431
Binary code	4C00	6100	6200	6500	6C00	4100

(2) memberA3

Item	Value of code corresponding to character							
Label name	m	e	m	b	e	r	A	3
UTF-16	006D	0065	006D	0062	0065	0072	0041	0033
ASCII code	30303644	30303635	30303644	30303632	30303635	30303732	30303431	30303333
Binary code	6D00	6500	6D00	6200	6500	7200	4100	3300

■Data communication in ASCII code

Label points	Label name length	Label name	Label name length	Label name
0 0 0 2 30H 30H 30H 32H	0 0 0 6 30H 30H 30H 36H	(1)	0 0 0 8 30H 30H 30H 38H	(2)
Label specification (1st point)			Label specification (2nd point)	

In the figure (1) and (2), set the value of "ASCII code" indicated in the table of "Value of code corresponding to character" of each label name.

■Data communication in binary code

Label points	Label name length	Label name	Label name length	Label name
02H 00H	06H 00H	(1)	08H 00H	(2)
Label specification (1st point)			Label specification (2nd point)	

In the figure (1) and (2), set the value of "Binary code" indicated in the table of "Value of code corresponding to character" of each label name.

Points

Specify the number of the data to be read or written.

Setting method

The setting method of each item to specify the number of points is common.

Since data to be transmitted is 1920 bytes at maximum, the maximum number of points which can be specified varies depending on the label name length contained in the data.

■Data communication in ASCII code

Convert the numerical value to 4-digit ASCII code (hexadecimal), and send it from the upper digits.

■Data communication in binary code

Send 2-byte^{*1} numerical values from lower byte (L: bits 0 to 7).

*1 For C24, the additional code may be added. (☞ Page 35 Additional code (10H))

Ex.

For 3 points

ASCII code	Binary code										
<table border="1"><tr><td>0</td><td>0</td><td>0</td><td>3</td></tr><tr><td>30H</td><td>30H</td><td>30H</td><td>33H</td></tr></table>	0	0	0	3	30H	30H	30H	33H	<table border="1"><tr><td>03H</td><td>00H</td></tr></table>	03H	00H
0	0	0	3								
30H	30H	30H	33H								
03H	00H										

Array points

Specify the number of arrays.

Label points

Specify the number of labels.

Data type ID

The data type of the read label is stored.

When writing data, the data type ID is not specified. The specified Follow the data type of the specified label.

The value of data type ID of each data type is shown below.

Data type	Data type ID (decimal)	Setting value (hexadecimal)	
Bit	1	01H	
Word [Unsigned]/Bit String [16-bit]	2	02H	
Double Word [Unsigned]/Bit String [32-bit]	3	03H	
Word [Signed]	4	04H	
Double Word [Signed]	5	05H	
FLOAT [Single Precision]	6	06H	
FLOAT [Double Precision]	7	07H	
Time	8	08H	
String	9	09H	
String [Unicode]	10	0AH	
Pointer	Cannot be specified.		
Timer Counter Retentive timer	Contact Coil	1	01H
	Current value	2	02H
Long timer Long counter Long retentive timer	Contact Coil	1	01H
	Current value	3	03H

For an array type label and a structure type label, the data type of the element from which value is read is stored.

Setting method

■Data communication in ASCII code

Convert the numerical value to 2-digit ASCII code (hexadecimal), and send it from the upper digits.

■Data communication in binary code

Send a 1-byte numerical value.

Ex.

Double Word [Signed]

ASCII code	Binary code
<div style="border: 1px solid black; padding: 5px; display: inline-block;"> 0 5 30H , 35H </div>	<div style="border: 1px solid black; padding: 5px; display: inline-block;"> 05H </div>

Data length, unit specification

Specify the length of data to be read/written.

Unit specification

Specify the units of data length when reading/writing data from/to array in batch.

■Bit specification

The value of data length is handled as the number of bits.

Specify this when the data type of the label is bit.

ASCII code	Binary code										
<table border="1"> <tr><td>0</td><td>0</td><td>0</td><td>0</td></tr> <tr><td>30H</td><td>30H</td><td>30H</td><td>30H</td></tr> </table>	0	0	0	0	30H	30H	30H	30H	<table border="1"> <tr><td>00H</td><td>00H</td></tr> </table>	00H	00H
0	0	0	0								
30H	30H	30H	30H								
00H	00H										

Read data or write data are stored in 16 point unit of bit devices (2 bytes).

When data length is not a multiple of 16 at the time of bit specification, '0' is stored in an invalid area.

■Byte specification

The value of data length is handled as a number of bytes of read data or write data.

Specify when the data type of a label is other than bit.

ASCII code	Binary code										
<table border="1"> <tr><td>0</td><td>0</td><td>0</td><td>1</td></tr> <tr><td>30H</td><td>30H</td><td>30H</td><td>31H</td></tr> </table>	0	0	0	1	30H	30H	30H	31H	<table border="1"> <tr><td>01H</td><td>00H</td></tr> </table>	01H	00H
0	0	0	1								
30H	30H	30H	31H								
01H	00H										

Data length

Specify the length of read data or write data.

Specify the following values according to the data type of a label.

Specifying and writing data length which is not suited for the data type of label results in abnormal completion.

Data type	Batch read and write array type labels		Random read and write
	Unit specification	Array data length	Data length per 1 point label
Bit	Bit units	1 × Number of array element	2
Word [Unsigned]/Bit String [16-bit]	Byte units	2 × Number of array element	2
Double Word [Unsigned]/Bit String [32-bit]		4 × Number of array element	4
Word [Signed]		2 × Number of array element	2
Double Word [Signed]		4 × Number of array element	4
FLOAT [Single Precision]		4 × Number of array element	4
FLOAT [Double Precision]		8 × Number of array element	8
Time		4 × Number of array element	4
String		Depend on the number of character strings (1 per 1 character, including end NULL) ^{*1}	
String [Unicode]		Depend on the number of character strings (2 per 1 character, including end NULL) ^{*2}	
Pointer		Cannot be specified.	
Timer	Contact	Cannot be specified.	2
Counter	Coil		
Retentive timer	Current value		
Long timer	Contact		2
Long counter	Coil		
Long retentive timer	Current value		4

*1 Specify the following values per one array element/label.

Character string length specified to "Data Length of Character String Data Type" with an Engineering tool + 1
(When the value is an odd number, add 1 and specify with an even number.)

*2 Specify the following values per one array element/label.

(Character string length specified to "Data Length of Character String Data Type" with an Engineering tool + 1) × 2

■Data communication in ASCII code

Convert the numerical value to 4-digit ASCII code (hexadecimal), and send it from the upper digits.

■Data communication in binary code

Send 2-byte^{*1} numerical values from lower byte (L: bits 0 to 7).

*1 For C24, the additional code may be added. (☞ Page 35 Additional code (10H))

Setting example

■Batch read and write of array

For the bit specification, specify the number of bits to be accessed.

- Unit specification: Bit
- Label: Bit type 3 points
- Array data length: 1 bit × Number of array element (3) = 3 bits

ASCII code	Binary code										
<table border="1"> <tr><td>0</td><td>0</td><td>0</td><td>3</td></tr> <tr><td>30H</td><td>30H</td><td>30H</td><td>33H</td></tr> </table>	0	0	0	3	30H	30H	30H	33H	<table border="1"> <tr><td>03H</td><td>00H</td></tr> </table>	03H	00H
0	0	0	3								
30H	30H	30H	33H								
03H	00H										

For byte specification, specify the data length of the label to be accessed in byte unit.

- Unit specification: Byte
- Label: Word type 5 points
- Array data length: 2 bytes × (5) = 10 bytes

ASCII code	Binary code										
<table border="1"> <tr><td>0</td><td>0</td><td>0</td><td>A</td></tr> <tr><td>30H</td><td>30H</td><td>30H</td><td>3AH</td></tr> </table>	0	0	0	A	30H	30H	30H	3AH	<table border="1"> <tr><td>0AH</td><td>00H</td></tr> </table>	0AH	00H
0	0	0	A								
30H	30H	30H	3AH								
0AH	00H										

■Random read and write

For bit type, data length will be 2 (fixed value).

- Label: Bit type 1 point
- Data length: 2 (fixed)

ASCII code	Binary code										
<table border="1"> <tr><td>0</td><td>0</td><td>0</td><td>2</td></tr> <tr><td>30H</td><td>30H</td><td>30H</td><td>32H</td></tr> </table>	0	0	0	2	30H	30H	30H	32H	<table border="1"> <tr><td>02H</td><td>00H</td></tr> </table>	02H	00H
0	0	0	2								
30H	30H	30H	32H								
02H	00H										

The character string type [Unicode] will be 2 bytes per one character of UTF-16 code.

- Label: Character string type [Unicode] one point
- "Data Length of Character String Data Type" of an Engineering tool: 32
- Data length: Number of characters (32 + 1) × Data length per one character string (2) = 66 (42H)

ASCII code	Binary code										
<table border="1"> <tr><td>0</td><td>0</td><td>4</td><td>2</td></tr> <tr><td>30H</td><td>30H</td><td>34H</td><td>32H</td></tr> </table>	0	0	4	2	30H	30H	34H	32H	<table border="1"> <tr><td>42H</td><td>00H</td></tr> </table>	42H	00H
0	0	4	2								
30H	30H	34H	32H								
42H	00H										

Read data, write data

The read data is stored for reading, and the data to be written is stored for writing.

Data is stored with variable length. The length of data is specified by "Data length." (Page 132 Data length)

The storing method of data is same as that of reading or writing data in word units (bit device in 16-points). (Page 72 Read data, write data)

For bit type labels

Read data and write data are handled in 16-point units, but '0' is stored in data other than label points to be accessed.

Ex.

For bit type label 6 points

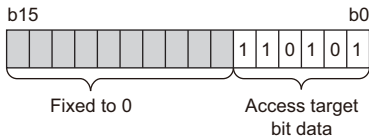

For character string type labels

Store NULL at the end of the valid character string. The data after NULL of the read data will be undefined value.

Item	Character string type of ASCII code		Character string type of Unicode
	Odd	Even number	
Number of character strings of label	Odd	Even number	—
NULL code to be stored to the end	NULL (00H)	NULL (00H)×2	NULL (0000H)
Data length of array element/label per one point	Character string specified to "Data Length of Character String Data Type" + 1	Character string specified to "Data Length of Character String Data Type" + 2	(Character string specified to "Data Length of Character String Data Type" + 1)×2

Ex.

For read data of 1-point character string type (ASCII code) label

- Label character string: 'ABCD' (4 characters)
- "Data Length of Character String Data Type" of an Engineering tool: 32
- Data length: Number of characters $(32 + 1) \times$ Data length per one character string (1) = 34 (22H)

ASCII code	Binary code																																																																	
<table border="1" style="width: 100%; text-align: center;"> <tr> <td colspan="2">B</td> <td colspan="2">A</td> <td colspan="2">D</td> <td colspan="2">C</td> <td colspan="2">NULL</td> <td colspan="2">NULL</td> <td>...</td> </tr> <tr> <td>4</td><td>2</td><td>4</td><td>1</td><td>4</td><td>4</td><td>4</td><td>3</td><td>0</td><td>0</td><td>0</td><td>0</td><td>...</td> </tr> <tr> <td>34_H</td><td>32_H</td><td>34_H</td><td>32_H</td><td>34_H</td><td>34_H</td><td>34_H</td><td>33_H</td><td>30_H</td><td>30_H</td><td>30_H</td><td>30_H</td><td>...</td> </tr> </table> <p style="text-align: center;">("Data Length of String Data Type"(32)+2)×2 bytes</p>	B		A		D		C		NULL		NULL		...	4	2	4	1	4	4	4	3	0	0	0	0	...	34 _H	32 _H	34 _H	32 _H	34 _H	34 _H	34 _H	33 _H	30 _H	30 _H	30 _H	30 _H	...	<table border="1" style="width: 100%; text-align: center;"> <tr> <td colspan="2">A</td> <td colspan="2">B</td> <td colspan="2">C</td> <td colspan="2">D</td> <td colspan="2">NULL</td> <td colspan="2">NULL</td> <td>...</td> </tr> <tr> <td>41_H</td><td>42_H</td><td>43_H</td><td>44_H</td><td>00_H</td><td>00_H</td><td>...</td><td>...</td><td>...</td><td>...</td><td>...</td><td>...</td><td>...</td> </tr> </table> <p style="text-align: center;">"Data Length of String Data Type"(32)+2 bytes</p>	A		B		C		D		NULL		NULL		...	41 _H	42 _H	43 _H	44 _H	00 _H	00 _H
B		A		D		C		NULL		NULL		...																																																						
4	2	4	1	4	4	4	3	0	0	0	0	...																																																						
34 _H	32 _H	34 _H	32 _H	34 _H	34 _H	34 _H	33 _H	30 _H	30 _H	30 _H	30 _H	...																																																						
A		B		C		D		NULL		NULL		...																																																						
41 _H	42 _H	43 _H	44 _H	00 _H	00 _H																																																						

Point

When communicating ASCII code character string data in ASCII code, data is rearranged every two characters and stored.

9.2 Batch Read and Write

Read/write data by specifying the continuous element of array in batch.

Batch read array type labels (command: 041A)

Read data by specifying the continuous element of array in batch.

Specify the array type label or array type element of structure label.

The labels other than array type can be specified in one point unit. (Specify the number of array element as '1'.)

Message format

The following shows the message format of the request data and response data of the command.

Request data

Command	Subcommand	Array points (n points)	Abbreviation specification	Array specification (first point)	...	Array specification (nth point)
---------	------------	----------------------------	-------------------------------	--------------------------------------	-----	------------------------------------

Response data

The read array data is stored for the number of array points which are specified with request data.

Array points (n points)	Array data (first point)	...	Array data (nth point)
----------------------------	-----------------------------	-----	---------------------------

Data specified by request data

Command

ASCII code	Binary code												
<table border="1"> <tr><td>0</td><td>4</td><td>1</td><td>A</td></tr> <tr><td>30H</td><td>34H</td><td>31H</td><td>41H</td></tr> </table>	0	4	1	A	30H	34H	31H	41H	<table border="1"> <tr><td>1A</td><td>04</td></tr> <tr><td>1AH</td><td>04H</td></tr> </table>	1A	04	1AH	04H
0	4	1	A										
30H	34H	31H	41H										
1A	04												
1AH	04H												

Subcommand

ASCII code	Binary code												
<table border="1"> <tr><td>0</td><td>0</td><td>0</td><td>0</td></tr> <tr><td>30H</td><td>30H</td><td>30H</td><td>30H</td></tr> </table>	0	0	0	0	30H	30H	30H	30H	<table border="1"> <tr><td>00</td><td>00</td></tr> <tr><td>00H</td><td>00H</td></tr> </table>	00	00	00H	00H
0	0	0	0										
30H	30H	30H	30H										
00	00												
00H	00H												

Array points

Specify the point of array to be read. (☞ Page 130 Points)

Abbreviation specification

Specify the label name length and label name to be abbreviated. (☞ Page 128 Abbreviation specification of label)

When do not abbreviate, specify '0'.

ASCII code	Binary code												
<table border="1"> <tr><td>0</td><td>0</td><td>0</td><td>0</td></tr> <tr><td>30H</td><td>30H</td><td>30H</td><td>30H</td></tr> </table>	0	0	0	0	30H	30H	30H	30H	<table border="1"> <tr><td>00</td><td>00</td></tr> <tr><td>00H</td><td>00H</td></tr> </table>	00	00	00H	00H
0	0	0	0										
30H	30H	30H	30H										
00	00												
00H	00H												



■Array specification

Specify the details of arrays for number of arrays specified to array points.

Label name length	Label name	Unit specification	Fixed values	Array data length
-------------------	------------	--------------------	--------------	-------------------

Array specification (Array one point)

Specify the following items for each array.

- Label name length, label name: Specify the label name and label length of a global label. ( Page 124 Labels)
- Unit specification: For the bit type labels, specify the unit specification in bit units (0). As for other than bit type label, specify the unit specification in byte units (1).
- Array data length: Specify the data size of array in the unit specified with "Unit specification." ( Page 132 Data length, unit specification)
- Fixed value: '0'

ASCII code	Binary code					
<table border="1"> <tr> <td>0</td> <td>0</td> </tr> <tr> <td>30H</td> <td>30H</td> </tr> </table>	0	0	30H	30H	<table border="1"> <tr> <td>00H</td> </tr> </table>	00H
0	0					
30H	30H					
00H						

Data stored in response data

■Array points

The same data as request data are stored.



■Array data

The read array data is stored for number of arrays which are specified with array point.

Data type ID	Unit specification	Array data length	Read data
--------------	--------------------	-------------------	-----------

Array data (Array one point)

The following items are stored for each array.

- Data type ID: The data type of the label name is stored with the defined ID. ( Page 131 Data type ID)
- Unit specification: For the bit type labels, specify the unit specification in bit units (0). As for other than bit type label, specify the unit specification in byte units (1).
- Array data length: Specify the data size of array in the unit specified with "Unit specification." ( Page 132 Data length, unit specification)
- Read data: The value of the read label is stored. ( Page 134 Read data, write data)

Point

When unit specification is bit specification, read data are stored in 16-bit (2-byte) units.

Communication example (Bit specification)

For one-dimensional array type label 'LbI', read 2-bit data from Lbl [2].

The value of the read label is as follows:

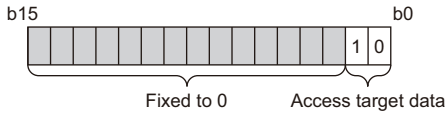

■Data communication in ASCII code

(Request data)

Subcommand	Array points	Abbreviation specification	Label name length	Label name	Unit specification (Fixed value)	Array data length
0 4 1 A 30H, 34H, 31H, 41H	0 0 0 0 30H, 30H, 30H, 30H	0 0 0 1 30H, 30H, 30H, 31H	0 0 0 0 30H, 30H, 30H, 30H	0 0 0 6 30H, 30H, 30H, 36H	(1) 0 0 0 0 30H, 30H 30H, 30H	0 0 0 2 30H, 30H, 30H, 32H

Array specification (Array one point)

In the figure (1), set the value of "ASCII code" indicated in the following table.

(1) Lbl[2]

Item	Value of code corresponding to character					
Label name	L	b	I	[2]
UTF-16	004C	0062	006C	005B	0032	005D
ASCII code	30303443	30303632	30303643	30303542	30303332	30303544

(Response data)

Array points	Data type ID	Unit specification	Array data length	Read data
0 0 0 1 30H, 30H, 30H, 31H	0 1 30H, 31H	0 0 30H, 30H	0 0 0 2 30H, 30H, 30H, 32H	0 2 30H, 32H

Array data (Array one point)

■Data communication in binary code

(Request data)

Subcommand	Array points	Abbreviation specification	Label name length	Label name	Unit specification (Fixed value)	Array data length
1AH, 04H 00H, 00H	01H, 00H 00H, 00H	06H, 00H 4CH, 00H, 62H, 00H, 6CH, 00H, 5BH, 00H, 32H, 00H, 5DH, 00H	L b I [2]	00H, 00H 02H, 00H		

Array specification (Array one point)

(Response data)

Array points	Data type ID	Unit specification	Array data length	Read data
01H, 00H 01H, 00H	01H, 00H 02H, 00H	02H, 00H 02H, 00H		

Array data (Array one point)

Communication example (Byte specification)

For one-dimensional array type label 'LbI', read 5-word data from Lbl [2].

■Data communication in ASCII code

(Request data)

Subcommand	Array points	Abbreviation specification	Label name length	Label name	Unit specification (Fixed value)	Array data length
0 4 1 A 30H, 34H, 31H, 41H	0 0 0 0 30H, 30H, 30H, 30H	0 0 0 1 30H, 30H, 30H, 31H	0 0 0 0 30H, 30H, 30H, 30H	0 0 0 6 30H, 30H, 30H, 36H	(1) 30H 31H	0 0 0 A 30H 30H 30H 41H

Array specification (Array one point)

In the figure (1), set the value of "ASCII code" indicated in the following table.

(1) Lbl[2]

Item	Value of code corresponding to character					
Label name	L	b	I	[2]
UTF-16	004C	0062	006C	005B	0032	005D
ASCII code	30303443	30303632	30303643	30303542	30303332	30303544

(Response data)

Array points	Data type ID	Unit specification	Array data length	Read data
0 0 0 1 30H, 30H, 30H, 31H	0 2 30H, 33H	0 1 30H, 31H	0 0 0 A 30H, 30H, 30H, 41H	0 0 4 4 0 0 6 1 0 0 7 4 0 0 6 1 0 0 3 1 30H, 30H, 34H, 34H, 30H, 30H, 36H, 31H, 30H, 30H, 37H, 34H, 30H, 30H, 36H, 31H, 30H, 30H, 33H, 31H

Array data (Array one point)

■Data communication in binary code

(Request data)

Subcommand	Array points	Abbreviation specification	Label name length	Label name	Unit specification (Fixed value)	Array data length
1AH, 04H	00H, 00H	01H, 00H	00H, 00H	L b I [2]	01H, 00H	0AH, 00H

Array specification (Array one point)

(Response data)

Array points	Data type ID	Unit specification	Array data length	Read data
01H, 00H	02H	01H	0AH, 00H	44H, 00H, 61H, 00H, 74H, 00H, 61H, 00H, 31H, 00H

Array data (Array one point)

Communication example (Abbreviate with structure type array)

Read the following data from the structure label 'Typ1', which has the array type element.

- 8 bytes from Typ1.led[2]
- 4 bytes from Typ1.No[1]

The notation of each label when using abbreviation specification (Typ1= %1) is as follows.

(1)Typ1

Item	Value of code corresponding to character			
Label name	T	y	p	1
UTF-16	0054	0079	0070	0031
ASCII code	30303534	30303739	30303730	30303331
Binary code	5400	7900	7000	3100

(2)Typ1.led[2]

Item	Value of code corresponding to character									
Abbreviated notation	%	1	.	l	e	d	[2]	
UTF-16	0025	0031	002E	006C	0065	0064	005B	0032	005D	
ASCII code	30303235	30303331	30303245	30303643	30303635	30303634	30303542	30303332	30303544	
Binary code	2500	3100	2E00	6C00	6500	6400	5B00	3200	5D00	

(3)Typ1.No[1]

Item	Value of code corresponding to character								
Abbreviated notation	%	1	.	N	o	[1]	
UTF-16	0025	0031	002E	004E	006F	005B	0031	005D	
ASCII code	30303235	30303331	30303245	30303445	30303646	30303542	30303331	30303544	
Binary code	2500	3100	2E00	4E00	6F00	5B00	3100	5D00	

■Data communication in ASCII code

(Request data)

Subcommand	Array points	Number of abbreviated points	Label name length	Label name
0 4 1 A 30H, 34H, 31H, 41H	0 0 0 0 30H, 30H, 30H, 30H	0 0 0 2 30H, 30H, 30H, 32H	0 0 0 1 30H, 30H, 30H, 31H	0 0 0 4 30H, 30H, 30H, 34H
Abbreviation specification				
Label name length	Label name	Unit specification (Fixed value)	Array data length	
0 0 0 9 30H, 30H, 30H, 39H	(2)	0 1 30H, 31H	0 0 0 8 30H, 30H, 30H, 38H	
Label name length	Label name	Unit specification (Fixed value)	Array data length	
0 0 0 8 30H, 30H, 30H, 38H	(3)	0 1 30H, 31H	0 0 0 4 30H, 30H, 30H, 34H	

In the figure (1) to (3), set the value of "ASCII code" indicated in the table of "Value of code corresponding to character" of each label name.

(Response data)

Array points	Data type ID	Unit specification	Array data length	Read data
0 0 0 2 30H, 30H, 30H, 32H	0 2 30H, 32H	0 1 30H, 31H	0 0 0 8 30H, 30H, 30H, 38H	0 0 3 1 0 0 3 2 0 0 3 3 0 0 3 4 30H, 30H, 33H, 31H, 30H, 30H, 33H, 32H, 30H, 30H, 33H, 33H, 30H, 30H, 33H, 34H
Read data of Typ1.led				
Data type ID	Unit specification	Array data length	Read data	
0 3 30H, 33H	0 1 30H, 31H	0 0 0 4 30H, 30H, 30H, 34H	0 0 3 0 0 0 3 1 30H, 30H, 33H, 30H, 30H, 30H, 33H, 31H	
Read data of Typ1.No				

■Data communication in binary code

(Request data)

Subcommand	Array points	Number of abbreviated points	Label name length	Label name			
1AH, 04H	00H, 00H	02H, 00H	01H, 00H	04H, 00H			
Abbreviation specification							
Label name length	Label name	Unit specification (Fixed value)	Array data length	Label name length	Label name	Unit specification (Fixed value)	Array data length
09H, 00H	(2)	01H, 00H	08H, 00H	0BH, 00H	(3)	01H, 00H	04H, 00H

In the figure (1) to (3), set the value of "Binary code" indicated in the table of "Value of code corresponding to character" of each label name.

(Response data)

Unit specification	Array points	Data type ID	Array data length	Read data	Unit specification	Data type ID	Array data length	Read data
02H, 00H	03H, 01H	08H, 00H	31H, 00H, 32H, 00H, 33H, 00H, 34H, 00H	03H, 01H	04H, 00H	30H, 00H, 31H, 00H		
Read data of Typ1.led					Read data of Typ1.No			

Batch write array type labels (command: 141A)

Write the values in batch with specifying the consecutive array elements.

Specify the array type labels or array type elements of structure type labels.

The labels other than array type can be specified in one point unit. (Specify the number of array element as '1'.)

Message format

The following shows the message format of the request data and response data of the command.

Request data

Command	Subcommand	Array points (n points)	Abbreviation specification	Array specification (first point)	...	Array specification (nth point)
---------	------------	----------------------------	-------------------------------	---	-----	---------------------------------------

Response data

There is no response data for this command.

Data specified by request data

Command

ASCII code	Binary code										
<table border="1"> <tr><td>1</td><td>4</td><td>1</td><td>A</td></tr> <tr><td>31H</td><td>34H</td><td>31H</td><td>41H</td></tr> </table>	1	4	1	A	31H	34H	31H	41H	<table border="1"> <tr><td>1A_H</td><td>14_H</td></tr> </table>	1A _H	14 _H
1	4	1	A								
31H	34H	31H	41H								
1A _H	14 _H										

Subcommand

ASCII code	Binary code										
<table border="1"> <tr><td>0</td><td>0</td><td>0</td><td>0</td></tr> <tr><td>30H</td><td>30H</td><td>30H</td><td>30H</td></tr> </table>	0	0	0	0	30H	30H	30H	30H	<table border="1"> <tr><td>00_H</td><td>00_H</td></tr> </table>	00 _H	00 _H
0	0	0	0								
30H	30H	30H	30H								
00 _H	00 _H										

Array points

Specify the point of array to be written. (☞ Page 130 Points)

Abbreviation specification

Specify the label name length and label name to be abbreviated. (☞ Page 128 Abbreviation specification of label)

When do not abbreviate, specify '0'.

ASCII code	Binary code										
<table border="1"> <tr><td>0</td><td>0</td><td>0</td><td>0</td></tr> <tr><td>30H</td><td>30H</td><td>30H</td><td>30H</td></tr> </table>	0	0	0	0	30H	30H	30H	30H	<table border="1"> <tr><td>00_H</td><td>00_H</td></tr> </table>	00 _H	00 _H
0	0	0	0								
30H	30H	30H	30H								
00 _H	00 _H										

Array specification

Specify the details of arrays for number of arrays specified to array points.

Label name length	Label name	Unit specification	Fixed values	Array data length	Write data
-------------------	------------	-----------------------	-----------------	-------------------	------------

Array specification (Array one point)

Specify the following items for each array.

- Label name length, label name: Specify the label name and label length of a global label. (☞ Page 124 Labels)
- Unit specification: For the bit type labels, specify the unit specification in bit units (0). As for other than bit type label, specify the unit specification in byte units (1).
- Array data length: Specify the data size of array in the unit specified with "Unit specification." (☞ Page 132 Data length, unit specification)
- Write data: Specify the value to be written. (☞ Page 134 Read data, write data)

- Fixed value: '0'

ASCII code	Binary code					
<table border="1"> <tr> <td>0</td> <td>0</td> </tr> <tr> <td>30H</td> <td>30H</td> </tr> </table>	0	0	30H	30H	<table border="1"> <tr> <td>00H</td> </tr> </table>	00H
0	0					
30H	30H					
00H						

Communication example (Bit specification)

For one-dimensional array type label 'Lbl', write 2-bit data from Lbl [2].

The value of the label to be written is as follows:

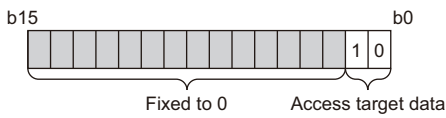

Data communication in ASCII code

(Request data)

Subcommand	Array points	Abbreviation specification
1 4 1 A	0 0 0 0	0 0 0 1
31H, 34H, 31H, 41H	30H, 30H, 30H, 30H	30H, 30H, 30H, 31H

Label name length	Label name	Unit specification (Fixed value)	Array data length	Write data
0 0 0 6	(1)	0 0	0 0 0 2	0 0 0 2
30H, 30H, 30H, 36H		30H 30H	30H, 30H, 30H, 32H	30H, 30H, 30H, 32H

Array specification (Array one point)

In the figure (1), set the value of "ASCII code" indicated in the following table.

(1) Lbl[2]

Item	Value of code corresponding to character					
Label name	L	b	l	[2]
UTF-16	004C	0062	006C	005B	0032	005D
ASCII code	30303443	30303632	30303643	30303542	30303332	30303544

Data communication in binary code

(Request data)

Subcommand	Array points	Abbreviation specification	Label name length	Label name	Unit specification	Array data length	Write data
1A	14	00	01	L b l [2]	00	02	02
1AH, 14H	00H, 00H	01H, 00H	00H, 00H	06H, 00H, 4CH, 00H, 62H, 00H, 6CH, 00H, 5BH, 00H, 32H, 00H, 5DH, 00H	00H	00H	02H, 00H

Array specification (Array one point)

Communication example (Byte specification)

For one-dimensional array type label 'Lbl', write 5-word data from Lbl [2].

Data communication in ASCII code

(Request data)

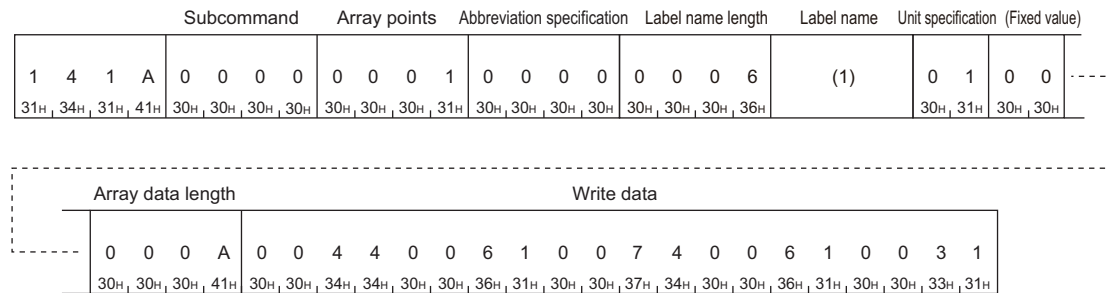

In the figure (1), set the value of "ASCII code" indicated in the following table.

(1) Lbl[2]

Item	Value of code corresponding to character					
Label name	L	b	l	[2]
UTF-16	004C	0062	006C	005B	0032	005D
ASCII code	30303443	30303632	30303643	30303542	30303332	30303544

Data communication in binary code

(Request data)

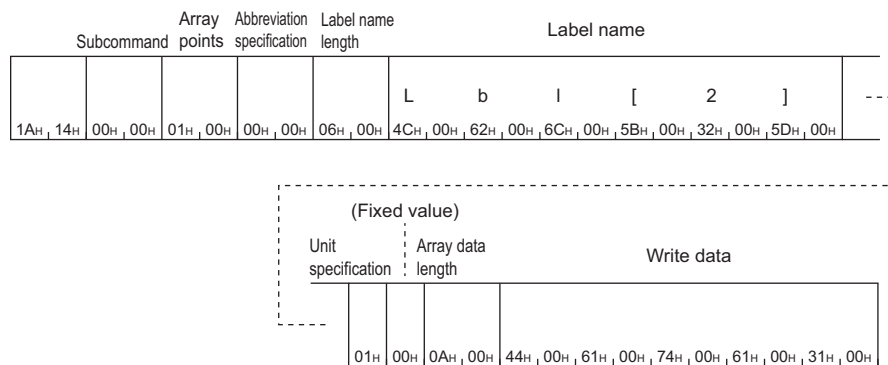

Communication example (Abbreviate with structure type array)

Write the following data to three-dimensional structure label 'Typ1', which has the array type element.

- 8 bytes from Typ1.led[5]
- 4 bytes from Typ1.No[7]

The notation of each label when using abbreviation specification (Typ1= %1) is as follows.

(1)Typ1

Item	Value of code corresponding to character			
Label name	T	y	p	1
UTF-16	0054	0079	0070	0031
ASCII code	30303534	30303739	30303730	30303331
Binary code	5400	7900	7000	3100

(2)Typ1.led[5]

Item	Value of code corresponding to character									
Abbreviated notation	%	1	.	l	e	d	[5]	
UTF-16	0025	0031	002E	006C	0065	0064	005B	0035	005D	
ASCII code	30303235	30303331	30303245	30303643	30303635	30303634	30303542	30303335	30303544	
Binary code	2500	3100	2E00	6C00	6500	6400	5B00	3500	5D00	

(3)Typ1.No[7]

Item	Value of code corresponding to character							
Abbreviated notation	%	1	.	N	o	[7]
UTF-16	0025	0031	002E	004E	006F	005B	0037	005D
ASCII code	30303235	30303331	30303245	30303445	30303646	30303542	30303337	30303544
Binary code	2500	3100	2E00	4E00	6F00	5B00	3700	5D00

■Data communication in ASCII code

(Request data)

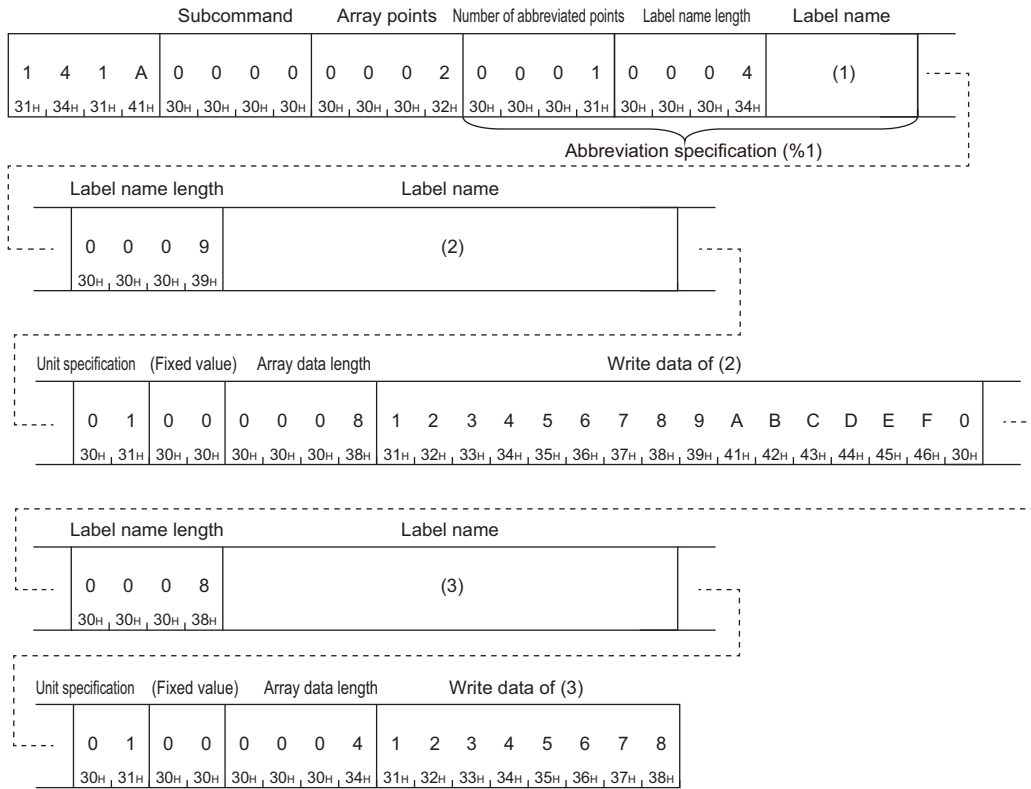

In the figure (1) to (3), set the value of "ASCII code" indicated in the table of "Value of code corresponding to character" of each label name.

■Data communication in binary code

(Request data)

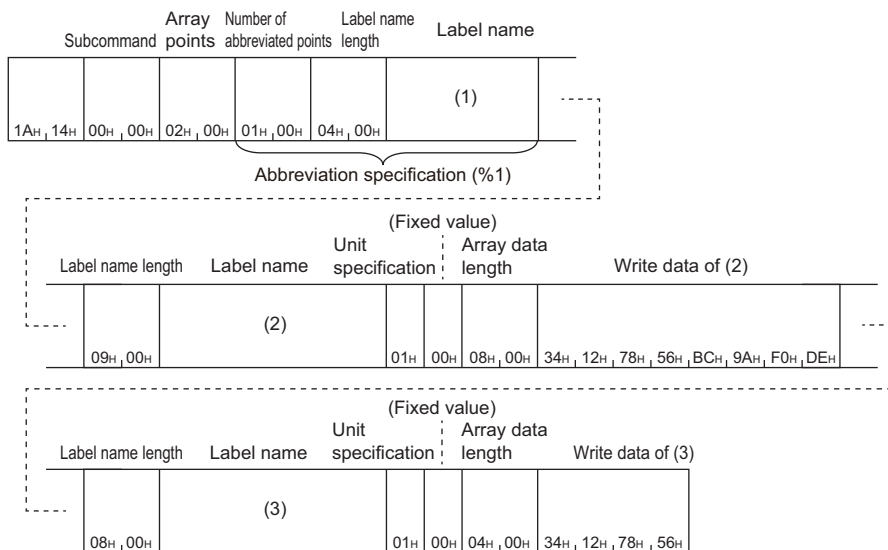

In the figure (1) to (3), set the value of "Binary code" indicated in the table of "Value of code corresponding to character" of each label name.

9.3 Random Read and Write

Specify a label and read/write value in one point unit. When reading and writing data in batch by specifying continuous elements of array, use batch read and write command. ( Page 135 Batch Read and Write)

Random read labels (command: 041C)

Read value in one point units by specifying multiple labels.

Message format

The following shows the message format of the request data and response data of the command.

Request data

Command	Subcommand	Label points (n points)	Abbreviation specification	Label specification (1st point)	...	Label specification (nth point)
---------	------------	----------------------------	-------------------------------	------------------------------------	-----	------------------------------------

Response data

The data of read label is stored for the number of label points specified with request data.

Label points (n points)	Label data (1st point)	...	Label data (nth point)
----------------------------	---------------------------	-----	---------------------------

Data specified by request data

Command

ASCII code	Binary code												
<table border="1"> <tr><td>0</td><td>4</td><td>1</td><td>C</td></tr> <tr><td>30H</td><td>34H</td><td>31H</td><td>43H</td></tr> </table>	0	4	1	C	30H	34H	31H	43H	<table border="1"> <tr><td>1C</td><td>04</td></tr> <tr><td>1CH</td><td>04H</td></tr> </table>	1C	04	1CH	04H
0	4	1	C										
30H	34H	31H	43H										
1C	04												
1CH	04H												

Subcommand

ASCII code	Binary code												
<table border="1"> <tr><td>0</td><td>0</td><td>0</td><td>0</td></tr> <tr><td>30H</td><td>30H</td><td>30H</td><td>30H</td></tr> </table>	0	0	0	0	30H	30H	30H	30H	<table border="1"> <tr><td>00</td><td>00</td></tr> <tr><td>00H</td><td>00H</td></tr> </table>	00	00	00H	00H
0	0	0	0										
30H	30H	30H	30H										
00	00												
00H	00H												

Label points

Specify the point of label to read. ( Page 130 Points)

Abbreviation specification

Specify the label name length and label name to be abbreviated. ( Page 128 Abbreviation specification of label)
When do not abbreviate, specify '0'.

ASCII code	Binary code												
<table border="1"> <tr><td>0</td><td>0</td><td>0</td><td>0</td></tr> <tr><td>30H</td><td>30H</td><td>30H</td><td>30H</td></tr> </table>	0	0	0	0	30H	30H	30H	30H	<table border="1"> <tr><td>00</td><td>00</td></tr> <tr><td>00H</td><td>00H</td></tr> </table>	00	00	00H	00H
0	0	0	0										
30H	30H	30H	30H										
00	00												
00H	00H												

Label specification

Specify the label name and label length of global label for the specified number of label points. ( Page 124 Labels)
For a structure type label or array type label, specify the data of each element.

Data stored in response data

Label points

The same data as request data are stored.

Label data

The data of read label for the specified number of label points is stored.

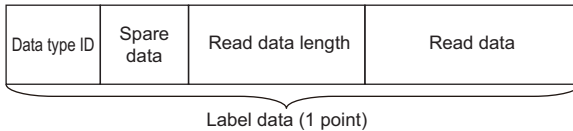

The following items are stored for each label.

- Data type ID: The data type of label name is stored with the defined ID. (☞ Page 131 Data type ID)
- Read data length: Specify the read data size in byte units. (☞ Page 132 Data length, unit specification)
- Read data: The value of read label is stored in the format of "Data type ID". (☞ Page 134 Read data, write data)
- Spare data: The 2-byte of system data for data communication in ASCII code, and the 1-byte*1 of system data for data communication in binary code is stored.

*1 For C24, the additional code may be added. (☞ Page 35 Additional code (10H))

Communication example

Read data from three labels.

- Lbl1 (bit type) = 1 (ON)
- Lbl2.Lbl[2] (word type array element of structure label) = 0031H
- Lbl3 (word type) = 0001H

The notation of each label when using abbreviation specification (Lbl2 = %1) is as follows.

(1) Lbl2 (abbreviation specification)

Item	Value of code corresponding to character			
	L	b	l	2
Label name	L	b	l	2
UTF-16	004C	0062	006C	0032
ASCII code	30303443	30303632	30303643	30303332
Binary code	4C00	6200	6C00	3200

(2) Lbl1

Item	Value of code corresponding to character			
	L	b	l	1
Label name	L	b	l	1
UTF-16	004C	0062	006C	0031
ASCII code	30303443	30303632	30303643	30303331
Binary code	4C00	6200	6C00	3100

(3) Lbl2.Lbl[2]

Item	Value of code corresponding to character									
	%	1	.	L	b	l	[2]	
Abbreviated notation	%	1	.	L	b	l	[2]	
UTF-16	0025	0031	002E	004C	0062	006C	005B	0032	005D	
ASCII code	30303235	30303331	30303245	30303443	30303632	30303643	30303542	30303332	30303544	
Binary code	2500	3100	2E00	4C00	6200	6C00	5B00	3200	5D00	

(4) Lbl3

Item	Value of code corresponding to character			
	L	b	l	3
Label name	L	b	l	3
UTF-16	004C	0062	006C	0033
ASCII code	30303443	30303632	30303643	30303333
Binary code	4C00	6200	6C00	3300

■Data communication in ASCII code

(Request data)

Subcommand	Label points	Number of abbreviated points	Label name length	Label name
0 4 1 C 30H, 34H, 31H, 43H	0 0 0 0 30H, 30H, 30H, 30H	0 0 0 3 30H, 30H, 30H, 33H	0 0 0 1 30H, 30H, 30H, 31H	0 0 0 4 30H, 30H, 30H, 34H
				(1)

Label name length	Label name	Label name length	Label name	Label name length	Label name
0 0 0 4 30H, 30H, 30H, 34H	(2)	0 0 0 9 30H, 30H, 30H, 39H	(3)	0 0 0 4 30H, 30H, 30H, 34H	(4)

In the figure (1) to (4), set the value of "ASCII code" indicated in the table of "Value of code corresponding to character" of each label name.

(Response data)

Label points	Data type ID	Spare data	Read data length	Read data
0 0 0 3 30H, 30H, 30H, 33H	0 1 30H, 31H	0 0 30H, 30H	0 0 0 2 30H, 30H, 30H, 32H	0 0 0 1 30H, 30H, 30H, 31H
			Label data (1st point)	

Data type ID	Spare data	Read data length	Read data	Data type ID	Spare data	Read data length	Read data
0 2 30H, 32H	0 0 30H, 30H	0 0 0 2 30H, 30H, 30H, 32H	0 0 3 1 30H, 30H, 33H, 31H	0 2 30H, 32H	0 0 30H, 30H	0 0 0 2 30H, 30H, 30H, 32H	0 0 0 1 30H, 30H, 30H, 31H
		Label data (2nd point)				Label data (3rd point)	

■Data communication in binary code

(Request data)

Subcommand	Label points	Number of abbreviated points	Label name length	Label name
1CH, 04H	00H, 00H	03H, 00H	01H, 00H	04H, 00H
				(1)

Label name length	Label name	Label name length	Label name	Label name length	Label name
04H, 00H	(2)	09H, 00H	(3)	04H, 00H	(4)

In the figure (1) to (4), set the value of "Binary code" indicated in the table of "Value of code corresponding to character" of each label name.

(Response data)

Label points	Spare data	Read data length	Read data	Spare data	Read data length	Read data	Spare data	Read data length	Read data
03H, 00H	01H, 00H	02H, 00H	01H, 00H	02H, 00H	02H, 00H	31H, 00H	02H, 00H	02H, 00H	01H, 00H
		Label data (1st point)		Label data (2nd point)		Label data (3rd point)			

Random write labels (command: 141B)

Write value in one point units by specifying multiple labels.

Message format

The following shows the message format of the request data and response data of the command.

Request data

Command	Subcommand	Label points (n points)	Abbreviation specification	Label specification (1st point)	...	Label specification (nth point)
---------	------------	-------------------------	----------------------------	---------------------------------	-----	---------------------------------

Response data

There is no response data for this command.

Data specified by request data

Command

ASCII code	Binary code										
<table border="1"> <tr> <td>1</td> <td>4</td> <td>1</td> <td>B</td> </tr> <tr> <td>31H</td> <td>34H</td> <td>31H</td> <td>42H</td> </tr> </table>	1	4	1	B	31H	34H	31H	42H	<table border="1"> <tr> <td>1B</td> <td>14H</td> </tr> </table>	1B	14H
1	4	1	B								
31H	34H	31H	42H								
1B	14H										

Subcommand

ASCII code	Binary code										
<table border="1"> <tr> <td>0</td> <td>0</td> <td>0</td> <td>0</td> </tr> <tr> <td>30H</td> <td>30H</td> <td>30H</td> <td>30H</td> </tr> </table>	0	0	0	0	30H	30H	30H	30H	<table border="1"> <tr> <td>00H</td> <td>00H</td> </tr> </table>	00H	00H
0	0	0	0								
30H	30H	30H	30H								
00H	00H										

Label points

Specify the number of label points to be written. (Page 130 Points)

Abbreviation specification

Specify the label name length and label name to be abbreviated. (Page 124 Labels)

When do not abbreviate, specify '0'.

ASCII code	Binary code										
<table border="1"> <tr> <td>0</td> <td>0</td> <td>0</td> <td>0</td> </tr> <tr> <td>30H</td> <td>30H</td> <td>30H</td> <td>30H</td> </tr> </table>	0	0	0	0	30H	30H	30H	30H	<table border="1"> <tr> <td>00H</td> <td>00H</td> </tr> </table>	00H	00H
0	0	0	0								
30H	30H	30H	30H								
00H	00H										

Label specification

Specify the label name and write data for the specified number of label points.

Label name length	Label name	Write data length	Write data
-------------------	------------	-------------------	------------

Label specification (1 point)

Specify the following items for each label.

- Label name length, label name: Specify the label name and label length of a global label. (Page 124 Labels)
- Write data length: Specify the read data size in byte unit. (Page 132 Data length, unit specification)
- Write data: Store the values of labels to be written. (Page 134 Read data, write data)

Communication example

Write data to three labels.

- Lbl1 (bit type) = 1 (ON)
- Lbl2.Lbl[2] (word type array element of structure label) = 0031H
- Lbl3 (word type) = 0001H

The notation of each label when using abbreviation specification (Lbl2 = %1) is as follows.

(1) Lbl2 (abbreviation specification)

Item	Value of code corresponding to character			
	L	b	l	2
Label name	L	b	l	2
UTF-16	004C	0062	006C	0032
ASCII code	30303443	30303632	30303643	30303332
Binary code	4C00	6200	6C00	3200

(2) Lbl1

Item	Value of code corresponding to character			
	L	b	l	1
Label name	L	b	l	1
UTF-16	004C	0062	006C	0031
ASCII code	30303443	30303632	30303643	30303331
Binary code	4C00	6200	6C00	3100

(3) Lbl2.Lbl[2]

Item	Value of code corresponding to character									
	%	1	.	L	b	l	[2]	
Abbreviated notation	%	1	.	L	b	l	[2]	
UTF-16	0025	0031	002E	004C	0062	006C	005B	0032	005D	
ASCII code	30303235	30303331	30303245	30303443	30303632	30303643	30303542	30303332	30303544	
Binary code	2500	3100	2E00	4C00	6200	6C00	5B00	3200	5D00	

(4) Lbl3

Item	Value of code corresponding to character			
	L	b	l	3
Label name	L	b	l	3
UTF-16	004C	0062	006C	0033
ASCII code	30303443	30303632	30303643	30303333
Binary code	4C00	6200	6C00	3300

■Data communication in ASCII code

(Request data)

Subcommand	Label points	Number of abbreviated points	Label name length	Label name
1 4 1 B 31H, 34H, 31H, 42H	0 0 0 0 30H, 30H, 30H, 30H	0 0 0 3 30H, 30H, 30H, 33H	0 0 0 1 30H, 30H, 30H, 31H	0 0 0 4 30H, 30H, 30H, 34H
				(1)

Label name length	Label name	Write data length	Write data
0 0 0 4 30H, 30H, 30H, 34H	(2)	0 0 0 2 30H, 30H, 30H, 32H	0 0 0 1 30H, 30H, 30H, 31H

Label name length	Label name	Write data length	Write data
0 0 0 9 30H, 30H, 30H, 39H	(3)	0 0 0 2 30H, 30H, 30H, 32H	0 0 3 1 30H, 30H, 33H, 31H

Label name length	Label name	Write data length	Write data
0 0 0 4 30H, 30H, 30H, 34H	(4)	0 0 0 2 30H, 30H, 30H, 32H	0 0 0 1 30H, 30H, 30H, 31H

In the figure (1) to (4), set the value of "ASCII code" indicated in the table of "Value of code corresponding to character" of each label name.

■Data communication in binary code

(Request data)

Subcommand	Label points	Number of abbreviated points	Label name length	Label name
1B, 14H	00H, 00H	03H, 00H	01H, 00H	04H, 00H
				(1)

Label name length	Label name	Write data length	Write data
04H, 00H	(2)	02H, 00H	01H, 00H

Label name length	Label name	Write data length	Write data
09H, 00H	(3)	02H, 00H	31H, 00H

Label name length	Label name	Write data length	Write data
04H, 00H	(4)	02H, 00H	01H, 00H

In the figure (1) to (4), set the value of "Binary code" indicated in the table of "Value of code corresponding to character" of each label name.

10 BUFFER MEMORY ACCESS

This chapter explains the commands which read and write the buffer memory.

Point

- The buffer memory can be accessed with device access function using module access device (Un\G).
- ➔ Page 442 Accessing module access devices
- ➔ Page 65 DEVICE ACCESS

10.1 Buffer Memory

This section explains the command which reads and writes data to the buffer memory of the supported device connected to the external device.

Restriction

The command can only be used for C24 (including multidrop connection station) and E71 connected to an external device. It cannot be used via network.

Point

This command is processed by C24/E71 connected to the CPU module without waiting for the END process.

Data to be specified in commands

This section explains the contents and specification methods for data items which are set in each command related to the access to the host station (supported device) buffer memory.

Start address

Specify the start address of the buffer memory to be read/written.

■Data communication in ASCII code

Convert the numerical value to 8-digit (hexadecimal) ASCII code, and send it from the upper digits.

■Data communication in binary code

Send 4-byte numerical values from the lower byte (L: bits 0 to 7).

Ex.

When the head area address is 1E1H

ASCII code	Binary code
0 0 0 0 0 1 E 1 30H , 30H , 30H , 30H , 30H , 31H , 45H , 31H	E1H , 01H , 00H , 00H

Word length

Specify the word length of the buffer memory to be read/written.

■Data communication in ASCII code

Convert the numerical value to 4-digit ASCII code (hexadecimal), and send it from the upper digits.

■Data communication in binary code

Send 2-byte numerical values from lower byte (L: bits 0 to 7).

Ex.

For 5 words and 20 words

Number of device points	ASCII code	Binary code										
5 words	<table border="1"> <tr><td>0</td><td>0</td><td>0</td><td>5</td></tr> <tr><td>30H</td><td>30H</td><td>30H</td><td>35H</td></tr> </table>	0	0	0	5	30H	30H	30H	35H	<table border="1"> <tr><td>05H</td><td>00H</td></tr> </table>	05H	00H
0	0	0	5									
30H	30H	30H	35H									
05H	00H											
20 words	<table border="1"> <tr><td>0</td><td>0</td><td>1</td><td>4</td></tr> <tr><td>30H</td><td>30H</td><td>31H</td><td>34H</td></tr> </table>	0	0	1	4	30H	30H	31H	34H	<table border="1"> <tr><td>14H</td><td>00H</td></tr> </table>	14H	00H
0	0	1	4									
30H	30H	31H	34H									
14H	00H											

Read data, write data

The read buffer memory value is stored for reading, and the data to be written is stored for writing.

This function reads/writes data in word unit.

■Data communication in ASCII code

Convert the numerical value to 4-digit ASCII code (hexadecimal), and send it from the upper digits.

■Data communication in binary code

Send 2-byte numerical values from lower byte (L: bits 0 to 7).

Ex.

When the data for one buffer memory address is 09C1H

ASCII code	Binary code										
<table border="1"> <tr><td>0</td><td>9</td><td>C</td><td>1</td></tr> <tr><td>30H</td><td>39H</td><td>43H</td><td>31H</td></tr> </table>	0	9	C	1	30H	39H	43H	31H	<table border="1"> <tr><td>C1H</td><td>09H</td></tr> </table>	C1H	09H
0	9	C	1								
30H	39H	43H	31H								
C1H	09H										

Batch read (command: 0613)

Read data from the buffer memory of the host station (supported device).

Message format

The following shows the message format of the request data and response data of the command.

Request data

Command	Subcommand	Start address	Word length
---------	------------	---------------	-------------

Response data

The value read from the buffer memory is stored. The data order differs depending on the type of code, ASCII code or binary code.

Page 152 Read data, write data

Data specified by request data

Command

ASCII code	Binary code										
<table border="1"><tr><td>0</td><td>6</td><td>1</td><td>3</td></tr><tr><td>30H</td><td>36H</td><td>31H</td><td>33H</td></tr></table>	0	6	1	3	30H	36H	31H	33H	<table border="1"><tr><td>13H</td><td>06H</td></tr></table>	13H	06H
0	6	1	3								
30H	36H	31H	33H								
13H	06H										

Subcommand

ASCII code	Binary code										
<table border="1"><tr><td>0</td><td>0</td><td>0</td><td>0</td></tr><tr><td>30H</td><td>30H</td><td>30H</td><td>30H</td></tr></table>	0	0	0	0	30H	30H	30H	30H	<table border="1"><tr><td>00H</td><td>00H</td></tr></table>	00H	00H
0	0	0	0								
30H	30H	30H	30H								
00H	00H										

Start address

Specify the buffer memory start address to be read. (Page 151 Start address)

Word length

Specify the word length of the buffer memory to be read. (Page 152 Word length)

Specification range: 1H to 1E0H (480)

Point

Specify the access range within the range of buffer memory.
(Start address + Word length - 1) ≤ Buffer memory range

Communication example

Read the data of the buffer memory addresses from 78H to 81H (120 to 129).

■Data communication in ASCII code

(Request data)

				Start address								Word length							
0	6	1	3	0	0	0	0	0	0	0	0	0	0	7	8	0	0	0	A
30H	36H	31H	33H	30H	30H	30H	30H	30H	30H	30H	30H	30H	30H	37H	38H	30H	30H	30H	41H

(Response data)

Read data 1				Read data 2				Read data 10				
0	5	0	0	0	9	C	1	...	0	0	C	8
30H	35H	30H	30H	30H	39H	43H	31H		30H	30H	43H	38H
Values of address 78H =0500H				Values of address 79H =09C1H				Values of address 81H =00C8H				

■Data communication in binary code

(Request data)

		Start address				Word length			
13H	06H	00H	00H	78H	00H	00H	00H	0AH	00H

(Response data)

Read data 1		Read data 2		Read data 10	
00H	05H	C1H	09H	...	C8H
Values of address 78H =0500H		Values of address 79H =09C1H		Values of address 81H =00C8H	

Batch write (command: 1613)

Write data to the buffer memory of the host station (supported device).

Restriction

Do not write any data in "System area" or "Write-protect area" in the buffer memory. Writing data to the "System area" or "Write-protect area" may cause malfunction of the programmable controller system.

Message format

The following shows the message format of the request data and response data of the command.

Request data

Command	Subcommand	Start address	Word length	Write data 1	...	Write data n
---------	------------	---------------	-------------	--------------	-----	--------------

Response data

There is no response data for this command.

Data specified by request data

Command

ASCII code	Binary code
1 6 1 3 31H, 36H, 31H, 33H	13H, 16H

Subcommand

ASCII code	Binary code
0 0 0 0 30H, 30H, 30H, 30H	00H, 00H

Start address

Specify the buffer memory start address to be written. (Page 151 Start address)

Word length

Specify the word length of the buffer memory to be written. (Page 152 Word length)

Specification range: 1H to 1E0H (480)

Write data

Specify the data to be written in the buffer memory. (Page 152 Read data, write data)

Point

Specify the access range within the range of buffer memory.
(Start address + Word length - 1) ≤ Buffer memory range

Communication example

Write the value to buffer memory addresses from 2680H to 2683H (9856 to 9859).

■Data communication in ASCII code

(Request data)

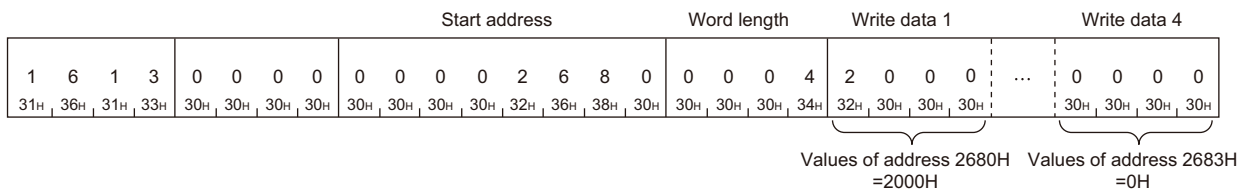

■Data communication in binary code

(Request data)

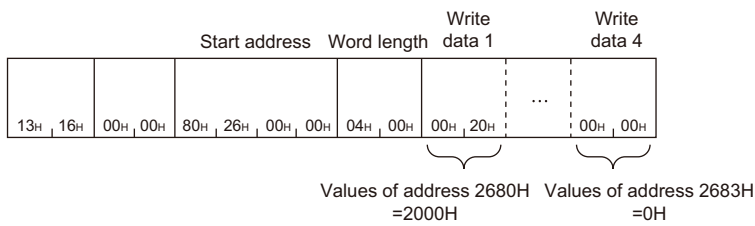

10.2 Intelligent Function Module

The section explains the commands to read from/write to the buffer memory of an intelligent function module.

Accessible modules

The following shows the accessible intelligent functional modules to buffer memory.

Accessing buffer memory using module access device (Un\G)

The intelligent function modules, which can be accessed the module access device (Un\G), can be accessed by the device access function.

☞ Page 442 Accessing module access devices

☞ Page 65 DEVICE ACCESS

Accessing buffer memory with calculating a start address



Use the command (0601, 1601) shown in this section to access the following devices.

Module	Model	Additional values when calculating start address
Load cell input module	Q61LD	2000H
Loop control module	Q62HLC	10000H
Analog—digital converter module	Q62AD-DGH, Q64AD, Q64AD-GH, Q66AD-DG, Q68AD-G, Q68ADV, Q68ADI	1008H
Digital—analog converter module	Q62DA, Q62DA-FG, Q62DAN, Q64DA, Q64DAN, Q66DA-G, Q68DAV, Q68DAI, Q68DAVN, Q68DAIN	1008H
Analog input/output module	Q64AD2DA	2000H
Temperature control module	Q64TCTT, Q64TCRT, Q64TCCTBW, Q64TCRTBW	1000H
Temperature input module (function version B)	Q64TD, Q64RD	2000H
Temperature input module (function version C)	Q64TD, Q64TDV-GH, Q64RD, Q64RD-G	8000H
Channel isolated thermocouple input module	Q68TD-G-H01, Q68TD-G-H02	1008H
Channel isolated RTD input module	Q68RD3-G	1008H
ID Interface module	QD35ID1, QD35ID2	4000H
Intelligent communication module	QD51, QD51-R24	10000H
Channel isolated pulse input module	QD60P8-G	2000H
High-speed counter module	QD62, QD62E, QD62D	3CH
Multichannel high-speed counter module	QD63P6	2000H
4Mpps capable high-speed counter module	QD64D2	2000H
Positioning module	QD70P4, QD70P8, QD70D4, QD70D8, QD72P3C3	5000H
	QD75P1, QD75P2, QD75P4, QD75D1, QD75D2, QD75D4, QD75M1, QD75M2, QD75M4, QD75MH1, QD75MH2, QD75MH4	10000H
High speed data logger module	QD81DL96	10000H
CC-Link system master/local module	QJ61BT11, QJ61BT11N	10000H
CC-Link/LT master module	QJ61CL12	01B4H
Serial communication module	QJ71C24N, QJ71C24N-R2, QJ71C24N-R4, QJ71C24, QJ71C24-R2	10000H
AS-i master module	QJ71AS92	10000H
Ethernet interface module	QJ71E71-100, QJ71E71-B5, QJ71E71-B2	10000H
FL-net (OPCN-2) interface module	QJ71FL71-T, QJ71FL71-B2, QJ71FL71-B5, QJ71FL71-T-F01, QJ71FL71-B2-F01, QJ71FL71-B5-F01	10000H
MODBUS interface module	QJ71MB91, QJ71MT91	10000H
MES interface module	QJ71MES96	10000H
Web server module	QJ71WS96	10000H
PROFIBUS-DP Interface module	QJ71PB92D	10000H
PROFIBUS-DP Master module	QJ71PB92V	10000H
PROFIBUS-DP Slave module	QJ71PB93D	10004H

By using the command (0601, 1601), MELSEC-QnA series special function modules can be accessed.

Module	Model	Additional values when calculating start address
CC-Link system master/local module	AJ61QBT11, A1SJ61QBT11	2000H
Ethernet interface module	AJ71QE71, AJ71QE71-B5, A1SJ71QE71-B2, A1SJ71QE71-B5	4000H
Serial communication module	AJ71QC24, AJ71QC24-R2, AJ71QC24-4, AJ71QC24N, AJ71QC24N-R2, AJ71QC24N-R4, A1SJ71QC24, A1SJ71QC24-R2, A1SJ71QC24N, A1SJ71QC24N-R2	4000H

When accessing buffer memory of MELSEC-A series special function modules, use the command of 1C/1E frame.

- 1C frame:  Page 383 Read and write Buffer Memory of Special Function Module
- 1E frame:  Page 432 Read and Write Buffer Memory of Special Function Module

Data to be specified in commands

This section explains the contents and specification methods for data items which are set in each command related to the access to the intelligent function module buffer memory.

Start address

Specify the start address of the buffer memory to be read/written.

■ Calculation method

To access the buffer memory of the intelligent function module which consisted of word units by byte unit, specify a start address calculated by byte unit.

Calculate the start address as follows:

Start address = (Buffer memory address × 2) + Additional value of a module

For the arbitrary additional value of the module, refer to the following section.

 Page 157 Accessing buffer memory with calculating a start address

Ex.

When specifying Q62DA buffer memory address 18H

$(18H \times 2) + 1008H = 30H + 1008H = 1038H$

■ Data communication in ASCII code

Convert the numerical value to 8-digit (hexadecimal) ASCII code, and send it from the upper digits.

■ Data communication in binary code

Send 4-byte numerical values from the lower byte (L: bits 0 to 7).

Ex.

When the start address is 1038H

ASCII code	Binary code																				
<table border="1"> <tr> <td>0</td><td>0</td><td>0</td><td>0</td><td>1</td><td>0</td><td>3</td><td>8</td> </tr> <tr> <td>30H</td><td>30H</td><td>30H</td><td>30H</td><td>31H</td><td>30H</td><td>33H</td><td>38H</td> </tr> </table>	0	0	0	0	1	0	3	8	30H	30H	30H	30H	31H	30H	33H	38H	<table border="1"> <tr> <td>38H</td><td>10H</td><td>00H</td><td>00H</td> </tr> </table>	38H	10H	00H	00H
0	0	0	0	1	0	3	8														
30H	30H	30H	30H	31H	30H	33H	38H														
38H	10H	00H	00H																		

Number of bytes

Specify the number of bytes of the data to be read/written.

■Calculation method

The buffer memory for intelligent function module consists of two bytes (one word) for one area. Calculate the number of bytes by 2-byte per data for one buffer memory address.

$$\text{Number of bytes} = (\text{Number of buffer memory address} \times 2)$$

Ex.

When accessing the buffer memory address 160 to 161 (A0H to A1H)

$$(161 - 160 + 1) \times 2 = 2 \times 2 = 4 \text{ bytes}$$

■Data communication in ASCII code

Convert the numerical value to 4-digit ASCII code (hexadecimal), and send it from the upper digits.

Use capitalized code for alphabetical letter.

■Data communication in binary code

Send 2-byte numerical values from lower byte (L: bits 0 to 7).

Ex.

For 20 bytes

Number of device points	ASCII code	Binary code										
20 bytes	<table border="1" style="margin-left: auto; margin-right: auto;"> <tr> <td>0</td> <td>0</td> <td>1</td> <td>4</td> </tr> <tr> <td>30H</td> <td>30H</td> <td>31H</td> <td>34H</td> </tr> </table>	0	0	1	4	30H	30H	31H	34H	<table border="1" style="margin-left: auto; margin-right: auto;"> <tr> <td>14H</td> <td>00H</td> </tr> </table>	14H	00H
0	0	1	4									
30H	30H	31H	34H									
14H	00H											

Module number

Specify the start input/output number of an intelligent function module to be accessed.

For the module number, specify the value obtained by dividing the start input/output number by 16 in 4 digits (hexadecimal).

■When the number of occupied slots are 2

Specify the value obtained by adding 1 to the module number for the following modules.

Module type	Model
Temperature control module	Q64TCTBW, Q64TCRTBW
Positioning module	QD70D4, QD70D8

■Data communication in ASCII code

Convert the numerical value to 4-digit ASCII code (hexadecimal), and send it from the upper digits.

Use capitalized code for alphabetical letter.

■Data communication in binary code

Send 2-byte numerical values from lower byte (L: bits 0 to 7).

Ex.

When accessing the positioning module whose start input/output number is 0080H

Module number	ASCII code	Binary code										
For QD70P4: 0008H	<table border="1" style="margin-left: auto; margin-right: auto;"> <tr> <td>0</td> <td>0</td> <td>0</td> <td>8</td> </tr> <tr> <td>30H</td> <td>30H</td> <td>30H</td> <td>38H</td> </tr> </table>	0	0	0	8	30H	30H	30H	38H	<table border="1" style="margin-left: auto; margin-right: auto;"> <tr> <td>08H</td> <td>00H</td> </tr> </table>	08H	00H
0	0	0	8									
30H	30H	30H	38H									
08H	00H											
For QD70D4 (occupied slots are 2): 0008H + 1 = 0009H	<table border="1" style="margin-left: auto; margin-right: auto;"> <tr> <td>0</td> <td>0</td> <td>0</td> <td>9</td> </tr> <tr> <td>30H</td> <td>30H</td> <td>30H</td> <td>39H</td> </tr> </table>	0	0	0	9	30H	30H	30H	39H	<table border="1" style="margin-left: auto; margin-right: auto;"> <tr> <td>09H</td> <td>00H</td> </tr> </table>	09H	00H
0	0	0	9									
30H	30H	30H	39H									
09H	00H											

Intelligent function module number of MELSECNET/H remote I/O station

Intelligent function module number of MELSECNET/H remote I/O station is the upper 2 digits of the last number represented with 3-digit number of the following "Input/output signal based on the remote I/O station".

Specify this with "Input/output signal based on the remote I/O station" regardless of the contents of common parameters set in the master station of MELSECNET/H remote I/O network.

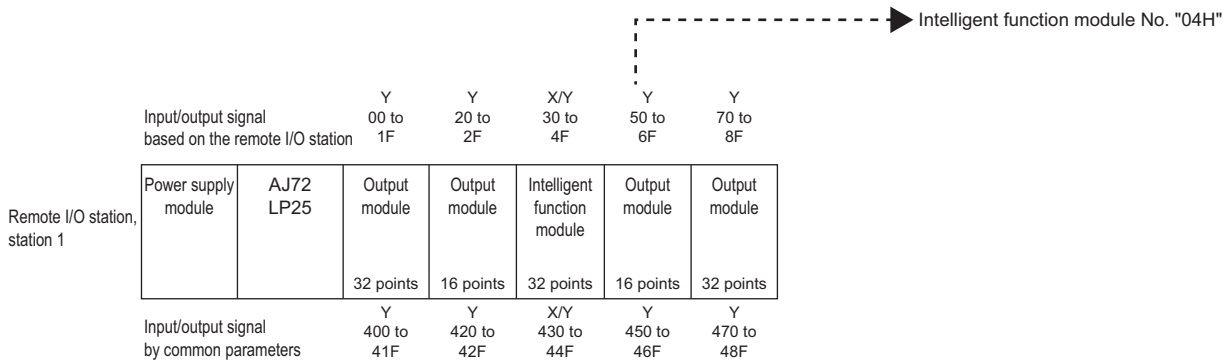

Read data, write data

The read buffer memory value is stored for reading, and the data to be written is stored for writing.

This function reads/writes data in byte unit.

Data communication in ASCII code

Handle a word data for one buffer memory address as 2-byte data.

Convert the value to 2-digit (hexadecimal) ASCII code per one byte, and send it from the upper digit.

Data communication in binary code

Handle a word data for one buffer memory address as 2-byte data.

Send 2-byte numerical values from lower byte (L: bits 0 to 7).

Ex.

When the data for one buffer memory address is 09C1H

ASCII code	Binary code										
<table border="1"> <tr> <td>C</td> <td>1</td> <td>0</td> <td>9</td> </tr> <tr> <td>43H</td> <td>31H</td> <td>30H</td> <td>39H</td> </tr> </table>	C	1	0	9	43H	31H	30H	39H	<table border="1"> <tr> <td>C1H</td> <td>09H</td> </tr> </table>	C1H	09H
C	1	0	9								
43H	31H	30H	39H								
C1H	09H										

When reading data from the following buffer memory addresses, 0H to 2H (additional value of the start address: 10000H)

Buffer memory		Read 6 bytes from address 0H			Read 4 bytes from address 1H				
Address	Stored data		Start address	Read data (byte unit)		Start address	Read data (byte unit)		
	Word unit	Byte unit		ASCII code	Binary code		ASCII code	Binary code	
0H	0003H	03H 00H	10000H	30H, 33H	03H	—			
				30H, 30H	00H				
1H	0001H	01H 00H		30H, 31H	01H		10002H	30H, 31H	01H
				30H, 30H	00H			30H, 30H	00H
2H	0012H	12H 00H		31H, 32H	12H			31H, 32H	12H
				30H, 30H	00H			30H, 30H	00H

Batch read (command: 0601)

Read data from the buffer memory of an intelligent function module.

Message format

The following shows the message format of the request data and response data of the command.

Request data

Command	Subcommand	Start address	Number of bytes	Module No.
---------	------------	---------------	-----------------	------------

Response data

The value read from the buffer memory is stored.

 Page 160 Read data, write data

Data specified by request data

Command

ASCII code	Binary code										
<table border="1"><tr><td>0</td><td>6</td><td>0</td><td>1</td></tr><tr><td>30H</td><td>36H</td><td>30H</td><td>31H</td></tr></table>	0	6	0	1	30H	36H	30H	31H	<table border="1"><tr><td>01H</td><td>06H</td></tr></table>	01H	06H
0	6	0	1								
30H	36H	30H	31H								
01H	06H										

Subcommand

ASCII code	Binary code										
<table border="1"><tr><td>0</td><td>0</td><td>0</td><td>0</td></tr><tr><td>30H</td><td>30H</td><td>30H</td><td>30H</td></tr></table>	0	0	0	0	30H	30H	30H	30H	<table border="1"><tr><td>00H</td><td>00H</td></tr></table>	00H	00H
0	0	0	0								
30H	30H	30H	30H								
00H	00H										

Start address

Specify the buffer memory start address to be read. ( Page 158 Start address)

Number of bytes

Specify the number of bytes of the buffer memory to be read. ( Page 159 Number of bytes)

Specification range: 2H to 780H (1920)

Module number

Specify the intelligent function module to be read. ( Page 159 Module number)

Point

Specify the access range within the range of buffer memory.

Communication example

Read the data of the buffer memory addresses 1H to 2H of Q62DA whose input/output signal is from 30H to 4FH (module No.: 03H).

Buffer memory of Q62DA			Data for command
Address	Name	Stored data (word unit)	Read data (byte unit)
1H	CH1 digital value	0001H	01H
			00H
2H	CH2 digital value	0012H	12H
			00H

■Data communication in ASCII code

(Request data)

Start address		Number of bytes	Module No.
0 6 0 1	0 0 0 0	0 0 0 0 1 0 0 A	0 0 0 3
30H, 36H, 30H, 31H	30H, 30H, 30H, 30H	30H, 30H, 30H, 30H, 31H, 30H, 30H, 41H	30H, 30H, 30H, 34H

(Response data)

Read data			
0 1	0 0	1 2	0 0
30H, 31H	30H, 30H	31H, 32H	30H, 30H

Values of address 1H =0001H Values of address 2H =0012H

■Data communication in binary code

(Request data)

Start address	Number of bytes	Module No.
01H, 06H	00H, 00H	0AH, 10H, 00H, 00H
	04H, 00H	03H, 00H

(Response data)

Read data			
01H	00H	12H	00H

Values of address 1H =0001H Values of address 2H =0012H

Batch write (command: 1601)

Write data to the buffer memory of an intelligent function module.

Restriction

Do not write any data in "System area" or "Write-protect area" in the buffer memory. Writing data to the "System area" or "Write-protect area" may cause malfunction of the programmable controller system.

Message format

The following shows the message format of the request data and response data of the command.

Request data

Command	Subcommand	Start address	Number of bytes	Module No.	Write data
---------	------------	---------------	-----------------	------------	------------

Response data

There is no response data for this command.

Data specified by request data

Command

ASCII code	Binary code
1 6 0 1 31H, 36H, 30H, 31H	01H, 16H

Subcommand

ASCII code	Binary code
0 0 0 0 30H, 30H, 30H, 30H	00H, 00H

Start address

Specify the buffer memory start address to be written. (Page 158 Start address)

Number of bytes

Specify the number of bytes of the buffer memory to be written. (Page 159 Number of bytes)

Specification range: 2H to 780H (1920)

Module number

Specify the intelligent function module to be written. (Page 159 Module number)

Write data

Specify the data to be written in the buffer memory. (Page 160 Read data, write data)

Point

Specify the access range within the range of buffer memory.

Communication example

Write data to the buffer memory addresses from 1H to 2H of Q62DA whose input/output signals are from 30H to 4FH (module No.: 03H).

Buffer memory of Q62DA			Data for command
Address	Name	Stored data (word unit)	Write data (byte unit)
1H	CH1 digital value	01F4H	F4H
			01H
2H	CH2 digital value	03E8H	E8H
			03H

■Data communication in ASCII code

(Request data)

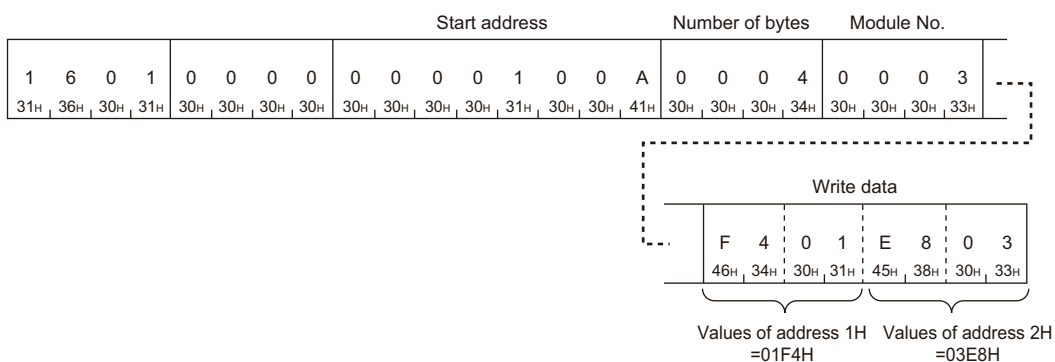

■Data communication in binary code

(Request data)

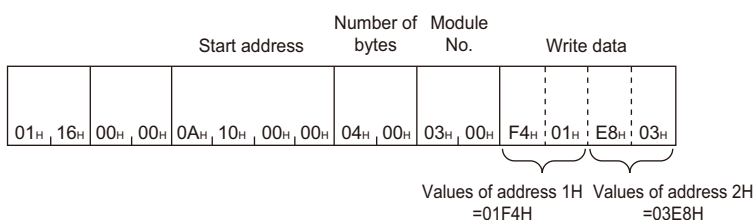

11 CONTROL MODULE OPERATION

This chapter explains the commands for changing operation status and performing test using the functions of the module.

11.1 Data to be specified in commands

This section explains the contents and specification methods for data items which are set in each command related to module control.

Mode

Select the operation when the request target module is already in remote operation by other device.

Setting method

■Data communication in ASCII code

Convert the numerical value to 4-digit ASCII code (hexadecimal), and send it from the upper digits.

■Data communication in binary code

Send 2-byte numerical values from lower byte (L: bits 0 to 7).

Process		ASCII code	Binary code										
Do not execute forcibly	Do not apply remote RUN/remote PAUSE while remote STOP/remote PAUSE is applied from other external device.	<table border="1"> <tr><td>0</td><td>0</td><td>0</td><td>1</td></tr> <tr><td>30H</td><td>30H</td><td>30H</td><td>31H</td></tr> </table>	0	0	0	1	30H	30H	30H	31H	<table border="1"> <tr><td>01H</td><td>00H</td></tr> </table>	01H	00H
0	0	0	1										
30H	30H	30H	31H										
01H	00H												
Execute forcibly	Apply remote RUN/remote PAUSE while remote STOP/remote PAUSE is applied from other external device.	<table border="1"> <tr><td>0</td><td>0</td><td>0</td><td>3</td></tr> <tr><td>30H</td><td>30H</td><td>30H</td><td>33H</td></tr> </table>	0	0	0	3	30H	30H	30H	33H	<table border="1"> <tr><td>03H</td><td>00H</td></tr> </table>	03H	00H
0	0	0	3										
30H	30H	30H	33H										
03H	00H												

Clear mode

Select the range of the device memory to be cleared by the initialization processing at remote RUN.

When the device initial values are set, they will be reflected after the process with the selected clear mode.

Setting method

■Data communication in ASCII code

Convert the numerical value to 2-digit ASCII code (hexadecimal), and send it from the upper digits.

■Data communication in binary code

Send a 1-byte numerical value.

Process		ASCII code	Binary code					
Do not clear	Do not clear device memory.	<table border="1"> <tr><td>0</td><td>0</td></tr> <tr><td>30H</td><td>30H</td></tr> </table>	0	0	30H	30H	<table border="1"> <tr><td>00H</td></tr> </table>	00H
0	0							
30H	30H							
00H								
Clear outside the range of latch	Clear the device memory outside the range of latch.	<table border="1"> <tr><td>0</td><td>1</td></tr> <tr><td>30H</td><td>31H</td></tr> </table>	0	1	30H	31H	<table border="1"> <tr><td>01H</td></tr> </table>	01H
0	1							
30H	31H							
01H								
All clear	Clear all device memory including the range of latch.	<table border="1"> <tr><td>0</td><td>2</td></tr> <tr><td>30H</td><td>32H</td></tr> </table>	0	2	30H	32H	<table border="1"> <tr><td>02H</td></tr> </table>	02H
0	2							
30H	32H							
02H								

Model name and model code

The model name and model code of the access target module.

Model name

The character string of a model name is stored in 16-digit ASCII code.

If the read model name is less than 16 characters, a space (20H) is stored for the shortage of the characters.

The model name is stored in ASCII code while communicating in binary code.

Ex.

For Q02HCPU

ASCII code, binary code

Q	0	2	H	C	P	U									
51H	30H	32H	48H	43H	50H	55H	20H	20H	20H	20H	20H	20H	20H	20H	20H

Model code

The model code of the module is stored.

■Data communication in ASCII code

Convert the numerical value to 4-digit ASCII code (hexadecimal), and send it from the upper digits.

■Data communication in binary code

Send 2-byte numerical values from lower byte (L: bits 0 to 7).

Ex.

For Q02HCPU (41H)

ASCII code	Binary code										
<table border="1"><tr><td>0</td><td>0</td><td>4</td><td>1</td></tr><tr><td>30H</td><td>30H</td><td>34H</td><td>31H</td></tr></table>	0	0	4	1	30H	30H	34H	31H	<table border="1"><tr><td>41H</td><td>00H</td></tr></table>	41H	00H
0	0	4	1								
30H	30H	34H	31H								
41H	00H										

Model name and model code list

The following shows the list of model names and model codes.

■MELSEC iQ-R series

Model name	Model code
RCPU	0360H
R00CPU	48A0H
R01CPU	48A1H
R02CPU	48A2H
R04CPU	4800H
R04ENCPU	4805H
R08CPU	4801H
R08ENCPU	4806H
R08PCPU	4841H
R08PSFCPU	4851H
R08SF CPU	4891H
R16CPU	4802H
R16ENCPU	4807H
R16PCPU	4842H
R16PSFCPU	4852H
R16SF CPU	4892H
R32CPU	4803H
R32ENCPU	4808H
R32PCPU	4843H
R32PSFCPU	4853H
R32SF CPU	4893H
R120CPU	4804H
R120ENCPU	4809H
R120PCPU	4844H
R120PSFCPU	4854H
R120SF CPU	4894H
RJ72GF15-T2	4860H
RJ72GF15-T2 (redundant system (single line))	4861H
RJ72GF15-T2 (redundant system (redundant line))	4862H



When a command is executed to an RCPU or a CC-Link IE Field Network remote head module from the module of which connected station is other than MELSEC iQ-R series, the model name 'RCPU' and the model code '0360H' are stored.

■MELSEC iQ-L series

Model name	Model code
L04HCPU	055DH
L08HCPU	055EH
L16HCPU	055FH

■MELSEC-L series

Model name	Model code
L02SCPU, L02SCPU-P	0543H
L02CPU, L02CPU-P	0541H
L06CPU, L06CPU-P	0544H
L26CPU, L26CPU-P	0545H
L26CPU-BT, L26CPU-PBT	0542H
LJ72GF15-T2	0641H

■MELSEC-Q series

Model name	Model code
Q00JCPU	0250H
Q00CPU	0251H
Q01CPU	0252H
Q02CPU, Q02HCPU, Q02PHCPU	0041H
Q06HCPU, Q06PHCPU	0042H
Q12HCPU, Q12PHCPU	0043H
Q25HCPU, Q25PHCPU	0044H
Q12PRHCPU	004BH
Q25PRHCPU	004CH
Q00UJCPU	0260H
Q00UCPU	0261H
Q01UCPU	0262H
Q02UCPU	0263H
Q03UDCPU, Q03UDECPU	0268H
Q03UDVCPU	0366H
Q04UDHCPU, Q04UDEHCPU	0269H
Q04UDVCPU, Q04UDPVCPU	0367H
Q06UDHCPU, Q06UDEHCPU	026AH
Q06UDVCPU, Q06UDPVCPU	0368H
Q10UDHCPU, Q10UDEHCPU	0266H
Q13UDHCPU, Q13UDEHCPU	026BH
Q13UDVCPU, Q13UDPVCPU	036AH
Q20UDHCPU, Q20UDEHCPU	0267H
Q26UDHCPU, Q26UDEHCPU	026CH
Q26UDVCPU, Q26UDPVCPU	036CH
Q50UDEHCPU	026DH
Q100UDEHCPU	026EH
QS001CPU	0230H

Remote password

Remote password length

Specify the number of characters of remote password.

- For MELSEC-Q/L series modules, the character string is fixed to 4 characters.
- For MELSEC iQ-R series modules, specify the number of character string of the remote password (6 to 32 characters).

■Data communication in ASCII code

Convert the numerical value to 4-digit ASCII code (hexadecimal), and send it from the upper digits.

■Data communication in binary code

Send 2-byte^{*1} numerical values from lower byte (L: bits 0 to 7).

*1 For C24, the additional code may be added. (Page 35 Additional code (10H))

Ex.

For 4 characters, 32 characters

Access target	ASCII code	Binary code										
MELSEC-Q/L series module (4 characters fixed)	<table border="1"> <tr> <td>0</td> <td>0</td> <td>0</td> <td>4</td> </tr> <tr> <td>30H</td> <td>30H</td> <td>30H</td> <td>34H</td> </tr> </table>	0	0	0	4	30H	30H	30H	34H	<table border="1"> <tr> <td>04H</td> <td>00H</td> </tr> </table>	04H	00H
0	0	0	4									
30H	30H	30H	34H									
04H	00H											
MELSEC iQ-R series module (32 characters)	<table border="1"> <tr> <td>0</td> <td>0</td> <td>2</td> <td>0</td> </tr> <tr> <td>30H</td> <td>30H</td> <td>32H</td> <td>30H</td> </tr> </table>	0	0	2	0	30H	30H	32H	30H	<table border="1"> <tr> <td>20H</td> <td>00H</td> </tr> </table>	20H	00H
0	0	2	0									
30H	30H	32H	30H									
20H	00H											

Remote password

The remote password is set by Engineering tool.

Specify the remote password in ASCII code while communicating in binary code.

Ex.

When the password is 'ABCDEF'

ASCII code, binary code	
A	B C D E F
41H	42H, 43H, 44H, 45H, 46H

Loopback data

Loopback data length

Number of bytes of loopback data.

■Data communication in ASCII code

Convert the numerical value to 4-digit ASCII code (hexadecimal), and send it from the upper digits.

■Data communication in binary code

Send 2-byte^{*1} numerical values from lower byte (L: bits 0 to 7).

*1 For C24, the additional code may be added. (☞ Page 35 Additional code (10H))

Ex.

For 5 bytes

ASCII code	Binary code										
<table border="1"><tr><td>0</td><td>0</td><td>0</td><td>5</td></tr><tr><td>30H</td><td>30H</td><td>30H</td><td>35H</td></tr></table>	0	0	0	5	30H	30H	30H	35H	<table border="1"><tr><td>05H</td><td>00H</td></tr></table>	05H	00H
0	0	0	5								
30H	30H	30H	35H								
05H	00H										

Loopback data

The following characters can be used.

- 0 to 9 (30H to 39H)
- A to F (41H to 46H)

Specify the loopback data in ASCII code while communicating in binary code.

Ex.

For 'ABCDEF'

ASCII code, binary code												
<table border="1"><tr><td>A</td><td>B</td><td>C</td><td>D</td><td>E</td><td>F</td></tr><tr><td>41H</td><td>42H</td><td>43H</td><td>44H</td><td>45H</td><td>46H</td></tr></table>	A	B	C	D	E	F	41H	42H	43H	44H	45H	46H
A	B	C	D	E	F							
41H	42H	43H	44H	45H	46H							

Communication error information

A data to specify the communication error information to be initialized.

The data is equivalent to the buffer memory '0H', '1H' of MELSEC-Q/L series C24.

Specify the value (16-bit integer) in bit unit. The communication error information and its corresponding bit are as follows.

Item	b15	b14	b13 to b8	b7	b6	b5	b4	b3	b2	b1	b0
Communication error information (CH1)	—	—	—	NEU	ACK	NAK	C/N	P/S	PRO	SIO	SD.WAIT
Communication error information (CH2)	CH1.ERR	CH2.ERR									

The communication error information to be initialized can be specified by turning the corresponding bit ON (1).

When the command is executed, the following corresponding bit of the buffer memory turns OFF (0).

"LED lighting status, communication error status" (Buffer memory 513 (201H), 514 (202H))

For MELSEC iQ-R series C24, specify '0'.

Setting method

■Data communication in ASCII code

Convert the numerical value to 4-digit ASCII code (hexadecimal), and send it from the upper digits.

■Data communication in binary code

Send 2-byte^{*1} numerical values from lower byte (L: bits 0 to 7).

*1 For C24, the additional code may be added. (Page 35 Additional code (10H))

Ex.

When initializing C/N, P/S, PRO, and SIO (bit 1 to 4) with MELSEC-Q/L series C24.

Item	ASCII code	Binary code										
Communication error information (CH1)	<table border="1"> <tr><td>0</td><td>0</td><td>1</td><td>E</td></tr> <tr><td>30H</td><td>30H</td><td>31H</td><td>45H</td></tr> </table>	0	0	1	E	30H	30H	31H	45H	<table border="1"> <tr><td>1E</td><td>00</td></tr> </table>	1E	00
0	0	1	E									
30H	30H	31H	45H									
1E	00											
Communication error information (CH2)	<table border="1"> <tr><td>0</td><td>0</td><td>0</td><td>0</td></tr> <tr><td>30H</td><td>30H</td><td>30H</td><td>30H</td></tr> </table>	0	0	0	0	30H	30H	30H	30H	<table border="1"> <tr><td>00</td><td>00</td></tr> </table>	00	00
0	0	0	0									
30H	30H	30H	30H									
00	00											

Ex.

For MELSEC iQ-R series

Item	ASCII code	Binary code										
Communication error information (CH1)	<table border="1"> <tr><td>0</td><td>0</td><td>0</td><td>0</td></tr> <tr><td>30H</td><td>30H</td><td>30H</td><td>30H</td></tr> </table>	0	0	0	0	30H	30H	30H	30H	<table border="1"> <tr><td>00</td><td>00</td></tr> </table>	00	00
0	0	0	0									
30H	30H	30H	30H									
00	00											
Communication error information (CH2)	<table border="1"> <tr><td>0</td><td>0</td><td>0</td><td>0</td></tr> <tr><td>30H</td><td>30H</td><td>30H</td><td>30H</td></tr> </table>	0	0	0	0	30H	30H	30H	30H	<table border="1"> <tr><td>00</td><td>00</td></tr> </table>	00	00
0	0	0	0									
30H	30H	30H	30H									
00	00											

11.2 Remote Operation

Change the operation status of CPU module.

For the remote operation function, refer to the manual of each CPU module.

Point

- When powering OFF to ON or resetting the access target CPU after applying remote RUN/STOP/PAUSE, the information of the remote operation will be cancelled. After powering OFF to ON or resetting CPU, the CPU operates with the status of the switch on the CPU module.
- When the system protection of the access target module is enabled, the remote operation cannot be performed and an error response will be returned. Disable the system protection of the CPU module.
- For E71, the communication using UDP/IP is recommended. For the communication using TCP/IP, re-establishment of the connection is required because the connection is disconnected at resetting CPU module.
- One communication of command provides remote operation for 1 station.

Remote RUN (command: 1001)

Perform remote RUN to the access target module.

Restriction

The command can be executed when the switch of the access target module is RUN. In the STOP status, the command is completed normally, however, the access target CPU will not be in RUN status.

Message format

The following shows the message format of the request data and response data of the command.

Request data

Command	Subcommand	Mode	Clear mode	Fixed values
---------	------------	------	------------	--------------

Response data

There is no response data for this command.

Data specified by request data

■Command

ASCII code	Binary code (for C24)*1	Binary code (for E71)														
<table border="1"> <tr><td>1</td><td>0</td><td>0</td><td>1</td></tr> <tr><td>31H</td><td>30H</td><td>30H</td><td>31H</td></tr> </table>	1	0	0	1	31H	30H	30H	31H	<table border="1"> <tr><td>01H</td><td>DLE</td><td>10H</td><td>10H</td></tr> </table>	01H	DLE	10H	10H	<table border="1"> <tr><td>01H</td><td>10H</td></tr> </table>	01H	10H
1	0	0	1													
31H	30H	30H	31H													
01H	DLE	10H	10H													
01H	10H															

*1 For C24, an additional code is added. (☞ Page 35 Additional code (10H))

■Subcommand

ASCII code	Binary code										
<table border="1"> <tr><td>0</td><td>0</td><td>0</td><td>0</td></tr> <tr><td>30H</td><td>30H</td><td>30H</td><td>30H</td></tr> </table>	0	0	0	0	30H	30H	30H	30H	<table border="1"> <tr><td>00H</td><td>00H</td></tr> </table>	00H	00H
0	0	0	0								
30H	30H	30H	30H								
00H	00H										

■Mode

Select the operation when the request target module is already in remote operation by other device. (☞ Page 165 Mode)

- 0001H: Do not execute forcibly
- 0003H: Execute forcibly

■Clear mode

Select the range of the device memory to be cleared by the initialization processing at remote RUN. (☞ Page 165 Clear mode)

- 00H: Do not clear
- 01H: Clear only outside the latch range
- 02H: All clear

■Fixed value

Fixed to '0'.

ASCII code	Binary code					
<table border="1"> <tr><td>0</td><td>0</td></tr> <tr><td>30H</td><td>30H</td></tr> </table>	0	0	30H	30H	<table border="1"> <tr><td>00H</td></tr> </table>	00H
0	0					
30H	30H					
00H						

Communication example

Remote RUN is performed when the mode is set to "Do not execute forcibly", and the clear mode is set to "All clear".

■Data communication in ASCII code

(Request data)

				Mode	Clear mode						
1	0	0	1	0	0	0	1	0	2	0	0
31H	30H	30H	31H	30H	30H	30H	30H	30H	32H	30H	30H

■Data communication in binary code

(Request data)

		Mode	Clear mode				
01H	10H	00H	00H	01H	00H	02H	00H

Remote STOP (command: 1002)

Perform remote STOP to the access target module.

Message format

The following shows the message format of the request data and response data of the command.

Request data

Command	Subcommand	Fixed values
---------	------------	--------------

Response data

There is no response data for this command.

Data specified by request data

Command

ASCII code	Binary code (for C24)*1	Binary code (for E71)														
<table border="1"> <tr><td>1</td><td>0</td><td>0</td><td>2</td></tr> <tr><td>31H</td><td>30H</td><td>30H</td><td>32H</td></tr> </table>	1	0	0	2	31H	30H	30H	32H	<table border="1"> <tr><td>02H</td><td>DLE</td><td>10H</td><td>10H</td></tr> </table>	02H	DLE	10H	10H	<table border="1"> <tr><td>02H</td><td>10H</td></tr> </table>	02H	10H
1	0	0	2													
31H	30H	30H	32H													
02H	DLE	10H	10H													
02H	10H															

*1 For C24, an additional code is added. (☞ Page 35 Additional code (10H))

Subcommand

ASCII code	Binary code										
<table border="1"> <tr><td>0</td><td>0</td><td>0</td><td>0</td></tr> <tr><td>30H</td><td>30H</td><td>30H</td><td>30H</td></tr> </table>	0	0	0	0	30H	30H	30H	30H	<table border="1"> <tr><td>00H</td><td>00H</td></tr> </table>	00H	00H
0	0	0	0								
30H	30H	30H	30H								
00H	00H										

Fixed value

The value is '0001H'.

Communication example

Perform remote STOP.

Data communication in ASCII code

(Request data)

1	0	0	2	0	0	0	0	0	0	0	1
31H	30H	30H	32H	30H	30H	30H	30H	30H	30H	30H	31H

Data communication in binary code

(Request data)

02H	10H	00H	00H	01H	00H
-----	-----	-----	-----	-----	-----

Remote PAUSE (command: 1003)

Perform remote PAUSE to the access target module.

Restriction

The command can be executed when the switch of the access target module is RUN. In the STOP status, the command is completed normally, however, the access target CPU will not be in PAUSE status.

Message format

The following shows the message format of the request data and response data of the command.

Request data

Command	Subcommand	Mode
---------	------------	------

Response data

There is no response data for this command.

Data specified by request data

Command

ASCII code	Binary code (for C24)*1	Binary code (for E71)														
<table border="1"> <tr><td>1</td><td>0</td><td>0</td><td>3</td></tr> <tr><td>31H</td><td>30H</td><td>30H</td><td>33H</td></tr> </table>	1	0	0	3	31H	30H	30H	33H	<table border="1"> <tr><td>03H</td><td>DLE</td><td>10H</td><td>10H</td></tr> </table>	03H	DLE	10H	10H	<table border="1"> <tr><td>03H</td><td>10H</td></tr> </table>	03H	10H
1	0	0	3													
31H	30H	30H	33H													
03H	DLE	10H	10H													
03H	10H															

*1 For C24, an additional code is added. (Page 35 Additional code (10H))

Subcommand

ASCII code	Binary code										
<table border="1"> <tr><td>0</td><td>0</td><td>0</td><td>0</td></tr> <tr><td>30H</td><td>30H</td><td>30H</td><td>30H</td></tr> </table>	0	0	0	0	30H	30H	30H	30H	<table border="1"> <tr><td>00H</td><td>00H</td></tr> </table>	00H	00H
0	0	0	0								
30H	30H	30H	30H								
00H	00H										

Mode

Select the operation when the request target module is already in remote operation by other device. (Page 165 Mode)

- 0001H: Do not execute forcibly
- 0003H: Execute forcibly

Communication example

Remote PAUSE is performed when the mode is set to "Do not execute forcibly".

Data communication in ASCII code

(Request data)

1	0	0	3	0	0	0	0	0	0	0	1
31H	30H	30H	33H	30H	30H	30H	30H	30H	30H	30H	31H

Data communication in binary code

(Request data)

03H	10H	00H	00H	01H	00H
-----	-----	-----	-----	-----	-----

Remote latch clear (command: 1005)

Perform remote latch clear to the access target module.

Restriction

- Execute the command after changing the status of the access target module to STOP.
- The remote latch clear cannot be performed when the access target CPU is in remote STOP or remote PAUSE by other devices. The command will be terminated abnormally. Clear the remote STOP or remote PAUSE before executing the command.

Message format

The following shows the message format of the request data and response data of the command.

Request data

Command	Subcommand	Fixed values
---------	------------	--------------

Response data

There is no response data for this command.

Data specified by request data

Command

ASCII code	Binary code (for C24)*1	Binary code (for E71)																		
<table border="1"> <tr><td>1</td><td>0</td><td>0</td><td>5</td></tr> <tr><td>31H</td><td>30H</td><td>30H</td><td>35H</td></tr> </table>	1	0	0	5	31H	30H	30H	35H	<table border="1"> <tr><td></td><td>DLE</td><td></td></tr> <tr><td>05H</td><td>10H</td><td>10H</td></tr> </table>		DLE		05H	10H	10H	<table border="1"> <tr><td></td><td></td></tr> <tr><td>05H</td><td>10H</td></tr> </table>			05H	10H
1	0	0	5																	
31H	30H	30H	35H																	
	DLE																			
05H	10H	10H																		
05H	10H																			

*1 For C24, an additional code is added. (Page 35 Additional code (10H))

Subcommand

ASCII code	Binary code												
<table border="1"> <tr><td>0</td><td>0</td><td>0</td><td>0</td></tr> <tr><td>30H</td><td>30H</td><td>30H</td><td>30H</td></tr> </table>	0	0	0	0	30H	30H	30H	30H	<table border="1"> <tr><td></td><td></td></tr> <tr><td>00H</td><td>00H</td></tr> </table>			00H	00H
0	0	0	0										
30H	30H	30H	30H										
00H	00H												

Fixed value

The value is '0001H'.

Communication example

Perform remote latch clear.

Data communication in ASCII code

(Request data)

1	0	0	5	0	0	0	0	0	0	0	1
31H	30H	30H	35H	30H	30H	30H	30H	30H	30H	30H	31H

Data communication in binary code

(Request data)

05H	10H	00H	00H	01H	00H

Remote RESET (command: 1006)

Perform remote RESET to the access target module.

Restriction

- Execute the command after changing the status of the access target module to STOP. If the CPU module is stopped due to the error, the command can be executed even when the switch of the CPU module is in the position of RUN,
- If a remote RESET operation enable/disable setting exists in the access target parameter, set it to enable.
- Remote RESET may not be performed due to the hardware error of the access target device.
- When performing remote RESET, the response message may not be returned because the access target CPU is reset.

Message format

The following shows the message format of the request data and response data of the command.

Request data

Command	Subcommand	Fixed values
---------	------------	--------------

Response data

There is no response data for this command.

Data specified by request data

Command

ASCII code	Binary code (for C24)*1	Binary code (for E71)														
<table border="1"> <tr><td>1</td><td>0</td><td>0</td><td>6</td></tr> <tr><td>31H</td><td>30H</td><td>30H</td><td>36H</td></tr> </table>	1	0	0	6	31H	30H	30H	36H	<table border="1"> <tr><td>06H</td><td>DLE</td><td>10H</td><td>10H</td></tr> </table>	06H	DLE	10H	10H	<table border="1"> <tr><td>06H</td><td>10H</td></tr> </table>	06H	10H
1	0	0	6													
31H	30H	30H	36H													
06H	DLE	10H	10H													
06H	10H															

*1 For C24, an additional code is added. (Page 35 Additional code (10H))

Subcommand

ASCII code	Binary code										
<table border="1"> <tr><td>0</td><td>0</td><td>0</td><td>0</td></tr> <tr><td>30H</td><td>30H</td><td>30H</td><td>30H</td></tr> </table>	0	0	0	0	30H	30H	30H	30H	<table border="1"> <tr><td>00H</td><td>00H</td></tr> </table>	00H	00H
0	0	0	0								
30H	30H	30H	30H								
00H	00H										

Fixed value

The value is '0001H'.

Communication example

Perform remote RESET.

Data communication in ASCII code

(Request data)

1	0	0	6	0	0	0	0	0	0	0	1
31H	30H	30H	36H	30H	30H	30H	30H	30H	30H	30H	31H

Data communication in binary code

(Request data)

06H	10H	00H	00H	01H	00H
-----	-----	-----	-----	-----	-----

Read CPU model name (command: 0101)

Read model name and model code from the access target module.

Message format

The following shows the message format of the request data and response data of the command.

Request data

Command	Subcommand
---------	------------

Response data

Model name and model code are stored. (☞ Page 166 Model name and model code)



- Discriminate the model name of the CPU with the model code.

Data specified by request data

Command

ASCII code	Binary code										
<table border="1"> <tr> <td>0</td> <td>1</td> <td>0</td> <td>1</td> </tr> <tr> <td>30H</td> <td>31H</td> <td>30H</td> <td>31H</td> </tr> </table>	0	1	0	1	30H	31H	30H	31H	<table border="1"> <tr> <td>01H</td> <td>01H</td> </tr> </table>	01H	01H
0	1	0	1								
30H	31H	30H	31H								
01H	01H										

Subcommand

ASCII code	Binary code										
<table border="1"> <tr> <td>0</td> <td>0</td> <td>0</td> <td>0</td> </tr> <tr> <td>30H</td> <td>30H</td> <td>30H</td> <td>30H</td> </tr> </table>	0	0	0	0	30H	30H	30H	30H	<table border="1"> <tr> <td>00H</td> <td>00H</td> </tr> </table>	00H	00H
0	0	0	0								
30H	30H	30H	30H								
00H	00H										

Communication example

Execute the command for Q02UCPU to read the model name and model code.

Data communication in ASCII code

(Request data)

0	1	0	1	0	0	0	0
30H	31H	30H	31H	30H	30H	30H	30H

(Response data)

Q	0	2	U	C	P	U	0	2	6	3
51H	30H	32H	55H	43H	50H	55H	20H	20H	20H	20H
							30H	32H	36H	33H

Data communication in binary code

(Request data)

01H	01H	00H	00H
-----	-----	-----	-----

(Response data)

Q	0	2	U	C	P	U	
51H	30H	32H	55H	43H	50H	55H	20H
							63H
							02H

11.3 Remote Password

This section explains the commands that unlock or lock the remote password.
For details on the remote password, refer to the manuals of access target CPU or CPU module.

Restriction

The command can only be used for C24 (including multidrop connection station) and E71 connected to the external device. It cannot be used via network.

For the modem connection, access route must be set as the same route as that of the connected station (host station).

( Page 45 ACCESS ROUTE SETTINGS)

Execution procedure

The communication with the module in which the remote password is set, follow the procedure shown below.

1. Line connection by modem (C24)/open processing for connection (E71)
2. Access permission (unlock processing) ( Page 180 Unlock (command: 1630))
3. Access processing

Perform data communication by various commands of MC protocol.

4. Access prohibition (lock processing) ( Page 182 Lock (command: 1631))

For C24 or TCP/IP communication of E71, the lock processing is performed automatically at modem disconnection/close processing.

5. Line disconnection/close processing of connection

Point

All the commands received when the remote password is locked will be an error response. Perform data communication after the unlock processing.

Unlock (command: 1630)

Specify the remote password to unlock the module. (The module can communicate.)

Restriction

If the incorrect password is entered several times, the password is locked out and cannot be cleared for a while.

Point

When the command is sent to the unlocked module, the unlock status is not changed. (The password verification is not performed.)

Message format

The following shows the message format of the request data and response data of the command.

Request data

Command	Subcommand	Remote password length	Remote password
---------	------------	------------------------	-----------------

Response data

There is no response data for this command.

Data specified by request data

Command

ASCII code	Binary code										
<table border="1"><tr><td>1</td><td>6</td><td>3</td><td>0</td></tr><tr><td>31H</td><td>36H</td><td>33H</td><td>30H</td></tr></table>	1	6	3	0	31H	36H	33H	30H	<table border="1"><tr><td>30H</td><td>16H</td></tr></table>	30H	16H
1	6	3	0								
31H	36H	33H	30H								
30H	16H										

Subcommand

ASCII code	Binary code										
<table border="1"><tr><td>0</td><td>0</td><td>0</td><td>0</td></tr><tr><td>30H</td><td>30H</td><td>30H</td><td>30H</td></tr></table>	0	0	0	0	30H	30H	30H	30H	<table border="1"><tr><td>00H</td><td>00H</td></tr></table>	00H	00H
0	0	0	0								
30H	30H	30H	30H								
00H	00H										

Remote password length

Specify the number of characters of remote password. ( Page 169 Remote password length)

Remote password

Specify the set remote password. ( Page 169 Remote password)

Communication example (for MELSEC-Q series)

Unlock the MELSEC-Q/L series module in which the following remote password has been set.

- Remote password: '1234' (4 characters)

Data communication in ASCII code

(Request data)

				Subcommand	Remote password length	Remote password									
1	6	3	0	0	0	0	0	0	0	0	4	1	2	3	4
31H	36H	33H	30H	30H	30H	30H	30H	30H	30H	30H	34H	31H	32H	33H	34H

Data communication in binary code

(Request data)

		Remote password length	Remote password						
			1	2	3	4			
30H	16H	00H	00H	04H	00H	31H	32H	33H	34H

Communication example (files for MELSEC iQ-R series)

Unlock the MELSEC iQ-R series module in which the following remote password has been set.

- Remote password: 'abcdefghijklmnopqrstuvwxy' (26 characters)

Data communication in ASCII code

(Request data)

				Subcommand	Remote password length	Remote password																															
1	6	3	0	0	0	0	0	0	0	1	A																										
31H	36H	33H	30H	30H	30H	30H	30H	30H	30H	31H	41H																										
												Remote password																									
												a	b	c	d	e	f	g	h	i	j	k	l	m	n	o	p	q	r	s	t	u	v	w	x	y	z
												61H	62H	63H	64H	65H	66H	67H	68H	69H	6AH	6BH	6CH	6DH	6EH	6FH	70H	71H	72H	73H	74H	75H	76H	77H	78H	79H	7AH

Data communication in binary code

(Request data)

		Remote password length	Remote password																												
30H	16H	00H	00H	1AH	00H																										
		Remote password																													
		a	b	c	d	e	f	g	h	i	j	k	l	m	n	o	p	q	r	s	t	u	v	w	x	y	z				
		61H	62H	63H	64H	65H	66H	67H	68H	69H	6AH	6BH	6CH	6DH	6EH	6FH	70H	71H	72H	73H	74H	75H	76H	77H	78H	79H	7AH				

Lock (command: 1631)

Specify the remote password to lock the module. (The module cannot communicate.)

Point

When the command is sent to the locked module, the lock status is not changed. (The password verification is not performed.)

Message format

The following shows the message format of the request data and response data of the command.

Request data

Command	Subcommand	Remote password length	Remote password
---------	------------	------------------------	-----------------

Response data

There is no response data for this command.

Data specified by request data

Command

ASCII code	Binary code										
<table border="1"><tr><td>1</td><td>6</td><td>3</td><td>1</td></tr><tr><td>31H</td><td>36H</td><td>33H</td><td>31H</td></tr></table>	1	6	3	1	31H	36H	33H	31H	<table border="1"><tr><td>31H</td><td>16H</td></tr></table>	31H	16H
1	6	3	1								
31H	36H	33H	31H								
31H	16H										

Subcommand

ASCII code	Binary code										
<table border="1"><tr><td>0</td><td>0</td><td>0</td><td>0</td></tr><tr><td>30H</td><td>30H</td><td>30H</td><td>30H</td></tr></table>	0	0	0	0	30H	30H	30H	30H	<table border="1"><tr><td>00H</td><td>00H</td></tr></table>	00H	00H
0	0	0	0								
30H	30H	30H	30H								
00H	00H										

Remote password length

Specify the number of characters of remote password. ( Page 169 Remote password length)

Remote password

Specify the set remote password. ( Page 169 Remote password)

Communication example (for MELSEC-Q series)

Lock the MELSEC-Q/L series module in which the following remote password has been set.

- Remote password: '1234' (4 characters)

■Data communication in ASCII code

(Request data)

Subcommand				Remote password length				Remote password							
1	6	3	1	0	0	0	0	0	0	0	4	1	2	3	4
31H	36H	33H	31H	30H	30H	30H	30H	30H	30H	30H	34H	31H	32H	33H	34H

■Data communication in binary code

(Request data)

Subcommand		Remote password length		Remote password			
				1	2	3	4
31H	16H	00H	00H	04H	00H	31H	32H
						33H	34H

Communication example (files for MELSEC iQ-R series)

Lock the MELSEC iQ-R series module in which the following password has been set.

- Remote password: 'abcdefghijklmnopqrstuvwxyz' (26 characters)

■Data communication in ASCII code

(Request data)

Subcommand				Remote password length				Remote password																													
1	6	3	1	0	0	0	0	0	0	1	A																										
31H	36H	33H	31H	30H	30H	30H	30H	30H	30H	31H	41H																										
												Remote password																									
												a	b	c	d	e	f	g	h	i	j	k	l	m	n	o	p	q	r	s	t	u	v	w	x	y	z
												61H	62H	63H	64H	65H	66H	67H	68H	69H	6AH	6BH	6CH	6DH	6EH	6FH	70H	71H	72H	73H	74H	75H	76H	77H	78H	79H	7AH

■Data communication in binary code

(Request data)

Subcommand		Remote password length		Remote password																																																	
31H	16H	00H	00H	1AH	00H																																																
																												Remote password																									
																												a	b	c	d	e	f	g	h	i	j	k	l	m	n	o	p	q	r	s	t	u	v	w	x	y	z
																												61H	62H	63H	64H	65H	66H	67H	68H	69H	6AH	6BH	6CH	6DH	6EH	6FH	70H	71H	72H	73H	74H	75H	76H	77H	78H	79H	7AH

11.4 Loopback Test

This chapter explains the commands for testing the connection and data communication between an external device and connected station.



The command can only be used for C24 (including multidrop connection station) and E71 connected to the external device. It cannot be used via network.

Loopback test (command: 0619)

Perform the test to check whether the communication between the external device and connected station is normal. By performing the loopback test, the connection with external devices and operation of data communication can be checked.

Message format

The following shows the message format of the request data and response data of the command.

Request data

Command	Subcommand	Number of loopback data	Loopback data
---------	------------	-------------------------	---------------

Response data

The same data as "Number of loopback data" and "Loopback data" specified for request message is stored. (Page 170 Loopback data)

Number of loopback data	Loopback data
-------------------------	---------------

Data specified by request data

Command

ASCII code	Binary code										
<table border="1"> <tr> <td>0</td> <td>6</td> <td>1</td> <td>9</td> </tr> <tr> <td>30H</td> <td>36H</td> <td>31H</td> <td>39H</td> </tr> </table>	0	6	1	9	30H	36H	31H	39H	<table border="1"> <tr> <td>19H</td> <td>06H</td> </tr> </table>	19H	06H
0	6	1	9								
30H	36H	31H	39H								
19H	06H										

Subcommand

ASCII code	Binary code										
<table border="1"> <tr> <td>0</td> <td>0</td> <td>0</td> <td>0</td> </tr> <tr> <td>30H</td> <td>30H</td> <td>30H</td> <td>30H</td> </tr> </table>	0	0	0	0	30H	30H	30H	30H	<table border="1"> <tr> <td>00H</td> <td>00H</td> </tr> </table>	00H	00H
0	0	0	0								
30H	30H	30H	30H								
00H	00H										

Number of loopback data, loopback data

Specify the data to be transmitted by loopback test. (Page 170 Loopback data)

The data can be specified within the range (numerals 0 to 9 and characters A to F) of 1 to 960 bytes.

Communication example

Perform the loopback test with the following loopback data.

- Loopback data: 'ABCDE' (5 characters)

■Data communication in ASCII code

(Request data)

Subcommand				Number of loopback data				Loopback data								
0	6	1	9	0	0	0	0	0	0	0	5	A	B	C	D	E
30H	36H	31H	39H	30H	30H	30H	30H	30H	30H	30H	35H	41H	42H	43H	44H	45H

(Response data)

Number of loopback data				Loopback data				
0	0	0	5	A	B	C	D	E
30H	30H	30H	35H	41H	42H	43H	44H	45H

■Data communication in binary code

(Request data)

Subcommand		Number of loopback data		Loopback data				
				A	B	C	D	E
19H	06H	00H	00H	41H	42H	43H	44H	45H

(Response data)

Number of loopback data	Loopback data				
	A	B	C	D	E
05H	41H	42H	43H	44H	45H

11.5 Clear Error Information

This section explains the command to initialize LED display and error information of buffer memory, and recover the supported device.

For details of the related LEDs, input/output signals, and buffer memory, refer to the manual of the access target module.

Turn indicator LED OFF, initialize error code (command: 1617)

Turn OFF the indicator LED of the serial communication module, and initialize the communication error information and error codes.



The command can only be used for C24 (including multidrop connection station) connected to the external device. It cannot be used via network.

Message format

The following shows the message format of the request data and response data of the command.

Request data

Command	Subcommand	Communication error information (CH1)	Communication error information (CH2)
---------	------------	---------------------------------------	---------------------------------------

Response data

There is no response data for this command.

Data specified by request data

Command

ASCII code	Binary code										
<table border="1"><tr><td>1</td><td>6</td><td>1</td><td>7</td></tr><tr><td>31H</td><td>36H</td><td>31H</td><td>37H</td></tr></table>	1	6	1	7	31H	36H	31H	37H	<table border="1"><tr><td>17H</td><td>16H</td></tr></table>	17H	16H
1	6	1	7								
31H	36H	31H	37H								
17H	16H										

■Subcommand

Target		ASCII code	Binary code										
MELSEC-Q/L series	CH1 side	<table border="1"> <tr><td>0</td><td>0</td><td>0</td><td>5</td></tr> <tr><td>30H</td><td>30H</td><td>30H</td><td>35H</td></tr> </table>	0	0	0	5	30H	30H	30H	35H	<table border="1"> <tr><td>05H</td><td>00H</td></tr> </table>	05H	00H
	0	0	0	5									
	30H	30H	30H	35H									
05H	00H												
CH2 side	<table border="1"> <tr><td>0</td><td>0</td><td>0</td><td>A</td></tr> <tr><td>30H</td><td>30H</td><td>30H</td><td>41H</td></tr> </table>	0	0	0	A	30H	30H	30H	41H	<table border="1"> <tr><td>0AH</td><td>00H</td></tr> </table>	0AH	00H	
0	0	0	A										
30H	30H	30H	41H										
0AH	00H												
CH1 side, CH2 side	<table border="1"> <tr><td>0</td><td>0</td><td>0</td><td>F</td></tr> <tr><td>30H</td><td>30H</td><td>30H</td><td>46H</td></tr> </table>	0	0	0	F	30H	30H	30H	46H	<table border="1"> <tr><td>0FH</td><td>00H</td></tr> </table>	0FH	00H	
0	0	0	F										
30H	30H	30H	46H										
0FH	00H												
MELSEC iQ-R series	CH1 side, CH2 side	<table border="1"> <tr><td>0</td><td>0</td><td>0</td><td>1</td></tr> <tr><td>30H</td><td>30H</td><td>30H</td><td>31H</td></tr> </table>	0	0	0	1	30H	30H	30H	31H	<table border="1"> <tr><td>01H</td><td>00H</td></tr> </table>	01H	00H
0	0	0	1										
30H	30H	30H	31H										
01H	00H												

Point

For C24 of MELSEC-Q/L series, 0 to 3 bits of subcommands are equivalent to the following functions of C24. The settings in the table above is recommended, even though the initialization can be performed with the values (0001H to 000FH) which combined ON/OFF arbitrarily.

- Bit 0: CH1 Error initialization request (YE) ON
- Bit 1: CH2 Error initialization request (YF) ON
- Bit 2: LED for CH1 OFF, communication error information initialization request (buffer memory address: 0H) ON
- Bit 3: LED for CH2 OFF, communication error information initialization request (buffer memory address: 1H) ON

■Communication error information

Specify the items in "LED lighting status, communication error status" to be initialized. (Page 171 Communication error information)

For MELSEC iQ-R series C24, specify '0'.

Communication example

Perform the following operations for CH1 interface of QJ71C24N-R2.

- ERR LED: OFF
- Input signal XE "Error occurrence": OFF
- Buffer memory 513 (201H) "LED lighting status, communication error status": Initialized (all items are OFF)
- Error code of buffer memory: Initialized (clear)

■Data communication in ASCII code

(Request data)

Subcommand	Communication error information (CH1)	Communication error information (CH2)
1 6 1 7	0 0 0 5	0 0 F F
31H, 36H, 33H, 31H	30H, 30H, 30H, 35H	30H, 30H, 46H, 46H
	30H, 30H, 30H, 30H	

■Data communication in binary code

(Request data)

Subcommand	Communication error information (CH1)	Communication error information (CH2)
17H, 16H	05H, 00H	FFH, 00H
		00H, 00H

Turn COM.ERR. LED OFF (command: 1617)

Turn the COM.ERR.LED of Ethernet interface module OFF.



The commands can be used for E71 connected to an external device and cannot be used via network.

Message format

The following shows the message format of the request data and response data of the command.

Request data

Command	Subcommand
---------	------------

Response data

There is no response data for this command.

Data specified by request data

Command

ASCII code	Binary code
1 6 1 7 31H, 36H, 31H, 37H	17H, 16H

Subcommand

ASCII code	Binary code
0 0 0 0 30H, 30H, 30H, 30H	00H, 00H

Communication example

Turn COM.ERR.LED OFF.

Data communication in ASCII code

(Request data)

Subcommand	
1 6 1 7 31H, 36H, 31H, 37H	0 0 0 0 30H, 30H, 30H, 30H

Data communication in binary code

(Request data)

Subcommand	
17H, 16H	00H, 00H

12 FILE CONTROL

This chapter explains the commands that operate files in the supported devices the CPU module.

Use this function in the following situations:

- To check the parameters and programs stored in the CPU module
- To change the parameters and programs in the CPU module according to the control content

For file name, extension, and storage location of files that can be handled by MC protocol, refer to the manual of the module to be accessed.

12.1 Execution Procedure

12

The following shows the file control procedures.

Procedure to read information from all files in directory (folder)

1. Read the file information from the head of the file.

Specify '1' for "Head file No." and '36' (upper limit) for "Number of requested file", and execute the 'read directory/file information' command. The file information of "Number of file information" is stored in the response data.

 Page 210 Read directory/file information (command: 1810)

2. Check if there is a file from which the file information is not read.

When "Number of file information" of the response data is in the status as shown below, it indicates that file information of all the files have been read. Complete the processing.

- MELSEC-Q/L series (when using subcommand '0000'): "Number of file information" < "Number of requested file"
- MELSEC iQ-R series (when using subcommand '0040'): "Number of file information" = -1 (FFFFH)

3. Read the file information from a file from which the file information is not read.

Specify "Number of requested file" = 36 (upper limit) to the request data, and execute the command.

For "Head file No.", specify one of the following value.

- MELSEC-Q/L series (when using subcommand '0000'): "Head file No." = previous "Head file No." + "Number of file information"
- MELSEC iQ-R series (when using subcommand '0040'): "Head file No." = previous "Last file No." + 1

 Page 210 Read directory/file information (command: 1810)

4. Repeat the procedure of Step 2 and later.



Point

The correct information cannot be obtained if the file operation is performed from other devices while reading information of all the files in the directory. Do not perform file operation from other devices while reading file information.

Procedure to read files

1. Check for file existence.



Any of the following commands can be used.

-  Page 210 Read directory/file information (command: 1810)
-  Page 216 Search directory/file information (command: 1811)

2. Read the files.

For read command, use open and close command to prohibit access from other devices.



Execute the commands in the following order.

-  Page 235 Open file (command: 1827)
-  Page 239 Read file (command: 1828)
-  Page 243 Close file (command: 182A)

Procedure to overwrite files

1. Check for file existence.



Any of the following commands can be used.

-  Page 210 Read directory/file information (command: 1810)
-  Page 216 Search directory/file information (command: 1811)

2. Write data to the file.

For writing data, use open and close command to prohibit access from other devices.

Execute the commands in the following order.

-  Page 235 Open file (command: 1827)
-  Page 241 Write to file (command: 1829)
-  Page 243 Close file (command: 182A)

Point

In the following cases, create a new file and write data to it after deleting the target file.

- When the target file is sequence program file (*.PRG) or FB file (*.PFB) of MELSEC iQ-R series.
- When changing the file size of MELSEC-Q/L series is required.

 Page 192 Procedure to delete files

 Page 191 Procedure to create new file and write data

Procedure to create new file and write data

The procedure varies depending on types of file. Refer to procedure according to file types.

File type	File extension		Reference
	MELSEC-Q/L series	MELSEC iQ-R series	
Header statement file	DAT	—	Page 191 When creation of temporary file is required
Sequence program file	QPG	PRG	
Device comment file	QCD	DCM	
Device initial value file	QDI	DID	
FB file	—	PFB	
File other than above			Page 191 When creation of temporary file is not required

Point 

Before creating a file, secure the free space of the target memory. It can be checked and secured by an Engineering tool.

When creation of temporary file is required

1. Create a new temporary file.

Register the file name and reserve the required capacity for the file.



The extension of the temporary file must be other than DAT, PRG, QPG, PFB, QCD, DCM, QDI, DID.

-  Page 219 Create new file (command: 1820)

2. Write data to the file.



For writing data, use open and close command to prohibit access from other devices.

Execute the commands in the following order.

-  Page 235 Open file (command: 1827)
-  Page 241 Write to file (command: 1829)
-  Page 243 Close file (command: 182A)

3. Create a file with the target file extension using the copy function.



After copying a file, delete the temporary file of the copy source as necessary.

-  Page 225 Copy file (command: 1824)
-  Page 222 Delete file (command: 1822)

When creation of temporary file is not required

1. Check for file existence.

Any of the following commands can be used.

-  Page 210 Read directory/file information (command: 1810)
-  Page 216 Search directory/file information (command: 1811)

2. Create a new file.



Register the file name to reserve the required capacity for the file.

-  Page 219 Create new file (command: 1820)

3. Write data to the file.

For writing data, use open and close command to prohibit access from other devices.



Execute the commands in the following order.

-  Page 235 Open file (command: 1827)
-  Page 241 Write to file (command: 1829)
-  Page 243 Close file (command: 182A)

Procedure to delete files

1. Check for file existence.

Any of the following commands can be used.

-  Page 210 Read directory/file information (command: 1810)
-  Page 216 Search directory/file information (command: 1811)

2. Delete the file.

-  Page 222 Delete file (command: 1822)



Procedure to copy files

Point

Before copying file, secure the free area of the target memory. It can be checked and secured with Engineering tool.



1. Check for file existence.

Any of the following commands can be used.

-  Page 210 Read directory/file information (command: 1810)
-  Page 216 Search directory/file information (command: 1811)

2. Copy the file.

After copying a file, delete the file of the copy source as necessary.

-  Page 225 Copy file (command: 1824)
-  Page 222 Delete file (command: 1822)

Procedure to modify file creation date and time

Modify the date of file creation by the 'modify file creation date and time' (command: 1826).

-  Page 232 Modify file creation date and time (command: 1826)

12.2 Considerations

The following shows the considerations for file control.

Files such as read programs and parameters

If the files such as program files and parameters which affect the system are read from the CPU module, keep the files for backup. Do not edit the data in the file on an external device. If the programs or parameters are required to be changed, use an Engineering tool.

Access for '\$MELPRJ\$' folder of RCPU

The \$MELPRJ\$ folder of RCPU is the folder that controls the data written from an Engineering. Do not access the \$MELPRJ\$ folder other than the purpose of data backup or restoration.

When performing data backup or restoration in the '\$MELPRJ\$' folder, read/write all the files in the '\$MELPRJ\$' folder. If only a part of '\$MELPRJ\$' folder is changed, it may not operate properly.

If the file is protected

When executing the following command, disable the protection (system protect of CPU module, the protection switch of SD memory card) of the access target CPU. If the command is executed with the access target protected, the command will be terminated abnormally.

Function	Reference
Create new file (Register file name)	Page 219 Create new file (command: 1820)
Delete file	Page 222 Delete file (command: 1822)
Copy file	Page 225 Copy file (command: 1824)
Modify file attribute	Page 229 Modify file attribute (command: 1825)
Modify file creation date and time	Page 232 Modify file creation date and time (command: 1826)
Write to file	Page 241 Write to file (command: 1829)

Files that cannot be modified while CPU module is in RUN

The executing file cannot be modified while the CPU module is in RUN.

When data write or delete command is executed to a file being executed, place CPU module in the STOP status. If the command is executed during RUN, the command completes abnormally.

 Page 464 Applicable Commands for Online Program Change

12.3 Data to be specified in commands

This section explains the contents and specification methods for data items which are set in each command related to file control.

Password

Specify the password of the file to be accessed.

The specification of a password differs depending on the module. Specify a password which corresponds to the module of access target.

For details on the password, refer to the manual of access target module.

Access target	Password to be set	Subcommand	Data specified by Message
MELSEC-Q series module	Password (4 characters)	0000	Password character string (fixed to 4 characters)
	File password 32 (4 characters)		
MELSEC-L series module	File password 32 (4 to 32 characters)	0004	Password character string (fixed to 32 characters)*1
MELSEC iQ-R series module	File password (6 to 32 characters)	0040	Number of password characters, password character string (variable length)

*1 If the password is less than 32 characters, append a space (code: 20H).

Password for MELSEC-Q series module (4 characters)

Use the subcommand '0000'.

■When a password is set

Send password character string in 4-digit ASCII code.

Specify the password in ASCII code during data communication in binary code as well.

Ex.

When the password is 'ABCD'

ASCII code, binary code

A	B	C	D
41H	42H	43H	44H

Restriction

When setting the password with the file password 32 function of High-speed universal model QCPU, set it with four characters.

■When a password is not set

Specify 20H for 4 bytes.

ASCII code, binary code

20H	20H	20H	20H
-----	-----	-----	-----

File password for MELSEC iQ-R series (6 to 32 characters)

Use the subcommand '0040'.

Point

If multiple wrong passwords are attempted continuously, the password will be locked out and cannot unlock the password for a while.

■When a password is set

Specify the number of characters and the character string of password.

Specify 'Password character string' with variable length. The length of data is specified in 'Number of characters'. (Page 199 Number of characters)

ASCII code	Binary code												
<table border="1"> <tr> <td>Number of characters</td> <td>Password character string</td> </tr> <tr> <td><input type="text"/></td> <td><input type="text"/></td> </tr> <tr> <td>(4 digits)</td> <td>(Variable length)</td> </tr> </table>	Number of characters	Password character string	<input type="text"/>	<input type="text"/>	(4 digits)	(Variable length)	<table border="1"> <tr> <td>Number of characters</td> <td>Password character string</td> </tr> <tr> <td><input type="text"/></td> <td><input type="text"/></td> </tr> <tr> <td>(2 bytes)</td> <td>(Variable length)</td> </tr> </table>	Number of characters	Password character string	<input type="text"/>	<input type="text"/>	(2 bytes)	(Variable length)
Number of characters	Password character string												
<input type="text"/>	<input type="text"/>												
(4 digits)	(Variable length)												
Number of characters	Password character string												
<input type="text"/>	<input type="text"/>												
(2 bytes)	(Variable length)												

Specify the password character string in ASCII code during data communication in binary code as well.

Ex.

Password is "ABCDEFGHIJKLMNOPQRSTUVWXYZ" (26 characters)

ASCII code	Binary code												
<table border="1"> <tr> <td>Number of characters</td> <td>Password character string</td> </tr> <tr> <td>0 0 1 A</td> <td>A B C D ... Z</td> </tr> <tr> <td>30H 30H 31H 41H</td> <td>41H 42H 43H 44H ... 5AH</td> </tr> </table>	Number of characters	Password character string	0 0 1 A	A B C D ... Z	30H 30H 31H 41H	41H 42H 43H 44H ... 5AH	<table border="1"> <tr> <td>Number of characters</td> <td>Password character string</td> </tr> <tr> <td></td> <td>A B C D ... Z</td> </tr> <tr> <td>1AH 00H</td> <td>41H 42H 43H 44H ... 5AH</td> </tr> </table>	Number of characters	Password character string		A B C D ... Z	1AH 00H	41H 42H 43H 44H ... 5AH
Number of characters	Password character string												
0 0 1 A	A B C D ... Z												
30H 30H 31H 41H	41H 42H 43H 44H ... 5AH												
Number of characters	Password character string												
	A B C D ... Z												
1AH 00H	41H 42H 43H 44H ... 5AH												

■When a password is not set

Specify with the number of character '0'.

ASCII code	Binary code			
<table border="1"> <tr> <td>0 0 0 0</td> </tr> <tr> <td>30H 30H 30H 30H</td> </tr> </table>	0 0 0 0	30H 30H 30H 30H	<table border="1"> <tr> <td>00H 00H</td> </tr> </table>	00H 00H
0 0 0 0				
30H 30H 30H 30H				
00H 00H				

Drive No.

This is a data to specify the drive in a CPU module of which files are to be managed.

Specified value	Target drive	
	RCPU	LCPU/QCPU/QnACPU
0000H	—	Program memory
0001H	Device/label memory (file storage area) The same operation when 0003H is specified.	SRAM card
0002H	SD memory card	Flash card, ATA card, SD memory card
0003H	Device/label memory (file storage area)	Standard RAM
0004H	Data memory	Standard ROM

12

Point

The program memory of RCPU cannot be accessed. When reading/writing program files, use the data memory. (Page 193 Access for '\$MELPRJ\$' folder of RCPU)

Setting method

■Data communication in ASCII code

Convert the numerical value that indicates access target drive to 4-digit ASCII code (hexadecimal), and send it from the upper digits.

■Data communication in binary code

Send 2-byte numerical values that indicate access target drive from the lower byte (L: bits 0 to 7).

Ex.

Drive No. is '0003H'

ASCII code	Binary code										
<table border="1"> <tr> <td>0</td> <td>0</td> <td>0</td> <td>3</td> </tr> <tr> <td>30H</td> <td>30H</td> <td>30H</td> <td>33H</td> </tr> </table>	0	0	0	3	30H	30H	30H	33H	<table border="1"> <tr> <td>03H</td> <td>00H</td> </tr> </table>	03H	00H
0	0	0	3								
30H	30H	30H	33H								
03H	00H										

File No.

This is a number for module to control files.

File No. can be obtained by following command.

☞ Page 216 Search directory/file information (command: 1811)

File No. of MELSEC-Q/L series module

Use the subcommand '0000'.

A file No. can be specified within the range of 1 to 256 (1H to 100H).

■Data communication in ASCII code

Convert the file No. to 4-digit ASCII code (hexadecimal), and send it from the upper digits.

■Data communication in binary code

Send 2-byte^{*1} numerical values that indicate file No. from lower byte (L: bits 0 to 7).

*1 For C24, the additional code may be added. (☞ Page 35 Additional code (10H))

Ex.
1FH

ASCII code	Binary code
0 0 1 F 30H, 30H, 31H, 46H	1FH, 00H

File No. of MELSEC iQ-R series module

Use the subcommand '0040'.

■Data communication in ASCII code

Convert the file No. to ASCII code 8 digits (hexadecimal), and transmit it from the upper digits.

■Data communication in binary code

Send 4-byte^{*1} numerical values that indicate file No. from the lower byte (L: bits 0 to 7).

*1 For C24, the additional code may be added. (☞ Page 35 Additional code (10H))

Ex.
1FH

ASCII code	Binary code
0 0 0 0 0 0 1 F 30H, 30H, 30H, 30H, 30H, 30H, 31H, 46H	1FH, 00H, 00H, 00H

Number of files

Specify the number of files to be accessed. The number of registered files or the number of accessed files are returned.

Setting method

■Data communication in ASCII code

Convert the numerical value to 4-digit ASCII code (hexadecimal), and send it from the upper digits.

■Data communication in binary code

Send 2-byte numerical values*¹ from the lower byte (L: bits 0 to 7).

*¹ For C24, the additional code may be added. (☞ Page 35 Additional code (10H))

Ex.

Number of file is 3

ASCII code	Binary code										
<table border="1"> <tr> <td>0</td> <td>0</td> <td>0</td> <td>3</td> </tr> <tr> <td>30H</td> <td>30H</td> <td>30H</td> <td>33H</td> </tr> </table>	0	0	0	3	30H	30H	30H	33H	<table border="1"> <tr> <td>03H</td> <td>00H</td> </tr> </table>	03H	00H
0	0	0	3								
30H	30H	30H	33H								
03H	00H										

Number of characters

This indicates the number of characters of variable length character string to be specified.

Setting method

■Data communication in ASCII code

Convert the numerical value to 4-digit ASCII code (hexadecimal), and send it from the upper digits.

■Data communication in binary code

Send 2-byte numerical values*¹ from the lower byte (L: bits 0 to 7).

*¹ For C24, the additional code may be added. (☞ Page 35 Additional code (10H))

Ex.

Number of characters is 86 characters (56H)

ASCII code	Binary code										
<table border="1"> <tr> <td>0</td> <td>0</td> <td>5</td> <td>6</td> </tr> <tr> <td>30H</td> <td>30H</td> <td>35H</td> <td>36H</td> </tr> </table>	0	0	5	6	30H	30H	35H	36H	<table border="1"> <tr> <td>56H</td> <td>00H</td> </tr> </table>	56H	00H
0	0	5	6								
30H	30H	35H	36H								
56H	00H										

Directory specification

Specify the absolute path to a file to be accessed.

Specify 'Path name' with variable length. The length of data is specified in 'Number of characters'. (☞ Page 199 Number of characters)

ASCII code	Binary code												
<table border="1"> <tr> <td>Number of characters</td> <td>Path name</td> </tr> <tr> <td><input type="text"/></td> <td><input type="text"/></td> </tr> <tr> <td>(4 digits)</td> <td>(Variable length)</td> </tr> </table>	Number of characters	Path name	<input type="text"/>	<input type="text"/>	(4 digits)	(Variable length)	<table border="1"> <tr> <td>Number of characters</td> <td>Path name</td> </tr> <tr> <td><input type="text"/></td> <td><input type="text"/></td> </tr> <tr> <td>(2 bytes)</td> <td>(Variable length)</td> </tr> </table>	Number of characters	Path name	<input type="text"/>	<input type="text"/>	(2 bytes)	(Variable length)
Number of characters	Path name												
<input type="text"/>	<input type="text"/>												
(4 digits)	(Variable length)												
Number of characters	Path name												
<input type="text"/>	<input type="text"/>												
(2 bytes)	(Variable length)												

Specify '0' for the root directory (root folder)

ASCII code	Binary code										
<table border="1"> <tr> <td>0</td> <td>0</td> <td>0</td> <td>0</td> </tr> <tr> <td>30H</td> <td>30H</td> <td>30H</td> <td>30H</td> </tr> </table>	0	0	0	0	30H	30H	30H	30H	<table border="1"> <tr> <td>00H</td> <td>00H</td> </tr> </table>	00H	00H
0	0	0	0								
30H	30H	30H	30H								
00H	00H										

Path name

Specify the absolute path by UTF-16 from the root folder.

"Drive name:\\" is not required in front of the path. Use '\\' (005CH) for the delimiter between the folder names.

■Data communication in ASCII code

Convert the numerical value of UTF-16, which indicates a path character string, to ASCII code (hexadecimal), and send it from the upper digits.

■Data communication in binary code

Send the numerical value of UTF-16 indicating the path character string from lower bytes (L: bits 0 to 7).

Ex.

Folder root folder 'A'

(UTF-16: 'A'= 0041)

ASCII code	Binary code										
<table border="1"><tr><td>0</td><td>0</td><td>4</td><td>1</td></tr><tr><td>30H</td><td>30H</td><td>34H</td><td>31H</td></tr></table>	0	0	4	1	30H	30H	34H	31H	<table border="1"><tr><td>41H</td><td>00H</td></tr></table>	41H	00H
0	0	4	1								
30H	30H	34H	31H								
41H	00H										

File name specification

Specify the file name to be accessed.

A file name differs in specification by the module. Specify a corresponding file name for the module of access target. For details of usable file name, refer to the manual of module for access target.

Access target	Usable file name	Subcommand	Data specified by Message
MELSEC-Q/L series module	File name (up to 8 characters) and extension (3 characters) Specify with ASCII code character string.	0000 0004	<ul style="list-style-type: none"> File name (8 characters fixed) and extension (3 characters fixed) Number of characters (up to 12 characters) and file name character string (including the extension)
MELSEC iQ-R series module	Path name, file name (up to 60 characters) and extension Specify with Unicode character string.	0040	<ul style="list-style-type: none"> Number of characters (up to 252 characters) and file name character string (including the path and extension)

Point 

Files other than the one described as usable files in the manuals of modules are for system. Do not change the file name.

File name of MELSEC-Q/L series module (File name and extension)

When using the subcommand 0000 for the read directory/file information (command: 1810), the file name (8 characters fixed) and the extension (3 characters fixed) are stored in the response data. A period is not inserted between the file name and the extension.

ASCII code, binary code

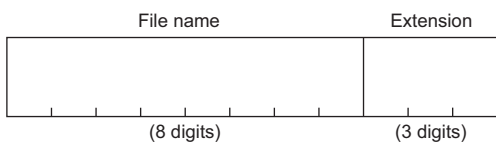

Specify the file name and the extension in ASCII code during data communication in binary code as well.

Ex.

The file name and the extension are "ABCDEFGH.QPG".

ASCII code, binary code

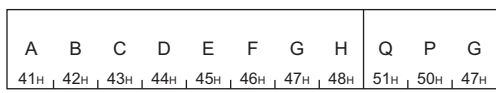

File name of MELSEC-Q/L series module (Number of characters and file name)

For the data other than response data of read directory/file information (command: 1810), specify with number of characters and file name character string.

Use the subcommand '0000' or '0004'.

The file name and the extension are specified as a variable length character string with a period inserted between them.

Specify the length of character string with "number of characters". (☞ Page 199 Number of characters)

ASCII code		Binary code	
Number of characters	File name + "." + Extension	Number of characters	File name + "." + Extension
<input type="text"/>	<input type="text"/>	<input type="text"/>	<input type="text"/>
(4 digits)	(Variable length)	(2 bytes)	(Variable length)

Specify "File name" + "Period (2EH)" + "Extension" in ASCII code during data communication in binary code as well.

Ex.

File name and the extension are "ABC.QPG". (7 characters including a period)

ASCII code		Binary code	
0 0 0 7	A B C . Q P G		A B C . Q P G
30H , 30H , 30H , 37H	41H , 42H , 43H , 2EH , 51H , 50H , 47H	07H , 00H	41H , 42H , 43H , 2EH , 51H , 50H , 47H

File name of MELSEC iQ-R series module (Number of characters and file name)

Use the subcommand '0040'.

Specify the file name including absolute path from the root folder with variable length.

The file name and the extension are specified by inserting a period between them. Specify the length of character string with "number of characters". ( Page 199 Number of characters)

ASCII code		Binary code	
Number of characters	File name + "." + Extension	Number of characters	File name + "." + Extension
<input type="text"/>	<input type="text"/>	<input type="text"/>	<input type="text"/>
(4 digits)	(Variable length)	(2 bytes)	(Variable length)

Specify "Path name" + "Period (002EH)" + "Extension" by Unicode(UTF-16).

"Drive name:\\" is not required in front of the path. Use '\\' (005CH) for the delimiter between the folder names.

For the characters that cannot be used for a file name and naming rules, refer to the manual of the access target module.

■Data communication in ASCII code

Convert the numerical value of UTF-16, which indicates a file name, to ASCII code (hexadecimal), and send it from the upper digits.

■Data communication in binary code

Send the numerical value of UTF-16 that indicates file name from the lower byte (L: bits 0 to 7).

Ex.

When the file name and the extension are 'LINE\LINE.CSV' (13 characters)

ASCII code		Binary code	
0 0 0 D	LINE\LINE.CSV		LINE\LINE.CSV
30H 30H 30H 44H		0DH 00H	

The value of the file name 'LINE\LINE.CSV' is as follows.

Item	Value of code corresponding to character												
	L	I	N	E	\	L	I	N	E	.	C	S	V
UTF-16	004C	0049	004E	0045	005C	004C	0049	004E	0045	002E	0043	0053	0056
ASCII code	3030 3443	3030 3439	3030 3445	3030 3435	3030 3543	3030 3443	3030 3439	3030 3445	3030 3435	3030 3245	3030 3433	3030 3533	3030 3536
Binary code	4C00	4900	4E00	4500	5C00	4C00	4900	4E00	4500	2E00	4300	5300	5600

Attribute

This indicates whether the data can be written to a file or directory.

File attribute

Read-only attribute	Archive attribute	ASCII code	Binary code										
Read-only	OFF	<table border="1"> <tr><td>0</td><td>0</td><td>0</td><td>1</td></tr> <tr><td>30H</td><td>30H</td><td>30H</td><td>31H</td></tr> </table>	0	0	0	1	30H	30H	30H	31H	<table border="1"> <tr><td>01H</td><td>00H</td></tr> </table>	01H	00H
	0	0	0	1									
30H	30H	30H	31H										
01H	00H												
ON	<table border="1"> <tr><td>0</td><td>0</td><td>2</td><td>1</td></tr> <tr><td>30H</td><td>30H</td><td>32H</td><td>31H</td></tr> </table>	0	0	2	1	30H	30H	32H	31H	<table border="1"> <tr><td>21H</td><td>00H</td></tr> </table>	21H	00H	
0	0	2	1										
30H	30H	32H	31H										
21H	00H												
Writable, readable	OFF	<table border="1"> <tr><td>0</td><td>0</td><td>0</td><td>0</td></tr> <tr><td>30H</td><td>30H</td><td>30H</td><td>30H</td></tr> </table>	0	0	0	0	30H	30H	30H	30H	<table border="1"> <tr><td>00H</td><td>00H</td></tr> </table>	00H	00H
	0	0	0	0									
30H	30H	30H	30H										
00H	00H												
ON	<table border="1"> <tr><td>0</td><td>0</td><td>2</td><td>0</td></tr> <tr><td>30H</td><td>30H</td><td>32H</td><td>30H</td></tr> </table>	0	0	2	0	30H	30H	32H	30H	<table border="1"> <tr><td>20H</td><td>00H</td></tr> </table>	20H	00H	
0	0	2	0										
30H	30H	32H	30H										
20H	00H												

Do not access the file in which the value other than above is stored in the attribute since the files are reserved for system use.

Attribute of directory (folder)

Read-only attribute	Archive attribute	ASCII code	Binary code										
Read-only	OFF	<table border="1"> <tr><td>0</td><td>0</td><td>1</td><td>1</td></tr> <tr><td>30H</td><td>30H</td><td>31H</td><td>31H</td></tr> </table>	0	0	1	1	30H	30H	31H	31H	<table border="1"> <tr><td>11H</td><td>00H</td></tr> </table>	11H	00H
	0	0	1	1									
30H	30H	31H	31H										
11H	00H												
ON	<table border="1"> <tr><td>0</td><td>0</td><td>3</td><td>1</td></tr> <tr><td>30H</td><td>30H</td><td>33H</td><td>31H</td></tr> </table>	0	0	3	1	30H	30H	33H	31H	<table border="1"> <tr><td>31H</td><td>00H</td></tr> </table>	31H	00H	
0	0	3	1										
30H	30H	33H	31H										
31H	00H												
Writable, readable	OFF	<table border="1"> <tr><td>0</td><td>0</td><td>1</td><td>0</td></tr> <tr><td>30H</td><td>30H</td><td>31H</td><td>30H</td></tr> </table>	0	0	1	0	30H	30H	31H	30H	<table border="1"> <tr><td>10H</td><td>00H</td></tr> </table>	10H	00H
	0	0	1	0									
30H	30H	31H	30H										
10H	00H												
ON	<table border="1"> <tr><td>0</td><td>0</td><td>3</td><td>0</td></tr> <tr><td>30H</td><td>30H</td><td>33H</td><td>30H</td></tr> </table>	0	0	3	0	30H	30H	33H	30H	<table border="1"> <tr><td>30H</td><td>00H</td></tr> </table>	30H	00H	
0	0	3	0										
30H	30H	33H	30H										
30H	00H												

Do not access the directory (folder) in which the value other than above is stored in the attribute since it is reserved for system use.

Creation date and time (last edit date and time)

This is a date and time when the current file contents are registered.

Setting method

Represent the date (year, month, day) and time (hour, minute, second) with 16-bit value, respectively.

■Data communication in ASCII code

Convert the respective numerical value to 4-digit ASCII code (hexadecimal) and send from the upper digits (time, year).

■Data communication in binary code

Send the respective 2-byte numerical value from the lower byte (L: bits 0 to 7).

Date (year, month, day)

Represent the year, month, and day with 16-bit value.

- Year: The binary value is represented with bits 9 to 15 by setting the year 1980 to '0'. *1
- Month: The binary value is represented with bits 5 to 8.
- Day: The binary value is represented with bits 0 to 4.

*1 This indicates incremental number of year by regarding 1980 as '0'.

Ex.

April 1st, 2010

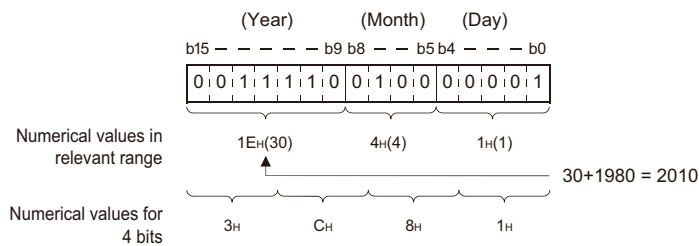

ASCII code	Binary code										
<table border="1"> <tr> <td>3</td> <td>C</td> <td>8</td> <td>1</td> </tr> <tr> <td>33H</td> <td>43H</td> <td>38H</td> <td>31H</td> </tr> </table>	3	C	8	1	33H	43H	38H	31H	<table border="1"> <tr> <td>81H</td> <td>3CH</td> </tr> </table>	81H	3CH
3	C	8	1								
33H	43H	38H	31H								
81H	3CH										

Time (hour, minute, second)

Represent the hour, minute, second with 16-bit value.

- Hour: The binary value is represented with bits 11 to 15.
- Minute: The binary value is represented with bits 5 to 10.
- Second: The binary value divided by 2 is represented with bits 0 to 4.

Ex.

When 20:50:58

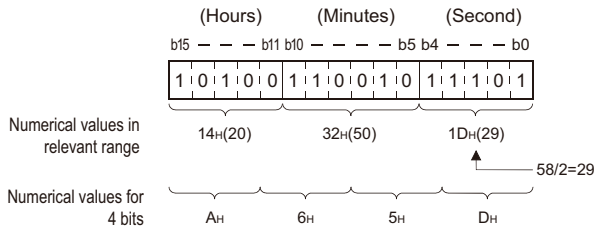

ASCII code	Binary code										
<table border="1"> <tr> <td>A</td> <td>6</td> <td>5</td> <td>D</td> </tr> <tr> <td>41H</td> <td>36H</td> <td>35H</td> <td>44H</td> </tr> </table>	A	6	5	D	41H	36H	35H	44H	<table border="1"> <tr> <td>5DH</td> <td>A6H</td> </tr> </table>	5DH	A6H
A	6	5	D								
41H	36H	35H	44H								
5DH	A6H										

File size

This indicates the file capacity in byte units.

Setting method

■Data communication in ASCII code

Convert the numerical value to 8-digit ASCII code (hexadecimal), and send it from the upper digits.

■Data communication in binary code

Send 4-byte numerical values*1 from the lower byte (L: bits 0 to 7).

*1 For C24, the additional code may be added. (☞ Page 35 Additional code (10H))

Ex.

The file size is 7168 bytes

ASCII code	Binary code																				
<table border="1"> <tr> <td>0</td> <td>0</td> <td>0</td> <td>0</td> <td>1</td> <td>C</td> <td>0</td> <td>0</td> </tr> <tr> <td>30H</td> <td>30H</td> <td>30H</td> <td>30H</td> <td>31H</td> <td>43H</td> <td>30H</td> <td>30H</td> </tr> </table>	0	0	0	0	1	C	0	0	30H	30H	30H	30H	31H	43H	30H	30H	<table border="1"> <tr> <td>00H</td> <td>1CH</td> <td>00H</td> <td>00H</td> </tr> </table>	00H	1CH	00H	00H
0	0	0	0	1	C	0	0														
30H	30H	30H	30H	31H	43H	30H	30H														
00H	1CH	00H	00H																		

File pointer No.

This is a number for CPU module to manage files.
 The file pointer No. can be acquired with the following command.
 ☞ Page 235 Open file (command: 1827)

Setting method

■Data communication in ASCII code

Send 4-byte*1 ASCII code data.

■Data communication in binary code

Send 2-byte*1 numerical value.

*1 For C24, the additional code may be added. (☞ Page 35 Additional code (10H))

Ex.

For AH

ASCII code	Binary code										
<table border="1"> <tr> <td>0</td> <td>0</td> <td>0</td> <td>A</td> </tr> <tr> <td>30H</td> <td>30H</td> <td>30H</td> <td>3AH</td> </tr> </table>	0	0	0	A	30H	30H	30H	3AH	<table border="1"> <tr> <td>0AH</td> <td>00H</td> </tr> </table>	0AH	00H
0	0	0	A								
30H	30H	30H	3AH								
0AH	00H										

Offset address

Specify the address (one address/one byte) from the head (offset address: 0H) of each file with an even number.

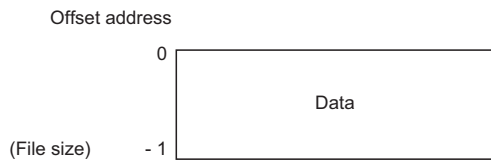

Setting method

■Data communication in ASCII code

Convert the numerical value to 8-digit ASCII code (hexadecimal), and send it from the upper digits.

■Data communication in binary code

Send 4-byte numerical values*1 from the lower byte (L: bits 0 to 7).

*1 For C24, the additional code may be added. (☞ Page 35 Additional code (10H))

Ex.

Offset address is 780H(1920)

ASCII code	Binary code																				
<table border="1"> <tr> <td>0</td> <td>0</td> <td>0</td> <td>0</td> <td>0</td> <td>7</td> <td>8</td> <td>0</td> </tr> <tr> <td>30H</td> <td>30H</td> <td>30H</td> <td>30H</td> <td>30H</td> <td>37H</td> <td>38H</td> <td>30H</td> </tr> </table>	0	0	0	0	0	7	8	0	30H	30H	30H	30H	30H	37H	38H	30H	<table border="1"> <tr> <td>80H</td> <td>07H</td> <td>00H</td> <td>00H</td> </tr> </table>	80H	07H	00H	00H
0	0	0	0	0	7	8	0														
30H	30H	30H	30H	30H	37H	38H	30H														
80H	07H	00H	00H																		

Number of bytes

Specify the number of bytes of data to be read or written as one address/one byte.

Setting method

■Data communication in ASCII code

Convert the numerical value to 4-digit ASCII code (hexadecimal), and send it from the upper digits.

■Data communication in binary code

Send 2-byte numerical values*1 from the lower byte (L: bits 0 to 7).

*1 For C24, the additional code may be added. (☞ Page 35 Additional code (10H))

Ex.

Number of bytes is 780H(1920)

ASCII code	Binary code
0 7 8 0 30H 37H 38H 30H	80H 07H

Read data, write data

This is a content of file to be read/written. The data for 1 address is handled as 1-byte.

Read data

The data which have been read is stored.

The "Read data" is variable length. The length of data is specified with "Number of bytes read".

Write data

The data to be written is stored.

The "Write data" is variable length. The length of data is specified with "Number of bytes written".

The order of data must be the same as the read data.

■Data communication in ASCII code

Convert the 1-byte data (1 address) to 2-digit ASCII code (hexadecimal) ,and send it from the upper digits.

■Data communication in binary code

Send 1 address as 1 byte.

Open mode

Specify whether the specified file is open for reading or for writing with the 'open file' (command: 1827).

Item	ASCII code	Binary code										
For reading	<table border="1"> <tr><td>0</td><td>0</td><td>0</td><td>0</td></tr> <tr><td>30H</td><td>30H</td><td>30H</td><td>30H</td></tr> </table>	0	0	0	0	30H	30H	30H	30H	<table border="1"> <tr><td>00H</td><td>00H</td></tr> </table>	00H	00H
0	0	0	0									
30H	30H	30H	30H									
00H	00H											
For writing	<table border="1"> <tr><td>0</td><td>1</td><td>0</td><td>0</td></tr> <tr><td>30H</td><td>31H</td><td>30H</td><td>30H</td></tr> </table>	0	1	0	0	30H	31H	30H	30H	<table border="1"> <tr><td>00H</td><td>01H</td></tr> </table>	00H	01H
0	1	0	0									
30H	31H	30H	30H									
00H	01H											

Close type

Specify a target to be closed with the 'close file' (command: 182A).

File to unlock	ASCII code	Binary code										
A file specified by the file pointer	<table border="1"> <tr><td>0</td><td>0</td><td>0</td><td>0</td></tr> <tr><td>30H</td><td>30H</td><td>30H</td><td>30H</td></tr> </table>	0	0	0	0	30H	30H	30H	30H	<table border="1"> <tr><td>00H</td><td>00H</td></tr> </table>	00H	00H
0	0	0	0									
30H	30H	30H	30H									
00H	00H											
All files	<table border="1"> <tr><td>0</td><td>0</td><td>0</td><td>1</td></tr> <tr><td>30H</td><td>30H</td><td>30H</td><td>31H</td></tr> </table>	0	0	0	1	30H	30H	30H	31H	<table border="1"> <tr><td>01H</td><td>00H</td></tr> </table>	01H	00H
	0	0	0	1								
30H	30H	30H	31H									
01H	00H											
	<table border="1"> <tr><td>0</td><td>0</td><td>0</td><td>2</td></tr> <tr><td>30H</td><td>30H</td><td>30H</td><td>32H</td></tr> </table>	0	0	0	2	30H	30H	30H	32H	<table border="1"> <tr><td>02H</td><td>00H</td></tr> </table>	02H	00H
0	0	0	2									
30H	30H	30H	32H									
02H	00H											

When all files are specified for unlock, the external device that executes the close (command: 182A) closes all files being open regardless of the hierarchy of drive No. or directory (folder). (There is no difference between 0001H and 0002H.) The files which were opened by the other devices cannot be closed.

Executing the command to files locked by the other external device results in abnormal completion of the command.



Files are closed by restarting a module (such as resetting CPU module).

12.4 File Check

Read directory (folder), file name, file creation date and time, and file No. in the specified drive.
The presence of files to be accessed and the file No. to access can be checked.

Read directory/file information (command: 1810)

For the specified storage destination file, read the file name, file creation date and time (last edit date and time) etc.
Read the file information from the head file specified with the file No. to the specified number of files.

Message format

The following shows the message format of the request data and response data of the command.

Request data

Command	Subcommand	Fixed values	Drive No.	Head file No.	Number of requested files	Directory specification
---------	------------	--------------	-----------	---------------	---------------------------	-------------------------

Response data

Number of file information (n points)	Last file No.	File	Last edit date and time	File size	...	File	Last edit date and time	File size
		Directory/file information(1st point)				Directory/file information(nth point)		

Data specified by request data

Command

ASCII code	Binary code (for C24)*1	Binary code (for E71)																		
<table border="1"> <tr><td>1</td><td>8</td><td>1</td><td>0</td></tr> <tr><td>31H</td><td>38H</td><td>31H</td><td>30H</td></tr> </table>	1	8	1	0	31H	38H	31H	30H	<table border="1"> <tr><td>DLE</td><td></td><td></td></tr> <tr><td>10H</td><td>10H</td><td>18H</td></tr> </table>	DLE			10H	10H	18H	<table border="1"> <tr><td></td><td></td></tr> <tr><td>10H</td><td>18H</td></tr> </table>			10H	18H
1	8	1	0																	
31H	38H	31H	30H																	
DLE																				
10H	10H	18H																		
10H	18H																			

*1 For C24, an additional code is added. (Page 35 Additional code (10H))

Subcommand

Item	ASCII code	Binary code												
For MELSEC-Q/L series	<table border="1"> <tr><td>0</td><td>0</td><td>0</td><td>0</td></tr> <tr><td>30H</td><td>30H</td><td>30H</td><td>30H</td></tr> </table>	0	0	0	0	30H	30H	30H	30H	<table border="1"> <tr><td></td><td></td></tr> <tr><td>00H</td><td>00H</td></tr> </table>			00H	00H
0	0	0	0											
30H	30H	30H	30H											
00H	00H													
For MELSEC iQ-R series	<table border="1"> <tr><td>0</td><td>0</td><td>4</td><td>0</td></tr> <tr><td>30H</td><td>30H</td><td>34H</td><td>30H</td></tr> </table>	0	0	4	0	30H	30H	34H	30H	<table border="1"> <tr><td></td><td></td></tr> <tr><td>40H</td><td>00H</td></tr> </table>			40H	00H
0	0	4	0											
30H	30H	34H	30H											
40H	00H													

Fixed value

Specify 30H in 4 bytes.

ASCII code, binary code



Drive No.

Specify the access target drive. (Page 197 Drive No.)

Head file No.

Specify the file No. of the file from which the file information is to be read. (Page 198 File No.)

File No. can be obtained by following command.

Page 216 Search directory/file information (command: 1811)

Number of requested file

Specify the number of files from which file information is read in the range of 1 to 36. (Page 199 Number of files)

Directory specification

Depending on the access target, specify any of the following:

- MELSEC iQ-R series (when using subcommand '0040'): Specify the target folder with an absolute path. (Page 199 Directory specification)
- MELSEC-Q/L series (when using subcommand '0000'): Specify '0'.

ASCII code	Binary code

Point

When checking all files in the specified directory (folder), refer to the following section.
 Page 189 Procedure to read information from all files in directory (folder)

Data stored in response data

Number of file information

The number of file information which has been read is stored. (Page 199 Number of files)

In the following situation, the number of file information will be fewer than the number of requested file.

- When using subcommand '0040', the data of "Number of requested file" cannot be stored at one communication because the file name length is too long.
- When the number of files exist following the "Head file No." is less than the "Number of requested file".

When no files exist after the specified head file No., the following value is stored.

- MELSEC-Q/L series (when using subcommand '0000'): "Number of file information" = '0'
- MELSEC iQ-R series (when using subcommand '0040'): "Number of file information" = -1 (FFFFH)

Last file No.

The file No. of the last file from which file information was read is stored. (Page 198 File No.)

For MELSEC-Q/L series (subcommand '0000'), last file No. is not stored.

Point

File No. is also assigned for the system-reserved data that cannot acquire the directory/file information, therefore, the "Last file No." may differ from the file No. of the last file for the read file information.

Acquire the file No. using the following command.

Page 216 Search directory/file information (command: 1811)

Use "Last file No." in the following process.

Page 189 Procedure to read information from all files in directory (folder)

■Directory/file information

Information for number of file information is stored.

When folders exist in the specified storage destination, the information for the folder is also read.



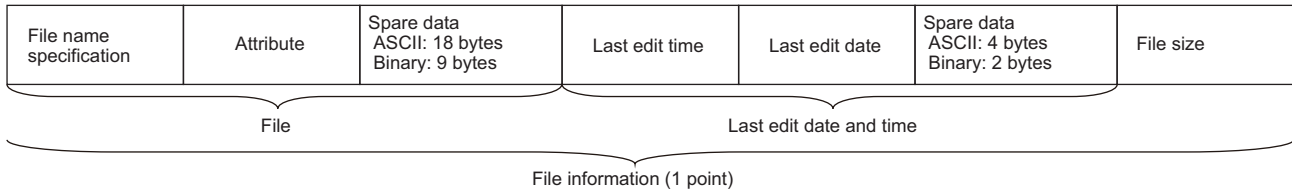

The information of the current directory (.) and the parent directory (..) are read at the same time.



The following items are stored for each file.

- File name specification: The file name is stored. The format differs depending on the subcommand. (Path name is not included in the file name even when using the subcommand 0040.)

Subcommand	Reference
For MELSEC-Q/L series (Subcommand: 0000)	Page 201 File name of MELSEC-Q/L series module (File name and extension)
For MELSEC iQ-R series (Subcommand:0040)	Page 203 File name of MELSEC iQ-R series module (Number of characters and file name)

- Attribute: The file attributes are stored. ( Page 204 Attribute)
 - Last edit time, Last edit date: The last edit date and time are stored. ( Page 205 Creation date and time (last edit date and time))
 - Spare data: The system data which are 18 or 4 bytes during data communication in ASCII code and 9 or 2 bytes*¹ during data communication in binary code are stored.
 - File size: Capacity of file is stored in byte unit. ( Page 206 File size)
- *¹ For C24, the additional code may be added. ( Page 35 Additional code (10H))

Point

For a folder, the following values will be stored.

- Attribute: Attribute of the directory (folder) is stored. ( Page 204 Attribute of directory (folder))
- Last edit time, Last edit date: The folder creation date and time are stored.
- File size: '0' is stored.

Communication example (files for MELSEC-Q/L series)

Read directory/file information under the following conditions.

- Drive No.: 0
- Head file No.: 1
- Number of requested files: 3

■Data communication in ASCII code

(Request data)

Subcommand				(Fixed value)				Drive No.				Head file No.				Number of file requests				Directory specification (Fixed values)			
1	8	1	0	0	0	0	0	0	0	0	0	0	0	0	1	0	0	0	3	0	0	0	0
31 _H	38 _H	31 _H	30 _H	30 _H	30 _H	30 _H	30 _H	30 _H	30 _H	30 _H	30 _H	30 _H	30 _H	30 _H	31 _H	30 _H	30 _H	30 _H	33 _H	30 _H	30 _H	30 _H	30 _H

(Response data)

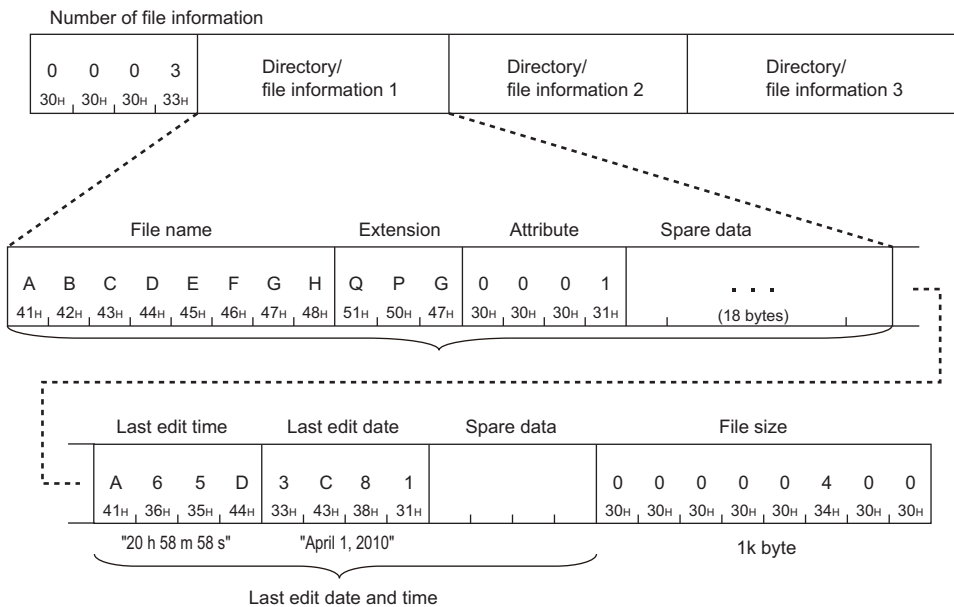

■Data communication in binary code

(Request data)

Subcommand		(Fixed value)		Drive No.	Head file No.	Number of file requests	Directory specification (Fixed values)
10 _H	18 _H	00 _H	00 _H	30 _H	30 _H	30 _H	30 _H
00 _H	00 _H	01 _H	00 _H	03 _H	00 _H	00 _H	00 _H

(Response data)

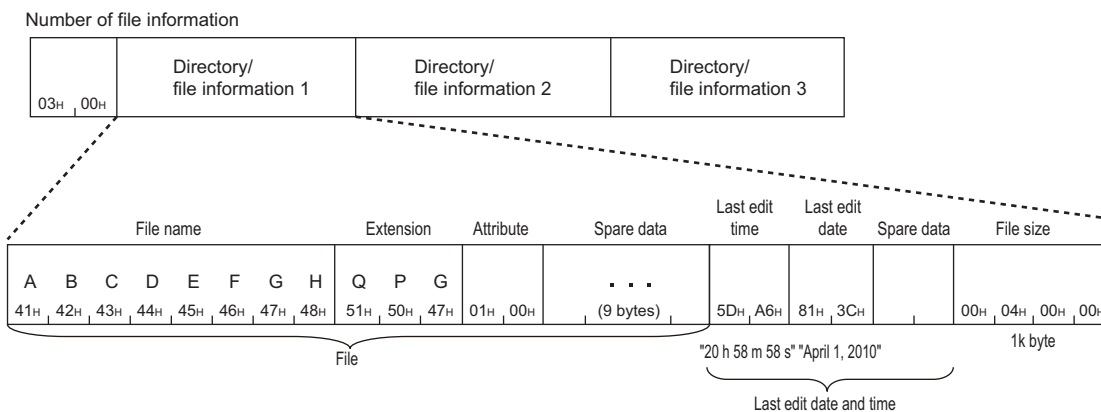

Communication example (files for MELSEC iQ-R series)

Read directory/file information under the following conditions.

- Drive No.: 4
- Head file No.: 1
- Number of requested files: 3

The path names of directory are shown in the following table.

(1) SUBDIR (6 characters)

Item	Value of code corresponding to character					
Path name	S	U	B	D	I	R
UTF-16	0053	0055	0042	0044	0049	0052
ASCII code	30303533	30303535	30303432	30303434	30303439	30303532
Binary code	5300	5500	4200	4400	4900	5200

The following shows the file name of a directory/file information to be read.

The current directory information is stored in the directory/file information 1.

The parent directory information is stored in the directory/file information 2.

Directory	Number of file name characters	Character code	
Current directory	1	File name	.
		UTF-16	002E
		ASCII code	30303245
		Binary code	2E00
Parent directory	2	File name	.
		UTF-16	002E 002E
		ASCII code	30303245 30303245
		Binary code	2E00 2E00

The following shows the file name of the directory/file information 3.

(2) LINE.CSV (8 characters)

Item	Value of code corresponding to character							
File name	L	I	N	E	.	C	S	V
UTF-16	004C	0049	004E	0045	002E	0043	0053	0056
ASCII code	30303443	30303439	30303445	30303435	30303245	30303433	30303533	30303536
Binary code	4C00	4900	4E00	4500	2E00	4300	5300	5600

■Data communication in ASCII code

(Request data)

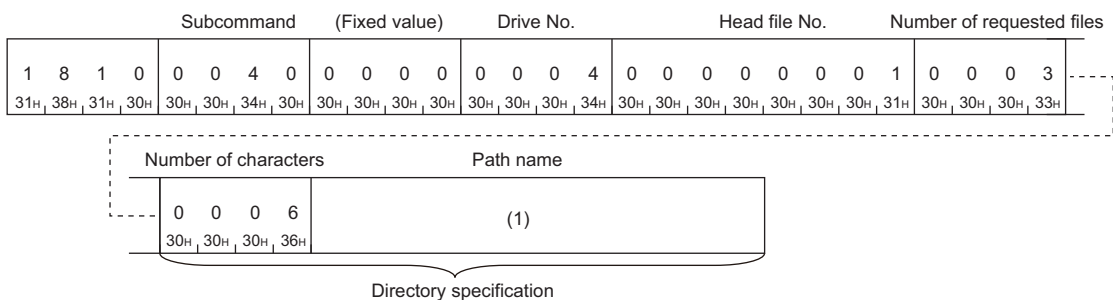

In the figure (1), set the value of "ASCII code" in the table of "Value of code corresponding to character" in "Path name".

(Response data)

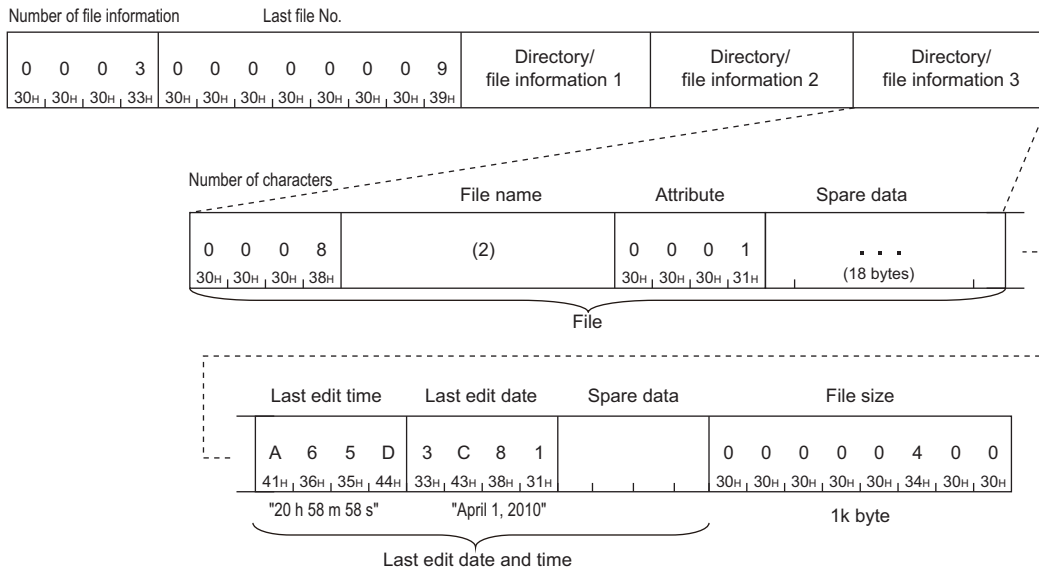

In the figure (2), set the value of "ASCII code" in the table of "Value of code corresponding to character" in "File name".

■Data communication in binary code

(Request data)

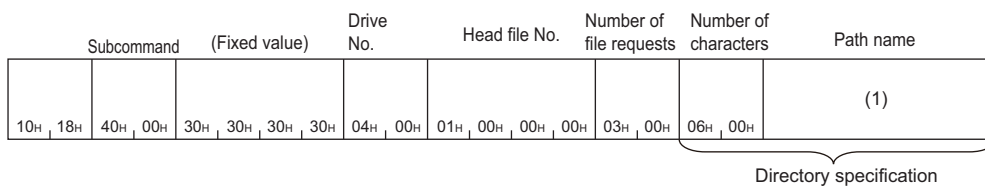

In the figure (1), set the value of "Binary code" in the table of "Value of code corresponding to character" in "Path name".

(Response data)

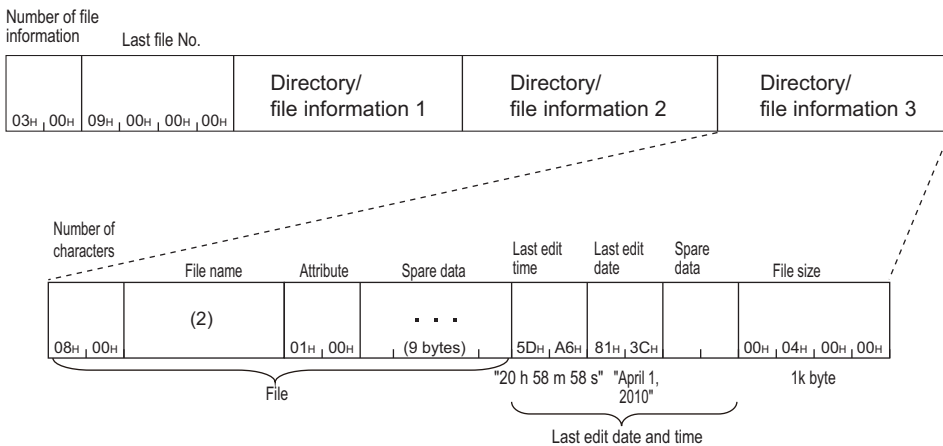

In the figure (2), set the value of "Binary code" in the table of "Value of code corresponding to character" in "File name".

Search directory/file information (command: 1811)

Read the file No. of the specified file.

The file No. indicates the registration number of a file when the file is written to the module.

Message format

The following shows the message format of the request data and response data of the command.

Request data

Command	Subcommand	Fixed values 1	Drive No.	Fixed values 2	Number of file name characters	File name
---------	------------	----------------	-----------	----------------	--------------------------------	-----------

Response data

File No. is stored. (☞ Page 198 File No.)

If the file with the specified name does not exist, the command completes abnormally.

Data specified by request data

Command

ASCII code	Binary code										
<table border="1"> <tr><td>1</td><td>8</td><td>1</td><td>1</td></tr> <tr><td>31H</td><td>38H</td><td>31H</td><td>31H</td></tr> </table>	1	8	1	1	31H	38H	31H	31H	<table border="1"> <tr><td>11H</td><td>18H</td></tr> </table>	11H	18H
1	8	1	1								
31H	38H	31H	31H								
11H	18H										

Subcommand

Item	ASCII code	Binary code										
For MELSEC-Q/L series	<table border="1"> <tr><td>0</td><td>0</td><td>0</td><td>0</td></tr> <tr><td>30H</td><td>30H</td><td>30H</td><td>30H</td></tr> </table>	0	0	0	0	30H	30H	30H	30H	<table border="1"> <tr><td>00H</td><td>00H</td></tr> </table>	00H	00H
0	0	0	0									
30H	30H	30H	30H									
00H	00H											
For MELSEC iQ-R series	<table border="1"> <tr><td>0</td><td>0</td><td>4</td><td>0</td></tr> <tr><td>30H</td><td>30H</td><td>34H</td><td>30H</td></tr> </table>	0	0	4	0	30H	30H	34H	30H	<table border="1"> <tr><td>40H</td><td>00H</td></tr> </table>	40H	00H
0	0	4	0									
30H	30H	34H	30H									
40H	00H											

Fixed value 1

Specify the following fixed value.

- MELSEC iQ-R series (when using subcommand '0040'): Specify '0'.

ASCII code	Binary code												
<table border="1"> <tr><td>0</td><td>0</td><td>0</td><td>0</td></tr> <tr><td>30H</td><td>30H</td><td>30H</td><td>30H</td></tr> </table>	0	0	0	0	30H	30H	30H	30H	<table border="1"> <tr><td>00H</td><td>00H</td><td>00H</td><td>00H</td></tr> </table>	00H	00H	00H	00H
0	0	0	0										
30H	30H	30H	30H										
00H	00H	00H	00H										

- MELSEC-Q/L series (when using subcommand '0000'): Specify 20H in 4 bytes.

ASCII code, binary code

<table border="1"> <tr><td>20H</td><td>20H</td><td>20H</td><td>20H</td></tr> </table>	20H	20H	20H	20H
20H	20H	20H	20H	

Drive No.

Specify the access target drive. (☞ Page 197 Drive No.)

■Fixed value 2

Specify '0'.

ASCII code	Binary code										
<table border="1"> <tr><td>0</td><td>0</td><td>0</td><td>0</td></tr> <tr><td>30H</td><td>30H</td><td>30H</td><td>30H</td></tr> </table>	0	0	0	0	30H	30H	30H	30H	<table border="1"> <tr><td>00H</td><td>00H</td></tr> </table>	00H	00H
0	0	0	0								
30H	30H	30H	30H								
00H	00H										

■Number of file name characters, file name

Specify the file name of which file No. is to be read. (☞ Page 201 File name specification)

Communication example (files for MELSEC-Q series)

Read the file No. in the following conditions.

- Password: 4 spaces (code: 20H)
- Drive No.: 0
- File name: ABC.QPG (file No.6)

■Data communication in ASCII code

(Request data)

Subcommand				(Fixed value 1)	Drive No.	(Fixed value 2)	Number of file name characters	File name																						
1	8	1	1	0	0	0	0	A	B	C	.	Q	P	G																
31H	38H	31H	31H	30H	30H	30H	30H	20H	20H	20H	20H	30H	30H	30H	30H	30H	30H	30H	30H	30H	30H	30H	37H	41H	42H	43H	2EH	51H	50H	47H

(Response data)

File No.

0	0	0	6
30H	30H	30H	36H

■Data communication in binary code

(Request data)

Subcommand		(Fixed value 1)	Drive No.	(Fixed value 2)	Number of file name characters	File name
						A B C . Q P G
11H	18H	00H	00H	00H	07H	41H 42H 43H 2EH 51H 50H 47H

(Response data)

File No.

06H	00H
-----	-----

Communication example (files for MELSEC iQ-R series)

Read the file No. in the following conditions.

- Drive No.: 4
- File No.: 6

The file name is as follows:

(1) LINE\LINE.CSV (13 characters)

Item	Value of code corresponding to character												
File name	L	I	N	E	\	L	I	N	E	.	C	S	V
UTF-16	004C	0049	004E	0045	005C	004C	0049	004E	0045	002E	0043	0053	0056
ASCII code	3030	3030	3030	3030	3030	3030	3030	3030	3030	3030	3030	3030	3030
	3443	3439	3445	3435	3543	3443	3439	3445	3435	3245	3433	3533	3536
Binary code	4C00	4900	4E00	4500	5C00	4C00	4900	4E00	4500	2E00	4300	5300	5600

■Data communication in ASCII code

(Request data)

Subcommand	(Fixed value 1)	Drive No.	(Fixed value 2)	Number of file name characters	File name
1 8 1 1 31H, 38H, 31H, 31H	0 0 4 0 30H, 30H, 34H, 30H	0 0 0 0 30H, 30H, 30H, 30H	0 0 0 4 30H, 30H, 30H, 34H	0 0 0 0 30H, 30H, 30H, 30H	0 0 0 D 30H, 30H, 30H, 44H
					(1)

In the figure (1), set the value of "ASCII code" in the table of "Value of code corresponding to character" in "File name".

(Response data)

File No.
0 0 0 0 0 0 6 30H, 30H, 30H, 30H, 30H, 30H, 39H, 36H

■Data communication in binary code

(Request data)

Subcommand	(Fixed value 1)	Drive No.	(Fixed value 2)	Number of file name characters	File name
					(1)
11H, 18H	40H, 00H	00H, 00H, 00H, 00H	04H, 00H	00H, 00H	0DH, 00H

In the figure (1), set the value of "Binary code" in the table of "Value of code corresponding to character" in "File name".

(Response data)

File No.
06H, 00H, 00H, 00H

12.5 File Creation and Deletion

Create a new file or delete a file.

Create new file (command: 1820)

Create a file with specifying its size.

A folder cannot be created with this command. Create a folder with an Engineering tool.



The time on a module is registered as the last edit date and time in a file created using this function.

Message format

The following shows the message format of the request data and response data of the command.

Request data

Command	Subcommand	Password	Drive No.	File size	Number of file name characters	File name
---------	------------	----------	-----------	-----------	--------------------------------	-----------

Response data

There is no response data for this command.

Data specified by request data

Command

ASCII code	Binary code										
<table border="1"> <tr><td>1</td><td>8</td><td>2</td><td>0</td></tr> <tr><td>31H</td><td>38H</td><td>32H</td><td>30H</td></tr> </table>	1	8	2	0	31H	38H	32H	30H	<table border="1"> <tr><td>20H</td><td>18H</td></tr> </table>	20H	18H
1	8	2	0								
31H	38H	32H	30H								
20H	18H										

Subcommand

Item	ASCII code	Binary code										
For MELSEC-Q/L series	<table border="1"> <tr><td>0</td><td>0</td><td>0</td><td>0</td></tr> <tr><td>30H</td><td>30H</td><td>30H</td><td>30H</td></tr> </table>	0	0	0	0	30H	30H	30H	30H	<table border="1"> <tr><td>00H</td><td>00H</td></tr> </table>	00H	00H
0	0	0	0									
30H	30H	30H	30H									
00H	00H											
For MELSEC iQ-R series	<table border="1"> <tr><td>0</td><td>0</td><td>4</td><td>0</td></tr> <tr><td>30H</td><td>30H</td><td>34H</td><td>30H</td></tr> </table>	0	0	4	0	30H	30H	34H	30H	<table border="1"> <tr><td>40H</td><td>00H</td></tr> </table>	40H	00H
0	0	4	0									
30H	30H	34H	30H									
40H	00H											

Password

Specify the following fixed value.

- MELSEC iQ-R series (when using subcommand '0040'): Specify '0'.

ASCII code	Binary code												
<table border="1"> <tr><td>0</td><td>0</td><td>0</td><td>0</td></tr> <tr><td>30H</td><td>30H</td><td>30H</td><td>30H</td></tr> </table>	0	0	0	0	30H	30H	30H	30H	<table border="1"> <tr><td>00H</td><td>00H</td><td>00H</td><td>00H</td></tr> </table>	00H	00H	00H	00H
0	0	0	0										
30H	30H	30H	30H										
00H	00H	00H	00H										

- MELSEC-Q/L series (when using subcommand '0000'): Specify 20H in 4 bytes.

ASCII code, binary code				
<table border="1"> <tr><td>20H</td><td>20H</td><td>20H</td><td>20H</td></tr> </table>	20H	20H	20H	20H
20H	20H	20H	20H	

■ Drive No.

Specify the access target drive. (☞ Page 197 Drive No.)

■ File size

Specify the file capacity in byte unit. (☞ Page 206 File size)

■ Number of file name characters, file name

Specify the file name to be created. (☞ Page 201 File name specification)

Communication example (files for MELSEC-Q series)

Create a new file in the following conditions:

- Password: 4 spaces (code: 20H)
- Drive No.: 0
- File name: ABC.CSV
- File size: 1K byte

■ Data communication in ASCII code

(Request data)

Subcommand				Password				Drive No.				File size											
1	8	2	0	0	0	0	0	0	0	0	0	0	0	0	0	4	0	0	0				
31H	38H	32H	30H	30H	30H	30H	30H	20H	20H	20H	20H	30H	30H	30H	30H	30H	30H	30H	30H	34H	30H	30H	30H

Number of file name characters				File name							
0	0	0	7	A	B	C	.	C	S	V	
30H	30H	30H	37H	41H	42H	43H	2EH	43H	53H	56H	

■ Data communication in binary code

(Request data)

Subcommand		Password		Drive No.		File size		Number of file name characters		File name												
20H	18H	00H	00H	20H	20H	20H	20H	00H	00H	00H	40H	00H	00H	07H	00H	A	B	C	.	C	S	V

Communication example (files for MELSEC iQ-R series)

Create a new file in the following conditions:

- Drive No.: 4
- File size: 7168 byte
- File name: LINE.CSV (8 characters)

The value of the file name is as follows:

(1) LINE.CSV (8 characters)

Item	Value of code corresponding to character							
File name	L	I	N	E	.	C	S	V
UTF-16	004C	0049	004E	0045	002E	0043	0053	0056
ASCII code	30303443	30303439	30303445	30303435	30303245	30303433	30303533	30303536
Binary code	4C00	4900	4E00	4500	2E00	4300	5300	5600

■Data communication in ASCII code

(Request data)

Subcommand				(Fixed value)	Drive No.	File size	Number of file name characters	File name
1	8	2	0	0 0 0 0	0 0 0 4	0 0 0 0 1 C 0 0	0 0 0 8	(1)
31H	38H	32H	30H	30H, 30H, 30H, 30H	30H, 30H, 30H, 34H	30H, 30H, 30H, 30H, 31H, 43H, 30H, 30H	30H, 30H, 30H, 38H	

In the figure (1), set the value of "ASCII code" in the table of "Value of code corresponding to character" in "File name".

■Data communication in binary code

(Request data)

Subcommand			Drive No.	File size	Number of file name characters	File name
						(1)
20H	18H	40H, 00H	04H, 00H	00H, 1CH, 00H, 00H	08H, 00H	

In the figure (1), set the value of "Binary code" in the table of "Value of code corresponding to character" in "File name".

Delete file (command: 1822)

Delete a file.

Point

If files are deleted while a programmable controller system is in operation, the system may be stopped. Determine the timing of file deletion for the entire programmable controller system.

Restriction

- The files on which the 'open file' command is being executed cannot be deleted. Close the file before deleting it. (☞ Page 235 Open file (command: 1827), Page 243 Close file (command: 182A))
- The file being executed cannot be deleted when CPU module is state of RUN. Delete the file after placing CPU module to the STOP state. (☞ Page 464 Applicable Commands for Online Program Change)

Message format

The following shows the message format of the request data and response data of the command.

Request data

Command	Subcommand	Password	Drive No.	Number of file name characters	File name
---------	------------	----------	-----------	--------------------------------	-----------

Response data

There is no response data for this command.

Data specified by request data

Command

ASCII code	Binary code										
<table border="1"> <tr> <td>1</td> <td>8</td> <td>2</td> <td>2</td> </tr> <tr> <td>31H</td> <td>38H</td> <td>32H</td> <td>32H</td> </tr> </table>	1	8	2	2	31H	38H	32H	32H	<table border="1"> <tr> <td>22H</td> <td>18H</td> </tr> </table>	22H	18H
1	8	2	2								
31H	38H	32H	32H								
22H	18H										

Subcommand

Item	ASCII code	Binary code										
For MELSEC-Q series	<table border="1"> <tr> <td>0</td> <td>0</td> <td>0</td> <td>0</td> </tr> <tr> <td>30H</td> <td>30H</td> <td>30H</td> <td>30H</td> </tr> </table>	0	0	0	0	30H	30H	30H	30H	<table border="1"> <tr> <td>00H</td> <td>00H</td> </tr> </table>	00H	00H
0	0	0	0									
30H	30H	30H	30H									
00H	00H											
For MELSEC-L series	<table border="1"> <tr> <td>0</td> <td>0</td> <td>0</td> <td>4</td> </tr> <tr> <td>30H</td> <td>30H</td> <td>30H</td> <td>34H</td> </tr> </table>	0	0	0	4	30H	30H	30H	34H	<table border="1"> <tr> <td>04H</td> <td>00H</td> </tr> </table>	04H	00H
0	0	0	4									
30H	30H	30H	34H									
04H	00H											
For MELSEC iQ-R series	<table border="1"> <tr> <td>0</td> <td>0</td> <td>4</td> <td>0</td> </tr> <tr> <td>30H</td> <td>30H</td> <td>34H</td> <td>30H</td> </tr> </table>	0	0	4	0	30H	30H	34H	30H	<table border="1"> <tr> <td>40H</td> <td>00H</td> </tr> </table>	40H	00H
0	0	4	0									
30H	30H	34H	30H									
40H	00H											

Password

Specify the password of the file. (☞ Page 194 Password)

Drive No.

Specify the access target drive. (☞ Page 197 Drive No.)

Number of file name characters, file name

Specify the file name to be deleted. (Page 201 File name specification)

Communication example (files for MELSEC-Q series)

Delete the file under the following conditions:

- Password: 1234
- Drive No.: 0
- File name: ABC.QPG

Data communication in ASCII code

(Request data)

Subcommand				Password				Drive No.				Number of file name characters				File name										
1	8	2	2	0	0	0	0	1	2	3	4	0	0	0	0	0	0	0	7	A	B	C	.	Q	P	G
31H	38H	32H	32H	30H	30H	30H	30H	31H	32H	33H	34H	30H	30H	30H	30H	30H	30H	30H	37H	41H	42H	43H	2EH	51H	50H	47H

Data communication in binary code

(Request data)

Subcommand		Password		Drive No.		Number of file name characters		File name										
		1	2	3	4			A	B	C	.	Q	P	G				
22H	18H	00H	00H	31H	32H	33H	34H	00H	00H	07H	00H	41H	42H	43H	2EH	51H	50H	47H

Communication example (files for MELSEC-L series)

Delete the file under the following conditions:

- Password: AbCd1234□...□(24 spaces, code: 20H)
- Drive No.: 0
- File name: MAIN.QPG

Data communication in ASCII code

(Request data)

Subcommand				Password (fixed to 32 characters)												Drive No.						
1	8	2	2	0	0	0	4	A	b	C	d	1	2	3	4	0	0	0	0			
31H	38H	32H	32H	30H	30H	30H	34H	41H	62H	43H	64H	31H	32H	33H	34H	20H	...	20H	30H	30H	30H	30H

Number of file name characters				File name							
0	0	0	8	M	A	I	N	.	Q	P	G
30H	30H	30H	38H	4DH	41H	49H	4EH	2EH	51H	50H	47H

Data communication in binary code

(Request data)

Subcommand		Password		Drive No.		Number of file name characters		File name																		
		A	b	C	d	1	2	3	4			M	A	I	N	.	Q	P	G							
22H	18H	04H	00H	41H	62H	43H	64H	31H	32H	33H	34H	20H	...	20H	00H	00H	08H	00H	4DH	41H	49H	4EH	2EH	51H	50H	47H

Copy file (command: 1824)

Copy a file.

Restriction

When this command is executed to files of parameter and a program being executed, place CPU module in the STOP status. (Page 464 Commands that cannot be executed during RUN)

Message format

The following shows the message format of the request data and response data of the command.

Request data

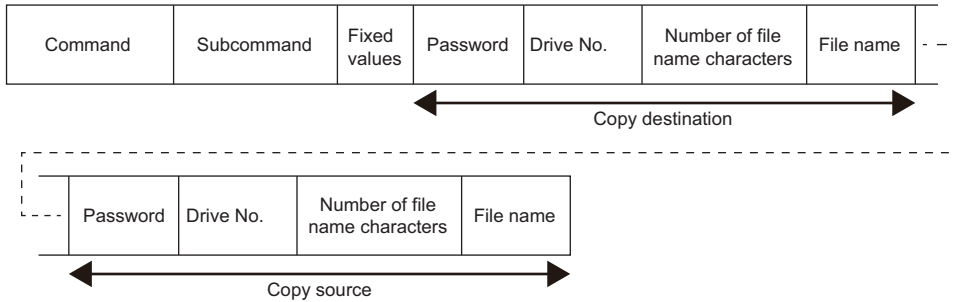

Response data

There is no response data for this command.

Data specified by request data

Command

ASCII code	Binary code										
<table border="1"> <tr><td>1</td><td>8</td><td>2</td><td>4</td></tr> <tr><td>31H</td><td>38H</td><td>32H</td><td>34H</td></tr> </table>	1	8	2	4	31H	38H	32H	34H	<table border="1"> <tr><td>24H</td><td>18H</td></tr> </table>	24H	18H
1	8	2	4								
31H	38H	32H	34H								
24H	18H										

Subcommand

Item	ASCII code	Binary code										
For MELSEC-Q series	<table border="1"> <tr><td>0</td><td>0</td><td>0</td><td>0</td></tr> <tr><td>30H</td><td>30H</td><td>30H</td><td>30H</td></tr> </table>	0	0	0	0	30H	30H	30H	30H	<table border="1"> <tr><td>00H</td><td>00H</td></tr> </table>	00H	00H
0	0	0	0									
30H	30H	30H	30H									
00H	00H											
For MELSEC-L series	<table border="1"> <tr><td>0</td><td>0</td><td>0</td><td>4</td></tr> <tr><td>30H</td><td>30H</td><td>30H</td><td>34H</td></tr> </table>	0	0	0	4	30H	30H	30H	34H	<table border="1"> <tr><td>04H</td><td>00H</td></tr> </table>	04H	00H
0	0	0	4									
30H	30H	30H	34H									
04H	00H											
For MELSEC iQ-R series	<table border="1"> <tr><td>0</td><td>0</td><td>4</td><td>0</td></tr> <tr><td>30H</td><td>30H</td><td>34H</td><td>30H</td></tr> </table>	0	0	4	0	30H	30H	34H	30H	<table border="1"> <tr><td>40H</td><td>00H</td></tr> </table>	40H	00H
0	0	4	0									
30H	30H	34H	30H									
40H	00H											

Fixed value

Specify '0'.

ASCII code	Binary code														
<table border="1"> <tr><td>30H</td><td>30H</td><td>30H</td><td>30H</td><td>...</td><td>30H</td></tr> </table> <p>(16 characters)</p>	30H	30H	30H	30H	...	30H	<table border="1"> <tr><td> </td><td> </td><td> </td><td> </td><td> </td><td> </td><td> </td><td> </td></tr> </table> <p>(8 bytes)</p>								
30H	30H	30H	30H	...	30H										

■ Password

Specify the password of the access target file. (☞ Page 194 Password)

■ Drive No.

Specify the access target drive. (☞ Page 197 Drive No.)



Program memory (drive No.0) of RCPU cannot be specified.

■ Number of file name characters, file name

Specify the file name to be copied. (☞ Page 201 File name specification)

Communication example (files for MELSEC-Q series)

Copy the file under the following conditions:

- Copy source/destination password: 1234
- Drive No. of copy source, drive No. of copy destination: 0
- Copy source file name: ABC.QPG
- Copy source file name: CBA.QPG

■ Data communication in ASCII code

(Request data)

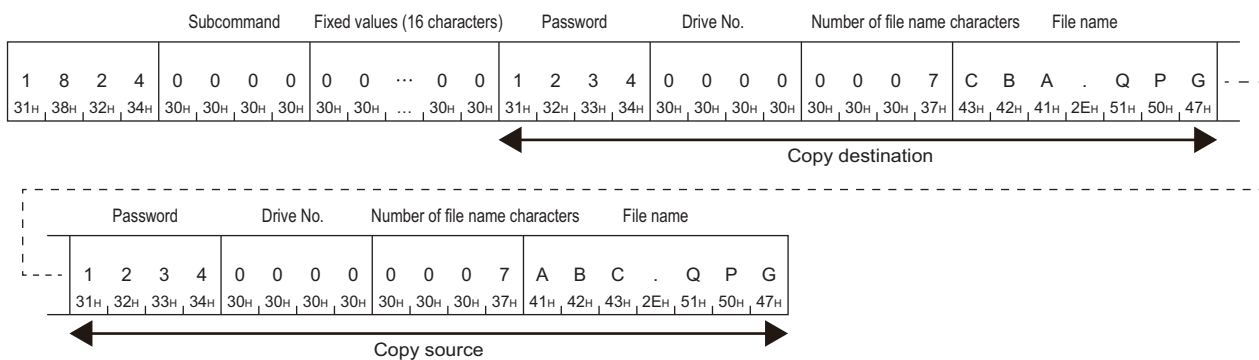

■ Data communication in binary code

(Request data)

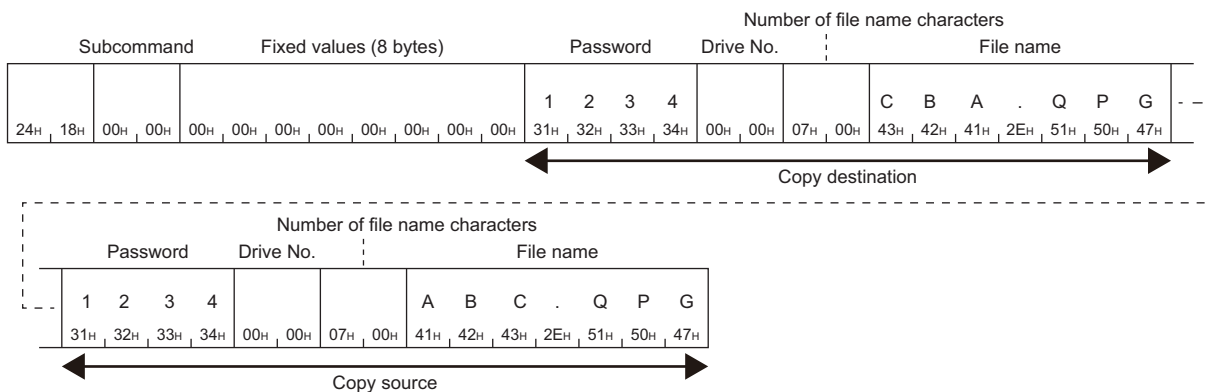

Communication example (files for MELSEC-L series)

Copy the file under the following conditions:

- Password copy source/destination AbCd1234□...□(24 spaces, code: 20H)
- Drive No. of copy source, drive No. of copy destination: 0
- Copy source file name: MAIN.QPG
- Copy source file name: DEST.QPG

■Data communication in ASCII code

(Request data)

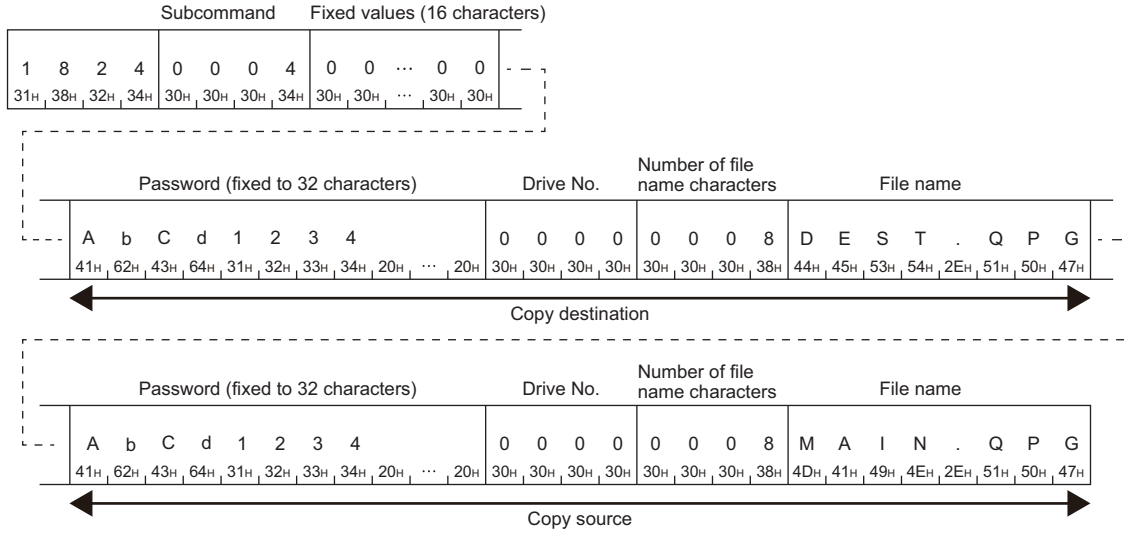

■Data communication in binary code

(Request data)

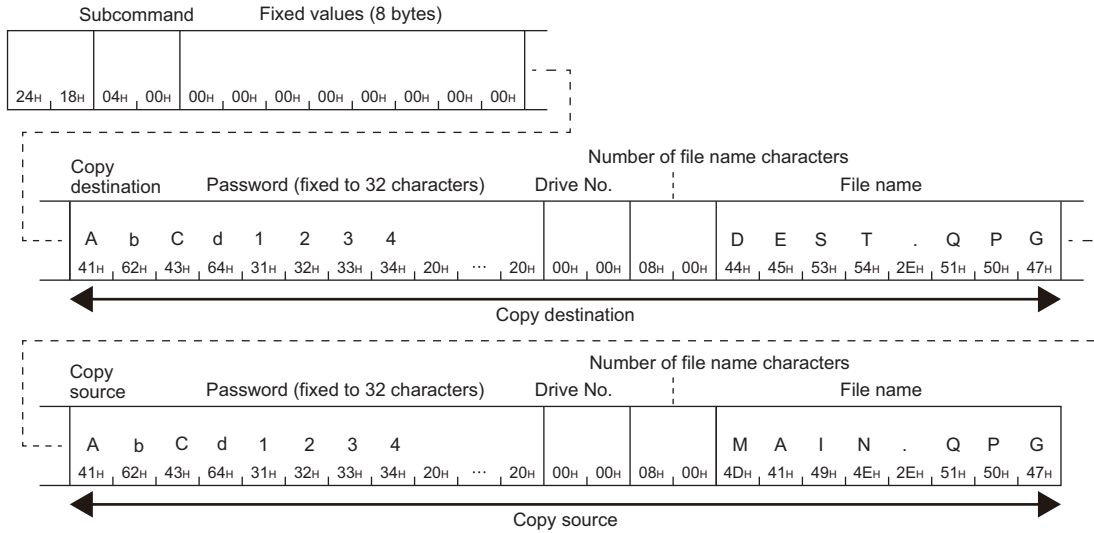

12.6 File Modification

Read or write data from/to the specified file. Lock the file with the open/close file command during reading or writing so that the file contents will not be changed from other devices. The file is not required to be locked with the open file command when commands other than read/write file command are executed.

When modifying the file attributes and the last edit date and time, executing the open command is not required.

Modify file attribute (command: 1825)

Change the file attributes (read only/writable).



When this command is executed to files of parameter and a program being executed, place CPU module in the STOP status. (☞ Page 464 Commands that cannot be executed during RUN)

Message format

The following shows the message format of the request data and response data of the command.

Request data

Command	Subcommand	Password	Drive No.	Attribute	Number of file name characters	File name
---------	------------	----------	-----------	-----------	--------------------------------	-----------

Response data

There is no response data for this command.

Data specified by request data

Command

ASCII code	Binary code										
<table border="1"> <tr> <td>1</td> <td>8</td> <td>2</td> <td>5</td> </tr> <tr> <td>31H</td> <td>38H</td> <td>32H</td> <td>35H</td> </tr> </table>	1	8	2	5	31H	38H	32H	35H	<table border="1"> <tr> <td>25H</td> <td>18H</td> </tr> </table>	25H	18H
1	8	2	5								
31H	38H	32H	35H								
25H	18H										

Subcommand

Item	ASCII code	Binary code										
For MELSEC-Q series	<table border="1"> <tr> <td>0</td> <td>0</td> <td>0</td> <td>0</td> </tr> <tr> <td>30H</td> <td>30H</td> <td>30H</td> <td>30H</td> </tr> </table>	0	0	0	0	30H	30H	30H	30H	<table border="1"> <tr> <td>00H</td> <td>00H</td> </tr> </table>	00H	00H
0	0	0	0									
30H	30H	30H	30H									
00H	00H											
For MELSEC-L series	<table border="1"> <tr> <td>0</td> <td>0</td> <td>0</td> <td>4</td> </tr> <tr> <td>30H</td> <td>30H</td> <td>30H</td> <td>34H</td> </tr> </table>	0	0	0	4	30H	30H	30H	34H	<table border="1"> <tr> <td>04H</td> <td>00H</td> </tr> </table>	04H	00H
0	0	0	4									
30H	30H	30H	34H									
04H	00H											
For MELSEC iQ-R series	<table border="1"> <tr> <td>0</td> <td>0</td> <td>4</td> <td>0</td> </tr> <tr> <td>30H</td> <td>30H</td> <td>34H</td> <td>30H</td> </tr> </table>	0	0	4	0	30H	30H	34H	30H	<table border="1"> <tr> <td>40H</td> <td>00H</td> </tr> </table>	40H	00H
0	0	4	0									
30H	30H	34H	30H									
40H	00H											

Password

Specify the password of the access target file. (☞ Page 194 Password)

■Drive No.

Specify the access target drive. (☞ Page 197 Drive No.)

■Attribute

Specify the file attribute. (☞ Page 204 Attribute)

- Read only: 01H
- Readable, writable: 20H

Do not specify the value other than above since the values are reserved for system use.

■Number of file name characters, file name

Specify the file name to modify attribute. (☞ Page 201 File name specification)

Communication example (files for MELSEC-Q series)

Change the file attribute in the following conditions.

- Password: 1234
- Drive No.: 0
- File name: ABC.QPG
- Attribute: Read only: 01H

■Data communication in ASCII code

(Request data)

Subcommand	Password	Drive No.	Attribute	Number of file name characters	File name
1 8 2 5 31H, 38H, 32H, 35H	0 0 0 0 30H, 30H, 30H, 30H	1 2 3 4 31H, 32H, 33H, 34H	0 0 0 0 30H, 30H, 30H, 30H	0 0 0 1 30H, 30H, 30H, 31H	0 0 0 7 30H, 30H, 30H, 37H
					A B C . Q P G 41H, 42H, 43H, 2EH, 51H, 50H, 47H

■Data communication in binary code

(Request data)

Subcommand	Password	Drive No.	Attribute	Number of file name characters	File name
	1 2 3 4 31H, 32H, 33H, 34H				A B C . Q P G 41H, 42H, 43H, 2EH, 51H, 50H, 47H
25H, 18H	00H, 00H	00H, 00H	01H, 00H	07H, 00H	

Communication example (files for MELSEC-L series)

Change the file attribute in the following conditions.

- Password: AbCd1234□...□(24 spaces, code: 20H)
- Drive No.: 0
- File name: MAIN.QPG
- Attribute: Read only: 01H

■Data communication in ASCII code

(Request data)

Subcommand	Password (fixed to 32 characters)	Drive No.	Attribute	Number of file name characters	File name
1 8 2 5 31H, 38H, 32H, 35H	0 0 0 4 30H, 30H, 30H, 34H	A b C d 1 2 3 4 41H, 62H, 43H, 64H, 31H, 32H, 33H, 34H, 20H, ..., 20H	0 0 0 0 30H, 30H, 30H, 30H	0 0 0 1 30H, 30H, 30H, 31H	
					M A I N . Q P G 4DH, 41H, 49H, 4EH, 2EH, 51H, 50H, 47H

■Data communication in binary code

(Request data)

Subcommand	Password (fixed to 32 characters)	Drive No.	Attribute	Number of file name characters	File name
	A b C d 1 2 3 4 41H, 62H, 43H, 64H, 31H, 32H, 33H, 34H, 20H, ..., 20H				M A I N . Q P G 4DH, 41H, 49H, 4EH, 2EH, 51H, 50H, 47H
25H, 18H	04H, 00H	00H, 00H	01H, 00H	08H, 00H	

Communication example (files for MELSEC iQ-R series)

Change the file attribute in the following conditions.

- Password: A to Z (26 characters)
- Drive No.: 4
- Attribute: Read only: 01H

The file name is as follows:

(1) LINE.CSV (8 characters)

Item	Value of code corresponding to character							
File name	L	I	N	E	.	C	S	V
UTF-16	004C	0049	004E	0045	002E	0043	0053	0056
ASCII code	30303443	30303439	30303445	30303435	30303245	30303433	30303533	30303536
Binary code	4C00	4900	4E00	4500	2E00	4300	5300	5600

■Data communication in ASCII code

(Request data)

Subcommand		Number of password characters				Password											
1	8	2	5	0	0	4	0	0	0	1	A	A	B	C	D	...	Z
31H	38H	32H	35H	30H	30H	34H	30H	30H	30H	31H	41H	41H	42H	43H	44H		5AH

Drive No.		Attribute		Number of file name characters			File name					
0	0	0	4	0	0	0	1	0	0	0	8	(1)
30H	30H	30H	34H	30H	30H	30H	31H	30H	30H	30H	38H	

■Data communication in binary code

(Request data)

Subcommand		Number of password characters		Password						Drive No.	Attribute	Number of file name characters		File name			
		A	B	C	D	...	Z					(1)					
25H	18H	40H	00H	1AH	00H	41H	42H	43H	44H		5AH	04H	00H	01H	00H	08H	00H

Modify file creation date and time (command: 1826)

Modify the file creation date and time.

Restriction

When this command is executed to files of parameter and a program being executed, place CPU module in the STOP status. (Page 464 Commands that cannot be executed during RUN)

Message format

The following shows the message format of the request data and response data of the command.

Request data

Command	Subcommand	Fixed values	Drive No.	Date to change	Time to change	Number of file name characters	File name
---------	------------	--------------	-----------	----------------	----------------	--------------------------------	-----------

Response data

There is no response data for this command.

Data specified by request data

Command

ASCII code	Binary code										
<table border="1"> <tr> <td>1</td> <td>8</td> <td>2</td> <td>6</td> </tr> <tr> <td>31H</td> <td>38H</td> <td>32H</td> <td>36H</td> </tr> </table>	1	8	2	6	31H	38H	32H	36H	<table border="1"> <tr> <td>26H</td> <td>18H</td> </tr> </table>	26H	18H
1	8	2	6								
31H	38H	32H	36H								
26H	18H										

Subcommand

Item	ASCII code	Binary code										
For MELSEC-Q/L series	<table border="1"> <tr> <td>0</td> <td>0</td> <td>0</td> <td>0</td> </tr> <tr> <td>30H</td> <td>30H</td> <td>30H</td> <td>30H</td> </tr> </table>	0	0	0	0	30H	30H	30H	30H	<table border="1"> <tr> <td>00H</td> <td>00H</td> </tr> </table>	00H	00H
0	0	0	0									
30H	30H	30H	30H									
00H	00H											
For MELSEC iQ-R series	<table border="1"> <tr> <td>0</td> <td>0</td> <td>4</td> <td>0</td> </tr> <tr> <td>30H</td> <td>30H</td> <td>34H</td> <td>30H</td> </tr> </table>	0	0	4	0	30H	30H	34H	30H	<table border="1"> <tr> <td>40H</td> <td>00H</td> </tr> </table>	40H	00H
0	0	4	0									
30H	30H	34H	30H									
40H	00H											

Fixed value

Specify '0'.

ASCII code	Binary code												
<table border="1"> <tr> <td>0</td> <td>0</td> <td>0</td> <td>0</td> </tr> <tr> <td>30H</td> <td>30H</td> <td>30H</td> <td>30H</td> </tr> </table>	0	0	0	0	30H	30H	30H	30H	<table border="1"> <tr> <td>00H</td> <td>00H</td> <td>00H</td> <td>00H</td> </tr> </table>	00H	00H	00H	00H
0	0	0	0										
30H	30H	30H	30H										
00H	00H	00H	00H										

Drive No.

Specify the access target drive. (Page 197 Drive No.)

Date to change, time to change

The file of the last edit date and time is modified with the specified date and time. (Page 205 Creation date and time (last edit date and time))

Number of file name characters, file name

Specify the file name to modify attribute. (Page 201 File name specification)

Communication example (files for MELSEC-Q series)

Modify the date and time of file creation under the following conditions.

- Drive No.: 0
- Date to change: 2010/04/01
- Time to change: 20:50:58
- File name: ABC.QPG

■Data communication in ASCII code

(Request data)

Subcommand				(Fixed value)				Drive No.				Date to change				Time to change			
1	8	2	6	0	0	0	0	0	0	0	0	3	C	8	1	A	6	5	D
31H	38H	32H	36H	30H	30H	30H	30H	30H	30H	30H	30H	33H	43H	38H	31H	41H	36H	35H	44H

Number of file name characters				File name						
0	0	0	7	A	B	C	. Q P G			
30H	30H	30H	37H	41H	42H	43H	2EH	51H	50H	47H

■Data communication in binary code

(Request data)

Subcommand		(Fixed value)		Drive No.	Date to change	Time to change	Number of file name characters	File name									
								A	B	C	. Q P G						
26H	18H	00H	00H	00H	81H	3CH	5DH	A6H	07H	00H	41H	42H	43H	2EH	51H	50H	47H

Communication example (files for MELSEC iQ-R series)

Modify the date and time of file creation under the following conditions.

- Drive No.: 4
- Date to change: 2010/04/01
- Time to change: 20:50:58

The file name is as follows:

(1) LINE.CSV (8 characters)

Item	Value of code corresponding to character							
File name	L	I	N	E	.	C	S	V
UTF-16	004C	0049	004E	0045	002E	0043	0053	0056
ASCII code	30303443	30303439	30303445	30303435	30303245	30303433	30303533	30303536
Binary code	4C00	4900	4E00	4500	2E00	4300	5300	5600

■Data communication in ASCII code

(Request data)

Subcommand				(Fixed value)				Drive No.				Date to change				Time to change							
1	8	2	6	0	0	4	0	0	0	0	0	0	0	0	4	3	C	8	1	A	6	5	D
31H	38H	32H	36H	30H	30H	34H	30H	30H	30H	30H	30H	30H	30H	30H	34H	33H	43H	38H	31H	41H	36H	35H	44H

Number of file name characters				File name			
0	0	0	8	(1)			
30H	30H	30H	38H				

■Data communication in binary code

(Request data)

Subcommand				(Fixed value)				Drive No.		Date to change		Time to change		Number of file name characters		File name	
														(1)			
26H	18H	40H	00H	00H	00H	00H	00H	04H	00H	81H	3CH	5DH	A6H	08H	00H		

Open file (command: 1827)

Open a file and lock the file so that the file contents are not modified from other devices.

Point

The file is unlocked by any of the following.

- Close file (command: 182A)
- Restarting a module. (Resetting the CPU module, etc.)

Message format

The following shows the message format of the request data and response data of the command.

Request data

Command	Subcommand	Password	Open mode	Drive No.	Number of file name characters	File name
---------	------------	----------	-----------	-----------	--------------------------------	-----------

Response data

The file pointer No. is stored. (Page 207 File pointer No.)

Data specified by request data

Command

ASCII code	Binary code										
<table border="1"> <tr> <td>1</td> <td>8</td> <td>2</td> <td>7</td> </tr> <tr> <td>31H</td> <td>38H</td> <td>32H</td> <td>37H</td> </tr> </table>	1	8	2	7	31H	38H	32H	37H	<table border="1"> <tr> <td>27H</td> <td>18H</td> </tr> </table>	27H	18H
1	8	2	7								
31H	38H	32H	37H								
27H	18H										

Subcommand

Item	ASCII code	Binary code										
For MELSEC-Q series	<table border="1"> <tr> <td>0</td> <td>0</td> <td>0</td> <td>0</td> </tr> <tr> <td>30H</td> <td>30H</td> <td>30H</td> <td>30H</td> </tr> </table>	0	0	0	0	30H	30H	30H	30H	<table border="1"> <tr> <td>00H</td> <td>00H</td> </tr> </table>	00H	00H
0	0	0	0									
30H	30H	30H	30H									
00H	00H											
For MELSEC-L series	<table border="1"> <tr> <td>0</td> <td>0</td> <td>0</td> <td>4</td> </tr> <tr> <td>30H</td> <td>30H</td> <td>30H</td> <td>34H</td> </tr> </table>	0	0	0	4	30H	30H	30H	34H	<table border="1"> <tr> <td>04H</td> <td>00H</td> </tr> </table>	04H	00H
0	0	0	4									
30H	30H	30H	34H									
04H	00H											
For MELSEC iQ-R series	<table border="1"> <tr> <td>0</td> <td>0</td> <td>4</td> <td>0</td> </tr> <tr> <td>30H</td> <td>30H</td> <td>34H</td> <td>30H</td> </tr> </table>	0	0	4	0	30H	30H	34H	30H	<table border="1"> <tr> <td>40H</td> <td>00H</td> </tr> </table>	40H	00H
0	0	4	0									
30H	30H	34H	30H									
40H	00H											

Password

Specify the password of the access target file. (Page 194 Password)

Open mode

Specify whether the specified file is open for reading or for writing. (Page 209 Open mode)

- Open for read: 0000H
- Open for write: 0100H

■ Drive No.

Specify the access target drive. (☞ Page 197 Drive No.)

■ Number of file name characters, file name

Specify the file name to be open. (☞ Page 201 File name specification)

Communication example (files for MELSEC-Q series)

Open the file of QCPU in the following conditions.

- Password: 1234
- Drive No.: 0
- File name: ABC.QPG
- Open mode: Open for write

■ Data communication in ASCII code

(Request data)

Subcommand	Password	Open mode	Drive No.	Number of file name characters	File name
1 8 2 7 31H, 38H, 32H, 37H	0 0 0 0 30H, 30H, 30H, 30H	1 2 3 4 31H, 32H, 33H, 34H	0 1 0 0 30H, 31H, 30H, 30H	0 0 0 0 30H, 30H, 30H, 30H	0 0 0 7 30H, 30H, 30H, 37H
					A B C . Q P G 41H, 42H, 43H, 2EH, 51H, 50H, 47H

(Response data)

File pointer No.

0 0 0 0 30H, 30H, 30H, 30H

■ Data communication in binary code

(Request data)

Subcommand	Password	Open mode	Drive No.	Number of file name characters	File name
	1 2 3 4 31H, 32H, 33H, 34H				A B C . Q P G 41H, 42H, 43H, 2EH, 51H, 50H, 47H
27H, 18H	00H, 00H	00H, 01H	00H, 00H	07H, 00H	

(Response data)

File pointer No.

00H, 00H

Communication example (files for MELSEC-L series)

Open the file of LCPU in the following condition.

- Password: AbCd1234□...□(24 spaces, code: 20H)
- Drive No.: 0
- File name: MAIN.QPG
- Open mode: Open for write

■Data communication in ASCII code

(Request data)

Subcommand				Password (fixed to 32 characters)												Open mode				Drive No.						
1	8	2	7	0	0	0	4	A	b	C	d	1	2	3	4	0	1	0	0	0	0	0	0			
31H	38H	32H	37H	30H	30H	30H	34H	41H	62H	43H	64H	31H	32H	33H	34H	20H	...	20H	30H	31H	30H	30H	30H	30H	30H	30H

Number of file name characters				File name											
0	0	0	8	M	A	I	N	.	Q	P	G				
30H	30H	30H	38H	4DH	41H	49H	4EH	2EH	51H	50H	47H				

(Response data)

File pointer No.

0	0	0	0
30H	30H	30H	30H

■Data communication in binary code

(Request data)

Subcommand				Password (fixed to 32 characters)												Open mode		Drive No.	Number of file name characters				File name											
				A	b	C	d	1	2	3	4									M	A	I	N	.	Q	P	G							
27H	18H	04H	00H	41H	62H	43H	64H	31H	32H	33H	34H	20H	...	20H	00H	01H	00H	00H	08H	00H	4DH	41H	49H	4EH	2EH	51H	50H	47H						

(Response data)

File pointer No.

00H	00H
-----	-----

Communication example (files for MELSEC iQ-R series)

Open a file of MELSEC iQ-R series CPU module.

- Password: A to Z (26 characters)
- Drive No.: 4
- Open mode: Open for write

The file name is as follows:

(1) LINE.CSV (8 characters)

Item	Value of code corresponding to character							
File name	L	I	N	E	.	C	S	V
UTF-16	004C	0049	004E	0045	002E	0043	0053	0056
ASCII code	30303443	30303439	30303445	30303435	30303245	30303433	30303533	30303536
Binary code	4C00	4900	4E00	4500	2E00	4300	5300	5600

■Data communication in ASCII code

(Request data)

Subcommand				Number of password characters				Password															
1	8	2	7	0	0	4	0	0	0	1	A	A	B	C	D	...	Z						
31H	38H	32H	37H	30H	30H	34H	30H	30H	30H	31H	41H	41H	42H	43H	44H		5AH						
Open mode				Drive No.				Number of file name characters				File name											
0	1	0	0	0	0	0	4	0	0	0	8	(1)											
30H	31H	30H	30H	30H	30H	30H	34H	30H	30H	30H	38H												

(Response data)

File pointer No.

0	0	0	0
30H	30H	30H	30H

■Data communication in binary code

(Request data)

Subcommand		Number of password characters		Password													Open mode	Drive No.	Number of file name characters		File name
				A	B	C	D	...	Z											(1)	
27H	18H	40H	00H	1AH	00H	41H	42H	43H	44H		34H	00H	01H	04H	00H	08H	00H				

(Response data)

File pointer No.

00H	00H
-----	-----

Read file (command: 1828)

Read a file content.

Use the open/close command in order to prohibit access from other devices when this command is used.

Message format

The following shows the message format of the request data and response data of the command.

Request data

Command	Subcommand	File pointer No.	Offset address	Number of bytes read
---------	------------	------------------	----------------	----------------------

Response data

The data which have been read is stored.

Number of bytes read	Read data
----------------------	-----------

Data specified by request data

Command

ASCII code	Binary code										
<table border="1"> <tr><td>1</td><td>8</td><td>2</td><td>8</td></tr> <tr><td>31H</td><td>38H</td><td>32H</td><td>38H</td></tr> </table>	1	8	2	8	31H	38H	32H	38H	<table border="1"> <tr><td>28H</td><td>18H</td></tr> </table>	28H	18H
1	8	2	8								
31H	38H	32H	38H								
28H	18H										

Subcommand

ASCII code	Binary code										
<table border="1"> <tr><td>0</td><td>0</td><td>0</td><td>0</td></tr> <tr><td>30H</td><td>30H</td><td>30H</td><td>30H</td></tr> </table>	0	0	0	0	30H	30H	30H	30H	<table border="1"> <tr><td>00H</td><td>00H</td></tr> </table>	00H	00H
0	0	0	0								
30H	30H	30H	30H								
00H	00H										

File pointer No.

Specify the file pointer No. obtained with the 'open file' (command: 1827). (☞ Page 207 File pointer No.)

Offset address

Specify the start address to start reading. (☞ Page 207 Offset address)

Number of bytes read

Specify the number of bytes to be read from file in the range of 0 to 1920. (☞ Page 208 Number of bytes)

Specify it as one address/one byte.



When the file size is 1921 bytes or more, use an offset address and read data divide into multiple steps. The file size can be checked by reading directory/file information (command: 1810).

☞ Page 210 Read directory/file information (command: 1810)

Data stored in response data

Number of bytes read

The number of data bytes read from file is stored. (☞ Page 208 Number of bytes)

Read data

The contents of the read file are stored.

Communication example

Read the file under the following conditions:

- File pointer No.: 0
- Number of bytes read: 1K bytes

■Data communication in ASCII code

(Request data)

				Subcommand	File pointer No.	Offset address	Number of bytes read
1	8	2	8	0 0 0 0	0 0 0 0	0 0 0 0 0 0 0 0	0 4 0 0
31H	38H	32H	38H	30H, 30H, 30H, 30H	30H, 30H, 30H, 30H	30H, 30H, 30H, 30H, 30H, 30H, 30H, 30H	30H, 34H, 30H, 30H

(Response data)

Number of bytes read Read data

0 4 0 0	(Contents of a file)
30H, 34H, 30H, 30H	

■Data communication in binary code

(Request data)

		File pointer No.			Number of bytes read
Subcommand	:	Offset address			
28H, 18H	00H, 00H	00H, 00H	00H, 00H, 00H, 00H	00H, 04H	

(Response data)

Number of bytes read Read data

00H, 04H	(Contents of a file)
----------	----------------------

Write to file (command: 1829)

Write content to a file.

Use the open/close command in order to prohibit access from other devices when this command is used.

Restriction

When this command is executed to files of parameter and a program being executed, place CPU module in the STOP status. (☞ Page 464 Commands that cannot be executed during RUN)

Message format

The following shows the message format of the request data and response data of the command.

Request data

Command	Subcommand	File pointer No.	Offset address	Number of bytes written	Write data
---------	------------	------------------	----------------	-------------------------	------------

Response data

The number of data bytes written in the file is stored. (☞ Page 208 Number of bytes)

Data specified by request data

Command

ASCII code	Binary code										
<table border="1"> <tr><td>1</td><td>8</td><td>2</td><td>9</td></tr> <tr><td>31H</td><td>38H</td><td>32H</td><td>39H</td></tr> </table>	1	8	2	9	31H	38H	32H	39H	<table border="1"> <tr><td>29H</td><td>18H</td></tr> </table>	29H	18H
1	8	2	9								
31H	38H	32H	39H								
29H	18H										

Subcommand

ASCII code	Binary code										
<table border="1"> <tr><td>0</td><td>0</td><td>0</td><td>0</td></tr> <tr><td>30H</td><td>30H</td><td>30H</td><td>30H</td></tr> </table>	0	0	0	0	30H	30H	30H	30H	<table border="1"> <tr><td>00H</td><td>00H</td></tr> </table>	00H	00H
0	0	0	0								
30H	30H	30H	30H								
00H	00H										

File pointer No.

Specify the file pointer No. obtained with the 'open file' (command: 1827). (☞ Page 207 File pointer No.)

Offset address

Specify the start address to start writing. (☞ Page 207 Offset address)

- Writing data to a file of which drive name is '00H' (program memory): Specify the address in multiples of 4 (0, 4, 8,... in decimal notation).
- Writing data to a file of which drive name is other than '00H': Specify the addresses in even numbered addresses (0, 2, 4, 6, 8,... In decimal notation).

Number of bytes written

Specify the number of bytes to be written to a file in the range of 0 to 1920. (☞ Page 208 Number of bytes)

Specify it as one address/one byte.

Point

Write data to the file within the file size reserved by creating new file.

When the file size is 1921 bytes or more, use an offset address and write data divide into multiple steps. The file size can be checked by reading directory/file information (command: 1810).

☞ Page 210 Read directory/file information (command: 1810)

■Write data

Specify the data to be written to a file.

Communication example

Write the file under the following conditions:

- File pointer No.: 0
- Offset address: 0
- Number of bytes written: 1K byte

■Data communication in ASCII code

(Request data)

	Subcommand	File pointer No.	Offset address	Number of bytes written	Write data
	1 8 2 9 31H, 38H, 32H, 39H	0 0 0 0 30H, 30H, 30H, 30H	0 0 0 0 0 0 0 0 30H, 30H, 30H, 30H, 30H, 30H, 30H, 30H	0 4 0 0 30H, 34H, 30H, 30H	(Contents of a file)

(Response data)

Number of bytes written

0 4 0 0 30H, 34H, 30H, 30H

■Data communication in binary code

(Request data)

	Subcommand	File pointer No.	Offset address	Number of bytes written	Write data
	29H, 18H	00H, 00H	00H, 00H, 00H, 00H	00H, 04H	(Contents of a file)

(Response data)

Number of bytes written

00H, 04H

Close file (command: 182A)

Close a file and unlock the file which has been locked by the 'open file' (command: 1827).

Message format

The following shows the message format of the request data and response data of the command.

Request data

Command	Subcommand	File pointer No.	Close type
---------	------------	------------------	------------

Response data

There is no response data for this command.

Data specified by request data

Command

ASCII code	Binary code
1 8 2 A 31H, 38H, 32H, 41H	2AH, 18H

Subcommand

ASCII code	Binary code
0 0 0 0 30H, 30H, 30H, 30H	00H, 00H

File pointer No.

Specify the file pointer No. obtained with the 'open file' (command: 1827). (☞ Page 207 File pointer No.)

Close type

Specify the file to be closed. (☞ Page 209 Close type)

When closing a file specified by file pointer, specify '0'.

ASCII code	Binary code
0 0 0 0 30H, 30H, 30H, 30H	00H, 00H

The locked files which have been opened by other devices cannot be unlocked.

Executing the command to files which have been opened by the other external device results in abnormal completion of the command.



Files are closed by restarting a module (such as resetting CPU module).

Communication example

Close the file under the following conditions:

- File pointer No.: 0
- Close type: 2

■Data communication in ASCII code

(Request data)

				Subcommand	File pointer No.	Close type
1	8	2	A	0 0 0 0	0 0 0 0	0 0 0 2
31H	38H	32H	41H	30H, 30H, 30H, 30H	30H, 30H, 30H, 30H	30H, 30H, 30H, 32H

■Data communication in binary code

(Request data)

				File pointer No.
Subcommand	Close type			
2AH, 18H	00H, 00H	00H, 00H	02H, 00H	

13 SERIAL COMMUNICATION MODULE DEDICATED COMMANDS

This chapter explains the dedicated commands for serial communication module.

13.1 User Frame

A user frame is a data name which is used to send/receive data by registering the fixed format portion in a message to be communicated between an external device and serial communication module.

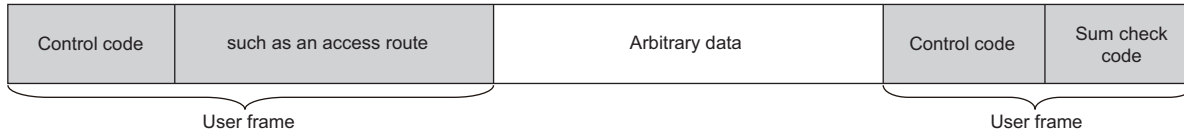

Control code or sum check code in the message are registered as a default registration frame.

The data such as an access route can be registered to the user frame.

By using the user frame, the following data communication can be performed.

- Transmission of on-demand data by MC protocol
- Data communication by nonprocedural protocol

This section explains the commands for an external device to register, delete, and read user frames to C24. For transmission and reception of data using a user frame, refer to the following manual.

📖 MELSEC-Q/L Serial Communication Module User's Manual (Application)

📖 MELSEC iQ-R Serial Communication Module User's Manual(Application)

Restriction

The command can only be used for C24 (including multidrop connection station) connected to the external device. It cannot be used via network.

Point

This command is processed by the connected C24/E71 without waiting for the END processing by CPU module.

Data to be specified in command

This section explains the contents and specification methods for data items which are set in each command related to the user frame.

Frame No.

Specify the number of target user frame.

Type	Setting value	Registration destination	Remarks
Default registration frame	1H to 3E7H	ROM for C24 operating system	Read only
User frame	3E8H to 4AFH	Flash ROM of C24	Read, write, delete
	8001H to 801FH	Buffer memory of C24 (addresses 1B00H to 1FF6H)	Read, write, delete

■Data communication in ASCII code

Convert the numerical value to 4-digit ASCII code (hexadecimal), and send it from the upper digits.

■Data communication in binary code

Send 2-byte numerical values from lower byte (L: bits 0 to 7).

Ex.

For 3E8H

ASCII code	Binary code										
<table border="1"> <tr> <td>0</td> <td>3</td> <td>E</td> <td>8</td> </tr> <tr> <td>30H</td> <td>33H</td> <td>45H</td> <td>38H</td> </tr> </table>	0	3	E	8	30H	33H	45H	38H	<table border="1"> <tr> <td>E8</td> <td>03H</td> </tr> </table>	E8	03H
0	3	E	8								
30H	33H	45H	38H								
E8	03H										

Number of registration data byte, number of frame byte

Specify the number of bytes of registration data.

Function	Setting value
Data registration, read data	1H to 50H (1 to 80)
Deletion	0H

For the number of registration data byte, calculate the variable data as 2 bytes.

For the number of frame byte, calculate the variable data as 1 byte.

For the variable data, refer to the following manuals.

📖 MELSEC-Q/L Serial Communication Module User's Manual (Application)

📖 MELSEC iQ-R Serial Communication Module User's Manual(Application)

■Data communication in ASCII code

Convert the numerical value to 4-digit ASCII code (hexadecimal), and send it from the upper digits.

■Data communication in binary code

Send 2-byte numerical values from lower byte (L: bits 0 to 7).

Ex.

When the registration data is ETX + variable data (sum check code) + CR + LF

Number of registration data byte = 1-byte (ETX) + 2-byte (variable data) + 1-byte (CR) + 1-byte (LF) = 5

Number of frame byte = 1-byte (ETX) + 1-byte (variable data) + 1-byte (CR) + 1-byte (LF) = 4

Item	ASCII code	Binary code										
Number of registration data byte	<table border="1"> <tr> <td>0</td> <td>0</td> <td>0</td> <td>5</td> </tr> <tr> <td>30H</td> <td>30H</td> <td>30H</td> <td>35H</td> </tr> </table>	0	0	0	5	30H	30H	30H	35H	<table border="1"> <tr> <td>05H</td> <td>00H</td> </tr> </table>	05H	00H
0	0	0	5									
30H	30H	30H	35H									
05H	00H											
Number of frame byte	<table border="1"> <tr> <td>0</td> <td>0</td> <td>0</td> <td>4</td> </tr> <tr> <td>30H</td> <td>30H</td> <td>30H</td> <td>34H</td> </tr> </table>	0	0	0	4	30H	30H	30H	34H	<table border="1"> <tr> <td>04H</td> <td>00H</td> </tr> </table>	04H	00H
0	0	0	4									
30H	30H	30H	34H									
04H	00H											

Registration data

The following shows the content of data in a user frame.

■Data communication in ASCII code

Convert the data to 2-digit (hexadecimal) ASCII code, and send it from the upper digit.

■Data communication in binary code

Send data from the first frame.

Ex.

When the registration data is ETX + Variable data (sum check code) + CR + LF

ASCII code	Binary code																				
<p style="text-align: center;">Variable data (Sum check code)</p> <table style="width: 100%; border-collapse: collapse;"> <tr> <td style="text-align: center;">ETX</td> <td style="text-align: center;">⋮</td> <td style="text-align: center;">CR</td> <td style="text-align: center;">LF</td> </tr> <tr> <td style="text-align: center;">0 3</td> <td style="text-align: center;">F F F 1</td> <td style="text-align: center;">0 D</td> <td style="text-align: center;">0 A</td> </tr> <tr> <td style="text-align: center;">30H, 33H</td> <td style="text-align: center;">46H, 46H, 46H, 31H</td> <td style="text-align: center;">30H, 44H</td> <td style="text-align: center;">30H, 41H</td> </tr> </table>	ETX	⋮	CR	LF	0 3	F F F 1	0 D	0 A	30H, 33H	46H, 46H, 46H, 31H	30H, 44H	30H, 41H	<p style="text-align: center;">Variable data (Sum check code)</p> <table style="width: 100%; border-collapse: collapse;"> <tr> <td style="text-align: center;">ETX</td> <td style="text-align: center;">⋮</td> <td style="text-align: center;">CR</td> <td style="text-align: center;">LF</td> </tr> <tr> <td style="text-align: center;">03H</td> <td style="text-align: center;">FFH, F0H</td> <td style="text-align: center;">0DH</td> <td style="text-align: center;">0AH</td> </tr> </table>	ETX	⋮	CR	LF	03H	FFH, F0H	0DH	0AH
ETX	⋮	CR	LF																		
0 3	F F F 1	0 D	0 A																		
30H, 33H	46H, 46H, 46H, 31H	30H, 44H	30H, 41H																		
ETX	⋮	CR	LF																		
03H	FFH, F0H	0DH	0AH																		

Read registered data (command: 0610)

Read the registered content of user frames.

Message format

The following shows the message format of the request data and response data of the command.

Request data

Command	Subcommand	Frame No.
---------	------------	-----------

Response data

The read registration data is stored.

Registration data byte count	Frame byte count	Registration data
---------------------------------	---------------------	-------------------

Data specified by request data

Command

ASCII code	Binary code ^{*1}												
<table border="1"> <tr> <td>0</td> <td>6</td> <td>1</td> <td>0</td> </tr> <tr> <td>30H</td> <td>36H</td> <td>31H</td> <td>30H</td> </tr> </table>	0	6	1	0	30H	36H	31H	30H	<table border="1"> <tr> <td>DLE</td> <td></td> </tr> <tr> <td>10H</td> <td>10H, 06H</td> </tr> </table>	DLE		10H	10H, 06H
0	6	1	0										
30H	36H	31H	30H										
DLE													
10H	10H, 06H												

*1 For C24, an additional code is added. (☞ Page 35 Additional code (10H))

Subcommand

ASCII code	Binary code										
<table border="1"> <tr> <td>0</td> <td>0</td> <td>0</td> <td>0</td> </tr> <tr> <td>30H</td> <td>30H</td> <td>30H</td> <td>30H</td> </tr> </table>	0	0	0	0	30H	30H	30H	30H	<table border="1"> <tr> <td>00H</td> <td>00H</td> </tr> </table>	00H	00H
0	0	0	0								
30H	30H	30H	30H								
00H	00H										

Frame No.

Specify the number of user frame to be read. (☞ Page 246 Frame No.)

Type	Setting value	Registration destination
Default registration frame	1H to 3E7H	ROM for C24 operating system
User frame	3E8H to 4AFH	Flash ROM of C24
	8001H to 801FH	Buffer memory of C24 (addresses 1B00H to 1FF6H)

Point

When the frame No. whose user frame is not registered is specified, an error occurs and an abnormal response is returned.

Data to be stored by response data

Number of registration data byte, number of frame byte

The data byte count of the registration data is stored. (☞ Page 246 Number of registration data byte, number of frame byte)

Registration data

The data content of user frames to be registered is stored. (☞ Page 247 Registration data)

Communication example

Read the following registration data from frame No. 3E8H.

Registration data: ETX + Variable data (sum check code) + CR + LF

■Data communication in ASCII code

(Request data)

Command	Subcommand	Frame No.
0 6 1 0	0 0 0 0	0 3 E 8
30H 36H 31H 30H	30H 30H 30H 30H	30H 38H 45H 38H

(Response data)

Number of registration data byte	Number of frame byte	ETX	Variable data	CR	LF
0 0 0 5	0 0 0 4	0 3	F F F 1	0 D	0 A
30H 30H 30H 35H	30H 30H 30H 34H	30H 33H	46H 46H 46H 31H	30H 44H	30H 41H

■Data communication in binary code

(Request data)

Subcommand	Frame No.
10H 10H 06H	00H 00H E8H 03H

(Response data)

Number of registration data byte	Number of frame byte	ETX	Variable data	CR	LF
05H 00H	04H 00H	03H	FFH F0H	0DH	0AH

Register data (command: 1610)

Register user frames to C24.

Restriction

For MELSEC iQ-R series, the user frame is replaced with the contents registered using module extended parameters by powering OFF → ON or switching the CPU module STOP → RUN. For more information on user frame registration using module extended parameters, refer to the following manual.

 MELSEC iQ-R Serial Communication Module User's Manual(Application)

Point

When registering a user frame with the same frame No. again, deleted the user frame first and registered again. If it is attempted to register a user frame by specifying an already registered frame No., an error occurs and an abnormal response is returned.

Message format

The following shows the message format of the request data and response data of the command.

Request data

Command	Subcommand	Frame No.	Number of registration data byte	Number of frame byte	Registration data
---------	------------	-----------	----------------------------------	----------------------	-------------------

Response data

There is no response data for this command.

Data specified by request data

Command

ASCII code	Binary code*1												
<table border="1"> <tr> <td>1</td> <td>6</td> <td>1</td> <td>0</td> </tr> <tr> <td>31H</td> <td>36H</td> <td>31H</td> <td>30H</td> </tr> </table>	1	6	1	0	31H	36H	31H	30H	<table border="1"> <tr> <td>DLE</td> <td></td> </tr> <tr> <td>10H</td> <td>10H, 16H</td> </tr> </table>	DLE		10H	10H, 16H
1	6	1	0										
31H	36H	31H	30H										
DLE													
10H	10H, 16H												

*1 For C24, an additional code is added. ( Page 35 Additional code (10H))

Subcommand

ASCII code	Binary code									
<table border="1"> <tr> <td>0</td> <td>0</td> <td>0</td> <td>0</td> </tr> <tr> <td>30H</td> <td>30H</td> <td>30H</td> <td>30H</td> </tr> </table>	0	0	0	0	30H	30H	30H	30H	<table border="1"> <tr> <td>00H, 00H</td> </tr> </table>	00H, 00H
0	0	0	0							
30H	30H	30H	30H							
00H, 00H										

Frame No.

Specify the number of user frame to be registered. ( Page 246 Frame No.)

Type	Setting value	Registration destination
User frame	3E8H to 4AFH	Flash ROM of C24
	8001H to 801FH	Buffer memory of C24 (addresses 1B00H to 1FF6H)

Number of registration data byte, number of frame byte

Specify the byte count of registration data within the range of 1 to 80. ( Page 246 Number of registration data byte, number of frame byte)

Registration data

Store the content of user frame data to be registered. ( Page 247 Registration data)

Communication example

Register the following data in frame No. 3E8H.

Registration data: ETX + Variable data (sum check code) + CR + LF

■Data communication in ASCII code

(Request data)

Command	Subcommand	Frame No.	Number of registration data byte	Number of frame byte	ETX	Variable data	CR	LF
1 6 1 0 31H, 36H, 31H, 30H	0 0 0 0 30H, 30H, 30H, 30H	0 3 E 8 30H, 38H, 45H, 38H	0 0 0 5 30H, 30H, 30H, 35H	0 0 0 4 30H, 30H, 30H, 34H	0 3 30H, 33H	F F F 1 46H, 46H, 46H, 31H	0 D 30H, 44H	0 A 30H, 41H

← Registration data →

■Data communication in binary code

(Request data)

Command	Subcommand	Frame No.	Number of registration data byte	Number of frame byte	ETX	Variable data	CR	LF
10H, 10H, 16H	00H, 00H	E8H, 03H	05H, 00H	04H, 00H	03H	FFH, F1H	0DH	0AH

← Registration data →

Delete registered data (command: 1610)

Delete the registered user frame.

Message format

The following shows the message format of the request data and response data of the command.

Request data

Command	Subcommand	Frame No.	Number of registration data byte	Number of frame byte
---------	------------	-----------	----------------------------------	----------------------

Response data

There is no response data for this command.

Data specified by request data

Command

ASCII code	Binary code ^{*1}												
<table border="1"> <tr><td>1</td><td>6</td><td>1</td><td>0</td></tr> <tr><td>31H</td><td>36H</td><td>31H</td><td>30H</td></tr> </table>	1	6	1	0	31H	36H	31H	30H	<table border="1"> <tr><td>DLE</td><td></td></tr> <tr><td>10H</td><td>10H, 16H</td></tr> </table>	DLE		10H	10H, 16H
1	6	1	0										
31H	36H	31H	30H										
DLE													
10H	10H, 16H												

*1 For C24, an additional code is added. (☞ Page 35 Additional code (10H))

Subcommand

ASCII code	Binary code										
<table border="1"> <tr><td>0</td><td>0</td><td>0</td><td>1</td></tr> <tr><td>30H</td><td>30H</td><td>30H</td><td>31H</td></tr> </table>	0	0	0	1	30H	30H	30H	31H	<table border="1"> <tr><td>01H</td><td>00H</td></tr> </table>	01H	00H
0	0	0	1								
30H	30H	30H	31H								
01H	00H										

Frame No.

Specify the number of user frame to be deleted. (☞ Page 246 Frame No.)

Type	Setting value	Registration destination
User frame	3E8H to 4AFH	Flash ROM of C24
	8001H to 801FH	Buffer memory of C24 (addresses 1B00H to 1FF6H)

Point

When the frame No. whose user frame is not registered is specified, an error occurs and an abnormal response is returned.

Number of registration data byte, number of frame byte

Specify '0'.

ASCII code	Binary code										
<table border="1"> <tr><td>0</td><td>0</td><td>0</td><td>0</td></tr> <tr><td>30H</td><td>30H</td><td>30H</td><td>30H</td></tr> </table>	0	0	0	0	30H	30H	30H	30H	<table border="1"> <tr><td>00H</td><td>00H</td></tr> </table>	00H	00H
0	0	0	0								
30H	30H	30H	30H								
00H	00H										

Communication example

Delete the registration data of frame No. 3E8H.

■Data communication in ASCII code

(Request data)

Command				Subcommand				Frame No.				Number of registration data byte				Number of frame byte			
1	6	1	0	0	0	0	1	0	3	E	8	0	0	0	0	0	0	0	0
31H	36H	31H	30H	30H	30H	30H	31H	30H	33H	45H	38H	30H	30H	30H	30H	30H	30H	30H	30H

■Data communication in binary code

(Request data)

Command		Subcommand		Frame No.		Number of registration data byte		Number of frame byte		
10H	10H	16H	01H	00H	E8H	03H	00H	00H	00H	00H

13.2 Global Function

The global function is a function to turn ON/OFF the global signals (input signals: X1A/X1B) of serial communication module connected to external devices with the multidrop communications.

This is used as interlock signals for emergency command, simultaneous startup, and applicability of data transmission/reception to CPU modules.

Restriction

The command can only be used for C24 (including multidrop connection station) connected to the external device. It cannot be used via network.

Point

The global signal is turned OFF by powering OFF, resetting, or switching the mode of CPU module.

Compatibility with global function of Computer link module

This function (command: 1618) is compatible with GW command for dedicated protocol of Computer link module.

■ Operation of serial communication module when GW command is received

When GW command is executed from Computer link module connected with the multidrop connection, the global signal (input signal: X1A/X1B) at the side where the command was received turns ON/OFF.

- Received from CH1: X1A
- Received from CH2: X1B

■ Command: Operation of computer link module when 1618 is received

When this function (command: 1618) is used to Computer link module, the global signal (input signal: X2) of Computer link module turns ON/OFF.

Global signal ON/OFF (command: 1618)

Turn ON/OFF the global signal from an external device.

Message format

The following shows the message format of the request data and response data of the command.

Request data

Command	Subcommand	Global signal specification
---------	------------	-----------------------------

Response data

There is no response data for this command.

Data specified by request data

Command

ASCII code	Binary code										
<table border="1"> <tr> <td>1</td> <td>6</td> <td>1</td> <td>8</td> </tr> <tr> <td>31H</td> <td>36H</td> <td>31H</td> <td>38H</td> </tr> </table>	1	6	1	8	31H	36H	31H	38H	<table border="1"> <tr> <td>18H</td> <td>16H</td> </tr> </table>	18H	16H
1	6	1	8								
31H	36H	31H	38H								
18H	16H										

Subcommand

Item	ASCII code	Binary code										
OFF	<table border="1"> <tr> <td>0</td> <td>0</td> <td>0</td> <td>0</td> </tr> <tr> <td>30H</td> <td>30H</td> <td>30H</td> <td>30H</td> </tr> </table>	0	0	0	0	30H	30H	30H	30H	<table border="1"> <tr> <td>00H</td> <td>00H</td> </tr> </table>	00H	00H
0	0	0	0									
30H	30H	30H	30H									
00H	00H											
ON	<table border="1"> <tr> <td>0</td> <td>0</td> <td>0</td> <td>1</td> </tr> <tr> <td>30H</td> <td>30H</td> <td>30H</td> <td>31H</td> </tr> </table>	0	0	0	1	30H	30H	30H	31H	<table border="1"> <tr> <td>01H</td> <td>00H</td> </tr> </table>	01H	00H
0	0	0	1									
30H	30H	30H	31H									
01H	00H											

Global signal specification

Specify which global signal (X1A or X1B) is turned ON/OFF.

Global signal to be turned ON/OFF	ASCII code	Binary code										
Global signal at the side where command was received <ul style="list-style-type: none"> Received from CH1: X1A Received from CH2: X1B 	<table border="1"> <tr> <td>0</td> <td>0</td> <td>0</td> <td>0</td> </tr> <tr> <td>30H</td> <td>30H</td> <td>30H</td> <td>30H</td> </tr> </table>	0	0	0	0	30H	30H	30H	30H	<table border="1"> <tr> <td>00H</td> <td>00H</td> </tr> </table>	00H	00H
0	0	0	0									
30H	30H	30H	30H									
00H	00H											
X1A regardless of the interface	<table border="1"> <tr> <td>0</td> <td>0</td> <td>0</td> <td>1</td> </tr> <tr> <td>30H</td> <td>30H</td> <td>30H</td> <td>31H</td> </tr> </table>	0	0	0	1	30H	30H	30H	31H	<table border="1"> <tr> <td>01H</td> <td>00H</td> </tr> </table>	01H	00H
0	0	0	1									
30H	30H	30H	31H									
01H	00H											
X1B regardless of the interface	<table border="1"> <tr> <td>0</td> <td>0</td> <td>0</td> <td>2</td> </tr> <tr> <td>30H</td> <td>30H</td> <td>30H</td> <td>32H</td> </tr> </table>	0	0	0	2	30H	30H	30H	32H	<table border="1"> <tr> <td>02H</td> <td>00H</td> </tr> </table>	02H	00H
0	0	0	2									
30H	30H	30H	32H									
02H	00H											



The target station (all stations/only 1 specified station) of which global signal is turned ON/OFF is specified by a station No.

Page 50 Station No.

Communication example (turn ON)

Turn the global signal X1A ON.

■Data communications in ASCII code (Format 1)

(Request data)

Command	Subcommand	Global signal specification
1 6 1 8	0 0 0 1	0 0 0 1
31H, 36H, 31H, 38H	30H, 30H, 30H, 31H	30H, 30H, 30H, 31H

■Data communications in binary code (Format 5)

(Request data)

Command	Subcommand	Global signal specification
18H, 16H	01H, 00H	01H, 00H

Communication example (turn OFF)

Turn OFF the global signal X1A.

■Data communications in ASCII code (Format 1)

(Request data)

Command	Subcommand	Global signal specification
1 6 1 8	0 0 0 0	0 0 0 1
31H, 36H, 31H, 38H	30H, 30H, 30H, 30H	30H, 30H, 30H, 31H

■Data communications in binary code (Format 5)

(Request data)

Command	Subcommand	Global signal specification
18H, 16H	00H, 00H	01H, 00H

13.3 Transmission sequence initialization function

The transmission sequence initialization function is a function to initialize the transmission sequence of data communication using format 5 of 4C frame, and to place C24 into the state where it waits to receive commands from external devices.

Restriction

The command can only be used for C24 (including multidrop connection station) connected to the external device. It cannot be used via network.

Initialize transmission sequence (command: 1615)

Initialize the transmission sequence of data communication using format 5 of 4C frame, and make C24 wait to receive commands from external devices.

Point

This function is equivalent to EOT, CL during data communication in ASCII code. Use the control codes, EOT, CL during data communication in ASCII code. (Page 34 EOT(04H), CL(0CH))

Message format

The following shows the message format of the request data and response data of the command.

Request data

Command	Subcommand
---------	------------

Response data

There is no response data for this command.

Data specified by request data

Command

Binary code

15H, 16H

Subcommand

Binary code

00H, 00H

Communication example

Initialize transmission sequence.

(Request data)

Subcommand	
15H, 16H	00H, 00H

13.4 Mode Switching Function

The mode switching function is a function to switch the current communication protocol (operation mode) or transmission specification for the specified interface from external devices after C24 starts up. For more details on the mode switching function, refer to the following manuals.

- 📖 MELSEC-Q/L Serial Communication Module User's Manual (Application)
- 📖 MELSEC iQ-R Serial Communication Module User's Manual (Application)



The command can only be used for C24 (including multidrop connection station) connected to the external device. It cannot be used via network.

Data to be specified in command

This section explains the contents and specification method for data item which is set in the command to switch mode.

Channel No.

Specify the target interface.

Target interface	ASCII code	Binary code					
CH1	<table border="1"> <tr><td>0</td><td>1</td></tr> <tr><td>30H</td><td>31H</td></tr> </table>	0	1	30H	31H	<table border="1"> <tr><td>01H</td></tr> </table>	01H
0	1						
30H	31H						
01H							
CH2	<table border="1"> <tr><td>0</td><td>2</td></tr> <tr><td>30H</td><td>32H</td></tr> </table>	0	2	30H	32H	<table border="1"> <tr><td>02H</td></tr> </table>	02H
0	2						
30H	32H						
02H							

Switching instruction

Select which specify the contents to be switched, by data in the command or by Engineering tool.

Bit	Item	Setting of Engineering tool	OFF (0)	ON (1)
b0	Mode No.	Communication protocol setting	Specified by Engineering tool	Specified by command
b1	Transmission setting	Transmission setting		
b2	Communication speed	Communication speed setting		
b3 to b7	(Fixed to '0')			

■Data communication in ASCII code

Convert the numerical value to 2-digit ASCII code (hexadecimal), and send it from the upper digits.

■Data communication in binary code

Send a 1-byte numerical value from lower byte (L: bits 0 to 7).

Ex.

When the switching instruction is '1' (Only mode No. is specified by command)

ASCII code	Binary code					
<table border="1"> <tr><td>0</td><td>1</td></tr> <tr><td>30H</td><td>31H</td></tr> </table>	0	1	30H	31H	<table border="1"> <tr><td>01H</td></tr> </table>	01H
0	1					
30H	31H					
01H						

Mode No.

Specify the communication protocol setting after switching the C24 mode.

Mode No.	Operation mode
01H	MC Protocol (Format 1)
02H	MC Protocol (Format 2)
03H	MC Protocol (Format 3)
04H	MC Protocol (Format 4)
05H	MC Protocol (Format 5)
06H	Nonprocedural protocol
07H	Bidirectional protocol
09H	Predefined protocol
0AH	MODBUS slave (RTU)*1
0BH	MODBUS slave (ASCII)*1
FFH	MELSOFT connection, GX Developer connection

*1 Can be specified only for MELSEC iQ-R series serial communication modules the firmware versions of which are '13' or later.

■Data communication in ASCII code

Convert the numerical value to 2-digit ASCII code (hexadecimal), and send it from the upper digits.

■Data communication in binary code

Send a 1-byte numerical value from lower byte (L: bits 0 to 7).

Ex.

When mode No. is '1' (MC protocol (Format 1))

ASCII code	Binary code
0 1 30H, 31H	01H

Transmission setting

Specify the transmission setting after switching the C24 mode.

Bit	Item	OFF (0)	ON (1)
b0	Operation setting	Independent	Interlink
b1	Data bit	7	8
b2	Parity bit	None	Yes
b3	Odd/even parity	Odd	Even
b4	Stop bit	1	2
b5	Sum check code	None	Yes
b6	Online change	Disable	Enable
b7	Setting change	Disable	Enable

Point

For the transmission setting, refer to the following manuals.

 MELSEC iQ-R Serial Communication Module User's Manual(Application)

 MELSEC-Q/L Serial Communication Module User's Manual (Application)

■Data communication in ASCII code

Convert the numerical value to 4-digit ASCII code (hexadecimal), and send it from the upper digits.

■Data communication in binary code

Send a 1-byte numerical value from lower byte (L: bits 0 to 7).

When the transmission settings are as follows:

Bit	Item	Setting	ON/OFF
b0	Operation setting	Independent	OFF
b1	Data bit	8	ON
b2	Parity bit	Yes	ON
b3	Odd/even parity	Odd	OFF
b4	Stop bit	1	OFF
b5	Sum check code	Yes	ON
b6	Online change	Enable	ON
b7	Setting change	Enable	ON

ASCII code	Binary code
<div style="border: 1px solid black; padding: 5px; width: fit-content;"> E 6 45H 36H </div>	<div style="border: 1px solid black; padding: 5px; width: fit-content;"> E6H </div>

Communication speed

Specify the communication speed after switching the C24 mode.

Specified value	Communication speed
0FH	50bps
00H	300bps
01H	600bps
02H	1200bps
03H	2400bps
04H	4800bps
05H	9600bps
06H	14400bps
07H	19200bps
08H	28800bps
09H	38400bps
0AH	57600bps
0BH	115200bps
0CH	230400bps

13

Point

The communication speed that can be set differs depending on the module or channel.

For the communication speed setting, refer to the following manuals.

 MELSEC iQ-R Serial Communication Module User's Manual(Application)

 MELSEC-Q/L Serial Communication Module User's Manual (Application)

■Data communication in ASCII code

Convert the numerical value to 4-digit ASCII code (hexadecimal), and send it from the upper digits.

■Data communication in binary code

Send a 1-byte numerical value from lower byte (L: bits 0 to 7).

Ex.

For communication speed 05H (9600 bps)

ASCII code	Binary code					
<table border="1"><tr><td>0</td><td>5</td></tr><tr><td>30H</td><td>35H</td></tr></table>	0	5	30H	35H	<table border="1"><tr><td>05H</td></tr></table>	05H
0	5					
30H	35H					
05H						

Switch mode (command: 1612)

Switch the C24 mode from external devices.

Message format

The following shows the message format of the request data and response data of the command.

Request data

Command	Subcommand	Channel No.	Switching instruction	Mode No.	Transmission setting	Communication speed

Response data

There is no response data for this command.

Data specified by request data

Command

ASCII code	Binary code
1 6 1 2 31H, 36H, 31H, 32H	12H, 16H

Subcommand

ASCII code	Binary code
0 0 0 0 30H, 30H, 30H, 30H	00H, 00H

Channel No.

Specify the target interface (CH1/CH2). (☞ Page 258 Channel No.)

Switching instruction

Select which specify the contents to be switched, by data in the command or by Engineering tool. (☞ Page 258 Switching instruction)

○: Specified by command, —: Specified by Engineering tool

Switching instruction	Mode No.	Transmission setting	Communication speed
0	—	—	—
1	○	—	—
2	—	○	—
3	○	○	—
4	—	—	○
5	○	—	○
6	—	○	○
7	○	○	○

Mode No.

Specify the operation mode within the range of 1 to BH or FFH. (☞ Page 259 Mode No.)

When the setting by command enabled (Switching instruction: 1, 3, 5, or 7), the operation mode is changed according to the specified value.

As for the setting by command is disabled (Switching instruction: 0, 2, 4, or 6), the operation mode is changed according to the Communication protocol setting set with Engineering tool

Even when the setting by command is disabled, specify the value (1 to BH or FFH). (Do not specify '0'.)

■Transmission setting

Specify the transmission setting. (☞ Page 260 Transmission setting)

When the setting by command is enabled (Switching instruction: 2, 3, 6, or 7), the transmission setting is changed according to the specified value.

As for the setting by command is disabled (Switching instruction: 0, 1, 4, or 5), the transmission setting is changed according to the transmission setting set with Engineering tool

When the setting is invalid, specify '0'.

ASCII code	Binary code
<div style="border: 1px solid black; padding: 5px; width: fit-content;"> 0 0 30H , 30H </div>	<div style="border: 1px solid black; padding: 5px; width: fit-content;"> 00H </div>

■Communication speed

Specify the communication speed. (☞ Page 261 Communication speed)

When the setting by command is enabled (Switching instruction: 4, 5, 6, or 7), the communication speed is changed according to the specified value.

When the setting by command is disabled (Switching instruction: 0, 1, 2, or 3), the communication speed is changed according to the communication speed setting set with Engineering tool.

When the setting is invalid, specify '0'.

ASCII code	Binary code
<div style="border: 1px solid black; padding: 5px; width: fit-content;"> 0 0 30H , 30H </div>	<div style="border: 1px solid black; padding: 5px; width: fit-content;"> 00H </div>

Communication example

Perform mode switching for CH1 interface.

- Operation mode: MC protocol (Format 1) (Specified value: 01H)
- Operation setting: Following settings (Specified value: B0H)

Item	Setting	Bit	ON/OFF
Operation setting	Independent	b0	OFF
Data bit	7	b1	OFF
Parity bit	None	b2	OFF
Odd/even parity	Odd	b3	OFF
Stop bit	2	b4	ON
Sum check code	Yes	b5	ON
Online change	Disable	b6	OFF
Setting change	Enable	b7	ON

- Communication speed: 9600bps (Specified value: 05H)

■Data communication in ASCII code

(Request data)

Command				Subcommand				Channel No.	Switching instruction	Mode No.	Transmission setting	Communication speed					
1	6	1	2	0	0	0	0	0	1	0	7	0	1	B	0	0	5
31H	36H	31H	32H	30H	30H	30H	30H	30H	31H	30H	37H	30H	30H	42H	30H	30H	35H

■Data communication in binary code

(Request data)

Command		Subcommand		Channel No.	Switching instruction	Mode No.	Transmission setting	Communication speed
12H	16H	00H	00H	01H	07H	01H	B0H	05H

13.5 Programmable controller CPU monitoring function

Programmable controller CPU monitoring function is a function that C24 monitors CPU module with the monitoring information which was registered in advance.

For the Programmable controller CPU monitoring function, refer to the following manuals.

- MELSEC iQ-R Serial Communication Module User's Manual(Application)
- MELSEC-Q/L Serial Communication Module User's Manual (Application)



The command can only be used for C24 (including multidrop connection station) connected to the external device. It cannot be used via network.

Data to be specified in command

Cycle time units

Specify the unit of cycle time.

Time unit	ASCII code	Binary code					
100 ms	<table border="1"> <tr><td>0</td><td>0</td></tr> <tr><td>30H</td><td>30H</td></tr> </table>	0	0	30H	30H	<table border="1"> <tr><td>00H</td></tr> </table>	00H
0	0						
30H	30H						
00H							
1 second	<table border="1"> <tr><td>0</td><td>1</td></tr> <tr><td>30H</td><td>31H</td></tr> </table>	0	1	30H	31H	<table border="1"> <tr><td>01H</td></tr> </table>	01H
0	1						
30H	31H						
01H							
1 minute	<table border="1"> <tr><td>0</td><td>2</td></tr> <tr><td>30H</td><td>32H</td></tr> </table>	0	2	30H	32H	<table border="1"> <tr><td>02H</td></tr> </table>	02H
0	2						
30H	32H						
02H							

Cycle time

Specify the time interval (period for 1 cycle) that C24 reads the monitoring information from CPU module.

■Data communication in ASCII code

Convert the numerical value to 4-digit ASCII code (hexadecimal), and send it from the upper digits.

■Data communication in binary code

Send 2-byte numerical values from lower byte (L: bits 0 to 7).

Programmable controller CPU monitoring function

Specify the send timing (fixed cycle send/condition match send) of the monitoring result.

Programmable controller CPU monitoring function	ASCII code	Binary code					
Fixed cycle send (Sending information in the cycle time interval.)	<table border="1"> <tr><td>0</td><td>1</td></tr> <tr><td>30H</td><td>31H</td></tr> </table>	0	1	30H	31H	<table border="1"> <tr><td>01H</td></tr> </table>	01H
0	1						
30H	31H						
01H							
Condition match send (Sending information when the specified condition matches.)	<table border="1"> <tr><td>0</td><td>2</td></tr> <tr><td>30H</td><td>32H</td></tr> </table>	0	2	30H	32H	<table border="1"> <tr><td>02H</td></tr> </table>	02H
0	2						
30H	32H						
02H							

CPU error monitoring, CPU status information

Specify whether to perform error monitoring for the host station CPU module.

CPU error monitoring	ASCII code	Binary code					
Do not perform error monitoring for the host station CPU module.	<table border="1"> <tr> <td>0</td> <td>0</td> </tr> <tr> <td>30H</td> <td>30H</td> </tr> </table>	0	0	30H	30H	<table border="1"> <tr> <td>00H</td> </tr> </table>	00H
0	0						
30H	30H						
00H							
Perform error monitoring for the host station CPU module.	<table border="1"> <tr> <td>0</td> <td>1</td> </tr> <tr> <td>30H</td> <td>31H</td> </tr> </table>	0	1	30H	31H	<table border="1"> <tr> <td>01H</td> </tr> </table>	01H
0	1						
30H	31H						
01H							

When the error monitoring is performed, the CPU monitoring result is stored in the response data as a CPU status information.

The following values are stored in the CPU status information.

Specified value	CPU status
0000H	During normal operation
0001H	Module warning occurring
0002H	Module error/module system error occurring

■Data communication in ASCII code

Convert the numerical value to 4-digit ASCII code (hexadecimal) and store it in the 'Device Data' in the following format from upper digits.

0	1	0	0	0	0	0	0	0	0	0	1	Device data
30H	31H	30H	30H	30H	30H	30H	30H	30H	30H	30H	31H	

■Data communication in binary code

Store the 2-byte numerical values in the 'Device Data' in the following format from lower byte (L: bits 0 to 7).

01H	00H	00H	00H	01H	00H	Device data
-----	-----	-----	-----	-----	-----	-------------

Monitoring condition

When 'fixed cycle send' is specified with the programmable controller CPU monitoring function, specify '0'.

ASCII code	Binary code										
<table border="1"> <tr> <td>0</td> <td>0</td> <td>0</td> <td>0</td> </tr> <tr> <td>30H</td> <td>30H</td> <td>30H</td> <td>30H</td> </tr> </table>	0	0	0	0	30H	30H	30H	30H	<table border="1"> <tr> <td>00H</td> <td>00H</td> </tr> </table>	00H	00H
0	0	0	0								
30H	30H	30H	30H								
00H	00H										

When 'condition match send' is specified with the Programmable controller CPU monitoring function, specify the value below.

The timing to send the result can be selected.

- Edge trigger transmission: Send the result when the condition matches.
- Level trigger transmission: Send the result in the cycle time interval during the condition matches

Edge trigger transmission	Level trigger transmission	Monitoring condition	Device type that can be specified
0001H	0101H	ON/OFF status of device = ON/OFF status of monitoring condition	Bit device
		Device value = Monitoring condition value	Word device
0002H	0102H	ON/OFF status of device ≠ ON/OFF status of monitoring condition	Bit device
		Device value ≠ Monitoring condition value	Word device

Edge trigger transmission	Level trigger transmission	Monitoring condition		Device type that can be specified
0003H	0103H	Device value ≤ Monitoring condition value	Unsigned	Word device
0004H	0104H	Device value < Monitoring condition value		
0005H	0105H	Device value ≥ Monitoring condition value		
0006H	0106H	Device value > Monitoring condition value		
0007H	0107H	Device value ≤ Monitoring condition value	Signed	
0008H	0108H	Device value < Monitoring condition value		
0009H	0109H	Device value ≥ Monitoring condition value		
000AH	010AH	Device value > Monitoring condition value		

■Data communication in ASCII code

Convert the numerical value to 4-digit ASCII code (hexadecimal), and send it from the upper digits.

■Data communication in binary code

Send 2-byte numerical values from lower byte (L: bits 0 to 7).

Monitoring condition value

When 'fixed cycle send' is specified with the Programmable controller CPU monitoring function, specify '0'.

ASCII code	Binary code										
<table border="1"> <tr><td>0</td><td>0</td><td>0</td><td>0</td></tr> <tr><td>30H</td><td>30H</td><td>30H</td><td>30H</td></tr> </table>	0	0	0	0	30H	30H	30H	30H	<table border="1"> <tr><td>00H</td><td>00H</td></tr> </table>	00H	00H
0	0	0	0								
30H	30H	30H	30H								
00H	00H										

When 'condition match send' is specified with the Programmable controller CPU monitoring function, specify the value below.

Monitoring condition value	Monitoring condition value	Device type
0000H	OFF	Bit device
0001H	ON	
0000H to FFFFH	Numerical value	Word device

■Data communication in ASCII code

Convert the numerical value to 4-digit ASCII code (hexadecimal), and send it from the upper digits.

■Data communication in binary code

Send 2-byte numerical values from lower byte (L: bits 0 to 7).

Register (command: 0630)

Register the target devices to be monitored with the Programmable controller CPU monitoring function and its monitoring conditions in CPU module.

Specify the monitoring target device for multiple blocks with the consecutive word devices and bit devices treated as one block. The host station CPU module can also be specified as error monitoring target.

The monitoring is started when executing the registration command.

Message format

The following shows the message format of the request data and response data of the command.

Request data

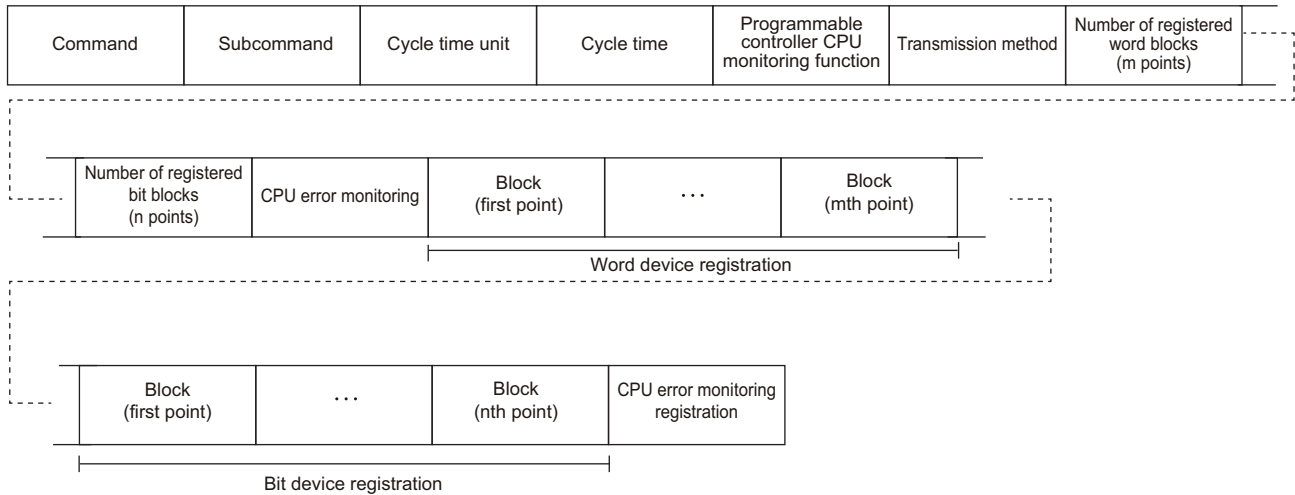

Response data

The device information of the monitoring result and programmable controller CPU status information are stored.

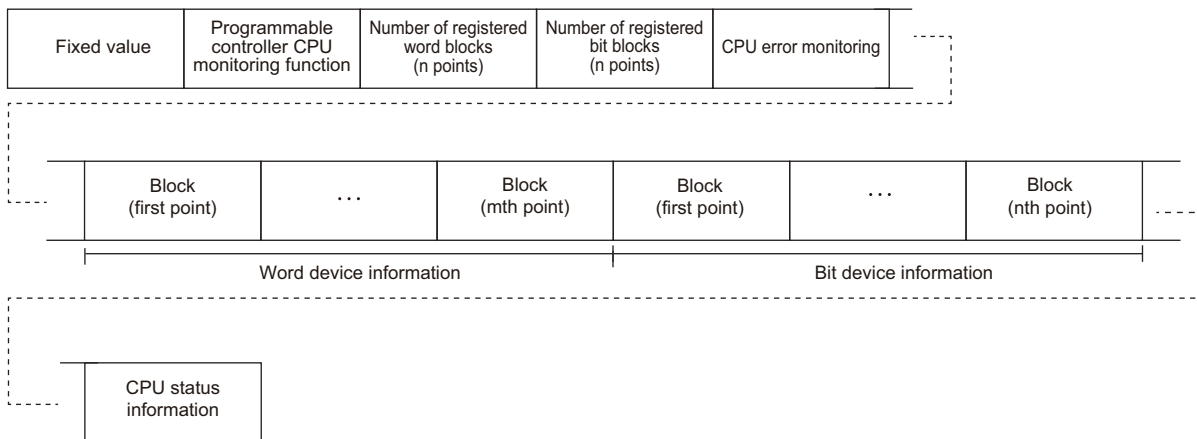

The response data of this command will be sent as same as that of the on-demand function.

For the transmission methods and its timing of monitoring result, refer to the following manuals.

- MELSEC iQ-R Serial Communication Module User's Manual(Application)
- MELSEC-Q/L Serial Communication Module User's Manual (Application)

Data specified by request data

■Command

ASCII code	Binary code										
<table border="1"> <tr><td>0</td><td>6</td><td>3</td><td>0</td></tr> <tr><td>30H</td><td>36H</td><td>33H</td><td>30H</td></tr> </table>	0	6	3	0	30H	36H	33H	30H	<table border="1"> <tr><td>30H</td><td>06H</td></tr> </table>	30H	06H
0	6	3	0								
30H	36H	33H	30H								
30H	06H										

■Subcommand

ASCII code	Binary code										
<table border="1"> <tr><td>0</td><td>0</td><td>0</td><td>0</td></tr> <tr><td>30H</td><td>30H</td><td>30H</td><td>30H</td></tr> </table>	0	0	0	0	30H	30H	30H	30H	<table border="1"> <tr><td>00H</td><td>00H</td></tr> </table>	00H	00H
0	0	0	0								
30H	30H	30H	30H								
00H	00H										

■Cycle time units, cycle time

Specify the following time interval (period for 1 cycle). ([Page 265 Cycle time](#))

- Time interval that C24 reads monitoring information from CPU module
- Transmission interval of monitoring result when 'fixed cycle send' is specified with the Programmable controller CPU monitoring function

The time unit (100 ms/1 second/1 minute) can be selected. ([Page 265 Cycle time units](#))

■Programmable controller CPU monitoring function

Specify the send timing (fixed cycle send/condition match send) of the monitoring result. ([Page 265 Programmable controller CPU monitoring function](#))

■Transmission method

Fixed '0'.

ASCII code	Binary code					
<table border="1"> <tr><td>0</td><td>0</td></tr> <tr><td>30H</td><td>30H</td></tr> </table>	0	0	30H	30H	<table border="1"> <tr><td>00H</td></tr> </table>	00H
0	0					
30H	30H					
00H						

■Number of registered word blocks, number of registered bit blocks

Specify the number of blocks of word device registration and bit device registration. ([Page 71 Number of blocks](#))

■CPU error monitoring, CPU error monitoring registration

Specify whether to perform error monitoring (status monitoring) of host station CPU module together. ([Page 266 CPU error monitoring, CPU status information](#))

- When do not perform CPU error monitoring (0): CPU error monitoring registration is not required.
- When perform CPU error monitoring (1): Register the following fixed values to CPU error monitoring registration.

ASCII code	Binary code																																																				
<table border="1"> <tr> <td>0</td><td>1</td><td>0</td><td>0</td><td>0</td><td>0</td><td>0</td><td>0</td><td>0</td><td>0</td><td>0</td><td>0</td><td>1</td><td>0</td><td>0</td><td>0</td><td>5</td><td>0</td><td>0</td><td>0</td><td>1</td> </tr> <tr> <td>30H</td><td>31H</td><td>30H</td><td>30H</td><td>30H</td><td>30H</td><td>30H</td><td>30H</td><td>30H</td><td>30H</td><td>30H</td><td>30H</td><td>31H</td><td>30H</td><td>30H</td><td>30H</td><td>35H</td><td>30H</td><td>30H</td><td>30H</td><td>31H</td> </tr> </table>	0	1	0	0	0	0	0	0	0	0	0	0	1	0	0	0	5	0	0	0	1	30H	31H	30H	30H	30H	30H	30H	30H	30H	30H	30H	30H	31H	30H	30H	30H	35H	30H	30H	30H	31H	<table border="1"> <tr> <td>00H</td><td>00H</td><td>00H</td><td>01H</td><td>01H</td><td>00H</td><td>05H</td><td>00H</td><td>01H</td><td>00H</td> </tr> </table>	00H	00H	00H	01H	01H	00H	05H	00H	01H	00H
0	1	0	0	0	0	0	0	0	0	0	0	1	0	0	0	5	0	0	0	1																																	
30H	31H	30H	30H	30H	30H	30H	30H	30H	30H	30H	30H	31H	30H	30H	30H	35H	30H	30H	30H	31H																																	
00H	00H	00H	01H	01H	00H	05H	00H	01H	00H																																												

■Word device registration, bit device registration

Specify the monitoring target device for multiple blocks with the consecutive word devices and bit devices treated as one block.

Specify the following items for each block.

Monitoring start device	Number of registered points	Monitoring condition	Monitoring condition value
Block (1 point)			

- Monitoring start device: Specify the device code and device number. (☞ Page 65 Devices)
- Number of registered points: Specify the device points from the start device in word units. (☞ Page 70 Number of device points)
- Monitoring condition: Specify the monitoring condition and transmission method for the device to be registered. (☞ Page 266 Monitoring condition)
- Monitoring condition value: Specify a value to judge the conditions have been matched or ON/OFF state of the bit. (☞ Page 267 Monitoring condition value)

Data to be stored by response data

■Fixed value

ASCII code	Binary code										
<table border="1"> <tr> <td>2</td> <td>1</td> <td>0</td> <td>2</td> </tr> <tr> <td>32H</td> <td>31H</td> <td>30H</td> <td>32H</td> </tr> </table>	2	1	0	2	32H	31H	30H	32H	<table border="1"> <tr> <td>02H</td> <td>21H</td> </tr> </table>	02H	21H
2	1	0	2								
32H	31H	30H	32H								
02H	21H										

■Programmable controller CPU monitoring function

The send timing (fixed cycle send/condition match send) of the monitoring result is stored. (☞ Page 265 Programmable controller CPU monitoring function)

■Number of registered word blocks, number of registered bit blocks

The number of blocks of word device information and bit device information are stored. (☞ Page 71 Number of blocks)

■Word device information, bit device information

The information of device, whose monitoring condition is satisfied, is stored for multiple blocks with the consecutive word devices and bit devices treated as one block.

The following items are stored for each block.

Monitoring start device	Number of registered points	Device data
Block (1 point)		

- Monitoring start device: Device code and device number are stored. (☞ Page 65 Devices)
- Number of registered points: Number of device data points is stored in word unit. (☞ Page 70 Number of device points)
- Device data: The device value is stored.

The order of device data differ depending on the setting of "Word/byte units designation" in Engineering tool.

For byte units, handle the word data as 2-byte data and send the numerical values from the lower byte (L: bits 0 to 7).

Ex.

2 points data of word device (1234H, 5678H)

- Word unit (0)

ASCII code	Binary code																				
<table border="1"> <tr> <td>1</td> <td>2</td> <td>3</td> <td>4</td> <td>5</td> <td>6</td> <td>7</td> <td>8</td> </tr> <tr> <td>31H</td> <td>32H</td> <td>33H</td> <td>34H</td> <td>35H</td> <td>36H</td> <td>37H</td> <td>38H</td> </tr> </table>	1	2	3	4	5	6	7	8	31H	32H	33H	34H	35H	36H	37H	38H	<table border="1"> <tr> <td>12H</td> <td>34H</td> <td>56H</td> <td>78H</td> </tr> </table>	12H	34H	56H	78H
1	2	3	4	5	6	7	8														
31H	32H	33H	34H	35H	36H	37H	38H														
12H	34H	56H	78H																		

- Byte unit (1)

ASCII code	Binary code																				
<table border="1"> <tr> <td>3</td> <td>4</td> <td>1</td> <td>2</td> <td>7</td> <td>8</td> <td>5</td> <td>6</td> </tr> <tr> <td>33H</td> <td>34H</td> <td>31H</td> <td>32H</td> <td>37H</td> <td>38H</td> <td>35H</td> <td>36H</td> </tr> </table>	3	4	1	2	7	8	5	6	33H	34H	31H	32H	37H	38H	35H	36H	<table border="1"> <tr> <td>34H</td> <td>12H</td> <td>78H</td> <td>56H</td> </tr> </table>	34H	12H	78H	56H
3	4	1	2	7	8	5	6														
33H	34H	31H	32H	37H	38H	35H	36H														
34H	12H	78H	56H																		

■CPU error monitoring, CPU status information

Specify whether to include the result of error monitoring (state monitoring) of the host station CPU module. (☞ Page 266 CPU error monitoring, CPU status information)

- When do not perform CPU error monitoring (0): CPU status information is not stored.
- When perform CPU error monitoring (1): CPU status information is stored.

Communication example (for fixed cycle send)

Perform the Programmable controller CPU monitoring registration with the following conditions.

- Cycle time units, cycle time: 30 seconds
- Programmable controller CPU monitoring function: Fixed cycle send
- Number of registered word blocks: 2 blocks
- Number of registered bit blocks: 1 block
- CPU error monitoring: Included

Block	Monitoring start device	Registered points
Word device registration (1-point)	D0	4 points
Word device registration (2-point)	W100	8 points
Bit device registration (1-point)	M0	2 points

The response data indicates the following data.

(1) Word device information (1-point)

Device data		D0	D1	D2	D3
Device value	Decimal	99	4144	5445	10240
	Hexadecimal	0063H	1030H	1545H	2800H
ASCII code	Word unit	30303633	31303330	31353435	32383030
	Byte unit	36333030	33303130	34353135	30303238
Binary code	Word unit	0063	101030 ^{*1}	1545	2800
	Byte unit	6300	301010 ^{*1}	4515	0028

*1 The additional code is added. (☞ Page 35 Additional code (10H))

(2) Bit device information (1-point)

Device data		M15 to M8	M7 to M0	M31 to M24	M23 to M16
Device value	Bit	0 0 0 1 0 0 0 1	0 0 1 1 0 0 0 1	0 1 0 0 1 0 0 0	0 1 0 0 1 0 0 1
	Byte	11H	31H	48H	49H
	Word	1131H		4849H	
ASCII code	Word unit	31313331		34383439	
	Byte unit	33313131		34393438	
Binary code	Word unit	1131		4849	
	Byte unit	3111		4948	

(3) CPU status information

- CPU status information: Module warning occurring (0001)

■Data communication in binary code

(Request data)

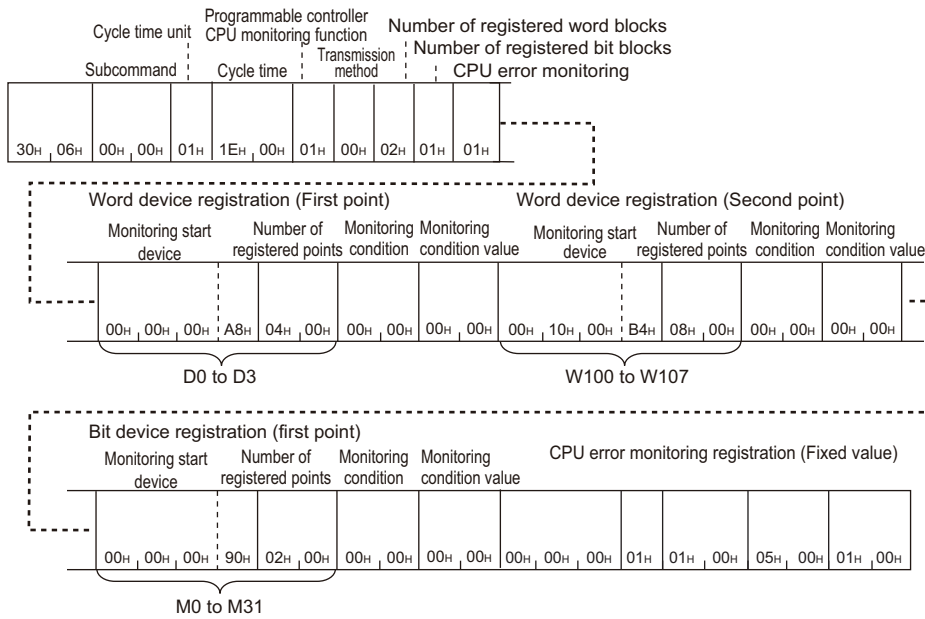

(Response data)

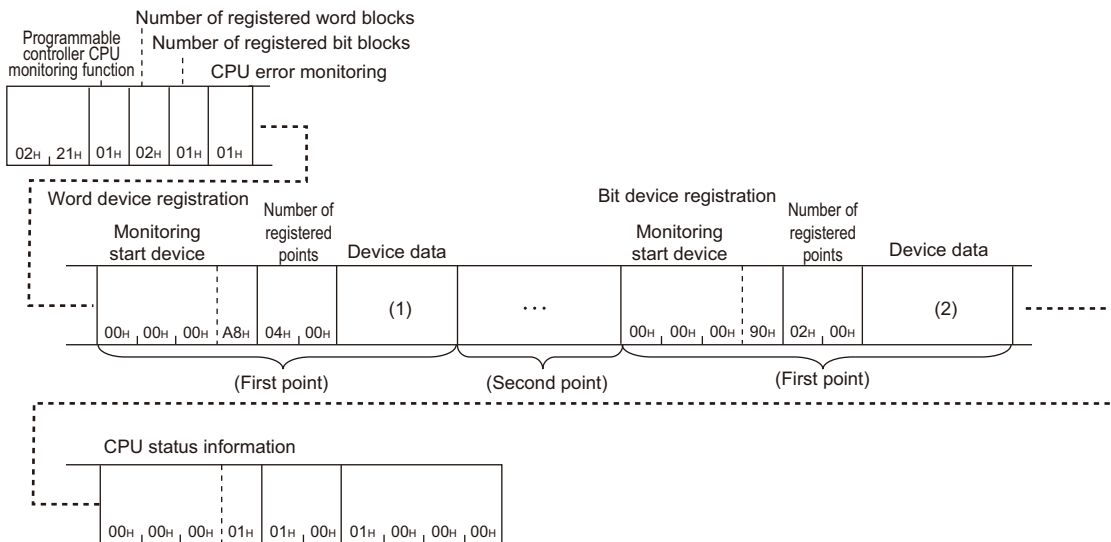

In the figure (1) and (2), set the value of "Binary code" in the tables of "Device data" of each response data. The order of device data differ depending on the setting of "Word/byte units designation" in Engineering tool.

Communication example (for condition match send)

Perform the Programmable controller CPU monitoring registration function with the following conditions.

- Cycle time units, cycle time: 30 seconds
- Programmable controller CPU monitoring function: Condition match send
- Number of registered word blocks: 2 blocks
- Number of registered bit blocks: 1 block
- CPU error monitoring designation: Included

Block	Monitoring start device	Number of registered points	Monitoring condition	Monitoring condition value
Word device registration (1-point)	D0	4 points	Edge triggered transmission: Device value = Monitoring condition value	99
Word device registration (2-point)	W100	8 points	Edge triggered transmission: Device value ≠ Monitoring condition value	0
Bit device registration (1-point)	M0	2 points	Edge trigger transmission: ON/OFF status of device ≠ ON/OFF status of monitoring condition	OFF

The response data indicates the following data.

For the condition match send, the registration data information will be sent individually. (Device information will be sent per block.)

(1) When the condition of D0 = 99 (word device registration (first point) of request data) is satisfied.

Device data		D0	D1	D2	D3
Device value	Decimal	99	4144	5445	10240
	Hexadecimal	0063H	1030H	1545H	2800H
ASCII code	Word unit	30303633	31303330	31353435	32383030
	Byte unit	36333030	33303130	34353135	30303238
Binary code	Word unit	0063	101030 ^{*1}	1545	2800
	Byte unit	6300	301010 ^{*1}	4515	0028

*1 The additional code is added. (☞ Page 35 Additional code (10H))

(2) When the condition of M0 ≠ OFF (bit device registration (1 point) of request data) is satisfied.

Device data		M15 to M8	M7 to M0	M31 to M24	M23 to M16
Device value	Bit	0 0 0 1 0 0 0 1	0 0 1 1 0 0 0 1	0 1 0 0 1 0 0 0	0 1 0 0 1 0 0 1
	Byte	11H	31H	48H	49H
	Word	1131H		4849H	
ASCII code	Word unit	31313331		34383439	
	Byte unit	33313131		34393438	
Binary code	Word unit	1131		4849	
	Byte unit	3111		4948	

(3) When CPU error monitoring condition is satisfied

- CPU status information: Module warning occurring (0001)

When the error is detected at the first time, the monitoring result is sent with the equivalent method to the edge trigger transmission.

■Data communication in ASCII code

(Request data)

Subcommand	Cycle time unit	Cycle time	Programmable controller CPU monitoring function	Transmission method	Number of registered word blocks	Number of registered bit blocks	CPU error monitoring
0 6 3 0 30H, 36H, 33H, 30H	0 0 0 0 30H, 30H, 30H, 30H	0 1 30H, 31H	0 0 1 E 30H, 30H, 31H, 45H	0 2 30H, 32H	0 0 30H, 30H	0 2 30H, 32H	0 1 30H, 31H

Monitoring start device	Number of registered points	Monitoring condition	Monitoring condition value
D * 0 0 0 0 0 0 44H, 2AH, 30H, 30H, 30H, 30H, 30H, 30H	0 0 0 4 30H, 30H, 30H, 34H	0 0 0 1 30H, 30H, 30H, 31H	0 0 6 3 30H, 30H, 36H, 33H
D0 to D3		D0=99	

Monitoring start device	Number of registered points	Monitoring condition	Monitoring condition value
W * 0 0 0 1 0 0 57H, 2AH, 30H, 30H, 30H, 31H, 30H, 30H	0 0 0 8 30H, 30H, 30H, 38H	0 0 0 2 30H, 30H, 30H, 32H	0 0 0 0 30H, 30H, 30H, 30H
W100 to D107		W100≠0	

Monitoring start device	Number of registered points	Monitoring condition	Monitoring condition value
M * 0 0 0 0 0 0 4DH, 2AH, 30H, 30H, 30H, 30H, 30H, 30H	0 0 0 2 30H, 30H, 30H, 32H	0 0 0 2 30H, 30H, 30H, 32H	0 0 0 0 30H, 30H, 30H, 30H
M0 to M31		M0≠OFF	

Fixed value	Number of registered word blocks	Number of registered bit blocks	CPU error monitoring
0 1 30H, 31H	0 0 0 0 0 0 30H, 30H, 30H, 30H, 30H, 30H	0 0 0 1 30H, 30H, 30H, 31H	0 0 0 5 30H, 30H, 30H, 35H

(Response data)

When the condition (D0 = 99) of word device registration (first point) is established

Fixed value	Programmable controller CPU monitoring function	Number of registered word blocks	Number of registered bit blocks	CPU error monitoring	Monitoring start device	Number of registered points	Device data
2 1 0 2 32H, 31H, 30H, 32H	0 2 30H, 32H	0 1 30H, 31H	0 0 30H, 30H	0 0 30H, 30H	D * 0 0 0 0 0 0 44H, 2AH, 30H, 30H, 30H, 30H, 30H, 30H	0 0 0 4 30H, 30H, 30H, 34H	(1)

Word device information

When the condition (M0 ≠ OFF) of bit device registration (first point) is established

Fixed value	Programmable controller CPU monitoring function	Number of registered word blocks	Number of registered bit blocks	CPU error monitoring	Monitoring start device	Number of registered points	Device data
2 1 0 2 32H, 31H, 30H, 32H	0 2 30H, 32H	0 0 30H, 30H	0 1 30H, 31H	0 0 30H, 30H	M * 0 0 0 0 0 0 4DH, 2AH, 30H, 30H, 30H, 30H, 30H, 30H	0 0 0 2 30H, 30H, 30H, 32H	(2)

Bit device information

When the condition of CPU error monitoring is established (Module warning being generated)

Fixed value	Programmable controller CPU monitoring function	Number of registered word blocks	Number of registered bit blocks	CPU error monitoring	Fixed value	Device data
2 1 0 2 32H, 31H, 30H, 32H	0 2 30H, 32H	0 0 30H, 30H	0 0 30H, 30H	0 1 30H, 31H	0 1 0 0 0 0 0 0 30H, 31H, 30H, 30H, 30H, 30H, 30H, 30H	0 0 0 1 0 0 0 1 30H, 30H, 30H, 32H, 30H, 30H, 30H, 32H

CPU status information

In the figure (1) and (2), set the value of "ASCII Code" in the table of "Device data" of each response data.

The order of device data differ depending on the setting of "Word/byte units designation" in Engineering tool.

■Data communication in binary code

(Request data)

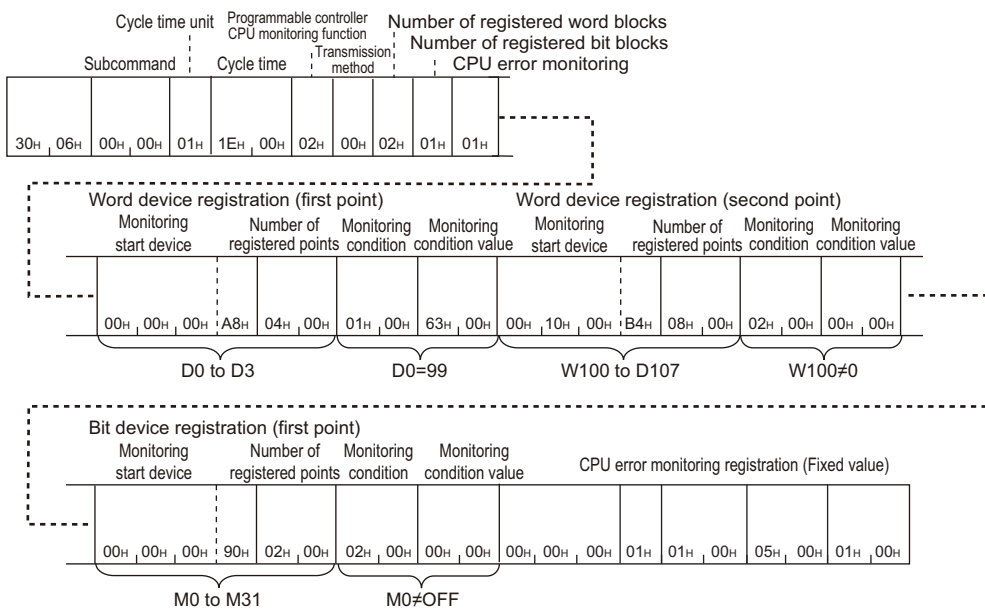

(Response data)

When the condition (D0 = 99) of word device registration (first point) is established

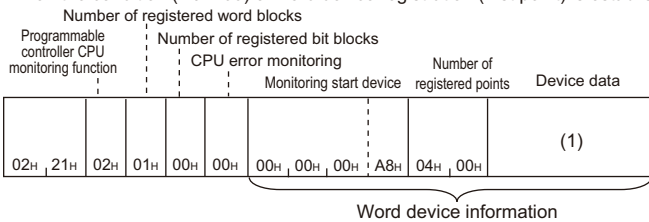

When the condition (M0 ≠ OFF) of bit device registration (first point) is established

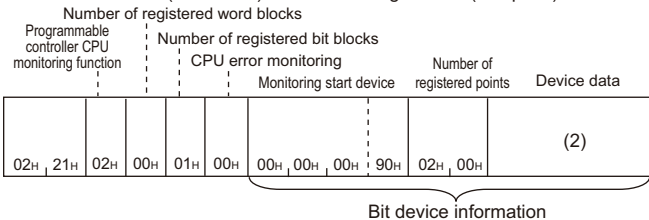

When the condition of CPU error monitoring is established (Module warning being generated)

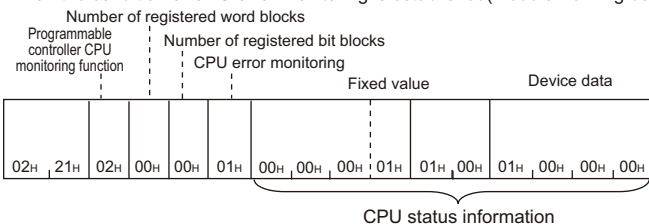

In the figure (1) and (2), set the value of "Binary code" in the tables of "Device data" of each response data. The order of device data differ depending on the setting of "Word/byte units designation" in Engineering tool.

Deregister (command: 0631)

Deregister the Programmable controller CPU monitoring function.
Execute the cancel command to end monitoring.

Message format

The following shows the message format of the request data and response data of the command.

Request data

Command	Subcommand
---------	------------

Response data

There is no response data for this command.

Data specified by request data

Command

ASCII code	Binary code										
<table border="1"><tr><td>0</td><td>6</td><td>3</td><td>1</td></tr><tr><td>30H</td><td>36H</td><td>33H</td><td>31H</td></tr></table>	0	6	3	1	30H	36H	33H	31H	<table border="1"><tr><td>31H</td><td>06H</td></tr></table>	31H	06H
0	6	3	1								
30H	36H	33H	31H								
31H	06H										

Subcommand

ASCII code	Binary code										
<table border="1"><tr><td>0</td><td>0</td><td>0</td><td>0</td></tr><tr><td>30H</td><td>30H</td><td>30H</td><td>30H</td></tr></table>	0	0	0	0	30H	30H	30H	30H	<table border="1"><tr><td>00H</td><td>00H</td></tr></table>	00H	00H
0	0	0	0								
30H	30H	30H	30H								
00H	00H										

Communication example

Deregister the Programmable controller CPU monitoring function.

Data communication in ASCII code

(Request data)

Subcommand							
0	6	3	1	0	0	0	0
30H	36H	30H	31H	30H	30H	30H	30H

Data communication in binary code

(Request data)

Subcommand	
31H	06H
00H	00H

13.6 On-demand function

On-demand function is a function that transmits data to external device using MC protocol after starting up the function from CPU module.

This function can be used to sent the emergency data that is required to notify to external devices from the CPU module.

Restriction 

The command can only be used for C24 connected to the external device on 1:1 basis. It cannot be used via network.

If the on-demand function is used with multidrop connection of 1:n station or m:n station, the on-demand data will be collapsed and proper data is not sent.

Settings for using the on-demand function

The following shows the setting items for the on-demand function.

Settings of serial communication module

Set the following values in the parameter of serial communication module or the buffer memory.

Setting item	Description	Corresponding buffer memory	
		CH1	CH2
Communication protocol setting	Set the format of the message format to be used. <ul style="list-style-type: none"> MC protocol (Format 1) to MC protocol (Format 4): Data is sent by 1C frame MC protocol (Format 5): Data is send by 4C frame. 	—	—
Word/byte units designation	Set the unit of data length (number of data).	150 (96H)	310 (136H)
Buffer memory start address designation	Set the start address of the buffer memory to be used for the on-demand function.	160 (A0H)	320 (140H)
Data length designation	Set the data length of the area to which the transmitted data is stored by the on-demand function.	161 (A1H)	321 (141H)

The execution result is stored in the following:



Execution result	Description	Corresponding buffer memory	
		CH1	CH2
On-demand execution results	<ul style="list-style-type: none"> Normal completion: 0 Abnormal completion (error code): Other than 0 	598 (256H)	614 (266H)

Point 

The setting content can be checked and changed by using any of the following Engineering tools.

- GX Works3 (Module parameter)
- GX Works2, GX Configurator-SC

For details on the setting items and buffer memory, refer to the following manuals.

-  MELSEC iQ-R Serial Communication Module User's Manual(Application)
-  MELSEC-Q/L Serial Communication Module User's Manual (Application)



Specification of interface to be sent and send data

Specify the transmission channel (CH1/CH2) and data equivalent to the response data with the arguments of the following dedicated instruction. Set the arguments in the program.

- G(P).ONDEMAND

Point 

For the dedicated instruction "G(P).ONDEMAND", refer to the following manuals.



-  MELSEC iQ-R Programming Manual (Module Dedicated Instructions)
-  MELSEC-Q/L Serial Communication Module User's Manual (Application)

Execution procedure

The procedures for the on-demand function are as shown below.

Procedure for CPU module and C24

The following shows the procedure to send data using the on-demand function from CPU module.

1. Set the items for the on-demand function.
 Page 279 Settings for using the on-demand function
2. Execute the serial communication module dedicated instruction 'G (P). ONDEMAND'.
 -  MELSEC iQ-R Programming Manual (Module Dedicated Instructions)
 -  MELSEC-Q/L Serial Communication Module User's Manual (Application)

Procedure for external device

The following shows the procedure to receive the data (on-demand data) transmitted using the on-demand function from CPU module.

1. Receive the message.
2. Judge whether the received message is issued from the on-demand function by "PC No.". For the message of on-demand function, 'PC No.' will be 'FE'. ( Page 52 Network No., PC No.)
3. Process the received on-demand data.

Execution timing

The following shows the execution timing of send/receive processing while C24 is being sending/receiving other message of MC protocol, when data transmission instruction by the on-demand function is executed in the CPU module.

Point When sending on-demand data or response data, the timeout check is performed by send monitoring timer (timer 2). if a timeout error occurs, change the send monitoring time (timer 2).

When C24 is receiving request message of other command from external device

C24 sends on-demand data before the response message to the external device is sent.

- Full-duplex communication: C24 sends on-demand data during the request message from the external device is being received.

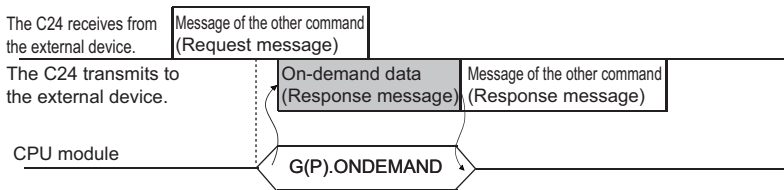

- Half-duplex communication: C24 sends on-demand data after the request message from the external device has been received.

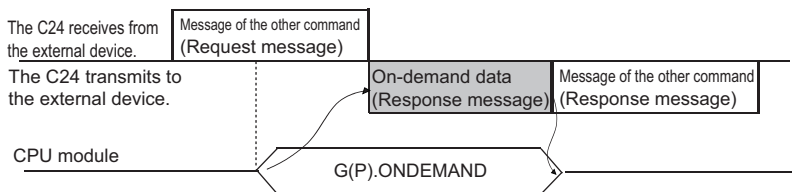

When C24 is sending response message of other command to external device

C24 sends the on-demand data to the external device after the response message to the external device.

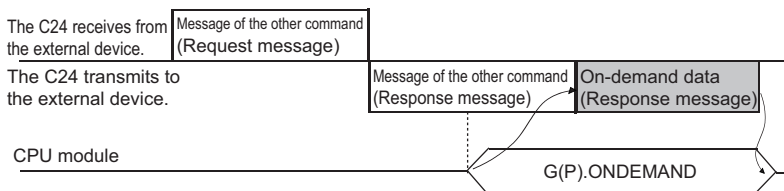

On-demand (command: 2101)

Send data using the on-demand function from CPU module. Any message other than send data is added automatically in the message format selected in the communication protocol setting. ('FE' is specified to the 'PC No.' for the access route.)

- Communication protocol setting is MC protocol (Format 1) to MC protocol (Format 4): Message format of 1C frame
- Communication protocol setting is MC protocol (Format 5): Message format of 4C frame

Point

When using 2C/3C/4C frame (Format 1 to 4), register the message format of each format in the user frame.

☞ Page 29 Message Formats of Each Protocol

For the user frames, refer to the following manuals.

- MELSEC iQ-R Serial Communication Module User's Manual (Application)
- MELSEC-Q/L Serial Communication Module User's Manual (Application)

Message format

The following shows the message format of the request data and response data of the command.

Request data

There is no request data for this command.

Response data

Command	Transmission data
---------	-------------------

Data stored in response data

Command

It is added only when the message is sent with MC protocol format 5 specified in the communication protocol setting.

Binary code

01H, 21H

Transmission data

The transmission data specified in the dedicated instruction 'G(P).ONDEMAND' is stored.

The order of data differ depending on the setting of "Word/byte units designation" in Engineering tool.

For byte units, handle the word data as 2-byte data and send the numerical values from the lower byte (L: bits 0 to 7).

Ex.

When transmitting 2-word data (1234H, 5678H)

- Word unit (0)

ASCII code	Binary code																								
<table border="1"> <tr> <td>1</td><td>2</td><td>3</td><td>4</td> <td>5</td><td>6</td><td>7</td><td>8</td> </tr> <tr> <td>31H</td><td>32H</td><td>33H</td><td>34H</td> <td>35H</td><td>36H</td><td>37H</td><td>38H</td> </tr> </table>	1	2	3	4	5	6	7	8	31H	32H	33H	34H	35H	36H	37H	38H	<table border="1"> <tr> <td></td><td></td> <td></td><td></td> </tr> <tr> <td>12H</td><td>34H</td> <td>56H</td><td>78H</td> </tr> </table>					12H	34H	56H	78H
1	2	3	4	5	6	7	8																		
31H	32H	33H	34H	35H	36H	37H	38H																		
12H	34H	56H	78H																						

- Byte unit (1)

ASCII code	Binary code																								
<table border="1"> <tr> <td>3</td><td>4</td><td>1</td><td>2</td> <td>7</td><td>8</td><td>5</td><td>6</td> </tr> <tr> <td>33H</td><td>34H</td><td>31H</td><td>32H</td> <td>37H</td><td>38H</td><td>35H</td><td>36H</td> </tr> </table>	3	4	1	2	7	8	5	6	33H	34H	31H	32H	37H	38H	35H	36H	<table border="1"> <tr> <td></td><td></td> <td></td><td></td> </tr> <tr> <td>34H</td><td>12H</td> <td>78H</td><td>56H</td> </tr> </table>					34H	12H	78H	56H
3	4	1	2	7	8	5	6																		
33H	34H	31H	32H	37H	38H	35H	36H																		
34H	12H	78H	56H																						

Communication example (communication protocol setting is format 1 to 4)

Send 2-word data (1234H, 5678H) to the external device from the CPU module under the following settings.

- Communication protocol setting: MC protocol (Format 1 to 4)
- Word/byte units designation: Word unit

(Response data)

Transmission data							
1	2	3	4	5	6	7	8
31H	32H	33H	34H	35H	36H	37H	48H

Communication example (communication protocol is format 5)

Send 2-word data (1234H, 5678H) to the external device from the CPU module under the following settings.

- Communication protocol setting: MC Protocol (Format 5)
- Word/byte units designation: Word unit

(Response data)

Command	Transmission data
01H 21H	12H 34H 56H 78H

PART 4

COMPATIBILITY WITH QnA SERIES

This part explains the specifications when using MELSEC-QnA series devices.

14 MELSEC-QnA SERIES SUPPORTED SPECIFICATIONS

15 QnACPU DEDICATED COMMANDS

14 MELSEC-QnA SERIES SUPPORTED SPECIFICATIONS

This chapter explains the specifications of the messages of MC protocol and accessible ranges when using the MELSEC-QnA series devices as follows:

- When accessing system including MELSEC-QnA series modules
- When utilizing software for data communication created for MELSEC-QnA series programmable controller.

14.1 Frames and Commands that can be used

When accessing MELSEC-QnA series modules, all frames of MC protocol can be used.

However, the commands that can be used have some restrictions. (☞ Page 471 Accessible Modules for Each Command)

QnA-compatible frame

The following frames have compatibility with the message protocol and the message format for MELSEC-QnA series.

Frame	Compatible message format	Accessible range
4C frame	Dedicated protocols for MELSEC-QnA series serial communication modules (QnA extension frame)	Page 45 Accessible range of 4C frame
3C frame	Dedicated protocols for MELSEC-QnA series serial communication modules (QnA frame)	Page 46 Accessible range of 3C frame
2C frame	Dedicated protocols for MELSEC-QnA series serial communication modules (QnA simplified frame)	Page 46 Accessible range of 2C frame
3E frame	Message formats for MELSEC-QnA series Ethernet interface modules	Page 48 Accessible range of 4E frame, 3E frame

14.2 Accessible Modules

Accessible to the following MELSEC-QnA series modules within the access range.

Accessible modules to other stations

The following modules of other station can be accessed.

Type	Model name
CPU module	Q2ACPU, Q2ACPU-S1, Q2ASCPU, Q2ASCPU-S1, Q2ASHCPU, Q2ASHCPU-S1, Q3ACPU, Q4ACPU
Redundant system	Q4ARCPU
MELSECNET/10 remote I/O	AJ72QLP25(G), AJ72QBR15, A1SJ72QLP25, A1SJ72QBR15
Special function module	Refer to the following section. ☞ Page 157 Accessible modules

Modules that can be relayed between networks

The following shows the modules that can be relayed between networks when accessing a MELSEC-QnA series module.

■MELSEC-QnA series modules

Network	Model name
MELSECNET/10	QJ71LP21, QJ71LP21-25, QJ71LP21S-25, QJ71LP21G, QJ71BR11 (MELSECNET/10 mode) AJ71QLP21 (S/G), AJ71QBR11, A1SJ71QLP21 (S), A1SJ71QBR11
Ethernet ^{*1}	AJ71QE71N3-T, AJ71QE71N-B5, AJ71QE71N-B2, AJ71QE71N-T, AJ71QE71N-B5T, A1SJ71QE71N3-T, A1SJ71QE71N-B5, A1SJ71QE71N-B2, A1SJ71QE71N-T, A1SJ71QE71N-B5T, AJ71QE71, AJ71QE71-B5, A1SJ71QE71-B2, A1SJ71QE71-B5

*1 QnA series Ethernet interface modules can be relayed between networks when using the module with the function version B or later. Check the function version with the production date printed on the rating plate on the side of the module. (Manufactured date: Year (lower two digits), Month (two digits), function version (one digit))

■ Modules other than MELSEC-QnA series

Network	Module type	Model
CC-Link IE Field Network	CC-Link IE Field Network master/local module	LJ71GF11-T2, QJ71GF11-T2, QS0J71GF11-T2
CC-Link IE Controller Network	CC-Link IE Controller Network module	QJ71GP21-SX, QJ71GP21S-SX
MELSECNET/H	MELSECNET/H module	QJ71LP21, QJ71LP21-25, QJ71LP21S-25, QJ71LP21G, QJ71BR11, QJ71NT11B
Ethernet	Ethernet interface module	LJ71E71-100, QJ71E71-100, QJ71E71-B5, QJ71E71-B2, QJ71E71

 Page 21 Modules that can be relayed between networks

14.3 Considerations

The following shows the considerations when using MELSEC-QnA series devices.

Considerations when connecting E71

■ Setting range of monitoring timer

When accessing QnACPU for the first time, the wait time for CPU monitoring timer is required before receiving a response message because QnACPU identifies the CPU type. Be sure to set a value within the setting range shown below.

Access target	Monitoring timer
Connected station (host station)	1H to 28H (0.25 s to 10 s)
Other station	2H to F0H (0.5 s to 60 s)

15 QnACPU DEDICATED COMMANDS

This chapter shows the QnACPU dedicated commands.

15.1 QnACPU Dedicated Commands List

The following shows the list of QnACPU dedicated commands.



There are some commands that cannot be executed while the CPU module is in RUN. Refer to the following section.

☞ Page 464 Applicable Commands for Online Program Change



For the number of points processed per communication, refer to the following section.

☞ Page 466 Number of Processing per One Communication

Drive memory defragmentation

Function	Command	Description	Subcommand
Read memory usage status	0205	Reads the cluster usage status of the driver.	0000
Defragment memory	1207	Increases the consecutive free area by defragmenting the drive memory. (Defragmentation of file storage position)	0000

File control

Function	Command	Description	Subcommand
Read file information table	Without header statement 0201	Reads a file list (file name, last edit date and time, file size).	0000 —
	With header statement 0202	Reads a file list (header statement attached to a file, file name, last edit date and time, file size).	0000 —
Read file presence (Search file)	0203	Reads existence of specified file, file No., and file size.	0000 —
Read file No. usage status	0204	Reads file No. usage status.	0000 —
Read file	0206	Reads content of file.	0000 —
Lock file	0808	Locks the file in order to prevent the file contents from being edited from other devices while accessing the specified file.	0001 Register
		Unlocks the file.	0000 Deregister
Create new file (Register file name)	1202	Secures the file area for the specified file name.	0000 —
Write to file	1203	Writes the specified data (n byte) to a file.	0000 Arbitrary data
		Writes the specified data (1 word) for a file for n bytes.	0001 Identical data (FILL)
Modify file information	1204	Modifies the date and time of the last edit of the file.	0000 Modify last edit date and time
		Modifies the file name and file size.	0001 File name, size
		Modifies the file name, file size, and last edit date and time.	0002 Batch modify
Delete file	1205	Deletes a file.	0000 —
Copy file	1206	Copies a file.	0000 —

15.2 Defragmentation of Drive Memory

An external device performs the following functions for other station QnACPU drive which stores parameters and program files that the sequence programs are written.

Read drive memory usage status

Check the usage status of the drive memory (cluster usage status) of the specified drive.

Defragment drive memory

When the valid data written in the drive memory is not consecutive, increase the consecutive free area in cluster unit by defragmentation.



A cluster is the minimum unit when files are stored to drive memory (such as memory card) and the memory containing data is managed by FAT^{*1}.

The size of one cluster of each QnACPU drive is as follows:

- Internal memory : 4096 bytes
- Other memory : 512 bytes

For example, if a data less than 512 bytes is written to a memory card, one cluster of drive memory is used to write the data.

If 513 to 1024 bytes of data are written, two clusters of drive memory is used to write the data.

*1 An abbreviation for 'File Allocation Table'. A table used by the operating system to manage the location of files on the drive memory.

■ Images of drive memory defragmentation

□: Cluster in not used (empty), ■: Cluster is being used (valid data is written in it)

- Before drive memory defragmentation

Cluster	b15	b14	b13	b12	b11	b10	b9	b8	b7	b6	b5	b4	b3	b2	b1	b0
First 16 clusters	■ ^{*1}	■	■	□	□	□	□	■	■	■	■	■	■	■	■	■ ^{*2}
.	■	■	■	■	■	□	■	■	■	■	■	■	■	■	□	□
.	■	■	■	■	□	□	□	□	□	□	□	□	■	■	■	■
.	□	■	■	■	■	■	■	■	□	□	■	■	■	■	■	■
.
.	□	■	■	■	□	□	□	□	□	□	□	□	□	■	■	■
Last 16 clusters	□ ^{*3}	□	□	□	□	□	■	■	■	■	■	■	■	□	□	□



- After drive memory defragmentation

Cluster	b15	b14	b13	b12	b11	b10	b9	b8	b7	b6	b5	b4	b3	b2	b1	b0
First 16 clusters	■ ^{*1}	■	■	■	■	■	■	■	■	■	■	■	■	■	■	■ ^{*2}
.	■	■	■	■	■	■	■	■	■	■	■	■	■	■	■	■
.	■	■	■	■	■	■	■	■	■	■	■	■	■	■	■	■
.	□	□	□	□	■	■	■	■	■	■	■	■	■	■	■	■
.
.	□	□	□	□	□	□	□	□	□	□	□	□	□	□	□	□
Last 16 clusters	□ ^{*3}	□	□	□	□	□	□	□	□	□	□	□	□	□	□	□

*1 16th cluster from the head cluster

*2 First cluster

*3 Last cluster

Data to be specified in commands

The following explains the data to be specified in commands when an external device performs defragmentation to the drive memory of QnACPU.

Keyword

A data to allow/prohibit the access to the drive, which is the character string (up to 6 characters) that are registered to the specified drive.

When a keyword has already been registered, specify the same keyword.

■Data communication in ASCII code

Use the keyword registered in the specified drive and send as is.

■Data communication in binary code

Convert the keyword registered in the specified drive to 3-byte binary code, and send it from lower byte (L: bits 0 to 7).

Ex.

When the registered keyword is '012345'

Values converted to binary code	Transmission order
01H, 23H, 45H	45H, 23H, 01H

Ex.

When the keyword registered is '012300'

Values converted to binary code	Transmission order
01H, 23H, 00H	00H, 23H, 01H

■The content of data when a keyword is not registered in a specified drive

- Data communication in ASCII code: '000000'
- Data communication in binary code: '00H', '00H', '00H'

Setting flag

A data that indicates whether the keyword registered to the specified drive is specified to the keyword above.

■Data communication in ASCII code

Convert the numerical value to 2-digit ASCII code (hexadecimal), and send it from the upper digits.

■Data communication in binary code

Send a 1-byte numerical value.

■Setting flag to be specified

Setting value	Content to be specified
00H	Keyword is invalid (specify a dummy)
01H	Keyword is enabled (specify the keyword registered in the specified drive).

Drive name

A data to perform reading usage status of drive memory, or specify the QnACPU drive to perform defragmentation.

■Data communication in ASCII code

Convert the numerical value that indicates access target drive to 4-digit ASCII code (hexadecimal), and send it from the upper digits.

■Data communication in binary code

Send 2-byte numerical values that indicate access target drive from the lower byte (L: bits 0 to 7).

■Specified content of drive name (Other content cannot be specified.)

Setting value	Target drive
0000H	Internal memory (built-in RAM)
0001H	RAM area of memory card A
0002H	ROM area of memory card A
0003H	RAM area of memory card B
0004H	ROM area of memory card B
000FH	Drive that the parameter files currently used (specified with the QnACPU dip switch) is stored.

Cluster No.

A data to specify the first cluster No. within the range of drive memory whose usage status is to be read. Specify the data in multiples of 16 (00H, 10H, 20H... in hexadecimal notation).

■Data communication in ASCII code

Convert the cluster No. which is higher than '00H' to 4-digit (hexadecimal) ASCII code, and send it from the upper digits.

■Data communication in binary code

Send 2-byte numerical values that indicate cluster No. which is higher that '00H' from lower byte (L: bits 0 to 7).

■Drive memory defragmentation

When performing defragmentation of drive memory, specification of the cluster No. is not required.

Number of clusters to be read

A data to specify the number of clusters within the range of drive memory whose usage status is to be read. Specify the data in multiples of 16 (10H, 20H... in hexadecimal notation).

■Data communication in ASCII code

Convert the number of clusters '10H' to '100H' (16 to 256) to 4-digit ASCII code (hexadecimal), and send them from the upper digits.

■Data communication in binary code

Send 2-byte numerical value that indicates the number of clusters from '10H' to '100H' (16 to 256) from lower byte (L: bits 0 to 7).

■Drive memory defragmentation

When performing defragmentation of drive memory, specification of the number of clusters to be read is not required.

Point

Specify the number of clusters to be read within the range of the usable memory size after formatting the drive to be read from.

- Number of clusters = Usable memory size/Number of bytes in one cluster (4096 or 512)

For the number of bytes in one cluster, refer to the following section.

☞ Page 289 Defragment drive memory

Free cluster table

A data indicating the status of cluster usage. It is a response data to 'read drive memory usage status' (command: 0205).

■Data communication in ASCII code

The numerical value that indicates usage status is converted to n-digit (hexadecimal) ASCII code and sent to the external device. (16 clusters/4 digits)

■Data communication in binary code

An m-byte numerical value that indicates usage status is sent to the external device. (16 clusters/2 bytes)

■Content of free cluster table

The usage status of each cluster is indicated by one cluster per bit.

Ex.

0: Empty, 1: Used

Cluster	b15	b14	b13	b12	b11	b10	b9	b8	b7	b6	b5	b4	b3	b2	b1	b0	Values for 16 bits
First 16 clusters	0 ^{*1}	0	1	1	1	1	0	0	1	1	1	1	1	1	1	1 ^{*2}	3CFFH
.	0	0	0	0	0	0	0	0	0	0	1	1	1	1	1	1	003FH
.
.	0	0	0	0	0	0	0	0	0	0	0	0	0	0	0	0	0000H
Last 16 clusters	0 ^{*3}	0	0	0	0	0	0	0	0	0	0	0	0	0	0	0	0000H

*1 16th cluster from the head cluster

*2 First cluster

*3 Last cluster

When the usage status is as shown above, the content of free cluster table that is returned to the external device is as follows:

- When 32 clusters are returned while communicating in ASCII code
'3CFF003F' is returned and it is sent from '3'.
- When 32 clusters are returned while communicating in binary code
'FFH', '3CH', '3FH', and '00H' are returned and these are sent from 'FFH'.

■Drive memory defragmentation

When performing defragmentation of drive memory, the free cluster table is not returned.

Read drive memory usage status (command: 0205)

Read the usage status of the drive memory.

Point

When creating a new file (registering new file), a consecutive free area for the file size to be created is required.

To calculate the capacity (size) of the consecutive free area of the specified drive, check the number of consecutive free clusters (number of consecutive OFF bits) by reading the usage status of that drive memory. Capacity of consecutive free area (size) = number of consecutive free cluster × 4096 or 512 (byte)

When the consecutive area is insufficient, perform the following memory defragmentation.

☞ Page 295 Defragment drive memory (command: 1207)

Message format

The following shows the message format of the request data and response data of the command.

Request data

ASCII

0	2	0	5	Subcommand	Keyword	Setting flag	Drive name	Cluster No.	Number of clusters to be read
30H	32H	30H	35H						

Binary

	Subcommand	Setting flag	Keyword	Drive name	Cluster No.	Number of clusters to be read
05H	02H					

Response data

The free cluster table is stored. The order of data differs depending on the ASCII code or binary code.

☞ Page 292 Free cluster table

Data specified by request data

Command

ASCII code	Binary code										
<table border="1"> <tr> <td>0</td> <td>2</td> <td>0</td> <td>5</td> </tr> <tr> <td>30H</td> <td>32H</td> <td>30H</td> <td>35H</td> </tr> </table>	0	2	0	5	30H	32H	30H	35H	<table border="1"> <tr> <td>05H</td> <td>02H</td> </tr> </table>	05H	02H
0	2	0	5								
30H	32H	30H	35H								
05H	02H										

Subcommand

ASCII code	Binary code										
<table border="1"> <tr> <td>0</td> <td>0</td> <td>0</td> <td>0</td> </tr> <tr> <td>30H</td> <td>30H</td> <td>30H</td> <td>30H</td> </tr> </table>	0	0	0	0	30H	30H	30H	30H	<table border="1"> <tr> <td>00H</td> <td>00H</td> </tr> </table>	00H	00H
0	0	0	0								
30H	30H	30H	30H								
00H	00H										

Keyword

Set whether to allow/prohibit access to a drive. (☞ Page 298 Keyword)

Setting flag

This indicates whether the keyword registered in the specified drive matches the keyword of request data. (☞ Page 290 Setting flag)

Drive name

Read the usage status of the drive memory, and specify the QnACPU drive to be defragmented. (☞ Page 291 Drive name)

Cluster No.

Specify the first cluster No. within the range of drive memory whose usage status is to be read. (☞ Page 291 Cluster No.)

■Number of clusters to be read

Specify the number of clusters within the range of drive memory whose usage status is to be read. (☞ Page 291 Number of clusters to be read)

Communication example

Read the usage status of the drive memory of the RAM area in a memory card A (drive name: 01H) for 32 clusters.

■Data communication in ASCII code

(Request data)

Subcommand	Keyword	Setting flag	Drive name	Cluster No.	Number of clusters to be read
0 2 0 5	0 0 0 0	0 1	0 0 0 1	0 0 0 0	0 0 2 0
30H, 32H, 30H, 35H	30H, 30H, 30H, 30H	30H, 31H	30H, 30H, 30H, 31H	30H, 30H, 30H, 30H	30H, 30H, 32H, 30H

(Response data)

Free cluster table

Cluster No.0 to 15	Cluster No.16 to 31
3 C F F	0 0 3 F
33H, 43H, 46H, 46H	30H, 30H, 33H, 46H

■Data communication in binary code

(Request data)

Subcommand	Setting flag	Keyword	Drive name	Cluster No.	Number of clusters to be read
05H, 02H	00H, 00H	01H	45H, 23H, 01H	01H, 00H	00H, 00H
					20H, 00H

(Response data)

Free cluster table

Cluster No.0 to 15	Cluster No.16 to 31
FFH, 3CH	3FH, 00H

Defragment drive memory (command: 1207)

Perform the defragmentation of drive memory.

Perform the defragmentation of drive memory in the following situation.

- When the specified QnACPU is STOP.
- The usage status of drive memory (check with command 0205) is not consecutive and the files cannot be stored.

Message format

The following shows the message format of the request data and response data of the command.

Request data

ASCII

1	2	0	7	Subcommand	Keyword	Setting flag	Drive name
31H	32H	30H	37H				

Binary

	Subcommand	Setting flag	Keyword	Drive name
07H	12H			

Response data

There is no response data for this command.



In the following cases, an error occurs and an abnormal response will be returned.

- When QnACPU is protected by system protection.
- When the keyword registered in the specified drive is not specified.
- When the drive memory is faulty (defective cluster, etc.).
- When the subdirectory is created by using an IC memory card read/writer.
- When the file is not stored in one consecutive area by using an IC memory card read/writer.

Data specified by request data

Command

ASCII code	Binary code										
<table border="1"><tr><td>1</td><td>2</td><td>0</td><td>7</td></tr><tr><td>31H</td><td>32H</td><td>30H</td><td>37H</td></tr></table>	1	2	0	7	31H	32H	30H	37H	<table border="1"><tr><td>07H</td><td>12H</td></tr></table>	07H	12H
1	2	0	7								
31H	32H	30H	37H								
07H	12H										

Subcommand

ASCII code	Binary code										
<table border="1"><tr><td>0</td><td>0</td><td>0</td><td>0</td></tr><tr><td>30H</td><td>30H</td><td>30H</td><td>30H</td></tr></table>	0	0	0	0	30H	30H	30H	30H	<table border="1"><tr><td>00H</td><td>00H</td></tr></table>	00H	00H
0	0	0	0								
30H	30H	30H	30H								
00H	00H										

Keyword

Set whether to allow/prohibit access to a drive. (☞ Page 298 Keyword)

Setting flag

This indicates whether the keyword registered in the specified drive matches the keyword of request data. (☞ Page 290 Setting flag)

Drive name

Read the usage status of the drive memory, and specify the QnACPU drive to be defragmented. (☞ Page 291 Drive name)

Communication example

Perform defragmentation for the drive memory of the RAM area in a memory card A (drive name: 01H).

■Data communication in ASCII code

(Request data)

Subcommand				Keyword					Setting flag		Drive name								
1	2	0	7	0	0	0	0	0	1	2	3	4	0	0	1	0	0	0	1
31H	32H	30H	37H	30H	30H	30H	30H	30H	31H	32H	33H	34H	30H	30H	31H	30H	30H	30H	31H

■Data communication in binary code

(Request data)

Subcommand		Setting flag	Keyword		Drive name				
07H	12H	00H	00H	01H	40H	23H	01H	01H	00H

15.3 File Control

Read, register, and delete files in QnACPU modules.

Use this function in the following situations:

- Read parameters and sequence programs from an external device
- Write the files read from CPU module to an external device according to the commands.

For the file name, extension, and location of a file stored in CPU module, refer to the user's manual (function explanation, program fundamentals) of the CPU module used.

Considerations for file control

The following are the considerations when managing files in QnACPU.

Editing files

The files read from CPU module are used for storage on an external device.

The external device cannot edit the content of a file read from CPU module.

Data read/write

When the data of the entire file size cannot be read/written in a single communication, use several communications to read/write the data.

The file size can be verified using the following functions.

Function	Reference
Read file information table function	Page 308 Read file information table without header statement (command: 0201) Page 311 Read file information table with header statement (command: 0202)
Read file presence function	Page 314 Read file presence (Search file) (command: 0203)

System protection

If the CPU module is protected by system protection when using the following functions, an error occurs and an abnormal completion message is returned.

Function	Reference
Create new file (Register file name)	Page 323 Create new file (Register file name) (command: 1202)
Write to file	Page 325 Write to file (command: 1203)
Delete file	Page 335 Delete file (command: 1205)
Copy file	Page 337 Copy file (command: 1206)
Modify file information (date created, attribute)	Page 329 Modify file information (command: 1204)

Registration of keyword

When registering a keyword in the file, keep the registered keyword.

When accessing the following files, specifying the registered keyword when opening or reading/writing to that file is required.

- Parameter file
- Program files

File attribute

The file attribute is valid only when the following functions are used. For other commands, the attribute is handled as a dummy.

Function	Reference
Read file information table function	Page 308 Read file information table without header statement (command: 0201) Page 311 Read file information table with header statement (command: 0202)
Create new file (Register file name)	Page 323 Create new file (Register file name) (command: 1202)
Modify file information (date created, attribute)	Page 329 Modify file information (command: 1204)

Data to be specified in commands

This section explains the data to be specified in command when an external device manages files in the CPU module.

Keyword

Allow/prohibit the access to the specified drive.
When a keyword has already been registered, specify the same keyword.
For the content of the data, refer to the following section.

☞ Page 290 Keyword

Setting flag

A data that indicates whether the keyword registered to the specified drive is specified to the keyword above.
For the content of the data, refer to the following section.

☞ Page 290 Setting flag

Drive name, Drive No.

A data to specify the drive in a CPU module of which files are to be managed.
For the method on how to specify the drive name and its corresponding drive, refer to the following section.

☞ Page 291 Drive name

File No.

A value to specify the registered number when a file specified by file name and extension is registered (written) to CPU module, or the registration number when registering to CPU module.

■Data communication in ASCII code

Convert the file No. to 4-digit ASCII code (hexadecimal), and send it from the upper digits.

■Data communication in binary code

Send the 2-byte*1 value that indicates file No. from the lower byte (L: bits 0 to 7).

*1 For C24, the additional code may be added. (☞ Page 35 Additional code (10H))

Ex.
1FH

ASCII code	Binary code
0 0 1 F 30H 30H 31H 46H	1FH 00H

■Specified content of file No.

Value to be specified	Description	Content to be specified
01H to 100H	File No.	Specify when the file No. is known.
FFFFH	File No. unknown	Specify when C24/E71 searches for file No. (The request to read/write data from/to C24/E71 will be delayed for more than one sequence scan time.)

Point

The file No. of the registered file can be checked using the following functions.

- ☞ Page 308 Read file information table without header statement (command: 0201)
- ☞ Page 311 Read file information table with header statement (command: 0202)
- ☞ Page 314 Read file presence (Search file) (command: 0203)

The unused file No. at registering new file can be checked using the following function.

- ☞ Page 316 Read file No. usage status (command: 0204)

Number of requested file, total number of registered files, number of file information

A data that indicates the number of request files, number of files registered in the specified drive, and number of files that return file information when reading file information.

■Data communication in ASCII code

Convert the numerical value described in the reference section relevant to the corresponding function to 4-digit ASCII code (hexadecimal), and send it from the upper digits.

■Data communication in binary code

Send the 2-byte numerical value described in the reference section relevant to the corresponding function from each low byte (L: bits 0 to 7).

File name, extension, and attribute

■For file name, extension, and storage location that can be specified

For file name, extension, and storage location of files that can be specified in CPU modules, refer to the user's manual (function explanation, program fundamentals) of the CPU module used.

Point

Files not described in the user's manual (function explanation, program fundamentals) of the CPU module used may also be shown for file control. Do not access them since they are for the system use.

■When creating files or changing the file names

When creating a new file or changing the file name, specify the file name (up to 8 characters) and extension (3 characters) in accordance with the file naming rule of Engineering tool.

■File name, extension

For QnACPU, specify the file name by a file name + extension.

Item	Specification method
File name	Specify the file name within 8 characters. If the file name is less than 8 characters, add space (code: 20H) after the file name and fill the characters to 8 characters.
Extension	Specify the extension within 3 characters.

Ex.

When the file name is 'ABC.QPG'

File name: ABC □□□□QPG (□ indicates a space)

■Attribute

Add an attribute a file.

Specify the attribute with 1 byte.

Specify '20H' as an attribute value (disk files that can be read/written) at a new file creation and when a dummy is specified.

When the attribute of the created file is not changed, the attribute of readable/writable disk file will be attached.

Point

The attributes for the existing files can be checked using the following functions.

☞ Page 308 Read file information table without header statement (command: 0201)

☞ Page 311 Read file information table with header statement (command: 0202)

The attribute of the created files can be changed between '01H' (Read Only file) ⇔ '20H' (readable/writable disk file).

☞ Page 329 Modify file information (command: 1204)

Last edit time and last edit date

A data that indicates the date and time when the current file content was registered.

■Data communication in ASCII code

Convert the numerical value to a 4-digit (hexadecimal) ASCII code and send it from upper digits (time, year). When dummy is specified, send '0000H'.

■Data communication in binary code

Send 2-byte numerical value from lower bytes (L: bits 0 to 7). When dummy is specified, send '0000H'.

■Date (year, month, day)

Specify year, month, and day with 16-bit value.

- Year: The binary value is represented with bits 9 to 15 by setting the year 1980 to '0'. *1
- Month: Specify the binary value in bit 5 to 8.
- Day: Specify the binary value in bit 0 to 4.

*1 This indicates incremental number of year by regarding 1980 as '0'.

Ex.

April 1st, 2010

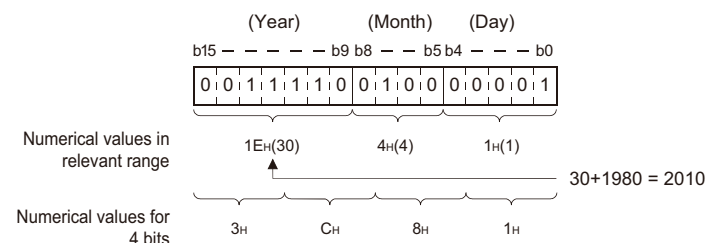

ASCII code	Binary code
3 C 8 1 33H, 43H, 38H, 31H	81H, 3CH

■Time (hour, minute, second)

Represent hour, minute, and second with 16-bit value.

- Hour: Represent binary value with bit 11 to 15.
- Minute: Represent binary value with bit 5 to 10.
- Second: Represent binary value ÷2 with bit 0 to 4.

Ex.

When 20:50:58

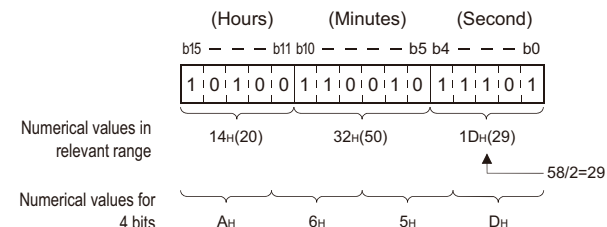

ASCII code	Binary code
A 6 5 D 41H, 36H, 35H, 44H	5DH, A6H

File size

A data that indicates the current file size in number of bytes.

■Data communication in ASCII code

Convert the numerical value to 8-digit (hexadecimal) ASCII code, and send it from the upper digits.

■Data communication in binary code

Send 4-byte^{*1} numerical from the lower byte (L: bits 0 to 7).

*1 For C24, the additional code may be added. (☞ Page 35 Additional code (10H))

Ex.

The file size is 7168 bytes

ASCII code	Binary code
0 0 0 0 1 C 0 0 30H, 30H, 30H, 30H, 31H, 43H, 30H, 30H	00H, 1CH, 00H, 00H

Header statement

A header statement given to the file specified by Engineering tool supporting QnACPU (up to 32 characters).

■Data communication in ASCII code

Send data from the first character.

If the header statement is less than 32 characters, append a space (code: 20H).

Ex.

The header statement at the registration is '1 line-PC5'

The header statement becomes '1 line-PC5□□□...' , and is sequentially sent from '1'. (□: indicating a space.)

■Data communication in binary code

Use the character code of header statement as binary value, and send if from the first character.

When the header statement is less than 32 characters, 20H is added for the shortage.

Ex.

The header statement at registration is '1 line-PC5'

The header statement becomes 31H, 20H, 6CH, 69H, 6EH, 65H, 2DH, 50H, 43H, 35H, 20H, 20H..., and is sequentially sent from 31H.

Offset address

A data to specify the start address of the file range for which data is read and written.

Specify the address (one address/one byte) from the head (offset address: 0H) of each file with an even number.

■Data communication in ASCII code

Convert the address described in the reference section relevant to the corresponding function to 8-digit (hexadecimal) ASCII code, and send it from the upper digits.

■Data communication in binary code

Send 4-byte numerical values described in the reference section relevant to the corresponding function from lower byte (L: bits 0 to 7).

■Offset addresses that can be specified

Check the file size (number of bytes) with the following read file information table functions, and calculate the offset address (0H to nH) by the size.

☞ Page 308 Read file information table without header statement (command: 0201)

☞ Page 311 Read file information table with header statement (command: 0202)

Number of bytes read, number of bytes written

A data to specify the number of bytes in the file range from/to which data is read/written. Specify it as one address per one byte.

■Data communication in ASCII code

Convert the numerical value described in the reference section of the relevant function to 4-digit ASCII code (hexadecimal), and send it from the upper digits.

■Data communication in binary code

Send 2-byte numerical value described in the reference section of the relevant function from the lower byte (L: bits 0 to 7).

Read data, write data (for batch read and batch write functions)

A data read from or to be written to the file in the CPU module.

■Data communication in ASCII code

Convert one byte (one address) to 2-digit ASCII code (hexadecimal), and send it for the specified number of bytes from the upper digits.

■Data communication in binary code

Send the specified number of bytes as one byte for one address.

■Data order

- When reading data: Store the data to the external device without changing the order of data read from the CPU module.
- When writing data: Specify the data without changing the order of data read from CPU module.

Write data (identical data write function)

A data for the identical data write function used to wrote the identical data to the existing QnACPU files.

■Data communication in ASCII code

Convert the numerical value for one word to 4-digit ASCII code (hexadecimal), and send it from the upper digits.

■Data communication in binary code

Send the numerical value for one word from the lower byte (L: bits 0 to 7).

Capacity

A data to reserve the file area on the specified disk when registering a new file. Specify the data in the number of bytes.

■Data communication in ASCII code

Convert the numerical value which represents the area for specified file to be reserved in 2 words to 8-digit ASCII code (hexadecimal), and send it from the upper digits.

■Data communication in binary code

Send the numerical value which represents the area for the specified file to be reserved in 2 words from the lower byte (L: bits 0 to 7).

Point

A new file with the same contents as the existing file can be registered from an external device.

The size of the relevant existing file must be checked using the read file information table function.

☞ Page 308 Read file information table without header statement (command: 0201)

☞ Page 311 Read file information table with header statement (command: 0202)

☞ Page 314 Read file presence (Search file) (command: 0203)

Fixed value

Specify '0'.

ASCII code	Binary code										
<table border="1"> <tr> <td>0</td> <td>0</td> <td>0</td> <td>0</td> </tr> <tr> <td>30H</td> <td>30H</td> <td>30H</td> <td>30H</td> </tr> </table>	0	0	0	0	30H	30H	30H	30H	<table border="1"> <tr> <td>00H</td> <td>00H</td> </tr> </table>	00H	00H
0	0	0	0								
30H	30H	30H	30H								
00H	00H										

Modification pattern (for changing file name and file size)

A data to specify which information to be modified when information (file name, size, date and time created) of the existing file is modified.

■Data communication in ASCII code

Convert the numerical value to 4-digit ASCII code (hexadecimal), and send it from the upper digits.

■Data communication in binary code

Send 2-byte numerical value from the low byte (L: bits 0 to 7).

■Specified value and contents of modification pattern

Bit	Description	Value to be specified
b0	File name and extension specification existence	0: Do not modify the file name and extension, 1: Modify the file name and extension
b1	File attribute modification specification existence	0: Do not modify the attribute, 1: Modify the attribute
b2	Last edit time modification specification existence	0: Do not modify the last edit time, 1: Modify the last edit time
b3	Last edit date modification specification existence	0: Do not modify the last edit date, 1: Modify the last edit date
b4	Modification mode for date and time specification	When modifying date or time, specify which data to use. 0: Use date and time in a message, 1: Use date and time of QnACPU (specify dummy date and time in the message)
b5	File size modification specification existence	0: Do not modify the file size, 1: Modify the file size
b6 to b15	(fixed to '0')	

■Modifying the file creation date and time (command: 1204, subcommand: 0000)

04H, 08H, 0CH, 14H, 18H, or 1CH can be specified with 16 bits.

Bit string	b15	b14	b13	b12	b11	b10	b9	b8	b7	b6	b5	b4	b3	b2	b1	b0
Specification range	0	0	0	0	0	0	0	0	0	0	0	1/0	1/0	1/0	0	0

■Modifying the file name and file size (command: 1204, subcommand: 0001)

01H, 02H, 03H, 20H, 21H, 22H, or 23H can be specified with 16 bits.

Bit string	b15	b14	b13	b12	b11	b10	b9	b8	b7	b6	b5	b4	b3	b2	b1	b0
Specification range	0	0	0	0	0	0	0	0	0	0	1/0	0	0	0	1/0	1/0

■Modifying the file information in batch (command: 1204; subcommand: 0002)

The range from 01H to 3FH can be specified with 16 bits.

Bit string	b15	b14	b13	b12	b11	b10	b9	b8	b7	b6	b5	b4	b3	b2	b1	b0
Specification range	0	0	0	0	0	0	0	0	0	0	1/0	1/0	1/0	1/0	1/0	1/0

File No. usage

A data that shows the usage status of the file No. for 256 files to be returned to external devices when the usage status of file No. is read.

■Data communication in ASCII code

Convert the numerical value to 64-digit ASCII code (hexadecimal) and send it to the external device side. (File No. for 8 files: 2 digits)

■Data communication in binary code

Send the following 32-byte value which indicate the usage status to the external device side from the lower bytes (L: bits 0 to 7). (File No. for 8 files: 1 byte)

■Content of file No. usage

The usage status of each file No. is indicated as one file number per bit.

Ex.

File No. usage

0: Not used, 1: Used

Bit string	b7	b6	b5	b4	b3	b2	b1	b0	Values for 8 bits
1st byte	1 ^{*1}	1	0	1	0	0	1	1 ^{*2}	D3H
2nd byte	1	0	1	1	1	0	0	1	B9H
3rd byte	0	1	1	1	1	0	1	0	7AH
4th byte	1	0	0	1	0	1	1	0	96H
5th byte	0	1	1	1	0	0	0	1	71H
.
31st byte	0	0	0	0	0	0	0	0	FFH
32nd byte	0 ^{*3}	0	0	0	0	0	0	0	FFH

*1 Usage of file No. 8

*2 Usage of file No. 1

*3 Usage of file No. 256

The contents of file No. usage to be returned to external devices under the conditions above are shown below.

- Data communication in ASCII code: 'D3B97A' ... 'FFFF' are returned, and are sequentially send beginning from the 'D'.
- Data communication in binary code: 'D3H', 'B9H', '7AH' ... 'FFH', 'FFH' are returned, and sequentially send beginning from 'D3H'.

File lock mode

A data to specify whether or not a locked file is forcefully unlocked in order to allow access to the specified file from other devices.

■Data communication in ASCII code

Convert the numerical value to 4-digit ASCII code (hexadecimal), and send it from the upper digits.

■Data communication in binary code

Send 2-byte numerical value from the low byte (L: bits 0 to 7).

■Specified value and contents of the file lock mode (Other values cannot be specified.)

Specified value	Content to be specified
0000H	Unlock the locked file normally.
0002H	Unlock the locked file forcefully.

■Unlock method for locked file

There are two methods for locking files:

Method	Description
Normal execution	The locked file cannot be unlocked when other device has registered the file lock. When the file lock deregistration is requested, an error occurs and an abnormal response is returned.
Forced execution	The locked file is forcefully unlocked even if other device has registered the file lock. Use the forced execution function when a locked file cannot be unlocked because of problems in the device that registered the file lock.

Copy mode

A data to specify whether or not the last edit data and time of the source file to the target file at the completion of copying. The QnACPU management time at a new file creation will remain when the date and time are not copied.

■Data communication in ASCII code

Convert the numerical value to 4-digit ASCII code (hexadecimal), and send it from the upper digits.

■Data communication in binary code

Send 2-byte numerical value from the low byte (L: bits 0 to 7).

■Specified value and contents of the copy mode

Setting value	Content to be specified
0000H	Do not copy the last edit date and time of the source file at completion of copying.
0001H	Copy the last edit date and time of the source file at completion of copying.



File control execution procedure for the QnACPU

The following shows the procedures for executing file control on QnACPU.

Procedure when reading contents of file

1. Check for file existence.

Check with any of the following commands.

-  Page 308 Read file information table without header statement (command: 0201)
-  Page 311 Read file information table with header statement (command: 0202)
-  Page 314 Read file presence (Search file) (command: 0203)

2. Prohibit access from other devices. (Prohibit file content modification.)

-  Page 321 Register and deregister file locks (command: 0808)

3. Read all content of the file.

-  Page 318 Read file (command: 0206)

4. Allow access from other devices. (Allow file content modification.)

-  Page 321 Register and deregister file locks (command: 0808)

Point



Store the following file information of the file (for storage) read to an external device.

- File No.
- File name and file attribute
- File size

Procedure when overwriting data to existing file (changing file information)

1. Check for file existence.

Check with any of the following commands.

-  Page 308 Read file information table without header statement (command: 0201)
-  Page 311 Read file information table with header statement (command: 0202)
-  Page 314 Read file presence (Search file) (command: 0203)

2. Prohibit access from other devices. (Prohibit file content modification.)

-  Page 321 Register and deregister file locks (command: 0808)

3. Before changing the file size, change the QnACPU status to STOP. *1

4. Write data when overwriting or copying data, or changing file size.



-  Page 325 Write to file (command: 1203)

5. Modify the file creation date and time.

-  Page 329 Modify file information (command: 1204)

6. Allow access from other devices. (Allow file content modification.)



-  Page 321 Register and deregister file locks (command: 0808)

*1 The file size can be changed using the file information modification function ( Page 329 Modify file information (command: 1204)) only when the file size is made smaller. When the file size must be made larger, write data in the same procedure as create a new file. ( Page 307 Procedure for creating a new file and write data to it (creating a file by copying))

Procedure for creating a new file and write data to it (creating a file by copying)

1. Check for file existence.

Check with any of the following commands.

-  Page 308 Read file information table without header statement (command: 0201)
-  Page 311 Read file information table with header statement (command: 0202)
-  Page 314 Read file presence (Search file) (command: 0203)



2. Check unused file No. only when copying a file.

-  Page 316 Read file No. usage status (command: 0204)

3. Check the capacity of consecutive free area.

-  Page 293 Read drive memory usage status (command: 0205)

4. Delete an unnecessary file when free area is insufficient. Or, increase consecutive free area. *1

-  Page 307 Procedure for deleting files
-  Page 295 Defragment drive memory (command: 1207)

5. Register a file name and reserve the capacity.



-  Page 323 Create new file (Register file name) (command: 1202)

6. Prohibit access from other devices. (Prohibit file content modification.)

-  Page 321 Register and deregister file locks (command: 0808)

7. Write data to the file.

Write data with any of the following commands.

-  Page 325 Write to file (command: 1203)
-  Page 337 Copy file (command: 1206)

8. Modify the file creation date and time. (Can be skipped.)



-  Page 329 Modify file information (command: 1204)

9. Allow access from other devices. (Allow file content modification.)

-  Page 321 Register and deregister file locks (command: 0808)

10. Check the file No. of the created file only when creating a new file.



-  Page 314 Read file presence (Search file) (command: 0203)

*1 Use the remote STOP function ( Page 174 Remote STOP (command: 1002)) to place the QnACPU into the STOP status before defragmenting the memory. After the completion of the processing of this section, the remote RUN function ( Page 172 Remote RUN (command: 1001)) can be used to set the QnACPU to the RUN status.

Procedure for deleting files

1. Check for file existence.

Check with any of the following commands.

-  Page 308 Read file information table without header statement (command: 0201)
-  Page 311 Read file information table with header statement (command: 0202)
-  Page 314 Read file presence (Search file) (command: 0203)

2. Delete a file. *1

-  Page 335 Delete file (command: 1205)

*1 Determine the file deletion timing for the entire system, including the QnACPU and related devices.

Read file information table without header statement (command: 0201)

The following examples show the control procedure for reading file information table without header statement within the range of the specified file No.

Message format

The following shows the message format of the request data and response data of the command.

Request data

ASCII

0	2	0	1	Subcommand	Keyword	Setting flag	Drive name	File No.	Number of requested files
30H	32H	30H	31H						

Binary

	Subcommand	Setting flag	Keyword	Drive name	File No.	Number of requested files
02H	01H					

Response data

Total number of registered files	Number of file information	File No.	File name	Extension	Attribute	Last edit time	Last edit date	File size	...	File information (nth point)	
		File information (first point)									

Data specified by request data

Command

ASCII code	Binary code										
<table border="1"> <tr> <td>0</td> <td>2</td> <td>0</td> <td>1</td> </tr> <tr> <td>30H</td> <td>32H</td> <td>30H</td> <td>31H</td> </tr> </table>	0	2	0	1	30H	32H	30H	31H	<table border="1"> <tr> <td>01H</td> <td>02H</td> </tr> </table>	01H	02H
0	2	0	1								
30H	32H	30H	31H								
01H	02H										

Subcommand

ASCII code	Binary code										
<table border="1"> <tr> <td>0</td> <td>0</td> <td>0</td> <td>0</td> </tr> <tr> <td>30H</td> <td>30H</td> <td>30H</td> <td>30H</td> </tr> </table>	0	0	0	0	30H	30H	30H	30H	<table border="1"> <tr> <td>00H</td> <td>00H</td> </tr> </table>	00H	00H
0	0	0	0								
30H	30H	30H	30H								
00H	00H										

Keyword

Allow/prohibit the access to the file of the target memory. (Page 298 Keyword)

Setting flag

Data that indicates whether the keyword is registered in the specified drive. (Page 298 Setting flag)

Drive name

A data to specify the drive in a CPU module of which files are to be managed. (Page 298 Drive name, Drive No.)

File No.

A data to specify the registration number of files. (Page 298 File No.)

Specify within the following range.

$1 \leq \text{File No.} \leq 256$

■Number of requested file

Number of request files when reading file information. (☞ Page 299 Number of requested file, total number of registered files, number of file information)

Specify within the following range.

$1 \leq \text{Number of requested file} \leq 36$

Data stored by response data

■Total number of registered files

Number of files registered in the specified drive. (☞ Page 299 Number of requested file, total number of registered files, number of file information)

The value is returned within the following range.

$1 \leq \text{Total number of registered files} \leq 256$

■Number of file information

Number of files that return file information when reading the file information(☞ Page 299 Number of requested file, total number of registered files, number of file information)

The value is returned within the following range.

$0 \leq \text{Number of file information} \leq \text{Number of requested file}$

(0: No registered files after the specified head file No.)

■File No.

This indicates the registration number of a file. (☞ Page 298 File No.)

■File name

Character string data of a file name. (☞ Page 299 File name, extension, and attribute)

■Extension

A character string data of extension of a file. (☞ Page 299 File name, extension, and attribute)

■Attribute

A data that indicates the file attribute (applicability of data read/write). (☞ Page 299 File name, extension, and attribute)

■Last edit time and last edit date

A data that indicates the date and time when the current data was registered. (☞ Page 300 Last edit time and last edit date)

■File size

A data that indicates the capacity of the current file in number of bytes. (☞ Page 301 File size)

Point

- The total number of registered files is the current total number of files registered in the specified drive.
- When all the files are not registered within the specified file number range, the number of file information will be the number of files registered in the specified range (number of file information to be returned).

Communication example

Read the file information table without header statement in following conditions.

- Drive name: 1 (RAM area of memory card A)
- File No.: 10
- Number of requested file: 2

■Data communication in ASCII code

(Request data)

Subcommand				Keyword				Setting flag		Drive name			File No.			Number of requested files					
0	2	0	1	0	0	0	0	0	1	0	0	0	1	0	0	0	A	0	0	0	2
30 _H	32 _H	30 _H	31 _H	30 _H	30 _H	30 _H	30 _H	30 _H	31 _H	30 _H	30 _H	30 _H	31 _H	30 _H	30 _H	30 _H	41 _H	30 _H	30 _H	30 _H	32 _H

(Response data)

Total number of registered files				Number of file information			
0	0	1	F	0	0	0	2
30 _H	30 _H	31 _H	46 _H	30 _H	30 _H	30 _H	02 _H

File information 1 (Information of file No. 10)

File No.		File name				Extension		Attribute	Time of last update			Date of last update		File size																	
0	0	0	A	A	B	C	D	1	2	Q	P	G	A	6	5	D	2	0	2	8	0	0	0	0	1	C	0	0			
30 _H	30 _H	30 _H	41 _H	41 _H	42 _H	43 _H	44 _H	31 _H	32 _H	20 _H	20 _H	51 _H	50 _H	47 _H	20 _H	41 _H	36 _H	35 _H	44 _H	32 _H	30 _H	32 _H	38 _H	30 _H	30 _H	30 _H	30 _H	31 _H	43 _H	30 _H	30 _H

(20 hours 50 minutes 58 seconds) (January 8, 1996)

File information 2 (Information of file No. 11)

File No.		File name				Extension		Attribute	Time of last update			Date of last update		File size																	
0	0	0	B	E	F	G	H	5	Q	P	G	5	B	C	0	2	1	8	2	0	0	0	0	1	3	C	8				
30 _H	30 _H	30 _H	42 _H	45 _H	46 _H	47 _H	48 _H	35 _H	20 _H	20 _H	20 _H	51 _H	50 _H	47 _H	20 _H	35 _H	42 _H	43 _H	30 _H	32 _H	31 _H	38 _H	32 _H	30 _H	30 _H	30 _H	30 _H	31 _H	33 _H	43 _H	38 _H

(11 hours 30 minutes 00 seconds) (December 2, 1996)

■Data communication in binary code

(Request data)

Setting flag		File No.		Subcommand		Keyword		Drive name		Number of requested files	
01 _H	02 _H	00 _H	00 _H	01 _H	00 _H	20 _H	01 _H	01 _H	00 _H	0A _H	00 _H
02 _H	00 _H	00 _H	00 _H	01 _H	00 _H	20 _H	01 _H	01 _H	00 _H	0A _H	00 _H

(Response data)

Total number of registered files		Number of file information		File information 1 (Information of file No. 10)												Last edit time		File size				
				File No.		File name				Extension		Attribute	Last edit date									
1F _H	00 _H	02 _H	00 _H	0A _H	00 _H	A	B	C	D	1	2	Q	P	G	5D _H	A6 _H	28 _H	20 _H	00 _H	1C _H	00 _H	00 _H
(20 hours 50 minutes 58 seconds) (January 8, 1996)																						
				File information 2 (Information of file No. 11)												Last edit time		File size				
				File No.		File name				Extension		Attribute	Last edit date									
0B _H	00 _H	45 _H	46 _H	47 _H	48 _H	35 _H	20 _H	20 _H	20 _H	51 _H	50 _H	47 _H	20 _H	C0 _H	5B _H	82 _H	21 _H	C8 _H	13 _H	00 _H	00 _H	
(11 hours 30 minutes 00 seconds) (December 2, 1996)																						

Read file information table with header statement (command: 0202)

The following examples show the control procedure for reading file information table with header statement within the range of the specified file No.

Message format

The following shows the message format of the request data and response data of the command.

Request data

ASCII

0	2	0	2	Subcommand	Keyword	Setting flag	Drive name	File No.	Number of requested files
30H	32H	30H	32H						

Binary

	Subcommand	Setting flag	Keyword	Drive name	File No.	Number of requested files
02H	02H					

Response data

Total number of registered files	Number of file information	File No.	File name	Extension	Attribute	Last edit time	Last edit date	File size	Header statement	...	File information (nth point)

Data specified by request data

Command

ASCII code	Binary code										
<table border="1"> <tr><td>0</td><td>2</td><td>0</td><td>2</td></tr> <tr><td>30H</td><td>32H</td><td>30H</td><td>32H</td></tr> </table>	0	2	0	2	30H	32H	30H	32H	<table border="1"> <tr><td>02H</td><td>02H</td></tr> </table>	02H	02H
0	2	0	2								
30H	32H	30H	32H								
02H	02H										

Subcommand

ASCII code	Binary code										
<table border="1"> <tr><td>0</td><td>0</td><td>0</td><td>0</td></tr> <tr><td>30H</td><td>30H</td><td>30H</td><td>30H</td></tr> </table>	0	0	0	0	30H	30H	30H	30H	<table border="1"> <tr><td>00H</td><td>00H</td></tr> </table>	00H	00H
0	0	0	0								
30H	30H	30H	30H								
00H	00H										

Keyword

Allow/prohibit the access to the file of the target memory. (☞ Page 298 Keyword)

Setting flag

Data that indicates whether the keyword is registered in the specified drive. (☞ Page 298 Setting flag)

Drive name

A data to specify the drive in a CPU module of which files are to be managed. (☞ Page 298 Drive name, Drive No.)

File No.

A data to specify the registration number of files. (☞ Page 298 File No.)

Specify within the following range.

$$1 \leq \text{File No.} \leq 256$$

■Number of requested file

Number of request files when reading file information. (☞ Page 299 Number of requested file, total number of registered files, number of file information)

Specify within the following range.

$1 \leq \text{Number of requested file} \leq 16$

Data stored by response data

■Total number of registered files

Number of files registered in the specified drive. (☞ Page 299 Number of requested file, total number of registered files, number of file information)

The value is returned within the following range.

$1 \leq \text{Total number of registered files} \leq 256$

■Number of file information

Number of files that return file information when reading the file information(☞ Page 299 Number of requested file, total number of registered files, number of file information)

The value is returned within the following range.

$0 \leq \text{Number of file information} \leq \text{Number of requested file}$

(0: No registered files after the specified head file No.)

■File No.

This indicates the registration number of a file. (☞ Page 298 File No.)

■File name

Character string data of a file name. (☞ Page 299 File name, extension, and attribute)

■Extension

A character string data of extension of a file. (☞ Page 299 File name, extension, and attribute)

■Attribute

A data that indicates the file attribute (applicability of data read/write). (☞ Page 299 File name, extension, and attribute)

■Last edit time and last edit date

A data that indicates the date and time when the current data was registered. (☞ Page 300 Last edit time and last edit date)

■File size

A data that indicates the capacity of the current file in number of bytes. (☞ Page 301 File size)

■Header statement

The header statement attached to the file specified with Engineering tool. (☞ Page 301 Header statement)

Point

- The total number of registered files is the current total number of files registered in the designated drive.
- When all the files are not registered within the specified file number range, the number of file information will be the number of files registered in the specified range (number of file information to be returned).

Communication example

Read the file information table with header statement in following conditions.

- Drive name: 1 (RAM area of memory card A)
- File No.: 10
- Number of requested file: 2

■Data communication in ASCII code

(Request data)

Subcommand	Keyword	Setting flag	Drive name	File No.	Number of requested files
0 2 0 2 30H, 32H, 30H, 32H	0 0 0 0 30H, 30H, 30H, 30H	0 1 2 0 0 0 30H, 31H, 32H, 30H, 30H, 30H	0 1 30H, 31H	0 0 0 1 30H, 30H, 30H, 31H	0 0 0 A 30H, 30H, 30H, 41H

(Response data)

Total number of registered files Number of file information

0 0 1 F 30H, 30H, 31H, 46H	0 0 0 2 30H, 30H, 30H, 02H
-------------------------------	-------------------------------

File information 1 (Information of file No. 10)

File No.	File name	Extension	Attribute	Last edit time	Last edit date	File size
0 0 0 A 30H, 30H, 30H, 41H	A B C D 1 2 41H, 42H, 43H, 44H, 31H, 32H, 20H, 20H	Q P G 51H, 50H, 47H	20H	A 6 5 D 41H, 36H, 35H, 44H	2 0 2 8 32H, 30H, 32H, 38H	0 0 0 0 1 C 0 0 30H, 30H, 30H, 30H, 31H, 43H, 30H, 30H

(20 hours 50 minutes 58 seconds) (January 8, 1996)

Header statement (32 characters) File information 2 (Information of file No. 11)

A B ... 41H, 42H, ..., 20H, 20H	(The order of data items is the same as that of file information 1.)
------------------------------------	--

■Data communication in binary code

(Request data)

Subcommand	Keyword	Drive name	File No.	Number of requested files
02H, 02H	00H, 00H	01H	00H, 20H, 01H	01H, 00H

(Response data)

Total number of registered files Number of file information File information 1 (Information of file No. 10)

File No.	File name	Extension	Attribute	Last edit time	Last edit date	File size
1FH, 00H	A B C D 1 2 41H, 42H, 43H, 44H, 31H, 32H, 20H, 20H	Q P G 51H, 50H, 47H	20H	5DH, A6H 5DH, A6H	28H, 20H 28H, 20H	00H, 1CH, 00H, 00H 00H, 1CH, 00H, 00H

(20 hours 50 minutes 58 seconds) (January 8, 1996)

Header statement (32 characters) File information 2 (Information of file No. 11)

A B ... 41H, 42H, ..., 20H, 20H	(The order of data items is the same as that of file information 1.)
------------------------------------	--

Read file presence (Search file) (command: 0203)

The following examples show the control procedure for searching for the specified file, and reading its file No. and file size.

Message format

Request data

ASCII

0	2	0	3	Subcommand	Keyword	Setting flag	Drive name	File name	Extension	Attribute
30H	32H	30H	33H							

Binary

	Subcommand	Setting flag	Keyword	Drive name	File name	Extension	Attribute
03H	02H						

Response data

File No.	File size
----------	-----------



If the specified file does not exist, an error occurs and the end code at the occurrence of error is returned.

Data specified by request data

Command

ASCII code	Binary code										
<table border="1"> <tr> <td>0</td> <td>2</td> <td>0</td> <td>3</td> </tr> <tr> <td>30H</td> <td>32H</td> <td>30H</td> <td>33H</td> </tr> </table>	0	2	0	3	30H	32H	30H	33H	<table border="1"> <tr> <td>03H</td> <td>02H</td> </tr> </table>	03H	02H
0	2	0	3								
30H	32H	30H	33H								
03H	02H										

Subcommand

ASCII code	Binary code										
<table border="1"> <tr> <td>0</td> <td>0</td> <td>0</td> <td>0</td> </tr> <tr> <td>30H</td> <td>30H</td> <td>30H</td> <td>30H</td> </tr> </table>	0	0	0	0	30H	30H	30H	30H	<table border="1"> <tr> <td>00H</td> <td>00H</td> </tr> </table>	00H	00H
0	0	0	0								
30H	30H	30H	30H								
00H	00H										

Keyword

Allow/prohibit the access to the file of the target memory. (Page 298 Keyword)

Setting flag

Data that indicates whether the keyword is registered in the specified drive. (Page 298 Setting flag)

Drive name

A data to specify the drive in a CPU module of which files are to be managed. (Page 298 Drive name, Drive No.)

File name

Character string data of a file name. (Page 299 File name, extension, and attribute)

Extension

A character string data of extension of a file. (Page 299 File name, extension, and attribute)

Attribute

A data to specify the file attribute (applicability of data read/write). (Page 299 File name, extension, and attribute)
Handle the file attribute to be read as dummy data.

Data stored by response data

■File No.

This indicates the registration number of a file. (☞ Page 298 File No.)

■File size

This value indicates the capacity of the current file in number of bytes. (☞ Page 301 File size)

Communication example

Read the existence of a specified file under the following condition.

- Drive name: 1 (RAM area of memory card A)
- File name: ABC12.QPG

■Data communication in ASCII code

(Request data)

Subcommand				Keyword				Setting flag		Drive name				File name			Extension			Attribute					
0	2	0	3	0	0	0	0	0	1	0	0	0	1	A	B	C	1	2	□	□	□	Q	P	G	□
30H	32H	30H	33H	30H	30H	30H	30H	30H	31H	30H	30H	30H	31H	41H	42H	43H	31H	32H	20H	20H	20H	51H	50H	47H	20H

(Response data)

File No.				File size							
0	0	0	1	0	0	0	0	1	C	0	0
30H	30H	30H	31H	30H	30H	30H	30H	31H	43H	30H	30H

■Data communication in binary code

(Request data)

Subcommand		Setting flag	Keyword		Drive name		File name			Extension		Attribute							
03H	02H	01H	00H	23H	01H	01H	00H	41H	42H	43H	31H	32H	20H	20H	20H	51H	50H	47H	20H

(Response data)

File No.		File size			
01H	00H	00H	1CH	00H	00H

Read file No. usage status (command: 0204)

The following examples show the control procedure for reading the usage status of a file No.

Message format

Request data

ASCII

0	2	0	4	Subcommand	Keyword	Setting flag	Drive name
30H	32H	30H	34H				

Binary

	Subcommand	Setting flag	Keyword	Drive name
04H	02H			

Response data

The file No. of usage status is stored. (☞ Page 304 File No. usage)



When a drive memory that cannot store maximum of 256 files is specified, the file No. of which file cannot be stored (shortage) will be in use (the corresponding bit will be '1').

Data specified by request data

Command

ASCII code	Binary code										
<table border="1"> <tr> <td>0</td> <td>2</td> <td>0</td> <td>4</td> </tr> <tr> <td>30H</td> <td>32H</td> <td>30H</td> <td>34H</td> </tr> </table>	0	2	0	4	30H	32H	30H	34H	<table border="1"> <tr> <td>04H</td> <td>02H</td> </tr> </table>	04H	02H
0	2	0	4								
30H	32H	30H	34H								
04H	02H										

Subcommand

ASCII code	Binary code										
<table border="1"> <tr> <td>0</td> <td>0</td> <td>0</td> <td>0</td> </tr> <tr> <td>30H</td> <td>30H</td> <td>30H</td> <td>30H</td> </tr> </table>	0	0	0	0	30H	30H	30H	30H	<table border="1"> <tr> <td>00H</td> <td>00H</td> </tr> </table>	00H	00H
0	0	0	0								
30H	30H	30H	30H								
00H	00H										

Keyword

Allow/prohibit the access to the file of the target memory. (☞ Page 298 Keyword)

Setting flag

Data that indicates whether the keyword is registered in the specified drive. (☞ Page 298 Setting flag)

Drive name

A data to specify the drive in a CPU module of which files are to be managed. (☞ Page 298 Drive name, Drive No.)

Communication example

Read the file No. usage in the following conditions.

- Drive name: 1 (RAM area of memory card A)

■Data communication in ASCII code

(Request data)

Subcommand				Keyword				Setting flag		Drive name									
0	2	0	4	0	0	0	0	0	1	2	3	0	0	0	1	0	0	0	1
30H	32H	30H	34H	30H	30H	30H	30H	30H	31H	32H	33H	30H	30H	30H	31H	30H	30H	30H	31H

(Response data)

File No. usage status (64 characters)

D 3	B 9 7 A 9 6 ... F F	F F
44H, 33H	42H, 39H, 37H, 41H, 39H, 36H, ... , 46H, 46H	46H, 46H
No.1 to 8	No.9 to No.248	No.249 to 256

■Data communication in binary code

(Request data)

Subcommand		Setting flag	Keyword		Drive name				
04H	02H	00H	00H	01H	00H	23H	01H	01H	00H

(Response data)

File No. usage status (32 bytes)		
D3H	B9H, 7AH, 96H, ...	FFH
No.1 to 8	No.9 to No.248	No.249 to 256

Read file (command: 0206)

The following examples show the control procedure for reading the data written in the specified file.

Point 

The maximum number of data bytes to be read per one time is fixed. Read all the data written to the specified file with adjusting the offset address and number of bytes read, and dividing them for several times.

Additionally, save the read data to the external device.

Check the file size with the following function.

 Page 308 Read file information table without header statement (command: 0201)

 Page 311 Read file information table with header statement (command: 0202)

 Page 314 Read file presence (Search file) (command: 0203)

Message format

Request data

ASCII

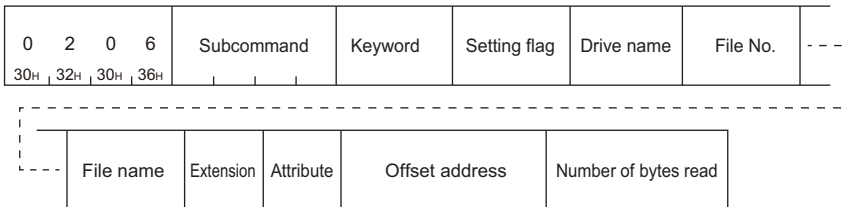

Binary

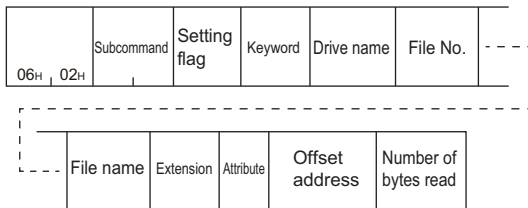

Response data

The read data are stored.

 Page 302 Read data, write data (for batch read and batch write functions)

Data specified by request data

■Command

ASCII code	Binary code
0 2 0 6 30H 32H 30H 36H	06H 02H

■Subcommand

ASCII code	Binary code
0 0 0 0 30H 30H 30H 30H	00H 00H

■Keyword

Allow/prohibit the access to the file of the target memory. ( Page 298 Keyword)

■Setting flag

Data that indicates whether the keyword is registered in the specified drive. ( Page 298 Setting flag)

■Drive name

A data to specify the drive in a CPU module of which files are to be managed. ( Page 298 Drive name, Drive No.)

■File No.

A data to specify the registration number of files. ( Page 298 File No.)

Specify within the following range.

$1 \leq \text{File No.} \leq 256$

■File name

Character string data of a file name. ( Page 299 File name, extension, and attribute)

■Extension

A character string data of extension of a file. ( Page 299 File name, extension, and attribute)

■Attribute

A data to specify the file attribute (applicability of data read/write). ( Page 299 File name, extension, and attribute)

Handle the file attribute to be read as dummy data.

■Offset address

A data to specify the start address of the range from which data is read to a file. ( Page 301 Offset address)

Specify within the following range.

$0 \leq \text{Address (specify with even address)} \leq (\text{File size} - 1)$

■Number of bytes read

A data to specify the number of bytes of the range from which data is read to a file. ( Page 302 Number of bytes read, number of bytes written)

Specify within the following range.

$0 \leq \text{Number of bytes} \leq 960$

Communication example

Read the data written in the specified file under the following condition.

- Drive name: 1 (RAM area of memory card A)
- File No.: 1
- File name: ABC12.QPG
- Offset address: 100H
- Number of bytes read: 50 bytes

■Data communication in ASCII code

(Request data)

Subcommand				Keyword				Setting flag		Drive name				File No.									
0	2	0	6	0	0	0	0	0	1	0	0	0	1	0	0	0	1						
30H	32H	30H	36H	30H	30H	30H	30H	30H	31H	30H	30H	30H	31H	30H	30H	30H	31H						
File name								Extension		Attribute		Offset address				Number of bytes read							
A	B	C	1	2	□	□	□	Q	P	G	□	0	0	0	0	0	1	0	0	0	0	3	2
41H	42H	43H	31H	32H	20H	20H	20H	51H	50H	47H	20H	30H	30H	30H	30H	30H	31H	30H	30H	30H	30H	33H	32H

(Response data)

Data read (For 50 bytes)

1	3	5	F	0	C	0	2	...	0	1	0	B	1	E
31H	33H	35H	46H	30H	43H	30H	32H	...	30H	31H	30H	42H	31H	45H
Address 100H		Address 101H to 130H										Address 131H		

■Data communication in binary code

(Request data)

Subcommand		Setting flag		Keyword		Drive name		File No.		File name									
06H	02H	00H	00H	01H	00H	23H	01H	01H	00H	01H	00H	41H	42H	43H	31H	32H	20H	20H	20H
Extension		Attribute		Offset address				Number of bytes read											
51H	50H	47H	20H	00H	01H	00H	00H	32H	00H										

(Response data)

Data read (For 50 bytes)

13H	5FH	0CH	02H	...	01H	0BH	1EH						
Address 100H		Address 101H to 130H										Address 131H	

Register and deregister file locks (command: 0808)

The following examples show the control procedure for registering and deregistering a file lock.



Restarting QnACPU (such as resetting CPU module) with the file lock registered results in the file lock deregistered state.

Message format

Request data

Command	Subcommand	File lock mode	Drive name	File No.	File name	Extension	Attribute
---------	------------	----------------	------------	----------	-----------	-----------	-----------

Response data

There is no response data for this command.

Data specified by request data

Command

ASCII code	Binary code										
<table border="1"> <tr><td>0</td><td>8</td><td>0</td><td>8</td></tr> <tr><td>30H</td><td>38H</td><td>30H</td><td>38H</td></tr> </table>	0	8	0	8	30H	38H	30H	38H	<table border="1"> <tr><td>08H</td><td>08H</td></tr> </table>	08H	08H
0	8	0	8								
30H	38H	30H	38H								
08H	08H										

Subcommand

- Register

ASCII code	Binary code										
<table border="1"> <tr><td>0</td><td>0</td><td>0</td><td>1</td></tr> <tr><td>30H</td><td>30H</td><td>30H</td><td>31H</td></tr> </table>	0	0	0	1	30H	30H	30H	31H	<table border="1"> <tr><td>01H</td><td>00H</td></tr> </table>	01H	00H
0	0	0	1								
30H	30H	30H	31H								
01H	00H										

- Deregister

ASCII code	Binary code										
<table border="1"> <tr><td>0</td><td>0</td><td>0</td><td>0</td></tr> <tr><td>30H</td><td>30H</td><td>30H</td><td>30H</td></tr> </table>	0	0	0	0	30H	30H	30H	30H	<table border="1"> <tr><td>00H</td><td>00H</td></tr> </table>	00H	00H
0	0	0	0								
30H	30H	30H	30H								
00H	00H										

File lock mode

A data to specify whether a locked file is to be forcefully unlocked in order to allow other devices to access the specified file.

([Page 304 File lock mode](#))

Drive name

A data to specify the drive in a CPU module of which files are to be managed. ([Page 298 Drive name, Drive No.](#))

File No.

A data to specify the registration number of files. ([Page 298 File No.](#))

File name

Character string data of a file name. ([Page 299 File name, extension, and attribute](#))

Extension

A character string data of extension of a file. ([Page 299 File name, extension, and attribute](#))

Attribute

A data to specify the file attribute (applicability of data read/write). ([Page 299 File name, extension, and attribute](#))

The attribute assigned by a new file creation, etc. is valid as the attribute of the file that will be locked and unlocked. When registering and deregistering file lock, handle the file attribute as dummy data.

Communication example (Register)

Read the existence of a specified file under the following condition.

- File lock mode: 0 (usual practice)
- Drive name: 1 (RAM area of memory card A)
- File No.: 1
- File name: ABC12.QPG

■Data communication in ASCII code

(Request data)

Subcommand				File lock mode				Drive name				File No.			
0	8	0	8	0	0	0	1	0	0	0	1	0	0	0	1
30H	38H	30H	38H	30H	30H	30H	31H	30H	30H	30H	31H	30H	30H	30H	31H

File name								Extension			Attribute
A	B	C	1	2	□	□	□	Q	P	G	□
41H	42H	43H	31H	32H	20H	20H	20H	51H	50H	47H	20H

■Data communication in binary code

(Request data)

Subcommand		File lock mode		Drive name		File No.		File name				Extension		Attribute							
08H	08H	01H	00H	00H	00H	01H	00H	01H	00H	41H	42H	43H	31H	32H	20H	20H	20H	51H	50H	47H	20H

Create new file (Register file name) (command: 1202)

The following examples show the control procedure for registering a new file and reserving a file area on the specified disk. Write data to the file created using this function with the following function.

☞ Page 325 Write to file (command: 1203)

The content of file in which data is not written cannot be read.

Point

- A new file can be created on the specified drive memory within the size of consecutive unused clusters. Creating a new file considering the rest of the capacity for future use is recommended.
- The QnACPU management time is registered as the last edit date and time to a new file created using this function.

Message format

Request data

ASCII

1	2	0	2	Subcommand	Keyword	Setting flag	Drive name	Fixed value	Fixed value
31H	32H	30H	32H						

	File name	Extension	Attribute	Size	Fixed value				

Binary

	Subcommand	Setting flag	Keyword	Drive name	Fixed value	Fixed value			
02H	12H								

	File name	Extension	Attribute	Size	Fixed value				

Response data

File No. is stored. (☞ Page 298 File No.)

Data specified by request data

Command

ASCII code	Binary code										
<table border="1"> <tr><td>1</td><td>2</td><td>0</td><td>2</td></tr> <tr><td>31H</td><td>32H</td><td>30H</td><td>32H</td></tr> </table>	1	2	0	2	31H	32H	30H	32H	<table border="1"> <tr><td>02H</td><td>12H</td></tr> </table>	02H	12H
1	2	0	2								
31H	32H	30H	32H								
02H	12H										

Subcommand

ASCII code	Binary code										
<table border="1"> <tr><td>0</td><td>0</td><td>0</td><td>0</td></tr> <tr><td>30H</td><td>30H</td><td>30H</td><td>30H</td></tr> </table>	0	0	0	0	30H	30H	30H	30H	<table border="1"> <tr><td>00H</td><td>00H</td></tr> </table>	00H	00H
0	0	0	0								
30H	30H	30H	30H								
00H	00H										

Keyword

Allow/prohibit the access to the file of the target memory. (☞ Page 298 Keyword)

Setting flag

Data that indicates whether the keyword is registered in the specified drive. (☞ Page 298 Setting flag)

■Drive name

A data to specify the drive in a CPU module of which files are to be managed. (☞ Page 298 Drive name, Drive No.)

■Fixed value

'0000' (at the time of an ASCII code) or 0000H (at the time of a binary code) is transmitted. (☞ Page 303 Fixed value)

■File name

Character string data of a file name. (☞ Page 299 File name, extension, and attribute)

■Extension

A character string data of extension of a file. (☞ Page 299 File name, extension, and attribute)

■Attribute

A data to specify the file attribute (applicability of data read/write). (☞ Page 299 File name, extension, and attribute)

Specify '20H' (readable/writable disk file) for the attribute of a new file.

■Capacity

A data to reserve the file area on the specified disk when registering a new file. It is specified with the number of bytes.

(☞ Page 302 Capacity)

Communication example

Read the data written in the specified file under the following condition.

- Drive name: 1 (RAM area of memory card A)
- File name: ABC12.QPG
- Capacity: 172 bytes

■Data communication in ASCII code

(Request data)

Subcommand				Keyword				Setting flag		Drive name				Fixed value													
1	2	0	2	0	0	0	0	0	1	0	0	0	1	0	0	0	0										
31H	32H	30H	32H	30H	30H	30H	30H	30H	31H	32H	33H	30H	30H	30H	31H	30H	30H	30H	31H	30H	30H	30H	30H				
Fixed value				File name				Extension		Attribute		Size				Fixed value											
0	0	0	0	A	B	C	1	2	□	□	□	Q	P	G	□	0	0	0	0	0	0	A	C	0	0	0	0
30H	30H	30H	30H	41H	42H	43H	31H	32H	20H	20H	20H	51H	50H	47H	20H	30H	30H	30H	30H	30H	30H	41H	43H	30H	30H	30H	30H

(Response data)

0	0	0	A
30H	30H	30H	41H

■Data communication in binary code

(Request data)

Subcommand		Setting flag		Keyword		Drive name		Fixed value		Fixed value		File name				Extension							
02H	12H	00H	00H	01H	00H	23H	01H	01H	00H	00H	00H	00H	00H	41H	42H	43H	31H	32H	20H	20H	51H	50H	47H
Attribute		Size				Fixed value																	
20H	ACH	00H	00H	00H	00H	00H	00H																

(Response data)

A0H	00H
-----	-----

Write to file (command: 1203)

The following example shows the control procedure for writing the data of the file that has been read from the QnACPU and stored in an external device to the specified file ('batch write'), and the control procedure for writing n-bytes of arbitrary one-word data to the specified file ('identical data write (FILL)').

Point

The maximum number of data bytes to be read per one time is static.

- For batch writing, all the data read from QnACPU and stored to an external device must be written to the specified file with adjusting the offset address and number of bytes written and divide them for several times.
- For writing identical data, adjust the offset address and number of bytes written, and divide them and write arbitrary 1 word data within the range of specified file for several times. Note that, if the data size to be written remains 1 byte, the numerical value of upper bytes of 1 word data (bit 8 to 15) is not written since the data write is performed in byte units.

Message format

Request data

ASCII

1	2	0	3	Subcommand	Keyword	Setting flag	Drive name	File No.	File name	Extension	Attribute	
31H	32H	30H	33H									

Offset address	Number of bytes written	Write data
----------------	-------------------------	------------

Binary

	Subcommand	Setting flag	Keyword	Drive name	File No.	File name	Extension	Attribute	
03H	12H								

Offset address	Number of bytes written	Write data
----------------	-------------------------	------------

Response data

There is no response data for this command.

Point

An error occurs If one of the following files is specified while the QnACPU is in RUN, and error end code will be returned.

- Parameter file
- Currently executing file in the built-in RAM (drive name: 00H)

Data specified by request data

■Command

ASCII code	Binary code										
<table border="1"><tr><td>1</td><td>2</td><td>0</td><td>3</td></tr><tr><td>31H</td><td>32H</td><td>30H</td><td>33H</td></tr></table>	1	2	0	3	31H	32H	30H	33H	<table border="1"><tr><td>03H</td><td>12H</td></tr></table>	03H	12H
1	2	0	3								
31H	32H	30H	33H								
03H	12H										

■Subcommand

Type	ASCII code	Binary code										
Batch write	<table border="1"><tr><td>0</td><td>0</td><td>0</td><td>0</td></tr><tr><td>30H</td><td>30H</td><td>30H</td><td>30H</td></tr></table>	0	0	0	0	30H	30H	30H	30H	<table border="1"><tr><td>00H</td><td>00H</td></tr></table>	00H	00H
0	0	0	0									
30H	30H	30H	30H									
00H	00H											
Writing the identical data (FILL)	<table border="1"><tr><td>0</td><td>0</td><td>0</td><td>1</td></tr><tr><td>30H</td><td>30H</td><td>30H</td><td>31H</td></tr></table>	0	0	0	1	30H	30H	30H	31H	<table border="1"><tr><td>01H</td><td>00H</td></tr></table>	01H	00H
0	0	0	1									
30H	30H	30H	31H									
01H	00H											

■Keyword

Allow/prohibit the access to the file of the target memory. (☞ Page 298 Keyword)

■Setting flag

Data that indicates whether the keyword is registered in the specified drive. (☞ Page 298 Setting flag)

■Drive name

A data to specify the drive in a CPU module of which files are to be managed. (☞ Page 298 Drive name, Drive No.)

■File No.

A data to specify the registration number of files. (☞ Page 298 File No.)

■File name

Character string data of a file name. (☞ Page 299 File name, extension, and attribute)

■Extension

A character string data of extension of a file. (☞ Page 299 File name, extension, and attribute)

■Attribute

A data to specify the file attribute (applicability of data read/write). (☞ Page 299 File name, extension, and attribute)

The attribute assigned by a new file creation, etc. is valid as the attribute of the file to which data is written. When writing data, handle the attribute as dummy data.

■Offset address

A data which specifies the start address of the range in which data is written to a file. (☞ Page 301 Offset address)

Specify within the following range.

$0 \leq \text{Address} \leq (\text{File size} - 1)$

- Writing data to file of which drive name is '00H' (built-in RAM): Specify with multiples of 4 (0, 4, 8, ... in decimal notation).
- Writing to the file of which drive name is other than '00H': Specify with even number (for decimal data, 0, 2, 4, 6, 8, ...).

■Number of bytes written

Data to specify the number of bytes of data to be written. (☞ Page 302 Number of bytes read, number of bytes written)

Specify within the following range.

$0 \leq \text{Number of bytes} \leq 960$

■Write data

Data to be written to a file. (☞ Page 302 Read data, write data (for batch read and batch write functions))

Communication example (Batch write)

Batch write is executed under the following condition.

- Drive name: 1 (RAM area of memory card A)
- File No.: 1
- File name: ABC12.QPG
- Offset address: 7CH
- Number of bytes written: 416 bytes

■Data communication in ASCII code

(Request data)

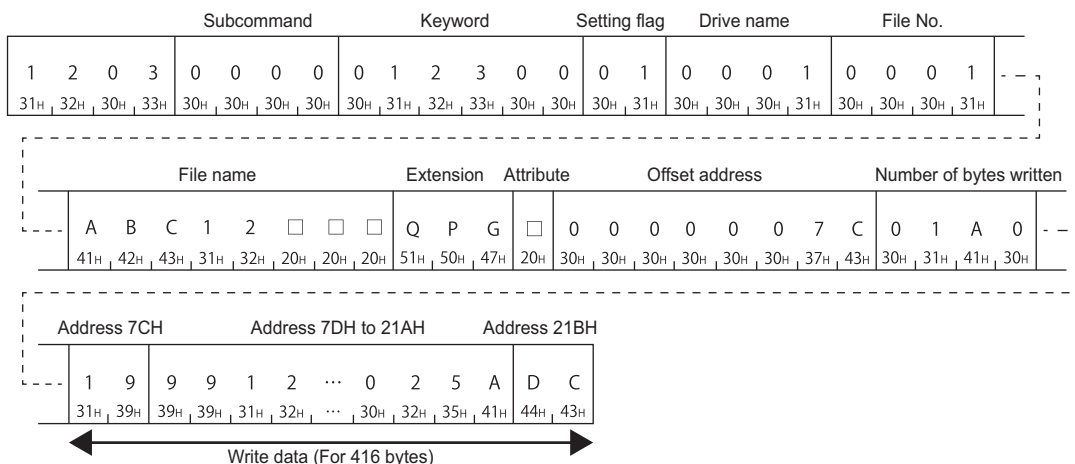

■Data communication in binary code

(Request data)

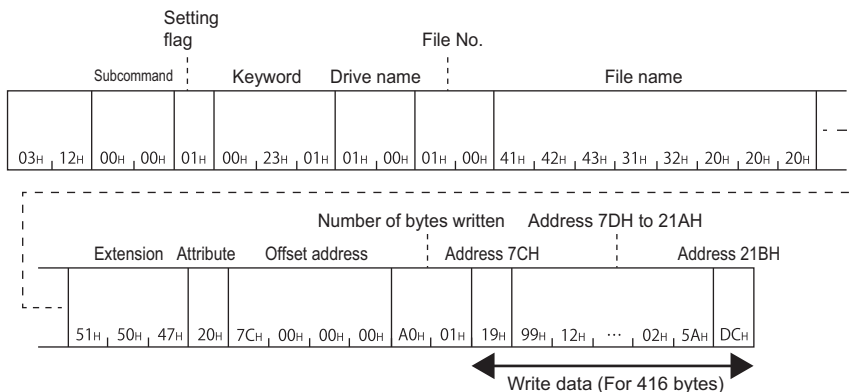

Communication example (Write identical data (FILL))

The identical data are written (FILL) by FFFFH under the following condition.

- Drive name: 1 (RAM area of memory card A)
- File No.: 1
- File name: ABC12.QPG
- Offset address: 7CH
- Number of bytes written: 416 bytes

■Data communication in ASCII code

(Request data)

Subcommand				Keyword				Setting flag		Drive name				File No.			
1	2	0	3	0	0	0	1	0	1	0	0	0	1	0	0	0	1
31H	32H	30H	33H	30H	30H	30H	31H	30H	31H	30H	30H	30H	31H	30H	30H	30H	31H

File name				Extension		Attribute		Offset address						Number of bytes written				Write data									
A	B	C	1	2	□	□	□	Q	P	G	□	0	0	0	0	0	0	7	C	0	1	A	0	F	F	F	F
41H	42H	43H	31H	32H	20H	20H	20H	51H	50H	47H	20H	30H	30H	30H	30H	30H	30H	37H	43H	30H	31H	41H	30H	46H	46H	46H	46H

■Data communication in binary code

(Request data)

Subcommand		Setting flag		Keyword		Drive name		File No.		File name									
03H	12H	01H	00H	01H	00H	23H	01H	01H	00H	01H	00H	41H	42H	43H	31H	32H	20H	20H	20H

Extension		Attribute		Offset address						Number of bytes written				Write data			
51H	50H	47H	20H	7CH	00H	00H	00H	A0H	01H	FFH	FFH						

Modify file information (command: 1204)

The following examples show the procedure to modify the file information of the specified file.

Message format

Request data

- Modify file creation date and time (subcommand: 0000)

ASCII

1	2	0	4	Subcommand	Keyword	Setting flag	Drive name	File No.	File name	Extension	Attribute
31H	32H	30H	34H								

Modification pattern	Last edit time	Last edit date
----------------------	----------------	----------------

Binary

04H	12H	Subcommand	Setting flag	Keyword	Drive name	File No.	File name	Extension	Attribute

Modification pattern	Last edit time	Last edit date
----------------------	----------------	----------------

- Modify file name, attribute, file size (subcommand: 0001)

ASCII

1	2	0	4	Subcommand	Keyword	Setting flag	Drive name	File No.	File name (Before modification)	Extension (Before modification)
31H	32H	30H	34H							

Attribute (Before modification)	Modification pattern	File name (After modification)	Extension (After modification)	Attribute (After modification)	File size	Fixed value
---------------------------------	----------------------	--------------------------------	--------------------------------	--------------------------------	-----------	-------------

Binary

04H	12H	Subcommand	Setting flag	Keyword	Drive name	File No.	File name (Before modification)	Extension (Before modification)

Attribute (Before modification)	Modification pattern	File name (After modification)	Extension (After modification)	Attribute (After modification)	File size	Fixed value
---------------------------------	----------------------	--------------------------------	--------------------------------	--------------------------------	-----------	-------------

Point

The size can be modified only while the QnACPU is in STOP. A consecutive free area of the specified size is necessary on the specified drive. The free area can be checked by reading memory usage status shown in the following section.

☞ Page 293 Read drive memory usage status (command: 0205)

- Batch modify file information (subcommand: 0002)

ASCII

1	2	0	4	Subcommand	Keyword	Setting flag	Drive name	File No.	File name (Before modification)	Extension (After modification)	
31H	32H	30H	34H								
Attribute (Before modification)		Modification pattern		File name (After modification)		Extension (After modification)		Attribute (After modification)		Last edit time	Last edit date
File size		Fixed value									

Binary

	Subcommand	Setting flag	Keyword	Drive name	File No.	File name (Before modification)	Extension (Before modification)
04H	12H						
Attribute (Before modification)	Modification pattern	File name (After modification)	Extension (After modification)	Attribute (After modification)	Last edit time	Last edit date	
File size	Fixed value						

■Response data

There is no response data for this command.

Point

An error occurs if one of the following files is specified while the QnACPU is in RUN, and error end code will be returned.

- Parameter file
- Currently executing file in the built-in RAM (drive name: 00H)

Data specified by request data

■Command

ASCII code	Binary code										
<table border="1"> <tr><td>1</td><td>2</td><td>0</td><td>4</td></tr> <tr><td>31H</td><td>32H</td><td>30H</td><td>34H</td></tr> </table>	1	2	0	4	31H	32H	30H	34H	<table border="1"> <tr><td>04H</td><td>12H</td></tr> </table>	04H	12H
1	2	0	4								
31H	32H	30H	34H								
04H	12H										

■Subcommand

Type	ASCII code	Binary code										
Modify file creation date and time	<table border="1"> <tr><td>0</td><td>0</td><td>0</td><td>0</td></tr> <tr><td>30H</td><td>30H</td><td>30H</td><td>30H</td></tr> </table>	0	0	0	0	30H	30H	30H	30H	<table border="1"> <tr><td>00H</td><td>00H</td></tr> </table>	00H	00H
0	0	0	0									
30H	30H	30H	30H									
00H	00H											
Modify file name, attribute, file size	<table border="1"> <tr><td>0</td><td>0</td><td>0</td><td>1</td></tr> <tr><td>30H</td><td>30H</td><td>30H</td><td>31H</td></tr> </table>	0	0	0	1	30H	30H	30H	31H	<table border="1"> <tr><td>01H</td><td>00H</td></tr> </table>	01H	00H
0	0	0	1									
30H	30H	30H	31H									
01H	00H											
Batch modify file information	<table border="1"> <tr><td>0</td><td>0</td><td>0</td><td>2</td></tr> <tr><td>30H</td><td>30H</td><td>30H</td><td>32H</td></tr> </table>	0	0	0	2	30H	30H	30H	32H	<table border="1"> <tr><td>02H</td><td>00H</td></tr> </table>	02H	00H
0	0	0	2									
30H	30H	30H	32H									
02H	00H											

■Keyword

Allow/prohibit the access to the file of the target memory. (☞ Page 298 Keyword)

■Setting flag

Data that indicates whether the keyword is registered in the specified drive. (☞ Page 298 Setting flag)

■Drive name

A data to specify the drive in a CPU module of which files are to be managed. (☞ Page 298 Drive name, Drive No.)

■File No.

A data to specify the registration number of files. (☞ Page 298 File No.)

Specify within the following range.

$1 \leq \text{File No.} \leq 256$

■File name

Character string data of a file name. (☞ Page 299 File name, extension, and attribute)

■Extension

A character string data of extension of a file. (☞ Page 299 File name, extension, and attribute)

■Attribute

A data to specify the file attribute (applicability of data read/write). (☞ Page 299 File name, extension, and attribute)

The attribute can only be modified between 01H (read only file) ⇔ 20H (read/write enabled file)

■Modification pattern

A data to specify which information is to modify when modifying information (file name, size, created date and time) of the existing file. (☞ Page 303 Modification pattern (for changing file name and file size))

■Last edit time and last edit date

A data that indicates the date and time when the current data was registered. (☞ Page 300 Last edit time and last edit date)

■File size

A data that indicates the capacity of the current file in number of bytes. (☞ Page 301 File size)

■Fixed value

Send '0000' (at the time of ASCII code) or 0000H (at the time of binary code). (☞ Page 303 Fixed value)

Communication example (Modify file creation time) (subcommand: 0000)

Modify the creation time of the following file.

- Drive name: 1 (RAM area of memory card A)
- File name: ABC12.QPG
- Modification pattern: 14H (specify the time of QnACPU for the last edit time.)

■Data communication in ASCII code

(Request data)

Subcommand				Keyword				Setting flag		Drive name				File No.									
1	2	0	4	0	0	0	0	0	1	0	0	0	1	F	F	F	F						
31H	32H	30H	34H	30H	30H	30H	30H	30H	31H	30H	30H	30H	31H	46H	46H	46H	46H						
File name																							
File name				Extension			Attribute	Modification pattern				Last edit time				Last edit date							
A	B	C	1	2	□	□	□	Q	P	G	□	0	0	1	4	0	0	0	0	0	0	0	0
41H	42H	43H	31H	32H	20H	20H	20H	51H	50H	47H	20H	30H	30H	31H	34H	30H	30H	30H	30H	30H	30H	30H	30H

■Data communication in binary code

(Request data)

Subcommand		Setting flag	Keyword		Drive name		File No.								
04H	12H	00H	00H	01H	00H	20H	01H	00H	FFH						
File name															
File name				Extension			Attribute	Modification pattern		Last edit date					
41H	42H	43H	31H	32H	20H	20H	20H	51H	50H	47H	20H	14H	00H	00H	00H

Communication example (Modify file name, attribute) (subcommand: 0001)

Modify the file name and attribute of the following file.

- Drive name: 1 (RAM area of memory card A)
- File No.: 1
- File name (before modification): ABC12.QPG
- File name (after modification): ABC1234.QPG
- Attribute (before modification): 20H (disk files that can be read/written)
- Attribute (after modification): 01H (read only file)

■Data communication in ASCII code

(Request data)

Subcommand				Keyword				Setting flag		Drive name				File No.			
1	2	0	4	0	0	0	1	0	1	0	0	0	1	0	0	0	1
31H	32H	30H	34H	30H	30H	30H	30H	30H	31H	30H	30H	30H	31H	30H	30H	30H	31H

File name (Before modification)				Extension (Before modification)		Modification pattern		File name (After modification)															
A	B	C	1	2	Q	P	G	0	0	0	3	A	B	C	1	2	3	4					
41H	42H	43H	31H	32H	20H	20H	20H	51H	50H	47H	20H	30H	30H	30H	33H	41H	42H	43H	31H	32H	33H	34H	20H

Extension (After modification)		File size						Fixed value				
Q	P	G	0	0	0	0	0	0	0	0	0	0
51H	50H	47H	01H	30H	30H	30H	30H	30H	30H	30H	30H	30H

■Data communication in binary code

(Request data)

Subcommand			Keyword			Drive name		File No.	
04H	12H	01H	00H	23H	01H	01H	00H	01H	00H

File name (Before modification)				Extension (Before modification)		Modification pattern		File name (After modification)													
41H	42H	43H	31H	32H	20H	20H	20H	51H	50H	47H	20H	03H	00H	41H	42H	43H	31H	32H	33H	34H	20H

Extension (After modification)		File size						Fixed value				
Q	P	G	00H	00H	00H	00H	00H	00H	00H	00H	00H	00H
51H	50H	47H	01H	00H	00H	00H	00H	00H	00H	00H	00H	

Communication example (Batch modify file information) (subcommand: 0002)

Modify the file name of the following files, attribute, and last edit date and time.

- Drive name: 1 (RAM area of memory card A)
- File No.: 1
- File name (before modification): ABC12.QPG
- File name (after modification): ABC1234.QPG
- Attribute (before modification): 20H (disk files that can be read/written)
- Attribute (after modification): 01H (read only file)
- Modification pattern: 1FH (Specify the date and time of QnACPU to the last edit day and last edit time)

■Data communication in ASCII code

(Request data)

Subcommand				Keyword				Setting flag		Drive name				File No.									
1	2	0	4	0	0	0	2	0	1	2	3	0	0	0	1	0	0	0	1	0	0	0	1
31H	32H	30H	34H	30H	30H	30H	30H	30H	31H	32H	33H	30H	30H	30H	31H	30H	30H	30H	31H	30H	30H	30H	31H
Attribute (Before modification)																							
File name (Before modification)				Extension (Before modification)				Modification pattern				File name (After modification)											
A	B	C	1	2	Q	P	G	0	0	1	F	A	B	C	1	2	3	4					
41H	42H	43H	31H	32H	20H	20H	20H	51H	50H	47H	20H	30H	30H	31H	46H	41H	42H	43H	31H	32H	33H	34H	20H
Attribute (After modification)																							
Extension (After modification)				Last edit time				Last edit date				File size				Fixed value							
Q	P	G		0	0	0	0	0	0	0	0	0	0	0	0	0	0	0	0	0	0	0	0
51H	50H	47H	01H	30H	30H	30H	30H	30H	30H	30H	30H	30H	30H	30H	30H	30H	30H	30H	30H	30H	30H	30H	30H

■Data communication in binary code

(Request data)

Subcommand				Keyword				Setting flag		Drive name				File No.											
04H	12H	02H	00H	01H	00H	23H	01H	01H	00H	01H	00H	01H	00H	01H	00H	01H	00H								
Extension (Before modification)																									
File name (Before modification)				Extension (Before modification)				Modification pattern				File name (After modification)													
41H	42H	43H	31H	32H	20H	20H	20H	51H	50H	47H	20H	1FH	00H	41H	42H	43H	31H	32H	33H	34H	20H				
Extension (After modification)																									
Extension (After modification)				Last edit time				Last edit date				File size				Fixed value									
51H	50H	47H	01H	00H	00H	00H	00H	00H	00H	00H	00H	00H	00H	00H	00H	00H	00H	00H	00H	00H	00H	00H	00H	00H	00H

Delete file (command: 1205)

The following examples show the procedure to delete the existing files.

Point

Determine the file deletion timing for the entire system, including the QnACPU and related devices.

The file in which the file lock has been registered cannot be deleted.

When QnACPU is in RUN, the following files cannot be deleted.

- Program file (□.QPG)
- Parameter file (□.QPA)
- Boot setting file (□.QBT)

Message format

Request data

ASCII

1	2	0	5	Subcommand	Keyword	Setting flag	Drive name	File No.	File name	Extension	Attribute
31H	32H	30H	35H								

Binary

	Subcommand	Setting flag	Keyword	Drive name	File No.	File name	Extension	Attribute
05H	12H							

Response data

There is no response data for this command.

Data specified by request data

Command

ASCII code	Binary code										
<table border="1"> <tr> <td>1</td> <td>2</td> <td>0</td> <td>5</td> </tr> <tr> <td>31H</td> <td>32H</td> <td>30H</td> <td>35H</td> </tr> </table>	1	2	0	5	31H	32H	30H	35H	<table border="1"> <tr> <td>05H</td> <td>12H</td> </tr> </table>	05H	12H
1	2	0	5								
31H	32H	30H	35H								
05H	12H										

Subcommand

ASCII code	Binary code										
<table border="1"> <tr> <td>0</td> <td>0</td> <td>0</td> <td>0</td> </tr> <tr> <td>30H</td> <td>30H</td> <td>30H</td> <td>30H</td> </tr> </table>	0	0	0	0	30H	30H	30H	30H	<table border="1"> <tr> <td>00H</td> <td>00H</td> </tr> </table>	00H	00H
0	0	0	0								
30H	30H	30H	30H								
00H	00H										

Keyword

Allow/prohibit the access to the file of the target memory. (☞ Page 298 Keyword)

Setting flag

Data that indicates whether the keyword is registered in the specified drive. (☞ Page 298 Setting flag)

Drive name

A data to specify the drive in a CPU module of which files are to be managed. (☞ Page 298 Drive name, Drive No.)

File No.

A data to specify the registration number of files. (☞ Page 298 File No.)

File name

Character string data of a file name. (☞ Page 299 File name, extension, and attribute)

■Extension

A character string data of extension of a file. (☞ Page 299 File name, extension, and attribute)

■Attribute

A data to specify the file attribute (applicability of data read/write). (☞ Page 299 File name, extension, and attribute)

When deleting a file, handle the attribute as dummy data.

Communication example

Delete files under the following conditions.

- Drive name: 1 (RAM area of memory card A)
- File No.: 1
- File name: ABC12.QPG

■Data communication in ASCII code

(Request data)

Subcommand					Keyword					Setting flag		Drive name				File No.			
1	2	0	5		0	0	0	0		0	1	0	0	0	1	0	0	0	1
31H	32H	30H	35H		30H	30H	30H	30H		30H	31H	30H	30H	30H	31H	30H	30H	30H	31H

File name										Extension			Attribute
A	B	C	1	2						Q	P	G	
41H	42H	43H	31H	32H	20H	20H	20H			51H	50H	47H	20H

■Data communication in binary code

(Request data)

Subcommand		Setting flag		Keyword			Drive name		File No.		
05H	12H	00H	00H	01H	00H	23H	01H	01H	00H	01H	00H

File name										Extension			Attribute
41H	42H	43H	31H	32H	20H	20H	20H			51H	50H	47H	20H

Copy file (command: 1206)

The following examples show the procedure to copy a file. (For QnACPU)

The maximum number of data bytes to be copied per one time is static. For the data which are already written, adjust the offset address and number of copy bytes, and divide them and write to the new registration file for several times.

Message format

Request data

ASCII

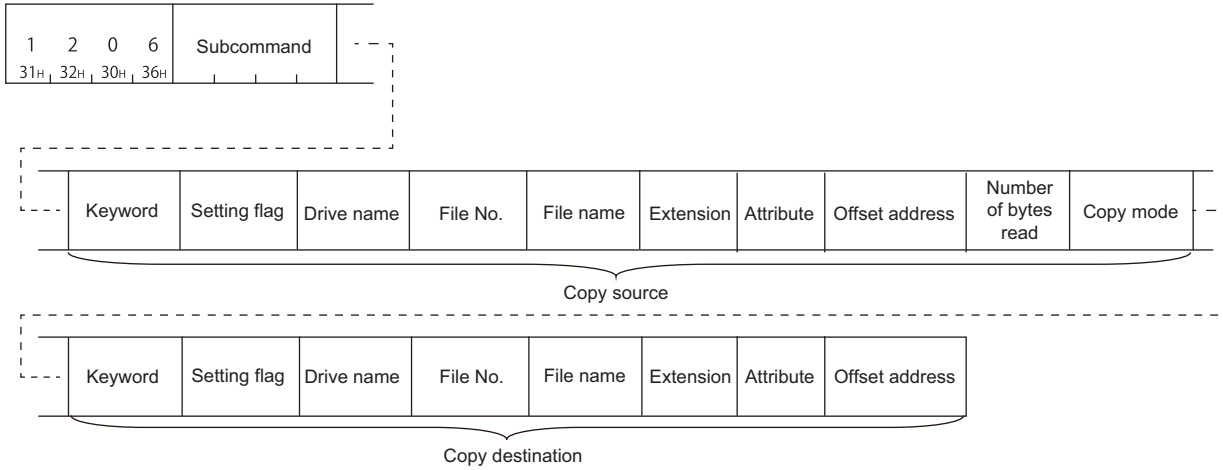

Binary

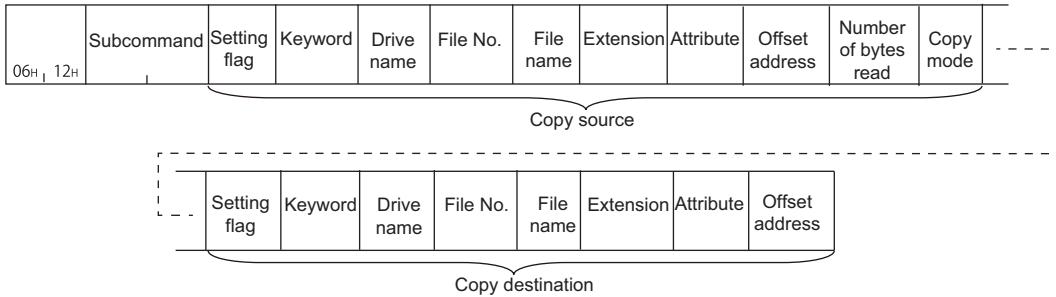

Response data

There is no response data for this command.

Point

An error occurs if one of the following files is specified while the QnACPU is in RUN, and error end code will be returned.

- Parameter file
- Currently executing file in the built-in RAM (drive name: 00H)

Data specified by request data

■Command

ASCII code	Binary code										
<table border="1"><tr><td>1</td><td>2</td><td>0</td><td>6</td></tr><tr><td>31H</td><td>32H</td><td>30H</td><td>36H</td></tr></table>	1	2	0	6	31H	32H	30H	36H	<table border="1"><tr><td>06H</td><td>12H</td></tr></table>	06H	12H
1	2	0	6								
31H	32H	30H	36H								
06H	12H										

■Subcommand

ASCII code	Binary code										
<table border="1"><tr><td>0</td><td>0</td><td>0</td><td>0</td></tr><tr><td>30H</td><td>30H</td><td>30H</td><td>30H</td></tr></table>	0	0	0	0	30H	30H	30H	30H	<table border="1"><tr><td>00H</td><td>00H</td></tr></table>	00H	00H
0	0	0	0								
30H	30H	30H	30H								
00H	00H										

■Keyword

Allow/prohibit the access to the file of the target memory. (☞ Page 298 Keyword)

■Setting flag

This indicates whether the keyword registered in the specified drive matches the keyword of request data. (☞ Page 290 Setting flag)

■Drive name

A data to specify the drive in a CPU module of which files are to be managed. (☞ Page 298 Drive name, Drive No.)

■File No.

A data to specify the registration number of files. (☞ Page 298 File No.)

■File name

Character string data of a file name. (☞ Page 299 File name, extension, and attribute)

■Extension

A character string data of extension of a file. (☞ Page 299 File name, extension, and attribute)

■Attribute

A data to specify the file attribute (applicability of data read/write). (☞ Page 299 File name, extension, and attribute)

The attribute assigned by a new file creation, etc. is valid as the attribute of the source and destination files. When copying a file, handle the attribute as dummy data.

■Offset address

A data to specify the start address of the range from which data is read to a file. (☞ Page 301 Offset address)

Specify within the following range.

Offset address: $0 \leq \text{Address} \leq (\text{File size} - 1)$

- Copy to the file whose drive name is '00H' (Built-in RAM): Specify with multiples of 4 (0, 4, 8, ... in decimal notation).
- Copy to the file whose drive name is other than '00H': Specify with even number (for decimal data, 0, 2, 4, 6, 8, ...).

■Number of bytes read (number of copy bytes)

A data to specify the range from which data is read in byte unit to file. Specify the data as one address per one byte.

(☞ Page 302 Number of bytes read, number of bytes written)

Specify within the following range.

Number of copied bytes: $0 \leq \text{Number of bytes} \leq 480$

■Copy mode

A data to specify whether to copy the last edit time and data of the source file to the target file at the completion of copying.

When the time and date are not copied, the QnACPU management time at a new file creation will remain. (☞ Page 305

Copy mode)

Communication example

Copy the file under the following conditions:

- Drive name (copy source): 1 (RAM area of memory card A)
- Drive name (copy destination): 3 (RAM area of memory card B)
- File No. (copy source): 1H (1)
- File No. (copy destination): AH (10)
- File name (copy source): ABC12.QPG
- File name (copy destination): ABC12001.QPG
- Offset address (copy source): 1E0H
- Number of bytes read (copy source): 480 bytes
- Copy mode (copy source): 0 (Do not copy the last edit date and time of the copy source.)

■Data communication in ASCII code

(Request data)

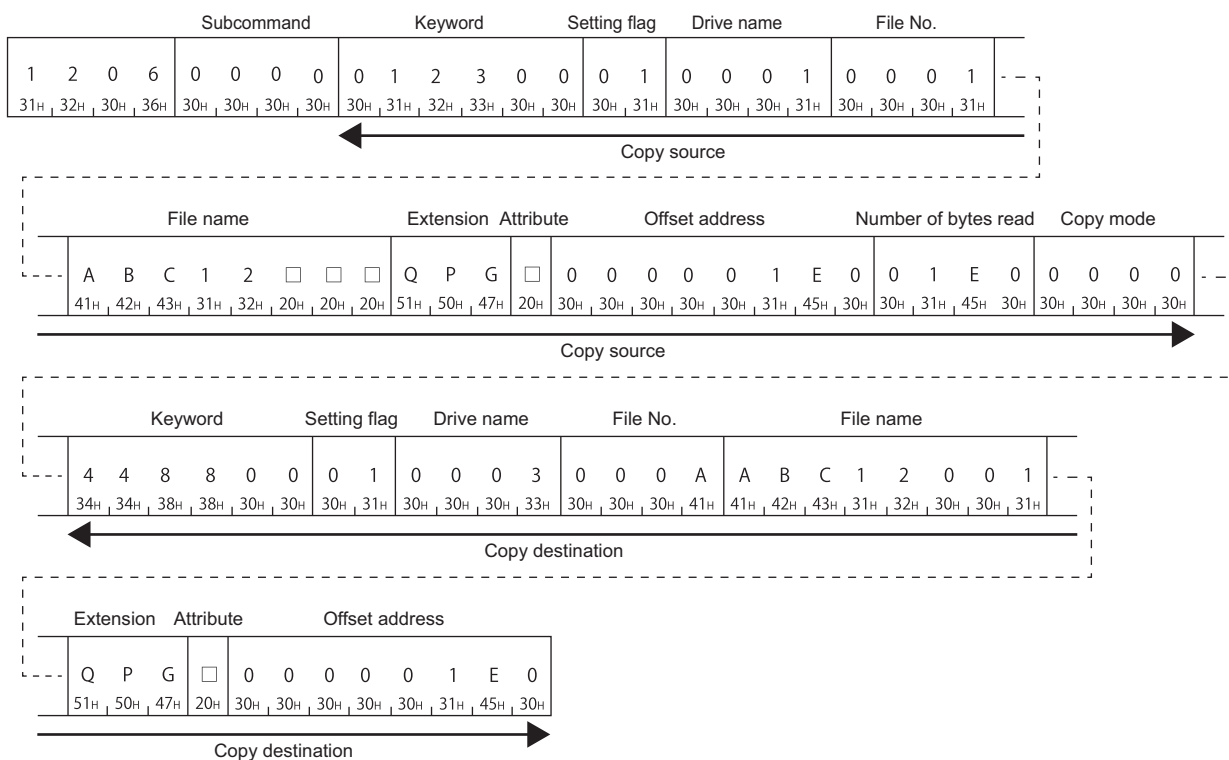

■Data communication in binary code

(Request data)

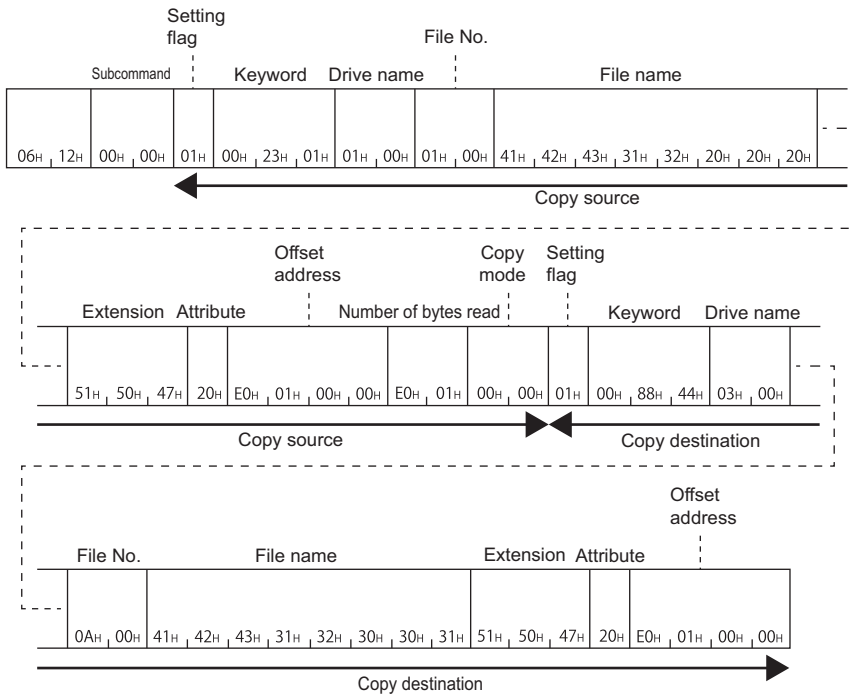

This part explains the specifications when using MELSEC-A series devices.

16 MELSEC-A SERIES SUPPORTED SPECIFICATIONS

17 COMMUNICATING USING 1C FRAMES

18 COMMUNICATING USING 1E FRAMES

16 MELSEC-A SERIES SUPPORTED SPECIFICATIONS

This chapter explains the specifications of the messages of MC protocol and access ranges when using the MELSEC-A series devices as follows:

- When accessing system including MELSEC-A series modules
- When utilizing the software for data communication created for MELSEC-A series programmable controller.

16.1 Frames and Commands that can be Used

When accessing MELSEC-A series modules, all frames of MC protocol can be used.

However, the commands that can be used have some restrictions. ( Page 471 Accessible Modules for Each Command)

A compatible frame

The following frames have compatibility with the message protocol and the message format for MELSEC-A series.

Frame	Compatible message format	Accessible range
1C frame	Dedicated protocols for MELSEC-A series computer link modules	Page 47 Accessible range of 1C frame
1E frame	Message formats for MELSEC-A series Ethernet interface modules	Page 49 Accessible range of 1E frame

16.2 Accessible modules

The following MELSEC-A series modules can be accessed within the access range.

Accessible modules to other stations

The following modules can be accessed.

Type	Model name
CPU module	A1NCP, A2NCP, A2NCP-S1, A3NCP, A2ACP, A2ACP-S1, A3ACP, A2UCP, A2UCP-S1, A3UCP, A4UCP A1SCP, A1SJCP(-S3), A1SHCP, A1SJHCP, A2SCP, A2SHCP, A2USCP, A2USCP-S1, A2USHCP-S1 A0J2HCP
	Q02CPU-A, Q02HCP-A, Q06HCP-A
	A2CCPUC24 and A2CCPUC24-PRF (when connected to an external device by multidrop connection.)
MELSECNET/10 remote I/O	AJ72LP25 (G), AJ72BR15
Special function module	Refer to the following section.  Page 385 Accessible modules

Modules that can be relayed between networks

For the modules that can be relayed between networks when accessing MELSEC-A series module, refer to the following table.

■MELSEC-A series module

Network	Model name
MELSECNET/10	AJ71LP21 (G), AJ71BR11, A1SJ71LP21, A1SJ71BR11

■Module other than MELSEC-A series

 Page 286 Modules that can be relayed between networks

16.3 Considerations

The following shows the considerations when using MELSEC-A series devices.

Considerations when connecting C24

■When a computer link module is included in multidrop connection

Access in ASCII code (format 1 to format 4). A binary code (format 5) cannot be used. (Including the access to the connected station)

Considerations when connecting E71

■Setting range of monitoring timer

When accessing ACPU for the first time, the wait time for CPU monitoring timer is required before receiving a response message because QnACPU identifies the CPU type. Be sure to set a value within the setting range shown below.

Access target	Monitoring timer
Connected station (host station)	1H to 28H (0.25 s to 10 s)
Other station	2H to F0H (0.5 s to 60 s)

17 COMMUNICATING USING 1C FRAMES

This chapter explains the functions when accessing using 1C frame and their message format.

1C frame is compatible with the communication function of the dedicated protocols supported by A series computer link modules.

Only the commands for 1C frame explained in this chapter can be used for 1C frame.

17.1 Message Format

This section explains the message format when communicating data using 1C frame.

Message format

Request message

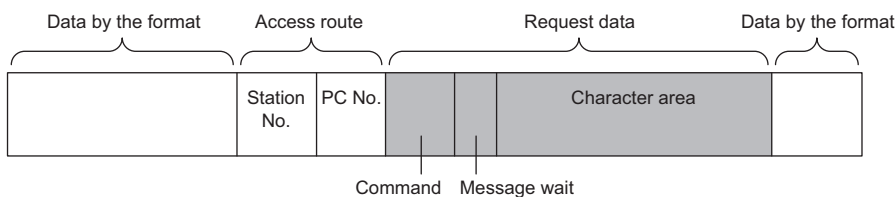

Response message (Normal completion: Response data)

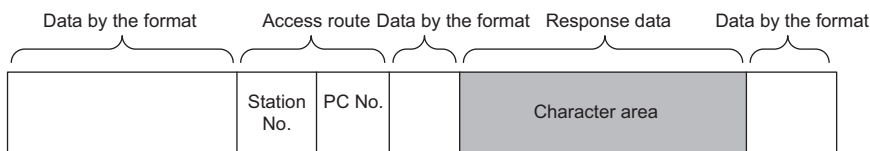

Response message (Normal completion: No response data)

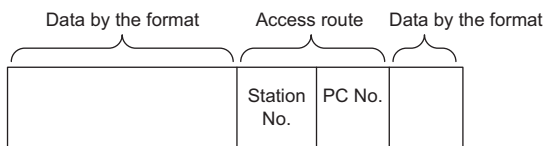

Response message (Abnormal completion)

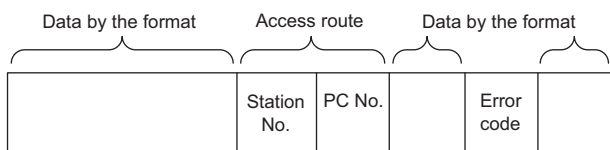

Setting data

Set the following items.

Item	Description	Reference
Data by format	The message formats differ depending on the set format (Format 1 to Format 4).	Page 29 Message Formats of Each Protocol
Access route	Station No.	Page 50 Station No.
	PC No.	Page 52 Network No., PC No.

Item		Description	Reference
Request data	Command	Specify the function to request such as read or write.	Page 346 Command
	Message wait	A data to generate a delay time for response transmission. Specify the wait time within the range of 0 to 150 ms in 10 ms units.	Page 347 Message wait
	Character area	A data that instructs the CPU module to execute a request specified by command. The content of the character areas differs depending on the command.	Page 347 Character area
Response data	Character area	A data that C24 returns to a request specified by a command. The content of the character areas differs depending on the command.	
Error code		Error code indicates the content of occurred error.	Page 348 Error code

17.2 Details of Setting Data

This section explains how to specify the common data items and their content in each message.

Command

Set the command type. (☞ Page 349 Command and Function Lists for 1C Frame)

The setting values for each command are as follows.

Function	ACPU common command		AnA/AnUCPU common command		Reference
	Symbol	ASCII code	Symbol	ASCII code	
Device memory read and write	BR	42H, 52H	JR	4AH, 52H	Page 354 Batch read (bit units) (command: BR, JR)
	WR	57H, 52H	QR	51H, 52H	Page 356 Batch read (word units) (command: WR, QR)
	BW	42H, 57H	JW	4AH, 57H	Page 358 Batch write (bit units) (command: BW, JW)
	WW	57H, 57H	QW	51H, 57H	Page 360 Batch write (word units) (command: WW, QW)
	BT	42H, 54H	JT	4AH, 54H	Page 362 Test (random write) (bit units) (command: BT, JT)
	WT	57H, 54H	QT	51H, 54H	Page 364 Test (random write) (word units) (command: WT, QT)
	BM	42H, 4DH	JM	4AH, 4DH	Page 367 Register monitor data (bit units) (command: BM, JM)
	WM	57H, 4DH	QM	51H, 4DH	Page 368 Register monitor data (word units) (command: WM, QM)
	MB	4DH, 42H	MJ	4DH, 4AH	Page 369 Monitor (bit units) (command: MB, MJ)
	MN	4DH, 4EH	MQ	4DH, 51H	Page 370 Monitor (word units) (command: MN, MQ)
Read and write extended file register	ER	45H, 52H	—	—	Page 375 Batch read (command: ER)
	EW	45H, 57H	—	—	Page 376 Batch write (command: EW)
	—	—	NR	4EH, 52H	Page 381 Direct read (command: NR)
	—	—	NW	4EH, 57H	Page 382 Direct write (command: NW)
	ET	45H, 54H	—	—	Page 377 Test (random write) (command: ET)
	EM	45H, 4DH	—	—	Page 379 Register monitor data (command: EM)
	ME	4DH, 45H	—	—	Page 380 Monitor (command: ME)
Read/write buffer memory of special function module	TR	54H, 52H	—	—	Page 386 Batch read (command: TR)
	TW	54H, 57H	—	—	Page 388 Batch write (command: TW)
Loopback test	TT	54H, 54H	—	—	Page 389 Loopback test (Command: TT)

Setting method

Use the commands by converting to 2-digit (hexadecimal) ASCII codes.

Ex.

Device memory batch read (BR) in bit unit

B	R
42H	52H

Message wait

Message wait is a data to generate a delay time for response transmission.

Some external devices may take time to become receiving status after sending a command.

Specify the minimum wait time to send the result after C24 is received a command from an external device. Specify the wait time in accordance with the specifications of the external device.

Setting method

Specify the wait time within the range of 0 to 150 ms in 10 ms units.

Convert 0H to FH (0 to 15) to 1-digit (hexadecimal) ASCII codes regarding 10 ms as 1H.

Ex.

When the message wait time is 100 ms

If the following value is set to message wait in request message, after passing 100 ms or more, transmission of a response message will be started.

A
41H

Character area

The content of the character areas differs depending on the command.

The character area of request data is equivalent to the character A area and the character C area of the dedicated protocols for A series computer link module. The character area of response data is equivalent to the character B area of a dedicated protocols.

- Character area A: A data that C24 instructs the CPU module to perform the read request specified by command.
- Character area B: A data that C24 returns to a request specified by a command.
- Character area C: A data that C24 instructs the CPU module to perform the write request specified by command.

When reading data (Response data)

The following shows the image when the response data (character B area of the dedicated protocol) is included in the response message.

(The head of the message data in the figure is a control code of format 1. [Page 29 Message Formats of Each Protocol](#))

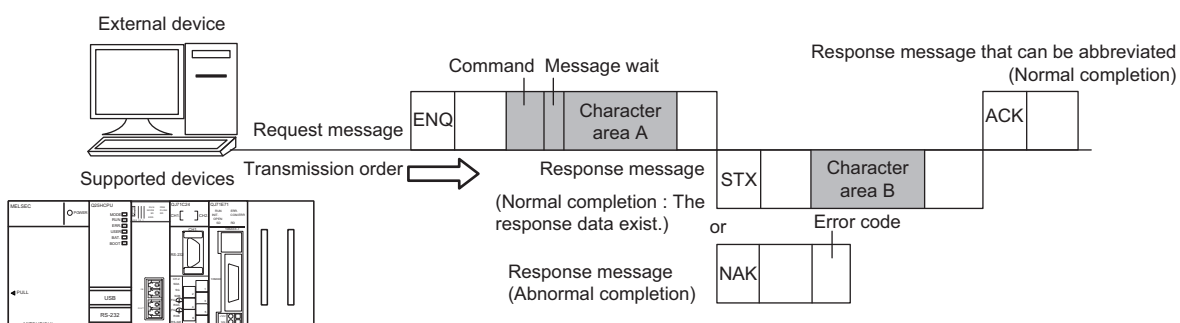

When writing data (No response data)

The following shows the image when the response data is not included in the response message.

(The head of the message data in the figure is a control code of format 1. [Page 29 Message Formats of Each Protocol](#))

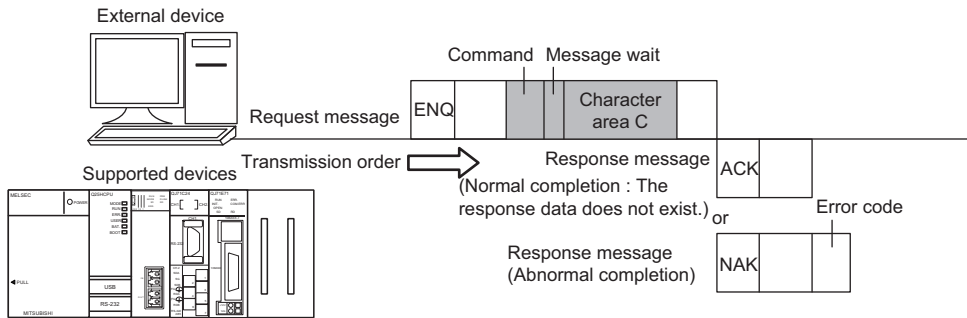

Error code

Error code indicates the content of occurred error.

If more than one error occurs at the same time, the error code detected first is returned.

For the content of error code and its corrective action, refer to the user's manual of the module used.

[MELSEC iQ-R Serial Communication Module User's Manual\(Application\)](#)

[Q Corresponding Serial Communication Module User's Manual \(Basic\)](#)

[MELSEC-L Serial Communication Module User's Manual \(Basic\)](#)

Setting method

Convert the numerical value to 2-digit ASCII code (hexadecimal), and send it from the upper digits.

Ex.

For error code 05H

0	5
30H	35H

17.3 Command and Function Lists for 1C Frame

Use the following commands for data communication using 1C frame.

Function		ACPU common command	AnA/AnUCPU common command	Description	
Device memory *1	Batch read	Bit units	BR	JR	Reads bit devices (X, Y, M, etc.) in 1-point units.
		Word units	WR	QR	Reads bit devices (X, Y, M, etc.) in 16-point units. Reads word devices (D, T, C, etc.) in 1-point units.
	Batch write	Bit units	BW	JW	Writes bit devices (X, Y, M, etc.) in 1-point units.
		Word units	WW	QW	Writes bit devices (X, Y, M, etc.) in 16-point units. Writes word devices (D, T, C, etc.) in 1-point units.
	Test (random write)	Bit units	BT	JT	Set/reset devices and device numbers to bit devices (X, Y, M, etc.) by specifying them randomly in 1 point unit.
		Word units	WT	QT	Set/reset devices and device numbers to bit devices (X, Y, M, etc.) by specifying them randomly in 16 point units. Write devices and device numbers to word devices (D, T, C, etc.) by specifying them randomly in 1 point units.
	Register monitor data *2	Bit units	BM	JM	Registers bit devices (X, Y, M, etc.) to be monitored in 1-point units
		Word units	WM	QM	Registers bit devices (X, Y, M, etc.) to be monitored in 16-point units. Registers word devices (D, T, C, etc.) to be monitored in 1-point units.
	Monitor	Bit units	MB	MJ	Monitors the devices registered by monitor data registration.
		Word units	MN	MQ	
Extended file register	Batch read		ER	—	Reads extended file register (R) in 1-point units.
	Batch write		EW	—	Writes extended file register (R) in 1-point units.
	Direct read	Word units	—	NR	Read data in 1 point units by specifying the consecutive device number regardless of the block number of extended file register.
	Direct write	Word units	—	NW	Write data in 1 point units by specifying the consecutive device number regardless of the block number of extended file register.
	Test (Random write)		ET	—	Write block numbers and device numbers to extended file register (R) by specifying them randomly in 1 point units.
	Register monitor data *2		EM	—	Register extended file register (R) in 1-point units.
	Monitor	Word units	ME	—	Monitor the extended file register (R) registered by monitor data registration.
Special function module	Batch read		TR	—	Reads data in the buffer memory of a special function module.
	Batch write		TW	—	Writes data to the buffer memory of a special function module.
Loopback test			TT	—	Send (returns) characters received from an external device back to the external device unchanged.

*1 Use the dedicated commands for extended registers to read/write extended file registers from/to ACPUs.

*2 The devices for the five types of commands (BM, JM, WM, QM, EM) for registering monitor data can be registered simultaneously in C24 for each interface.

ACPU common command, AnA/AnUCPU common command

ACPU common command is a communication function issued by MC protocol. The command is accessible for ACPUs.

AnA/AnUCPU common command is a command for AnACPU and AnUCPU. The command cannot be executed for other than AnA/AnUCPU.

○: Executable, △: Executable (with restrictions), ×: Not executable

Type	ACPU other than AnA/AnUCPU	AnA/AnUCPU	Module other than ACPUs
ACPU common command	○	○	△
AnA/AnUCPU common command	×	○	△

When accessing modules other than ACPUs, there is a restriction for the accessible device range.

☞ Page 350 Considerations when accessing devices other than ACPUs module

17.4 Device Memory Read and Write

This section explains the specification content and examples of the control procedure when reading from/writing to the device memory are as shown below.

For the message formats other than request data and response data, refer to the following sections.

☞ Page 344 Message Format, Page 346 Details of Setting Data

Point

To read and write the extended file register, use the commands dedicated to the extended file register.

☞ Page 371 Read and Write Extended File Register

Considerations

The considerations when reading/writing device memory using the commands described in this section.

Considerations when accessing devices other than ACPU module

■ Accessible devices

Only the devices with the same names that exist in ACPU can be accessed within the device range of AnACPU.

☞ Page 352 Accessible device range

The following devices cannot be accessed from the external devices:

- Added devices
- Latch relay (L) and step relay (S)*¹
- File register (R) of QnACPU

*¹ Even when the latch relay (L) or step relay (S) is specified, the internal relay (M) can be accessed.

■ Special relays and special registers

Special relays and special registers can be accessed within the following range.

- Access SM1000 to SM1255 by specifying M9000 to M9255.
- Access SD1000 to SD1255 by specifying D9000 to D9255.

■ Universal model QCPU

Use the Universal model QCPU with a serial number whose first five digits are '10102' or later.

As for the serial number whose first five digits are '10101' or earlier, access using 2C/3C/4C frame.

Data to be specified in command

Device codes, device numbers

The settings of each device when reading/writing device memory can be performed using device code and device number as shown in the following figure.

Specify the device to be accessed by a device code and a device number.

The setting data size differ between ACPU common commands and AnA/AnUCPU commands.

The setting data size differ when the device type is timer or counter.

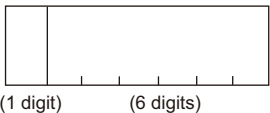
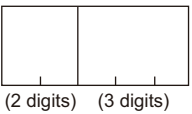
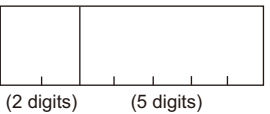
Device type	ACPU common command	AnA/AnUCPU common command
Other than timer and counter	<div style="text-align: center;"> Device code Device number  (1 digit) (4 digits) </div>	<div style="text-align: center;"> Device code Device number  (1 digit) (6 digits) </div>
Timer, counter	<div style="text-align: center;"> Device code Device number  (2 digits) (3 digits) </div>	<div style="text-align: center;"> Device code Device number  (2 digits) (5 digits) </div>

■ACPU common commands

- Device code: Convert the device name to 1-digit ASCII code (2-digits for timer or counter), and send it from the upper digits.
- Device number: Convert the numerical value to 4-digit ASCII code (3-digits for timer or counter), and send it from the upper digits.

■AnA/AnUCPU common commands

- Device code: Convert the device name to 1-digit ASCII code (2-digits for timer or counter), and send it from the upper digits.
- Device number: Convert the numerical value to 6-digit ASCII code (5-digits for timer and counter), and send it from the upper digits.

Ex.

Current value of input (X) 40 and timer (T) 10

Device	ACPU common command	AnA/AnUCPU common command																								
Input (X) 40	<div style="text-align: center;"> <table border="1"> <tr><td>X</td><td>0</td><td>0</td><td>4</td><td>0</td></tr> <tr><td>58H</td><td>30H</td><td>30H</td><td>34H</td><td>30H</td></tr> </table> </div>	X	0	0	4	0	58H	30H	30H	34H	30H	<div style="text-align: center;"> <table border="1"> <tr><td>X</td><td>0</td><td>0</td><td>0</td><td>0</td><td>4</td><td>0</td></tr> <tr><td>58H</td><td>30H</td><td>30H</td><td>30H</td><td>30H</td><td>34H</td><td>30H</td></tr> </table> </div>	X	0	0	0	0	4	0	58H	30H	30H	30H	30H	34H	30H
X	0	0	4	0																						
58H	30H	30H	34H	30H																						
X	0	0	0	0	4	0																				
58H	30H	30H	30H	30H	34H	30H																				
Current value of timer (T) 10	<div style="text-align: center;"> <table border="1"> <tr><td>T</td><td>S</td><td>0</td><td>1</td><td>0</td></tr> <tr><td>54H</td><td>4EH</td><td>30H</td><td>31H</td><td>30H</td></tr> </table> </div>	T	S	0	1	0	54H	4EH	30H	31H	30H	<div style="text-align: center;"> <table border="1"> <tr><td>T</td><td>S</td><td>0</td><td>0</td><td>0</td><td>1</td><td>0</td></tr> <tr><td>54H</td><td>4EH</td><td>30H</td><td>30H</td><td>30H</td><td>31H</td><td>30H</td></tr> </table> </div>	T	S	0	0	0	1	0	54H	4EH	30H	30H	30H	31H	30H
T	S	0	1	0																						
54H	4EH	30H	31H	30H																						
T	S	0	0	0	1	0																				
54H	4EH	30H	30H	30H	31H	30H																				

Accessible device range

The following table shows the devices and device number range that can be specified when accessing the device memory. Access the CPU module within the range of device number that can be used by commands and the range of the device number that can be used in the access target CPU. (☞ Page 350 Considerations when accessing devices other than ACPU module)

□: Specify 0 (30H) or space (20H)

Device				Device code	Device number		
Device name	Symbol	Type	Representation		ACPU common command	AnA/AnUCPU common command	
Input	X	Bit	Hexadecimal	X	□□□0 to □7FF	□□□□0 to □□1FFF	
Output	Y	Bit	Hexadecimal	Y	□□□0 to □7FF	□□□□0 to □□1FFF	
Internal relay	M	Bit	Decimal	M	□□□0 to 2047	□□□□0 to □□8191	
Latch relay	L	Bit	Decimal	L	□□□0 to 2047	□□□□0 to □□8191	
Step relay	S	Bit	Decimal	S	□□□0 to 2047	□□□□0 to □□8191	
Annunciator	F	Bit	Decimal	F	□□□0 to □255	□□□□0 to □□2047	
Link relay	B	Bit	Hexadecimal	B	□□□0 to □3FF	□□□□0 to □□1FFF	
Timer	Current value	T	Word	Decimal	TN	□□0 to 255	□□□□0 to □2047
	Contact		Bit	Decimal	TS		
	Coil		Bit	Decimal	TC		
Counter	Current value	C	Word	Decimal	CN	□□0 to 255	□□□□0 to □1023
	Contact		Bit	Decimal	CS		
	Coil		Bit	Decimal	CC		
Data register	D	Word	Decimal	D	□□□0 to 1023	□□□□0 to □□8191	
Link register	W	Word	Hexadecimal	W	□□□0 to □3FF	□□□□0 to □□1FFF	
File register	R	Word	Decimal	R	□□□0 to 8191	□□□□0 to □□8191	
Special relay	M	Bit	Decimal	M	9000 to 9255	□□9000 to □□9255	
Special register	D	Word	Decimal	D	9000 to 9255	□□9000 to □□9255	

Restriction

- Do not write data to the devices which cannot be written in the range of the special relays (M9000 to M9255) and special registers (D9000 to D9255). For details on the special relays and special registers, refer to manual of ACPU to be accessed.
- The range of M, L, and S devices can be specified for MELSEC-A series CPU module, however, if the range of M is specified by L or S or vice versa, they are processed equivalently.

Point

- For word unit specification, the head device number of bit device must be specified in multiple of 16.
- For special relay M9000 or later, (9000 + multiple of 16) can be specified.

Number of device points

Specify the number of device points to be read or written.

Convert the numerical value to 2-digit ASCII code (hexadecimal), and send it from the upper digits.

Specify the number of device points in one command within the device points that can be processed in one communication.

☞ Page 466 Number of Processing per One Communication

Specify '00' for 256 points.

Ex.

5 points, 20 points, 256 points

Number of device points	ASCII code				
5 points	<table border="1"> <tr> <td>0</td> <td>5</td> </tr> <tr> <td>30H</td> <td>35H</td> </tr> </table>	0	5	30H	35H
0	5				
30H	35H				
20 points	<table border="1"> <tr> <td>1</td> <td>4</td> </tr> <tr> <td>31H</td> <td>34H</td> </tr> </table>	1	4	31H	34H
1	4				
31H	34H				
256 points	<table border="1"> <tr> <td>0</td> <td>0</td> </tr> <tr> <td>30H</td> <td>30H</td> </tr> </table>	0	0	30H	30H
0	0				
30H	30H				

Read data, write data

The data storage method is the same as reading/writing data with device access of 4C/3C/2C frame. (☞ Page 72 Read data, write data)

Batch read (bit units) (command: BR, JR)

Reads bit devices (X, Y, M, etc.) in batch.

Message format

The following shows the message format of the request data and response data of the command.

Request data

Command	Message wait	Head device	Number of device points
---------	--------------	-------------	-------------------------

Response data

The value of read device is stored in bit units. (☞ Page 72 Read data, write data)

Data specified by request data

Command

ACPU common	AnA/AnUCPU common								
<table border="1"><tr><td>B</td><td>R</td></tr><tr><td>42H</td><td>52H</td></tr></table>	B	R	42H	52H	<table border="1"><tr><td>J</td><td>R</td></tr><tr><td>4AH</td><td>52H</td></tr></table>	J	R	4AH	52H
B	R								
42H	52H								
J	R								
4AH	52H								

Message wait

Specify the delayed time of the response transmission. (☞ Page 347 Message wait)

Head device

Specify the head device. (☞ Page 351 Device codes, device numbers)

Number of device points

Convert the numerical value to 2-digit ASCII code (hexadecimal), and send it from the upper digits.

Specify the number of device points within the following range:

- $1 \leq \text{Number of device points} \leq 256$ (for 256 points, specify '00H')
- $\text{Head device No.} + \text{Number of device points} - 1 \leq \text{Maximum device No.}$

Communication example

Read data in bit units under the following conditions.

- Message wait: 100 ms
- Head device: X040
- Number of device points: 5 points

(Request data)

■When using BR (ACPU common command)

Message wait			Head device					Number of device points	
B	R	A	X	0	0	4	0	0	5
42H	52H	41H	58H	30H	30H	34H	30H	30H	35H

■When using JR (AnA/AnUCPU common command)

Message wait			Head device							Number of device points	
J	R	A	X	0	0	0	0	4	0	0	5
4AH	52H	41H	58H	30H	30H	30H	30H	34H	30H	30H	35H

(Response data)

Data read				
0	1	1	0	1
30H	31H	31H	30H	31H
(X40)	(X41)	(X42)	(X43)	(X44)

Batch read (word units) (command: WR, QR)

Reads bit devices (X, Y, M, etc.) in 16-point units.

Reads word devices (D, T, C, etc.) in 1-point units

Message format

The following shows the message format of the request data and response data of the command.

Request data

Command	Message wait	Head device	Number of device points (Number of words)
---------	--------------	-------------	--

Response data

The value of read device is stored in word units. (☞ Page 72 Read data, write data)

Data specified by request data

Command

ACPU common	AnA/AnUCPU common								
<table border="1"><tr><td>W</td><td>R</td></tr><tr><td>57H</td><td>52H</td></tr></table>	W	R	57H	52H	<table border="1"><tr><td>Q</td><td>R</td></tr><tr><td>51H</td><td>52H</td></tr></table>	Q	R	51H	52H
W	R								
57H	52H								
Q	R								
51H	52H								

Message wait

Specify the delayed time of the response transmission. (☞ Page 347 Message wait)

Head device

Specify the head device. (☞ Page 351 Device codes, device numbers)

Number of device points

Convert the numerical value to 2-digit ASCII code (hexadecimal), and send it from the upper digits.

Specify the number of device points within the following range:

- For bit device: $1 \leq \text{Number of device points} \leq 32$
- For bit device: $\text{Head device No.} + \text{Number of device points} \times 16 - 1 \leq \text{Maximum device No.}$
- For word device: $1 \leq \text{Number of device points} \leq 64$
- For word device: $\text{Head device No.} + \text{Number of device points} - 1 \leq \text{Maximum device No.}$

Point

- When specifying bit devices, set the head device No. in multiples of 16 (0, 16, ... in decimal notation).

Communication example (Reading bit device memory)

Read bit devices in 16-point units under the following conditions.

- Message wait: 0 ms
- Head device: X040
- Number of device points: 32 points (2 words)

(Request data)

■When using WR (ACPU common command)

Message wait			Head device				Number of device points (Number of words)		
W	R	0	X	0	0	4	0	0	2
57 _H	52 _H	30 _H	58 _H	30 _H	30 _H	34 _H	30 _H	30 _H	32 _H

■When using QR (AnA/AnUCPU common command)

Message wait			Head device				Number of device points (Number of words)		
Q	R	0	X	0	0	0	4	0	2
51 _H	52 _H	30 _H	58 _H	30 _H	30 _H	30 _H	34 _H	30 _H	32 _H

(Response data)

Data read							
0001 (Hexadecimal : 1) 31 _H	0010 (Hexadecimal : 2) 32 _H	0011 (Hexadecimal : 3) 33 _H	0100 (Hexadecimal : 4) 34 _H	1010 (Hexadecimal : A) 41 _H	1011 (Hexadecimal : B) 42 _H	1100 (Hexadecimal : C) 43 _H	1101 (Hexadecimal : D) 44 _H
(X4F) to (X4C)	(X4B) to (X48)	(X47) to (X44)	(X43) to (X40)	(X5F) to (X5C)	(X5B) to (X58)	(X57) to (X54)	(X53) to (X50)

Communication example (Reading word device memory)

Read word devices in 1-point units under the following conditions.

- Message wait: 0 ms
- Head device: Current value of T123
- Number of device points: 2 points (2 words)

(Request data)

■When using WR (ACPU common command)

Message wait			Head device				Number of device points (Number of words)		
W	R	0	T	N	1	2	3	0	2
57 _H	52 _H	30 _H	54 _H	4E _H	31 _H	32 _H	33 _H	30 _H	32 _H

■When using QR (AnA/AnUCPU common command)

Message wait			Head device				Number of device points (Number of words)				
Q	R	0	T	N	0	0	1	2	3	0	2
51 _H	52 _H	30 _H	54 _H	4E _H	30 _H	30 _H	31 _H	32 _H	33 _H	30 _H	32 _H

(Response data)

Data read							
7	B	C	9	1	2	3	4
37 _H	42 _H	43 _H	39 _H	31 _H	32 _H	33 _H	34 _H
(T123)				(T124)			

Batch write (bit units) (command: BW, JW)

Writes bit devices (X, Y, M, etc.) in batch.

Message format

The following shows the message format of the request data and response data of the command.

Request data

ACPU common command

Command	Message wait	Head device	Number of device points	Write data for the number of device points
---------	--------------	-------------	-------------------------	--

Response data

There is no response data for this command.

Data specified by request data

Command

ACPU common	AnA/AnUCPU common								
<table border="1"><tr><td>B</td><td>W</td></tr><tr><td>42H</td><td>57H</td></tr></table>	B	W	42H	57H	<table border="1"><tr><td>J</td><td>W</td></tr><tr><td>4AH</td><td>57H</td></tr></table>	J	W	4AH	57H
B	W								
42H	57H								
J	W								
4AH	57H								

Message wait

Specify the delayed time of the response transmission. (☞ Page 347 Message wait)

Head device

Specify the head device. (☞ Page 351 Device codes, device numbers)

Number of device points

Convert the numerical value to 2-digit ASCII code (hexadecimal), and send it from the upper digits.

Specify the number of device points within the following range:

- $1 \leq \text{Number of device points} \leq 160$
- $\text{Head device No.} + \text{Number of device points} - 1 \leq \text{Maximum device No.}$

Write data for the number of device points

Store the data to be written in batch. (☞ Page 353 Read data, write data)

Communication example

Write data in bit units in batch under the following conditions.

- Message wait: 0 ms
- Head device: M903
- Number of device points: 5 points

(Request data)

■When using BW (ACPU common command)

Message wait		Number of device points (Number of words)												
		Head device						Write data for the number of device points						
B	W	0	M	0	9	0	3	0	5	0	1	1	0	1
42 _H	57 _H	30 _H	4D _H	30 _H	39 _H	30 _H	33 _H	30 _H	35 _H	30 _H	31 _H	31 _H	30 _H	31 _H
(M903) (M904) (M905) (M906) (M907)														

■When using JW (AnA/AnUCPU common command)

Message wait		Number of device points (Number of words)														
		Head device						Write data for the number of device points								
J	W	0	M	0	0	0	9	0	3	0	5	0	1	1	0	1
4A _H	57 _H	30 _H	4D _H	30 _H	30 _H	30 _H	39 _H	30 _H	33 _H	30 _H	35 _H	30 _H	31 _H	31 _H	30 _H	31 _H
(M903) (M904) (M905) (M906) (M907)																

Batch write (word units) (command: WW, QW)

Write data to bit devices (X, Y, M, etc.) in 16-point units.

Write data to word devices (D, T, C, etc.) in 1-point units.

Message format

The following shows the message format of the request data and response data of the command.

Request data

Command	Message wait	Head device	Number of device points	Write data for the number of device points
---------	--------------	-------------	-------------------------	--

Response data

There is no response data for this command.

Data specified by request data

Command

ACPU common	AnA/AnUCPU common								
<table border="1"><tr><td>W</td><td>W</td></tr><tr><td>57H</td><td>57H</td></tr></table>	W	W	57H	57H	<table border="1"><tr><td>Q</td><td>W</td></tr><tr><td>51H</td><td>57H</td></tr></table>	Q	W	51H	57H
W	W								
57H	57H								
Q	W								
51H	57H								

Message wait

Specify the delayed time of the response transmission. (☞ Page 347 Message wait)

Head device

Specify the head device. (☞ Page 351 Device codes, device numbers)

Number of device points

Convert the numerical value to 2-digit ASCII code (hexadecimal), and send it from the upper digits.

Specify the number of device points within the following range:

- For bit device: $1 \leq \text{Number of device points} \leq 10$
- For bit device: $\text{Head device No.} + \text{Number of device points} \times 16 - 1 \leq \text{Maximum device No.}$
- For word device: $1 \leq \text{Number of device points} \leq 64$
- For word device: $\text{Head device No.} + \text{Number of device points} - 1 \leq \text{Maximum device No.}$

Write data for the number of device points

Store 4-digit data per one device point. (☞ Page 353 Read data, write data)

Point

When specifying bit devices, set the head device No. in multiples of 16 (0, 16, ... in decimal notation).

Communication example (Writing to word bit memory)

Write data to bit devices in 16-point units under the following conditions.

- Message wait: 0 ms
- Head device: M640
- Number of device points: 32 points (2 words)

(Request data)

■When using WW (ACPU common command)

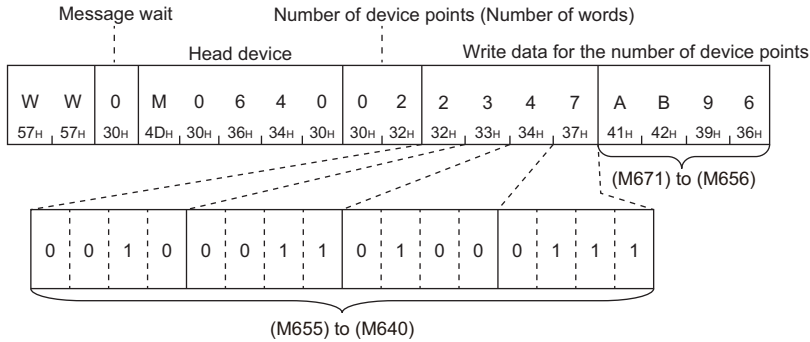

■When using QW (AnA/AnUCPU common command)

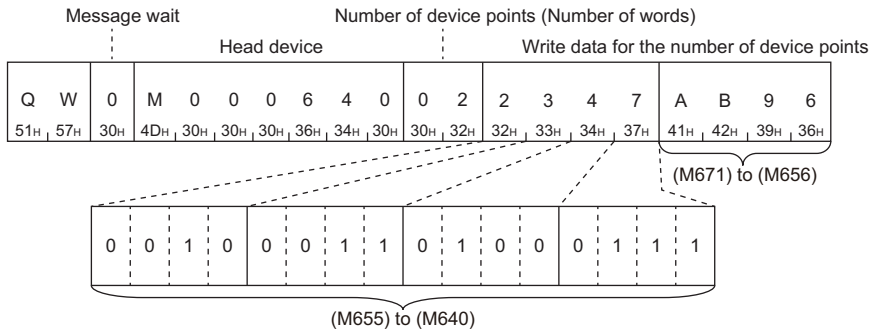

Communication example (Writing to word device memory)

Write data to word devices in 1-point units under the following conditions.

- Message wait: 0 ms
- Head device: D0
- Number of device points: 2 points (2 words)

(Request data)

■When using WW (ACPU common command)

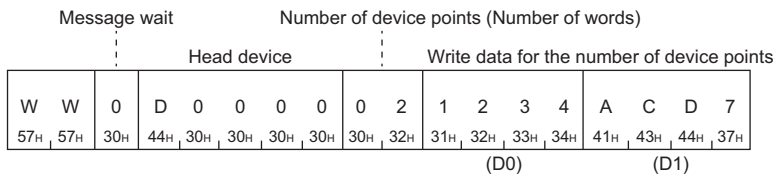

■When using QW (AnA/AnUCPU common command)

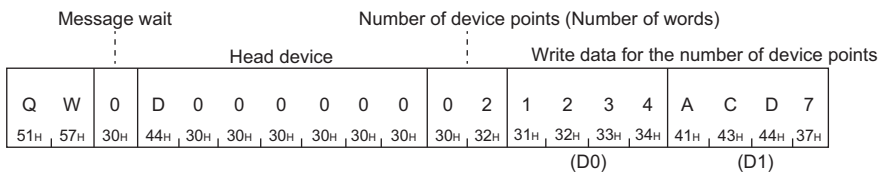

Test (random write) (bit units) (command: BT, JT)

Set/reset devices and device numbers to bit devices (X, Y, M, etc.) by specifying them randomly in 1 point units.

Message format

The following shows the message format of the request data and response data of the command.

Request data

Command	Message wait	Number of device points (n points)	Device (first point)	Set/reset (first point)	...	Device (nth point)	Set/reset (nth point)
---------	--------------	------------------------------------	----------------------	-------------------------	-----	--------------------	-----------------------

Response data

There is no response data for this command.

Data specified by request data

Command

ACPU common	AnA/AnUCPU common								
<table border="1"><tr><td>B</td><td>T</td></tr><tr><td>42H</td><td>54H</td></tr></table>	B	T	42H	54H	<table border="1"><tr><td>J</td><td>T</td></tr><tr><td>4AH</td><td>54H</td></tr></table>	J	T	4AH	54H
B	T								
42H	54H								
J	T								
4AH	54H								

Message wait

Specify the delayed time of the response transmission. (☞ Page 347 Message wait)

Number of device points

Convert the numerical value to 2-digit ASCII code (hexadecimal), and send it from the upper digits.

Specify the number of device points within the following range:

- $1 \leq \text{Number of device points} \leq 20$

Device

Specify the device to test. (☞ Page 351 Device codes, device numbers)

Set/Reset

- 0 (30H): Reset (OFF)
- 1 (31H): Set (ON)

Communication example

Perform the test in bit units under the following conditions.

- Message wait: 0 ms
- Number of device points: 3 points
- Device: Turn ON M50, turn OFF B31A, and turn ON Y02F

(Request data)

■When using BT (ACPU common command)

Message wait		Number of device points (Number of words)		Device		Set/ reset	Device		Set/ reset	Device		Set/ reset
B	T	0	0 3	M	0 0 5 0	1	B	0 3 1 A	0	Y	0 0 2 F	1
42 _H	54 _H	30 _H	30 _H , 33 _H	4D _H	30 _H , 30 _H , 35 _H , 30 _H	31 _H	42 _H	30 _H , 33 _H , 31 _H , 41 _H	30 _H	59 _H	30 _H , 30 _H , 32 _H , 46 _H	31 _H

■When using JT (AnA/AnUCPU common command)

Message wait		Number of device points (Number of words)		Device		Set/ reset	Device		Set/ reset
J	T	0	0 3	M	0 0 0 0 5 0	1	B	0 0 0 3 1 A	0
4A _H	54 _H	30 _H	30 _H , 33 _H	4D _H	30 _H , 30 _H , 30 _H , 30 _H , 35 _H , 30 _H	31 _H	42 _H	30 _H , 30 _H , 30 _H , 33 _H , 31 _H , 41 _H	30 _H

Device		Set/ reset
Y	0 0 0 0 2 F	1
59 _H	30 _H , 30 _H , 30 _H , 30 _H , 32 _H , 46 _H	31 _H

Test (random write) (word units) (command: WT, QT)

Set/reset devices and device numbers to bit devices (X, Y, M, etc.) by specifying them randomly in 16 point units.
Write devices and device numbers to word devices (D, T, C, etc.) by specifying them randomly in 1 point units.
A mixture of word devices and bit devices (16 bit units) can be specified.

Message format

The following shows the message format of the request data and response data of the command.

Request data

Command	Message wait	Number of device points (n points)	Device (first point)	Write data (first point)	...	Device (nth point)	Write data (nth point)
---------	--------------	------------------------------------	----------------------	--------------------------	-----	--------------------	------------------------

Response data

There is no response data for this command.

Data specified by request data

Command

ACPU common	AnA/AnUCPU common								
<table border="1"><tr><td>W</td><td>T</td></tr><tr><td>57H</td><td>54H</td></tr></table>	W	T	57H	54H	<table border="1"><tr><td>Q</td><td>T</td></tr><tr><td>51H</td><td>54H</td></tr></table>	Q	T	51H	54H
W	T								
57H	54H								
Q	T								
51H	54H								

Message wait

Specify the delayed time of the response transmission. (📖 Page 347 Message wait)

Number of device points

Convert the numerical value to 2-digit ASCII code (hexadecimal), and send it from the upper digits.
Specify the number of device points within the following range:

- $1 \leq \text{Number of device points} \leq 10$ (for bit device : 10 (16 points are designated as 1))

Device

Specify the device to test. (📖 Page 351 Device codes, device numbers)

Write data

Store 4-digit data per one device point. (📖 Page 353 Read data, write data)



When specifying bit devices, set the head device No. in multiples of 16 (0, 16, ... in decimal notation).

Communication example

Write data with mixture specification of word devices and bit devices (16-point unit) under the following conditions.

- Message wait: 0 ms
- Number of device points: 3 points (3 words)
- Device: Set 1234H to D500, BCA9H from Y100 to Y10F, and 64H to current values of C100

(Request data)

■When using WT (ACPU common command)

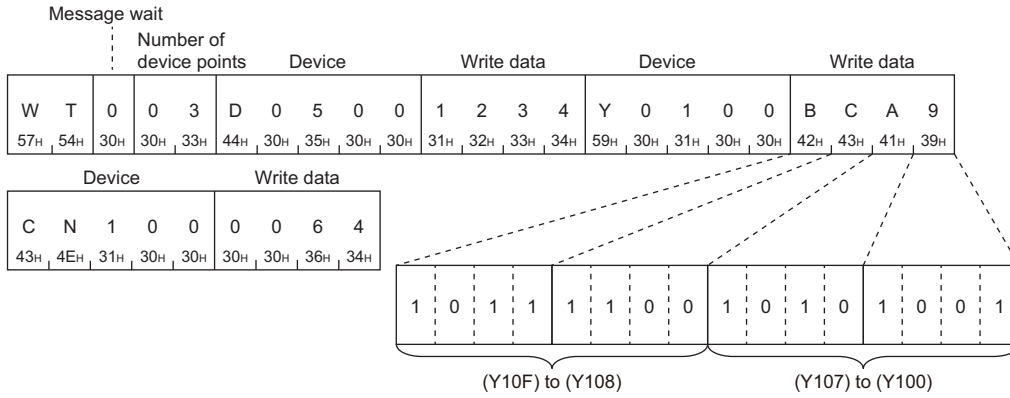

■When using QT (AnA/AnUCPU common command)

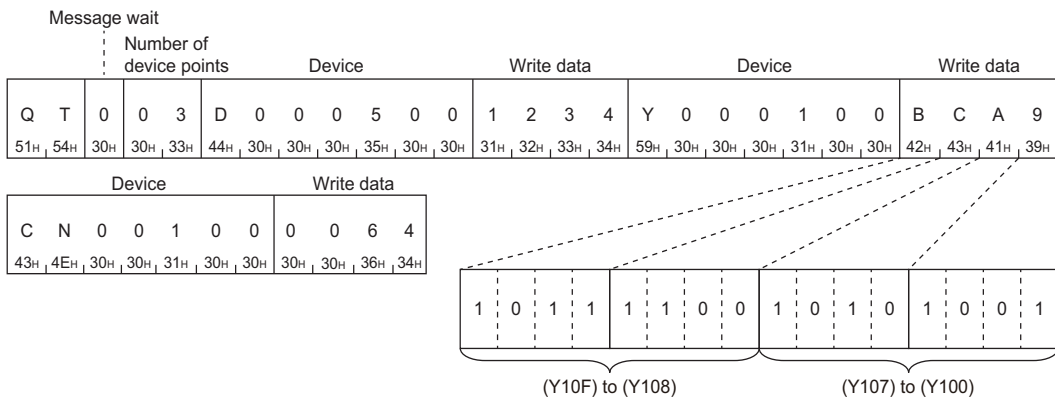

Monitor (Command: BM, JM, WM, QM, MB, MJ, MN, MQ)

The monitor data registration function registers the devices and numbers to be monitored from an external device to C24. The monitor function reads the data of the registered devices from the CPU module and processes it in the external device. When the batch read (BR/WR/JR/QR) is performed, the read device numbers will be consecutive, however, by using this function, devices can be monitored by specifying the device numbers randomly. The following example shows the control procedure for monitoring and registering name and number of the devices to be monitored to the C24.

Monitoring procedure

1. Process the monitor data registration (Edit of commands for registration and transmission of device specification.)
 - ACPU common commands: BM, WM
 - AnA/AnUCPU common commands: JM, QM
2. Perform read process. (Execution of command for monitoring.)
 - ACPU common commands: MB, MN
 - AnA/AnUCPU common commands: MJ, MQ
3. Process the data. (Screen display, etc.)
4. If do not change the devices to be monitored, return to step 2, and repeat the process.

Point

- When monitoring data as the procedure shown above, the monitor data registration is required. If monitoring data without registering the data, a protocol error occurs.
 - The content of registered monitor data are deleted when C24 is rebooted.
 - The devices can be registered for each command for bit units (BM or JM), word units (WM or QM), or the extended file register (EM) in C24. (Monitoring extended file register  Page 378 Monitor (command: EM, ME))
 - When registering device memory of the CPU module as a monitor data from more than one C24s on the same station, the recently registered device memory will be available since the registration data is overwritten.
-

Register monitor data (bit units) (command: BM, JM)

Set the bit devices (X, Y, M, etc.) to be monitored in 1-point units.

Monitor the device memory registered in bit units using the following command.

Page 369 Monitor (bit units) (command: MB, MJ)

Request data

Command	Message wait	Number of device points (n points)	Device (first point)	...	Device (nth point)
---------	--------------	------------------------------------	----------------------	-----	--------------------

- Command

ACPU common	AnA/AnUCPU common								
<table border="1"> <tr> <td>B</td> <td>M</td> </tr> <tr> <td>42H</td> <td>4DH</td> </tr> </table>	B	M	42H	4DH	<table border="1"> <tr> <td>J</td> <td>M</td> </tr> <tr> <td>4AH</td> <td>4DH</td> </tr> </table>	J	M	4AH	4DH
B	M								
42H	4DH								
J	M								
4AH	4DH								

- Message wait: Specify the delayed time of the response transmission. (Page 347 Message wait)
- Number of device points: Convert the numerical value to 2-digit ASCII code (hexadecimal), and send it from the upper digits.
- Device: Specify the devices to be monitored. (Page 351 Device codes, device numbers)

Point

Specify the number of device points within the following range:

$$1 \leq \text{Number of device points} \leq 40$$

When using the BM command and accessing ACPUs other than AnA/AnU, device X (input) has two processing points per point.

Response data

There is no response data for this command.

Communication example (Monitor data registration in bit units)

Perform monitor data registration of the bit device under the following conditions.

- Message wait: 0 ms
- Number of device points: 3 points (3 bits)
- Device: Contacts of X40, Y060, and T123.

(Request data)

- When using BM (ACPU common command)

		Message wait		Number of device points		Device				Device				Device					
B	M	0	0	3	X	0	0	4	0	Y	0	0	6	0	T	S	1	2	3
42H	4DH	30H	30H	33H	58H	30H	35H	34H	30H	59H	30H	30H	36H	30H	54H	53H	31H	32H	33H

- When using JM (AnA/AnUCPU common command)

		Message wait		Number of device points		Device				Device				Device									
J	M	0	0	3	X	0	0	0	4	0	Y	0	0	0	6	0	T	S	0	0	1	2	3
4AH	4DH	30H	30H	33H	58H	30H	30H	30H	34H	30H	59H	30H	30H	30H	36H	30H	54H	53H	30H	30H	31H	32H	33H

Register monitor data (word units) (command: WM, QM)

Register the bit devices (X, Y, M, etc.) to be monitored in 16-point units.

Register the word devices (D, T, C, etc.) to be monitored in 1-point units.

A mixture of word devices and bit devices (16 bit units) can be specified.

Monitor the device memory registered in word units using the following command.

☞ Page 370 Monitor (word units) (command: MN, MQ)

Request data

Command	Message wait	Number of device points (n points)	Device (first point)	...	Device (nth point)
---------	--------------	------------------------------------	----------------------	-----	--------------------

- Command

ACPU common	AnA/AnUCPU common								
<table border="1"> <tr> <td>W</td> <td>M</td> </tr> <tr> <td>57H</td> <td>4DH</td> </tr> </table>	W	M	57H	4DH	<table border="1"> <tr> <td>Q</td> <td>M</td> </tr> <tr> <td>51H</td> <td>4DH</td> </tr> </table>	Q	M	51H	4DH
W	M								
57H	4DH								
Q	M								
51H	4DH								

- Message wait: Specify the delayed time of the response transmission. (☞ Page 347 Message wait)
- Number of device points: Convert the numerical value to 2-digit ASCII code (hexadecimal), and send it from the upper digits.
- Device: Specify the devices to be monitored. (☞ Page 351 Device codes, device numbers)

Point

Specify the number of device points within the following range:

$$1 \leq \text{Number of device points} \leq 20$$

When using the WM command and accessing ACPU other than AnA/AnU, device X (input) has two processing points per point.

Response data

There is no response data for this command.

Communication example (Monitor data registration in word units)

Register the monitor data in a word unit under the following conditions.

- Message wait: 0 ms
- Number of device points: 4 points (4 words)
- Device: Current value of D15, W11E, and T123, and Y060 to Y06F

(Request data)

- When using WM (ACPU common command)

Message wait		Number of device points		Device				Device				Device				Device								
W	M	0	0	4	D	0	0	1	5	W	0	1	1	E	T	N	1	2	3	Y	0	0	6	0
57H	4DH	30H	30H	34H	44H	30H	30H	31H	35H	57H	30H	31H	31H	45H	54H	4EH	31H	32H	33H	59H	30H	30H	36H	30H

- When using QM (AnA/AnUCPU common command)

Message wait		Number of device points		Device				Device				Device													
Q	M	0	0	4	D	0	0	0	0	1	5	W	0	0	0	1	1	E	T	N	0	0	1	2	3
51H	4DH	30H	30H	34H	44H	30H	30H	30H	30H	31H	35H	57H	30H	30H	30H	31H	31H	45H	54H	4EH	30H	30H	31H	32H	33H

Device							
Y	0	0	0	0	6	0	
59H	30H	30H	30H	30H	36H	30H	

Monitor (bit units) (command: MB, MJ)

Monitor the registered bit devices (X, Y, M, etc.).

Point

- The bit device memory registered with BM command is monitored using MB command.
- The bit device memory registered with JM command is monitored using MJ command.

Request data

Command	Message wait
---------	--------------

- Command

ACPU common	AnA/AnUCPU common								
<table border="1"> <tr> <td>M</td> <td>B</td> </tr> <tr> <td>4D_H</td> <td>42_H</td> </tr> </table>	M	B	4D _H	42 _H	<table border="1"> <tr> <td>M</td> <td>J</td> </tr> <tr> <td>4D_H</td> <td>4A_H</td> </tr> </table>	M	J	4D _H	4A _H
M	B								
4D _H	42 _H								
M	J								
4D _H	4A _H								

- Message wait: Specify the delayed time of the response transmission. (Page 347 Message wait)

Response data

Monitoring result (For the number of device points)

The value of read device is stored in bit units. (Page 72 Read data, write data)

Communication example

Monitor bit devices specified with monitor data registration under the following conditions.

- Message wait: 0 ms
- Registered devices for monitoring: 3 points (3 bits) of contacts for X040, Y060 and T123.

(Request data)

- When using MB (ACPU common command)

Message wait

M	B	0
4D _H	42 _H	30 _H

- When using MJ (AnA/AnUCPU common command)

Message wait

M	J	0
4D _H	4A _H	30 _H

(Response data)

Monitoring result (For the number of device points)

1	0	1
31 _H	30 _H	31 _H

(X040) (Y060) (Contact of T123)

Monitor (word units) (command: MN, MQ)

Monitor the registered bit devices (X, Y, M, etc.) in 16-point units.

Monitor the registered word device (D, T, C, etc.) in 1-point unit.

Point

- The bit device memory registered with WM command is monitored using MN command.
- The bit device memory registered with QM command is monitored using MQ command.

Request data

Command	Message wait
---------	--------------

- Command

ACPU common	AnA/AnUCPU common								
<table border="1"> <tr> <td>M</td> <td>N</td> </tr> <tr> <td>4DH</td> <td>4EH</td> </tr> </table>	M	N	4DH	4EH	<table border="1"> <tr> <td>M</td> <td>Q</td> </tr> <tr> <td>4DH</td> <td>51H</td> </tr> </table>	M	Q	4DH	51H
M	N								
4DH	4EH								
M	Q								
4DH	51H								

- Message wait: Specify the delayed time of the response transmission. (Page 347 Message wait)

Response data

Monitoring result (For the number of device points)

The value of read device is stored in word units. (Page 72 Read data, write data)

Communication example

Monitor bit devices or word devices specified with monitor data registration under the following conditions.

- Message wait: 0 ms
- Registered devices for monitoring: Current values of D15, W11E, T123, and 4 points (4 words) of Y060 to Y06F.

(Request data)

- When using MN (ACPU common command)

Message wait

M	N	0
4DH	4EH	30H

- When using MQ (AnA/AnUCPU common command)

Message wait

M	Q	0
4DH	51H	30H

(Response data)

Monitoring result (For the number of device points)

1	2	3	4	0	0	5	0	0	0	6	4	0	0	0	0	0	1	1	1	0	1	1	0	0	1	0	0
(Decimal : 4660)				(Decimal : 80)				(Decimal : 100)				30H				37H				36H				34H			
31H, 32H, 33H, 34H				30H, 30H, 35H, 30H				30H, 30H, 36H, 34H																			
(D15)				(W11E)				(Current value of T123)				(Y06F) to (Y06C)				(Y06B) to (Y068)				(Y067) to (Y064)				(Y063) to (Y060)			

17.5 Read and Write Extended File Register

The extended file register is a memory area that stores required data and operation result for various data processing by using the software package for extended file register 'SW0GHP-UTLPC-FN1' or 'SW0SRX-FNUP' (hereinafter abbreviated to UTLPC-FN1 and FNUP) and AnACPU and AnUSCPU extended file register dedicated instructions. The extended file register uses free area of user memory area in CPU module as a file register.

The following example shows the control procedure to read and write extended file register.

Considerations for reading and writing extended file register

The following shows the considerations when reading writing extended file register using the commands described in this section.

Accessible CPU modules

Only CPU modules that can handle the extended file register can be accessed.

This function cannot be used for CPU modules that cannot handle an extended file register (such as A1N).

Error detection for block numbers that do not exist

Depending on the type of memory cassette inserted in the CPU module, an error (character area error '06H') may not be detected even when a read/write operation is performed by specifying the block numbers that do not exist. In this case, the read data is incorrect. If writing data to the CPU module, the user memory of the CPU module will be collapsed.

Check the type of memory cassette and parameter settings before using these functions.

Memory cassette model name	Block numbers that do not cause character area error (06H)		
	A0J2H, A2, A3CPU	A2N, A3NCPU	A3H, AnA, AnUCPU
A3NMCA-12	No.10 to No.11		
A3NMCA-18	—	No.10 to No.28	
A3NMCA-24	—	No.13 to No.20	No.13 to No.28
A3NMCA-40	—	No.21 to No.28	
A3AMCA-96	—	No.21 to No.48 ^{*1}	

*1 A3AMCA-96 can be used for A3A, A3U, and A4UCPU.

For details, refer to the manual of UTLPC-FN1 or FNUP, or user's manual of the access target CPU module.

Block numbers of extended file register that can be handled by A2USCPU(S1)

The block numbers of the extended file register that can be handled by A2USCPU(S1) is as follows.

- A2USCPU: No.1 to 3
- A2USCPU-S1: No.1 to 8, No.10 to 16

Extended file register of R/L/Q/QnACPU

The extended file register of R/L/Q/QnACPU cannot be read/written.

Specification method for extended file register

The specification method differs depending on the command.

- ACPU common command: Specify with device number and block number.
- AnA/AnUCPU common command: Specify the address from device number 0 of block number 1 as a device number.
(Access with the consecutive device number of extended file register using usable number of blocks \times 8192 points.)

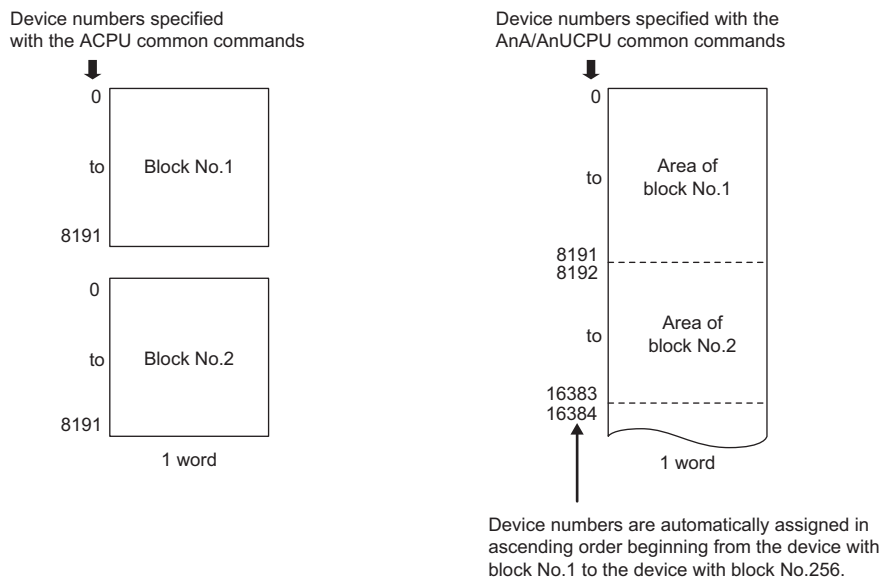

Range of block number and device number that can be specified

An extended file register has blocks numbered from '0' to 'n' (the n differs depending on the memory cassette). Block number '0' has a number of points registered with a parameter of the CPU module, while block numbers '1' to 'n' have a register of 8192 points in each block.

However, the range that can be read from or written to the CPU module will be the range specified in the parameter of 0 block. The range of block numbers and device numbers that can be specified differ depending on the type of memory cassette and the parameter setting in the CPU module. For details, refer to the operating manual of UTLP-FN1 or FNUP, or user's manuals of AnACPU and AnUCPU.

Point

- The AnA/AnUCPU common commands can be used for reading/writing data to the extended file register of block number 1 to 256. In addition, the commands can be used regardless of the existence of file register parameter.
- When accessing the file register (R) set by parameter or when accessing it by specifying block number, use ACPU common commands.

Device number (address) specification using AnA/AnUCPU common commands

By using AnA/AnU common command function, the extended file register of block number 1 to 256 can be accessed regardless of each block number by specifying the address from device number '0' of the block number '1' as a device number. (Access with the consecutive device number of extended file register using usable number of blocks × 8192 points.)

■Device number calculation method

The calculation formula of the head device number to be specified by AnA/AnUCPU common commands is as follow:
(When specifying the device number 'm' (0 to 8191) of n block (more than 1) from the head of the block.)

$$\text{Head device number} = (n - 1) \times 8192 + m$$

■Range of device number that can be specified

The range of device number that can be specified are as follows.

$$0 \text{ to } (\text{number of available blocks} \times 8192) - 1$$

A device number is not assigned to a block number which does not exist in the memory cassette. As shown below, the device numbers are automatically assigned by skipping block numbers that do not exist in the memory cassette.

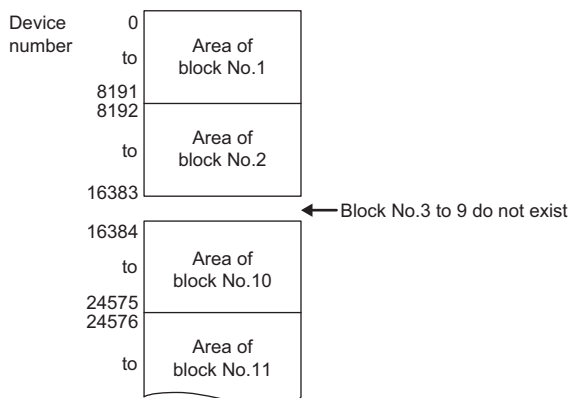

The following table shows the range of device numbers to be specified when using AnA/AnUCPU common commands for 28 blocks per each block.

Device number	Position of target block	Device number	Position of target block
0 to 8191	First block R0 to R8191	114688 to 122879	15th block R0 to R8191
8192 to 16383	2nd block R0 to R8191	122880 to 131071	16th block R0 to R8191
16384 to 24575	3rd block R0 to R8191	131072 to 139263	17th block R0 to R8191
24576 to 32767	4th block R0 to R8191	139264 to 147455	18th block R0 to R8191
32768 to 40959	5th block R0 to R8191	147456 to 155647	19th block R0 to R8191
40960 to 49151	6th block R0 to R8191	155648 to 163839	20th block R0 to R8191
49152 to 57343	7th block R0 to R8191	163840 to 172031	21st block R0 to R8191
57344 to 65535	8th block R0 to R8191	172032 to 180223	22nd block R0 to R8191
65536 to 73727	9th block R0 to R8191	180224 to 188415	23rd block R0 to R8191
73728 to 81919	10th block R0 to R8191	188416 to 196607	24th block R0 to R8191
81920 to 90111	11th block R0 to R8191	196608 to 204799	25th block R0 to R8191
90112 to 98303	12th block R0 to R8191	204800 to 212991	26th block R0 to R8191
98304 to 106495	13th block R0 to R8191	212992 to 221183	27th block R0 to R8191
106496 to 114687	14th block R0 to R8191	221184 to 229375	28th block R0 to R8191

Data to be specified in command

Device number

■ACPU common command

Specify the block number and device number with 7 digits.

- When the block number is less than 2 digits
'Block number (2 digits)' + 'R' + 'Device number (4 digits)'
- When the block number is 3 digits
'Block number (3 digits)' + 'Device number (4 digits)'

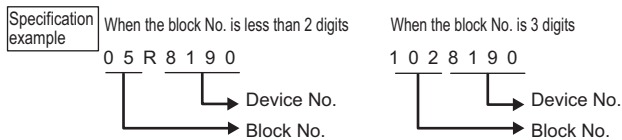

■AnA/AnUCPU common command

Specify the address from device number 0 of block number 1 in 7 digits.

☞ Page 373 Device number (address) specification using AnA/AnUCPU common commands

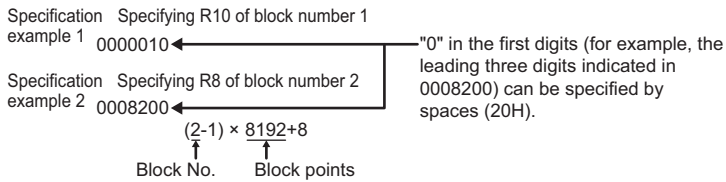

Batch read (command: ER)

Read extended file register (R) in 1-point units.

Message format

The following shows the message format of the request data and response data of the command.

Request data

E	R	Message wait	Head device No.	Number of device points (Number of words)
45H	52H			

Response data

The value of read device is stored in word units. (Page 72 Read data, write data)

Data specified by request data

Command

ACPU common

E	R
45H	52H

Message wait

Specify the delayed time of the response transmission. (Page 347 Message wait)

Head device No.

Specify the block number and device number of head device with 7 digits. (Page 374 Device number)

Number of device points

Convert the numerical value to 2-digit ASCII code (hexadecimal), and send it from the upper digits.

Specify the number of device points within the following range:

- $1 \leq \text{Number of device points} \leq 64$
- $\text{Head device No.} + \text{Number of device points} - 1 \leq \text{Maximum device No.}$

Communication example

Read data of 2 points (R8190 and R8191) of block number 12 under the following conditions.

- Message wait: 0 ms
- Block number: 12
- Head device: R8190
- Number of device points: 2 points (2 words)

(Request data)

		Message wait								Number of device points (Number of words)	
		⋮	Head device No.								
E	R	0	1	2	R	8	1	9	0	0	2
45H	52H	30H	31H	32H	52H	38H	31H	39H	30H	30H	32H

(Response data)

Data read							
1	2	3	4	7	A	B	C
(Decimal : 4660)				(Decimal : 31420)			
31H	32H	33H	34H	37H	41H	42H	43H
(R8190 in NO.12)				(R8191 in NO.12)			

Batch write (command: EW)

Write extended file register (R) in 1-point units.

Message format

The following shows the message format of the request data and response data of the command.

Request data

E	W	Message wait	Head device No.	Number of device points	Write data for the number of device points
45H	57H				

Response data

There is no response data for this command.

Data specified by request data

Command

ACPU common

E	W
45H	57H

Message wait

Specify the delayed time of the response transmission. (☞ Page 347 Message wait)

Head device No.

Specify the block number and device number of head device with 7 digits. (☞ Page 374 Device number)

Number of device points

Convert the numerical value to 2-digit ASCII code (hexadecimal), and send it from the upper digits.

Specify the number of device points within the following range:

- $1 \leq \text{Number of device points} \leq 64$
- : Head device No. + Number of device points - 1 \leq Maximum device No.

Write data for the number of device points

Store the data to be written in batch.

Communication example

Write data of 3 points (R7010 to R7012) of block number 5 under the following conditions.

- Message wait: 0 ms
- Block number: 5
- Head device: R7010
- Number of device points: 3 points (3 words)

(Request data)

Message wait		Number of device points (Number of words)																					
⋮		⋮																					
Head device No.		Write data for the number of device points																					
E	W	0	0	5	R	7	0	1	0	0	3	0	1	2	3	A	B	C	7	3	3	2	2
45H	57H	30H	30H	35H	52H	37H	30H	31H	30H	30H	33H	30H	31H	32H	33H	41H	42H	43H	37H	33H	33H	32H	32H
											(Decimal : 291)			(Decimal : 21753)			(Decimal : 13090)						
											(R7010 in No.5)			(R7011 in No.5)			(R7012 in No.5)						

Test (random write) (command: ET)

Specify the block number and device number to the extended file register (R) in 1-point units and write them randomly.

Message format

The following shows the message format of the request data and response data of the command.

Request data

Data for the number of device points

E 45 _H	T 54 _H	Message wait	Number of device points	Device No.	Write data
----------------------	----------------------	--------------	-------------------------	------------	------------

Response data

There is no response data for this command.

Data specified by request data

Command

ACPU common

E 45 _H	T 54 _H
----------------------	----------------------

Message wait

Specify the delayed time of the response transmission. (☞ Page 347 Message wait)

Number of device points

Convert the numerical value to 2-digit ASCII code (hexadecimal), and send it from the upper digits. Specify the number of device points within the following range:

- 1 ≤ Number of device points ≤ 10

Device number

Specify the block number and device number to be test with 7 digits. (☞ Page 374 Device number)

Write data

Store 4 characters per one device point.

Communication example

Write data of three points (3 words) randomly under the following conditions.

- Message wait: 0 ms
- Number of device points: 3 points (3 words)
- Device: Set R1234H to R1050 of block number 5, 1A1BH to R2121 of block number 7, and 506H to R3210 of block number 10.



(Request data)

Message wait		Number of device points		Device							Write data				Device							Write data			
E	T	0	0	0	5	R	1	0	5	0	1	2	3	4	0	7	R	2	1	2	1	1	A	1	B
45 _H	54 _H	30 _H	30 _H , 33 _H	30 _H , 35 _H	52 _H , 31 _H	30 _H	35 _H	30 _H	31 _H	32 _H	33 _H	34 _H	30 _H	37 _H	52 _H	32 _H	31 _H	32 _H	31 _H	31 _H	41 _H	31 _H	42 _H		
Device				Write data																					
1				0																					
R				5																					
3				0																					
2				6																					
1																									
0																									
31 _H	30 _H	52 _H	33 _H , 32 _H	31 _H	30 _H	30 _H	35 _H	30 _H	36 _H																

Monitor (command: EM, ME)

The monitor data registration function registers the devices and numbers to be monitored from an external device to C24. The monitor function reads the data of the registered devices from the CPU module and processes it in the external device. When the batch read (ER) or direct read (NR) is performed, the read device numbers will be consecutive, however, by using this function, devices can be monitored by specifying the device numbers randomly. The following example shows the control procedure for monitoring and registering name and number of the devices to be monitored to the C24.

Monitoring procedure

1. Process the monitor data registration (Edit of EM command and transmission of device specification.)
 -  Page 379 Register monitor data (command: EM)
2. Perform read process. (Execution of ME command)
 -  Page 380 Monitor (command: ME)
3. Process the data. (Screen display, etc.)
4. If do not change the devices to be monitored, return to step 2, and repeat the process.

Point

- When monitoring data as the procedure shown above, the monitor data registration is required. If monitoring data without registering the data, a protocol error occurs.
 - The content of registered monitor data are deleted when C24 is rebooted.
 - Five kinds of monitor data can be registered for the extended file register (EM), device memory in bit units (BM or JM), and word units (WM or QM).
 - When registering device memory of the CPU module as a monitor data from more than one external devices on the same station, the recently registered device memory will be available since the registration data is overwritten. (Monitoring device memory  Page 366 Monitor (Command: BM, JM, WM, QM, MB, MJ, MN, MQ))
-

Register monitor data (command: EM)

Register the device number to be monitored in 1-point units.

Monitor the extended file register registered with EM command using the following command.

Page 380 Monitor (command: ME)

Request data

E	M	Message wait	Number of device points	Device No. (for the number of device points)
45 _H	4D _H			

- Command

ACPU common

E	M
45 _H	4D _H

- Message wait: Specify the delayed time of the response transmission. (Page 347 Message wait)
- Number of device points: Convert the numerical value to 2-digit ASCII code (hexadecimal), and send it from the upper digits.
- Device number: Specify the block number and device number of the device to be monitored with 7 digits. (Page 374 Device number)

Point

Specify the number of device points within the following range:

$$1 \leq \text{Number of device points} \leq 20$$

Response data

There is no response data for this command.

Communication example

Perform monitor data registration of 4 points (4 words) under the following conditions.

- Message wait: 0 ms
- Number of device points: 4 points (4 words)
- Device number: Register R1234 of block number 5, R2345 of block number 6, R3055 of block number 15, and R8000 of block number 17.

(When the extended file register of block number 1 to 8 and 10 to 17 exist.)

E M		0 0 4		0 5 R 1 2 3 4				0 6 R 2 3 4 5				1 5 R 3 0 5 5													
45 _H	4D _H	30 _H	30 _H	34 _H	30 _H	35 _H	52 _H	31 _H	32 _H	33 _H	34 _H	30 _H	36 _H	52 _H	32 _H	33 _H	34 _H	35 _H	31 _H	35 _H	52 _H	33 _H	30 _H	35 _H	35 _H

Device No.			
1	7	R	8 0 0 0
31 _H	37 _H	52 _H	38 _H
30 _H	30 _H	30 _H	30 _H

Monitor (command: ME)

Monitor the registered extended file registers.

■Message format

- Request data

M	E	Message wait
4D _H	45 _H	

- Response data

Monitoring result (For the number of device points)

The value of read device is stored in word units. ( Page 72 Read data, write data)

■Data specified by request data

- Command

ACPU common

M	E
4D _H	45 _H

- Message wait: Specify the delayed time of the response transmission. ( Page 347 Message wait)

■Communication example

Monitor data of 4 points (4 word) specified with monitor data registration under the following conditions.

- Message wait: 0 ms
- Registered devices for monitoring: R1234 of block number 5, R2345 of block number 6, R3055 of block number 15, and 4-point of R8000 of block number 17.

(Request data)

Message wait		
M	E	0
4D _H	45 _H	30 _H

(Response data)

Monitoring result (For the number of device points)

3 5 0 1 (Decimal : 13569)	4 F 5 B (Decimal : 20315)	0 1 5 0 (Decimal : 366)	1 C 2 D (Decimal : 366)
33 _H 35 _H 30 _H 31 _H	34 _H 46 _H 35 _H 42 _H	30 _H 31 _H 35 _H 30 _H	31 _H 43 _H 32 _H 44 _H
(R1234 in No.5)	(R2345 in No.6)	(R3055 in No.15)	(R800 in No.17)

Direct read (command: NR)

Read extended file register in 1-point (1 word) units by specifying the consecutive device number of extended file register.

Message format

The following shows the message format of the request data and response data of the command.

Request data

N 4EH	R 52H	Message wait	Head device No.	Number of device points (Number of words)
----------	----------	--------------	-----------------	--

Response data

The value of read device is stored in word units. (Page 72 Read data, write data)

Data specified by request data

Command

ACPU common

N	R
4EH	52H

Message wait

Specify the delayed time of the response transmission. (Page 347 Message wait)

Head device No.

Specify the device number of head device with 7 digits. (Page 374 Device number)

Number of device points

Convert the numerical value to 2-digit ASCII code (hexadecimal), and send it from the upper digits.

Specify the number of device points within the following range:

- $1 \leq \text{Number of device points} \leq 64$
- $\text{Head device No.} + \text{Number of device points} - 1 \leq \text{Maximum device No.}$

Communication example

Read data of 2 points (R8190 and R8191) of block number 2 under the following conditions.

- Message wait: 0 ms
- Block number: 2
- Head device: R8190
- Number of device points: 2 points (2 words)

(Request data)

		Message wait								Number of device points (Number of words)	
		⋮									
			Head device No.								
N	R	0	0	0	1	6	3	8	2	0	2
4EH	52H	30H	30H	30H	31H	36H	33H	38H	32H	30H	32H

(Response data)

Data read							
1	2	3	4	7	A	B	C
(Decimal : 4660)				(Decimal : 31420)			
31H	32H	33H	34H	37H	41H	42H	43H
(R8190 in No.2)				(R8191 in No.2)			

Direct write (command: NW)

Write extended file register in 1-point (1 word) units by specifying the consecutive device number of extended file register.

Message format

The following shows the message format of the request data and response data of the command.

Request data

N 4EH	W 57H	Message wait	Head device No.	Number of device points	Write data for the number of device points
----------	----------	--------------	-----------------	-------------------------	--

Response data

There is no response data for this command.

Data specified by request data

Command

ACPU common

N 4EH	W 57H
----------	----------

Message wait

Specify the delayed time of the response transmission. (☞ Page 347 Message wait)

Head device No.

Specify the device number of head device with 7 digits. (☞ Page 374 Device number)

Number of device points

Convert the numerical value to 2-digit ASCII code (hexadecimal), and send it from the upper digits.

Specify the number of device points within the following range:

- $1 \leq \text{Number of device points} \leq 64$
- $\text{Head device No.} + \text{Number of device points} - 1 \leq \text{Maximum device No.}$

Write data for the number of device points

Store 4-digit data per one device point.

Communication example

Write data of 3 points under the following conditions.

- Message wait: 0 ms
- Write data: Write R8190 and R8191 of block number 12 and R0 of block number 13.
(When the extended file register of block number 1 to 8 and 10 to 13 exist.)
- Number of device points: 3 points (3 words)

(Request data)

N W		Message wait	Head device No.							Number of device points (Number of words)		Write data for the number of device points													
4EH	57H	30H	0	0	0	9	0	1	1	0	0	3	0	1	2	3	A	B	C	7	3	3	2	2	
			(Decimal : 291)							(Decimal : 291)		(Decimal : 21753)							(Decimal : 13090)						
			(R8190 in No.12)							(R8191 in No.12)		(R0 in No.13)													

17.6 Read and write Buffer Memory of Special Function Module

The following examples the commands that performs data read/write to the buffer memory of MELSEC-A series special function modules.



This command accesses in byte units regardless of the word/byte specification.

Data to be specified in command

This section explains the contents and specification methods for data items which are set in each command related to the access to the special function module buffer memory.

For details of the specification method of address and module number for commands (TR, TW), refer to the following manual.

Computer Link Module (Com. link func./Print. func.) User's Manual

Start address

Specify the start address of the buffer memory to be read/written.

Convert the numerical value to 5-digit ASCII code (hexadecimal), and send it from the upper digits.

■ Calculation method

Calculate the start address as follows:

Start address = (Buffer memory address $\times 2$) + the arbitrary additional value of a module

For the additional values (buffer memory start address) for each module, refer to the following section.

Page 385 Accessible modules

Ex.

When specifying buffer memory address 1H of AD61

$(1H \times 2) + 80H = 82H$

Byte length

Specify the byte length of the special function module buffer memory data to be read/written.

Convert the numerical value to 2-digit ASCII code (hexadecimal), and send it from the upper digits.

Read data, write data

The read buffer memory value is stored for reading, and the data to be written is stored for writing.

This function reads/writes data in byte unit.

Page 160 Read data, write data

Special function module No.

Specify the last input/output signal (I/O address) of the special function module. (Specify the upper 2-digit in 3-digit representation.)

Convert the numerical value to 2-digit ASCII code (hexadecimal), and send it from the upper digits.

■Special function module No. which occupies 1 slot

Special function module No. is the upper 2 digits of the input/output signal (I/O address) of the last number represented with 3-digits on the slot where the module is mounted.

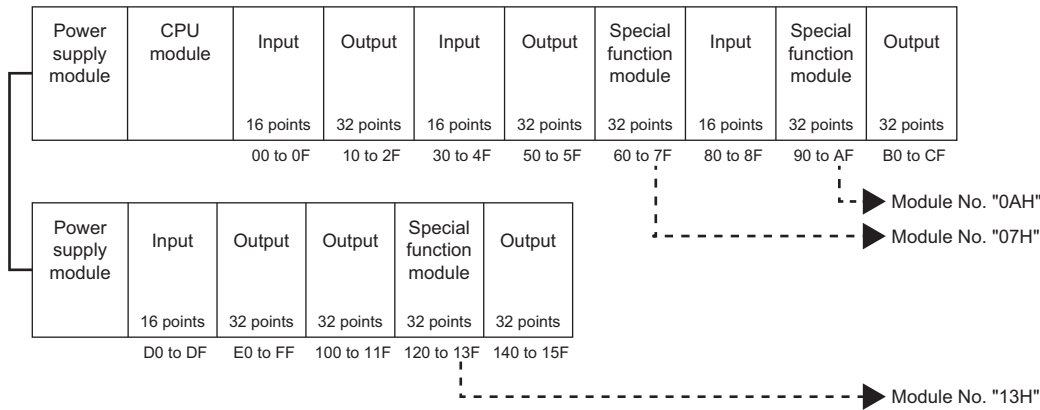

■Special function module No. which occupies 2 slots

For a special function module which occupies two slots, the number of occupied points for each slot is fixed for each module.

Special function module No. specified for the operation procedure is the upper 2 digits of the input/output signal (I/O address) of the last number represented with 3-digits of the slot assigned as a special function module on the slot.

For details of the assigned slot for each module, refer to the manual of the modules.

Ex.

A module that assign the first part of the slots as empty slots (AD72, A84AD, etc.)

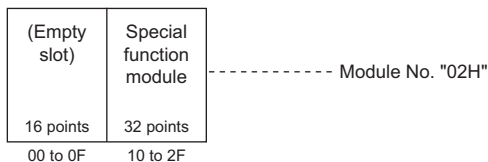

Ex.

A module that assign the last part of the slots as empty slots (A61LS, etc.)

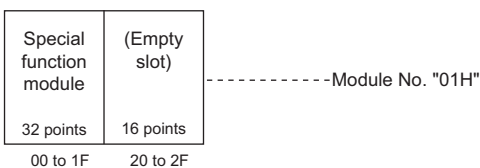

Ex.

A module in which both assignment of special function module and I/O assignment exist (A81CPU)

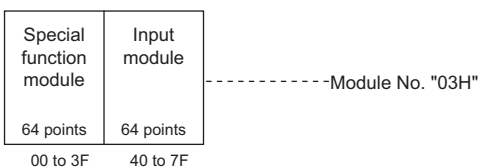

Accessible modules

The accessible special function modules are as follows.

Module	Type	Additional values when calculating start address (Buffer memory start address)	Module number when module is mounted on slot 0
High-speed counter module	AD61 (S1)	80H	01H
	A1SD61, A1SD62 (E/D)	10H	01H
Analog-digital converter module	A616AD	10H	01H
	A68AD(S2), A68ADN	80H	01H
	A84AD	10H	02H
	A1S64AD	10H	01H
Digital-analog converter module	A616DAI, A616DAV A62DA (S1) A68DAV/DAI A1S62DA	10H	01H
Temperature-digital converter module	A616TD A68RD3/4 A1S62RD3/4	10H	01H
PID control module	A81CPU	200H	03H
Position detection module	A61LS	80H	01H
	A62LS (S5)	80H	02H
MELSECNET/MINI master module	AJ71PT32 (S3), AJ71T32-S3 A1SJ71PT32-S3	20H	01H
CC-Link system master/local module	AJ61BT11	2000H	01H
	A1SJ61BT11	2000H	01H
Multidrop link module	AJ71C22 (S1)	1000H	01H
Computer link module	AJ71C24 (S3/S6/S8)	1000H	01H
	AJ71UC24 A1SJ71 (U) C24-R2 A1SJ71 (U) C24-PRF A1SJ71 (U) C24-R4	400H	01H
Intelligent communication module	AD51H (S3), AD51H (S3)	800H	02H
Terminal interface module	AJ71C21 (S1)	400H	01H
B/NET interface module	AJ71B62	20H	01H
SUMINET interface module	AJ71P41	400H	01H
Ethernet interface module	AJ71E71 (S3)	400H	01H
	A1SJ71E71 (S3)	4000H	01H
External fault diagnosis module	AD51FD (S3)	280H	02H
Graphic controller module	AD57G (S3)	280H	02H
Vision sensor module	AS25VS, AS50VS	100H	02H
	AS50VS-GN	80H	02H
Memory card interface module	AD59 (S1)	1800H	01H
Positioning module	AD70 (D) (S2)	80H	01H
	AD71 (S1/S2/S7)	200H	01H
	AD72 A1SD71-S2/S7	200H	02H
	AD75P1/P2/P3 (S3), AD75M1/M2/M3 A1SD75P1/P2/P3 (S3), A1SD75M1/M2/M3	800H	01H
Positioning module for 1 axis	A1SD70	80H	01H
Analog input/output module	A1S63ADA	10H	01H
Temperature control module	A1S64TCTT (BW)-S1 A1S64TCRT (BW)-S1 A1S64TCTRT (BW) A1S62TCTT (BW)-S2 A1S62TCRT (BW)-S2	20H	01H

Batch read (command: TR)

Read the buffer memory of a special function module.

Message format

The following shows the message format of the request data and response data of the command.

Request data

T 54H	R 52H	Message wait	Start address	Byte length	Special function module No.
----------	----------	--------------	---------------	-------------	--------------------------------

Response data

The value read from the buffer memory is stored.

2-digit ASCII code data is stored per 1 byte of buffer memory data.

Data specified by request data

Command

ACPU common

T 54H	R 52H
----------	----------

Message wait

Specify the delayed time of the response transmission. (☞ Page 347 Message wait)

Start address

Specify the start address of the buffer memory to be read in five digits. (☞ Page 386 Start address)

Byte length

Convert the numerical value to 2-digit ASCII code (hexadecimal), and send it from the upper digits.

Specify the byte length within the following ranges:

- $1 \leq \text{Byte length} \leq 128$

Special function module No.

Specify with 2 digits. (☞ Page 386 Special function module No.)

Point

The content of one data may cross 2 or 3 bytes depending on the special function module. For the specifications of byte length, refer to the manual of each module.

Communication example

Read data of 4 bytes under the following conditions.

- Message wait: 0 ms
- Start address: 7F0H
- Byte length: 4 bytes
- Special function module No.: 13 (input/output signals are 120H to 13FH)

(Request data)

Message wait		Start address				Byte length		Special function module No.			
T	R	0	0	0	7	F	0	0	4	1	3
54H, 52H	30H	30H, 30H, 37H, 46H, 30H					30H, 34H	31H, 33H			

(Response data)

Data read						Start address		Buffer memory	
1	2	7	8	4	3	(7F0H)	7812H		
31H, 32H	37H, 38H			34H, 33H	6	(7F2H)	6543H		
7F0H			7F2H						

Batch write (command: TW)

Write data to the buffer memory of a special function module.

Message format

The following shows the message format of the request data and response data of the command.

Request data

T 54H	W 57H	Message wait	Start address	Byte length	Special function module No.	Write data
----------	----------	--------------	---------------	-------------	-----------------------------	------------

Response data

There is no response data for this command.

Data specified by request data

Command

ACPU common

T 54H	W 57H
----------	----------

Message wait

Specify the delayed time of the response transmission. (☞ Page 347 Message wait)

Start address

Specify the start address of the buffer memory to be written in five digits. (☞ Page 386 Start address)

Byte length

Convert the numerical value to 2-digit ASCII code (hexadecimal), and send it from the upper digits.

Specify the byte length within the following ranges:

- $1 \leq \text{Byte length} \leq 128$

Special function module No.

Specify in two characters. (☞ Page 386 Special function module No.)

Write data

Store the data written to buffer memory.



The content of one data may cross 2 or 3 bytes depending on the special function module. For the specifications of byte length, refer to the manual of each module.

Communication example

Write data of 4 bytes under the following conditions.

- Message wait: 0 ms
- Start address: 27FAH
- Byte length: 4 bytes
- Special function module No.: 13 (input/output signals are 120H to 13FH)

(Request data)

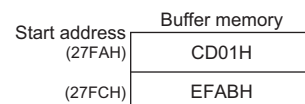
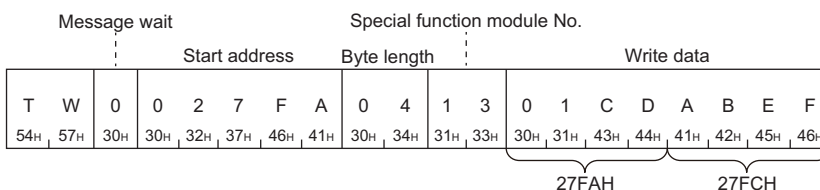

17.7 Loopback Test

A loopback test checks whether the communication function between an external device and C24 operates normally.

Loopback test (Command: TT)

Return the characters received from an external device to the external device unchanged.

Message format

The following shows the message format of the request data and response data of the command.

Request data

T 54H	T 54H	Message wait	Character length	Loopback data
----------	----------	--------------	------------------	---------------

Response data

Character length	Loopback data
------------------	---------------

Data specified by request data

Command

ACPU common

T 54H	T 54H
----------	----------

Message wait

Specify the delayed time of the response transmission. (☞ Page 347 Message wait)

Character length

Convert the numerical value to 2-digit ASCII code (hexadecimal), and send it from the upper digits.

Specify the character length within the following range:

- $1 \leq \text{Character length} \leq 254$

Loopback data

Store the loopback data for character length.

Data stored by response data

Character length

The same data as request data is stored.

Loopback data

The same data as request data is stored.



Specify 'FF' for PC No.

Communication example

Return 5-digit data received from an external device to the external device unchanged under the following conditions.

- Message wait: 0 ms
- Character length: 5 characters
- Loopback data: 'ABCDE'

(Request data)

		Message wait				Character length		Loopback data		
T	T	0	0	5	A	B	C	D	E	
54 _H	54 _H	30 _H	30 _H	35 _H	41 _H	42 _H	43 _H	44 _H	45 _H	

(Response data)

Character length		Loopback data				
0	5	A	B	C	D	E
30 _H	35 _H	41 _H	42 _H	43 _H	44 _H	45 _H

18 COMMUNICATING USING 1E FRAMES

This chapter explains the functions when accessing using 1E frame and their message format. 1E frame is compatible with the communication function supported by MELSEC-A series Ethernet interface modules. Only the commands for 1E frame explained in this chapter can be used for 1E frame.

18.1 Message Format

This section explains the message format when communicating data using 1E frame.

Message format

Request message

Header	Subheader	PC No.	ACPU monitoring timer	Request data
--------	-----------	--------	-----------------------	--------------

Response message (Normal completion: Response data)

Header	Subheader	End code	Response data
--------	-----------	----------	---------------

Response message (Normal completion: No response data)

Header	Subheader	End code
--------	-----------	----------

Response message (Abnormal completion)

Header	Subheader	End code	Abnormal code
--------	-----------	----------	---------------

Setting data

Set the following items.

Item	Description	Reference
Header	A header of Ethernet. Normally, it is added automatically.	Page 392 Header
Subheader	Set the command type.	Page 392 Subheader
PC No.	Specify the network module station No. of an access target.	Page 393 PC No.
ACPU monitoring timer	Set the wait time up to the completion of reading and writing processing.	Page 394 ACPU monitoring timer
Request data	Set the commands that indicates request content.	Page 397 Read and Write Device Memory
Response data	For the response data, store the read data for the command at normal completion. Refer to "Response data" rows of each command.	Page 418 Read and Write Extended File Register Page 432 Read and Write Buffer Memory of Special Function Module
End code Abnormal code	The command processing result is stored.	Page 395 End code, Abnormal code

18.2 Details of Setting Data

This section explains how to specify the common data items and their content in each message.

Header

A header for TCP/IP and UDP/IP. A header of a request message is added on the external device side and sent. Normally, it is added automatically by an external device. A header for a response message is set automatically by E71.

Subheader

Set the command type. (☞ Page 396 Commands and Function List for 1E Frame)

The setting values for each command are as follows.

Function	Subheader		Reference
	Request message	Response message	
Read and write device memory	00H	80H	Page 403 Batch read in bit units (command: 00)
	01H	81H	Page 405 Batch read in word units (command: 01)
	02H	82H	Page 407 Batch write in bit units (command: 02)
	03H	83H	Page 409 Batch write in word units (command: 03)
	04H	84H	Page 410 Test in bit units (random write) (command: 04)
	05H	85H	Page 412 Test in word units (random write) (command: 05)
	06H	86H	Page 415 Register monitor data(command: 06, 07)
	07H	87H	Page 415 Register monitor data(command: 06, 07)
	08H	88H	Page 416 Monitor in bit units (command: 08)
Read and write extended file register	09H	89H	Page 417 Monitor in word units (command: 09)
	17H	97H	Page 419 Batch read (command: 17)
	18H	98H	Page 421 Batch write (command: 18)
	19H	99H	Page 423 Test (random write) (command: 19)
	1AH	9AH	Page 426 Register monitor data (command: 1A)
	1BH	9BH	Page 427 Monitoring (command: 1B)
	3BH	BBH	Page 428 Direct read (command: 3B)
Read and write buffer memory of special function module	3CH	BCH	Page 430 Direct write (command: 3C)
	0EH	8EH	Page 434 Batch read (command: 0E)
	0FH	8FH	Page 436 Batch write (command: 0F)

Setting method

■Data communication in ASCII code

Convert the numerical value to 2-digit ASCII code (hexadecimal), and send it from the upper digits.

■Data communication in binary code

Send a 1-byte numerical value.

Ex.

Device memory batch read (word units)

Request message

ASCII code	Binary code					
<table border="1"> <tr> <td>0</td> <td>0</td> </tr> <tr> <td>30H</td> <td>30H</td> </tr> </table>	0	0	30H	30H	<table border="1"> <tr> <td>00H</td> </tr> </table>	00H
0	0					
30H	30H					
00H						

Response message

ASCII code	Binary code					
<table border="1"> <tr> <td>8</td> <td>0</td> </tr> <tr> <td>38H</td> <td>30H</td> </tr> </table>	8	0	38H	30H	<table border="1"> <tr> <td>80H</td> </tr> </table>	80H
8	0					
38H	30H					
80H						

PC No.

Specify the station No. of the access target.

Accessing the connected station (host station)

Specify 'FF'.

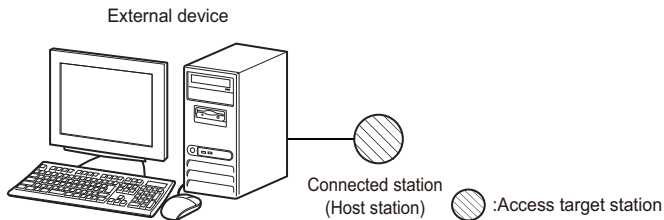

Accessing other stations via network

Specify the network module station No.01H to 40H (1 to 64) of the access target.

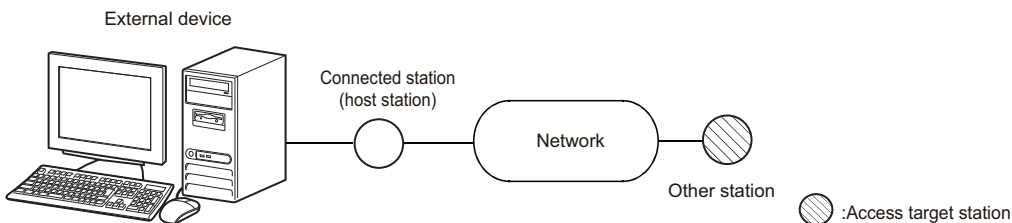

Setting method

■Data communication in ASCII code

Convert the numerical value to 2-digit ASCII code (hexadecimal), and send it from the upper digits.

■Data communication in binary code

Send a 1-byte numerical value.

Ex.

Accessing the connected station (host station)

ASCII code	Binary code
F F 46H 46H	FFH

When accessing other station of network station No. '3'.

ASCII code	Binary code
0 3 30H 33H	03H

Point

The station No. of the network module can be checked by using the following parameters of Engineering tool.

- GX Developer and GX Works2: "Network Parameter"
- GX Works3: "Module Parameter"

The network module station No. is set in decimal. However, the PC No. is set in hexadecimal.

When specifying the network of the access target is required, set "Valid Module During Other Station Access" with an Engineering tool.

ACPU monitoring timer

Set the wait time up to the completion of reading and writing processing.

- 0000H (0): Wait infinitely (Waits until a processing is completed.)
- 0001H to FFFFH (1 to 65535): Waiting time (unit: 250 ms)

To perform normal data communication, using the timer within the setting range in the table below is recommended depending on the communication destination.

Access target	The recommended value for monitoring timer
Connected station (host station)	1H to 28H (0.25 s to 10 s)
Other station	2H to F0H (0.5 s to 60 s)

Point

When accessing QnACPU or ACPUs for the first time, the wait time for CPU monitoring timer is required before receiving a response message because QnACPU identifies the CPU type. Be sure to set a value within the range of recommended range.

Setting method

■Data communication in ASCII code

Convert the numerical value to 4-digit ASCII code (hexadecimal), and send it from the upper digits.

■Data communication in binary code

Send 2-byte numerical values from lower byte (L: bits 0 to 7).

Ex.

When specifying '10H' for the monitoring timer

ASCII code	Binary code										
<table border="1"><tr><td>0</td><td>0</td><td>1</td><td>0</td></tr><tr><td>30H</td><td>30H</td><td>31H</td><td>30H</td></tr></table>	0	0	1	0	30H	30H	31H	30H	<table border="1"><tr><td>10H</td><td>00H</td></tr></table>	10H	00H
0	0	1	0								
30H	30H	31H	30H								
10H	00H										

End code, Abnormal code

The command processing result is stored.

End code

At normal completion, '0' is stored.

At abnormal completion, an error code of the access target is stored.

Error code indicates the content of occurred error.

If more than one error occurs at the same time, the error code detected first is returned.

For the content of error code and its corrective action, refer to the user's manual of the module used.

📖 QCPU User's Manual (Hardware Design, Maintenance and Inspection)

📖 MELSEC-L CPU Module User's Manual (Hardware Design, Maintenance and Inspection)

📖 Q Corresponding Ethernet Interface Module User's Manual (Basic)

📖 MELSEC-L Ethernet Interface Module User's Manual (Basic)

Abnormal code

When an end code is '5BH', the details of abnormal content are displayed.

Setting method

■Data communication in ASCII code

Convert the numerical value to 2-digit ASCII code (hexadecimal), and send it from the upper digits.

■Data communication in binary code

Use a 1-byte value.

Ex.

Normal completion

ASCII code	Binary code
0 0 30H 30H	00H

When Error code '10H' is returned

ASCII code	Binary code
1 0 31H 30H	10H

When error code '5BH' and an abnormal code '10H' (PC No. error) are returned,

ASCII code	Binary code
5 B 1 0 35H 42H 31H 30H	5BH 10H

18.3 Commands and Function List for 1E Frame

Use the following commands for data communication using 1E frame.

Function		Command	Description	
Device memory ^{*1}	Batch read	Bit units	00H	Reads bit devices (X, Y, M, etc.) in 1-point units.
		Word units	01H	Reads bit devices (X, Y, M, etc.) in 16-point units. Reads word devices (D, T, C, etc.) in 1-point units.
	Batch write	Bit units	02H	Writes bit devices (X, Y, M, etc.) in 1-point units.
		Word units	03H	Writes bit devices (X, Y, M, etc.) in 16-point units. Writes word devices (D, T, C, etc.) in 1-point units.
	Test (random write)	Bit units	04H	Specify the devices and device numbers of bit devices (X, Y, M, etc.) in 1-point units randomly, and set/reset them.
		Word units	05H	Specify the devices and device numbers of bit devices (X, Y, M, etc.) in 16-point units randomly, and set/reset them. Specify the devices and device numbers of word devices (D, T, C, etc.) in 1-point units randomly, and write them.
	Register monitor data ^{*2}	Bit units	06H	Registers bit devices (X, Y, M, etc.) to be monitored in 1-point units
		Word units	07H	Registers bit devices (X, Y, M, etc.) to be monitored in 16-point units. Registers word devices (D, T, C, etc.) to be monitored in 1-point units.
	Monitoring	Bit units	08H	Monitors the devices registered by monitor data registration.
		Word units	09H	
Extended file register	Batch read		17H	Reads extended file register (R) in 1-point units.
	Batch write		18H	Writes extended file register (R) in 1-point units.
	Test (random write)		19H	Specify the block numbers and device numbers in 1-point units and write them to the extended file register (R) randomly.
	Register monitor data ^{*2}		1AH	Registers extended file register (R) in 1-point units.
	Monitoring		1BH	Monitors extended file register (R) with monitor data registered.
	Direct read		3BH	Reads extended file register in 1-point units with direct designation.
	Direct write		3CH	Writes extended file register in 1-point units by direct specification.
Special function module	Batch read		0EH	Reads the content in the buffer memory of a special function module.
	Batch write		0FH	Writes data to the buffer memory of a special function module.

*1 Use the dedicated commands for extended registers when performing extended file registers read/write.

*2 The devices that can be registered to E71 is for 1 command out of the three types of commands (06H, 07H, 1AH).
The specified device recently used by any of the above commands is registered to E71.

18.4 Read and Write Device Memory

This section explains the specification content and examples of the request data and the response data when reading and writing device memory.

For the message formats other than request data and response data, refer to the following sections.

☞ Page 391 Message Format, Page 391 Details of Setting Data

Point

To read and write the extended file register, use the commands dedicated to the extended file register.

☞ Page 418 Read and Write Extended File Register

Considerations

Considerations when reading/writing data to module other than ACPU module

■ Accessible devices

Only the devices with the same names that exist in ACPU can be accessed within the device range of AnACPU.

The following devices cannot be accessed from the external devices:

- Added devices
- Latch relay (L) and step relay (S)
- File register (R)

■ Special relays and special registers

Special relays and special registers can be accessed within the following range.

- Access SM1000 to SM1255 by specifying M9000 to M9255.
- Access SD1000 to SD1255 by specifying D9000 to D9255.

■ Universal model QCPU

Use the Universal model QCPU with a serial number whose first five digits are '10102' or later.

When the module with the serial number whose first five digits are '10101' or earlier, access using 3E frame or 4E frame.

When accessing the built-in Ethernet port of the CPU module, refer to the following manual.

📖 QnUCPU User's Manual (Communication via Built-in Ethernet Port)

Data to be specified in command

Device codes and device numbers

The settings of each device when reading/writing device memory can be performed using device code and device number as shown in the following figure.

Specify the device to be accessed by a device code and a device number.

The data order differs between ASCII code or binary code.

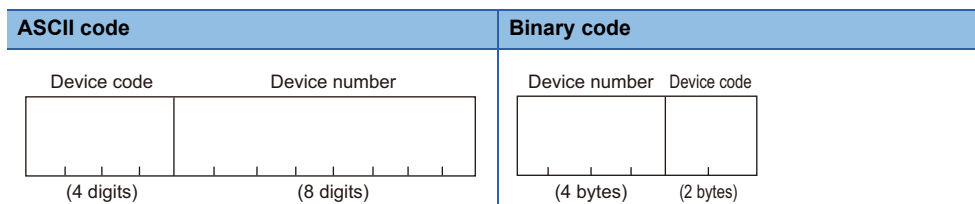

■ Data communication in ASCII code

- Device code: Convert the numerical value to 4-digit ASCII code (hexadecimal), and send it from the upper digits.
- Device number: Convert the numerical value to 8-digit ASCII code (hexadecimal), and send it from the upper digits.

■ Data communication in binary code

- Device number: Send 4-byte numerical values from the lower byte (L: bits 0 to 7).
- Device code: Send 2-byte numerical values from lower byte (L: bits 0 to 7).

Ex.

Data register (D) 1234 (device number is decimal)

Convert a device number to hexadecimal. '1234' (decimal)→'4D2' (hexadecimal)

ASCII code		Binary code	
4 34H, 34H, 32H, 30H	0 0 0 0 0 4 D 2 30H, 30H, 30H, 30H, 30H, 34H, 44H, 32H	D2H, 04H, 00H, 00H	20H, 44H

For the values of each device code, refer to the following section.

□: Space

Device name	Symbol	Type	Representation	Device code		
Input	X	Bit	Hexadecimal	X□	5820H	
Output	Y	Bit	Hexadecimal	Y□	5920H	
Internal relay (include in latch relay and step relay)	M/L/S	Bit	Decimal	M□	4D20H	
Annunciator	F	Bit	Decimal	F□	4620H	
Link relay	B	Bit	Hexadecimal	B□	4220H	
Timer	Current value	T	Word	Decimal	TN	544EH
	Contact		Bit	Decimal	TS	5453H
	Coil		Bit	Decimal	TC	5443H
Counter	Current value	C	Word	Decimal	CN	434EH
	Contact		Bit	Decimal	CS	4353H
	Coil		Bit	Decimal	CC	4343H
Data register	D	Word	Decimal	D□	4420H	
Link register	W	Word	Hexadecimal	W□	5720H	
File register	R	Word	Decimal	R□	5220H	

Access the devices within the range that can be used in the access target CPU.

For the accessible device range, refer to the following section.

☞ Page 399 Accessible device range

Point 

- For word unit specification, the head device number of bit device must be specified in multiple of 16.
- For special relay M9000 or later, (9000 + multiple of 16) can be specified.

Accessible device range

■List of devices (ACPU other than AnU)

Specify the device number within the range of the access target module.

○: Accessible, —: No device

Device	Device range	Device number	A1S A1SH A1SJ A1SJH A1 A1N	A2S A2SH A2 A2N A2C A2CJ A0J2H	A2-S1 A2N-S1	A3 A3N	A2A	A2A-S1	A3A
Input	X0 to X0FF	0000H to 00FFH	○	○			○		
	X100 to X1FF	0100H to 01FFH	—	○			○		
	X200 to X3FF	0200H to 03FFH	—	—	○		—	○	
	X400 to X7FF	0400H to 07FFH	—	—		○	—		○
Output	Y0 to Y0FF	0000H to 00FFH	○	○			○		
	Y100 to Y1FF	0100H to 01FFH	—	○			○		
	Y200 to Y3FF	0200H to 03FFH	—	—	○		—	○	
	Y400 to Y7FF	0400H to 07FFH	—	—		○	—		○
Internal relay (Including latch relay and step relay)	M0 to M2047	0000H to 07FFH	○	○			○		
	M2048 to M8191	0800H to 1FFFH	—	—			○		
	M9000 to M9255	2328H to 2427H	○	○			○		
Annunciator	F0 to F255	0000H to 00FFH	○	○			○		
	F256 to F2047	0100H to 07FFH	—	—			○		
Link relay	B0 to B3FF	0000H to 03FFH	○	○			○		
	B400 to BFFF	0400H to 0FFFH	—	—			○		
Timer	Current value	T0 to T255	○	○			○		
		T256 to T2047	—	—			○		
	Contact	T0 to T255	○	○			○		
		T256 to T2047	—	—			○		
	Coil	T0 to T255	○	○			○		
		T256 to T2047	—	—			○		
Counter	Current value	C0 to C255	○	○			○		
		C256 to C1023	—	—			○		
	Contact	C0 to C255	○	○			○		
		C256 to C1023	—	—			○		
	Coil	C0 to C255	○	○			○		
		C256 to C1023	—	—			○		
Data register	D0 to D1023	0000H to 03FFH	○	○			○		
	D1024 to D6143	0400H to 17FFH	—	—			○		
	D9000 to D9255	2328H to 2427H	○	○			○		
Link register	W0 to W3FF	0000H to 03FFH	○	○			○		
	W400 to WFFF	0400H to 0FFFH	—	—			○		
File register	R0 to R4095	0000H to 0FFFH	—	○			○		
	R4096 to R8191	1000H to 1FFFH	—	—		○	○		

Restriction

- Do not write data to the devices which cannot be written in the range of the special relays (M9000 to M9255) and special registers (D9000 to D9255). For details on the special relays and special registers, refer to manual of ACPU to be accessed.
- For L and S, perform accessing by specifying 'M' (For example, to access L100, specify M100.)

■List of devices (AnUCPU, QnACPU)

Specify the device within the range of AnACPU.

☞ Page 397 Considerations when reading/writing data to module other than ACPU module

○: Accessible, ×: Not accessible, —: No device

Device	Device range	Device number	A2US A2U	A2US-S1 A2USH-S1 A2U-S1	A3U A4U	Q2A Q2AS Q2ASH	Q2A-S1 Q2AS-S1 Q2ASH-S1	Q3A Q4A Q4AR
Input	X0 to X1FF	0000H to 01FFH	○			○		
	X200 to X3FF	0200H to 03FFH	—	○		—	○	
	X400 to X7FF	0400H to 07FFH	—		○	—		○
Output	Y0 to Y1FF	0000H to 01FFH	○			○		
	Y200 to Y3FF	0200H to 03FFH	—	○		—	○	
	Y400 to Y7FF	0400H to 07FFH	—		○	—		○
Internal relay (Including latch relay and step relay)	M0 to M8191	0000H to 1FFFH	○			○		
	M9000 to M9255 (SM1000 to SM1255)	2328H to 2427H	○			○		
Annunciator	F0 to F2047	0000H to 07FFH	○			○		
Link relay	B0 to BFFF	0000H to 0FFFH	○			○		
Timer	Current value	T0 to T2047	○			○		
	Contact	T0 to T2047	○			○		
	Coil	T0 to T2047	○			○		
Counter	Current value	C0 to C1023	○			○		
	Contact	C0 to C1023	○			○		
	Coil	C0 to C1023	○			○		
Data register	D0 to D6143	0000H to 17FFH	○			○		
	D9000 to D9255 (SD1000 to SD1255)	2328H to 2427H	○			○		
Link register	W0 to WFFF	0000H to 0FFFH	○			○		
File register	R0 to R8191	0000H to 1FFFH	○			×		

Restriction

- Do not write data to the devices which cannot be written in the range of the special relays (M9000 to M9255) and special registers (D9000 to D9255). For details on the special relays and special registers, refer to the programming manual of ACPU.
- For L and S, perform accessing by specifying 'M' (For example, to access L100, specify M100.)

■ Device list (QCPU, LCPU, safety CPU)

Specify the device within the range of AnACPU.

☞ Page 397 Considerations when reading/writing data to module other than ACPU module

○: Accessible, ×: Not accessible, —: No device

Device		Device range	Device number	Basic model QCPU Safety CPU	QCPU other than left LCPU
Input		X0 to X7FF	0000H to 07FFH	○	
Output		Y0 to Y7FF	0000H to 07FFH	○	
Internal relay		M0 to M8191	0000H to 1FFFH	○	
		M9000 to M9255 (SM1000 to SM1255)	2328H to 2427H	—	○
Annunciator		F0 to F1023	0000H to 03FFH	○	
		F1024 to F2047	0400H to 07FFH	—	○
Link relay		B0 to B7FF	0000H to 07FFH	○	
		B800 to BFFF	0800H to 0FFFH	—	○
Timer	Current value	T0 to T511	0000H to 01FFH	○	
		T512 to T2047	0200H to 07FFH	—	○
	Contact	T0 to T511	0000H to 01FFH	○	
		T512 to T2047	0200H to 07FFH	—	○
	Coil	T0 to T511	0000H to 01FFH	○	
		T512 to T2047	0200H to 07FFH	—	○
Counter	Current value	C0 to C511	0000H to 01FFH	○	
		C512 to C1023	0200H to 03FFH	—	○
	Contact	C0 to C511	0000H to 01FFH	○	
		C512 to C1023	0200H to 03FFH	—	○
	Coil	C0 to C511	0000H to 01FFH	○	
		C512 to C1023	0200H to 03FFH	—	○
Data register		D0 to D6143	0000H to 17FFH	○	
		D9000 to D9255 (SD1000 to SD1255)	2328H to 2427H	—	○
Link register		W0 to W7FF	0000H to 07FFH	○	
		W800 to WFFF	0800H to 0FFFH	—	○
File register		R0 or more	0000H or more	×	

Number of device points

Specify the number of device points to be read or written.

Specify the number of device points in one command within the device points that can be processed in one communication.

☞ Page 466 Number of Processing per One Communication

Specify '00' for 256 points.

■Data communication in ASCII code

Convert the numerical value to 2-digit ASCII code (hexadecimal), and send it from the upper digits.

Use capitalized code for alphabetical letter.

■Data communication in binary code

Send a 1-byte numerical value.

Ex.

5 points, 20 points, 256 points

Number of device points	ASCII code	Binary code					
5 points	<table border="1"><tr><td>0</td><td>5</td></tr><tr><td>30H</td><td>35H</td></tr></table>	0	5	30H	35H	<table border="1"><tr><td>05H</td></tr></table>	05H
0	5						
30H	35H						
05H							
20 points	<table border="1"><tr><td>1</td><td>4</td></tr><tr><td>31H</td><td>34H</td></tr></table>	1	4	31H	34H	<table border="1"><tr><td>14H</td></tr></table>	14H
1	4						
31H	34H						
14H							
256 points	<table border="1"><tr><td>0</td><td>0</td></tr><tr><td>30H</td><td>30H</td></tr></table>	0	0	30H	30H	<table border="1"><tr><td>00H</td></tr></table>	00H
0	0						
30H	30H						
00H							

Read data, write data

The read data is stored for reading, and the data to be written is stored for writing. The data order differs between bit units or word units.

Batch read in bit units (command: 00)

Read bit devices (X, Y, M, etc.) in 1-point units.

Message format

The following shows the message format of the request data and response data of the command.

Specify the command type by subheader. (👉 Page 392 Subheader)

Request data

Head device	Number of device points	Fixed value
-------------	-------------------------	-------------

Response data

The data for the number of device points are stored.

(👉 Page 402 Read data, write data)

Point

For ASCII code, when the number of device points are specified in an odd number, one byte of dummy data (30H) will be added to the response data. For example, if a data for three points are read, data for four points is returned. The last byte will be a dummy data.

Data specified by request data

Head device

Specify the head device number of bit devices to be read. (👉 Page 397 Device codes and device numbers)

Number of device points

Specify the number of the bit device points to be read.

Specify '00H' when the number of device points is to 256 points. (👉 Page 402 Number of device points)

Fixed value

Fixed to '0'.

ASCII code	Binary code					
<table border="1"> <tr><td>0</td><td>0</td></tr> <tr><td>30H</td><td>30H</td></tr> </table>	0	0	30H	30H	<table border="1"> <tr><td>00H</td></tr> </table>	00H
0	0					
30H	30H					
00H						

Communication example

Read the bit devices in the CPU module with E71 mounted under the following conditions.

- Head device: M100
- Number of device points: 12 points

■Data communication in ASCII code

(Request data)

Head device												Number of device points			
4	D	2	0	0	0	0	0	0	0	6	4	0	C	0	0
34H	44H	32H	30H	30H	30H	30H	30H	30H	30H	36H	34H	30H	43H	30H	30H

(Response data)

Data for the number of specified device points											
1	0	1	0	1	0	1	0	1	0	1	0
31H	30H	31H	30H	31H	30H	31H	30H	31H	30H	31H	30H
(M100)				to							(M111)

■Data communication in binary code

(Request data)

Head device						Number of device points	
64H	00H	00H	00H	20H	4DH	0CH	00H

(Response data)

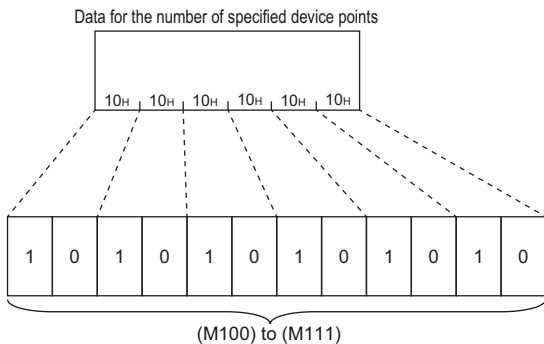

Batch read in word units (command: 01)

Reads bit devices (X, Y, M, etc.) in 16-point units.

Reads word devices (D, T, C, etc.) in 1-point units

Message format

The following shows the message format of the request data and response data of the command.

Request data

Head device	Number of device points	Fixed value
-------------	-------------------------	-------------

Response data

The data for the number of device points are stored.

The data order differs between ASCII code or binary code. (☞ Page 402 Read data, write data)

Data specified by request data

Head device

Specify the head device of the device to be read. (☞ Page 397 Device codes and device numbers)

Number of device points

Specify the device number to be read.

Specify '00H' when the number of device points is to 256 points. (☞ Page 402 Number of device points)

When specifying bit devices, set the head device No. in multiples of 16 (0, 16, ... in decimal notation).

Fixed value

Fixed to '0'.

ASCII code	Binary code					
<table border="1"><tr><td>0</td><td>0</td></tr><tr><td>30H</td><td>30H</td></tr></table>	0	0	30H	30H	<table border="1"><tr><td>00H</td></tr></table>	00H
0	0					
30H	30H					
00H						

Communication example

Read the bit devices in the CPU module with E71 mounted under the following conditions.

- Head device: Y40
- Number of device points: 32 points (2 bytes)

■Data communication in ASCII code

(Request data)

Head device												Number of device points			
5	9	2	0	0	0	0	0	0	0	4	0	0	2	0	0
35H	39H	32H	30H	30H	30H	30H	30H	30H	30H	34H	30H	30H	32H	30H	30H

(Response data)

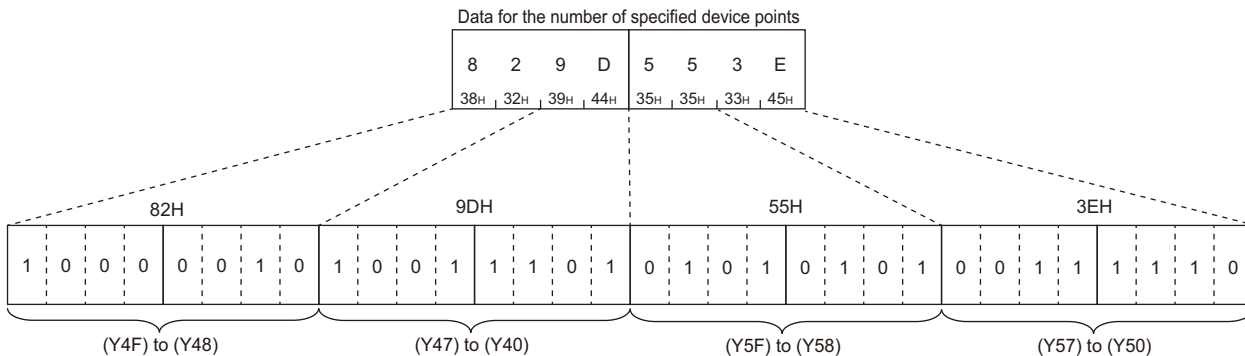

■Data communication in binary code

(Request data)

Head device						Number of device points	
40H	00H	00H	00H	20H	59H	02H	00H

(Response data)

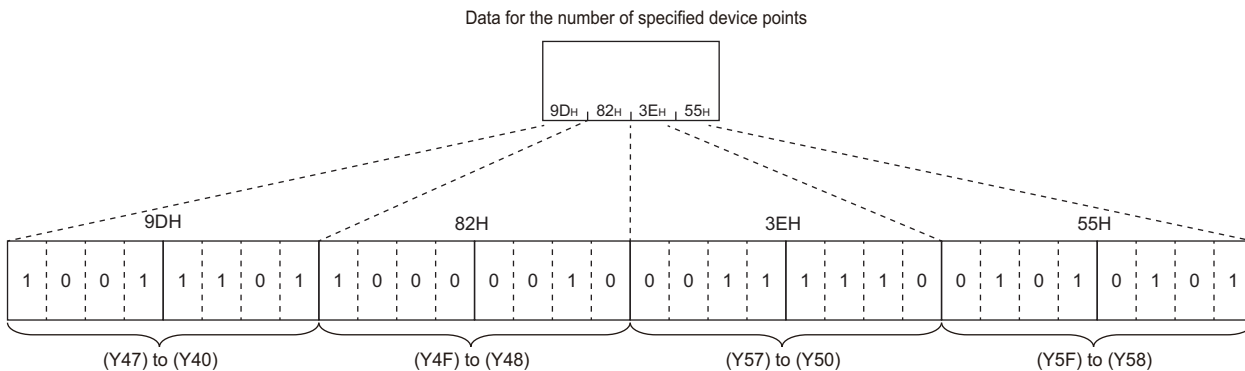

Batch write in bit units (command: 02)

Write bit devices (X, Y, M, etc.) in 1-point units.

Message format

The following shows the message format of the request data and response data of the command.

Request data

Head device	Number of device points	Fixed value	Write data
-------------	-------------------------	-------------	------------

Response data

There is no response data for this command.

Data specified by request data

Head device

Specify the head device of the bit device to be written. (☞ Page 397 Device codes and device numbers)

Fixed value

Fixed to '0'.

ASCII code	Binary code					
<table border="1"><tr><td>0</td><td>0</td></tr><tr><td>30H</td><td>30H</td></tr></table>	0	0	30H	30H	<table border="1"><tr><td>00H</td></tr></table>	00H
0	0					
30H	30H					
00H						

Number of device points

Specify the bit device points to be written.

Specify '00H' when the number of device points is to 256 points. (☞ Page 402 Number of device points)

Write data

Stored data for the number of device points to be written.

- 0 (30H): OFF
- 1 (31H): ON

Communication example

Write the bit devices in the CPU module with E71 mounted under the following conditions.

- Head device: M50
- Number of device points: 12 points

■Data communication in ASCII code

(Request data)

Head device												Number of device points		Data for the number of specified device points						
4	4	2	0	0	0	0	0	0	0	3	2	0	3	0	0	1	1	...	0	1
34H	44H	32H	30H	30H	30H	30H	30H	30H	30H	33H	32H	30H	43H	30H	30H	31H	31H	...	30H	31H
														(M50)	to	(M61)				

■Data communication in binary code

(Request data)

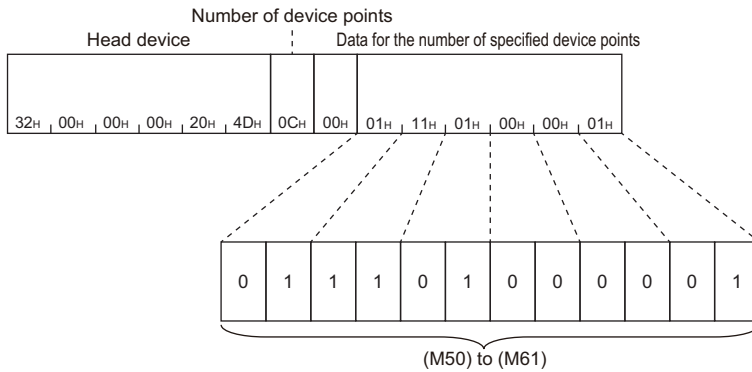

Batch write in word units (command: 03)

Write bit devices (X, Y, M, etc.) in 16-point units.

Write word devices (D, T, C, etc.) in 1-point units.

Message format

The following shows the message format of the request data and response data of the command.

Request data

Head device	Number of device points	Fixed value	Write data
-------------	-------------------------	-------------	------------

Response data

There is no response data for this command.

Data specified by request data

Head device

Specify the head device of the device to be written.

Number of device points

Specify the number of device points to be written.

Specify '00H' when the number of device points is to 256 points.

When specifying bit devices, set the head device No. in multiples of 16 (0, 16, ... in decimal notation).

Fixed value

Fixed to '0'.

ASCII code	Binary code					
<table border="1"> <tr><td>0</td><td>0</td></tr> <tr><td>30H</td><td>30H</td></tr> </table>	0	0	30H	30H	<table border="1"> <tr><td>00H</td></tr> </table>	00H
0	0					
30H	30H					
00H						

Write data

Stored data for the number of device points to be written.

The data order differs between ASCII code or binary code. (☞ Page 402 Read data, write data)

Communication example

Write the devices in the CPU module with E71 mounted under the following conditions.

- Head device: D100
- Number of device points: 3 points

Data communication in ASCII code

(Request data)

Head device												Number of device points				Data for the number of specified device points											
4	4	2	0	0	0	0	0	0	0	6	4	0	3	0	0	1	2	3	4	9	8	7	6	0	1	0	9
34H	34H	32H	30H	30H	30H	30H	30H	30H	30H	36H	34H	30H	33H	30H	30H	31H	32H	33H	34H	39H	38H	37H	36H	30H	31H	30H	39H
																(D100)			(D101)			(D102)					

Data communication in binary code

(Request data)

Head device						Number of device points		Data for the number of specified device points					
64H	00H	00H	00H	20H	44H	03H	00H	34H	12H	76H	98H	09H	01H
								(D100)		(D101)		(D102)	

Test in bit units (random write) (command: 04)

Specify the devices and device numbers of bit devices (X, Y, M, etc.) in 1-point units randomly, and set/reset them.

Message format

The following shows the message format of the request data and response data of the command.

Request data

There is no request data for this command.

Number of device points (n points)	Fixed value	Specified device (first point)	ON/OFF specification (first point)	...	Specified device (nth point)	ON/OFF specification (nth point)
------------------------------------	-------------	--------------------------------	------------------------------------	-----	------------------------------	----------------------------------

Response data

There is no response data for this command.

Data specified by request data

Number of device points

Specify the number of points of the bit device to be set/reset. (☞ Page 402 Number of device points)

Fixed value

Fixed to '0'.

ASCII code	Binary code					
<table border="1"> <tr><td>0</td><td>0</td></tr> <tr><td>30H</td><td>30H</td></tr> </table>	0	0	30H	30H	<table border="1"> <tr><td>00H</td></tr> </table>	00H
0	0					
30H	30H					
00H						

Specified device

Specify the bit devices to be set/reset. (☞ Page 397 Device codes and device numbers)

ON/OFF specification

Specify set/reset.

Processing	ASCII code	Binary code					
Reset	<table border="1"> <tr><td>0</td><td>0</td></tr> <tr><td>30H</td><td>30H</td></tr> </table>	0	0	30H	30H	<table border="1"> <tr><td>00H</td></tr> </table>	00H
0	0						
30H	30H						
00H							
Set	<table border="1"> <tr><td>0</td><td>1</td></tr> <tr><td>30H</td><td>31H</td></tr> </table>	0	1	30H	31H	<table border="1"> <tr><td>01H</td></tr> </table>	01H
0	1						
30H	31H						
01H							

Communication example

Set/reset the bit devices in CPU module with E71 mounted under the following conditions.

- Number of device points: 3 points
- Data for the number of specified device points: Specify Y94 to ON, M60 to OFF, and B26 to ON.

■Data communication in ASCII code

(Request data)

Number of device points	Specified device (first point)	ON/OFF specification (first point)
0 3 30H, 33H	5 9 2 0 0 0 0 0 0 0 0 0 9 4 35H, 39H, 32H, 30H, 30H, 30H, 30H, 30H, 30H, 30H, 30H, 39H, 34H	0 1 30H, 31H
	(Y94)	(ON)
	4 D 2 0 0 0 0 0 0 0 0 3 C 34H, 44H, 32H, 30H, 30H, 30H, 30H, 30H, 30H, 30H, 33H, 43H	0 0 30H, 30H
	(M60)	(OFF)
	4 2 2 0 0 0 0 0 0 0 2 6 34H, 32H, 32H, 30H, 30H, 30H, 30H, 30H, 30H, 30H, 32H, 36H	0 1 30H, 31H
	(B26)	(ON)

■Data communication in binary code

(Request data)

Number of device points	Specified device (first point)	ON/OFF specification (first point)	Specified device (second point)	ON/OFF specification (second point)	Specified device (third point)	ON/OFF specification (third point)
03H 00H	94H, 00H, 00H, 00H, 20H, 59H	01H	3CH, 00H, 00H, 00H, 20H, 4DH	00H	26H, 00H, 00H, 00H, 20H, 42H	01H
	(Y94)	(ON)	(M60)	(OFF)	(B26)	(ON)

Test in word units (random write) (command: 05)

Specify the devices and device numbers of bit devices (X, Y, M, etc.) in 16-point units randomly, and set/reset them.
Specify the devices and device numbers of word devices (D, T, C, etc.) in 1-point units randomly, and write them.

Message format

The following shows the message format of the request data and response data of the command.

Request data

Number of device points (n points)	Fixed value	Specified device (first point)	ON/OFF specification (first point)	...	Specified device (nth point)	ON/OFF specification (nth point)
---------------------------------------	-------------	-----------------------------------	--	-----	---------------------------------	--

Response data

There is no response data for this command.

Data specified by request data

Number of device points

Specify the number of device points to be set/reset. (☞ Page 402 Number of device points)

When specifying bit devices, set the head device No. in multiples of 16 (0, 16, ... in decimal notation).

Fixed value

Fixed to '0'.

ASCII code	Binary code
0 0 30H, 30H	00H

Specified device

Specify the device to be set/reset. (☞ Page 397 Device codes and device numbers)

ON/OFF specification

Store the data to be written.

Communication example

Set/reset the devices in the CPU module with E71 mounted under the following condition.

- Number of device points: 3 points
- Data for the number of specified device points: Specify Y80 to 8F to ON/OFF, W26 to '1234H', and the current value of C18 to '50H'.

■Data communication in ASCII code

(Request data)

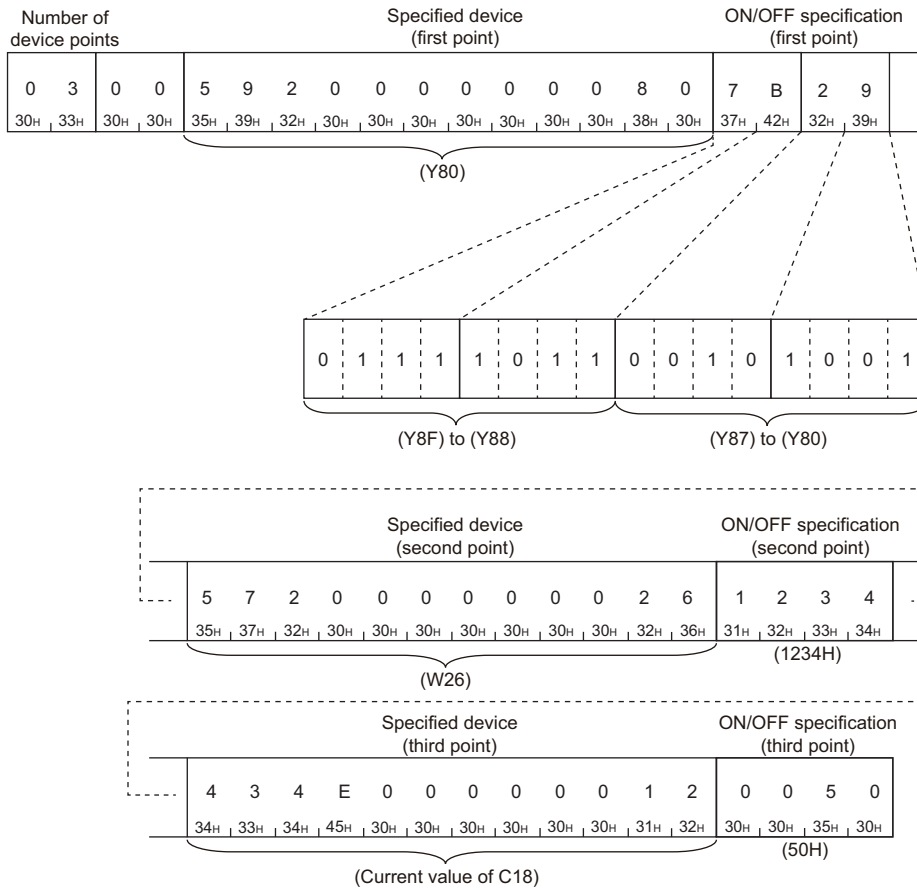

■Data communication in binary code

(Request data)

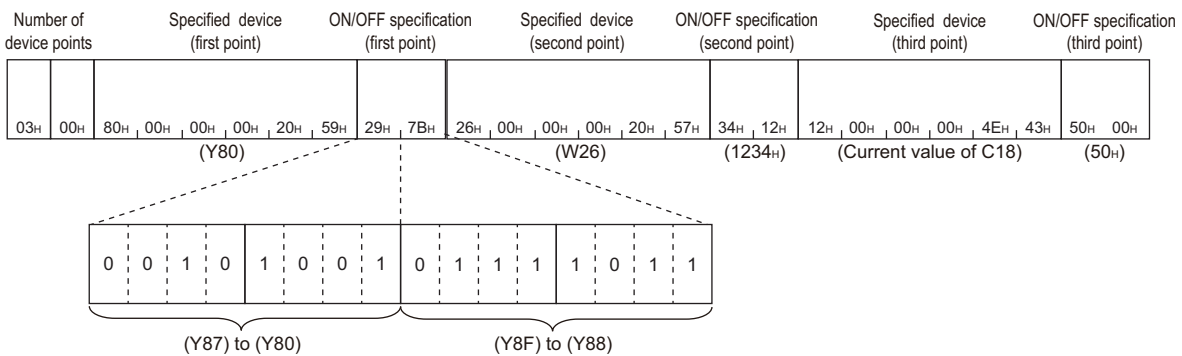

Monitor device memory (command: 06, 07, 08, 09)

The ON/OFF status or contents of devices in the CPU module can be monitored from an external device by registering the devices and device numbers to be monitored to E71 in advance and executing the monitor command from the external device.

When reading device memory in batch, the read device numbers will be consecutive. However, when reading them using the monitor command, the devices can be monitored randomly by specifying the arbitrary devices and device numbers.

For monitoring the extended file register, refer to the following section.

 Page 425 Monitor extended file registers (command: 1A, 1B)

Procedure for monitoring

1. Register the devices to be monitored from the external device to E71 by registering monitor data.
2. Execute the read processing by a monitor command.
3. Process the data.
4. If do not change the devices to be monitored, return to step 2, and repeat the process.

Point

- When monitoring data as the procedure shown above, the monitor data registration is required. If monitoring data without registering the data, a protocol error occurs.
 - The content of registered monitor data is deleted when turning the power OFF or the resetting the CPU module.
 - There are three types of commands for monitor data registration; expansion file register, device memory bit unit, and device memory word unit. The recently registered one command out of three types of commands can be registered to E71.
 - When registering device memory of the CPU module as a monitoring data from more than one external devices on the same station, the recently registered device memory will be available since the registration data is overwritten.
-

Register monitor data(command: 06, 07)

Registers bit devices (X, Y, M, etc.) to be monitored in 1-point units. (Command: 06)

Registers bit devices (X, Y, M, etc.) to be monitored in 16-point units. (Command: 07)

Registers word devices (D, T, C, etc.) to be monitored in 1-point units. (Command: 07)

Request data

Number of device points (n points)	Fixed value	Device number (first point)	...	Device number (nth point)
---------------------------------------	----------------	--------------------------------	-----	------------------------------

- Number of device points: Specify the number of devices to be registered as a monitoring data. (Page 402 Number of device points)
- Fixed value: '0'

ASCII code	Binary code					
<table border="1"> <tr><td>0</td><td>0</td></tr> <tr><td>30H</td><td>30H</td></tr> </table>	0	0	30H	30H	<table border="1"> <tr><td>00H</td></tr> </table>	00H
0	0					
30H	30H					
00H						

- Device number: Specify the device number to be registered as a monitor data. (Page 397 Device codes and device numbers)

Point

When specifying bit devices at monitor data registration in word unit, set the device numbers in multiples of 16 (0, 16, ... in decimal notation).

Response data

There is no response data for this command.

Communication example

Register devices as a monitoring data in the CPU module with E71 mounted under the following conditions.

- Number of device points: 3 points
- Device number: Y46, M12, B2C

(Request data)

(ASCII code)

Number of device points		Device number																					
0	3	0	0	5	9	2	0	0	0	0	0	0	0	0	4	6							
30H	33H	30H	30H	35H	39H	32H	30H	30H	30H	30H	30H	30H	30H	30H	34H	36H							
(Y46)																							
Device number												Device number											
4	D	2	0	0	0	0	0	0	0	0	C	4	2	2	E	0	0	0	0	0	0	2	C
34H	44H	32H	30H	30H	30H	30H	30H	30H	30H	30H	43H	34H	32H	32H	45H	30H	30H	30H	30H	30H	30H	32H	43H
(M12)												(B2C)											

(Binary code)

Number of device points		Device number				Device number				Device number									
03H	00H	46H	00H	00H	00H	20H	59H	0CH	00H	00H	00H	20H	4DH	2CH	00H	00H	00H	20H	42H
(Y46)								(M12)				(B2C)							

Monitor in bit units (command: 08)

Monitor the bit devices for which monitor data is registered.

Request data

There is no request data for this command.

Response data

The value of the read device is stored in byte units.

The data order differs between ASCII code or binary code.



If the number of device points registered to be monitored is an odd number, dummy data 0 (30H) is added when the monitoring is executed. For example, if the number of device points registered to be monitored is three points, data for four points is returned. The last byte will be a dummy data.

Communication example

Monitor the devices registered with monitor data registration in the CPU module with E71 mounted under the following conditions.

- Number of registered device points: 3 points
- Number of registered device numbers: Y46, M12, B2C

(Response data)

(ASCII code)

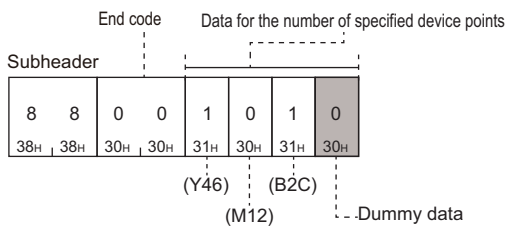

(Binary code)

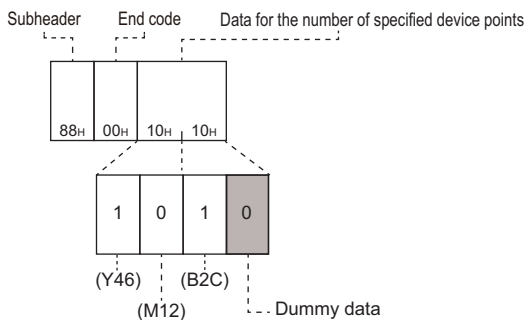

Monitor in word units (command: 09)

Monitor word devices and bit devices (16 point units) which are registered as a monitor data.

Request data

There is no request data for this command.

Response data

The value of the read device is stored in word units.

The data order differs between ASCII code or binary code.

Communication example

Monitor the devices registered with monitor data registration in the CPU module with E71 mounted under the following conditions.

- Number of registered device numbers: Y50 to 5F, D38, W1E

(Response data)

(ASCII code)

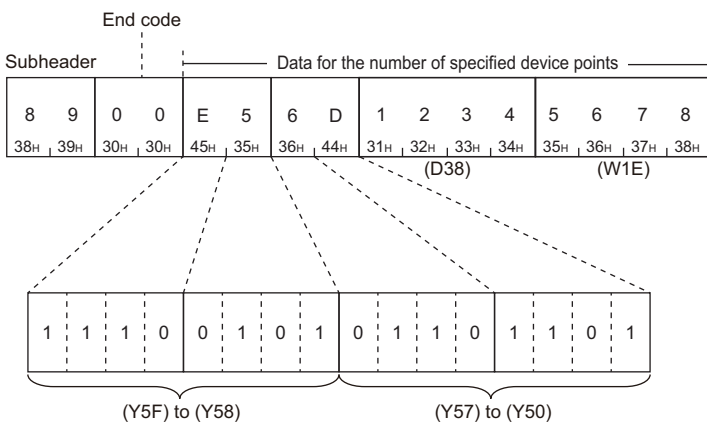

(Binary code)

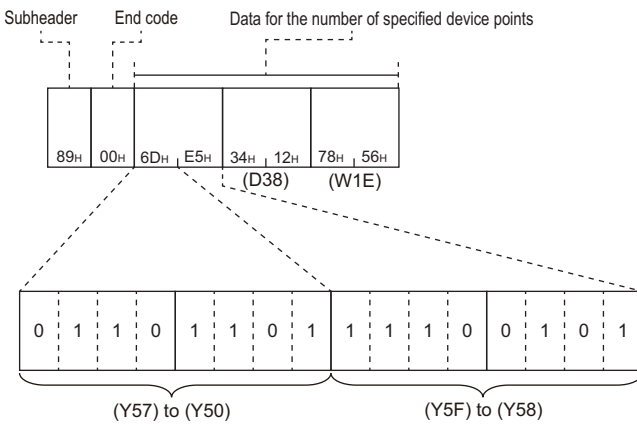

18.5 Read and Write Extended File Register

The extended file register is a memory area that stores required data and operation result for various data processing and AnACPU and AnUSCPU extended file register dedicated instructions by using the software package for extended file register 'SW0GHP-UTLPC-FN1' or 'SW0SRX-FNUP' (hereinafter abbreviated to UTLP-FN1 and FNUP). The extended file register uses free area of user memory area in CPU module as a file register.

This section explains the commands for reading and writing extended file register.

For the message formats other than request data and response data, refer to the following sections.

☞ Page 391 Message Format, Page 391 Details of Setting Data

Restriction

For the considerations when reading and writing extended file register, refer to the following section.

☞ Page 371 Considerations for reading and writing extended file register

For the specification method of the extended file register, refer to the following section.

☞ Page 372 Specification method for extended file register

Data to be specified in command

Block number

Specify the block number of the extended file register.

■Data communication in ASCII code

Convert the numerical value to 4-digit ASCII code (hexadecimal), and send it from the upper digits.

■Data communication in binary code

Send 2-byte numerical value.

Device number

Specify the device number of the extended file register.

When reading or writing (command: 3B, 3C) extended file register directly, refer to the following section.

☞ Page 373 Device number (address) specification using AnA/AnUCPU common commands

■Data communication in ASCII code

Convert the numerical value to 12-digit ASCII code (hexadecimal), and send it from the upper digits.

■Data communication in binary code

Send 6-byte numerical value.

Batch read (command: 17)

Read extended file register (R) in 1-point units.

Message format

The following shows the message format of the request data and response data of the command.

■Request data

(ASCII code)

Block No.	Device number	Number of device points	0 0 30H 30H
-----------	---------------	-------------------------	------------------

(Binary code)

Device number	Block No.	Number of device points	00H
---------------	-----------	-------------------------	-----

■Response data

The data for the number of device points are stored.

The data order differs between ASCII code or binary code. (☞ Page 402 Read data, write data)

Data specified by request data

■Device number

Specify the head device of the extended file register to be read. (☞ Page 418 Device number)

■Block number

Specify the block number of the extended file register to be read. (☞ Page 418 Block number)

■Number of device points

Specify the points of extended file register to be read.

Specify '00H' when the number of device points is to 256 points. (☞ Page 402 Number of device points)

Communication example

Read the extended file registers in the CPU module with E71 mounted under the following conditions.

- Block number: No.2
- Device number: R70
- Number of device points: 3 points

■Data communication in ASCII code

(Request data)

Block No.				Device number										Number of device points					
0	0	0	2	5	2	2	0	0	0	0	0	0	0	4	6	0	3	0	0
30H	30H	30H	32H	35H	32H	32H	30H	30H	30H	30H	30H	30H	30H	34H	36H	30H	33H	30H	30H

(Response data)

Data for the number of specified device points											
1	2	3	4	8	7	6	5	0	1	3	F
31H	32H	33H	34H	38H	37H	36H	35H	30H	31H	33H	46H
(R70 in No.2)				(R71 in No.2)				(R72 in No.2)			

■Data communication in binary code

(Request data)

Device number				Block No.				Number of device points			
46H	00H	00H	00H	20H	52H	02H	00H	03H	00H		

(Response data)

Data for the number of specified device points											
34H	12H	65H	87H	3FH	01H						
(R70 in No.2)				(R71 in No.2)				(R72 in No.2)			

Batch write (command: 18)

Write to extended file register (R) in 1-point units.

Message format

The following shows the message format of the request data and response data of the command.

Request data

(ASCII code)

Block No.	Device number	Number of device points	0 0 30H 30H	Data for the number of specified device points
-----------	---------------	-------------------------	------------------	--

(Binary code)

Device number	Block No.	Number of device points	00H	Data for the number of specified device points
---------------	-----------	-------------------------	-----	--

Response data

There is no response data for this command.

Data specified by request data

Device number

Specify the head device number of the extended file register to be written. (☞ Page 418 Device number)

Block number

Specify the block number of the extended file register to be written. (☞ Page 418 Block number)

Number of device points

Specify the number of the data points to be write.

Specify '00H' when the number of device points is to 256 points. (☞ Page 402 Number of device points)

Data for the number of specified device points

Store the data to be written to the extended file registers.

Communication example

Write data to extended file registers in the CPU module with E71 mounted under the following conditions.

- Block number: No.3
- Device number: R100
- Number of device points: 3 points

■Data communication in ASCII code

(Request data)

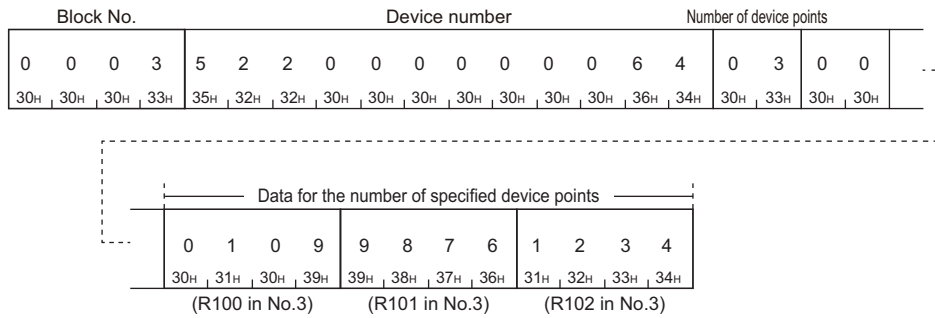

■Data communication in binary code

(Request data)

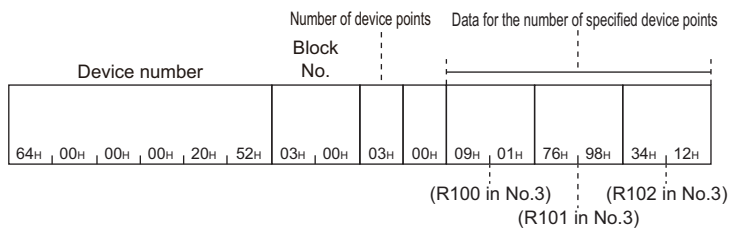

Test (random write) (command: 19)

Specify the block numbers and device numbers in 1-point units and write them randomly to extended file register (R).

Message format

The following shows the message format of the request data and response data of the command.

■Request data

(ASCII code)

Number of device points	0	0	Block No.	Device number	Write data
	30H	30H			

(Binary code)

Number of device points	00H	Device number	Block No.	Write data

■Response data

There is no response data for this command.

Data specified by request data

■Number of device points

Specify the number of points of the data to be written. (☞ Page 402 Number of device points)

■Device number

Specify the head device of the extended file register to be written. (☞ Page 418 Device number)

■Block number

Specify the block number of the extended file register to be written. (☞ Page 418 Block number)

■Write data

Store the data to be written to the extended file registers.

Monitor extended file registers (command: 1A, 1B)

The contents of extended file registers in the CPU module can be monitored from an external device by registering the block numbers and device numbers to be monitored to E71 in advance and executing the monitor command from the external device.

When reading extended file register in batch, the read device numbers will be consecutive. However, when reading them using the monitor command, the extended file registers can be read randomly by specifying the file registers of arbitrary block numbers and device numbers.

Procedure for monitoring

1. Register block numbers and device numbers of the extended file registers to be monitored to E71 by monitor data registration.
2. Execute read processing by monitoring.
3. Process the data.
4. If do not change the devices to be monitored, return to step 2, and repeat the process.

Point

- When monitoring data as the procedure shown above, the monitor data registration is required. If monitoring data without registering the data, an error occurs (END code: 57H).
- The content of registered monitor data is deleted when turning the power OFF or the resetting the CPU module.
- There are three types of commands for monitor data registration; extended file register, device memory bit unit, and device memory word unit. The recently registered one command out of three types of commands can be registered to E71.
- When registering device memory of the CPU module as a monitoring data from more than one external devices on the same station, the recently registered device memory will be available since the registration data is overwritten.

Register monitor data (command: 1A)

Register device numbers to be monitored in 1-point units.

Request data

(ASCII code)

Number of device points	0 0		Block No.	Device number
	30H	30H		

(Binary code)

Number of device points	00H		Device number	Block No.
	00H			

- Number of device points: Specify the number of points of the extended file registers to be registered as a monitor data. (Page 402 Number of device points)
- Device number: Specify the extended file registers to be registered as a monitor data. (Page 418 Device number)
- Block number: Specify the block number of the extended file registers to be registered as a monitor data. (Page 418 Block number)

Response data

There is no response data for this command.

Communication example

Register devices as a monitoring data in the CPU module with E71 mounted under the following conditions.

- Data to be registered: R15 of block number 2 and R28 of block number 3

(Request data)

(ASCII code)

Number of device points		Block No.				Device number															
0	2	0	0	0	0	0	2	5	2	2	0	0	0	0	0	0	0	0	0	0	6
30H	32H	30H	30H	30H	30H	30H	32H	35H	32H	32H	30H	30H	30H	30H	30H	30H	30H	30H	30H	30H	46H

R15 of block No.2

Block No.				Device number												
0	0	0	3	5	2	2	0	0	0	0	0	0	0	0	1	C
30H	30H	30H	33H	35H	32H	32H	30H	30H	30H	30H	30H	30H	30H	30H	31H	43H

R28 of block No.3

(Binary code)

Number of device points		Device number				Block No.		Device number				Block No.					
02H	00H	0FH	00H	00H	00H	20H	52H	02H	00H	1CH	00H	00H	00H	20H	52H	03H	00H

(R15 in block No.2) (R28 in block No.3)

Monitoring (command: 1B)

Monitor the extended file registers registered by monitor data registration.

■Data specified by request data

There is no request data for this command.

■Response data

Store the monitoring result.

■Communication example

Monitor the following extended file registers registered by monitor data registration.

- Monitor data registration: R15 in block number 2 and R28 in block number 3

(Response data)

(ASCII code)

Monitoring result							
E	5	6	D	1	2	3	4
45H	35H	36H	44H	31H	32H	33H	34H

(R15 in block No.2) (R28 in block No.3)

(Binary code)

Monitoring result			
6DH	E5H	34H	12H

(R15 in block No.2) (R28 in block No.3)

Direct read (command: 3B)

Read extended file register in 1-point (1 word) units by specifying the consecutive device numbers of extended file register. This command is a dedicated command for AnACPU. (The command is equivalent to AnA/AnUCPU common commands of 1C protocol.)

Message format

The following shows the message format of the request data and response data of the command.

Request data

Device number	Number of device points	Fixed value
---------------	-------------------------	-------------

Response data

The data for the number of device points are stored.

([↩](#) Page 402 Read data, write data)

Data specified by request data

Device number

Specify the start address of the extended file register to be read. ([↩](#) Page 418 Device number)

Number of device points

Specify the points of extended file register to be read.

Specify '00H' when the number of device points is to 256 points. ([↩](#) Page 402 Number of device points)

Fixed value

Fixed to '0'.

ASCII code	Binary code					
<table border="1"><tr><td>0</td><td>0</td></tr><tr><td>30H</td><td>30H</td></tr></table>	0	0	30H	30H	<table border="1"><tr><td>00H</td></tr></table>	00H
0	0					
30H	30H					
00H						

Communication example

Read the extended file registers directly in the CPU module with E71 mounted under the following conditions.

- Block number: No.0
- Device number: R70
- Number of device points: 4 points

■Data communication in ASCII code

(Request data)

Block No.				Device number								Number of device points						
0	0	0	2	5	2	2	0	0	0	0	0	0	4	6	0	4	0	0
30H	30H	30H	32H	35H	32H	32H	30H	30H	30H	30H	30H	30H	34H	36H	30H	34H	30H	30H

(Response data)

Data for the number of specified device points															
1	2	3	4	8	7	6	5	0	1	3	F	0	0	2	0
31H	32H	33H	34H	38H	37H	36H	35H	30H	31H	33H	46H	30H	30H	32H	30H
(R70 in No.0)				(R71 in No.0)				(R72 in No.0)				(R73 in No.0)			

■Data communication in binary code

(Request data)

Device number						Number of device points	
46H	00H	00H	00H	20H	52H	04H	00H

(Response data)

Data for the number of specified device points							
34H	12H	65H	87H	3FH	01H	20H	00H
(R70 in No.0)		(R71 in No.0)		(R72 in No.0)		(R73 in No.0)	

Direct write (command: 3C)

Write extended file register in 1-point (1 word) units by specifying the consecutive device number of extended file register. This command is a dedicated command for AnACPU. (The command is equivalent to AnA/AnUCPU common commands of 1C protocol.)

Message format

The following shows the message format of the request data and response data of the command.

Request data

Device number	Number of device points	Fixed value	Data for the number of specified device points
---------------	-------------------------	-------------	--

Response data

There is no response data for this command.

Data specified by request data

Device number

Specify the start address of the extended file register to be written. (☞ Page 418 Device number)

Number of device points

Specify the number of extended file registers to be written. (☞ Page 402 Number of device points)
Specify '00H' when the number of device points is to 256 points.

Fixed value

Fixed to '0'.

ASCII code	Binary code					
<table border="1"><tr><td>0</td><td>0</td></tr><tr><td>30H</td><td>30H</td></tr></table>	0	0	30H	30H	<table border="1"><tr><td>00H</td></tr></table>	00H
0	0					
30H	30H					
00H						

Data for the number of specified device points

Stored data for the number of device points to be written.

Communication example

Write data to the extended file registers directly in the CPU module with E71 mounted under the following conditions.

- Block number: No.0
- Device number: R100
- Number of device points: 3 points

■Data communication in ASCII code

(Request data)

Device number												Number of device points				Data for the number of specified device points											
5	2	2	0	0	0	0	0	0	0	6	4	0	3	0	0	0	1	0	9	9	8	7	6	1	2	3	4
35H	32H	32H	30H	30H	30H	30H	30H	30H	30H	36H	34H	30H	33H	30H	30H	30H	31H	30H	39H	39H	38H	37H	36H	31H	32H	33H	34H
																(R100 in No.0)				(R101 in No.0)				(R102 in No.0)			

■Data communication in binary code

(Request data)

Device number								Number of device points				Data for the number of specified device points							
64H	00H	00H	00H	20H	52H	03H	00H	09H	01H	76H	98H	34H	12H						
								(R100 in No.0)				(R101 in No.0)				(R102 in No.0)			

18.6 Read and Write Buffer Memory of Special Function Module

The section explains the commands that read/write data from/to buffer memory of MELSEC-A series special function module. For the message formats other than request data and response data, refer to the following sections.

☞ Page 391 Message Format, Page 391 Details of Setting Data

Point

This command accesses in byte units.

Data to be specified in command

This section explains the contents and specification methods for data items which are set in each command related to the access to the special function module buffer memory.

Start address

Specify the start address of the buffer memory to be read/written.

The value to specify is the same as 1C frame.

☞ Page 384 Special function module No.

■Data communication in ASCII code

Convert the numerical value to 6-digit ASCII code (hexadecimal), and send it from the upper digits.

■Data communication in binary code

Send 3-byte numerical values from lower byte (L: bits 0 to 7).

Ex.

When the head area address is 1E1H

ASCII code	Binary code
0 0 0 1 E 1 30H, 30H, 30H, 31H, 45H, 31H	E1H, 01H, 00H

Byte length

Specify the byte length of the buffer memory to be read or written.

Specify '00' for 256 bytes.

■Data communication in ASCII code

Convert the numerical value to 2-digit ASCII code (hexadecimal), and send it from the upper digits.

■Data communication in binary code

Send a 1-byte numerical value.

Ex.

For 5 bytes, 20 bytes, 256 bytes.

Number of device points	ASCII code	Binary code					
5 bytes	<table border="1"> <tr> <td>0</td> <td>5</td> </tr> <tr> <td>30H</td> <td>35H</td> </tr> </table>	0	5	30H	35H	<table border="1"> <tr> <td>05H</td> </tr> </table>	05H
0	5						
30H	35H						
05H							
20 bytes	<table border="1"> <tr> <td>1</td> <td>4</td> </tr> <tr> <td>31H</td> <td>34H</td> </tr> </table>	1	4	31H	34H	<table border="1"> <tr> <td>14H</td> </tr> </table>	14H
1	4						
31H	34H						
14H							
256 bytes	<table border="1"> <tr> <td>0</td> <td>0</td> </tr> <tr> <td>30H</td> <td>30H</td> </tr> </table>	0	0	30H	30H	<table border="1"> <tr> <td>00H</td> </tr> </table>	00H
0	0						
30H	30H						
00H							

Read data, write data

The read buffer memory value is stored for reading, and the data to be written is stored for writing.

This function reads and writes data in byte units.

☞ Page 160 Read data, write data

Special function module No.

Specify the last input/output signal (I/O address) of the special function module. (Specify the upper 2-digit of 3-digit representation.)

The value to specify is the same as 1C frame.

☞ Page 384 Special function module No.

■Data communication in ASCII code

Convert the numerical value to 2-digit ASCII code (hexadecimal), and send it from the upper digits.

■Data communication in binary code

Send a 1-byte numerical value.

Accessible modules

Special function modules that can be accessed buffer memory are the same as 1C frame.

☞ Page 385 Accessible modules

Batch read (command: 0E)

Read the buffer memory of a special function module.

Message format

The following shows the message format of the request data and response data of the command.

Request data

Start address	Byte length	Special function module No.	Fixed value
---------------	-------------	-----------------------------	-------------

Response data

The data read from buffer memory is stored. (☞ Page 433 Read data, write data)

Data specified by request data

Start address

Specify the buffer memory start address to be read. (☞ Page 432 Start address)

Byte length

Specify the byte length of buffer memory to be read.

Specify '00H' when the number of device points is to 256 points. (☞ Page 433 Byte length)

Special function module No.

Specify the special function module No. of the buffer memory to be read.

Fixed value

Fixed to '0'.

ASCII code	Binary code					
<table border="1"><tr><td>0</td><td>0</td></tr><tr><td>30H</td><td>30H</td></tr></table>	0	0	30H	30H	<table border="1"><tr><td>00H</td></tr></table>	00H
0	0					
30H	30H					
00H						

Communication example

Read the buffer memory of the special function module with E71 mounted in the same station under the following conditions.

- Special function module No.: 13H (buffer memory whose input/output signal is from 120H to 13FH)
- Start address: 7F0H
- Byte length: 4

■Data communication in ASCII code

(Request data)

Start address	Byte length	Special function module No.
0 0 0 7 F 0 30H 30H 30H 37H 46H 30H	0 4 30H 34H	1 3 0 0 31H 33H 30H 30H

(Response data)

Data read			
0 9 30H 39H (7F0H)	1 8 31H 38H (7F1H)	2 0 32H 30H (7F2H)	3 4 33H 34H (7F3H)

■Data communication in binary code

(Request data)

Head address	Byte length	Special function module No.
F0H 07H 00H 04H 13H 00H		

(Response data)

Data read			
09H (7F0H)	18H (7F1H)	20H (7F2H)	34H (7F3H)

Batch write (command: 0F)

Write data to the buffer memory of a special function module.

Message format

The following shows the message format of the request data and response data of the command.

Request data

Start address	Byte length	Special function module No.	Fixed value	Write data (for the length of specified bytes)
---------------	-------------	-----------------------------	-------------	--

Response data

There is no response data for this command.

Data specified by request data

Start address

Specify the buffer memory start address to be read. (☞ Page 432 Start address)

Byte length

Specify the byte length of buffer memory to be read.

Specify '00H' when the number of device points is to 256 points. (☞ Page 433 Byte length)

Special function module No.

Specify the special function module No. of the buffer memory to be read.

Fixed value

Fixed to '0'.

ASCII code	Binary code					
<table border="1"><tr><td>0</td><td>0</td></tr><tr><td>30H</td><td>30H</td></tr></table>	0	0	30H	30H	<table border="1"><tr><td>00H</td></tr></table>	00H
0	0					
30H	30H					
00H						

Write data

Store the data to be written in a buffer memory. (☞ Page 433 Read data, write data)

Communication example

Write data to buffer the memory of the special function module with E71 mounted in the same station under the following conditions.

- Special function module No.: 13H (buffer memory whose input/output signal is from 120H to 13FH)
- Start address: 750H
- Byte length: 4

■Data communication in ASCII code

(Request data)

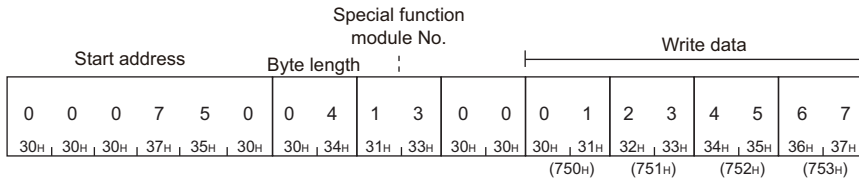

■Data communication in binary code

(Request data)

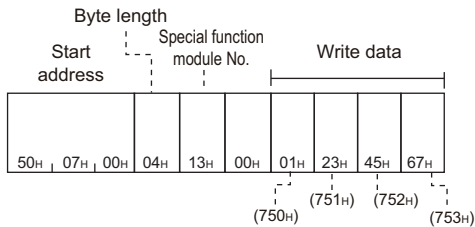

APPENDIX

Appendix 1 Read/Write by Device Extension Specification

Accesses shown below are available by setting the subcommand in a request data to 008□ or 00C0.

- Accessing link direct devices
- Accessing module access devices
- Accessing CPU buffer memory access devices
- Accessing by indexing network No. and the start input/output number
- Accessing by indexing the device number
- Accessing by specifying the device number with the value stored in word device with indirect specification

Device specification method for device extension specification

Replace the device portion in a message format of each command with a message format for extension specification described in this section when the extension is specified.

ASCII

When extension is not specified

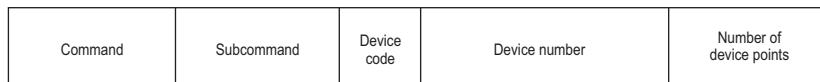

When extension is specified

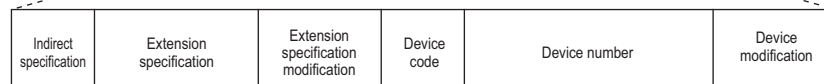

Binary

When extension is not specified

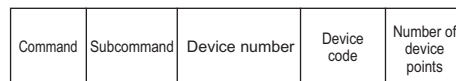

When extension is specified

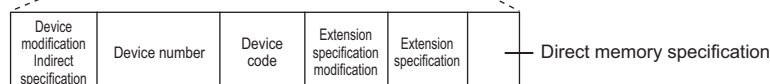

Point

With commands which can specify more than one device, the devices listed in the following section can be accessed by specifying '0' for "Extension specification", "Extension specification modification", "Direct memory specification".

☞ Page 68 Device code list

However, when 008□ or 00C0 is specified by "Subcommand", specify the device in the message format shown in this section. Message formats with extension not specified and message formats with extension specified cannot coexist in the same message.

Subcommands for device extension specification

Use the following subcommands for extension specification.

Item		ASCII code	Binary code										
For MELSEC-Q/ L series	When accessing in word units	<table border="1"> <tr> <td>0</td> <td>0</td> <td>8</td> <td>0</td> </tr> <tr> <td>30H</td> <td>30H</td> <td>38H</td> <td>30H</td> </tr> </table>	0	0	8	0	30H	30H	38H	30H	<table border="1"> <tr> <td>80H</td> <td>00H</td> </tr> </table>	80H	00H
	0	0	8	0									
	30H	30H	38H	30H									
80H	00H												
When accessing in bit units	<table border="1"> <tr> <td>0</td> <td>0</td> <td>8</td> <td>1</td> </tr> <tr> <td>30H</td> <td>30H</td> <td>38H</td> <td>31H</td> </tr> </table>	0	0	8	1	30H	30H	38H	31H	<table border="1"> <tr> <td>81H</td> <td>00H</td> </tr> </table>	81H	00H	
0	0	8	1										
30H	30H	38H	31H										
81H	00H												
When specifying monitor condition	<table border="1"> <tr> <td>0</td> <td>0</td> <td>C</td> <td>0</td> </tr> <tr> <td>30H</td> <td>30H</td> <td>43H</td> <td>30H</td> </tr> </table>	0	0	C	0	30H	30H	43H	30H	<table border="1"> <tr> <td>C0H</td> <td>00H</td> </tr> </table>	C0H	00H	
0	0	C	0										
30H	30H	43H	30H										
C0H	00H												
For MELSEC iQ-R series	When accessing in word units	<table border="1"> <tr> <td>0</td> <td>0</td> <td>8</td> <td>2</td> </tr> <tr> <td>30H</td> <td>30H</td> <td>38H</td> <td>32H</td> </tr> </table>	0	0	8	2	30H	30H	38H	32H	<table border="1"> <tr> <td>82H</td> <td>00H</td> </tr> </table>	82H	00H
	0	0	8	2									
30H	30H	38H	32H										
82H	00H												
When accessing in bit units	<table border="1"> <tr> <td>0</td> <td>0</td> <td>8</td> <td>3</td> </tr> <tr> <td>30H</td> <td>30H</td> <td>38H</td> <td>33H</td> </tr> </table>	0	0	8	3	30H	30H	38H	33H	<table border="1"> <tr> <td>83H</td> <td>00H</td> </tr> </table>	83H	00H	
0	0	8	3										
30H	30H	38H	33H										
83H	00H												

Accessing link direct devices

Access link devices of the network modules such as remote input (RX), remote output (RY), and link special relay (SB).

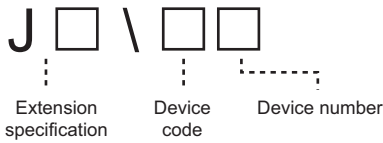

The following device access commands can be used for access.

Function	Command	Subcommand
Batch read	0401	0080, 0081, 0082, 0083
Batch write	1401	0080, 0081, 0082, 0083
Random read	0403	0080, 0082, 00C0
Random write	1402	0080, 0081, 0082, 0083
Batch read multiple blocks	0406	0080, 0082
Batch write multiple blocks	1406	0080, 0082
Register monitor data	0801	0080, 0082, 00C0

Message format for device extension specification

■Data communication in ASCII code

Subcommand type	ASCII code									
For MELSEC-Q/L series	<table border="1"> <thead> <tr> <th>Extension specification</th> <th>Device code</th> <th>Device number</th> </tr> </thead> <tbody> <tr> <td>0 0 J 30H, 30H 4AH</td> <td>0 0 0 30H, 30H, 30H</td> <td>0 0 0 30H, 30H, 30H</td> </tr> <tr> <td>(3 digits)</td> <td>(2 digits)</td> <td>(6 digits)</td> </tr> </tbody> </table>	Extension specification	Device code	Device number	0 0 J 30H, 30H 4AH	0 0 0 30H, 30H, 30H	0 0 0 30H, 30H, 30H	(3 digits)	(2 digits)	(6 digits)
Extension specification	Device code	Device number								
0 0 J 30H, 30H 4AH	0 0 0 30H, 30H, 30H	0 0 0 30H, 30H, 30H								
(3 digits)	(2 digits)	(6 digits)								
For MELSEC iQ-R series	<table border="1"> <thead> <tr> <th>Extension specification</th> <th>Device code</th> <th>Device number</th> </tr> </thead> <tbody> <tr> <td>0 0 J 30H, 30H 4AH</td> <td>0 0 0 0 30H, 30H, 30H, 30H</td> <td>0 0 0 0 30H, 30H, 30H, 30H</td> </tr> <tr> <td>(4 digits)</td> <td>(10 digits)</td> <td></td> </tr> </tbody> </table>	Extension specification	Device code	Device number	0 0 J 30H, 30H 4AH	0 0 0 0 30H, 30H, 30H, 30H	0 0 0 0 30H, 30H, 30H, 30H	(4 digits)	(10 digits)	
Extension specification	Device code	Device number								
0 0 J 30H, 30H 4AH	0 0 0 0 30H, 30H, 30H, 30H	0 0 0 0 30H, 30H, 30H, 30H								
(4 digits)	(10 digits)									

■Data communication in binary code

Subcommand type	Binary code									
For MELSEC-Q/L series	<table border="1"> <thead> <tr> <th>Device number</th> <th>Device code</th> <th>Extension specification</th> </tr> </thead> <tbody> <tr> <td>00H, 00H</td> <td>00H, 00H</td> <td>F9H</td> </tr> <tr> <td>(3 bytes)</td> <td>(1 byte)</td> <td></td> </tr> </tbody> </table>	Device number	Device code	Extension specification	00H, 00H	00H, 00H	F9H	(3 bytes)	(1 byte)	
Device number	Device code	Extension specification								
00H, 00H	00H, 00H	F9H								
(3 bytes)	(1 byte)									
For MELSEC iQ-R series	<table border="1"> <thead> <tr> <th>Device number</th> <th>Device code</th> <th>Extension specification</th> </tr> </thead> <tbody> <tr> <td>00H, 00H</td> <td>00H, 00H</td> <td>F9H</td> </tr> <tr> <td>(4 bytes)</td> <td>(2 bytes)</td> <td></td> </tr> </tbody> </table>	Device number	Device code	Extension specification	00H, 00H	00H, 00H	F9H	(4 bytes)	(2 bytes)	
Device number	Device code	Extension specification								
00H, 00H	00H, 00H	F9H								
(4 bytes)	(2 bytes)									

Data to be specified

Extension specification

Specify the access target network No. in hexadecimal.

- ASCII code: Specify J (4AH) at the head of data. Convert the numerical value to 3-digit ASCII code (hexadecimal), and send it from the upper digits.
- Binary code: Send 2-byte numerical values from the lower byte (L: bits 0 to 7).

Ex.

For network No.8

ASCII code	Binary code										
<table border="1"> <tr> <td>J</td> <td>0</td> <td>0</td> <td>8</td> </tr> <tr> <td>4AH</td> <td>30H</td> <td>30H</td> <td>38H</td> </tr> </table>	J	0	0	8	4AH	30H	30H	38H	<table border="1"> <tr> <td>08H</td> <td>00H</td> </tr> </table>	08H	00H
J	0	0	8								
4AH	30H	30H	38H								
08H	00H										

Point

Using the index register of CPU module, the access target network No. can be specified indirectly.

☞ Page 446 Access to index the network No. and start input/output number

Device code and device number

Specify the following devices. (☞ Page 65 Devices)

- Link input (X)
- Link output (Y)
- Link relay (B)
- Link special relay (SB)
- Link register (W)
- Link special register (SW)

For the values of device codes, refer to the following section.

☞ Page 68 Device code list

Point

Using the index register of CPU module, the access target device number can be specified indirectly.

☞ Page 447 Access to index the device number

Device extension specification example

Access W100 (J1\W100) of network No.1 by specifying subcommand 0080.

Data communication in ASCII code

Subcommand	Extension specification	Device code	Device number
0 0 8 0 30H 30H 38H 30H	0 0 30H 30H	J 0 0 1 4AH 30H 30H 31H	0 0 0 30H 30H 30H
		W * 57H 2AH	0 0 0 1 0 0 30H 30H 30H 31H 30H 30H
			0 0 0 30H 30H 30H

Data communication in binary code

Subcommand	Device number	Device code	Extension specification
80H 00H	00H 00H	00H 01H 00H	B4H
			00H 00H
			01H 00H
			F9H

A

Accessing module access devices

Access buffer memory of an intelligent function module.

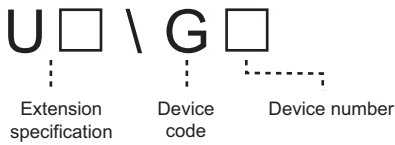

The following device access commands can be used for access.

Function	Command	Subcommand
Batch read	0401	0080, 0082
Batch write	1401	0080, 0082
Random read	0403	0080, 0082, 00C0
Random write	1402	0080, 0082
Batch read multiple blocks	0406	0080, 0082
Batch write multiple blocks	1406	0080, 0082
Register monitor data	0801	0080, 0082, 00C0

Message format for device extension specification

Data communication in ASCII code

Subcommand type	ASCII code							
For MELSEC-Q/L series	<table border="1"> <tr> <td>0 0 30H, 30H</td> <td>U 55H</td> <td>Extension specification</td> <td>0 0 0 30H, 30H, 30H</td> <td>Device code (2 digits)</td> <td>Device number (6 digits)</td> <td>0 0 0 30H, 30H, 30H</td> </tr> </table>	0 0 30H, 30H	U 55H	Extension specification	0 0 0 30H, 30H, 30H	Device code (2 digits)	Device number (6 digits)	0 0 0 30H, 30H, 30H
0 0 30H, 30H	U 55H	Extension specification	0 0 0 30H, 30H, 30H	Device code (2 digits)	Device number (6 digits)	0 0 0 30H, 30H, 30H		
For MELSEC iQ-R series	<table border="1"> <tr> <td>0 0 30H, 30H</td> <td>U 55H</td> <td>Extension specification</td> <td>0 0 0 0 30H, 30H, 30H, 30H</td> <td>Device code (4 digits)</td> <td>Device number (10 digits)</td> <td>0 0 0 0 30H, 30H, 30H, 30H</td> </tr> </table>	0 0 30H, 30H	U 55H	Extension specification	0 0 0 0 30H, 30H, 30H, 30H	Device code (4 digits)	Device number (10 digits)	0 0 0 0 30H, 30H, 30H, 30H
0 0 30H, 30H	U 55H	Extension specification	0 0 0 0 30H, 30H, 30H, 30H	Device code (4 digits)	Device number (10 digits)	0 0 0 0 30H, 30H, 30H, 30H		

Data communication in binary code

Subcommand type	Binary code				
For MELSEC-Q/L series	<table border="1"> <tr> <td>00H, 00H</td> <td>Device number (3 bytes)</td> <td>Device code (1 byte)</td> <td>Extension specification F8H</td> </tr> </table>	00H, 00H	Device number (3 bytes)	Device code (1 byte)	Extension specification F8H
00H, 00H	Device number (3 bytes)	Device code (1 byte)	Extension specification F8H		
For MELSEC iQ-R series	<table border="1"> <tr> <td>00H, 00H</td> <td>Device number (4 bytes)</td> <td>Device code (2 bytes)</td> <td>Extension specification F8H</td> </tr> </table>	00H, 00H	Device number (4 bytes)	Device code (2 bytes)	Extension specification F8H
00H, 00H	Device number (4 bytes)	Device code (2 bytes)	Extension specification F8H		

Data to be specified

Extension specification

Specify the value obtained by dividing the start input/output number of an intelligent function module by 16 in hexadecimal.

- ASCII code: Specify U (55H) at the head of data. Convert the numerical value to 3-digit ASCII code (hexadecimal), and send it from the upper digits.
- Binary code: Send 2-byte numerical values from the lower byte (L: bits 0 to 7).

Ex.

Start input/output number 0010H of a module

ASCII code	Binary code										
<table border="1"> <tr> <td>U</td> <td>0</td> <td>0</td> <td>1</td> </tr> <tr> <td>55H</td> <td>30H</td> <td>30H</td> <td>31H</td> </tr> </table>	U	0	0	1	55H	30H	30H	31H	<table border="1"> <tr> <td>01H</td> <td>00H</td> </tr> </table>	01H	00H
U	0	0	1								
55H	30H	30H	31H								
01H	00H										

Point

Indirect specification of the start input/output number can also be performed by using the CPU module index register.

☞ Page 446 Access to index the network No. and start input/output number

Device code and device number

Specify the following device. (☞ Page 65 Devices)

- Module access device (G)

For the values of device codes, refer to the following section.

☞ Page 68 Device code list

Point

Using the index register of CPU module, the access target device number can be specified indirectly.

☞ Page 447 Access to index the device number

A

Device extension specification example

Access the buffer memory (address: 1) of intelligent function module whose start input/output number is 0030H by specifying subcommand 0080.

Data communication in ASCII code

Subcommand	Extension specification	Device code	Device number
0 0 8 0 30H, 30H, 38H, 30H	0 0 U 0 0 3 30H, 30H, 55H, 30H, 30H, 33H	0 0 0 30H, 30H, 30H	G * 0 0 0 0 0 1 0 0 0 47H, 2AH, 30H, 30H, 30H, 30H, 30H, 31H, 30H, 30H, 30H

Data communication in binary code

Subcommand	Device number	Device code	Extension specification
80H, 00H	00H, 00H	01H, 00H, 00H	ABH, 00H, 00H, 03H, 00H, F8H

Accessing CPU buffer memory access device

Access the buffer memory of RCP.



Extension Device code Device number

The following device access commands can be used for access.

Function	Command	Subcommand
Batch read	0401	0082
Batch write	1401	0082
Random read	0403	0082
Random write	1402	0082
Batch read multiple blocks	0406	0082
Batch write multiple blocks	1406	0082
Register monitor data	0801	0082

Message format for device extension specification

■Data communication in ASCII code

Subcommand type	ASCII code																																																												
For MELSEC iQ-R series	<table border="1" style="width: 100%; text-align: center;"> <tr> <th colspan="4">Extension specification</th> <th colspan="4">Device code</th> <th colspan="4">Device number</th> </tr> <tr> <td>0</td><td>0</td><td>U</td><td>3</td> <td>0</td><td>0</td><td>0</td><td>0</td> <td>0</td><td>0</td><td>0</td><td>0</td> </tr> <tr> <td>30H</td><td>30H</td><td>55H</td><td>33H</td> <td>30H</td><td>30H</td><td>30H</td><td>30H</td> <td>30H</td><td>30H</td><td>30H</td><td>30H</td> </tr> <tr> <td colspan="4"> ----- </td> <td colspan="4"> ----- </td> <td colspan="4"> ----- </td> </tr> <tr> <td colspan="4"></td> <td colspan="4">(4 digits)</td> <td colspan="4">(10 digits)</td> </tr> </table>	Extension specification				Device code				Device number				0	0	U	3	0	0	0	0	0	0	0	0	30H	30H	55H	33H	30H	30H	30H	30H	30H	30H	30H	30H	-----				-----				-----								(4 digits)				(10 digits)			
Extension specification				Device code				Device number																																																					
0	0	U	3	0	0	0	0	0	0	0	0																																																		
30H	30H	55H	33H	30H	30H	30H	30H	30H	30H	30H	30H																																																		
-----				-----				-----																																																					
				(4 digits)				(10 digits)																																																					

■Data communication in binary code

Subcommand type	Binary code																								
For MELSEC iQ-R series	<table border="1" style="width: 100%; text-align: center;"> <tr> <th colspan="2">Device number</th> <th colspan="2">Device code</th> <th colspan="2">Extension specification</th> </tr> <tr> <td>00H</td><td>00H</td> <td>00H</td><td>00H</td> <td>00H</td><td>FAH</td> </tr> <tr> <td colspan="2"> ----- </td> <td colspan="2"> ----- </td> <td colspan="2"> ----- </td> </tr> <tr> <td colspan="2">(4 bytes)</td> <td colspan="2">(2 bytes)</td> <td colspan="2"></td> </tr> </table>	Device number		Device code		Extension specification		00H	00H	00H	00H	00H	FAH	-----		-----		-----		(4 bytes)		(2 bytes)			
Device number		Device code		Extension specification																					
00H	00H	00H	00H	00H	FAH																				
-----		-----		-----																					
(4 bytes)		(2 bytes)																							

Data to be specified

Extension specification

Specify the start input/output number of CPU module with the upper 3 digits of 4-digit in hexadecimal.

- ASCII code: Specify U (55H) at the head of data. Convert the numerical value to 3-digit ASCII code (hexadecimal), and send it from the upper digits.
- Binary code: Send 2-byte numerical values from the lower byte (L: bits 0 to 7).

The start input/output numbers of CPU modules to be specified are as shown below.

CPU number	Start input/output number of CPU module	Value to be specified
CPU No.1	3E00H	3E0H
CPU No.2	3E10H	3E1H
CPU No.3	3E20H	3E2H
CPU No.4	3E30H	3E3H

Ex.

For CPU No.4 (start input/output number: 3E30H)

ASCII code	Binary code										
<table border="1"> <tr> <td>U</td> <td>3</td> <td>E</td> <td>3</td> </tr> <tr> <td>55H</td> <td>33H</td> <td>45H</td> <td>33H</td> </tr> </table>	U	3	E	3	55H	33H	45H	33H	<table border="1"> <tr> <td>E3H</td> <td>03H</td> </tr> </table>	E3H	03H
U	3	E	3								
55H	33H	45H	33H								
E3H	03H										

Point

Indirect specification of the start input/output number of the CPU module can also be performed by using the CPU module index register.

☞ Page 446 Access to index the network No. and start input/output number

Device code and device number

Specify the following devices. (☞ Page 65 Devices)

- CPU buffer memory access device (G)
- CPU buffer memory access device (HG)

For the values of device codes, refer to the following section.

☞ Page 68 Device code list

Point

Using the index register of CPU module, the access target device number can be specified indirectly.

☞ Page 447 Access to index the device number

Device extension specification example

Access the buffer memory (address: 1) of the CPU No.1 (start input/output number: 03E0H) by specifying the subcommand 0082.

Data communication in ASCII code

Subcommand		Extension specification			Device code			Device number																									
0	0	8	2	0	0	U	3	E	0	0	0	0	0	G	*	*	*	0	0	0	0	0	0	0	0	0	0	0	1	0	0	0	0
30H	30H	38H	32H	30H	30H	55H	33H	45H	30H	30H	30H	30H	30H	47H	2AH	2AH	2AH	30H	30H	30H	30H	30H	30H	30H	30H	30H	30H	30H	31H	30H	30H	30H	30H

Data communication in binary code

Subcommand		Device number		Device code		Extension specification								
82H	00H	00H	00H	01H	00H	00H	00H	ABH	00H	00H	00H	E0H	03H	FAH

Access for index modification

Index modification is the indirect specification using index registers.

Accesses shown below are available by setting the subcommand in a request data to 008□ or 00C0.

Target data	Reference
Network No. or start input/output number	Page 446 Access to index the network No. and start input/output number
Device number	Page 447 Access to index the device number

The following device access commands can be used for access.

Function	Command	Subcommand
Random read	0403	0080, 0082, 00C0
Random write	1402	0080, 0081, 0082, 0083
Register monitor data	0801	0080, 0082, 00C0

Access to index the network No. and start input/output number

When accessing a link direct device, the access target network No. can be specified by the index register with indirect specification. Also, when accessing a module access device or a CPU buffer memory access device, the access target start input/output number can be specified by the index register with indirect specification.

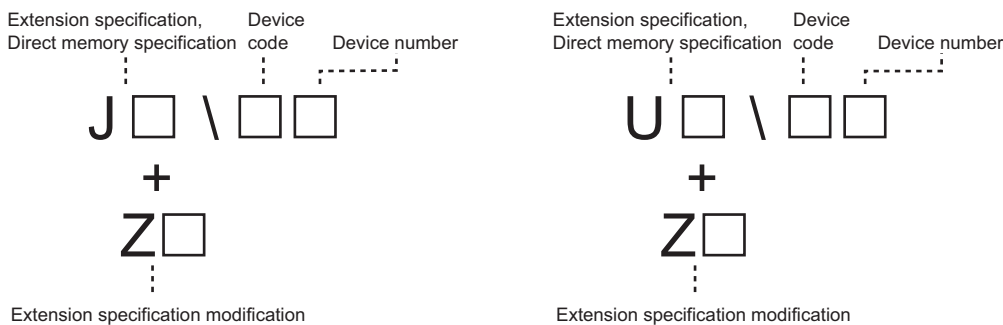

The access target can be switched with one message, by changing the value of the index register in CPU module programs.

Ex.

The access target can be switched by changing the value of 'Z0', when multiple network modules are mounted onto the access target.

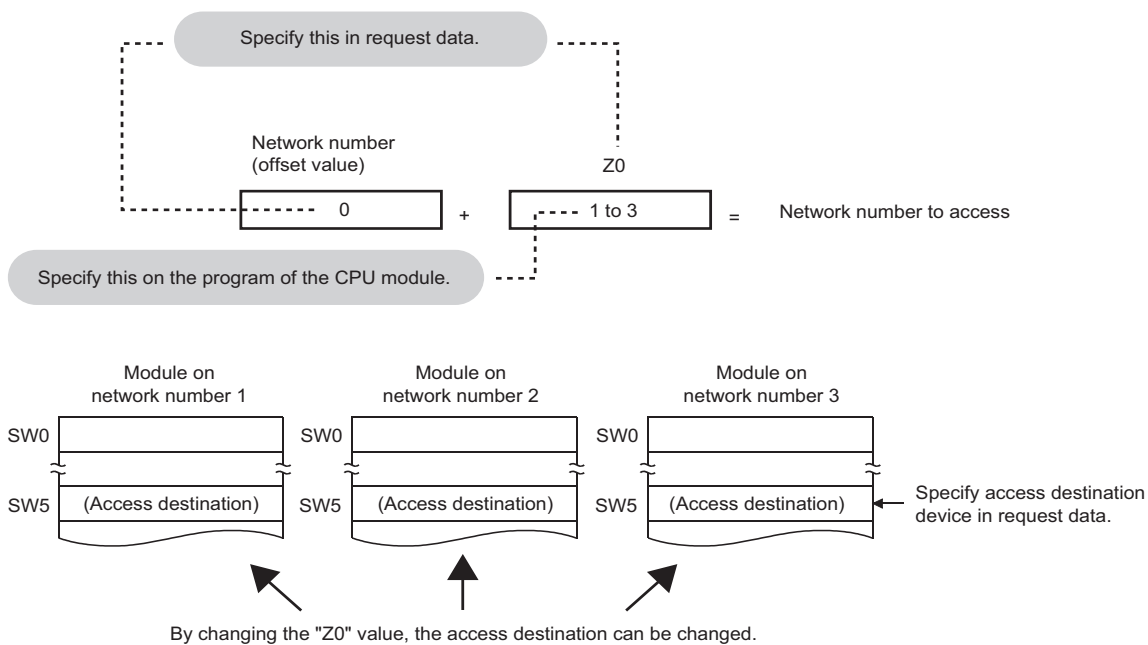

Access to index the device number

When accessing a device, indirect specification of the device number can be performed using index register.

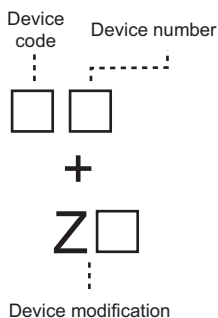

The access target can be switched with one message, by changing the value of the index register in CPU module programs.

Ex.

When accessing D4 by specifying D0 and Z0

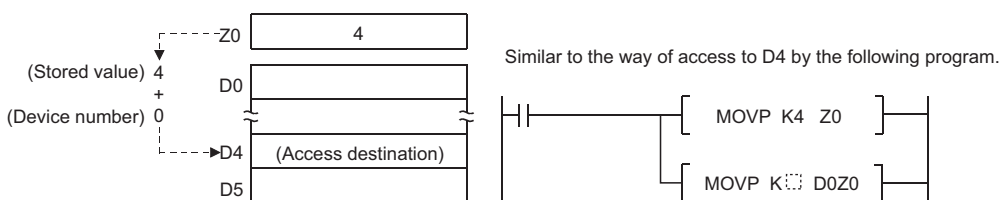
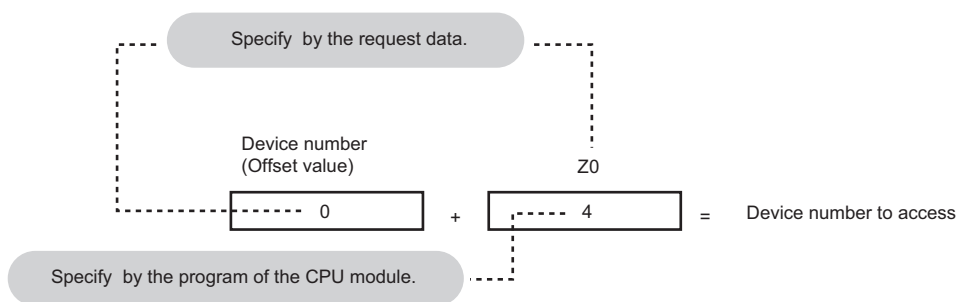

Ex.

When accessing M16 to M31 by specifying M0 and Z0 (Word units)

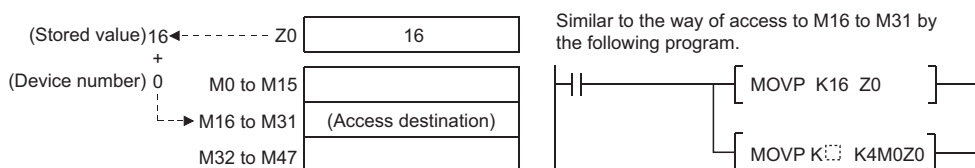
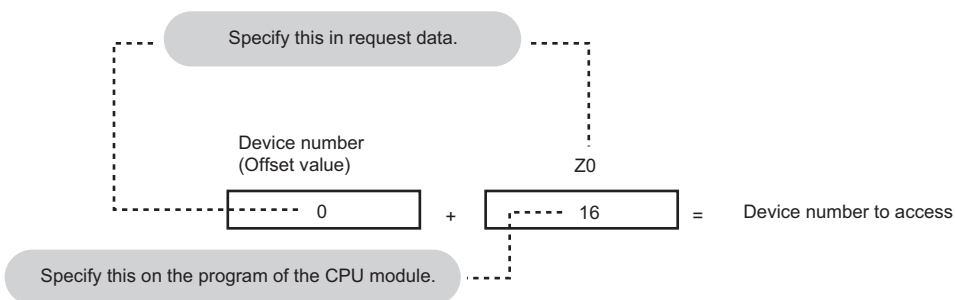

Message format for device extension specification

■Data communication in ASCII code

0 0 30H 30H	Extension specification	Extension specification modification	Device code	Device number	Device modification
------------------	-------------------------	--------------------------------------	-------------	---------------	---------------------

■Data communication in binary code

00H 00H	Device number	Device code	Extension specification modification	Extension specification	Direct memory specification
-----------	---------------	-------------	--------------------------------------	-------------------------	-----------------------------

The following shows the correspondence of each data.

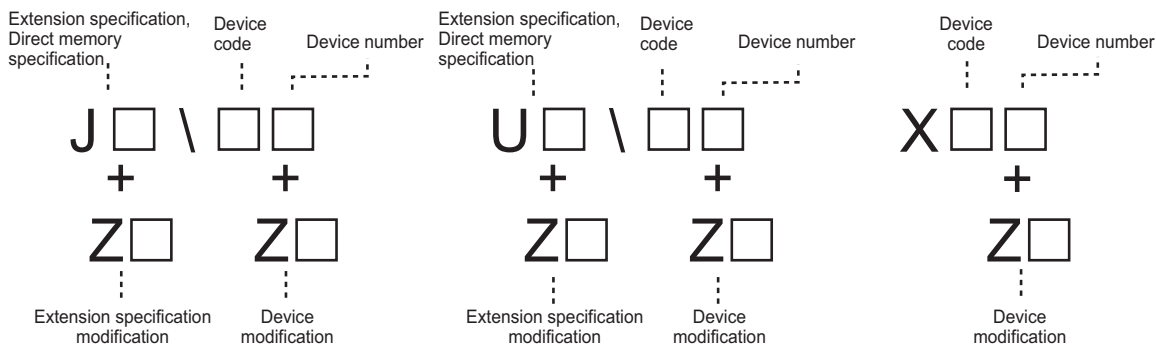

Data to be specified

■Extension specification, device code, and device number

Specify the access target network No. and the offset value of the start input/output number for extension specification.

When indexing a network No. and start input/output number by "Extension specification modification", the values specified by "Extension specification" will be the offset value.

When indexing a device number by "Device modification", the values specified by "Device number" will be the offset value.

For the data to be specified for each access device, refer to the following table.

Item	Reference
Link direct device	Page 441 Data to be specified
Module access device	Page 443 Data to be specified
CPU buffer memory access device	Page 445 Data to be specified

■Direct memory specification (only when communicating in binary code)

Specify the type of access device.

Item	Value to be specified
Link direct device	F9H
Module access device	F8H
CPU buffer memory access device	FAH

Specify '0' when accessing devices other than link direct device, module access device, and CPU buffer memory access device.

Binary code

Specify '0'.

00H 00H

■Extension specification modification

Specify the index register to be used when indexing the value specified by 'Extension specification'.

Access target	Devices to be used	ASCII code		Binary code	
		Device code	Device number	Device number	Fixed value
MELSEC iQ-R series module	Index register	Specify 'Z' and space with 2-digit ASCII code.	Specify the device number in decimal (2-digit ASCII code). (Specification range: 0 to 24)	Specify in hexadecimal. (Specification range: 00H to 18H)	40H
	Long index register	Specify 'LZ' with 2-digit ASCII code.	Specify the device number in decimal (2-digit ASCII code). (Specification range: 0 to 12)	Specify in hexadecimal. (Specification range: 00H to 0CH)	80H
MELSEC-Q/L series module	Index register	Specify 'Z' with 1-digit ASCII code.	Specify the device number in decimal (2-digit ASCII code). (Specification range: 0 to 15)	Specify in hexadecimal. (Specification range: 0 to F)	40H

Ex.

Index register (Z0)

Subcommand type	ASCII code	Binary code										
For MELSEC-Q/L series	<table border="1"> <tr><td>Z</td><td>0</td><td>0</td></tr> <tr><td>5AH</td><td>30H</td><td>30H</td></tr> </table>	Z	0	0	5AH	30H	30H	<table border="1"> <tr><td>00H</td><td>40H</td></tr> </table>	00H	40H		
Z	0	0										
5AH	30H	30H										
00H	40H											
For MELSEC iQ-R series	<table border="1"> <tr><td>Z</td><td></td><td>0</td><td>0</td></tr> <tr><td>5AH</td><td>20H</td><td>30H</td><td>30H</td></tr> </table>	Z		0	0	5AH	20H	30H	30H	<table border="1"> <tr><td>00H</td><td>40H</td></tr> </table>	00H	40H
Z		0	0									
5AH	20H	30H	30H									
00H	40H											

Ex.

Long index register (LZ0)

Subcommand type	ASCII code	Binary code										
For MELSEC iQ-R series	<table border="1"> <tr><td>L</td><td>Z</td><td>0</td><td>0</td></tr> <tr><td>4CH</td><td>5AH</td><td>30H</td><td>30H</td></tr> </table>	L	Z	0	0	4CH	5AH	30H	30H	<table border="1"> <tr><td>00H</td><td>80H</td></tr> </table>	00H	80H
L	Z	0	0									
4CH	5AH	30H	30H									
00H	80H											

When do not perform index modification, specify '0'.

Subcommand type	ASCII code	Binary code										
For MELSEC-Q/L series	<table border="1"> <tr><td>0</td><td>0</td><td>0</td></tr> <tr><td>30H</td><td>30H</td><td>30H</td></tr> </table>	0	0	0	30H	30H	30H	<table border="1"> <tr><td>00H</td><td>00H</td></tr> </table>	00H	00H		
0	0	0										
30H	30H	30H										
00H	00H											
For MELSEC iQ-R series	<table border="1"> <tr><td>0</td><td>0</td><td>0</td><td>0</td></tr> <tr><td>30H</td><td>30H</td><td>30H</td><td>30H</td></tr> </table>	0	0	0	0	30H	30H	30H	30H	<table border="1"> <tr><td>00H</td><td>00H</td></tr> </table>	00H	00H
0	0	0	0									
30H	30H	30H	30H									
00H	00H											

■Device modification

Specify the number of index register when indexing device number.

The data to be specified is the same as extension specification modification. (Page 449 Extension specification modification)

A

Communication example (indexing network No.)

Access W100 (J1Z0\W100) of network No.1 + Z0 by specifying subcommand 0080.

■Data communication in ASCII code

Subcommand				Extension specification			Extension specification modification		Device code		Device number												
0	0	8	0	0	0	J	0	0	1	Z	0	0	W	*	0	0	0	1	0	0	0	0	0
30H	30H	38H	30H	30H	30H	4AH	30H	30H	31H	5AH	30H	30H	57H	2AH	30H	30H	30H	31H	30H	30H	30H	30H	30H

■Data communication in binary code

Subcom mand	Device number	Device code	Extension specification modification	Extension specification	Direct memory specification						
80H	00H	00H	00H	01H	00H	B4H	00H	40H	01H	00H	F9H

Device extension specification example (When indexing the device number)

Access D100Z4 by specifying subcommand 0080.

■Data communication in ASCII code

Subcommand				Extension specification			Extension specification modification		Device code		Device number				Device modification								
0	0	8	0	0	0	0	0	0	0	0	0	0	D	*	0	0	0	1	0	0	Z	0	4
30H	30H	38H	30H	30H	30H	30H	30H	30H	30H	30H	30H	30H	44H	2AH	30H	30H	30H	31H	30H	30H	5AH	30H	34H

■Data communication in binary code

Subcom mand	Device modification	Device number	Device code	Extension specification modification	Extension specification	Direct memory specification						
80H	00H	04H	40H	64H	00H	00H	A8H	00H	00H	00H	00H	00H

Accessing devices for indirect specification

Access the device corresponding to the address stored in the word device (2 points).

Store the address of the access target device in the device for the indirect specification, and represent the data as '@ + device for indirect specification'.

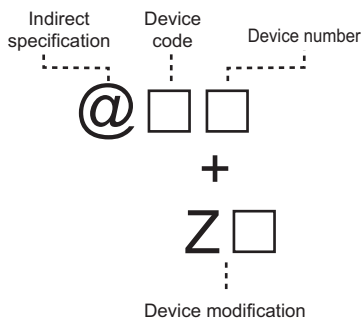

Point

For details on the indirect specification, refer to the following manual.
 MELSEC iQ-R CPU Module User's Manual (Application)

The following device access commands can be used for access.

Function	Command	Subcommand
Random read	0403	0080, 0082, 00C0
Random write	1402	0080, 0082
Register monitor data	0801	0080, 0082, 00C0

Message format for device extension specification

Data communication in ASCII code

Subcommand type	ASCII code												
For MELSEC-Q/L series	<table border="1"> <tr> <td>0 @</td> <td>0 0 0 0</td> <td>0 0 0</td> <td>Device code</td> <td>Device number</td> <td>Device modification</td> </tr> <tr> <td>30H, 40H</td> <td>30H, 30H, 30H, 30H</td> <td>30H, 30H, 30H</td> <td></td> <td></td> <td></td> </tr> </table>	0 @	0 0 0 0	0 0 0	Device code	Device number	Device modification	30H, 40H	30H, 30H, 30H, 30H	30H, 30H, 30H			
0 @	0 0 0 0	0 0 0	Device code	Device number	Device modification								
30H, 40H	30H, 30H, 30H, 30H	30H, 30H, 30H											
For MELSEC iQ-R series	<table border="1"> <tr> <td>0 @</td> <td>0 0 0 0</td> <td>0 0 0 0</td> <td>Device code</td> <td>Device number</td> <td>Device modification</td> </tr> <tr> <td>30H, 40H</td> <td>30H, 30H, 30H, 30H</td> <td>30H, 30H, 30H, 30H</td> <td></td> <td></td> <td></td> </tr> </table>	0 @	0 0 0 0	0 0 0 0	Device code	Device number	Device modification	30H, 40H	30H, 30H, 30H, 30H	30H, 30H, 30H, 30H			
0 @	0 0 0 0	0 0 0 0	Device code	Device number	Device modification								
30H, 40H	30H, 30H, 30H, 30H	30H, 30H, 30H, 30H											

Data communication in binary code

Subcommand type	Binary code												
For MELSEC-Q/L series	<table border="1"> <tr> <td>[] [] 8H</td> <td>Device number</td> <td>Device code</td> <td>00H, 00H</td> <td>00H, 00H</td> <td>00H</td> </tr> <tr> <td></td> <td></td> <td></td> <td></td> <td></td> <td></td> </tr> </table> <p>Indirect specification: [] [] 8H</p> <p>Device modification: [] [] 8H</p>	[] [] 8H	Device number	Device code	00H, 00H	00H, 00H	00H						
[] [] 8H	Device number	Device code	00H, 00H	00H, 00H	00H								
For MELSEC iQ-R series	<table border="1"> <tr> <td>[] [] 8H</td> <td>Device number</td> <td>Device code</td> <td>00H, 00H</td> <td>00H, 00H</td> <td>00H</td> </tr> <tr> <td></td> <td></td> <td></td> <td></td> <td></td> <td></td> </tr> </table> <p>Indirect specification: [] [] 8H</p> <p>Device modification: [] [] 8H</p>	[] [] 8H	Device number	Device code	00H, 00H	00H, 00H	00H						
[] [] 8H	Device number	Device code	00H, 00H	00H, 00H	00H								

A

Data to be specified

■Device code and device number

Specify the devices for indirect specification. (☞ Page 65 Devices)

Indirect specification can be used only for word devices.

When indexing a device number by "Device modification", the values specified by "Device number" will be the offset value.

For the values of device codes, refer to the following section.

☞ Page 68 Device code list

■Device modification

Specify the number of index register when the device number is indirectly specified with index register.

Subcommand type	Devices to be used	ASCII code		Binary code	
		Device code	Device number	Device number	Fixed value
For MELSEC iQ-R series	Index register	Specify 'Z' and space with 2-digit ASCII code.	Specify the device number in decimal (2-digit ASCII code). (Specification range: 0 to 24)	Specify in hexadecimal. (Specification range: 00H to 18H)	48H
	Long index register	Specify 'LZ' with 2-digit ASCII code.	Specify the device number in decimal (2-digit ASCII code). (Specification range: 0 to 12)	Specify in hexadecimal. (Specification range: 00H to 0CH)	88H
For MELSEC-Q/L series	Index register	Specify 'Z' with 1-digit ASCII code.	Specify the device number in decimal (2-digit ASCII code). (Specification range: 0 to 15)	Specify in hexadecimal. (Specification range: 0 to F)	48H

Ex.

Index register (Z0)

Subcommand type	ASCII code	Binary code										
For MELSEC-Q/L series	<table border="1"> <tr><td>Z</td><td>0</td><td>0</td></tr> <tr><td>5AH</td><td>30H</td><td>30H</td></tr> </table>	Z	0	0	5AH	30H	30H	<table border="1"> <tr><td>00H</td><td>48H</td></tr> </table>	00H	48H		
Z	0	0										
5AH	30H	30H										
00H	48H											
For MELSEC iQ-R series	<table border="1"> <tr><td>Z</td><td></td><td>0</td><td>0</td></tr> <tr><td>5AH</td><td>20H</td><td>30H</td><td>30H</td></tr> </table>	Z		0	0	5AH	20H	30H	30H	<table border="1"> <tr><td>00H</td><td>48H</td></tr> </table>	00H	48H
Z		0	0									
5AH	20H	30H	30H									
00H	48H											

Ex.

Long index register (LZ0)

Subcommand type	ASCII code	Binary code										
For MELSEC iQ-R series	<table border="1"> <tr><td>L</td><td>Z</td><td>0</td><td>0</td></tr> <tr><td>4CH</td><td>5AH</td><td>30H</td><td>30H</td></tr> </table>	L	Z	0	0	4CH	5AH	30H	30H	<table border="1"> <tr><td>00H</td><td>88H</td></tr> </table>	00H	88H
L	Z	0	0									
4CH	5AH	30H	30H									
00H	88H											

When do not perform index modification, specify the following.

Subcommand type	ASCII code	Binary code										
For MELSEC-Q/L series	<table border="1"> <tr><td>0</td><td>0</td><td>0</td></tr> <tr><td>30H</td><td>30H</td><td>30H</td></tr> </table>	0	0	0	30H	30H	30H	<table border="1"> <tr><td>00H</td><td>08H</td></tr> </table>	00H	08H		
0	0	0										
30H	30H	30H										
00H	08H											
For MELSEC iQ-R series	<table border="1"> <tr><td>0</td><td>0</td><td>0</td><td>0</td></tr> <tr><td>30H</td><td>30H</td><td>30H</td><td>30H</td></tr> </table>	0	0	0	0	30H	30H	30H	30H	<table border="1"> <tr><td>00H</td><td>08H</td></tr> </table>	00H	08H
0	0	0	0									
30H	30H	30H	30H									
00H	08H											

Device extension specification example (when do not perform index modification)

Access D100 by specifying the subcommand 0080 and using devices for indirect specification '@D0'.
Store the address of D100 in D0 with a program before executing the command.

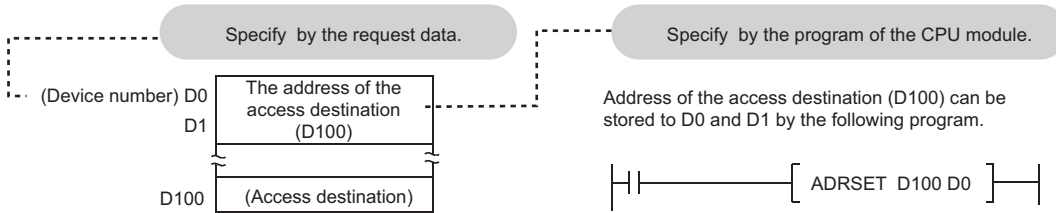

Data communication in ASCII code

Subcommand	Indirect specification	Device code	Device number	Device modification
0 0 8 0	0 0 @	0 0 0 0	0 0 0 0	0 0 0 0
30H, 30H, 38H, 30H	30H, 40H	30H, 30H, 30H, 30H	44H, 2AH	30H, 30H, 30H, 30H

Data communication in binary code

Subcommand	Device modification Indirect specification	Device number	Device code
80H, 00H	00H, 08H	00H, 00H, 00H	A8H, 00H, 00H, 00H, 00H

Device extension specification example (Index modification)

Access D100 by specifying subcommand 0080 and specify the index modified device for indirect specification @D0Z2.
Before executing the command, store the D100 address in D4 and '4' in Z2 with the program.

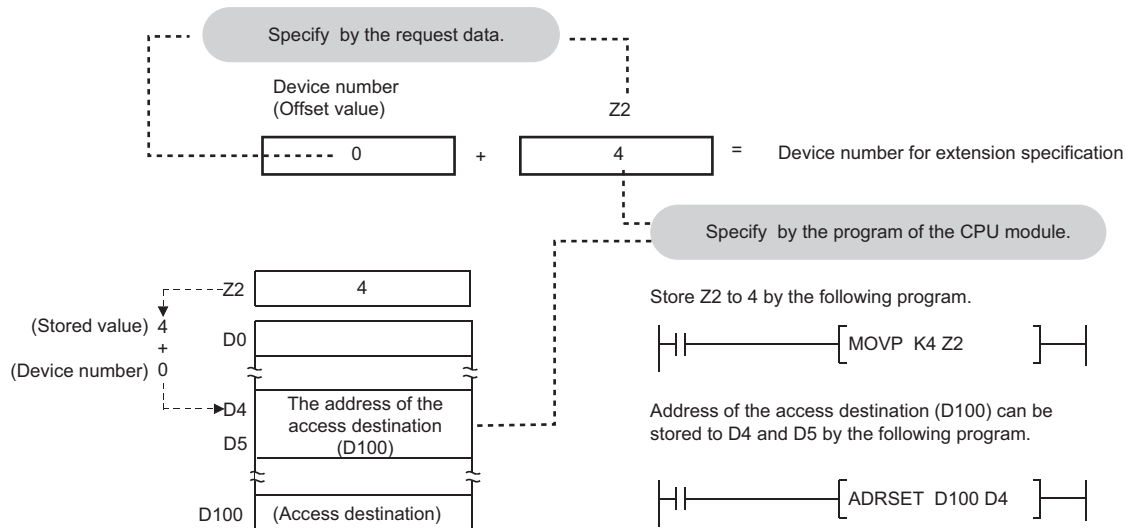

Data communication in ASCII code

Subcommand	Indirect specification	Device code	Device number	Device modification
0 0 8 0	0 0 @	0 0 0 0	0 0 0 0	Z 0 2
30H, 30H, 38H, 30H	30H, 40H	30H, 30H, 30H, 30H	44H, 2AH	5AH, 30H, 32H

Data communication in binary code

Subcommand	Device modification Indirect specification	Device number	Device code
80H, 00H	02H, 48H	00H, 00H, 00H	A8H, 00H, 00H, 00H, 00H

A

Appendix 2 Processing Time

Time chart and communication time of C24 transmission sequence

The following figure shows a communication time chart when accessing programmable controller from an external device via C24.

When accessing CPU module with C24 mounted from an external device

The following shows the time chart when the message wait time is specified.

For the number of scans required for processing a read/write request, refer to the following section.

☞ Page 459 Number of scans required for processing

For the number of points processed per communication, refer to the following section.

☞ Page 466 Number of Processing per One Communication

■ Reading data

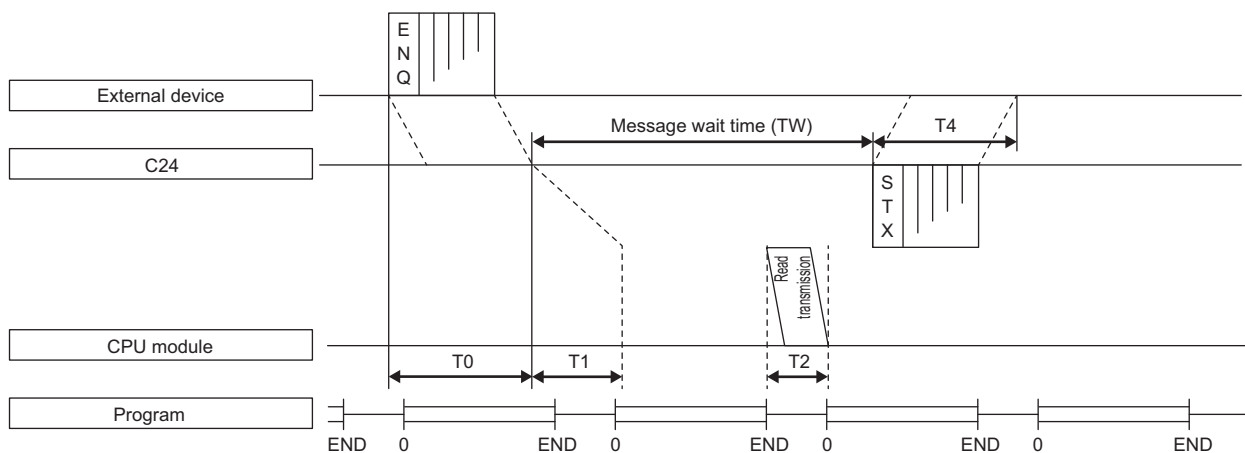

■ Writing data

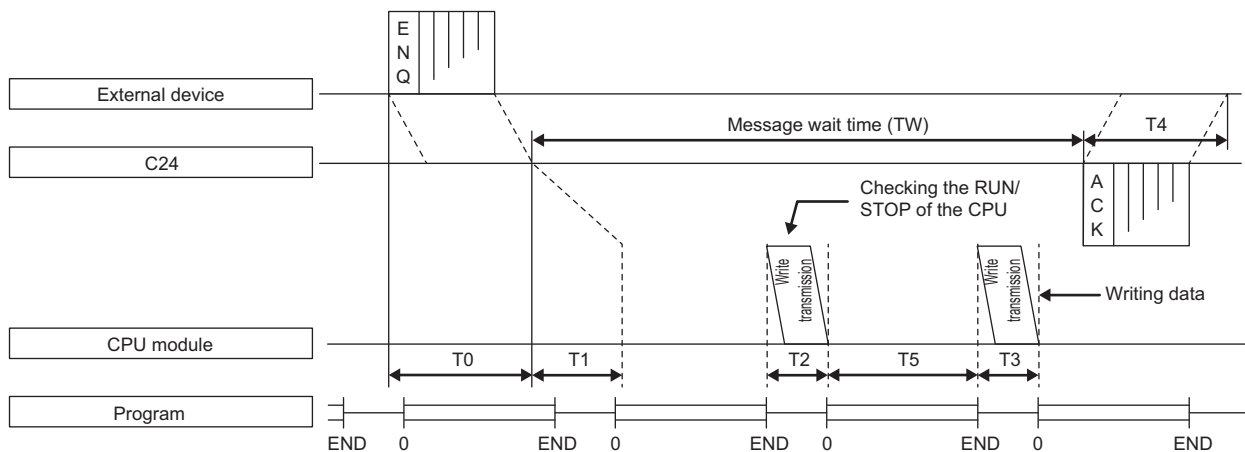

Point

- The communication between C24 and CPU module is always performed after END. Therefore, the scan time becomes longer according to the communication time (the time to interrupt to the CPU module).
- The number of scans required for processing to request read/write operation to the CPU module differs depending on the content of the request. For example, when a read operation that requires a scan is requested, it takes an extra time of 1 scan + T2.
- The number of scans required for the processing varies depending on the Service Processing Setting. It can be set in the parameter settings of Engineering tool. For details of Service Processing Setting, refer to the user's manual of the CPU module used.

Transmission time of transmission sequence

The following explains the approximate time required from when external device starts data transmission to when C24 returns the result.

The average of the above approximate time is shown below for the estimation of the processing time.

■When external device reads data from a programmable controller (unit: ms)

Communication time = Request message transmission time (T0) + $\frac{[(T1 + (1.5 \times \text{scan time}) + T2) \text{ or } TW]}{}$ + Response message transmission time (T4)
(When the value exceeds TW)

■When external device writes data to a programmable controller

Communication time = Request message transmission time (T0) + $\frac{[(T1 + (1.5 \times \text{scan time}) + T2 + T3 + T5) \text{ or } TW]}{}$ + Response message transmission time (T4)
(When the value exceeds TW)

$$T0, T4 = \frac{1000}{\text{Transmission rate}} \times \text{number of bits for 1 byte at transmission} \left(1 + \frac{7}{8} + \frac{0}{1} + \frac{1}{2} \right) \times \text{number of bytes}$$

Start bit Data length (7 or 8) Parity bit (0 or 1) Stop bit (1 or 2)

T1 = C24 processing time
 Depending on the access points (MIN to MAX), the following ranges.

RJ71C24(-R2/-R4)	: 12.0 to 45.0 ms
QJ71C24N(-R2/-R4), LJ71C24(-R2)	: 12.5 to 45.0 ms
QJ71C24(-R2)	: 13.0 to 70.0 ms

T2, T3 = CPU intervention time : 0.07 to 13.1ms
 T5 = Scan time (For functions that can process one scan, T3 and T5 equal 0.)
 TW = The set time when message wait time is set.

Transmission time when accessing other stations

This section explains the transmission time (T1) when accessing CC-Link IE, MELSECNET/H, or MELSECNET/10 on other station.



For details on the network systems, refer to the manual of each network system.

Transmission time (T1) to access other station (CC-Link IE, PLC network)

The following formula is for calculating the transmission time of CC-Link IE, MELSECNET/H (PLC network), and MELSECNET/10 (PLC network).

$$\text{Transmission time (T1)} = \frac{\text{Transmission delay time}}{*1} + \frac{1 \text{ scan time of the station on which the C24/E71 is loaded or internal processing time}}{\text{(When this value is more than the internal processing time.)}} \times \frac{(n + 1)}{*2 \quad *3}$$

Internal processing time C24 : Approximately 50 ms, E71 : Approximately 30 ms

- *1 Refer to the transmission delay time in the manual of the network system.
- *2 n=6
 - When performing the initial communication to the relevant station after powering ON or resetting CPU
 - When performing communication to stations excluding the currently communicated 16 stations
- n=1
 - When performing the second communication when the number of communication stations is 16 or less
 - When performing the second communication to the 16 stations communicated last
- *3 When online program change is disabled in C24/E71, '1' is added only when writing data from external device. (Set "Online change" with the "Switch setting" or "Parameter setting" of Engineering tool.)

Transmission time calculation example

The following example shows when C24 is mounted on the station on CC-Link IE controller network, and the device memory of other station on the same network is read. (When the number of communication station is 8 stations, and the second communication is performed)

- Processing times and settings
 - S_T: Scan time of transmission side 2 ms
 - S_R: Scan time of reception side 1 ms
 - LS : Link scan time 2 ms
 - α_T : Link refresh time of transmission side 1 ms
 - α_R : Link refresh time of reception side 1 ms
 - Simultaneous transient request: 2
 - Maximum transient request: 1

Ex.

Normal transmission delay time

$$\text{Transmission time (T1)} = \{(2 + 1 + 1 + 1) \times 2 + \frac{2}{2} \times 4 + (\frac{2}{1} - 1) \times \frac{2}{2} \times 2 + 50\} \times 1$$

(72ms) (S_T · α_T · S_R · α_R) (LS) (LS)

Ex.

Worst-case transmission delay time

$$\text{Transmission time (T1)} = \{(2 + 1 + 1 + 1) \times 2 + \frac{2}{2} \times 6 + (\frac{2}{1} - 1) \times \frac{2}{2} \times 2 + 50\} \times 1$$

(76ms) (S_T · α_T · S_R · α_R) (LS) (LS)

■Causes of transmission time (T1) delay

When a command that takes two scans to send is executed, the transmission time is twice the value obtained by the formula above .

When the access request is issued to the same station from multiple external devices simultaneously, refer to the precautions for data communication. (☞ Page 23 When accessing CPU module)

Point

Data transmission to the CPU module other than connected station (host station) on CC-Link IE, MELSECNET/H, or MELSECNET/10 may be delayed considerably depending on conditions. The transmission delay time can be shortened by limiting communication between an external device and the CPU module to the station with C24/E71 mounted, and communicating with programmable controllers on other stations by data link (LB, LW).

Transmission time (T1) to access other station (remote I/O net)

The following shows the transmission time for MELSECNET/H(remote I/O net) and MELSECNET/10(remote I/O net).

Restriction

MELSEC iQ-R series and MELSEC-L series are not supported.

$$\text{Transmission time (T1)} = \frac{\text{Transmission delay time} + 1 \text{ link scan time or internal processing time}}{*1} \times \frac{(n + 1)}{*2 *3}$$

(When this value is more than the internal processing time.)

Internal processing time C24 : Approximately 50 ms, E71 : Approximately 30 ms

*1 Refer to the transmission delay time in the reference manual (remote I/O network) of the network system.

*2 n=6

- When performing the initial communication to the relevant station after starting link.
- When communicating with stations other than the latest 16 stations communicated with.

n=1

- When performing the second communication when the number of communication stations is 16 or less
- When performing the second communication to the 16 stations communicated last

*3 When online program change is disabled in C24/E71, '1' is added only when writing data from external device.

(Set the parameter in the Switch Setting for C24. As for E71, set it in Operation Settings using Engineering tool.)

■Transmission time calculation example

The following example shows when C24 is mounted on the station on MELSECNET/H (remote I/O net), and the device memory of other station on the same network is read. (When the number of communication station is 8 stations, and the second communication is performed)

● Processing times

- S_m : Scan time of remote master station sequence program 12 ms
- α_m : Link refresh time of remote master station 5 ms
- LS : Link scan time 9 ms

Since the processing time is (S_m) > (LS), the transmission time (T1) will be as follows:

Ex.

When master station is one station

$$\text{Transmission time (T1)} = \frac{\{(12 + 5) \times 3 + 50\} \times 1}{(S_m \cdot \alpha_m)} = 101 \text{ms}$$

■ Causes of transmission time (T1) delay

When a command that takes two scans to send is executed, the transmission time is twice the value obtained by the formula above .

When the access request is issued to the same station from multiple external devices simultaneously, refer to the precautions for data communication. ( Page 23 When accessing CPU module)

Point

Data transmission to the CPU module other than connected station (host station) on MELSECNET/H may be delayed considerably depending on conditions. The transmission delay time can be shortened by limiting communication between an external device and the CPU module to the station with C24/E71 mounted, and communicating with programmable controllers on other stations by data link (LB, LW).

Number of scans required for processing

When connected to C24/E71

■RCPU, LHCPU, universal model QCPU, LCPU

Function			Command	Subcommand		Number of scans required for processing	
				Q/L	R	Online change is enabled	Online change is disabled
Device access	Batch read and write	Batch read in word units	0401	0000	0002	1	1
		Batch read in bit units		0001	0003	1	1
		Batch write in word units	1401	0000	0002	1	2
		Batch write in bit units		0001	0003	1	2
	Random read and write	Random read in word units	0403	0000	0002	1	1
		Random write in word units (test)	1402	0000	0002	1	2
		Random write in bit units (test)		0001	0003	1	2
	Batch read and write multiple blocks	Batch read multiple blocks	0406	0000	0002	1	1
		Batch write multiple blocks	1406	0000	0002	1	2
	Monitor device memory	Register monitor data	0801	0000	0002	0	0
Monitor		0802	0000		1	1	
Buffer memory access	Intelligent function module	Batch read	0601	0000		1	1
		Batch write	1601	0000		1	2
Module control	Remote control	Read CPU model name	0101	0000		1	1
File control	File check	Read directory/file information	1810	0000	0040	1	1
		Search directory/file information	1811	0000	0040	1	1
	File creation and deletion	Create new file	1820	0000	0040	1	2
		Delete file	1822	0000	0040	1	2
		Copy file	1824	0000	0040	1	2
	File modification	Modify file attribute	1825	0000	0040	1	2
		Modify file creation date and time	1826	0000	0040	1	2
		Open file	1827	0000	0040	1	1
		Read file	1828	0000	0040	1	1
		Write to file	1829	0000	0040	1	2
Close file	182A	0000	0040	1	1		

■Basic model QCPU

Function			Command	Subcommand		Number of scans required for processing	
				Q/L	R	Online change is enabled	Online change is disabled
Device access	Batch read and write	Batch read in word units	0401	0000		1	1
		Batch read in bit units		0001		1	1
		Batch write in word units	1401	0000		1	2
		Batch write in bit units		0001		1	2
	Random read and write	Random read in word units	0403	0000		1	1
		Random write in word units (test)	1402	0000		1	2
		Random write in bit units (test)		0001		1	2
	Batch read and write multiple blocks	Batch read multiple blocks	0406	0000		1	1
		Batch write multiple blocks	1406	0000		1	2
	Monitor device memory	Register monitor data	0801	0000		0	0
Monitor		0802	0000		1	1	



Function			Command	Subcommand	Number of scans required for processing	
					Online change is enabled	Online change is disabled
Buffer memory access	Intelligent function module	Batch read	0601	0000	1	1
		Batch write	1601	0000	1	2
Module control	Remote control	Read CPU model name	0101	0000	1	1

■ High performance model QCPU

Function			Command	Subcommand	Number of scans required for processing	
					Online change is enabled	Online change is disabled
Device access	Batch read and write	Batch read in word units	0401	0000	1	1
		Batch read in bit units		0001	1	1
		Batch write in word units	1401	0000	1	2
		Batch write in bit units		0001	1	2
	Random read and write	Random read in word units	0403	0000	1	1
		Random write in word units (test)	1402	0000	1	2
		Random write in bit units (test)		0001	1	2
	Batch read and write multiple blocks	Batch read multiple blocks	0406	0000	1	1
		Batch write multiple blocks	1406	0000	1	2
	Monitor device memory	Register monitor data	0801	0000	0	0
Monitor		0802	0000	1	1	
Buffer memory access	Intelligent function module	Batch read	0601	0000	0	0
		Batch write	1601	0000	0	1
Module control	Remote control	Read CPU model name	0101	0000	0	0
File control	File check	Read directory/file information	1810	0000	0	0
		Search directory/file information	1811	0000	0	0
	File creation and deletion	Create new file	1820	0000	1	2
		Delete file	1822	0000	0	1
		Copy file	1824	0000	1	2
	File modification	Modify file attribute	1825	0000	0	1
		Modify file creation date and time	1826	0000	0	1
		Open file	1827	0000	0	0
		Read file	1828	0000	1	1
		Write to file	1829	0000	1	2
Close file	182A	0000	0	0		

When serial communication function is used

Function			Command	Subcommand		Number of scans required for processing	
				Q/L	R	Online change is enabled	Online change is disabled
Device access	Batch read and write	Batch read in word units	0401	0000	0002	3	3
		Batch read in bit units		0001	0003	3	3
		Batch write in word units	1401	0000	0002	3	3
		Batch write in bit units		0001	0003	3	3
	Random read and write	Random read in word units	0403	0000	0002	3	3
		Random write in word units (test)	1402	0000	0002	3	3
		Random write in bit units (test)		0001	0003	3	3
	Monitor device memory	Register monitor data	0801	0000	0002	3	3
Monitor		0802	0000		3	3	

Appendix 3 Compatibility with Multiple CPU Systems

This section explains data communication using MC protocol when CPU modules are configured in the multiple CPU system.

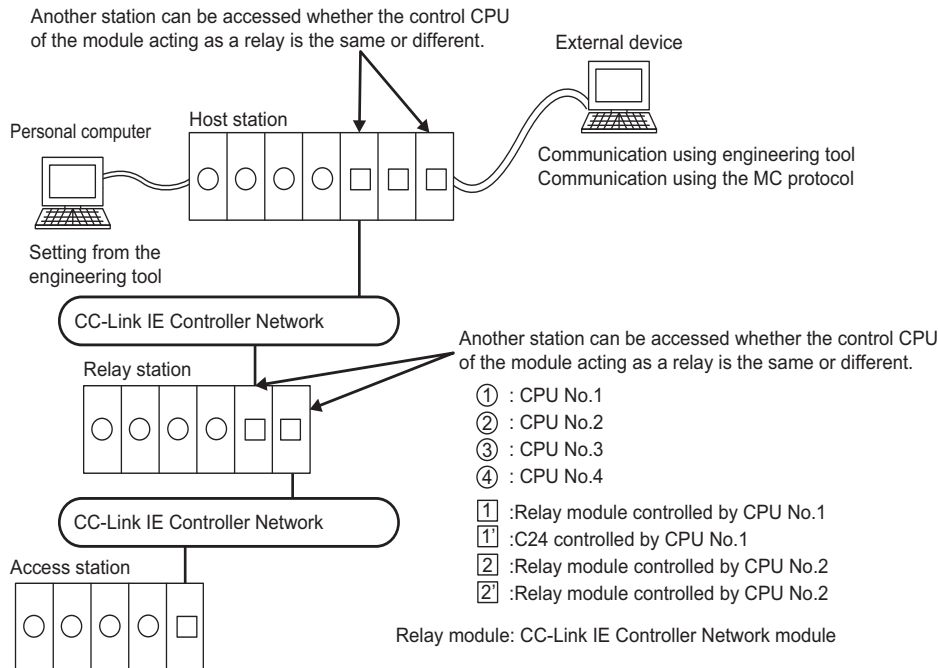

Point

By setting routing parameters (communication route) in advance, accessing programmable controllers in the following network systems are available.

- CC-Link IE Controller Network
- CC-Link IE Field Network
- MELSECNET/H
- MELSECNET/10
- Ethernet

Up to 8 target networks (relay stations: 7 stations) can be accessed.

When RCPU is configured in the multiple CPU system

Point

When using C24/E71 in the multiple CPU system of RCPU, refer to the following manual.

📖 MELSEC iQ-R Module Configuration Manual

Accessing multiple CPU system on connected station (host station)

■ Accessing multiple CPU system on connected station (host station) from external devices

Control CPU (set with Engineering tool) and non-control CPU of C24 can be accessed.

The usable commands vary depending on the access target RCPU (control CPU, non-control CPU).

Accessing multiple CPU system on other station

■ Accessing multiple CPU system on the other station (access station)

Control CPU and non-control CPU of the network module connected to the relay station can be accessed.

The usable command vary depending on the access target RCPU (control CPU, non-control CPU).

The modules which can be accessed to other stations via network are as follows.

- CC-Link IE, MELSECNET/H, MELSECNET/10 network module
- C24
- E71

When QCPU is configured in the multiple CPU system

Point

When using C24/E71 in the multiple CPU system of QCPU, refer to the following manual.

 QCPU User's Manual (Multiple CPU System)

Accessing multiple CPU system on connected station (host station)

■When using C24/E71 in the multiple CPU system

Use C24/E71 of which function version is B.

■Accessing multiple CPU system on connected station (host station) from external devices

Control CPU (set with Engineering tool) and non-control CPU of C24/E71 can be accessed.

The usable commands vary depending on the access target QCPU (control CPU, non-control CPU).

Using C24/E71 of which function version is A is also possible. In this case, QCPU No.1 is the control CPU of C24/E71.

Only the control CPU of C24/E71 can be accessed when accessing QCPU on the connected station (host station) from external devices.

Accessing multiple CPU system on other station

■Use the modules of which function version is B for each station.

Use the modules of which function version is B for each station as shown below.

Type	Module	Remarks
Connected station (host station)	QCPU	—
	C24/E71 connected to external device	Set the same control CPU for C24/E71 and network module.
	Network module connected to relay station/access station	
Relay station	QCPU	—
	Two modules connecting the network between the host station side and the access station side	
Access station	QCPU	—
	Network module connected to relay station	

■Accessing multiple CPU system on the other station (access station)

Control CPU and non-control CPU of the network module connected to the relay station can be accessed.

The usable commands vary depending on the access target QCPU (control CPU, non-control CPU).

When accessing other stations from external devices, and any module of which function version is A is included in the above modules of connected station (host station), relay station, or access station, only the control CPU of network module connected to the relay station can be accessed. In addition, accessing other station via a module which is controlled by the same control CPU is available.

The modules which can be accessed to other stations via network are as follows.

- CC-Link IE, MELSECNET/H, MELSECNET/10 network module
- C24
- E71

Appendix 4 Applicable Commands for Online Program Change

This section explains the applicability of each command according to the STOP/RUN status of CPU module and the settings by supported devices.

In this section, the commands that cannot be executed while CPU module is in the RUN status and the commands to enable/disable the online change with Engineering tool are shown. The commands not listed in the following tables can be used regardless of the CPU STOP/RUN status.

Commands that cannot be executed during RUN

The following commands cannot be executed while the CPU module is in RUN.

Set the CPU module to STOP and perform the command.

File handling

The file operation to specify the following files cannot be performed during RUN.

Type	Command	CPU module	Target file
Write	<ul style="list-style-type: none"> Copy file (command: 1824) Modify file attribute (command: 1825) Modify file creation date and time (command: 1826) Write to file (command: 1829) 	RCPU	Current execution file*1
		QCPU, LCPU	<ul style="list-style-type: none"> Parameter file (*.QPA) Current execution file of program memory (Drive name: 00H)
	<ul style="list-style-type: none"> Write to file (command: 1203) Copy file (command: 1206) Modify file information (command: 1204) Modify file name, attribute, file size (command: 1204) Batch modify file information (command: 1204) 	QnACPU	<ul style="list-style-type: none"> Parameter file (*.QPA) Currently executing file in the built-in RAM (drive name: 00H)
Deleting	<ul style="list-style-type: none"> Delete file (command: 1822) 	RCPU	Current execution file*1
		QCPU, LCPU	<ul style="list-style-type: none"> Program file (*.QPG) Parameter file (*.QPA) Boot setting file (*.QBT)
	<ul style="list-style-type: none"> Delete file (command: 1205) 	QnACPU	

*1 For details on the operations for the files of RCPU, refer to the following manual.

 MELSEC iQ-R CPU Module User's Manual (Application)

Module control

Type	Command	CPU module
Remote control Defragmentation of drive memory <ul style="list-style-type: none"> Defragment drive memory (command: 1207) QnACPU	<ul style="list-style-type: none"> Remote latch clear (command: 1005) Remote RESET (command: 1006) 	RCPU, LHCPU, QCPU, LCPU

Commands that enable/disable online change

The following shows the commands which can be executed while the CPU module is in the RUN status only when the online change is set to be enabled.

○: Executable, ×:Not executable

CPU state	STOP		RUN	
	Enable/Disable		Enable	Disable
Setting of online change	Enable/Disable		Enable	Disable
Applicability of command execution	○		○	×

Commands for 4C /3C/2C/4E/3E frame

Type	Command	4C, 3C, 4E, 3E	2C
Device access	Batch write in word units	1401	4
	Batch write in bit units		3
	Random write in word units (test)	1402	7
	Random write in bit units (test)		6
	Batch write multiple blocks	1406	—
Label access	Batch write array type labels	141A	—
	Random write labels	1418	
File control	Create new file	1820	—
	Delete file	1822	
	Copy file ^{*1}	1824	
	Modify file attribute	1825	
	Modify file creation date and time	1826	
	Write to file	1829	
	Create new file	1202	
	Write to file	1203	
	Modify file information	1204	
	Delete file	1205	

*1 For E71, data can be copied even if Online program change function is set to prohibit.

Commands for 1C/1E frame

Type	Command		1C	1E
Device memory	Batch write	Bit units	BW, JW	02H
		Word units	WW, QW	03H
	Test (random write)	Bit units	BT, JT	04H
		Word units	WT, QT	05H
Extended file register	Batch write		EW	18H
	Test (random write)		ET	19H
	Direct write	Word units	NW	3CH
Intelligent function module	Batch write		TW	0FH

Setting method for writing data to CPU during RUN

The setting to allowed/prohibit of Online program change function can be performed on the following screen of Engineering tool.

For details of the setting, refer to the user's manual of the supported device (C24/E71) used.

GX Works3

- C24: "Module Parameter" screen (transmission setting)
- E71: "Module Parameter" screen (Own Node Settings)

GX Works2

- C24: "Switch Settings" screen of Intelligent functional module (Transmission setting)
- E71: "Ethernet Operation Setting" screen

GX Developer

- C24: "Switch Setting for I/O and Intelligent Function Module" screen (Switch 1, b6 of switch 3)
- E71: "Ethernet Operation Setting" screen

Appendix 5 Number of Processing per One Communication

The following shows the number of processing per one communication with each command.

Commands for 4C/3C/4E/3E frame

Device access

The letter in the column of 'Access target' indicates the following module.

- iQ-R/iQ-L/Q/L: MELSEC iQ-R series, MELSEC iQ-L series, MELSEC-Q series, or MELSEC-L series module
- QnA: MELSEC-QnA series and other station module via MELSEC-QnA series network module
- A: MELSEC-A series module

For the restrictions of access target for each command and subcommand type, refer to the following section.

☞ Page 471 Accessible Modules for Each Command

Function	Command	Subcommand	Condition	Number of points processed per communication			
				iQ-R/iQ-L/Q/L	QnA	A	
Batch read and write	Batch read in word units	0401	0000	Word device points	960 points	480 points	64 points
			0002	Bit device points	960 words (15360 points)	480 words (7680 points)	32 words (512 points)
		Batch read in bit units	0001 0003	C24	7904 points	3952 points	256 points
	E71 (ASCII code)			3584 points	1792 points		
	E71 (Binary code)			7168 points	3584 points		
	Batch write in word units	1401	0000	0000	Word device points	960 points	480 points
0002				Bit device points	960 words (15360 points)	480 words (7680 points)	10 words (160 points)
Batch write in bit units			0001 0003	C24	7904 points	3952 points	160 points
		E71 (ASCII code)		3584 points	1792 points		
		E71 (Binary code)		7168 points	3584 points		
Random read and write		Random read in word units	0403	0000	Number of word access points + Number of double word access points	192 points	96 points
	0002 008□			96 points			
	Random write in word units (test)	1402	0000	(Number of word access points × 12) + (Number of double word access points × 14)	1920 points	960 points	10 points
					0002 008□		
	Random write in bit units (test)	0001	0003 008□	Number of bit access points	188 points	94 points	20 points
					94 points		
Batch read and write multiple blocks	Batch read multiple blocks	0406	0000	Number of word device blocks + Number of bit device blocks	120 points		—
			0002 008□		60 points		
	Batch write multiple blocks	1406	0000		120 points		
			0002 008□		60 points		
Monitor device memory	Register monitor data	0801	0000	Number of word access points + Number of double word access points	192 points	96 points	—
			0002 008□		96 points		
	Monitor	0802	0000	Read data	(Number of registered points)		

Label access

Function		Command	Subcommand	Number of points processed per communication
Batch read and write	Batch read array type labels	041A	0000	Depend on the label name length (total number of bytes are 1920 bytes or less)
	Batch write array type labels	141A	0000	
Random read and write	Random read labels	041C	0000	
	Random write labels	141B	0000	

Buffer memory access

Function		Command	Subcommand	Number of points processed per communication
Buffer memory	Batch read	0613	0000	480 words (960 bytes)
	Batch write	1613	0000	
Intelligent function module	Batch read	0601	0000	1920 bytes (960 words)
	Batch write	1601	0000	

Module control

Function		Command	Subcommand	Number of points processed per communication
Remote control	Remote RUN	1001	0000	(1 station)
	Remote STOP	1002	0000	(1 station)
	Remote PAUSE	1003	0000	(1 station)
	Remote latch clear	1005	0000	(1 station)
	Remote RESET	1006	0000	(1 station)
	Read CPU model name	0101	0000	(1 station)
Remote password	Unlock	1630	0000	—
	Lock	1631	0000	—
Loopback test		0619	0000	960 bytes (applicable only with a connected station)
Clear error information		1617	000□	(1 station)

File control

Function		Command	Subcommand	Number of points processed per communication
File check	Read directory/file information	1810	0000 0040	(for 36)
	Search directory/file information	1811	0000 0040	(for 1)
File creation and deletion	Create new file	1820	0000 0040	(for 1)
	Delete file	1822	0000 0004 0040	(for 1)
	Copy file	1824	0000 0004 0040	(for 1)
File modification	Modify file attribute	1825	0000 0004 0040	(for 1)
	Modify file creation date and time	1826	0000 0040	(for 1)
	Open file	1827	0000 0004 0040	(for 1)
	Read file	1828	0000 0040	1920 bytes
	Write to file	1829	0000 0040	1920 bytes
	Close file	182A	0000 0040	(for 1)

A

Serial communication module dedicated commands

Function		Command	Subcommand	Number of points processed per communication
User frame	Read registered data	0610	0000	80 bytes
	Register data	1610	0000	(1 station)
	Delete registered data		0001	(for 1 station/all stations)
Global		1618	0000 0001	(for 1 station/all stations)
Initialize transmission sequence		1615	0000	(1 station)
Switch mode		1612	0000	(1 station)
Programmable controller CPU monitoring	Register	0630	0000	960 points
	Deregister	0631	0000	—
On-demand		2101	—	(1 station)

QnA dedicated commands

Function		Command	Subcommand	Number of points processed per communication	
Drive memory defragmentation	Read memory usage status	0205	0000	(256 clusters)	
	Defragment memory	1207	0000	(1 station)	
File control	Read file information table	Without header statement	0201	0000	(for 36)
		With header statement	0202	0000	(for 16)
	Read file presence (Search file)	0203	0000	(for 1)	
	Read file No. usage status	0204	0000	(for 256)	
	Read file	0206	0000	960 bytes	
	Lock file	0808	0001	0000	(for 1)
			0000		
	Create new file (Register file name)	1202	0000	(for 1)	
	Write to file	1203	0000	0000	960 bytes
			0001	0000	For file size
	Modify file information	1204	0000	0000	(for 1)
			0001	0000	
			0002	0000	
	Delete file	1205	0000	0000	(for 1)
Copy file	1206	0000	0000	480 bytes	

Commands for 2C frame

Refer to the processing points of the corresponding commands for 4C/3C/4E/3E frame

Commands for 1C frame

Function			Command	Number of points processed per communication	
Device memory	Batch read	Bit units	BR JR	256 points	
		Word units	Bit device	WR	32 words (512 points)
			Word device	QR	64 points
	Batch write	Bit units	BW JW	160 points	
		Word units	Bit device	WW	10 words (160 points)
			Word device	QW	64 points
	Test (random write)	Bit units	BT JT	20 points	
		Word units	Bit device	WT	10 words (160 points)
			Word device	QT	10 points
	Register monitor data	Bit units	BM JM	40 points ^{*1}	
		Word units	Bit device	WM	20 words (320 points) ^{*1}
			Word device	QM	20 points
Monitor	Bit units	MB MJ	Number of registered points		
	Word units	MN MQ	Number of registered points		
Extended file register	Batch read		ER	64 points	
	Batch write		EW	64 points	
	Test (random write)		ET	10 points	
	Register monitor data		EM	20 points	
	Monitor		ME	Number of registered points	
	Direct read	Word units	NR	64 points	
	Direct write	Word units	NW	64 points	
Special function module	Batch read		TR	128 bytes	
	Batch write		TW	128 bytes	
Loopback test			TT	254 bytes	

*1 For ACPU other than AnA/AnU, device X (input) has two processing points per point. When the X is included in the specified device, set the number of device points to meet the following.

$((\text{Specified points for } X \times 2) + \text{Specified points for other devices}) \leq \text{Number of points processed per communication.}$

If only X is specified, the number of points processed per one communication will be one half the value shown in the table.

A

Commands for 1E frame

Function			Command	Number of points processed per communication	
Device memory	Batch read	Bit units	00H	256 points	
		Word units	Bit device	01H	128 words (2048 points)
			Word device		256 points
	Batch write	Bit units	02H	256 points	
		Word units	Bit device	03H	40 words (640 points)
			Word device		256 points
	Test (random write)	Bit units	04H	80 points	
		Word units	Bit device	05H	40 words (640 points)
			Word device		40 points
	Register monitor data	Bit units	06H	40 points ^{*1}	
Word units		Bit device	07H	20 words (320 points) ^{*1}	
		Word device		20 points	
Monitor	Bit units	08H	Number of registered points		
	Word units	09H	Number of registered points		
Extended file register	Batch read		17H	256 points	
	Batch write		18H	256 points	
	Test (random write)		19H	40 points	
	Register monitor data		1AH	20 points	
	Monitor		1BH	—	
	Direct read		3BH	256 points	
	Direct write		3CH	256 points	
Special function module	Batch read		0EH	256 bytes (128 words)	
	Batch write		0FH	256 bytes (128 words)	

*1 For ACPU other than AnA/AnU, device X (input) has two processing points per point. When the X is included in the specified device, set the number of device points to meet the following.
 ((Specified points for X × 2) + Specified points for other devices) ≤ Number of points processed per communication.
 If only X is specified, the number of points processed per one communication will be one half the value shown in the table.

Appendix 6 Accessible Modules for Each Command

The following shows the access target modules that can be specified by a request message.

For the functions and commands which can be used for supported devices, refer to the user's manual of each device.

Access target modules

The character in the column of 'Access target' indicates the following module.

- iQ-R: MELSEC-iQ-R series CPU module and mounted intelligent function module
- iQ-L: MELSEC iQ-L series CPU module and mounded MELSEC-L series intelligent function module
- Q/L: MELSEC-Q series or MELSEC-L series CPU module and the mounted intelligent functional module
- QnA: MELSEC-QnA series CPU module and mounted special function module
- A: MELSEC-A series CPU module and mounted special function module
- QS: Safety CPU module and the mounted intelligent functional module
- H: Module of MELSECNET/H remote station
- 10: Module of MELSECNET/10 remote station
- Head(iQ-R): MELSEC iQ-R CC-Link IE Field Network remote head module
- Head(L): Head module of CC-Link IE Field Network

Commands for 4C/3C/4E/3E frame

Device access

○: Executable, △: Executable (with restrictions), ×: Not executable

Function	Command	Subcommand	Access target											Reference			
			CPU module							Remote I/O		Head					
			iQ-R	iQ-L	L	Q	QnA	A	QS	H	10	iQ-R	L				
Batch read and write	0401	0000 0080	△ ^{*1}	△ ^{*1}	○	○	○	○	○	○	○	○	○	○	△ ^{*1}	○	Page 86 Batch read in word units (command: 0401)
		0002 0082	○ ^{*2}	×	×	×	×	×	×	×	×	×	×	○ ^{*2}	×		
		0001 0081	△ ^{*1}	△ ^{*1}	○	○	○	○	○	○	○	○	×	△ ^{*1}	○	Page 90 Batch read in bit units (command: 0401)	
		0003 0083	○ ^{*2}	×	×	×	×	×	×	×	×	×	○ ^{*2}	×			
	1401	0000 0080	△ ^{*1}	△ ^{*1}	○	○	○	○	○	×	○	×	△ ^{*1}	○	Page 92 Batch write in word units (command: 1401)		
		0002 0082	○ ^{*2}	×	×	×	×	×	×	×	×	×	○ ^{*2}	×			
		0001 0081	△ ^{*1}	△ ^{*1}	○	○	○	○	×	○	×	△ ^{*1}	○	Page 95 Batch write in bit units (command: 1401)			
		0003 0083	○ ^{*2}	×	×	×	×	×	×	×	×	○ ^{*2}	×				
Random read and write	0403	0000 0080	△ ^{*1}	△ ^{*1}	○	○	○	×	○	○	×	△ ^{*1}	○	Page 97 Random read in word units (command: 0403)			
		0040 00C0	×	×	×	△ ^{*3}	○	×	×	○	×	×	×				
		0002 0082	○ ^{*2}	×	×	×	×	×	×	×	×	○ ^{*2}	×				
	1402	0000 0080	△ ^{*1}	△ ^{*1}	○	○	○	○	×	○	×	△ ^{*1}	○	Page 104 Random write in word units (test) (command: 1402)			
		0002 0082	○ ^{*2}	×	×	×	×	×	×	×	×	○ ^{*2}	×				
		0001 0081	△ ^{*1}	△ ^{*1}	○	○	○	○	×	○	×	△ ^{*1}	○	Page 108 Random write in bit units (test) (command: 1402)			
		0003 0083	○ ^{*2}	×	×	×	×	×	×	×	×	○ ^{*2}	×				



Function	Command	Subcommand	Access target											Reference	
			CPU module							Remote I/O		Head			
			iQ-R	iQ-L	L	Q	QnA	A	QS	H	10	iQ-R	L		
Batch read and write multiple blocks	0406	0000 0080	△*1	△*1	○	○	△*4	×	○	○	○	×	△*1	○	Page 111 Batch read multiple blocks (command: 0406)
		0002 0082	○*2	×	×	×	×	×	×	×	×	×	○*2	×	
	1406	0000 0080	△*1	△*1	○	○	△*4	×	×	○	×	×	△*1	○	Page 115 Batch write multiple blocks (command: 1406)
		0002 0082	○*2	×	×	×	×	×	×	×	×	×	○*2	×	
Monitor device memory	0801	0000 0080	△*1	△*1	○	○	○	×	×	○	×	×	△*1	○	Page 120 Register monitor data (command: 0801)
		0040 00C0	×	×	×	△*3	×	×	×	○	×	×	×		
		0002 0082	○*2	×	×	×	×	×	×	×	×	×	○*2	×	
	0802	0000	○	○	○	○	○	×	×	○	×	○	○	Page 121 Monitor (command: 0802)	

*1 Some devices and device ranges cannot be specified. (☞ Page 68 Device code list)

*2 The command can be used when both access target and connected station are MELSEC iQ-R series module.

*3 The command can be specified when using Basic model QCPU, High Performance model QCPU, and Process CPU.

*4 QnACPU and Q2AS(H) CPU with the version 9707B or later can be used.

Label access

The command can be used when both access target and connected station are MELSEC iQ-R series module.

☞ Page 124 LABEL ACCESS

Buffer memory access

○: Executable, △: Executable (with restrictions), ×: Not executable

Function	Command	Subcommand	Access target											Reference
			CPU module							Remote I/O		Head		
			iQ-R	iQ-L	L	Q	QnA	A	QS	H	10	iQ-R	L	
Buffer memory	0613	0000	— *1											Page 153 Batch read (command: 0613)
	1613	0000	— *1											Page 155 Batch write (command: 1613)
Intelligent function module	0601	0000	×	×	○	○	○	×	○	○	×	×	○	Page 161 Batch read (command: 0601)
	1601	0000	×	×	○	○	○	×	×	○	×	×	○	Page 163 Batch write (command: 1601)

*1 The command can only be used for C24 (including multidrop connection station) and E71 connected to the external device.

Module control

○: Executable, △: Executable (with restrictions), ×: Not executable

Function	Command	Subcommand	Access target											Reference
			CPU module							Remote I/O		Head		
			iQ-R	iQ-L	L	Q	QnA	A	QS	H	10	iQ-R	L	
Remote control	1001	0000	○	○	○	○	○	×	×	×	×	○	○	Page 172 Remote RUN (command: 1001)
	1002	0000	○	○	○	○	○	×	×	×	×	○	○	Page 174 Remote STOP (command: 1002)
	1003	0000	○	○	○	○	○	×	×	×	×	×	×	Page 175 Remote PAUSE (command: 1003)
	1005	0000	○	○	○	○	○	×	×	×	×	×	×	Page 176 Remote latch clear (command: 1005)
	1006	0000	○	○	○	○	○	×	×	×	×	○	○	Page 177 Remote RESET (command: 1006)
	0101	0000	○	○	○	○	×	×	○	×	×	○	○	Page 178 Read CPU model name (command: 0101)
Remote password	1630	0000	—*1											Page 180 Unlock (command: 1630)
	1631	0000	—*2											Page 182 Lock (command: 1631)
Loopback test	0619	0000	—*1											Page 184 Loopback test (command: 0619)
Clear error information	1617	0000	—*1											Page 186 Turn indicator LED OFF, initialize error code (command: 1617)

*1 The command can only be used for C24 (including multidrop connection station) and E71 connected to the external device.

*2 The command can only be used for E71 connected to an external device.

File control

○: Executable, △: Executable (with restrictions), ×: Not executable

Function	Command	Subcommand	Access target											Reference
			CPU module							Remote I/O		Head		
			iQ-R	iQ-L	L	Q	QnA	A	QS	H	10	iQ-R	L	
File check	1810	0000	×	×	○	○	×	×	○	×	×	×	○	Page 210 Read directory/file information (command: 1810)
		0040	○*1	×	×	×	×	×	×	×	×	○*1	×	
	1811	0000	×	×	○	○	×	×	○	×	×	×	○	Page 216 Search directory/file information (command: 1811)
		0040	○*1	×	×	×	×	×	×	×	×	○*1	×	

Function	Command	Subcommand	Access target											Reference	
			CPU module							Remote I/O		Head			
			iQ-R	iQ-L	L	Q	QnA	A	QS	H	10	iQ-R	L		
File creation and deletion	1820	0000	×	×	○	○	×	×	×	×	×	×	×	○	Page 219 Create new file (command: 1820)
		0040	○ ^{*1}	×	×	×	×	×	×	×	×	×	○ ^{*1}	×	
	1822	0000	×	×	△ ^{*2}	○	×	×	×	×	×	×	×	△ ^{*2}	Page 222 Delete file (command: 1822)
		0004	×	×	○ ^{*3}	×	×	×	×	×	×	×	×	○	
		0040	○ ^{*1}	×	×	×	×	×	×	×	×	×	○ ^{*1}	×	
	1824	0000	×	×	△ ^{*2}	○	×	×	×	×	×	×	×	△ ^{*2}	Page 225 Copy file (command: 1824)
		0004	×	×	○ ^{*3}	×	×	×	×	×	×	×	×	○	
		0040	○ ^{*1}	×	×	×	×	×	×	×	×	×	○ ^{*1}	×	
	Modify file	1825	0000	×	×	△ ^{*2}	○	×	×	×	×	×	×	×	△ ^{*2}
0004			×	×	○ ^{*3}	×	×	×	×	×	×	×	×	○	
0040			○ ^{*1}	×	×	×	×	×	×	×	×	×	○ ^{*1}	×	
1826		0000	×	×	○	○	×	×	×	×	×	×	×	○	Page 232 Modify file creation date and time (command: 1826)
		0040	○ ^{*1}	×	×	×	×	×	×	×	×	×	○ ^{*1}	×	
1827		0000	×	×	△ ^{*2}	○	×	×	○	×	×	×	×	△ ^{*2}	Page 235 Open file (command: 1827)
		0004	×	×	○ ^{*3}	×	×	×	×	×	×	×	×	○	
		0040	○ ^{*1}	×	×	×	×	×	×	×	×	×	○ ^{*1}	×	
1828		0000	○	×	○	○	×	×	○	×	×	×	○	○	Page 239 Read file (command: 1828)
1829		0000	○	×	○	○	×	×	×	×	×	×	○	○	Page 241 Write to file (command: 1829)
182A		0000	○	×	○	○	×	×	○	×	×	×	○	○	Page 243 Close file (command: 182A)

*1 The command can be used when both access target and connected station are MELSEC iQ-R series module.

*2 It can be used when password is not set to the target file.

*3 The command can be used when both access target and connected station are MELSEC-L series module.

Serial communication dedicated commands

The command can only be used for C24 (including multidrop connection station) connected to the external device.

☞ Page 245 SERIAL COMMUNICATION MODULE DEDICATED COMMANDS

QnACPU dedicated commands

The QnACPU dedicated commands can only be executed when access target is QnACPU.

☞ Page 288 QnACPU DEDICATED COMMANDS

Commands for 2C frame

The command can only be used for C24 (including multidrop connection station) and its control CPU module connected to the external device.

Cannot be used via network.

○: Executable, △: Executable (with restrictions)

Function	Command	Access target						Reference
		CPU module					Head	
		iQ-R	iQ-L	L	Q	QnA	iQ-R	
Device access	1	△*1	△*1	○	○	○	△*1	Page 90 Batch read in bit units (command: 0401)
	2	△*1	△*1	○	○	○	△*1	Page 86 Batch read in word units (command: 0401)
	3	△*1	△*1	○	○	○	△*1	Page 95 Batch write in bit units (command: 1401)
	4	△*1	△*1	○	○	○	△*1	Page 92 Batch write in word units (command: 1401)
	5	△*1	△*1	○	○	○	△*1	Page 97 Random read in word units (command: 0403)
	6	△*1	△*1	○	○	○	△*1	Page 108 Random write in bit units (test) (command: 1402)
	7	△*1	△*1	○	○	○	△*1	Page 104 Random write in word units (test) (command: 1402)
	8	△*1	△*1	○	○	○	△*1	Page 120 Register monitor data (command: 0801)
	9	○	○	○	○	○	○	Page 121 Monitor (command: 0802)

*1 Some devices and device ranges cannot be specified. (☞ Page 68 Device code list)

Commands for 1C frame

○: Executable, ×:Not executable

Function			Command	Access target									Reference
				CPU module							Remote I/O	Head	
				iQ-R	iQ-L	L	Q*1	QnA	A	QS	H	iQ-R	
Device memory	Batch read	Bit units	BR JR	△*2	×	△*2	△*2	△*2	○	△*2	△*2	△*2	Page 354 Batch read (bit units) (command: BR, JR)
		Word units	WR QR	△*2	×	△*2	△*2	△*2	○	△*2	△*2	△*2	Page 356 Batch read (word units) (command: WR, QR)
	Batch write	Bit units	BW JW	△*2	×	△*2	△*2	△*2	○	×	△*2	△*2	Page 358 Batch write (bit units) (command: BW, JW)
		Word units	WW QW	△*2	×	△*2	△*2	△*2	○	×	△*2	△*2	Page 360 Batch write (word units) (command: WW, QW)
	Test (random write)	Bit units	BT JT	△*2	×	△*2	△*2	△*2	○	×	△*2	△*2	Page 362 Test (random write) (bit units) (command: BT, JT)
		Word units	WT QT	△*2	×	△*2	△*2	△*2	○	×	△*2	△*2	Page 364 Test (random write) (word units) (command: WT, QT)
	Register monitor data	Bit units	BM JM	△*2	×	△*2	△*2	△*2	○	×	△*2	△*2	Page 367 Register monitor data (bit units) (command: BM, JM)
		Word units	WM QM	△*2	×	△*2	△*2	△*2	○	×	△*2	△*2	Page 368 Register monitor data (word units) (command: WM, QM)
Monitor	Bit units	MB MJ	○	×	○	○	○	○	×	○	○	Page 369 Monitor (bit units) (command: MB, MJ)	
	Word units	MN MQ	○	×	○	○	○	○	×	○	○	Page 370 Monitor (word units) (command: MN, MQ)	

Function		Command	Access target									Reference	
			CPU module							Remote I/O	Head		
			iQ-R	iQ-L	L	Q*1	QnA	A	QS	H	iQ-R		
Extended file register	Batch read	ER	×	×	×	×	×	○	×	×	×	Page 375 Batch read (command: ER)	
	Batch write	EW	×	×	×	×	×	○	×	×	×	Page 376 Batch write (command: EW)	
	Test (random write)	ET	×	×	×	×	×	○	×	×	×	Page 377 Test (random write) (command: ET)	
	Register monitor data	EM	×	×	×	×	×	○	×	×	×	Page 379 Register monitor data (command: EM)	
	Monitor	ME	×	×	×	×	×	○	×	×	×	Page 380 Monitor (command: ME)	
	Direct read	Word units	NR	×	×	×	×	×	○	×	×	×	Page 381 Direct read (command: NR)
	Direct write	Word units	NW	×	×	×	×	×	○	×	×	×	Page 382 Direct write (command: NW)
Special function module	Batch read	TR	×	×	×	×	×	○	×	×	○	Page 386 Batch read (command: TR)	
	Batch write	TW	×	×	×	×	×	○	×	×	○	Page 388 Batch write (command: TW)	
Loopback test		TT	—*3									Page 389 Loopback test (Command: TT)	

*1 When accessing Universal model QCPU, use the module with a serial number whose first five digits are '10102' or later. If using a module with a serial number whose first five digits are '10101' or earlier, access with 2C/3C/4C frame.

*2 Read/write the devices within the range of AnCPU, AnNCPU, AnACPU, or AnUCPU. The added new devices and their ranges cannot be specified.

*3 The command can only be used for C24 (including multidrop connection station) connected to the external device.

Commands for 1E frame

○: Executable, ×:Not executable

Function			Command	Access target					Reference
				CPU module					
				L	Q ^{*1}	Qn A	A	QS	
Device memory	Batch read	Bit units	00H	△ ^{*2}	△ ^{*2}	△ ^{*2}	○	△ ^{*2}	Page 403 Batch read in bit units (command: 00)
		Word units	01H	△ ^{*2}	△ ^{*2}	△ ^{*2}	○	△ ^{*2}	Page 405 Batch read in word units (command: 01)
	Batch write	Bit units	02H	△ ^{*2}	△ ^{*2}	△ ^{*2}	○	×	Page 407 Batch write in bit units (command: 02)
		Word units	03H	△ ^{*2}	△ ^{*2}	△ ^{*2}	○	×	Page 409 Batch write in word units (command: 03)
	Test (random write)	Bit units	04H	△ ^{*2}	△ ^{*2}	△ ^{*2}	○	×	Page 410 Test in bit units (random write) (command: 04)
		Word units	05H	△ ^{*2}	△ ^{*2}	△ ^{*2}	○	×	Page 412 Test in word units (random write) (command: 05)
	Register monitor data ^{*3}	Bit units	06H	△ ^{*2}	△ ^{*2}	△ ^{*2}	○	×	Page 415 Register monitor data(command: 06, 07)
		Word units	07H	△ ^{*2}	△ ^{*2}	△ ^{*2}	○	×	
Monitor	Bit units	08H	○	○	○	○	×	Page 416 Monitor in bit units (command: 08)	
	Word units	09H	○	○	○	○	×	Page 417 Monitor in word units (command: 09)	
Extended file register	Batch read		17H	×	×	×	○	×	Page 419 Batch read (command: 17)
	Batch write		18H	×	×	×	○	×	Page 421 Batch write (command: 18)
	Test (random write)		19H	×	×	×	○	×	Page 423 Test (random write) (command: 19)
	Register monitor data ^{*3}		1AH	×	×	×	○	×	Page 426 Register monitor data (command: 1A)
	Monitor		1BH	×	×	×	○	×	Page 427 Monitoring (command: 1B)
	Direct read		3BH	×	×	×	○	×	Page 428 Direct read (command: 3B)
	Direct write		3CH	×	×	×	○	×	Page 430 Direct write (command: 3C)
Special function module	Batch read		0EH	×	×	×	○	×	Page 434 Batch read (command: 0E)
	Batch write		0FH	×	×	×	○	×	Page 436 Batch write (command: 0F)

*1 When accessing Universal model QCPU, use the module with a serial number whose first five digits are '10102' or later. If using a module with a serial number whose first five digits are '10101' or earlier, access with 3E/4E frame.

In addition, when accessing a built-in Ethernet port CPU, refer to the following manual.

 QnUCPU User's Manual (Communication via Built-in Ethernet Port)

*2 Read/write the devices within the range of AnACPU. The added new devices and their ranges cannot be specified.

*3 The devices that can be registered to E71 is for 1 command out of the three types of commands (06H, 07H, 1AH).

The specified device recently used by any of the above commands is registered to E71.

Appendix 7 Setting Examples

This section explains the setting example of the message.

Setting examples of message for serial communication module

The following shows the setting example when using a command from a serial communication module.

Examples of device access in ASCII code (Format 1, 3C frame)

The following shows the setting example when using a command for format 1 and 3C frame.

■ Device reading

- Format 1 (sum check enabled), 3C frame
- Access target: QCPU of the connected station (host station)
- Command: Batch read in word units (command: 0401)
- Device: M100 to M131 (for 2 words)

1. Read values from devices.

Request message

Control code	Frame ID No.		Access route							
			Station No.		Network No.		PC No.		Self-station No.	
ENQ	3C frame		Host station							
	F	9	0	0	0	0	F	F	0	0
05H	46H	39H	30H	30H	30H	30H	46H	46H	30H	30H
—	The subtotal of the additional value of binary data = 22BH									

Request data																			Sum check code*1	
Command				Subcommand				Device code		Head device number				Number of device points						
0	4	0	1	0	0	0	0	M	*	0	0	0	1	0	0	0	0	2	0	A
30H	34H	30H	31H	30H	30H	30H	30H	4DH	2AH	30H	30H	30H	31H	30H	30H	30H	30H	32H	30H	41H
The subtotal of the additional value of binary data = 3DFH																			—	

*1 The addition result of the sum check range: 22BH+3DF=60AH

2. Receive the result.

Response message (Normal completion: Response data)

Control code	Frame ID No.		Access route							
			Station No.		Network No.		PC No.		Self-station No.	
STX	3C frame		Host station							
	F	9	0	0	0	0	F	F	0	0
02H	46H	39H	30H	30H	30H	30H	46H	46H	30H	30H
—	The subtotal of the additional value of binary data = 22BH									

Response data (read data)*2								Control code	Sum check code*1	
1	2	3	4	0	0	0	2	ETX	B	A
31H	32H	33H	34H	30H	30H	30H	32H	03H	42H	41H
The subtotal of the additional value of binary data = 18FH									—	

*1 The addition result of the sum check range: 22BH + 18F = 3BAH

*2 The value of read data corresponds to the access target device as follows.

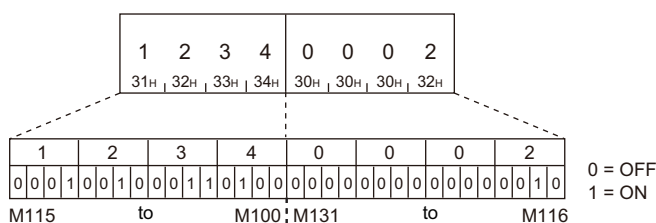

A

■ Device writing

- Format 1 (sum check enabled), 3C frame
- Access target: QCPU of the connected station (host station)
- Command: Batch write in word units (command: 1401)
- Device: M100 to M131 (for 2 words)

1. Write values to devices.

Request message

Control code	Frame ID No.		Access route							
			Station No.		Network No.		PC No.		Self-station No.	
ENQ	3C frame		Host station							
	F	9	0	0	0	0	F	F	0	0
05H	46H	39H	30H	30H	30H	30H	46H	46H	30H	30H
—	The subtotal of the additional value of binary data = 22BH									

Request data																					
Command				Subcommand				Device code		Head device number						Number of device points					
1	4	0	1	0	0	0	0	M	*	0	0	0	1	0	0	0	0	0	0	0	2
31H	34H	30H	31H	30H	30H	30H	30H	4DH	2AH	30H	30H	30H	31H	30H	30H	30H	30H	30H	30H	30H	32H

The subtotal of the additional value of binary data = 3E0H

Request data										Sum check code ^{*1}	
Write data ^{*2}											
2	3	4	7	A	B	9	6	C	D		
32H	33H	34H	37H	41H	42H	39H	36H	43H	44H		
The subtotal of the additional value of binary data = 1C2H										—	

*1 The addition result of the sum check range: 22BH + 3E0H + 1C2H = 7CDH

*2 The value of write data corresponds to the access target device as follows.

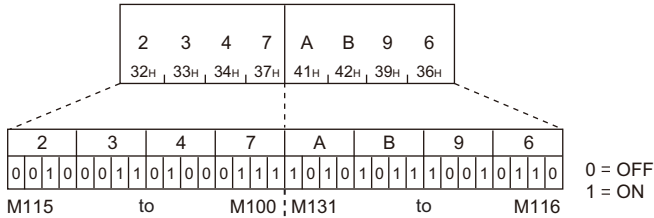

2. Receive the result.

Response message (Normal completion: No response data)

Control code	Frame ID No.		Access route							
			Station No.		Network No.		PC No.		Self-station No.	
ACK	3C frame		Host station							
	F	9	0	0	0	0	F	F	0	0
06H	46H	39H	30H	30H	30H	30H	46H	46H	30H	30H

Examples of device access in binary code (Format 5, 4C frame)

The following shows the setting example when using a command for format 5 and 4C frame.

■ Device reading

- Format 5 (sum check enabled), 4C frame
- Access target: QCPU of the connected station (host station)
- Command: Batch read in word units (command: 0401)
- Device: M100 to M131 (for 2 words)

1. Read values from devices.

Request message

Control code		Number of data bytes ^{*1}		Frame ID No.	Access route							
					Station No.	Network No.	PC No.	Request destination module I/O No.	Request destination module station No.	Self-station No.		
DLE	STX	18 bytes		4C frame	Host station							
10H	02H	12H	00H	F8H	00H	00H	FFH	FFH	03H	00H	00H	
—		The subtotal of the additional value of binary data = 30BH										

Request data										Control code		Sum check code ^{*2}	
Command	Subcommand		Head device number			Device code	Number of device points						
0401	0000		100			M	2		DLE	ETX	0	6	
01H	04H	00H	00H	64H	00H	00H	90H	02H	00H	10H	03H	30H	36H
The subtotal of the additional value of binary data = FBH										—		—	

*1 Frame ID No. (1 byte) + Access route (7 bytes) + Request data (10 bytes)

*2 The addition result of the sum check range: 30BH + FBH = 406H

2. Receive the result.

Response message (Normal completion: Response data)

Control code		Number of data bytes ^{*1}		Frame ID No.	Access route									
					Station No.	Network No.	PC No.	Request destination module I/O No.	Request destination module station No.	Self-station No.				
DLE	STX	16 bytes		4C frame	Host station									
10H	02H	10H	10H	00H	F8H	00H	00H	FFH	FFH	03H	00H	00H		
—		— ^{*2}		The subtotal of the additional value of binary data = 309H										

Response ID code		Normal completion code		Response data (read data) ^{*4}				Control code		Sum check code ^{*3}	
FFFFH		0000H		M100 to M115		M116 to M131		DLE	ETX	4	F
FFH	FFH	00H	00H	34H	12H	02H	00H	10H	03H	34H	46H
The subtotal of the additional value of binary data = 246H										—	

*1 Frame ID No. (1 byte) + Access route (7 bytes) + Response ID code (2 bytes) + Normal completion code (2 bytes) + Response data (4 bytes)

*2 Additional code. Calculate the sum check code except for the additional code. (Page 35 Additional code (10H))

*3 The addition result of the sum check range: 309H + 246h = 54FH

*4 The value of read data corresponds to the access target device as follows.

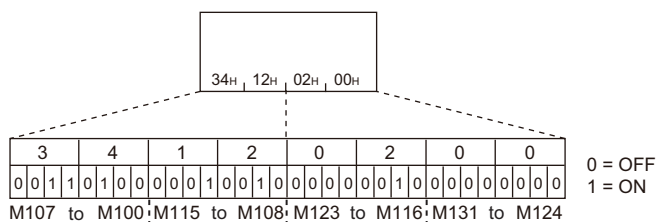

■ Device writing

- Format 5 (sum check enabled), 4C frame
- Access target: QCPU of the connected station (host station)
- Command: Batch write in word units (command: 1401)
- Device: M100 to M131 (for 2 words)

1. Write values to devices.

Request message

Control code		Number of data bytes ^{*1}		Frame ID No.	Access route							
					Station No.	Network No.	PC No.	Request destination module I/O No.		Request destination module station No.	Self-station No.	
DLE	STX	22 bytes		4C frame	Host station							
10H	02H	16H	00H	F8H	00H	00H	FFH	FFH	03H	00H	00H	
—		The subtotal of the additional value of binary data = 30FH										

Request data														Control code		Sum check code ^{*2}	
Command		Subcommand		Head device number			Device code	Number of device points		Write data ^{*3}							
1401		0000		100			M	2		M100 to M115		M116 to M131		DLE	ETX	C	5
01H	14H	00H	00H	64H	00H	00H	90H	02H	00H	47H	23H	96H	ABH	10H	03H	43H	35H
The subtotal of the additional value of binary data = 2B6H														—		—	

*1 Frame ID No. (1 byte) + Access route (7 bytes) + Request data (14 bytes)

*2 The addition result of the sum check range: 30FH + 2B6H = 5C5H

*3 The value of write data corresponds to the access target device as follows.

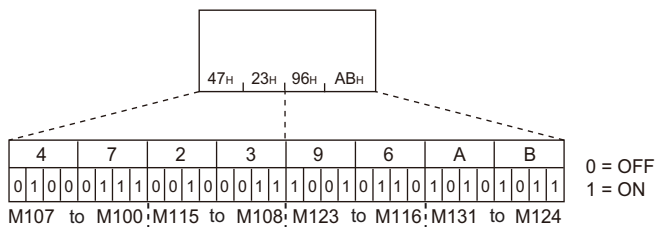

2. Receive the result.

Response message (Normal completion: No response data)

Control code		Number of data bytes ^{*1}		Frame ID No.	Access route							
					Station No.	Network No.	PC No.	Request destination module I/O No.		Request destination module station No.	Self-station No.	
DLE	STX	12 bytes		4C frame	Host station							
10H	02H	0CH	00H	F8H	00H	00H	FFH	FFH	03H	00H	00H	
—		The subtotal of the additional value of binary data = 305H										

Response ID code		Normal completion code		Control code		Sum check code ^{*2}	
FFFFH		0000H		DLE	ETX	0	3
FFH	FFH	00H	00H	10H	03H	30H	33H
The subtotal of the additional value of binary data = 1FEH				—		—	

*1 Frame ID No. (1 byte) + Access route (7 bytes) + Response ID code (2 bytes) + Normal completion code (2 bytes)

*2 The addition result of the sum check range: 305H + 1FEH = 503H

Setting examples of message for Ethernet interface module

The following shows the setting example when using a command from an Ethernet interface module.

Examples of device access in ASCII code (3E frame)

The following shows the setting example when using a command for ASCII code and 3E frame.

■Device reading

- ASCII code, 3E frame
- Access target: QCPU of the connected station (host station)
- Command: Batch read in word units (command: 0401)
- Device: M100 to M131 (for 2 words)

1. Read values from devices.

Request message

Subheader	Access route												Request data length ^{*1}				Monitoring timer					
	Network No.		PC No.		Request destination module I/O No.				Request destination module station No.													
3E frame (request)	Host station												24				4 seconds					
5	0	0	0	0	0	0	F	F	0	3	F	F	0	0	0	0	1	8	0	0	1	0
35H	30H	30H	30H	30H	30H	30H	46H	46H	30H	33H	46H	46H	30H	30H	30H	30H	31H	38H	30H	30H	31H	30H

Request data																			
Command				Subcommand				Device code		Head device number				Number of device points					
0	4	0	1	0	0	0	0	M	*	0	0	0	1	0	0	0	0	0	2
30H	34H	30H	31H	30H	30H	30H	30H	4DH	2AH	30H	30H	30H	31H	30H	30H	30H	30H	30H	32H

*1 Monitoring timer (4 bytes) + Request data (20 bytes)

2. Receive the result.

Response message (Normal completion: Response data)

Subheader	Access route												Response data length ^{*1}				End code					
	Network No.		PC No.		Request destination module I/O No.				Request destination module station No.													
3E frame (response)	Host station												12				0000H					
D	0	0	0	0	0	0	F	F	0	3	F	F	0	0	0	0	0	C	0	0	0	0
44H	30H	30H	30H	30H	30H	30H	46H	46H	30H	33H	46H	46H	30H	30H	30H	30H	30H	43H	30H	30H	30H	30H

Response data (read data) ^{*2}							
1		2		3		4	
31H		32H		33H		34H	

*1 End code (4 bytes) + Response data (8 bytes)

*2 The value of read data corresponds to the access target device as follows.

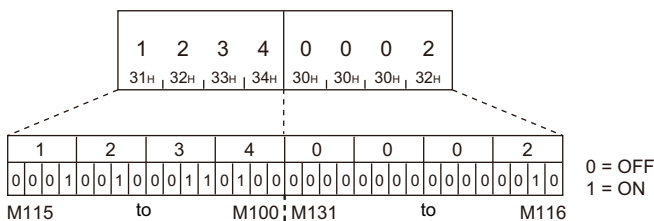

■ Device writing

- ASCII code, 3E frame
- Access target: QCPU of the connected station (host station)
- Command: Batch write in word units (command: 1401)
- Device: M100 to M131 (for 2 words)

1. Write values to devices.

Request message

Subheader	Access route												Request data length ^{*1}	Monitoring timer								
	Network No.	PC No.	Request destination module I/O No.				Request destination module station No.															
3E frame (request)	Host station												32	4 seconds								
5	0	0	0	0	0	0	F	F	0	3	F	F	0	0	0	0	2	0	0	0	1	0
35H	30H	30H	30H	30H	30H	46H	46H	30H	33H	46H	46H	30H	30H	30H	30H	32H	30H	30H	30H	30H	31H	30H

Request data																				
Command				Subcommand				Device code				Head device number				Number of device points				
1	4	0	1	0	0	0	0	M	*	0	0	0	1	0	0	0	0	0	2	
31H	34H	30H	31H	30H	30H	30H	30H	4DH	2AH	30H	30H	30H	31H	30H	30H	30H	30H	30H	30H	32H

Request data							
Write data ^{*2}							
2	3	4	7	A	B	9	6
32H	33H	34H	37H	41H	42H	39H	36H

*1 Monitoring timer (4 bytes) + Request data (28 bytes)

*2 The value of write data corresponds to the access target device as follows.

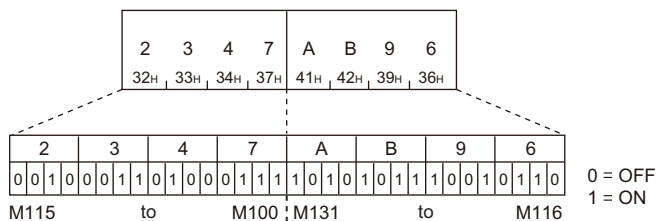

2. Receive the result.

Response message (Normal completion: No response data)

Subheader	Access route												Response data length ^{*1}	End code							
	Network No.	PC No.	Request destination module I/O No.				Request destination module station No.														
3E frame (response)	Host station												4	0000H							
D	0	0	0	0	0	0	F	F	0	3	F	F	0	0	0	0	4	0	0	0	0
44H	30H	30H	30H	30H	30H	46H	46H	30H	33H	46H	46H	30H	30H	30H	30H	34H	30H	30H	30H	30H	

*1 End code (4 bytes)

■ Device writing

- Binary code, 3E frame
- Access target: QCPU of the connected station (host station)
- Command: batch write in word units (command: 1401)
- Device: M100 to M131 (for 2 words)

1. Write values to devices.

Request message

Subheader	Access route						Request data length ^{*1}		Monitoring timer	
	Network No.	PC No.	Request destination module I/O No.		Request destination module station No.					
3E frame (request)	Host station						16		4 seconds	
50H	00H	00H	FFH	FFH	03H	00H	10H	00H	10H	00H

Request data															
Command		Subcommand		Head device number			Device code	Number of device points		Write data ^{*2}					
1401		0000		100			M	2		M100 to M115				M116 to M131	
01H	14H	00H	00H	64H	00H	00H	90H	02H	00H	47H	23H	96H	ABH		

*1 Monitoring timer (2 bytes) + Request data (14 bytes)

*2 The value of write data corresponds to the access target device as follows.

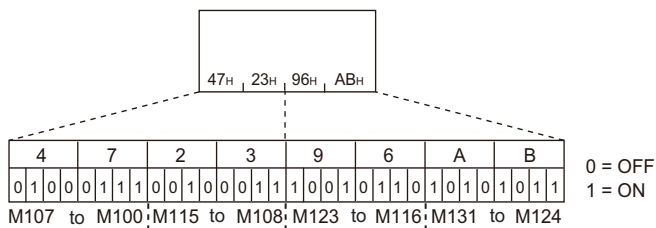

2. Receive the result.

Response message (Normal completion: No response data)

Subheader	Access route						Response data length ^{*1}		End code	
	Network No.	PC No.	Request destination module I/O No.		Request destination module station No.					
3E frame (response)	Host station						2		0000H	
D0H	00H	00H	FFH	FFH	03H	00H	02H	00H	00H	00H

*1 End code (2 bytes)

Setting examples of access route

The following shows the setting example of each access route for each frame. For the details of each setting item, refer to the following section.

☞ Page 50 Details of Setting Data

Accessing the connected station (host station)

The following shows the setting example for accessing the connected station (host station).

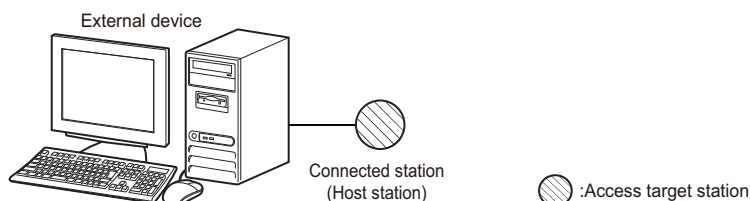

—: Unnecessary

Access target	Frame	Station No.	Network No.	PC No.	Request destination module I/O No.	Request destination module station No.	Self-station No.
Connected station (host station)	4C	00	00	FF	03FF	00	00
	3C	00	00	FF	—	—	00
	2C	00	—	—	—	—	00
	1C	00	—	FF	—	—	—
	4E/3E	—	00	FF	03FF	00	—
	1E	—	—	FF	—	—	—
Multiple CPU system (Multiple CPU No.1)	4C	00	00	FF	03E0	00	00
	4E/3E	—	00	FF	03E0	00	—
Redundant system (Control system CPU)	4C	00	00	FF	03D0	00	00
	4E/3E	—	00	FF	03D0	00	—

Specify the CPU module of an access target in the request destination module I/O No.

☞ Page 56 Accessing multiple CPU system, redundant system

A

Connecting with a multidrop connection

When accessing a multidrop connection station, specify the station No. of an access target to the station No.

When requiring to distinguish request sources in a m:n connection, specify the station No. of an external device to the self-station No.

The following shows setting examples for accessing a multidrop connection station.

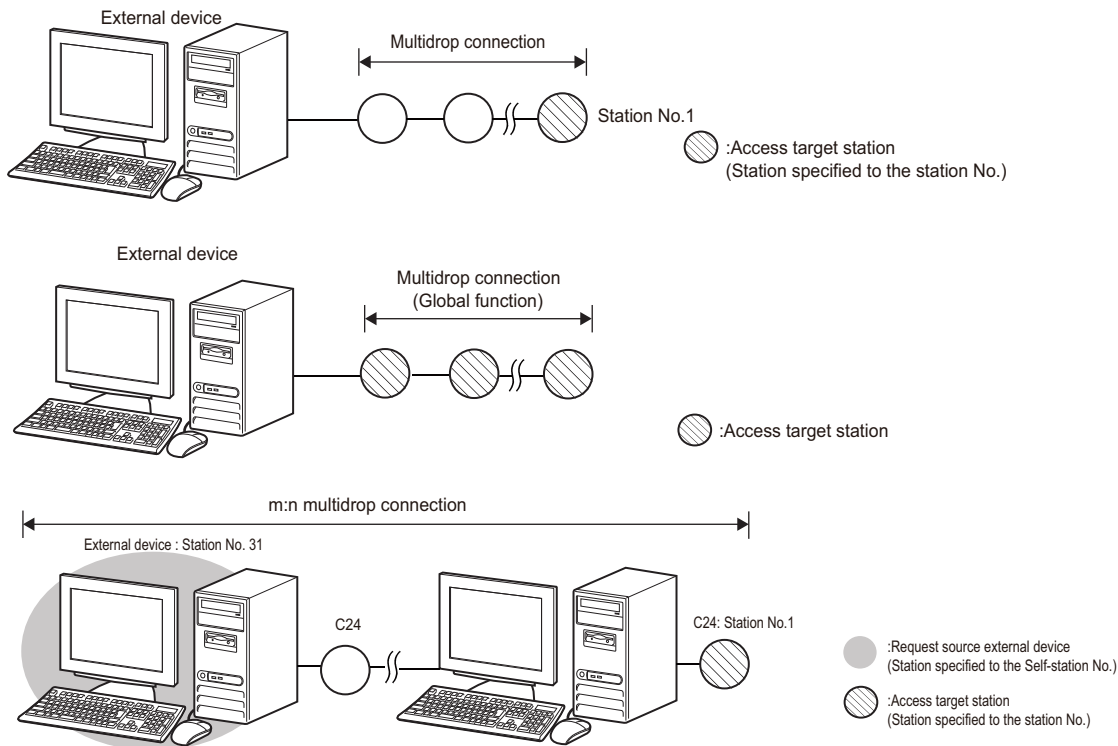

—: Unnecessary

Access target	Frame	Station No.	Network No.	PC No.	Request destination module I/O No.	Request destination module station No.	Self-station No.
Multidrop connection station • Station No.1	4C	01	00	FF	03FF	00	00
	3C	01	00	FF	—	—	00
	2C	01	—	—	—	—	00
	1C	01	—	FF	—	—	—
All stations connected with a multidrop connection (Global function)	4C	FF	00	FF	03FF	00	00
	3C	FF	00	FF	—	—	00
	2C	FF	—	—	—	—	00
Multidrop connection station (At m:n connection) • Station No.1 • Station No.31 (1FH) of the external device	4C	01	00	FF	03FF	00	1F
	3C	01	00	FF	—	—	1F
	2C	01	—	—	—	—	1F

■When accessing from an Ethernet interface module

When accessing a multidrop connection station with the frames (4E frame, 3E frame) for the Ethernet interface module, specify the start input/output number of a multidrop connection source module (relay station) and the station No. of an access target to the request destination I/O No. and the request destination module station No. For the request destination I/O No., specify the value obtained by dividing the start input/output number by 16 in 4 digits (hexadecimal).

The following shows the setting example of the cases below.

- Multidrop connection source module of the relay station: Start input/output number 0050H (request destination module I/O No.0005H)
- Multidrop connection station of the access target: Station No.1

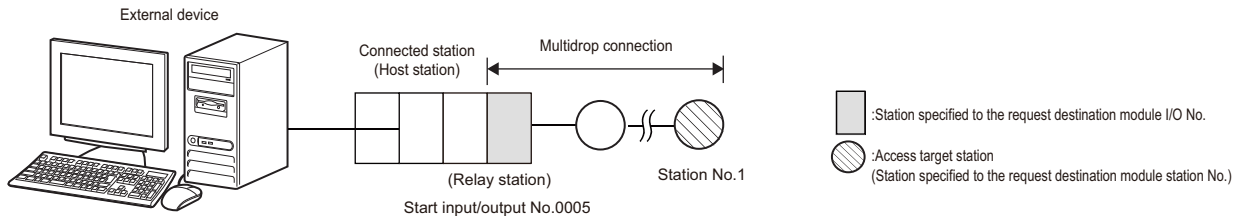

—: Unnecessary

Access target	Frame	Station No.	Network No.	PC No.	Request destination module I/O No.	Request destination module station No.	Self-station No.
Multidrop connection station	4E/3E	—	00	FF	0005	01	—

Accessing via network

When accessing other stations via network, specify the network No. and station No. of an access target network module to the network No. and PC No.

The following shows setting examples for accessing other stations via network (network No. 1, station No.2) without a multidrop connection.

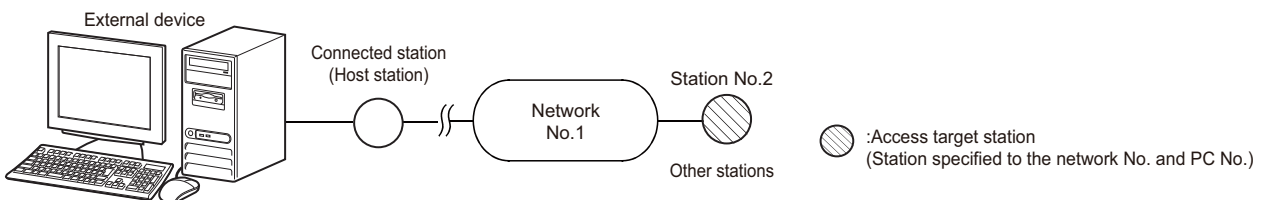

—: Unnecessary

Access target	Frame	Station No.	Network No.	PC No.	Request destination module I/O No.	Request destination module station No.	Self-station No.
Other station via network • Network No. 1 • Station No. 2	4C	00	01	02	03FF	00	00
	3C	00	01	02	—	—	00
	4E/3E	—	01	02	03FF	00	—
Other station accessed via the network module set in the "Valid Module During Other Station Access" setting. • Station No. 2	4C	00	FE	02	03FF	00	00
	3C	00	FE	02	—	—	00
	1C	00	—	02	—	—	—
	4E/3E	—	FE	02	03FF	00	—
	1E	—	—	02	—	—	—

Connecting with a multidrop link and via network

The following shows setting examples for connecting with a multidrop connection and via network.

Other stations via network from a multidrop connection

Specify the setting for a multidrop connection including the connected station (host station) and the setting for a connection via network each.

Specify the station No. of a multidrop connection station for a relay to the station No.

Specify the network No. and station No. of an access target to the network No. and PC No.

The following shows the setting example of the cases below.

- Multidrop connection station of the relay station: Station No.1
- Network module of the access target: Network No.1, station No.2

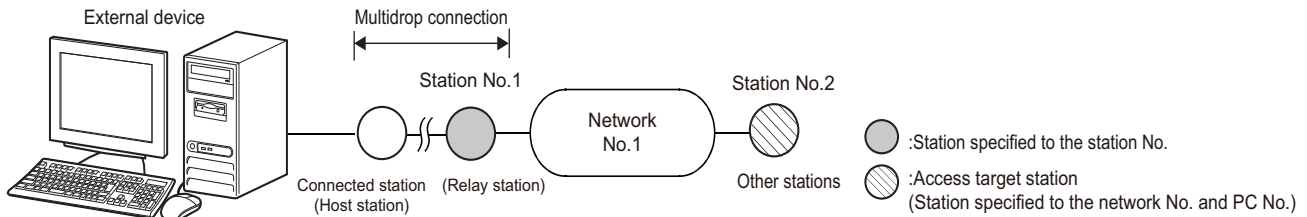

—: Unnecessary

Access target	Frame	Station No.	Network No.	PC No.	Request destination module I/O No.	Request destination module station No.	Self-station No.
Other stations via network from a multidrop connection	4C	01	01	02	03FF	00	00
	3C	01	01	02	—	—	00

Multidrop connection station via network

For accessing a multidrop connection station in the target via network, specify the start input/output number of a multidrop connection source module and the station No. of an access target to the request destination module I/O No. and the request destination module station No. For the request destination module I/O No., specify the value obtained by dividing the start input/output number by 16 in 4 digits (hexadecimal).

Specify the network No. and station No. of a network module for a relay station to the network No. and PC No.

The following shows the setting example of the cases below.

- Network module for the relay station: Network No.1, station No.2
- Multidrop connection source module of the relay station: Start input/output number 0050H (request destination module I/O No.0005H)
- Multidrop connection station of the access target: Station No.1

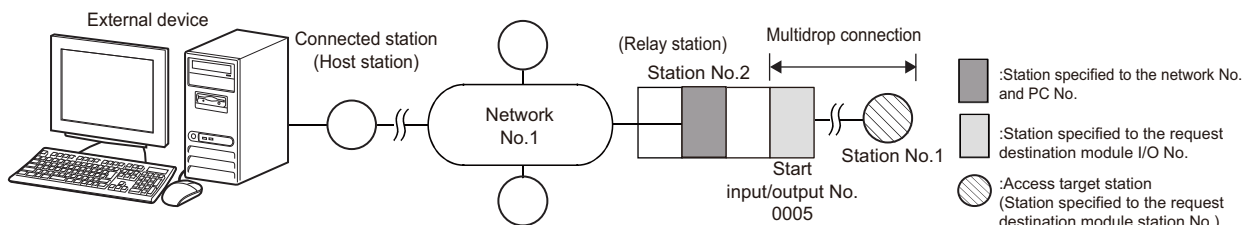

—: Unnecessary

Access target	Frame	Station No.	Network No.	PC No.	Request destination module I/O No.	Request destination module station No.	Self-station No.
Multidrop connection station via network	4C	00	01	02	0005	01	00
	4E/3E	—	01	02	0005	01	—

INDEX

0 to 9

1C frame	28,47
1E frame	40,49
2C frame	28,46
3C frame	28,46
3E frame	40,48
4C frame	28,45
4E frame	40,48

A

Accessible module	20
Accessible range	20
ACPU monitoring timer	394
Additional code	35
ASCII code	28,39

B

Binary code	28,39
Buffer memory	151,383,432

C

Clear error information	186
Cluster	289
Command	60
Command list	60
Connected station (host station)	14
Control code	34

D

Device	65,350,397
Device code	66,351,397
Device extension specification	438
Drive memory	289

E

Error code	38,348
Error information	44
Extended file register	371,418

F

File	189,297
Format	28
Format 1	29
Format 2	30
Format 3	31
Format 4	32
Format 5	33
Frame	28,40
Frame ID No.	36

G

Global function	254
-----------------	-----

H

Header	42
--------	----

I

Index modification	446
Intelligent function module	157

K

Keyword	290
---------	-----

L

Label	124
LED OFF	186,188
Loopback test	184,389

M

Message format	29,41
Mode switching function	258
Monitoring timer	43
Multiple CPU systems	462

N

Network No.	52
Number of processing per one communication	466

O

On-demand function	279
Online program change	464
Other station	14

P

Password	194
PC No.	52,393
Processing time	454
Processing timing of CPU module	23
Programmable controller CPU monitoring function	265

R

Relay station	14
Remote operation	172
Remote password	179
Request destination module I/O number	55
Request destination module station No.	55
Request message	14
Response message	14

S

Self-station No.	58
Serial communication function	21,461
Serial number	42
Special function module	383,432

Station No.	50
Subheader	42
Sum check code	36

T

Transmission sequence initialization function . . .	257
Transmission time when accessing other stations	456

U

User frame	245
----------------------	-----

MEMO

REVISIONS

*The manual number is given on the bottom left of the back cover.

Revision date	*Manual number	Description
December 1999 to July 2013	SH(NA)-080008-A to SH(NA)-080008-S	Due to the transition to the e-Manual, the details of revision have been deleted.
June 2014	SH(NA)-080008-T	Complete revision (layout change) ■ Added models RJ71C24, RJ71C24-R2, RJ71C24-R4
July 2014	SH(NA)-080008-U	Minor correction.
August 2015	SH(NA)-080008-V	■ Added or modified parts Section 6.2, Section 8.1, Section 8.2, Section 8.3, Section 8.4, Section 8.5, Chapter 9, Section 12.4, Appendix 7
May 2016	SH(NA)-080008-W	■ Added or modified parts Section 3.2, Section 6.2, Section 8.1, Section 8.2, Section 8.3, Section 8.4, Chapter 9, Section 11.1, Section 12.4, Appendix 6
November 2017	SH(NA)-080008-X	■ Added or modified parts DISCONTINUED MODELS, Section 8.2, Section 11.1
October 2019	SH(NA)-080008-Y	■ Added or modified parts TERMS, GENERIC TERMS AND ABBREVIATIONS, Section 3.2, Section 7.1, Section 8.2, Section 8.3, Section 8.4, Section 11.1, Appendix 1, Appendix 2, Appendix 5, Appendix 6
May 2020	SH(NA)-080008-Z	■ Added or modified part Section 13.4
April 2021	SH(NA)-080008-AA	■ Added or modified parts SAFETY PRECAUTIONS, CONDITIONS OF USE FOR THE PRODUCT, Section 8.1
May 2022	SH(NA)-080008-AB	■ Added or modified part Section 3.2

Japanese manual number: SH-080003-AH

This manual confers no industrial property rights or any rights of any other kind, nor does it confer any patent licenses. Mitsubishi Electric Corporation cannot be held responsible for any problems involving industrial property rights which may occur as a result of using the contents noted in this manual.

© 1999 MITSUBISHI ELECTRIC CORPORATION

WARRANTY

Please confirm the following product warranty details before using this product.

1. Gratis Warranty Term and Gratis Warranty Range

If any faults or defects (hereinafter "Failure") found to be the responsibility of Mitsubishi occurs during use of the product within the gratis warranty term, the product shall be repaired at no cost via the sales representative or Mitsubishi Service Company.

However, if repairs are required onsite at domestic or overseas location, expenses to send an engineer will be solely at the customer's discretion. Mitsubishi shall not be held responsible for any re-commissioning, maintenance, or testing on-site that involves replacement of the failed module.

[Gratis Warranty Term]

The gratis warranty term of the product shall be for one year after the date of purchase or delivery to a designated place. Note that after manufacture and shipment from Mitsubishi, the maximum distribution period shall be six (6) months, and the longest gratis warranty term after manufacturing shall be eighteen (18) months. The gratis warranty term of repair parts shall not exceed the gratis warranty term before repairs.

[Gratis Warranty Range]

- (1) The range shall be limited to normal use within the usage state, usage methods and usage environment, etc., which follow the conditions and precautions, etc., given in the instruction manual, user's manual and caution labels on the product.
- (2) Even within the gratis warranty term, repairs shall be charged for in the following cases.
 1. Failure occurring from inappropriate storage or handling, carelessness or negligence by the user. Failure caused by the user's hardware or software design.
 2. Failure caused by unapproved modifications, etc., to the product by the user.
 3. When the Mitsubishi product is assembled into a user's device, Failure that could have been avoided if functions or structures, judged as necessary in the legal safety measures the user's device is subject to or as necessary by industry standards, had been provided.
 4. Failure that could have been avoided if consumable parts (battery, backlight, fuse, etc.) designated in the instruction manual had been correctly serviced or replaced.
 5. Failure caused by external irresistible forces such as fires or abnormal voltages, and Failure caused by force majeure such as earthquakes, lightning, wind and water damage.
 6. Failure caused by reasons unpredictable by scientific technology standards at time of shipment from Mitsubishi.
 7. Any other failure found not to be the responsibility of Mitsubishi or that admitted not to be so by the user.

2. Onerous repair term after discontinuation of production

- (1) Mitsubishi shall accept onerous product repairs for seven (7) years after production of the product is discontinued. Discontinuation of production shall be notified with Mitsubishi Technical Bulletins, etc.
- (2) Product supply (including repair parts) is not available after production is discontinued.

3. Overseas service

Overseas, repairs shall be accepted by Mitsubishi's local overseas FA Center. Note that the repair conditions at each FA Center may differ.

4. Exclusion of loss in opportunity and secondary loss from warranty liability

Regardless of the gratis warranty term, Mitsubishi shall not be liable for compensation to:

- (1) Damages caused by any cause found not to be the responsibility of Mitsubishi.
- (2) Loss in opportunity, lost profits incurred to the user by Failures of Mitsubishi products.
- (3) Special damages and secondary damages whether foreseeable or not, compensation for accidents, and compensation for damages to products other than Mitsubishi products.
- (4) Replacement by the user, maintenance of on-site equipment, start-up test run and other tasks.

5. Changes in product specifications

The specifications given in the catalogs, manuals or technical documents are subject to change without prior notice.

TRADEMARKS

Unicode is either a registered trademark or a trademark of Unicode, Inc. in the United States and other countries.

The company names, system names and product names mentioned in this manual are either registered trademarks or trademarks of their respective companies.

In some cases, trademark symbols such as [™] or [®] are not specified in this manual.

SH(NA)-080008-AB(2205)KWIX

MODEL: MC-PROTOCOL-R-E

MODEL CODE: 13JF89

MITSUBISHI ELECTRIC CORPORATION

HEAD OFFICE : TOKYO BUILDING, 2-7-3 MARUNOUCHI, CHIYODA-KU, TOKYO 100-8310, JAPAN
NAGOYA WORKS : 1-14, YADA-MINAMI 5-CHOME, HIGASHI-KU, NAGOYA, JAPAN

When exported from Japan, this manual does not require application to the
Ministry of Economy, Trade and Industry for service transaction permission.

Specifications subject to change without notice.