

MELSOFT

Engineering Software

GX LogViewer Version 1 Operating Manual

-SW1DNN-VIEWER-M

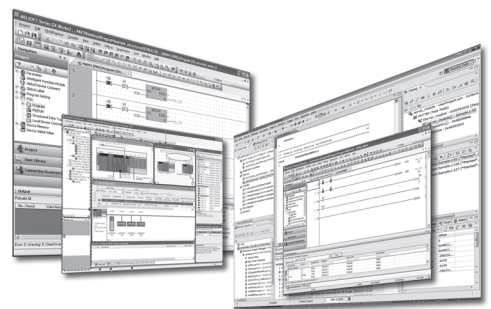

SAFETY PRECAUTIONS

(Read these precautions before using this product.)

Before using this product, please read this manual carefully and pay full attention to safety to handle the product correctly. If products are used in a different way from that specified by manufacturers, the protection function of the products may not work properly.

The precautions given in this manual are concerned with this product only. For the safety precautions for the programmable controller system, refer to the user's manual for the module used and MELSEC iQ-R Module Configuration Manual.

In this manual, the safety precautions are classified into two levels: "⚠ WARNING" and "⚠ CAUTION".



WARNING

Indicates that incorrect handling may cause hazardous conditions, resulting in death or severe injury.



CAUTION

Indicates that incorrect handling may cause hazardous conditions, resulting in minor or moderate injury or property damage.

Under some circumstances, failure to observe the precautions given under "⚠ CAUTION" may lead to serious consequences.

Observe the precautions of both levels because they are important for personal and system safety.

Make sure that the end users read this manual and then keep the manual in a safe place for future reference.

[Security Precautions]



WARNING

- To maintain the security (confidentiality, integrity, and availability) of the programmable controller and the system against unauthorized access, denial-of-service (DoS) attacks, computer viruses, and other cyberattacks from external devices via the network, take appropriate measures such as firewalls, virtual private networks (VPNs), and antivirus solutions.
-

CONDITIONS OF USE FOR THE PRODUCT

- (1) MELSEC programmable controller ("the PRODUCT") shall be used in conditions;
- i) where any problem, fault or failure occurring in the PRODUCT, if any, shall not lead to any major or serious accident; and
 - ii) where the backup and fail-safe function are systematically or automatically provided outside of the PRODUCT for the case of any problem, fault or failure occurring in the PRODUCT.
- (2) The PRODUCT has been designed and manufactured for the purpose of being used in general industries. MITSUBISHI ELECTRIC SHALL HAVE NO RESPONSIBILITY OR LIABILITY (INCLUDING, BUT NOT LIMITED TO ANY AND ALL RESPONSIBILITY OR LIABILITY BASED ON CONTRACT, WARRANTY, TORT, PRODUCT LIABILITY) FOR ANY INJURY OR DEATH TO PERSONS OR LOSS OR DAMAGE TO PROPERTY CAUSED BY the PRODUCT THAT ARE OPERATED OR USED IN APPLICATION NOT INTENDED OR EXCLUDED BY INSTRUCTIONS, PRECAUTIONS, OR WARNING CONTAINED IN MITSUBISHI ELECTRIC USER'S, INSTRUCTION AND/OR SAFETY MANUALS, TECHNICAL BULLETINS AND GUIDELINES FOR the PRODUCT.
- ("Prohibited Application")
- Prohibited Applications include, but not limited to, the use of the PRODUCT in;
- Nuclear Power Plants and any other power plants operated by Power companies, and/or any other cases in which the public could be affected if any problem or fault occurs in the PRODUCT.
 - Railway companies or Public service purposes, and/or any other cases in which establishment of a special quality assurance system is required by the Purchaser or End User.
 - Aircraft or Aerospace, Medical applications, Train equipment, transport equipment such as Elevator and Escalator, Incineration and Fuel devices, Vehicles, Manned transportation, Equipment for Recreation and Amusement, and Safety devices, handling of Nuclear or Hazardous Materials or Chemicals, Mining and Drilling, and/or other applications where there is a significant risk of injury to the public or property.
- Notwithstanding the above restrictions, Mitsubishi Electric may in its sole discretion, authorize use of the PRODUCT in one or more of the Prohibited Applications, provided that the usage of the PRODUCT is limited only for the specific applications agreed to by Mitsubishi Electric and provided further that no special quality assurance or fail-safe, redundant or other safety features which exceed the general specifications of the PRODUCTS are required. For details, please contact the Mitsubishi Electric representative in your region.
- (3) Mitsubishi Electric shall have no responsibility or liability for any problems involving programmable controller trouble and system trouble caused by DoS attacks, unauthorized access, computer viruses, and other cyberattacks.

INTRODUCTION

Thank you for your patronage. We appreciate your purchase of the engineering software, MELSOFT series.

This manual describes the operations of GX LogViewer.

Before using the product, please read this manual carefully and develop familiarity with the functions and performance of GX LogViewer to handle the products correctly.

Note that the menu names and operating procedures may differ depending on an operating system in use and its version.

When reading this manual, replace the names and procedures with the applicable ones as necessary.

CONTENTS

SAFETY PRECAUTIONS	1
CONDITIONS OF USE FOR THE PRODUCT	2
INTRODUCTION	3
RELEVANT MANUAL	9
TERMS	10
GENERIC TERMS AND ABBREVIATIONS	11
DEFINITION OF FILES	11
TARGETS FOR EXPLANATIONS	13
CHAPTER 1 OVERVIEW	14
1.1 Overview of GX LogViewer	14
1.2 Features	16
CHAPTER 2 SYSTEM CONFIGURATION	21
2.1 Operating Environment	21
2.2 System Configuration	21
Supported module	22
Displaying data logged by an RCPUCPU	24
Displaying data logged by an LHCPU	26
Displaying data logged by an FX5CPU	28
Displaying data logged by a QnUDVCPU or an LCPUCPU	30
Displaying data logged by a data logger or data communication	31
Displaying data logged by an analog module	33
Displaying data logged by a motion module	37
Displaying data logged by a motion controller	38
Displaying data being simulated by GX Simulator3 or MU Simulator	40
Displaying data by linking with the GX Works3 offline monitor function	41
Considerations for connection	42
CHAPTER 3 FUNCTION LIST	45
3.1 When Connecting to a CPU Module	46
3.2 When Connecting to a Data Logger	47
3.3 When Connecting to a Data Communication	48
3.4 When Connecting to a Motion Module	49
3.5 When Connecting to a Motion Controller	50
3.6 When Connecting to GX Simulator3 or MU Simulator	51
3.7 When Linking with the GX Works3 Offline Monitor Function	52
3.8 When Displaying a CSV File or JSON File in GX LogViewer Format	53
CHAPTER 4 OBTAINING AND START OF GX LogViewer	54
4.1 Obtaining of GX LogViewer	54
4.2 Installation and Uninstallation	54
4.3 Start and End	55
4.4 Display Language Switching	55
CHAPTER 5 OPERATION FLOWS	56
5.1 Displaying Data of a CPU Module or an Analog Module	59

5.2	Displaying Data/Events of a Data Logger	60
5.3	Displaying Data of a Data Communication	61
5.4	Displaying Data of a Motion Module	62
5.5	Displaying Data of a Motion Controller	63
5.6	Displaying Simulator Data	64
5.7	Displaying a GX LogViewer Format CSV File	65
	Displaying data saved with a logging module for energy measuring module	65
	Displaying sampling trace data saved in GX Works2	65
	Displaying data saved with Flexible High-Speed I/O Control Module Configuration Tool	65
	Displaying data saved with a CC-Link IE TSN FPGA module	66
CHAPTER 6 SCREEN CONFIGURATION		67
6.1	Main Window	67
6.2	Child Windows	68
6.3	Assistant Window	70
6.4	Menu Configuration	71
CHAPTER 7 CONNECTING TO MODULE		75
7.1	Selecting a Connection Destination Device	75
	Connection destination and connection methods	76
7.2	Connecting to an RCPU	77
	Transfer setup screen	77
	Method for connecting to an RCPU	77
7.3	Connecting to an LHCPU	79
	Transfer setup screen	79
	Method for connecting to an LHCPU	79
7.4	Connecting to an FX5CPU	81
	Transfer setup screen	81
	Method for connecting to an FX5CPU	81
7.5	Connecting to a QCPU or an LCPU	83
	Transfer setup screen	83
	Method for connecting to a QCPU or an LCPU	84
7.6	Connecting to a Data Logger or Data Communication	86
	Transfer setup screen	86
	Method for connecting to a data logger or data communication	86
7.7	Connecting to a Motion Module	88
	Transfer setup screen	88
	Method for connecting to a motion module	89
7.8	Connecting to a Motion Controller	90
	Transfer setup screen	90
	Method for connecting to a motion controller	91
7.9	Connecting to an RCPU Simulator or an FX5CPU Simulator	92
	Transfer setup screen	92
7.10	Connecting to Motion Module Simulator	94
CHAPTER 8 USING TREND GRAPH FUNCTION		95
8.1	Overview	95
8.2	Screen Configuration	100
	Trend window	100
	Graph legend area	102

Graph area	103
Difference information area	105
Status bar	106
8.3 Displaying Trend Graph	109
Displaying logged devices and labels (Historical trend)	110
Displaying the current device status (Realtime trend)	112
Displaying the current statuses of devices and labels (Realtime monitor)	113
Operating monitoring status of the realtime trend/realtime monitor function	151
8.4 Checking Data	152
Checking and comparing data values/statuses	152
Adding a log marker to data	154
Changing the data to be displayed in the graph area	159
8.5 Operating Trend Graphs	163
Displaying/hiding graphs	164
Aligning graphs	166
Superimposing graphs	166
Moving cursor by specifying value/time/index	167
Switching the graph display method	174
Specifying the upper and lower bounds/Y axis scale	175
Specifying a division value of grids	179
Displaying an operation result of the CALC function (CALC data) on a trend graph	182
Widening/narrowing the display scale	189
Moving graph up/down/left/right	190
Synchronizing the time	191
Expanding/reducing the time scale	192
Displaying the previous or next trend graph consecutively	193
8.6 Changing Display Items in Graph Area	199
Displaying multiple cursors	199
Displaying cursor labels	200
Displaying data names	200
Switching data names	201
Displaying grid	205
Changing graph plot formats	205
Changing a display of time-scale label	206
Switching the display language of data names	206
8.7 Changing Graph Appearance	207
Changing color and type of graph	208
Highlighting graph	210
Thickening graph line	210
8.8 Registering and Applying a Graphical Display Setting	211
8.9 Applying the Graph Display Automatically When Opening a Window	214
8.10 Displaying a Graph as Data Values/statuses	215
8.11 Initializing the Graph Display	218
8.12 Graph Display for Missing Data or Time Reversed Data	219
8.13 Displaying Abnormal Graphs	221
8.14 Handling Incorrect Values	222
CHAPTER 9 USING EVENT MONITORING FUNCTION	223
<hr/>	
9.1 Overview	223
9.2 Screen Configuration	225

Event window	225
Event list	226
Status bar	227
9.3 Displaying Event List	228
Displaying logged events (Historical event)	228
Displaying ongoing events (Realtime event)	229
Operating monitoring status of the realtime event function	230
9.4 Operating Event List	231
Displaying only events that meet specific conditions (Filtering)	231
Sorting events (Sorting)	232
Switching the display language of event logging names and comments	233
Displaying the previous or next event consecutively	234
9.5 Changing Display Settings of Event List	239
CHAPTER 10 SAVING LOGGING FILE TO PERSONAL COMPUTER	241
CHAPTER 11 USING WINDOWS/FOLDERS DISPLAYED IN PAST	243
11.1 Overview	243
11.2 Adding/Restoring Frequently-Used Window Configuration to Menu	244
11.3 Redisplaying Recently-Used Windows	246
11.4 Redisplaying Recently-Used Folders	246
CHAPTER 12 SAVING DISPLAYED DATA/EVENTS	247
12.1 Save Target Data/Event	247
12.2 Saving Displayed Data	248
Saving displayed data to CSV file	249
Saving displayed data to Unicode text file	281
Saving a displayed trend graph to an image file	299
12.3 Saving Displayed Events	300
Saving displayed events to CSV file	300
Saving displayed events to Unicode text file	305
Saving displayed events to an image file	308
CHAPTER 13 SAVING FILES BY CONVERTING FILE FORMATS	309
13.1 Using the Logging File Conversion Function	311
Converting a binary file into a CSV file or Unicode text file	311
Setting the output format	312
13.2 Using the Recording File Conversion Function	314
Converting a recording file into a Unicode text file	314
Saving/reading a recording file conversion setting	316
Labels and devices which can be specified	317
13.3 Format	319
Converting a data logging file	319
Converting an event logging file	322
Converting a recording file	323
CHAPTER 14 PRINTING TREND GRAPHS	325
14.1 Print Settings	325
14.2 Checking Print Preview	326

CHAPTER 15 HELP MENU	327
15.1 Opening Manual	327
15.2 Connecting to MITSUBISHI ELECTRIC FA Global Website	327
15.3 Version Information	327
CHAPTER 16 TROUBLESHOOTING	329
APPENDIX	331
Appendix 1 Additions and Changes from Previous Version	331
Appendix 2 USB Driver Installation Procedure	338
Appendix 3 PING Test	339
Appendix 4 Version Compatibility	340
Appendix 5 Open Source Software	341
Software information	341
INDEX	342
REVISIONS	344
INFORMATION AND SERVICES	346
TRADEMARKS	346
COPYRIGHTS	346

RELEVANT MANUAL

Manual name [manual number]	Description	Available form
GX LogViewer Version 1 Operating Manual [SH-080915ENG] (this manual)	Basic operations of GX LogViewer and system configurations, functions, and operation methods of devices, software, or files to display data in GX LogViewer	Print book e-Manual PDF
GX LogViewer Version 1 Operating Manual (Edgecross) [SH-082096ENG]	System configurations, functions, and operation methods to display data of the following software in GX LogViewer <ul style="list-style-type: none">• Edgecross Basic Software• Real-time Data Analyzer	e-Manual PDF

Point

e-Manual refers to the Mitsubishi Electric FA electronic book manuals that can be browsed using a dedicated tool.

e-Manual has the following features:

- Required information can be cross-searched in multiple manuals.
- Other manuals can be accessed from the links in the manual.
- Hardware specifications of each part can be found from the product figures.
- Pages that users often browse can be bookmarked.
- Sample programs can be copied to an engineering tool.

TERMS

Unless otherwise specified, this manual uses the following terms.

Term	Description
Engineering tool	A tool used for setting up programmable controllers, programming, debugging, and maintenance.
Safety program	A program for performing safety control.

GENERIC TERMS AND ABBREVIATIONS

Unless otherwise specified, this manual uses the following generic terms and abbreviations.

Generic term/abbreviation	Description
Analog module	A MELSEC iQ-R series analog module, a MELSEC-Q series analog module, a MELSEC-L series analog module
Configuration tool	CPU Module Logging Configuration Tool, MELSEC iQ-R Series High Speed Data Logger Module Configuration Tool, MELSEC-Q Series High Speed Data Logger Module Configuration Tool, BOX Data Logger Configuration Tool, MELSEC iQ-R Series High Speed Data Communication Module Configuration Tool, MELSEC-Q Series High Speed Data Communication Module Configuration Tool
CPU module	RCPUs, LHCPUs, FX5CPUs, QnUDVCPUs, LCPUs
Data communication	A MELSEC iQ-R series high speed data communication module, a MELSEC-Q series high speed data communication module
Data logger	A MELSEC iQ-R series high speed data logger module, a MELSEC-Q series high speed data logger module, a BOX data logger
FX5CPU	A MELSEC iQ-F series CPU module
FX5CPU simulator	GX Simulator3 that is simulating the operation of an FX5CPU
High speed data logger module	A MELSEC iQ-R series high speed data logger module, a MELSEC-Q series high speed data logger module
LCPU	A MELSEC-L series CPU module
LHCPU	A MELSEC iQ-L series CPU module
Logging module for energy measuring module	A logging module for energy measuring modules (EcoMonitorLight and EcoMonitorPlus)
Memory card	SD memory cards, CompactFlash cards, ATA cards
Motion controller	A MELSEC iQ-R series motion controller
Motion module	A MELSEC iQ-R series motion module
Motion module simulator	MU Simulator that is simulating the operation of a MELSEC iQ-R series motion module
QCPU	A MELSEC-Q series CPU module
QnUDVCPU	A high-speed universal model QCPU, universal model process CPU
RCPU	A MELSEC iQ-R series CPU module
RCPU simulator	GX Simulator3 that is simulating the operation of an RCPU
Simulator	GX Simulator3 that is simulating the operations of an RCPU and FX5CPU, and MU Simulator that is simulating the operation of a MELSEC iQ-R series motion module
(Camera) Recorder module	A MELSEC iQ-R series recorder module, a MELSEC iQ-R series camera recorder module

DEFINITION OF FILES

Unless otherwise specified, this manual uses the following file definitions.

File	Description
Logging file	A data logging file and an event logging file
Data logging file	A file in which data sampled by a CPU module, high speed data logger module, analog module, motion module, motion module simulator, or BOX data logger is saved in a specified format. A servo system recorder result file of a motion controller is also included.
Event logging file	A file in which events sampled by a high speed data logger module or BOX data logger are saved in a specified format
Recording file	A file which is output by the recording function of a (camera) recorder module
CSV file in GX LogViewer format	A CSV file which is converted/saved by the functions of GX LogViewer. A CSV file to which the following data is output in the file format that can be displayed in GX LogViewer is included: <ul style="list-style-type: none"> • Sampling trace data • Simulation result and sampling data saved with MELSEC iQ-R series Flexible High-Speed I/O Control Module Configuration Tool • Simulation result and sampling data saved with MELSEC-L series Flexible High-Speed I/O Control Module Configuration Tool A logging file which is sampled by the following modules is also included: <ul style="list-style-type: none"> • Logging module for energy measuring module • CC-Link IE TSN FPGA module
JSON file in GX LogViewer format	A JSON file in a file format that can be displayed in GX LogViewer (excluding a JSON file logged by a motion module and the motion module simulator)

File	Description
Log marker information file	A file with log marker information that is generated when adding a log marker to data

TARGETS FOR EXPLANATIONS

At the beginning of explanations in this manual, target modules, simulators, files, and data for explanations are shown in a table format.

Target modules, simulators, files, and data for explanation

The abbreviations in the tables show the following modules, simulators, files, and data.

Abbreviation	Target module/simulator/file/data for explanation
R CPU	MELSEC iQ-R series CPU module
R logger	MELSEC iQ-R series high speed data logger module
R communication	MELSEC iQ-R series high speed data communication module
R analog	MELSEC iQ-R series analog module
R motion module	MELSEC iQ-R series motion module
R motion controller	MELSEC iQ-R series motion controller
R CPU simulator	GX Simulator3 that is simulating the operation of an R CPU
R motion module simulator	MU Simulator that is simulating the operation of a MELSEC iQ-R series motion module
LH CPU	MELSEC iQ-L series CPU module
FX5 CPU	MELSEC iQ-F series CPU module
FX5 CPU simulator	GX Simulator3 that is simulating the operation of an FX5 CPU
QnUDV CPU	<ul style="list-style-type: none"> • High-speed universal model Q CPU • Universal model process CPU
Q logger	MELSEC-Q series high speed data logger module
Q communication	MELSEC-Q series high speed data communication module
Q analog	MELSEC-Q series analog module
L CPU	MELSEC-L series CPU module
L analog	MELSEC-L series analog module
BOX	BOX data logger
Offline monitor	Data being displayed by the GX Works3 offline monitor function
Others	<ul style="list-style-type: none"> • CSV file in GX LogViewer format • JSON file in GX LogViewer format

Ex.

When all modules are targets for explanation

Type	Target for explanation ( Page 13 Target modules, simulators, files, and data for explanation)
Module	R CPU, LH CPU, FX5 CPU, QnUDV CPU, L CPU, R analog, Q analog, L analog, BOX, R logger, Q logger, R communication, Q communication, R motion module, R motion controller
Simulator	R CPU simulator, FX5 CPU simulator, R motion module simulator
Others	Offline monitor, others

When only analog modules are targets for explanation

Type	Target for explanation ( Page 13 Target modules, simulators, files, and data for explanation)
Module	R analog, Q analog, L analog

For details on the target modules, refer to the following:

 Page 22 Supported module

1 OVERVIEW

Type	Target for explanation ( Page 13 Target modules, simulators, files, and data for explanation)
Module	RCPU, LHCPU, FX5CPU, QnUDVCPU, LCPUI, R analog, Q analog, L analog, BOX, R logger, Q logger, R communication, Q communication, R motion module, R motion controller
Simulator	RCPU simulator, FX5CPU simulator, R motion module simulator
Others	Offline monitor, others

1.1 Overview of GX LogViewer

GX LogViewer is a tool to display and analyze large-volume data, which has been sampled by various modules having the data collection functions, with an easy-to-understand operation.

The connection target can be set by the same operation as that of a configuration tool and an engineering tool, and data can be checked easily.

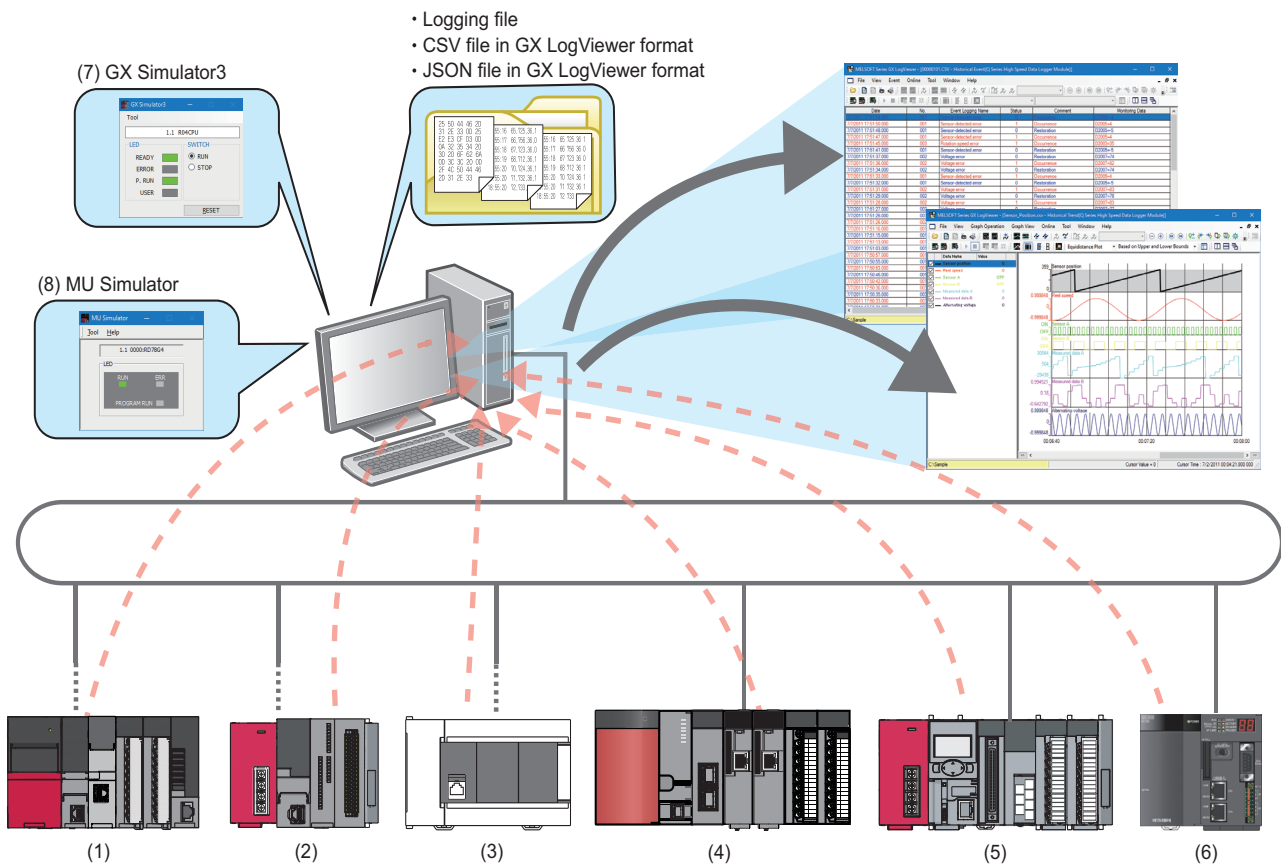

No.	Connection destination	Reference of logging file
(1)	RCPU	SD memory card Data memory
	MELSEC iQ-R series high speed data logger module	
	MELSEC iQ-R series high speed data communication module	
	MELSEC iQ-R series analog module	
	MELSEC iQ-R series motion module	
(2)	MELSEC iQ-R series motion controller	SD memory card Data memory
	LHCPU	
(3)	FX5CPU	SD memory card

No.	Connection destination	Reference of logging file
(4)	QnUDVCPU	SD memory card
	MELSEC-Q series high speed data logger module	ATA card
	MELSEC-Q series high speed data communication module	CompactFlash card
	MELSEC-Q series analog module	
(5)	LCPU	SD memory card
	MELSEC-L series analog module	
(6)	BOX data logger	CompactFlash card
(7)	GX Simulator3	—
(8)	MU Simulator	Personal computer

1.2 Features

This section explains the features of GX LogViewer.

Displaying sampled data and events visually

Data can efficiently be checked since data and event, which have been sampled and saved with a module, GX Works2, or GX Works3, are visually displayed.

Data shift can be easily checked.

Trend graph display

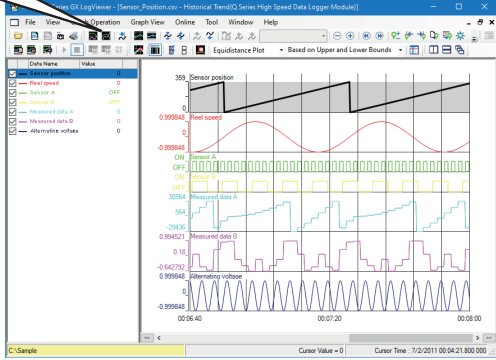

History of event occurrences/restorations can be checked.

Event monitor display

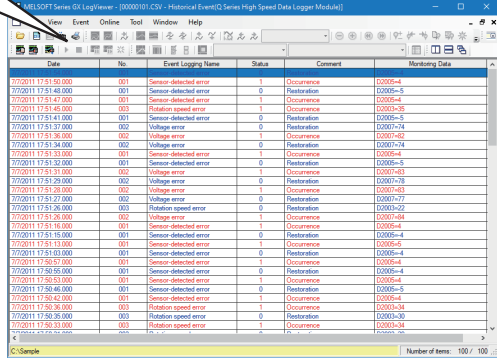

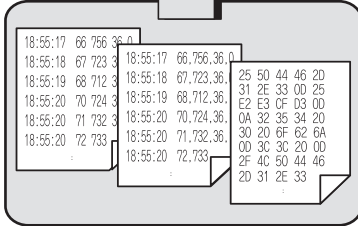

(1)

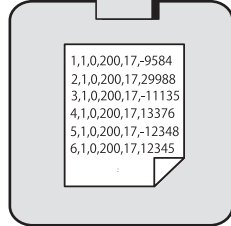

(2)

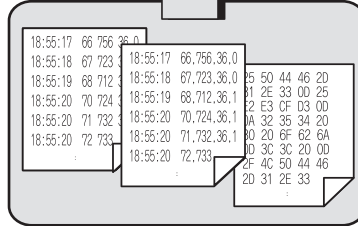

(3)

(1)	(2)	(3)
Sampled data (data logging)	Data in GX LogViewer format	Event occurrence/restoration data (event logging)
Unicode text format	CSV format (GX LogViewer format)	Unicode text format
CSV format	JSON format (GX LogViewer format)	CSV format
Binary format		Binary format
JSON format		

Easy adjustment of graph with the automatic adjustment function or dragging graphs

Graph layout can easily be adjusted by using the automatic adjustment function or dragging a graph (without looking at this manual).

Data can instantly be checked since graph layout is intuitively and smoothly adjusted with only a mouse.

■Graph arrangement and superimposed display

Multiple data can be compared by superimposing graphs.

Graphs are easily viewable by arranging them at equal spaces.

☞ Page 166 Aligning graphs

☞ Page 166 Superimposing graphs

■Automatic graph adjustment

- Display method: Based on upper and lower bounds

Display size is automatically adjusted according to the maximum and minimum values of data.

☞ Page 175 Specifying the upper and lower bounds/Y axis scale

- Display method: Based on the division value of grids

A division value of grids is automatically adjusted according to the maximum and minimum values of data.

☞ Page 179 Specifying a division value of grids

■Display size adjustment

Enlarge the error location.

☞ Page 189 Widening/narrowing the display scale

■ Moving a graph

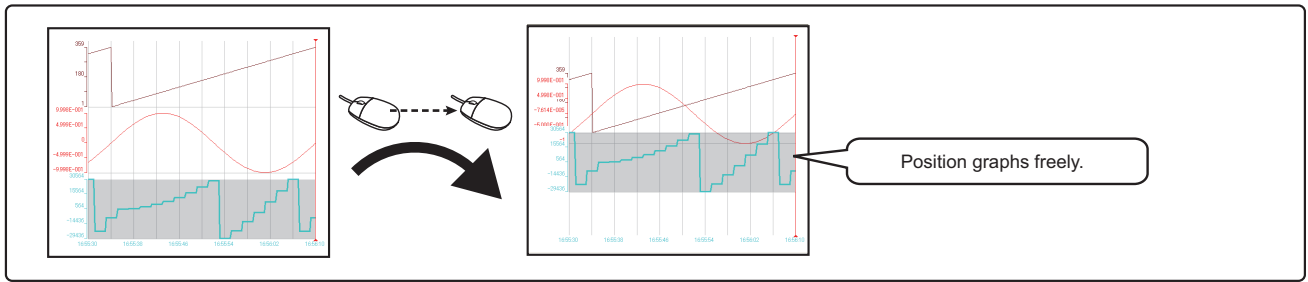

☞ Page 190 Moving graph up/down/left/right

Instant check of data changes with an easy-to-understand operation

Data change can instantly be checked with two cursors (multiple cursor function).

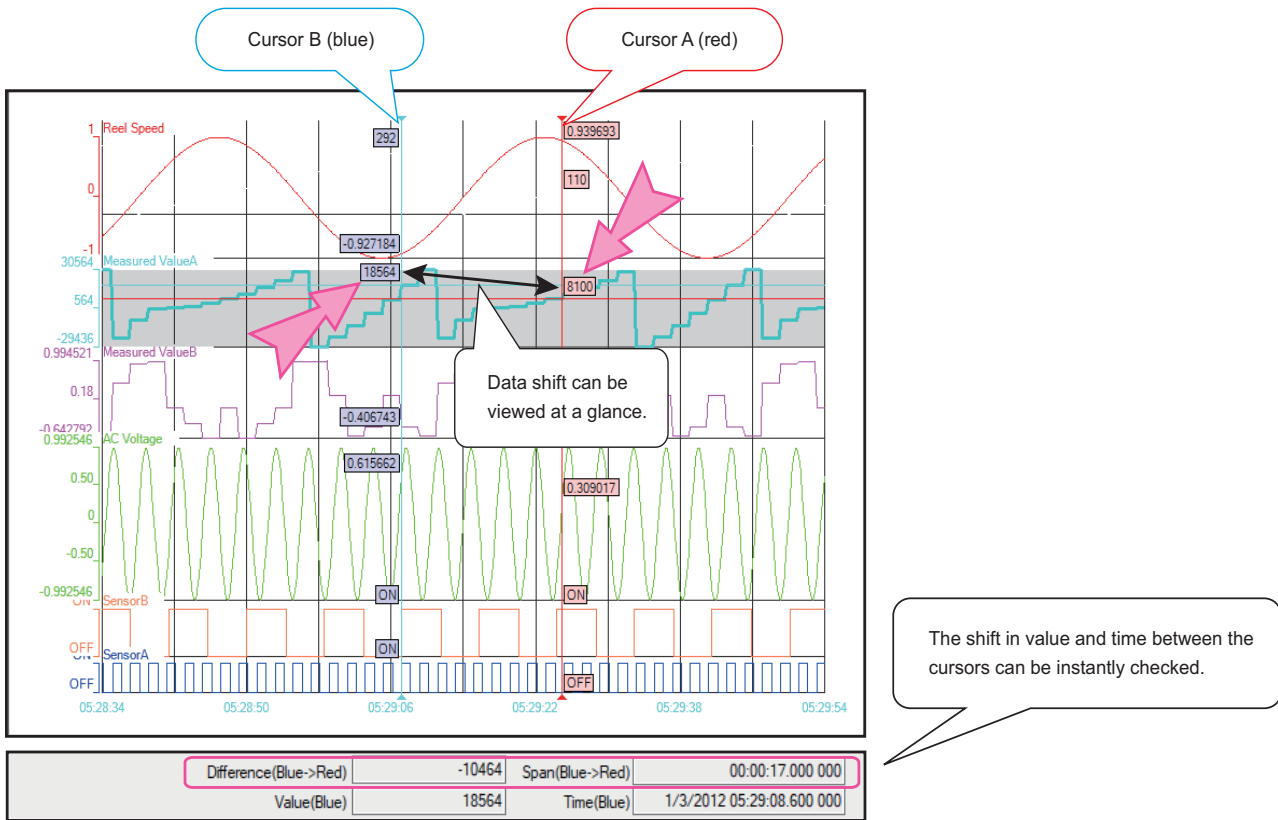

Page 199 Displaying multiple cursors

Instant check of target data

A data value can instantly be checked by jumping the cursor to the position of a specified value, time, or index (a sequential number assigned to an individual record) on a trend graph.

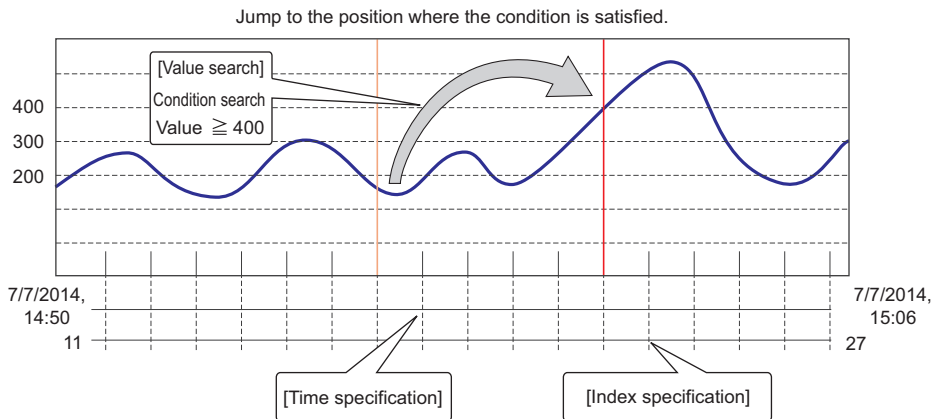

Page 167 Moving cursor by specifying value/time/index

Easy check of differences in logging data among multiple files

Differences of each piece of data can be checked with the same time interval by displaying the logging data, which has been stored in multiple files, on the same graph area.

Furthermore, graphs can be superimposed and the time can be synchronized with a simple operation, and these enable easy data comparison among multiple files.

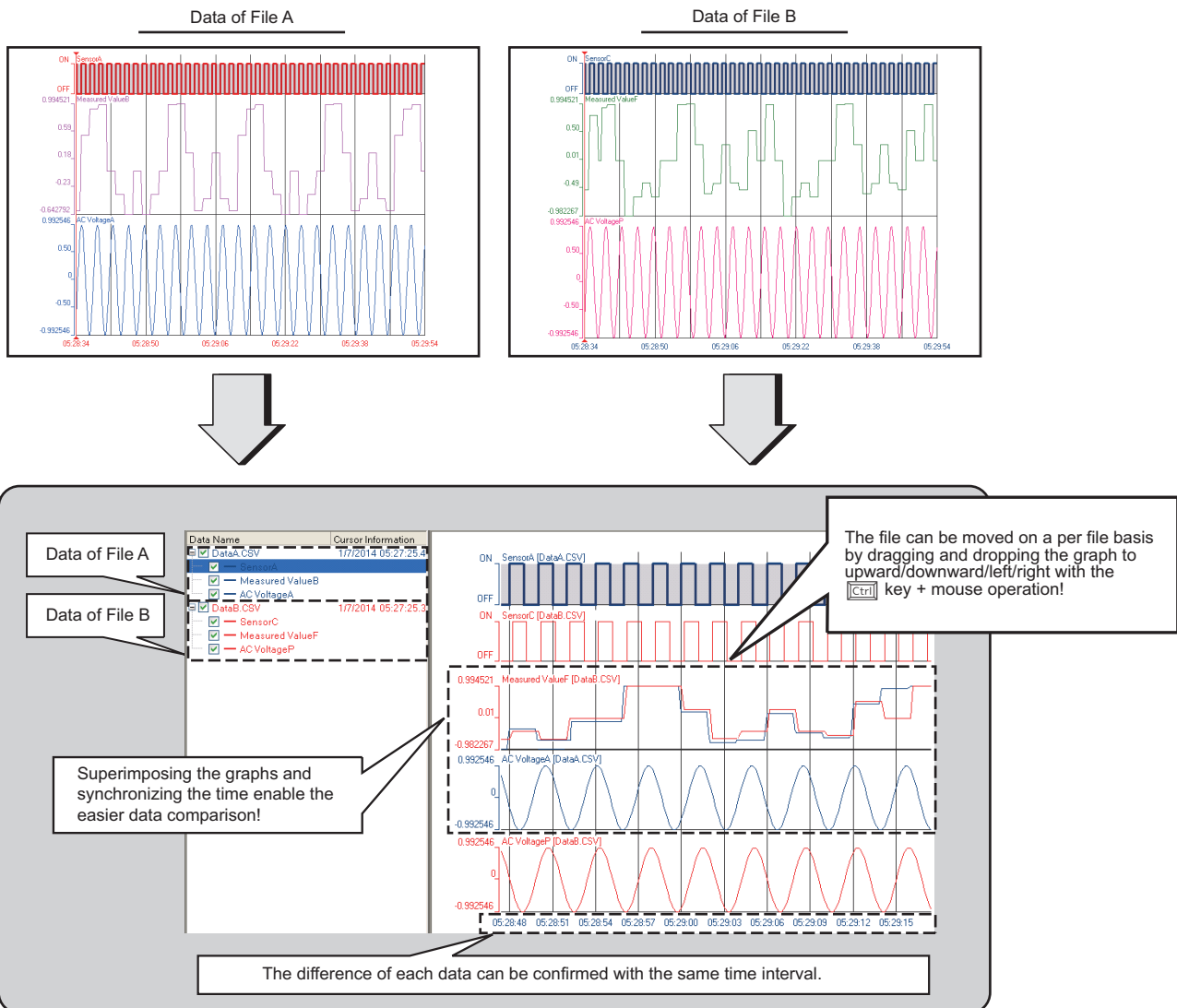

☞ Page 159 Changing the data to be displayed in the graph area

☞ Page 190 Moving graph up/down/left/right

☞ Page 191 Synchronizing the time

2 SYSTEM CONFIGURATION

This chapter explains the operating environment and the system configuration of GX LogViewer.

2.1 Operating Environment

For the operating environment of GX LogViewer, refer to the following:

 CPU Module Logging Configuration Tool/GX LogViewer Installation Instructions (BCN-P5999-0506)

The above manual is stored in the "Manual" folder which is stored in the same folder as the installer.

2.2 System Configuration

Type	Target for explanation ( Page 13 Target modules, simulators, files, and data for explanation)
Module	RCPU, LHCPU, FX5CPU, QnUDVCPU, LCPU, R analog, Q analog, L analog, BOX, R logger, Q logger, R communication, Q communication, R motion module, R motion controller
Simulator	RCPU simulator, FX5CPU simulator, R motion module simulator
Others	Offline monitor

This section shows the system configurations to display data logged by each module in GX LogViewer.

Item	Reference
System configuration	Page 24 Displaying data logged by an RCPU
	Page 26 Displaying data logged by an LHCPU
	Page 28 Displaying data logged by an FX5CPU
	Page 30 Displaying data logged by a QnUDVCPU or an LCPU
	Page 33 Displaying data logged by an analog module
	Page 31 Displaying data logged by a data logger or data communication
	Page 37 Displaying data logged by a motion module
	Page 38 Displaying data logged by a motion controller
	Page 40 Displaying data being simulated by GX Simulator3 or MU Simulator
	Page 41 Displaying data by linking with the GX Works3 offline monitor function

Supported module

The following table shows modules supported by GX LogViewer.

Product name		Generic term in this manual	Model name
MELSEC iQ-R series CPU module	Programmable controller CPU	RnCPU	R00CPU, R01CPU, R02CPU, R04CPU, R08CPU, R16CPU, R32CPU, R120CPU
		RnENCPU	R04ENCPU, R08ENCPU, R16ENCPU, R32ENCPU, R120ENCPU
	Process CPU	RnPCPU	R08PCPU, R16PCPU, R32PCPU, R120PCPU
	Safety CPU	RnSFPCPU	R08SFPCPU, R16SFPCPU, R32SFPCPU, R120SFPCPU
MELSEC iQ-R series high speed data logger module		—	RD81DL96
MELSEC iQ-R series high speed data communication module		—	RD81DC96
MELSEC iQ-R series analog module	Analog input	—	R60ADV8, R60ADI8, R60AD4, R60ADH4, R60AD8-G, R60AD16-G
	Temperature input	—	R60TD8-G, R60RD8-G
MELSEC iQ-R series motion module		—	RD78G4, RD78G8, RD78G16, RD78G32, RD78G64, RD78GHV, RD78GHW
MELSEC iQ-R series motion controller		RnMTCPU	R16MTCPU, R32MTCPU, R64MTCPU
MELSEC iQ-L series CPU module		LHCPU	L04HCPU, L08HCPU, L16HCPU, L32HCPU
MELSEC iQ-F series CPU module		FX5UJCPU	FX5UJ-24MR/ES, FX5UJ-24MT/ES, FX5UJ-24MT/ESS, FX5UJ-40MR/ES, FX5UJ-40MT/ES, FX5UJ-40MT/ESS, FX5UJ-60MR/ES, FX5UJ-60MT/ES, FX5UJ-60MT/ESS, FX5UJ-24MR/DS, FX5UJ-24MT/DS, FX5UJ-24MT/DSS, FX5UJ-40MR/DS, FX5UJ-40MT/DS, FX5UJ-40MT/DSS, FX5UJ-60MR/DS, FX5UJ-60MT/DS, FX5UJ-60MT/DSS
		FX5UCPU	FX5U-32MR/ES, FX5U-32MT/ES, FX5U-32MT/ESS, FX5U-64MR/ES, FX5U-64MT/ES, FX5U-64MT/ESS, FX5U-80MR/ES, FX5U-80MT/ES, FX5U-80MT/ESS, FX5U-32MR/DS, FX5U-32MT/DS, FX5U-32MT/DSS, FX5U-64MR/DS, FX5U-64MT/DS, FX5U-64MT/DSS, FX5U-80MR/DS, FX5U-80MT/DS, FX5U-80MT/DSS
		FX5UCCPU	FX5UC-32MT/D, FX5UC-32MT/DSS, FX5UC-32MT/DS-TS, FX5UC-32MT/DSS-TS, FX5UC-32MR/DS-TS, FX5UC-64MT/D, FX5UC-64MT/DSS, FX5UC-96MT/D, FX5UC-96MT/DSS
		FX5SCPU	FX5S-30MR/ES, FX5S-30MT/ES, FX5S-30MT/ESS, FX5S-40MR/ES, FX5S-40MT/ES, FX5S-40MT/ESS, FX5S-60MR/ES, FX5S-60MT/ES, FX5S-60MT/ESS, FX5S-80MR/ES, FX5S-80MT/ES, FX5S-80MT/ESS
MELSEC-Q series CPU module	High-speed universal model QCPU	QnUDVCPU	Q03UDVCPU, Q04UDVCPU, Q06UDVCPU, Q13UDVCPU, Q26UDVCPU
			Q04UDPVCPU, Q06UDPVCPU, Q13UDPVCPU, Q26UDPVCPU
	Universal model process CPU	—	Q00UJCPU, Q00UCPU, Q01UCPU, Q02UCPU, Q03UDCPU, Q03UDECPU, Q04UDHCPU, Q04UDEHCPU, Q06UDHCPU, Q06UDEHCPU, Q10UDHCPU, Q10UDEHCPU, Q13UDHCPU, Q13UDEHCPU, Q20UDHCPU, Q20UDEHCPU, Q26UDHCPU, Q26UDEHCPU, Q50UDEHCPU, Q100UDEHCPU
	Universal model QCPU	—	Q00UJCPU, Q00UCPU, Q01UCPU, Q02UCPU, Q03UDCPU, Q03UDECPU, Q04UDHCPU, Q04UDEHCPU, Q06UDHCPU, Q06UDEHCPU, Q10UDHCPU, Q10UDEHCPU, Q13UDHCPU, Q13UDEHCPU, Q20UDHCPU, Q20UDEHCPU, Q26UDHCPU, Q26UDEHCPU, Q50UDEHCPU, Q100UDEHCPU
	Process CPU	—	Q02PHCPU, Q06PHCPU, Q12PHCPU, Q25PHCPU
	Basic model QCPU	—	Q00JCPU, Q00CPU, Q01CPU
	Redundant CPU	—	Q12PRHCPU, Q25PRHCPU
High performance model QCPU		—	Q02CPU, Q02HCPU, Q06HCPU, Q12HCPU, Q25HCPU
MELSEC-Q series high speed data logger module		—	QD81DL96
MELSEC-Q series high speed data communication module		—	QJ71DC96
MELSEC-Q series analog module	Analog input	—	Q64ADH
	Current transformer input	—	Q68CT

Product name		Generic term in this manual	Model name
MELSEC-L series CPU module		—	L02CPU, L02CPU-P, L06CPU, L06CPU-P, L26CPU, L26CPU-P, L26CPU-BT, L26CPU-PBT
MELSEC-L series analog module	Analog input	—	L60AD4, L60AD4-2GH
	Analog I/O	—	L60AD2DA2
BOX data logger		—	NZ2DL

Displaying data logged by an RCP

Type	Target for explanation ( Page 13 Target modules, simulators, files, and data for explanation)
Module	RCP

The system configuration to display data logged by an RCP in GX LogViewer is shown below.

The connectable route is the same as the connection with CPU Module Logging Configuration Tool.

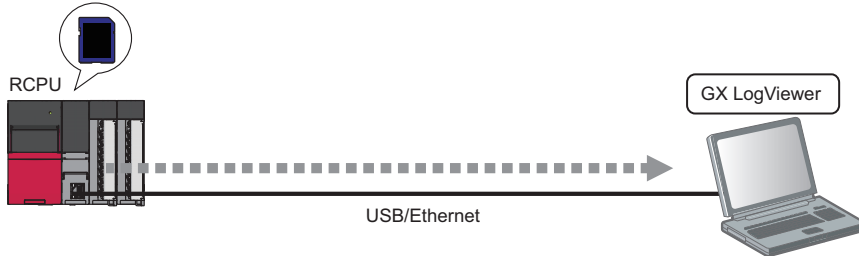

An RCP can be connected to a personal computer with the following communication routes.

Item	Reference
Type of communication route	Page 25 Connection through a USB port
	Page 25 Connection through an Ethernet port

Point

For details on the considerations for connecting to an RCP with a USB or an Ethernet, refer to the following:

 Page 42 Considerations for connection

Connection through a USB port

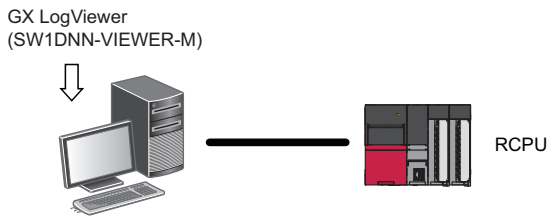

■ Connection with USB cables

Use the following for the connection:

- USB cable (USB A type — USB miniB type)
- USB adapter (USB B type — USB miniB type)

Point

When using a USB cable for the first time, install the USB driver.

☞ Page 338 USB Driver Installation Procedure

Connection through an Ethernet port

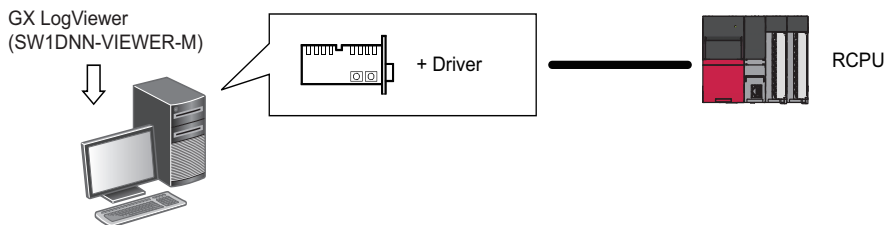

Use an Ethernet board that is built-in to a personal computer or commercially available.

■ Connection via a hub

An RCPU (programmable controller on the own station or another station) can be connected to a personal computer via a hub in a local network^{*1}.

The IP address of an RCPU needs to be specified for this connection.

■ Direct connection

An RCPU can directly be connected to a configuration/display personal computer on a 1:1 basis with an Ethernet cable without a hub^{*1}.

The IP address of an RCPU does not need to be specified for this connection.

^{*1} For an RnENCPU, use an Ethernet port of the CPU part in order to connect to a personal computer. An Ethernet port of the network part cannot be used for this connection.

Displaying data logged by an LHCPU

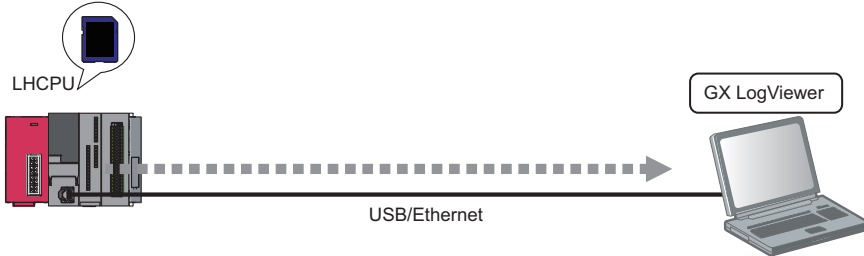

Type	Target for explanation ( Page 13 Target modules, simulators, files, and data for explanation)
Module	LHCPU

The system configuration to display data logged by an LHCPU in GX LogViewer is shown below.
 The connectable route is the same as the connection with CPU Module Logging Configuration Tool.



An LHCPU can be connected to a personal computer with the following communication routes.

Item	Reference
Type of communication route	Page 26 Connection through a USB port
	Page 27 Connection through an Ethernet port

Point  For details on the considerations for connecting to an LHCPU with a USB or an Ethernet, refer to the following:
 Page 42 Considerations for connection

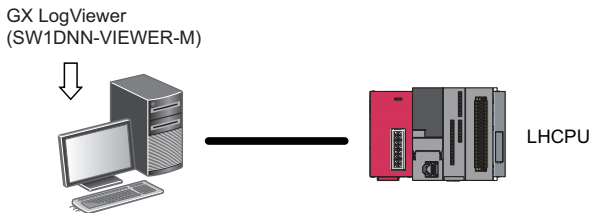

Connection through a USB port



■ Connection with USB cables

Use the following for the connection:

- USB cable (USB A type — USB miniB type)
- USB adapter (USB B type — USB miniB type)

Point  When using a USB cable for the first time, install the USB driver.
 Page 338 USB Driver Installation Procedure

Connection through an Ethernet port

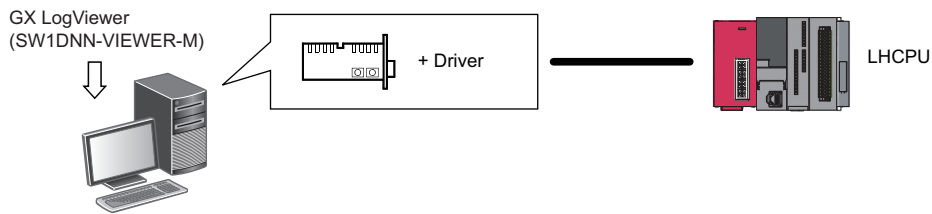

Use an Ethernet board that is built-in to a personal computer or commercially available.

■Connection via a hub

An LHCPU (programmable controller on the own station or another station) can be connected to a personal computer via a hub in a local network.

The IP address of an LHCPU needs to be specified for this connection.

■Direct connection

An LHCPU can directly be connected to a configuration/display personal computer on a 1:1 basis with an Ethernet cable without a hub.

The IP address of an LHCPU does not need to be specified for this connection.

Displaying data logged by an FX5CPU

Type	Target for explanation ( Page 13 Target modules, simulators, files, and data for explanation)
Module	FX5CPU

The system configuration to display data logged by an FX5CPU in GX LogViewer is shown below.
 The connectable route is the same as the connection with CPU Module Logging Configuration Tool.
 Only an FX5UJCPU and an FX5SCPU can be connected through a USB port.

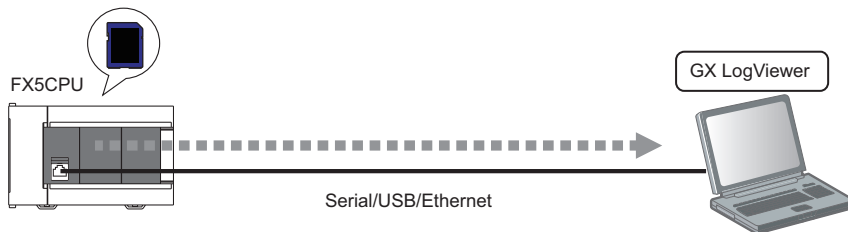

An FX5CPU can be connected to a personal computer with the following communication routes.

Item	Reference
Type of communication route	Page 29 Connection through a serial port
	Page 29 Connection through a USB port
	Page 29 Connection through an Ethernet port

Point

For details on the considerations for connecting to an FX5CPU with a USB or an Ethernet, refer to the following:

 Page 42 Considerations for connection

Connection through a serial port

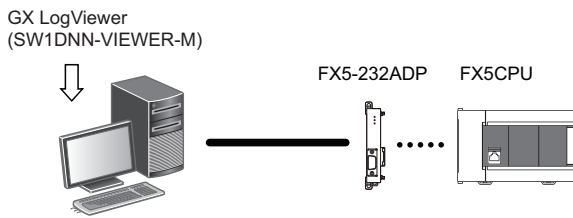

Point

An expansion board or extension adapter is required to connect with an RS232 cable.

For details on the connection methods, refer to the following:

📖 MELSEC iQ-F FX5 User's Manual (Application)

Connection through a USB port

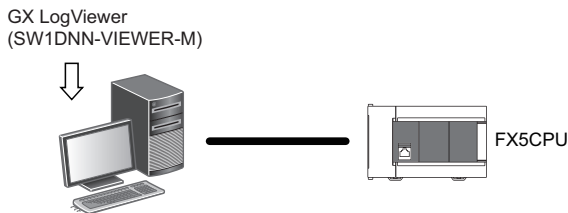

■ Connection with USB cables

Use the following for the connection:

- USB cable (USB A type — USB miniB type)
- USB adapter (USB B type — USB miniB type)

Point

When using a USB cable for the first time, install the USB driver.

👉 Page 338 USB Driver Installation Procedure

Connection through an Ethernet port

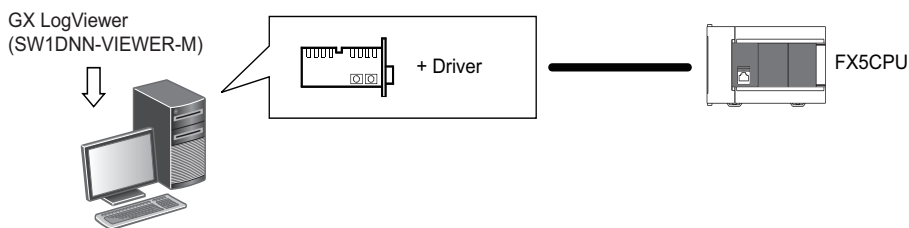

Use an Ethernet board that is built-in to a personal computer or commercially available.

■ Connection via a hub

An FX5CPU (programmable controller on the own station or another station) can be connected to a personal computer via a hub in a local network.

The IP address of an FX5CPU needs to be specified for this connection.

■ Direct connection

An FX5CPU can directly be connected to a configuration/display personal computer on a 1:1 basis with an Ethernet cable without a hub.

The IP address of an FX5CPU does not need to be specified for this connection.

Displaying data logged by a QnUDVCPU or an LCPU

Type	Target for explanation (Page 13 Target modules, simulators, files, and data for explanation)
Module	QnUDVCPU, LCPU

The system configuration to display data logged by a QnUDVCPU or an LCPU in GX LogViewer is shown below. The connectable route is the same as the connection with CPU Module Logging Configuration Tool.

Ex.

The system configuration to display data logged by an LCPU in GX LogViewer

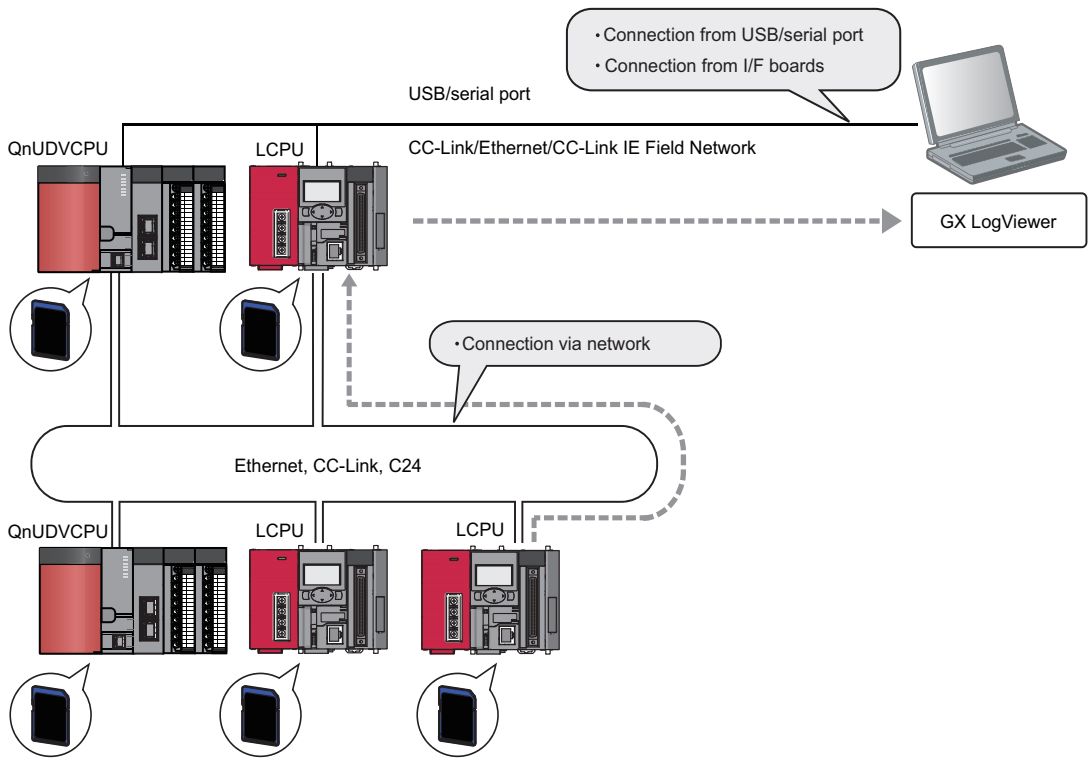

A QnUDVCPU and an LCPU can be connected to a personal computer with the following communication routes.

Item	Reference
Type of communication route	Page 35 Connection through a USB or serial port(Connection via network)
	Page 36 Connection through an I/F board

Point

For details on the considerations for connecting to a QnUDVCPU or an LCPU with a USB or an Ethernet, refer to the following:

[Page 42 Considerations for connection](#)

Displaying data logged by a data logger or data communication

Type	Target for explanation ( Page 13 Target modules, simulators, files, and data for explanation)
Module	BOX, R logger, Q logger, R communication, Q communication

The system configuration to display data logged by a data logger or data communication in GX LogViewer is shown below. Each data logger or data communication needs to be connected to a personal computer in order to display data logged by the module in GX LogViewer.

The connectable route is the same as the connection with the configuration tools for a data logger and data communication.

Point 

A BOX data logger has three ports: serial port, Ethernet port (CH1), and Ethernet port (CH2). For details on the CPU modules, configuration/display personal computers, and various servers connectable to each port, refer to the following:
 [BOX Data Logger User's Manual](#)

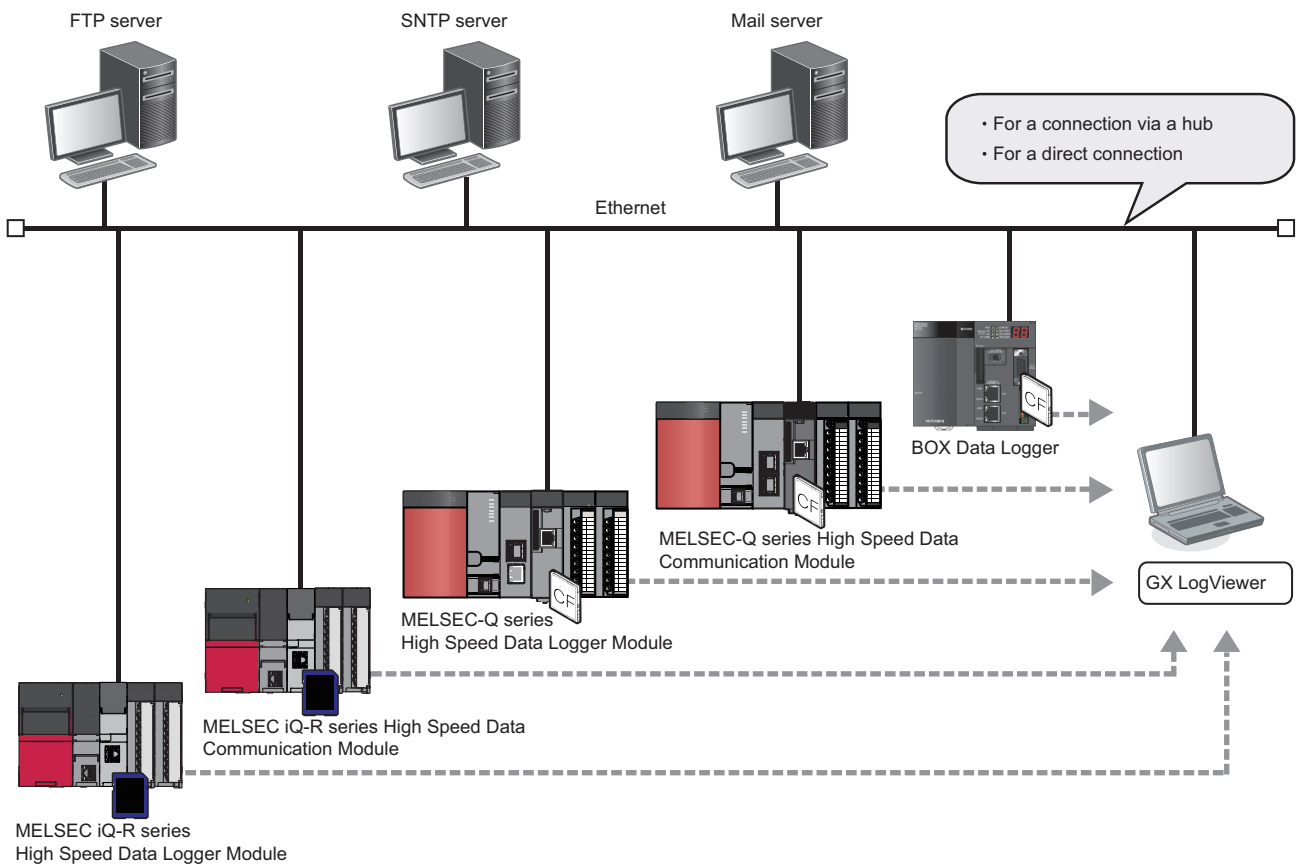

A data logger and data communication can be connected to an Ethernet port of a personal computer with the following communication routes.

Item	Reference
Type of communication route	Page 32 Connection via a hub
	Page 32 Direct connection

An Ethernet (twisted pair) cable (sold separately) compliant with IEEE802.3 10BASE-T/100BASE-TX standards can be used. For details on the Ethernet communication specifications, refer to the user's manuals of a data logger or data communication.

For details on the considerations for connecting to a data logger or data communication with a USB or an Ethernet cable, refer to the following:

☞ Page 42 Considerations for connection

Connection through an Ethernet port

■ Connection via a hub

A data logger or data communication can be connected to a personal computer via a hub in a local network. The IP address of a data logger or data communication needs to be specified for this connection.

Ex.

Connecting to a MELSEC-Q series high speed data logger module via a hub

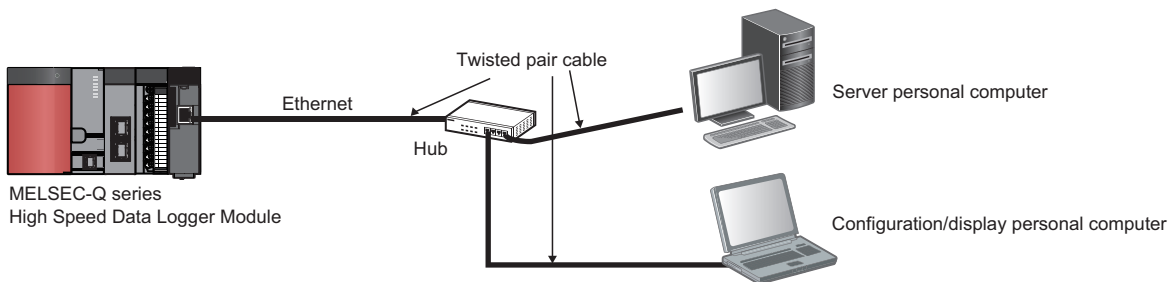

■ Direct connection

A data logger and data communication can directly be connected to a configuration/display personal computer on a 1:1 basis with an Ethernet cable (crossover cable) without a hub.

The IP address of a data logger or data communication does not need to be specified for this connection. (Broadcast is used.)

A straight cable can be used for a BOX data logger.

Displaying data logged by an analog module

Type	Target for explanation ( Page 13 Target modules, simulators, files, and data for explanation)
Module	R analog, Q analog, L analog

The system configuration to display data logged by an analog module in GX LogViewer is shown below. However, the data is saved in a memory card inserted in an RCP, LHCPU, QCPU, or LCP. Therefore, a personal computer needs to be connected to each CPU in order to acquire the logged data.

Point 

For details on the methods for saving data from an analog module to a memory card, refer to the user's manuals of each analog module.

Ex.

The system configuration to acquire and display data logged by a MELSEC iQ-R/MELSEC-L series analog module in GX LogViewer

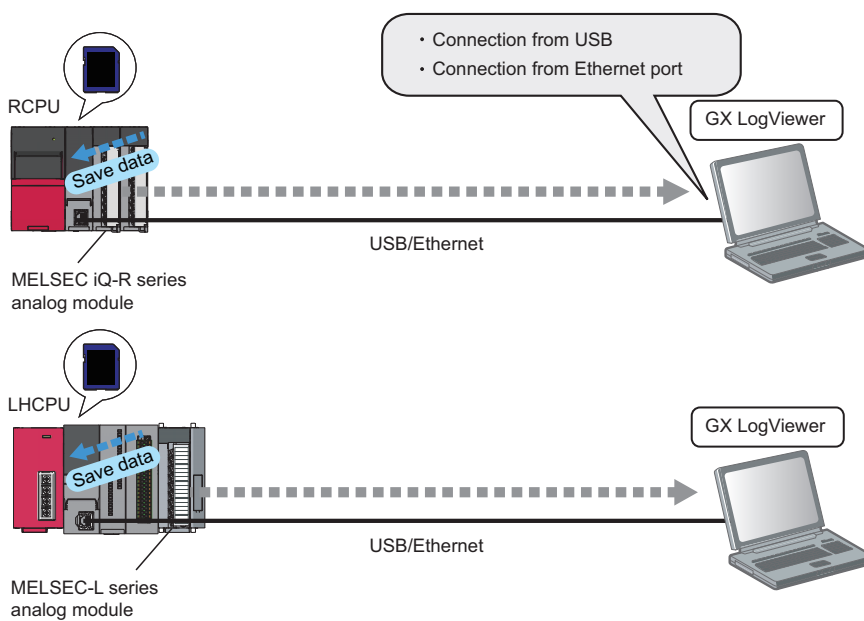

The communication route for a MELSEC iQ-R series analog module is the same as that for an RCP.

 Page 24 Displaying data logged by an RCP

The communication route for a MELSEC-L series analog module is the same as that for an LHCPU.

 Page 26 Displaying data logged by an LHCPU

Ex.

The system configuration to acquire and display data logged by a MELSEC-Q/MELSEC-L series analog module in GX LogViewer

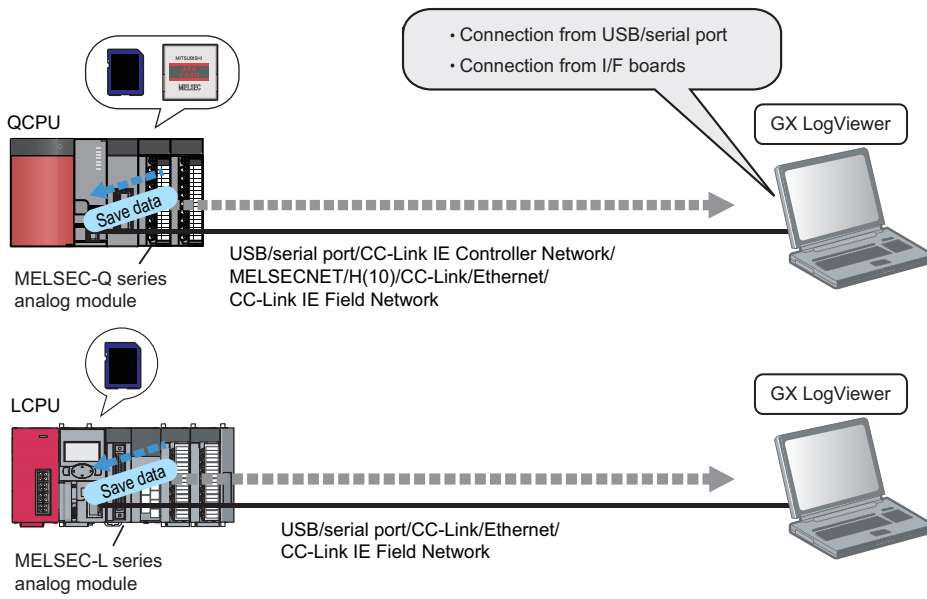

Restriction

For L60AD4, the logging function is supported only by modules with a serial number whose first five digits are '13041' or higher.

Connection through a USB or serial port

The following figure shows the system configuration connectable with a USB or serial port of a personal computer.

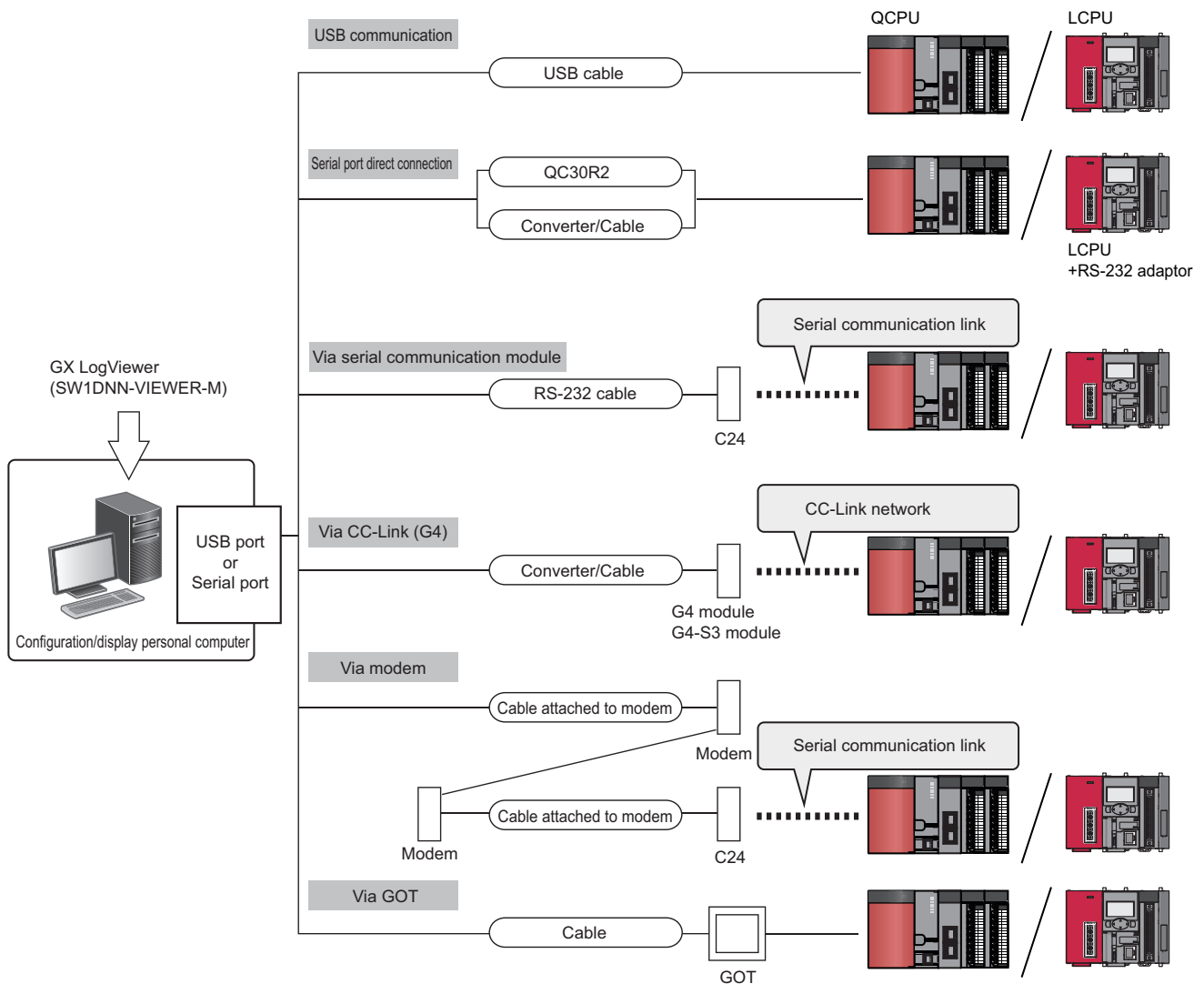

■ Connection with USB cables

Use the following for the connection:

- USB cable (USB A type — USB miniB type)
- USB adapter (USB B type — USB miniB type)

Point

- When using a USB cable for the first time, install the USB driver.

☞ Page 338 USB Driver Installation Procedure

- For the method for checking the COM port number in order to connect a personal computer to a QCPU or an LCPU with a cable such as a USB/RS-232 conversion cable, refer to the manuals of each cable.

■Connection with an RS-232 cable

The RS-232 cable, of which the operations are ensured by Mitsubishi Electric Corporation, is shown below.

Model name	
QC30R2 (Personal computer connector: 9-pin D-sub connector)	Mitsubishi Electric Corporation RS-232 cable



Precautions

- For high-speed communication (transmission rate: 115.2/57.6 kbps), use a personal computer supporting high-speed communication.
- When a communication error occurs, retry after reducing the setting value of the transmission rate.

■Connection via a GOT

The GOT transparent function enables access to a QCPU or an LCPU via a GOT.

For details on the GOT transparent function, refer to the following:

Connection Manual of GOT2000 Series

Connection through an I/F board

The following figure shows the system configuration to connect a QCPU or an LCPU by an I/F board mounted on a personal computer.

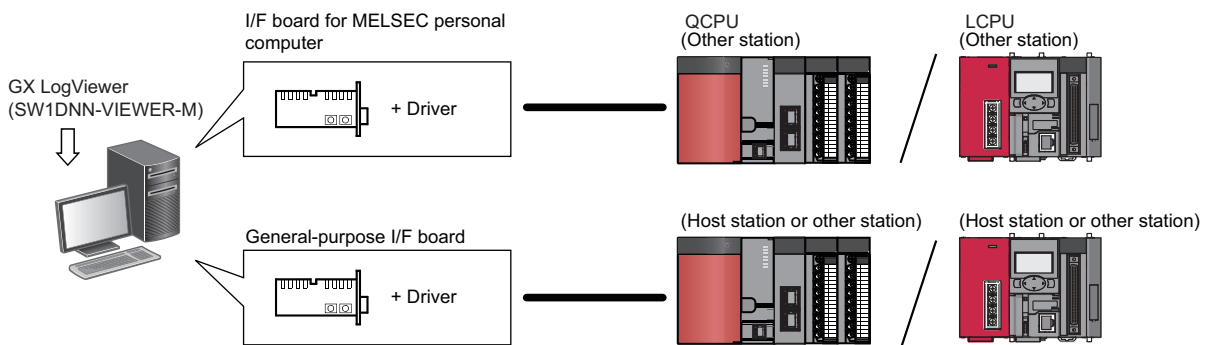

I/F board name	
I/F board for MELSEC personal computer	MELSECNET/H board
	CC-Link IE Controller Network board
	CC-Link IE Field Network board
	CC-Link Ver.1 board
	CC-Link Ver.2 board
General-purpose I/F board	Ethernet board

For more details on the connectable QCPUs, LCPUs, model names of I/F board and drivers, refer to the manuals of each I/F board.

Restriction

- The TCP connection is recommended for the Ethernet connection.
- For the Ethernet direct connection or UDP connection, it takes longer to open a logging file, or save a logging file to a personal computer.

Displaying data logged by a motion module

Type	Target for explanation ( Page 13 Target modules, simulators, files, and data for explanation)
Module	R motion module



The system configuration to display data logged by a motion module in GX LogViewer is shown below.

A USB cable or an Ethernet cable needs to be connected to an RCPU.

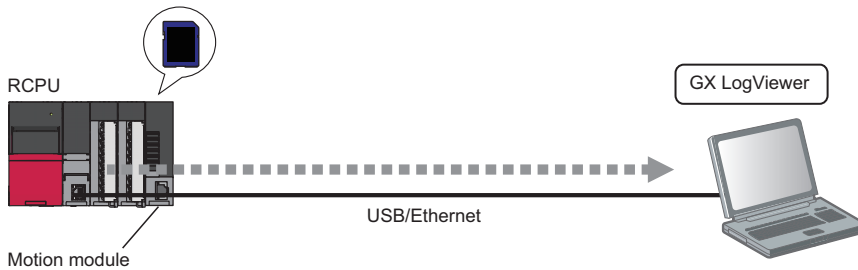
By connecting the cable to the RCPU, a personal computer can be connected to a motion module via the RCPU.



For the connection between an RCPU and a personal computer, refer to the following:

-  Page 25 Connection through a USB port
-  Page 25 Connection through an Ethernet port

Displaying data logged by a motion controller

Type	Target for explanation ( Page 13 Target modules, simulators, files, and data for explanation)
Module	R motion controller

The system configuration to display data logged by a motion controller (servo system recorder result file) in GX LogViewer is shown below.

A USB cable or an Ethernet cable needs to be connected to an RCPU.

By connecting the cable to the RCPU, a personal computer can be connected to a motion controller via the RCPU.

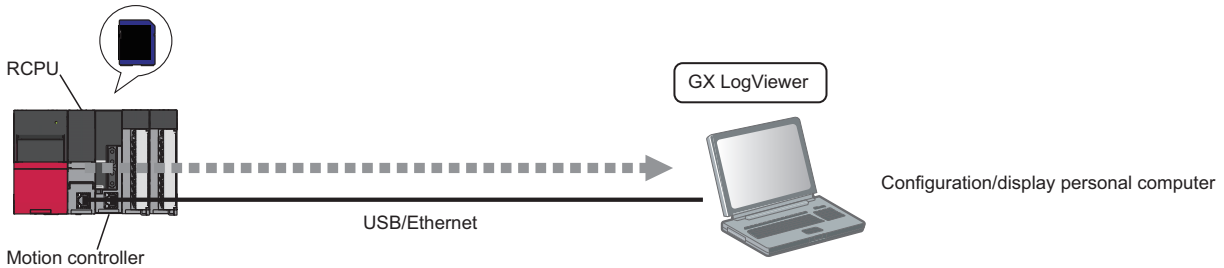

An RCPU can be connected to a personal computer with the following communication routes.

Item	Reference
Type of communication route	Page 25 Connection through a USB port
	Page 25 Connection through an Ethernet port

A configuration/display personal computer can also be connected to a motion controller without using an RCPU.

In that case, an Ethernet cable needs to be connected to the motion controller.

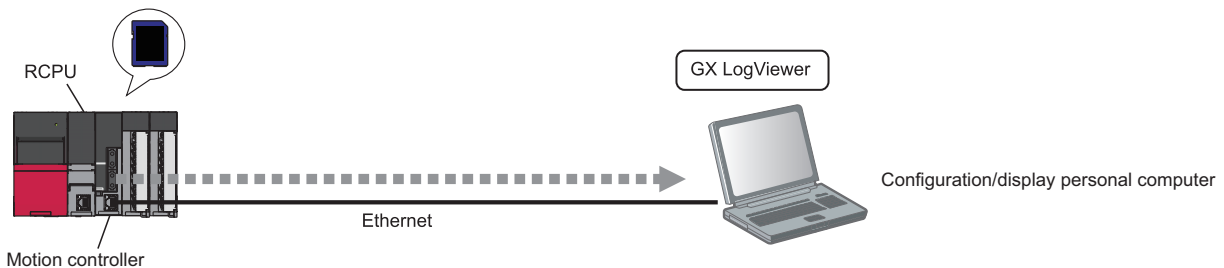

A motion controller can be connected to a personal computer with the following communication route.

Item	Reference
Type of communication route	Page 39 Connection through an Ethernet port

Point

For the considerations for connecting a motion controller and personal computer, refer to Help for MT Developer2.

Connection through an Ethernet port

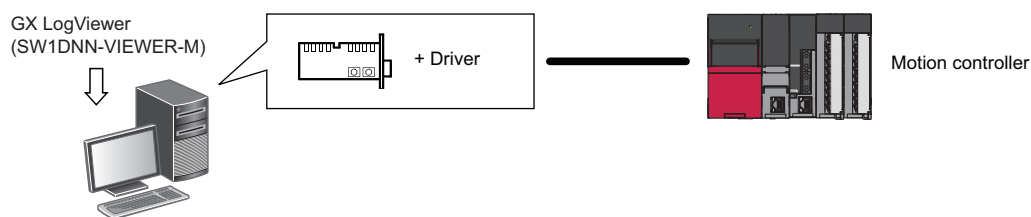

Use an Ethernet board that is built-in to a personal computer or commercially available.

■Connection via a hub

A motion controller can be connected to a configuration/display personal computer via a hub in a local network.

The IP address of a motion controller needs to be specified for this connection.

■Direct connection

A motion controller can directly be connected to a configuration/display personal computer on a 1:1 basis with an Ethernet cable without a hub.

The IP address of an motion controller does not need to be specified for this connection.

Displaying data being simulated by GX Simulator3 or MU Simulator

Type	Target for explanation ( Page 13 Target modules, simulators, files, and data for explanation)
Simulator	RCPMU simulator, FX5CPU simulator, R motion module simulator

The following shows the system configuration to display data of an RCPMU or FX5CPU being simulated by GX Simulator3, or data of a motion module being simulated by MU Simulator in GX LogViewer.

When simulating with GX Simulator3

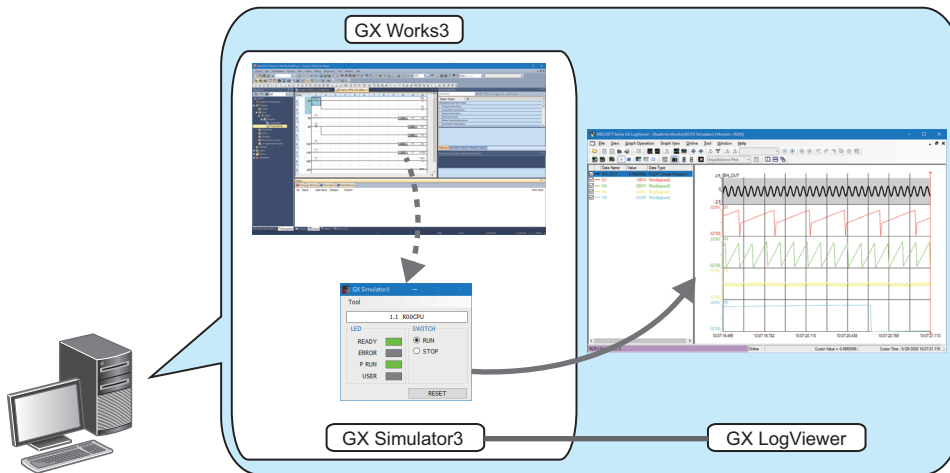

When simulating with MU Simulator

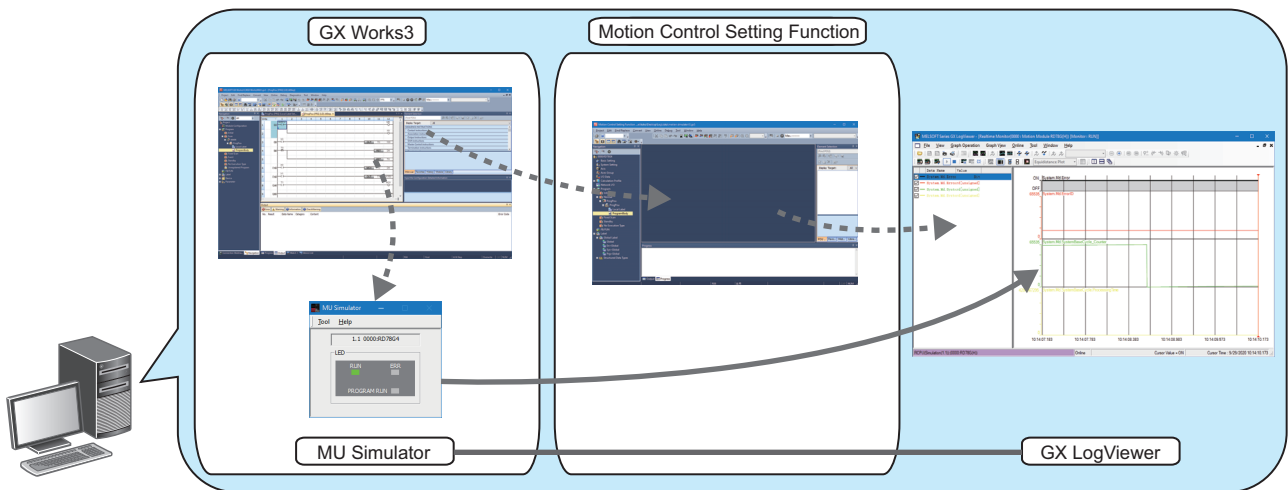

Displaying data by linking with the GX Works3 offline monitor function

Type	Target for explanation ( Page 13 Target modules, simulators, files, and data for explanation)
Others	Offline monitor

The following shows the system configuration to display data, which is displayed by the GX Works3 offline monitor function, in GX LogViewer.

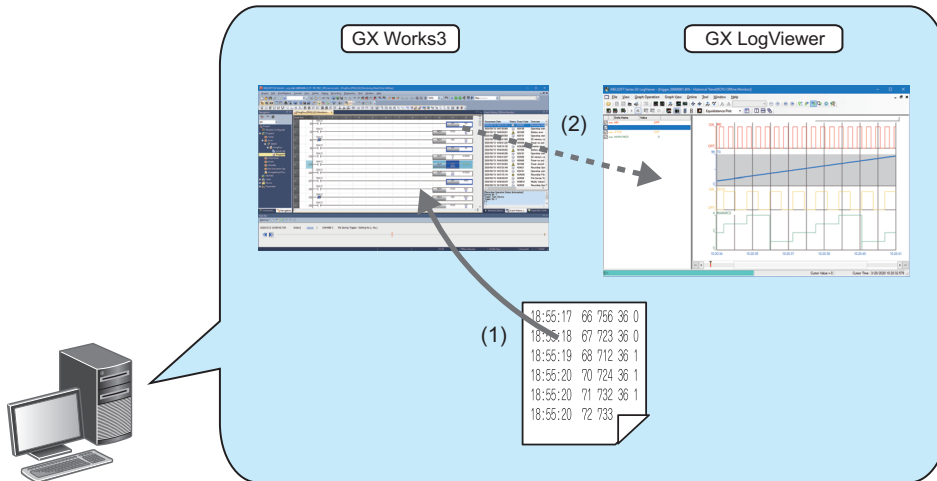

- (1) Select a data logging file or recording file when starting the GX Works3 offline monitor function.
 - (2) Select a device or label in a watch window or program editor of GX Works3 and display it in a waveform in GX LogViewer. Moreover, when selecting another device or label, it can be added to the graph being displayed.
- For details on the GX Works3 offline monitor function, refer to the following:
 GX Works3 Operating Manual

Considerations for connection

Type	Target for explanation ( Page 13 Target modules, simulators, files, and data for explanation)
Module	RCPU, LHCPU, FX5CPU, QnUDVCP, LCPU, R analog, Q analog, L analog, BOX, R logger, Q logger, R communication, Q communication, R motion module, R motion controller

The following sections show the considerations for connecting to a module with a USB or an Ethernet cable.

Considerations for USB connection

Note the following points when connecting a personal computer and a module by USB connection.

■Connecting more than one module to a single personal computer

Only one module can be connected at a time.

Connection in the following configurations is not applicable.

- Connection to multiple programmable controller CPUs from a personal computer with multiple USB ports

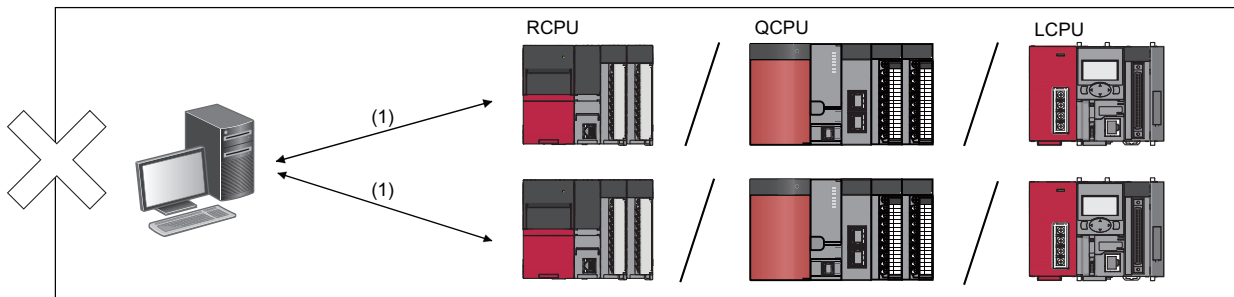

- Connection to multiple programmable controller CPUs via a USB hub

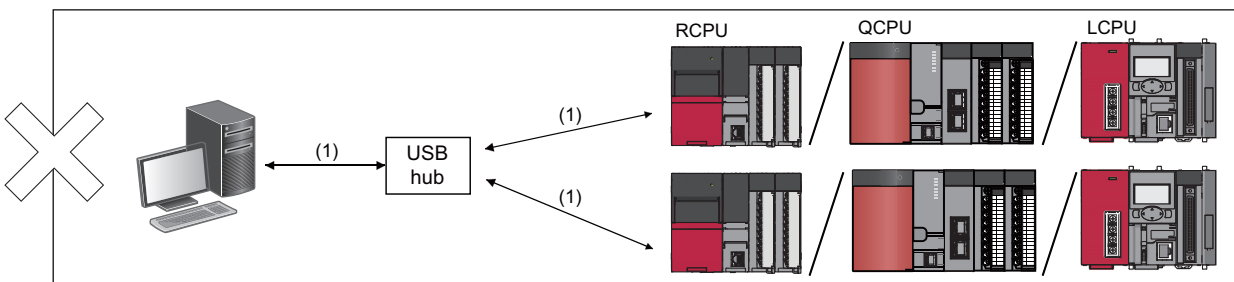

(1): USB cable

Considerations for Ethernet connection

Note the following points when connecting a personal computer and a module by Ethernet connection.

■ Connection via a hub

- The network setting on a personal computer needs to be set so that its network address is the same as that of a module to connect.

Ex.

For a MELSEC-Q series high speed data logger module

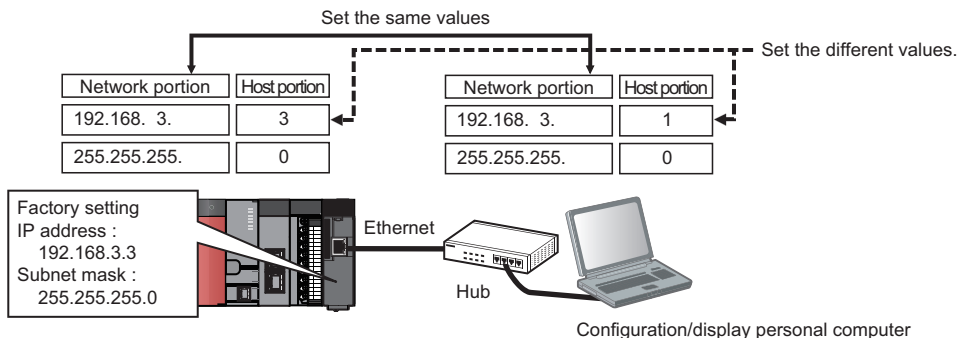

- A data logger and data communication can be connected only by LAN connection. Connection via the Internet is not available.

■ Direct connection

- Connections which are not direct connections

Direct connection cannot be set up in a configuration where a single module is connected with a single personal computer via a hub.

Ex.

For a MELSEC-Q series high speed data logger module

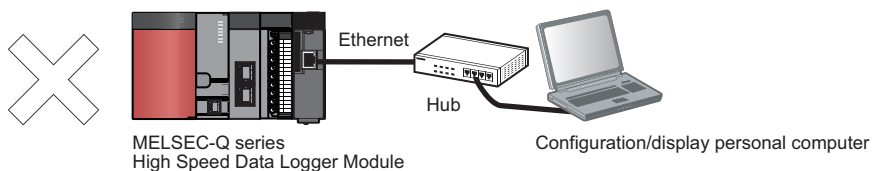

- Conditions where communication cannot be established by direct connection

If the following conditions are satisfied, communication by direct connection may not be available.

In that case, review the settings of the module and the personal computer.

Ex.

When all the bits of the module IP address corresponding to the '0' parts of the personal computer subnet mask are ON or OFF

- Module IP address: 64. 64. 255. 255
- Personal computer IP address: 64. 64. 1. 1
- Personal computer subnet mask: 255. 255. 0. 0

Ex.

When all the bits of the module IP address corresponding to the host address of each class for the personal computer IP address are ON or OFF

- Module IP address: 64. 64. 255. 255
- Personal computer IP address: 192. 168. 0. 1
- Personal computer subnet mask: 255. 255. 0. 0
- IP addresses of each class are as follows:
 - ClassA: 0. x. x. x to 127. x. x. x
 - ClassB: 128. x. x. x to 191. x. x. x
 - ClassC: 192. x. x. x to 223. x. x. x
- Host addresses of each class are the '0' parts below.
 - ClassA: 255. 0. 0. 0
 - ClassB: 255. 255. 0. 0
 - ClassC: 255. 255. 255. 0

Ex.

When the module IP address is automatically acquired by DHCP

- Connection with LAN line
 - Do not communicate by connecting to LAN line directly.
 - This may increase the line load and affect the communications of other devices.
- Direct connection with a BOX data logger
 - To connect a BOX data logger and a configuration/display personal computer directly, connect an Ethernet cable to the Ethernet port (CH1). Another Ethernet port (CH2) cannot be used for this connection.

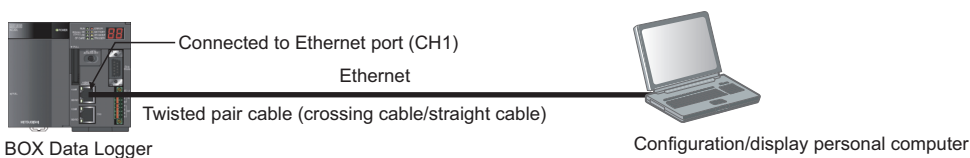

■When the Windows® firewall setting is enabled

Disable the Windows firewall setting.

■When multiple IP addresses are enabled at the same time

In the configuration where multiple IP addresses are enabled at the same time as shown below, do not configure the settings for direct connection.

- An IP address is assigned to each Ethernet port of a personal computer with multiple Ethernet ports (network device)
- A wireless LAN setting is enabled in addition to an Ethernet port of a personal computer
- Multiple IP addresses are assigned to a single Ethernet port of a personal computer

Considerations for realtime monitor connection

Note the following points when connecting a personal computer and a module.

■Connection including Ethernet in the communication route

The UDP connection is not available, except for the direct connection. Use the TCP connection.

■Connection to an FX5CPU

RS-232 cables cannot be used for the connection. Use Ethernet cables.

3 FUNCTION LIST

This chapter explains the major functions of GX LogViewer that are available when connecting to each module or simulator, or displaying a file.

Point

For the functions that are available when connecting to Edgecross Basic Software or Real-time Data Analyzer, refer to the following:

 GX LogViewer Version 1 Operating Manual (Edgecross)

3.1 When Connecting to a CPU Module

Type	Target for explanation ( Page 13 Target modules, simulators, files, and data for explanation)	
Module	RCPU, LHCPU, FX5CPU, QnUDVCP, LCP, R analog, Q analog, L analog	
Function	Description	Reference
Assistant	Displays major functions from displaying graphs of logged devices to saving them for using the functions easily.	Page 70 Assistant Window
Connection setup	Direct connection	Connects a personal computer to a CPU module on a 1:1 basis (available only for Ethernet connection or USB connection).
	Searching modules	Searches and connects a built-in Ethernet port QnUDVCP or LCP on the network (available only for Ethernet connection).
Trend graph	Historical trend	Displays past data sampled by the data logging function on the trend graph.
	Realtime monitor	Displays the current data sampled by an RCP, LHCP, FX5CP or LCP on the trend graph.
	Checking data	Checks data using cursors.
	Operating trend graph	Operates a trend graph (such as aligning, widening/narrowing, or moving the graph).
	Changing display item in graph area	Changes display items in a graph area (such as multiple cursors or cursor labels).
	Changing graph appearance	Changes graph appearance (such as color, line type, or line thickness of the graph).
	Registering/applying graphical display settings	Registers the display setting information of the trend graph being displayed, and applies it to another trend graph.
	Applying graphical display automatically	Stores the graphical display information being displayed by each data logging setting, and applies it to graphs automatically when opening the trend window next time.
	Displaying dump	Displays a graph being displayed in a historical trend window as the data values/statuses.
Initializing graphical display	Restores changed graphical display to the initial state (the state where graph appearance such as the color has not been changed).	
Logging file save	Saves data logging files saved in a memory card to a personal computer.	Page 241 SAVING LOGGING FILE TO PERSONAL COMPUTER
Window/ folder restore	Adding/restoring frequently-used window configurations	Adds window layout and data of the trend window displayed frequently to the menu in order to restore them easily.
	Redisplaying recently-used windows/folders	Adds recently-used windows or folders to the menu automatically in order to redisplay them easily.
Displayed data save	Saves the data being displayed on the trend graph to a personal computer as a CSV file, Unicode text file, or image file (BMP/JPG/PNG). The file format that can be saved differs depending on the source data.	Page 248 Saving Displayed Data
Trend graph print	Prints the trend graph being displayed.	Page 325 PRINTING TREND GRAPHS

3.2 When Connecting to a Data Logger

Type	Target for explanation ( Page 13 Target modules, simulators, files, and data for explanation)	
Module	BOX, R logger, Q logger	
Function	Description	Reference
Assistant	Displays major functions from displaying graphs of logged devices to saving them for using the functions easily.	Page 70 Assistant Window
Connection setup	Direct connection	Connects a personal computer to a data logger on a 1:1 basis.
	Searching modules	Searches a data logger on the network and connects to it.
Trend graph	Historical trend	Displays past data sampled by the data logging function on the trend graph.
	Realtime trend	Displays the current data sampled by a data logger on the trend graph.
	Checking data	Checks data using cursors.
	Operating trend graph	Operates a trend graph (such as aligning, widening/narrowing, or moving the graph).
	Changing display item in graph area	Changes display items in a graph area (such as multiple cursors or cursor labels).
	Changing graph appearance	Changes graph appearance (such as color, line type, or line thickness of the graph).
	Registering/applying graphical display settings	Registers the display setting information of the trend graph being displayed, and applies it to another trend graph.
	Applying graphical display automatically	Stores the graphical display information being displayed by each label group setting, and applies them to the graph automatically when open the trend window next time.
	Displaying dump	Displays a graph being displayed in a historical trend window as the data values/statuses.
	Initializing graphical display	Restores changed graphical display to the initial state (the state where graph appearance such as the color has not been changed).
Event monitoring	Historical event	Displays past events sampled by the event logging function in an event list.
	Realtime event	Displays ongoing events sampled by the event logging function in an event list.
	Operating event list	Operates an event list (such as sorting and filtering).
	Changing display settings of event list	Customizes the display settings of event list (such as font color and display items).
Logging file save	Saves logging files saved in a memory card to a personal computer.	Page 241 SAVING LOGGING FILE TO PERSONAL COMPUTER
Window/ folder restore	Adding/restoring frequently-used window configurations	Adds window layout and data of the trend window displayed frequently to the menu in order to restore them easily.
	Redisplaying recently-used windows/folders	Adds recently-used windows or folders to the menu automatically in order to redisplay them easily.
Displayed data/event save	Saves data being displayed on the trend graph and events being displayed in the event list to a personal computer as a CSV file, Unicode text file, or image file (BMP/JPG/PNG). The file format that can be saved differs depending on the source data/event.	Page 248 Saving Displayed Data
Logging file conversion	Converts the logged binary file into CSV file or Unicode text file.	Page 309 SAVING FILES BY CONVERTING FILE FORMATS
Trend graph print	Prints the trend graph being displayed.	Page 325 PRINTING TREND GRAPHS

3.3 When Connecting to a Data Communication

Type	Target for explanation ( Page 13 Target modules, simulators, files, and data for explanation)		
Module	R communication, Q communication		
Function	Description	Reference	
Assistant	Displays major functions from displaying graphs of logged devices to saving them for using the functions easily.	Page 70 Assistant Window	
Connection setup	Direct connection	Connects a personal computer to a data communication on a 1:1 basis.	
Searching modules	Searches a data communication on the network and connects to it.		
Trend graph	Historical trend	Displays saved past data on the trend graph. Only CSV files or Unicode text files in which realtime trend data has been saved are displayed.	Page 110 Displaying logged devices and labels (Historical trend)
	Realtime trend	Displays the current data sampled by a data communication on the trend graph.	Page 112 Displaying the current device status (Realtime trend)
	Checking data	Checks data using cursors.	Page 152 Checking Data
	Operating trend graph	Operates a trend graph (such as aligning, widening/narrowing, or moving the graph).	Page 163 Operating Trend Graphs
	Changing display item in graph area	Changes display items in a graph area (such as multiple cursors or cursor labels).	Page 199 Changing Display Items in Graph Area
	Changing graph appearance	Changes graph appearance (such as color, line type, or line thickness of the graph).	Page 207 Changing Graph Appearance
	Registering/applying graphical display settings	Registers the display setting information of the trend graph being displayed, and applies it to another trend graph.	Page 211 Registering and Applying a Graphical Display Setting
	Applying graphical display automatically	Stores the graphical display information being displayed by each label group setting, and applies them to the graph automatically when open the trend window next time.	Page 214 Applying the Graph Display Automatically When Opening a Window
	Displaying dump	Displays a graph being displayed in a historical trend window as the data values/statuses.	Page 215 Displaying a Graph as Data Values/statuses
	Initializing graphical display	Restores changed graphical display to the initial state (the state where graph appearance such as the color has not been changed).	Page 218 Initializing the Graph Display
Window/ folder restore	Adding/restoring frequently-used window configurations	Adds window layout and data of the trend window displayed frequently to the menu in order to restore them easily.	Page 244 Adding/Restoring Frequently-Used Window Configuration to Menu
Redisplaying recently-used windows/folders	Adds recently-used windows or folders to the menu automatically in order to redisplay them easily.		Page 246 Redisplaying Recently-Used Windows Page 246 Redisplaying Recently-Used Folders
Displayed data save	Saves the data being displayed on the trend graph to a personal computer as a CSV file, Unicode text file, or image file (BMP/JPG/PNG).		Page 248 Saving Displayed Data
Trend graph print	Prints the trend graph being displayed.		Page 325 PRINTING TREND GRAPHS

3.4 When Connecting to a Motion Module

Type	Target for explanation ( Page 13 Target modules, simulators, files, and data for explanation)	
Module	R motion module	
Function	Description	Reference
Assistant	Displays major functions from displaying graphs of logged devices to saving them for using the functions easily.	Page 70 Assistant Window
Connection setup	Direct connection	Connects a personal computer to a motion module via an RCPU.
Trend graph	Historical trend	Displays past data sampled by the data logging function on the trend graph.
	Realtime monitor	Displays current data sampled by a motion module on the trend graph.
	Checking data	Checks data using cursors.
	Operating trend graph	Operates a trend graph (such as aligning, widening/narrowing, or moving the graph).
	Changing display item in graph area	Changes display items in a graph area (such as multiple cursors or cursor labels).
	Changing graph appearance	Changes graph appearance (such as color, line type, or line thickness of the graph).
	Registering/applying graphical display settings	Registers the display setting information of the trend graph being displayed, and applies it to another trend graph.
	Applying graphical display automatically	Stores the graphical display information being displayed by each data logging setting, and applies it to graphs automatically when opening the trend window next time.
	Displaying dump	Displays a graph being displayed in a historical trend window as the data values/statuses.
Initializing graphical display	Restores changed graphical display to the initial state (the state where graph appearance such as the color has not been changed).	
Logging file save	Saves data logging files saved in the data memory or a memory card to a personal computer.	Page 241 SAVING LOGGING FILE TO PERSONAL COMPUTER
Window/ folder restore	Adding/restoring frequently-used window configurations	Adds window layout and data of the trend window displayed frequently to the menu in order to restore them easily.
	Redisplaying recently-used windows/folders	Adds recently-used windows or folders to the menu automatically in order to redisplay them easily.
Displayed data save	Saves the data being displayed on the trend graph to a personal computer as a CSV file or image file (BMP/JPG/PNG).	Page 248 Saving Displayed Data
Trend graph print	Prints the trend graph being displayed.	Page 325 PRINTING TREND GRAPHS

3.5 When Connecting to a Motion Controller

Type	Target for explanation ( Page 13 Target modules, simulators, files, and data for explanation)		
Module	R motion controller		
Function		Description	Reference
Assistant		Displays major functions from displaying graphs of logged devices to saving them for using the functions easily.	Page 70 Assistant Window
Connection setup	Direct connection	Connects a personal computer to a motion controller via an RCP. Alternatively, connects a personal computer to a motion controller on a 1:1 basis.	Page 90 Connecting to a Motion Controller
Trend graph	Historical trend	Displays past data sampled by the servo system recorder function on the trend graph.	Page 110 Displaying logged devices and labels (Historical trend) Page 98 Files that can be displayed
	Checking data	Checks data using cursors.	Page 152 Checking Data
	Operating trend graph	Operates a trend graph (such as aligning, widening/narrowing, or moving the graph).	Page 163 Operating Trend Graphs
	Changing display item in graph area	Changes display items in a graph area (such as multiple cursors or cursor labels).	Page 199 Changing Display Items in Graph Area
	Changing graph appearance	Changes graph appearance (such as color, line type, or line thickness of the graph).	Page 207 Changing Graph Appearance
	Registering/applying graphical display settings	Registers the display setting information of the trend graph being displayed, and applies it to another trend graph.	Page 211 Registering and Applying a Graphical Display Setting
	Applying graphical display automatically	Stores the graphical display information being displayed by each data logging setting, and applies it to graphs automatically when opening the trend window next time.	Page 214 Applying the Graph Display Automatically When Opening a Window
	Displaying dump	Displays a graph being displayed in a historical trend window as the data values/statuses.	Page 215 Displaying a Graph as Data Values/statuses
	Initializing graphical display	Restores changed graphical display to the initial state (the state where graph appearance such as the color has not been changed).	Page 218 Initializing the Graph Display
Logging file save		Saves data logging files saved in the data memory or a memory card to a personal computer.	Page 241 SAVING LOGGING FILE TO PERSONAL COMPUTER
Window/ folder restore	Adding/restoring frequently-used window configurations	Adds window layout and data of the trend window displayed frequently to the menu in order to restore them easily.	Page 244 Adding/Restoring Frequently-Used Window Configuration to Menu
	Redisplaying recently-used windows/folders	Adds recently-used windows or folders to the menu automatically in order to redisplay them easily.	Page 246 Redisplaying Recently-Used Windows Page 246 Redisplaying Recently-Used Folders
Displayed data save		Saves the data being displayed on the trend graph to a personal computer as a CSV file or image file (BMP/JPG/PNG).	Page 248 Saving Displayed Data
Trend graph print		Prints the trend graph being displayed.	Page 325 PRINTING TREND GRAPHS

3.6 When Connecting to GX Simulator3 or MU Simulator

Type		Target for explanation ( Page 13 Target modules, simulators, files, and data for explanation)	
Simulator		RCPU simulator, FX5CPU simulator, R motion module simulator	
Function		Description	Reference
Assistant		Displays major functions from displaying graphs of logged devices to saving them for using the functions easily.	Page 70 Assistant Window
Trend graph	Historical trend	Displays past data sampled by the data logging function of motion module simulator on the trend graph. For an RCPUR simulator or FX5CPU simulator, only a Unicode text file in which realtime monitor data is saved is displayed.	Page 110 Displaying logged devices and labels (Historical trend) Page 98 Files that can be displayed
	Realtime monitor	Displays the data being simulated by an RCPUR simulator, FX5CPU simulator, or motion module simulator on the trend graph.	Page 113 Displaying the current statuses of devices and labels (Realtime monitor)
	Checking data	Checks data using cursors.	Page 152 Checking Data
	Operating trend graph	Operates a trend graph (such as aligning, widening/narrowing, or moving the graph).	Page 163 Operating Trend Graphs
	Changing display item in graph area	Changes display items in a graph area (such as multiple cursors or cursor labels).	Page 199 Changing Display Items in Graph Area
	Changing graph appearance	Changes graph appearance (such as color, line type, or line thickness of the graph).	Page 207 Changing Graph Appearance
	Registering/applying graphical display settings	Registers the display setting information of the trend graph being displayed, and applies it to another trend graph.	Page 211 Registering and Applying a Graphical Display Setting
	Applying graphical display automatically	Stores the graphical display information being displayed by each data logging setting, and applies it to graphs automatically when opening the trend window next time.	Page 214 Applying the Graph Display Automatically When Opening a Window
	Displaying dump	Displays a graph being displayed in a historical trend window as the data values/statuses.	Page 215 Displaying a Graph as Data Values/statuses
	Initializing graphical display	Restores changed graphical display to the initial state (the state where graph appearance such as the color has not been changed).	Page 218 Initializing the Graph Display
Window/ folder restore	Adding/restoring frequently-used window configurations	Adds window layout and data of the trend window displayed frequently to the menu in order to restore them easily.	Page 244 Adding/Restoring Frequently-Used Window Configuration to Menu
	Redisplaying recently-used windows	Adds recently-used windows to the menu automatically in order to redisplay them easily.	Page 246 Redisplaying Recently-Used Windows
Displayed data save		Saves the data being displayed on the trend graph to a personal computer as a Unicode text file or image file (BMP/JPG/PNG).	Page 248 Saving Displayed Data
Trend graph print		Prints the trend graph being displayed.	Page 325 PRINTING TREND GRAPHS

3.7 When Linking with the GX Works3 Offline Monitor Function

Type	Target for explanation ( Page 13 Target modules, simulators, files, and data for explanation)		
Others	Offline monitor		
Function	Description		Reference
Trend graph	Historical trend	Displays past data sampled by the data logging function or recording function on the trend graph.	Page 110 Displaying logged devices and labels (Historical trend) Page 98 Files that can be displayed
	Checking data	Checks data using cursors.	Page 152 Checking Data
	Operating trend graph	Operates a trend graph (such as aligning, widening/narrowing, or moving the graph).	Page 163 Operating Trend Graphs
	Changing display item in graph area	Changes display items in a graph area (such as multiple cursors or cursor labels).	Page 199 Changing Display Items in Graph Area
	Changing graph appearance	Changes graph appearance (such as color, line type, or line thickness of the graph).	Page 207 Changing Graph Appearance
	Registering/applying graphical display settings	Registers the display setting information of the trend graph being displayed, and applies it to another trend graph.	Page 211 Registering and Applying a Graphical Display Setting
	Applying graphical display automatically	Stores the graphical display information being displayed by each data logging setting, and applies it to graphs automatically when opening the trend window next time.	Page 214 Applying the Graph Display Automatically When Opening a Window
	Displaying dump	Displays a graph being displayed in a historical trend window as the data values/statuses.	Page 215 Displaying a Graph as Data Values/statuses
	Initializing graphical display	Restores changed graphical display to the initial state (the state where graph appearance such as the color has not been changed).	Page 218 Initializing the Graph Display
Displayed data save		Saves the data being displayed on the trend graph to a personal computer as a Unicode text file or image file (BMP/JPG/PNG).	Page 248 Saving Displayed Data
Recording file conversion		Converts a recording file into a Unicode text file.	Page 309 SAVING FILES BY CONVERTING FILE FORMATS
Trend graph print		Prints the trend graph being displayed.	Page 325 PRINTING TREND GRAPHS

3.8 When Displaying a CSV File or JSON File in GX LogViewer Format

Type	Target for explanation ( Page 13 Target modules, simulators, files, and data for explanation)		
Others	Others		
Function	Description	Reference	
Trend graph	Historical trend	Displays saved past data on the trend graph.	Page 110 Displaying logged devices and labels (Historical trend) Page 98 Files that can be displayed
	Checking data	Checks data using cursors.	Page 152 Checking Data
	Operating trend graph	Operates a trend graph (such as aligning, widening/narrowing, or moving the graph).	Page 163 Operating Trend Graphs
	Changing display item in graph area	Changes display items in a graph area (such as multiple cursors or cursor labels).	Page 199 Changing Display Items in Graph Area
	Changing graph appearance	Changes graph appearance (such as color, line type, or line thickness of the graph).	Page 207 Changing Graph Appearance
	Registering/applying graphical display settings	Registers the display setting information of the trend graph being displayed, and applies it to another trend graph.	Page 211 Registering and Applying a Graphical Display Setting
	Applying graphical display automatically	Stores the graphical display information being displayed by each label group setting, and applies them to the graph automatically when open the trend window next time.	Page 214 Applying the Graph Display Automatically When Opening a Window
	Displaying dump	Displays a graph being displayed in a historical trend window as the data values/statuses.	Page 215 Displaying a Graph as Data Values/statuses
Window/ folder restore	Initializing graphical display	Restores changed graphical display to the initial state (the state where graph appearance such as the color has not been changed).	Page 218 Initializing the Graph Display
	Adding/restoring frequently-used window configurations	Adds window layout and data of the trend window displayed frequently to the menu in order to restore them easily.	Page 244 Adding/Restoring Frequently-Used Window Configuration to Menu
Displayed data save	Redisplaying recently-used windows/folders	Adds recently-used windows or folders to the menu automatically in order to redisplay them easily.	Page 246 Redisplaying Recently-Used Windows Page 246 Redisplaying Recently-Used Folders
		Saves the data being displayed on the trend graph to a personal computer as a CSV file or image file (BMP/JPG/PNG).	Page 248 Saving Displayed Data
Trend graph print	Prints the trend graph being displayed.	Page 325 PRINTING TREND GRAPHS	

4 OBTAINING AND START OF GX LogViewer

4.1 Obtaining of GX LogViewer

In Japan

GX LogViewer can be downloaded from Mitsubishi Electric FA site.

www.MitsubishiElectric.co.jp/fa

For downloading GX LogViewer, please register for a free membership on Mitsubishi Electric FA site in advance.

In other countries

For the information on how to obtain GX LogViewer, please contact your local Mitsubishi Electric sales office or representative.

4.2 Installation and Uninstallation

For the installation/uninstallation procedure of GX LogViewer, refer to the following:

 CPU Module Logging Configuration Tool/GX LogViewer Installation Instructions (BCN-P5999-0506)

The above manual is stored in the "Manual" folder which is stored in the same folder as the installer.

4.3 Start and End

This section explains the operation methods for starting and ending GX LogViewer.

Start

Operating procedure

Select GX LogViewer from "MELSOFT" in Windows Start.

■ Starting GX LogViewer by specifying the display position and window size

The display position and window size of GX LogViewer at startup can be specified by specifying the following options in a command line.

- To start in full screen
-WINDOWSIZE
 - To start by specifying the display position (left^{*1}, top^{*2}) and window size (width, height)
-WINDOWSIZE=left,top,width,height
- *1 For 'left,' enter an integer value by taking the upper left of the main display as the coordinates (0,0) and the rightward direction as positive.
When specifying '0,' the window frame is displayed transparently by Windows settings; therefore, a gap appears for a few pixels on the left side of the main display.
(This can be avoided by turning high contrast mode ON in Windows settings.)
- *2 For 'top,' enter an integer value by taking the upper left of the main display as the coordinates (0,0) and the downward direction as positive.

Ex.

When starting GX LogViewer from the command prompt, specify the installation path of GX LogViewer and option as follows.

When starting GX LogViewer from a shortcut, specify an option in "Target" in the shortcut properties as follows.

- To start in full screen
"C:\Program Files (x86)\MELSOFT\VIEWER\GLViewer.exe" "-WINDOWSIZE"
- To start at the specified display position and in the specified window size, and open a data logging file (D:\Files\loggingdata.bin)
"C:\Program Files (x86)\MELSOFT\VIEWER\GLViewer.exe" "-WINDOWSIZE=10,20,1500,1000" "D:\Files\loggingdata.bin"

End

Operating procedure

Select [File] ⇒ [Exit].

4.4 Display Language Switching

GX LogViewer supports multiple languages, and therefore the display language such as one on the menu can be switched on a personal computer.

Operating procedure

Select [View] ⇒ [Switch Display Language].

Precautions

- If the display language differs from the one for the operating system, displayed texts may get cut.
- The display language may not be switched in some parts of display items (such as "Host" or "Other station" for a connection destination). In addition, window names may not be displayed in the selected language.

5 OPERATION FLOWS

This chapter explains the operation flows to display the following data in GX LogViewer.

- Data and events sampled by a module
- Data being displayed by the GX Works3 offline monitor function
- Data of a GX LogViewer format CSV file
- Data of a GX LogViewer format JSON file

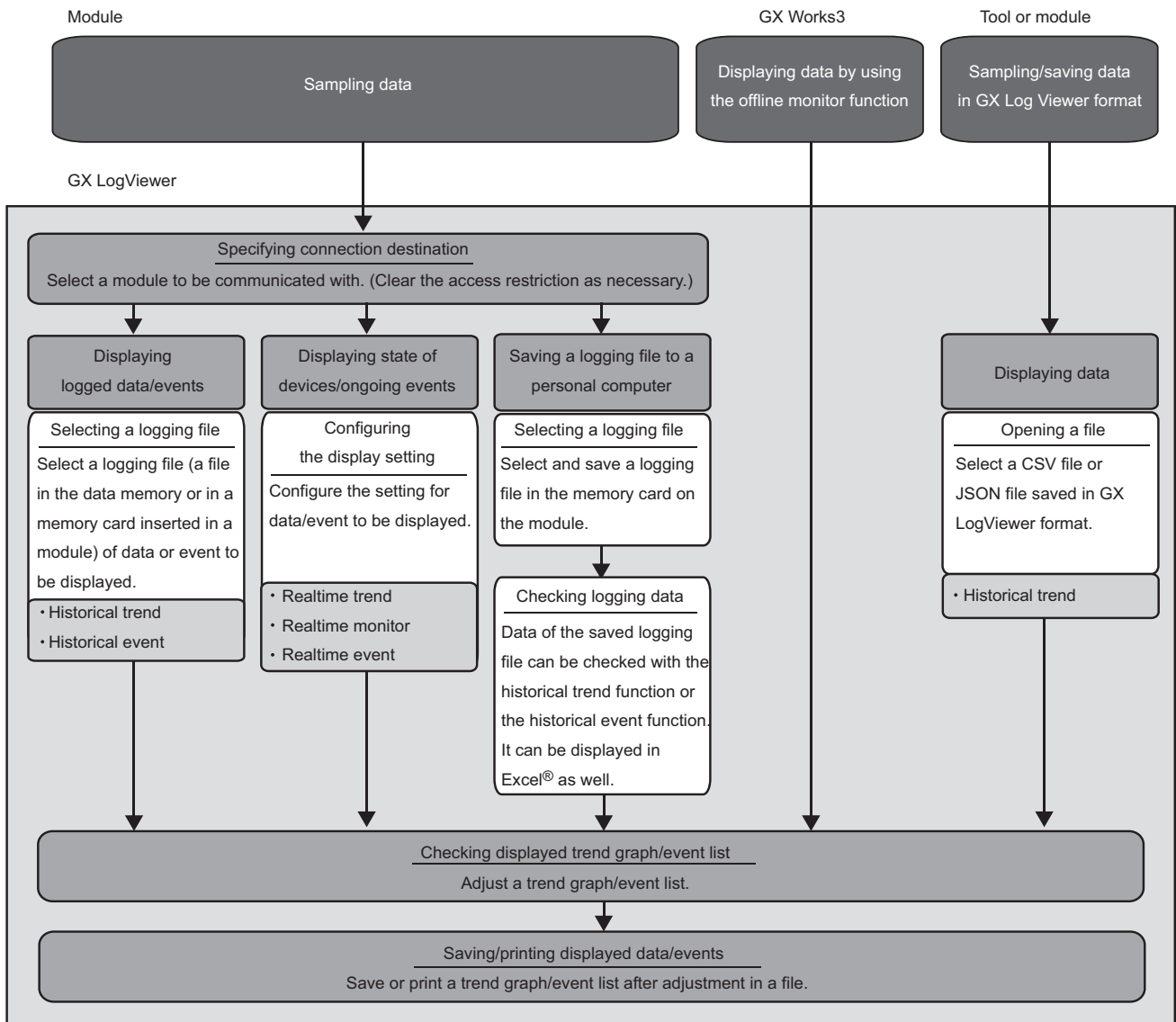

For details on each item, refer to the following:

Item	Reference
Specifying connection destination	Page 75 CONNECTING TO MODULE
Displaying logged data/events	Page 110 Displaying logged devices and labels (Historical trend) Page 228 Displaying logged events (Historical event)
Displaying state of devices/ongoing events	Page 112 Displaying the current device status (Realtime trend) Page 113 Displaying the current statuses of devices and labels (Realtime monitor) Page 229 Displaying ongoing events (Realtime event)
Saving a logging file to a personal computer	Page 241 SAVING LOGGING FILE TO PERSONAL COMPUTER
Displaying a CSV file or JSON file in GX LogViewer format	Page 110 Displaying logged devices and labels (Historical trend)
Checking displayed trend graph/event list	Page 152 Checking Data Page 163 Operating Trend Graphs Page 199 Changing Display Items in Graph Area Page 207 Changing Graph Appearance Page 211 Registering and Applying a Graphical Display Setting Page 214 Applying the Graph Display Automatically When Opening a Window Page 215 Displaying a Graph as Data Values/statuses Page 218 Initializing the Graph Display
Saving/printing displayed data/events	Page 247 SAVING DISPLAYED DATA/EVENTS Page 325 PRINTING TREND GRAPHS

For the methods of displaying each data, refer to the following:

Item	Reference
Data of a CPU module or an analog module	Page 59 Displaying Data of a CPU Module or an Analog Module
Data/events of a data logger	Page 60 Displaying Data/Events of a Data Logger
Data of a data communication	Page 61 Displaying Data of a Data Communication
Data of a motion module	Page 62 Displaying Data of a Motion Module
Data of a motion controller	Page 63 Displaying Data of a Motion Controller
Data of a simulator	Page 64 Displaying Simulator Data
Data being displayed by the GX Works3 offline monitor function	 GX Works3 Operating Manual
CSV file in GX LogViewer format	Page 65 Displaying a GX LogViewer Format CSV File

Save target memory card type for data logged by an analog module

Data logged by an analog module is saved in a memory card inserted in a CPU module.

Therefore, select the data logging file in the memory card inserted in the CPU module when displaying sampled data on GX LogViewer.

Connection target CPU modules and types of save destination memory card when using an analog module are as follows:

Analog module to be logged	Connection target CPU module	Type of save destination memory card
MELSEC-Q series analog module	QCPU (excluding QnUDVCPU)	ATA card
MELSEC iQ-R series analog module	RCPU	SD memory card
MELSEC-Q series analog module	QnUDVCPU	
MELSEC-L series analog module	LHCPU or LCPU	

Access restriction when a connection destination is specified

When an access restriction has been set to a module by the remote password or access authentication, the connection target cannot be specified in GX LogViewer.

Clear the access restriction on the "Enter remote password" screen or "Access Authentication" screen.





- For details on the remote password, refer to the user's manual of a CPU module.
- For details on the access authentication, refer to the manual of a data logger or data communication.

5.1 Displaying Data of a CPU Module or an Analog Module

Type	Target for explanation ( Page 13 Target modules, simulators, files, and data for explanation)
Module	RCPU, LHCPU, FX5CPU, QnUDVCP, LCP, R analog, Q analog, L analog

Operating procedure

For the procedure for connecting to a module, refer to the following:

-  Page 77 Connecting to an RCP
-  Page 79 Connecting to an LHCP
-  Page 81 Connecting to an FX5CP
-  Page 83 Connecting to a QCP or an LCP

■Displaying data saved in a personal computer

Drag a data logging file to be displayed and drop it onto the main window.

■Displaying data saved in a CPU module

1. Select [Online] ⇒ [Open Logging File] ().
2. Select a data logging file saved in either of the following:
 - Data memory
 - Memory card inserted in the module

 Page 110 Displaying a data logging file saved by the data logging function of a CPU module, analog module, or motion module

■Displaying the status of a current device or label (for using an RCP, LHCP, FX5CP, or LCP only)

1. Select [Online] ⇒ [Realtime Monitor] ().
2. Configure the realtime monitor setting.

 Page 114 Starting the realtime monitor function (for RCP, RCP simulator, LHCP, FX5CP, FX5CP simulator, or LCP)

■Saving a data logging file to a personal computer

1. Select [Online] ⇒ [Save Logging File to PC] ().
2. Select a data logging file (a file in data memory or in a memory card inserted in a module) to be saved.

Data of a saved data logging file can be checked with the historical trend function. It can be displayed in Excel as well.

 Page 241 SAVING LOGGING FILE TO PERSONAL COMPUTER

5.2 Displaying Data/Events of a Data Logger

Type	Target for explanation ( Page 13 Target modules, simulators, files, and data for explanation)
Module	BOX, R logger, Q logger

Operating procedure

For the procedure for connecting to a module, refer to the following:

 Page 86 Connecting to a Data Logger or Data Communication

■Displaying data saved in a personal computer

Drag a data logging file to be displayed and drop it onto the main window.

■Displaying data saved in a data logger

1. Select [Online] ⇒ [Open Logging File] ().

2. Select a data logging file to be displayed.

 Page 111 Displaying a data logging file saved by the data logging function of a data logger

■Displaying events saved in a personal computer

Drag an event logging file for displaying and drop it onto the main window.

■Displaying events saved in a data logger

1. Select [Online] ⇒ [Open Logging File] ().

2. Select an event logging file to be displayed.

 Page 228 Displaying event logging files saved with the event logging function of a data logger

■Displaying the current device status

1. Select [Online] ⇒ [Realtime Monitor] ().

2. Select a data logging setting to be displayed.

 Page 112 Displaying the current device status of a data logger

■Displaying ongoing events

1. Select [Online] ⇒ [Realtime Monitor] ().

2. Select an event logging setting to be displayed.

 Page 229 Displaying ongoing events (Realtime event)

■Saving a logging file to a personal computer

1. Select [Online] ⇒ [Save Logging File to PC] ().

2. Select a logging file to be saved.

Saved logging file data can be checked with the historical trend function or historical event function. It can be displayed in Excel as well.

 Page 241 SAVING LOGGING FILE TO PERSONAL COMPUTER

5.3 Displaying Data of a Data Communication

Type	Target for explanation ( Page 13 Target modules, simulators, files, and data for explanation)
Module	R communication, Q communication

Operating procedure

For the procedure for connecting to a module, refer to the following:

 Page 86 Connecting to a Data Logger or Data Communication

■Displaying data saved in a personal computer (only CSV files or Unicode text files in which the data displayed with the realtime trend function is saved)

Drag a file to be displayed and drop it onto the main window.

■Displaying the current device status

1. Select [Online] ⇔ [Realtime Monitor] (.

2. Select a data logging setting to be displayed.

 Page 112 Displaying the current device status of a data communication

5.4 Displaying Data of a Motion Module

Type	Target for explanation ( Page 13 Target modules, simulators, files, and data for explanation)
Module	R motion module

Operating procedure



For the procedure for connecting to a module, refer to the following:

 Page 88 Connecting to a Motion Module



■Displaying data saved in a personal computer

Drag a data logging file to be displayed and drop it onto the main window.



■Displaying data saved in a motion module

1. Select [Online] ⇒ [Open Logging File] ().
2. Select a data logging file (a file in data memory or in a memory card inserted in a module) to be displayed.
 Page 110 Displaying a data logging file saved by the data logging function of a CPU module, analog module, or motion module

■Displaying the status of a current device or label

1. Select [Online] ⇒ [Realtime Monitor] ().
2. Configure the monitoring setting in activated Motion System Logging Setting to start monitoring.*1
 Page 114 Starting the realtime monitor function (for motion module)
*1 For details on Motion System Logging Setting, refer to the manual of the motion control setting function.
For the method for referring to the motion control setting function manual, refer to the following:
 Page 94 Referring to the motion control setting function manual

■Saving a data logging file to a personal computer

1. Select [Online] ⇒ [Save Logging File to PC] ().
2. Select a data logging file (a file in data memory or in a memory card inserted in a module) to be saved.
Data of a saved data logging file can be checked with the historical trend function.
 Page 241 SAVING LOGGING FILE TO PERSONAL COMPUTER

5.5 Displaying Data of a Motion Controller

Type	Target for explanation ( Page 13 Target modules, simulators, files, and data for explanation)
Module	R motion controller

Operating procedure



For the procedure for connecting to a module, refer to the following:

 Page 90 Connecting to a Motion Controller

■Displaying data saved in a personal computer

Drag a data logging file to be displayed and drop it onto the main window.

■Displaying data saved in a motion controller

1. Select [Online] ⇒ [Open Logging File] ().
2. Select a data logging file (a file in data memory or in a memory card inserted in a module) to be displayed.
 Page 110 Displaying a data logging file saved by the servo system recorder function of a motion controller

■Saving a data logging file to a personal computer

1. Select [Online] ⇒ [Save Logging File to PC] ().
2. Select a data logging file (a file in data memory or in a memory card inserted in a module) to be saved.
Data of a saved data logging file can be checked with the historical trend function.

 Page 241 SAVING LOGGING FILE TO PERSONAL COMPUTER

5.6 Displaying Simulator Data

Type	Target for explanation ( Page 13 Target modules, simulators, files, and data for explanation)
Simulator	R CPU simulator, FX5CPU simulator, R motion module simulator

For an R CPU simulator and an FX5CPU simulator

Operating procedure

For the method for connecting to an R CPU or FX5CPU simulator, refer to the following:

 Page 92 Connecting to an R CPU Simulator or an FX5CPU Simulator

■ Displaying data saved in a personal computer (only Unicode text files in which the data displayed by the realtime monitor function is saved)

Drag a file to be displayed and drop it onto the main window.

■ Displaying the status of a current device or label

1. Select [Online] ⇔ [Realtime Monitor] (.

2. Configure the realtime monitor setting.

 Page 114 Starting the realtime monitor function (for R CPU, R CPU simulator, LH CPU, FX5CPU, FX5CPU simulator, or L CPU)

For the motion module simulator

For the procedure for connecting to the motion module simulator, refer to the manual of the motion control setting function.

For the method for referring to the motion control setting function manual, refer to the following:

 Page 94 Referring to the motion control setting function manual

5.7 Displaying a GX LogViewer Format CSV File

Type	Target for explanation ( Page 13 Target modules, simulators, files, and data for explanation)
Others	Others

This section shows the method of displaying a GX LogViewer format CSV file in GX LogViewer.

Displaying data saved with a logging module for energy measuring module

For the methods for saving logging data in a CSV file format, refer to the manuals of the logging module for energy measuring module.

- Obtaining manuals of the logging module for energy measuring module in Japan

The manuals of the logging module for energy measuring module can be downloaded from Mitsubishi Electric FA site. www.MitsubishiElectric.co.jp/fa

- Obtaining manuals of the logging module for energy measuring module in other countries

For information on how to obtain the manual, please contact your local Mitsubishi Electric sales office or representative.

Operating procedure

Drag GX LogViewer format data which is saved in a logging module for energy measuring module and drop it onto the main window.

Displaying sampling trace data saved in GX Works2

Display sampling trace data in GX LogViewer format saved with GX Works2.

For the methods of saving sampling trace data in GX LogViewer format, refer to the following:

 GX Works2 Version 1 Operating Manual (Common)

Restriction

Saving sampling trace data in GX LogViewer format is supported with Japanese version of GX Works2 Version 1.90U or later, English version of GX Works2 Version 1.91V or later, and Chinese version of GX Works2 Version 1.91V or later.

Operating procedure

Drag GX LogViewer format sampling trace data and drop it onto the main window.

Displaying data saved with Flexible High-Speed I/O Control Module Configuration Tool

Display a simulation result and sampling data in GX LogViewer format saved with Flexible High-Speed I/O Control Module Configuration Tool.

For the methods of saving a simulation result and sampling data in GX LogViewer format, refer to the following:

 MELSEC iQ-R Flexible High-Speed I/O Control Module User's Manual (Application)

 MELSEC-L Flexible High-Speed I/O Control Module User's Manual

Operating procedure

Drag a GX LogViewer format simulation result or sampling data and drop it onto the main window.

Displaying data saved with a CC-Link IE TSN FPGA module

For the methods of saving logging data in a CSV file format, refer to the following:

 CC-Link IE TSN FPGA Module User's Manual

Display logging data in a CSV file format saved with a CC-Link IE TSN FPGA module.

Operating procedure

Drag data which is saved with a CC-Link IE TSN FPGA module and drop it onto the main window.

6 SCREEN CONFIGURATION

6.1 Main Window

The following figure shows the main window configuration of GX LogViewer.

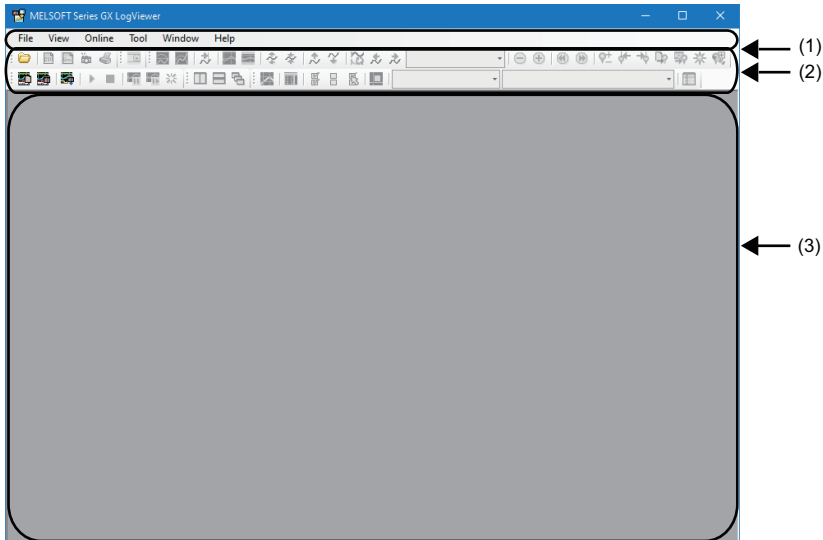

- (1): Menu bar
- (2): Toolbar
- (3): Main window

Only one main window can be displayed on the desktop since multiple pieces of GX LogViewer cannot be activated.

6.2 Child Windows

Child windows (trend windows/event windows) are displayed in the main window. Multiple child windows can be displayed by each logging file and each logging data.

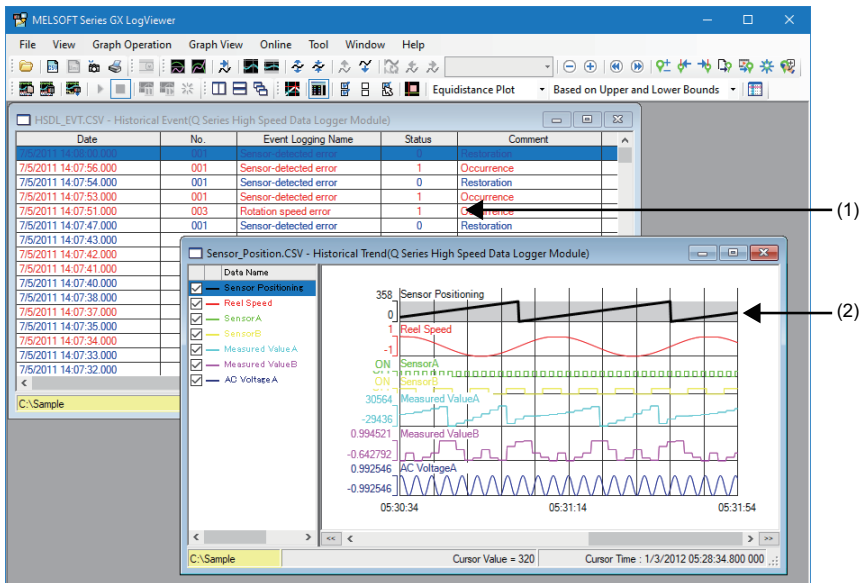

Name of window	Function	Reference
(1) Event window	Event monitoring function	Page 225 Event window
(2) Trend window	Trend graph function	Page 100 Trend window

Restriction

- When connecting to multiple RCPUs, LHCPUs, or LCPUs, only one trend window for real-time monitor can be displayed.
- When connecting to a single data logger or BOX data logger, up to two windows can be displayed in any combination of realtime trend windows and/or realtime event windows.
- When connecting to a single data communication, the number of realtime trend windows and/or realtime event windows that can be displayed simultaneously is as follows:
 - For high speed sampling: up to two screens
 - For general sampling: up to four screens (When two screens are used for high speed sampling, the number of screen can be displayed for general sampling is up to two screens.)
- The maximum number of GX LogViewer accessible to a single module at the same time varies by module.

Operating procedure

■Tiling windows vertically/horizontally, or cascading windows

Select [Window] ⇒ [Tile Vertically] (☐) / [Tile Horizontally] (☐) / [Cascade] (☐).

<Tile vertically>

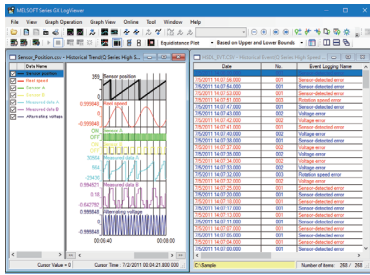

<Tile horizontally>

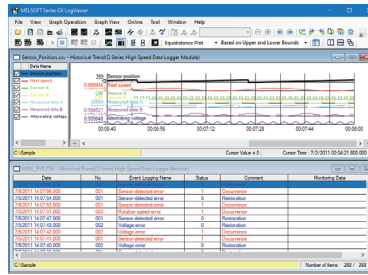

<Cascade>

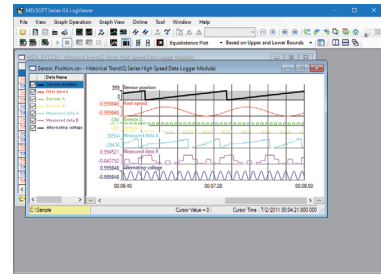

■Bringing hidden window to front

Select a file name or data logging setting/event logging setting to bring the selected child window to the front.

- Select [Window] ⇒ [(window name)].

6.3 Assistant Window

Major functions from displaying graphs of logged devices to saving them can easily be used by selecting the assistant menu.

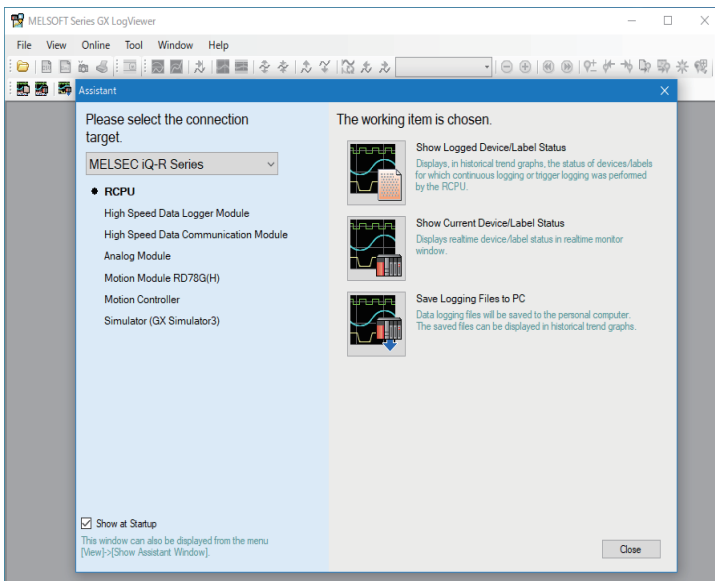

To reopen the window, select [View] ⇒ [Show Assistant Window].

6.4 Menu Configuration

The following tables show menus of GX LogViewer.

[File]	Reference
⇒ [Open]	Page 111 Displaying a data logging file saved in a personal computer
⇒ [Recent Folders] ⇒ [(folder name)]	Page 246 Redisplaying Recently-Used Folders
⇒ [Close]	—
⇒ [Save As] ⇒ [Save CSV File]	Page 247 SAVING DISPLAYED DATA/EVENTS
⇒ [Save As] ⇒ [Save Unicode Text File]	
⇒ [Save As] ⇒ [Save Image File]	
⇒ [Print]	Page 325 PRINTING TREND GRAPHS
⇒ [Import and Export]	Page 211 Registering and Applying a Graphical Display Setting Page 244 Adding/Restoring Frequently-Used Window Configuration to Menu
⇒ [Exit]	—
[View]	Reference
⇒ [Toolbar] ⇒ [Standard]	—
⇒ [Toolbar] ⇒ [Online]	
⇒ [Toolbar] ⇒ [Graph Operation]	
⇒ [Toolbar] ⇒ [Graph View]	
⇒ [Toolbar] ⇒ [Event]	
⇒ [Toolbar] ⇒ [Window]	
⇒ [Show Assistant Window]	Page 70 Assistant Window
⇒ [Switch Display Language]	Page 55 Display Language Switching
[Graph Operation]	Reference
⇒ [Graph Alignment]	Page 166 Aligning graphs
⇒ [Graph Superimpose]	Page 166 Superimposing graphs
⇒ [Jump Cursor]	Page 167 Moving cursor by specifying value/time/index
⇒ [Auto Adjust Upper/Lower Bound] ⇒ [For Period on Window]	Page 175 Specifying the upper and lower bounds/Y axis scale
⇒ [Auto Adjust Upper/Lower Bound] ⇒ [For All Period]	
⇒ [Edit Upper/Lower Bound]	
⇒ [Change Upper/Lower Bound/Y Axis Scale in Batch]	Page 189 Widening/narrowing the display scale
⇒ [Adjust Scale] ⇒ [Widen Graph]	
⇒ [Adjust Scale] ⇒ [Narrow Graph]	Page 190 Moving graph up/down/left/right
⇒ [Adjust Graph Location] ⇒ [Move Up Graph]	
⇒ [Adjust Graph Location] ⇒ [Move Down Graph]	Page 191 Synchronizing the time
⇒ [Adjust Graph Location] ⇒ [Synchronize with Time of Head File]	
⇒ [Adjust Graph Location] ⇒ [Move Graph to Left]	
⇒ [Adjust Graph Location] ⇒ [Move Graph to Right]	Page 190 Moving graph up/down/left/right
⇒ [Adjust Graph Location] ⇒ [Horizontal Moving Quantity]	
⇒ [Adjust Font Size of Graph Legends] ⇒ [Expansion Font Size]	Page 102 Graph legend area
⇒ [Adjust Font Size of Graph Legends] ⇒ [Reduction Font Size]	Page 192 Expanding/reducing the time scale
⇒ [Adjust Time Scale] ⇒ [Expansion Time Scale]	
⇒ [Adjust Time Scale] ⇒ [Reduction Time Scale]	Page 193 Displaying the previous or next trend graph consecutively
⇒ [Show Previous Graph]	
⇒ [Show Next Graph]	Page 162 Changing the display range of data
⇒ [Change Waveform Display Range]	

[Graph Operation]	Reference
⇒ [Add/Delete Log Marker to Red Cursor Location]	Page 154 Adding a log marker to data
⇒ [Move Red Cursor to Previous Log Marker Location]	
⇒ [Move Red Cursor to Next Log Marker Location]	
⇒ [Read Log Marker Information]	
⇒ [Read Log Marker Information from GX VideoViewer]	
⇒ [Delete All Log Markers]	
⇒ [Edit Comment/Color of Log Marker]	
[Graph View]	Reference
⇒ [Multiple Cursor]	Page 199 Displaying multiple cursors
⇒ [Cursor Label]	Page 200 Displaying cursor labels
⇒ [Graph Highlight]	Page 210 Highlighting graph
⇒ [Bold Line]	Page 210 Thickening graph line
⇒ [Data Name]	Page 200 Displaying data names
⇒ [Grid] ⇒ [Vertical Line]	Page 205 Displaying grid
⇒ [Grid] ⇒ [Horizontal Line]	
⇒ [Plot Format] ⇒ [Equidistance Plot]	Page 205 Changing graph plot formats
⇒ [Plot Format] ⇒ [Time Interval Plot]	
⇒ [Time Label] ⇒ [Time]	Page 206 Changing a display of time-scale label
⇒ [Time Label] ⇒ [Date]	
⇒ [Time Label] ⇒ [Date and Time]	
⇒ [Time Label] ⇒ [Index]	
⇒ [Set Language] ⇒ [(data logging file name)] *1 ⇒ [Chinese Simplified]	
⇒ [Set Language] ⇒ [(data logging file name)] *1 ⇒ [Chinese Traditional]	
⇒ [Set Language] ⇒ [(data logging file name)] *1 ⇒ [English]	
⇒ [Set Language] ⇒ [(data logging file name)] *1 ⇒ [Japanese]	
⇒ [Set Language] ⇒ [(data logging file name)] *1 ⇒ [Korean]	
⇒ [Set Language] ⇒ [(data logging file name)] *1 ⇒ [Unicode (UTF-8)]	
⇒ [Switch Display Method] ⇒ [Based on Upper and Lower Bounds]	Page 174 Switching the graph display method
⇒ [Switch Display Method] ⇒ [Based on Division Value of Grids]	
⇒ [CALC Function] ⇒ [New]	Page 182 Displaying an operation result of the CALC function (CALC data) on a trend graph
⇒ [CALC Function] ⇒ [Delete]	
⇒ [CALC Function] ⇒ [Setting Confirmation]	
⇒ [Dump Display]	Page 215 Displaying a Graph as Data Values/statuses
⇒ [Graph Legends]	Page 102 Graph legend area
⇒ [Show All Graphs]	Page 164 Displaying/hiding graphs
⇒ [Hide All Graphs]	
⇒ [Change the Data to Draw Graphs]	Page 159 Changing the data to be displayed in the graph area
⇒ [Switch Data Name]	Page 201 Switching data names
⇒ [Displays Device Comment Column in Graph Legends]	Page 102 Graph legend area
⇒ [Displays Unit Column in Graph Legends]	
⇒ [Register Graphical Display Settings]	Page 211 Registering and Applying a Graphical Display Setting
⇒ [Operate Graphical Display Settings]	
⇒ [Recent Graphical Display Settings]	
⇒ [Set Graph View by the Auto Reflect Function]	Page 214 Applying the Graph Display Automatically When Opening a Window
⇒ [Initialize Graph View]	Page 218 Initializing the Graph Display
⇒ [Graph Properties]	Page 207 Changing Graph Appearance
*1 The data logging file name shown in the historical window is displayed.	
[Event]	Reference
⇒ [Filter]	Page 231 Displaying only events that meet specific conditions (Filtering)

[Event]	Reference
⇒ [Sort] ⇒ [Date]	Page 232 Sorting events (Sorting)
⇒ [Sort] ⇒ [No.]	
⇒ [Sort] ⇒ [Event Logging Name]	
⇒ [Sort] ⇒ [Status]	
⇒ [Sort] ⇒ [Comment]	
⇒ [Sort] ⇒ [Monitoring Data]	
⇒ [Set Language] ⇒ [(event logging file name)] *2⇒ [Chinese Simplified]	Page 233 Switching the display language of event logging names and comments
⇒ [Set Language] ⇒ [(event logging file name)] *2⇒ [Chinese Traditional]	
⇒ [Set Language] ⇒ [(event logging file name)] *2⇒ [English]	
⇒ [Set Language] ⇒ [(event logging file name)] *2⇒ [Japanese]	
⇒ [Set Language] ⇒ [(event logging file name)] *2⇒ [Korean]	
⇒ [Set Language] ⇒ [(event logging file name)] *2⇒ [Unicode (UTF-8)]	
⇒ [Show Previous Event]	Page 234 Displaying the previous or next event consecutively
⇒ [Show Next Event]	
⇒ [Event Properties]	Page 239 Changing Display Settings of Event List
*2 The event logging file name shown in the historical window is displayed.	
[Online]	Reference
⇒ [Open Logging File]	Page 110 Displaying logged devices and labels (Historical trend) Page 228 Displaying logged events (Historical event)
⇒ [Realtime Monitor]	Page 112 Displaying the current device status (Realtime trend) Page 113 Displaying the current statuses of devices and labels (Realtime monitor) Page 229 Displaying ongoing events (Realtime event)
⇒ [Recent Folders] ⇒ [(folder name)]	Page 246 Redisplaying Recently-Used Folders
⇒ [Save Logging File to PC]	Page 241 SAVING LOGGING FILE TO PERSONAL COMPUTER
⇒ [Begin Monitor]	Page 151 Operating monitoring status of the realtime trend/realtime monitor function
⇒ [End Monitor]	
⇒ [Pause Monitor]	
⇒ [Restart Monitor]	
⇒ [Clear Graph]	
[Tool]	Reference
⇒ [Start Logging Configuration Tool]	—
⇒ [Start MELSEC iQ-R Series High Speed Data Logger Module Configuration Tool]	Page 117 Realtime monitor setting (RCPU or RCPUs simulator) Page 139 Realtime monitor setting (FX5CPU or FX5CPU simulator) Page 143 Realtime monitor setting (LCPU)
⇒ [Start MELSEC iQ-R Series High Speed Data Communication Module Configuration Tool]	
⇒ [Start MELSEC-Q Series High Speed Data Logger Module Configuration Tool]	
⇒ [Start MELSEC-Q Series High Speed Data Communication Module Configuration Tool]	
⇒ [Start BOX Data Logger Configuration Tool]	
⇒ [Realtime Monitor Setting]	
⇒ [MotionSystem Logging]	—
⇒ [Logging File Conversion]	Page 309 SAVING FILES BY CONVERTING FILE FORMATS
⇒ [Recording File Conversion]	
⇒ [Option] ⇒ [Use an OpenGL and Draw Graphs]	Page 109 Displaying Trend Graph
[Window]	Reference
⇒ [Frequently-used Window Configuration] ⇒ [Add To Frequently-used Window Configuration]	Page 244 Adding/Restoring Frequently-Used Window Configuration to Menu
⇒ [Recent Windows] ⇒ [Historical Trend]	Page 246 Redisplaying Recently-Used Windows
⇒ [Recent Windows] ⇒ [Realtime Trend]	
⇒ [Recent Windows] ⇒ [Historical Event]	
⇒ [Recent Windows] ⇒ [Realtime Event]	
⇒ [Recent Windows] ⇒ [Realtime Monitor]	

[Window]	Reference
⇒ [Tile Vertically]	Page 68 Child Windows
⇒ [Tile Horizontally]	
⇒ [Cascade]	
⇒ [Close All Windows]	—
⇒ [(name of child window)]	Page 68 Child Windows
[Help]	Reference
⇒ [Open Manual]	Page 327 Opening Manual
⇒ [Connection to MITSUBISHI ELECTRIC FA Global Website]	Page 327 Connecting to MITSUBISHI ELECTRIC FA Global Website
⇒ [About GX LogViewer]	Page 327 Version Information

7 CONNECTING TO MODULE

To display or acquire logging data in a module, the module needs to be set as a connection target. This chapter explains the connection methods for each module.



7.1 Selecting a Connection Destination Device

Type	Target for explanation ( Page 13 Target modules, simulators, files, and data for explanation)
Module	RCPU, LHCPU, FX5CPU, QnUDVCPU, LCPU, R analog, Q analog, L analog, BOX, R logger, Q logger, R communication, Q communication, R motion module, R motion controller
Simulator	RCPU simulator, FX5CPU simulator, R motion module simulator

A device to be connected can be set in the "Connection Destination" screen.

Window

Select any of the following menus.

- Select [Online] ⇒ [Open Logging File] ().
- Select [Online] ⇒ [Save Logging File to PC] ().
- Select [Online] ⇒ [Realtime Monitor] ().

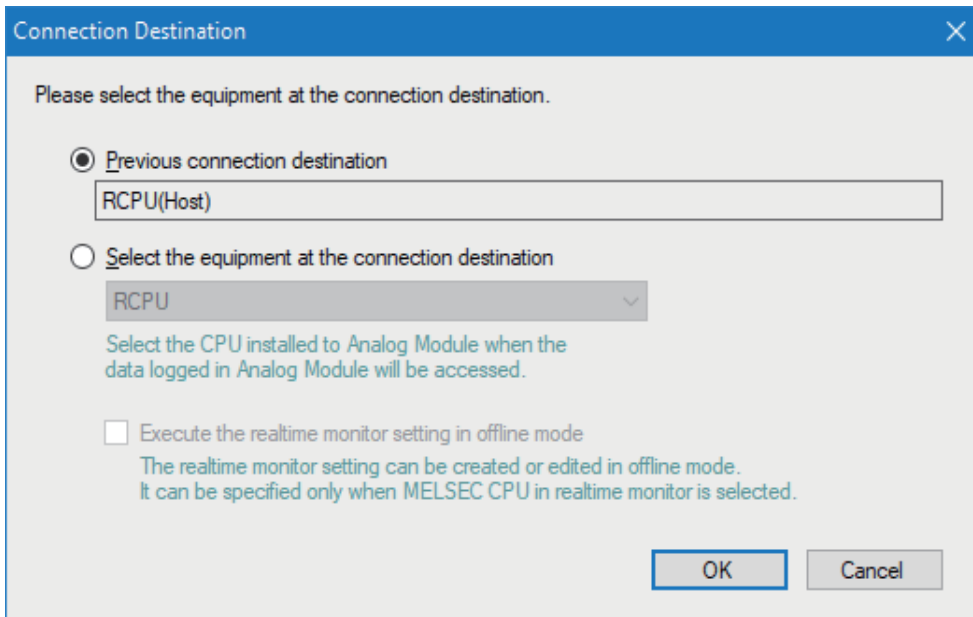

Options displayed in "Select the equipment at the connection destination" vary depending on a menu.

Operating procedure

Select a device to be connected, and click the [OK] button.

Connection destination and connection methods

For the methods for connecting to each connection destination device, refer to the following:

Connection destination device	Reference
RCPU	Page 77 Connecting to an RCPU
MELSEC iQ-R series high speed data logger module	Page 86 Connecting to a Data Logger or Data Communication
MELSEC iQ-R series high speed data communication module	
MELSEC iQ-R series motion module	Page 88 Connecting to a Motion Module
MELSEC iQ-R series motion controller	Page 90 Connecting to a Motion Controller
RCPU simulator	Page 92 Connecting to an RCPU Simulator or an FX5CPU Simulator
Motion module simulator	Page 94 Connecting to Motion Module Simulator
LHCPU	Page 79 Connecting to an LHCPU
FX5CPU	Page 81 Connecting to an FX5CPU
FX5CPU simulator	Page 92 Connecting to an RCPU Simulator or an FX5CPU Simulator
QCPU	Page 83 Connecting to a QCPU or an LCPU
MELSEC-Q series high speed data logger module	Page 86 Connecting to a Data Logger or Data Communication
MELSEC-Q series high speed data communication module	
LCPU	Page 83 Connecting to a QCPU or an LCPU
BOX data logger	Page 86 Connecting to a Data Logger or Data Communication

Point

● Access restriction when a connection destination is specified

When an access restriction has been set to a module by the remote password or access authentication, the connection target cannot be specified in GX LogViewer.

Clear the access restriction on the "Enter remote password" screen or "Access Authentication" screen.

- For details on the remote password, refer to the user's manual of a CPU module.
- For details on the access authentication, refer to the manual of a data logger or data communication.

7.2 Connecting to an RCPU

Type	Target for explanation ( Page 13 Target modules, simulators, files, and data for explanation)
Module	RCPU, R analog

When "RCPU" is selected in the "Connection Destination" screen, the "Transfer Setup" screen appears.

In the screen, a connection route to an RCPU in which a data logging file is saved needs to be specified to connect to the RCPU.

Transfer setup screen

Window

Select "RCPU" in the "Connection Destination" screen.

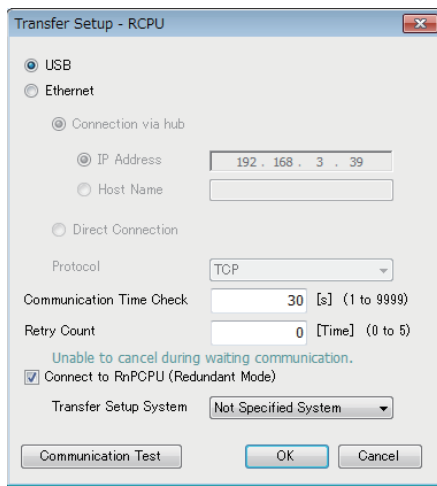

Method for connecting to an RCPU

The following connection methods are available for an RCPU.

 Page 77 Direct connection with a USB cable

 Page 78 Connection with an Ethernet cable

Direct connection with a USB cable

Operating procedure

1. Select "USB."
2. To connect to an RnPCPU (redundant mode), select "Connect to RnPCPU (Redundant Mode)," and specify a system for the connection target.
3. Click the [OK] button.

Connection with an Ethernet cable

■Direct connection

An IP address does not need to be specified for this connection.

Operating procedure

1. In the "Transfer Setup" screen, select "Ethernet" first, then select "Direct Connection."
2. To connect to an RnPCPU (redundant mode), select "Connect to RnPCPU (Redundant Mode)," and specify a system for the connection target.
3. Click the [OK] button.

■Connection via a hub

An IP address or host name needs to be specified.

Operating procedure

1. In the "Transfer Setup" screen, select "Ethernet" first, then select "Connection via hub."
2. Enter the IP address or host name of an RCPU to be connected.
3. To connect to an RnPCPU (redundant mode), select "Connect to RnPCPU (Redundant Mode)," and specify a system for the connection target.
4. Click the [OK] button.

7.3 Connecting to an LHCPU

Type	Target for explanation ( Page 13 Target modules, simulators, files, and data for explanation)
Module	LHCPU

When "LHCPU" is selected in the "Connection Destination" screen, the "Transfer Setup" screen appears.

In the screen, a connection route to an LHCPU in which a data logging file is saved needs to be specified to connect to the LHCPU.

Transfer setup screen

Window

Select "LHCPU" in the "Connection Destination" screen.

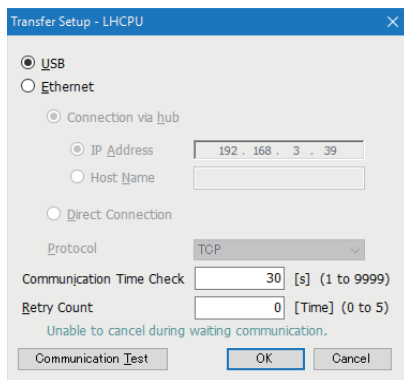

7

Method for connecting to an LHCPU

The following connection methods are available for an LHCPU.

 Page 79 Direct connection with a USB cable

 Page 80 Connection with an Ethernet cable

Direct connection with a USB cable

Operating procedure

1. Select "USB."
2. Click the [OK] button.

Connection with an Ethernet cable

■Direct connection

An IP address does not need to be specified for this connection.

Operating procedure

1. In the "Transfer Setup" screen, select "Ethernet" first, then select "Direct Connection."
2. Click the [OK] button.

■Connection via a hub

An IP address or host name needs to be specified.

Operating procedure

1. In the "Transfer Setup" screen, select "Ethernet" first, then select "Connection via hub."
2. Enter the IP address or host name of an LHCPU to be connected.
3. Click the [OK] button.

7.4 Connecting to an FX5CPU

Type	Target for explanation ( Page 13 Target modules, simulators, files, and data for explanation)
Module	FX5CPU

When "FX5CPU" is selected in the "Connection Destination" screen, the "Transfer Setup" screen appears. In the screen, a connection route to an FX5CPU that contains a memory card saving a data logging file needs to be specified to connect to the FX5CPU.

Transfer setup screen

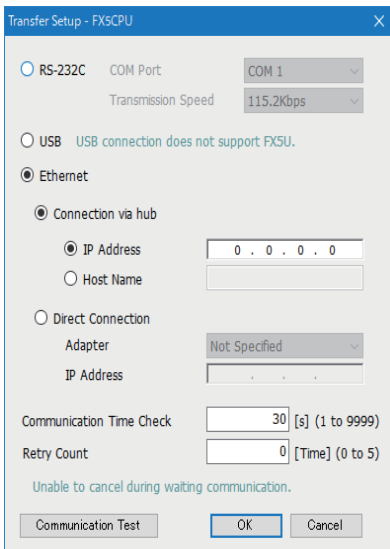

Window

Select "FX5CPU" in the "Connection Destination" screen.



Method for connecting to an FX5CPU

The following connection methods are available for an FX5CPU.

-  Page 81 Connection with a serial cable
-  Page 82 Direct connection with a USB cable
-  Page 82 Connection with an Ethernet cable

Connection with a serial cable

Operating procedure

1. In the "Transfer Setup" screen, select "RS-232C."
2. Select a COM port to be used.
3. Select a transmission rate.
4. Click the [OK] button.

Restriction

The realtime monitor function does not support RS-232C connection. To perform the realtime monitor function, select "USB" or "Ethernet."

Direct connection with a USB cable

Operating procedure

1. Select "USB."
2. Click the [OK] button.

Connection with an Ethernet cable

■Direct connection

An IP address does not need to be specified for this connection.

Operating procedure

1. In the "Transfer Setup" screen, select "Ethernet" first, then select "Direct Connection."
2. Select a network adapter, which is used on the personal computer side, for "Adapter."
3. Click the [OK] button.

■Connection via a hub

An IP address or host name needs to be specified.

Operating procedure

1. In the "Transfer Setup" screen, select "Ethernet" first, then select "Connection via hub."
2. Enter the IP address or host name of an FX5CPU to be connected.
3. Click the [OK] button.

7.5 Connecting to a QCPU or an LCPU

Type	Target for explanation ( Page 13 Target modules, simulators, files, and data for explanation)
Module	QnUDVCPU, LCPU, Q analog, L analog

When "QCPU" or "LCPU" is selected in the "Connection Destination" screen, the "Transfer Setup" screen appears. In the screen, a connection route to a QCPU or an LCPU that contains a memory card saving a data logging file needs to be specified to connect to the QCPU or LCPU.

Transfer setup screen

Window

Select "QCPU"/"LCPU" in the "Connection Destination" screen.

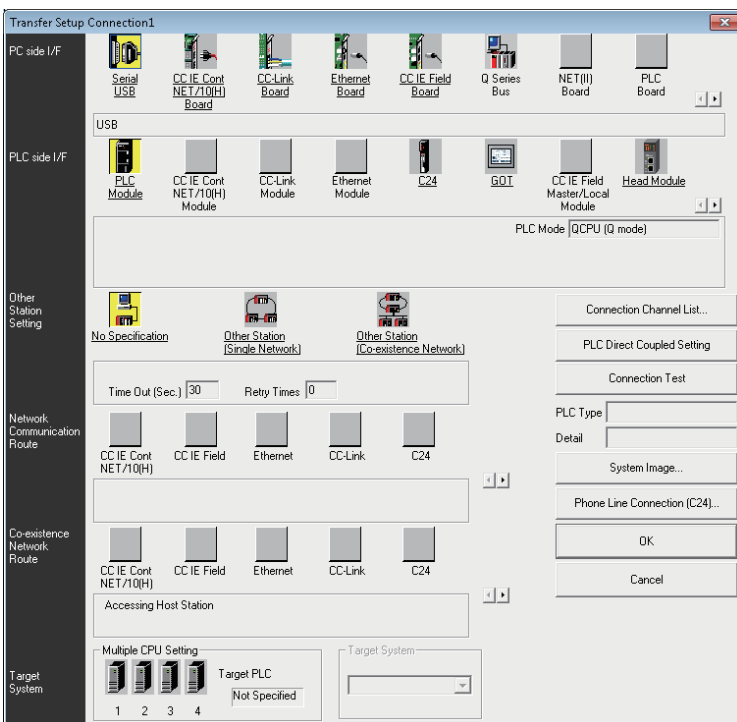

An item underlined on the "Transfer Setup" screen can be set the detail by double-clicking it. In addition, an item that has been set is highlighted in yellow.

Displayed items

Item	Description	
Other Station Setting	No Specification	Specify this to access to a QCPU or an LCPU directly connected to a personal computer.
	Other Station [Single Network]*1	Specify this to access to a QCPU or an LCPU on another station via only one kind of network (including a multi-tier system) such as CC-Link only, C24 module only, or Ethernet only.
	Other Station [Co-existence Network]*1	Specify this to connect a QCPU or an LCPU to a CPU module on another station via a CC-Link network or a serial communication module by connecting a personal computer to the QCPU or LCPU.
Network Communication Route	Select a network type, network No., station No., and start I/O No. of a network routed in order to access to a programmable controller CPU on another station. The setting items differ depending on the selected network type.	
[Connection Channel List] button	A communication route can be selected with checking the route image displayed on the screen. Set a network No., station No., and other settings depending on the access target.	

*1 When the host station is specified, select "No Specification."

Method for connecting to a QCPU or an LCPU

The following connection methods are available for a QCPU or an LCPU.

- ☞ Page 84 Direct connection with a USB or an Ethernet cable
- ☞ Page 84 Connection via a network

Direct connection with a USB or an Ethernet cable

Direct connection can be set by selecting "USB" or "Ethernet" on the "Transfer Setup" screen.

Operating procedure

1. Click the [PLC Direct Coupled Setting] button on the "Transfer Setup" screen.
2. Select "USB" or "Ethernet," and click the [Yes] button.
3. Click the [OK] button in the "Transfer Setup" screen.

Connection via a network

Connection via a network can be set on the "Transfer Setup" screen.

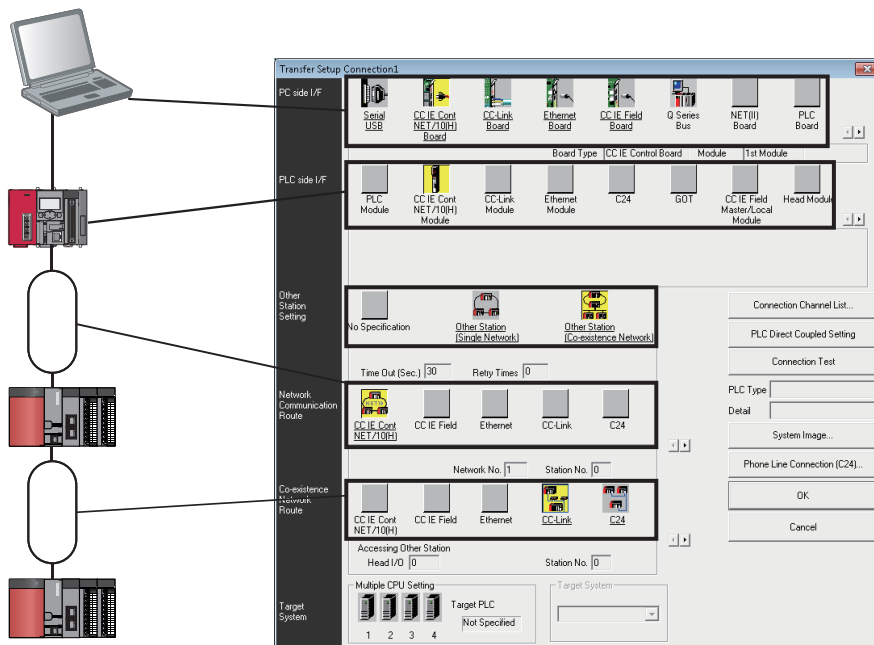

Operating procedure

1. Specify a connection interface of a personal computer, to which GX LogViewer has been installed, for "PC side I/F" on the "Transfer Setup" screen.
2. Specify a connection interface of a programmable controller CPU for "PLC side I/F."
When connecting to a built-in Ethernet port CPU, a QCPU or an LCPU on the network can be searched and specified.
(☞ Page 85 Searching and specifying a built-in Ethernet port CPU module on a network)
3. Specify the presence of other stations for "Other Station Setting."
4. For "Network Communication Route" or "Co-existence Network Route," select a network type, network No., station No., and start I/O No. of a network routed in order to access to a programmable controller CPU on another station, and click the [OK] button.

■ Searching and specifying a built-in Ethernet port CPU module on a network

A built-in Ethernet port CPU on a network can be searched to connect on the "PLC side I/F Detailed Setting of PLC Module" screen.

Operating procedure

1. Select "Ethernet board" for "PC side I/F" on the "Transfer Setup" screen, and double-click "CPU module" for "PLC side I/F."
2. Select a CPU mode (LCPU or QCPU (Q mode)) to be connected to a personal computer for "PLC Mode."
3. Select "Connection via hub," and click the [Find CPU (Built-in Ethernet port) on Network] button.
4. Select a target CPU module from the connection destination CPU information list, and click the [Selection IP Address Input] button.
5. Click the [OK] button.

Precautions

A warning message may appear when clicking the [Find CPU (Built-in Ethernet port) on Network] button. Click the [Allow access] button to continue the operation.

■ Setting example (for CC-Link system)

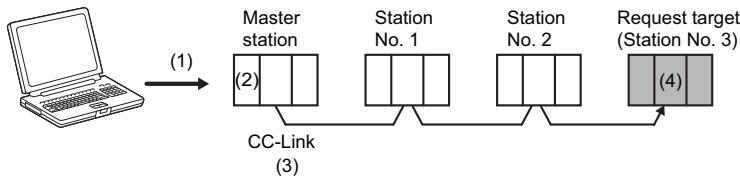

(1) **PLC side I/F Serial Setting**
 Selection: RS-232C
 COM Port: COM 1
 Transmission Speed: 115.2Kbps

(2) **PLC side I/F Detailed Setting of PLC Module**
 PLC Mode: QCPU (Q mode)

(3) **Other Station Detailed Setting**
 Check at Communication Time: 30 sec
 Retry Times: 0 Times

(4) **Network Communication Route Detailed Setting of CC-Link**
 Head I/O: 31
 Station No.: 0

Precautions

When a CPU module is connected directly or via a serial communication module, the station No. in order to access to a programmable controller CPU on another station via CC-Link is from 0 (master) to 63.

7.6 Connecting to a Data Logger or Data Communication

Type	Target for explanation ( Page 13 Target modules, simulators, files, and data for explanation)
Module	BOX, R logger, Q logger, R communication, Q communication

When a data logger or data communication is selected in the "Connection Destination" screen, the "Transfer Setup" screen appears.

In the screen, a device to be connected and its route need to be specified to connect to the device.

Transfer setup screen

Window

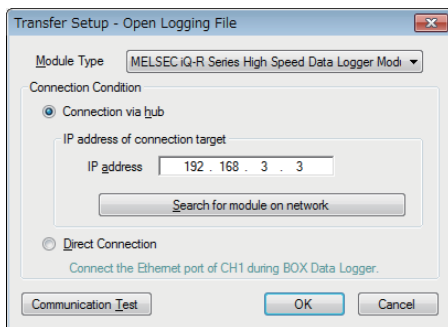

Select any of the following modules in the "Connection Destination" screen.

- MELSEC iQ-R Series High Speed Data Logger Module
- MELSEC iQ-R Series High Speed Data Communication Module
- MELSEC-Q Series High Speed Data Logger Module
- MELSEC-Q Series High Speed Data Communication Module
- BOX Data Logger



Method for connecting to a data logger or data communication

The following connection methods are available for a data logger or data communication.

-  Page 87 Connection via a hub
-  Page 87 Direct connection

Connection via a hub

A data logger or data communication can be connected via a hub.

When an IP address has been set to a data logger or data communication, the module can be specified by either one of the following methods.

■ Entering and specifying the IP address of a data logger or data communication to be connected directly

Operating procedure

1. Select "Connection via hub" on the "Transfer Setup" screen.
2. Enter the IP address of a data logger or data communication to be connected, and click the [OK] button.

Precautions

Communication with a data logger and data communication cannot be established when logging on to the operating system of a personal computer with the Guest account.

■ Searching and specifying a data logger or data communication on a network

Operating procedure

1. Click the [Search for module on network] button in the "Transfer Setup" screen.
The information list of a data logger or data communication appears.
2. Select a data logger or data communication to be connected from the list, and click the [OK] button.
3. Click the [OK] button in the "Transfer Setup" screen.

Direct connection

A data logger or data communication can directly be connected to an Ethernet port of a personal computer with a crossover cable.

An IP address does not need to be specified for this connection.

A straight cable can be used for a BOX data logger.

Operating procedure

Select "Direct Connection" in the "Transfer Setup" screen, and click the [OK] button.

7.7 Connecting to a Motion Module

Type	Target for explanation ( Page 13 Target modules, simulators, files, and data for explanation)
Module	R motion module

When "MELSEC iQ-R Series Motion Module RD78G(H)" is selected in the "Connection Destination" screen, the "Transfer Setup" screen appears.

In the screen, a connection route to a motion module in which a data logging file is saved needs to be specified to connect to the motion module via an RCP.

Transfer setup screen

Window

Select "MELSEC iQ-R Series Motion Module RD78G(H)" in the "Connection Destination" screen.

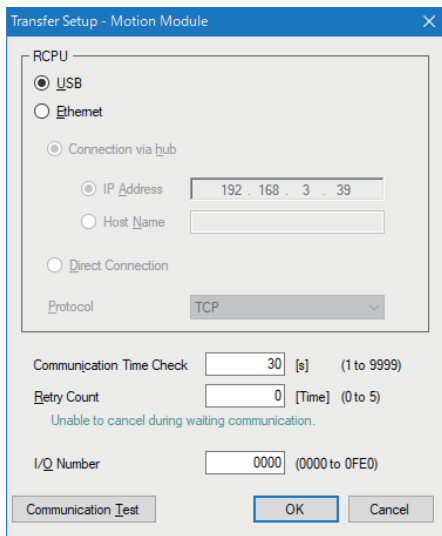

Method for connecting to a motion module

The following connection methods are available for a motion module.

☞ Page 89 Direct connection with a USB cable

☞ Page 89 Connection with an Ethernet cable

Point

Each cable needs to be connected to an RCPU since a personal computer is connected to a motion module via the RCPU.

For details, refer to the following:

☞ Page 37 Displaying data logged by a motion module

Direct connection with a USB cable

Operating procedure

1. In the "Transfer Setup" screen, select "USB."
2. Enter the I/O number of the motion module to be connected.
3. Click the [OK] button.

Connection with an Ethernet cable

■Direct connection

An IP address does not need to be specified for this connection.

Operating procedure

1. In the "Transfer Setup" screen, select "Ethernet" first, then select "Direct Connection."
2. Enter the I/O number of the motion module to be connected.
3. Click the [OK] button.

■Connection via a hub

An IP address or host name needs to be specified.

Operating procedure

1. In the "Transfer Setup" screen, select "Ethernet" first, then select "Connection via hub."
2. Enter the IP address or host name of an RCPU to be connected.
3. Enter the I/O number of the motion module to be connected.
4. Click the [OK] button.

7.8 Connecting to a Motion Controller

Type	Target for explanation ( Page 13 Target modules, simulators, files, and data for explanation)
Module	R motion controller

When "MELSEC iQ-R Series Motion Controller" is selected in the "Connection Destination" screen, the "Transfer Setup" screen appears.

In the screen, a connection route to a motion controller in which a data logging file is saved needs to be specified to connect to the motion controller via an RCPU.

A personal computer can also be connected to a motion controller without using an RCPU.

Transfer setup screen

Window

Select "MELSEC iQ-R Series Motion Controller" in the "Connection Destination" screen.

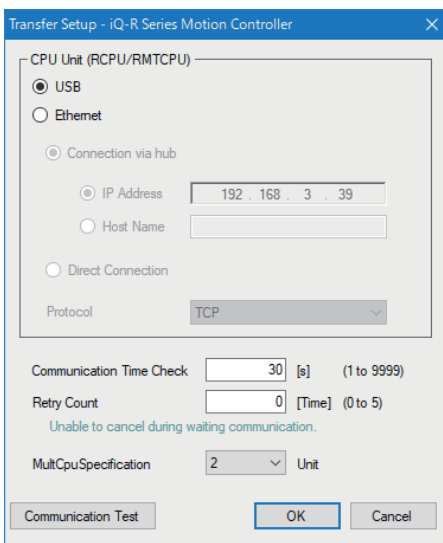

Method for connecting to a motion controller

The following connection methods are available for a motion controller.

☞ Page 91 Direct connection with a USB cable (via an RCPU)

☞ Page 91 Connection with an Ethernet cable

Point

- When starting GX LogViewer from MT Developer2, the information set in MT Developer2 can be applied. In this case, the connection destination information is input automatically.
For details, refer to Help for MT Developer2.
- Each cable needs to be connected to an RCPU to connect a personal computer to a motion controller via an RCPU.
For details, refer to the following:
☞ Page 38 Displaying data logged by a motion controller

Direct connection with a USB cable (via an RCPU)

Operating procedure

1. In the "Transfer Setup" screen, select "USB."
2. Enter the CPU No. in a multiple CPU system of a motion controller to be connected.
3. Click the [OK] button.

Connection with an Ethernet cable

■Direct connection

An IP address does not need to be specified for this connection.

Operating procedure

1. In the "Transfer Setup" screen, select "Ethernet" first, then select "Direct Connection."
2. Enter the CPU No. in a multiple CPU system of a motion controller to be connected.
3. Click the [OK] button.

■Connection via a hub

An IP address or host name needs to be specified.

Operating procedure

1. In the "Transfer Setup" screen, select "Ethernet" first, then select "Connection via hub."
2. Enter the IP address or host name of an RCPU to be connected.
When not using an RCPU, enter the IP address or host name of an RnMTCPU to be connected.
3. Enter the CPU No. in a multiple CPU system of a motion controller to be connected.
4. Click the [OK] button.

7.9 Connecting to an RCPU Simulator or an FX5CPU Simulator

Type	Target for explanation ( Page 13 Target modules, simulators, files, and data for explanation)
Simulator	RCPU simulator, FX5CPU simulator

When "RCPU Simulator (GX Simulator3)" or "FX5CPU Simulator (GX Simulator3)" is selected in the "Connection Destination" screen, the "Transfer Setup" screen appears.

In the screen, a simulator needs to be specified to be connected.

Transfer setup screen

Window

Select "RCPU Simulator (GX Simulator3)" or "FX5CPU Simulator (GX Simulator3)" in the "Connection Destination" screen.

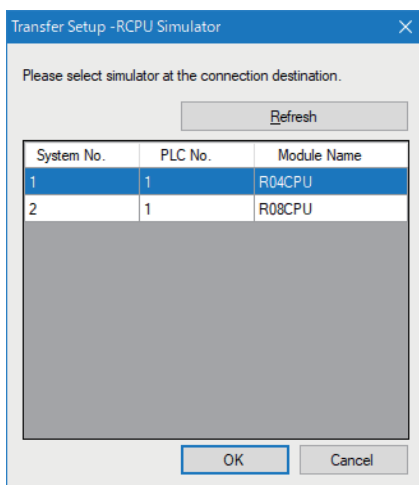

- To monitor data of CPU modules being simulated by GX Simulator3 in GX LogViewer, GX Works3 the software version of which is 1.050C or later must be installed.
- CPU modules being simulated by GX Simulator3 are listed in the "Transfer Setup" screen. When starting or ending simulation after the "Transfer Setup" screen appears, click the [Refresh] button to update the list.
- All CPU modules being simulated by GX Simulator3 are listed in the "Transfer Setup" screen; therefore, CPU modules that are not compatible with the realtime monitor function may also be included in the list. In that case, select a CPU module that support the realtime monitor function.
- When connecting to an RCPU simulator or FX5CPU simulator by selecting "Previous connection destination" in the "Connection Destination" screen, the simulator the following information of which matches the previously-connected simulator is connected.
 - Connection destination (RCPU simulator or FX5CPU simulator)
 - System No.
 - PLC No.

When the above information of both the simulator that is connected by selecting "Previous connection destination" and the simulator that was connected last time matches, the simulators are recognized as the same, even though they are different.

In that case, a different program may be simulated from the program simulated last time.

- GX Simulator3 does not support some functions of a CPU module.

For the functions that are supported by GX Simulator3, refer to the following:

 GX Works3 Operating Manual

7.10 Connecting to Motion Module Simulator

Type	Target for explanation ( Page 13 Target modules, simulators, files, and data for explanation)
Simulator	R motion module simulator

The motion module simulator can be connected by only GX LogViewer that is activated from the GX Works3 motion control setting function.

For the connection methods, refer to the manual of the motion control setting function. The method for referring to the manual is shown as below:

Referring to the motion control setting function manual

Operating procedure

1. Start the motion control setting function from GX Works3.*1
2. Select [Help] ⇒ [Motion Control Setting Function Help] in the "Motion Control Setting Function" screen. e-Manual Viewer starts and the manual appears.

*1 For the method for starting the motion control setting function, refer to the following:
 GX Works3 Operating Manual

Point

To monitor data of a motion module being simulated by MU Simulator in GX LogViewer, GX Works3 the software version of which is 1.065T or later must be installed.

8 USING TREND GRAPH FUNCTION

Type	Target for explanation ( Page 13 Target modules, simulators, files, and data for explanation)
Module	RCPU, LHCPU, FX5CPU, QnUDVCP, LCP, R analog, Q analog, L analog, BOX, R logger, Q logger, R communication, Q communication, R motion module, R motion controller
Simulator	RCPU simulator, FX5CPU simulator, R motion module simulator
Others	Offline monitor, others

8.1 Overview

This function displays data sampled by the data collection function of a module, a GX LogViewer format CSV file, and a GX LogViewer format JSON file in a graph format.

The following three types of trend graph functions can be used.

- Historical trend
- Realtime trend
- Realtime monitor

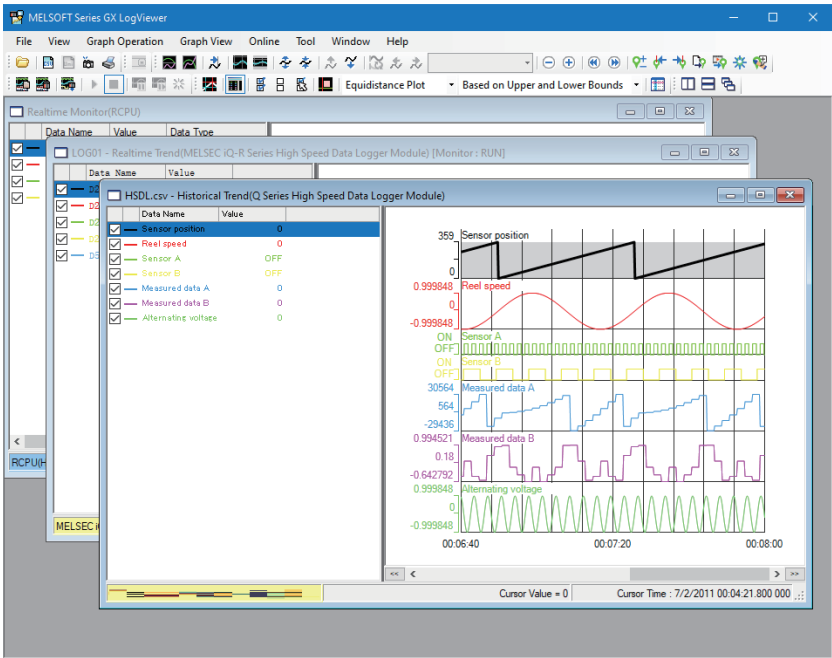

Modules and file supporting the trend graph functions are shown below.

○: Supported, ×: Not supported

Series	Module/file	Historical trend	Realtime trend	Realtime monitor
MELSEC iQ-R series	RCPUCPU	○ ^{*1}	×	○ ^{*2}
	High speed data logger module	○	○	×
	High speed data communication module	×	○	×
	Analog module	○	×	×
	Motion module	○	×	○
	Motion controller	○	×	×
	RCPUCPU simulator	×	×	○ ^{*2}
	Motion module simulator	○	×	○
MELSEC iQ-L series	LHCPU	○	×	○
MELSEC iQ-F series	FX5CPU	○	×	○
	FX5CPU simulator	×	×	○
MELSEC-Q series	QnUDVCPUCPU	○	×	×
	High speed data logger module	○	○	×
	High speed data communication module	×	○	×
	Analog module	○	×	×
MELSEC-L series	LCPU	○	×	○
	Analog module	○	×	×
Others	BOX data logger	○	○	×
	Data being displayed by the GX Works3 offline monitor function	○	×	×
	CSV file in GX LogViewer format	○	×	×
	JSON file in GX LogViewer format	○	×	×

*1 R00CPU does not support the historical trend function.

*2 RnPCPUs do not support the realtime monitor function.

Historical trend

Type	Target for explanation ( Page 13 Target modules, simulators, files, and data for explanation)
Module	RCPU, LHCPU, FX5CPU, QnUDVCP, LCP, R analog, Q analog, L analog, BOX, R logger, Q logger, R motion module, R motion controller
Simulator	R motion module simulator
Others	Offline monitor, others

The following data is displayed:

- Data logging file in the data memory
- Data logging file in a memory card inserted in a CPU module
- Data logging file in a personal computer
- CSV file in GX LogViewer format
- JSON file in GX LogViewer format

Saved past data can be checked anytime.

RCPU and LHCPUs support access to data logging files saved in the data memory.

Note that R00CPU does not support the historical trend function.

For the operation to display the data, refer to the following:

Data type	Reference
Data sampled by the data logging function of a CPU module, analog module, or motion module	Page 110 Displaying a data logging file saved by the data logging function of a CPU module, analog module, or motion module
Data sampled by the servo system recorder function of a motion controller	Page 110 Displaying a data logging file saved by the servo system recorder function of a motion controller
Data sampled by a data logger	Page 111 Displaying a data logging file saved by the data logging function of a data logger
Data saved in a personal computer or inserted memory card	Page 111 Displaying a data logging file saved in a personal computer

Realtime trend

Type	Target for explanation ( Page 13 Target modules, simulators, files, and data for explanation)
Module	BOX, R logger, Q logger, R communication, Q communication

The realtime trend function displays the latest data sampled by a data logger or data communication.

Data is constantly updated so that the data history from the start of monitoring to the present time can be checked.

To display the realtime trend graph, a personal computer and a module need to be connected to each other online.

For the operation to display the data, refer to the following:

 Page 112 Displaying the current device status (Realtime trend)

Realtime monitor

The realtime monitor function displays the latest data sampled by each module.

Type	Target for explanation ( Page 13 Target modules, simulators, files, and data for explanation)
Module	RCPUCPU, LHCPU, FX5CPU, LCPU, R communication, Q communication, R motion module
Simulator	RCPUCPU simulator, FX5CPU simulator, R motion module simulator

Data is constantly updated so that the data history from the start of monitoring to the present time can be checked.

To display the realtime monitor graph, a personal computer and a module need to be connected to each other online.

RnPCPUs do not support the realtime monitor function.

For the operation to display the data, refer to the following:

 Page 113 Displaying the current statuses of devices and labels (Realtime monitor)

Files that can be displayed

The following table shows the files that can be displayed in GX LogViewer.

○: Supported, —: N/A

File type		.csv	.txt[Unicode]	.bin	.json	.melrc
Data logging file of an RCPUCPU		○ ^{*1*2}	○ ^{*1}	○ ^{*1}	—	—
Data logging file of a MELSEC iQ-R series high speed data logger module		○	○	○	—	—
Data logging file of a MELSEC iQ-R series analog module		○	—	—	—	—
Data logging file of a MELSEC iQ-R series motion module		○	—	—	○	—
Data logging file of a MELSEC iQ-R series motion controller		○	—	—	—	—
Data logging file of an LHCPU		—	○	○	—	—
Data logging file of an FX5CPU		○	—	○	—	—
Data logging file of a QnUDVCPU		○	—	—	—	—
Data logging file of a MELSEC-Q series high speed data logger module		○	—	○	—	—
Data logging file of a MELSEC-Q series analog module		○	—	—	—	—
Data logging file of an LCPU		○	—	—	—	—
Data logging file of a MELSEC-L series analog module		○	—	—	—	—
Data logging file of a BOX data logger		○	—	○	—	—
Recording file ^{*3}		—	—	—	—	○
CSV file in GX LogViewer format	Data saved with a logging module for energy measuring module	○	—	—	—	—
	Sampling trace data (GX Works2)	○	—	—	—	—
	Simulation result and sampling data saved with MELSEC iQ-R series Flexible High-Speed I/O Control Module Configuration Tool	○	—	—	—	—
	Simulation result and sampling data saved with MELSEC-L series Flexible High-Speed I/O Control Module Configuration Tool	○	—	—	—	—
	Data saved with a CC-Link IE TSN FPGA module	○	—	—	—	—
JSON file in GX LogViewer format		—	—	—	○	—

- *1 · If data is output to a file includes a comma (,), the entire data which includes a comma in the file is enclosed with double quotes (""). (Example: 123,456 → "123,456")
 - If data output to a file includes a double quote ("), the double quote is doubled. In addition, the entire data which includes a double quote is enclosed with double quotes. (Example: 123"456 → "123""456")
- *2 · If data output to a file includes a character that cannot be converted to ASCII in the following row and columns, the character is replaced with a period (.) in the file: the comment row, the execution program name column in the data row, and the data columns in the data name row, the program name row, and the device comment row.
 - If data output to a file includes a character that cannot be converted to ASCII in the following columns, the character is replaced with an asterisk (*) in the file: the trigger information columns in the data type information row and the data row.
- *3 The file cannot be opened directly in GX LogViewer. It can be opened only by the following operations:
 - Selecting a recording file when starting the GX Works3 offline monitor function and displaying the waveform in GX LogViewer
 - Adding a recording file by selecting [Graph View] ⇒ [Change the Data to Draw Graphs] () when displaying recording file data in GX LogViewer according to the operation stated above

Point

The file formats that can be displayed and the viewing formats of data acquired from modules or tools other than GX LogViewer may differ from data saved in GX LogViewer even when the data is sampled by the same modules or tools.

For the details on the file saved with GX LogViewer, refer to the following:

 Page 247 SAVING DISPLAYED DATA/EVENTS

8.2 Screen Configuration

This section explains the screen configuration of the trend window.

Trend window

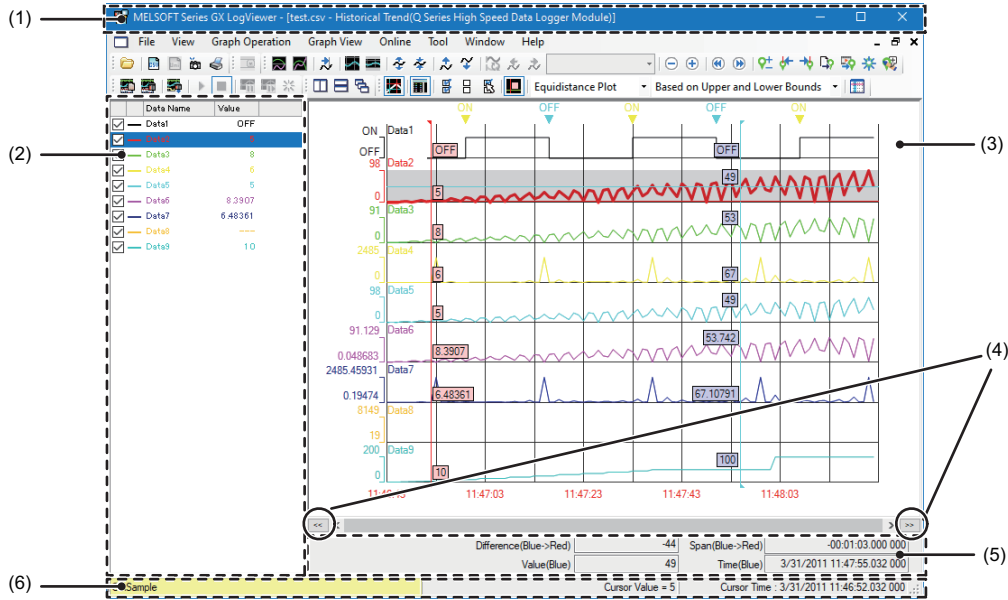

When linking with the GX Works3 offline monitor function, the following screen that contains the map area ((7) to (13) in the figure below) is displayed:

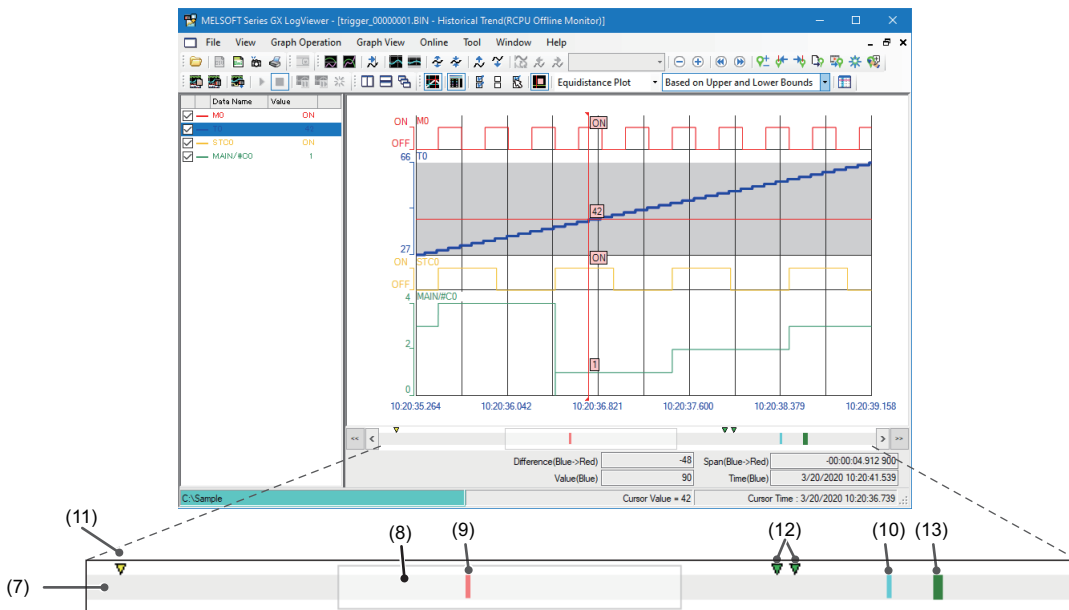

Displayed items

Item	Description		Reference
(1) Title bar	Historical trend	Displays the name of a file, function, and module etc.	—
	Realtime trend	Displays the monitor status and the name of a data logging setting, a function, and a module.	
	Realtime monitor	Displays the monitor status and the name of a function and a module.	
(2) Graph legend area	<ul style="list-style-type: none"> Displays the list of data names and their values that can be displayed in the graph area. (Up to 32 legends) In the realtime monitor window, "Device/Label" is displayed as one of the display items instead of "Data Name." 		Page 102 Graph legend area
(3) Graph area	Displays data selected in the graph legend area.		Page 103 Trend window
(4) [<<] button	Displays the previous (old) graph.		Page 195 Displaying the previous graph
(4) [>>] button	Displays the next (new) graph.		Page 197 Displaying the next graph
(5) Difference information area	Displays the difference information between two cursors while displaying multiple cursors.		Page 105 Difference information area
(6) Status bar	Displays the basic status of the selected data.		Page 106 Status bar
(7) Map area	—	Indicates the whole range of logging file data that is displayed in the graph area. Map area displays the position of the following items which are displayed in the graph area: red cursor, blue cursor, trigger mark, log markers, and values displayed in "Search Results" of the cursor jump function.	—
	(8) Map bar	Indicates the range of data displayed in the graph area. By dragging the map bar horizontally, the data range displayed in the graph area is scrolled.	
	(9) Red cursor	Displays the position of the red cursor displayed in the graph area. The cursor synchronizes and links with the slider in the seek bar of GX Works3. For details on the seek bar and slider of GX Works3, refer to the following:  GX Works3 Operating Manual	
	(10) Blue cursor	Displays the position of the blue cursor displayed in the graph area.	
	(11) Trigger mark	Displays the position of the trigger mark displayed in the graph area.	
	(12) Log marker	Displays the position of the log marker.	
	(13) Search result list	Displays the position of values displayed in the "Search Results" of the cursor jump function.	
			Page 154 Adding a log marker to data
			Page 168 Jumping cursor by searching value

Graph legend area

Ex.

Displaying a data logging file of an RCPU that has values both in the data name and device comment rows

- When device comments and units are hidden

	Data Name	Value
<input type="checkbox"/>	— LTO	ON
<input checked="" type="checkbox"/>	— Unwinder speed	200
<input checked="" type="checkbox"/>	— Winder speed	94
<input type="checkbox"/>	— Sensor position	523
<input checked="" type="checkbox"/>	— LT5	ON
<input checked="" type="checkbox"/>	— Processing	OFF

Data value/status at the cursor displayed as a standard (vertical red cursor line)

- When device comments are displayed

	Data Name	Device Comment	Value
<input type="checkbox"/>	— LTO		ON
<input checked="" type="checkbox"/>	— LT1	Unwinder speed	200
<input checked="" type="checkbox"/>	— LT2	Winder speed	94
<input type="checkbox"/>	— LT3	Sensor position	523
<input checked="" type="checkbox"/>	— LT5		ON
<input checked="" type="checkbox"/>	— LT7	Processing	OFF

Ex.

Displaying a motion module data logging file to which units are output

- When units are displayed

	Data Name	Value	Unit
<input checked="" type="checkbox"/>	— Axis01_Md.AxisStatus	6	
<input checked="" type="checkbox"/>	— Axis01_Md.CumulativePosition	-2.307E+006	mm
<input checked="" type="checkbox"/>	— Axis01_Md.CommandedVelocity	5000	mm/ms
<input checked="" type="checkbox"/>	— Axis01_Md.CommandedAcceleration	3000	mm/ms ²
<input checked="" type="checkbox"/>	— Axis01_Md.CommandedAcceleration	3000	mm/ms ²
<input checked="" type="checkbox"/>	— Axis01_Md.SetPosition	-2.307E+006	mm

Description	Operating procedure
Changing data displayed in the list	Select [Graph View] ⇒ [Change the Data to Draw Graphs] (). ☞ Page 159 Changing the data to be displayed in the graph area
Switching data names of the data displayed in the list to other names ^{*1}	Select [Graph View] ⇒ [Switch Data Name]. ☞ Page 201 Switching data names
Displaying or hiding the graph legend area	Select [Graph View] ⇒ [Graph Legends] ().
Changing the font size	Select [Graph Operation] ⇒ [Adjust Font Size of Graph Legends] ⇒ [Expansion Font Size]/[Reduction Font Size].
Displaying/hiding device comments ^{*1*2*3}	Select [Graph View] ⇒ [Displays Device Comment Column in Graph Legends].
Displaying/Hiding units	Select [Graph View] ⇒ [Displays Unit Column in Graph Legends].

*1 Data names cannot be switched to other names when device comments are displayed.

*2 For a data logging file of an RCPU or LHCPU that has values both in the data name and device comment rows, content displayed in the data name column in the graph legend area is as follows:

- When device comments are displayed, data names are displayed.
- When device comments are hidden, device comments are displayed.

*3 When a device comment contains a line feed, the line feed will be replaced with a space.

Graph area

Trend window

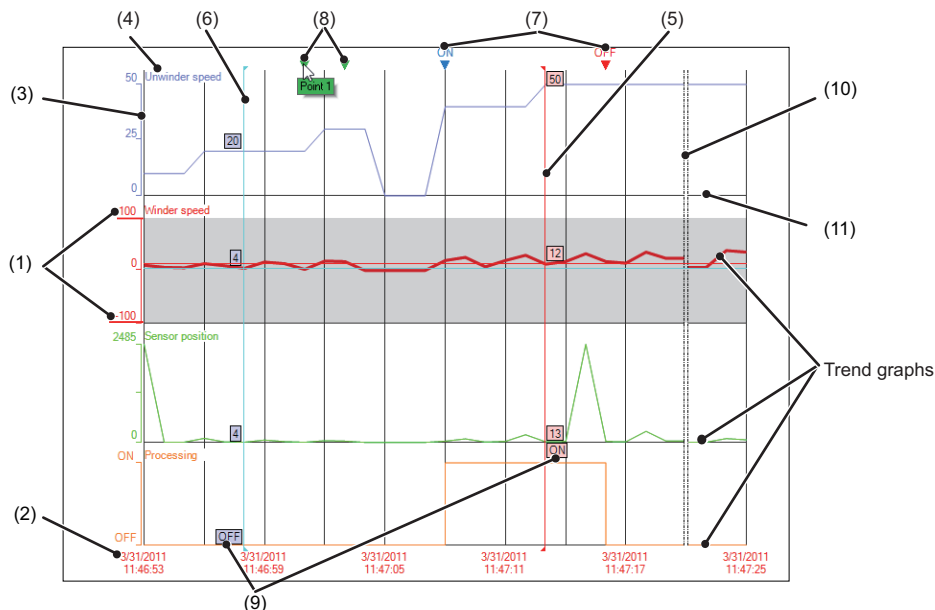



Displayed items

Item	Description	Reference
(1) Upper/lower bounds	A maximum value/minimum value in the display area of each trend graph is displayed. When scaling, the upper bound, lower bound, and intermediate value are underlined. When "Based on Division Value of Grids" is selected for the graph display method, a division value of grids in the display area of each trend graph is also displayed.	Page 175 Specifying the upper and lower bounds/Y axis scale Page 179 Specifying a division value of grids
(2) Time-scale label ^{1*2*3} (X axis label)	The time scale is displayed. • Time ⁴ /Date ⁴ /Date and Time ⁴ /Index Since an analog module does not have time information in the logging data, only the index display is available.	Page 206 Changing a display of time-scale label
(3) Y axis	The following scales are indicated. • Single line: linearity • Double line: logarithm	—
(4) Data name	A name of data being displayed on a graph is displayed. The name will be the same as that in the data name column in the graph legend area. (☞ Page 102 Graph legend area) • A file name is also displayed when displaying data on a graph in the time interval plot display format. (☞ Page 205 Changing graph plot formats) • When displaying a data logging file to which units are output on a graph, each unit is displayed at the start of data name.	—
(5) Red cursor	A cursor that is displayed as standard. (Displayed at the left edge of the graph area every time the window is opened.)	Page 152 Checking and comparing data values/statuses
(6) Blue cursor	A cursor that is displayed for comparison. It is displayed only when the Multiple cursor function is activated. (Displayed at the left edge of the graph area every time the window is opened.)	—
(7) Trigger mark	A mark to indicate the point where a trigger condition (ON/OFF) is satisfied.	Page 208 Changing color and type of graph
(8) Log marker	A point where a log marker is added. A comment that links to a log marker is displayed by placing the mouse cursor on the log marker. In addition, the color of a log marker can be changed.	Page 154 Adding a log marker to data
(9) Cursor label	The value at the point of intersection between the cursor and a graph is displayed.	Page 200 Displaying cursor labels
(10) Data missing line	Lines to separate the area where data could not be sampled from the other area.	Page 219 Graph Display for Missing Data or Time Reversed Data
(11) Grid	A vertical line and horizontal line to divide the graph drawing area.	Page 205 Displaying grid

- *1 For a data logging file in which any of "year," "month," "day," "hour," "minute," or "second" of the data line output format (that can be set with a configuration tool) is missing, only the index display is available.
- *2 For a realtime trend window or a realtime monitor window, the displayed date and time depend on the time setting for CPU module. Therefore, it may be different from the time on the personal computer in use.
- *3 When the data of an RCP or FX5CPU being simulated by GX Simulator3, or data of a motion module being simulated by MU Simulator is displayed, the simulation time is displayed on a time-scale label. Therefore, the time of the module being simulated may be different from the time displayed on a time-scale label. For details on the simulation time, refer to the following manual.
 GX Works3 Operating Manual
- *4 *(asterisk) is displayed when the date information does not exist, or when the date information does not contain "year, month, and day" information.

Point 

- The background color, color and type of graph line, trigger mark color, and grid color can be changed. ( Page 207 Changing Graph Appearance)
 - The data names displayed in the graph area can be switched to arbitrary character strings. ( Page 201 Switching data names)
 - Up to 32 trend graphs can be displayed in the graph area.
 - For a realtime monitor window, it is up to 31.
-

Difference information area

The following display methods are available for the difference information area.

- Time display
- Index display

<For time display>

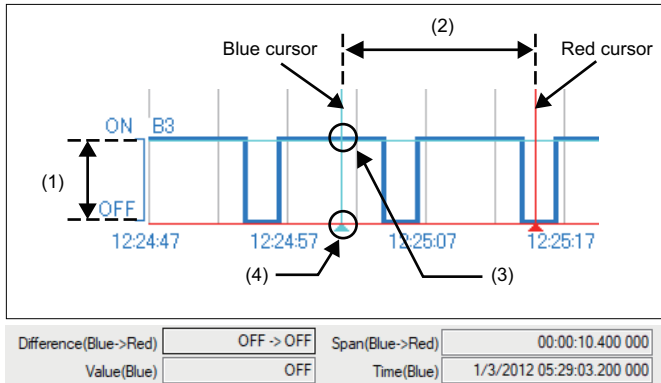

<For index display>

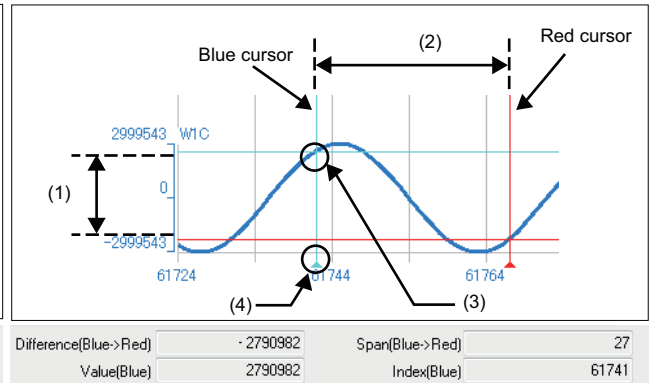

Since an analog module does not have time information in the logging data, only the index display is available.

Displayed items

Item	Description
(1) Difference (Blue → Red)	Displays difference information of a value. <ul style="list-style-type: none"> • When a graph is bit data (ON → OFF, OFF → ON, ON → ON, OFF → OFF) • When a graph is word data (Value at the red cursor — Value at the blue cursor)
(2) Span (Blue → Red)	Displays difference information of time or index. (time or index at the red cursor — time or index at the blue cursor) ■ Display example for time display <ul style="list-style-type: none"> • When the span is 01:23:45.123456000 (the digit of 100 nanosecond does not exist or is 0) 01:23:45.123 456 • When the span is 01:23:45.123456789 (the digit of 100 nanosecond is not 0) 01:23:45.123 456 7⁴
(3) Value (Blue)	Displays the value at the point of intersection between the blue cursor and a selected trend graph.
(4) Time (Blue) ^{*1,2} / Index (Blue) ^{*1}	Displays time and index at the blue cursor. ■ Display example of "Time (Blue)" ^{*3} <ul style="list-style-type: none"> • When the time is 1/1/2018 01:23:45.123456000 (the digit of 100 nanosecond does not exist or is 0) 1/1/2018 01:23:45.123 456 • When the time is 1/1/2018 01:23:45.123456789 (the digit of 100 nanosecond is not 0) 1/1/2018 01:23:45.123 456 7⁴

*1 *(asterisk) is displayed when the date information does not exist, or when the date information does not contain "year, month, and day" information.

*2 When the data of an RCPUCPU or FX5CPU being simulated by GX Simulator3, or data of a motion module being simulated by MU Simulator is displayed, the simulation time is displayed for "Time(Blue)."
Therefore, the time of the module being simulated may be different from the time displayed for "Time(Blue)."
For details on the simulation time, refer to the following manual.

GX Works3 Operating Manual

*3 When the values of the data sampling interval are output to the data logging file, the time is displayed in milliseconds.

*4 The numbers of the digits of 10 nanosecond and 1 nanosecond are not displayed because they are rounded down.

Status bar

Ex.

When directly connecting to a MELSEC iQ-R series high speed data logger module and displaying a realtime trend window in the index display



Ex.

When connecting to an LCPUR by Ethernet and displaying a historical trend window in the time display



Displayed items

Item	Description
(1) Acquisition source of data ^{*1}	Displays the acquisition source of data being displayed in characters and colors. (Page 107 Acquisition source of data)
(2) Communication status	Displays "Online" or "Offline" according to the communication status. (For the realtime trend function or the realtime monitor function only)
(3) Cursor value	Displays the value at the point of intersection between the red cursor and a selected trend graph. • Program name ^{*2} and step number ^{*2} of a logging data
(4) Cursor time ^{*3,4} /Index	Displays time or index at the red cursor. ■ Display example of "Cursor time" ^{*5} • When the time is 1/1/2018 01:23:45.123456000 (the digit of 100 nanosecond does not exist or is 0) 1/1/2018 01:23:45.123 456 • When the time is 1/1/2018 01:23:45.123456789 (the digit of 100 nanosecond is not 0) 1/1/2018 01:23:45.123 456 7 ^{*6}

*1 When displaying logging data with the historical trend function, the connected module may be different from the module that sampled the logging data in the memory card.

In that case, the following information will be displayed.

Title bar (displayed characters): Module that sampled logging data in the memory card

Status bar (displayed characters): Connected module

Status bar (background color): Module that sampled logging data in the memory card

For details on the title bar and status bar, refer to the following:

Page 100 Trend window

*2 These are displayed only when displaying data logged by a CPU module.

*3 *(asterisk) is displayed when the date information does not exist, or when the date information does not contain "year, month, and day" information.

*4 When the data of an RCPUR or FX5CPU being simulated by GX Simulator3, or the data of a motion module being simulated by MU Simulator is displayed, the simulation time is displayed for "Cursor Time."

Therefore, the time of the module being simulated may be different from the time displayed for "Cursor Time."

For details on the simulation time, refer to the following manual.

GX Works3 Operating Manual

*5 When the values of the data sampling interval are output to the data logging file, the time is displayed in milliseconds.

*6 The numbers of the digits of 10 nanosecond and 1 nanosecond are not displayed because they are rounded down.

■ Acquisition source of data













- Displayed characters

Realtime monitor	<ul style="list-style-type: none"> • Connecting to an RCPU: RCPU(connection route)*1 • Connecting to a MELSEC iQ-R series motion module: RCPU(connection route)*1:(I/O number:model name) • Connecting to an RCPU simulator: RCPU Simulator(system number of the simulator.PLC number) • Connecting to the motion module simulator: RCPU(simulation(system number of the simulator.PLC number));(I/O number:model name) • Connecting to an LHCPU: LHCPU(connection route)*1 • Connecting to an FX5CPU: FX5CPU(connection route)*1 • Connecting to an FX5CPU simulator: FX5CPU Simulator(system number of the simulator) • Connecting to an LCPU: LCPU(connection route)*1
Realtime trend	Displays the IP address of a data logger or data communication being communicated with or displays "Direct Connection."
Historical trend	<p>Displays the acquisition source of a data logging file being displayed.</p> <ul style="list-style-type: none"> • Connecting to an RCPU: RCPU(connection route)*1:/file path • Connecting to an RnPCPU (redundant mode): RnPCPU(connection route)*1("System A" or "System B")*2:/file path • Connecting to a MELSEC iQ-R series high speed data logger module: MELSEC iQ-R Series High Speed Data Logger Module(IP address or "Direct Connection"):/file path • Connecting to a MELSEC iQ-R series motion module: RCPU(connection route)*1:(I/O number:model name)/file path • Connecting to a MELSEC iQ-R series motion controller: RMTCPU(connection route)*1:/file path • Connecting to the motion module simulator: RCPU(simulation(system number of the simulator.PLC number));(I/O number:model name) • Connecting to an LHCPU: LHCPU(connection route)*1:/file path • Connecting to an FX5CPU: FX5CPU(connection route)*1:/file path • Connecting to a QCPU: QCPU(connection route)*1:/file path • Connecting to a MELSEC-Q series high speed data logger module: Q Series High Speed Data Logger Module(IP address or "Direct Connection"):/file path • Connecting to an LCPU: LCPU(connection route)*1:/file path • Connecting to a BOX data logger: BOX Data Logger(IP address or "Direct Connection"):/file path • Using data saved in a personal computer or an inserted memory card: File path

*1 For the connection route, the route specified in the "Transfer Setup" screen is displayed.

*2 The system that acquired a data logging file ("System A" or "System B") is displayed.

• Background color

Data Source	Background color
RCPU QnUDVCPU	Pale blue 
MELSEC iQ-R series High Speed Data Logger Module MELSEC iQ-R Series High Speed Data Communication Module MELSEC iQ-R series analog module MELSEC-Q series High Speed Data Logger Module MELSEC-Q Series High Speed Data Communication Module MELSEC-Q series analog module Simulation result and sampling data saved with MELSEC iQ-R series Flexible High-Speed I/O Control Module Configuration Tool Recording file (Data of which a recording file displayed by the GX Works3 offline monitor function is saved in GX LogViewer in a file format/data converted by the recording file conversion function)	Light yellow 
MELSEC iQ-R series motion module MELSEC iQ-R series motion controller	Cyan 
RCPU Simulator FX5CPU Simulator Motion module simulator	Lilac 
LHCPU	Orange 
FX5CPU	Pink 
LCPU	Rose 
MELSEC-L series analog module Flexible High-Speed I/O Control Module Configuration Tool Simulation result and sampling data saved with MELSEC-L series	Light green 
RCPU (Offline monitor) LHCPU (Offline monitor) FX5CPU (Offline monitor) Recording file (Offline monitor)	Blue-green 
BOX Data Logger Logging module for energy measuring module CC-Link IE TSN FPGA module	Lime 
Sampling trace data	Gold 
JSON file in GX LogViewer format	Color information stored in a JSON file (Default: Cyan) 

8.3 Displaying Trend Graph

This section explains how to display logging data sampled by a module on a trend graph.

The maximum total number of records that can be displayed by the trend graph function and the event monitoring function is 1,000,001.

☞ Page 110 Displaying logged devices and labels (Historical trend)

☞ Page 112 Displaying the current device status (Realtime trend)

☞ Page 113 Displaying the current statuses of devices and labels (Realtime monitor)

☞ Page 151 Operating monitoring status of the realtime trend/realtime monitor function

Point

It takes more time to draw graphs when a large number of points are to be plotted.

Using OpenGL which is API for 2D/3D graphics applications improves that as follows:

- For the realtime trend function or realtime monitor function: Graphs can be drawn at high speed.
- For the historical trend function: The time required to open a file can be shortened. Graphs can be drawn at high speed in response to the scroll operation of the trend window.

[Tool] ⇒ [Option] ⇒ [Use an OpenGL and Draw Graphs]

Displaying logged devices and labels (Historical trend)

Type	Target for explanation ( Page 13 Target modules, simulators, files, and data for explanation)
Module	RCPU, LHCPU, FX5CPU, QnUDVCP, LCP, R analog, Q analog, L analog, BOX, R logger, Q logger, R motion module, R motion controller
Simulator	R motion module simulator
Others	Offline monitor, others

By specifying a following file saved in a personal computer, memory card, or data memory using the historical trend function, the data can be displayed on a trend graph.

- Data logging file saved by the data logging function of a CPU module, data logger, analog module, motion module, or motion module simulator
- Data logging file saved by the servo system recorder function of a motion controller
- Data being displayed by the GX Works3 offline monitor function
- CSV file in GX LogViewer format
- JSON file in GX LogViewer format

Precautions

- RCPUs and LHCPUs support access to data logging files saved in the data memory.
- R00CPU does not support the historical trend function.

Operating procedure

■ Displaying a data logging file saved by the data logging function of a CPU module, analog module, or motion module

1. Select [Online] ⇨ [Open Logging File] ().
2. Select any of the following in the "Connection Destination" screen:
 - RCPU
 - LHCPU
 - FX5CPU
 - QCPU
 - LCP
 - MELSEC iQ-R series motion module RD78G(H)
3. Specify a connection method and route in the "Transfer Setup" screen.
4. Select a target memory ^{*1} and a data logging file in the "Logging File" screen, and click the [Open File] button. (Multiple selections not allowed.)

*1 It is selectable when using an RCPU, LHCPU, or motion module.

■ Displaying a data logging file saved by the servo system recorder function of a motion controller

1. Select [Online] ⇨ [Open Logging File] ().
2. Select "MELSEC iQ-R Series Motion Controller" in the "Connection Destination" screen.
3. Specify a connection method and route in the "Transfer Setup" screen.
4. Select a target memory and a data logging file in the "Logging File" screen, and click the [Open File] button. (Multiple selections not allowed.)

■Displaying a data logging file saved by the data logging function of a data logger

1. Select [Online] ⇒ [Open Logging File] ()
2. Select "MELSEC iQ-R Series High Speed Data Logger Module," "MELSEC-Q Series High Speed Data Logger Module," or "BOX Data Logger" in the "Connection Destination" screen.
3. Specify a data logger to be connected and its connection route in the "Transfer Setup" screen.
4. Select a data logging file from the list in the "Logging File" screen, and click the [Open File] button. (Multiple selections not allowed.)

■Displaying a data logging file saved by the data logging function of motion module simulator

Refer to the manual of the motion control setting function.

For the method for referring to the motion control setting function manual, refer to the following:

 Page 94 Referring to the motion control setting function manual

■Displaying a data logging file saved in a personal computer

There are two methods to display a file.

- Select [File] ⇒ [Open] () , and specify a data logging file saved in a personal computer.
- Drag a data logging file saved in a personal computer and drop it onto the main window.

(Example: Displaying "HSDL.CSV" on the desktop)

Displaying the current device status (Realtime trend)

Type	Target for explanation ( Page 13 Target modules, simulators, files, and data for explanation)
Module	BOX, R logger, Q logger, R communication, Q communication

By specifying the data logging setting of a data logger or data communication using the realtime trend function, the data can be displayed on a trend graph.

Operating procedure

■Displaying the current device status of a data logger

1. Select [Online] ⇒ [Realtime Monitor] (.
2. Select any of the following in the "Connection Destination" screen:
 - MELSEC iQ-R series high speed data logger module
 - MELSEC-Q series high speed data logger module
 - BOX data logger
3. Specify a connection condition in the "Transfer Setup" screen and click the [OK] button.
4. Select a data logging setting to be set from the list on the "Select Logging Setting" screen, and click the [Open] button.

■Displaying the current device status of a data communication

1. Select [Online] ⇒ [Realtime Monitor] (.
2. Select either of the following in the "Connection Destination" screen:
 - MELSEC iQ-R series high speed data communication module
 - MELSEC-Q series high speed data communication module
3. Specify a connection condition in the "Transfer Setup" screen and click the [OK] button.
4. Select a label group setting to be set from the list on the "Select Label Group Setting" screen, and click the [Open] button.
5. Specify a data transfer setting in the "Realtime Transfer Setting" screen and click the [OK] button.

Displaying the current statuses of devices and labels (Realtime monitor)

Type	Target for explanation ( Page 13 Target modules, simulators, files, and data for explanation)
Module	RCP, LHCPU, FX5CPU, LCPU, R motion module
Simulator	RCP simulator, FX5CPU simulator, R motion module simulator

By using the realtime monitor function, the device and label information set in the realtime monitor setting can be displayed on a trend graph.

The following shows references that describe the operating procedures and settings of the realtime monitor function.

Description	Reference	
Operating procedure	How to start the realtime monitor function	Page 114 Starting the realtime monitor function (for RCP, RCP simulator, LHCPU, FX5CPU, FX5CPU simulator, or LCPU)
		Page 114 Starting the realtime monitor function (for motion module)
		Page 114 Starting the realtime monitor function (for motion module simulator)
		Page 115 Starting the realtime monitor function from GX Works3 (for RCP/LHCPU/FX5CPU)
		Page 116 Starting the realtime monitor function from GX Works2
	How to configure the realtime monitor setting when a CPU module is not connected	Page 116 Configuring the realtime monitor setting when a CPU module is not connected
Setting content	Realtime monitor setting	Page 117 Realtime monitor setting (RCP or RCP simulator)
		Page 129 Realtime monitor setting (LHCPU)
		Page 139 Realtime monitor setting (FX5CPU or FX5CPU simulator)
		Page 143 Realtime monitor setting (LCPU)
Considerations	Considerations for setting the step number specification in the timing condition	Page 148 Considerations for setting the step number specification in the timing condition
Others	Realtime monitor processing time	Page 148 Realtime monitor processing time
	When the realtime monitor function cannot be started	Page 149 The realtime monitor function cannot be started
	When the realtime monitor function is stopped	Page 150 The realtime monitor function is stopped

Precautions

- RnPCPUs do not support the realtime monitor function.
- While monitoring a motion module and the motion module simulator in real-time, data which is sampled by decimating data points for a waveform display is displayed in the realtime monitor window. After stopping the real-time monitoring, data sampled at the collection interval that is set in Motion System Logging Setting is displayed in the historical trend window.

Operating procedure

■ Starting the realtime monitor function (for RCP, RCP simulator, LHCP, FX5CP, FX5CP simulator, or LCP)

1. Select [Online] ⇒ [Realtime Monitor] (.
2. Select any of the following in the "Connection Destination" screen:
 - RCP
 - RCP Simulator (GX Simulator3)
 - LHCP
 - FX5CP
 - FX5CP Simulator (GX Simulator3)
 - LCP
3. Specify a connection method and route in the "Transfer Setup" screen.
4. Configure the monitoring settings in the "Realtime Monitor Setting" screen, and click the [Monitor Start] button.
 - ☞ Page 117 Realtime monitor setting (RCP or RCP simulator)
 - ☞ Page 129 Realtime monitor setting (LHCP)
 - ☞ Page 139 Realtime monitor setting (FX5CP or FX5CP simulator)
 - ☞ Page 143 Realtime monitor setting (LCP)

■ Starting the realtime monitor function (for motion module)

1. Select [Online] ⇒ [Realtime Monitor] (.
 2. Select "MELSEC iQ-R Series Motion Module RD78G(H)" in the "Connection Destination" screen.
 3. Specify a connection method and route in the "Transfer Setup" screen.
 4. Configure the monitoring setting in activated Motion System Logging Setting to start monitoring.*1
- *1 For details on Motion System Logging Setting, refer to the manual of the motion control setting function.
For the method for referring to the motion control setting function manual, refer to the following:
☞ Page 94 Referring to the motion control setting function manual

■ Starting the realtime monitor function (for motion module simulator)

Refer to the manual of the motion control setting function.

For the method for referring to the motion control setting function manual, refer to the following:

- ☞ Page 94 Referring to the motion control setting function manual

■ Starting the realtime monitor function from GX Works3 (for RCPU/LHCPU/FX5CPU)

When registering the data name and data type of a selected device/label automatically to the realtime monitor setting, start the operation from step 1. When not registering the data name and data type automatically, start from step 2.

1. Select a device/label on a program editor*¹ or on a watch window in GX Works3.
At this time, select a device/label to be registered in the realtime monitor setting.
2. Perform either of the following operations in GX Works3:
 - Select [Tool] ⇒ [Realtime Monitor Function].
 - Right-click the selected device/label and select [Wave Display (Realtime Monitor)] from the shortcut menu.
 The "Realtime Monitor Setting" screen appears.
At this time, the following information in GX Works3 has already been registered in the realtime monitor setting.
 - Module type of a project
 - Current connection destination of a project*²
 - Display language*³
 - Data name and data type of the device/label*⁴
3. Configure the monitoring settings in the "Realtime Monitor Setting" screen, and click the [Monitor Start] button.

☞ Page 117 Realtime monitor setting (RCPU or RCPU simulator)

☞ Page 129 Realtime monitor setting (LHCPU)

☞ Page 139 Realtime monitor setting (FX5CPU or FX5CPU simulator)

*1 An SFC diagram editor is not supported.

*2 When the connection destination settings are not available in GX LogViewer, "Transfer Setup" screen appears. Specify the connection method in the displayed screen.

*3 When the display language is not available in GX LogViewer, the information is displayed in English.

*4 A data name and data type of a label are not registered automatically when connecting to an FX5CPU.

Precautions

- When an error message is displayed in GX LogViewer, the realtime monitor function cannot be started.
Close the error message before starting the realtime monitor function from GX Works3.
- A device whose data type is "-" on a watch window in GX Works3 is not registered automatically.
- A GX Works3 project whose security version is '2' is not supported.
Therefore, when connecting to an RCPU and selecting a label in step 1, the realtime monitor function cannot be started.
Start the realtime monitor function after changing the security version to '1' and writing the GX Works3 project to the CPU module.

For the method for changing the security version, refer to the following:

☞ GX Works3 Operating Manual

Point

- To register data names and data types automatically when connecting to an FX5CPU, GX Works3 the software version of which is 1.055H or later must be installed.

When connecting to an RCPU or LHCPU, GX Works3 the software version of which is 1.080J or later must be installed.

For the version compatibility between GX LogViewer and GX Works3, refer to the following:

☞ Page 340 Version Compatibility

- Up to 31 devices can be registered to the realtime monitor setting.

When selecting 32 devices or more on a program editor or on a watch window in GX Works3 and performing the procedure to register devices automatically to the realtime monitor setting, only the devices from the first to the 31st of the display order are registered. This operation cannot be performed on an SFC diagram editor.

■Starting the realtime monitor function from GX Works2

1. Select [Tool] ⇒ [Realtime Monitor Function] from the menu of GX Works2.
The "Realtime Monitor Setting" screen is displayed.
Information in GX Works2 (module type and current connection destination of a project^{*1}) is retained in the displayed screen.

2. Configure the monitoring settings in the "Realtime Monitor Setting" screen, and click the [Monitor Start] button.
☞ Page 143 Realtime monitor setting (LCPUs)

*1 When the connection destination settings are not available in GX LogViewer, "Transfer Setup" screen appears. Specify the connection method in the displayed screen.

■Configuring the realtime monitor setting when a CPU module is not connected

1. Select [Online] ⇒ [Realtime Monitor] () .
2. Select any of the following in the "Connection Destination" screen, and select the checkbox of "Execute the realtime monitor setting in offline mode."

- RCPUs
- LHCPUs
- FX5CPUs
- LCPUs

3. Click the [OK] button.

4. Configure the monitoring settings in the "Realtime Monitor Setting" screen.

☞ Page 117 Realtime monitor setting (RCPUs or RCPUs simulator)

☞ Page 129 Realtime monitor setting (LHCPUs)

☞ Page 139 Realtime monitor setting (FX5CPUs or FX5CPUs simulator)

☞ Page 143 Realtime monitor setting (LCPUs)

5. Click the [Save to Files] button to save the setting file to arbitrary folder.

By clicking the [Read from Files] button on the "Realtime Monitor Setting" screen and specifying the setting file, the realtime monitor setting configured in advance can be displayed.

Realtime monitor setting (RCPU or RCPUSIMULATOR)

A monitor target, a monitoring condition (start/stop/timing), and the buffer capacity can be set in the "Realtime Monitor Setting" screen.

In addition, a label to be monitored can be specified by loading a GX Works3 project.

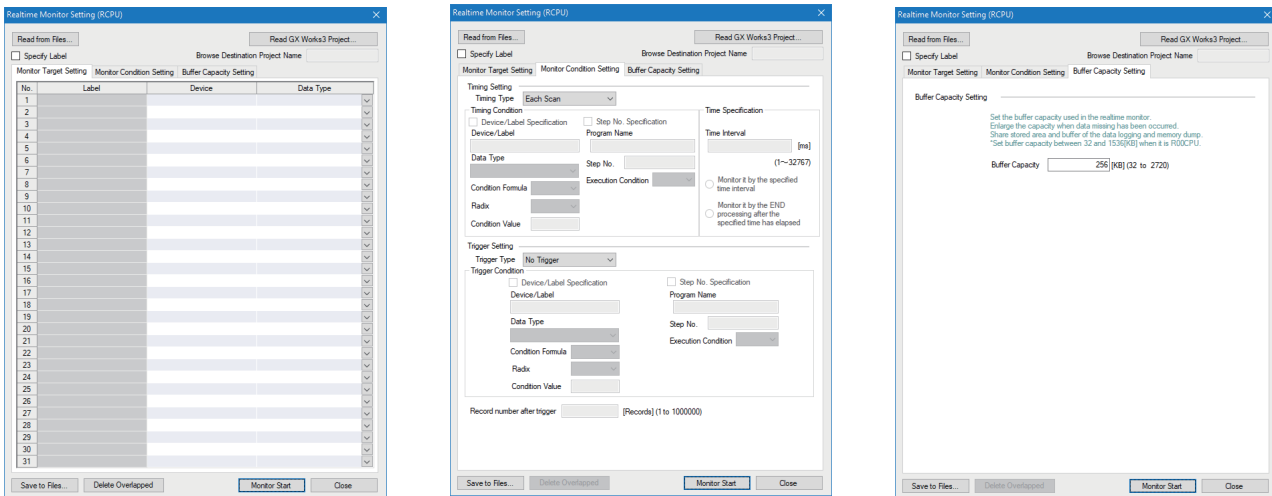

Point

When loading a GX Works3 project in GX LogViewer, only labels which can be registered in a Watch window of GX Works3 can be specified as a monitoring target or a monitoring condition.

Input format of labels/devices

The input formats of labels and devices are as follows:

Type	Input format
Global label	Label name
Local label	Program block name/Label name
Global device	Device name
Local device	Program name/#Device name ('#' is not necessary for index register (Z))

For structures and arrays, enter the items by referring to the following table.

Type	Target	Input format
Structure	Label (structure)	Label name
	Structure member	Label name.member name
Array	Label (array)	Label name excluding an array notation
	Array index and the specific dimension part of array (more than two-dimensional array)	Label name[three-dimensional index] [two-dimensional index] [one-dimensional index]
Structure array	Label (structure array)	Label name
	Specific member	Label name[three-dimensional index] [two-dimensional index] [one-dimensional index].member name

■ Specifying a label

The following shows the procedure to load a GX Works3 project and specify a label as a monitoring target or a monitoring condition.

1. Click the [Read GX Works3 Project] button in the "Realtime Monitor Setting" screen.
2. Select a project file of GX Works3.
3. Click the [Open] button.
4. Select the "Specify Label" checkbox.

Precautions

● Software version of GX Works3

To monitor a label, GX Works3 the software version of which is 1.045X or later must be installed.

● Security version of a GX Works3 project

A GX Works3 project whose security version is '2' is not supported.

Start the realtime monitor function after changing the security version to '1' and writing the GX Works3 project to the CPU module.

For the method for changing the security version, refer to the following:

 GX Works3 Operating Manual

● Before using the realtime monitor function

The project in a CPU module should be matched with a GX Works3 project loaded into GX LogViewer.

Before using the realtime monitor function, write the following data to a CPU module by using GX Works3 according to a specified label.

Label	Data that must be written
Global label	Project loaded into GX LogViewer (global label setting file)
Local label	<ul style="list-style-type: none">• Project loaded into GX LogViewer (program file with a specified name)• CPU parameter including a program name specified in GX LogViewer

Note that the realtime monitor function cannot be used in the following cases:

Label	Description
Global label	<ul style="list-style-type: none">• The global label setting file is not included in a CPU module.• The global label setting file in a CPU module is not matched with a project (global label setting file) loaded into GX LogViewer.
Local label	<ul style="list-style-type: none">• CPU parameters and a program file with the specified name are not included in a CPU module.• The specified program name is not set in "Program Setting" of "CPU Parameter" in GX Works3.• A program file with the specified name in a CPU module is not matched with the project (program file with the specified name) loaded into GX LogViewer.

- Period from when importing a project to when using the realtime monitor function

Do not write the following files to a CPU module in the period from when importing a project to when using the realtime monitor function.

Label	Description
Global label	Global label setting file to which a global label was added, changed, or deleted
Local label	Program file to which a program was changed (Adding, changing, or deleting a local label is included.)

If a file above is written, label assignment is changed and the specified labels may not be monitored. In that case, perform any of the following operations.

- Re-load a GX Works3 project into GX LogViewer and re-write the project to a CPU module by using GX Works3.
- Select [Online] ⇒ [Read from PLC] in GX Works3 and read the project from a CPU module. Save the project in GX Works3 and re-write it to the CPU module. Then, re-load the project into GX LogViewer.

Point

By using SD940 (Stop direction at file change on label specification) prevents a wrong label monitoring. By turning ON the 15th of SD940, the realtime monitor function can be stopped at the following timing.

- A CPU module is in the RUN state: after the global label setting file or program file is written
- A CPU module is in the STOP state: after the global label setting file or program file is written or when the operation status of a CPU module is turned to RUN after any of the files was written

For details on SD940, refer to the following:

 MELSEC iQ-R CPU Module User's Manual (Application)

- After starting the realtime monitor function

When monitoring a local label in a program of which the program name (execution order) is specified in "Program Setting" of "CPU Parameter" in GX Works3, do not write data in which a CPU parameter is changed to a CPU module again after starting monitoring. Doing so causes an error after data writing is completed because data in the CPU module is not matched with that in GX LogViewer.

Change CPU parameters before starting monitoring.

- Device and data type

The device and the data type corresponding to a specified label are set automatically. Note that the set device and data type cannot be changed.

■ Specifying a local label

By entering the name of a program file or local device name, the local device can be specified as a monitoring target or monitoring condition.

Precautions

● Before using the realtime monitor function

To monitor a local device, GX Works3 the software version of which is 1.045X or later must be installed.

Before using the realtime monitor function, write the following data to a CPU module by using GX Works3.

Device	Data that must be written
Local device	CPU parameter including a program name specified in GX LogViewer

Note that the realtime monitor function cannot be used in the following cases:

Device	Description
Local device	<ul style="list-style-type: none">• CPU parameters are not included in a CPU module.• The specified program name is not set in "Program Setting" of "CPU Parameter" in GX Works3.

● After starting the realtime monitor function

When monitoring a local device in a program of which the program name (execution order) is specified in "Program Setting" of "CPU Parameter" in GX Works3, do not write data in which a CPU parameter is changed to a CPU module again after starting monitoring. Doing so causes an error after data writing is completed because data in the CPU module is not matched with that in GX LogViewer.

Change CPU parameters before starting monitoring.

● Local index register, local long index register and file register for which "Use File Register of Each Program" is selected
For the following registers (device), a monitoring target and/or monitoring condition cannot be specified with a program file name.

- Local index register
- Local long index register
- File register for which "Use File Register of Each Program" is selected in "File Setting" of "CPU Parameter" in GX Works3.

By transferring data of the device above to the global devices in a GX Works3 program in advance, the devices can be specified as a monitoring target and/or monitoring condition in GX LogViewer.

■ Specifying a link direct device

Link direct devices whose points are greater than the following range cannot be specified. In order to specify the target devices as monitoring targets or monitoring conditions, refresh the devices to a CPU module and specify the refreshed devices.

- J□\SB or J□\SW: 512 points
- J□\X or J□\Y: 16K points
- J□\B: 32K points
- J□\W: 128K points

CPU modules and the firmware versions that support the range above are as follows.

- R00CPU, R01CPU, R02CPU: The firmware version is "11" or later
- R04CPU, R04ENCPU, R08CPU, R08ENCPU, R16CPU, R16ENCPU, R32CPU, R32ENCPU, R120CPU, R120ENCPU: The firmware version is "43" or later

■ Specifying a module access device, link direct device, and CPU buffer memory access device of an RnSF CPU

Starting the realtime monitor function with the following settings may cause data inconsistency.

- Monitoring target: U□\G, J□\W, J□\SW, U3E□\G, and U3E□\HG of an RnSF CPU
- Data type of monitoring target: Double-precision real number

■The [Monitor Target Setting] tab

Specify a label or device to be monitored and their data types.

When starting GX LogViewer in the state where a device/label on a program editor or on a watch window is selected in GX Works3, the selected device/label is registered automatically.

The following table shows the labels and devices which can be specified on the [Monitor Target Setting] tab.

Item	Description		
Label ^{*1,2} ^{*3,4}	Global label	VAR_GLOBAL VAR_GLOBAL_RETAIN	
	Local label ^{*5}	VAR VAR_RETAIN	
		<ul style="list-style-type: none"> ■Basic data type/Array^{*6,7,8} <ul style="list-style-type: none"> • Bit^{*9} • Word [signed]^{*10} • Double word [signed] • Word [unsigned]^{*10} • Double word [unsigned] • Single-precision real number • Double-precision real number • Timer type • Retentive timer type • Counter type • Long timer type • Long retentive timer type • Long counter type ■Structure^{*7,8,11} 	
Device ^{*2}	Global device ^{*12}	Bit device	X, DX, Y, DY, M, L, F, SM, V, B, SB, T (contact) ^{*13} , T (coil) ^{*14} , ST (contact) ^{*13} , ST (coil) ^{*14} , C (contact) ^{*13} , C (coil) ^{*14} , LT (contact) ^{*13} , LT (coil) ^{*14} , LST (contact) ^{*13} , LST (coil) ^{*14} , LC (contact) ^{*13} , LC (coil) ^{*14} , FX, FY, BL□\S ^{*15} , J□\X, J□\Y, J□\SB, J□\B
		Bit device (Bit-specified word device)	D, SD, W, SW, RD, R, ZR, FD, U□\G, J□\W, J□\SW, U3E□\G, U3E□\HG
		Word device	T (current value) ^{*16} , ST (current value) ^{*16} , C (current value) ^{*16} , D, SD, W, SW, RD, R, ZR, Z, FD, U□\G, J□\W, J□\SW, U3E□\G, U3E□\HG
		Word device (Digit-specified bit device) ^{*17}	X, Y, M, L, F, SM, B, SB, BL□\S ^{*15} , J□\X, J□\Y, J□\SB, J□\B
		Double-word device	LT (current value) ^{*16} , LST (current value) ^{*16} , LC (current value) ^{*16} , LZ
		Double-word device (Digit-specified bit device) ^{*17}	X, Y, M, L, F, SM, B, SB, BL□\S ^{*15} , J□\X, J□\Y, J□\SB, J□\B
	Local device ^{*12,18}	Bit device	M, V, T (contact) ^{*13} , T (coil) ^{*14} , ST (contact) ^{*13} , ST (coil) ^{*14} , C (contact) ^{*13} , C (coil) ^{*14} , LT (contact) ^{*13} , LT (coil) ^{*14} , LST (contact) ^{*13} , LST (coil) ^{*14} , LC (contact) ^{*13} , LC (coil) ^{*14}
		Bit device (Bit-specified word device)	D
		Word device	T (current value) ^{*16} , ST(current value) ^{*16} , C(current value) ^{*16} , D
		Word device (Digit-specified bit device) ^{*17}	M
		Double-word device	LT (current value) ^{*16} , LST (current value) ^{*16} , LC (current value) ^{*16}
		Double-word device (Digit-specified bit device) ^{*17}	M

- *1 Upper and lower cases of displayed label names may be different from those of label names in GX Works3.
- *2 The total of device points and label points can be specified up to 16 points in a word conversion.
However, bit devices and bit type labels can be specified up to 16 points.
- *3 For RnSFCPU, labels cannot be specified.
- *4 Labels using a special character (such as an umlaut character) may not be specified.
- *5 Local labels in function blocks cannot be specified.
- *6 For labels of which the data type is array, specify array elements.
For labels of which the data type is structure array, specify structure member and array elements.
- *7 When specifying a label of which the data type is an array without specifying the range, the first element of the array is monitored.
(Example: when the label 'bLabel1[0..9]' is specified as 'bLabel1', the monitoring target will be 'bLabel1[0]').
- *8 When entering an element outside of the range of the array, an indefinite value will be specified. Enter an element which is in the range of the array.
- *9 Labels that are specified in digit specification cannot be specified.
- *10 Word type Labels can be specified as bits.
- *11 For labels of which the data type is structure, specify structure members.
- *12 The indirect-specified and index-modified devices cannot be specified.
- *13 T (contact), ST (contact), C (contact), LT (contact), LST (contact), and LC (contact) are specified with TS, STS, CS, LTS, LSTS, and LCS respectively.
- *14 T (coil), ST (coil), C (coil), LT (coil), LST (coil) and LC (coil) are specified with TC, STC, CC, LTC, LSTC, and LCC respectively.
- *15 For RnSFCPU, when specifying BL□\S and starting the realtime monitor function, an error occurs even though BL□\S can be specified.
- *16 T (current value), ST (current value), C (current value), LT (current value), LST (current value), and LC (current value) can be specified with T/TN, ST/STN, C/CN, LT/LTN, LST/LSTN, and LC/LCN respectively.
- *17 Digit specification for bit device is available only for K1 to K8.
- *18 For RnSFCPU, when specifying a local device and starting the realtime monitor function, an error occurs even though local devices can be specified.

Point

- A device or label copied from another application (Example: the watch window of an engineering tool, Excel) can be pasted or inserted in the device or label column.
Operation method:
Right-click on the device or label column ⇒ select [Paste device/label copied in other application software]/ [Insert device/label copied in other application software] from the shortcut menu.
In another way to paste a copied device or label, press **Ctrl** + **Shift** + **V** keys.
- Duplicated devices or labels can be deleted.
Operation method:
After setting a monitoring target, click the [Delete Overlapped Data] button.

■The [Monitor Condition Setting] tab - "Timing Type"

Item	Description
Each Scan	Monitors data at the timing of END processing for each scan.
Condition Specification* ¹	Monitors data at the timing of the specified condition.
Time Specification** ^{1,2}	Monitors data by the specified time interval or at the timing of the first END processing after exceeding the specified time.

*1 RnSFCPU do not support these items.

*2 Only when using the following CPU modules, this item can be specified.

Model name	Firmware version
R00CPU, R01CPU, R02CPU	"08" or later
R04CPU, R04ENCPU, R08CPU, R08ENCPU, R16CPU, R16ENCPU, R32CPU, R32ENCPU, R120CPU, R120ENCPU	"40" or later

■The [Monitor Condition Setting] tab - "Timing Condition" - "Device/Label Specification"

Data is monitored when the specified condition of a device and label is satisfied during END processing.

Item	Description		Setting range	
Device* ¹	Global device	Bit device	X, Y, M, L, F, SM, V, B, SB, T (contact) ² , ST (contact) ² , C (contact) ² , LT (contact) ² , LST (contact) ² , LC (contact) ² , FX, FY, BL□\S, J□\X, J□\Y, J□\SB, J□\B	—
		Bit device (Bit-specified word device)	D, SD, W, SW, RD, R, ZR, FD, U□\G, J□\W, J□\SW, U3E□\G, U3E□\HG	—
		Word device	T (current value) ³ , ST (current value) ³ , C (current value) ³ , D, SD, W, SW, RD, R, ZR, Z, FD, U□\G, J□\W, J□\SW, U3E□\G, U3E□\HG	—
		Word device (Digit-specified bit device) ⁴	X, Y, M, L, F, SM, B, SB, BL□\S, J□\X, J□\Y, J□\SB, J□\B	—
		Double-word device	LT (current value) ³ , LST (current value) ³ , LC (current value) ³ , LZ	—
		Double-word device (Digit-specified bit device) ⁴	X, Y, M, L, F, SM, B, SB, BL□\S, J□\X, J□\Y, J□\SB, J□\B	—
	Local device	Bit device	M, V, T (contact) ² , ST (contact) ² , C (contact) ² , LT (contact) ² , LST (contact) ² , LC (contact) ²	—
		Bit device (Bit-specified word device)	D	—
		Word device	T (current value) ³ , ST (current value) ³ , C (current value) ³ , D	—
		Word device (Digit-specified bit device) ⁴	M	—
		Double-word device	LT (current value) ³ , LST (current value) ³ , LC (current value) ³	—
		Double-word device (Digit-specified bit device) ⁴	M	—
Label* ^{5,6}	Global Label	VAR_GLOBAL	<ul style="list-style-type: none"> ■Basic data type/Array^{8,9,10} <ul style="list-style-type: none"> • Bit¹¹ • Word [signed]¹² • Double word [signed] • Word [unsigned]¹² • Double word [unsigned] • Timer type <ul style="list-style-type: none"> • Retentive timer type • Counter type • Long timer type • Long retentive timer type • Long counter type ■Structure^{9,10,13} 	—
		VAR_GLOBAL_RETAIN		—
	Local label* ⁷	VAR		—
		VAR_RETAIN		—

Item	Description	Setting range
Condition Formula	<p>■A bit device is specified</p> <p>"↑": When a bit device rises Monitors data when the specified device status is changed from OFF to ON.</p> <p>"↓": When a bit device falls Monitors data when the specified device status is changed from ON to OFF.</p> <p>■A word device or double-word device is specified</p> <p>"=": When a word device value or double-word device value meet the specified value Monitors data when the current value of a specified device satisfies the condition value.</p> <p>"Change": When a word device or double-word device data is changed Monitors data when the current value of a specified device is changed.</p>	<ul style="list-style-type: none"> • Bit device specification "↑", "↓" • Word device or double-word device specification "=", "Change"
Radix	Specify a radix of the condition value when a word device or double-word device is specified.	"Decimal" or "Hexadecimal"
Condition Value	Set a value to be compared with a device or label value.	<ul style="list-style-type: none"> • For a word device Decimal: -32768 to 32767 Hexadecimal: 0H to FFFFH • For a double-word device Decimal: -2147483648 to 2147483647 Hexadecimal: 0H to FFFFFFFFH

- *1 The indirect-specified and index-modified devices cannot be specified.
- *2 T (contact), ST (contact), C (contact), LT (contact), LST (contact), and LC (contact) are specified with TS, STS, CS, LTS, LSTS, and LCS respectively.
- *3 T (current value), ST (current value), C (current value), LT (current value), LST (current value), and LC (current value) can be specified with T/TN, ST/STN, C/CN, LT/LTN, LST/LSTN, and LC/LCN respectively.
- *4 Digit specification for bit device is available only for K1 to K8.
- *5 Upper and lower cases of displayed label names may be different from those of label names in GX Works3.
- *6 Labels using a special character (such as an umlaut character) may not be specified.
- *7 Local labels in function blocks cannot be specified.
- *8 For labels of which the data type is array, specify array elements.
For labels of which the data type is structure array, specify structure member and array elements.
- *9 When specifying a label of which the data type is an array without specifying the range, the first element of the array is monitored.
(Example: when the label 'bLabel1[0..9]' is specified as 'bLabel1', the monitoring target will be 'bLabel1[0].')
- *10 When entering an element outside of the range of the array, an indefinite value will be specified. Enter an element which is in the range of the array.
- *11 Labels that are specified in digit specification cannot be specified.
- *12 Word type Labels can be specified as bits.
- *13 For labels of which the data type is structure, specify structure members.

■The [Monitor Condition Setting] tab - "Timing Condition" - "Step No. Specification"

Data is monitored when the specified condition is satisfied immediately before the specified step is activate.

Item	Description	Setting range
Program Name	Set a program name for the program to be monitored by satisfaction of condition for the specified step No.	Up to 60 characters
Step No.	Set a step No. to monitor data by satisfaction of the condition.	0 to 1228799
Execution Condition	Select the monitoring operation condition from the following: "Always": Any time Always monitors data at the specified step. "ON": When an execution condition is ON Monitors data while the operation of the specified step is satisfied. "OFF": When an execution condition is OFF Monitors data while the operation of the specified step is not satisfied. "↑": When an execution condition rises Monitors data at the timing when the operation of the specified step turns into the satisfied state from the not-satisfied state. "↓": When an execution condition falls Monitors data at the timing when the operation of the specified step turns into the not-satisfied state from the satisfied state.	"Always" "ON" "OFF" "↑" "↓"

■The [Monitor Condition Setting] tab - "Time Specification"

Item	Description	Setting range
Time Interval	Set a time interval for monitoring the data.	1 to 32767 [ms] (unit: ms)
Monitor it by the specified time interval ^{*1}	Monitors data by the specified time interval.	—
Monitor it by the END processing after the specified time has elapsed	Monitors data at the timing of the first END processing after exceeding the specified time. When the set time interval is shorter than the scan time, data is monitored every scan time.	—

*1 An error within 5% may be caused between the specified time interval and the actual time interval to monitor data.

■The [Monitor Condition Setting] tab - "Trigger Type"

A trigger mark is displayed on the graph area once a trigger is detected.

Item	Description
No Trigger	Monitors data without specifying a trigger condition.
1 Time	Stops monitoring once the specified number of records has been monitored since a trigger was detected.
Continuous	Keeps monitoring up to the monitoring stop operation, and detect triggers during the period.

■The [Monitor Condition Setting] tab - "Trigger Condition" - "Device/Label Specification"

A trigger is detected when the specified condition of a device and label is satisfied during END processing.

Item	Description		Setting range	
Device ^{*1}	Global device	Bit device	X, Y, M, L, F, SM, V, B, SB, T (contact) ^{*2} , ST (contact) ^{*2} , C (contact) ^{*2} , LT (contact) ^{*2} , LST (contact) ^{*2} , LC (contact) ^{*2} , FX, FY	—
		Bit device (Bit-specified word device)	D, SD, W, SW, RD, R, ZR, FD	—
		Word device	T (current value) ^{*3} , ST (current value) ^{*3} , C (current value) ^{*3} , D, SD, W, SW, RD, R, ZR, FD	—
		Double-word device	LT (current value) ^{*3} , LST (current value) ^{*3} , LC (current value) ^{*3}	—
	Local device ^{*4}	Bit device	M, V, T (contact) ^{*2} , ST (contact) ^{*2} , C (contact) ^{*2} , LT (contact) ^{*2} , LST (contact) ^{*2} , LC (contact) ^{*2}	—
		Bit device (Bit-specified word device)	D	—
		Word device	T (current value) ^{*3} , ST (current value) ^{*3} , C (current value) ^{*3} , D	—
		Double-word device	LT (current value) ^{*3} , LST (current value) ^{*3} , LC (current value) ^{*3}	—
Label ^{*5*6*7}	Global label	VAR_GLOBAL	<ul style="list-style-type: none"> ■Basic data type/Array^{*9*10*11} <ul style="list-style-type: none"> • Bit^{*12} • Word [signed] • Double word [signed] • Word [unsigned]^{*13} • Double word [unsigned]^{*13} • Timer type <ul style="list-style-type: none"> • Retentive timer type • Counter type • Long timer type • Long retentive timer type • Long counter type ■Structure^{*10*11*14} 	—
		VAR_GLOBAL_RETAIN		—
	Local label ^{*8}	VAR		—
		VAR_RETAIN		—
Condition Formula	<p>■A bit device is specified</p> <p>"↑": When a bit device rises Generates a trigger when the specified device status is changed from OFF to ON.</p> <p>"↓": When a bit device falls Generates a trigger when the specified device status is changed from ON to OFF.</p> <p>■A word device or double-word device is specified</p> <p>"=": When a word device value or double-word device value meet the specified value Generates a trigger when the current value of a specified device satisfies the condition value.</p> <p>"Change": When a word device or double-word device data is changed Generates a trigger when the current value of a specified device is changed.</p>		<ul style="list-style-type: none"> • Bit device specification "↑," "↓" • Word device or double-word device specification "=," "Change" 	
Radix	Specify a radix of the condition value when a word device or double-word device is specified.		"Decimal" or "Hexadecimal"	
Condition Value	Set a value to be compared with a device or label value.		<ul style="list-style-type: none"> • For a word device Decimal: -32768 to 32767 Hexadecimal: 0H to FFFFH • For a double-word device Decimal: -2147483648 to 2147483647 Hexadecimal: 0H to FFFFFFFFH 	

- *1 The digit-specified bit devices, indirect-specified, or index-modified devices cannot be specified.
- *2 T (contact), ST (contact), C (contact), LT (contact), LST (contact), and LC (contact) are specified with TS, STS, CS, LTS, LSTS, and LCS respectively.
- *3 T (current value), ST (current value), C (current value), LT (current value), LST (current value), and LC (current value) can be specified with T/TN, ST/STN, C/CN, LT/LTN, LST/LSTN, and LC/LCN respectively.
- *4 For RnSFCPU, when specifying a local device and starting the realtime monitor function, an error occurs even though local devices can be specified.
- *5 For RnSFCPU, labels cannot be specified.
- *6 Upper and lower cases of displayed label names may be different from those of label names in GX Works3.
- *7 Labels using a special character (such as an umlaut character) may not be specified.
- *8 Local labels in function blocks cannot be specified.
- *9 For labels of which the data type is array, specify array elements.
For labels of which the data type is structure array, specify structure member and array elements.
- *10 When specifying a label of which the data type is an array without specifying the range, the first element of the array is monitored.
(Example: when the label 'bLabel1[0..9]' is specified as 'bLabel1', the monitoring target will be 'bLabel1[0].')
- *11 When entering an element outside of the range of the array, an indefinite value will be specified. Enter an element which is in the range of the array.
- *12 Labels that are specified in digit specification cannot be specified.
- *13 Word type Labels can be specified as bits.
- *14 For labels of which the data type is structure, specify structure members.

■The [Monitor Condition Setting] tab - "Trigger Condition" - "Step No. Specification"

A trigger is detected when the specified condition is satisfied immediately before the specified step is activate.

Item	Description	Setting range
Program Name*1	Set a program name for the program in which a trigger is generated by satisfaction of the condition for the specified step No.	Up to 60 characters
Step No.	Set a step No. to generate a trigger by satisfaction of the condition.	0 to 1228799
Execution Condition	Select the trigger generation condition from the following: "Always": Any time Generates a trigger at the specified step. "ON": When an execution condition is ON Generates a trigger when the operation of the specified step has been satisfied. "OFF": When an execution condition is OFF Generates a trigger when the operation of the specified step is not satisfied. "↑": When an execution condition rises Generates a trigger at the timing when the operation of the specified step has turned into the satisfied state from the not-satisfied state. "↓": When an execution condition falls Generates a trigger at the timing when the operation of the specified step has turned into the not-satisfied state from the satisfied state.	"Always" "ON" "OFF" "↑" "↓"

*1 Safety programs cannot be set.

■The [Monitor Condition Setting] tab - "Record number after trigger"

To specify the number of records from when a trigger condition is satisfied to when a monitoring is stopped, specify the number for "Record number after trigger."

Item	Description
Record number after trigger	Set the number of records to be monitored after a trigger was detected. (Dropped data occurred after trigger detection are not included in the record after trigger.)

The diagram illustrates the timing of data recording relative to a trigger event. A horizontal timeline starts with a vertical arrow labeled 'Start monitoring'. A second vertical arrow labeled 'Trigger condition satisfaction' occurs later. A third vertical arrow labeled 'Stop monitoring' occurs at the end. A double-headed arrow labeled 'Sampled data' spans from 'Start monitoring' to 'Stop monitoring'. A shorter double-headed arrow labeled 'Record number after trigger (including the trigger)' starts at 'Trigger condition satisfaction' and ends at 'Stop monitoring'. A longer double-headed arrow labeled 'Number of records can be monitored' spans from 'Start monitoring' to 'Stop monitoring'.

■The [Buffer Capacity Setting] tab

Specify a buffer capacity. Insufficient buffer capacity increases the probability of processing overload occurrence.

For details on processing overload, refer to the following:

 MELSEC iQ-R CPU Module User's Manual (Application)

Module	Capacity	Using in conjunction with other functions of CPU module	How to check the free buffer capacity
RCPU	32 to 2720 KB* ¹	To use the realtime monitor function in conjunction with the data logging function and the memory dump function, set the capacity within the range that meets the following conditions. <ul style="list-style-type: none"> The total of data logging buffer capacities + Memory dump buffer capacity + Realtime monitor buffer capacity \leq 3072 KB 	Can be checked with the special register, SD1484.

*1 When using R00CPU, the buffer capacity is 32 to 1536 KB.

Point

- When setting both the device/label specification and the step number specification in "Timing Condition": Data is monitored when the condition specified in "Device/Label Specification" is satisfied in the step number specified in "Step No. Specification."
- When monitoring by specifying a time interval with the CPU module that does not support specifying a time interval:
Monitoring is performed at the fixed time interval (0.5 to 1000 ms) by setting any steps of a periodic interruption program and a periodic execution type program for "Step No. Specification" in "Timing Condition."

Restriction

- "Step No. Specification" cannot be set for ST programs, programs in FBs, SFC programs, and programs that consist of multiple elements, because their step No. cannot be checked.
- When the size of the program in a CPU module or the number of the devices to be monitored is large, the cycle that GX LogViewer monitors the data of devices may be slower than the cycle that device values change.
For example, when a bit device turn OFF and ON quickly, the trend graph of the device keeps being displayed in the ON state because the falling of the device is not recognized.
- Some devices cannot be monitored (accessed) in a multiple CPU configuration. For details, refer to the following:

 MELSEC iQ-R CPU Module User's Manual (Application)

Realtime monitor setting (LHCPU)

A monitor target, a monitoring condition (start/stop/timing), and the buffer capacity can be set in the "Realtime Monitor Setting" screen.

In addition, a label to be monitored can be specified by loading a GX Works3 project.

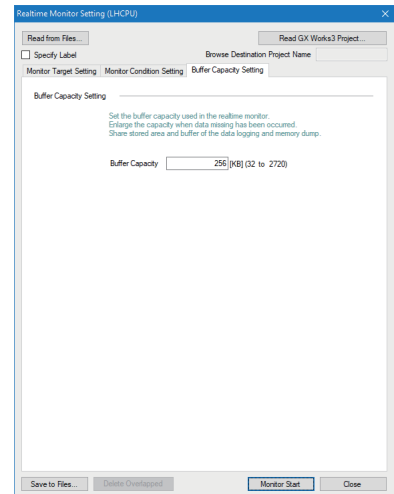
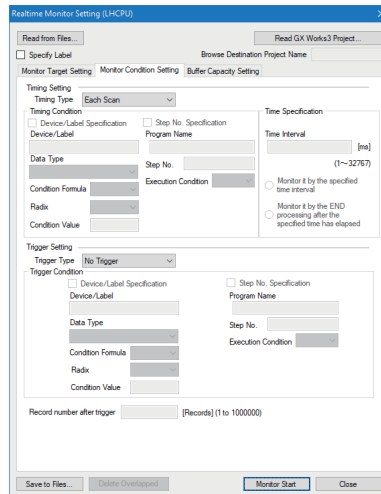
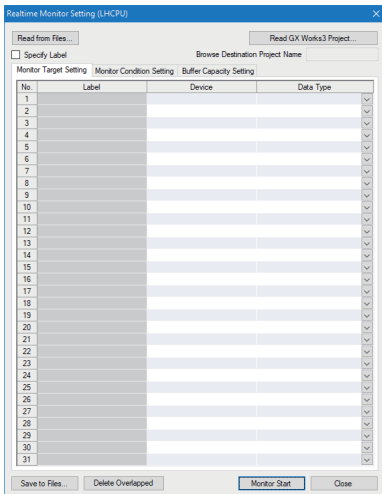

- For the input formats of labels and local devices, refer to the following:

📄 Page 117 Input format of labels/devices

- When loading a GX Works3 project in GX LogViewer, only labels which can be registered in a Watch window of GX Works3 can be specified as a monitoring target or a monitoring condition.

■ Specifying a label

The following shows the procedure to load a GX Works3 project and specify a label as a monitoring target or a monitoring condition.

1. Click the [Read GX Works3 Project] button in the "Realtime Monitor Setting" screen.
2. Select a project file of GX Works3.
3. Click the [Open] button.
4. Select the "Specify Label" checkbox.

Precautions

- Before using the realtime monitor function

The project in a CPU module should be matched with a GX Works3 project loaded into GX LogViewer.

Before using the realtime monitor function, write the following data to a CPU module by using GX Works3 according to a specified label.

Label	Data that must be written
Global label	Project loaded into GX LogViewer (global label setting file)
Local label	<ul style="list-style-type: none"> • Project loaded into GX LogViewer (program file with a specified name) • CPU parameter including a program name specified in GX LogViewer

Note that the realtime monitor function cannot be used in the following cases:

Label	Description
Global label	<ul style="list-style-type: none"> • The global label setting file is not included in a CPU module. • The global label setting file in a CPU module is not matched with a project (global label setting file) loaded into GX LogViewer.
Local label	<ul style="list-style-type: none"> • CPU parameters and a program file with the specified name are not included in a CPU module. • The specified program name is not set in "Program Setting" of "CPU Parameter" in GX Works3. • A program file with the specified name in a CPU module is not matched with the project (program file with the specified name) loaded into GX LogViewer.

● Period from when importing a project to when using the realtime monitor function

Do not write the following files to a CPU module in the period from when importing a project to when using the realtime monitor function.

Label	Description
Global label	Global label setting file to which a global label was added, changed, or deleted
Local label	Program file to which a program was changed (Adding, changing, or deleting a local label is included.)

If a file above is written, label assignment is changed and the specified labels may not be monitored. In that case, perform any of the following operations.

- Re-load a GX Works3 project into GX LogViewer and re-write the project to a CPU module by using GX Works3.
- Select [Online] ⇔ [Read from PLC] in GX Works3 and read the project from a CPU module. Save the project in GX Works3 and re-write it to the CPU module. Then, re-load the project into GX LogViewer.

● After starting the realtime monitor function

When monitoring a local label in a program of which the program name (execution order) is specified in "Program Setting" of "CPU Parameter" in GX Works3, do not write data in which a CPU parameter is changed to a CPU module again after starting monitoring. Doing so causes an error after data writing is completed because data in the CPU module is not matched with that in GX LogViewer.

Change CPU parameters before starting monitoring.

● Device and data type

The device and the data type corresponding to a specified label are set automatically. Note that the set device and data type cannot be changed.

■ Specifying a local label

By entering the name of a program file or local device name, the local device can be specified as a monitoring target or monitoring condition.

Precautions

● Before using the realtime monitor function

Before using the realtime monitor function, write the following data to a CPU module by using GX Works3.

Device	Data that must be written
Local device	CPU parameter including a program name specified in GX LogViewer

Note that the realtime monitor function cannot be used in the following cases:

Device	Description
Local device	<ul style="list-style-type: none">• CPU parameters are not included in a CPU module.• The specified program name is not set in "Program Setting" of "CPU Parameter" in GX Works3.

● After starting the realtime monitor function

When monitoring a local device in a program of which the program name (execution order) is specified in "Program Setting" of "CPU Parameter" in GX Works3, do not write data in which a CPU parameter is changed to a CPU module again after starting monitoring. Doing so causes an error after data writing is completed because data in the CPU module is not matched with that in GX LogViewer.

Change CPU parameters before starting monitoring.

● Local index register, local long index register and file register for which "Use File Register of Each Program" is selected
For the following registers (device), a monitoring target and/or monitoring condition cannot be specified with a program file name.

- Local index register
- Local long index register
- File register for which "Use File Register of Each Program" is selected in "File Setting" of "CPU Parameter" in GX Works3.

By transferring data of the device above to the global devices in a GX Works3 program in advance, the devices can be specified as a monitoring target and/or monitoring condition in GX LogViewer.

■The [Monitor Target Setting] tab

Specify a label or device to be monitored and their data types.

When starting GX LogViewer in the state where a device/label on a program editor or on a watch window is selected in GX Works3, the selected device/label is registered automatically.

The following table shows the labels and devices which can be specified on the [Monitor Target Setting] tab.

Item	Description		
Label ^{*1,2} ^{*3}	Global label	VAR_GLOBAL VAR_GLOBAL_RETAIN	
	Local label ^{*4}	VAR VAR_RETAIN	
		<ul style="list-style-type: none"> ■Basic data type/Array^{*5,6,7} <ul style="list-style-type: none"> • Bit^{*8} • Word [signed]^{*9} • Double word [signed] • Word [unsigned]^{*9} • Double word [unsigned] • Single-precision real number • Double-precision real number • Timer type • Retentive timer type • Counter type • Long timer type • Long retentive timer type • Long counter type ■Structure^{*6,7,10} 	
Device ^{*2}	Global device ^{*11}	Bit device	X, DX, Y, DY, M, L, F, SM, V, B, SB, T (contact) ^{*12} , T (coil) ^{*13} , ST (contact) ^{*12} , ST (coil) ^{*13} , C (contact) ^{*12} , C (coil) ^{*13} , LT (contact) ^{*12} , LT (coil) ^{*13} , LST (contact) ^{*12} , LST (coil) ^{*13} , LC (contact) ^{*12} , LC (coil) ^{*13} , FX, FY, BL□\S, J□\X, J□\Y, J□\SB
		Bit device (Bit-specified word device)	D, SD, W, SW, RD, R, ZR, FD, U□\G, J□\W, J□\SW, U3E0\G
		Word device	T (current value) ^{*14} , ST (current value) ^{*14} , C (current value) ^{*14} , D, SD, W, SW, RD, R, ZR, Z, FD, U□\G, U3E0\G, J□\W, J□\SW
		Word device (Digit-specified bit device) ^{*15}	X, Y, M, L, F, SM, B, SB, BL□\S, J□\X, J□\Y, J□\SB
		Double-word device	LT (current value) ^{*14} , LST (current value) ^{*14} , LC (current value) ^{*14} , LZ
		Double-word device (Digit-specified bit device) ^{*15}	X, Y, M, L, F, SM, B, SB, BL□\S, J□\X, J□\Y, J□\SB
	Local device ^{*11}	Bit device	M, V, T (contact) ^{*12} , T (coil) ^{*13} , ST (contact) ^{*12} , ST (coil) ^{*13} , C (contact) ^{*12} , C (coil) ^{*13} , LT (contact) ^{*12} , LT (coil) ^{*13} , LST (contact) ^{*12} , LST (coil) ^{*13} , LC (contact) ^{*12} , LC (coil) ^{*13}
		Bit device (Bit-specified word device)	D
		Word device	T (current value) ^{*14} , ST(current value) ^{*14} , C(current value) ^{*14} , D
		Word device (Digit-specified bit device) ^{*15}	M
		Double-word device	LT (current value) ^{*14} , LST (current value) ^{*14} , LC (current value) ^{*14}
		Double-word device (Digit-specified bit device) ^{*15}	M

- *1 Upper and lower cases of displayed label names may be different from those of label names in GX Works3.
- *2 The total of device points and label points can be specified up to 16 points in a word conversion.
However, bit devices and bit type labels can be specified up to 16 points.
- *3 Labels using a special character (such as an umlaut character) may not be specified.
- *4 Local labels in function blocks cannot be specified.
- *5 For labels of which the data type is array, specify array elements.
For labels of which the data type is structure array, specify structure member and array elements.
- *6 When specifying a label of which the data type is an array without specifying the range, the first element of the array is monitored.
(Example: when the label 'bLabel1[0..9]' is specified as 'bLabel1', the monitoring target will be 'bLabel1[0].')
- *7 When entering an element outside of the range of the array, an indefinite value will be specified. Enter an element which is in the range of the array.
- *8 Labels that are specified in digit specification cannot be specified.
- *9 Word type Labels can be specified as bits.
- *10 For labels of which the data type is structure, specify structure members.
- *11 The indirect-specified and index-modified devices cannot be specified.
- *12 T (contact), ST (contact), C (contact), LT (contact), LST (contact), and LC (contact) are specified with TS, STS, CS, LTS, LSTS, and LCS respectively.
- *13 T (coil), ST (coil), C (coil), LT (coil), LST (coil) and LC (coil) are specified with TC, STC, CC, LTC, LSTC, and LCC respectively.
- *14 T (current value), ST (current value), C (current value), LT (current value), LST (current value), and LC (current value) can be specified with T/TN, ST/STN, C/CN, LT/LTN, LST/LSTN, and LC/LCN respectively.
- *15 Digit specification for bit device is available only for K1 to K8.

Point 

- A device or label copied from another application (Example: the watch window of an engineering tool, Excel) can be pasted or inserted in the device or label column.
Operation method:
Right-click on the device or label column ⇒ select [Paste device/label copied in other application software]/ [Insert device/label copied in other application software] from the shortcut menu.
In another way to paste a copied device or label, press **Ctrl** + **Shift** + **V** keys.
- Duplicated devices or labels can be deleted.
Operation method:
After setting a monitoring target, click the [Delete Overlapped Data] button.

■The [Monitor Condition Setting] tab - "Timing Type"

Item	Description
Each Scan	Monitors data at the timing of END processing for each scan.
Condition Specification	Monitors data at the timing of the specified condition.
Time Specification	Monitors data by the specified time interval or at the timing of the first END processing after exceeding the specified time.

■The [Monitor Condition Setting] tab - "Timing Condition" - "Device/Label Specification"

Data is monitored when the specified condition of a device and label is satisfied during END processing.

Item	Description		Setting range	
Device* ¹	Global device	Bit device	X, Y, M, L, F, SM, V, B, SB, T (contact) ^{*2} , ST (contact) ^{*2} , C (contact) ^{*2} , LT (contact) ^{*2} , LST (contact) ^{*2} , LC (contact) ^{*2} , FX, FY, BL□\S, J□\X, J□\Y, J□\SB	—
		Bit device (Bit-specified word device)	D, SD, W, SW, RD, R, ZR, FD, U□\G, J□\W, J□\SW, U3E0\G	—
		Word device	T (current value) ^{*3} , ST (current value) ^{*3} , C (current value) ^{*3} , D, SD, W, SW, RD, R, ZR, Z, FD, U□\G, U3E0\G, J□\W, J□\SW	—
		Word device (Digit-specified bit device) ^{*4}	X, Y, M, L, F, SM, B, SB, BL□\S, J□\X, J□\Y, J□\SB	—
		Double-word device	LT (current value) ^{*3} , LST (current value) ^{*3} , LC (current value) ^{*3} , LZ	—
		Double-word device (Digit-specified bit device) ^{*4}	X, Y, M, L, F, SM, B, SB, BL□\S, J□\X, J□\Y, J□\SB	—
	Local device	Bit device	M, V, T (contact) ^{*2} , ST (contact) ^{*2} , C (contact) ^{*2} , LT (contact) ^{*2} , LST (contact) ^{*2} , LC (contact) ^{*2}	—
		Bit device (Bit-specified word device)	D	—
		Word device	T (current value) ^{*3} , ST(current value) ^{*3} , C(current value) ^{*3} , D	—
		Word device (Digit-specified bit device) ^{*4}	M	—
		Double-word device	LT (current value) ^{*3} , LST (current value) ^{*3} , LC (current value) ^{*3}	—
		Double-word device (Digit-specified bit device) ^{*4}	M	—
Label* ^{5,6}	Global label	VAR_GLOBAL	<ul style="list-style-type: none"> ■Basic data type/Array^{*8,9,10} <ul style="list-style-type: none"> • Bit^{*11} • Word [signed]^{*12} • Double word [signed] • Word [unsigned]^{*12} • Double word [unsigned] • Timer type • Retentive timer type • Counter type • Long timer type • Long retentive timer type • Long counter type ■Structure^{*9,10,13} 	—
		VAR_GLOBAL_RETAIN		—
	Local label* ⁷	VAR		—
		VAR_RETAIN		—
Condition Formula	<p>■A bit device is specified</p> <p>"↑": When a bit device rises Monitors data when the specified device status is changed from OFF to ON.</p> <p>"↓": When a bit device falls Monitors data when the specified device status is changed from ON to OFF.</p> <p>■A word device or double-word device is specified</p> <p>"=": When a word device value or double-word device value meet the specified value Monitors data when the current value of a specified device satisfies the condition value.</p> <p>"Change": When a word device or double-word device data is changed Monitors data when the current value of a specified device is changed.</p>		<ul style="list-style-type: none"> • Bit device specification "↑", "↓" • Word device or double-word device specification "=", "Change" 	
Radix	Specify a radix of the condition value when a word device or double-word device is specified.		"Decimal" or "Hexadecimal"	
Condition Value	Set a value to be compared with a device or label value.		<ul style="list-style-type: none"> • For a word device Decimal: -32768 to 32767 Hexadecimal: 0H to FFFFH • For a double-word device Decimal: -2147483648 to 2147483647 Hexadecimal: 0H to FFFFFFFFH 	

- *1 The indirect-specified and index-modified devices cannot be specified.
- *2 T (contact), ST (contact), C (contact), LT (contact), LST (contact), and LC (contact) are specified with TS, STS, CS, LTS, LSTS, and LCS respectively.
- *3 T (current value), ST (current value), C (current value), LT (current value), LST (current value), and LC (current value) can be specified with T/TN, ST/STN, C/CN, LT/LTN, LST/LSTN, and LC/LCN respectively.
- *4 Digit specification for bit device is available only for K1 to K8.
- *5 Upper and lower cases of displayed label names may be different from those of label names in GX Works3.
- *6 Labels using a special character (such as an umlaut character) may not be specified.
- *7 Local labels in function blocks cannot be specified.
- *8 For labels of which the data type is array, specify array elements.
For labels of which the data type is structure array, specify structure member and array elements.
- *9 When specifying a label of which the data type is an array without specifying the range, the first element of the array is monitored.
(Example: when the label 'bLabel1[0..9]' is specified as 'bLabel1', the monitoring target will be 'bLabel1[0].')
- *10 When entering an element outside of the range of the array, an indefinite value will be specified. Enter an element which is in the range of the array.
- *11 Labels that are specified in digit specification cannot be specified.
- *12 Word type Labels can be specified as bits.
- *13 For labels of which the data type is structure, specify structure members.

■The [Monitor Condition Setting] tab - "Timing Condition" - "Step No. Specification"

Data is monitored when the specified condition is satisfied immediately before the specified step is activate.

Item	Description	Setting range
Program Name	Set a program name for the program to be monitored by satisfaction of condition for the specified step No.	Up to 60 characters
Step No.	Set a step No. to monitor data by satisfaction of the condition.	0 to 1228799
Execution Condition	Select the monitoring operation condition from the following: "Always": Any time Always monitors data at the specified step. "ON": When an execution condition is ON Monitors data while the operation of the specified step is satisfied. "OFF": When an execution condition is OFF Monitors data while the operation of the specified step is not satisfied. "↑": When an execution condition rises Monitors data at the timing when the operation of the specified step turns into the satisfied state from the not-satisfied state. "↓": When an execution condition falls Monitors data at the timing when the operation of the specified step turns into the not-satisfied state from the satisfied state.	"Always" "ON" "OFF" "↑" "↓"

■The [Monitor Condition Setting] tab - "Time Specification"

Item	Description	Setting range
Time Interval	Set a time interval for monitoring the data.	1 to 32767 [ms] (unit: ms)
Monitor it by the specified time interval*1	Monitors data by the specified time interval.	—
Monitor it by the END processing after the specified time has elapsed	Monitors data at the timing of the first END processing after exceeding the specified time. When the set time interval is shorter than the scan time, data is monitored every scan time.	

*1 An error within 5% may be caused between the specified time interval and the actual time interval to monitor data.

■The [Monitor Condition Setting] tab - "Trigger Type"

A trigger mark is displayed on the graph area once a trigger is detected.

Item	Description
No Trigger	Monitors data without specifying a trigger condition.
1 Time	Stops monitoring once the specified number of records has been monitored since a trigger was detected.
Continuous	Keeps monitoring up to the monitoring stop operation, and detect triggers during the period.

■The [Monitor Condition Setting] tab - "Trigger Condition" - "Device/Label Specification"

A trigger is detected when the specified condition of a device and label is satisfied during END processing.

Item	Description		Setting range	
Device ^{*1}	Global device	Bit device	X, Y, M, L, F, SM, V, B, SB, T (contact) ^{*2} , ST (contact) ^{*2} , C (contact) ^{*2} , LT (contact) ^{*2} , LST (contact) ^{*2} , LC (contact) ^{*2} , FX, FY	—
		Bit device (Bit-specified word device)	D, SD, W, SW, RD, R, ZR, FD	—
		Word device	T (current value) ^{*3} , ST (current value) ^{*3} , C (current value) ^{*3} , D, SD, W, SW, RD, R, ZR, FD	—
		Double-word device	LT (current value) ^{*3} , LST (current value) ^{*3} , LC (current value) ^{*3}	—
	Local device	Bit device	M, V, T (contact) ^{*2} , ST (contact) ^{*2} , C (contact) ^{*2} , LT (contact) ^{*2} , LST (contact) ^{*2} , LC (contact) ^{*2}	—
		Bit device (Bit-specified word device)	D	—
		Word device	T (current value) ^{*3} , ST(current value) ^{*3} , C(current value) ^{*3} , D	—
		Double-word device	LT (current value) ^{*3} , LST (current value) ^{*3} , LC (current value) ^{*3}	—
Label ^{*4*5}	Global label	VAR_GLOBAL	■Basic data type/Array ^{*7*8*9} <ul style="list-style-type: none"> • Bit^{*10} • Word [signed] • Double word [signed] • Word [unsigned]^{*11} • Double word [unsigned]^{*11} • Timer type • Retentive timer type • Counter type • Long timer type • Long retentive timer type • Long counter type ■Structure ^{*8*9*12}	—
		VAR_GLOBAL_RETAIN		—
	Local label ^{*6}	VAR		—
		VAR_RETAIN		—
Condition Formula	■A bit device is specified "↑": When a bit device rises Generates a trigger when the specified device status is changed from OFF to ON. "↓": When a bit device falls Generates a trigger when the specified device status is changed from ON to OFF. ■A word device or double-word device is specified "=": When a word device value or double-word device value meet the specified value Generates a trigger when the current value of a specified device satisfies the condition value. "Change": When a word device or double-word device data is changed Generates a trigger when the current value of a specified device is changed.		• Bit device specification "↑," "↓" • Word device or double-word device specification "=", "Change"	
Radix	Specify a radix of the condition value when a word device or double-word device is specified.		"Decimal" or "Hexadecimal"	
Condition Value	Set a value to be compared with a device or label value.		• For a word device Decimal: -32768 to 32767 Hexadecimal: 0H to FFFFH • For a double-word device Decimal: -2147483648 to 2147483647 Hexadecimal: 0H to FFFFFFFFH	

- *1 The digit-specified bit devices, indirect-specified, or index-modified devices cannot be specified.
- *2 T (contact), ST (contact), C (contact), LT (contact), LST (contact), and LC (contact) are specified with TS, STS, CS, LTS, LSTS, and LCS respectively.
- *3 T (current value), ST (current value), C (current value), LT (current value), LST (current value), and LC (current value) can be specified with T/TN, ST/STN, C/CN, LT/LTN, LST/LSTN, and LC/LCN respectively.
- *4 Upper and lower cases of displayed label names may be different from those of label names in GX Works3.
- *5 Labels using a special character (such as an umlaut character) may not be specified.
- *6 Local labels in function blocks cannot be specified.
- *7 For labels of which the data type is array, specify array elements.
For labels of which the data type is structure array, specify structure member and array elements.
- *8 When specifying a label of which the data type is an array without specifying the range, the first element of the array is monitored.
(Example: when the label 'bLabel1[0..9]' is specified as 'bLabel1', the monitoring target will be 'bLabel1[0]'.)
- *9 When entering an element outside of the range of the array, an indefinite value will be specified. Enter an element which is in the range of the array.
- *10 Labels that are specified in digit specification cannot be specified.
- *11 Word type Labels can be specified as bits.
- *12 For labels of which the data type is structure, specify structure members.

■The [Monitor Condition Setting] tab - "Trigger Condition" - "Step No. Specification"

A trigger is detected when the specified condition is satisfied immediately before the specified step is activate.

Item	Description	Setting range
Program Name	Set a program name for the program in which a trigger is generated by satisfaction of the condition for the specified step No.	Up to 60 characters
Step No.	Set a step No. to generate a trigger by satisfaction of the condition.	0 to 1228799
Execution Condition	Select the trigger generation condition from the following: "Always": Any time Generates a trigger at the specified step. "ON": When an execution condition is ON Generates a trigger when the operation of the specified step has been satisfied. "OFF": When an execution condition is OFF Generates a trigger when the operation of the specified step is not satisfied. "↑": When an execution condition rises Generates a trigger at the timing when the operation of the specified step has turned into the satisfied state from the not-satisfied state. "↓": When an execution condition falls Generates a trigger at the timing when the operation of the specified step has turned into the not-satisfied state from the satisfied state.	"Always" "ON" "OFF" "↑" "↓"

■The [Monitor Condition Setting] tab - "Record number after trigger"

To specify the number of records from when a trigger condition is satisfied to when a monitoring is stopped, specify the number for "Record number after trigger."

Item	Description
Record number after trigger	Set the number of records to be monitored after a trigger was detected. (Dropped data occurred after trigger detection are not included in the record after trigger.) <div style="text-align: center; margin-top: 10px;"> </div>

■The [Buffer Capacity Setting] tab

Specify a buffer capacity. Insufficient buffer capacity increases the probability of processing overload occurrence.

Module	Capacity	Using in conjunction with other functions of CPU module	How to check the free buffer capacity
LHCPU	32 to 2720 KB	To use the realtime monitor function in conjunction with the data logging function and the memory dump function, set the capacity within the range that meets the following conditions. <ul style="list-style-type: none">• The total of data logging buffer capacities + Memory dump buffer capacity + Realtime monitor buffer capacity \leq 3072 KB	Can be checked with the special register, SD1484.

Point

- When setting both the device/label specification and the step number specification in "Timing Condition": Data is monitored when the condition specified in "Device/Label Specification" is satisfied in the step number specified in "Step No. Specification."
- When monitoring by specifying a time interval with the CPU module that does not support specifying a time interval:
Monitoring is performed at the fixed time interval (0.5 to 1000 ms) by setting any steps of a periodic interruption program and a periodic execution type program for "Step No. Specification" in "Timing Condition."

Restriction

- "Step No. Specification" cannot be set for ST programs, programs in FBs, SFC programs, and programs that consist of multiple elements, because their step No. cannot be checked.
- When the size of the program in a CPU module or the number of the devices to be monitored is large, the cycle that GX LogViewer monitors the data of devices may be slower than the cycle that device values change.
For example, when a bit device turn OFF and ON quickly, the trend graph of the device keeps being displayed in the ON state because the falling of the device is not recognized.

Realtime monitor setting (FX5CPU or FX5CPU simulator)

A monitor target, a monitoring condition (start/stop/timing), and the buffer capacity can be set in the "Realtime Monitor Setting" screen.

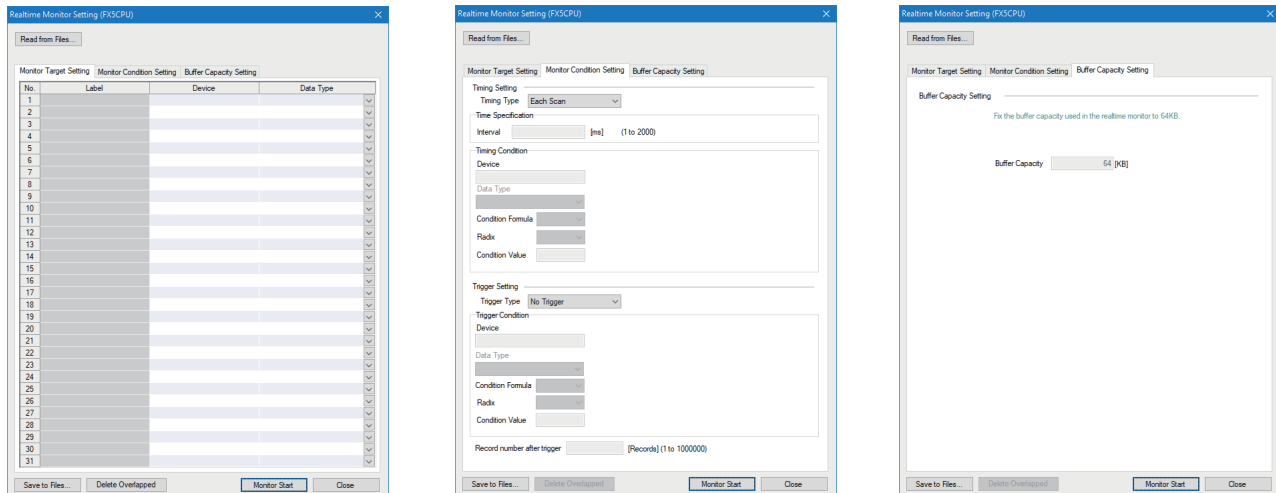

■The [Monitor Target Setting] tab

Specify a device for monitoring and its data type.

When starting GX LogViewer in the state where the devices on a program editor or on a watch window are selected in GX Works3, the selected devices are registered automatically.

However, devices whose data types are "-" on a watch window in GX Works3 are not registered automatically.

In addition, when connecting to an FX5CPU simulator, devices are not registered automatically.

Type	Device ^{*1*2*3}
Bit device	X, DX, Y, DY, M, L, F, SM, B, SB, TS (contact), TC (coil), STS (contact), STC (coil), CS (contact), CC (coil), LCS (contact), LCC (coil), BL□S ^{*4}
Word device	T (current value), ST (current value), C (current value), D, SD, W, SW, R, U□\G ^{*5}
Double-word device	LC (current value)

*1 The indirect-specified and index-modified devices cannot be specified.

*2 Digit specification of bit devices and bit specification of word devices are not available.

*3 The total of device points can be specified up to 16 points in a word conversion.
However, bit devices can be specified up to 16 points.

*4 Can be specified for only an FX5UCPU.

*5 Can be specified for only an FX5UCPU and FX5UJCPU.

Point

- A device or label copied from another application (Example: the watch window of an engineering tool, Excel) can be pasted or inserted in the device or label column.
Operation method:
Right-click on the device or label column ⇒ select [Paste device/label copied in other application software]/[Insert device/label copied in other application software] from the shortcut menu.
In another way to paste a copied device or label, press **Ctrl** + **Shift** + **V** keys.
- Duplicated devices or labels can be deleted.
Operation method:
After setting a monitoring target, click the [Delete Overlapped Data] button.

■The [Monitor Condition Setting] tab - "Timing Type"

Item	Description
Each Scan	Monitors data at the timing of END processing for each scan.
Time Specification	Monitors data at the timing of the first END processing after exceeding the specified time. When the set time interval is shorter than the scan time, data is monitored every scan time.
Condition Specification	Monitors data at the timing of the specified condition.
RTM Instruction Specification	Monitors data at the timing when the RTM instruction is executed.

■The [Monitor Condition Setting] tab - "Time Specification"

Item	Description	Setting range
Interval	Set a time interval for monitoring the data.	1 to 2000 [ms] (unit: ms)

■The [Monitor Condition Setting] tab - "Timing Condition"

Data is monitored when the specified condition of a device is satisfied during END processing.

Item	Description	Setting range
Device *1*2	Bit device X, Y, M, L, F, SM, B, SB, TS (contact), STS (contact), CS (contact), LCS (contact), BL□S ³	—
	Word device T (current value), ST (current value), C (current value), D, SD, W, SW, R, U□\G ⁴	—
	Double-word device LC (current value)	—
Condition Formula	<p>■A bit device is specified</p> <p>"↑": When a bit device rises Monitors data when the specified device status is changed from OFF to ON.</p> <p>"↓": When a bit device falls Monitors data when the specified device status is changed from ON to OFF.</p> <p>■A word device or double-word device is specified</p> <p>"=": When a word device value or double-word device value meet the specified value Monitors data when the current value of a specified device satisfies the condition value.</p> <p>"Change": When a word device or double-word device data is changed Monitors data when the current value of a specified device is changed.</p>	<ul style="list-style-type: none"> • Bit device specification "↑," "↓" • Word device or double-word device specification "=," "Change"
Radix	Specify a radix of the condition value when a word device or double-word device is specified.	"Decimal" or "Hexadecimal"
Condition Value	Set a value to be compared with a device value.	<ul style="list-style-type: none"> • For a word device Decimal: -32768 to 32767 Hexadecimal: 0H to FFFFH • For a double-word device Decimal: -2147483648 to 2147483647 Hexadecimal: 0H to FFFFFFFFH

*1 The indirect-specified and index-modified devices cannot be specified.

*2 Digit specification of bit devices and bit specification of word devices are not available.

*3 Can be specified for only an FX5UCPU.

*4 Can be specified for only an FX5UCPU and FX5UJCPU.

■The [Monitor Condition Setting] tab - "Trigger Type"

A trigger mark is displayed on the graph area once a trigger is detected.

Item	Description
No Trigger	Monitors data without specifying a trigger condition.
1 Time	Stops monitoring once the specified number of records has been monitored since a trigger was detected.
Continuous	Keeps monitoring up to the monitoring stop operation, and detect triggers during the period.

■The [Monitor Condition Setting] tab - "Trigger Condition"

A trigger is detected when the specified condition of a device is satisfied during END processing.

Item	Description	Setting range
Device ^{*1*2}	Bit device	X, Y, M, L, F, SM, B, SB, TS (contact), STS (contact), CS (contact), LCS (contact)
	Word device	T (current value), ST (current value), C (current value), D, SD, W, SW, R
	Double-word device	LC (current value)
Condition Formula	<p>■A bit device is specified</p> <p>"↑": When a bit device rises Generates a trigger when the specified device status is changed from OFF to ON.</p> <p>"↓": When a bit device falls Generates a trigger when the specified device status is changed from ON to OFF.</p> <p>■A word device or double-word device is specified</p> <p>"=": When a word device value or double-word device value meet the specified value Generates a trigger when the current value of a specified device satisfies the condition value.</p> <p>"Change": When a word device or double-word device data is changed Generates a trigger when the current value of a specified device is changed.</p>	<ul style="list-style-type: none"> • Bit device specification "↑", "↓" • Word device or double-word device specification "=", "Change"
Radix	Specify a radix of the condition value when a word device or double-word device is specified.	"Decimal" or "Hexadecimal"
Condition Value	Set a value to be compared with a device value.	<ul style="list-style-type: none"> • For a word device Decimal: -32768 to 32767 Hexadecimal: 0H to FFFFH • For a double-word device Decimal: -2147483648 to 2147483647 Hexadecimal: 0H to FFFFFFFFH

*1 The indirect-specified and index-modified devices cannot be specified.

*2 Digit specification of bit devices and bit specification of word devices are not available.

■The [Monitor Condition Setting] tab - "Record number after trigger"

To specify the number of records from when a trigger condition is satisfied to when a monitoring is stopped, specify the number for "Record number after trigger."

Item	Description
Record number after trigger	<p>Set the number of records to be monitored after a trigger was detected. (Dropped data occurred after trigger detection are not included in the record after trigger.)</p>

■The [Buffer Capacity Setting] tab

The buffer capacity setting is displayed.

Module	Capacity	How to check the free buffer capacity
FX5CPU	64 KB (fixed)	Can be checked with the special register, SD1484.

Restriction

When the size of the program in a CPU module or the number of the devices to be monitored is large, the cycle that GX LogViewer monitors the data of devices may be slower than the cycle that device values change.

For example, when a bit device turn OFF and ON quickly, the trend graph of the device keeps being displayed in the ON state because the falling of the device is not recognized.

Realtime monitor setting (LCPU)

A monitor target, a monitoring condition (start/stop/timing), and the buffer capacity can be set in the "Realtime Monitor Setting" screen.

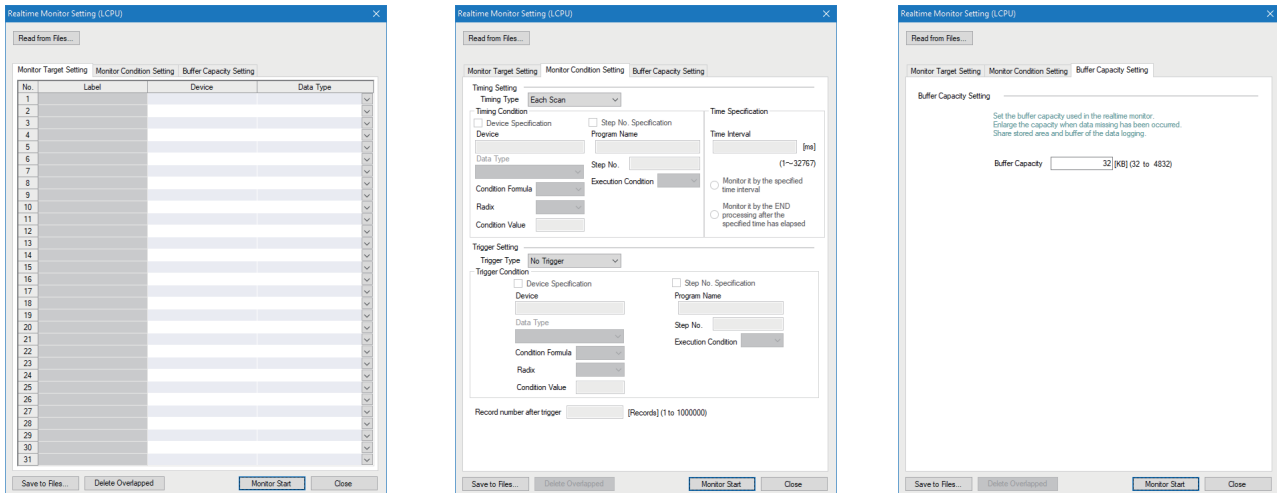

■The [Monitor Target Setting] tab

Specify a device for monitoring and its data type.

Type	Device ^{*1*2*3}
Bit device	X, DX, Y, DY, M, L, F, SM, V, B, SB, T (contact) ^{*4} , T (coil) ^{*5} , ST (contact) ^{*4} , ST (coil) ^{*5} , C (contact) ^{*4} , C (coil) ^{*5} , FX, FY, BL□\S, J□\X ^{*8} , J□\Y ^{*8} , J□\SB ^{*8}
Bit device (Bit-specified word device)	D, SD, W, SW, R, ZR, FD, U□\G ^{*8} , J□\W ^{*8} , J□\SW ^{*8}
Word device	T (current value), ST (current value), C (current value), D, SD, W, SW, R, ZR, Z ^{*6} , FD, U□\G ^{*8} , J□\W ^{*8} , J□\SW ^{*8}
Word device (Digit-specified bit device) ^{*7}	X, Y, M, L, F, SM, V, B, SB, BL□\S, J□\X ^{*8} , J□\Y ^{*8} , J□\SB ^{*8}

- *1 Although index modification can be specified, indirect specification is not available to the above devices excluding FX, FY, FD, BL□\S, and bit-specified word device.
- *2 The total of device points can be specified up to 16 points in a word conversion. However, bit devices can be specified up to 16 points.
- *3 Local device of the program set in the "Program Name" can be monitored when selecting the "Step No. Specification" on the "Timing Condition" screen.
- *4 T (contact), ST (contact), and C (contact) are specified with TS, SS, and CS respectively.
- *5 T (coil), ST (coil), and C (coil) are specified with TC, SC, and CC respectively.
- *6 'ZZ' can be also specified for index modification. It can be specified regardless of the PLC parameter setting.
- *7 Digit specification for bit device is available only for K1 to K8.
- *8 Specifying devices for modules which do not exist or inaccessible devices of a module will not result in an error, but undefined value will be displayed.

Point

- A device or label copied from another application (Example: the watch window of an engineering tool, Excel) can be pasted or inserted in the device or label column.
Operation method:
Right-click on the device or label column ⇒ select [Paste device/label copied in other application software]/ [Insert device/label copied in other application software] from the shortcut menu.
In another way to paste a copied device or label, press **Ctrl** + **Shift** + **V** keys.
- Duplicated devices or labels can be deleted.
Operation method:
After setting a monitoring target, click the [Delete Overlapped Data] button.

■The [Monitor Condition Setting] tab - "Timing Type"

Item	Description
Each Scan	Monitors data at the timing of END processing for each scan.
Condition Specification	Monitors data at the timing of the specified condition.

■The [Monitor Condition Setting] tab - "Timing Condition" - "Device Specification"

Data is monitored when the specified condition of a device is satisfied during END processing.

Item	Description	Setting range	
Device* ¹	Bit device	X, Y, M, L, F, SM, V, B, SB, T (contact)* ² , ST (contact)* ² , C (contact)* ² , FX, FY, BL□\S, J□\X, J□\Y, J□\SB	—
	Bit device (Bit-specified word device)	D, SD, W, SW, R, ZR, FD, U□\G, J□\W, J□\SW	—
	Word device	T (current value), ST (current value), C (current value), D, SD, W, SW, R, ZR, Z, FD, U□\G, J□\W, J□\SW	—
	Word device (Digit-specified bit device)* ³	X, Y, M, L, F, SM, V, B, SB, BL□\S, J□\X, J□\Y, J□\SB	—
Condition Formula	<p>■A bit device is specified</p> <p>"↑": When a bit device rises Monitors data when the specified device status is changed from OFF to ON.</p> <p>"↓": When a bit device falls Monitors data when the specified device status is changed from ON to OFF.</p> <p>■A word device is specified</p> <p>"=": When a word device meets the specified value Monitors data when the current value of a specified device satisfies the condition value.</p> <p>"Change": When a word device data is changed Monitors data when the current value of a specified device is changed.</p>	<ul style="list-style-type: none"> • Bit device specification "↑", "↓" • Word device specification "=", "Change" 	
Radix	Specify a radix of the condition value when a word device is specified.	"Decimal" or "Hexadecimal"	
Condition Value	Set a value to be compared with a device value.	<ul style="list-style-type: none"> • Decimal: -32768 to 32767 • Hexadecimal: 0H to FFFFH 	

*1 Index modification can be specified to above devices excluding FX, FY, FD, BL□\S, and bit-specified word device. The indirect-specified T, C, ST, D, W, SW, R, ZR, U□\G, J□\W, and J□\SW can be specified.

*2 T (contact), ST (contact), and C (contact) are specified with TS, SS, and CS respectively.

*3 Digit specification for bit device is available only for K1 to K4.

■The [Monitor Condition Setting] tab - "Timing Condition" - "Step No. Specification"

Data is monitored when the specified condition is satisfied immediately before the specified step is activate.

Item	Description	Setting range
Program Name	Set a program name for the program to be monitored by satisfaction of condition for the specified step No.	Up to 8 characters
Step No.	Set a step No. to monitor data by satisfaction of the condition.	0 to 266239
Execution Condition	Select the monitoring operation condition from the following: "Always": Any time Always monitors data at the specified step. "ON": When an execution condition is ON Monitors data while the operation of the specified step is satisfied. "OFF": When an execution condition is OFF Monitors data while the operation of the specified step is not satisfied. "↑": When an execution condition rises Monitors data at the timing when the operation of the specified step turns into the satisfied state from the not-satisfied state. "↓": When an execution condition falls Monitors data at the timing when the operation of the specified step turns into the not-satisfied state from the satisfied state.	"Always" "ON" "OFF" "↑" "↓"

■The [Monitor Condition Setting] tab - "Trigger Type"

A trigger mark is displayed on the graph area once a trigger is detected.

Item	Description
No Trigger	Monitors data without specifying a trigger condition.
1 Time	Stops monitoring once the specified number of records has been monitored since a trigger was detected.
Continuous	Keeps monitoring up to the monitoring stop operation, and detect triggers during the period.

■The [Monitor Condition Setting] tab - "Trigger Condition" - "Device Specification"

A trigger is detected when the specified condition of a device is satisfied during END processing.

Item	Description	Setting range
Device ^{*1}	Bit device X, Y, M, L, F, SM, V, B, SB, T (contact) ^{*2} , ST (contact) ^{*2} , C (contact) ^{*2} , FX, FY	—
	Bit device (Bit-specified word device) D, SD, W, SW, R, ZR, FD	—
	Word device T (current value), ST (current value), C (current value), D, SD, W, SW, R, ZR, FD	—
Condition Formula	■A bit device is specified "↑": When a bit device rises Generates a trigger when the specified device status is changed from OFF to ON. "↓": When a bit device falls Generates a trigger when the specified device status is changed from ON to OFF. ■A word device is specified "=": When a word device meets the specified value Generates a trigger when the current value of a specified device satisfies the condition value. "Change": When a word device data is changed Generates a trigger when the current value of a specified device is changed.	• Bit device specification "↑", "↓" • Word device specification "=", "Change"
Radix	Specify a radix of the condition value when a word device is specified.	"Decimal" or "Hexadecimal"
Condition Value	Set a value to be compared with a device value.	• Decimal: -32768 to 32767 • Hexadecimal: 0H to FFFFH

*1 The indirect-specified and index-modified devices cannot be specified.

*2 T (contact), ST (contact), and C (contact) are specified with TS, SS, and CS respectively.

■The [Monitor Condition Setting] tab - "Trigger Condition" - "Step No. Specification"

A trigger is detected when the specified condition is satisfied immediately before the specified step is activate.

Item	Description	Setting range
Program Name	Set a program name for the program in which a trigger is generated by satisfaction of the condition for the specified step No.	Up to 8 characters
Step No.	Set a step No. to generate a trigger by satisfaction of the condition.	0 to 266239
Execution Condition	Select the trigger generation condition from the following: "Always": Any time Generates a trigger at the specified step. "ON": When an execution condition is ON Generates a trigger when the operation of the specified step has been satisfied. "OFF": When an execution condition is OFF Generates a trigger when the operation of the specified step is not satisfied. "↑": When an execution condition rises Generates a trigger at the timing when the operation of the specified step has turned into the satisfied state from the not-satisfied state. "↓": When an execution condition falls Generates a trigger at the timing when the operation of the specified step has turned into the not-satisfied state from the satisfied state.	"Always" "ON" "OFF" "↑" "↓"

■The [Monitor Condition Setting] tab - "Record number after trigger"

To specify the number of records from when a trigger condition is satisfied to when a monitoring is stopped, specify the number for "Record number after trigger."

Item	Description
Record number after trigger	<p>Set the number of records to be monitored after a trigger was detected. (Dropped data occurred after trigger detection are not included in the record after trigger.)</p>

■The [Buffer Capacity Setting] tab

Specify a buffer capacity. Insufficient buffer capacity increases the probability of processing overload occurrence.

For details on processing overload, refer to the following:

 QnUDVCPU/LCPU User's Manual (Data Logging Function)

Module	Capacity	Using in conjunction with other functions of CPU module	How to check the free buffer capacity
LCPU	32 to 4832 KB	<p>To use the realtime monitor function in conjunction with the data logging function, set the capacity within the range that meets the following conditions.</p> <ul style="list-style-type: none"> The total of data logging buffer capacities + Realtime monitor buffer capacity \leq 5120 KB <p>The buffer capacity for the data logging function can be checked by reading the logging setting from the CPU module with CPU Module Logging Configuration Tool.</p> <p> QnUDVCPU/LCPU User's Manual (Data Logging Function)</p>	Can be checked with the special register, SD830.

Point

- When setting both the device specification and the step number specification in "Timing Condition": data is monitored when the specified condition is satisfied in the specified step.
- When monitoring by specifying a time interval:
Monitoring is performed at the fixed time interval (0.5 to 1000 ms) by setting any steps of a periodic interruption program and a periodic execution type program for "Step No. Specification" in "Timing Condition."

Restriction

When the size of the program in a CPU module or the number of the devices to be monitored is large, the cycle that GX LogViewer monitors the data of devices may be slower than the cycle that device values change.

For example, when a bit device turn OFF and ON quickly, the trend graph of the device keeps being displayed in the ON state because the falling of the device is not recognized.

Considerations for setting the step number specification in the timing condition

When a realtime monitor is performed, scan time is increased by the realtime monitor processing time.

Set the watchdog timer, and create the interrupt program (set the fixed cycle interval) in consideration of the realtime monitor processing time.

Realtime monitor processing time

The time increase of the scan time when the realtime monitor function is performed can be calculated using the calculation formula below:

Time increase of scan time

$$T_{rm} = KM1 + (KM2 \times N1) + (KM3 \times N2) [\mu s]$$

T_{rm} : Time increase of scan time when the realtime monitor function is performed

$N1$: Number of word device points

$N2$: Number of bit device points

$KM1$: Constant (Common processing time)

$KM2$: Constant (Word device processing time)

$KM3$: Constant (Bit device processing time)

- Global label, global device (X, Y, M, L, B, F, SB, V, T, ST, C, LT, LST, LC, D, W, SW, FX, FY, SM, FD, SD, BL□\S)

Constant name	R00/R01/R02CPU	R04CPU	R08/R16/R32/R120CPU	R08/R16/R32/R120SFCPU	L04HCPU	L08H/L16H/L32HCPU	L26CPU/L26CPU-BT	L06CPU	L02CPU
KM1	149.00	149.00	149.00	149.00	149.00	149.00	64.00	74.00	79.00
KM2	3.20	3.20	3.20	3.20	3.20	3.20	0.56	0.60	0.68
KM3	0.80	0.80	0.80	0.80	0.80	0.80	0.75	0.87	0.95

- File register (R, ZR)

Constant name	R00/R01/R02CPU	R04CPU	R08/R16/R32/R120CPU	R08/R16/R32/R120SFCPU	L04HCPU	L08H/L16H/L32HCPU	L26CPU/L26CPU-BT	L06CPU	L02CPU
KM1	149.00	149.00	149.00	149.00	149.00	149.00	64.00	74.00	79.00
KM2	3.50	3.50	3.50	3.50	3.50	3.50	0.66	0.70	0.78
KM3	1.10	1.10	1.10	1.10	1.10	1.10	0.91	1.03	1.11

- Module access device (U□\G, U3E□\G, U3E□\HG), link direct device (J□\W, J□\X, J□\SW, J□\Y, J□\SB, J□\B^{*1})

*1 LHCPUs and LCPUs do not support it.

Constant name	R00/R01/R02CPU	R04CPU	R08/R16/R32/R120CPU	R08/R16/R32/R120SFCPU	L04HCPU	L08H/L16H/L32HCPU	L26CPU/L26CPU-BT	L06CPU	L02CPU
KM1	180.00	156.00	156.00	156.00	156.00	156.00	112.00	125.12	128.10
KM2	11.30	11.60	11.60	11.60	14.40	14.40	12.00	14.20	14.50
KM3	12.80	8.90	8.90	8.90	13.80	13.80	13.50	15.00	15.06

- Local device (M, V, T, ST, C, LT, LST, LC, D), local label

Constant name	R00/R01/R02CPU	R04CPU	R08/R16/R32/R120CPU	L04HCPU	L08H/L16H/L32HCPU
KM1	149.00	149.00	149.00	149.00	149.00
KM2	8.80	6.20	6.20	6.20	6.20
KM3	5.80	3.10	3.10	3.10	3.10

Case where unable to start or stop the realtime monitor function

When a project loaded into GX LogViewer is not matched with that in an RCP or LHCP, the realtime monitor function is locked (exclusive control) to prevent the data inconsistency.

■The realtime monitor function cannot be started

Before performing the realtime monitor function, when changing a setting item in the realtime monitor setting and re-writing the data including the change to an RCP or LHCP by using any of the following functions, the data will not be matched with that loaded into GX LogViewer. The data is exclusively controlled, therefore the realtime monitor function cannot be started.

○: Can be started, —: Cannot be started

Function	File	Specified item in the realtime monitor setting				
		Global device	Local device	Global label	Local label	Step number
Online program change	Program file	○	○	—	—	—
File batch online change	Global label setting file	○	○	—	—	—
Writing data to a programmable controller	CPU parameter file	○	—	○	—	○
Data restoration (CPU module)	Program file	○	○	○	—	—
File transfer (FTP server) SLMP communication	Global label setting file	○	○	—	○	○

■The realtime monitor function is stopped

While performing the realtime monitor function, when changing a setting item in the realtime monitor setting and re-writing the data including the change to an RCP or LHCPU by using any of the following functions, the realtime monitor function will be stopped due to the exclusive control.

Depending on whether the 15th bit of SD940 is ON or OFF, the functions and files which stop the real-time monitor function are different.

For details, refer to 'Point' in the following section.

☞ Page 118 Specifying a label

• The 15th bit of SD940 is OFF:

○: Continued, —: Stopped

Function	File	Specified item in the realtime monitor setting				
		Global device	Global device	Global label	Local label	Step number
Online program change	Program file	○	○	○	○	—
File batch online change	Global label setting file	○	○	○	○	○
Writing data to a programmable controller	CPU parameter file	○	—	○	—	○
Data restoration (CPU module)	Program file	○	○	○	○	—
File transfer (FTP server) SLMP communication	Global label setting file	○	○	○	○	○

• The 15th bit of SD940 is ON:

○: Continued, —: Stopped

Function	File	Specified item in the realtime monitor setting				
		Global device	Local device	Global label	Local label	Step number
Online program change	Program file	○	○	○	—	—
File batch online change	Global label setting file	○	○	—	○	○
Writing data to a programmable controller	CPU parameter file	○	—	○	—	○
Data restoration (CPU module)	Program file	○	○	○	—	—
File transfer (FTP server) SLMP communication	Global label setting file	○	○	—	○	○

Operating monitoring status of the realtime trend/realtime monitor function

Type	Target for explanation ( Page 13 Target modules, simulators, files, and data for explanation)
Module	RCPU, LHCPU, FX5CPU, LCPU, BOX, R logger, Q logger, R communication, Q communication, R motion module
Simulator	RCPU simulator, FX5CPU simulator, R motion module simulator

Changing the monitoring status and controlling a graph can be performed by using the realtime trend or realtime monitor function.

Function name	Supported module
Realtime trend	Data logger and data communication
Realtime monitor	RCPUs, RCPU simulator, motion modules, motion module simulator, LHCPUs, FX5CPUs, FX5CPU simulator, and LCPUs

Operating procedure

■Starting monitoring

- Select [Online] ⇒ [Begin Monitor] ().

This operation starts the communication with a module, and turns the monitoring status from Stop to Run.

■Stopping monitoring

- Select [Online] ⇒ [End Monitor] ().

This operation disconnects the communication with a module, and stops a trend graph drawing.

■Pausing graph update

- Select [Online] ⇒ [Pause Monitor] ().

This operation suspends a trend graph drawing with communication continued. (Data sampling is continued.)

■Restarting graph update

- Select [Online] ⇒ [Restart Monitor] ().

This operation restarts the trend graph drawing from the monitoring paused status.

The data sampled while the monitoring had been paused is not displayed on the graph temporarily, but it is displayed on the trend graph after the monitoring is restarted.

■Clearing graphs

- Select [Online] ⇒ [Clear Graph] ().



This operation clears trend graphs being drawn in the graph area.

Graph drawing for the data being sampled is restarted immediately after clearing.

8.4 Checking Data

Type	Target for explanation ( Page 13 Target modules, simulators, files, and data for explanation)
Module	RCPU, LHCPU, FX5CPU, QnUDVCP, LCP, R analog, Q analog, L analog, BOX, R logger, Q logger, R communication, Q communication, R motion module, R motion controller
Simulator	RCPU simulator, FX5CPU simulator, R motion module simulator
Others	Offline monitor, others

This section explains how to check data displayed in the trend window.

-  Page 152 Checking and comparing data values/statuses
-  Page 154 Adding a log marker to data
-  Page 159 Changing the data to be displayed in the graph area

Checking and comparing data values/statuses

The data values/statuses on the trend graph can be checked and compared.

Ex.

When linking with the GX Works3 offline monitor function

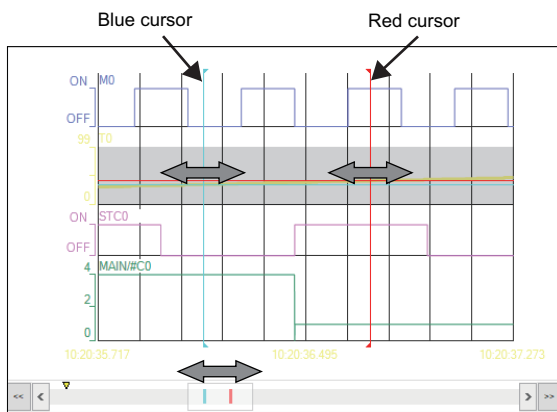



Point

When linking with the GX Works3 offline monitor function and displaying recording file data, a device comment is displayed on the tooltip by placing the mouse cursor on a data name in the graph area.

Precautions

- Stop or pause the monitoring when operating the cursors on the Realtime trend graph/Realtime monitor graph.
- The Multiple cursor function needs to be activated to display the blue cursor.

For details on the Multiple cursor function and the difference information area, refer to the following:

-  Page 199 Displaying multiple cursors
-  Page 105 Difference information area

Moving cursors

Operating procedure

■ Moving the red cursor or blue cursor

Drag the red cursor/blue cursor to the right/left using a mouse.

In another way, press the **Ctrl** + **←**/**→** keys for the red cursor and press **Shift** + **←**/**→** keys for the blue cursor.

■ Moving the red cursor and the blue cursor simultaneously

Drag the red cursor or the blue cursor while pressing the **Shift** + **Ctrl** keys.

In another way, press the **Shift** + **Ctrl** + **←**/**→** keys.

■ Moving to both the red cursor and the blue cursor to where the mouse cursor is placed over

While multiple cursors are displayed, right-click and select [Move Red and Blue Cursors Here] from the shortcut menu.

■ Moving graph only without moving cursors

Move the scroll bar or map bar to the right/left in the trend window.

In another way, press the **PgUp**/**PgDown** key (moving the scroll bar or map bar to the right/left), or press the **Home**/**End** key (moving the scroll bar or map bar to the right/left periphery).

■ Moving the cursor by specifying value/time/index

The cursor can be moved to the specified position (value/time/index) by using the cursor jump function.

For details on the cursor jump function, refer to the following:

 Page 167 Moving cursor by specifying value/time/index

Checking a data value/status

Operating procedure

■ Checking value/status using red cursor

1. Move the red cursor to the position where the value/status is checked.
2. Check the values displayed on the cursor value and the cursor time/index field on the status bar.

■ Checking value/status using blue cursor

1. Move the blue cursor to the position where the value/status is checked.
2. Check the values displayed in "Value (Blue)" and "Time (Blue)/Index (Blue)" in the difference information area.

Point

- Data value/status can also be displayed at the cursor label by selecting [Graph View] ⇒ [Cursor Label] (.
- The cursor may be moved to the intervening space of plots for an unselected file. In this case, the data value at the cursor is displayed as an estimated value obtained by linear interpolation, and displayed in parentheses.

Comparing data values/status

Operating procedure

1. Move the red cursor and the blue cursor to the two positions where data value/status are compared.
2. Compare the data values/status by the difference of the value displayed in "Difference (Blue → Red)" and "Span (Blue → Red)" in the difference information area.

Adding a log marker to data

Log markers can be added to data being displayed in the historical window.

This function will be useful for analyzing data by adding log markers to any data to be analyzed.

Ex.

When linking with the GX Works3 offline monitor function

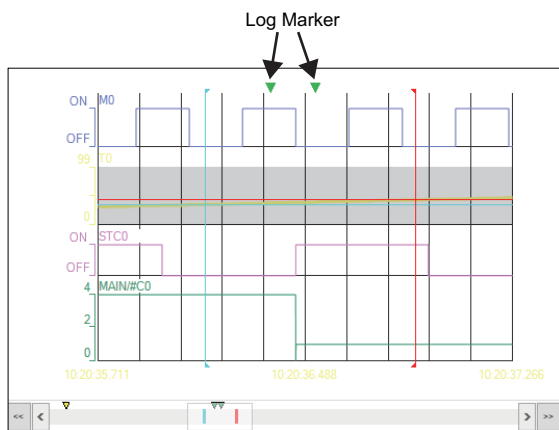

Up to 100 log markers can be added per file.

Added log markers are saved as a log marker information file (*.lmc, *.lms) in a folder where a file in which log markers are added is stored. (Example: when adding log markers to a logging file whose name is "0001.bin," a log marker information file with the name "0001.bin.lmc" is generated in the folder where the logging file is stored.)

When a log marker information file already exists in the folder where a file in which log markers are added is stored, the existing log marker information file will be overwritten.

A log marker information file can be shared with GX Works3 and GX VideoViewer. Sharable log marker information is as follows:

Sharing with GX Works3

Description	Operating procedure
When linking with the GX Works3 offline monitor function, the operations shown in the right column are automatically synchronized with GX Works3.	<ul style="list-style-type: none"> Page 156 Adding a log marker Page 156 Deleting a log marker Page 156 Moving the red cursor to the position of a log marker Page 157 Deleting all log markers Page 158 Editing a comment and color of a log marker
When not linking with the GX Works3 offline monitor function, a log marker information file generated in GX Works3 can be read.	Page 156 When not linking with the GX Works3 offline monitor function

For details on the operations for a log marker in GX Works3, refer to the following:

GX Works3 Operating Manual

Sharing with GX VideoViewer

Description	Operating procedure
When opening a video file in GX VideoViewer, log marker information can be read from a video file selected in the window of GX VideoViewer.	Page 157 When opening a video file in GX VideoViewer
When not opening a video file in GX VideoViewer, a log marker information file generated in GX VideoViewer can be read.	Page 157 When not opening a video file in GX VideoViewer

For details on the operations for a log marker in GX VideoViewer, refer to the following:

GX VideoViewer Version 1 Operating Manual

Precautions

To use all the log marker functions described in this manual, install the latest GX LogViewer, GX Works3, and GX VideoViewer.

The extension of a log marker information file differs depending on the tool used to generate the file and its software version.

■Extension of a log marker information file

Extension	Tool that generates a log marker information file	Version
*.lms	GX LogViewer	1.106K
	GX Works3	1.065T and 1.066U
*.lmcs	GX LogViewer	1.112R or later
	GX Works3	1.070Y or later
*.vms	GX VideoViewer	—

The following restrictions apply depending on the software version of each tool.

■Sharing log marker information with GX Work3

GX LogViewer version	GX Works3 (1.065T and 1.066U)	GX Works3 (1.070Y or later)
1.106K	<ul style="list-style-type: none"> A comment and color cannot be edited. When linking with the GX Works3 offline monitor function, log marker information can be shared; however, the information is not automatically synchronized. <p>To reflect changes made in log marker information after adding or deleting log markers either in GX LogViewer or GX Works3, add or delete a log marker or read log marker information in the other tool.</p>	<ul style="list-style-type: none"> Log marker information cannot be shared or synchronized. A log marker information file (*.lmcs) generated in GX Works3 (1.070Y or later) cannot be read in GX LogViewer (1.106K).
1.112R or later	<ul style="list-style-type: none"> Log marker information cannot be shared or synchronized. A log marker information file (*.lmcs) generated in GX LogViewer (1.112R or later) cannot be read in GX Works3 (1.065T and 1.066U). 	<p>For available functions, refer to the following:</p> <p>☞ Page 154 Sharing with GX Works3</p>

■Sharing log marker information with GX VideoViewer



A log marker information file (*.vms) generated in GX VideoViewer can be read in GX LogViewer (1.106K); however, the comments and colors edited in GX VideoViewer are not applied.

■Reading a log marker information file generated in GX LogViewer

A log marker information file (*.lmcs) generated in GX LogViewer (1.112R or later) cannot be read in GX LogViewer (1.106K).





Adding a log marker

Operating procedure

1. Move the red cursor to the position of a log marker to be added.
2. Select [Graph Operation] ⇒ [Add/Delete Log Marker to Red Cursor Location] ().
Alternatively, press the  +  keys.



Deleting a log marker

Operating procedure





1. Move the red cursor to the position of a log marker to be deleted.
 Page 156 Moving the red cursor to the position of a log marker
2. Select [Graph Operation] ⇒ [Add/Delete Log Marker to Red Cursor Location] ().
Alternatively, press the  +  keys.

Moving the red cursor to the position of a log marker

Operating procedure

Select [Graph Operation] ⇒ [Move Red Cursor to Previous Log Marker Location] () or [Move Red Cursor to Next Log Marker Location] ().

Alternatively, the red cursor can be moved to the log marker position by pressing the following shortcut keys:

-  +  (moves the red cursor to the previous log marker position)
-  +  (moves the red cursor to the next log marker position)

When linking with the GX Works3 offline monitor function, the slider on the seek bar in GX Works3 moves as the red cursor is moved in GX LogViewer.

Reading log marker information of GX LogViewer or GX Works3

■When linking with the GX Works3 offline monitor function

Log marker information of GX LogViewer and GX Works3 is synchronized automatically.

■When not linking with the GX Works3 offline monitor function

Operating procedure

1. Select [Graph Operation] ⇒ [Read Log Marker Information] ().
2. Select a log marker information file (*.lmcs, *.lms) from a folder where a file in which log markers are added is stored, and then click the [Open] button. (Example: when reading log marker information from a logging file whose name is "0001.bin," select a log marker information file with the name "0001.bin.lmcs" in a folder where the logging file is stored.)



Note that when reading a log marker information file, in which a log marker is present at the same position as the existing log marker, the comment and color information of log marker in the log marker information file will not be applied.

Reading log marker information of GX VideoViewer.

■When opening a video file in GX VideoViewer

Operating procedure

Select [Graph Operation] ⇒ [Read Log Marker Information from GX VideoViewer] ().

Alternatively, press the  +  keys.

Note that when reading log marker information from a video file, in which a log marker is present at the same position as the existing log marker, the comment and color information of log marker in the video file will not be applied.

■When not opening a video file in GX VideoViewer

Operating procedure

1. Select [Graph Operation] ⇒ [Read Log Marker Information] ().
2. Select a log marker information file (*.vms) from a folder where a video file (*.mkv) in which log markers are added in GX VideoViewer is stored, and then click the [Open] button. (Example: when reading log marker information from a video file whose name is "0002.mkv," select a log marker information file with the name "0002.mkv.vms" in a folder where the video file is stored.)

Note that when reading a log marker information file, in which a log marker is present at the same position as the existing log marker, the comment and color information of log marker in the log marker information file will not be applied.

Deleting all log markers

Operating procedure

Select [Graph Operation] ⇒ [Delete All Log Markers] ().

When linking with the GX Works3 offline monitor function and displaying a recording file exceeding the maximum number of records that can be displayed in GX LogViewer, all log markers out of the display range are also deleted.

Editing a comment and color of a log marker

Operating procedure

1. Select [Graph Operation] ⇒ [Edit Comment/Color of Log Marker] (🌐).
Alternatively, press the **[Ctrl]+[E]** keys.
The following screen appears.

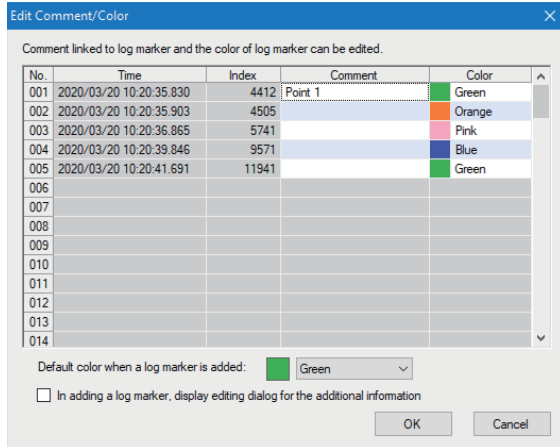

2. To edit a comment: Click the "Comment" column for a log marker, and enter a comment (up to 256 characters).
To change a color: Select any color from the pull-down list of the "Color" column for a log marker.
3. Click the [OK] button.

Point

- The default color for a new log marker can be changed from the pull-down list of "Default color when a log marker is added."
- By selecting the checkbox of "In adding a log marker, display editing dialog for the additional information," the "Edit Comment/Color" screen appears every time a log marker is added.

Precautions

In the "Index" of the "Edit Comment/Color" screen, values which are incremented by one from the start of currently displayed trend graph are displayed. Therefore, values may be different from the index values in a data logging file that are displayed in the graph area and status bar.

Changing the data to be displayed in the graph area

Data to be displayed in the graph area can be changed, added, or deleted.

Window

Select [Graph View] ⇒ [Change the Data to Draw Graphs] (F8).

Alternatively, press the **Ctrl** + **U** keys.

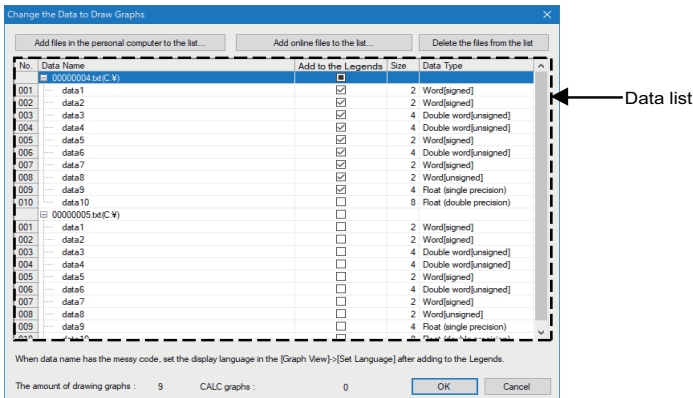

When linking with the GX Works3 offline monitor function and displaying recording file data, the following screen is displayed:

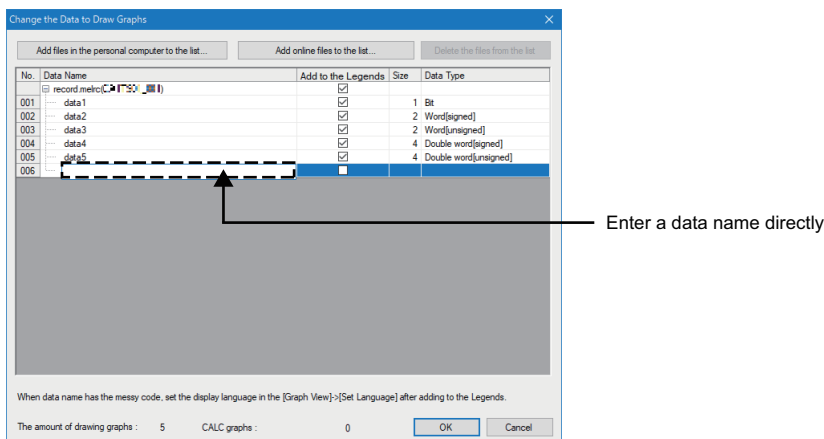

When displaying device comments in the graph legend area, the following screen is displayed:

A content of the device comment column in the following screen is the same as that of the device comment column in the graph legend area.

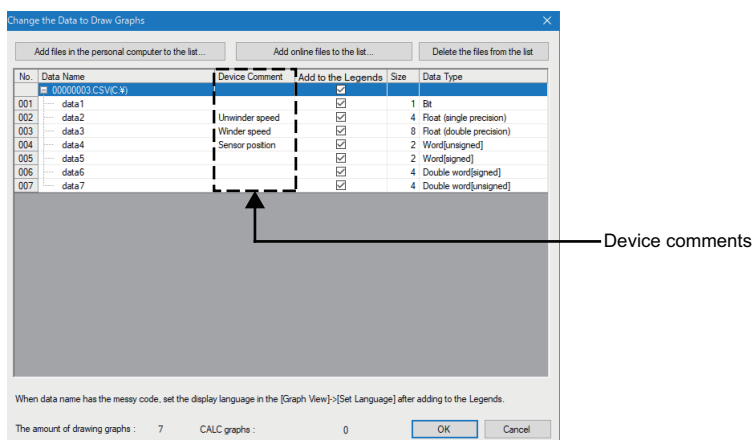

For the method for displaying device comments in the graph legend area, refer to the following:

Page 102 Graph legend area

Adding/deleting data to/from the graph legend area

The data for displaying in the graph legend area can be added or deleted.

Operating procedure

■ Adding data to graph legend area

Select the checkbox of data to be displayed in the graph legend area, and click the [OK] button.

■ Deleting data from graph legend area

Unselect the data to be deleted on the graph legend area, and click the [OK] button.

Adding/deleting data to/from a data list

When linking with the GX Works3 offline monitor function and displaying recording file data in GX LogViewer, maximum 32 data sets can be added to the data list by entering the data name directly into the list. Additionally, data in the data list can be deleted.

Operating procedure

■ Adding a data name

1. Enter a label or device name directly into a blank row, and press the key.
2. Click the [OK] button.

■ Deleting a data name

1. Clear a row where a label or device name has been entered, and press the key.
2. Click the [OK] button.

Adding/deleting logging data in another file

Logging data in another file can also be added to or deleted from the graph legend area on the same trend window. When the equidistance plot display format is set for the graph display format, it will be changed to the time interval plot display format by adding logging data in another file.

For details on the time interval plot display format, refer to the following:

☞ Page 205 Changing graph plot formats

Operating procedure

■ Adding data stored in a personal computer to graph legend area

1. Click the [Add files in the personal computer to the list] button and select a file to be added.
2. Select the checkbox of data to be displayed in the graph legend area, and click the [OK] button.
Note that CALC data in the file cannot be added.

■ Adding data stored in a personal computer to the graph legend area (when adding a recording file of which the total number of records is 100,001 or more)

1. Click the [Add files in the personal computer to the list] button and select a file to be added.
2. Set the display range by moving the bar in the "Waveform Display Range Specification" screen and click the [Open] button.

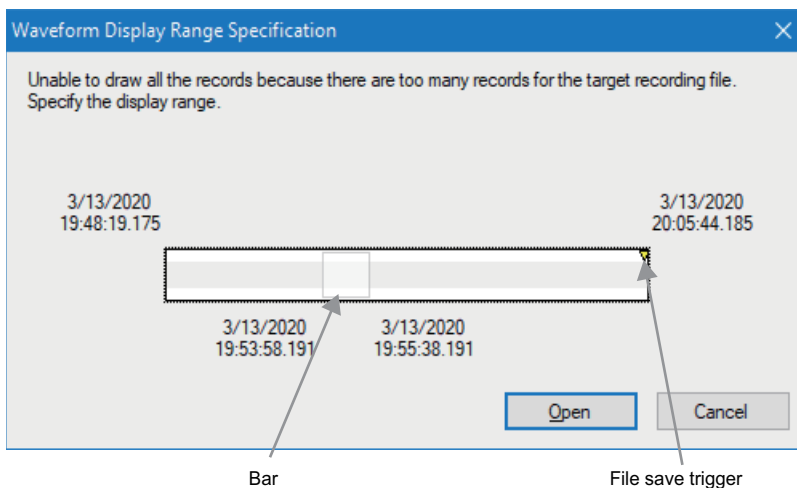

3. Select the checkbox of data to be displayed in the graph legend area, and click the [OK] button.

■ Adding data stored in target module to graph legend area

1. Click the [Add online files to the list] button, and set the connection destination. (☞ Page 75 CONNECTING TO MODULE)
2. Select the file to be added on the "Logging File" screen and click the [Open File] button.
3. Select the checkbox of data to be displayed in the graph legend area, and click the [OK] button.

■ Deleting added file

Select the file to be deleted on a data list, and click the [Delete the files from the list] button.

Point

The file can also be added by dragging and dropping the data logging file saved in a personal computer onto a data list.

Changing the display range of data

When selecting a recording file whose total number of records is 50,001 or more at the start of the GX Works3 offline monitor function and displaying it in a waveform in GX LogViewer, 50,000 records of data whose range is centered at the position of a slider on a seek bar in GX Works3 are displayed.

Operating procedure

■ Changing the display range using a bar

1. Select [Graph Operation] ⇒ [Change Waveform Display Range].
2. Set the display range by moving the bar in the "Change Waveform Display Range" screen and click the [Open] button.

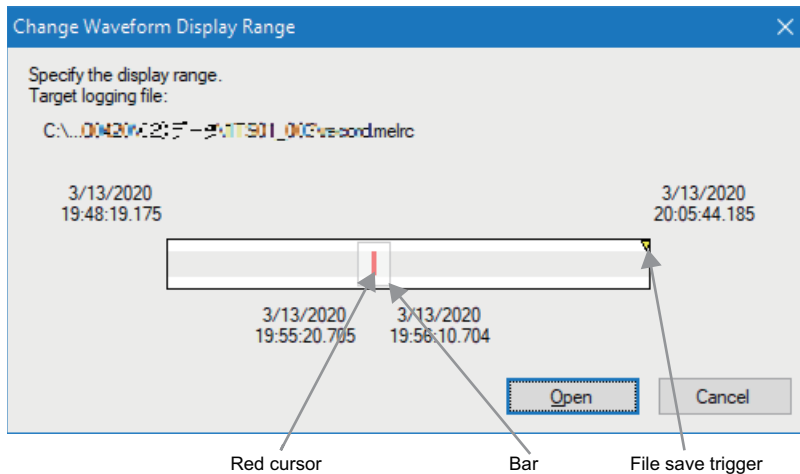

■ Displaying the previous or next data of displayed data

By the following procedure, up to 100,000 records of data can be displayed.

1. Select [Graph Operation] ⇒ [Show Previous Graph] (⏪) or [Show Next Graph] (⏩).
2. Click the [<<] or [>>] button.

Ex.

When selecting [Show Previous Graph] (⏪)

- (1) By clicking [<<] while displaying 50,000 records of data, the additional 50,000 records are added in front of the records being displayed; thus, totally 100,000 records are displayed.
- (2) By clicking the [<<] button while displaying 100,000 records of data, the latest 50,000 out of the 100,000 records are deleted and the additional 50,000 records, which are older than the displaying data range, are added.

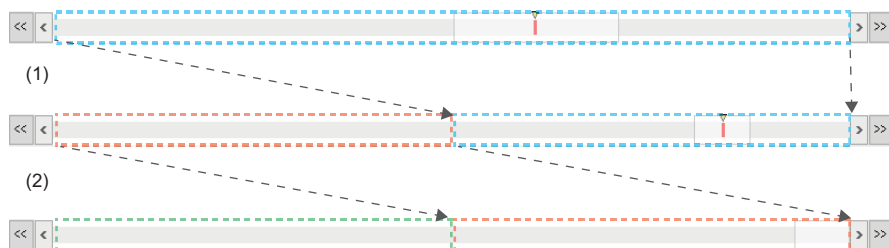













When linking with the GX Works3 offline monitor function and displaying a recording file exceeding the total number of records that can be displayed in GX LogViewer, the cursor value and cursor time of the red cursor may be displayed as "Out of Display Range." For checking the cursor value and cursor time, change the data display range according to the procedure in this section or move a slider on a seek bar in GX Works3 to make the red cursor be positioned within the display range. For checking the cursor value and cursor time, change the data display range according to the procedure in this section or move a slider on a seek bar in GX Works3 to make the red cursor be positioned within the display range.



8.5 Operating Trend Graphs

Type	Target for explanation ( Page 13 Target modules, simulators, files, and data for explanation)
Module	RCPU, LHCPU, FX5CPU, QnUDVCPU, LCPU, R analog, Q analog, L analog, BOX, R logger, Q logger, R communication, Q communication, R motion module, R motion controller
Simulator	RCPU simulator, FX5CPU simulator, R motion module simulator
Others	Offline monitor, others

This section explains the operation methods of trend graphs to improve the data check efficiency.

-  Page 164 Displaying/hiding graphs
-  Page 166 Aligning graphs
-  Page 166 Superimposing graphs
-  Page 167 Moving cursor by specifying value/time/index
-  Page 174 Switching the graph display method
-  Page 175 Specifying the upper and lower bounds/Y axis scale
-  Page 179 Specifying a division value of grids
-  Page 182 Displaying an operation result of the CALC function (CALC data) on a trend graph
-  Page 189 Widening/narrowing the display scale
-  Page 190 Moving graph up/down/left/right
-  Page 191 Synchronizing the time
-  Page 192 Expanding/reducing the time scale
-  Page 193 Displaying the previous or next trend graph consecutively

Point

- Graph display information can be named and registered to apply for another window. ( Page 211 Registering and Applying a Graphical Display Setting)
- The graph display can be set to automatically apply the setting when a window with the same data logging setting is opened next time. ( Page 214 Applying the Graph Display Automatically When Opening a Window)

Displaying/hiding graphs

A trend graph can be displayed or hidden in a graph area.

Individual display/hide

A trend graph can be displayed or hidden in a graph area by selecting the data individually from the graph legend area.

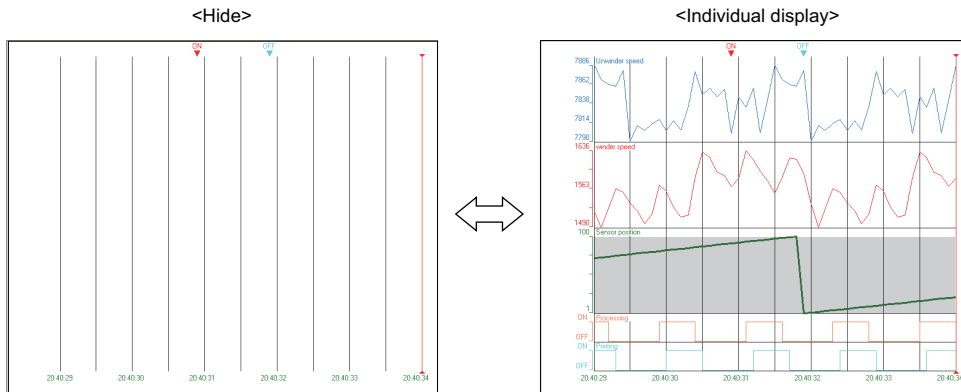

Operating procedure

Whether to display or hidden a graph can be changed with the checkboxes in the graph legend area.

- To display a graph, select the checkbox of the corresponding data.
- To hide a graph, unselect the checkbox if the corresponding data.

	Data Name	Value
<input type="checkbox"/>	Sensor Positioning	120
<input checked="" type="checkbox"/>	Reel Speed	0.866025
<input checked="" type="checkbox"/>	SensorA	ON
<input type="checkbox"/>	SensorB	ON
<input type="checkbox"/>	Measured ValueA	12100

Batch display

The trend graphs of all the data listed in the graph legend area can be displayed.

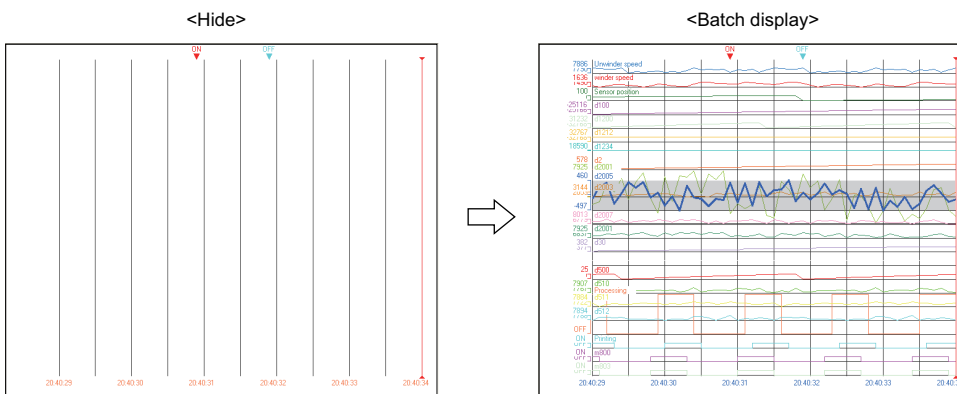

Operating procedure

Select [Graph View] ⇒ [Show All Graphs] ().

Batch hide

The trend graphs of all the data listed in the graph legend area can be hidden.

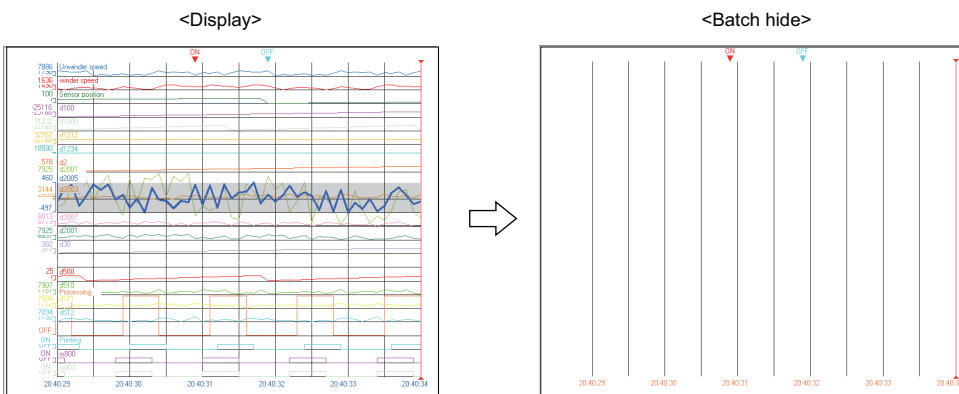

Operating procedure

Select [Graph View] ⇒ [Hide All Graphs] ().

Aligning graphs

All the trend graphs displayed in the graph area can be aligned without overlapping. Trend graphs are aligned in the order of data listed in the graph legend area.

<Before alignment>

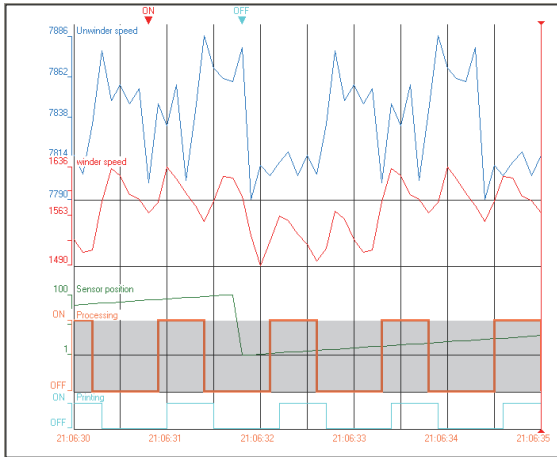

<After alignment>

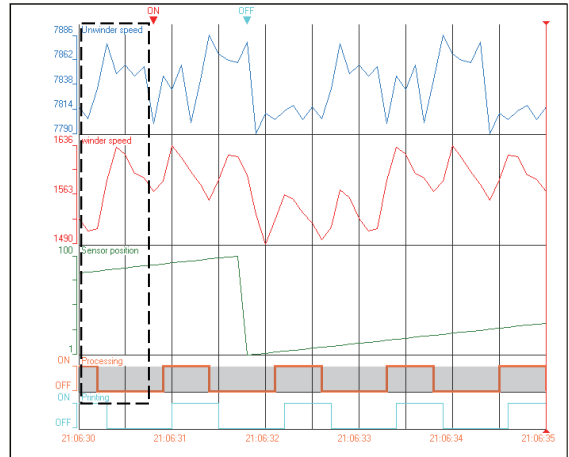

Operating procedure

Select [Graph Operation] ⇒ [Graph Alignment] ().

Superimposing graphs

All displayed trend graphs can be superimposed and displayed on a graph area.

<Before superimposing>

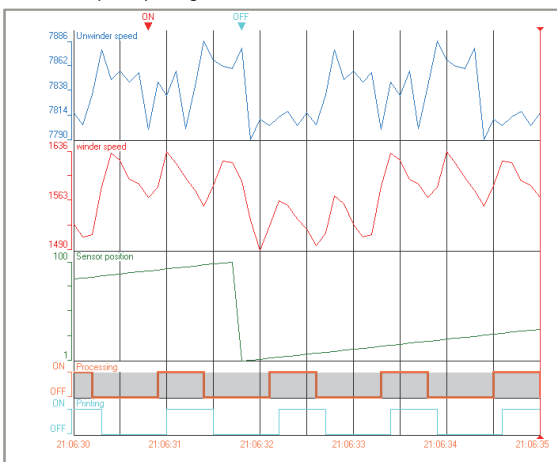

<After superimposing>

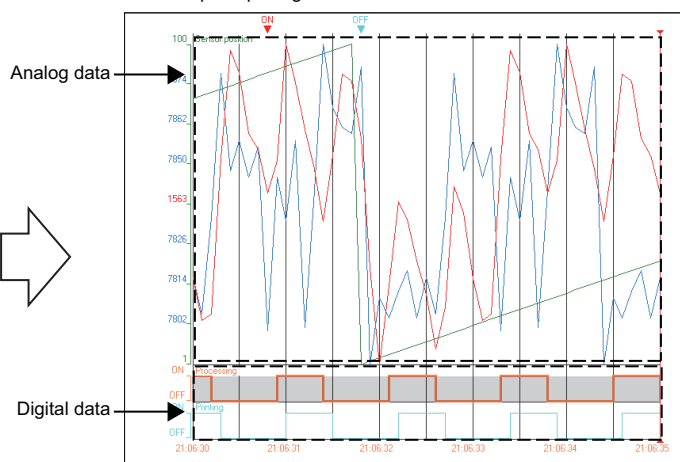

Operating procedure

Select [Graph Operation] ⇒ [Graph Superimpose] ().

Moving cursor by specifying value/time/index

By using the cursor jump function, the cursor can be moved to the specified value, time, or index position on the trend graph for checking data value or status.

Since an analog module does not have time information, the cursor jump function can be used only by specifying value or index.

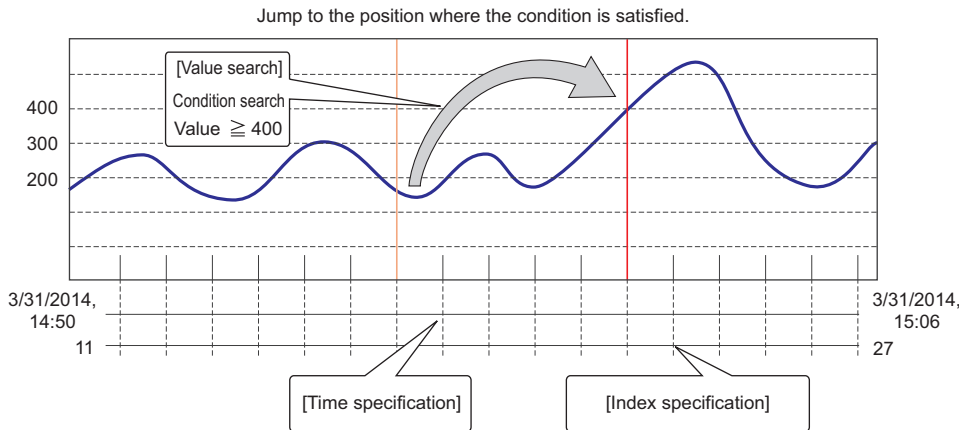

Precautions

Stop or pause the monitoring when operating the cursors on the Realtime trend graph/Realtime monitor graph.

Window

Select [Graph Operation] ⇒ [Jump Cursor] (🔍).

Data of the graph legend area can be selected in "Data name."

For the methods of adding data to the graph legend area, refer to the following:

📖 Page 159 Changing the data to be displayed in the graph area

For details on each tab, refer to the following:

Tab	Reference
Value	Page 168 Jumping cursor by searching value
Time	Page 173 Jumping cursor by specifying time
Index	Page 173 Jumping cursor by specifying index

Jumping cursor by searching value

By specifying a "Search Type" and setting search conditions, the selected cursor can be jumped to positions where the conditions are satisfied.

Up to three conditions can be specified simultaneously.

The search type varies depending on the data type being selected.

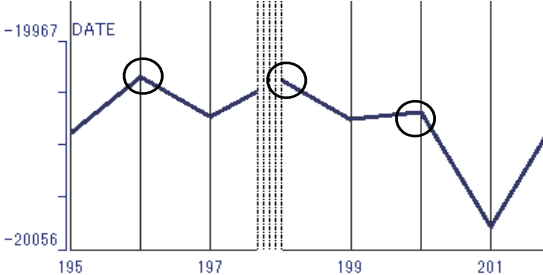
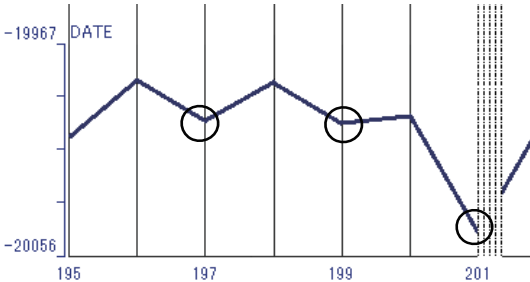
Search type	Description	
When the data type is bit	Up	Jumps to the position where the selected data turns from OFF to ON.
	Down	Jumps to the position where the selected data turns from ON to OFF.
	Up/Down	Jumps to the position where the selected data turns from OFF to ON or ON to OFF.
	Conditional	Searches for values by specifying a condition and jumps to the position where the condition is satisfied.
	Comparison	Compares the values of the selected data and the specified data, and jumps to the position where the condition is satisfied. (If data which has the same data type as the currently selected data does not exist, this item will not be displayed in "Search Type.")
When the data type is other than bit	Conditional	Searches for values by specifying a condition and jumps to the position where the condition is satisfied. (☞ Page 172 Conditional search)
	Max	Jumps to positions where the maximum value of the selected data is located.
	Min	Jumps to positions where the minimum value of the selected data is located.
	Maximal	The cursor is moved to the position where the increased value of the selected data starts decreasing. However, the positions where the increased value becomes flat are not considered as the position of maximal value. Example: 
	Minimal	The cursor is moved to the position where the decreased value of the selected data starts increasing. However, the positions where the decreased value becomes flat are not considered as the position of minimal values. Example: 
Comparison	Compares the values of the selected data and the specified data, and jumps to the position where the condition is satisfied. (If data which has the same data type as the currently selected data does not exist, this item will not be displayed in "Search Type.")	

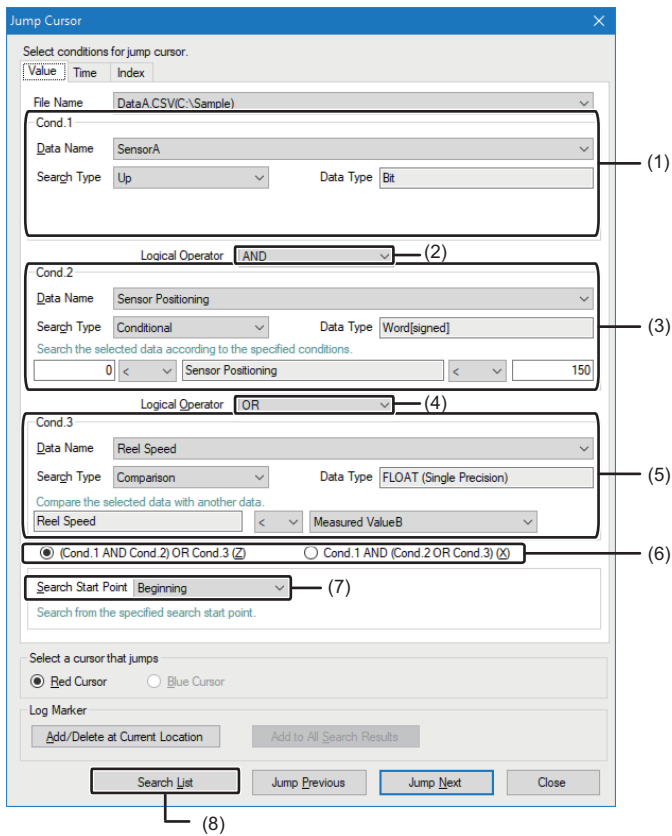

Displayed items

Item	Display content
(1) Cond.1	Specify the first search condition.
(2) Logical operator for condition 1 and 2	Select a logical operator [AND] or [OR] for condition 1 and 2.
(3) Cond.2	Specify the second search condition.
(4) Logical operator for condition 2 and 3	Select a logical operator [AND] or [OR] for condition 2 and 3.
(5) Cond.3	Specify the third search condition.
(6) Pattern selection for logical operation	When three conditions are specified and the selected logical operators (2) and (4) are different, select a pattern by which to perform the logical operation.
(7) Search Start Point	Select a starting point for search.
(8) Search List	The list of records which satisfy search conditions is displayed.

The following shows the operation procedure for specifying three search conditions.

When specifying one or two conditions, specify one or two conditions first, then perform the operating procedure 7.

Operating procedure

1. Select the [Value] tab in the "Jump Cursor" screen.
2. Specify a condition *1 in "Cond.1."
3. Select a logical operator for condition 1 and 2.
4. Specify a condition *1 in "Cond.2."
5. Select a logical operator for condition 2 and 3.
6. Specify a condition *1 in "Cond.3."
 Select a pattern of logical operation in the following cases:
 - A logical operator for condition 1 and 2 is [AND], and [OR] for condition 2 and 3.
 - A logical operator for condition 1 and 2 is [OR], and [AND] for condition 2 and 3.
7. Click the [Jump Previous] or [Jump Next] button. A cursor jumps to a record which satisfies search conditions.
 Alternatively, by clicking the [Search List] button, records which satisfy search conditions are displayed in "Search Results" as shown below. By selecting a record, a cursor jumps to the position of the record.

Select conditions for jump cursor.

Value Time Index

Search Results: 598

Date	Index	SensorA	Sensor Positioning	Reel Speed
2012/01/03 05:28:34.800	980	ON	320	-0.642788
2012/01/03 05:28:35.000	981	OFF	322	-0.615661
2012/01/03 05:28:35.200	982	OFF	324	-0.587785
2012/01/03 05:28:36.000	986	ON	332	-0.469471
2012/01/03 05:28:36.200	987	ON	334	-0.438371
2012/01/03 05:28:36.400	988	ON	336	-0.406736
2012/01/03 05:28:36.600	989	ON	338	-0.374607
2012/01/03 05:28:36.800	990	ON	340	-0.34202
2012/01/03 05:28:37.000	991	OFF	342	-0.309017
2012/01/03 05:28:37.200	992	OFF	344	-0.275638
2012/01/03 05:28:37.400	993	OFF	346	-0.241922
2012/01/03 05:28:37.600	994	OFF	348	-0.207912
2012/01/03 05:28:37.800	995	OFF	350	-0.173648
2012/01/03 05:28:38.000	996	ON	352	-0.139173
2012/01/03 05:28:38.200	997	ON	354	-0.104529
2012/01/03 05:28:38.400	998	ON	356	-0.069756
2012/01/03 05:28:38.600	999	ON	358	-0.0349
2012/01/03 05:28:38.800	1000	ON	0	0
2012/01/03 05:28:39.000	1001	OFF	2	0.034899
2012/01/03 05:28:39.200	1002	OFF	4	0.069756
2012/01/03 05:28:39.400	1003	OFF	6	0.104528
2012/01/03 05:28:39.600	1004	OFF	8	0.139173
2012/01/03 05:28:39.800	1005	OFF	10	0.173648
2012/01/03 05:28:40.000	1006	ON	12	0.207912

Select a cursor that jumps

Red Cursor Blue Cursor

Log Marker

Add/Delete at Current Location Add to All Search Results

Return to Settings Jump Previous Jump Next Close

- *1 For details on selecting "Conditional" in "Search Type," refer to the following:
 Page 172 Conditional search

● By specifying "Search Start Point" before clicking the [Search List] button, search results from any point can be displayed.

Any one of the following items can be selected.

- "Beginning":
Starts searching from the first index of a file.
- "Red Cursor" and "Blue Cursor":
Starts searching from the current position of either cursor.
 - "Blue Cursor" can be selected only when multiple cursors are displayed in the graph area.
 - When selecting "Max" or "Min" for "Search Type," the maximum or minimum value from the current position of each cursor is displayed instead of the maximum or minimum value of the whole data in the data logging file.

Note that the [Jump Previous] and [Jump Next] buttons are not available for this function.

● By clicking the [Add/Delete at Current Location] button, a log marker can be added or deleted to/from the current red cursor position.

(It can also be performed by pressing the **Ctrl** + **M** keys.)

● By clicking the [Add to All Search Results] button, log markers can be added to the positions of all records in "Search Results."

(It can also be performed by pressing the **Ctrl** + **L** keys.)

■ Conditional search

This function searches for values by specifying a condition and jumps a cursor to the position where the condition is satisfied. The following shows examples of the search range for a specified condition.

Conditional search range	Example of specification
When searching for a value in a range between 0 and 100, use both condition combo boxes.	
When searching for a value less than 1000, use the condition box on the right side only.	
When searching for a value -1000 or more, use the condition box on the left side only.	
When searching for a value 2500, use the condition box on either side.	
When searching for a value other than -1500, use the condition box on either side.	

Precautions

- A rounding error occurs when searching for a floating-point value.
When a single-precision/double-precision floating-point is entered into the text box on the left/right, values entered in scientific form are rounded off to three decimal places.
- A comparison with a value which exceeds the number of significant values cannot be performed.
When searching for values which exceed the number of significant values, search between a two values, one greater than and one less than the desired value.

Ex.

Checking a match with 1.23456E+10

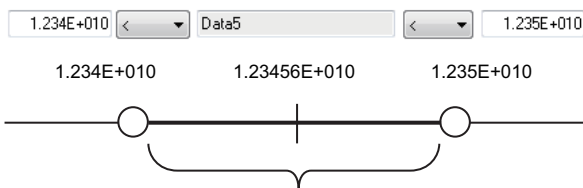

Check a match with values within this range. (Boundary values are not included.)

Jumping cursor by specifying time

Operating procedure

1. Select the [Time] tab in the "Jump Cursor" screen.
2. Specify the conditions of date and time of the jump destination.
3. Click the [Jump Previous]/[Jump Next] button.

The following table shows the setting examples of time condition and their operation results.

Item	Description	
Millisecond	Example ^{*1}	Specify '300' for the millisecond only.
	Result	2018/06/30 19:30:30 300 ← previous ← 2018/06/30 19:30:31 300 → next → 2018/06/30 19:30:32 300
Second	Example ^{*1}	Specify '30' for the second only.
	Result	2018/06/30 19:36:30 000 ← previous ← 2018/06/30 19:37:30 000 → next → 2018/06/30 19:38:30 000
Minute	Example ^{*1}	Specify '30' for the minute only.
	Result	2018/06/30 18:30:00 000 ← previous ← 2018/06/30 19:30:00 000 → next → 2018/06/30 20:30:00 000
Hour	Example ^{*1}	Specify '00' for the hour only.
	Result	2018/06/30 00:00:00 000 ← previous ← 2018/07/01 00:00:00 000 → next → 2018/07/02 00:00:00 000

*1 The logging interval is set to 1 millisecond.

Jumping cursor by specifying index

Operating procedure

1. Select the [Index] tab in the "Jump Cursor" screen.
2. Specify the index of the jump destination.
3. Click the [Jump Previous]/[Jump Next] button.

Switching the graph display method

The display method of graphs displayed in a trend window can be switched to "Based on Upper and Lower Bounds" or "Based on Division Value of Grids."

"Based on Upper and Lower Bounds" is a method to display a graph by specifying the upper and lower bounds.

For details, refer to the following:

 Page 175 Specifying the upper and lower bounds/Y axis scale

"Based on Division Value of Grids" is a method to display a graph by specifying a division value of grids (a value per one grid).

For details, refer to the following:

 Page 179 Specifying a division value of grids

Operating procedure

Select [Based on Upper and Lower Bounds]/[Based on Division Value of Grids] from the pull-down list () in the toolbar.

Alternatively, select [Graph View] ⇒ [Switch Display Method] ⇒ [Based on Upper and Lower Bounds]/[Based on Division Value of Grids].

Precautions

When switching the graph display method, the graph display may change.

Specifying the upper and lower bounds/Y axis scale

The upper and lower bounds on a trend graph selected in the graph area can be specified so that the graph is displayed within the bounds.

The upper and lower bounds can be adjusted automatically or manually.

CALC data also can be adjusted by this operation.

To perform this operation, switch the graph display method to "Based on Upper and Lower Bounds."

☞ Page 174 Switching the graph display method

Adjusting the upper and lower bounds automatically

Operating procedure

■ Adjusting a graph within the displayed period

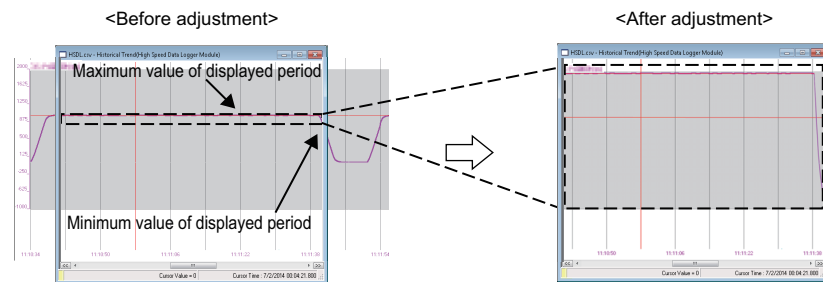

Select [Graph Operation] ⇒ [Auto Adjust Upper/Lower Bound] ⇒ [For Period on Window] (📊).

■ Adjusting a graph within the entire period

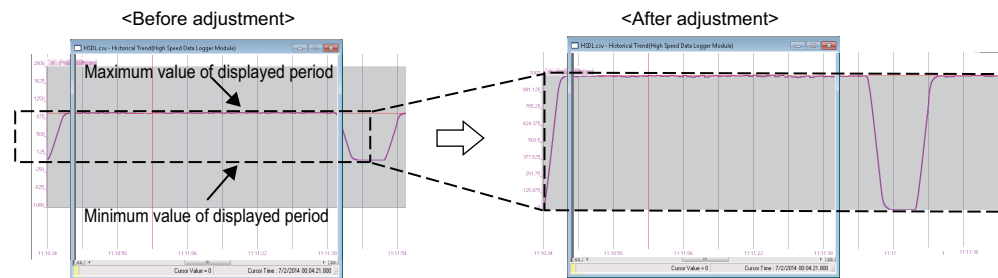

Select [Graph Operation] ⇒ [Auto Adjust Upper/Lower Bound] ⇒ [For All Period] (📊).

Adjusting the upper and lower bounds/Y axis scale manually

A graph can be adjusted manually by entering values for the upper and lower bounds in each text box.

Data higher than the value set for the upper bound is shown as the same as the upper bound, and data which is equal or less than the value set for the lower bound is shown as the same value as the lower bound.

The type of Y axis scale can be changed (linearity/logarithm).

■ Specifying a value on a graph directly

Specify the upper and lower bounds directly on each graph.

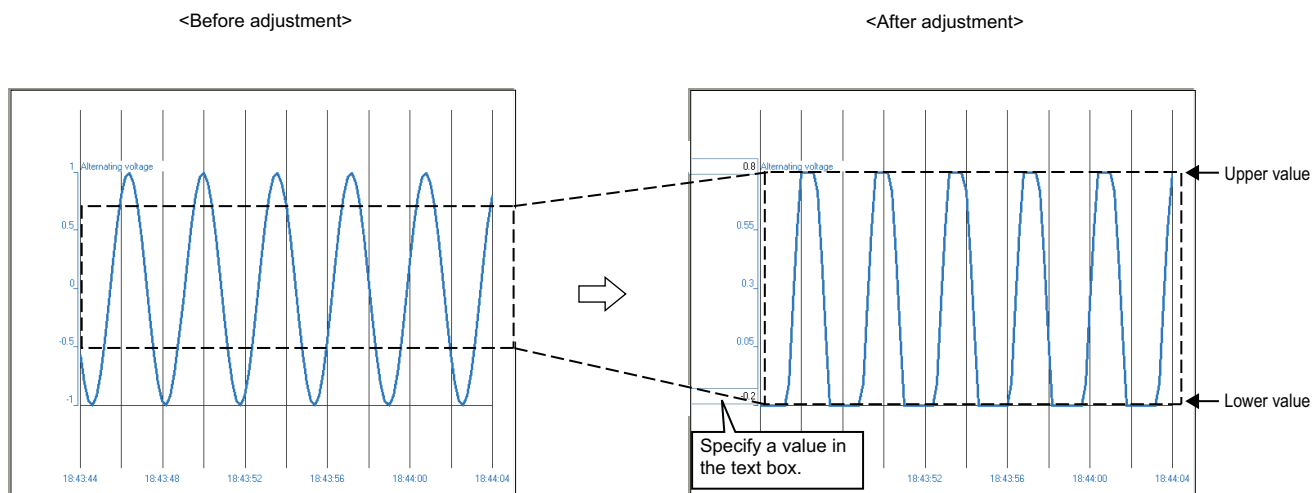

Operating procedure

1. Double-click in the graph area to be adjusted.
Alternatively, select [Graph Operation] ⇒ [Based on Upper and Lower Bounds].
2. Enter a value in the text box.

Point

The text box for specifying the upper and lower bounds also appears by pressing the $\boxed{F12}$ key.

■ Editing the upper and lower bounds/Y axis scale in a batch

The upper and lower bounds/Y axis scale can be edited in a batch.

Change Upper/Lower Bound/Y Axis Scale in Batch

Specify upper/lower bound and Y axis scale. Specify conversion formula when the data is being scaled.
The data value to 0 or less cannot be displayed in graph when Y axis scale is logarithm.

No.	Data Name	Unit	Upper Bound	Lower Bound	Y Axis Scale	Scaling			
						Operator 1	Value 1	Operator 2	Value 2
001	Axis01.Md.AxisStatus		2767	-32768	Linearity				
002	Axis01.Md.CumulativePosition	mm	2.307E+006	-4.058E+006	Linearity				
003	Axis01.Md.CommandedVelocity	mm/ms	1.797E+308	-1.797E+308	Linearity				
004	Axis01.Md.CommandedAcceleration	mm/ms ²	1.797E+308	-1.797E+308	Linearity				
005	Axis01.Md.CommandedAcceleration	mm/ms ²	1.797E+308	-1.797E+308	Linearity				
006	Axis01.Md.SetPosition	mm	2.307E+006	-4.058E+006	Linearity				
007	Axis01.Md.SetVelocity	mm/ms	5.753E+001	-1.175E+002	Linearity				
008	Axis01.Md.SetAcceleration	mm/ms ²	8.000E+003	3.000E+003	Linearity				
009	Axis01.Md.TargetVelocity	mm/ms	1.797E+308	-1.797E+308	Linearity				
010	Axis01.Md.TargetAcceleration	mm/ms ²	1.797E+308	-1.797E+308	Linearity				
011	Axis01.Md.TargetDeceleration	mm/ms ²	1.797E+308	-1.797E+308	Linearity				
012	Axis01.Md.AccelerationLimit	mm/ms ²	1.797E+308	-1.797E+308	Linearity				
013	Axis01.Md.DecelerationLimit	mm/ms ²	1.797E+308	-1.797E+308	Linearity				
014	Axis01.Md.JerkLimit	mm/ms ³	1.797E+308	-1.797E+308	Linearity				
015	Axis0003.Md.AxisStatus		4		Linearity				
016	Axis0003.Md.CumulativePosition	µm	191940.074	-195995	Linearity				
017	Axis0003.Md.CommandedVelocity	µm/s	0	0	Linearity				

OK Cancel Apply

In the "Unit" column, the same contents as the "Unit" column in the graph legend area are displayed.

When units are not displayed in the graph legend area, the "Unit" column will not be displayed.

To display units in the graph legend area, refer to the following:

☞ Page 102 Graph legend area

Operating procedure

1. Select [Graph Operation] ⇨ [Change Upper/Lower Bound/Y Axis Scale in Batch].
2. Enter a value for the upper and lower bounds, and change the type of Y axis scale. To scaling data, specify an operator and a value.

■Values for the upper and lower bounds

The following table shows the applicable characters, number of characters, and value range for the upper and lower bounds.

Item	Description
Applicable characters	Numerals (0 to 9), alphabets ('E', 'e'), signs ('-', '+', '.'), and decimal point (.) Note that the alphabets ('E', 'e') are for the exponent notation. Entered values are regarded as values in a decimal fixed point notation or a decimal exponent notation. Example: '111' is not regarded as a binary number but as '111' in decimal. '11E3' is not regarded as a hexadecimal number but as '11000' in a decimal exponent notation.
Applicable number of characters	Up to 11 characters
Applicable value range	Linearity Exponent notation: -1.797E+308 to -2.225E-308, 0, and 2.225E-308 to 1.797E+308 Fixed point notation: -9999999999 to 9999999999 Note that entering a value which is in 'upper bound ≤ lower bound' is not applicable.
	Logarithm Exponent notation: 2.225E-308 to 1.797E+308 Fixed point notation: 0.000000001 to 9999999999 Note that entering a value which is in 'upper bound ≤ lower bound' is not applicable.

■Scaling

For the linear function transformation of sampled device values, a conversion equation needs to be specified.

The following table shows the applicable characters, number of characters, and value range for scaling.

Item	Description
Applicable characters	Numerals (0 to 9), negative sign (-), and decimal point (.) Entered values are regarded as values in a decimal fixed point notation.
Applicable number of characters	Up to 10 characters
Applicable value range	Fixed point notation: -999999999 to 9999999999

Precautions

- If the values acquired as the operation result exceed the limit of the upper value or lower value of each data type, the file cannot be opened in GX LogViewer the software version of which is 1.72A or earlier.
- When the data type is an integer type, values after the decimal point in the operation result are rounded off.

Data type		Lower limit value	Upper limit value
Integer type	Word [signed]	-32768	32767
	Double word [signed]	-2147483648	2147483647
	Word [unsigned]	0	65535
	Double word [unsigned]	0	4294967295
	16bit BCD	0000	9999
	32bit BCD	00000000	99999999
Float type	Float (single precision)	-3.4028235E+38	3.4028235E+38
	Float (double precision)	-1.79769313486231570E+308	1.79769313486231570E+308

Specifying a division value of grids

A division value of grids (a value per one grid) on a trend graph selected in the graph area can be specified so that the graph is displayed at the division value of grids.

The division value of grids can be adjusted automatically or manually.

To perform this operation, switch the graph display method to "Based on Division Value of Grids."

☞ Page 174 Switching the graph display method

Restriction

The following restrictions apply when using a floating point number for a lower bound and division value of Y axis grids.

- Range of a lower bound: $-1.000E+302$ to $-1.000E-302$, 0, and $1.000E-302$ to $1.000E+302$
- Range of a division value of Y axis grids: $1.000E-300$ to $1.000E+300$
- Difference between a lower bound and division value of Y axis grids: Within 10 to the power of 10.

When the value is out of the range, an error message appears, and if the difference between the values exceeds 10 to the power of 10, it will be adjusted automatically.

Adjusting a division value of grids automatically

Operating procedure

■ Adjusting a graph within the displayed period

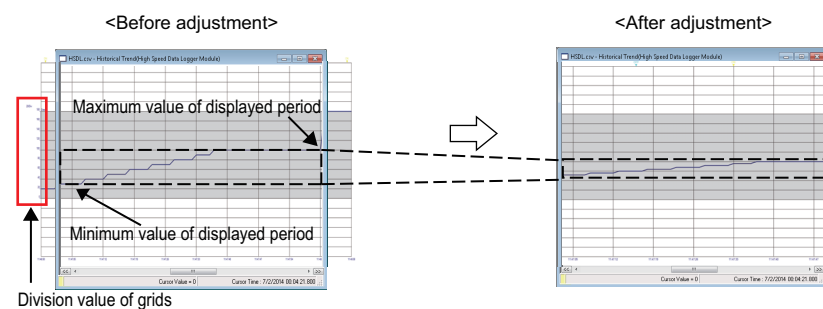

Select [Graph Operation] ⇒ [Auto Adjust Upper/Lower Bound] ⇒ [For Period on Window] (📐).

■ Adjusting a graph within the entire period

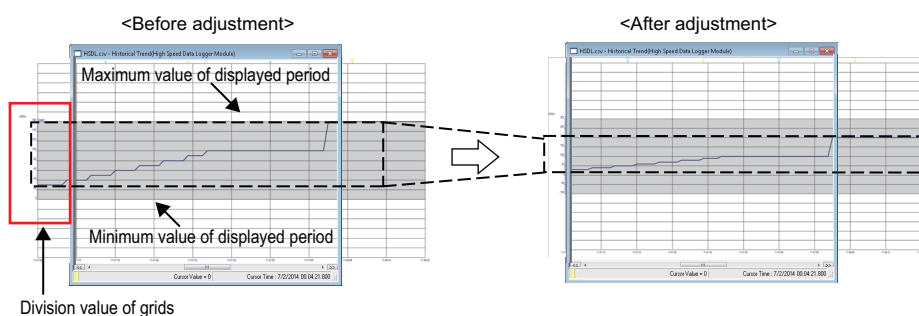

Select [Graph Operation] ⇒ [Auto Adjust Upper/Lower Bound] ⇒ [For All Period] (📐).

Point

After the automatic adjustment, the division value of grids is edited to 1×10^n or 5×10^n . ($n=0, \pm 1, \pm 2, \pm 3, \dots$)

Adjusting a division value of grids manually

A graph can be adjusted manually by editing a central value and division value of Y axis grids.

A central value is a value in the middle of the Y axis in the graph area.

A division value of Y axis grids is a value per one grid of the Y axis in the graph area.

Moreover, the graph can be adjusted in a batch by editing a lower bound and division value of Y axis grids.

 Page 181 Editing a lower bound and division value of Y axis grids in a batch

■ Specifying a value on a graph directly

Specify a central value and division value of Y axis grids directly on each graph.

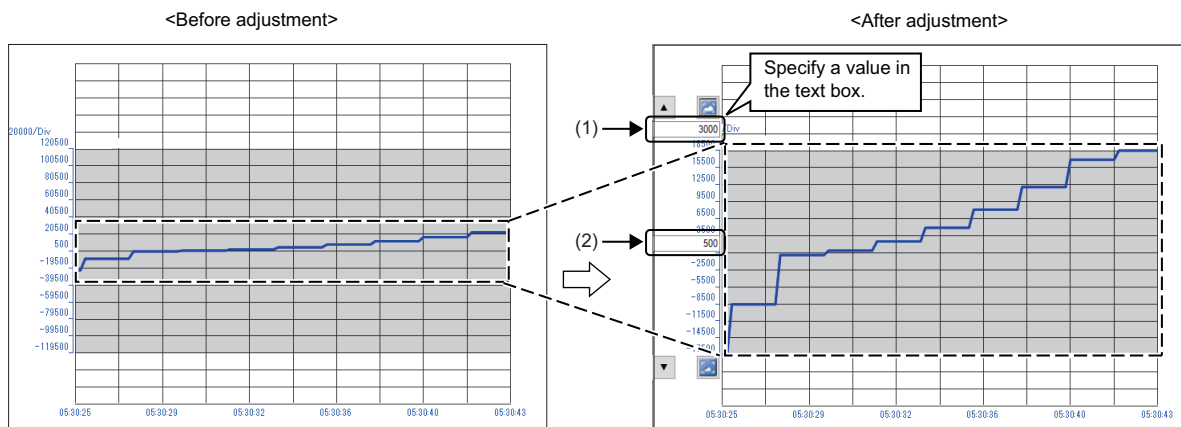







(1): Division value of Y axis grids

(2): Central value

Operating procedure

1. Double-click in the graph area to be adjusted.
Alternatively, select [Graph Operation] ⇒ [Based on Upper and Lower Bounds].
2. Enter a value in the text box.

Point

- The text box for specifying a central value and division value of Y axis grids appears by pressing the  key.
- The central value also can be edited by clicking  /  (Scroll) after double-clicking in the graph area.
By clicking , the central value increases for the division value of Y axis grids.
By clicking , the central value decreases for the division value of Y axis grids.
- The division value of Y axis grids can be edited by clicking  (Zoom In) /  (Zoom Out) after double-clicking in the graph area.
When zooming in/out on a graph, the graph is widened or narrowed around the intermediate value between the upper/lower bounds.

■Editing a lower bound and division value of Y axis grids in a batch

A lower bound and division value of Y axis grids can be edited in a batch.

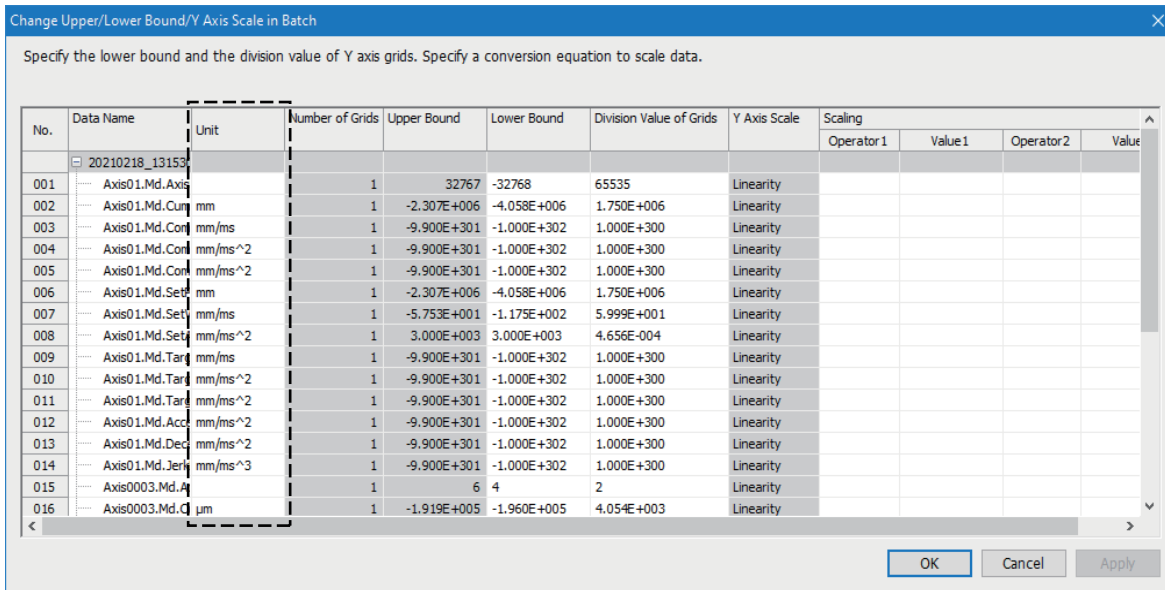

In the "Unit" column, the same contents as the "Unit" column in the graph legend area are displayed.

When units are not displayed in the graph legend area, the "Unit" column will not be displayed.

To display units in the graph legend area, refer to the following:

☞ Page 102 Graph legend area

Operating procedure

1. Select [Graph Operation] ⇒ [Change Upper/Lower Bound/Y Axis Scale in Batch].
2. Specify a value for a lower bound and division value of Y axis grids. To scale data, specify an operator and a value.

■Value for a lower bound and division value of Y axis grids

The following table shows the applicable characters, number of characters, and value range for a lower bound and division value of Y axis grids.

Item	Description
Applicable characters	Numerals (0 to 9), alphabets ('E', 'e'), signs ('-', '+', '.'), and decimal point (.) Note that the alphabets ('E', 'e') are for the exponent notation. Entered values are regarded as values in a decimal fixed point notation or a decimal exponent notation. Example: '111' is not regarded as a binary number but as '111' in decimal. '11E3' is not regarded as a hexadecimal number but as '11000' in a decimal exponent notation.
Applicable number of characters	Up to 11 characters
Applicable value range	Value for a lower bound
	Division value of Y axis grids

■Central value

For a central value, a value that results in the following condition can be entered: a lower bound, which is automatically calculated from a division value of Y axis grids and the number of grids, falls within the applicable range.

For the applicable range of a lower bound, refer to the following:

☞ Page 181 Value for a lower bound and division value of Y axis grids

■Scaling

For the linear function transformation of sampled device values, a conversion equation needs to be specified.

For the applicable characters, number of characters, value range, and precautions for scaling, refer to the following:

☞ Page 178 Scaling

Displaying an operation result of the CALC function (CALC data) on a trend graph

Logging data can be operated with the CALC function, and the result can be displayed in a waveform on a trend graph (historical trend window).

An operation result can be checked and adjusted on a trend graph as other data.

When displaying logging data by linking with the GX Works3 offline monitor function, the CALC function cannot be used.

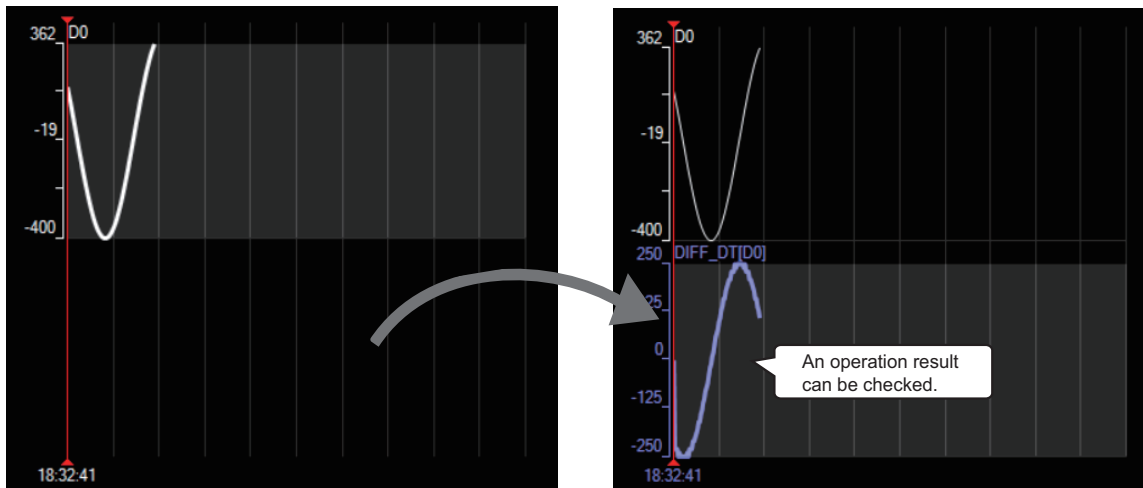



Adding/deleting CALC data

An operation result of the CALC function (CALC data) can be added or deleted to/from a trend graph (historical trend window).

Operating procedure

■ Adding CALC data

1. Select logging data to be operated on a trend graph (historical trend window), and select [Graph View] ⇒ [CALC Function] () ⇒ [New].
2. Set the operation details of the CALC function in the "New CALC" screen, and click the [OK] button. ( Page 183 CALC function setting screen)

■ Deleting CALC data

Select the CALC data to be deleted on a trend graph (historical trend window), and select [Graph View] ⇒ [CALC Function] () ⇒ [Delete].

Point

- Up to eight units of CALC data can be displayed in a graph area. (Up to 32 units of data can be displayed including other trend graphs.)
- A color and line type of the CALC data can be changed in the "Graph Properties" screen. For details, refer to the following:
 Page 209 Changing settings in the Graph Properties screen

CALC function setting screen

Operation details of the CALC function can be set.
Created CALC data can be checked in this screen.

Window

■Creating new CALC data

Select [Graph View] ⇒ [CALC Function]() ⇒ [New].

■Checking a setting

Select CALC data of which setting contents are to be checked on a trend graph (historical trend window), and select [Graph View] ⇒ [CALC Function]() ⇒ [Setting Confirmation].

Ex.

The following screen is a screen example of the "New CALC" screen.

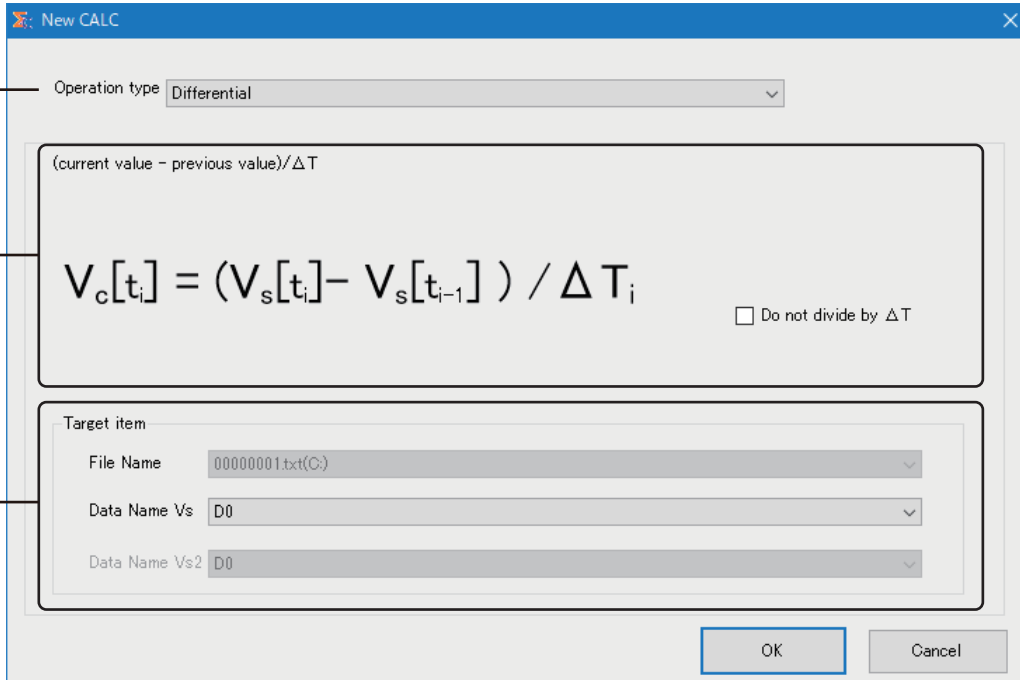

(1) Operation type: Differential

(2) Operation details area:
 (current value - previous value)/ΔT

$$V_c[t_i] = (V_s[t_i] - V_s[t_{i-1}]) / \Delta T_i$$
 Do not divide by ΔT

(3) Target item:
 File Name: 00000001.txt(C)
 Data Name Vs: D0
 Data Name Vs2: D0

OK Cancel

8

Displayed items

Item	Description	
(1) Operation type	Select an operation type.	
(2) Operation details area	The description of an operation formula and items that required to be set are displayed. Displayed contents differ depending on an operation type.	
(3) Target item	File Name* ¹	A name of a file in which the logging data selected when displaying this screen exists is displayed.
	Data Name Vs	Select operation target logging data. Logging data which is displayed in the graph (excluding bits) can be selected from the pull-down list among the logging data in a file displayed in "File Name."* ¹
	Data Name Vs2	Select operation target logging data when selecting "Operations 1 between data"/"Operations 2 between data" for "Operation type." Logging data which is displayed in the graph (excluding bits) can be selected from the pull-down list among the logging data in a file displayed in "File Name."* ¹

*¹ Displayed only when a graph is displayed in the time interval plot display format.

Point

The tooltip is displayed by placing the mouse cursor on the illustration of an operation formula in the operation details area, and the details of a variable can be checked.

Operation formula

Operation is performed with the CALC function based on the operation formula set in the "New CALC" screen. This section explains the details on operation formulas.

■Display format in an operation formula

The display format in an operation formula differs depending on the graph plot formats as follows:

Graph plot format	Display format in an operation formula	Description
Equidistance plot format	St	Start record number
	Ed	End record number
	i	Record number (St ≤ i ≤ Ed)
	Vs[i]	Value of the i-th record of operation target data
	Vs2[i]	Value of the i-th record of operation target data 2
	Vc[i]	CALC data value in the i-th record
	t _i	Time of the i-th record
	ΔT _i	t _i - t _{i-1}
Time interval plot format	t _{st}	Start time of operation range setting
	t _{ed}	End time of operation range setting
	t _i	t _{st} ...t _{ed} (The i-th time when collected data exists in the operation range)
	Vs[t _i]	Value at time t _i of operation target data
	Vs2[t _i]	Value at time t _i of operation target data 2
	Vc[t _i]	Value of CALC data at time t _i
	ΔT _i	t _i - t _{i-1}

■Specifications of an operation formula

An operation formula is displayed in the operation details area in the "New CALC" screen and "CALC setting confirmation" screen. (☞ Page 183 CALC function setting screen)

The following table shows the operation formulas for each operation type.

Operation type	Operation formula		Remark
	Description	Graph plot format	
Differential	(Current value - previous value) ÷ difference in time ΔT (Unit: second)	<p>■Equidistance plot format Example) i = St+1...Ed (For i = St, Vc[i] = 0)</p> $V_c[i] = (V_s[i] - V_s[i-1]) / \Delta T_i$ <p>■Time interval plot format Example) t_i = t_{st}+1...t_{ed} (For t_i = t_{st}, Vc[t_i] = 0)</p> $V_c[t_i] = (V_s[t_i] - V_s[t_{i-1}]) / \Delta T_i$	When selecting the checkbox of "Do not divide by ΔT," an operation formula is 'Current value - previous value.'
Integral	The summation of the current value × (previous value - difference in time of the current value ΔT (unit: second)) from the start point	<p>■Equidistance plot format Example) i = St+1...Ed (For i = St, Vc[i] = 0)</p> $V_c[i] = \sum_{j=St}^i (V_s[j] \Delta T_j)$ <p>■Time interval plot format Example) t_i = t_{st}+1...t_{ed} (For i = t_{st}, Vc[t_i] = 0)</p> $V_c[t_i] = \sum_{t=t_{st}}^{t_i} (V_s[t] \Delta T_i)$	When selecting the checkbox of "Do not use ΔT," this will be the summation from the start point.

Operation type	Operation formula		Remark
	Description	Graph plot format	
Operations 1 between data*1	Data 1 and data 2 are operated and then the result and constant C are operated. • (Data 1 · data 2) <input type="checkbox"/> constant C*2	<p>■Equidistance plot format</p> $V_c[i] = (V_s[i] \text{ } V_{s2}[i+d]) \text{ } C$ <p>■Time interval plot format</p> $V_c[t_i] = (V_s[t_i] \text{ } V_{s2}[t_i+d]) \text{ } C$	<ul style="list-style-type: none"> When a constant is not used, unselect the checkbox of "Use constant." For a constant, a value with a double-precision real number can be entered. When entering a value for "Point Shift," the entered value can be added to data 2 for operation. When entering a value for "Point Shift," a value of $V_c[i]$ in the range in which $[i+d]$ exceeds the total number of records will be '0.'
Operations 2 between data*1	Data 1 and constant C are operated and then the result and data 2 are operated. • (Data 1 <input type="checkbox"/> constant C) · data 2*2	<p>■Equidistance plot format</p> $V_c[i] = (V_s[i] \text{ } C) \text{ } V_{s2}[i+d]$ <p>■Time interval plot format</p> $V_c[t_i] = (V_s[t_i] \text{ } C) \text{ } V_{s2}[t_i+d]$	
Average	An average value of the sampled data is calculated.	<p>■Equidistance plot format</p> $V_c[i] = \left(\sum_{j=St}^i v_s[j] \right) / i$ <p>■Time interval plot format</p> $V_c[t_i] = \left(\sum_{t=st}^{t_i} v_s[t] \right) / i$	—
Average absolute value	An average value of the absolute value of the sampled data is calculated.	<p>■Equidistance plot format</p> $V_c[i] = \left(\sum_{j=St}^i v_s[j] \right) / i$ <p>■Time interval plot format</p> $V_c[t_i] = \left(\sum_{t=st}^{t_i} v_s[t] \right) / i$	—
RootMeanSquare	An average value of the squares of the sampled data is calculated.	<p>■Equidistance plot format</p> $V_c[i] = \sqrt{\left\{ \left(\sum_{j=St}^i v_s[j]^2 \right) / i \right\}}$ <p>■Time interval plot format</p> $V_c[t_i] = \sqrt{\left\{ \left(\sum_{t=st}^{t_i} v_s[t]^2 \right) / i \right\}}$	—
MovingAverage	An average value is calculated for the specified number of records.	<p>■Equidistance plot format</p> $V_c[i] = \left(\sum_{j=i-m+1}^i v_s[j] \right) / m$ <p>■Time interval plot format</p> $V_c[t_i] = \left(\sum_{t=t(i-m+1)}^{t_i} v_s[t] \right) / m$	<ul style="list-style-type: none"> Specify the number of records (2 to 'total records - 1') to calculate an average value for "m." A moving average is calculated from the m-th to the end point, and in the period from the start to the m-th ($i=st..m-1$), the operation formula is $V_c[t_i]=0$.

*1 A point shift can be specified only for the equidistance plot display format.

*2 and · indicates an operator (+, -, ×, and /).

CALC data specification

■CALC data name

The following table shows the data names of CALC data.

Operation type*1	Data name
Differential	<ul style="list-style-type: none"> ■When "Do not divide by ΔT" is not selected DIFF_DT[%s] ■When "Do not divide by ΔT" is selected DIFF[%s]
Integral	<ul style="list-style-type: none"> ■When "Do not use ΔT" is not selected INTEGRAL_DT[%s] ■When "Do not use ΔT" is selected INTEGRAL[%s]
Operations 1 between data	<ul style="list-style-type: none"> ■When a value is not set for a point shift (([%s]○[%s2]) □%3 ■When a value is set for a point shift (([%s]○[%s2,SH %d pts]) □ %3
Operations 2 between data	<ul style="list-style-type: none"> ■When a value is not set for a point shift (([%s]□%3)○[%s2] ■When a value is set for a point shift (([%s]□%3)○[%s2,SH %d pts]
Average	AVE[%s]
Average absolute value	ABS_AVE[%s]
RootMeanSquare	SQR_AVE[%s]
MovingAverage	MOV_AVE(m=%m)[%s]

*1 [%s], [%s2], ○, □, %3, %d, and %m indicate the following meanings:

- [%s]: Data Name Vs
- [%s2]: Data Name Vs2
- ○ and □: Operator
- %3: Constant
- %d: Value of a point shift
- %m: Value of 'm'

■CALC data type

The data type of CALC data is all double-precision real number.

■Items to which the original data of an operation target is applied

For the following data, the original data of an operation target is applied.

- Index number
- Program number
- Step number
- Time information

However, some units, device comment data, and program name may not be applied depending on the operation type.

The following table shows whether data can be applied or not for each operation type.

○: Can be applied, ×: Cannot be applied

Operation type	Unit	Device comment data and program name
Differential	×	○
Integral	×	○
Operations 1 between data	×	×
Operations 2 between data	×	×
Average	○	○
Average absolute value	○	○
RootMeanSquare	○	○
MovingAverage	○	○

Saving CALC data to a file

When saving CALC data as a CSV file or Unicode text file, CALC data column is output next to the trigger information column. For details on the CSV file format and Unicode text file format, refer to the following:

☞ Page 249 Format specification of CSV file

☞ Page 281 Format specification of Unicode text file

CALC data can be restored by reading a saved file by using the following menu:

- [File] ⇒ [Open]

Note that if the read CALC data setting is invalid, the CALC data cannot be restored.

Checking the setting contents of CALC data

The setting contents of CALC data can be checked.

Operating procedure

Select CALC data of which setting contents are to be checked on a trend graph (historical trend window), and select [Graph View] ⇒ [CALC Function]() ⇒ [Setting Confirmation].

Menus which are not supported by the CALC function

CALC function is not supported by the realtime monitor function and a restoring function of the graphical display settings.

Therefore, the following menus cannot be used for CALC data:

- [File] ⇒ [Import and Export]
- [Graph View] ⇒ [Register Graphical Display Settings]/[Operate Graphical Display Settings]/[Set Graph View by the Auto Reflect Function]
- [Window] ⇒ [Frequently-used Window Configuration] ⇒ [Add to Frequently-used Window Configuration]
- [Window] ⇒ [Recent Windows] ⇒ [Historical Trend]

Considerations

■When operation is canceled

When there is a problem in logging data such as when the operation target logging data is missed, operation is canceled basically.

Note that for "Operations 1 between data"/"Operations 2 between data", only when a point shift is '0,' operation continues even if there is a problem in data.

■When data for which scaling is set is operated

When scaling has been set for the operation target logging data of the CALC function, operation is performed with a value when a scaling is not set.

■When CALC data is deleted

When logging data used for the CALC data operation is not displayed on a trend graph by performing any of the following operations, the CALC data will be deleted.

- "Add to the Legends" is unselected in the "Change the Data to Draw Graphs" screen.
- A file is deleted from the list in the "Change the Data to Draw Graphs" screen.
- A graph plot format is changed to the equidistance plot format when multiple files are displayed in the time interval plot format.

■When changing a graph plot format

In the time interval plot, a point shift for operations between data cannot be used.

Therefore, when changing a graph plot format from the equidistance plot to the time interval plot, a value of a point shift will be '0.'

■When reading CALC data in a different version

When reading a CSV file and Unicode text file including CALC data that is output in GX LogViewer Version 1.148E or later in GX LogViewer Version 1.142Y or earlier, the CALC data cannot be read.

Widening/narrowing the display scale

The selected trend graph in the graph area can be widened or narrowed to the direction of longitudinal axis.

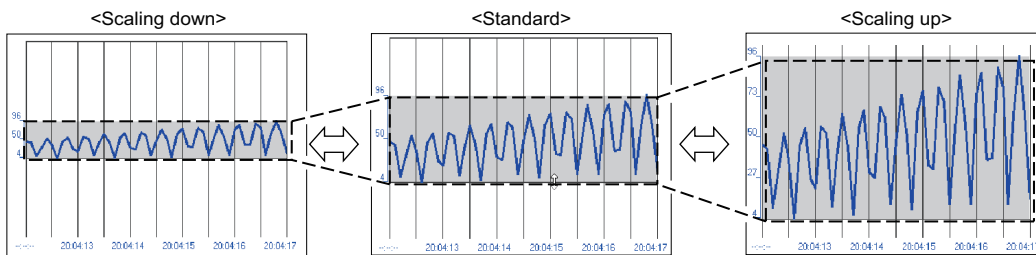

Operating procedure

Select the upper end/lower end of a trend graph with a mouse, and drag it upward/downward.

Alternatively, select [Graph Operation] ⇒ [Adjust Scale] ⇒ [Widen Graph] (🔍)/[Narrow Graph] (🔍).

Point

The scale can be adjusted by scrolling the mouse wheel while pressing the **Alt** key.

Scrolling the mouse wheel up widens the graph, and scrolling it down narrows the graph.

Precautions

When "Based on Division Value of Grids" is selected for the graph display method, a trend graph is widened or narrowed in grid units.

Moving graph up/down/left/right

A trend graph displayed in the graph area can be moved up, down, left, or right.

When logging data of more than one file is displayed on the same graph area, the trend graph can be moved left or right by setting the time unit to be moved.

For the methods of adding logging data, refer to the following:

☞ Page 159 Changing the data to be displayed in the graph area

Moving a graph up/down

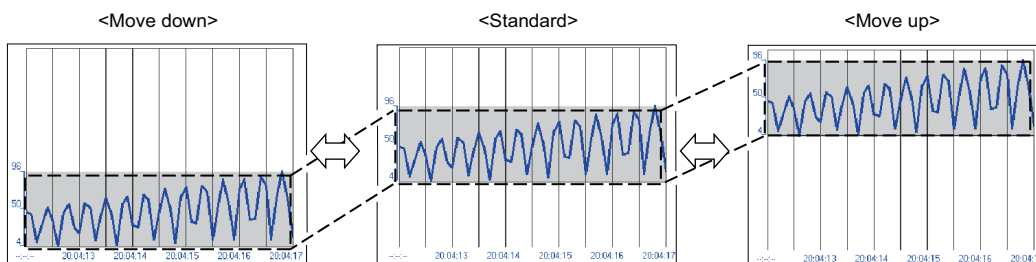

Operating procedure

Select a trend graph with a mouse and drag it upward/downward.

Alternatively, select [Graph Operation] ⇒ [Adjust Graph Location] ⇒ [Move Up Graph] (📈) / [Move Down Graph] (📉).

Point

- The graph can be moved by scrolling the mouse wheel while pressing the **[Shift]** and **[Alt]** key. Scrolling the mouse wheel up moves the graph upward, and scrolling it down moves the graph downward.
- When logging data of more than one file is displayed, all of the data in the same file can be moved up or down by dragging a graph line upward or downward with the **[Ctrl]** key held down.

For the methods of displaying logging data of multiple files, refer to the following:

☞ Page 159 Changing the data to be displayed in the graph area

Precautions

When "Based on Division Value of Grids" is selected for the graph display method, a trend graph is moved in grid units.

Moving graphs left/right

When logging data of more than one file is displayed in the time interval plot display format, the graphs can be moved to the left or right.

However, graphs of data being displayed by the GX Works3 offline monitor function cannot be moved.

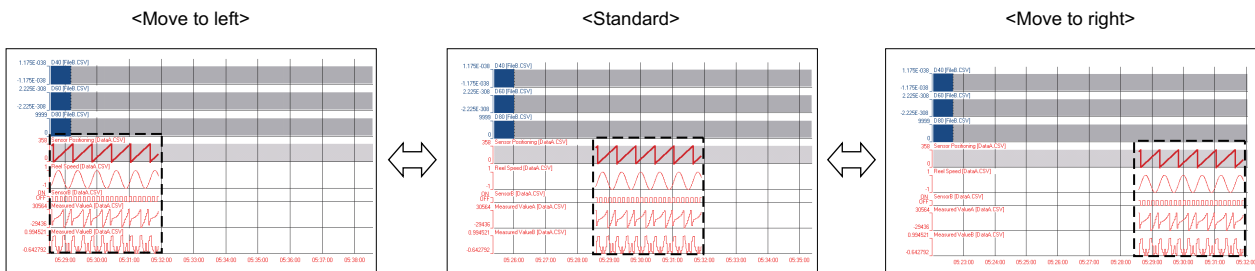

Operating procedure

Select a trend graph with a mouse and drag it to the left or right.

Alternatively, select [Graph Operation] ⇒ [Adjust Graph Location] ⇒ [Move Graph to Left] (🔍) / [Move Graph to Right] (🔍).

Setting the time unit to move graphs left/right

The time unit can be set to move a graph to the left or right.

Operating procedure

Select a phase between [50μs] and [12h] from the pull-down list in the tool bar.

Alternatively, select [Graph Operation] ⇒ [Adjust Graph Location] ⇒ [Horizontal Moving Quantity], and select a phase between [50μs] and [12h].

Synchronizing the time

When logging data of more than one file is displayed on the same graph area, the time of the multiple data logging files with different start times can be synchronized and the graph location can be adjusted.

For the methods of adding logging data, refer to the following:

📖 Page 159 Changing the data to be displayed in the graph area

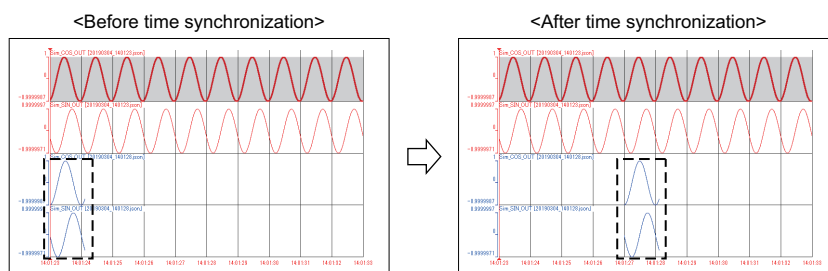

Operating procedure

1. Select logging data.
2. Select [Graph Operation] ⇒ [Adjust Graph Location] ⇒ [Synchronize with Time of Head File] (🔍).
Alternatively, press the **[Alt]** + **[Shift]** + **[S]** keys.

Point

The time of all files can be synchronized with that of a head file by selecting logging data of the head file in step 1.

Expanding/reducing the time scale

The time scale in the graph area can be expanded or reduced.

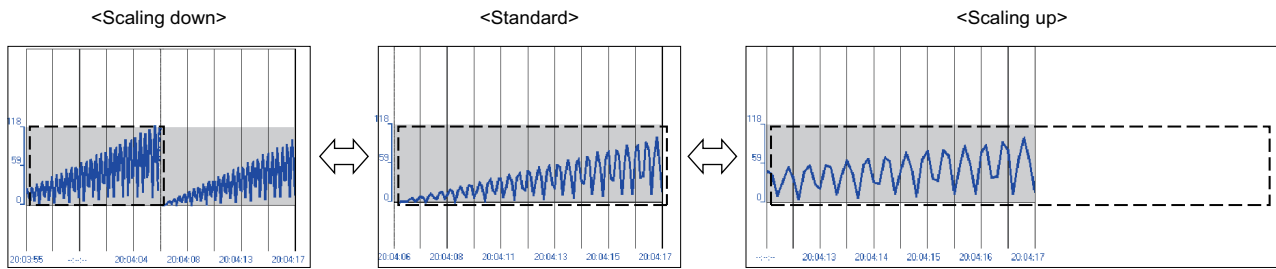

Operating procedure

Select [Graph Operation] ⇒ [Adjust Time Scale] ⇒ [Expansion Time Scale] (+) / [Reduction Time Scale] (-).

Point

The time scale can be adjusted by scrolling the mouse wheel with the **Ctrl** key held down. Scrolling the mouse wheel up expands the time scale, and scrolling it down reduces the time scale.

Displaying the previous or next trend graph consecutively

Normally, one data logging file is displayed in a historical trend window. However, data in the previous or next data logging file can be displayed simultaneously by using this function.

This enables the consecutive view of divided data logging files.

Target	Display condition	Display order
Data logging file of a MELSEC iQ-R series high speed data logger module	<ul style="list-style-type: none"> The file extensions are the same. Data is sampled with the same type of module. 	Dictionary order by file names (in the order of number, symbol, alphabet, and others)
Data logging file ^{*1} of a MELSEC iQ-R series motion module	<ul style="list-style-type: none"> The file extensions are the same. Data is sampled with the same type of module. The date and time format (YYYYMMDD_hhmmss.extension) is used for the file names. The files are saved in the same folder. 	Chronological order by file names
Data logging file of a MELSEC iQ-R series motion controller		
JSON file in GX LogViewer format		
Data logging file other than above	<ul style="list-style-type: none"> The file extensions are the same. Data is sampled with the same type of module. File names are sequentially numbered.^{*2} 	Sequential number order by file names

*1 If a data logging file which is logged by a motion module with the firmware version of '15' or earlier is used for this function, a graph will be displayed with data of the combined parts missing.

*2 Whether the file names are sequential is judged by the last eight numbers of them.

The date and numbers of time added to a file name is not subject to the sequential number.

(Example) When the file name is '20160204_103840_00000001.TXT', only '00000001' is the information to judge the sequential number.

Point

When CALC data exists in a trend graph displayed consecutively, the setting of the CALC data is applied, and operation of the displayed data is performed again with the CALC function.

Restriction

The following data is not available for this function:

- Data logged by data communication
- Data logged by an analog module
- Data being displayed by the GX Works3 offline monitor function
- Data of which a recording file displayed by the GX Works3 offline monitor function is saved in GX LogViewer in a file format
- Data of a GX LogViewer format CSV file

The following data may not be available for this function:

- Data of a GX LogViewer format JSON file

When linking with the GX Works3 offline monitor function and displaying a recording file of which the total number of record is 50,001 or more, the display range of data in the recording file can be changed by using this function. For the operation procedure, refer to the following:

For the operation procedure, refer to the following:

 Page 162 Displaying the previous or next data of displayed data

Precautions

■Data of the previous or next data logging files can not be displayed

Data of the previous or next data logging file may not be displayed if any of the following operations is performed in the data logging file in a personal computer.

In that case, set the folder so that it will be the same folder configuration as the one under '/LOGGING' in an SD memory card or a CompactFlash card before starting the operation.

- The name of a folder and a data logging file under the data name has been changed.
- The previous or next data logging file has been deleted.
- Data logging file names are not numbered sequentially.
- There are some data logging files with the same sequential number

■Data logging files of an RnPCPU (redundant mode)

Each data logging file of an RnPCPU (redundant mode) is added an identifier at the end of the file name.

Whether the system has been switched is judged by the identifier.

- **_NC**: A data logging file saved when the system has not been switched.
- **_CS**: The last data logging file saved after the control system was switched to the standby system.
- **_SC**: The first data logging file saved after the standby system was switched to the control system.
- **_SS**: A data logging file saved when the system is returned to standby again after the standby system was switched to the control system (when the system is returned to standby while the data logging file is being written)

For details of the data logging files of an RnPCPU (redundant mode), refer to the following:

📖 MELSEC iQ-R Process CPU Module User's Manual

The following figure shows the range of data logging files of an RnPCPU (redundant mode) that can consecutively be displayed.

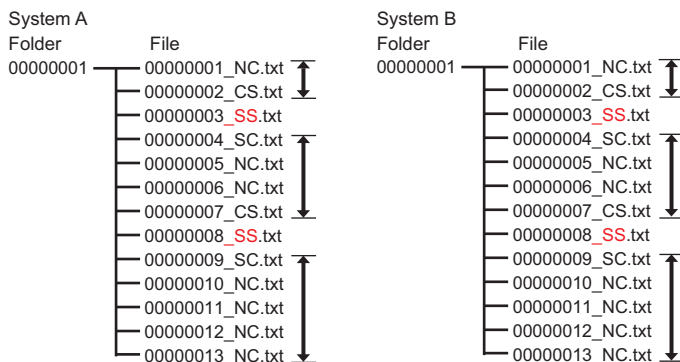

A data logging file of an RnPCPU (redundant mode) can not be consecutively displayed with a data logging file of the different system.

In addition, a data logging file of an RnPCPU (redundant mode) can be displayed only when sequentially numbered and added an identifier except for 'SS'.

A data logging file with the identifier '_SS' cannot consecutively be displayed with other files.

Displaying the previous graph

- Operating from the normal status
- Example: Displaying data of a MELSEC-Q series high speed data logger module

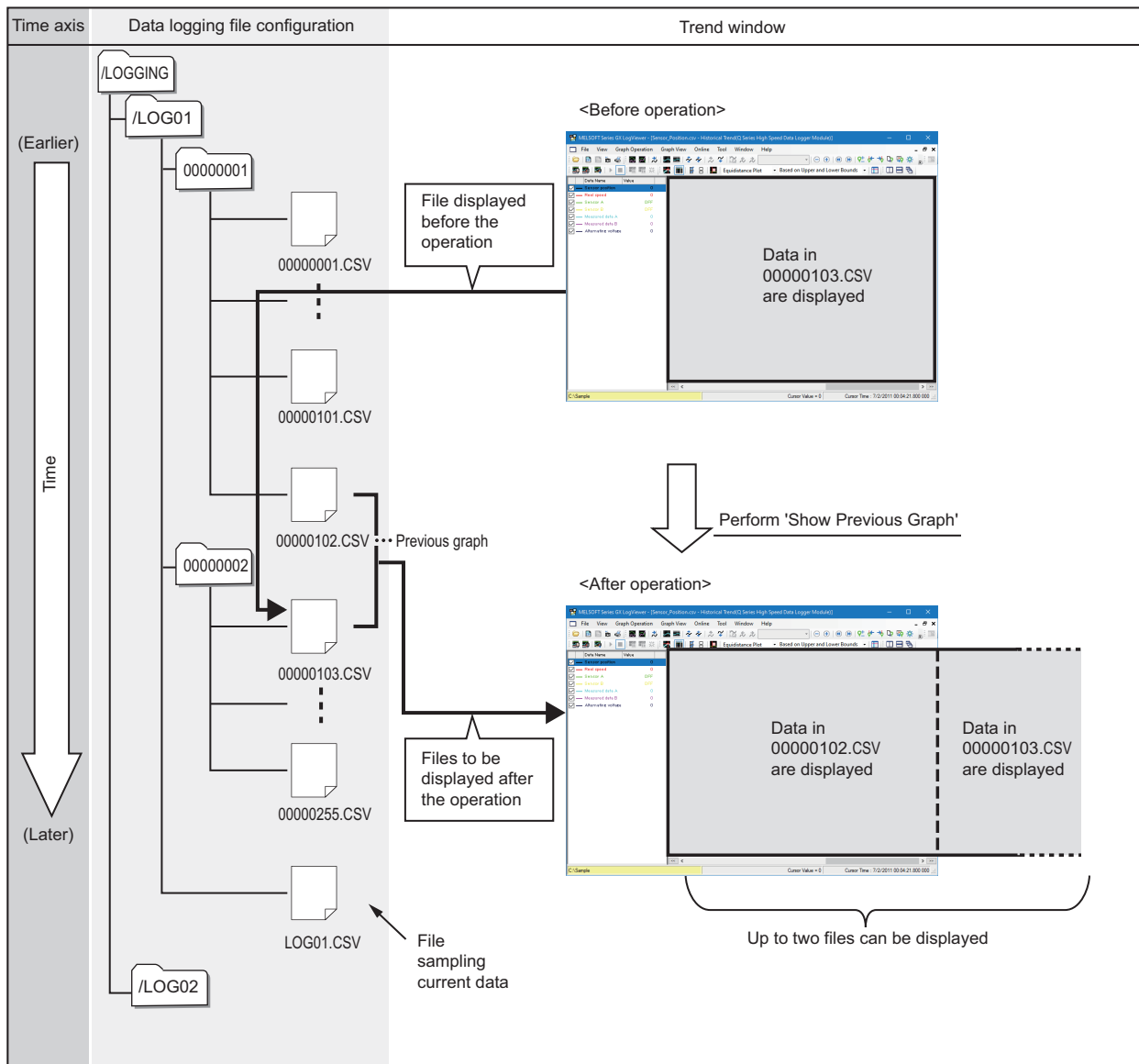

- Operating from the status when the previous graph is already displayed
Example: Displaying data of a MELSEC-Q series high speed data logger module

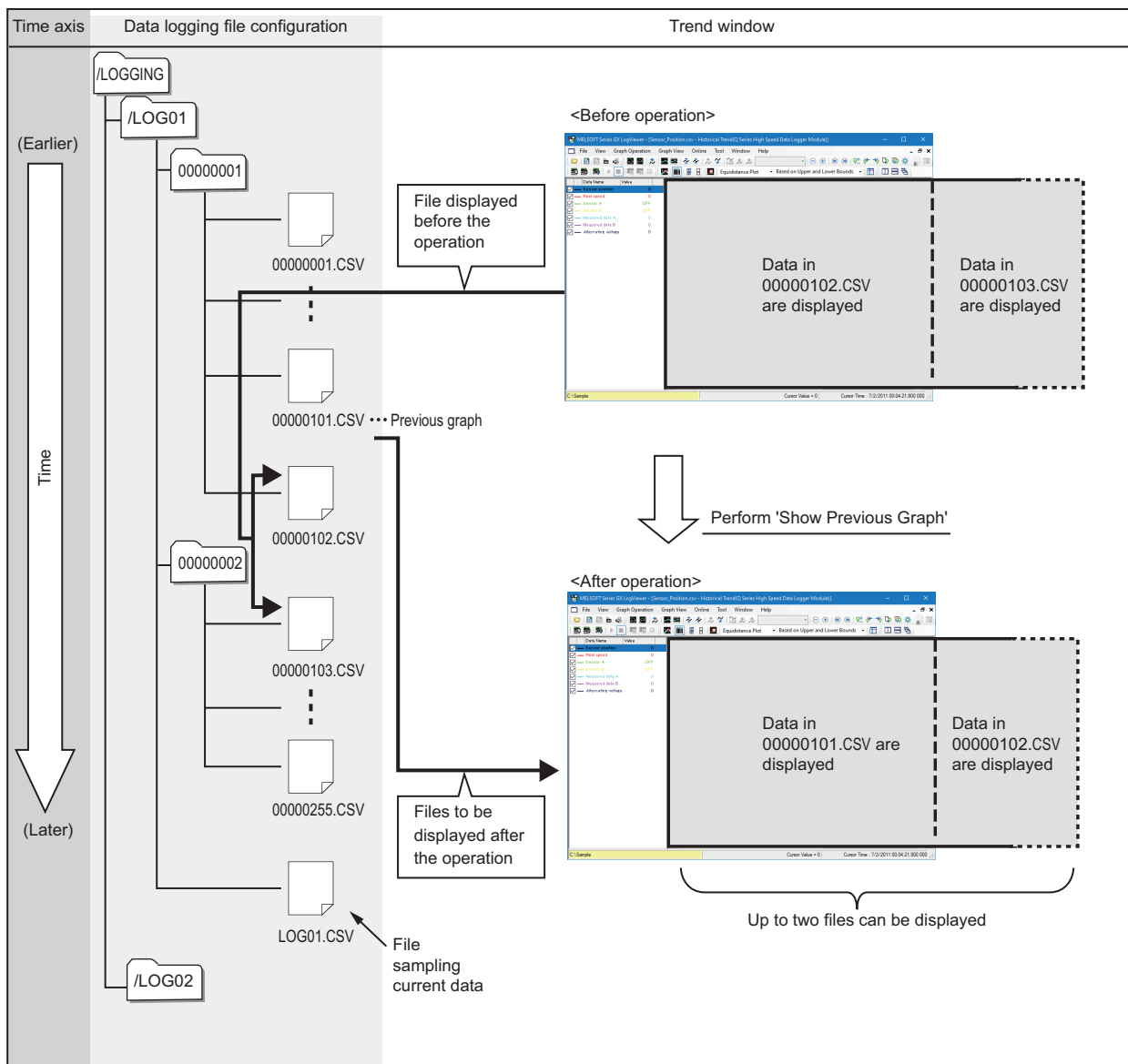

Operating procedure

1. Select [Graph Operation] ⇒ [Show Previous Graph] (◀).
2. Click the [◀] button.

The previous graph cannot be displayed to a Data logging file of which serial number assigned to the file name is the smallest number.

Displaying the next graph

- Operating from the normal status
- Example: Displaying data of a MELSEC-Q series high speed data logger module

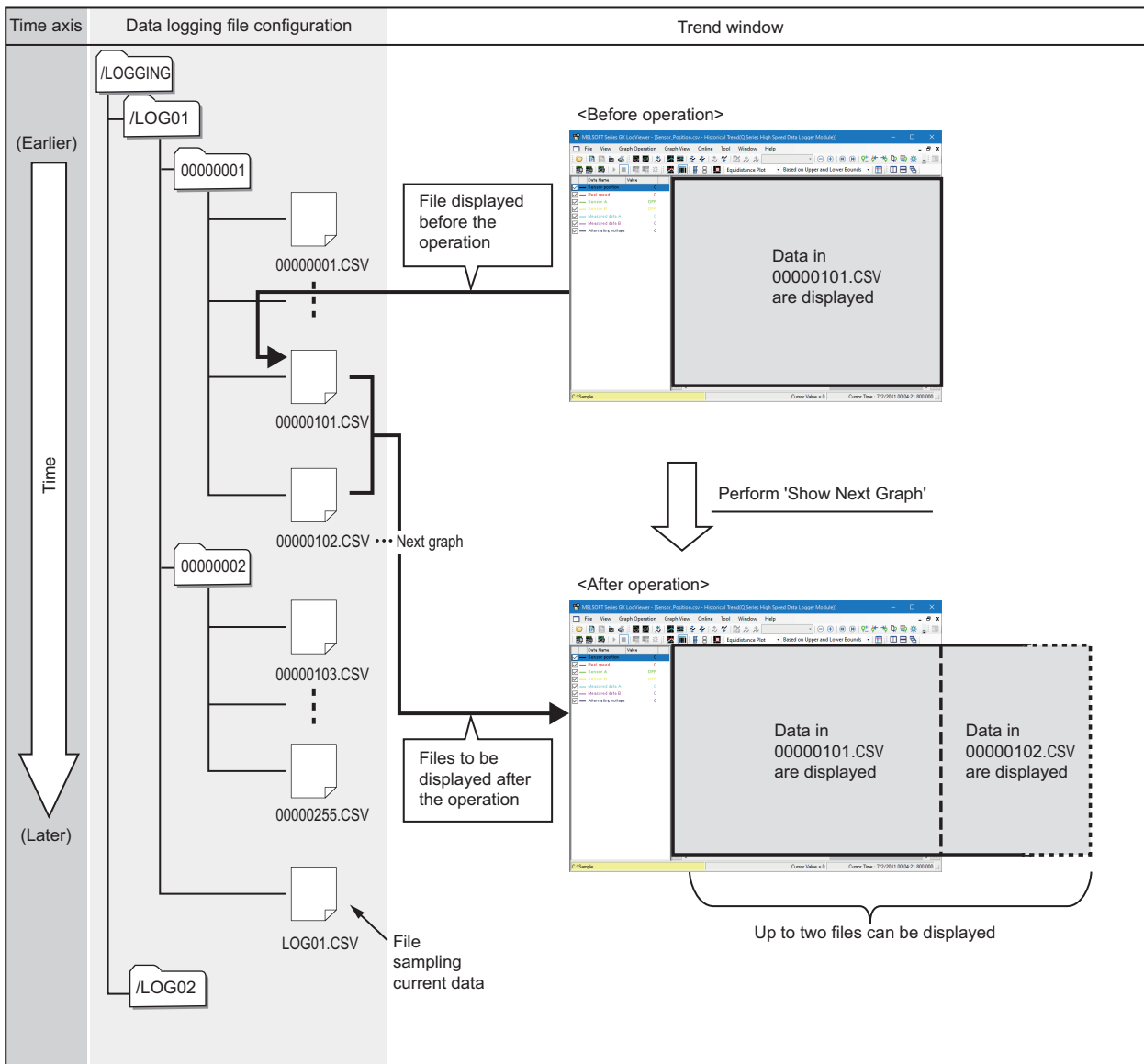

- Operating from the status when the next graph is already displayed
Example: Displaying data of a MELSEC-Q series high speed data logger module

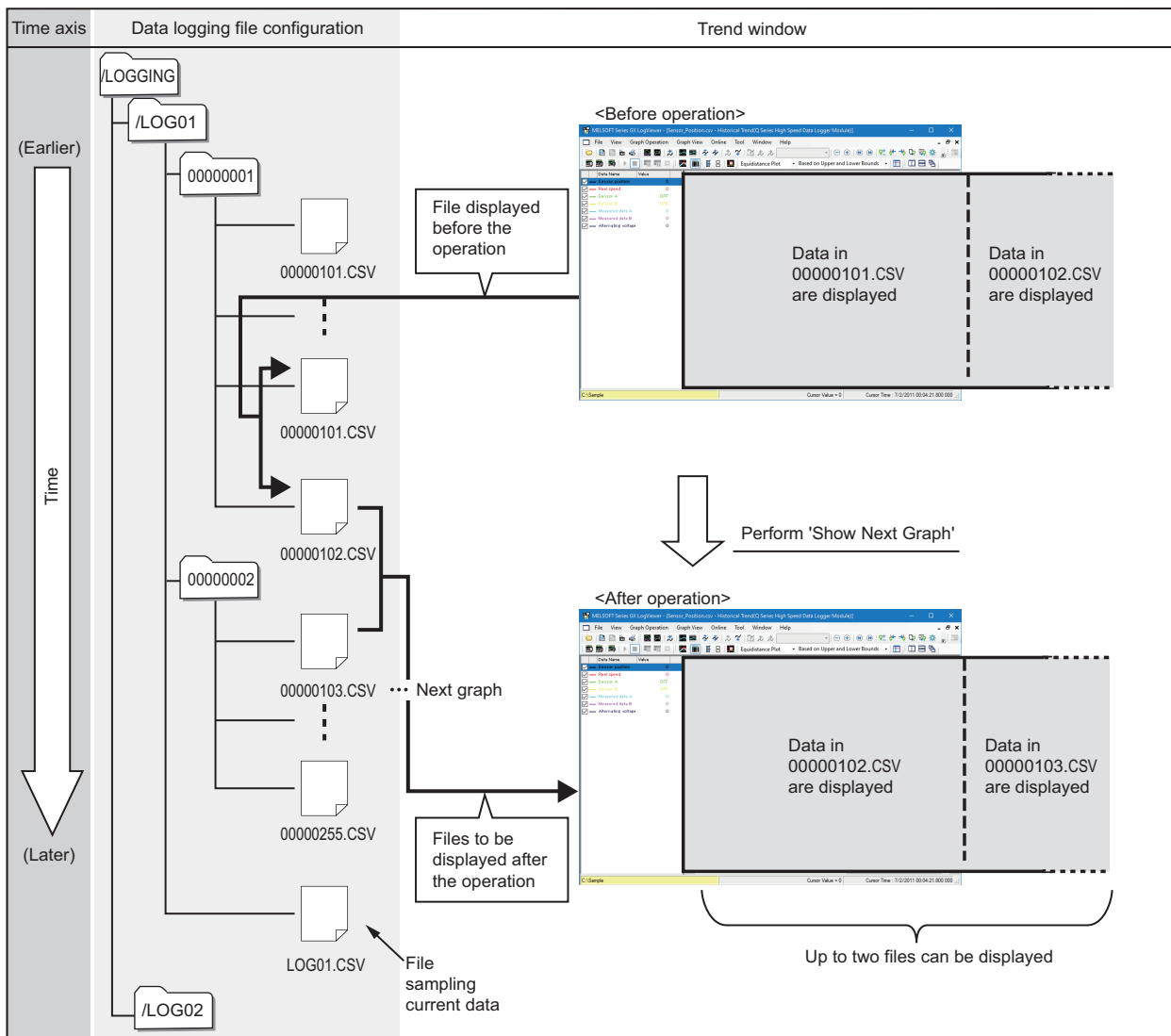

Operating procedure

1. Select [Graph Operation] ⇒ [Show Next Graph] (▶▶).
2. Click the [>>] button.

The next graph cannot be displayed to a Data logging file (a file that is sampling the current data) of which serial number is not assigned to the file name.

8.6 Changing Display Items in Graph Area

This section explains the methods of changing the display items in the graph area.
Data on trend graphs can easily be checked by changing the display items.

- ☞ Page 199 Displaying multiple cursors
- ☞ Page 200 Displaying cursor labels
- ☞ Page 200 Displaying data names
- ☞ Page 201 Switching data names
- ☞ Page 205 Displaying grid
- ☞ Page 205 Changing graph plot formats
- ☞ Page 206 Changing a display of time-scale label
- ☞ Page 206 Switching the display language of data names

Point

- Information of display items in a graph area (except for the language specified with the language selection function, multiple cursors, and ones set in "Graph Area Style" on the "Graph Properties" screen) can be named and registered to apply for another window. (☞ Page 211 Registering and Applying a Graphical Display Setting)
- The graph display can be set to automatically apply the setting when a window with the same data logging setting is opened next time. (☞ Page 214 Applying the Graph Display Automatically When Opening a Window)

Displaying multiple cursors

The number of cursors displayed in the graph area can be switched.

As standard, only the red cursor is displayed, but both the red cursor and the blue cursor can be displayed by setting the multiple cursor display.

While multiple cursors are displayed, the difference information area is also displayed.

For details on cursor operations, refer to the following:

- ☞ Page 153 Moving cursors

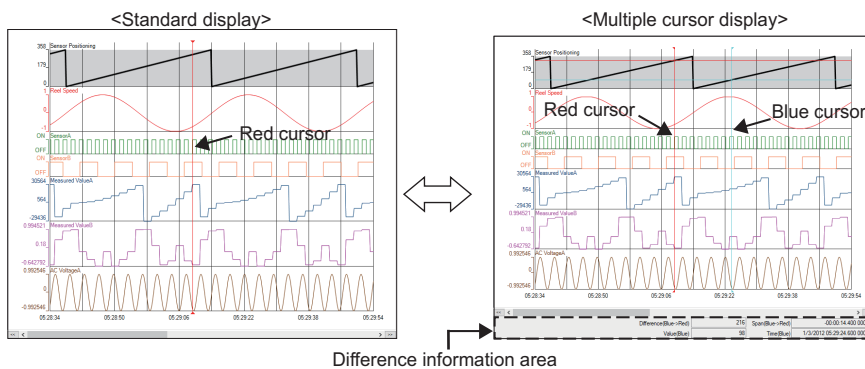

Operating procedure

Select [Graph View] ⇒ [Multiple Cursor] (📏).

Precautions

Stop or pause monitoring when switching to the multiple cursor display.

Displaying cursor labels

Cursor labels in the graph area can be displayed or hidden.

Labels for the red cursor are displayed at the right of the cursor, and labels for the blue cursor are displayed at the left of the cursor.

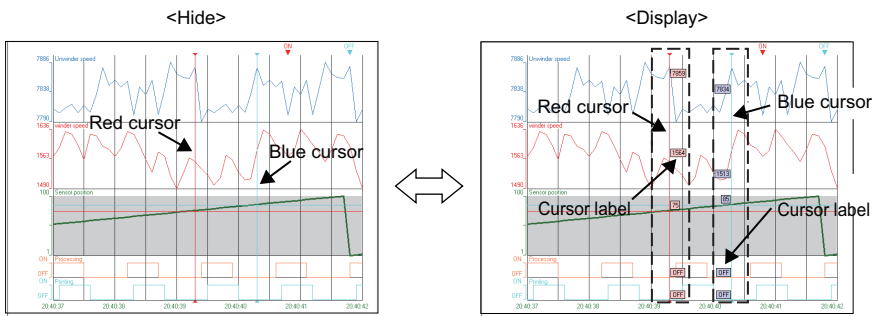

Operating procedure

Select [Graph View] ⇒ [Cursor Label] ().

Displaying data names

Data names in the graph area can be displayed or hidden.

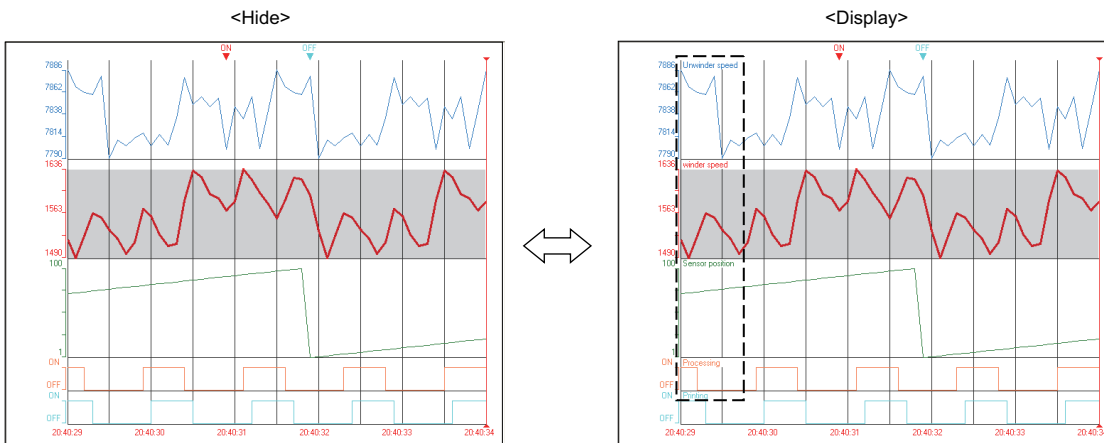

Operating procedure

Select [Graph View] ⇒ [Data Name].



When the realtime monitor window is activated, "Device/Label" is displayed as a display item instead of "Data Name."

Switching data names

Data names in the graph legend area and the graph area can be switched to other names by using a data name switch file. By entering data names in a template file to create a data name switch file and browsing the data name switch file, the data names of devices and labels displayed in the graph legend area and the graph area in the windows opened by the following functions are switched to the entered data names.

- Historical trend
- Realtime trend
- Realtime monitor

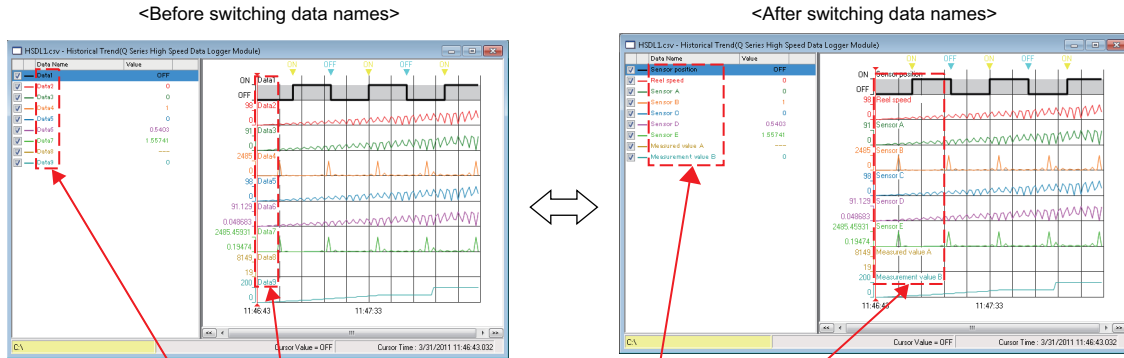

<Data Name Switch File>

Data Name Switch File				
Original Data Name	Data Name 1	Data Name 2	Data Name 3	Data Name 4
Data1	Sensor position			
Data2	Reel speed			
Data3	Sensor A			
Data4	Sensor B			
Data5	Sensor C			
Data6	Sensor D			
Data7	Sensor E			
Data8	Measured value A			
Data9	Measurement value B			
Data10	AC voltage			

Operating procedure

1. Open the "Switch Data Name" screen. (☞ Page 202 Displaying the Switch Data Name screen)
2. Create a data name switch file. (☞ Page 203 Creating a data name switch file)
3. Browse the data name switch file and select a data name in a header line corresponded to the data names to be displayed. (☞ Page 204 Selecting data names to be displayed)

Restriction

- Stop monitoring data before switching data names to other names because data names cannot be switched when the monitoring process status is being performed or being paused.
- When another data name than the original data name is selected in the "Switch Data Name" screen, the data cannot be saved to a CSV file or a Unicode text file. For saving the data to these files, select the original data name or initialize the graph display. (☞ Page 218 Initializing the Graph Display)
- When the device comment column is displayed in the graph legend area, data names cannot be switched. To switch data names, hide the device comment column in the graph legend area. (☞ Page 102 Graph legend area)

Point

- By using the 'Resister Graphical Display Settings' function, the switched data names can be registered as a display pattern of a 'graph display setting' and be applied to other trend windows. (☞ Page 211 Registering a graphical display setting)
- By using the 'Initialize Graph View' function, the switched data names can be restored to the original data names. (☞ Page 218 Initializing the Graph Display)
- By using the 'Set Graph View by the Auto Reflect Function' function, the switched data names can be displayed without switching data names again when opening the graph with the same data logging setting. (☞ Page 214 Applying the Graph Display Automatically When Opening a Window)

Displaying the Switch Data Name screen

In this screen, create a template file, browse a data name switch file, and select a data name in a header line corresponded to the data names to be displayed.

Window

Select [Graph View] ⇔ [Switch Data Name].

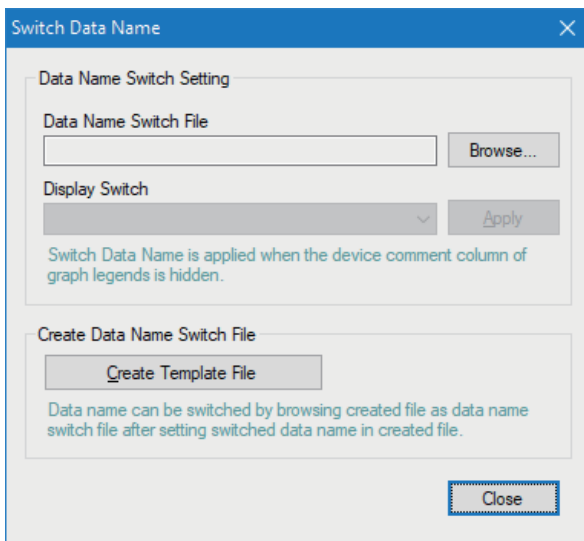

Creating a data name switch file

Enter data names to be displayed in a graph legend area and a graph area to a template file for creating a data name switch file.

Operating procedure

1. Click the [Create Template File] button in the "Switch Data Name" screen.
2. Enter a file name in the "Create Template File" screen and click the [Save] button.
3. Open the saved template file and enter data names to a header line and a data part.

■ Entering data names in a template file

Enter data names in a header line and a data part in a template file.

Ex.

When opening a template file in spreadsheet software

(1) →	Data Name Switch File				
(2) →	Original Data Name	Data Name 1	Data Name 2	Data Name 3	Data Name 4
(3) {	Data1				
	Data2				
	Data3				
	Data4				
	Data5				
	Data6				
	Data7				
	Data8				

Row name	Column number	Output content of a template file	Operation to a data name switch file
(1) Explanation of file	1st column	Data Name Switch File	—
(2) Header line	1st column	Original Data Name	Enter a data name to be displayed in the pull-down list of "Display Switch" in the "Switch Data Name" screen.*1*2
	2nd column	Data Name 1	
	3rd column	Data Name 2	
	4th column	Data Name 3	
	5th column	Data Name 4	
	6th column and later	Blank	
(3) Data part	1st column	Data names of devices and labels that can be displayed in the following windows.*3*4 <ul style="list-style-type: none"> • Historical Trend window • Realtime Trend window • Realtime Monitor window 	Enter data names to be displayed in a graph legend area and a graph area.*1*2*5
	2nd column and later	Blank	

*1 The data names can be entered from the 1st column to the 17th column.

*2 The data names can be entered within 1024 letters.

*3 Even if multiple devices/labels with the same data name are used, only one of them is output to the template file.

*4 The data names that are deleted from the graph legend area by the change the data to draw graphs function are displayed as well.

*5 The data names can be entered from the 1st row to the 1026th row.

Point

- The following describes the detailed formats of a CSV file.
The type of the file is CSV (tab delimited).
The character code is Unicode (UTF-16 Little Endian with BOM).
- When CALC data exists, the CALC data name is also output.

Selecting data names to be displayed

Browse a data name switch file for selecting data names to be displayed in a graph legend area and a graph area.

Operating procedure

1. Click the [Browse] button in the "Switch Data Name" screen.
 2. Select a data name switch file in the "Browse Data Name Switch File" screen and click the [Open] button.
 3. Select a data name from the pull-down list of "Display Switch"*1 and click the [Apply] button.
- *1 Select the data name in the same column as the data names to be displayed in the graph legend area and the graph area.
For instance, select the data name entered in the second column of the header line for displaying the data names entered in the second column of the data part to the graph legend area and the graph area.

Precautions

The file that does not have data names in the second column and later cannot be browsed. Enter data names into the file in advance.

In addition, browsing a data name switch file is failed and the original data names are displayed in the following situations.

- The data name switch file in which the first column is empty is selected.
- The column in which the data part is empty is selected for "Display Switch."

Displaying grid

The grid (vertical lines or horizontal lines) in the graph area can be displayed or hidden.

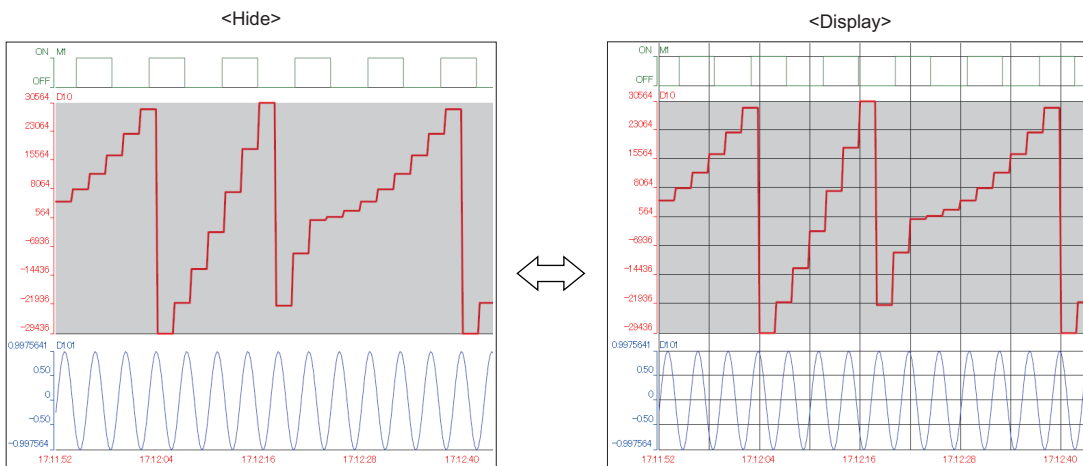

Operating procedure

[Graph View] ⇒ [Grid] ⇒ [Vertical Line]/[Horizontal Line]

Changing graph plot formats

The plot format of graphs displayed in a historical trend window can be changed to the equidistance plot format or the time interval plot format.

The equidistance plot display format is a format which displays the sampled data in an equal interval regardless of time.

The time interval plot display format is a format which displays the graph in a fixed time interval.

When displaying logging data of more than one file on the same graph area, the time interval plot display format is applied.

Displaying data with fixed time interval allows easier comparison between multiple data.

For the methods of adding logging data, refer to the following:

☞ Page 159 Changing the data to be displayed in the graph area

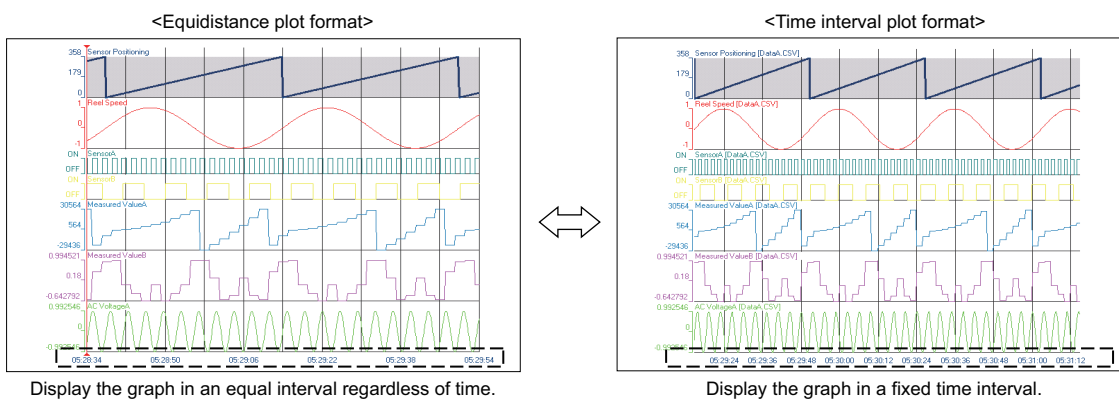

Operating procedure

Select [Equidistance Plot]/[Time Interval Plot] from the pull-down list () in the toolbar.

Alternatively, select [Graph View] ⇒ [Plot Format] ⇒ [Equidistance Plot]/[Time Interval Plot].

Changing a display of time-scale label

The display of a time-scale label in the graph area can be changed to the time display, date display, date and time display, or index display.

Since an analog module does not have time information in the logging data, only the index display is available.

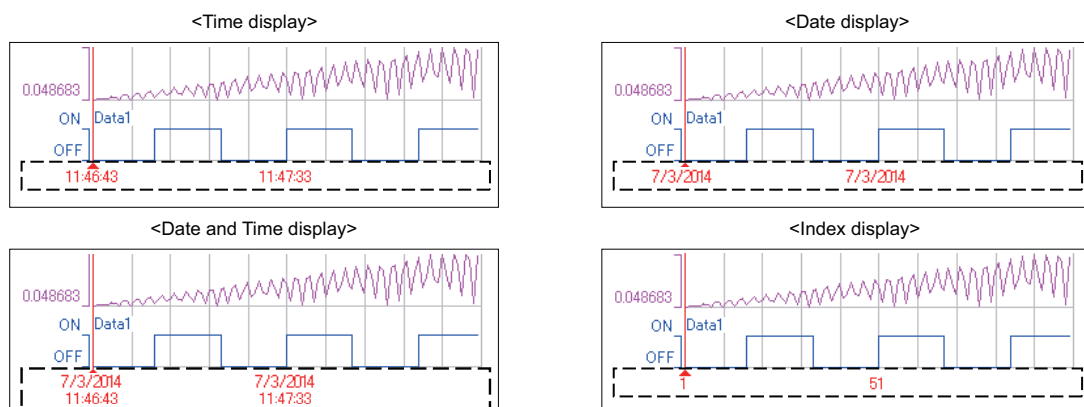

Operating procedure

Select [Graph View] ⇒ [Time Label] ⇒ [Time]/[Date]/[Date and Time]/[Index].

Precautions

- A data logging file, in which any of "year," "month," "day," "hour," "minute," or "second" of the data line output format (can be set with a configuration tool) is missing, is displayed with Index only. For data of which all of units following the missing unit are to be output even when any of "hour," "minute," or "second" is missing; however, the time display/date display/date and time display are available by treating the missing unit as '0.'
- When the time display or date and time display is applied to the time-scale label and the realtime monitor function is performed for a long time, the time displayed on the time-scale label will be different from the actual time.

Switching the display language of data names

A display language of data names displayed in a historical trend window can be switched.

When displaying a data logging file, the data names are displayed in a language of the characters being used in the loaded file.

If characters of codes which can be used in multiple languages or characters of inapplicable languages are used for data names, those characters may be corrupted.

If characters are corrupted, switch the display language.

Operating procedure

Select [Graph View] ⇒ [Set Language] ⇒ [(data logging file name)]^{*1} ⇒ [Chinese Simplified]^{*2}/[Chinese Traditional]^{*2}/[English]^{*2}/[Japanese]^{*2}/[Korean]^{*2}/[Unicode (UTF-8)]^{*2}.

*1 The data logging file name shown in the historical window is displayed.

*2 The display language cannot be selected when the following data are displayed.

- Data in a Unicode text file
- Data in a JSON file
- Data in a binary file sampled by an RCPU, LHCPU, and FX5CPU
- Data in a binary file sampled by a MELSEC iQ-R series high speed data logger module
- Data in a CSV file sampled by a MELSEC iQ-R series motion module

8.7 Changing Graph Appearance



This section explains the methods of changing graph appearance.

 Page 208 Changing color and type of graph

 Page 210 Highlighting graph

 Page 210 Thickening graph line

Point

- Graph display information can be named and registered to apply for another window. ( Page 211 Registering and Applying a Graphical Display Setting)
 - The graph display can be set to automatically apply the setting when a window with the same data logging setting is opened next time. ( Page 214 Applying the Graph Display Automatically When Opening a Window)
-

Changing color and type of graph

The settings of graphs displayed in a trend window can be changed.

The following figure shows the settings that can be changed.

- (1) Color and line type of graph
- (2) Trigger ON color
- (3) Trigger OFF color
- (4) Background color
- (5) Grid color

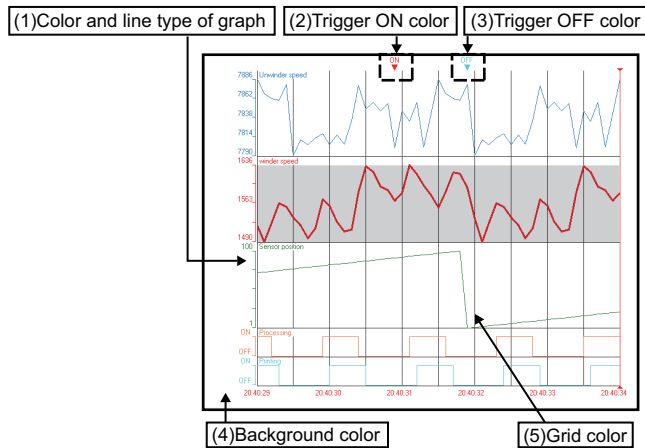

The color settings for the background, grid, and trigger ON and OFF are common to all trend windows, so any changes are applied to all the trend windows being displayed; however, the color settings does not support the 'Set Graph View by the Auto Reflect Function' function.

Point

- Color and line type of graph can be specified for each data.
- Customized colors can be used for the graphic property and the event property in common.
([Page 209 Changing settings in the Graph Properties screen](#)) ([Page 240 Displaying the Event Properties screen](#))

Changing settings in the Graph Properties screen

Window

Select [Graph View] ⇒ [Graph Properties].

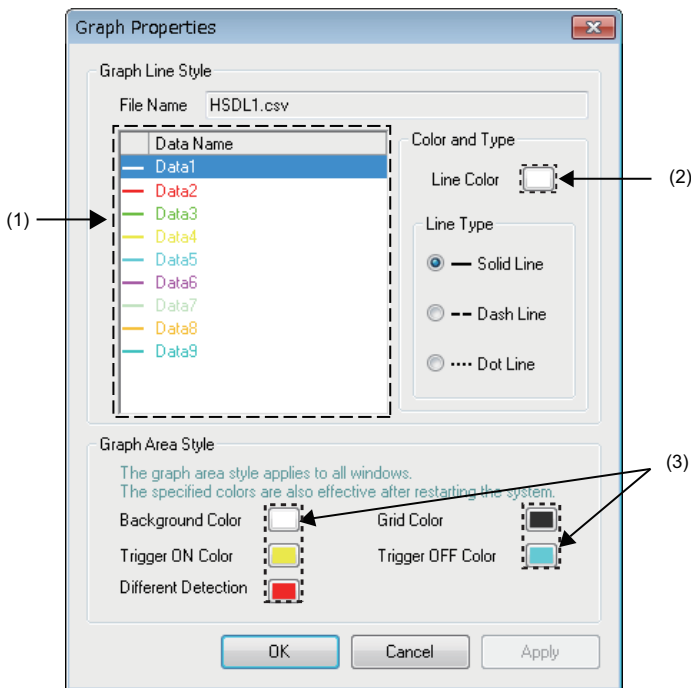

8

Operating procedure

■ Changing graph color

1. Select data whose graph color is changed from the list of the graph legend area (1).
2. Click the color button (2) for "Line Color."
3. Select a color to be changed from "Basic colors" or "Custom colors" in the "Color" screen, and click the [OK] button.

■ Changing graph line type

1. Select a data whose graph line type to be changed from the list of the graph legend area.
2. Select a type from "Line Type," and click the [OK] button.

■ Changing graph area setting (background color, grid color, trigger ON color, and trigger OFF color)

1. Click the color button (3) for the setting to be changed.
2. Select a color to be changed from "Basic colors" or "Custom colors" in the "Color" screen, and click the [OK] button.

Point

Color and line type of CALC data also can be changed in this screen.

Highlighting graph

The display area of the selected trend graph can be highlighted.

The highlighted display is also applied to a graph printed on a paper.

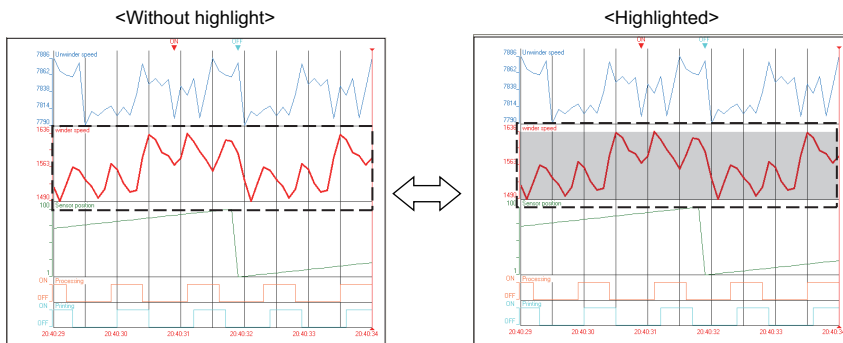

Operating procedure

Select [Graph View] ⇒ [Graph Highlight].

Thickening graph line

The line of the selected trend graph can be thickened.

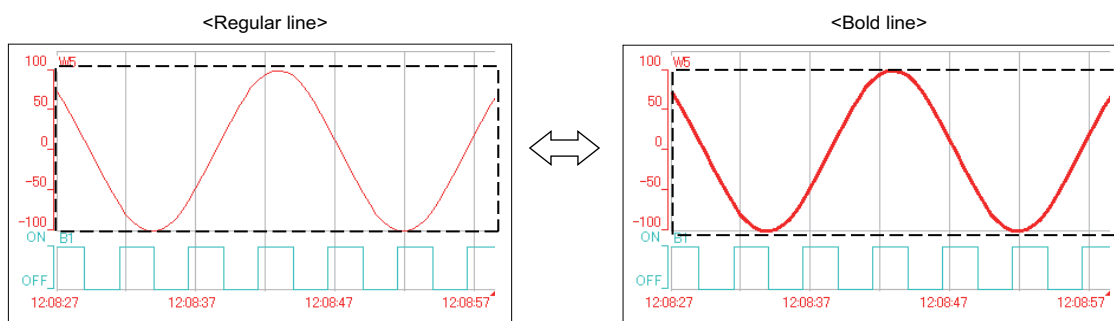

Operating procedure

Select [Graph View] ⇒ [Bold line].

8.8 Registering and Applying a Graphical Display Setting

Display information of a graph being displayed (graph line color and type, upper and lower bound, display item in a graph area *1, highlighted display, bold display, display status of graph legend area) can be registered as a 'graphical display setting' and applied to another trend window.

*1 The setting information in the language selection setting is excluded. For the target items of a graphical display setting, refer to the following:

- ☞ Page 163 Operating Trend Graphs
- ☞ Page 199 Changing Display Items in Graph Area
- ☞ Page 207 Changing Graph Appearance

Registering a graphical display setting

Window

Select [Graph View] ⇒ [Register Graphical Display Settings].

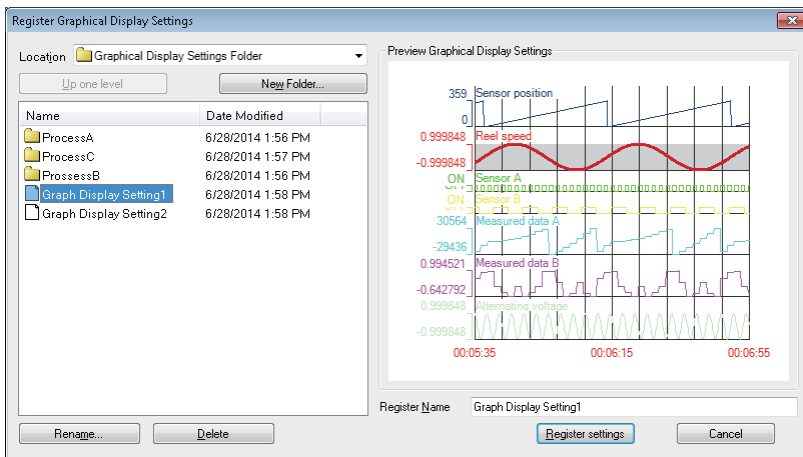

Operating procedure

Enter a name to be registered and click the [Register Settings] button.

Point

A new folder can be created under a folder being selected on the "Register Graphical Display Settings" screen. Select the folder name and click the [New Folder] button.

Operating a graphical display setting

Window

Select [Graph View] ⇒ [Operate Graphical Display Settings].

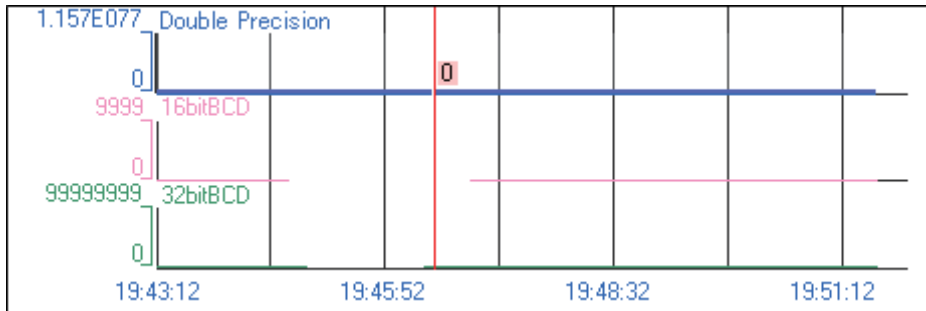

Operating procedure

■Applying a registered graphical display setting to another trend window

Select a display setting to apply, and click the [Reflect settings] button.

■Deleting or renaming a registered graphical display setting

Select a display setting to be renamed/deleted, and click the [Rename] button or the [Delete] button.

Applying a graph display setting

A recently-used graph display setting is applied to the trend window.

Operating procedure

1. Select [Graph View] ⇒ [Recent Graphical Display Settings] to display the list of recently-used graph display settings in the menu.
2. Select a graph display setting to be applied from the list of the recently-used graph display settings.

Importing/Exporting a graphical display setting

- Importing files: All information included in an export file is imported. All registered graph display settings are cleared before importing.
- Exporting: The folder hierarchy information is also saved in an export file.

Window

Select [File] ⇒ [Import and Export].

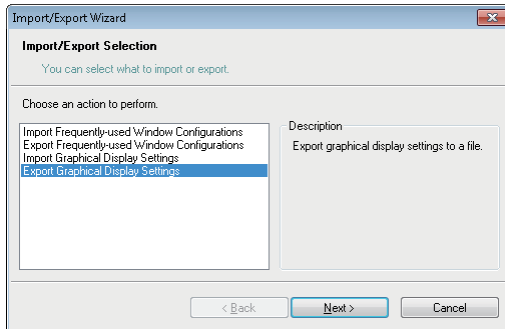

Operating procedure

1. Select "Import Graphical Display Settings"/ "Export Graphical Display Settings," and click the [Next] button.
2. Specify the path of a file to be imported or the path where data is exported, and a file name, then click the [Next] button.
3. Click the [Finish] button.

8.9 Applying the Graph Display Automatically When Opening a Window

The automatic application function stores the display information of a graph being displayed (graph line color and type, upper and lower bound, display item in a graph area^{*1}, highlighted display, bold display, display status of graph legend area) for each data logging setting, and applies to a graph automatically when a window is opened next time.

By using this function, it is not required to set the setting again when displaying a graph with the same data logging setting as same as last time.

*1 The setting information in the language selection setting is excluded. For the target items of a graphical display setting, refer to the following:

-  Page 163 Operating Trend Graphs
-  Page 199 Changing Display Items in Graph Area
-  Page 207 Changing Graph Appearance

Operating procedure

Select [Graph View] ⇨ [Set Graph View by the Auto Reflect Function].

Restriction

By using this function after switching data names to other names by the data name switch function, the switched data names can be automatically applied to the graph with the same data logging setting as the graph that has the switched data names. In that case, the data size, the output format of the data, and the name of all labels and devices in both graphs need to be matched.

Point

To restore the settings to the initial settings, initialize the graph display first, then set the automatic application function again.

8.10 Displaying a Graph as Data Values/statuses

Graphs displayed in a historical trend window can be displayed as the data values/statuses.

Window

Select [Graph View] ⇒ [Dump Display] ().

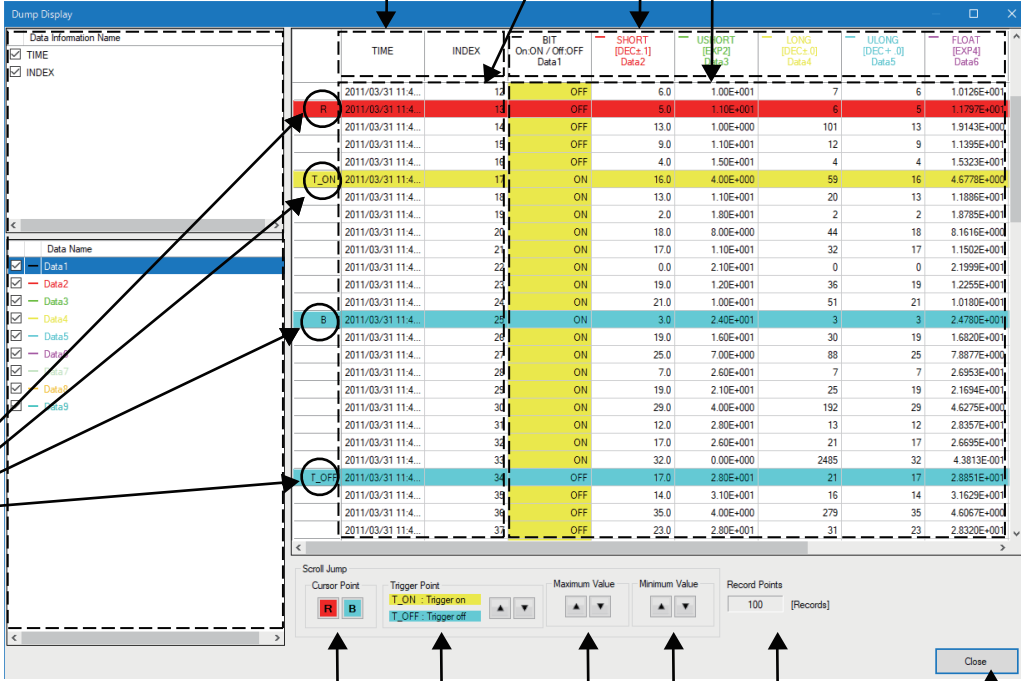

The screenshot shows the 'Dump Display' window with a table of data. Annotations (1) through (12) point to specific UI elements:

- (1) Points to the 'Data Information Name' list on the left.
- (2) Points to the 'Data Name' list on the left.
- (3) Points to the 'TIME' column header.
- (4) Points to the 'BIT' column header.
- (5) Points to the 'SHORT [DEC=1] Data2' column header.
- (6) Points to the 'US [DEC=2] Data3' column header.
- (7) Points to the 'Cursor Point' dropdown menu.
- (8) Points to the 'Trigger Point' dropdown menu.
- (9) Points to the 'Maximum Value' dropdown menu.
- (10) Points to the 'Minimum Value' dropdown menu.
- (11) Points to the 'Record Points' input field.
- (12) Points to the 'Close' button.

TIME	INDEX	BIT On/ON / Off/OFF Data1	SHORT [DEC=1] Data2	US [DEC=2] Data3	LONG [DEC=3] Data4	ULONG [DEC=4] Data5	FLD [DEC=5] Data6
2011/03/31 11:4...	13	OFF	6.0	1.00E+001	7	6	1.0128E+001
2011/03/31 11:4...	14	OFF	5.0	1.10E+001	6	5	1.1797E+001
2011/03/31 11:4...	14	OFF	13.0	1.00E+000	101	13	1.9143E+000
2011/03/31 11:4...	14	OFF	9.0	1.10E+001	12	9	1.1395E+001
2011/03/31 11:4...	18	OFF	4.0	1.50E+001	4	4	1.5323E+001
2011/03/31 11:4...	17	ON	16.0	4.00E+000	59	16	4.6778E+000
2011/03/31 11:4...	19	ON	13.0	1.10E+001	20	13	1.1886E+001
2011/03/31 11:4...	19	ON	2.0	1.80E+001	2	2	1.8785E+001
2011/03/31 11:4...	20	ON	18.0	8.00E+000	44	18	8.1616E+000
2011/03/31 11:4...	21	ON	17.0	1.10E+001	32	17	1.1502E+001
2011/03/31 11:4...	22	ON	0.0	2.10E+001	0	0	2.1999E+001
2011/03/31 11:4...	22	ON	19.0	1.20E+001	36	19	1.2255E+001
2011/03/31 11:4...	24	ON	21.0	1.00E+001	51	21	1.0180E+001
2011/03/31 11:4...	28	ON	3.0	2.40E+001	3	3	2.4780E+001
2011/03/31 11:4...	28	ON	19.0	1.60E+001	30	19	1.6820E+001
2011/03/31 11:4...	29	ON	25.0	7.00E+000	88	25	7.8877E+000
2011/03/31 11:4...	28	ON	7.0	2.60E+001	7	7	2.6953E+001
2011/03/31 11:4...	28	ON	19.0	2.10E+001	25	19	2.1634E+001
2011/03/31 11:4...	30	ON	29.0	4.00E+000	192	29	4.6275E+000
2011/03/31 11:4...	31	ON	12.0	2.80E+001	13	12	2.8357E+001
2011/03/31 11:4...	33	ON	17.0	2.60E+001	21	17	2.6695E+001
2011/03/31 11:4...	33	ON	32.0	0.00E+000	2485	32	4.3813E+001
2011/03/31 11:4...	34	OFF	17.0	2.80E+001	21	17	2.8851E+001
2011/03/31 11:4...	39	OFF	14.0	3.10E+001	16	14	3.1629E+001
2011/03/31 11:4...	39	OFF	35.0	4.00E+000	279	35	4.6067E+000
2011/03/31 11:4...	33	OFF	23.0	2.80E+001	31	23	2.8320E+001

Displayed items

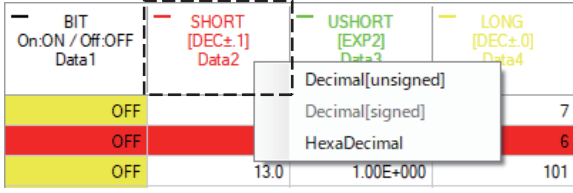
Item		Description
(1) Graph legend area	Data information name list	By selecting a checkbox, the data information name is displayed in the data information name area.
	Data name list	By selecting a checkbox, the value corresponding to the data name is displayed in the data name area.
(2) Trigger point and cursor point ^{*1}		<ul style="list-style-type: none"> • "T_ON" is displayed at a trigger occurrence point. • "T_OFF" is displayed at a trigger clear point. • "R" is displayed on the row of this screen corresponding to the position of the red cursor in the graph area. • "B" is displayed on the row of this screen corresponding to the position of the blue cursor in the graph area.
(3) data information name		The data information name of which the checkbox is selected in the data information name list is displayed.
(4) Data name		<p>The data name of which the checkbox is selected in the data name list is displayed.</p> <p>■Bit data 1st row: Waveform color and data type 2nd row: Output format for ON or OFF 3rd row: Data name in the graph legend area</p> <p>■Data other than bit data 1st row: Waveform color and data type^{*2} 2nd row: Output format of the data type^{*3*4} 3rd row: Data name in the graph legend area 4th and later rows: unit (in the case where units are included in a file)</p> <ul style="list-style-type: none"> • When the data type is SHORT, USHORT, LONG, ULONG, BCD16, or BCD32, the output format of data to be displayed in the data column can be switched between 'Decimal [unsigned]', 'Decimal [signed]', and 'Hexadecimal' in the menu displayed by right-clicking the data name column.^{*5*6} 
(5) Data information		<p>The contents of the data information row stored in a file are displayed.</p> <p>■Display example</p> <ul style="list-style-type: none"> • When the time is 1/1/2018 01:23:45.123456000 (the digit of 100 nanosecond does not exist or is 0) 1/1/2018 01:23:45.123456 • When the time is 1/1/2018 01:23:45.123456789 (the digit of 100 nanosecond is not 0) 1/1/2018 01:23:45.1234567^{*7}
(6) Data		<p>■Bit data "OFF" or "ON" is displayed.</p> <p>■Data other than bit data The values stored in a file are displayed as they are.</p> <p>■CALC data A CALC data value is displayed.</p>
(7) Cursor	[R] button	The cursor jumps to the position where the red cursor is located in the graph area.
	[B] button	The cursor jumps to the position where the blue cursor is located in the graph area. It cannot be clicked when the blue cursor is not displayed.
(8) Trigger	[▲] button	The cursor jumps to the trigger occurrence points or trigger clear points above the selected row.
	[▼] button	The cursor jumps to the trigger occurrence points or trigger clear points under the selected row.
(9) Maximum value	[▲] button	The cursor jumps to the position of the maximum value in the range from the row above the selected row to the first point.
	[▼] button	The cursor jumps to the position of the maximum value in the range from the row under the selected row to the last point.
(10) Minimum value	[▲] button	The cursor jumps to the position of the minimum value in the range from the row above the selected row to the first point.
	[▼] button	The cursor jumps to the position of the minimum value in the range from the row under the selected row to the last point.
(11) Total number of records		The total number of records is displayed.
(12) [Close] button		Click this to close the "Dump Window" screen.

- *1 When displaying logging data of multiple files in a historical trend window, if a mouse cursor is placed on a different file from the one displayed in this screen and time data does not exist at the cursor point, a cursor point is not displayed.
- *2 For data types, "BCD16" is displayed for 16-bits data and "BCD32" is displayed for 32-bit data.
- *3 For word or double-word data, "DEC (sign) .(number of digits of a decimal point)" is displayed.
- *4 For a single-precision real number or double-precision real number, "DEC. (number of digits of a decimal point)" or "EXP. (number of digits of a decimal point)" is displayed.
- *5 When the data type is BCD16 or BCD32, the output format can be switched between 'Decimal [unsigned]' and 'Hexadecimal'.
- *6 When the output format of data is an exponent (EXP), the menu will not be displayed by right-clicking the column because the output format cannot be switched.
- *7 The numbers of the digits of 10 nanosecond and 1 nanosecond are not displayed because they are rounded down.

8.11 Initializing the Graph Display

Changed graphical display can be restored to the initial state (the state where graph appearance such as the color has not been changed).

Operating procedure

1. Select a trend window to be initialized. (Activate it.)
2. Select [Graph View] ⇒ [Initialize View].

Point

- Even if initializing the graph display to which the automatic application function has already been set, the graph display set in the automatic application function is applied when opening the trend window with the same data logging setting next time.
 - If CALC data exists, the data is deleted by this operation.
-

8.12 Graph Display for Missing Data or Time Reversed Data

This section explains the graph display when the data is missing, or the time information is reversed.

Graph display for missing data

The missing data is displayed as two vertical dashed-dotted lines.

The equidistance plot display format: A time-scale label is displayed as "****.***.***".

The time interval plot display format: the missing period is displayed as gray.

For more details on missing data, refer to manuals for respective modules.

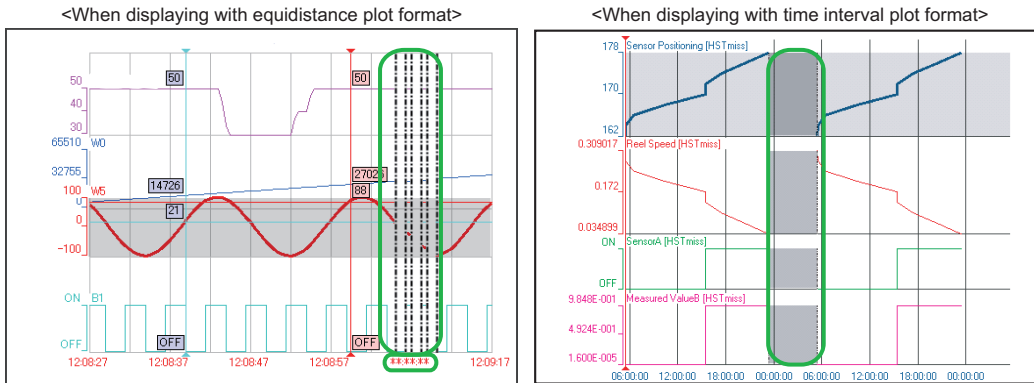

■Displaying value in the graph legend area for missing data

When the cursor is placed between the two dashed-dotted lines for missing data, "---" is displayed for the value on the graph legend area.

■Displaying cursor value and difference information for missing data

When the cursor is placed between the two dashed-dotted lines for missing data, the cursor value and the cursor time on the status bar are displayed as follows.

- Cursor Value:---
- Cursor Time:****/**/** ****.***.*** **** **

When the red cursor/blue cursors point out the data missing area while multiple cursors are displayed, the difference and span fields in the difference information area are displayed as shown below.

- Difference:---
- Span:****.***.*** **** **

Graph display for reversed data

When displaying a graph with the time interval plot display format, the reversed period is displayed as oblique stripe, in case data time is reversed owing to the time change of a module.

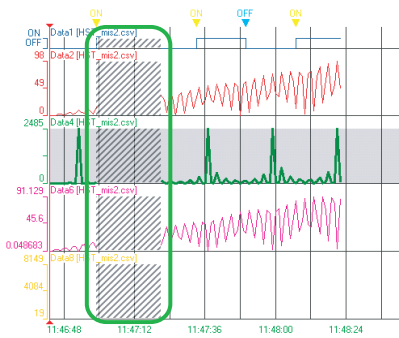

When the data of a CPU module is sampled at less than 1 millisecond interval, '0' is output to all digits of microsecond or less of the sampled time in the file to which the sampled data output.

Therefore, the sampled time output to the file may be duplicated.

When displaying a graph including the data of the duplicated time, the graph during the duplicated period is displayed as oblique stripe as well as the reversed period.

DATETIME[YYYY/MM/DD hh:mm:ss.ssssss]	INTERVAL
TIME(UTC+09:00)	INTERVAL[us]
2000/09/19 04:16:15.3420000	400
2000/09/19 04:16:15.3430000	400
2000/09/19 04:16:15.3430000	400
2000/09/19 04:16:15.3430000	400
2000/09/19 04:16:15.3440000	400
2000/09/19 04:16:15.3440000	400
2000/09/19 04:16:15.3450000	400
2000/09/19 04:16:15.3450000	400
2000/09/19 04:16:15.3450000	400
2000/09/19 04:16:15.3460000	400
2000/09/19 04:16:15.3460000	400
2000/09/19 04:16:15.3460000	300

8.13 Displaying Abnormal Graphs

An abnormal graph is displayed when the value of data is a nonnumeric or infinite value.

When a float (single precision, double precision) is expressed as a numeric value, a bit string that is not recognized as a numeric value is handled as a nonnumeric value.

By the scaling function of a data logger or data communication, the data value may become plus infinite/minus infinite values.

Graph display on the trend window

- A graph is not displayed while data which is used as a non-numeric value or an invalid value continues.
- The cursor labels of a graph are not displayed while data which is used as a non-numeric value or an invalid value continues.
- For the plus infinite value, the graph attaches to the upper limit display value.
- For the minus infinite value, the graph attaches to the lower limit display value.

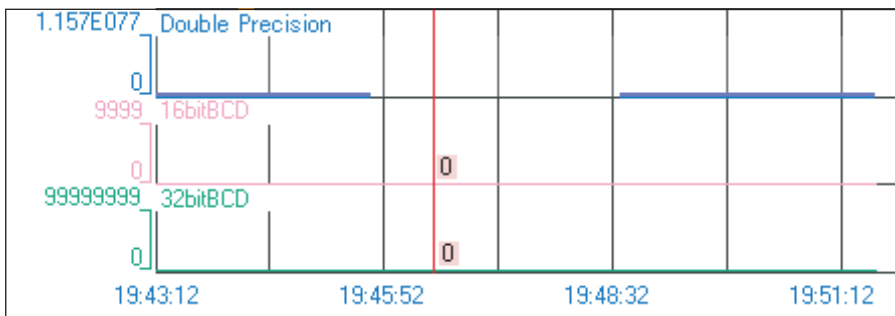

Cursor values displayed in the graph legend area

- Nonnumeric value: NaN
 - Plus infinite value: +Inf
 - Minus infinite value: -Inf
 - "#" data: ---
- | | |
|--|-----|
| <input checked="" type="checkbox"/> Double Precision | NaN |
| <input checked="" type="checkbox"/> 16bitBCD | 0 |
| <input checked="" type="checkbox"/> 32bitBCD | 0 |

Cursor value and difference information displayed on status bar of trend window

The cursor value on the status bar, and "Difference (Blue → Red)" and "Value (Blue)" in the difference information area are also displayed as follows:

- Nonnumeric value: NaN
- Plus infinite value: +Inf
- Minus infinite value: -Inf
- "#" data: ---

Difference[Blue→Red]	NaN
Value[Blue]	1
Cursor Value = NaN	

8.14 Handling Incorrect Values

In any of the following cases, data values are regarded as incorrect values.

- A data value of the data type except for the single-precision real number or double-precision real number is a non-numeric value (NaN).
- A data value is 0 or less in a logarithmic display.

The following explains the notation of incorrect values on the trend window.

Graph display on the trend window

- A graph is not displayed while an incorrect value continues.
- A cursor label of a graph is not displayed while incorrect values continue.
- While multiple cursors are displayed, the horizontal cursor that indicates an intersection with a graph is not displayed.

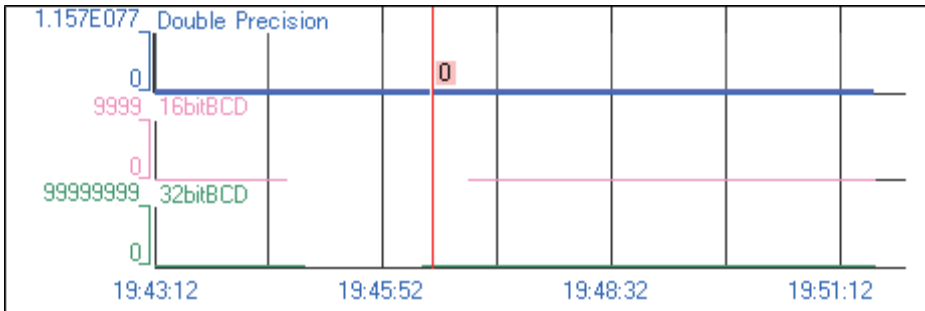

Cursor values displayed in the graph legend area

When the cursor is placed at the plot of an incorrect value, "---" is displayed for the value in the graph legend area.

✓	Double Precision	0
✓	16bitBCD	---
✓	32bitBCD	---

Cursor value and difference information displayed on status bar of trend window

When the cursor is placed at the plot of an incorrect value, "---" is displayed for the cursor value field on the status bar.

The cursor value of the blue cursor while multiple cursors are displayed will also be displayed in the same way.

"---" is also displayed for the difference field when the red cursor/blue cursor is placed at the incorrect value.

Difference[Blue->Red]	---
Value[Blue]	0
Cursor Value =	---

9 USING EVENT MONITORING FUNCTION

Type	Target for explanation ( Page 13 Target modules, simulators, files, and data for explanation)
Module	BOX, R logger, Q logger

9.1 Overview

This function displays events sampled with the event logging function of a data logger in the list format. The following two types of the event monitoring functions can be used.

- Historical event
- Realtime event

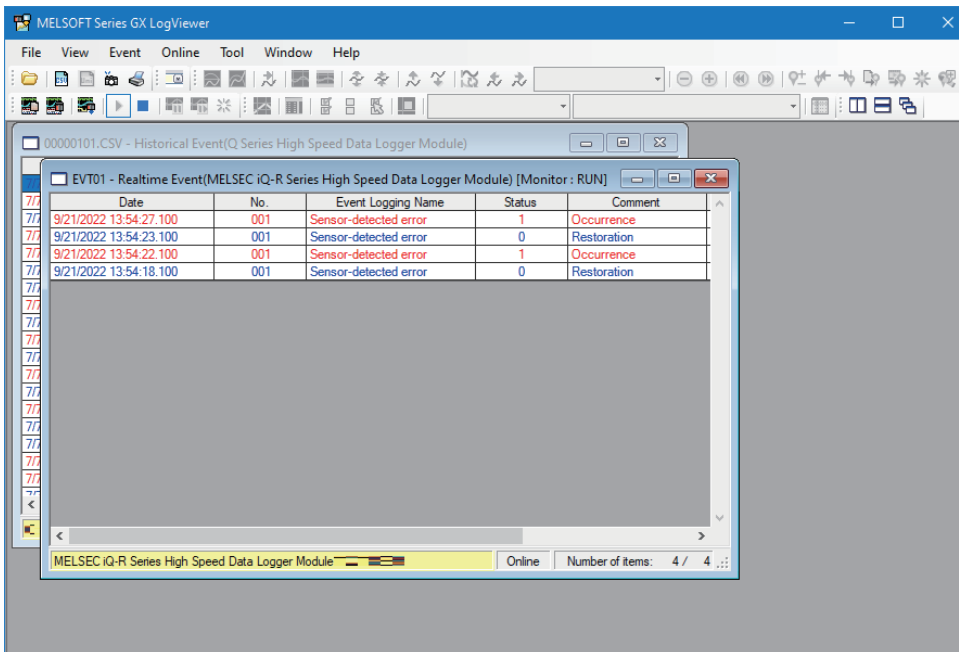

Modules supporting the event monitoring functions are shown below.

○: Supported, ×: Not supported

Series	Supported module	Historical event	Realtime event
MELSEC iQ-R series	RCPU	×	×
	High speed data logger module	○	○
	High speed data communication module	×	×
	Analog module	×	×
	Motion module	×	×
MELSEC iQ-L series	LHCPU	×	×
MELSEC iQ-F series	FX5CPU	×	×
MELSEC-Q series	QnUDVCPU	×	×
	High speed data logger module	○	○
	High speed data communication module	×	×
	Analog module	×	×
MELSEC-L series	LCPU	×	×
	Analog module	×	×
Others	BOX data logger	○	○

Historical event

Type	Target for explanation ( Page 13 Target modules, simulators, files, and data for explanation)
Module	BOX, R logger, Q logger

An event logging file saved in an SD memory card or a CompactFlash card in a data logger can be displayed.
Saved past events can be confirmed anytime.

■Displaying data sampled by a data logger

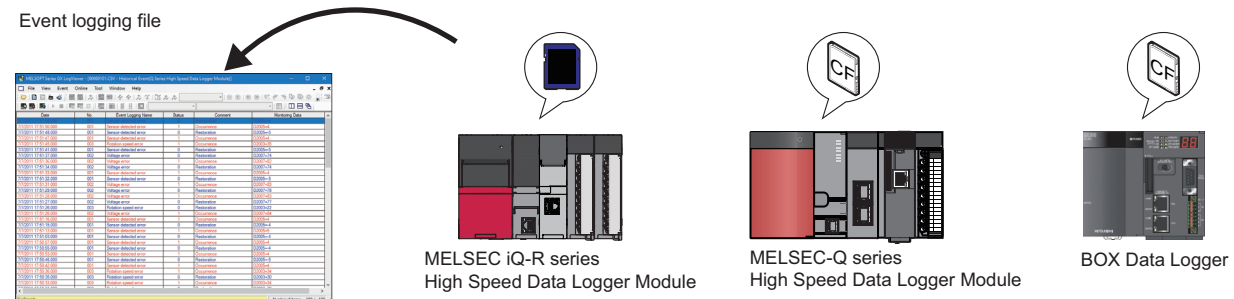

 Page 228 Displaying event logging files saved with the event logging function of a data logger

■Displaying data saved in a personal computer or inserted memory card

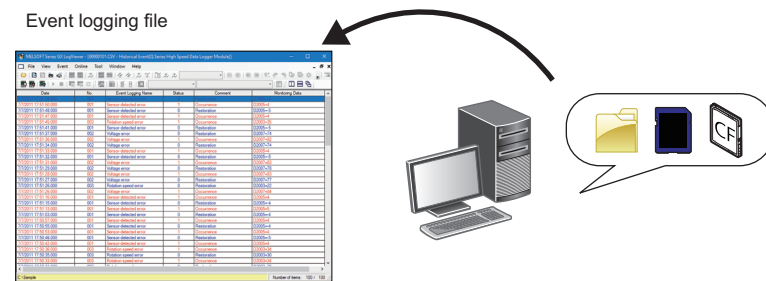

 Page 228 Displaying Event logging files saved in a personal computer

Realtime event

Type	Target for explanation ( Page 13 Target modules, simulators, files, and data for explanation)
Module	BOX, R logger, Q logger

The latest event sampled by a data logger is displayed.
Events are constantly updated so that the event history from the start of monitoring up to the present time can be checked.
To display the Realtime event list, a personal computer and a data logger need to be connected to each other online.

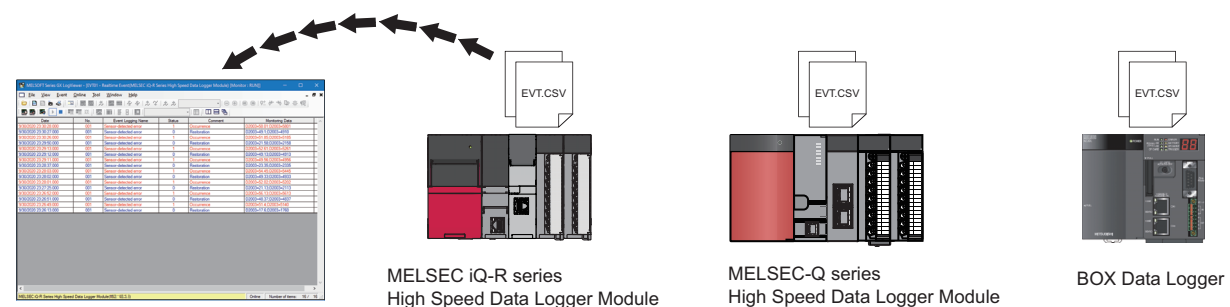

 Page 229 Displaying ongoing events (Realtime event)

Files that can be displayed

For the file formats of modules and tools that can be displayed in GX LogViewer, refer to the following:

 Page 98 Files that can be displayed

9.2 Screen Configuration

Type	Target for explanation ( Page 13 Target modules, simulators, files, and data for explanation)
Module	BOX, R logger, Q logger

This section explains the screen configuration of event windows.

Event window

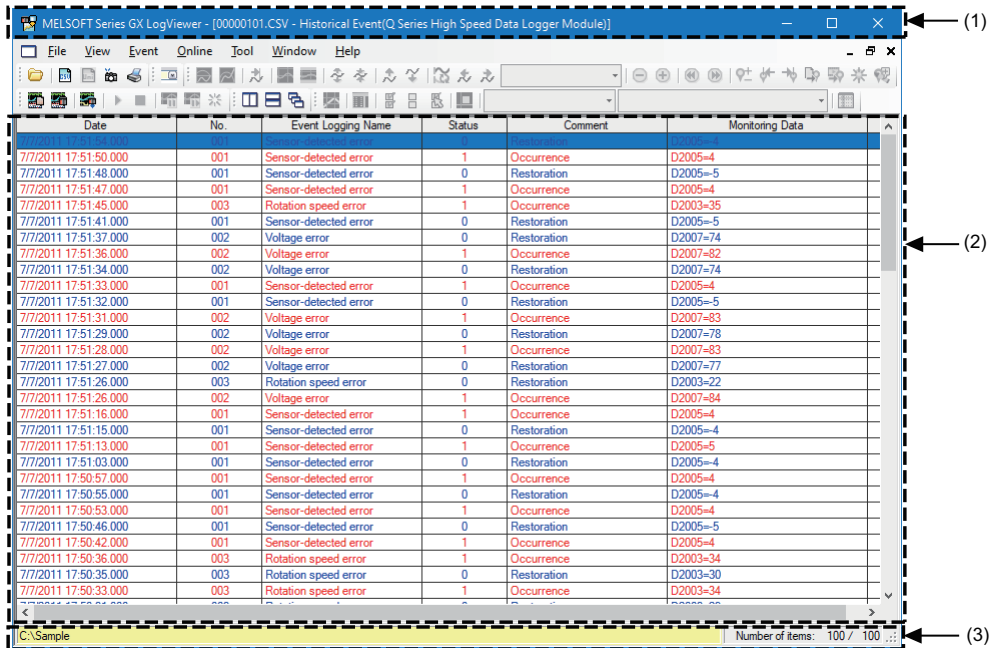

Up to 2000 realtime events of data is displayed.

Displayed items

Item	Description		Reference
(1) Title bar	Historical Event	Displays the name of a file, function, and module.	—
	Realtime Event	Displays the monitor status and the name of a data logging setting, a function, and a module.	—
(2) Event list	Displays a list of events occurred.		Page 226 Event list
(3) Status bar	Displays the source of an event logging file and the communication status with a data logger.		Page 227 Status bar

Event list

Date	No.	Event Logging Name	Status	Comment	Monitoring Data
7/7/2011 18:01:19.000	003	Rotation speed error	1	Occurrence	D2003=31
7/7/2011 18:01:12.000	002	Voltage error	0	Restoration	D2007=77
7/7/2011 18:01:09.000	001	Sensor-detected error	1	Occurrence	D2005=3
7/7/2011 18:01:10.000	001	Sensor-detected error	0	Restoration	D2005=3
7/7/2011 18:01:07.000	002	Voltage error	0	Restoration	D2007=77
7/7/2011 18:01:04.000	001	Sensor-detected error	1	Occurrence	D2005=5
7/7/2011 18:01:02.000	003	Rotation speed error	0	Restoration	D2003=21
7/7/2011 18:01:02.000	002	Voltage error	1	Occurrence	D2007=85
7/7/2011 18:01:02.000	001	Sensor-detected error	0	Restoration	D2005=5
7/7/2011 18:01:01.000	001	Sensor-detected error	1	Occurrence	D2005=5
7/7/2011 18:01:00.000	001	Sensor-detected error	0	Restoration	D2005=5
7/7/2011 18:00:55.000	001	Sensor-detected error	1	Occurrence	D2005=4
7/7/2011 18:00:40.000	001	Sensor-detected error	0	Restoration	D2005=5
7/7/2011 18:00:38.000	001	Sensor-detected error	1	Occurrence	D2005=4
7/7/2011 18:00:36.000	001	Sensor-detected error	0	Restoration	D2005=5
7/7/2011 18:00:35.000	001	Sensor-detected error	1	Occurrence	D2005=4
7/7/2011 18:00:34.000	001	Sensor-detected error	0	Restoration	D2005=5
7/7/2011 18:00:33.000	001	Sensor-detected error	1	Occurrence	D2005=5
7/7/2011 18:00:32.000	001	Sensor-detected error	0	Restoration	D2005=3
7/7/2011 18:00:28.000	001	Sensor-detected error	1	Occurrence	D2005=5
7/7/2011 18:00:27.000	001	Sensor-detected error	0	Restoration	D2005=3
7/7/2011 18:00:22.000	001	Sensor-detected error	1	Occurrence	D2005=4
7/7/2011 18:00:13.000	001	Sensor-detected error	0	Restoration	D2005=5
7/7/2011 18:00:11.000	001	Sensor-detected error	1	Occurrence	D2005=5
7/7/2011 18:00:10.000	003	Rotation speed error	1	Occurrence	D2003=36

(1)

Displayed items

Item	Description	Reference
Date*1	Displays the day and time of occurrence/restoration of an event.	—
No. Event Logging Name	Displays an event logging name and its number set with MELSEC iQ-R Series High Speed Data Logger Module Configuration Tool, MELSEC-Q Series High Speed Data Logger Module Configuration Tool, and BOX Data Logger Configuration Tool.	—
Status	Displays occurrence/restoration with the following values. • 1: Occurrence • 0: Restoration	—
Comment	Displays an occurrence comment/restoration comment.	—
Monitoring Data	Displays a name and value of monitoring data in the following format. (Event logging name) = (Event value); (Event logging name) = (Event value); to (Event logging name) = (Event value)	—
(1) Filter row	Specify a filtering condition.	Page 231 Displaying only events that meet specific conditions (Filtering)

*1 Since the date and time in the "Date" column depends on the time setting for CPU module, they may be different from the time on the personal computer in use.

Status bar

Ex.

For the historical event function (sorting)

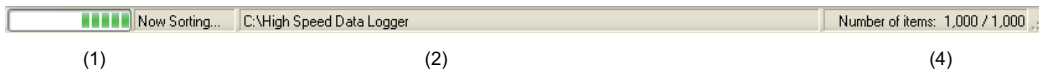

Ex.

For the realtime event function

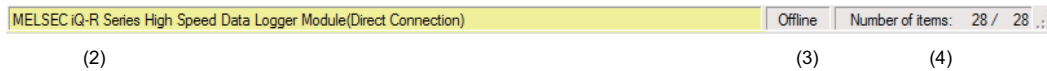

Displayed items

Item	Description
(1) Sorting/filtering performance status	Displays the performance status while the Sorting/Filtering function is performed.
(2) Source to obtain event logging file and file type ^{*1}	Displays the source and file type of the event logging file being displayed with respective characters and colors. (☞ Page 227 Source to obtain event logging file and file type)
(3) Communication status	Displays "Online" or "Offline." (For the realtime event function only)
(4) Number of items	Displays the number of events displayed in the event list in the following format. Number of items: (number of items being displayed)/(total number of events)

*1 When displaying an event with the historical event function, the connected module may be different from the module with which the logging data in the memory card was sampled.

In that case, the following information will be displayed.

Title bar (Displayed Characters): Module that sampled logging data in the memory card

Status bar (displayed characters): Connected module

Status bar (Background Color): Module that sampled logging data in the memory card

For details on the title bar and status bar, refer to the following:

☞ Page 225 Event window

■ Source to obtain event logging file and file type

- Displayed characters

Historical event	Displays the source to obtain the event logging file being displayed. <ul style="list-style-type: none"> • Connecting to a MELSEC iQ-R series high speed data logger module: MELSEC iQ-R Series High Speed Data Logger Module(IP address or "Direct Connection"):file path • Connecting to a MELSEC-Q series high speed data logger module: Q Series High Speed Data Logger Module(IP address or "Direct Connection"):file path • Connecting to a BOX data logger: BOX Data Logger(IP address or "Direct Connection"):file path • Using data saved in a personal computer or inserted memory card: File path
Realtime event	Displays the IP address of a data logger being communicated with, or "Direct Connection."

- Background color

Logging file type	Background color
MELSEC iQ-R series High Speed Data Logger Module MELSEC-Q series High Speed Data Logger Module	Light yellow
BOX Data Logger	Lime

9.3 Displaying Event List

This section explains how to display events sampled by a data logger in the event list.

The maximum total number of records that can be displayed by the trend graph function and the event monitoring function is 1,000,001.

☞ Page 228 Displaying logged events (Historical event)

☞ Page 229 Displaying ongoing events (Realtime event)

☞ Page 230 Operating monitoring status of the realtime event function

Displaying logged events (Historical event)

Type	Target for explanation (☞ Page 13 Target modules, simulators, files, and data for explanation)
Module	BOX, R logger, Q logger

By specifying a file saved in a personal computer or a memory card and using the historical event function, the data can be displayed in the event list.

Saved file	Description
Event logging file saved with the event logging function of a data logger	An event logging file saved in an SD memory card or a CompactFlash card with the event logging function of a data logger is displayed in the historical event list.
Event logging files saved in a personal computer	An event logging file saved in a personal computer or an inserted memory card is displayed in the historical event list. For the method of saving a logging file to a personal computer or a memory card, refer to the following: ☞ Page 241 SAVING LOGGING FILE TO PERSONAL COMPUTER

Operating procedure

■ Displaying event logging files saved with the event logging function of a data logger

1. Select [Online] ⇒ [Open Logging File] (.
2. Select "MELSEC iQ-R Series High Speed Data Logger Module," "MELSEC-Q Series High Speed Data Logger Module," or "BOX Data Logger" in the "Connection Destination" screen.
3. Specify a module to be connected and its route in the "Transfer Setup" screen.
4. Select an event logging file from the list in the "File Browser" screen, and click the [Open File] button. (Multiple selections not allowed.)

■ Displaying Event logging files saved in a personal computer

There are two methods to display a file.

- Select [File] ⇒ [Open] () , and specify an event logging file saved in a personal computer.
- Drag and drop an event logging file saved in a personal computer onto the main window.

(Example: Displaying "HSDL_EVT.CSV" on the desktop)

Displaying ongoing events (Realtime event)

Type	Target for explanation ( Page 13 Target modules, simulators, files, and data for explanation)
Module	BOX, R logger, Q logger

By specifying the event logging setting of a module and using the realtime event function, the data can be displayed in the event list.

Operating procedure

1. Select [Online] ⇒ [Realtime Monitor] ().
2. Select "MELSEC iQ-R Series High Speed Data Logger Module," "MELSEC-Q Series High Speed Data Logger Module," or "BOX Data Logger" in the "Transfer Setup" screen.
3. Select the [Event Logging] tab in the "Select Logging Setting" screen.
4. Select an event logging setting to be set from the list, and click the [Open] button.

Operating monitoring status of the realtime event function

Type	Target for explanation ( Page 13 Target modules, simulators, files, and data for explanation)
Module	BOX, R logger, Q logger

The monitoring status can be changed by using the realtime event function.

Operating procedure

■ Starting monitoring

- Select [Online] ⇒ [Begin Monitor] ().

This operation starts the communication with a module, and turns the monitoring status from Stop to Run.

■ Stopping monitoring





- Select [Online] ⇒ [End Monitor] ().

This operation disconnects the communication with a module, and stops updating the event list.

9.4 Operating Event List

Type	Target for explanation ( Page 13 Target modules, simulators, files, and data for explanation)
Module	BOX, R logger, Q logger

The following functions are available to display the event list depending on the intended purpose.

-  Page 231 Displaying only events that meet specific conditions (Filtering)
-  Page 232 Sorting events (Sorting)
-  Page 233 Switching the display language of event logging names and comments
-  Page 234 Displaying the previous or next event consecutively

Displaying only events that meet specific conditions (Filtering)

Events displayed in the event list can be displayed on the specific conditions (filtering condition) by each column.

When multiple conditions are specified, only events that meet all of the conditions are displayed in the event list.

A new event which occurs after filtering is displayed in an event list only if it matches the filtering conditions.

Filtering is executed with not perfect match but partial match of a string specified in a cell of the filter row.

Ex.

Specifying 'Voltage error' as a filtering condition for the "Event Logging Name" column.

■ Before filtering

Date	No.	Event Logging Name	Status	Comment	Monitoring Data
7/7/2011 18:01:19.000	003	Rotation speed error	1	Occurrence	D2003=31
7/7/2011 18:01:12.000	002	Voltage error	0	Restoration	D2007=77
7/7/2011 18:01:10.000	002	Voltage error	1	Occurrence	D2007=83
7/7/2011 18:01:10.000	001	Sensor-detected error	0	Restoration	D2005=3
7/7/2011 18:01:07.000	002	Voltage error	0	Restoration	D2007=77
7/7/2011 18:01:04.000	001	Sensor-detected error	1	Occurrence	D2005=5
7/7/2011 18:01:02.000	003	Rotation speed error	0	Restoration	D2003=21
7/7/2011 18:01:02.000	002	Voltage error	1	Occurrence	D2007=85
7/7/2011 18:01:02.000	001	Sensor-detected error	0	Restoration	D2005=5
7/7/2011 18:01:01.000	001	Sensor-detected error	1	Occurrence	D2005=5
7/7/2011 18:01:00.000	001	Sensor-detected error	0	Restoration	D2005=5

■ After filtering

Date	No.	Event Logging Name	Status	Comment	Monitoring Data
		Voltage error			
7/7/2011 18:01:12.000	002	Voltage error	0	Restoration	D2007=77
7/7/2011 18:01:10.000	002	Voltage error	1	Occurrence	D2007=83
7/7/2011 18:01:07.000	002	Voltage error	0	Restoration	D2007=77
7/7/2011 18:01:02.000	002	Voltage error	1	Occurrence	D2007=85
7/7/2011 18:00:02.000	002	Voltage error	0	Restoration	D2007=74
7/7/2011 18:00:01.000	002	Voltage error	1	Occurrence	D2007=81
7/7/2011 18:00:00.000	002	Voltage error	0	Restoration	D2007=73
7/7/2011 17:59:59.000	002	Voltage error	1	Occurrence	D2007=81
7/7/2011 17:59:55.000	002	Voltage error	0	Restoration	D2007=79
7/7/2011 17:59:54.000	002	Voltage error	1	Occurrence	D2007=82

Operating procedure

1. Select [Event] ⇒ [Filter] .

2. Set a filtering condition to the filter row.

■ Filtering by "Date"

1. Select "Enable Filter" on the "Filter Period Settings" screen.

2. Select the dates for "Filtering Begin Date" and "Filtering End Date" ^{*1}, and click the [OK] button.

*1 Without specifying "Filtering Begin Date," all of events older than date and time specified in "Filtering End Date" are displayed. Without specifying "Filtering End Date," all of events newer than date and time specified in "Filtering Begin Date" are displayed.

■ Filtering by an item selected from a list box

1. Click a cell in the filter row.

2. From the list box, select an item to filter events by. (List box selection is not available in the "Monitoring Data" column.)

■Filtering by an item input directly

1. Click a cell in the filter row, and enter a filtering condition directly.
2. Press the key.

■Clearing filtering conditions

Perform any of the operations below:

- Select "Disable Filter" on the "Filter Period Settings" screen.
- Select "(Empty)" in a list box.
- Clear a cell of the filter row.
- Hide the filter row.

Sorting events (Sorting)

Events displayed in the event list can be sorted in ascending order (▲) or descending order (▼) by the value of each column. Events which occurred after the sort are inserted to the list in a status maintaining the sorting order.

Ex.

Sorting "Event Logging Name" in ascending order (▲)

■Before sorting

Date ▼	No.	Event Logging Name	Status	Comment	Monitoring Data
7/7/2011 18:01:19.000	003	Rotation speed error	1	Occurrence	D2003=31
7/7/2011 18:01:12.000	002	Voltage error	0	Restoration	D2007=77
7/7/2011 18:01:10.000	001	Sensor-detected error	0	Restoration	D2005=3
7/7/2011 18:01:10.000	002	Voltage error	1	Occurrence	D2007=83
7/7/2011 18:01:07.000	002	Voltage error	0	Restoration	D2007=77
7/7/2011 18:01:04.000	001	Sensor-detected error	1	Occurrence	D2005=5
7/7/2011 18:01:02.000	001	Sensor-detected error	0	Restoration	D2005=5
7/7/2011 18:01:02.000	002	Voltage error	1	Occurrence	D2007=85
7/7/2011 18:01:02.000	003	Rotation speed error	0	Restoration	D2003=21
7/7/2011 18:01:01.000	001	Sensor-detected error	1	Occurrence	D2005=5

■After sorting

Date	No.	Event Logging Name ▲	Status	Comment	Monitoring Data
7/7/2011 18:01:19.000	003	Rotation speed error	1	Occurrence	D2003=31
7/7/2011 18:01:02.000	003	Rotation speed error	0	Restoration	D2003=21
7/7/2011 18:00:10.000	003	Rotation speed error	1	Occurrence	D2003=36
7/7/2011 18:00:08.000	003	Rotation speed error	0	Restoration	D2003=28
7/7/2011 18:00:07.000	003	Rotation speed error	1	Occurrence	D2003=32
7/7/2011 17:59:50.000	003	Rotation speed error	0	Restoration	D2003=18
7/7/2011 17:59:02.000	003	Rotation speed error	1	Occurrence	D2003=37
7/7/2011 18:01:10.000	001	Sensor-detected error	0	Restoration	D2005=3
7/7/2011 18:01:04.000	001	Sensor-detected error	1	Occurrence	D2005=5
7/7/2011 18:01:02.000	001	Sensor-detected error	0	Restoration	D2005=5

Operating procedure

Select [Event] ⇒ [Sort] ⇒ [Date]/[No.]/[Event Logging Name]/[Status]/[Comment]/[Monitoring Data].

Alternatively, click the item name displayed on the top of each column.

Switching the display language of event logging names and comments

A display language of event logging names and comments in a historical event window can be switched.

Event logging names and comments are displayed in a language of the characters being used in a read file when displaying an Event logging file. If characters of codes which can be used in multiple languages or characters of inapplicable languages are used for data names, those characters may be corrupted.

If characters are corrupted, switch the display language.

Operating procedure

Select [Event] ⇒ [Set Language] ⇒ [(event logging file name)]^{*1} ⇒ [Chinese Simplified]^{*2}/[Chinese Traditional]^{*2}/[English]^{*2}/[Japanese]^{*2}/[Korean]^{*2}/[Unicode (UTF-8)]^{*2}.

*1 The event logging file name shown in the historical window is displayed.

*2 The display language cannot be selected when the following events are displayed.

- Events of Unicode text files
- Events of binary files sampled by a MELSEC iQ-R series high speed data logger module

Precautions

The filtering needs to be disabled when switching the language.

Sorting is cleared when switching the language while events have been sorted.

Displaying the previous or next event consecutively

Normally, one Event logging file is displayed on a historical event window. However, data in the previous/next Event logging file can be displayed simultaneously by using this function.

This function enables the consecutive view of divided Event logging files.

Target	Display condition	Display order
Event logging file of a MELSEC iQ-R series high speed data logger module	<ul style="list-style-type: none">The file extensions are the same.	Dictionary order by file names (in the order of number, symbol, alphabet, and others)
Event logging file other than that of a MELSEC iQ-R series high speed data logger module	<ul style="list-style-type: none">The file extensions are the same.File names are sequential.	Sequential number order by file names

Precautions

Previous/next Event logging file may not be displayed if any of the operations below is performed using an Event logging file saved in a personal computer.

If the previous/next Event logging file cannot be displayed, create the same folder configuration as the one under "/EVENT" in a CompactFlash card before operating.

- A name of a folder or an Event logging file following the name has been changed.
- The previous/next Event logging file has been deleted.
- File names of Event logging files are not in series.

Displaying the previous event

- Operating from the normal status

Example: Displaying data of a MELSEC-Q series high speed data logger module

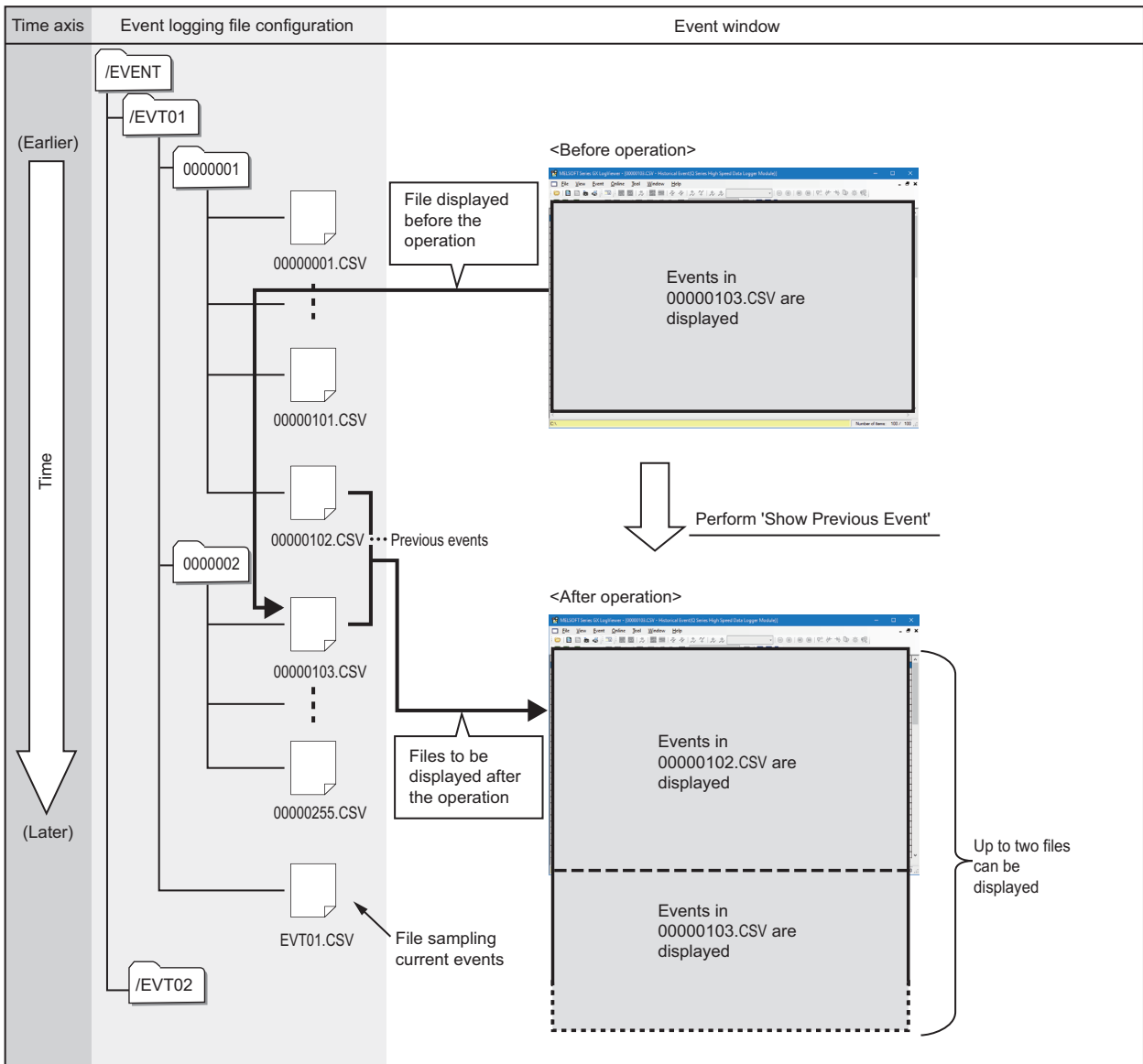

- Operating from the status when the previous graph is already displayed
Example: Displaying data of a MELSEC-Q series high speed data logger module

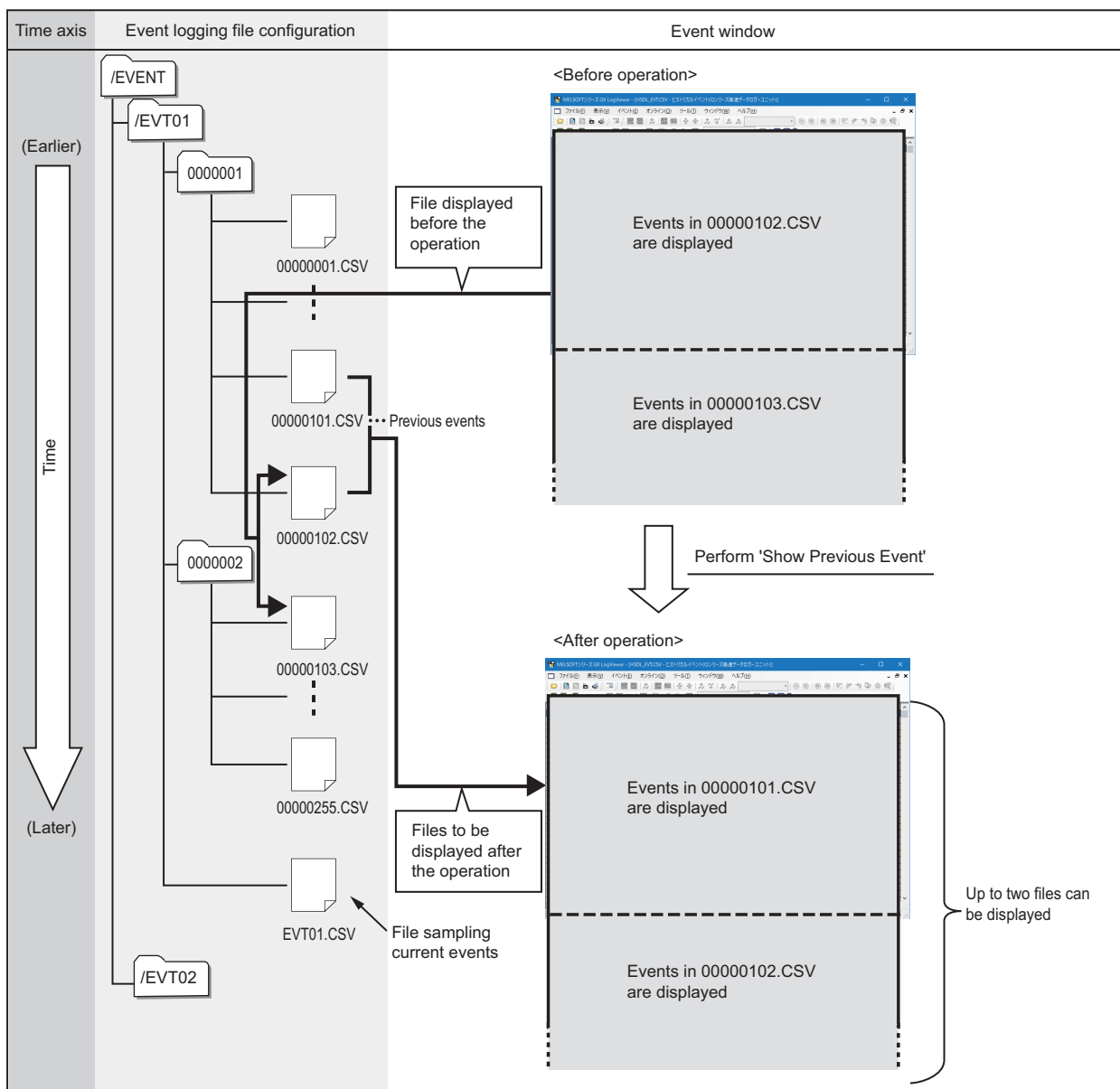

Operating procedure

Select [Event] ⇒ [Show Previous Event].

- The previous event cannot be displayed to an Event logging file of which serial number assigned to the file name is the smallest number.

Displaying the next event

- Operating from the normal status

Example: Displaying data of a MELSEC-Q series high speed data logger module

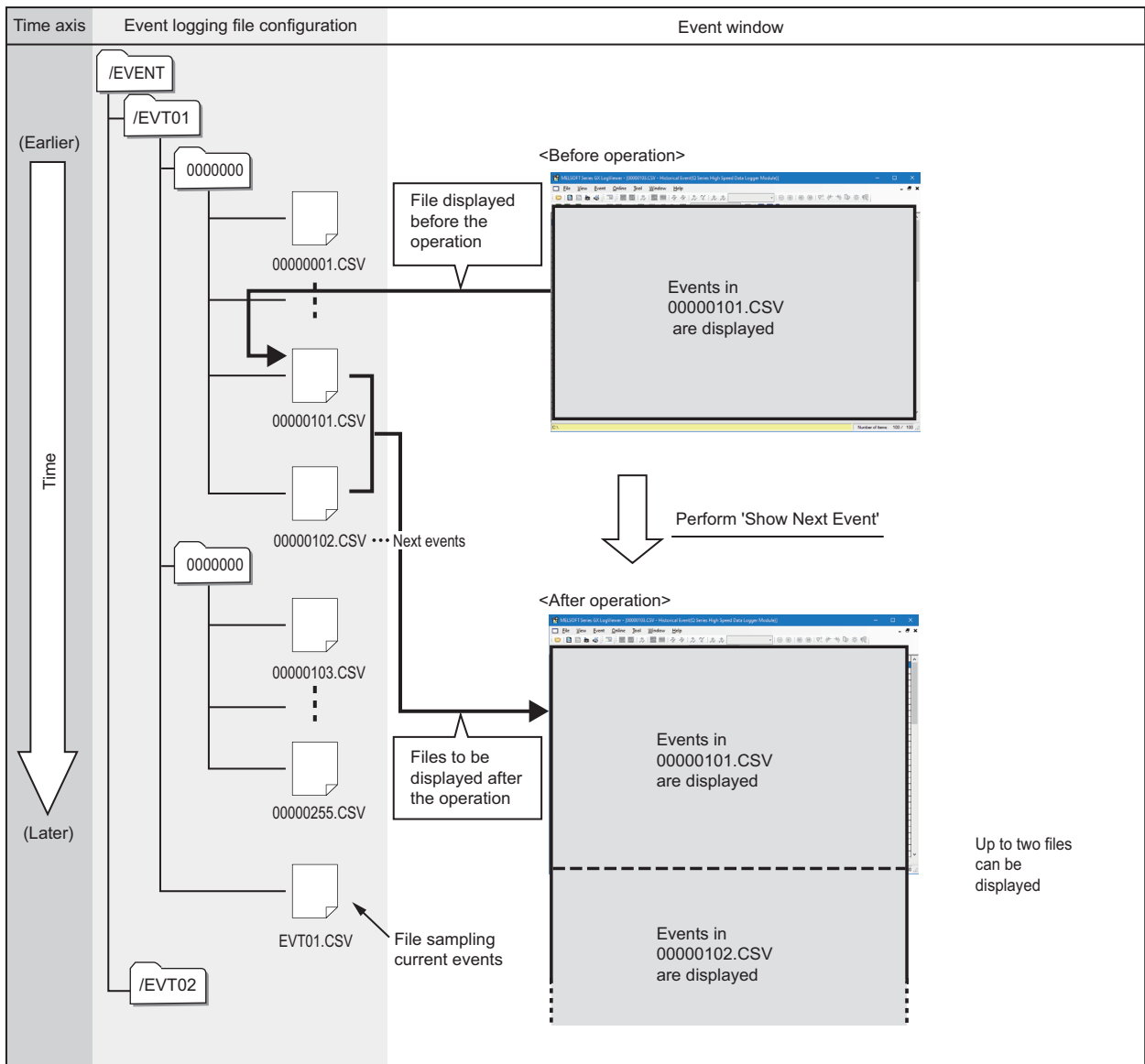

- Operating from the status when the next graph is already displayed
 Example: Displaying data of a MELSEC-Q series high speed data logger module

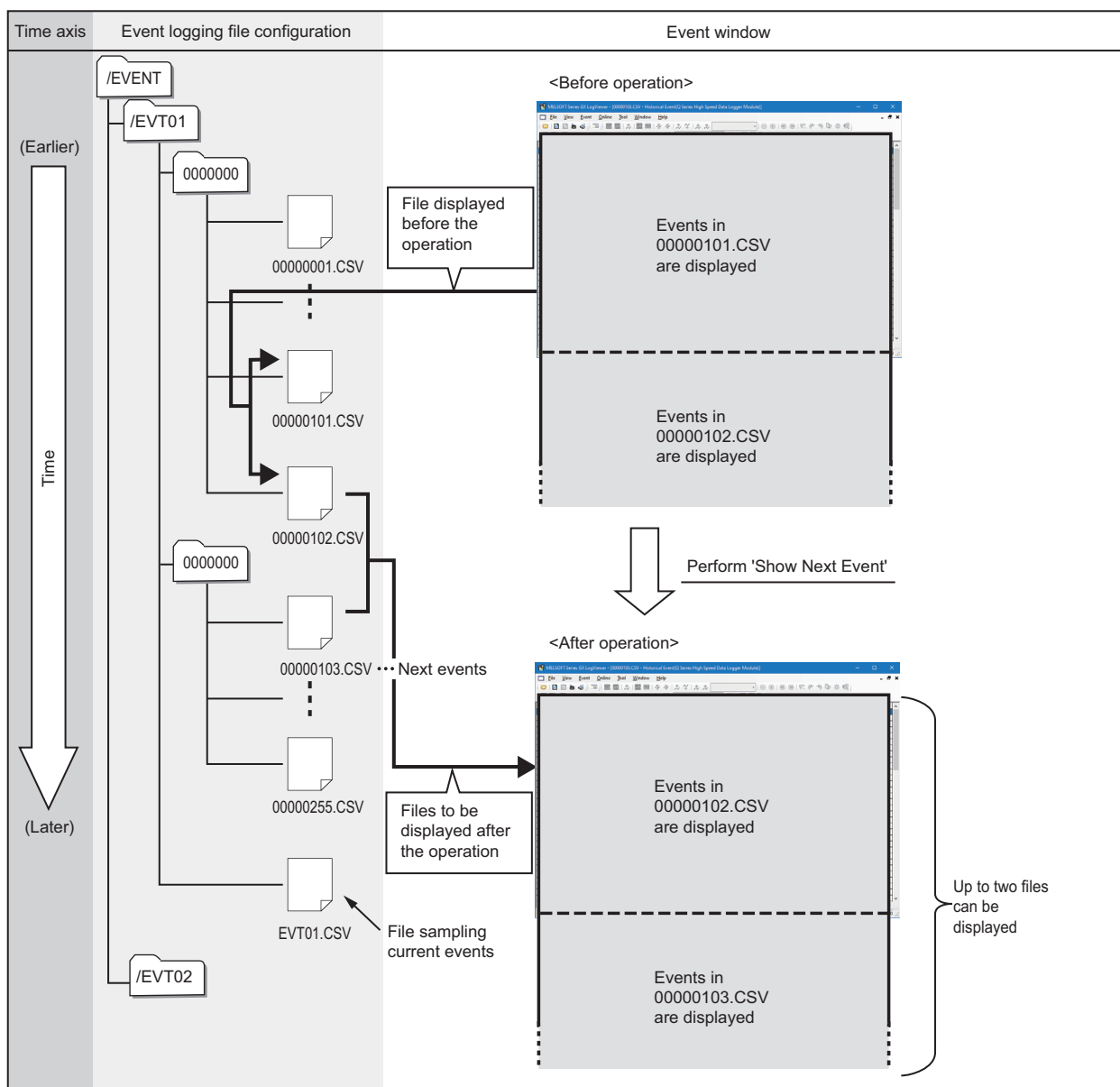

Operating procedure

Select [Event] ⇨ [Show next Event].

- The next event cannot be displayed to an Event logging file (a file that is sampling the current events) of which serial number is not assigned to the file name.
- Sorting is cleared when the function to show previous/next event is performed while events have been sorted.

9.5 Changing Display Settings of Event List

Type	Target for explanation ( Page 13 Target modules, simulators, files, and data for explanation)
Module	BOX, R logger, Q logger

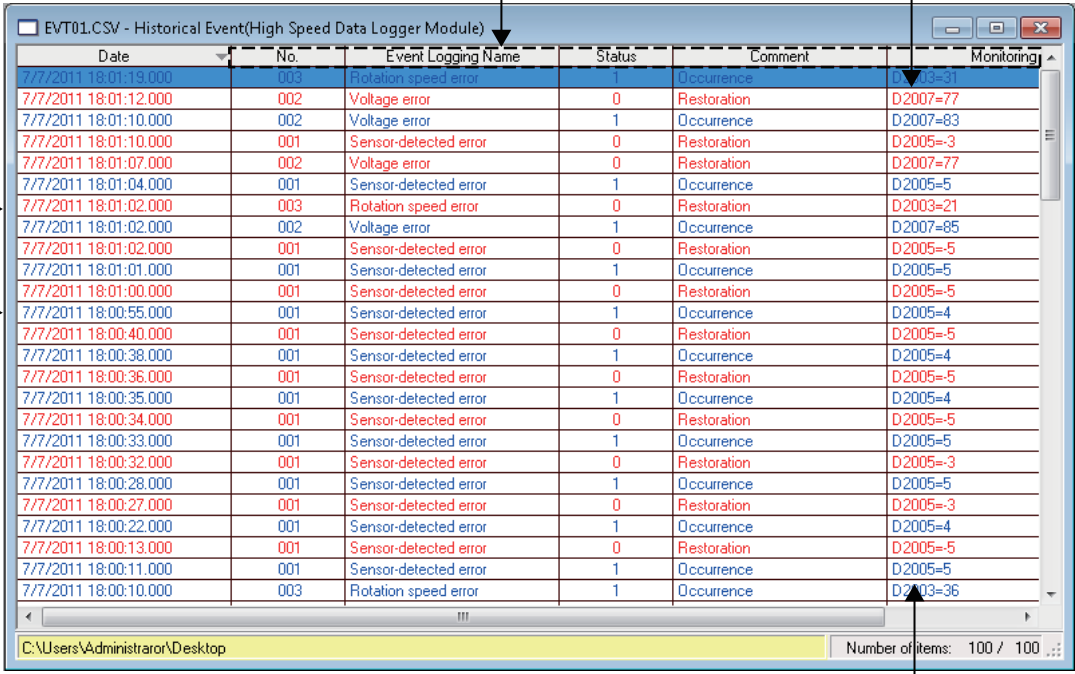

This section explains how to customize font color, background color, and display items in the event list.

The following figure shows customizable settings in an event list. The settings are changed on the "Event Properties" screen. The setting of the event property is common in all event windows. Therefore, any change is applied to all event windows being displayed.



The screenshot shows a window titled "EVT01.CSV - Historical Event(High Speed Data Logger Module)". The window contains a table with the following columns: Date, No., Event Logging Name, Status, Occurrence, Comment, and Monitoring. The table lists various events such as "Rotation speed error", "Voltage error", "Sensor-detected error", and "Restoration" with their respective dates, numbers, and statuses. Callouts point to specific elements: "Occurrence color" points to the "Occurrence" column; "Switching display/hide" points to the "Monitoring" column; "Grid color" points to the grid lines; "Restoration color" points to the "Restoration" entries; and "Background color" points to the background of the table.

Point

Customized colors can be used for the graphic property and the event property in common. ( Page 209 Changing settings in the Graph Properties screen) ( Page 240 Displaying the Event Properties screen)

Displaying the Event Properties screen

Window

Select [Event] ⇒ [Event Properties].

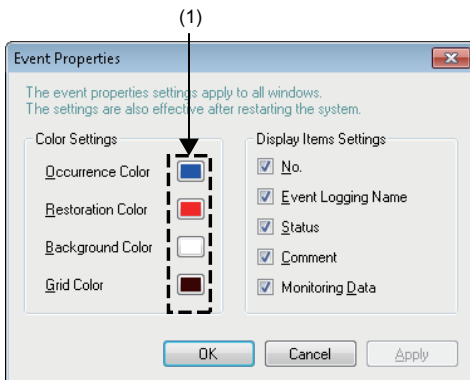

Operating procedure

■ Changing color settings (occurrence color, restoration color, background color, grid color)

1. Click the color button (1) of an item to be changed.
2. Select a color to be changed from "Basic colors" or "Custom colors" in the "Color" screen, and click the [OK] button.

■ Changing display items settings (No., event logging name, status, comment, monitoring data)

Clear the item not to display in the event list in "Display Item Settings."

10 SAVING LOGGING FILE TO PERSONAL COMPUTER

Type	Target for explanation ( Page 13 Target modules, simulators, files, and data for explanation)
Module	R CPU, LH CPU, FX5 CPU, QnUDV CPU, L CPU, R analog, Q analog, L analog, BOX, R logger, Q logger, R motion module, R motion controller
Simulator	R motion module simulator









This chapter explains how to save the following logging files to a personal computer:

- Logging file in the data memory
- Logging file in a memory card inserted in a module

The saved logging files can be checked with the historical trend function or the historical event function.

Operating procedure

■ Saving a logging file of a CPU module, data logger, analog module, motion module, or motion controller to a personal computer

1. Select [Online] ⇒ [Save Logging File to PC] ().
2. Select a device from which logging files are obtained in the "Connection Destination" screen.
3. Specify a module to be connected and the connection method in the "Transfer Setup" screen.
 -  Page 77 Connecting to an R CPU
 -  Page 79 Connecting to an LH CPU
 -  Page 81 Connecting to an FX5 CPU
 -  Page 83 Connecting to a Q CPU or an L CPU
 -  Page 86 Connecting to a Data Logger or Data Communication
 -  Page 88 Connecting to a Motion Module
 -  Page 90 Connecting to a Motion Controller
4. Select a file to be saved from a list in the "Logging File" screen, and click the [Save to PC] button. (Multiple selections not allowed.)
5. Specify the destination to save the file.
 - Saving a single file: Save the file by specifying the file name.
 - Saving multiple files: Save multiple files at once by specifying a folder. A save destination folder cannot be specified for each file. Additionally, the file name cannot be changed.

■ Saving a data logging file of the motion module simulator to a personal computer

Refer to the manual of the motion control setting function.

For the method for referring to the motion control setting function manual, refer to the following:

 Page 94 Referring to the motion control setting function manual

Precautions

The file format of a CSV file/Unicode text file saved with the logging file save function, which is explained in this chapter, differs from that of the file saved with the displayed data/event saving function, which is explained in the after-mentioned chapter, "Saving displayed data/events." ( Page 247 SAVING DISPLAYED DATA/EVENTS)

For more details on file formats of Unicode text file/CSV file obtained directly from a module and saved with the logging file save function, refer to manuals for respective modules.

Restriction

Updating other monitoring data may be delayed in the following cases since saving Data logging file requires time:

- Saving a Data logging file while the data logging function is being performed.
- Saving a large-volume Data logging file

MEMO

11 USING WINDOWS/FOLDERS DISPLAYED IN PAST

Type	Target for explanation (☞ Page 13 Target modules, simulators, files, and data for explanation)
Module	RCPU, LHCPU, FX5CPU, QnUDVCP, LCP, R analog, Q analog, L analog, BOX, R logger, Q logger, R communication, Q communication, R motion module, R motion controller
Simulator	RCPU simulator, FX5CPU simulator, R motion module simulator
Others	Others

11.1 Overview

The window/folder information of the windows being displayed can be saved with the 'Frequently-used Window Configuration' function, the 'Resent Windows' function, or the 'Recent Folders' function to redisplay them easily next time.

Function name	Description	Target settings to be saved	Reference
Frequently-used Window Configuration	Names the information (listed in the right column) of all the windows being displayed, and adds them to the menu. The added window can be redisplayed easily from the menu.	<ul style="list-style-type: none"> Window layout of each window Connection information with a module and information of the logging file save destination All of the data and events being displayed Displaying trend window^{*1} Displaying event window^{*2} Sorting status and filtering condition of an event list 	Page 244 Adding/Restoring Frequently-Used Window Configuration to Menu
Recent Windows ^{*3}	Adds all the windows being displayed to the menu automatically. The added window can be redisplayed easily from the menu.	<ul style="list-style-type: none"> Connection information with a module and information of the logging file save destination All of the data and events being displayed Displaying trend window^{*1} Displaying event window^{*2} Sorting status and filtering condition of an event list 	Page 246 Redisplaying Recently-Used Windows
Recent Folders	Adds a folder specified when opening or saving a file to the menu automatically. The added folder can be opened easily from the menu to select a logging file.	Save destination of data and events being displayed <ul style="list-style-type: none"> Directory path in a personal computer Directory path of a memory card inserted in a module 	Page 246 Redisplaying Recently-Used Folders

*1 Back ground color, grid color, and trigger ON/OFF color of a trend window are excluded.

*2 Background color, grid color, occurrence/restoration color, and display selection status of each column are excluded.

*3 When connecting to an RCP, FX5CPU simulator by selecting "Recent Windows," the simulator the following information of which matches the previously-connected simulator is connected.

- Connection destination (RCP simulator or FX5CPU simulator)
- System No.
- PLC No.

When the above information of both the simulator that is connected by selecting "Recent Windows" and the simulator that was connected last time matches, the simulators are recognized as the same, even though they are different.

In that case, a different program may be simulated from the program simulated last time.

11.2 Adding/Restoring Frequently-Used Window Configuration to Menu

Trend windows or event windows displayed frequently can be added to the menu as frequently-used window configurations, and redisplayed easily.

Frequently-used window configurations can be exported and used for other logon users or a personal computer.

Up to 50 windows can be added to frequently-used window configurations.

Operating procedure

■ Adding a frequently-used window configuration to the menu

1. Arrange a window configuration to be added as a frequently-used window configuration.
2. Select [Window] ⇒ [Frequently-used Window Configuration] ⇒ [Add to Frequently-used Window Configuration].
3. Enter a name in the "Add to Frequently-used Window Configuration" screen, and click the [OK] button.

Restriction

This function does not support the following operations:

- The historical trend window started from GX Works3
- The realtime monitor window of a motion module and motion module simulator
- CALC data displayed in a historical trend window

In addition, the CALC data cannot be restored.

Point

A new folder can be created under the folder being selected on the "Add to Frequently-used Window Configuration" screen. Select a folder name and click the [New Folder] button.

■ Restoring a frequently-used window configuration

Select [Window] ⇒ [Frequently-used Window Configuration] ⇒ [(name of a frequently-used window configuration)].

■ Deleting, renaming, or sorting a frequently-used window configuration

Select [Window] ⇒ [Frequently-used Window Configuration] ⇒ [(name of a frequently-used window configuration)], and right-click it. Then, select [Delete]/[Rename]/[Sort by Name] from the shortcut menu.

■ Changing order of frequently-used window configurations in the menu

Select [Window] ⇒ [Frequently-used Window Configuration] ⇒ [(name of a frequently-used window configuration)], and drag it to the desired position.

Importing/Exporting frequently-used window configurations

- Importing: All information included in an export file is imported.
The import operation discards all registered frequently-used window configurations, and then imports a file.
- Exporting: The folder hierarchy information is also saved in an export file.

Window

Select [File] ⇒ [Import and Export].

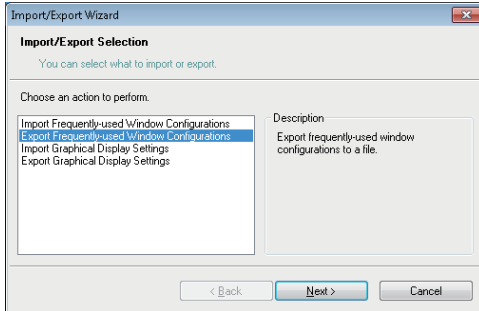

11

Operating procedure

1. Select "Import Frequently-used Window Configurations"/"Export Frequently-used Window Configurations," and click the [Next] button.
2. Specify the path of a file to be imported or the path where data is exported, and a file name, then click the [Next] button.
3. Click the [Finish] button.

11.3 Redisplaying Recently-Used Windows

Trend windows or event windows displayed recently can be added to the menu automatically as recent windows, and redisplayed easily.

Up to nine recent windows can be saved by each of the window types. The chronologically oldest window setting is removed from the menu when the tenth window is added. Only one realtime monitor window can be saved.

Operating procedure

Select [Window] ⇒ [Recent Windows] ⇒ [Historical Trend]/[Realtime Trend]/[Historical Event]/[Realtime Event]/[Realtime Monitor].

Restriction

- This function does not support the realtime monitor window of a motion module and motion module simulator.
 - If data in a memory card is changed after saving the displayed window setting, the window configuration may not be restored as a recent window.
 - CALC data displayed in a historical trend window cannot be restored.
-

11.4 Redisplaying Recently-Used Folders

Folders used recently can be added to the menu automatically as recent folders, and can be easily opened.

Up to nine recent folders can be saved. The chronologically oldest recent folder setting is removed from the menu when the tenth recent folder is added.

Operating procedure

■Opening a logging file in a personal computer

Select [File] ⇒ [Recent Folders].

■Opening a logging file in a folder of the data memory or memory card inserted in a module

Select [Online] ⇒ [Recent Folders].

12 SAVING DISPLAYED DATA/EVENTS

Type	Target for explanation ( Page 13 Target modules, simulators, files, and data for explanation)
Module	RCPU, LHCPU, FX5CPU, QnUDVCP, LCP, R analog, Q analog, L analog, BOX, R logger, Q logger, R communication, Q communication, R motion module, R motion controller
Simulator	RCPU simulator, FX5CPU simulator, R motion module simulator
Others	Offline monitor, others

This function saves data being displayed in a trend window and an event being displayed in an event window to a personal computer as a CSV file, Unicode text file, or image file (BMP/JPG/PNG).

The saved CSV file and Unicode text file can be displayed on the trend window and event window.

12.1 Save Target Data/Event

The data and event being displayed on the active trend window and event window can be saved.

The data being displayed in the realtime trend window or the realtime monitor window can be saved in CSV format or Unicode format only when the monitoring process is stopped or the graph drawing is suspended.

Point 

When two data logging files or two event logging files are consecutively displayed, the data or events in two files can be saved to one file.

File formats that can be saved by using this function

All data and events being displayed can be saved in the image format.

Whether data can be saved in the CSV format or Unicode format depends on the following conditions:

- Function being used
- File formats of data and events being displayed

The following tables show the file formats of data and events that can be saved in the CSV format or Unicode format.

Historical trend or historical event function

File format of data/event being displayed	File format that can be saved by using this function	File format specification
CSV file	CSV file	Page 249 Saving displayed data to CSV file Page 300 Saving displayed events to CSV file
Unicode text file	Unicode text file	Page 281 Saving displayed data to Unicode text file Page 305 Saving displayed events to Unicode text file
Binary file	For data and events of the following modules: • RCP • MELSEC iQ-R series high speed data logger module • LHCP • FX5CP	Page 281 Saving displayed data to Unicode text file Page 305 Saving displayed events to Unicode text file
	For data and events of the following modules: • MELSEC-Q series high speed data logger module • BOX data logger	Page 249 Saving displayed data to CSV file Page 300 Saving displayed events to CSV file
Recording file (data being displayed by linking with the GX Works3 offline monitor function)	Unicode text file (Only the range being displayed in GX LogViewer can be saved.)	Page 281 Saving displayed data to Unicode text file
JSON file	CSV file	Page 249 Saving displayed data to CSV file

■ Realtime trend, realtime monitor, or realtime event function

Module/file/data	File format that can be saved by using this function	File format specification
RCPU	Unicode text file	Page 282 RCPU or RCPU simulator
RCPU simulator		
LHCPU	Unicode text file	Page 290 LHCPU
FX5CPU	Unicode text file	Page 294 FX5CPU or FX5CPU simulator
FX5CPU simulator		
MELSEC iQ-R series high speed data logger module*1	CSV file	<ul style="list-style-type: none"> For the realtime trend function: <ul style="list-style-type: none"> ☞ Page 253 MELSEC iQ-R series high speed data logger module For the realtime event function: <ul style="list-style-type: none"> ☞ Page 301 MELSEC iQ-R series high speed data logger module
	Unicode text file	<ul style="list-style-type: none"> For the realtime trend function: <ul style="list-style-type: none"> ☞ Page 286 MELSEC iQ-R series high speed data logger module For the realtime event function: <ul style="list-style-type: none"> ☞ Page 306 MELSEC iQ-R series high speed data logger module
MELSEC iQ-R series high speed data communication module	Unicode text file	Page 288 MELSEC iQ-R series high speed data communication module
MELSEC-Q series high speed data logger module	CSV file	<ul style="list-style-type: none"> For the realtime trend function: <ul style="list-style-type: none"> ☞ Page 259 MELSEC-Q series high speed data logger module or BOX data logger For the realtime event function: <ul style="list-style-type: none"> ☞ Page 303 MELSEC-Q series high speed data logger module or BOX data logger
BOX data logger		
MELSEC-Q series high speed data communication module	CSV file	Page 261 MELSEC-Q series high speed data communication module
LCPU	CSV file	Page 257 QnUDVCPUL/LCPU

*1 The file formats that can be saved by using this function differs depending on the one set in a logging setting for the realtime trend/ realtime event function.

- When the file format set in the data logging setting is CSV: CSV file
- When the file format set in the data logging setting is other than CSV: Unicode text file

Precautions

The following data cannot be saved in the CSV format or Unicode format: Data of MELSEC iQ-R series motion modules and data being displayed by the realtime file monitor function of motion module simulator.

It can be saved in the image format only.

12.2 Saving Displayed Data

Type	Target for explanation (☞ Page 13 Target modules, simulators, files, and data for explanation)
Module	RCPU, LHCPU, FX5CPU, QnUDVCPUL, LCPU, R analog, Q analog, L analog, BOX, R logger, Q logger, R communication, Q communication, R motion module, R motion controller
Simulator	RCPU simulator, FX5CPU simulator, R motion module simulator
Others	Offline monitor, others

This section explains how to save data being displayed in the active trend window to any of the following files.

File format	Reference
CSV file	Page 249 Saving displayed data to CSV file
Unicode text file	Page 281 Saving displayed data to Unicode text file
Image file	Page 299 Saving a displayed trend graph to an image file

Saving displayed data to CSV file

Type	Target for explanation ( Page 13 Target modules, simulators, files, and data for explanation)
Module	RCP, FX5CPU, QnUDVCP, LCP, R analog, Q analog, L analog, BOX, R logger, Q logger, Q communication, R motion module, R motion controller
Simulator	R motion module simulator
Others	Others

Data being displayed in the graph legend area of the active trend window can be saved to a CSV file.

When saving data displayed in the historical trend window, the data names are saved in the language specified with the language selection function.

The data to be saved is as shown below.

- Historical trend window: Data of a data logging file being displayed
- Realtime trend window/Realtime monitor window: Data received from the start of monitoring to the pause/stop of graph drawing

Data removed from the graph legend area is not saved.

Restriction

When data names to be displayed are switched by using the switch data name function, the data cannot be saved to a CSV file.

Operating procedure

1. Select [File] ⇒ [Save As] ⇒ [Save CSV File] ().
2. Enter a file name, and click the [Save] button.

Format specification of CSV file

CSV file format may differ depending on file types. For details on the format, refer to the following:

File type	Reference	
RCP	Page 250 RCP	
MELSEC iQ-R series high speed data logger module	Page 253 MELSEC iQ-R series high speed data logger module	
FX5CPU	Page 255 FX5CPU	
QnUDVCP	Page 257 QnUDVCP/LCP	
LCP		
MELSEC-Q series high speed data logger module	Page 259 MELSEC-Q series high speed data logger module or BOX data logger	
BOX data logger		
MELSEC-Q series high speed data communication module	Page 261 MELSEC-Q series high speed data communication module	
Analog module	Page 263 Analog module	
MELSEC iQ-R series motion module	Page 265 MELSEC iQ-R series motion module or motion module simulator	
Motion module simulator		
MELSEC iQ-R series motion controller	Page 267 MELSEC iQ-R series motion controller	
CSV file in GX LogViewer format	Logging module for energy measuring module	Page 269 Logging module for energy measuring module
	Sampling trace	Page 271 Sampling trace
	Simulation result and sampling data saved with MELSEC iQ-R series Flexible High-Speed I/O Control Module Configuration Tool	Page 272 Simulation result and sampling data saved with MELSEC iQ-R series Flexible High-Speed I/O Control Module Configuration Tool
	Simulation result and sampling data saved with MELSEC-L series Flexible High-Speed I/O Control Module Configuration Tool	Page 274 Simulation result and sampling data saved with MELSEC-L series Flexible High-Speed I/O Control Module Configuration Tool
	CC-Link IE TSN FPGA module	Page 276 CC-Link IE TSN FPGA module
JSON file in GX LogViewer format	Page 278 JSON file in GX LogViewer format	

RCPU

This section shows the format of the CSV file in which data of an RCPU displayed in GX LogViewer is saved.



The CSV file format explained in this section differs from that acquired from an RCPU.

For details on the CSV file format acquired from the module, refer to the following:

MELSEC iQ-R CPU Module User's Manual (Application)

Item	Description
Delimiter	Comma (,)
Line feed code	CRLF(0x0D, 0x0A)
Character code	ASCII
Number of rows	Up to 131006 rows (data rows + 6)

Ex.

When opening a CSV file in spreadsheet software

(1) →	[LOGGING]	RCPU_2	3	4	5	7	2	6		
(2) →	LOG01									
(3) →	DATETIME[YYYY/MM/DD hh:mm:ss	ms]	INTERVAL	STEP NO.	PROGRAM NO.	PROGRAM NAME	INDEX	USHORT[DEC.0]	TRIGGER[*]	CALC[SRC=1:KIND=DIFF: DIS_DT=T]
(4) →	TIME	msec	INTERVAL[us]	STEP NO.	PROGRAM NO.	PROGRAM NAME	INDEX	ProgPou/ulabel1	Trigger	DIFF[ProgPou/ulabel1]
(5) →										
(6) →								MAIN		MAIN
(7) {	2020/9/8 1:04	304	200	0	1	MAIN	55001	0		0
	2020/9/8 1:04	304	200	0	1		55002	0		0
	2020/9/8 1:04	305	200	0	1		55003	0		0
	2020/9/8 1:04	305	200	0	1		55004	0		0
	2020/9/8 1:04	305	200	0	1		55005	0		0

Row name	Column number	Column name	Output content
(1) File information	1st column	File type	Fixed character: [LOGGING]
	2nd column	Type information_file version	Fixed character: <ul style="list-style-type: none"> A case in which the version is 1.76E or earlier, or only global labels are displayed in 1.82L or later version: RCPU_1 A case in which a local device or a label is displayed in 1.82L or later version: RCPU_2
	3rd column	Number for data type information row	Fixed value: <ul style="list-style-type: none"> With comment row: 3 Without comment row: 2
	4th column	Number for data name row	Fixed value: <ul style="list-style-type: none"> With comment row: 4 Without comment row: 3
	5th column	Number for device comment row	Fixed value: <ul style="list-style-type: none"> With comment row: 5 Without comment row: 4
	6th column	Number for data starting row	Fixed value: <ul style="list-style-type: none"> ■A case in which "RCPU_1" is output to the type information_file version column • With comment row: 6 • Without comment row: 5 ■A case in which "RCPU_2" is output to the type information_file version column • With comment row: 7 • Without comment row: 6
	7th column	Number for comment row ^{*1}	Fixed value: 2
	8th column	Number for program name row ^{*2}	Fixed value: <ul style="list-style-type: none"> With comment row: 6 Without comment row: 5
(2) Comment ^{*3}	1st column	—	A comment set with a configuration tool is displayed.

Row name	Column number	Column name	Output content
(3) Data type information	1st column	Date and time column ^{*4}	Fixed character: DATETIME[YYYY/MM/DD hh:mm:ss
	2nd column	Millisecond column ^{*4}	Fixed character: ms]
	3rd column	Data sampling interval column	Fixed character: INTERVAL
	4th column	Execution step number column	Fixed character: STEP NO.
	5th column	Execution program number column	Fixed character: PROGRAM NO.
	6th column	Execution program name column	Fixed character: PROGRAM NAME
	7th column	Index column	Fixed character: INDEX
	8th column and later	Data column	Data type of sampled data Output format: Output character for the data type [additional information]  Page 279 Output character for the data type
	Last column of the data column + 1st column	Trigger information column	Output format: TRIGGER[(trigger ON string)] ^{*5}
	Trigger information column + 1st column	CALC data column ^{*6}	CALC[Setting information of CALC data]
(4) Data name	1st column	Date and time column ^{*4}	Fixed character: TIME
	2nd column	Millisecond column ^{*4}	Fixed character: msec
	3rd column	Data sampling interval column	Fixed character: INTERVAL[us]
	4th column	Execution step number column	Fixed character: STEP NO.
	5th column	Execution program number column	Fixed character: PROGRAM NO.
	6th column	Execution program name column	Fixed character: PROGRAM NAME
	7th column	Index column	Fixed character: INDEX
	8th column and later	Data column	Output format: Device number or data name ^{*7}
	Last column of the data column + 1st column	Trigger information column	Fixed character: Trigger
	Trigger information column + 1st column	CALC data column ^{*6}	Output format: CALC data name
(5) Device comment	1st column	Date and time column	Blank
	2nd column	Millisecond column	Blank
	3rd column	Data sampling interval column	Blank
	4th column	Execution step number column	Blank
	5th column	Execution program number column	Blank
	6th column	Execution program name column	Blank
	7th column	Index column	Blank
	8th column and later	Data column	<ul style="list-style-type: none"> • When "Output device comments" is selected in the "data setting": Output comments of the specified comment number • When "Output device comments" is not selected in the "data setting": Blank
	Last column of the data column + 1st column	Trigger information column	Blank
	Trigger information column + 1st column	CALC data column ^{*6}	<ul style="list-style-type: none"> • When there is device comment information in CALC data: Character string of the device comment • When there is no device comment information in CALC data: Blank

Row name	Column number	Column name	Output content
(6) Program name ^{*8}	1st column	Date and time column	Blank
	2nd column	Millisecond column	Blank
	3rd column	Data sampling interval column	Blank
	4th column	Execution step number column	Blank
	5th column	Execution program number column	Blank
	6th column	Execution program name column	Blank
	7th column	Index column	Blank
	8th column and later	Data column	<ul style="list-style-type: none"> • A case in which sampled data is local devices or local labels: Specified program name • A case in which sampled data is global devices or global labels: Blank
	Last column of the data column + 1st column	Trigger information column	Blank
	Trigger information column + 1st column	CALC data column ^{*6}	<ul style="list-style-type: none"> • When there is program name information in CALC data: Program name • When there is no program name information in CALC data: Blank
(7) Data	1st column	Date and time column ^{*4}	Date and time information Output format: YYYY/MM/DD hh:mm:ss
	2nd column	Millisecond column ^{*4}	Value of milliseconds
	3rd column	Data sampling interval column ^{*9}	Value of the data sampling interval time
	4th column	Execution step number column ^{*9}	Value of the execution step No. Output format: Integer value
	5th column	Execution program number column ^{*9}	Value of the execution program No. Output format: Integer value
	6th column	Execution program name column ^{*9}	Execution program name Output format: STRING (program name)
	7th column	Index column ^{*10}	Value of an index Output format: Integer value
	8th column and later	Data column	Value of a sampled device Output format: Value corresponding to the type in the data type information row
	Last column of the data column + 1st column	Trigger information column	Information at the time when a trigger occurred Output format: String specified by configuration tool
	Trigger information column + 1st column	CALC data column ^{*6}	Value of a CALC data name Output format: DOUBLE

*1 This column is not output when the comment row is not output to the logging data.

*2 This column is not output when "RCPU_1" is output to the type information_file version column.

*3 This row is not output when the comment row is not output to the logging data.

*4 When "Output date" is not selected in the configuration tool, the date and time column and the millisecond column are not output when saving data as a CSV file by using this function.

*5 For the continuous logging, "" is output for 'trigger ON string'.

*6 If there is no CALC data, this column is not output.

*7 A program name is not output as well as the data column output from an RCPUs.

*8 This row is not output when "RCPU_1" is output to the type information_file version column.

*9 When data, of which the column is not output due to the setting of a configuration tool, is saved in a CSV file, only the delimiter "," (comma) is output to the column of the item corresponding to the data.

*10 Even when "Output indexes" is not selected in the configuration tool, sequentially numbered indexes starting from one are automatically output when saving data as a CSV file by using this function.

Precautions

When saving a data logging file which includes a comma (,) and double quote (") by using this function, the file is saved as below, which is the same as a data logging file acquired from RCPUs.

- If data output to a file includes a comma (,), the entire data which includes a comma in the file is enclosed with double quotes (""). (Example: 123,456 → "123,456")
- If data output to a file includes a double quote ("), the double quote is doubled. In addition, the entire data which includes a double quote is enclosed with double quotes. (Example: 123"456 → "123""456")

■MELSEC iQ-R series high speed data logger module

This section shows the format of the CSV file in which data of a MELSEC iQ-R series high speed data logger module displayed in GX LogViewer is saved.



The CSV file format explained in this section differs from that acquired from a MELSEC iQ-R series high speed data logger module.

For details on the CSV file format acquired from the module, refer to the following:

MELSEC iQ-R High Speed Data Logger Module User's Manual (Application)

Item	Description
Delimiter	Comma (,)
Line feed code	CRLF(0x0D, 0x0A)
Character code	ASCII
Number of rows	Up to 200004 rows (data rows + 4)

Ex.

When opening a CSV file in spreadsheet software

(1) →	[LOGGING]	RD81DL96_1	3	4	5	2	
(2) →	LOG01_1						
(3) →	DATETIME[YYYY/MM/DD hh:mm:ss	us]	INDEX	SHORT[DEC.0]	SHORT[DEC.0]	SHORT[DEC.0]	TRIGGER[*;-] CALC[SRC=1:KIND =DIFF:DIS_DT=T]
(4) →	TIME	usec	INDEX	d0	d10	d20	Trigger DIFF[d0]
(5) {	2000/1/10 6:27	200000	1	0	0	0	0
	2000/1/10 6:27	200000	2	0	0	0	0
	2000/1/10 6:27	200000	3	0	0	0	0
	2000/1/10 6:27	200000	4	0	0	0	0
	2000/1/10 6:27	200000	5	0	0	0	0

Row name	Column number	Column name	Output content
(1) File information	1st column	File type	Fixed character: [LOGGING]
	2nd column	Type information_file version	Fixed character: RD81DL96_(Version number) (Example) RD81DL96_1
	3rd column	Number for data type information row	Fixed value: • With comment row: 3 • Without comment row: 2
	4th column	Number for data name row	Fixed value: • With comment row: 4 • Without comment row: 3
	5th column	Number for data starting row	Fixed value: • With comment row: 5 • Without comment row: 4
	6th column	Number for comment row ^{*1}	Fixed value: 2
(2) Comment ^{*2}	1st column	—	A comment set with a configuration tool is displayed.
(3) Data type information	1st column	Date and time column ^{*3*4}	Fixed character: DATETIME[YYYY/MM/DD hh:mm:ss
	2nd column	Microsecond column ^{*3*5}	Fixed character: us]
	3rd column	Index column	Fixed character: INDEX
	4th column and later	Data column ^{*4}	Data type of sampled data Output format: Output character for the data type [additional information] Page 279 Output character for the data type
	Last column of the data column + 1st column	Trigger information column ^{*4}	Output format: TRIGGER[(trigger ON string);(trigger OFF string)] ^{*6}
	Trigger information column + 1st column	CALC data column ^{*7}	CALC[Setting information of CALC data]

Row name	Column number	Column name	Output content
(4) Data name	1st column	Date and time column ^{*3*4}	Fixed character: TIME
	2nd column	Microsecond column ^{*3*5}	Fixed character: usec
	3rd column	Index column	Fixed character: INDEX
	4th column and later	Data column ^{*4}	Output format: Data name
	Last column of the data column + 1st column	Trigger information column ^{*4}	Output format: String specified by configuration tool
	Trigger information column + 1st column	CALC data column ^{*7}	Output format: CALC data name
(5) Data	For saving data displayed in a historical trend window, data is output in the order that it was stored in a Data logging file. For saving data displayed in a realtime trend window, data is output in the order that it was received.		
	1st column	Date and time column ^{*3*4}	Date and time information Output format: YYYY/MM/DD hh:mm:ss
	2nd column	Microsecond column ^{*3*5}	Value of microseconds
	3rd column	Index column ^{*8}	Value of an index Output format: Integer value
	4th column and later	Data column ^{*4}	Value of a sampled device Output format: Value corresponding to the type in the data type information row
	Last column of the data column + 1st column	Trigger information column ^{*4}	Information at the time when a trigger occurred Output format: String specified by configuration tool
	Trigger information column + 1st column	CALC data column ^{*7}	Value of a CALC data name Output format: DOUBLE

*1 This column is not output when the comment row is not output to the logging data.

*2 This row is not output either when the comment row is not output to the logging data or when the logging data displayed in the realtime trend window is saved in a file.

*3 When "Output date column"/"Output date information" is not selected in the configuration tool, the date and time column and the microsecond column are not output when saving data as a CSV file by using this function.

*4 It is output in the set output format when the logging file conversion function is used.

*5 The microsecond column is not output when the logging file conversion function is used.

*6 When output contents are not specified for "Trigger information column" in the configuration tool, data is output as shown below when saving it as a CSV file by using this function.
TRIGGER[*;-]

*7 If there is no CALC data, this column is not output.

*8 Even when "Output index column"/"Output indexes" is not selected in the configuration tool, sequentially numbered indexes starting from one are automatically output when saving data as a CSV file by using this function.

■FX5CPU

This section shows the format of the CSV file in which data of an FX5CPU displayed in GX LogViewer is saved.



The CSV file format explained in this section differs from that acquired from an FX5CPU.

For details on the CSV file format acquired from the module, refer to the following:

MELSEC iQ-F FX5 User's Manual (Application)

Item	Description
Delimiter	Comma (,)
Line feed code	CRLF(0x0D, 0x0A)
Character code	ASCII
Number of rows	Up to 131004 rows (data rows + 4)

Ex.

When opening a CSV file in spreadsheet software

(1) →	[LOGGING]	FX5CPU_2	3	4	5	2	
(2) →	LOG01						
(3) →	DATETIME[YYYY/MM/DD hh:mm:ss	ms]	INTERVAL	INDEX	SHORT[DEC.0]	TRIGGER[*]	CALC[SRC=1:KIND=DIFF:DIS_DT=F]
(4) →	TIME	msec	INTERVAL[us]	INDEX	D250	Trigger	DIFF_DT[D250]
(5) {	2020/1/29 17:10	382	0	1	1496		0
	2020/1/29 17:10	582	200000	2	1500		20
	2020/1/29 17:10	782	200000	3	1504		20
	2020/1/29 17:10	982	200000	4	1508		20
	2020/1/29 17:10	182	200000	5	1512		20

Row name	Column number	Column name	Output content
(1) File information	1st column	File type	Fixed character: [LOGGING]
	2nd column	Type information_file version	Fixed character: FX5CPU_(Version information) (Example) FX5CPU_2
	3rd column	Number for data type information row	Fixed value: • With comment row: 3 • Without comment row: 2
	4th column	Number for data name row	Fixed value: • With comment row: 4 • Without comment row: 3
	5th column	Number for data starting row	Fixed value: • With comment row: 5 • Without comment row: 4
	6th column	Number for comment row ^{*1}	Fixed value: 2
(2) Comment ^{*2}	1st column	—	A comment set with a configuration tool is displayed.
(3) Data type information	1st column	Date and time column ^{*3}	Fixed character: DATETIME[YYYY/MM/DD hh:mm:ss
	2nd column	Millisecond column ^{*3}	Fixed character: ms]
	3rd column	Data sampling interval column	Fixed character: INTERVAL
	4th column	Index column	Fixed character: INDEX
	5th column and later	Data column	Data type of sampled data Output format: Output character for the data type [additional information] Page 279 Output character for the data type
	Last column of the data column + 1st column	Trigger information column	Output format: TRIGGER[(trigger ON string)] ^{*4}
	Trigger information column + 1st column	CALC data column ^{*5}	CALC[Setting information of CALC data]

Row name	Column number	Column name	Output content
(4) Data name	1st column	Date and time column ^{*3}	Fixed character: TIME
	2nd column	Millisecond column ^{*3}	Fixed character: msec
	3rd column	Data sampling interval column	Fixed character: INTERVAL[us]
	4th column	Index column	Fixed character: INDEX
	5th column and later	Data column	Output format: Device number or device comments
	Last column of the data column + 1st column	Trigger information column	Fixed character: Trigger
	Trigger information column + 1st column	CALC data column ^{*5}	Output format: CALC data name
(5) Data	1st column	Date and time column ^{*3}	Date and time information Output format: YYYY/MM/DD hh:mm:ss
	2nd column	Millisecond column ^{*3}	Value of milliseconds
	3rd column	Data sampling interval column ^{*6}	Value of the data sampling interval time
	4th column	Index column ^{*7}	Value of an index Output format: Integer value
	5th column and later	Data column	Value of a sampled device Output format: Value corresponding to the type in the data type information row
	Last column of the data column + 1st column	Trigger information column	Information at the time when a trigger occurred Output format: String specified by configuration tool
	Trigger information column + 1st column	CALC data column ^{*5}	Value of a CALC data name Output format: DOUBLE

*1 This column is not output when the comment row is not output to the logging data.

*2 This row is not output either when the comment row is not output to the logging data or when the logging data displayed in the realtime monitor window is saved in a file.

*3 When "Output date" is not selected in the configuration tool, the date and time column and the millisecond column are not output when saving data as a CSV file by using this function.

4 """" is output for 'trigger ON string' for the continuous logging.

*5 If there is no CALC data, this column is not output.

*6 When data, of which the column is not output due to the setting of a configuration tool, is saved in a CSV file, only the delimiter "," (comma) is output to the column of the item corresponding to the data.

*7 Even when "Output index column" is not selected in the configuration tool, sequentially numbered indexes starting from one are automatically output when saving data as a CSV file by using this function.

■ QnUDVCPU/LCPU

This section shows the format of the CSV file in which data of a QnUDVCPU or an LCPU that is displayed in GX LogViewer is saved.



The CSV file format explained in this section differs from that acquired from a QnUDVCPU or an LCPU.

For details on the CSV file format acquired from each module, refer to the following:

QnUDVCPU/LCPU User's Manual (Data Logging Function)

Item	Description
Delimiter	Comma (,)
Line feed code	CRLF(0x0D, 0x0A)
Character code	ASCII
Number of rows	Up to 131004 rows (data rows + 4)
	Realtime monitor window: Up to 1000004 rows (data rows + 3)

Ex.

When opening a CSV file in spreadsheet software

(1) →	[LOGGING]	L1		3	4	5	2						
(2) →	Logging output result												
(3) →	DATETIME[YYYY/MM/DD hh:mm:ss	ms]	INTERVAL	STEP NO.	PROGRAM NAME	INDEX	SHORT[DEC.0]	FLOAT[DEC.7]	BIT[1:0]	TRIGGER[*]	CALC[SRC=1:KIND=FOUR _1:SRC2=2:OP=+:PO=0]		
(4) →	TIME	msec	INTERVAL[us]	STEP NO.	PROGRAM NAME	INDEX	D0	D1	M0	Trigger	(([D0] + [D1])		
(5) {		2009/07/28 17:11:52	688	200000	69 MAIN	36001	71	0.9455186	1			71.94551861	
		2009/07/28 17:11:52	888	200000	69 MAIN	36002	73	0.9563047	1			73.95630473	
		2009/07/28 17:11:53	88	200000	69 MAIN	36003	75	0.9659258	1			75.96592581	
		2009/07/28 17:11:53	288	200000	69 MAIN	36004	77	0.9743701	1			77.97437012	
		2009/07/28 17:11:53	488	200000	69 MAIN	36005	79	0.9816272	1			79.98162723	

Row name	Column number	Column name	Output content
(1) File information	1st column	File type	Fixed character: [LOGGING]
	2nd column	Type information_file version	Fixed character: • QnUDVCPU: Q1 • LCPU: L1
	3rd column	Number for data type information row	Fixed value: • With comment row: 3 • Without comment row: 2
	4th column	Number for data name row	Fixed value: • With comment row: 4 • Without comment row: 3
	5th column	Number for data starting row	Fixed value: • With comment row: 5 • Without comment row: 4
	6th column	Number for comment row ^{*1}	Fixed value: 2
(2) Comment ^{*2}	1st column	—	A comment set with a configuration tool is displayed.
(3) Data type information	1st column	Date and time column ^{*3}	Fixed character: DATETIME[YYYY/MM/DD hh:mm:ss
	2nd column	Millisecond column ^{*3}	Fixed character: ms]
	3rd column	Data sampling interval column	Fixed character: INTERVAL
	4th column	Execution step number column	Fixed character: STEP NO.
	5th column	Execution program name column	Fixed character: PROGRAM NAME
	6th column	Index column	Fixed character: INDEX
	7th column and later	Data column	Data type of sampled data Output format: Output character for the data type [additional information] Page 279 Output character for the data type
	Last column of the data column + 1st column	Trigger information column	Output format: TRIGGER[(trigger ON string)] ^{*4}
	Trigger information column + 1st column	CALC data column ^{*5}	CALC[Setting information of CALC data]

Row name	Column number	Column name	Output content
(4) Data name	1st column	Date and time column ^{*3}	Fixed character: TIME
	2nd column	Millisecond column ^{*3}	Fixed character: msec
	3rd column	Data sampling interval column	Fixed character: INTERVAL[us]
	4th column	Execution step number column	Fixed character: STEP NO.
	5th column	Execution program name column	Fixed character: PROGRAM NAME
	6th column	Index column	Fixed character: INDEX
	7th column and later	Data column	Output format: Device number or device comments
	Last column of the data column + 1st column	Trigger information column	Fixed character: Trigger
	Trigger information column + 1st column	CALC data column ^{*5}	Output format: CALC data name
(5) Data	1st column	Date and time column ^{*3}	Date and time information Output format: YYYY/MM/DD hh:mm:ss
	2nd column	Millisecond column ^{*3}	Value of milliseconds
	3rd column	Data sampling interval column ^{*6}	Value of the data sampling interval time
	4th column	Execution step number column ^{*6}	Value of the execution step No. Output format: Integer value
	5th column	Execution program name column ^{*6}	Execution program name Output format: STRING (program name)
	6th column	Index column ^{*7}	Value of an index Output format: Integer value
	7th column and later	Data column	Value of a sampled device Output format: Value corresponding to the type in the data type information row
	Last column of the data column + 1st column	Trigger information column	Information at the time when a trigger occurred Output format: String specified by configuration tool
	Trigger information column + 1st column	CALC data column ^{*5}	Value of a CALC data name Output format: DOUBLE

*1 This column is not output when the comment row is not output to the logging data.

*2 This row is not output either when the comment row is not output to the logging data or when the logging data displayed in the realtime monitor window is saved in a file.

*3 When "Output date column" is not selected in the configuration tool, the date and time column and the millisecond column are not output when saving data as a CSV file by using this function.

*4 "" is output for 'trigger ON string' for the continuous logging.

*5 If there is no CALC data, this column is not output.

*6 When data, of which the column is not output due to the setting of a configuration tool, is saved in a CSV file, only the delimiter "," (comma) is output to the column of the item corresponding to the data.

*7 Even when "Output index column" is not selected in the configuration tool, sequentially numbered indexes starting from one are automatically output when saving data as a CSV file by using this function.



■ MELSEC-Q series high speed data logger module or BOX data logger

This section shows the format of the CSV file in which data of a MELSEC-Q series high speed data logger module or a BOX data logger displayed in GX LogViewer is saved.

Point

The CSV file format explained in this section differs from that acquired from a MELSEC-Q series high speed data logger module or BOX data logger.

For details on the CSV file format acquired from each module, refer to the following:

-  High Speed Data Logger Module User's Manual
-  BOX Data Logger User's Manual

Item	Description
Delimiter	Comma (,)
Line feed code	CRLF(0x0D, 0x0A)
Character code	ASCII
Number of rows	Up to 200003 rows (data rows + 3)

12

Ex.

When opening a CSV file in spreadsheet software

(1) →	[LOGGING]	1	2	3	4			
(2) →	DATETIME[YYYY/MM/DD hh:mm:ss]	us]	INDEX	BIT[On;Off]	SHORT[DEC.0]	FLOAT[DEC.7]	TRIGGER[*;-]	CALC[SRC=6:KIND =DIFF:DIS_DT=F]
(3) →	TIME	usec	INDEX	Data1	Data2	Data3	Trigger	DIFF_DT[Data3]
(4) {	2011/03/31 11:46:43	32000	1 Off			0	0.5403	0
	2011/03/31 11:46:44	32000	2 Off			1	0.83229	0.291989982
	2011/03/31 11:46:45	32000	3 Off			0	2.97	2.137710035
	2011/03/31 11:46:46	32001	4 Off			3	2.6146	-0.35539973
	2011/03/31 11:46:47	32002	5 Off			4	1.4183	-1.196298714

Row name	Column number	Column name	Output content
(1) File information	1st column	File type	Fixed character: [LOGGING]
	2nd column	Type information_file version	Fixed value or fixed character: • MELSEC-Q series high speed data logger module: 1 • BOX data logger: NZ2DL_(Version number) (Example) NZ2DL_2
	3rd column	Number for data type information row	Fixed value: 2
	4th column	Number for data name row	Fixed value: 3
	5th column	Number for data starting row	Fixed value: 4
(2) Data type information	1st column	Date and time column ^{*1*2}	Fixed character: DATETIME[YYYY/MM/DD hh:mm:ss]
	2nd column	Microsecond column ^{*1*3}	Fixed character: us]
	3rd column	Index column	Fixed character: INDEX
	4th column and later	Data column ^{*2}	Data type of sampled data Output format: Output character for the data type [additional information]  Page 279 Output character for the data type
	Last column of the data column + 1st column	Trigger information column ^{*2}	Output format: TRIGGER[(trigger ON string);(trigger OFF string)] ^{*4}
	Trigger information column + 1st column	CALC data column ^{*5}	CALC[Setting information of CALC data]

Row name	Column number	Column name	Output content
(3) Data name	1st column	Date and time column ^{*1*2}	Fixed character: TIME
	2nd column	Microsecond column ^{*1*3}	Fixed character: usec
	3rd column	Index column	Fixed character: INDEX
	4th column and later	Data column ^{*2}	Output format: Data name
	Last column of the data column + 1st column	Trigger information column ^{*2}	Output format: String specified by configuration tool
	Trigger information column + 1st column	CALC data column ^{*5}	Output format: CALC data name
(4) Data	For saving data displayed in a historical trend window, data is output in the order that it was stored in a Data logging file. For saving data displayed in a realtime trend window, data is output in the order that it was received.		
	1st column	Date and time column ^{*1*2}	Date and time information Output format: YYYY/MM/DD hh:mm:ss
	2nd column	Microsecond column ^{*1*3}	Value of microseconds
	3rd column	Index column ^{*6}	Value of an index Output format: Integer value
	4th column and later	Data column ^{*2}	Value of a sampled device Output format: Value corresponding to the type in the data type information row
	Last column of the data column + 1st column	Trigger information column ^{*2}	Information at the time when a trigger occurred Output format: String specified by configuration tool
	Trigger information column + 1st column	CALC data column ^{*5}	Value of a CALC data name Output format: DOUBLE

*1 When "Output date column"/"Output date information" is not selected in the configuration tool, the date and time column and the microsecond column are not output when saving data as a CSV file by using this function.

*2 It is output in the set output format when the logging file conversion function is used.

*3 The microsecond column is not output when the logging file conversion function is used.

*4 When output contents are not specified for "Trigger information column" in the configuration tool, data is output as shown below when saving it as a CSV file by using this function.
TRIGGER[*;-]

*5 If there is no CALC data, this column is not output.

*6 Even when "Output index column"/"Output indexes" is not selected in the configuration tool, sequentially numbered indexes starting from one are automatically output when saving data as a CSV file by using this function.

■MELSEC-Q series high speed data communication module

This section shows the format of the CSV file in which data of MELSEC-Q series high speed data communication module displayed in GX LogViewer is saved.

Item	Description
Delimiter	Comma (,)
Line feed code	CRLF(0x0D, 0x0A)
Character code	ASCII
Number of rows	Up to 100004 rows (data rows + 3)

Ex.

When opening a CSV file in spreadsheet software

(1) →	[LOGGING]	QJ71DC96_1	2	3	4	
(2) →	DATETIME[YYYY/MM/DD hh:mm:ss	us]	INDEX	DOUBLE[DEC.14]	TRIGGER[*;-] CALC[SRC=1:KIND=DIFF:DIS_DT=F]	
(3) →	TIME	usec	INDEX	D0	Trigger	DIFF_DT[D0]
(4) {	2000/1/1 0:02	600000	1	0.995219544		0
	2000/1/1 0:02	600000	2	0.994237943		-0.000981602
	2000/1/1 0:02	600000	3	0.993165034		-0.001072908
	2000/1/1 0:02	600000	4	0.992000918		-0.001164116
	2000/1/1 0:03	600000	5	0.990745701		-0.001255217

Row name	Column number	Column name	Output content
(1) File information	1st column	File type	Fixed character: [LOGGING]
	2nd column	Type information_file version	Fixed character: QJ71DC96_(Version number) (Example) QJ71DC96_1
	3rd column	Number for data type information row	Fixed value: 2
	4th column	Number for data name row	Fixed value: 3
	5th column	Number for data starting row	Fixed value: 4
(2) Data type information	1st column	Date and time column	Fixed character: DATETIME[YYYY/MM/DD hh:mm:ss
	2nd column	Microsecond column	Fixed character: us]
	3rd column	Index column	Fixed character: INDEX
	4th column and later	Data column	Data type of sampled data Output format: Output character for the data type [additional information] ☞ Page 279 Output character for the data type
	Last column of the data column + 1st column	Trigger information column	Fixed character: TRIGGER[*;-]
	Trigger information column + 1st column	CALC data column ^{*1}	CALC[Setting information of CALC data]
(3) Data name	1st column	Date and time column	Fixed character: TIME
	2nd column	Microsecond column	Fixed character: usec
	3rd column	Index column	Fixed character: INDEX
	4th column and later	Data column	Output format: Data name
	Last column of the data column + 1st column	Trigger information column	Fixed character: Trigger
	Trigger information column + 1st column	CALC data column ^{*1}	Output format: CALC data name

Row name	Column number	Column name	Output content
(4) Data	For saving data displayed in a historical trend window, data is output in the order that it was stored in a Data logging file. For saving data displayed in a realtime trend window, data is output in the order that it was received.		
	1st column	Date and time column	Date and time information Output format: YYYY/MM/DD hh:mm:ss
	2nd column	Microsecond column	Value of microseconds
	3rd column	Index column	Value of an index Output format: Integer value
	4th column and later	Data column	Value of a sampled device Output format: Value corresponding to the type in the data type information row
	Last column of the data column + 1st column	Trigger information column	— (Blank)
	Trigger information column + 1st column	CALC data column ^{*1}	Value of a CALC data name Output format: DOUBLE

*1 If there is no CALC data, this column is not output.

■Analog module

This section shows the format of the CSV file in which data of an analog module displayed in GX LogViewer is saved.



The CSV file format explained in this section differs from that acquired from an analog module.

For details on the CSV file format acquired from analog modules, refer to the user's manual of each analog module.

Item	Description
Delimiter	Comma (,)
Line feed code	CRLF(0x0D, 0x0A)
Character code	Q68CT, R60AD8-G, R60AD16-G, R60RD8-G, R60TD8-G: ASCII Q64ADH, L60AD4, L60AD4-2GH, L60AD2DA2, R60AD4, R60ADV8, R60ADI8: ASCII
Number of rows	Q64ADH, L60AD4, L60AD4-2GH, L60AD2DA2, R60AD4, R60ADV8, R60ADI8: Up to 10003 rows (data rows + 3) R60AD8-G, R60AD16-G, R60RD8-G, R60TD8-G: Up to 1003 rows (data rows + 3) Q68CT: Up to 5003 rows (data rows + 3) R60ADH4: Up to 90003 rows (data rows + 3)



When opening a CSV file in spreadsheet software

(1) →	[LOGGING]	LAD1		2		3	4
(2) →	INDEX	SHORT[DEC.0]		TRIGGER[*]		CALC[SRC=1:KIND=DIFF:DIS_DT=T]	
(3) →	INDEX	DATE:2011/02/16 20:05:16 I/O:0240 CH:3 CYCLE: 3ms 840us		Trigger		DIFF[DATE:2011/02/16 20:05:16 I/O:0240 CH:3 CYCLE: 3ms 840us]	
(4) {	1						0
	2		-20031				55
	3		-19976				-29
	4		-20005				22
	5		-19983				-26

Row name	Column number	Column name	Output content
(1) File information	1st column	File type	Fixed character: [LOGGING]
	2nd column	Type information_file version	The file version of an analog module differs depending on the module type. For details, refer to the user's manual of each module. (Example) Q68CT: Q68CT_1 (Example) L60AD4: LAD1
	3rd column	Number for data type information row	Fixed value: 2
	4th column	Number for data name row	Fixed value: 3
	5th column	Number for data starting row	Fixed value: 4
(2) Data type information	1st column	Index column	Fixed character: INDEX
	2nd column and later	Data column	Data type of sampled data Output format: Output character for the data type [additional information] ☞ Page 279 Output character for the data type
	Last column of the data column + 1st column	Trigger information column	Fixed character: TRIGGER[(trigger ON string)] ^{*1}
	Trigger information column + 1st column	CALC data column ^{*2}	CALC[Setting information of CALC data]

Row name	Column number	Column name	Output content
(3) Data name	1st column	Index column	Fixed character: INDEX
	2nd column and later	Data column	Output format: <ul style="list-style-type: none"> • "DATE:" Hold trigger generated time • "I/O:" XY address number to acquire logging data • "CH:" Target channel • "CYCLE:" Logging cycle (Fixed character is displayed in " ")
	Last column of the data column + 1st column	Trigger information column	Fixed character: Trigger
	Trigger information column + 1st column	CALC data column ^{*2}	Output format: CALC data name
(4) Data	For saving data displayed in a historical trend window, data is output in the order that it was stored in a Data logging file.		
	1st column	Index column ^{*3}	Value of an index Output format: Integer value
	2nd column and later	Data column	Value of a sampled device Output format: Value corresponding to the type in the data type information row
	Last column of the data column + 1st column	Trigger information column	Information at the time when a trigger occurred
	Trigger information column + 1st column	CALC data column ^{*2}	Value of a CALC data name Output format: DOUBLE

*1 "" is output for 'trigger ON string'.

*2 If there is no CALC data, this column is not output.

*3 Indexes are not output to a data logging file in an analog module. Therefore, sequentially numbered indexes starting from one are automatically output when saving data as a CSV file.

■MELSEC iQ-R series motion module or motion module simulator

This section shows the format of the CSV file in which CSV file data of a MELSEC iQ-R series motion module or motion module simulator displayed in GX LogViewer is saved.

For the format of the CSV file in which JSON file data displayed in GX LogViewer is saved, refer to the following:

📄 Page 278 JSON file in GX LogViewer format



The CSV file format explained in this section differs from that acquired from a MELSEC iQ-R series motion module.

For details on the CSV file format acquired from the module, refer to the following:

📖 MELSEC iQ-R Motion Module User's Manual (Application)

Item	Description
Delimiter	Comma (,)
Line feed code	CRLF(0x0D, 0x0A)
Character code	Unicode (UTF-8)
Number of rows	Up to 1000004 rows (data rows + 4)

Ex.

When opening a CSV file in spreadsheet software

(1) →	[LOGGING]	RD78G(H)_1	2	3	4		
(2) →	DATETIME[YYYY/MM/DD hh:mm:ss.ssssss]	INDEX	SHORT[DEC.0]	SHORT[DEC.0]	ULONG[DEC.0]	TRIGGER[*]	CALC[SRC=1:KIND=DIFF:DIS_DT=T]
(3) →	TIME	INDEX	System.Md.Backup RestoreStatus	System.Md.Backup RestoreStatus	System.Md.Buffermemory FreeMcfbArea	Trigger	DIFF[System.Md.Backup RestoreStatus]
(4) {	2023/09/11 12:46:40.40	1	0	0	999992		0
	2023/09/11 12:46:40.40	2	0	0	999992		0
	2023/09/11 12:46:40.40	3	0	0	999992		0
	2023/09/11 12:46:40.40	4	0	0	999992		0
	2023/09/11 12:46:40.40	5	0	0	999992		0
	2023/09/11 12:46:40.40	6	0	0	999992		0
	2023/09/11 12:46:40.40	7	0	0	999992		0

Row name	Column number	Column name	Output content
(1) File information	1st column	File type	Fixed character: [LOGGING]
	2nd column	Type information_file version	Fixed character: RD78G(H)_(Version number) (Example) RD78G(H)_1
	3rd column	Number for data type information row	Fixed value: 2
	4th column	Number for data name row	Fixed value: 3
	5th column	Number for data starting row	Fixed value: 4
(2) Data type information	1st column	Date and time column	Fixed character: DATETIME[YYYY/MM/DD hh:mm:ss.ssssss]
	2nd column	Index column	Fixed character: INDEX
	3rd column and later	Data column	Data type of sampled data Output format: Output character for the data type [additional information] 📄 Page 279 Output character for the data type
	Last column of the data column + 1st column	Trigger information column	Output format: TRIGGER[(trigger ON string)] ^{*1}
	Trigger information column + 1st column	CALC data column ^{*2}	CALC[Setting information of CALC data]

Row name	Column number	Column name	Output content
(3) Data name	1st column	Date and time column	Fixed character: TIME
	2nd column	Index column	Fixed character: INDEX
	3rd column and later	Data column	Output format: Data name
	Last column of the data column + 1st column	Trigger information column	Fixed character: Trigger
	Trigger information column + 1st column	CALC data column ^{*2}	Output format: CALC data name
(4) Data	1st column	Date and time column	Date and time information Output format: YYYY/MM/DD hh:mm:ss:ssssss
	2nd column	Index column	Value of an index Output format: Integer value
	3rd column and later	Data column	Value of a sampled device Output format: Value corresponding to the type in the data type information row
	Last column of the data column + 1st column	Trigger information column	Information at the time when a trigger occurred
	Trigger information column + 1st column	CALC data column ^{*2}	Value of a CALC data name Output format: DOUBLE

*1 "" is output for 'trigger ON string'.

*2 If there is no CALC data, this column is not output.

■MELSEC iQ-R series motion controller

This section shows the format of the CSV file in which CSV file data of a MELSEC iQ-R series motion controller displayed in GX LogViewer is saved.



The CSV file format explained in this section differs from that acquired from a MELSEC iQ-R series motion controller.

For details on the CSV file format acquired from the controller, refer to the following:

MELSEC iQ-R Motion Controller User's Manual

Item	Description
Delimiter	Comma (,)
Line feed code	CRLF(0x0D, 0x0A)
Character code	ASCII
Number of rows	Up to 150005 rows (data rows + 6)

Ex.

When opening a CSV file in spreadsheet software

(1) →	[LOGGING]	RMTCPU_1	2	3	6	4	5		CALC[SRC=4:KIND=F
(2) →	DATETIME[YYYY/MM/DD hh:mm:ss.ssssss]	INDEX	SHORT[DEC.0]	SHORT[DEC.0]	BIT[1;0]	LONG[DEC.0]	LONG[DEC.0]	TRIGGER["**"]	OUR_1:SRC2=1:OP=
(3) →	TIME	INDEX	SD522	SD0	M30054	D32000	D32002	Trigger	+ :PO=0]
(4) →			Motion operation cycle	Diagnostic error	Operation cycle over flag	Ax.1-Feed current value	Ax.1-Actual Current Value		(([D32000] + [SD522])
(5) {			us			pulse	pulse		
	2022/3/17 16:25:55.55	1	56	8928	1	0	0		56
	2022/3/17 16:25:55.55	2	289	8928	1	0	0		289
	2022/3/17 16:25:55.55	3	70	8928	1	0	0		70
	2022/3/17 16:25:55.55	4	293	8928	1	0	0		293
	2022/3/17 16:25:55.55	5	71	8928	1	0	0		71

Row name	Column number	Column name	Output content
(1) File information	1st column	File type	Fixed character: [LOGGING]
	2nd column	Type information_file version	Fixed character: RMTCPU_(Version number) (Example)RMTCPU_1
	3rd column	Number for data type information row	Fixed value: 2
	4th column	Number for data name row	Fixed value: 3
	5th column	Number for data starting row	Starting number of data rows
	6th column	Number for device comment row	Number indicating the device comment row
	7th column	Unit information row	Number indicating the unit information row
(2) Data type information	1st column	Date and time column	Fixed character: DATETIME[YYYY/MM/DD hh:mm:ss.ssssss]
	2nd column	Index column	Fixed character: INDEX
	3rd column and later	Data column	Data type of sampled data Output format: Output character for the data type [additional information] Page 279 Output character for the data type
	Last column of the data column + 1st column	Trigger information column	Output format: TRIGGER[(trigger ON string)] ¹
	Trigger information column + 1st column	CALC data column ²	CALC[Setting information of CALC data]

Row name	Column number	Column name	Output content
(3) Data name	1st column	Date and time column	Fixed character: TIME
	2nd column	Index column	Fixed character: INDEX
	3rd column and later	Data column	Output format: Data name
	Last column of the data column + 1st column	Trigger information column	Fixed character: Trigger
	Trigger information column + 1st column	CALC data column ^{*2}	Output format: CALC data name
(4) Unit	1st column	Date and time column	Blank
	2nd column	Index column	Blank
	3rd column and later	Data column	Data includes units: Unit character string Data does not include units: Blank
	Last column of the data column + 1st column	Trigger information column	Blank
	Trigger information column + 1st column	CALC data column ^{*2}	Data includes units: Unit character string Data does not include units: Blank
(5) Data	1st column	Date and time column	Date and time information Output format: YYYY/MM/DD hh:mm:ss:sssss
	2nd column	Index column	Value of an index Output format: Integer value
	3rd column and later	Data column	Value of a sampled device Output format: Value corresponding to the type in the data type information row
	Last column of the data column + 1st column	Trigger information column	Information at the time when a trigger occurred
	Trigger information column + 1st column	CALC data column ^{*2}	Value of a CALC data name Output format: DOUBLE

*1 "" is output for 'trigger ON string'.

*2 If there is no CALC data, this column is not output.

■Logging module for energy measuring module

This section shows the format of the CSV file in which data of a logging module for energy measuring module displayed in GX LogViewer is saved.

Point

The CSV file format explained in this section differs from that acquired from a logging module for energy measuring module.

For details on the CSV file format acquired from a logging module for energy measuring module, refer to the manual of the logging module for energy measuring module.

- Obtaining manuals of the logging module for energy measuring module in Japan

The manuals can be downloaded from Mitsubishi Electric FA site.

www.MitsubishiElectric.co.jp/fa

- Obtaining manuals of the logging module for energy measuring module in other countries

For information on how to obtain the manual, please contact your local Mitsubishi Electric sales office or representative.

Item	Description
Delimiter	Comma (,)
Line feed code	CRLF(0x0D, 0x0A)
Character code	ASCII
Number of rows	Up to 3603 rows (data rows + 3)

Ex.

When opening a CSV file in spreadsheet software

(1) →	[LOGGING]	YM_1	2	3	4				
(2) →	DATETIME[YYYY/MM/DD hh:mm:ss	us]	INDEX	DOUBLE[DEC.14]	DOUBLE[DEC.14]	DOUBLE[DEC.14]	DOUBLE[DEC.14]	TRIGGER[*;-]	CALC[SRC=2:KIND=FOUR_1: SRC2=1:OP=+:PO=0]
(3) →	TIME	usec	INDEX	ch1_W[kW]	ch1_V[V]	ch1_A[A]	ch1_PF[%]	Trigger	(([ch1_V[V]] + [ch1_W[kW]]))
(4) {	2013/3/11 20:00	0	1	4801	3102	552	84.1		7903
	2013/3/11 20:00	0	2	4801	3102	552	84.1		7903
	2013/3/11 20:00	0	3	4801	3102	552	84.1		7903
	2013/3/11 20:00	0	4	4801	3102	552	84.1		7903
	2013/3/11 20:00	0	5	4801	3102	552	84.1		7903

Row name	Column number	Column name	Output content
(1) File information	1st column	File type	Fixed character: [LOGGING]
	2nd column	Type information_file version	Fixed character: YM_(Version number) (Example) YM_1
	3rd column	Number for data type information row	Fixed value: 2
	4th column	Number for data name row	Fixed value: 3
	5th column	Number for data starting row	Fixed value: 4
(2) Data type information	1st column	Date and time column	Fixed character: DATETIME[YYYY/MM/DD hh:mm:ss
	2nd column	Microsecond column	Fixed character: us]
	3rd column	Index column	Fixed character: INDEX
	4th column and later	Data column	Data type of sampled data Output format: Output character for the data type [additional information] Page 279 Output character for the data type
	Last column of the data column + 1st column	Trigger information column	Fixed character: TRIGGER[*;-]
	Trigger information column + 1st column	CALC data column ^{*1}	CALC[Setting information of CALC data]

Row name	Column number	Column name	Output content
(3) Data name	1st column	Date and time column	Fixed character: TIME
	2nd column	Microsecond column	Fixed character: usec
	3rd column	Index column	Fixed character: INDEX
	4th column and later	Data column	Output format: Data name
	Last column of the data column + 1st column	Trigger information column	Fixed character: Trigger
	Trigger information column + 1st column	CALC data column ^{*1}	Output format: CALC data name
(4) Data	For saving data displayed in a historical trend window, data is output in the order that it was stored in a Data logging file. For saving data displayed in a realtime trend window, data is output in the order that it was received.		
	1st column	Date and time column	Date and time information Output format: YYYY/MM/DD hh:mm:ss
	2nd column	Microsecond column	Value of microseconds Fixed value: 0
	3rd column	Index column	Value of an index Output format: Integer value
	4th column and later	Data column	Value of a sampled device Output format: Value corresponding to the type in the data type information row
	Last column of the data column + 1st column	Trigger information column	— (Blank)
	Trigger information column + 1st column	CALC data column ^{*1}	Value of a CALC data name Output format: DOUBLE

*1 If there is no CALC data, this column is not output.

■ Sampling trace

This section shows the format of the CSV file in which data of sampling trace data displayed in GX LogViewer is saved.

Item	Description
Delimiter	Comma (,)
Line feed code	CRLF(0x0D, 0x0A)
Character code	ASCII
Number of rows	Up to 8196 rows (data rows + 4)

Ex.

When opening a CSV file in spreadsheet software

(1) →	[LOGGING]	SamplingTrace_1	2	3	4			
(2) →	INDEX	BIT[1;0]	BIT[1;0]	BIT[1;0]	LONG[DEC.0]	SHORT[DEC.0]	TRIGGER[*]	CALC[SRC=4;KIND=DIFF;DIS_DT=T]
(3) →	INDEX	M0	M1	M8191	D0	D12287	Trigger	DIFF[D0]
(4) {	1	1	0	0	0	200		0
	2	1	0	0	0	200		0
	3	1	0	0	0	200		0
	4	1	0	0	0	200		0
	5	1	0	0	0	200		0

Row name	Column number	Column name	Output content
(1) File information	1st column	File type	Fixed character: [LOGGING]
	2nd column	Type information_file version	Fixed character: SamplingTrace_(Version number) (Example) SamplingTrace_1
	3rd column	Number for data type information row	Fixed value: 2
	4th column	Number for data name row	Fixed value: 3
	5th column	Number for data starting row	Fixed value: 4
(2) Data type information	1st column	Index column	Fixed character: INDEX
	2nd column and later	Data column	Data type of sampled data Output format: Output character for the data type [additional information] ☞ Page 279 Output character for the data type
	Last column of the data column + 1st column	Trigger information column	Fixed character: TRIGGER[(trigger ON string)] ^{*1}
	Trigger information column + 1st column	CALC data column ^{*2}	CALC[Setting information of CALC data]
(3) Data name	1st column	Index column	Fixed character: INDEX
	2nd column and later	Data column	Device or device comment
	Last column of the data column + 1st column	Trigger information column	Fixed character: Trigger
	Trigger information column + 1st column	CALC data column ^{*2}	Output format: CALC data name
(4) Data	1st column	Index column ^{*3}	Value of an index Output format: Integer value
	2nd column and later	Data column	Value of a sampled device Output format: Value corresponding to the type in the data type information row
	Last column of the data column + 1st column	Trigger information column	Information at the time when a trigger occurred
	Trigger information column + 1st column	CALC data column ^{*2}	Value of a CALC data name Output format: DOUBLE

*1 "" is output for 'trigger ON string'.

*2 If there is no CALC data, this column is not output.

*3 Sequentially numbered indexes starting from one are automatically output when data in which indexes are not output is saved as a CSV file.

■ Simulation result and sampling data saved with MELSEC iQ-R series Flexible High-Speed I/O Control Module Configuration Tool

This section shows the format of the CSV file in which a simulation result and sampling data of a MELSEC iQ-R series Flexible High-Speed I/O Control Module Configuration Tool displayed in GX LogViewer are saved.

Point

The CSV file format explained in this section differs from that of a simulation result and sampling data saved with MELSEC iQ-R series Flexible High-Speed I/O Control Module Configuration Tool.

For details on the CSV file format of a simulation result and sampling data, refer to the following:

 MELSEC iQ-R Flexible High-Speed I/O Control Module User's Manual (Application)

Item	Description
Delimiter	Comma (,)
Line feed code	CRLF(0x0D, 0x0A)
Character code	ASCII
Number of rows	Up to 2051 rows (data rows + 3)

Ex.

When opening a CSV file in spreadsheet software

(1) →	[LOGGING]	RD40PD01_1	2	3	4						
(2) →	DATETIME[YYYY/MM/DD hh:mm:ss]	us]	INDEX	BIT[1:0]	BIT[1:0]	BIT[1:0]	BIT[1:0]	ULONG[DEC.0]	TRIGGER[*]	CALC[SRC=5:KIN D=DIFF:DIS_DT=T	
(3) →	TIME	usec	INDEX	IN 0	IN 1	OUT 0	OUT 1	Label1	Trigger	DIFF[Label1]	
(4) {	2016/6/1 17:38	714000	1	0	0	0	0		0		0
	2016/6/1 17:38	714000	2	0	0	0	0		0		0
	2016/6/1 17:38	714000	3	0	0	0	0		0		0
	2016/6/1 17:38	714000	4	0	0	0	0		0		0
	2016/6/1 17:38	714000	5	0	0	0	0		0		0

Row name	Column number	Column name	Output content
(1) File information	1st column	File type	Fixed character: [LOGGING]
	2nd column	Type information_file version	Fixed character: RD40PD01_(Version number) (Example) RD40PD01_1
	3rd column	Number for data type information row	Number indicating the data type information row Fixed value: 2
	4th column	Number for data name row	Number indicating the data name row Fixed value: 3
	5th column	Number for data starting row	Starting number of data rows Fixed value: 4
(2) Data type information	1st column	Date and time column ^{*1*2}	Fixed character: DATETIME[YYYY/MM/DD hh:mm:ss]
	2nd column	Microsecond column ^{*1*2}	Fixed character: us]
	3rd column	Index column	Index column Fixed character: INDEX
	4th column and later	Data column	Data type of sampled data Output format: Output character for the data type [additional information]  Page 279 Output character for the data type
	Last column of the data column + 1st column	Trigger information column	Fixed character: TRIGGER[(trigger ON string)] ^{*3}
	Trigger information column + 1st column	CALC data column ^{*4}	CALC[Setting information of CALC data]

Row name	Column number	Column name	Output content
(3) Data name	1st column	Date and time column ^{*1*2}	Fixed character: TIME
	2nd column	Microsecond column ^{*1*2}	Fixed character: usec
	3rd column	Index column	Fixed character: INDEX
	4th column and later	Data column	<ul style="list-style-type: none"> An input terminal or output terminal in the hardware logic outline window in MELSEC iQ-R series Flexible High-Speed I/O Control Module Configuration Tool: (block name) An input terminal or output terminal in the multi function counter block detail window in MELSEC iQ-R series Flexible High-Speed I/O Control Module Configuration Tool: (multi function counter name) (block name) (terminal name)
	Last column of the data column + 1st column	Trigger information column	Fixed character: Trigger
	Trigger information column + 1st column	CALC data column ^{*4}	Output format: CALC data name
(4) Data	1st column	Date and time column ^{*1*2}	Date and time information Output format: YYYY/MM/DD hh:mm:ss
	2nd column	Microsecond column ^{*1*2}	Value of microseconds
	3rd column	Index column ^{*5}	Value of an index Output format: Integer value
	4th column and later	Data column	Value of a terminal or block Output format: Value corresponding to the type in the data type information row
	Last column of the data column + 1st column	Trigger information column	Information at the time when a trigger occurred
	Trigger information column + 1st column	CALC data column ^{*4}	Value of a CALC data name Output format: DOUBLE

*1 For data in which the date and time column is not output, the column and the microsecond column are not output when saving the data as a CSV file by using this function.

*2 For a simulation result, the date and time column and the millisecond column are not output.

*3 "" is output for 'trigger ON string'.

*4 If there is no CALC data, this column is not output.

*5 Sequentially numbered indexes starting from one are automatically output when data in which indexes are not output is saved as a CSV file.

■ Simulation result and sampling data saved with MELSEC-L series Flexible High-Speed I/O Control Module Configuration Tool

This section shows the format of the CSV file in which a simulation result and sampling data of a MELSEC-L series Flexible High-Speed I/O Control Module Configuration Tool displayed in GX LogViewer are saved.

Point

The CSV file format explained in this section differs from that of a simulation result and sampling data saved with MELSEC-L series Flexible High-Speed I/O Control Module Configuration Tool.

For details on the CSV file format of a simulation result and sampling data, refer to the following:

 MELSEC-L Flexible High-Speed I/O Control Module User's Manual

Item	Description
Delimiter	Comma (,)
Line feed code	CRLF(0x0D, 0x0A)
Character code	ASCII
Number of rows	Up to 2051 rows (data rows + 3)

Ex.

When opening a CSV file in spreadsheet software

(1) →	[LOGGING]	LD40PD01_1	2	3	4						
(2) →	DATETIME[YYYY/MM/DD hh:mm:ss	us]	INDEX	BIT[1;0]	BIT[1;0]	BIT[1;0]	BIT[1;0]	ULONG[DEC.0]	TRIGGER[*]	CALC[SRC=5:KIN D=DIFF:DIS_DT=	
(3) →	TIME	usec	INDEX	IN 0	IN 1	OUT 0	OUT 1	Label1	Trigger	DIFF[Label1]	
(4) {	2016/6/23 13:04	717000	1	0	0	0	0		0		0
	2016/6/23 13:04	717000	2	0	0	0	0		1		1
	2016/6/23 13:04	717000	3	0	0	0	0		2		1
	2016/6/23 13:04	717000	4	0	0	0	0		3		1
	2016/6/23 13:04	717000	5	0	0	0	0		4		1

Row name	Column number	Column name	Output content
(1) File information	1st column	File type	Fixed character: [LOGGING]
	2nd column	Type information_file version	Fixed character: LD40PD01_(Version number) (Example) LD40PD01_1
	3rd column	Number for data type information row	Number indicating the data type information row Fixed value: 2
	4th column	Number for data name row	Number indicating the data name row Fixed value: 3
	5th column	Number for data starting row	Starting number of data rows Fixed value: 4
(2) Data type information	1st column	Date and time column ^{*1*2}	Fixed character: DATETIME[YYYY/MM/DD hh:mm:ss
	2nd column	Microsecond column ^{*1*2}	Fixed character: us]
	3rd column	Index column	Index column Fixed character: INDEX
	4th column and later	Data column	Data type of sampled data Output format: Output character for the data type [additional information]  Page 279 Output character for the data type
	Last column of the data column + 1st column	Trigger information column	Fixed character: TRIGGER[(trigger ON string)] ^{*3}
	Trigger information column + 1st column	CALC data column ^{*4}	CALC[Setting information of CALC data]

Row name	Column number	Column name	Output content
(3) Data name	1st column	Date and time column ^{*1*2}	Fixed character: TIME
	2nd column	Microsecond column ^{*1*2}	Fixed character: usec
	3rd column	Index column	Fixed character: INDEX
	4th column and later	Data column	<ul style="list-style-type: none"> An input terminal or output terminal in the hardware logic outline window in MELSEC-L series Flexible High-Speed I/O Control Module Configuration Tool: (block name) An input terminal or output terminal in the multi function counter block detail window in MELSEC-L series Flexible High-Speed I/O Control Module Configuration Tool: (multi function counter name) (block name) (terminal name)
	Last column of the data column + 1st column	Trigger information column	Fixed character: Trigger
	Trigger information column + 1st column	CALC data column ^{*4}	Output format: CALC data name
(4) Data	1st column	Date and time column ^{*1*2}	Date and time information Output format: YYYY/MM/DD hh:mm:ss
	2nd column	Microsecond column ^{*1*2}	Value of microseconds
	3rd column	Index column ^{*5}	Value of an index Output format: Integer value
	4th column and later	Data column	Value of a terminal Output format: Value corresponding to the type in the data type information row
	Last column of the data column + 1st column	Trigger information column	Information at the time when a trigger occurred
	Trigger information column + 1st column	CALC data column ^{*4}	Value of a CALC data name Output format: DOUBLE

- *1 For data in which the date and time column is not output, the column and the microsecond column are not output when saving the data as a CSV file by using this function.
- *2 For a simulation result, the date and time column and the millisecond column are not output.
- *3 "" is output for 'trigger ON string'.
- *4 If there is no CALC data, this column is not output.
- *5 Sequentially numbered indexes starting from one are automatically output when data in which indexes are not output is saved as a CSV file.

■CC-Link IE TSN FPGA module

This section shows the format of the CSV file in which data of a CC-Link IE TSN FPGA module displayed in GX LogViewer is saved.



The CSV file format explained in this section differs from that acquired from a CC-Link IE TSN FPGA module. For details on the CSV file format acquired from the module, refer to the following:

[CC-Link IE TSN FPGA Module User's Manual](#)

Item	Description
Delimiter	Comma (,)
Line feed code	CRLF(0x0D, 0x0A)
Character code	ASCII
Number of rows	Up to 524291 rows (data rows + 3)

Ex.

When opening a CSV file in spreadsheet software

(1) →	[LOGGING]	NZ2GN2S-D41_1	2	3	4			
(2) →	DATETIME[YYYY/MM/DD hh:mm:ss us]		INDEX	BIT[1;0]	BIT[1;0]	BIT[1;0]	BIT[1;0]	TRIGGER[*]
(3) →	TIME	usec	INDEX	No.0 bit0	No.0 bit1	No.0 bit2	No.0 bit3	Trigger
(4) {	2022/11/15 14:28	254006	1	1	0	0	0	
	2022/11/15 14:28	286774	2	1	0	0	0	
	2022/11/15 14:28	319542	3	1	0	0	0	
	2022/11/15 14:28	352310	4	1	0	0	0	
	2022/11/15 14:28	385078	5	1	0	0	0	

Row name	Column number	Column name	Output content
(1) File information	1st column	File type	Fixed character: [LOGGING]
	2nd column	Type information_file version	Fixed character: NZ2GN2S-D41_(Version number) (Example) NZ2GN2S-D41_1
	3rd column	Number for data type information row	Number indicating the data type information row Fixed value: 2
	4th column	Number for data name row	Number indicating the data name row Fixed value: 3
	5th column	Number for data starting row	Starting number of data rows Fixed value: 4
(2) Data type information	1st column	Date and time column	Fixed character: DATETIME[YYYY/MM/DD hh:mm:ss
	2nd column	Microsecond column	Fixed character: us]
	3rd column	Index column	Index column Fixed character: INDEX
	4th column and later	Data column	Data type of sampled data Output format: Output character for the data type [additional information] Page 280 Output character for the data type (CC-Link IE TSN FPGA module)
	Last column of the data column + 1st column	Trigger information column	Fixed character: TRIGGER[(trigger ON string)] ^{*1}
(3) Data name	1st column	Date and time column	Fixed character: TIME
	2nd column	Microsecond column	Fixed character: usec
	3rd column	Index column	Fixed character: INDEX
	4th column and later	Data column	Output format: (CSV format setting No.) (bit range corresponding to the CSV format setting) (Example) No.1 bit0, No.2 bit[0:15], No.3 bit[0:31]
	Last column of the data column + 1st column	Trigger information column	Fixed character: Trigger

Row name	Column number	Column name	Output content
(4) Data	1st column	Date and time column	Date and time information Output format: YYYY/MM/DD hh:mm:ss
	2nd column	Microsecond column	Value of microseconds
	3rd column	Index column	Value of an index Output format: Integer value
	4th column and later	Data column	Value of a sampled device Output format: Value corresponding to the type in the data type information row
	Last column of the data column + 1st column	Trigger information column	Information at the time when a trigger occurred

*1 "" is output for 'trigger ON string'.

■JSON file in GX LogViewer format

This section shows the format of the CSV file in which data of a GX LogViewer format JSON file displayed in GX LogViewer is saved.

Item	Description
Delimiter	Comma (,)
Line feed code	CRLF(0x0D, 0x0A)
Character code	Unicode (UTF-8)
Number of rows *1	Up to 1000005 rows (data rows + 5)

*1 It differs depending on the module and the tool.

Ex.

When opening a CSV file in spreadsheet software

(1) →	[LOGGING]	JSON_1	3	4	6	5		
(2) →	RD78G(H)	0x10CCFF	TRUE					
(3) →	DATETIME[YYYY/MM/DD hh:mm:ss.ssssss]	INDEX	SHORT[DEC.0]	DOUBLE[DEC.14]	DOUBLE[DEC.14]	DOUBLE[DEC.14]	DOUBLE[DEC.14]	TRIGGER[*] CALC[SRC=3:KIND =DIFF:DIS_DT=F]
(4) →	TIME	INDEX	Axis01.Md.Axis Status	Axis01.Md.Cumulat ivePosition	Axis01.Md.Comman dedVelocity	Axis01.Md.Comman dedAcceleration	Axis01.Md.Comman dedAcceleration	Trigger DIFF_DT[Axis01.Md .CommandedVelocit
(5) →				mm	mm/ms	mm/ms ²	mm/ms ²	
(6) {	2021/02/18 13:15:11.11	30001	6	-2307487.575	5000	3000	3000	0
	2021/02/18 13:15:11.11	30002	6	-2307722.628	5000	3000	3000	0
	2021/02/18 13:15:11.11	30003	6	-2307957.669	5000	3000	3000	0
	2021/02/18 13:15:11.11	30004	6	-2308192.698	5000	3000	3000	0
	2021/02/18 13:15:11.11	30005	6	-2308427.715	5000	3000	3000	0

Row name	Column number	Column name	Output content
(1) File information	1st column	File type	Fixed character: [LOGGING]
	2nd column	Type information_file version	Fixed character: JSON_(Version number) (Example) JSON_1
	3rd column	Number for data type information row	Fixed value: 3
	4th column	Number for data name row	Fixed value: 4
	5th column	Number for data starting row	Fixed value: • With unit row: 6 • Without unit row: 5
	6th column	Number for comment row*1	Blank
	7th column	Number for unit row*1	Fixed value: 5
(2) JSON file inherent information*2	1st column	Module name	Name of an engineering tool or a model of which data is collected
	2nd column	Status bar color	Color information (RGB value) stored in a JSON file Default: 00FF00
	3rd column	Availability of combining graphs	Available: true*3 Not available: false*3
(3) Data type information	1st column	Date and time column	Fixed character: DATETIME[YYYY/MM/DD hh:mm:ss.ssssss]
	2nd column	Index column	Fixed character: INDEX
	3rd column and later	Data column	Data type of sampled data Output format: Output character for the data type [additional information] 📖 Page 279 Output character for the data type
	Last column of the data column + 1st column	Trigger information column	Fixed character: TRIGGER[(trigger ON string)]*4
	Trigger information column + 1st column	CALC data column*5	CALC[Setting information of CALC data]

Row name	Column number	Column name	Output content
(4) Data name	1st column	Date and time column	Fixed character: TIME
	2nd column	Index column	Fixed character: INDEX
	3rd column and later	Data column	Output format: Data name
	Last column of the data column + 1st column	Trigger information column	Output format: String specified by configuration tool
	Trigger information column + 1st column	CALC data column ^{*5}	Output format: CALC data name
(5) Unit ^{*6}	1st column	Date and time column	Blank
	2nd column	Index column	Blank
	3rd column and later	Data name column	Data includes units: Unit character string Data does not include units: Blank
	Last column of the data column + 1st column	Trigger information column	Blank
	Trigger information column + 1st column	CALC data column ^{*5}	Data includes units: Unit character string Data does not include units: Blank
(6) Data	1st column	Date and time column	Date and time information Output format: YYYY/MM/DD hh:mm:ss:ssssss
	2nd column	Index column	Value of an index Output format: Integer value
	3rd column and later	Data column	Value of a sampled device Output format: Value corresponding to the type in the data type information row
	Last column of the data column + 1st column	Trigger information column	Information at the time when a trigger occurred Output format: String specified by configuration tool
	Trigger information column + 1st column	CALC data column ^{*5}	Value of a CALC data name Output format: DOUBLE

- *1 This column is not output when the unit row is not output to the logging data.
- *2 This row is output only when "Type information_file version" is "JSON_1."
- *3 'True' is output in the version 1.118X or later, and 'false' in the version 1.115U or earlier.
- *4 "" is output for 'trigger ON string'.
- *5 If there is no CALC data, this column is not output.
- *6 This column is not output when the unit row is not output to the logging data.

■Output character for the data type

Data type	Output character for the data type	Output content
Bit	BIT	BIT[(ON string);(OFF string)] ^{*1}
Word [unsigned]	USHORT	USHORT[DEC.0] ^{*2}
Word [signed]	SHORT	SHORT[DEC.0] ^{*2}
Double word [unsigned]	ULONG	ULONG[DEC.0] ^{*2}
Double word [signed]	LONG	LONG[DEC.0] ^{*2}
Float (single precision)	FLOAT	FLOAT[DEC.7] ^{*2*3}
Float (double precision)	DOUBLE	DOUBLE[DEC.14] ^{*2*3}
16bit BCD	BCD16	BCD16[DEC.0] ^{*2}
32bit BCD	BCD32	BCD32[DEC.0] ^{*2}

- *1 In a historical trend window on which a CSV file is opened, a trigger ON string and trigger OFF string are displayed according to the information in the file.
On a realtime trend window on which a binary file is opened, "" and "-" are displayed for 'trigger ON string' and 'trigger OFF string' respectively when a CSV file is output.
- *2 [DEC.(number of digits after the decimal point)] is displayed. (DEC: decimal format)
- *3 The number of digits after the decimal point is not always same as the specified one.
(Example) For 1.2345, '1.2345' is output, not '1.2345000'.

■Output character for the data type (CC-Link IE TSN FPGA module)

Data type	Output character for the data type	Output content
Bit	BIT	BIT[1;0]
Word [signed]	SHORT	SHORT[DEC.0] ^{*1}
Word [unsigned]	USHORT	USHORT[DEC.0] ^{*1}
Word [unsigned]	USHORT	USHORT[HEX.0]
Double word [signed]	LONG	LONG[DEC.0] ^{*1}
Double word [unsigned]	ULONG	ULONG[DEC.0] ^{*1}
Double word [unsigned]	ULONG	ULONG[HEX.0]

*1 [DEC.(number of digits after the decimal point)] is displayed. (DEC: decimal format)

Saving displayed data to Unicode text file

Type	Target for explanation ( Page 13 Target modules, simulators, files, and data for explanation)
Module	RCPU, LHCPU, FX5CPU, R logger, R communication
Simulator	RCPU simulator, FX5CPU simulator
Others	Offline monitor

Data being displayed on the graphs in the active trend window can be saved to a Unicode text file.

The data to be saved is as shown below.

- Historical trend window: Data of a data logging file being displayed
- Realtime monitor window: Data received from the start of monitoring to the pause/stop of graph drawing

Data removed from the graph legend area is not saved.

Restriction

When data names to be displayed are switched by using the switch data name function, the data cannot be saved to a Unicode text file.

Operating procedure

1. Select [File] ⇒ [Save As] ⇒ [Save Unicode Text File] ().
2. Enter a file name, and click the [Save] button.

Format specification of Unicode text file

Unicode text file format may differ depending on file types. For details on the format, refer to the following:

File type	Reference
RCPU	Page 282 RCPUs or RCPUs simulator
RCPU simulator	
MELSEC iQ-R series high speed data logger module	Page 286 MELSEC iQ-R series high speed data logger module
MELSEC iQ-R series high speed data communication module	Page 288 MELSEC iQ-R series high speed data communication module
LHCPU	Page 290 LHCPU
FX5CPU	Page 294 FX5CPU or FX5CPU simulator
FX5CPU simulator	
Recording file	Page 296 Recording file

■RCPU or RCPU simulator

This section shows the format of the Unicode text file in which data of an RCPU or RCPU simulator displayed in GX LogViewer is saved.



The Unicode text file format explained in this section differs from that acquired from an RCPU.

For details on the Unicode text file format acquired from the module, refer to the following:

MELSEC iQ-R CPU Module User's Manual (Application)

Item	Description
Delimiter	Tab
Line feed code	CRLF(0x0D, 0x0A)
Character code	Unicode
Character encoding method	UTF-16 (little-endian)
Field data	Not enclosed with double quotes (""). A tab cannot be used for each unit of data.
Number of rows	Data logging file: Up to 131005 rows (data rows + 5)
	Realtime monitor window: Up to 1000005 rows (data rows + 4)

Ex.

When opening a Unicode text file in spreadsheet software

(1) →	[LOGGING]	RCPU_2	3	4	5	7	2	6		
(2) →	LOG01									
(3) →	DATETIME[YYYY/M M/DD hh:mm:ss	ms]	INTERVAL	STEP NO.	PROGRAM NO.	PROGRAM NAME	INDEX	USHORT[DEC.0]	TRIGGER[*]	CALC[SRC=1:KIND=INTEG:DI S_DT=T]
(4) →	TIME	msec	INTERVAL[us]	STEP NO.	PROGRAM NO.	PROGRAM NAME	INDEX	ProgPou/ulabel1	Trigger	INTEGRAL[ProgPou/ulabel1]
(5) →										
(6) →								MAIN		MAIN
(7) {	2020/9/10 0:43	318	200	0	1	MAIN	103001	0		0
	2020/9/10 0:43	318	200	0	1		103002	0		0
	2020/9/10 0:43	318	200	0	1		103003	0		0
	2020/9/10 0:43	319	200	0	1		103004	0		0
	2020/9/10 0:43	319	200	0	1		103005	0		0

Row name	Column number	Column name	Output content
(1) File information	1st column	File type	Fixed character: [LOGGING]
	2nd column	Type information_file version	Fixed character: <ul style="list-style-type: none"> • A case in which the version is 1.76E or earlier, or only global labels are displayed in 1.82L or later version: RCPU_1 • A case in which a local device or a label is displayed in 1.82L or later version: RCPU_2
	3rd column	Number for data type information row	Fixed value: <ul style="list-style-type: none"> • With comment row: 3 • Without comment row: 2
	4th column	Number for data name row	Fixed value: <ul style="list-style-type: none"> • With comment row: 4 • Without comment row: 3
	5th column	Number for device comment row	Fixed value: <ul style="list-style-type: none"> • With comment row: 5 • Without comment row: 4
	6th column	Number for data starting row	Fixed value: <ul style="list-style-type: none"> ■A case in which "RCPU_1" is output to the type information_file version column • With comment row: 6 • Without comment row: 5 ■A case in which "RCPU_2" is output to the type information_file version column • With comment row: 7 • Without comment row: 6
	7th column	Number for comment row ^{*1}	Fixed value: 2
	8th column	Number for program name row ^{*2}	Fixed value: <ul style="list-style-type: none"> • With comment row: 6 • Without comment row: 5

Row name	Column number	Column name	Output content
(2) Comment ^{*3}	1st column	—	A comment set with a configuration tool is displayed.
(3) Data type information	1st column	Date and time column ^{*4*5}	Fixed character: DATETIME[YYYY/MM/DD hh:mm:ss]
	2nd column	Millisecond column ^{*4*6}	Fixed character: ms]
	3rd column	Data sampling interval column	Fixed character: INTERVAL
	4th column	Execution step number column	Fixed character: STEP NO.
	5th column	Execution program number column	Fixed character: PROGRAM NO.
	6th column	Execution program name column	Fixed character: PROGRAM NAME
	7th column	Index column	Fixed character: INDEX
	8th column and later	Data column	Data type of sampled data ^{*7} Output format: Output character for the data type [additional information]  Page 298 Output character for the data type
	Last column of the data column + 1st column	Trigger information column ^{*5}	Output format: TRIGGER[(trigger ON string)] ^{*8}
	Trigger information column + 1st column	CALC data column ^{*9}	CALC[Setting information of CALC data]
(4) Data name	1st column	Date and time column ^{*4*5}	Fixed character: TIME
	2nd column	Millisecond column ^{*4*6}	Fixed character: msec
	3rd column	Data sampling interval column	Fixed character: INTERVAL[us]
	4th column	Execution step number column	Fixed character: STEP NO.
	5th column	Execution program number column	Fixed character: PROGRAM NO.
	6th column	Execution program name column	Fixed character: PROGRAM NAME
	7th column	Index column	Fixed character: INDEX
	8th column and later	Data column ^{*10}	Output format: Device number or data name
	Last column of the data column + 1st column	Trigger information column ^{*5}	Fixed character: Trigger
	Trigger information column + 1st column	CALC data column ^{*9}	Output format: CALC data name
(5) Device comment	1st column	Date and time column	Blank
	2nd column	Millisecond column	Blank
	3rd column	Data sampling interval column	Blank
	4th column	Execution step number column	Blank
	5th column	Execution program number column	Blank
	6th column	Execution program name column	Blank
	7th column	Index column	Blank
	8th column and later	Data column ^{*11}	<ul style="list-style-type: none"> • When "Output device comments" is selected in the "data setting" Comments of the specified comment number • When "Output device comments" is not selected in the "data setting," or for the data saved in the realtime monitor window: Blank
	Last column of the data column + 1st column	Trigger information column	Blank
	Trigger information column + 1st column	CALC data column ^{*9}	<ul style="list-style-type: none"> • When there is device comment information in CALC data: Character string of the device comment • When there is no device comment information in CALC data: Blank

Row name	Column number	Column name	Output content
(6) Program name ^{*12}	1st column	Date and time column	Blank
	2nd column	Millisecond column	Blank
	3rd column	Data sampling interval column	Blank
	4th column	Execution step number column	Blank
	5th column	Execution program number column	Blank
	6th column	Execution program name column	Blank
	7th column	Index column	Blank
	8th column and later	Data column	<ul style="list-style-type: none"> • A case in which sampled data is local devices or local labels: Specified program name • A case in which sampled data is global devices or global labels: Blank
	Last column of the data column + 1st column	Trigger information column	Blank
	Trigger information column + 1st column	CALC data column ^{*9}	<ul style="list-style-type: none"> • When there is program name information in CALC data: Program name • When there is no program name information in CALC data: Blank
(7) Data	1st column	Date and time column ^{*4*5}	Date and time information Output format: YYYY/MM/DD hh:mm:ss
	2nd column	Millisecond column ^{*4*6}	Value of milliseconds
	3rd column	Data sampling interval column ^{*13*14}	Value of the data sampling interval time
	4th column	Execution step number column ^{*13}	Value of the execution step No. Output format: Integer value
	5th column	Execution program number column ^{*13}	Value of the execution program No. Output format: Integer value
	6th column	Execution program name column ^{*13}	Execution program name Output format: STRING (program name)
	7th column	Index column ^{*15}	Value of an index Output format: Integer value
	8th column and later	Data column	Value of a sampled device ^{*16*17} Output format: Value corresponding to the type in the data type information row
	Last column of the data column + 1st column	Trigger information column ^{*5}	Information at the time when a trigger occurred Output format: String specified by configuration tool
	Trigger information column + 1st column	CALC data column ^{*9}	Value of a CALC data name Output format: DOUBLE

- *1 This column is not output either when the comment row is not output to the logging data or when the logging data displayed in the realtime monitor window is saved in a file.
- *2 This column is not output when "RCPU_1" is output to the type information_file version column.
- *3 This row is not output either when the comment row is not output to the logging data or when the logging data displayed in the realtime monitor window is saved in a file.
- *4 When "Output date" is not selected in the configuration tool, the date and time column and the millisecond column are not output when saving data as a Unicode text file by using this function.
- *5 It is output in the set output format when the logging file conversion function is used.
- *6 The millisecond column is not output when the logging file conversion function is used.
- *7 Refer to the following when using the logging file conversion function.
 - ☞ Page 321 Output character for the data type
- *8 For the continuous logging or for the data saved in the realtime monitor window, "*" is output for 'trigger ON string'.
- *9 If there is no CALC data, this column is not output.
- *10 A data name is output when the logging file conversion function is used.
- *11 A device comment name is output when the logging file conversion function is used.
- *12 This row is not output when "RCPU_1" is output to the type information_file version column.
- *13 When data, of which the column is not output due to the setting of a configuration tool, is saved in a Unicode text file, only the delimiter (tab character) is output to the column of the item corresponding to the data.
- *14 When monitoring data by specifying a time interval by the realtime monitor function, an error within 5% may be caused between the specified time interval and the actual time interval to monitor data. In that case, when the data is output to a Unicode text file, the sampling intervals output to this column may be unsteady.
- *15 Even when "Output indexes" is not selected in the configuration tool, sequentially numbered indexes starting from one are automatically output when saving data as a Unicode text file by using this function.
- *16 Refer to the following when using the logging file conversion function.
 - ☞ Page 321 Output character for a device value
- *17 A program name is not output as well as the data column output from an RCPU.

Precautions

When saving a data logging file which includes a comma (,) and double quote (") by using this function, the file is saved as below, which is the same as a data logging file acquired from RCPU.

- If data output to a file includes a comma (,), the entire data which includes a comma in the file is enclosed with double quotes ("""). (Example: 123,456 → "123,456")
- If data output to a file includes a double quote ("), the double quote is doubled. In addition, the entire data which includes a double quote is enclosed with double quotes. (Example: 123"456 → "123""456")

■MELSEC iQ-R series high speed data logger module

This section shows the format of the Unicode text file in which data of MELSEC iQ-R series high speed data logger module displayed in GX LogViewer is saved.



The Unicode text file format explained in this section differs from that acquired from a MELSEC iQ-R series high speed data logger module.

For details on the Unicode text file format acquired from the module, refer to the following:

MELSEC iQ-R High Speed Data Logger Module User's Manual (Application)

Item	Description
Delimiter	Tab
Line feed code	CRLF(0x0D, 0x0A)
Character code	Unicode
Character encoding method	UTF-16 (little-endian)
Field data	Not enclosed with double quotes (""). A tab cannot be used for each unit of data.
Number of rows	Up to 200004 rows (data rows + 4)

Ex.

When opening a Unicode text file in spreadsheet software

(1) →	[LOGGING]	RD81DL96_1	3	4	5	2		
(2) →	LOG01_1							
(3) →	DATETIME[YYYY/MM/DD hh:mm:ss	us]	INDEX	SHORT[DEC.0]	SHORT[DEC.0]	SHORT[DEC.0]	TRIGGER[*;-]	CALC[SRC=1:KIND =DIFF:DIS_DT=T]
(4) →	TIME	usec	INDEX	d0	d10	d20	Trigger	DIFF[d0]
(5) {	2000/1/10 6:27	200000	1	0	0	0		0
	2000/1/10 6:27	200000	2	0	0	0		0
	2000/1/10 6:27	200000	3	0	0	0		0
	2000/1/10 6:27	200000	4	0	0	0		0
	2000/1/10 6:27	200000	5	0	0	0		0

Row name	Column number	Column name	Output content
(1) File information	1st column	File type	Fixed character: [LOGGING]
	2nd column	Type information_file version	Fixed character: RD81DL96_(Version number) (Example) RD81DL96_1
	3rd column	Number for data type information row	Fixed value: • With comment row: 3 • Without comment row: 2
	4th column	Number for data name row	Fixed value: • With comment row: 4 • Without comment row: 3
	5th column	Number for data starting row	Fixed value: • With comment row: 5 • Without comment row: 4
	6th column	Number for comment row ^{*1}	Fixed value: 2
(2) Comment ^{*2}	1st column	—	A comment set with a configuration tool is displayed.
(3) Data type information	1st column	Date and time column ^{*3*4}	Fixed character: DATETIME[YYYY/MM/DD hh:mm:ss
	2nd column	Microsecond column ^{*3*5}	Fixed character: us]
	3rd column	Index column	Fixed character: INDEX
	4th column and later	Data column ^{*4}	Data type of sampled data Output format: Output character for the data type [additional information] Page 298 Output character for the data type
	Last column of the data column + 1st column	Trigger information column ^{*4}	Output format: TRIGGER[(trigger ON string);(trigger OFF string)] ^{*6}
	Trigger information column + 1st column	CALC data column ^{*7}	CALC[Setting information of CALC data]

Row name	Column number	Column name	Output content
(4) Data name	1st column	Date and time column ^{*3*4}	Fixed character: TIME
	2nd column	Microsecond column ^{*3*5}	Fixed character: usec
	3rd column	Index column	Fixed character: INDEX
	4th column and later	Data column ^{*4}	Output format: Data name
	Last column of the data column + 1st column	Trigger information column ^{*4}	Output format: String specified by configuration tool
	Trigger information column + 1st column	CALC data column ^{*7}	Output format: CALC data name
(5) Data	For saving data displayed in a historical trend window, data is output in the order that it was stored in a Data logging file. For saving data displayed in a realtime trend window, data is output in the order that it was received.		
	1st column	Date and time column ^{*3*4}	Date and time information Output format: YYYY/MM/DD hh:mm:ss
	2nd column	Microsecond column ^{*3*5}	Value of microseconds
	3rd column	Index column ^{*8}	Value of an index Output format: Integer value
	4th column and later	Data column ^{*4}	Value of a sampled device Output format: Value corresponding to the type in the data type information row
	Last column of the data column + 1st column	Trigger information column ^{*4}	Information at the time when a trigger occurred Output format: String specified by configuration tool
	Trigger information column + 1st column	CALC data column ^{*7}	Value of a CALC data name Output format: DOUBLE

*1 This column is not output when the comment row is not output to the logging data.

*2 This row is not output either when the comment row is not output to the logging data or when the logging data displayed in the realtime trend window is saved in a file.

*3 When "Output date column"/"Output date information" is not selected in the configuration tool, the date and time column and the microsecond column are not output when saving data as a Unicode text file by using this function.

*4 It is output in the set output format when the logging file conversion function is used.

*5 The microsecond column is not output when the logging file conversion function is used.

*6 When output contents are not specified for "Trigger information column" in the configuration tool, data is output as shown below when saving it as a Unicode text file by using this function.
TRIGGER[*;-]

*7 If there is no CALC data, this column is not output.

*8 Even when "Output index column"/"Output indexes" is not selected in the configuration tool, sequentially numbered indexes starting from one are automatically output when saving data as a Unicode text file by using this function.

■MELSEC iQ-R series high speed data communication module

This section shows the format of the Unicode text file in which data of MELSEC iQ-R series high speed data communication module displayed in GX LogViewer is saved.

Item	Description
Delimiter	Tab
Line feed code	CRLF(0x0D, 0x0A)
Character code	Unicode
Character encoding method	UTF-16 (little-endian)
Field data	Not enclosed with double quotes (""). A tab cannot be used for each unit of data.
Number of rows	Up to 100004 rows (data rows + 3)

Ex.

When opening a Unicode text file in spreadsheet software

(1) →	[LOGGING]	RD81DC96_1	2	3	4		
(2) →	DATETIME[YYYY/MM/DD hh:mm:ss us]		INDEX	SHORT[DEC.0]	SHORT[DEC.0]	TRIGGER[*]	CALC[SRC=1:KIND=DIFF:DIS_DT=F]
(3) →	TIME	usec	INDEX	D0	D15	Trigger	DIFF_DT[D0]
(4) {	2021/3/11 18:32	300000	1	193	0		0
	2021/3/11 18:32	400000	2	170	0		-230
	2021/3/11 18:32	500000	3	147	0		-230
	2021/3/11 18:32	600000	4	124	0		-230
	2021/3/11 18:32	700000	5	99	0		-250

Row name	Column number	Column name	Output content
(1) File information	1st column	File type	Fixed character: [LOGGING]
	2nd column	Type information_file version	Fixed character: RD81DC96_(version number) (Example) RD81DC96_1
	3rd column	Number for data type information row	Fixed value: 2
	4th column	Number for data name row	Fixed value: 3
	5th column	Number for data starting row	Fixed value: 4
(2) Data type information	1st column	Date and time column ^{*1}	Fixed character: DATETIME[YYYY/MM/DD hh:mm:ss
	2nd column	Microsecond column ^{*1}	Fixed character: us]
	3rd column	Index column	Fixed character: INDEX
	4th column and later	Data column	Data type of sampled data Output format: Output character for the data type [additional information] ☞ Page 279 Output character for the data type
	Last column of the data column + 1st column	Trigger information column	Fixed character: TRIGGER[*]
	Trigger information column + 1st column	CALC data column ^{*2}	CALC[Setting information of CALC data]
(3) Data name	1st column	Date and time column ^{*1}	Fixed character: TIME
	2nd column	Microsecond column ^{*1}	Fixed character: usec
	3rd column	Index column	Fixed character: INDEX
	4th column and later	Data column	Output format: Data name
	Last column of the data column + 1st column	Trigger information column	Fixed character: Trigger
	Trigger information column + 1st column	CALC data column ^{*2}	Output format: CALC data name

Row name	Column number	Column name	Output content
(4) Data	1st column	Date and time column ^{*1}	Date and time information Output format: YYYY/MM/DD hh:mm:ss
	2nd column	Microsecond column ^{*1}	Value of microseconds
	3rd column	Index column	Value of index ^{*3} Output format: Integer value
	4th column and later	Data column	Value of the name of collected data Output format: Value corresponding to the type in the data type information row
	Last column of the data column + 1st column	Trigger information column	— (Blank)
	Trigger information column + 1st column	CALC data column ^{*2}	Value of a CALC data name Output format: DOUBLE

*1 For data of which the data and time column is not output, the data and time column and microsecond column are not output even if the data is saved to a Unicode text file by using this function.

*2 If there is no CALC data, this column is not output.

*3 If data of which indexes are not output is saved in a CSV file, indexes will be output automatically in the sequential order from one.

■ LHCPU

This section shows the format of the Unicode text file in which data of LHCPU displayed in GX LogViewer is saved.



The Unicode text file format explained in this section differs from that acquired from an LHCPU.

Item	Description
Delimiter	Tab
Line feed code	CRLF(0x0D, 0x0A)
Character code	Unicode
Character encoding method	UTF-16 (little-endian)
Field data	Not enclosed with double quotes (""). A tab cannot be used for each unit of data.
Number of rows	Data logging file: Up to 131005 rows (data rows + 5) Realtime monitor window: Up to 1000005 rows (data rows + 4)

Ex.

When opening a Unicode text file in spreadsheet software

(1) →	[LOGGING]	LHCPU_2	3	4	5	7	2	6		
(2) →	LOG01									
(3) →	DATETIME[YYYY/MM/DD hh:mm:ss	ms]	INTERVAL	STEP NO.	PROGRAM NO.	PROGRAM NAME	INDEX	USHORT[DEC.0]	TRIGGER[*]	CALC[SRC=1:KIND =INTEG:DIS_DT=T]
(4) →	TIME	msec	INTERVAL[us]	STEP NO.	PROGRAM NO.	PROGRAM NAME	INDEX	ProgPou/ulabel3	Trigger	INTEGRAL[ProgPou /ulabel3]
(5) →										
(6) →								MAIN1		MAIN1
(7) }	2019/9/5 19:13	531	200	0	1	MAIN	53001	0		0
	2019/9/5 19:13	531	200	0	1		53002	0		0
	2019/9/5 19:13	531	200	0	1		53003	0		0
	2019/9/5 19:13	531	200	0	1		53004	0		0
	2019/9/5 19:13	531	200	0	1		53005	0		0

Row name	Column number	Column name	Output content
(1) File information	1st column	File type	Fixed character: [LOGGING]
	2nd column	Type information_file version	Fixed character: • A case in which only global devices are displayed: LHCPU_1 • A case in which a local device or a label is displayed: LHCPU_2
	3rd column	Number for data type information row	Fixed value: • With comment row: 3 • Without comment row: 2
	4th column	Number for data name row	Fixed value: • With comment row: 4 • Without comment row: 3
	5th column	Number for device comment row	Fixed value: • With comment row: 5 • Without comment row: 4
	6th column	Number for data starting row	Fixed value: ■ A case in which "LHCPU_1" is output to the type information_file version column • With comment row: 6 • Without comment row: 5 ■ A case in which "LHCPU_2" is output to the type information_file version column • With comment row: 7 • Without comment row: 6
	7th column	Number for comment row ^{*1}	Fixed value: 2
	8th column	Number for program name row ^{*2}	Fixed value: • With comment row: 6 • Without comment row: 5
(2) Comment ^{*3}	1st column	—	A comment set with a configuration tool is displayed.

Row name	Column number	Column name	Output content
(3) Data type information	1st column	Date and time column ^{*4*5}	Fixed character: DATETIME[YYYY/MM/DD hh:mm:ss
	2nd column	Millisecond column ^{*4*6}	Fixed character: ms]
	3rd column	Data sampling interval column	Fixed character: INTERVAL
	4th column	Execution step number column	Fixed character: STEP NO.
	5th column	Execution program number column	Fixed character: PROGRAM NO.
	6th column	Execution program name column	Fixed character: PROGRAM NAME
	7th column	Index column	Fixed character: INDEX
	8th column and later	Data column	Data type of sampled data ^{*7} Output format: Output character for the data type [additional information]  Page 298 Output character for the data type
	Last column of the data column + 1st column	Trigger information column ^{*5}	Output format: TRIGGER[(trigger ON string)] ^{*8}
	Trigger information column + 1st column	CALC data column ^{*9}	CALC[Setting information of CALC data]
(4) Data name	1st column	Date and time column ^{*4*5}	Fixed character: TIME
	2nd column	Millisecond column ^{*4*6}	Fixed character: msec
	3rd column	Data sampling interval column	Fixed character: INTERVAL[us]
	4th column	Execution step number column	Fixed character: STEP NO.
	5th column	Execution program number column	Fixed character: PROGRAM NO.
	6th column	Execution program name column	Fixed character: PROGRAM NAME
	7th column	Index column	Fixed character: INDEX
	8th column and later	Data column ^{*10}	Output format: Device number or data name
	Last column of the data column + 1st column	Trigger information column ^{*5}	Fixed character: Trigger
	Trigger information column + 1st column	CALC data column ^{*9}	Output format: CALC data name
(5) Device comment	1st column	Date and time column	Blank
	2nd column	Millisecond column	Blank
	3rd column	Data sampling interval column	Blank
	4th column	Execution step number column	Blank
	5th column	Execution program number column	Blank
	6th column	Execution program name column	Blank
	7th column	Index column	Blank
	8th column and later	Data column ^{*11}	<ul style="list-style-type: none"> • When "Output device comments" is selected in the "data setting" Comments of the specified comment number • When "Output device comments" is not selected in the "data setting," or for the data saved in the realtime monitor window: Blank
	Last column of the data column + 1st column	Trigger information column	Blank
	Trigger information column + 1st column	CALC data column ^{*9}	<ul style="list-style-type: none"> • When there is device comment information in CALC data: Character sting of the device comment • When there is no device comment information in CALC data: Blank

Row name	Column number	Column name	Output content
(6) Program name ^{*12}	1st column	Date and time column	Blank
	2nd column	Millisecond column	Blank
	3rd column	Data sampling interval column	Blank
	4th column	Execution step number column	Blank
	5th column	Execution program number column	Blank
	6th column	Execution program name column	Blank
	7th column	Index column	Blank
	8th column and later	Data column	<ul style="list-style-type: none"> • A case in which sampled data is local devices or local labels: Specified program name • A case in which sampled data is global devices or global labels: Blank
	Last column of the data column + 1st column	Trigger information column	Blank
	Trigger information column + 1st column	CALC data column ^{*9}	<ul style="list-style-type: none"> • When there is program name information in CALC data: Program name • When there is no program name information in CALC data: Blank
(7) Data	1st column	Date and time column ^{*4*5}	Date and time information Output format: YYYY/MM/DD hh:mm:ss
	2nd column	Millisecond column ^{*4*6}	Value of milliseconds
	3rd column	Data sampling interval column ^{*13*14}	Value of the data sampling interval time
	4th column	Execution step number column ^{*13}	Value of the execution step No. Output format: Integer value
	5th column	Execution program number column ^{*13}	Value of the execution program No. Output format: Integer value
	6th column	Execution program name column ^{*13}	Execution program name Output format: STRING (program name)
	7th column	Index column ^{*15}	Value of an index Output format: Integer value
	8th column and later	Data column	Value of a sampled device ^{*16*17} Output format: Value corresponding to the type in the data type information row
	Last column of the data column + 1st column	Trigger information column ^{*5}	Information at the time when a trigger occurred Output format: String specified by configuration tool
	Trigger information column + 1st column	CALC data column ^{*9}	Value of a CALC data name Output format: DOUBLE

- *1 This column is not output either when the comment row is not output to the logging data or when the logging data displayed in the realtime monitor window is saved in a file.
- *2 This column is not output when "LHCPU_1" is output to the type information_file version column.
- *3 This row is not output either when the comment row is not output to the logging data or when the logging data displayed in the realtime monitor window is saved in a file.
- *4 When "Output date" is not selected in the configuration tool, the date and time column and the millisecond column are not output when saving data as a Unicode text file by using this function.
- *5 It is output in the set output format when the logging file conversion function is used.
- *6 The millisecond column is not output when the logging file conversion function is used.
- *7 Refer to the following when using the logging file conversion function.
☞ Page 321 Output character for the data type
- *8 For the continuous logging or for the data saved in the realtime monitor window, "*" is output for 'trigger ON string'.
- *9 If there is no CALC data, this column is not output.
- *10 A data name is output when the logging file conversion function is used.
- *11 A device comment name is output when the logging file conversion function is used.
- *12 This row is not output when "LHCPU_1" is output to the type information_file version column.
- *13 When data, of which the column is not output due to the setting of a configuration tool, is saved in a Unicode text file, only the delimiter (tab character) is output to the column of the item corresponding to the data.
- *14 When monitoring data by specifying a time interval by the realtime monitor function, an error within 5% may be caused between the specified time interval and the actual time interval to monitor data. In that case, when the data is output to a Unicode text file, the sampling intervals output to this column may be unsteady.
- *15 Even when "Output indexes" is not selected in the configuration tool, sequentially numbered indexes starting from one are automatically output when saving data as a Unicode text file by using this function.
- *16 Refer to the following when using the logging file conversion function.
☞ Page 321 Output character for a device value
- *17 A program name is not output as well as the data column output from an LHCPU.

■FX5CPU or FX5CPU simulator

This section shows the format of the Unicode text file in which data of an FX5CPU or FX5CPU simulator displayed in GX LogViewer is saved.

Item	Description
Delimiter	Tab
Line feed code	CRLF(0x0D, 0x0A)
Character code	Unicode
Character encoding method	UTF-16 (little-endian)
Field data	Not enclosed with double quotes (""). A tab cannot be used for each unit of data.
Number of rows	Up to 131005 rows (data rows + 5)
	Realtime monitor window: Up to 1000005 rows (data rows + 4)

Ex.

When opening a Unicode text file in spreadsheet software

(1) →	[LOGGING]	FX5CPU_1	3	4	5	2	
(2) →	LOG01						
(3) →	DATETIME[YYYY/MM/DD hh:mm:ss]	ms]	INTERVAL	INDEX	SHORT[DEC.0]	TRIGGER[*]	CALC[SRC=1:KIND= DIFF:DIS_DT=T]
(4) →	TIME	msec	INTERVAL[us]	INDEX	D1	Trigger	DIFF[D1]
(5) {	2016/6/24 10:53	482	0	1	-18604		0
	2016/6/24 10:53	492	10000	2	-18551		53
	2016/6/24 10:53	502	10000	3	-18488		63
	2016/6/24 10:53	512	10000	4	-18428		60
	2016/6/24 10:53	522	10000	5	-18366		62

Row name	Column number	Column name	Output content
(1) File information	1st column	File type	Fixed character: [LOGGING]
	2nd column	Type information_file version	Fixed character: • FX5CPU_1
	3rd column	Number for data type information row	Fixed value: • With comment row: 3 • Without comment row: 2
	4th column	Number for data name row	Fixed value: • With comment row: 4 • Without comment row: 3
	5th column	Number for data starting row	Fixed value: • With comment row: 5 • Without comment row: 4
	6th column	Number for comment row ^{*1}	Fixed value: 2
(2) Comment ^{*2}	1st column	—	A comment set with a configuration tool is displayed.
(3) Data type information	1st column	Date and time column ^{*3*4}	Fixed character: DATETIME[YYYY/MM/DD hh:mm:ss
	2nd column	Millisecond column ^{*3*5}	Fixed character: ms]
	3rd column	Data sampling interval column	Fixed character: INTERVAL
	4th column	Index column	Fixed character: INDEX
	5th column and later	Data column	Data type of sampled data ^{*6} Output format: Output character for the data type [additional information] ☞ Page 298 Output character for the data type
	Last column of the data column + 1st column	Trigger information column ^{*4}	Output format: TRIGGER[(trigger ON string)] ^{*7}
	Trigger information column + 1st column	CALC data column ^{*8}	CALC[Setting information of CALC data]

Row name	Column number	Column name	Output content
(4) Data name	1st column	Date and time column ^{*3*4}	Fixed character: TIME
	2nd column	Millisecond column ^{*3*5}	Fixed character: msec
	3rd column	Data sampling interval column	Fixed character: INTERVAL[us]
	4th column	Index column	Fixed character: INDEX
	5th column and later	Data column ^{*9}	Output format: Device number or device labels
	Last column of the data column + 1st column	Trigger information column ^{*4}	Fixed character: Trigger
	Trigger information column + 1st column	CALC data column ^{*8}	Output format: CALC data name
(5) Data	1st column	Date and time column ^{*3*4}	Date and time information Output format: YYYY/MM/DD hh:mm:ss
	2nd column	Millisecond column ^{*3*5}	Value of milliseconds
	3rd column	Data sampling interval column ^{*10}	Value of the data sampling interval time
	4th column	Index column ^{*11}	Value of an index Output format: Integer value
	5th column and later	Data column	Value of a sampled device ^{*12} Output format: Value corresponding to the type in the data type information row
	Last column of the data column + 1st column	Trigger information column ^{*4}	Information at the time when a trigger occurred Output format: String specified by configuration tool
	Trigger information column + 1st column	CALC data column ^{*8}	Value of a CALC data name Output format: DOUBLE

*1 This column is not output when the comment row is not output to the logging data.

*2 This row is not output when the comment row is not output to the logging data.

*3 When "Output date" is not selected in the configuration tool, the date and time column and the millisecond column are not output when saving data as a Unicode text file by using this function.

*4 It is output in the set output format when the logging file conversion function is used.

*5 The millisecond column is not output when the logging file conversion function is used.

*6 Refer to the following when using the logging file conversion function.

 Page 321 Output character for the data type

*7 For the continuous logging, "" is output for 'trigger ON string'.

*8 If there is no CALC data, this column is not output.

*9 A data name is output when the logging file conversion function is used.

*10 When data, of which the column is not output due to the setting of a configuration tool, is saved in a Unicode text file, only the delimiter (tab character) is output to the column of the item corresponding to the data.

*11 Even when "Output indexes" is not selected in the configuration tool, sequentially numbered indexes starting from one are automatically output when saving data as a Unicode text file by using this function.

*12 Refer to the following when using the logging file conversion function.

 Page 321 Output character for a device value

■Recording file

This section shows the file format of the Unicode text file in which the following data displayed in GX LogViewer is saved.

- Data of a recording file linking with the GX Works3 offline monitor function
- Data of a Unicode text file converted with the recording file conversion function

Item	Description
Delimiter	Tab
Line feed code	CRLF(0x0D, 0x0A)
Character code	Unicode
Character encoding method	UTF-16 (little-endian)
Field data	Not enclosed with double quotes (""). A tab cannot be used for each unit of data.
Number of rows	Up to 100005 rows (data rows + 5)

Ex.

When opening a Unicode text file in spreadsheet software

(1) →	[LOGGING]	RD81RC96_1	2	3	4	6	5		
(2) →	DATETIME[YYYY/MM/DD hh:mm:ss	us]	INDEX	USHORT[DEC.0]	SHORT[DEC.0]	SHORT[DEC.0]	SHORT[DEC.0]	TRIGGER[*]	CALC[SRC=1:KIND=DIFF:DIS_DT=F]
(3) →	TIME	usec	INDEX	C0	D0	D1	#D0	Trigger	DIFF_DT[D0]
(4) →									
(5) →							MAIN		
(6) {	2001/2/13 6:51	38000	1	20	23869	23869	-17808		0
	2001/2/13 6:51	38719	2	20	23869	23869	-17808		0
	2001/2/13 6:51	39000	3	20	23869	23869	-17808		0
	2001/2/13 6:51	40000	4	20	23869	23869	-17808		0
	2001/2/13 6:51	41000	5	20	23869	23869	23863		0

Row name	Column number	Column name	Output content
(1) File information	1st column	File type	Fixed character: [LOGGING]
	2nd column	Type information_file version	Fixed character: RD81RC96_1
	3rd column	Number for data type information row	Fixed value: 2
	4th column	Number for data name row	Fixed value: 3
	5th column	Number for device comment row	Fixed value: 4
	6th column	Number for data starting row	Fixed value: 6
	7th column	Number for program name row	Fixed value: 5
(2) Data type information	1st column	Date and time column	Fixed character: DATETIME[YYYY/MM/DD hh:mm:ss
	2nd column	Microsecond column	Fixed character: us]
	3rd column	Index column	Fixed character: INDEX
	4th column and later	Data column	Data type of sampled data Output format: Output character for the data type [additional information] ☞ Page 279 Output character for the data type
	Last column of the data column + 1st column	Trigger information column	Fixed character: TRIGGER[*]
	Trigger information column + 1st column	CALC data column*1	CALC[Setting information of CALC data]
(3) Data name	1st column	Date and time column	Fixed character: TIME
	2nd column	Microsecond column	Fixed character: usec
	3rd column	Index column	Fixed character: INDEX
	4th column and later	Data column	Output format: Device number or data name
	Last column of the data column + 1st column	Trigger information column	Fixed character: Trigger
	Trigger information column + 1st column	CALC data column*1	Output format: CALC data name

Row name	Column number	Column name	Output content
(4) Device comment ^{*2}	1st column	Date and time column	Blank
	2nd column	Microsecond column	Blank
	3rd column	Index column	Blank
	4th column and later	Data column ^{*3}	<ul style="list-style-type: none"> • When device comments are saved: Comments • When device comments are not saved: Blank
	Last column of the data column + 1st column	Trigger information column	Blank
	Trigger information column + 1st column	CALC data column ^{*1*3}	<ul style="list-style-type: none"> • When there is comment information in CALC data: Comments • When there is no comment information in CALC data: Blank
(5) Program name ^{*4}	1st column	Date and time column	Blank
	2nd column	Microsecond column	Blank
	3rd column	Index column	Blank
	4th column and later	Data column	<ul style="list-style-type: none"> • With program name: Program names • Without program name: Blank
	Last column of the data column + 1st column	Trigger information column	Blank
	Trigger information column + 1st column	CALC data column ^{*1}	<ul style="list-style-type: none"> • When there is program name information in CALC data: Program name • When there is no program name information in CALC data: Blank
(6) Data	1st column	Date and time column	Date and time information Output format: YYYY/MM/DD hh:mm:ss
	2nd column	Microsecond column	Value of microseconds
	3rd column	Index column	Value of an index (in ascending order) Output format: Integer value
	4th column and later	Data column	Value ^{*5} of the name of collected data Output format: Value corresponding to the type in the data type information row
	Last column of the data column + 1st column	Trigger information column	Information at the time when a trigger occurred ^{*6}
	Trigger information column + 1st column	CALC data column ^{*1}	Value of a CALC data name Output format: DOUBLE

*1 If there is no CALC data, this column is not output.

*2 If device comments are not saved in the recording file, a new line will be output.

*3 When a Unicode text file converted by the recording file conversion function is saved with this function
 · When "To be outputted" is selected for "Device Comment Output Setting" or "Label Comment Output Setting" in the [Device Label Comment Setting] tab: Outputs comments
 · When "Not to be outputted" is selected for "Device Comment Output Setting" or "Label Comment Output Setting" in the [Device Label Comment Setting] tab: Blank

*4 If there are no program names, a new line will be output.

*5 A program name is not included in the data name.

*6 When a Unicode text file converted by the recording file conversion function is saved with this function, this column will be blank.

■ Output character for the data type

Data type	Output character for the data type	Output content
Bit	BIT	BIT[(ON string);(OFF string)] ^{*1}
Word [unsigned]	USHORT	USHORT[DEC.0] ^{*2}
Word [signed]	SHORT	SHORT[DEC.0] ^{*2}
Double word [unsigned]	ULONG	ULONG[DEC.0] ^{*2}
Double word [signed]	LONG	LONG[DEC.0] ^{*2}
Float (single precision)	FLOAT	FLOAT[DEC.7] ^{*2*3}
Float (double precision)	DOUBLE	DOUBLE[DEC.14] ^{*2*3}
16bit BCD	BCD16	BCD16[DEC.0] ^{*2}
32bit BCD	BCD32	BCD32[DEC.0] ^{*2}

*1 In a historical trend window on which a Unicode text file is opened, a trigger ON string and trigger OFF string are displayed according to the information in the file.

*2 [DEC.(number of digits after the decimal point)] is displayed. (DEC: decimal format)

*3 The number of digits after the decimal point is not always same as the specified one.
(Example) For 1.2345, '1.2345' is output, not '1.2345000'.

Saving a displayed trend graph to an image file

Type	Target for explanation ( Page 13 Target modules, simulators, files, and data for explanation)
Module	RCPU, LHCPU, FX5CPU, QnUDVCPU, LCPU, R analog, Q analog, L analog, BOX, R logger, Q logger, R communication, Q communication, R motion module, R motion controller
Simulator	RCPU simulator, FX5CPU simulator, R motion module simulator
Others	Offline monitor, others

A captured image of the active trend window can be saved to a file.

Click the [Save] button to save the image of an active trend window.

Operating procedure

1. Select [File] ⇒ [Save As] ⇒ [Save Image File] ().
2. Select a file format (BMP/JPG/PNG) to be used from "Save as type."
3. Enter a file name, and click the [Save] button.

12.3 Saving Displayed Events

Type	Target for explanation ( Page 13 Target modules, simulators, files, and data for explanation)
Module	BOX, R logger, Q logger

This section explains how to save events displayed in the active event window to either of the following file.

File format	Reference
CSV file	Page 300 Saving displayed events to CSV file
Unicode text file	Page 305 Saving displayed events to Unicode text file
Image file	Page 308 Saving displayed events to an image file

Saving displayed events to CSV file

Type	Target for explanation ( Page 13 Target modules, simulators, files, and data for explanation)
Module	BOX, R logger, Q logger

Events being displayed in the event list of the active event window can be saved to a CSV file.

When saving events displayed in the historical event window, the event logging names and the comments are saved in the language specified with the language selection function.

The data to be saved is as follows:

- Historical event window: Events of an event logging file being displayed
- Realtime event window: Events received from the start of monitoring to the click of the [Save] button

Operating procedure

1. Select [File] ⇒ [Save As] ⇒ [Save CSV File] ().
2. Enter a file name, and click the [Save] button.

Format specification of CSV file

File type	Reference
MELSEC iQ-R series high speed data logger module	Page 301 MELSEC iQ-R series high speed data logger module
MELSEC-Q series high speed data logger module	Page 303 MELSEC-Q series high speed data logger module or BOX data logger
BOX data logger	

■MELSEC iQ-R series high speed data logger module

This section shows the format of the CSV file in which data of a MELSEC iQ-R series high speed data logger module displayed in GX LogViewer is saved.



The CSV file format explained in this section differs from that acquired from a MELSEC iQ-R series high speed data logger module.

For details on the CSV file format acquired from the module, refer to the following:

MELSEC iQ-R High Speed Data Logger Module User's Manual (Application)

Item	Description
Delimiter	Comma (,)
Line feed code	CRLF(0x0D, 0x0A)
Character code	ASCII
Number of rows	Up to 200004 rows (data rows + 4)



When opening a CSV file in spreadsheet software

(1) →	[EVENT]	RD81DL96_1		3		4		5		2
(2) →	EVT01									
(3) →	DATETIME[YYYY/MM/DD hh:mm:ss	us]	SHORT[DEC.0]	STRING[64]	SHORT[DEC.0]	STRING[64]	STRING[4623]			
(4) →	TIME	usec	NUMBER	EVENT	STATUS	COMMENT	VALUES			
(5) {		2015/11/2 16:14:32	700000	1	Voltage error	1	Voltage error occurred	CO=37		
		2015/11/2 16:14:32	700000	2	Sensor-detected error	1	Execution error occurred			
		2015/11/2 16:14:33	200000	2	Sensor-detected error	0	Execution restored			
		2015/11/2 16:14:33	700000	2	Sensor-detected error	1	Execution error occurred			
		2015/11/2 16:14:34	200000	2	Sensor-detected error	0	Execution restored			

Row name	Column number	Column name	Output content
(1) File information	1st column	File type	Fixed character: [EVENT]
	2nd column	Type information_file version	Fixed character: RD81DL96_(Version number) (Example) RD81DL96_1
	3rd column	Number for data type information row	Fixed value: • With comment row: 3 • Without comment row: 2
	4th column	Number for data name row	Fixed value: • With comment row: 4 • Without comment row: 3
	5th column	Number for data starting row	Fixed value: • With comment row: 5 • Without comment row: 4
	6th column	Number for comment row	Fixed value: 2
(2) Comment ^{*1}	1st column	—	A comment set with a configuration tool is displayed.
(3) Data type information	1st column	Date and time column ^{*2}	Fixed character: DATETIME[YYYY/MM/DD hh:mm:ss
	2nd column	Microsecond column ^{*3}	Fixed character: us]
	3rd column	Number column	Data type of number column Fixed character: SHORT[DEC.0]
	4th column	Event logging name column	Data type of event logging name column Fixed character: STRING[64] ^{*4}
	5th column	Occurrence type column	Data type of occurrence type column Fixed character: SHORT[DEC.0]
	6th column	Occurrence comment column	Data type of the occurrence comment column Fixed character: STRING[64] ^{*4}
	7th column	Occurrence condition value column	Data type of occurrence condition value column Fixed character: STRING[4623] ^{*4}

Row name	Column number	Column name	Output content
(4) Data name	1st column	Date and time column ^{*2}	Fixed character: TIME
	2nd column	Microsecond column ^{*3}	Fixed character: usec
	3rd column	Number column	Fixed character: NUMBER
	4th column	Event logging name column	Fixed character: EVENT
	5th column	Occurrence type column	Fixed character: STATUS
	6th column	Occurrence comment column	Fixed character: COMMENT
	7th column	Occurrence condition value column ^{*5}	Fixed character: VALUES
(5) Data	For saving data displayed in a historical event window, data is output in the order that it was stored in an Event logging file. For saving data displayed in a realtime event window, data is output in the order that it was received.		

*1 This row is not output either when the comment row is not output to the logging data or when the logging data displayed in the realtime event window is saved in a file.

*2 It is output in the set output format when the logging file conversion function is used.

*3 The microsecond column is not output when the logging file conversion function is used.

*4 A number enclosed with [] indicates the maximum number of characters (unit: byte).

*5 In the occurrence condition value column, a comma (,), a semicolon (;), and double quotes (") are replaced with a period (.).

■MELSEC-Q series high speed data logger module or BOX data logger

This section shows the format of the CSV file in which data of a MELSEC-Q series high speed data logger module or a BOX data logger displayed in GX LogViewer is saved.



The CSV file format explained in this section differs from that acquired from a MELSEC-Q series high speed data logger module or BOX data logger.

For details on the CSV file format acquired from each module, refer to the following:

- High Speed Data Logger Module User's Manual
- BOX Data Logger User's Manual

Item	Description
Delimiter	Comma (,)
Line feed code	CRLF(0x0D, 0x0A)
Character code	ASCII
Number of rows	Up to 131073 rows (data rows + 3)



When opening a CSV file in spreadsheet software

(1) →	[EVENT]	1	2	3	4		
(2) →	DATETIME	SHORT	[DESTRING[32]	SHORT	[[STRING[32]	STRING	[16664]
(3) →	TIME	NUMBER	EVENT	STATUS	COMMENT	VALUES	
	58:19.0	2	Voltage error	0	Voltage restored	D1=0.731354,D10=0.000000	
	58:21.0	1	Sensor-detected error	1	Execution error occurred	DO=1.213192799E+30	
	58:22.0	1	Sensor-detected error	0	Execution restored	DO=0.000000	
	58:24.0	1	Sensor-detected error	1	Execution error occurred	DO=3.494843613E+18	
	58:26.0	1	Sensor-detected error	0	Execution restored	DO=0.000000	
	58:27.0	1	Sensor-detected error	1	Execution error occurred	DO=4.758394893E+27	

Row name	Column number	Column name	Output content
(1) File information	1st column	File type	Fixed character: [EVENT]
	2nd column	Type information_file version	Fixed value: 1
	3rd column	Number for data type information row	Fixed value: 2
	4th column	Number for data name row	Fixed value: 3
	5th column	Number for data starting row	Fixed value: 4
(2) Data type information	1st column	Date and time column ^{*1}	Fixed character: DATETIME[YYYY/MM/DD hh:mm:ss
	2nd column	Microsecond column ^{*2}	Fixed character: us]
	3rd column	Number column	Data type of number column Fixed character: SHORT[DEC.0]
	4th column	Event logging name column	Data type of event logging name column Fixed character: STRING[64] ^{*3}
	5th column	Occurrence type column	Data type of occurrence type column Fixed character: SHORT[DEC.0]
	6th column	Occurrence comment column	Data type of the occurrence comment column Fixed character: STRING[64] ^{*3}
	7th column	Occurrence condition value column	Data type of occurrence condition value column Fixed character: STRING[4623] ^{*3}
(3) Data name	1st column	Date and time column ^{*1}	Fixed character: TIME
	2nd column	Microsecond column ^{*2}	Fixed character: usec
	3rd column	Number column	Fixed character: NUMBER
	4th column	Event logging name column	Fixed character: EVENT
	5th column	Occurrence type column	Fixed character: STATUS
	6th column	Occurrence comment column	Fixed character: COMMENT
	7th column	Occurrence condition value column ^{*4}	Fixed character: VALUES
(4) Data	For saving data displayed in a historical event window, data is output in the order that it was stored in an Event logging file. For saving data displayed in a realtime event window, data is output in the order that it was received.		

- *1 It is output in the set output format when the logging file conversion function is used.
- *2 The microsecond column is not output when the logging file conversion function is used.
- *3 A number enclosed with [] indicates the maximum number of characters (unit: byte).
- *4 In the occurrence condition value column, a comma (,), a semicolon (;), and double quotes (") are replaced with a period (.

Saving displayed events to Unicode text file

Type	Target for explanation ( Page 13 Target modules, simulators, files, and data for explanation)
Module	R logger

Events being displayed in the event list of the active event window can be saved to a Unicode text file.

When saving events displayed in the historical event window, the event logging names and the comments are saved in the language specified with the language selection function.

The data to be saved is as follows:

- Historical event window: Events of an event logging file being displayed
- Realtime event window: Events received from the start of monitoring to the click of the [Save] button

Operating procedure

1. Select [File] ⇒ [Save As] ⇒ [Save Unicode Text File] ().
2. Enter a file name, and click the [Save] button.

Format specification of Unicode text file

■MELSEC iQ-R series high speed data logger module

This section shows the format of the Unicode text file in which data of MELSEC iQ-R series high speed data logger module displayed in GX LogViewer is saved.



The Unicode text file format explained in this section differs from that acquired from a MELSEC iQ-R series high speed data logger module.

For details on the Unicode text file format acquired from the module, refer to the following:

MELSEC iQ-R High Speed Data Logger Module User's Manual (Application)

Item	Description
Delimiter	Tab
Line feed code	CRLF(0x0D, 0x0A)
Character code	Unicode
Character encoding method	UTF-16 (little-endian)
Field data	Not enclosed with double quotes (""). A tab cannot be used for each unit of data.
Number of rows	Up to 200004 rows (data rows + 4)

Ex.

When opening a Unicode text file in spreadsheet software

(1) →	[EVENT]	RD81 DL96_1	3	4	5	2	
(2) →	EVT01						
(3) →	DATETIME[YYYY/MM/DD hh:mm:ss	us]	SHORT[DEC:0]	STRING[64]	SHORT[DEC:0]	STRING[64]	STRING[4623]
(4) →	TIME	usec	NUMBER	EVENT	STATUS	COMMENT	VALUES
(5) {	2015/11/2 16:14:32	700000	1	Voltage error	1	Voltage error occurred	C0=37
	2015/11/2 16:14:32	700000	2	Sensor-detected error	1	Execution error occurred	
	2015/11/2 16:14:33	200000	2	Sensor-detected error	0	Execution restored	
	2015/11/2 16:14:33	700000	2	Sensor-detected error	1	Execution error occurred	
	2015/11/2 16:14:34	200000	2	Sensor-detected error	0	Execution restored	

Row name	Column number	Column name	Output content
(1) File information	1st column	File type	Fixed character: [EVENT]
	2nd column	Type information_file version	Fixed character: RD81DL96_(Version number) (Example) RD81DL96_1
	3rd column	Number for data type information row	Fixed value: • With comment row: 3 • Without comment row: 2
	4th column	Number for data name row	Fixed value: • With comment row: 4 • Without comment row: 3
	5th column	Number for data starting row	Fixed value: • With comment row: 5 • Without comment row: 4
	6th column	Number for comment row	Fixed value: 2
(2) Comment ^{*1}	1st column	—	A comment set with a configuration tool is displayed.
(3) Data type information	1st column	Date and time column ^{*2}	Fixed character: DATETIME[YYYY/MM/DD hh:mm:ss
	2nd column	Microsecond column ^{*3}	Fixed character: us]
	3rd column	Number column	Data type of number column Fixed character: SHORT[DEC.0]
	4th column	Event logging name column	Fixed character: STRING[64] ^{*4}
	5th column	Occurrence type column	Fixed character: SHORT[DEC.0]
	6th column	Occurrence comment column	Fixed character: STRING[64] ^{*4}
	7th column	Occurrence condition value column	Fixed character: STRING[4623] ^{*4}

Row name	Column number	Column name	Output content
(4) Data name	1st column	Date and time column ^{*2}	Fixed character: TIME
	2nd column	Microsecond column ^{*3}	Fixed character: usec
	3rd column	Number column	Fixed character: NUMBER
	4th column	Event logging name column	Fixed character: EVENT
	5th column	Occurrence type column	Fixed character: STATUS
	6th column	Occurrence comment column	Fixed character: COMMENT
	7th column	Occurrence condition value column ^{*5}	Fixed character: VALUES
(5) Data	For saving data displayed in a historical event window, data is output in the order that it was stored in an Event logging file. For saving data displayed in a realtime event window, data is output in the order that it was received.		

*1 This row is not output either when the comment row is not output to the logging data or when the logging data displayed in the realtime event window is saved in a file.

*2 It is output in the set output format when the logging file conversion function is used.

*3 The microsecond column is not output when the logging file conversion function is used.

*4 A number enclosed with [] indicates the maximum number of characters (unit: byte).

*5 In the occurrence condition value column, a comma (,), a semicolon (;), and double quotes (") are replaced with a period (.).

Saving displayed events to an image file

Type	Target for explanation ( Page 13 Target modules, simulators, files, and data for explanation)
Module	BOX, R logger, Q logger

A captured image of the active event window can be saved to a file.

When the [Save] button is clicked, the image of an active event window is saved.

Operating procedure

1. Select [File] ⇒ [Save As] ⇒ [Save Image File] ().
2. Select a file format (BMP/JPG/PNG) to be used from "Save as type."
3. Enter a file name, and click the [Save] button.

13 SAVING FILES BY CONVERTING FILE FORMATS

Target for explanation

Logging file, recording file

Logging file conversion function

This function converts a logging file in the binary format into the CSV format or Unicode text format.

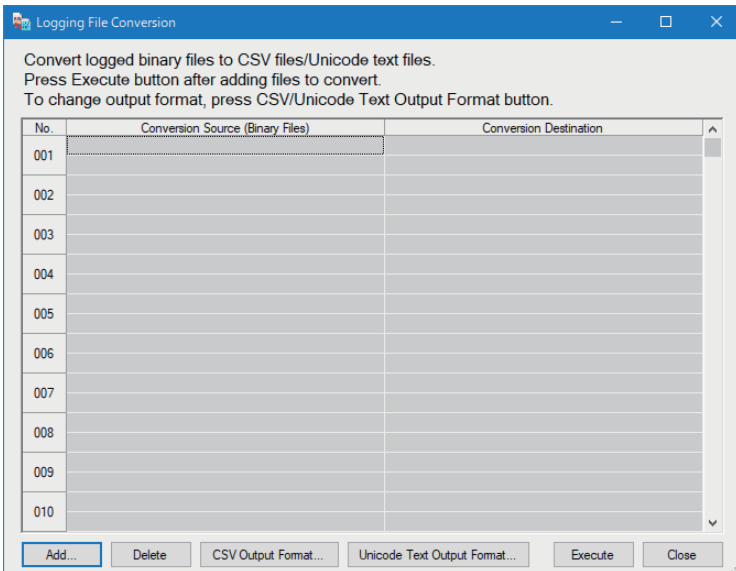

The following table shows the supported files by the logging file conversion function and the file format after conversion.

○: Supported, ×: Not supported

Supported file (binary file)	CSV file	Unicode text file
Data logging file of an RCPUCPU	×	○*1
Logging file of a MELSEC iQ-R series high speed data logger module	×	○
Data logging file of an LHCPU	×	○*1
Data logging file of an FX5CPU	×	○*1
Logging file of a MELSEC-Q series high speed data logger module	○	×
Logging file of a BOX data logger	○	×

*1 When converting the string type of logging data, for which the size is specified with an odd number in the configuration tool, the last character is converted to FFFDh. Specify the size with an even number when using this function.

Recording file conversion function

This function converts a recording file into the Unicode text format.

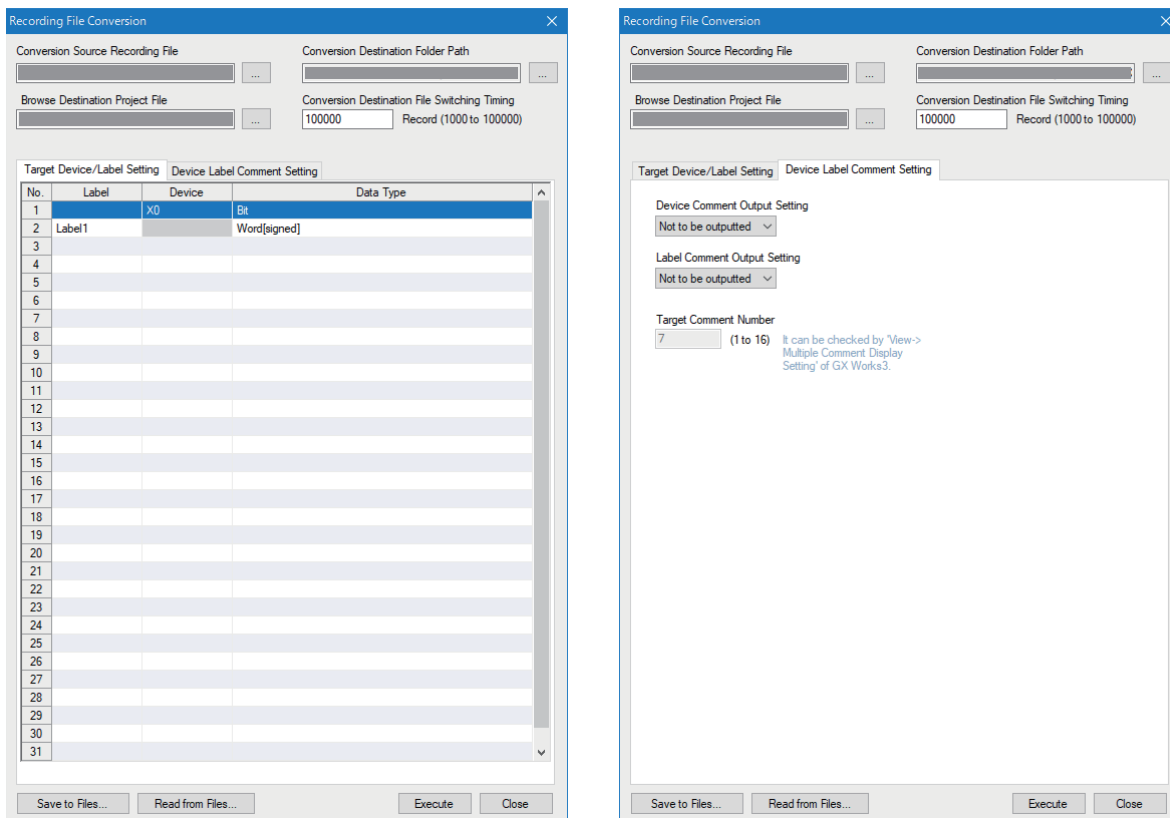

The following table shows the supported files by the recording file conversion function and the file format after conversion.

○: Supported, ×: Not supported

Supported file	CSV file	Unicode text file
Recording file of a recorder module	×	○
Recording file of a camera recorder module	×	○

13.1 Using the Logging File Conversion Function

A logged binary file can be converted into a CSV file or Unicode text file.

Converting a binary file into a CSV file or Unicode text file

Specify the file path of the conversion target and the conversion source binary file.

Window

Select [Tool] ⇒ [Logging File Conversion] ().

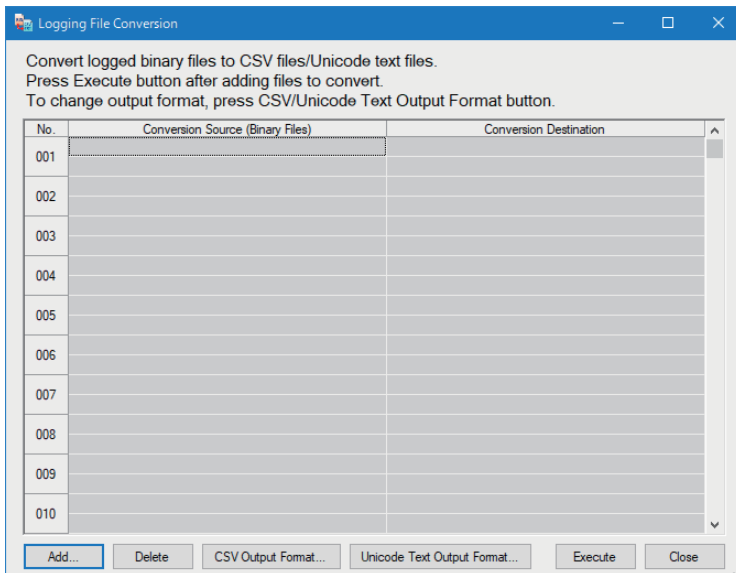

Operating procedure

1. Click the [Add] button and select the binary file to be converted. Then click the [Open] button.
2. Click the [CSV Output Format] button or the [Unicode Text Output Format] button.
3. Set the output format on the "CSV Output Format" screen or the "Unicode Text Output Format" screen. Then click the [OK] button. ( Page 312 Setting the output format)
4. Click the [Execute] button.

Setting the output format

Set the output format when a file is converted into a CSV file or a Unicode text file.

Ex.

When clicking the [Unicode Text Output Format] button on the "Logging File Conversion" screen.

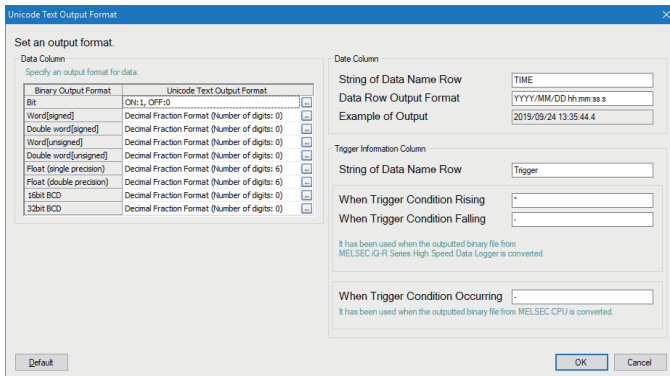

Displayed items

Item	Description	Reference		
Data column	Set the format of the data column that is output to a CSV file or Unicode text file.	—		
	Bit	Specify the output format of bit type data.	—	
	Word [signed]	Specify the output formats of numerical type data.*1	—	
	Double word [signed]			
	Word [unsigned]			
	Double word [unsigned]			
	Float (single precision)			
	Float (double precision)			
	16bit BCD			
32bit BCD				
Date column	String of Data name Raw*2	Specify the title of the data header line of the date column. (CSV: 32 alphanumeric characters, Unicode text: 32 characters)	—	
	Data Raw Output Format*2*3*4	Specify the output format of the data line of the date column. (CSV: 32 alphanumeric characters, Unicode text: 32 characters)	—	
		YYYY or YY	Year (4 digits) or year (2 digits)	—
		MM	Month (2 digits)	—
		DD	Day (2 digits)	—
		hh	Hour (2 digits)	—
		mm	Minute (2 digits)	—
		ss	Second (2 digits)	—
		.s	Digits after the decimal point in seconds (1 to 4 digits)*5	—
		ms	Millisecond (3 digits)*5	☞ Page 313 Date column
us	Microsecond (6 digits)*5	☞ Page 313 Date column		
Trigger information column*6	Specify the format of the trigger information that is output to a CSV file or a Unicode file.	—		

- *1 In "Number of digits in decimal part" on the "Output Format (integer/float)" screen, enter the same or smaller number of digits than the number of digits in decimal part of the logging data.
When entering the larger number of digits than the number of digits in decimal part of the logging data, a slight error can occur in the data after the conversion.
- *2 The date column can be split into multiple strings with commas.
In this case, enter the same number of commas in the "String of Data name Raw" and "Data Raw Output Format" field.
- *3 The date units must be consecutively specified.
For example, you cannot specify 'year/day' with the month omitted. You must specify it as 'year/month/date'.
- *4 When files are opened with Excel, the date column format is displayed in the default setting of Excel.
Set the cell format as necessary.
Specify the following user defined display format if year, month, date, hour, minute, second, millisecond information is to be displayed.
yyyy/mm/dd hh:mm:ss.000
- *5 Data value is rounded off to 0.1 millisecond unit when the high speed sampling is specified, and to 100 millisecond unit when the general sampling is specified.
- *6 This column is displayed only on the "Unicode Text Output Format" screen.

■Date column

To output time less than the second to a column, it needs to be separated with a comma (,).

Ex.

To output the millisecond column, enter ",(arbitrary header line title)" after "TIME" in the "String of Data Name Raw" field, and enter ",ms" after "hh:mm:ss" in the "Data Raw Output Format" field.

Item	Input contents
String of Data name Raw	TIME, (arbitrary header line title)
Data Raw Output Format	hh:mm:ss,ms

To output the microsecond column, enter ",(arbitrary header line title)" after "TIME" in the "String of Data Name Raw" field, and enter ",us" after "hh:mm:ss" in the "Data Raw Output Format" field.

Item	Input contents
String of Data name Raw	TIME, (arbitrary header line title)
Data Raw Output Format	hh:mm:ss,us

13.2 Using the Recording File Conversion Function

A recording file can be converted into a Unicode text file.

Converting a recording file into a Unicode text file

Window

When linking with the GX Works3 offline monitor function and displaying recording file data, select the following menu:

- Right-click the data and select [Recording File Conversion] from the shortcut menu.

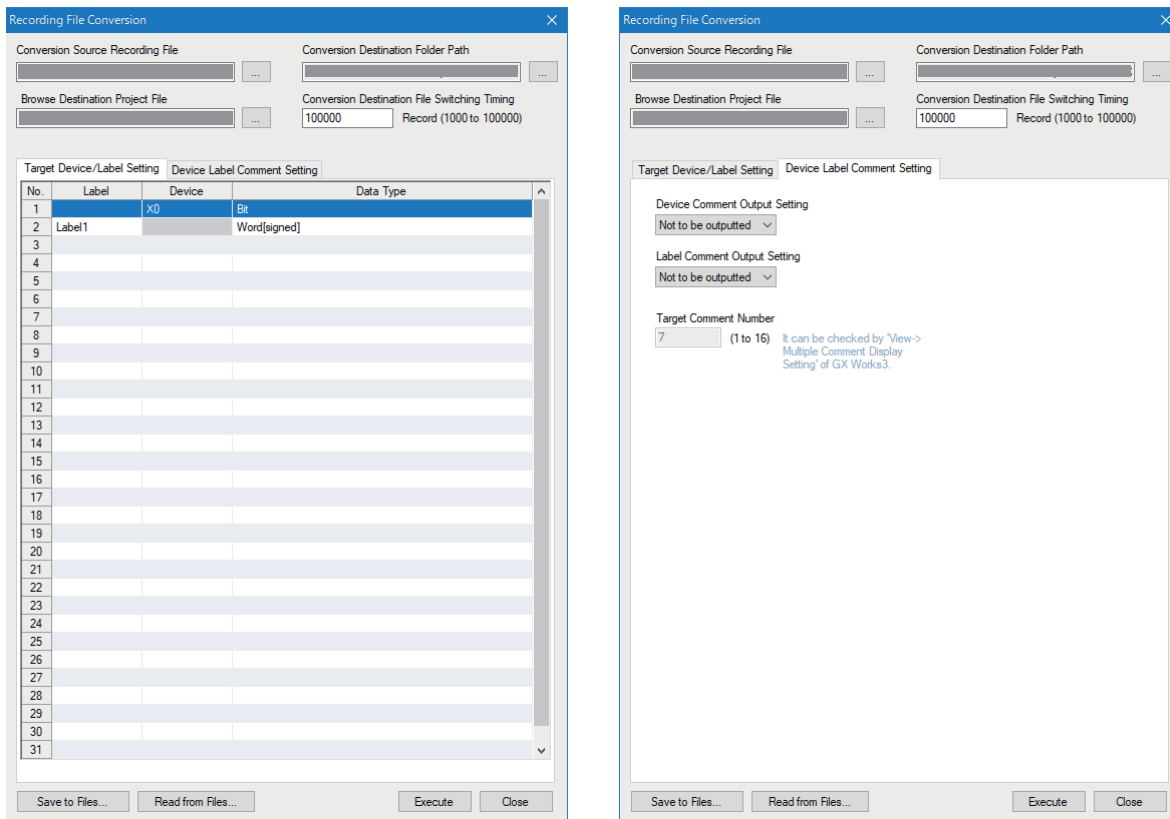

Operating procedure

1. Check or edit the setting contents of the following items. (The following items are set automatically when selecting the shortcut menu.)

- Conversion Source Recording File
- Conversion Destination Folder Path
- Browse Destination Project File
- Target Device/Label Setting

2. Check the setting contents in the [Device Label Comment Setting] tab.*1*2

3. Click the [Execute] button.

*1 "Target Comment Number" can be checked in the "Multiple Comments Display Setting" screen in GX Works3. For details on the "Multiple Comments Display Setting" screen, refer to the following:

GX Works3 Operating Manual

*2 Common device comments or global label comments are output.

The "Recording File Conversion" screen also can be displayed by selecting the following menu:

- [Tool] ⇒ [Recording File Conversion]

In this case, set the following items manually:

- Conversion Source Recording File
 - Conversion Destination Folder Path
 - Browse Destination Project File
 - Target Device/Label Setting
-

Saving/reading a recording file conversion setting

Saving a recording file conversion setting

The setting contents set in "Conversion Destination File Switching Timing" and the [Target Device/Label Setting] tab can be saved to an RCS file (*.rcs).

Operating procedure

1. Click the [Save to Files] button.
2. Specify a file name in the displayed screen, and click the [Save] button.

Precautions

If no device/label is set, an error occurs when saving a file.

Reading a recording file conversion setting

A recording file conversion setting saved to an RCS file (*.rcs) can be read.

Operating procedure

1. Click the [Read from Files] button.
2. Select a file from which settings to be read in the displayed screen, and click the [Open] button.

Precautions

If "Conversion Source Recording File" is not set, an error occurs when reading the setting file.

Labels and devices which can be specified

The following table shows the labels and devices which can be specified in the [Target Device/Label Setting] tab.

Item	Description		
Label*1*2	Global label	VAR_GLOBAL	<ul style="list-style-type: none"> ■Basic data type/Array • Bit • Word [signed] • Double word [signed] • Word [unsigned] • Double word [unsigned] • Single-precision real number • Double-precision real number • Time*3 • String*3 • String [Unicode]*3 • Timer type • Retentive timer type • Counter type • Long timer type • Long retentive timer type • Long counter type ■Structure
		VAR_GLOBAL_RETAIN	
	Local label	VAR	
		VAR_RETAIN	
Device*4	Global device	Bit device	X, Y, M, L, F, SM, V, B, SB, TS, TC, STS, STC, LTS, LTC, LSTS, LSTC, CS, CC, LCS, J□\X, J□\Y, J□\B, J□\SB, BL, BL□\S□
		Word device [signed]	D, SD, W, SW, RD, R, ZR, Z, TN, STN, CN, J□\W, J□\SW, U□\G, U3E□\G, U3E□\HG
		Double word device [signed]	LTN, LSTN, LCN, LZ
	Local device	Bit device	#M, #V, #TS, #TC, #LTS, #LTC, #STS, #STC, #LSTS, #LSTC, #CS, #CC, #LCS
		Word device [signed]	#TN, #STN, #CN, #D
		Double word device [signed]	#LTN, #LSTN, #LCN

*1 Labels that are specified in bit and digit specification cannot be specified.

*2 Labels using a special character (such as an umlaut character) may not be specified.

*3 When displaying data of a Unicode text file converted by this function in GX LogViewer, a label of the following data types cannot be displayed as a graph in a historical trend window.

- Time
- Sting
- String [Unicode]

*4 Devices that are specified in bit and digit specification, indirect-specified devices, and index-modified devices cannot be specified.

Point

A device or label copied from another application (example: the watch window of an engineering tool, Excel) can be pasted or inserted in the device or label column.

Operation method:

Right-click on the device or label column ⇨ select [Paste device/label copied in other application software]/ [Insert device/label copied in other application software] from the shortcut menu.

In another way to paste a copied device or label, press **Ctrl** + **Shift** + **V** keys.

Input format of labels/devices

The input formats of labels and devices are as follows:

Type	Input format
Global label	Label name
Local label	Program block name/Label name
Global device	Device name
Local device	Program name/#Device name

For structures, arrays, and data with timer types and counter types, enter the items by referring to the following table.

Data type	Target	Input format
Structure	Structure member	Label name.member name
Array	Array index and the specific dimension part of array (more than two-dimensional array)	Label name[three-dimensional index] [two-dimensional index] [one-dimensional index]
Structure array	Specific member	Label name[three-dimensional index] [two-dimensional index] [one-dimensional index].member name
Timer type		Label name.N
Retentive timer type		Label name.S
Counter type		Label name.C
Long timer type		
Long retentive timer type		
Long counter type		

13.3 Format

This section explains the format specifications of a CSV file or Unicode text file after a binary file is converted and of a Unicode text file after the recording file is converted.

Converting a data logging file

Format specification of CSV file

■MELSEC-Q series high speed data logger module or BOX data logger

The CSV file format explained in this section differs from that acquired from a MELSEC-Q series high speed data logger module or BOX data logger.

For details on the CSV file format acquired from each module, refer to the following:

 High Speed Data Logger Module User's Manual

 BOX Data Logger User's Manual

Item	Description
Delimiter	Comma (,)
Line feed code	CRLF(0x0D, 0x0A)
Character code	ASCII
Field data	<ul style="list-style-type: none">• Not enclosed with double quotes ("").• A double quotes (") and a comma (,) cannot be used for each unit of data.• However, a comma (,) can be included as a delimiter in "Date column" of the CSV output format. In this case, the date column is split into multiple rows and output to a CSV file.
Number of rows	Up to 100003 rows (data rows + 3)
File size	Up to 16777216 bytes Can be specified in a range of (10 to 16384) × 1024 bytes.

For the output contents of the CSV file after conversion, refer to the following:

 Page 259 MELSEC-Q series high speed data logger module or BOX data logger

Format specification of Unicode text file

■RCPU/LHCPU/FX5CPU

The Unicode text file format explained in this section differs from that acquired from an RCP, LHCPU, or FX5CPU.

For details on the Unicode text file format acquired from the module, refer to the following:

📖 MELSEC iQ-R CPU Module User's Manual (Application)

📖 MELSEC iQ-F FX5 User's Manual (Application)

Item	Description
Delimiter	Tab
Line feed code	CRLF(0x0D, 0x0A)
Character code	Unicode
Character encoding method	UTF-16 (little-endian)
Field data	<ul style="list-style-type: none">• Not enclosed with double quotes ("").• A double quotes (") cannot be used for each unit of data.• However, a comma (,) can be included as a delimiter in "Date column" of the Unicode text output format. In this case, the comma is replaced with a tab as the delimiter, and the date column is split into multiple rows and output to a Unicode text file.• When converting a data logging file of an FX5CPU, the character code of the string type data is changed from ASCII to Unicode.

For the output contents of the Unicode text file after conversion, refer to the following:

📖 Page 282 RCP or RCP simulator

📖 Page 290 LHCPU

📖 Page 294 FX5CPU or FX5CPU simulator

■MELSEC iQ-R series high speed data logger module

The Unicode text file format explained in this section differs from that acquired from a MELSEC iQ-R series high speed data logger module.

For details on the Unicode text file format acquired from the module, refer to the following:

📖 MELSEC iQ-R High Speed Data Logger Module User's Manual (Application)

Item	Description
Delimiter	Tab
Line feed code	CRLF(0x0D, 0x0A)
Character code	Unicode
Character encoding method	UTF-16 (little-endian)
Field data	<ul style="list-style-type: none">• Not enclosed with double quotes ("").• A double quotes (") cannot be used for each unit of data.• However, a comma (,) can be included as a delimiter in "Date column" of the Unicode text output format. In this case, the comma is replaced with a tab as the delimiter, and the date column is split into multiple rows and output to a Unicode text file.
Number of rows	Up to 100003 rows (data rows + 3)
File size	Up to 16777216 bytes Can be specified in a range of (10 to 16384) × 1024 bytes.

For the output contents of the Unicode text file after conversion, refer to the following:

📖 Page 286 MELSEC iQ-R series high speed data logger module

■Output character for the data type

Data type	Output character for the data type	Output content
Bit	BIT	BIT[(ON string);(OFF string)]
Word [signed]	SHORT	SHORT[(numerical value format ^{*1}).(number of digits of after the decimal point ^{*2})]
Double word [signed]	LONG	LONG[(numerical value format ^{*1}).(number of digits of after the decimal point ^{*2})]
Word [unsigned]	USHORT	USHORT[(numerical value format ^{*1}).(number of digits of after the decimal point ^{*2})]
Double word [unsigned]	ULONG	ULONG[(numerical value format ^{*1}).(number of digits of after the decimal point ^{*2})]
Float (single precision)	FLOAT	FLOAT[(numerical value format ^{*1}).(number of digits of after the decimal point ^{*2})]
String	STRING	STRING[(data length)]
Raw	RAW	RAW[(data length)]
Time	TIME	TIME

*1 It is output according to a selected numerical value format for the output format. (Decimal format: DEC, hexadecimal format: HEX, exponential format: EXP)

*2 The number of digits after the decimal point which has been specified for the output format is displayed.

■Output character for a device value

Data type	Output content
Bit	It is output according to the set output format.
Word [unsigned]	
Word [signed]	
Double word [unsigned]	
Double word [signed]	
Float (single precision)	
String	A logged string is output. ^{*1}
Raw	It is converted into a string in hexadecimal for each byte and displayed with no space.
Time	It is displayed in the range from 'T#-24d20h31m23s648ms' to 'T#24d20h31m23s647ms'.

*1 ASCII is used for the character code of the logging data of an FX5CPU.

When converting a data logging file into a Unicode text file, the character code of the string type data is changed from ASCII to Unicode.

Converting an event logging file

Format specification of CSV file

■MELSEC-Q series high speed data logger module or BOX data logger

The CSV file format explained in this section differs from that acquired from a MELSEC-Q series high speed data logger module or BOX data logger.

For details on the CSV file format acquired from each module, refer to the following:

 High Speed Data Logger Module User's Manual

 BOX Data Logger User's Manual

Item	Description
Delimiter	Comma (,)
Line feed code	CRLF(0x0D, 0x0A)
Character code	ASCII
Field data	<ul style="list-style-type: none">• Not enclosed with double quotes ("").• A double quotes (") and a comma (,) cannot be used for each unit of data.• However, a comma (,) can be included as a delimiter in "Date column" of the CSV output format. In this case, the date column is split into multiple rows and output to a CSV file.
Number of rows	Up to 100003 rows (data rows + 3)
File size	Up to 16777216 bytes Can be specified in a range of (10 to 16384) × 1024 bytes.

For the output contents of the CSV file after conversion, refer to the following:

 Page 303 MELSEC-Q series high speed data logger module or BOX data logger

Format specification of Unicode text file

■MELSEC iQ-R series high speed data logger module

The Unicode text file format explained in this section differs from that acquired from a MELSEC iQ-R series high speed data logger module.

For details on the Unicode text file format acquired from the module, refer to the following:

 MELSEC iQ-R High Speed Data Logger Module User's Manual (Application)

Item	Description
Delimiter	Tab
Line feed code	CRLF(0x0D, 0x0A)
Character code	Unicode
Character encoding method	UTF-16 (little-endian)
Field data	<ul style="list-style-type: none">• Not enclosed with double quotes ("").• A double quotes (") cannot be used for each unit of data.• However, a comma (,) can be included as a delimiter in "Date column" of the Unicode text output format. In this case, the comma is replaced with a tab as the delimiter, and the date column is split into multiple rows and output to a Unicode text file.
Number of rows	Up to 100003 rows (data rows + 3)
File size	Up to 16777216 bytes Can be specified in a range of (10 to 16384) × 1024 bytes.

For the output contents of the Unicode text file after conversion, refer to the following:

 Page 306 MELSEC iQ-R series high speed data logger module

Converting a recording file

Format specification of Unicode text file

Recorder module/camera recorder module

Item	Description
Delimiter	Tab
Line feed code	CRLF(0x0D, 0x0A)
Character code	Unicode
Character encoding method	UTF-16 (little-endian, with BOM)
Field data	Not enclosed with double quotes ("). A double quotes (") and a comma (,) cannot be used for each unit of data.*1

- *1
- If data is output to a file includes a comma (,), the entire data which includes a comma in the file is enclosed with double quotes ("). (Example: 123,456 → "123,456")
 - If data output to a file includes a double quote ("), the double quote is doubled. In addition, the entire data which includes a double quote is enclosed with double quotes. (Example: 123"456 → "123""456")

Ex.

When opening a Unicode text file in spreadsheet software

(1) →	[LOGGING]	RECORDING_1	2	3	4	7	6	
(2) →	DATETIME[YYYY/MM/DD hh:mm:ss.sss]	INDEX	BIT[1;0]	SHORT[DEC.0]	SHORT[DEC.0]	SHORT[DEC.0]	SHORT[DEC.0]	FLOAT[EXP.6]
(3) →	TIME(UTC+09:00)	INDEX	M1	D0	D1	#D2	D100	Label1
(4) }	COMMENT			Comment	Comment			
	Global							
(5) →						MAIN		
	2020/3/18 10:52	39455	1	9504	30652	5	14505	1
	2020/3/18 10:52	39454	1	9503	30651	5	14504	1
(6) }	2020/3/18 10:52	39453	1	9502	30650	5	14503	1
	2020/3/18 10:52	39452	1	9501	30649	5	14502	1
	2020/3/18 10:52	39451	1	9500	30648	5	14501	1

Row name	Column number	Column name	Output content
(1) File information	1st column	File type	Fixed character: [LOGGING]
	2nd column	Type information_file version	Fixed character: RECORDING_1
	3rd column	Number for data type information row	Fixed value: 2
	4th column	Number for data name row	Fixed value: 3
	5th column	Number for device/label comment row	<ul style="list-style-type: none"> • When a device comment/label comment is not output: Blank • When a device comment/label comment is output: 4
	6th column	Number for data starting row	<ul style="list-style-type: none"> • When a device comment and label comment are not output: 5 • When either of a device comment or label comment is output: 6 • When both of a device comment and label comment are output: 7
	7th column	Number for comment row	Blank
	8th column	Number for program name row	<ul style="list-style-type: none"> • When a device comment and label comment are not output: 4 • When either of a device comment or label comment is output: 5 • When both of a device comment and label comment are output: 6
(2) Data type information	1st column	Date and time column	Fixed value: DATETIME[YYYY/MM/DD hh:mm:ss.sss]
	2nd column	Index column	Fixed character: INDEX
	3rd column and later	Data column	Data type of sampled data Output format: Output character for the data type [additional information] ☞ Page 324 Output character for the data type
(3) Data name	1st column	Date and time column	Fixed character: TIME (time zone)
	2nd column	Index column	Fixed character: INDEX
	3rd column and later	Data column	Output format: Data name

Row name	Column number	Column name	Output content
(4) Device/label comment	1st column	Date and time column	<ul style="list-style-type: none"> When a device comment/label comment is not output: Blank When a device comment/label comment is output: Data name of a common device comment and global label comment^{*2}
	2nd column	Index column	Blank
	3rd column and later	Data column	<ul style="list-style-type: none"> When a device comment/label comment is not output: Blank When a device comment/label comment is output: Comments
(5) Program name	1st column	Date and time column	Blank
	2nd column	Index column	Blank
	3rd column and later	Data column	<ul style="list-style-type: none"> Local device or local label: Program names Global device or global label: Blank
(6) Data	1st column	Date and time column	Date and time information Output format: YYYY/MM/DD hh:mm:ss.sss
	2nd column	Index column	Value of an index (in ascending order) Output format: Integer value
	3rd column and later	Data column	Value of the name of collected data Output format: Value corresponding to the type in the data type information row

*2 Output in the following order:
Common device comment ⇒ global label comment

■ Output character for the data type

Data type	Output character for the data type	Output content
Bit	BIT	BIT[(ON string);(OFF string)]
Word [unsigned]	USHORT	USHORT[DEC.0]
Word [signed]	SHORT	SHORT[DEC.0]
Double word [unsigned]	ULONG	ULONG[DEC.0]
Double word [signed]	LONG	LONG[DEC.0]
Single-precision real number	FLOAT	FLOAT[EXP.6]
Double-precision real number	DOUBLE	DOUBLE[EXP.14]
String	STRING	STRING[(data length)]
Time	TIME	TIME

14 PRINTING TREND GRAPHS

Type	Target for explanation (☞ Page 13 Target modules, simulators, files, and data for explanation)
Module	RCPU, LHCPU, FX5CPU, QnUDVCP, LCP, R analog, Q analog, L analog, BOX, R logger, Q logger, R communication, Q communication, R motion module, R motion controller
Simulator	RCPU simulator, FX5CPU simulator, R motion module simulator
Others	Offline monitor, others

The trend graph print function is a function to print a trend graph on the screen while a historical trend graph, realtime trend graph, or realtime monitor graph is being displayed.

A graph area and a graph legend area displayed on an active trend window are printed.

Information such as connection target, data logging name, cursor time can also be printed in a header or footer.

When the data names displayed in a graph legend area and a graph area are switched to other names by using the switch data name function, the switched data names are printed in "Data Name" or "Device/Label."

14.1 Print Settings

This section explains the setting methods for printing.

14

Window

Select [File] ⇒ [Print] (🖨️).

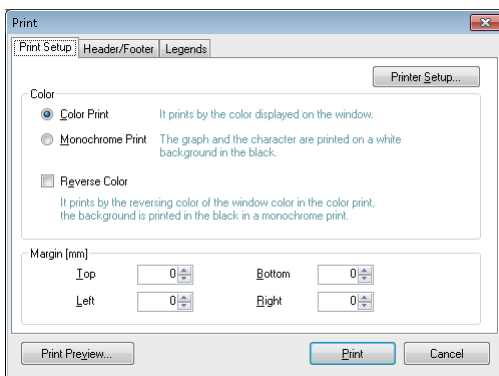

Operating procedure

1. Set the print color and margin.
2. Click the [Print Preview] button and check the print preview. (☞ Page 326 Checking Print Preview)
3. Click the [OK] button.

■Setting printer

1. Click the [Print Setup] button.
2. Specify the number of copies and a printer to be used, and click the [OK] button.

■Setting header/footer

Select the [Header/Footer] tab and set the header and footer to be printed.

■Setting graph legend output

Select the [Legends] tab and set the contents of graph legends to be printed.

14.2 Checking Print Preview

An output image can be checked by clicking the [Print Preview] button in the "Print" screen.

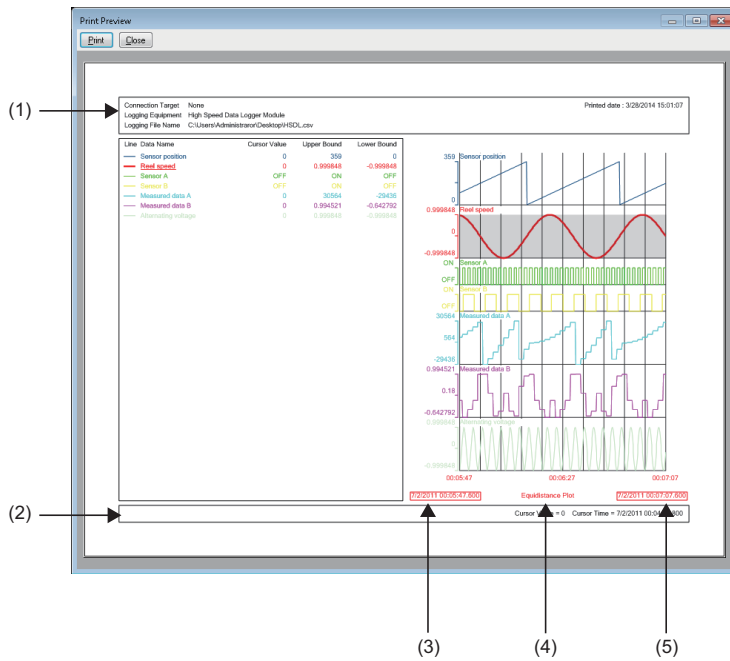

- (1): Header information
- (2): Footer information
- (3): Sampling start time
- (4): Plot display
- (5): Sampling end time

15 HELP MENU

15.1 Opening Manual

Open the operating manual of GX LogViewer.

Operating procedure

Select [Help] ⇒ [Open Manual].

15.2 Connecting to MITSUBISHI ELECTRIC FA Global Website

Open the MITSUBISHI ELECTRIC FA Global Website in a web browser.

Make sure your personal computer connect to the Internet in advance.

Operating procedure

Select [Help] ⇒ [Connection to MITSUBISHI ELECTRIC FA Global Website].

15.3 Version Information

This function displays the version information of GX LogViewer.

Operating procedure

Select [Help] ⇒ [About GX LogViewer].

MEMO

16 TROUBLESHOOTING

This chapter explains the errors which may occur when using GX LogViewer, and corrective actions correspond to those errors.

Symptom	Check point	Corrective action
Cannot communicate with the module. (Cannot operate online)	Is there a disconnection along the connection route?	<ul style="list-style-type: none"> • Connect the cables properly. • Replace the cable with new one.
	Is the IP address duplicated?	Correct the IP address.
	Does a firewall or proxy server exist along the connection route?	Ask your network administrator about the firewall and proxy server settings.
	Is Windows firewall enabled on the personal computer?	Disable Windows firewall on the personal computer when using the module search function or direct connection.
	Is antivirus software blocking Ethernet communications?	<ul style="list-style-type: none"> • Change the antivirus software settings to allow Ethernet communications. • Lower the antivirus software's security setting level. • Stop the antivirus software.
	Is there any problem on the personal computer?	Replace it with another personal computer.
	Are the authorities of the user logged on to Windows sufficient?	Log on as a user with a "standard" or higher access authority.
	Are multiple IP addresses enabled at the same time on the personal computer side?	<ul style="list-style-type: none"> • For direct connection, make sure multiple IP addresses are not enabled at the same time on the personal computer. • For direct connection, disable the wireless LAN function.
	Is "Direct Connection" set for the connection target of a data logger or data communication in the "Transfer Setup" screen?	For direct connection, connect a data logger or data communication and a personal computer on a 1:1 basis. ☞ Page 43 Direct connection
An error message is displayed when opening a logging file.	Is the logging file with only header line displayed?	After outputting the data, open the storage file.
	Is the logging file corrupted?	Check the file.
	Is a logging file that contains data exceeding the limit of the upper value or lower value of a data type opened in GX LogViewer the software version of which is 1.72A or earlier?(☞ Page 178 Scaling)	Open a logging file in GX LogViewer the software version of which is 1.76E or later.
A dashed-dotted line is displayed.	Has missing data occurred? ☞ Page 219 Graph Display for Missing Data or Time Reversed Data	Correct the data logging setting on the configuration tool to prevent the occurrence of missing data.
A dashed-dotted line is displayed on the realtime trend window.	Is logging of data displayed on the realtime trend window stopped because the number of saved files exceeded?	Delete the unnecessary saved files using the configuration tool, and restart the data logging.
The processing of opening or saving a logging file to a personal computer is slow.	Is Ethernet connected?	The TCP connection is recommended for the Ethernet connection. When using the Ethernet direct connection or UDP connection, it takes longer to open or save a logging file to a personal computer.
An error message is displayed when starting GX LogViewer.	—	Start GX LogViewer with the administrator authority.

When an abnormality exists in a module, functions of GX LogViewer may not operate normally. Refer to the user's manual of each CPU and perform troubleshooting.

MEMO

APPENDIX

Appendix 1 Additions and Changes from Previous Version

The following table shows the functions added and changed in GX LogViewer and the applicable software version. SW1DNN-VIEWER-J (Japanese), SW1DNN-VIEWER-E (English) and SW1DNN-VIEWER-C (Chinese) are integrated into SW1DNN-VIEWER-M (Multiple languages) Version 1.46Y.

- SW1DNN-VIEWER-M (Multiple languages)

Added/changed contents	Applicable software version
Display languages can be switched.	1.46Y or later
Simulation results saved with the following tool can be displayed: <ul style="list-style-type: none"> • MELSEC-L series Flexible High-Speed I/O Control Module Configuration Tool 	
Data logged by a following module can be displayed by using the historical trend function. <ul style="list-style-type: none"> • RCPU (R04ENCPU, R08ENCPU, R08SFCPU, R16ENCPU, R16SFCPU, R32ENCPU, R32SFCPU, R120ENCPU, and R120SFCPU) 	1.49B or later
Data of the following modules can be monitored by using the realtime monitor function: <ul style="list-style-type: none"> • RCPU (R04ENCPU, R08ENCPU, R16ENCPU, R32ENCPU, and R120ENCPU) 	
When monitoring data of an RCPU by using the realtime monitor function, a step relay with a block specification (BL□\S) can be specified to a device set on the following tabs: <ul style="list-style-type: none"> • [Monitor Target Setting] tab • "Timing Condition" in the [Monitor Condition Setting] tab 	
The following operating systems are supported: <ul style="list-style-type: none"> • German version • Italian version 	1.54G or later
Data logged by a following module can be displayed by using the historical trend function. <ul style="list-style-type: none"> • MELSEC iQ-R series high speed data logger module (RD81DL96) • MELSEC iQ-R series analog module (R60ADH4) 	
A logging file in the binary format can be converted into the CSV format or Unicode text format.	
The redundant mode of the following modules is supported: <ul style="list-style-type: none"> • RCPU (R08PCPU, R16PCPU, R32PCPU, and R120PCPU) 	1.58L or later
Windows 10 (32-bit version and 64-bit version) is supported.	
Data logged by a following module can be displayed by using the historical trend function. <ul style="list-style-type: none"> • MELSEC-Q series analog module (Q64ADH) that is in the high-speed logging mode 	
Data logged by a following module can be displayed by using the historical trend function. <ul style="list-style-type: none"> • FX5CPU (FX5U-32MR/ES, FX5U-32MT/ES, FX5U-32MT/ESS, FX5U-64MR/ES, FX5U-64MT/ES, FX5U-64MT/ESS, FX5U-64MR/DS, FX5U-64MT/DS, FX5U-64MT/DSS, FX5U-80MR/DS, FX5U-80MT/DS, FX5U-80MT/DSS, FX5UC-32MT/D, FX5UC-32MT/DSS, FX5UC-32MT/DS-TS, FX5UC-32MT/DSS-TS, FX5UC-32MR/DS-TS, FX5UC-64MT/D, FX5UC-64MT/DSS, FX5UC-96MT/D, and FX5UC-96MT/DSS) 	1.64S or later
Sampling data saved with the following tool can be displayed: <ul style="list-style-type: none"> • MELSEC iQ-R series Flexible High-Speed I/O Control Module Configuration Tool 	
A data logging file in the binary format logged by an RCPU or FX5CPU can be converted into the Unicode text format by using the logging file conversion function.	
Logging data can be checked by linking with the GX Works3 offline monitor function.	
The realtime monitor function can start from GX Works3.	1.70Y or later
Trend graphs can be displayed in a logarithmic decrement.	
A device copied from another application can be pasted or inserted in the device column in the [Monitor Target Setting] tab of the "Realtime Monitor Setting" screen.	
A recently-used graph display setting can be easily restored by selecting the [Recent Graphical Display Settings] menu.	1.72A or later
Both the red cursor and the blue cursor can simultaneously be moved to the specified position while multiple cursors are displayed.	

Added/changed contents	Applicable software version
Data logged by a following module can be displayed by using the historical trend function. <ul style="list-style-type: none"> • RCP (R01CPU and R02CPU) 	1.76E or later
Data of the following modules can be monitored by using the realtime monitor function: <ul style="list-style-type: none"> • RCP (R00CPU, R01CPU, and R02CPU) • FX5CPU (FX5U-32MR/ES, FX5U-32MT/ES, FX5U-32MT/ESS, FX5U-64MR/ES, FX5U-64MT/ES, FX5U-64MT/ESS, FX5U-80MR/ES, FX5U-80MT/ES, FX5U-80MT/ESS, FX5U-32MR/DS, FX5U-32MT/DS, FX5U-32MT/DSS, FX5U-64MR/DS, FX5U-64MT/DS, FX5U-64MT/DSS, FX5U-80MR/DS, FX5U-80MT/DS, FX5U-80MT/DSS, FX5UC-32MT/D, FX5UC-32MT/DSS, FX5UC-32MT/DS-TS, FX5UC-32MT/DSS-TS, FX5UC-32MR/DS-TS, FX5UC-64MT/D, FX5UC-64MT/DSS, FX5UC-96MT/D, and FX5UC-96MT/DSS) 	
Sampling data saved with the following tool can be displayed: <ul style="list-style-type: none"> • MELSEC-L series Flexible High-Speed I/O Control Module Configuration Tool 	
When connecting to an RCP, a reference target of a data logging file to be displayed or to be saved can be selected in the "Open Logging File" screen or "Save Logging Files to PC" screen.	
Logging data and monitor data can be scaled and displayed in the trend window.	
Data logged by an FX5CPU can be checked by linking with the GX Works3 offline monitor function.	
Windows 10 IoT Enterprise is supported.	1.82L or later
Real-time Data Analyzer is supported.	
Labels and local devices used in projects for the following modules can be specified: <ul style="list-style-type: none"> • RCP (R00CPU, R01CPU, R02CPU, R04CPU, R04ENCPU, R08CPU, R08ENCPU, R16CPU, R16ENCPU, R32CPU, R32ENCPU, R120CPU, and R120ENCPU) 	
Graphs displayed in a historical trend window can be displayed as data values/statuses by using the dump function.	
Data names can be switched to other names.	1.84N or later
When monitoring data of a following module by using the realtime monitor function, the time interval to monitor data can be specified. <ul style="list-style-type: none"> • RCP (R00CPU, R01CPU, R02CPU, R04CPU, R04ENCPU, R08CPU, R08ENCPU, R16CPU, R16ENCPU, R32CPU, R32ENCPU, R120CPU, and R120ENCPU) 	1.88S or later
Data of the following simulators can be monitored by using the realtime monitor function: <ul style="list-style-type: none"> • GX Simulator3 that is simulating the operation of an RCP • GX Simulator3 that is simulating the operation of an FX5CPU 	
The time displayed in a trend window can be displayed in microseconds or more.	
The time displayed in a trend window can be displayed in nanoseconds or more.	1.90U or later
When starting the realtime monitor function from GX Works3, devices of the following modules can be registered to the realtime monitor setting automatically: <ul style="list-style-type: none"> • FX5CPU (FX5U-32MR/ES, FX5U-32MT/ES, FX5U-32MT/ESS, FX5U-64MR/ES, FX5U-64MT/ES, FX5U-64MT/ESS, FX5U-80MR/ES, FX5U-80MT/ES, FX5U-80MT/ESS, FX5U-32MR/DS, FX5U-32MT/DS, FX5U-32MT/DSS, FX5U-64MR/DS, FX5U-64MT/DS, FX5U-64MT/DSS, FX5U-80MR/DS, FX5U-80MT/DS, and FX5U-80MT/DSS) 	1.94Y or later
Data logged by a following module can be displayed by using the historical trend function. <ul style="list-style-type: none"> • MELSEC iQ-R series motion module (RD78G4, RD78G8, RD78G16, RD78G32, and RD78G64) 	1.96A or later
Data logged by a following module can be displayed by using the historical trend function. <ul style="list-style-type: none"> • MELSEC iQ-R series motion module (RD78GHV and RD78GHW) • MELSEC iQ-L series CPU module (L04HCPU, L08HCPU, and L16HCPU) • FX5CPU (FX5UJ-24MR/ES, FX5UJ-24MT/ES, FX5UJ-24MT/ESS, FX5UJ-40MR/ES, FX5UJ-40MT/ES, FX5UJ-40MT/ESS, FX5UJ-60MR/ES, FX5UJ-60MT/ES, and FX5UJ-60MT/ESS) 	1.100E or later
Data of the following modules can be monitored by using the realtime monitor function: <ul style="list-style-type: none"> • RCP (R08SFCPU, R16SFCPU, R32SFCPU, and R120SFCPU) • MELSEC iQ-L series CPU module (L04HCPU, L08HCPU, and L16HCPU) • FX5CPU (FX5UJ-24MR/ES, FX5UJ-24MT/ES, FX5UJ-24MT/ESS, FX5UJ-40MR/ES, FX5UJ-40MT/ES, FX5UJ-40MT/ESS, FX5UJ-60MR/ES, FX5UJ-60MT/ES, and FX5UJ-60MT/ESS) 	

Added/changed contents	Applicable software version	
Data logged by the following simulator can be displayed by using the historical trend function: <ul style="list-style-type: none"> • MU Simulator that is simulating the operation of a MELSEC iQ-R series motion module 	1.106K or later	
Data of a JSON file in the GX LogViewer format can be displayed by using the historical trend function.		
A data logging file (*.csv) which is output by the following modules can be displayed by using the historical trend function: <ul style="list-style-type: none"> • FX5CPU*¹ 		
Data of the following modules and simulator can be monitored by using the realtime monitor function: <ul style="list-style-type: none"> • MELSEC iQ-R series motion module (RD78G4, RD78G8, RD78G16, RD78G32, RD78G64, RD78GHV, and RD78GHW) • MU Simulator that is simulating the operation of a MELSEC iQ-R series motion module 		
Log markers can be added to data when using the historical trend function.		
Duplicated labels and devices can be deleted when starting the realtime monitor function.		
A link direct device whose points are greater than the following range can be specified when monitoring data of an RCPU* ¹ by using the realtime monitor function: <ul style="list-style-type: none"> • J□\SB/J□\SW: 512 points, J□\X/J□\Y: 16K points, J□\B: 32K points, J□\W: 128K points 		
Data of a recording file can be displayed by linking with the GX Works3 offline monitor function.	1.112R or later	
When linking with the GX Works3 offline monitor function, the following functions become available: <ul style="list-style-type: none"> • Map area • Displaying the list of find results for value using the cursor jump function 		
A data logging file (*.csv) which is output by the following modules can be displayed by using the historical trend function: <ul style="list-style-type: none"> • RCPU*¹ 		
A device or label in a recording file sampled by an RnSFCPU can be displayed in a waveform by linking with the GX Works3 offline monitor function.		
Device comments can be displayed in the graph legend area.		
A comment and color of a log marker can be edited.		
A log marker information file generated in GX VideoViewer can be read.		
Windows XP® and Windows Vista® are no longer supported.		
Units can be displayed in the graph legend area and graph area when displaying data of which units are output.		
Data of the following module can be monitored using the realtime trend function: <ul style="list-style-type: none"> • MELSEC iQ-R series high speed data communication module (RD81DC96) 		1.118X or later
The following device can be specified when monitoring FX5UCPU data using the realtime monitor function: <ul style="list-style-type: none"> • BL□S 		
Multiple conditions can be specified for the cursor jump function.		
The previous or next trend graph can be displayed consecutively when displaying the following data: <ul style="list-style-type: none"> • Data logging file of a motion module • JSON file in GX LogViewer format 		
Data being displayed by linking with the GX Works3 offline monitor function can be saved as a Unicode text file.		
The time of multiple data logging files with different start times can be synchronized and the graph location can be adjusted by using the historical trend function.		
Log marker information can be read from a video file selected in the window of GX VideoViewer.		
When linking with the GX Works3 offline monitor function and displaying recording file data, a device comment can be checked in a graph area.	1.121B	
The display position and window size of GX LogViewer at startup can be specified by specifying an option in a command line.		
Data of the following modules can be displayed or monitored by using the historical trend function and realtime monitor function: <ul style="list-style-type: none"> • FX5CPU (FX5S-30MR/ES, FX5S-30MT/ES, FX5S-30MT/ESS, FX5S-40MR/ES, FX5S-40MT/ES, FX5S-40MT/ESS, FX5S-60MR/ES, FX5S-60MT/ES, FX5S-60MT/ESS, FX5S-80MR/ES, FX5S-80MT/ES, and FX5S-80MT/ESS) 		1.124E
When starting the realtime monitor function from GX Works3, a device or label of the following modules can be registered to the realtime monitor setting automatically: <ul style="list-style-type: none"> • RCPU (R00CPU, R01CPU, R02CPU, R04CPU, R04ENCPU, R08CPU, R08ENCPU, R16CPU, R16ENCPU, R32CPU, R32ENCPU, R120CPU, and R120ENCPU) • LHCPU (L04HCPU, L08HCPU, and L16HCPU) 		
When linking with the GX Works3 offline monitor function and displaying recording file data, a device can be added to the data from GX Works3.		
A division value of grids of a trend graph can be specified.		
Data logged by the following modules can be displayed by using the historical trend function. <ul style="list-style-type: none"> • MELSEC iQ-R series motion controller (R16MTCPU, R32MTCPU, and R64MTCPU) 	1.130L or later	
Windows 11 is supported.		



Added/changed contents	Applicable software version
Data of the following module can be displayed or monitored by using the historical trend function and realtime monitor function: • LHCPU (L32HCPU)	1.136S or later
The following link direct devices can be specified when monitoring LHCPU data by using the realtime monitor function: • J□\X, J□\Y, J□\SB, J□\W, J□\SW	
The following devices can be displayed in a waveform by linking with the GX Works3 offline monitor function and displaying recording file data: • BL□\S, BL	
Log markers can be added when using the cursor jump function.	
A shortcut key and toolbar icon are added for the following menu: • [Graph View] ⇨ [Change the Data to Draw Graphs]	
Windows 7, Windows 8, and Windows 8.1 are no longer supported.	1.142Y or later
MELSOFT Update Manager is supported.	
Data logged by the following modules can be displayed by using the historical trend function. • CC-Link IE TSN FPGA module • FX5CPU (FX5UJ-24MR/DS, FX5UJ-24MT/DS, FX5UJ-24MT/DSS, FX5UJ-40MR/DS, FX5UJ-40MT/DS, FX5UJ-40MT/DSS, FX5UJ-60MR/DS, FX5UJ-60MT/DS, FX5UJ-60MT/DSS)	
Data of the following modules can be monitored by using the realtime monitor function: • FX5CPU (FX5UJ-24MR/DS, FX5UJ-24MT/DS, FX5UJ-24MT/DSS, FX5UJ-40MR/DS, FX5UJ-40MT/DS, FX5UJ-40MT/DSS, FX5UJ-60MR/DS, FX5UJ-60MT/DS, FX5UJ-60MT/DSS)	
An operation result of the CALC function can be displayed in a historical trend window.	1.148E or later
A recording file can be converted into a Unicode text file by using the recording file conversion function.	
*1 For the supported model names, refer to the following: • SW1DNN-VIEWER-J (Japanese)	
Added/changed contents	Applicable software version
Windows 7 (32-bit version) is supported.	1.03D or later
Data including a following language can be displayed. • Chinese (Simplified) • English • Japanese	1.04E or later
Data including a following language and a character code can be displayed. • Chinese (Traditional) • Korean • Unicode (UTF-8)	1.07H or later
The cursor jump function can be executed by searching value.	1.10L or later
Windows 7 (64-bit version) is supported.	
Data logged by a following module can be displayed. • MELSEC-Q series analog module (Q64ADH) • MELSEC-L series analog module (L60AD4)	1.15R or later
A date can be displayed on a time-scale label.	
Automatic application of the graphical display setting is supported when displaying trend window.	
Graphical display of a trend graph being displayed can be initialized.	
Data logged by a following module can be displayed. • MELSEC-Q series analog module (Q68CT)	1.18U or later
Expand the maximum display point of the trend graph on one screen from 65535 to 100000, and the maximum save number of lines to the CSV file from 131073 to 200003 (data row+3).	1.20W or later
The plot format of the historical trend graph being displayed can be changed from equidistance plot format, which is conventional display format, to time interval plot format.	
When displaying with time interval plot format, logging data of another file can be added to the trend graph being displayed.	
When displaying logging data of multiple files on a trend graph, the graph can be moved to left or right.	
Sampling trace data in GX LogViewer format saved in GX Works2 Version 1.90U or later can be displayed.	
Data logged by a following module can be displayed. • QCPU (Q03UDVCP, Q04UDVCP, Q06UDVCP, Q13UDVCP and Q26UDVCP) • LCP (L26CP) • MELSEC-L series analog module (L60AD4-2GH)	1.25B or later
Data logged by a following module can be displayed. • LCP (L06CP)	1.26C or later

Added/changed contents	Applicable software version
Data logged by a following module can be displayed. <ul style="list-style-type: none"> • LCP (L06CPU-P and L26CPU-P) • MELSEC-L series analog module (L60AD2DA2) • Logging module for energy measuring module (EcoMonitorLight and EcoMonitorPlus) (EMU4-LM) Windows 8 (32-bit version and 64-bit version) is supported.	1.30G or later
A realtime trend graph of data obtained by a following module can be displayed. <ul style="list-style-type: none"> • MELSEC-Q series high speed data communication module (QJ71DC96) 	1.31H or later
The transparent function of GOT2000 is supported. Data logged by a following module can be displayed. <ul style="list-style-type: none"> • BOX data logger (NZ2DL) 	1.33K or later
Data logged by a following module can be displayed. <ul style="list-style-type: none"> • RCP (R04CPU, R08CPU, R16CPU, R32CPU, and R120CPU) • MELSEC iQ-R series analog module (R60AD4, R60ADV8, and R60AD18) Windows 8.1 (32-bit version and 64-bit version) is supported.	1.35M or later
A realtime monitor graph of data obtained by a following module can be displayed. <ul style="list-style-type: none"> • LCP (L02CPU, L02CPU-P, L06CPU, L06CPU-P, L26CPU, L26CPU-P, L26CPU-BT, and L26CPU-PBT) 	1.37P or later
A realtime monitor graph of data obtained by a following module can be displayed. <ul style="list-style-type: none"> • RCP (R04CPU, R08CPU, R16CPU, R32CPU, and R120CPU) The realtime monitor setting can be configured offline. "Frequently-used Window Configuration" and "Recent Windows" is included as a display format of a realtime monitor window.	1.40S or later
Data logged by a following module can be displayed. <ul style="list-style-type: none"> • RCP (R08PCPU, R16PCPU, R32PCPU, and R120PCPU) • MELSEC iQ-R series analog module (R60AD8-G, R60AD16-G, R60RD8-G, and R60TD8-G) The font size in the graph legend area can be adjusted. The upper and lower limit display values can be edited in batch. Displaying/hiding grids can be switched. In addition, horizontal lines can be displayed as grids. A graph can be drawn by using OpenGL.	1.43V or later

• SW1DNN-VIEWER-E (English)

Added/changed contents	Applicable software version
Data including a following language can be displayed. <ul style="list-style-type: none"> • Chinese (Simplified) • English • Japanese 	1.04E or later
The following operating systems are supported: <ul style="list-style-type: none"> • Simplified Chinese version • Traditional Chinese version 	
Windows 7 (32-bit version) is supported.	
Data including a following language and a character code can be displayed. <ul style="list-style-type: none"> • Chinese (Traditional) • Korean • Unicode (UTF-8) 	1.07H or later
Korean version of operating system is supported.	
The cursor jump function can be executed by searching value.	1.10L or later
Windows 7 (64-bit version) is supported.	
Data logged by a following module can be displayed. <ul style="list-style-type: none"> • MELSEC-Q series analog module (Q64ADH and Q68CT) • MELSEC-L series analog module (L60AD4) 	1.18U or later
A date can be displayed on a time-scale label.	
Automatic application of the graphical display setting is supported when displaying trend window.	
Graphical display of a trend graph being displayed can be initialized.	
Expand the maximum display point of the trend graph on one screen from 65535 to 100000, and the maximum save number of lines to the CSV file from 131073 to 200003 (data row+3).	1.26C or later
The plot format of the historical trend graph being displayed can be changed from equidistance plot format, which is conventional display format, to time interval plot format.	
When displaying with time interval plot format, logging data of another file can be added to the trend graph being displayed.	
When displaying logging data of multiple files on a trend graph, the graph can be moved to left or right.	
Sampling trace data in GX LogViewer format saved in GX Works2 Version 1.91V or later can be displayed.	
Data logged by a following module can be displayed. <ul style="list-style-type: none"> • QCPU (Q03UDVCP, Q04UDVCP, Q06UDVCP, Q13UDVCP and Q26UDVCP) • LCP (L06CPU and L26CPU) • MELSEC-L series analog module (L60AD4-2GH) 	
Windows 8 (32-bit version and 64-bit version) is supported.	1.32J or later
The transparent function of GOT2000 is supported.	
Data logged by a following module can be displayed. <ul style="list-style-type: none"> • LCP (L06CPU-P and L26CPU-P) • MELSEC-L series analog module (L60AD2DA2) • Logging module for energy measuring module (EcoMonitorLight and EcoMonitorPlus) (EMU4-LM) 	
A realtime trend graph of data obtained by a following module can be displayed. <ul style="list-style-type: none"> • MELSEC-Q series high speed data communication module (QJ71DC96) 	
Data logged by a following module can be displayed. <ul style="list-style-type: none"> • BOX data logger (NZ2DL) 	1.34L or later
Data logged by a following module can be displayed. <ul style="list-style-type: none"> • RCP (R04CPU, R08CPU, R16CPU, R32CPU, and R120CPU) • MELSEC iQ-R series analog module (R60AD4, R60ADV8, and R60ADI8) 	1.35M or later
Windows 8.1 (32-bit version and 64-bit version) is supported.	
A realtime monitor graph of data obtained by a following module can be displayed. <ul style="list-style-type: none"> • LCP (L02CPU, L02CPU-P, L06CPU, L06CPU-P, L26CPU, L26CPU-P, L26CPU-BT, and L26CPU-PBT) 	1.40S or later
The realtime monitor setting can be configured offline. <ul style="list-style-type: none"> • RCP (R04CPU, R08CPU, R16CPU, R32CPU, and R120CPU) 	
"Frequently-used Window Configuration" and "Recent Windows" is included as a display format of a realtime monitor window.	

Added/changed contents	Applicable software version
Data logged by a following module can be displayed. <ul style="list-style-type: none"> • RCPU (R08PCPU, R16PCPU, R32PCPU, and R120PCPU) • MELSEC iQ-R series analog module (R60AD8-G, R60AD16-G, R60RD8-G, and R60TD8-G) 	1.43V or later
The font size in the graph legend area can be adjusted.	
The upper and lower limit display values can be edited in batch.	
Displaying/hiding grids can be switched. In addition, horizontal lines can be displayed as grids.	
A graph can be drawn by using OpenGL.	
• SW1DNN-VIEWER-C (Chinese)	
Added/changed contents	Applicable software version
Data including a following language can be displayed. <ul style="list-style-type: none"> • Chinese (Simplified) • English • Japanese 	1.04E or later
The following operating systems are supported: <ul style="list-style-type: none"> • Simplified Chinese version • Traditional Chinese version 	
Windows 7 (32-bit version) is supported.	
Data including a following language and a character code can be displayed. <ul style="list-style-type: none"> • Chinese (Traditional) • Korean • Unicode (UTF-8) 	1.07H or later
The cursor jump function can be executed by searching value.	1.10L or later
Windows 7 (64-bit version) is supported.	
Data logged by a following module can be displayed. <ul style="list-style-type: none"> • MELSEC-Q series analog module (Q64ADH and Q68CT) • MELSEC-L series analog module (L60AD4) 	1.18U or later
A date can be displayed on a time-scale label.	
Automatic application of the graphical display setting is supported when displaying trend window.	
Graphical display of a trend graph being displayed can be initialized.	
Expand the maximum display point of the trend graph on one screen from 65535 to 100000, and the maximum save number of lines to the CSV file from 131073 to 200003 (data row+3).	1.26C or later
The plot format of the historical trend graph being displayed can be changed from equidistance plot format, which is conventional display format, to time interval plot format.	
When displaying with time interval plot format, logging data of another file can be added to the trend graph being displayed.	
When displaying logging data of multiple files on a trend graph, the graph can be moved to left or right.	
Sampling trace data in GX LogViewer format saved in GX Works2 Version 1.91V or later can be displayed.	
Data logged by a following module can be displayed. <ul style="list-style-type: none"> • QCPU (Q03UDVCP, Q04UDVCP, Q06UDVCP, Q13UDVCP and Q26UDVCP) • LCP (L06CPU and L26CPU) • MELSEC-L series analog module (L60AD4-2GH) 	



Appendix 2 USB Driver Installation Procedure

To communicate with a CPU module via USB, installing a USB driver is required.

Operating procedure

1. Connect the personal computer and the CPU module with a USB cable, and power ON the programmable controller.
2. Right-click "Unknown Device" and click "Update driver" in Windows Device Manager.
3. Select "Browse my computer for drivers" on the "Update Drivers" screen, and specify "Easysocket\USBDrivers" in the folder where GX LogViewer has been installed.

When an installation folder is not changed at installation, the installation folder is as follows:

- 64-bit version operating system: C:\Program Files (x86)\MELSOFT\Easysocket\USBDrivers
- 32-bit version operating system: C:\Program Files\MELSOFT\Easysocket\USBDrivers

When multiple MELSOFT products are already installed, specify "Easysocket\USBDrivers" in the folder of the first installed product.

If "Easysocket\USBDrivers" does not exist, search "USBDrivers" in the Windows explorer.

Appendix 3 PING Test

The following is an example for checking the connection by issuing the PING command to the module from a target equipment (personal computer) connected on the same Ethernet network (LAN).
(Example of checking the connection of a data logger or data communication with a target device on the same network address)

Operating procedure

1. Start Windows command prompt.
2. Enter the IP address of a data logger or data communication after 'ping' with a keyboard.

Example

3. Check the output result.

- When the communication is successful

```
>ping 192.168.3.3
Pinging 192.168.3.3 with 32 bytes of data:

Reply from 192.168.3.3: bytes=32 time<1ms TTL=128
Reply from 192.168.3.3: bytes=32 time<1ms TTL=128
Reply from 192.168.3.3: bytes=32 time<1ms TTL=128
Reply from 192.168.3.3: bytes=32 time<1ms TTL=128

Ping statistics for 192.168.3.3:
    Packets: Sent = 4, Received = 4, Lost = 0 (0% loss),
    Approximate round trip times in milli-seconds:
        Minimum = 0ms, Maximum = 0ms, Average = 0ms
```

- When the communication is unsuccessful

```
>ping 192.168.3.3
Pinging 192.168.3.3 with 32 bytes of data:
Request timed out.
Request timed out.
Request timed out.
Request timed out.

Ping statistics for 192.168.3.3:
    Packets: Sent = 4, Received = 0, Lost = 4 (100% loss),
```

When the communication is unsuccessful, check the following items and perform the PING test again.

- Network settings for a data logger, data communication or target device
- Cables, hub connection status, power status

Precautions

The PING test is only valid when the "Connection via hub" is set for a connection method.

Appendix 4 Version Compatibility

This section shows the software versions of GX LogViewer and each MELSOFT product that must be installed to link between GX LogViewer and the MELSOFT product.

Starting the realtime monitor function from GX Works3

The following table shows the software versions of GX LogViewer and GX Works3 that must be installed when activating GX LogViewer from GX Works3 and starting the realtime monitor function.

This function is available only when connecting to an RCP, LHCP, or FX5CP.

GX LogViewer	GX Works3
1.76E or later	1.040S or later

The following table shows the software versions of GX LogViewer and GX Works3 that must be installed to start GX LogViewer from GX Works3 with data names and data types of devices or labels registered to the realtime monitor setting automatically.

Connection destination	GX LogViewer	GX Works3
FX5CPU	1.94Y or later	1.055H or later
RCP	1.124E or later	1.080J or later
LHCP	1.124E or later	1.080J or later

For the procedure for starting the realtime monitor function from GX Works3, refer to the following:

 Page 115 Starting the realtime monitor function from GX Works3 (for RCP/LHCP/FX5CP)

Starting the realtime monitor function from GX Works2

The following table shows the software versions of GX LogViewer and GX Works2 that must be installed when activating GX LogViewer from GX Works2 and starting the realtime monitor function.

GX LogViewer	GX Works2
1.40S or later	1.519R or later

For the procedure for starting the realtime monitor function from GX Works2, refer to the following:

 Page 116 Starting the realtime monitor function from GX Works2

Linking with the GX Works3 offline monitor function

The following table shows the combination of software versions between GX LogViewer and GX Works3 that must be installed to link with the GX Works3 offline monitor function.

For details on the GX Works3 offline monitor function, refer to the following:

 GX Works3 Operating Manual

GX LogViewer	GX Works3
1.64S or later	1.030G or later and 1.063R or earlier
1.106K or later	1.065T or later

Appendix 5 Open Source Software

This software consists of multiple software components. Each of them is copyrighted by Mitsubishi Electric Corporation and/or third parties.

This software contains the following open source software.

- Software copyrighted by third parties and distributed as free software

Please refrain from inquiring about the source codes of this open source.

Software information

This product contains the following open source software.

JSON.NET

For the license of open source software, refer to the following:

 GX LogViewer Version 1 Operating Manual (Edgecross)

INDEX

A

Access restriction 58

C

Connection via a hub 25,27,29,32,39,43
Connection via hub 85,87
CSV file 249
Cursor 153
Cursor jump 167
Cursor label 200

D

Difference information area 101,105
Direct connection
. 25,27,29,32,39,43,77,79,82,84,87
Display language switching 55
Division value of grids 179

E

Editing lower bound and division value of Y axis
grids in a batch 181
Editing upper and lower bounds/Y axis scale in a
batch 177
Equidistance plot 205,219
Event properties 239

F

Filtering 231
Firewall 44

G

Graph area 101,103,199
Graph legend area 101
Graph Properties 209
Grid 205

H

Historical event 224,228
Historical trend 97,110
Host address 44

I

I/F board 36
Image file 299,308
Index 105,167
Inf 221
IP address 25,27,29,32,39,43,78,80,85,87

L

Language 206,233
Logging file conversion function 309

M

Missing data 219
Multiple cursor 199

N

NaN 221
Next event 237
Next graph 197

P

PING 339
Previous event 235
Previous graph 195
Print 325

R

Realtime event 224,229
Realtime monitor 98,113
Realtime trend 98,112
Recording file conversion function 310

S

Save 241,248
Scaling 178,181
Serial port 35
Sorting 232
Status bar 227
Subnet mask 43

T

Time interval plot 205,219
Time-scale label 103,206
Transfer setup 77,79,81,83,86,92
Transparent function 36

U

Unicode text file 281
Upper and lower bounds 175

MEMO

REVISIONS

*The manual number is given on the bottom left of the back cover.

Revision date	*Manual number	Description
January 2010 to September 2013	SH(NA)-080915ENG-A to SH(NA)-080915ENG-J	Due to the transition to the e-Manual, the details on revision have been deleted.
June 2014	SH(NA)-080915ENG-K	Complete revision (layout change)
October 2014	SH(NA)-080915ENG-L	■Added or modified parts Chapter 3, Section 5.2, Section 5.4, Section 6.1, Section 8.1, Section 8.2, Section 8.3, Section 11.1, Section 11.3, Section 12.2, Appendix 2
January 2015	SH(NA)-080915ENG-M	■Added or modified parts TERMS, Section 5.4, Section 8.2, Section 8.3, Section 8.5, Section 8.6, Chapter 15, Appendix 2
June 2015	SH(NA)-080915ENG-N	■Added or modified parts TERMS, Chapter 3, Section 4.4, Section 5.4, Section 6.4, Section 8.3, Section 8.6, Section 9.4, Section 12.2, Appendix 2
August 2015	SH(NA)-080915ENG-O	■Added or modified parts TERMS, Section 2.2, Section 5.2, Section 8.3, Appendix 2
January 2016	SH(NA)-080915ENG-P	■Added or modified parts TERMS, Section 2.1, Section 2.2, Chapter 3, Section 5.4, Section 6.2, Section 7.1, Section 7.4, Section 8.1, Section 8.2, Section 8.3, Section 8.5, Section 8.6, Section 9.1, Section 9.2, Section 9.3, Section 9.4, Section 12.2, Section 12.3, Chapter 13, Appendix 2
May 2016	SH(NA)-080915ENG-Q	■Added or modified parts TERMS, Section 1.1, Section 7.2, Section 8.1, Section 8.2, Section 8.5, Section 12.2, Section 12.3, Chapter 13, Section 13.1, Appendix 2
October 2016	SH(NA)-080915ENG-R	■Added or modified parts SAFETY PRECAUTIONS, TERMS, Section 1.1, Section 1.2, Section 2.1, Section 2.2, Section 5.3, Section 5.4, Chapter 6, Section 6.4, Section 7.1, Section 7.3, Section 8.1, Section 8.2, Section 8.3, Section 8.4, Section 8.5, Section 8.6, Section 9.1, Section 9.4, Chapter 10, Section 12.2, Chapter 13, Section 13.1, Section 13.2, Appendix 2
April 2017	SH(NA)-080915ENG-S	■Added or modified parts TERMS, Section 5.4, Section 8.2, Section 8.3, Section 8.5, Section 8.6, Section 8.13, Appendix 2
June 2017	SH(NA)-080915ENG-T	■Added or modified parts Section 5.4, Section 8.4, Section 8.8, Appendix 2
October 2017	SH(NA)-080915ENG-U	■Added or modified parts TERMS, Section 1.1, Section 2.1, Section 5.4, Section 7.1, Section 8.1, Section 8.2, Section 8.3, Section 8.4, Section 8.5, Chapter 10, Section 11.4, Section 12.2, Chapter 16, Appendix 2
April 2018	SH(NA)-080915ENG-V	■Added or modified parts TERMS, Chapter 1, Section 1.1, Section 2.1, Section 2.2, Chapter 3, Section 5.4, Chapter 6, Section 6.1, Section 6.2, Section 6.3, Section 6.4, Section 6.5, Section 7.1, Section 7.2, Section 7.3, Section 7.4, Section 7.5, Chapter 8, Section 8.1, Section 8.2, Section 8.3, Section 8.4, Section 8.5, Section 8.7, Section 8.10, Section 8.12, Section 8.13, Section 8.14, Chapter 9, Section 9.1, Section 9.2, Section 9.3, Section 9.4, Section 9.5, Chapter 10, Chapter 11, Section 11.1, Chapter 12, Section 12.2, Section 12.3, Chapter 13, Section 13.2, Chapter 14, Chapter 16, Appendix 2
June 2018	SH(NA)-080915ENG-W	■Added or modified parts Section 5.4, Section 8.2, Section 8.6, Section 8.9, Section 12.2, Section 13.1, Chapter 14, Appendix 2
October 2018	SH(NA)-080915ENG-X	■Added or modified parts Definitions of abbreviation, Chapter 1, Section 1.1, Section 1.2, Section 2.2, Chapter 3, Section 5.2, Section 5.3, Section 6.1, Section 6.3, Section 6.4, Section 6.5, Section 6.6, Section 7.1, Section 7.2, Section 7.3, Section 7.4, Section 7.5, Section 7.6, Chapter 8, Section 8.1, Section 8.2, Section 8.3, Section 8.4, Section 8.5, Section 8.6, Section 8.12, Section 8.13, Section 8.14, Chapter 9, Section 9.1, Section 9.2, Section 9.3, Section 9.4, Section 9.5, Chapter 10, Chapter 11, Chapter 12, Section 12.2, Section 12.3, Chapter 13, Chapter 14, Section 14.2, Appendix 2
February 2019	SH(NA)-080915ENG-Y	■Added or modified parts SAFETY PRECAUTIONS, INTRODUCTION, RELEVANT MANUAL, Chapter 3, Section 7.1, Section 8.2, Section 8.10, Appendix 2 Descriptions of Real-time Data Analyzer were moved to the following manual. 📖GX LogViewer Version 1 Operating Manual (Edgecross)
April 2019	SH(NA)-080915ENG-Z	■Added or modified parts Section 8.3, Appendix 2, Appendix 4
May 2019	SH(NA)-080915ENG-AA	■Added or modified parts Section 3.1, Section 3.2

Revision date	*Manual number	Description
June 2019	SH(NA)-080915ENG-AB	<p>■Added or modified parts</p> <p>RELEVANT MANUAL, TERMS, DEFINITIONS OF ABBREVIATION, Chapter 1, Section 1.1, Section 2.2, Section 3.1, Section 3.2, Section 3.3, Section 3.4, Section 3.5, Section 3.6, Chapter 5, Section 5.1, Section 5.2, Section 5.3, Section 5.4, Section 5.5, Section 5.6, Section 6.3, Section 6.4, Section 7.1, Section 7.2, Section 7.3, Section 7.4, Section 7.5, Section 7.6, Section 7.7, Chapter 8, Section 8.1, Section 8.2, Section 8.3, Section 8.4, Section 8.5, Section 8.12, Section 8.13, Section 8.14, Chapter 9, Section 9.1, Section 9.2, Section 9.3, Section 9.4, Section 9.5, Chapter 10, Chapter 11, Chapter 12, Section 12.2, Section 12.3, Chapter 13, Chapter 14, Appendix 2, Appendix 5</p>
October 2019	SH(NA)-080915ENG-AC	<p>■Added or modified parts</p> <p>TERMS, DEFINITIONS OF ABBREVIATION, Chapter 1, Section 1.1, Section 2.2, Section 3.1, Section 3.2, Section 3.3, Section 3.4, Section 3.5, Section 3.6, Chapter 5, Section 5.1, Section 5.2, Section 5.3, Section 5.4, Section 5.5, Section 5.6, Section 6.2, Section 6.3, Section 7.1, Section 7.2, Section 7.3, Section 7.4, Section 7.5, Section 7.6, Section 7.7, Section 7.8, Chapter 8, Section 8.1, Section 8.2, Section 8.3, Section 8.4, Section 8.5, Section 8.6, Section 8.12, Section 8.13, Section 8.14, Chapter 9, Section 9.1, Section 9.2, Section 9.3, Section 9.4, Section 9.5, Chapter 10, Chapter 11, Section 11.3, Chapter 12, Section 12.2, Section 12.3, Chapter 13, Section 13.1, Section 13.2, Chapter 14, Appendix 2</p>
May 2020	SH(NA)-080915ENG-AD	<p>■Added or modified parts</p> <p>TERMS, GENERIC TERMS AND ABBREVIATIONS, DEFINITION OF FILES, TARGETS FOR EXPLANATIONS, Chapter 1, Section 1.1, Section 1.2, Section 2.2, Section 3.4, Section 3.5, Section 3.6, Section 3.7, Chapter 5, Section 5.4, Section 5.5, Section 5.9, Section 6.4, Section 7.1, Section 7.9, Section 8.1, Section 8.2, Section 8.3, Section 8.4, Section 8.5, Section 8.6, Chapter 10, Section 11.3, Section 12.1, Section 12.2, Appendix 2, Appendix 4</p>
October 2020	SH(NA)-080915ENG-AE	<p>■Added or modified parts</p> <p>SAFETY PRECAUTIONS, CONDITIONS OF USE FOR THE PRODUCT, GENERIC TERMS AND ABBREVIATIONS, Section 6.4, Section 8.1, Section 8.2, Section 8.4, Section 8.6, Section 12.2, Appendix 2</p>
January 2021	SH(NA)-080915ENG-AF	<p>■Added or modified parts</p> <p>GENERIC TERMS AND ABBREVIATIONS, Section 8.1, Section 8.2, Section 8.3</p>
April 2021	SH(NA)-080915ENG-AG	<p>■Added or modified parts</p> <p>GENERIC TERMS AND ABBREVIATIONS, DEFINITION OF FILES, TARGETS FOR EXPLANATIONS, Section 1.1, Section 2.2, Section 3.3, Section 3.6, Section 6.3, Section 6.4, Section 7.1, Section 7.6, Section 8.1, Section 8.2, Section 8.3, Section 8.4, Section 8.5, Section 8.10, Section 9.1, Section 12.1, Section 12.2, Appendix 2</p>
July 2021	SH(NA)-080915ENG-AH	<p>■Added or modified parts</p> <p>Section 1.2, Section 4.3, Section 6.4, Section 8.4, Section 8.5, Appendix 2</p>
October 2021	SH(NA)-080915ENG-AI	<p>■Added or modified parts</p> <p>Section 1.2, Section 2.2, Section 6.4, Section 7.4, Section 8.2, Section 8.3, Section 8.5, Appendix 2, Appendix 4</p>
May 2022	SH(NA)-080915ENG-AJ	<p>■Added or modified parts</p> <p>GENERIC TERMS AND ABBREVIATIONS, DEFINITION OF FILES, TARGETS FOR EXPLANATIONS, Section 1.1, Section 2.2, Section 3.5, Chapter 5, Section 5.5, Section 7.1, Section 7.8, Chapter 8, Section 8.1, Section 8.2, Section 8.3, Section 8.5, Chapter 10, Section 11.2, Section 12.2, Appendix 1, Appendix 2</p>
October 2022	SH(NA)-080915ENG-AK	<p>■Added or modified parts</p> <p>SAFETY PRECAUTIONS, Section 1.2, Section 2.2, Section 8.1, Section 8.2, Section 8.3, Section 8.4, Section 8.5, Appendix 1</p>
April 2023	SH(NA)-080915ENG-AL	<p>■Added or modified parts</p> <p>DEFINITION OF FILES, Section 2.2, Section 5.7, Section 8.1, Section 8.2, Section 8.3, Section 12.2, Appendix 1</p>
November 2023	SH(NA)-080915ENG-AM	<p>■Added or modified parts</p> <p>Section 3.7, Section 6.4, Section 8.2, Section 8.3, Section 8.4, Section 8.5, Section 8.6, Section 8.7, Section 8.10, Section 8.11, Section 11.2, Section 11.3, Section 12.2, Chapter 13, Section 13.2, Section 13.3, Appendix 1</p>

Japanese manual number: SH-080887-AQ

This manual confers no industrial property rights or any rights of any other kind, nor does it confer any patent licenses. Mitsubishi Electric Corporation cannot be held responsible for any problems involving industrial property rights which may occur as a result of using the contents noted in this manual.

© 2010 MITSUBISHI ELECTRIC CORPORATION

INFORMATION AND SERVICES

For further information and services, please contact your local Mitsubishi Electric sales office or representative.
Visit our website to find our locations worldwide.

MITSUBISHI ELECTRIC Factory Automation Global Website
Locations Worldwide
www.MitsubishiElectric.com/fa/about-us/overseas/

TRADEMARKS

CompactFlash is either a registered trademark or a trademark of SanDisk Corporation.

Microsoft, Windows, Windows Vista, Windows XP, and Excel are trademarks of the Microsoft group of companies.

Unicode is either a registered trademark or a trademark of Unicode, Inc. in the United States and other countries.

The company names, system names and product names mentioned in this manual are either registered trademarks or trademarks of their respective companies.

In some cases, trademark symbols such as [™] or [®] are not specified in this manual.

COPYRIGHTS

For the open source software used in this product, refer to the following:

 Page 341 Open Source Software

SH(NA)-080915ENG-AM(2311)KWIX

MODEL:SW1DNN-VIEWER-O-E

MODEL CODE: 13JU68

MITSUBISHI ELECTRIC CORPORATION

HEAD OFFICE: TOKYO BLDG., 2-7-3, MARUNOUCHI, CHIYODA-KU, TOKYO 100-8310, JAPAN
NAGOYA WORKS: 1-14, YADA-MINAMI 5-CHOME, HIGASHI-KU, NAGOYA 461-8670, JAPAN

When exported from Japan, this manual does not require application to the
Ministry of Economy, Trade and Industry for service transaction permission.

Specifications subject to change without notice.